

ORIGINAL PAGE
BLACK AND WHITE PHOTOGRAPH

511-61
15311

Q-21

91-71361



Walter J. Freeman, M.D.

University of California
at Berkeley
Berkeley, California

Dr. Freeman received his M.D. degree from Yale University (1954), clinical training at Johns Hopkins University, and postdoctoral training in neuroscience at the University of California at Los Angeles. He is a professor of physiology in the Department of Molecular and Cellular Biology at the University of California at Berkeley. Dr. Freeman has published, extensively, articles on linear and nonlinear neurodynamics of sensory systems, including a monograph (Mass Action in the Nervous System, Academic, 1975).

IMPLEMENTATION OF PATTERN-RECOGNITION
ALGORITHMS DERIVED FROM OLFACTORY INFORMATION PROCESSING

Abstract

Sensory and perceptual information exists as space-time patterns of neural activity in cortex in two modes. Neural analysis of sensory input, as in feature extraction, is done with action potentials of single neurons in point processes. Neural synthesis of input with past experience and expectancy of future action is done with dendritic integration in local mean fields. Both kinds of activity are found to coexist in olfactory and visual cortex, each preceding and then following the other. The transformation of information from the pulse mode to the dendritic mode involves a state transition of the cortical network that can be modeled by a Hopf bifurcation in both software and hardware embodiments. These models show robust powers for amplification and correct classification of noisy and incomplete patterns corresponding to sensory inputs to biological nervous systems in attentive and motivated animals. The evidence is reviewed and the requirements are summarized for machine simulations of these operations.

IMPLEMENTATION OF PATTERN RECOGNITION ALGORITHMS
DERIVED FROM OLFACTORY INFORMATION PROCESSING

SUMMARY

1. Modes of information in cerebral cortex -
point process: action potential frequency
local mean field: dendritic potential amplitude
2. Spatial amplitude modulation of carrier waves -
olfactory bulb of rabbit
primary visual cortex of monkey
3. Implementation with high-dimensional nonlinear ODEs
linear integration
asymmetric sigmoid nonlinearity
modifiable associational connections
4. Comparison of software and hardware embodiments
amplification and classification
chaos and the tolerance of disorder

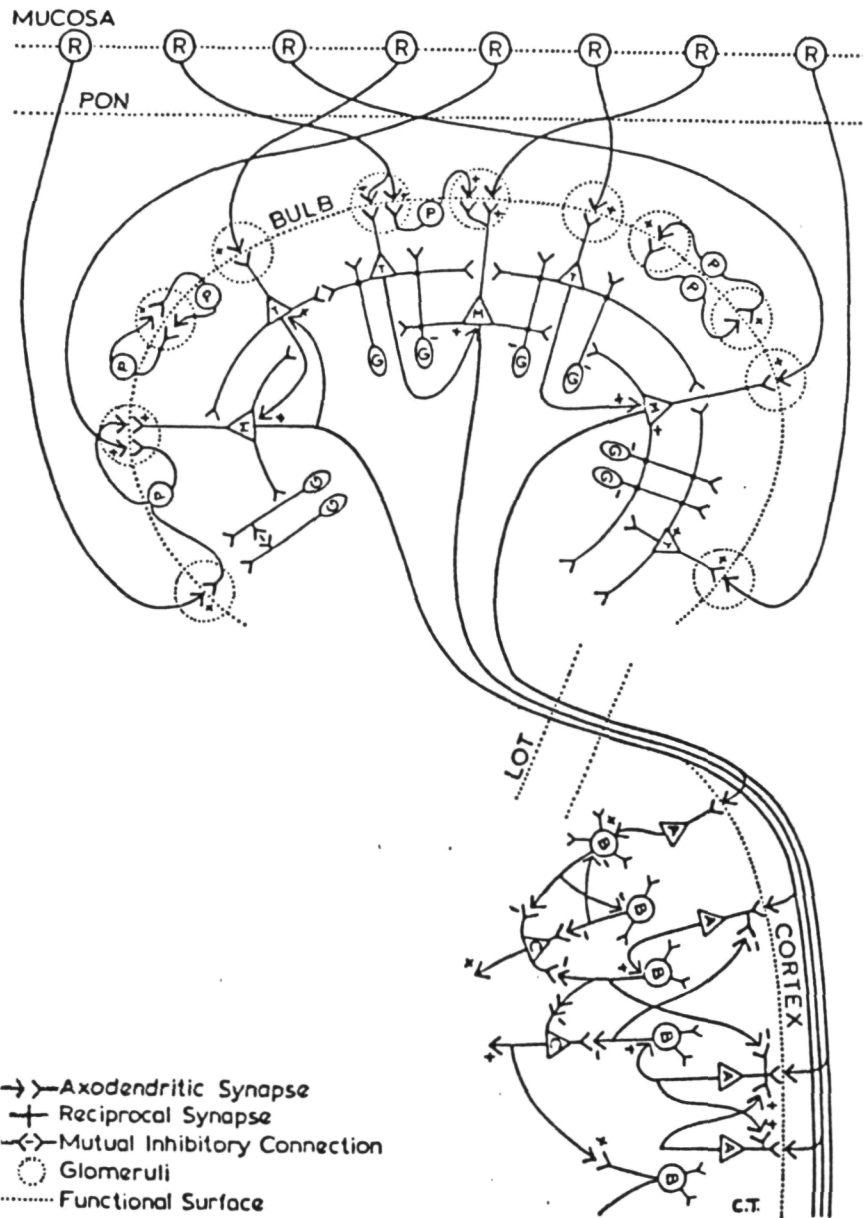

The main cell types in the olfactory bulb are the mitral and granule cells.

Mitral cells form a set of densely interconnected mutually excitatory cells. They also excite the granule cells. Mitral cell axons carry the output signal to the rest of the brain

Granule cells form a set of densely interconnected mutually inhibitory neurons. They also inhibit the mitral cells.

These two cell types are connected in a negative feedback loop. They form a neural oscillator. The olfactory bulb consists of approx. 2000 such coupled oscillators.

Excitatory couplings provide modifiable synapses in learning and perception. Inhibitory couplings provide stability and spatial contrast.

1977
 Biology-Anatomy
 9/77

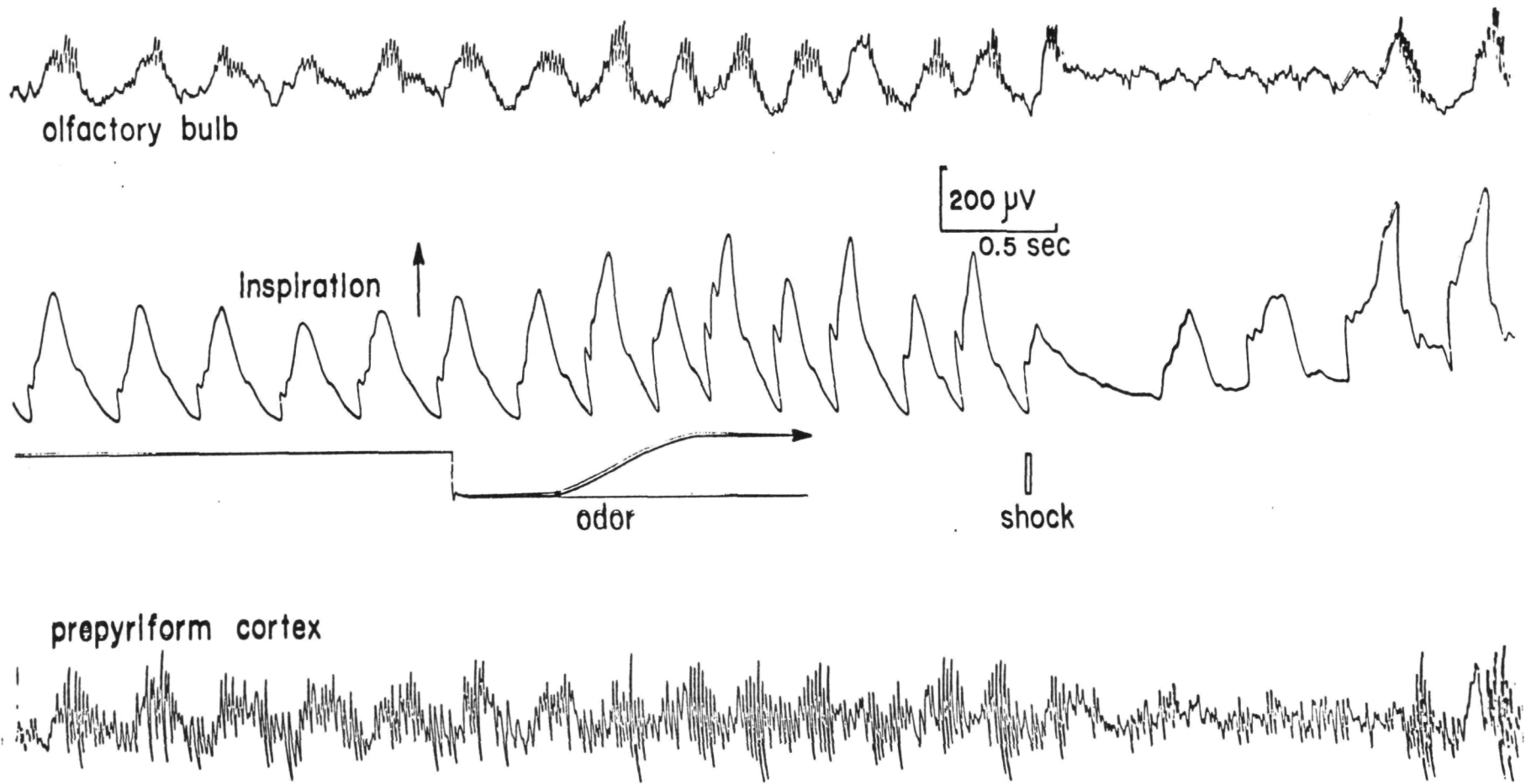

THE BULB GENERATES A BRIEF OSCILLATORY EEG BURST WITH EACH INSPIRATION, WHETHER OR NOT A CONDITIONED STIMULUS ODOR IS PRESENTED. THIS RECORDING IS FROM ONE TRIAL IN A WAKING RABBIT. THE SAME PATTERN OF EEG IS FOUND OVER THE WHOLE MAIN BULB.

EEG (100 msec)

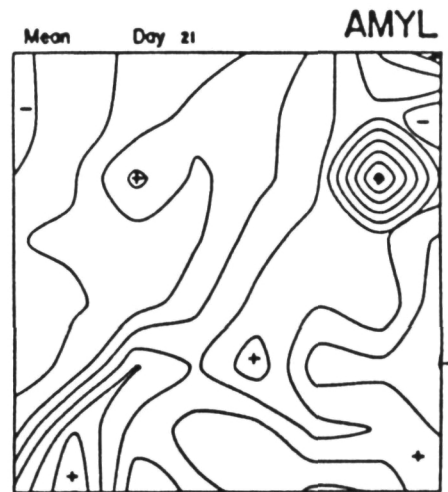
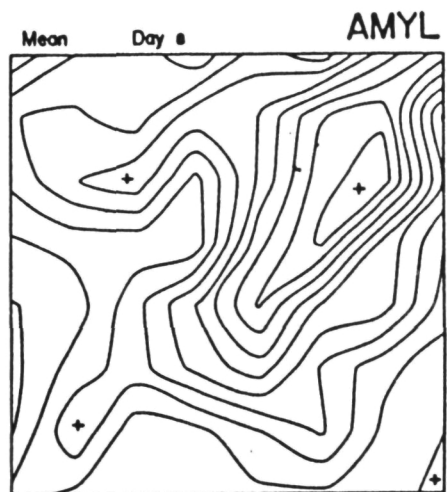
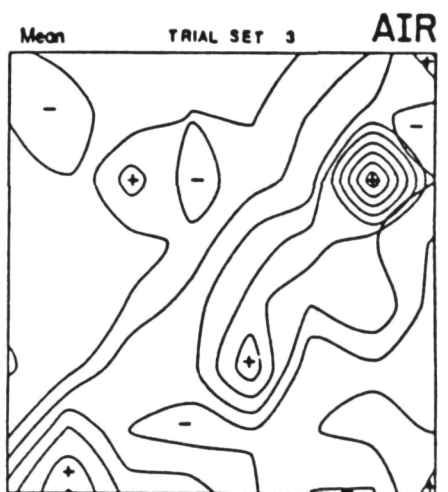
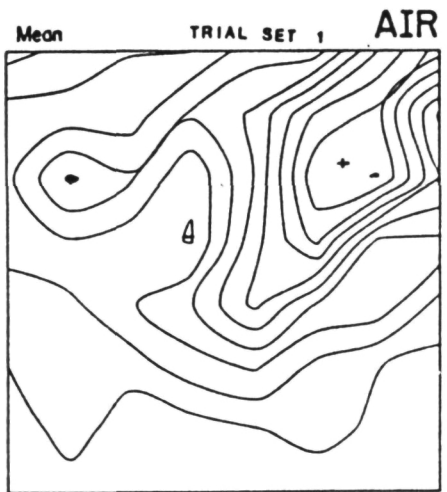
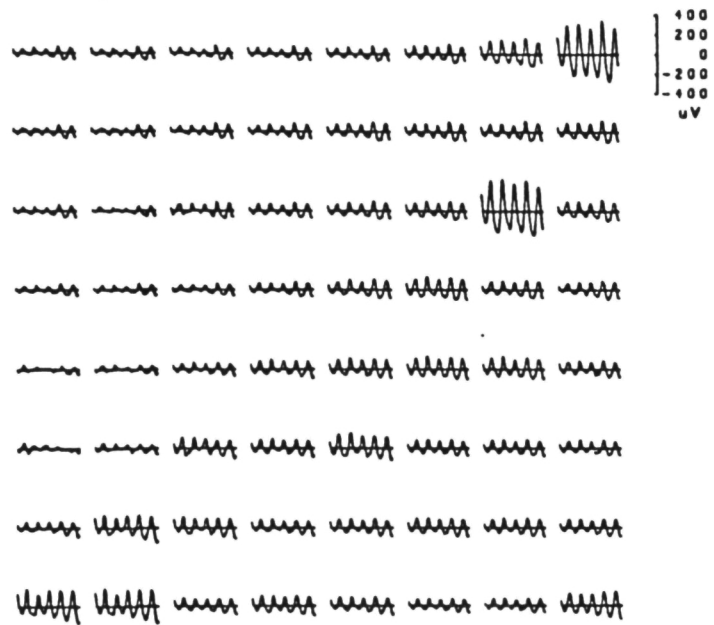

THE SPATIAL PATTERN OF ROOT MEAN SQUARE (RMS) AMPLITUDE FROM 64 EPIDURAL ELECTRODES (4 X 4 MM) CHANGES UNDER CONDITIONING AND RESTABILIZES AFTER EACH NEW TRAINING ODOR.

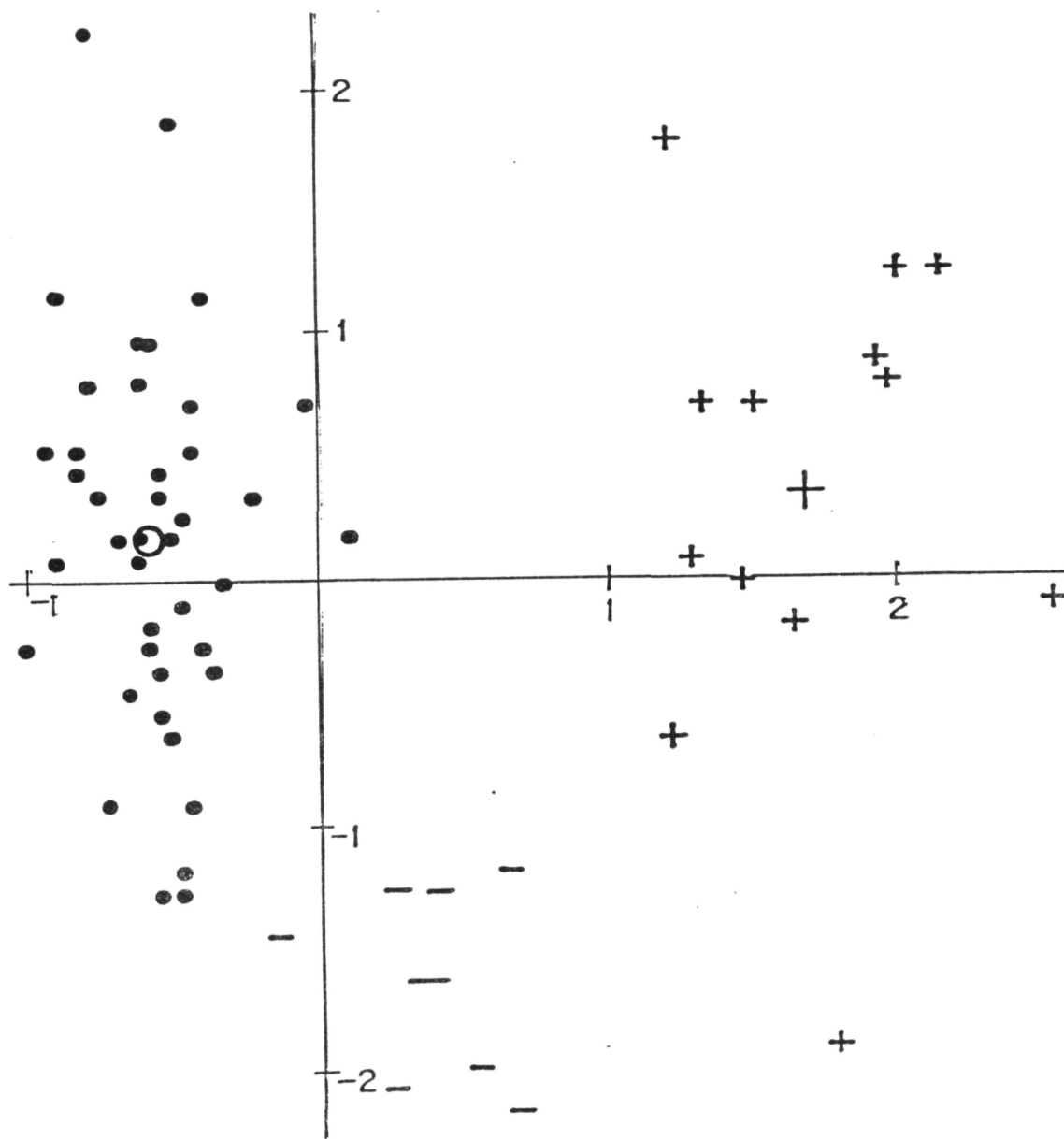

DISCRIMINANT ANALYSIS OF THE FACTOR SCORES SHOWS THAT 75% OF BURSTS ARE CORRECTLY CLASSIFIED WITH 2 DISCRIMINANT FUNCTIONS. A PLOT IS SHOWN OF THE DISCRIMINANT SPACE FOR ONE RABBIT.

cortical projection

- = electrodes (1-7)
- = bundles (I-V)
- - - = inferior occipital (IOS) and lunate (LS) sulci

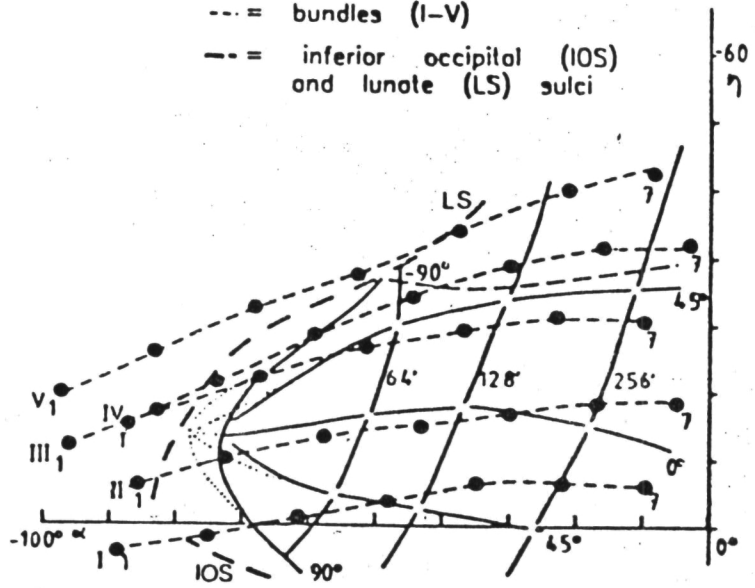

visual field projection

- = electrodes
- = bundles (fitted)

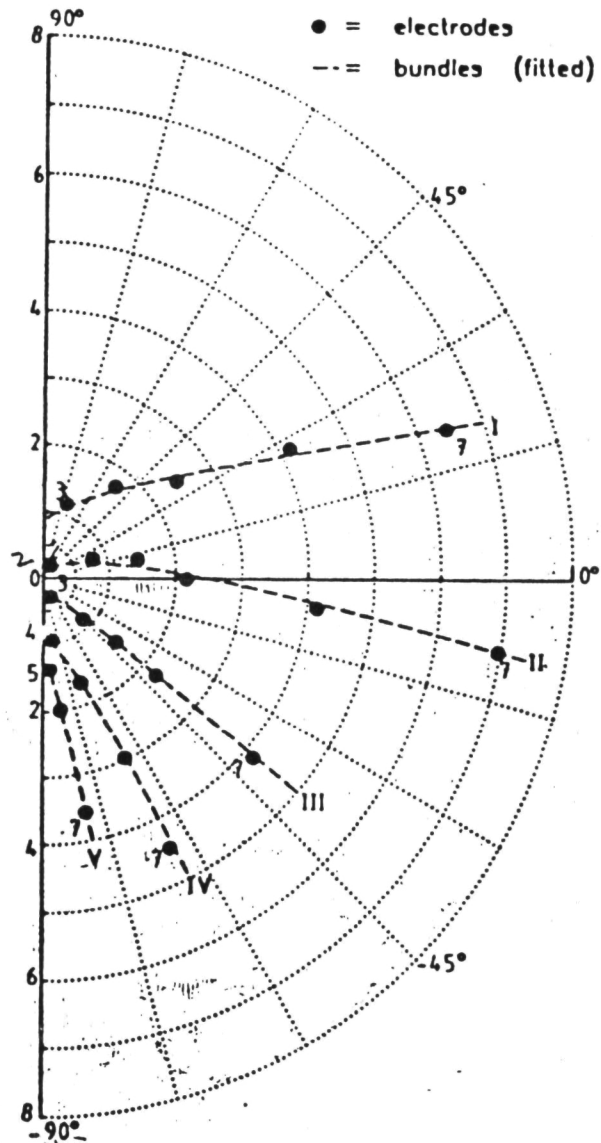

SCALE: 0030 uV/cm, 0050 ms/cm, ref= REF files: FCWJ11.

CORRECT RESPONSE

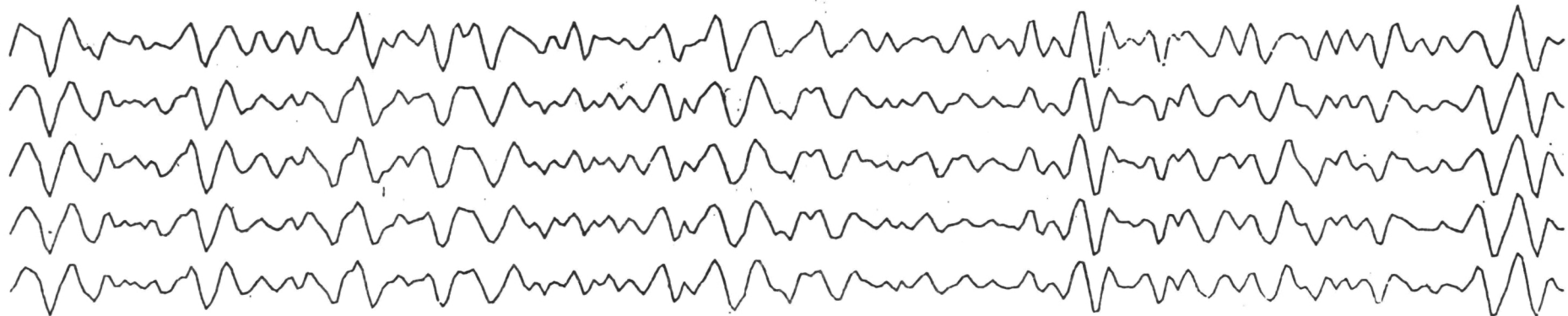
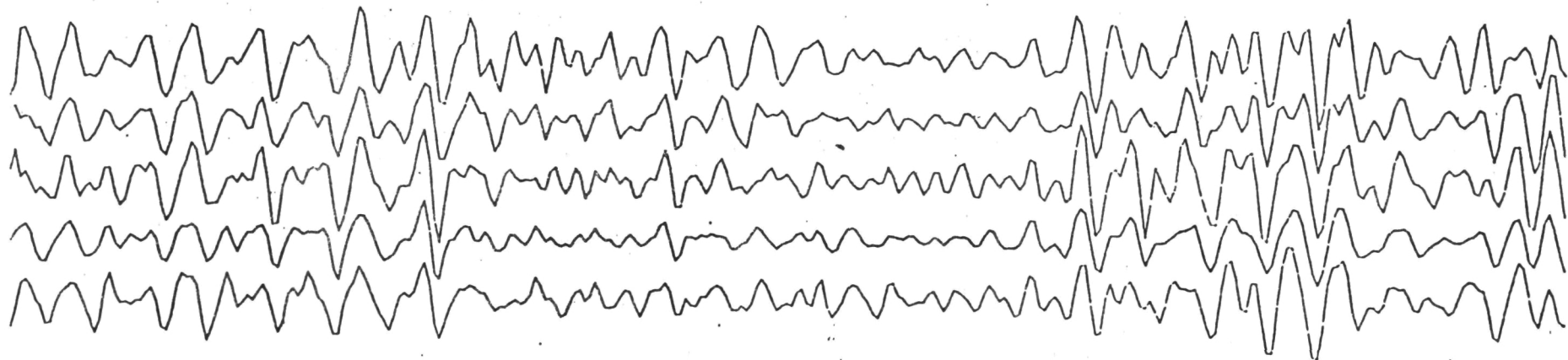
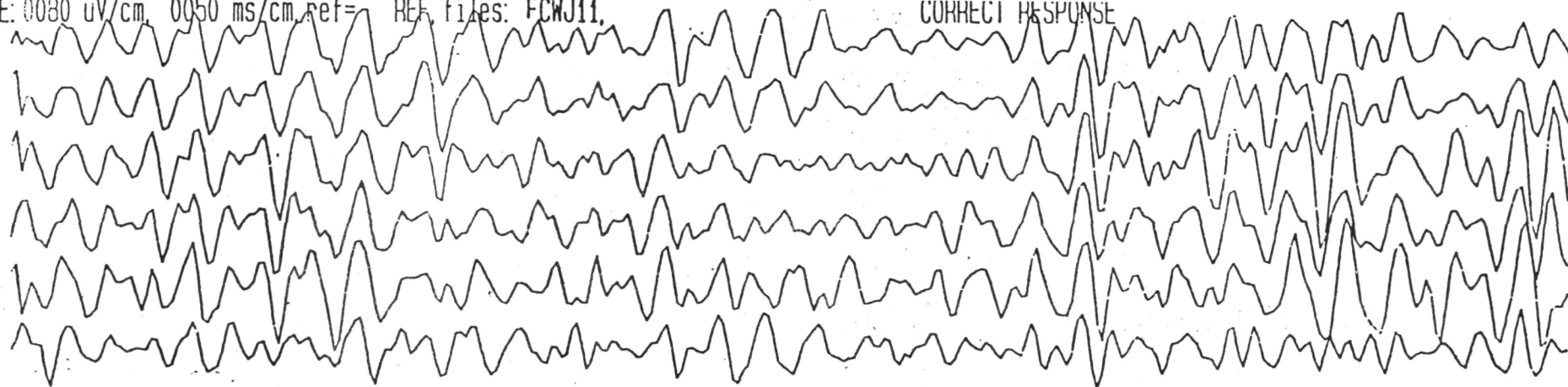

200-400 msec

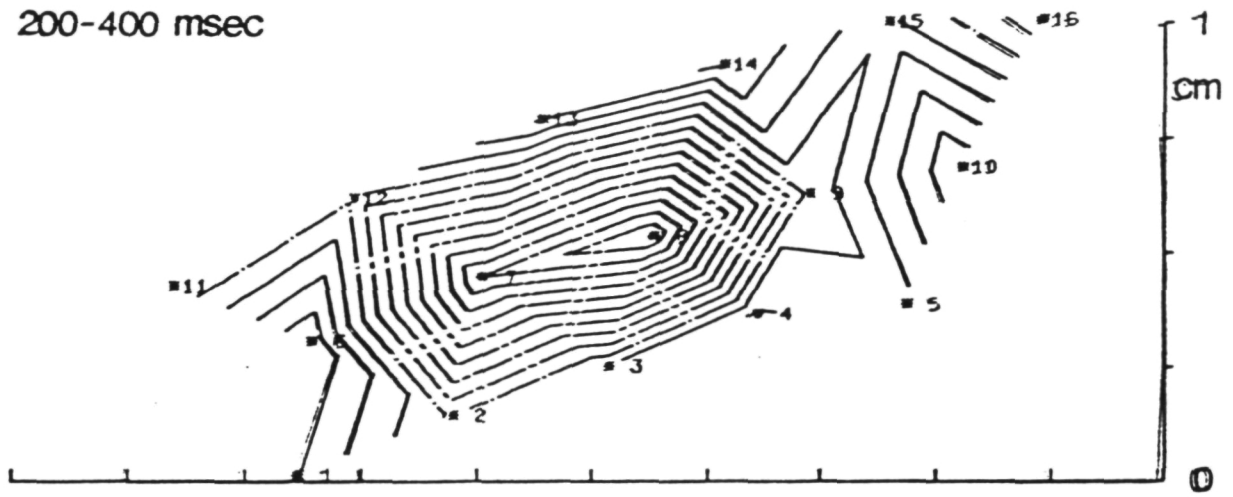

400-600 msec

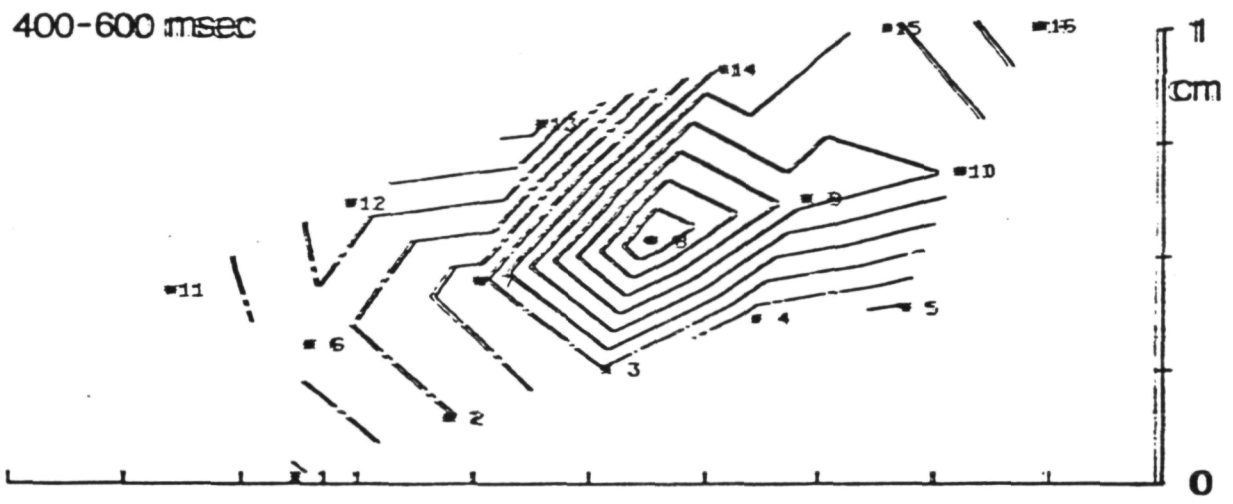

600-800 msec

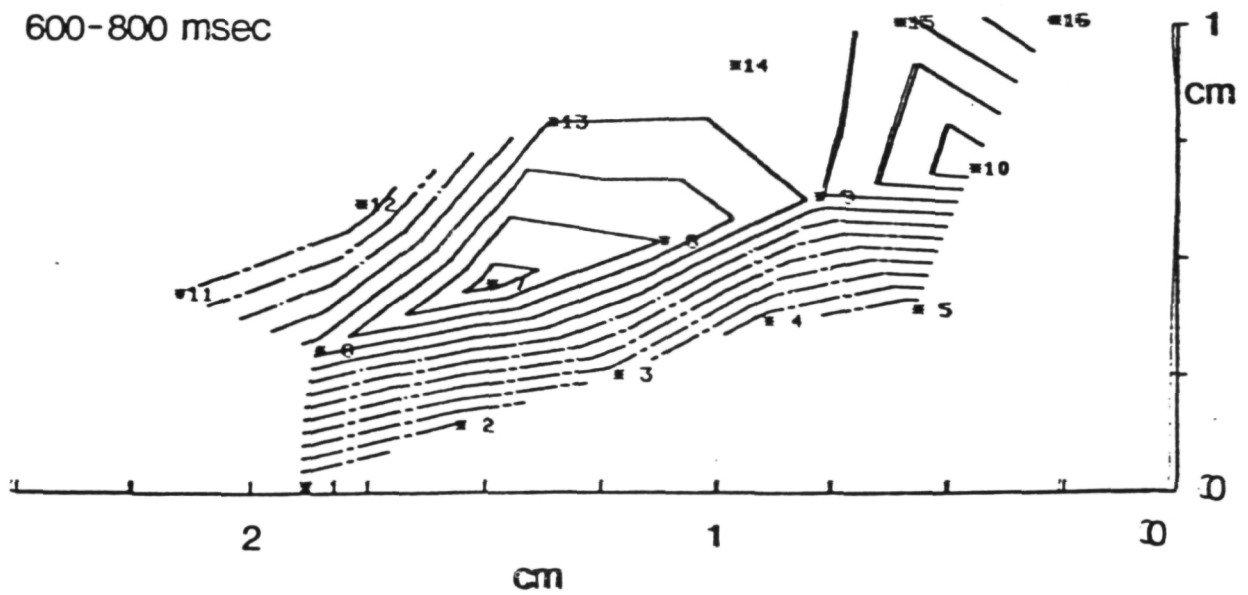

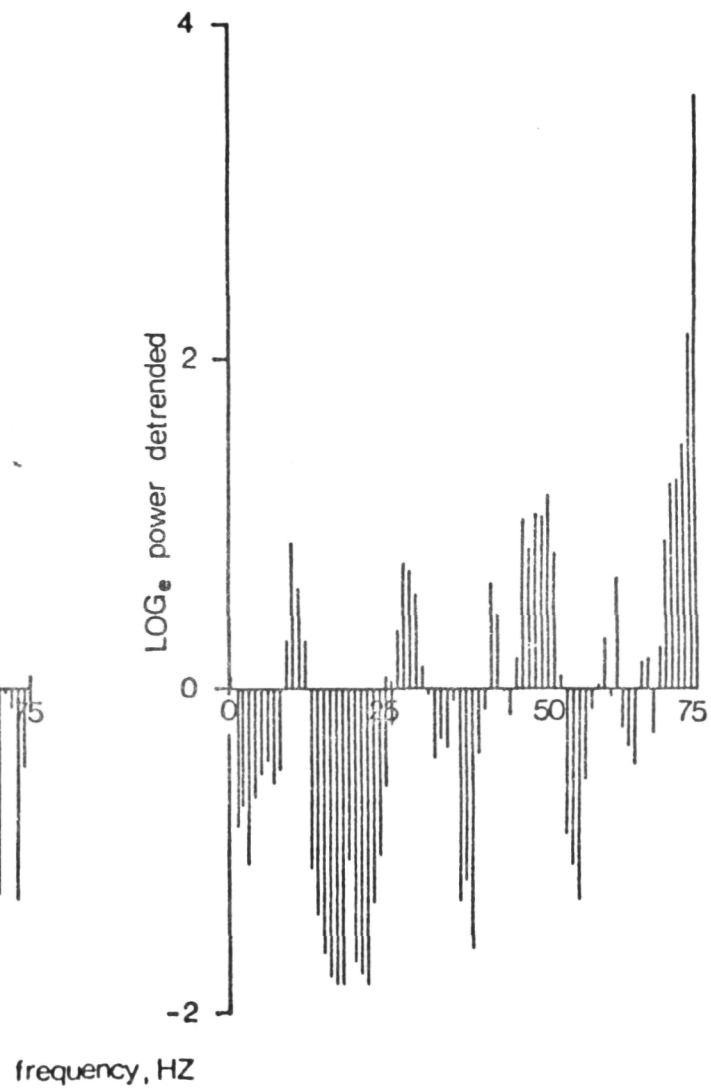
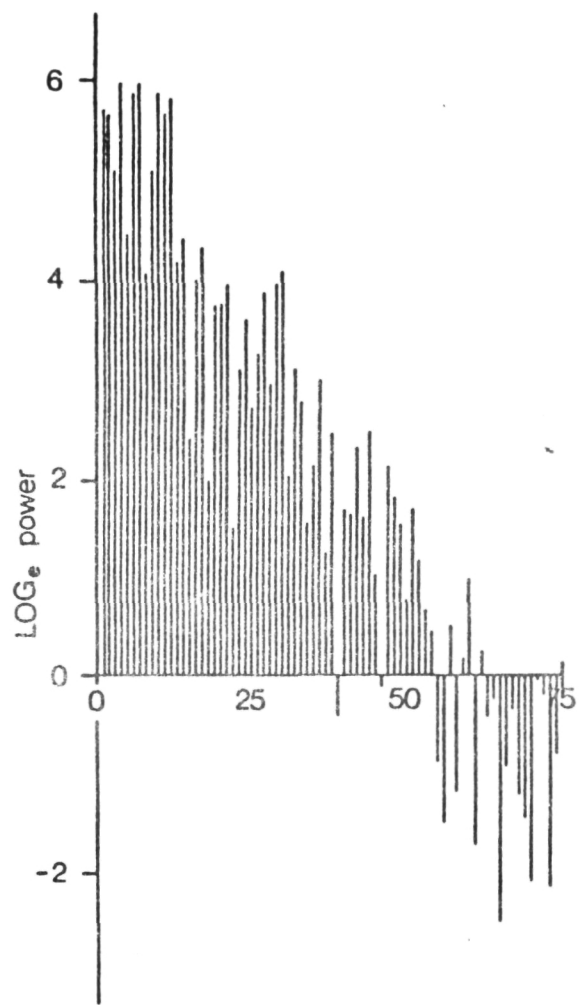
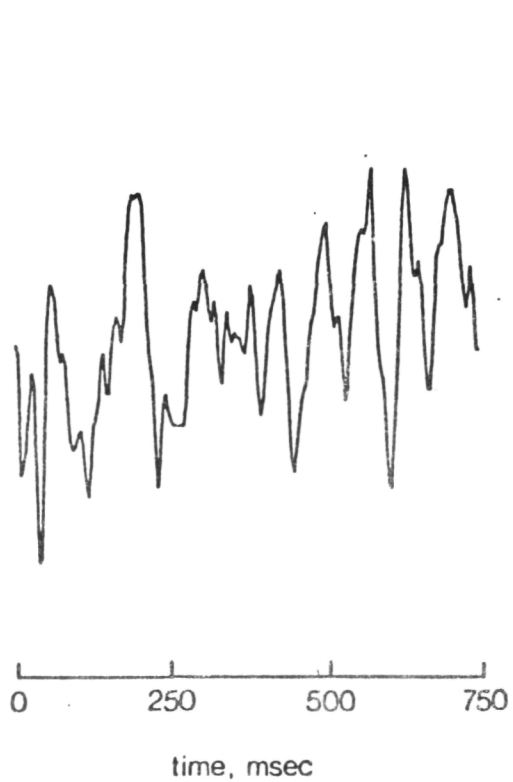

BASIC ELEMENTS :

1. Linear integrator - 2nd order.
2. Static sigmoid nonlinearity.
3. Hebb connection & assembly.
4. Parallel input & output.

KEY PROPERTIES:

1. Chaotic basal state.
2. Input-dependent gain.
3. Bifurcation on input.
4. Spatial pattern coding.

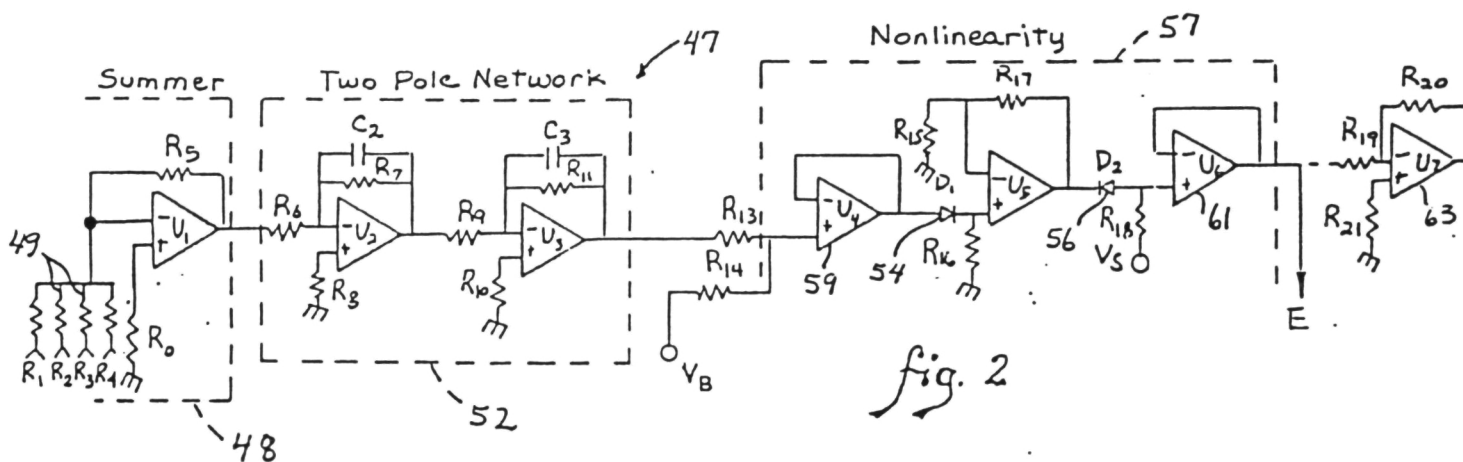
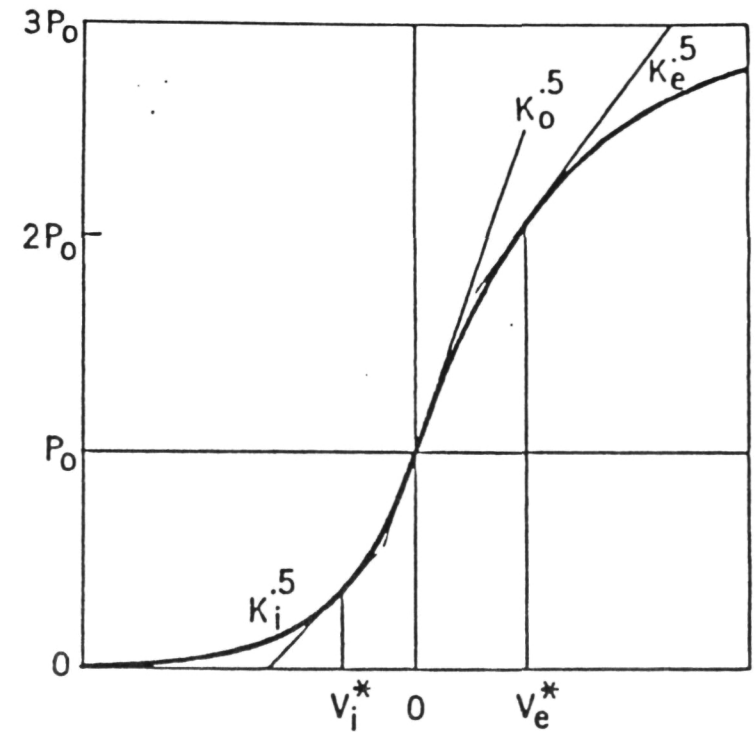
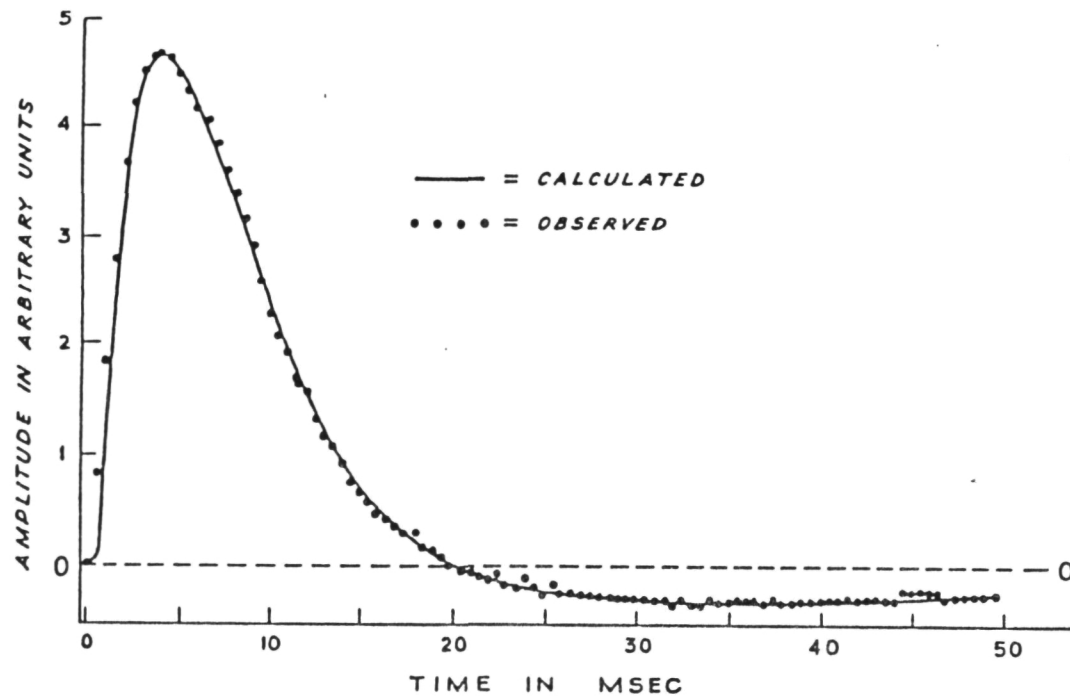

fig. 2



$$F(v_n) \triangleq \frac{1}{ab} \frac{d^2}{dt^2} [v_n(t)] + \frac{a+b}{ab} \frac{d}{dt} [v_n(t)] + v_n(t)$$

$$F(v_{e1,j}) = \zeta_e^{jk_{ee}} p_{e2,j} - \zeta_e^{jk_{ie}} (p_{e1,j} + p_{i2,j}) + \sum_{k \neq j}^N \zeta_e^{jk_{ek}} p_{e1,k} + I_j$$

$$F(v_{e2,j}) = \zeta_e^{jk_{ee}} p_{e1,j} - \zeta_i^{jk_{ie}} p_{i1,j}$$

$$F(v_{i2,j}) = \zeta_e^{jk_{ei}} p_{e1,j} - \zeta_i^{jk_{ii}} p_{i1,j}$$

$$F(v_{i1,j}) = \zeta_e^{jk_{ei}} (p_{e1,j} + p_{e2,j}) - \zeta_i^{jk_{ii}} p_{i2,j} - \zeta_i^{jk_{ii}} \sum_{k \neq j}^N p_{i1,k}$$

Walter J. Brennan, Jr.
 Department of Physical Chemistry
 University of Illinois
 Urbana, Illinois, U.S.A.

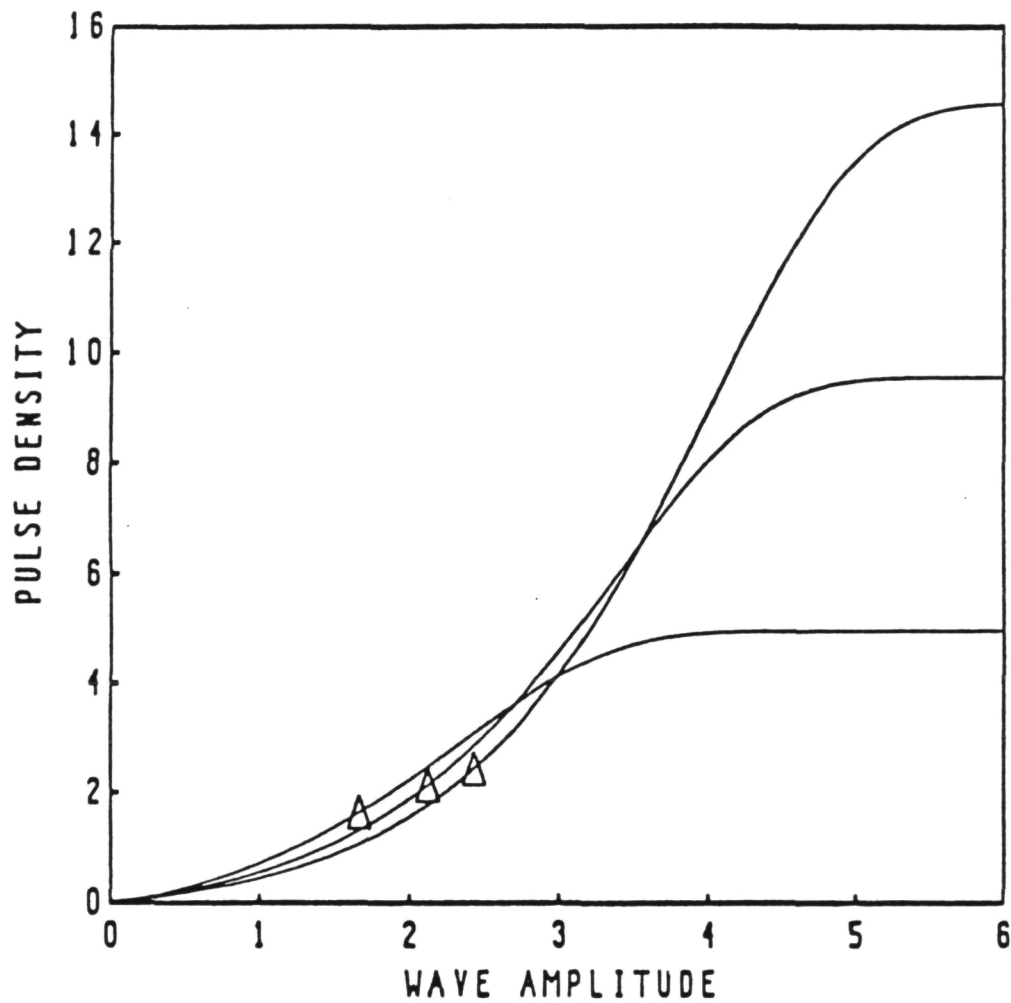

$$Q = Q_m \{ 1 - \exp [- (e^v - 1) / Q_m] \}, v > -\mu_0$$

$$Q = -1, v \leq \mu_0$$

$$\mu_0 = -\ln [1 - Q_m \ln (1 + 1/Q_m)]$$

$$\rho = \mu_0 (Q + 1)$$

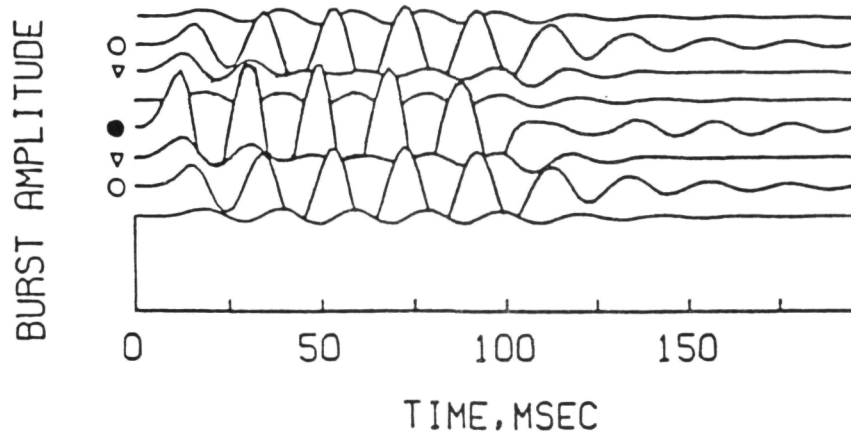
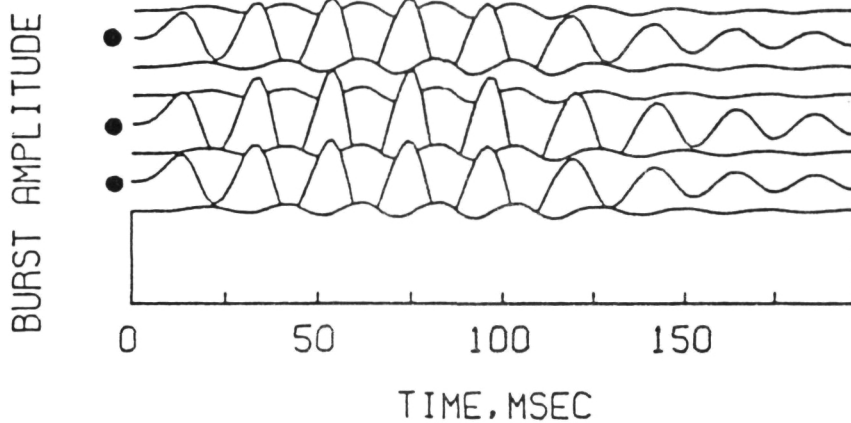
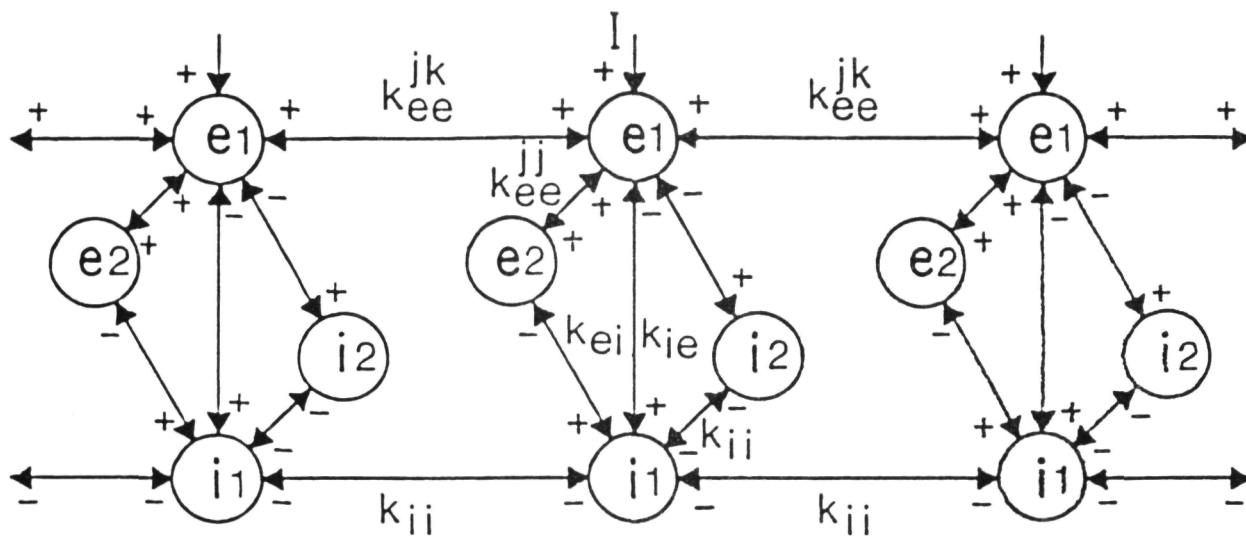

CORRELATION LEARNING RULE : a modified Hebb rule

changing synapse in the following way:
if both channel j and k are on, $K_{ee}(j,k) = K_{ee}(\text{high})$, otherwise, unchanged.

The output waveform in the 64-channel case

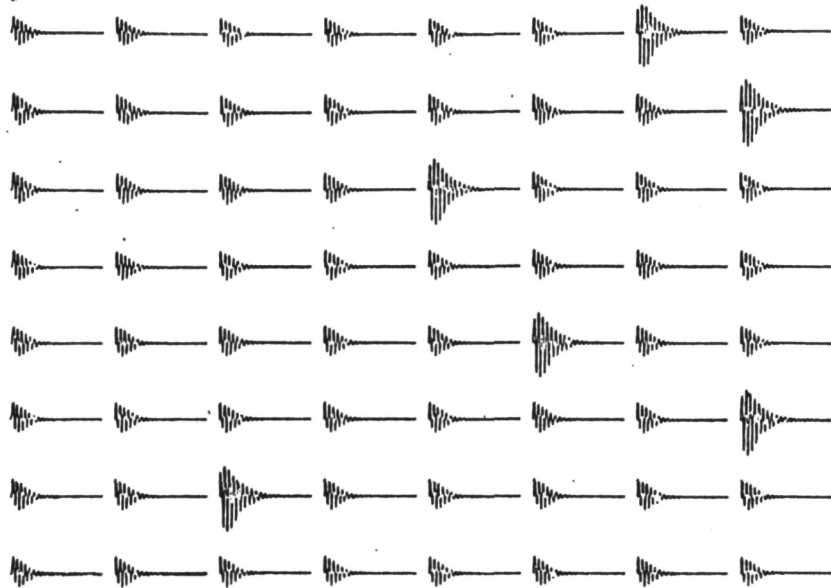

For the reduced interconnected KII set with 64-channel, the figure shows 100% clustering as well as perfect grouping.

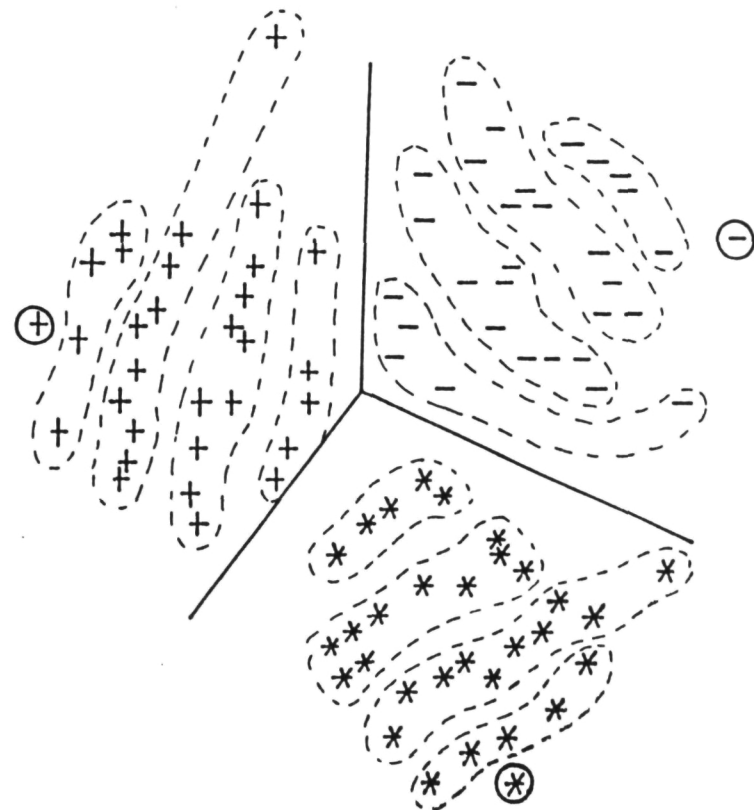

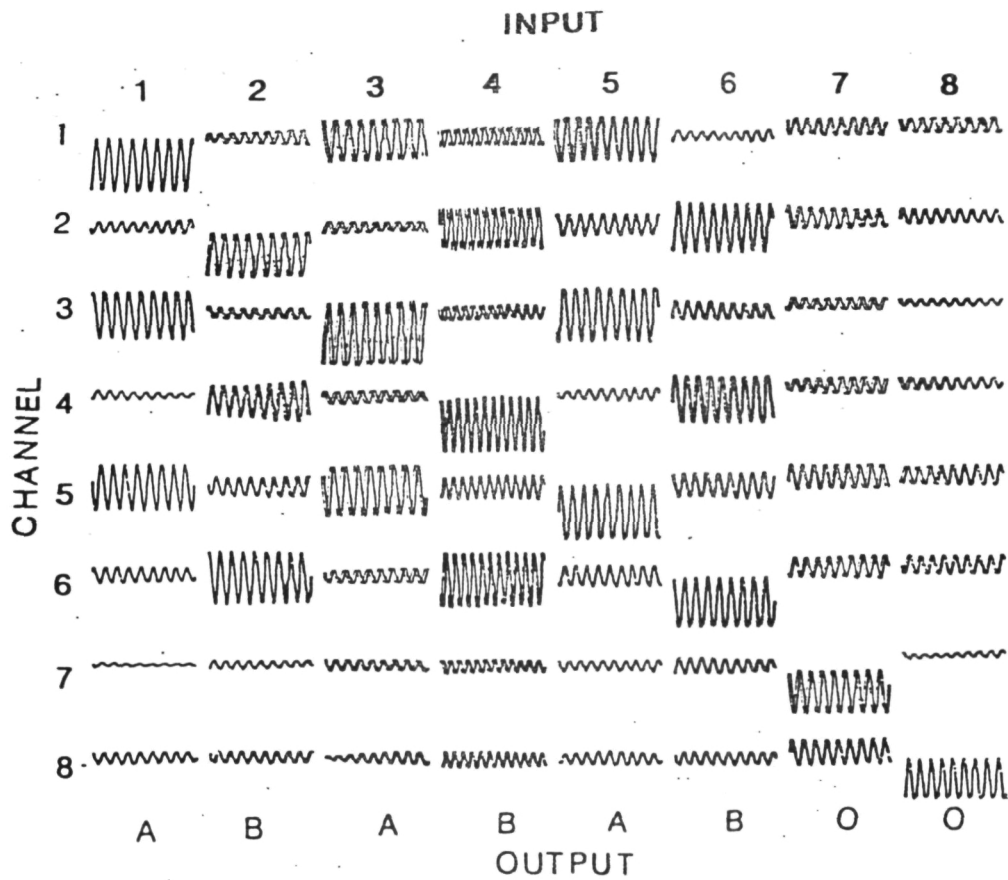
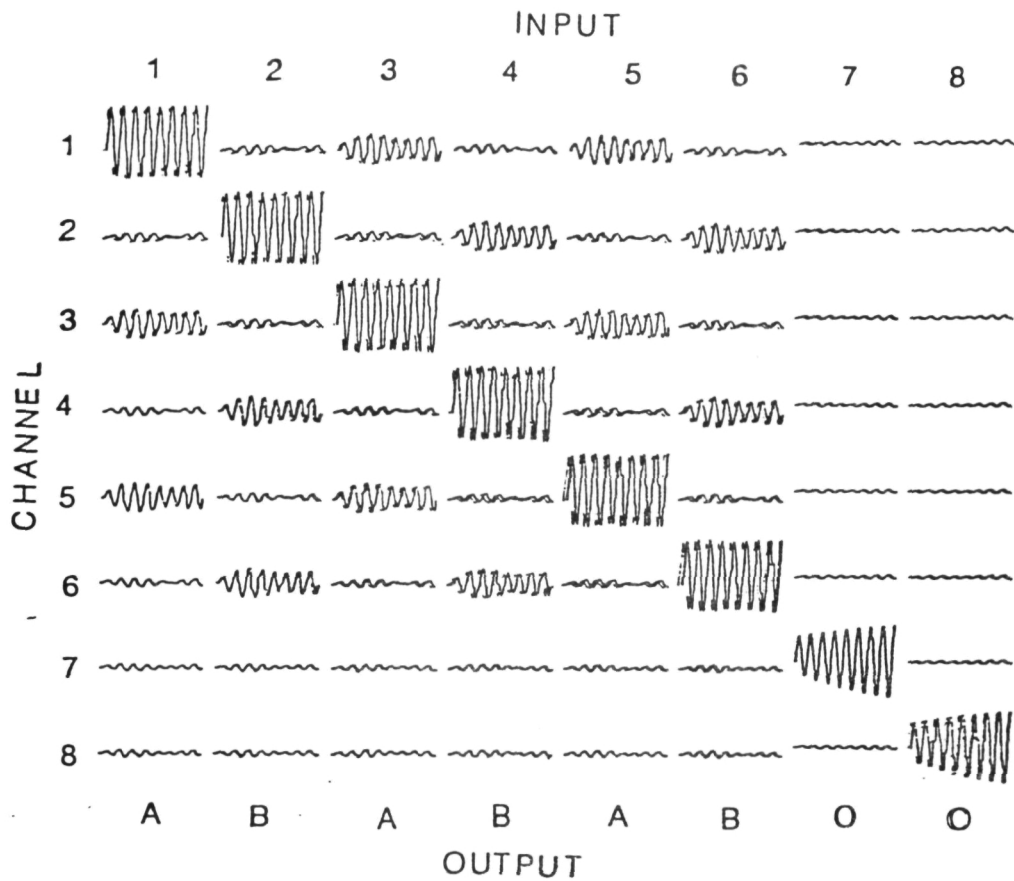

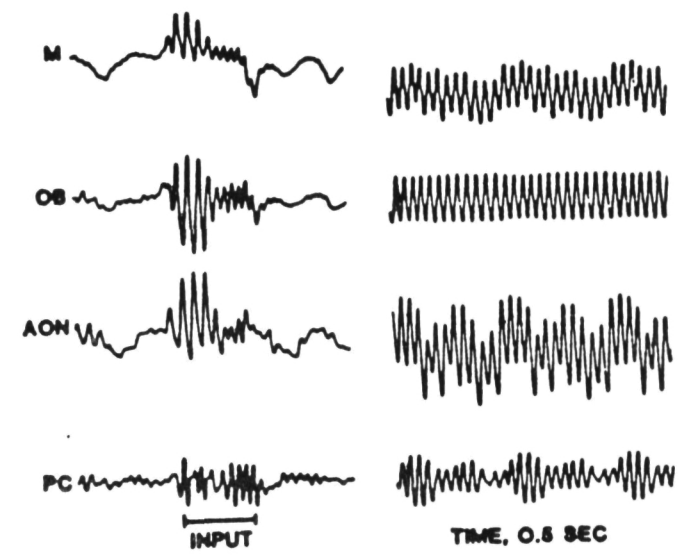
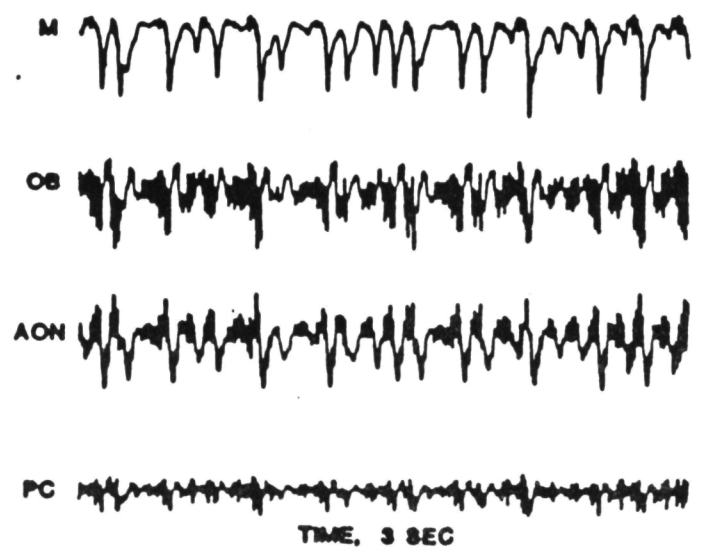
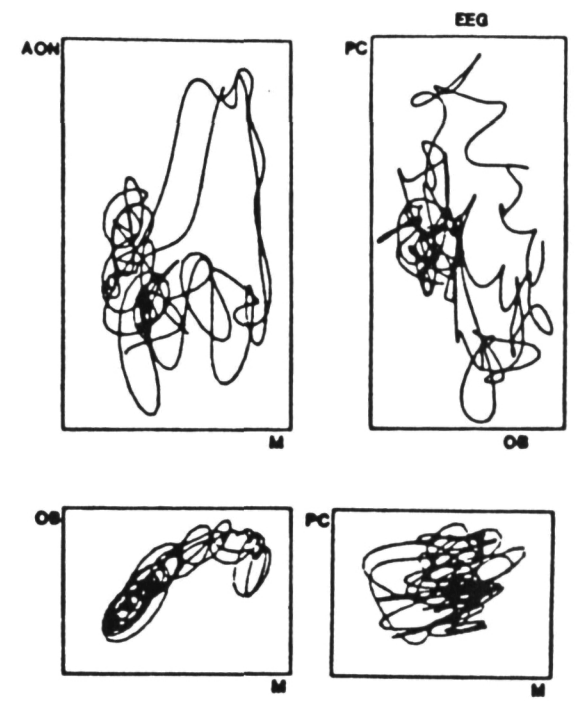
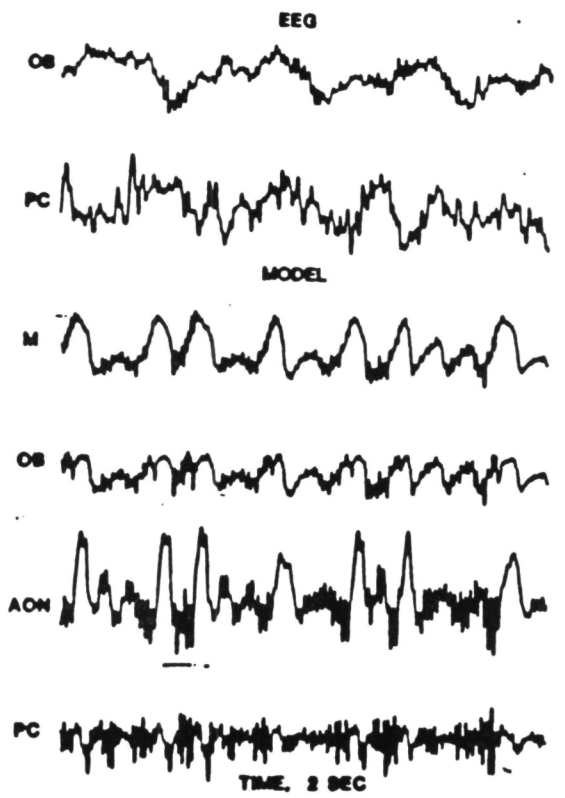
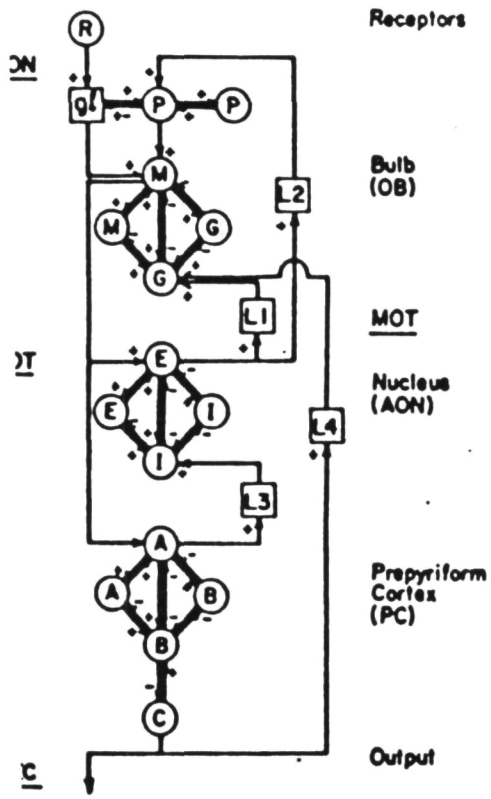

Physiology of the Olfactory Bulb
1967-1987
Walter J. Freeman
Department of Physiology-Anatomy
University of California, Berkeley

A. Physiological Studies

71. Freeman, W.J. Spatial divergence and temporal dispersion in primary olfactory nerve of cat. J. Neurophysiol. 35: 733-761, 1972.
72. Freeman, W.J. Measurement of open-loop responses to electrical stimulation in olfactory bulb of cat. J. Neurophysiol. 35: 745-761, 1972.
73. Freeman, W.J. Measurement of oscillatory responses to electrical stimulation in olfactory bulb of cat. J. Neurophysiol. 35: 762-779, 1972.
74. Freeman, W.J. Depth recording of averaged evoked potential of olfactory bulb. J. Neurophysiol. 35: 780-796, 1972.
82. Freeman, W.J. Topographic organization of primary olfactory nerve in cat and rabbit as shown by evoked potentials. Electroencephalogr. clin. Neurophysiol. 36: 33-45, 1974.
83. Freeman, W.J. Average transmission distance from mitral tufted to granule cells in olfactory bulb. Electroencephalogr. clin. Neurophysiol. 36: 609-618, 1974.
84. Freeman, W.J. Attenuation of transmission through glomeruli of olfactory bulb on paired shock stimulation. Brain Research 65: 77-90, 1974.
85. Freeman, W.J. Relation of glomerular neuronal activity to glomerular transmission attenuation. Brain Research 65: 91-107, 1974.
86. Freeman, W.J. A model for mutual excitation in a neuron population in olfactory bulb. Trans. IEEE Biomed. Engin. 21: 350-358, 1974.
87. Freeman, W.J. Stability characteristics of positive feedback in a neural population. Trans. IEEE Biomed. Engin. 21: 358-364, 1974.
109. Freeman, W.J. Spatial properties of an EEG event in the olfactory bulb and cortex. Electroenceph. & Clin. Neurophysiol 44: 586-605, 1978.
112. Freeman, W.J. Spatial frequency analysis of an EEG event in the olfactory bulb. In: Multidisciplinary Perspectives in Event-Related Brain potential Research: 531-546. Ed: D.A. Otto. U.S. Govt. Printing Office, EPA-600/9-77-043, 1978.
119. Freeman, W.J. Use of spatial deconvolution to compensate for distortion

- of EEG by volume conduction. IEEE Trans. Biomed. Engin. 27: 421-429, 1980c.
120. Bressler, S.L. and Freeman, W.J. Frequency analysis of olfactory system EEG in cat, rabbit and rat. Electroencephalogr. clin. Neurophysiol. 50: 19-24, 1980.
122. Gonzalez-Estrada, M.T. and Freeman, W.J. Effects on carnosine on olfactory bulb EEG, evoked potentials and D.C. potentials. Brain Research 202: 373-386, 1980.
145. Martinez, D.M. and Freeman, W.J. Periglomerular cell action on mitral cell in olfactory bulb shown by current source density analysis. Brain Research, 223-233.
131. Freeman, W.J. and W. Schneider. Changes in spatial patterns of rabbit olfactory EEG with conditioning to odors. Psychophysiology 19: 44-56, 1982.
132. Davis, G.W. and Freeman, W.J. On-line detection of respiratory events applied to behavioral conditioning in rabbits. IEEE Trans. Biomed. Engin. 29: 453-456, 1982.
136. Freeman, W.J., Viana Di Prisco, G. Davis, G.W., Whitney, T.M. Conditioning of relative frequency of sniffing by rabbits to odors. J. Comp. Psychol 97: 12-23, 1983.
151. Viana Di Prisco, G. and Freeman, Odor-related bulbar EEG spatial pattern analysis during appetitive conditioning in rabbits. Behav. Neurosci. 99: pp. 962-978, 1985.
169. Gray, C.M., Freeman, W.J. and Skinner, J.E. Chemical dependencies of learning in the rabbit olfactory bulb: acquisition of the transient spatial-pattern change depends on norepinephrine. Behavioral Neuroscience 100: 585-596, 1986.
153. Freeman, W.J. and Viana Di Prisco, G. Relation of olfactory EEG to behavior: Time series analysis. Behav. Neurosci. 100:753-763, 1986
170. Freeman, W.J. and Baird, B. Relation of olfactory EEG to behavior: Spatial analysis: Behav. Neurosci. 101:393-408, 1987.
179. Freeman, W.J. and Grajski, K.A. Relation of olfactory EEG to behavior: Factor analysis: Behav. Neurosci., 101: 766-777.

B. Theoretical Studies

49. Freeman, W.J. Analysis of function of cerebral cortex by use of control system theory. The Logistics Review 3: 5-40, 1967.
57. Freeman, W.J. Analog simulation of prepyriform cortex in the cat. Math.

BioScio. 2: 181-190, 1968.

65. Freeman, W.J. Spectral analysis of prepyriform averaged evoked potentials in cats. Journal of Biomed. System 1: 3-22, 1970.
78. Freeman, W.J. A model of the olfactory system. In: Neural Modelling, Brain Info. Serv. Report No. 1. Eds: Brazier, M.A.B., Walter, D.O., and Schneider, E. Univ. Calif., Los Angeles, pp. 41-62, 1973.
90. Ahn, S.M. and Freeman, W.J. Steady-state and limit cycle activity of mass of neurons forming simple feedback loops (II): distributed parameter model. Kybernetik 16: 127-132, 1974.
91. Ahn, S.M. and Freeman, W.J. Neural dynamics under noise in the olfactory system. Bio. Cybernetics 17:165-168, 1975.
103. Freeman, W.J. and S.M. Ahn. Spatial and temporal characteristic frequencies of interactive neural masses. Proceedings of IEEE International Conference on Cybernetics and Society: 279-284, Washington D.C., 1-3 November, 1976.
116. Freeman, W.J. Nonlinear gain mediating cortical stimulus-response relations. Biol. Cybernetics 35:237-247, 1979.
117. Freeman, W.J. Nonlinear dynamics of paleocortex manifested in the olfactory EEG. Biol. Cybernetics 35: 21-37, 1979.
118. Freeman, W.J. EEG analysis gives model of neuronal template-matching mechanism for sensory search with olfactory bulb. Biol. Cybernetics. 35.:221-234, 1979.
119. Freeman, W.J. Use of spatial deconvolution to compensate for distortion of EEG by volume conduction. IEEE Trans. Biomed. Engin.27: 421-429, 1980c.
125. Freeman, W.J. A neural mechanism for generalization over equivalent stimuli in the olfactory system. Amer. Math Soc. SIAM 13: 25-38,1981.
140. Freeman, W.J. Semi-autonomous control of input by nerve cell assemblies. In: Proc. IEEE International Conference on Computer Design: VLSI in Computers. New York, Computer Society Press, 1983, pp21-24.
139. Freeman, W.J. Dynamics of image formation by nerve cell assemblies. in: Synergetics of the Brain. Eds. E. Basar, H. Flohr, H. Haken, A.J. Mandell. Berlin, Springer Verlag, 1983, pp 102-121.
172. Freeman, W.J. Stimulation of chaotic EEG patterns with a dynamic model of the olfactory system. Biological Cybernetics 56: 139-150, 1987.
173. Freeman, W.J. and Van Dijk, B. Spatial patterns of visual cortical fast EEG during conditioned reflex in a rhesus monkey. Brain Research: 422: 267-276, 1987.

C. Reviews

75. Freeman, W.J. Linear analysis of the dynamics of neural masses. Annual Review of Biophysics and Bioengineering 1: 225-226, 1972.
76. Freeman, W.J. Waves, Pulses and the Theory of neural masses. Progress in Theoretical Biology 2: 87-165, 1972
124. Freeman, W.J. A physiological hypothesis on perception. Perspectives Biol. Med. 24: 561-592, 1981.
137. Freeman, W.J. The physiology of mental images. Academic Address. Biol. Psychiatry 18:1107-1125, 1983.
146. Freeman, W.J. La fisiologia de' las imagenes mentales. Salud Mental 7:3-8, 1984.
183. Viana Di Prisco, G. and Freeman, W.J. Representacion espaciotemporal dinamica de la informacion sensorial en el bulbo olfatorio. Acta Cientifica Venezolana 37: 526-531, 1986.
152. Freeman, W.J. and Skarda, C. Nonlinear dynamics, perception, and the EEG; the neo-Sherringtonian view. Brain Res. Reviews 10:147-175, 1985.
154. Freeman, W.J. Petit mal seizure spikes in olfactory bulb and cortex caused by runaway inhibition after exhaustion of excitation. Brain Res. Reviews 11:259-284, 1986.
155. Freeman, W.J. and Viana Di Prisco, G. EEG spatial pattern differences with discriminated odors manifest chaotic and limit cycle attractors in olfactory bulb of rabbits. In: Brain Theory, eds. Palm, G., and Aertsen, A. Berlin, Springer-Verlag., 97-119, 1986.
175. Skarda, C.A. and Freeman, W.J. How brains make chaos to make sense of the world. Brain and Behavioral Science 10: 161-195, 1987.
171. Freeman, W.J. Techniques used in the search for the physiological basis of the EEG. In: Gevins, A., and Remond, A. (eds) Handbook of EEG and Clin. Neurophysiol. Vol 3A, Part 2, Ch. 18. Amsterdam, Elsevier, 1987.

D. Book

96. Freeman, W.J. Mass Action in the Nervous System. 7 Chapters, 489 pp. Academic Press, New York, 1975.

NOTES