

# HYDRODYNAMIC DESIGN OF GENERIC PUMP COMPONENTS

FINAL TECHNICAL REPORT

JUNE 1991

Prepared for  
NATIONAL AERONAUTICS AND SPACE ADMINISTRATION  
MARSHALL SPACE FLIGHT CENTER

Huntsville, Alabama  
CONTRACT NAS8-38863  
June 28 1991

PREPARED BY:



A H J Eastland  
Principal Investigator

APPROVED BY:



H Dodson  
Program Manager

N92-11361

Unclas  
G3/37 0051134

(NASA-CR-184252) HYDRODYNAMIC DESIGN OF  
GENERIC PUMP COMPONENTS Final Technical  
Report, Jun. 1991 (Rockwell International  
Corp.) 232 p CSCL 131

ROCKETDYNE DIVISION OF ROCKWELL INTERNATIONAL CORPORATION  
6633 Canoga Avenue, Canoga Park, CA 91303

RI-RD-91-193

## TABLE OF CONTENTS

LIST OF FIGURES .....	ii
LIST OF TABLES .....	iii
1.0 INTRODUCTION.....	1
2.0 OBJECTIVES.....	1
3.0 TECHNICAL APPROACH.....	1
3.1 Design Point Selection.....	1
3.2 Design Constraints/Groundrules.....	1
3.3 Pump Speed Selection.....	2
3.4 Overall Pump performance/ Velocity triangle definition.....	2
3.5 Impeller Design.....	3
3.5.1 Blade definition and Hydrodynamic analysis.....	3
3.5.2 Stress analysis.....	4
3.5.3 Impeller blade CATIA model.....	4
3.6 Inducer Design.....	5
3.7 Impeller Inlet Flowfield Definition.....	5
4.0 CONCLUSION.....	6
REFERENCES.....	7
APPENDIX A	Impeller Coordinates - With Blade Fillets
APPENDIX B	Impeller Coordinates - Without Blade Fillets
APPENDIX C	Inducer XCoordinates - Without Blade Fillets
APPENDIX D	Impeller Inlet Flowfield Definition

## LIST OF FIGURES

- Figure 1 Convert Existing 3-Stage Pump to 2-Stage Pump  
Figure 2 NPSH Margin as a Function of Pump Speed and Flow Coefficient  
Figure 3 Comparison of Candidate Designs with Experience  
Figure 4 Impeller Tip Speed Versus Impeller Head Coefficient  
Figure 5 Impeller-to-Stator Spacing as a Function of Discharge Flow Angle  
Figure 6 Consortium Pump Stage Performance - H-Q Characteristic  
Figure 7 Consortium Pump Stage Performance - Efficiency Characteristic  
Figure 8 Consortium Pump Impeller Streamline Definition  
Figure 9 Consortium Pump Impeller Mean Streamline Blade Shape  
Figure 10 Consortium Pump Impeller R3DAP Prediction  
Figure 11 Consortium Pump Impeller Mean Full Blade Pressure Distribution  
Figure 12 Consortium Pump Impeller Mean Partial Blade Pressure Distribution  
Figure 13 Blade Structural Solidity  
Figure 14 Impeller Hub and Shroud Stress Distribution  
Figure 15 Impeller Blade Stress Distribution  
Figure 16 Isometric View of Impeller  
Figure 17 View of Impeller with Shroud Removed  
Figure 18 Pump Consortium Inducer Streamline No. 1  
Figure 19 Pump Consortium Inducer Streamline No. 5  
Figure 20 Pump Consortium Inducer Streamline No. 11  
Figure 21 Tip Pressure Distribution  
Figure 22 RMS Pressure Distribution  
Figure 23 Hub Pressure Distribution

## **LIST OF TABLES**

Table 1	Generic Fuel Pump Design Point Requirements
Table 2	Structural Design Groundrules
Table 3	Design Parameter Summary
Table 4	Inducer Design Requirements



## 1.0 INTRODUCTION

The NASA Marshall Space Flight Center is expediting the use of Computational Fluid Dynamics (CFD) in the design of propulsion system components by sponsoring technology programs that will develop, enhance, validate, and demonstrate CFD analysis tools. This task is part of a multiyear effort to demonstrate the application of CFD design tools for the definition of advanced hardware concepts for pump stages. The objectives of the program are twofold: to define advanced hardware concepts that improve the performance of pump stages through the use of CFD analysis methods; and to demonstrate these performance improvements in sub-component level rig tests and turbopump hot-fire tests.

## 2.0 OBJECTIVES

The objectives of this task were to define blade geometry for the inducer and centrifugal impeller of a liquid hydrogen pump for a generic gas generator cycle using current state-of-the-art design methods. The design point, groundrules and design margins used for these components were consistent with those currently being used for advanced booster engines. Surface models of both blades were developed and data files prepared so that the blade geometry can be distributed.

## 3.0 TECHNICAL APPROACH

### 3.1 Design Point Selection

The generic pump design point was selected to be compatible with the NLS fuel turbopump requirements at the time that the generic pump design was initiated. These requirements are shown in Table 1 and are consistent with a liquid Hydrogen pump for a gas generator cycle engine developing 640,000 lbs of thrust at a mixture ratio of 6.0 and a chamber pressure of 2474 psi.

### 3.2 Design Constraints/Groundrules

The structural groundrules used were the same as used for the NLS Advanced Development Program (ADP) Fuel turbopump, and are listed in Table 2. The key structural limits affecting the Hydrodynamic design were the inducer and impeller tip speed limits.

It was decided that the generic pump should bear as much similarity to the NLS fuel pump as possible in order to facilitate and reduce the cost of hot-fire testing. One of the key configuration trade studies performed during the course of the ADP program was whether the pump should have two or three stages. Part of the rationale for selecting three stages was that the development risk in achieving the high impeller head coefficient required for a two stage design was too high. It was therefore decided to design the inducer and impeller for a two-stage pump in this program to demonstrate the use of CFD in reducing performance development risk.

Figure 1 summarizes the changes required to convert the existing ALS 3 stage pump to the generic 2 stage pump. The most significant constraints on the resulting design were that the inducer tip diameter and the stator between the inducer and impeller should be the same for both designs in order to maintain the same inlet housing, and that the crossover and diffuser inlet diameters should be the same in order to maintain the same basic main housing and crossover castings.

### 3.3 Pump Speed Selection

It was necessary to increase the rotational speed of the pump over the three stage design in order to achieve the required head in two stages. As mentioned in 3.2 the inducer tip diameter was defined from the 3 stage design and so the pump speed was increased until the maximum allowable inducer tip speed was reached. This limit was based on the structural analysis of the ADP pump inducer which is very similar in design to the inducer for this pump. This resulted in a rotational speed of 30108 RPM and an inducer flow coefficient of 0.091. As shown in Figure 2 this still resulted in adequate suction performance margin.

### 3.4 Overall Pump performance/ Velocity triangle definition

Preliminary design programs, which use empirical correlations of loss, deviation angle and blockage, were used in combination with a Taguchi parametric analysis approach to optimize the velocity triangles and inlet and exit blade angle distributions, and to calculate overall stage performance. 8 design parameters were optimized for 18 evaluation criteria using the Taguchi method to determine the sensitivity of each of the evaluation criteria to each of the controllable design parameters.

Initially the inducer and stator of the three-stage design were optimized. The stator was then used unchanged in the two-stage design. Two impeller designs were considered. In the first the impeller tip diameter was kept the same as the three stage design and in the second the tip diameter was increased slightly to reduce the amount of diffusion in the impeller. A summary of the key impeller design parameters is shown in Table 3 with a comparison to the baseline three stage design.

Keeping the tip diameter the same (case A) resulted in a head coefficient of 0.6, which required 8 full and 8 partial blades to adequately control the flow in the blade passages, and resulted in a relative velocity ratio of 0.61. Increasing the tip diameter to 14.14 inches reduced the head coefficient to 0.572 which increased the relative velocity ratio to 0.7. Figure 3 shows a comparison with other Rocketdyne high head coefficient designs for impeller relative velocity ratio and exit tangential velocity. The 0.6 head coefficient design had more diffusion in the impeller passages than current experience while the 0.57 head coefficient design was at the limit of current experience. In addition, with only six full blades the lower head coefficient design has less blade blockage at the leading edge and thus better suction performance capability, the tip speed was still within the allowable limits (Figure 4) and, due the lower exit absolute flow angle the spacing between the impeller and the crossover was still within the guidelines of Reference 1 for limiting unsteady loads due to rotor/stator interactions (Figure 5). In view of this and in order to minimize the performance risk, yet still provide a challenge for the CFD codes, the 0.57 head coefficient impeller was selected.

The predicted stage performance is shown in Figures 6 and 7.

### 3.5 Impeller Design

#### 3.5.1 Blade definition and Hydrodynamic analysis

The impeller blade shapes were defined using a recently developed program that allows rapid iterations between geometry definition and hydrodynamic analysis programs. A high degree of optimization, within the limitations of the analysis programs, was therefore achieved.

Quasi-3D analysis was used with a streamline curvature analysis to calculate the flow in the meridional plane, and a potential flow analysis to calculate the blade loading.

Figures 8 to 12 show the blade geometry and the results of the hydrodynamic analysis for the rms streamline. The head distribution in the meridional direction is excellent (Figure 10) and, while high, the blade loading is relatively uniform with good placement of the partial blades (no discontinuities in the full blade surface pressure distribution - Figure 11).

### 3.5.2 Stress analysis

A preliminary stress analysis was performed using a 2-D axisymmetric FEM with blade solidities obtained from the 3-D CATIA model (Figure 13). It was assumed that, similar to the SSME High Pressure Fuel Pump impeller the pressure stresses on the blades were 10% of the centrifugal stresses and that the alternating stresses were 30% of the pressure stresses. The results are shown in Figures 14 and 15 and indicate that the design is adequate for burst and high cycle fatigue.

### 3.5.3 Impeller blade CATIA model

Two 3-D CAD models were made of the blade geometry using CATIA. The first model included the fillets between the blade surfaces and the hub and shroud surfaces and the second did not. Shaded image isometric views of the design with and without the shroud are shown in Figure 16 and 17.

For both models, point data was created along 11 streamlines on the blade surfaces and also on the hub and shroud contours. The data is presented in Appendices A and B. Each blade (full and partial) is defined by 200 points on each streamline in cartesian and cylindrical polar coordinate systems. For both coordinate systems the Z axis is parallel to the axis of rotation. The data starts at the hub and is ordered - full blade pressure surface for all streamlines, full blade suction surface for all streamlines, partial blade pressure surface for all streamlines, partial blade suction surface for all streamlines. The zero for both coordinate systems is at the intersection of the full blade leading edge with the hub and the tangential coordinate in the cylindrical polar coordinate system is negative in the direction of rotation.

### 3.6 Inducer Design

The inducer design requirements are shown in Table 4. The inlet NPSH requirements were based on the the minimum requirements of the NLS STME engine, the flow coefficient of 0.091 based on the pump speed selection and the head coefficient of 0.2 from the velocity triangle optimization.

The blade angle distributions were selected to optimize suction performance and achieve the required head. The thickness distributions were identical to those used on the ADP inducer design to ensure the structural acceptability of the blade. The same quasi-3D approach used to analyze the impeller was used to analyze the inducer. Figures 18 to 20 show a two dimensional representation of the blade along three streamline cuts, and Figures 21 to 23 show the predicted surface pressure distributions along the same streamlines. The pressure distributions are typical of low flow coefficient inducer designs.

Similar to the impeller, points were generated along the blade surfaces and along the hub contour. 11 streamlines were defined with 47 points on each blade surface. The points are defined in cylindrical polar coordinates with zero at the intersection of the leading edge meanline with the hub and the tangential direction positive in the direction of rotation of the pump. The points are listed in Appendix C, first defining all the pressure surfaces from hub to tip and then all the suction surfaces.

### 3.7 Impeller Inlet Flowfield Definition

To ensure that all subsequent CFD analyses of the impeller used the same inlet conditions, the impeller inlet flowfield was defined for three scenarios. For operation in LH2 two flowfields were defined: the stator exit flowfield was defined together with the recirculation flows (mass flow, density and three velocity components) calculated from the thermodynamic model of the pump; and for the second possibility the impeller inlet flowfield was defined assuming the recirculation mixed completely with the main throughflow. The validation data for the impeller will be taken in water on a model scaled to a 6 inch eye diameter and using the inducer designed for the ADP program with no stator upstream of the impeller. The impeller inlet flowfield was also defined for this

condition with the assumption that there would be no recirculation flows in the tester.

This data, together with definition of the impeller front shroud and hub cavities for potential future CFD analysis of the recirculation flows, is presented in Appendix D.

#### 4.0 CONCLUSION

Inducer and impeller blade geometries have been defined for a fuel pump fore a generic gas generator cycle. Blade surface data and inlet flowfield definition is available is sufficient detail to allow CFD analysis of the two components.

## **REFERENCES**

1. "Liquid Rocket Engine Centrifugal Flow Turbopumps" NASA SP-8109

**CONVERT EXISTING 3-STAGE PUMP TO 2-STAGE PUMP**

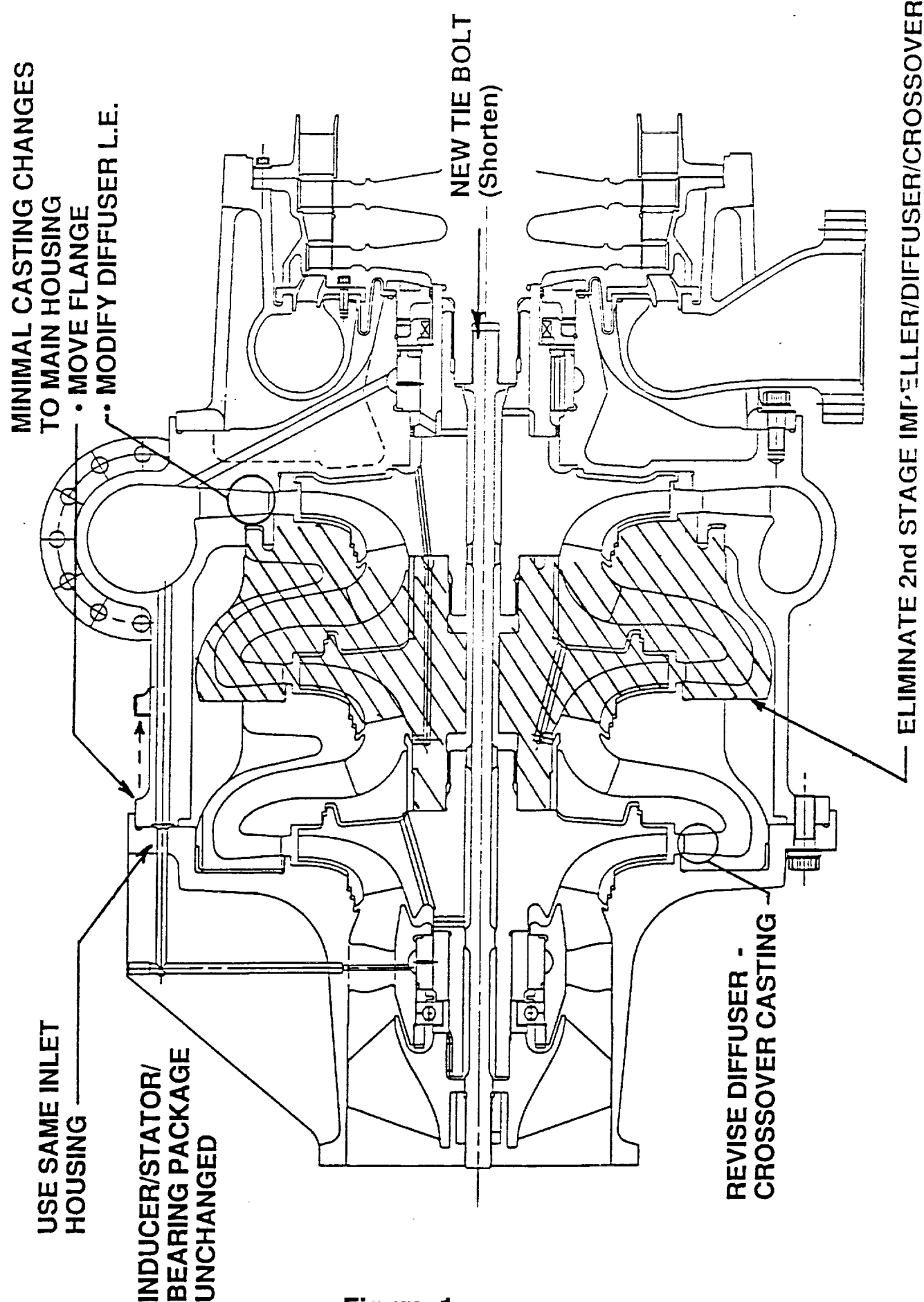

Figure 1



# NPSH MARGIN AS A FUNCTION OF PUMP SPEED AND FLOW COEFFICIENT

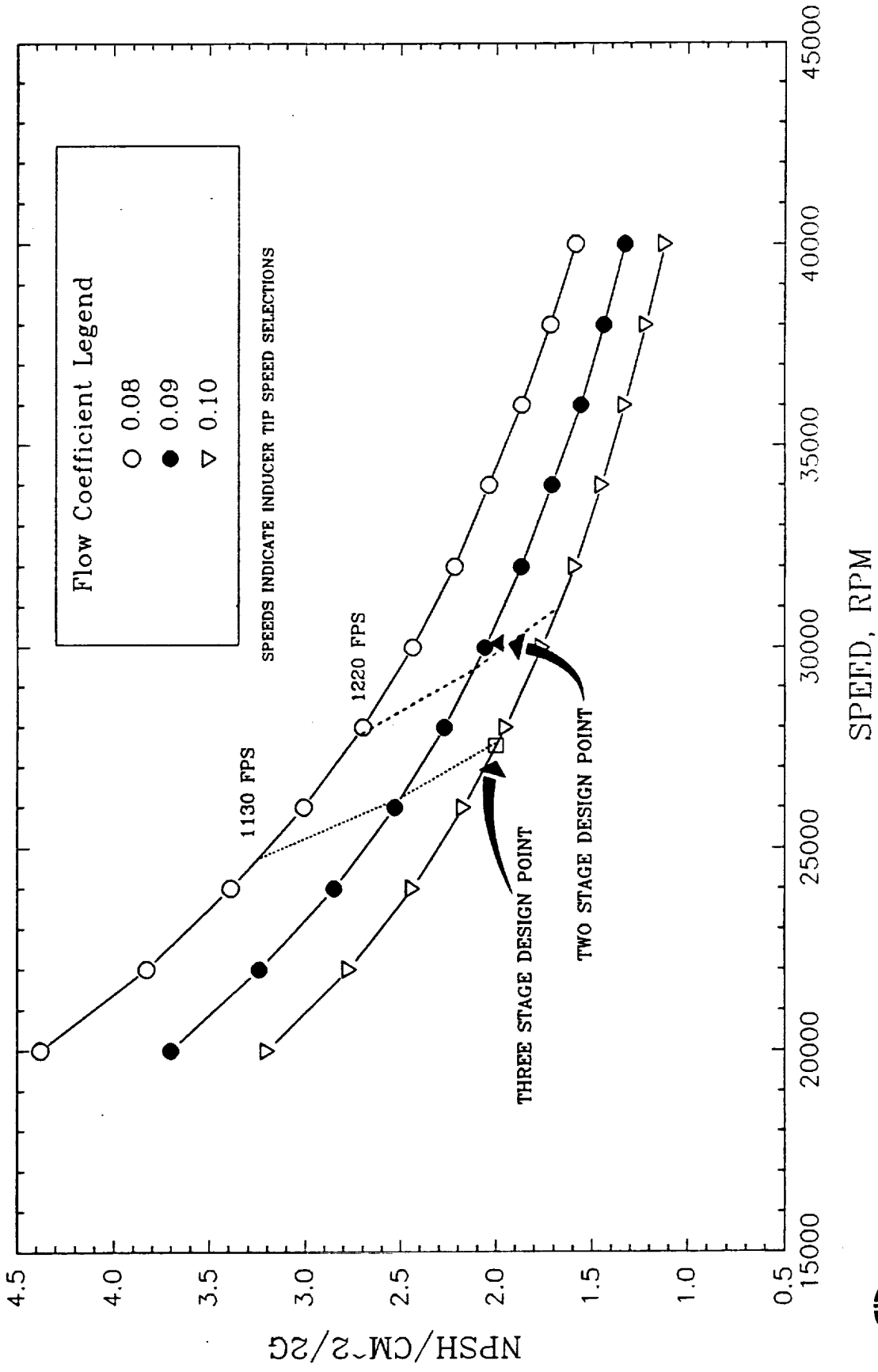

Figure 2

# COMPARISON OF CANDIDATE DESIGNS WITH EXPERIENCE

(.....) 2 STAGE, 8+8

(-----) 2 STAGE, 6+6

(——) 3 STAGE, BASELINE

IMPELLER RELATIVE VELOCITY RATIO (EXIT/INLET)

IMPELLER EXIT TANGENTIAL VELOCITY, CU/U

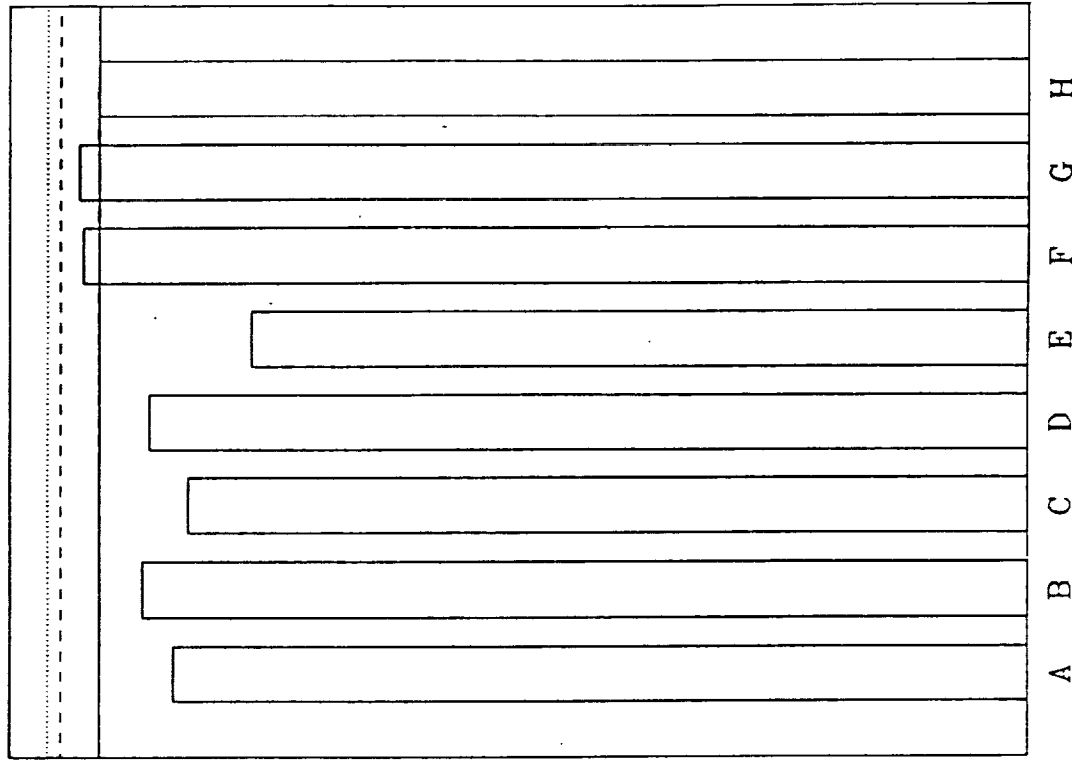
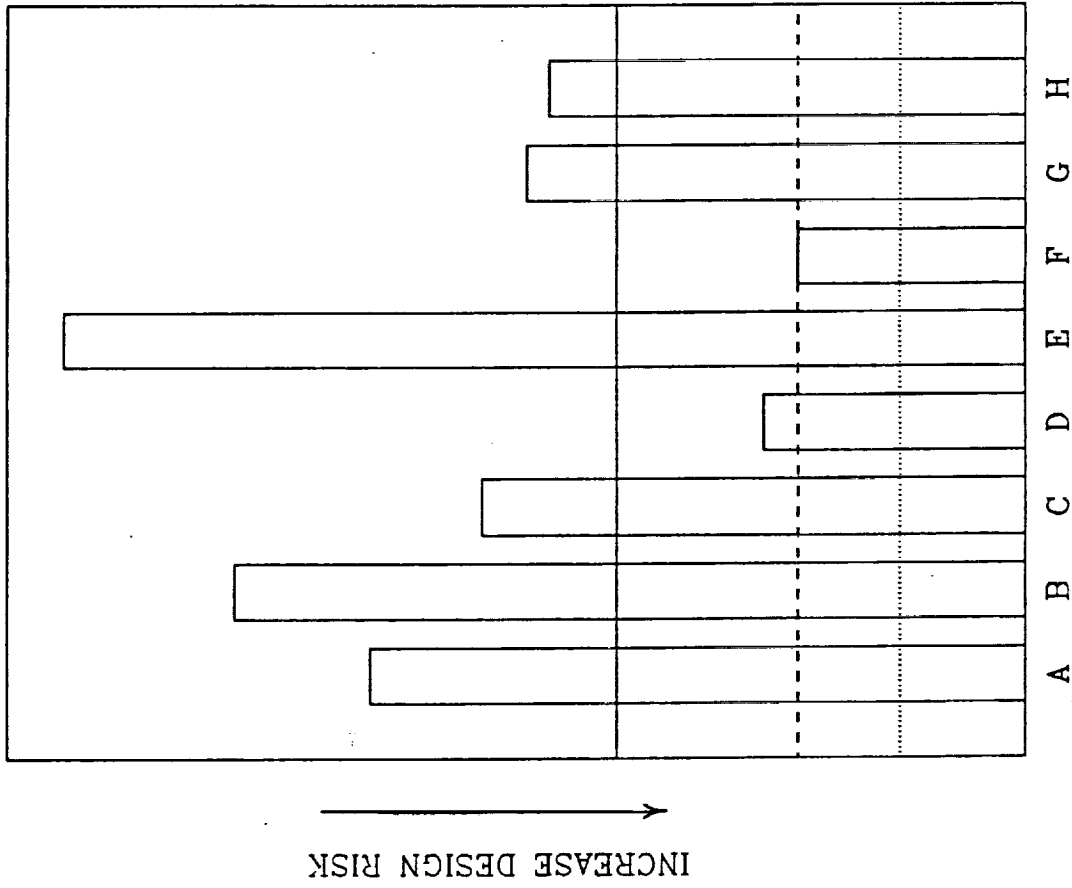

Figure 3

# IMPELLER TIP SPEED VERSUS IMPELLER HEAD COEFFICIENT TWO AND THREE STAGE PUMPS

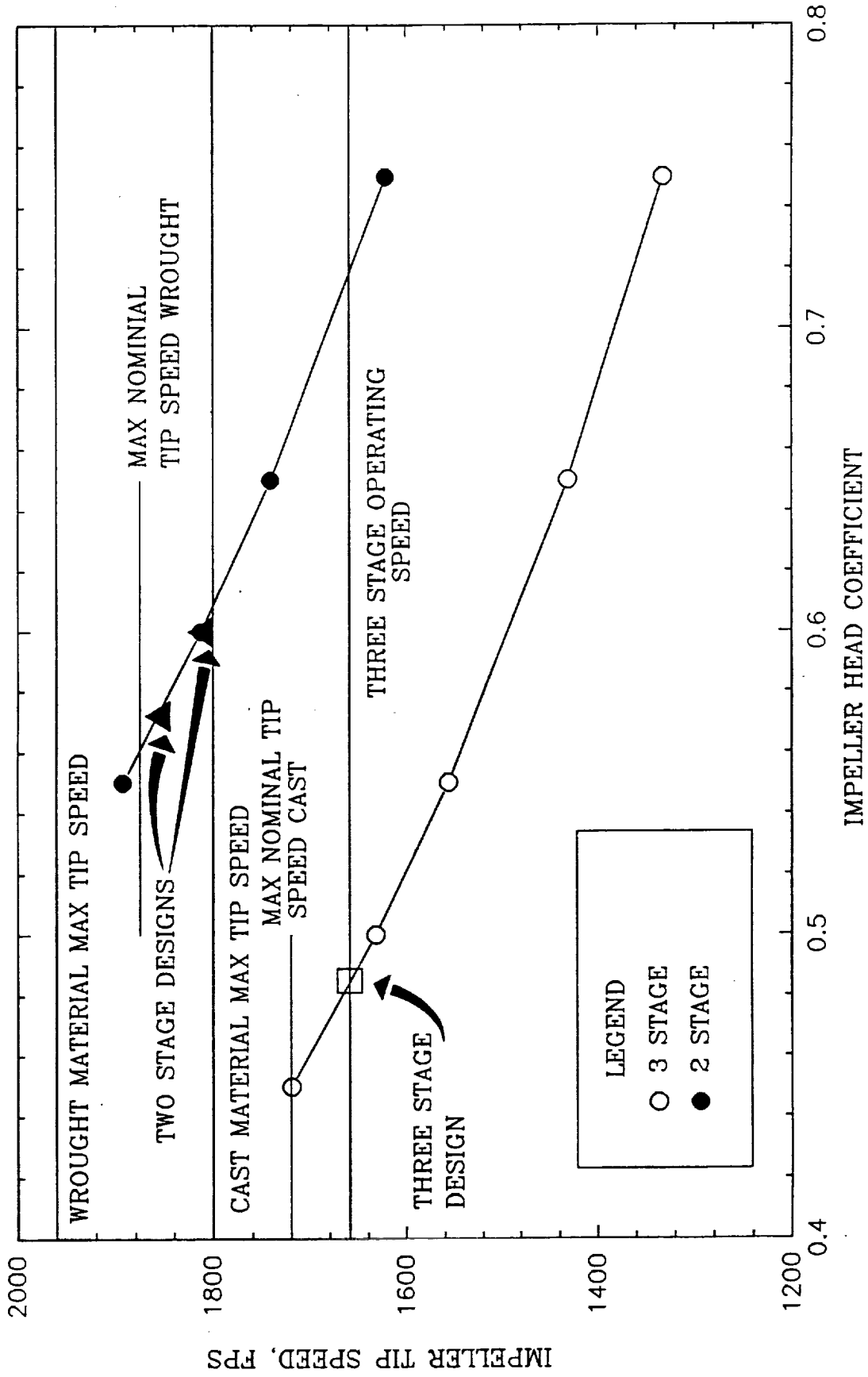

Figure 4

# IMPELLER-TO-STATOR SPACING AS A FUNCTION OF DISCHARGE FLOW ANGLE

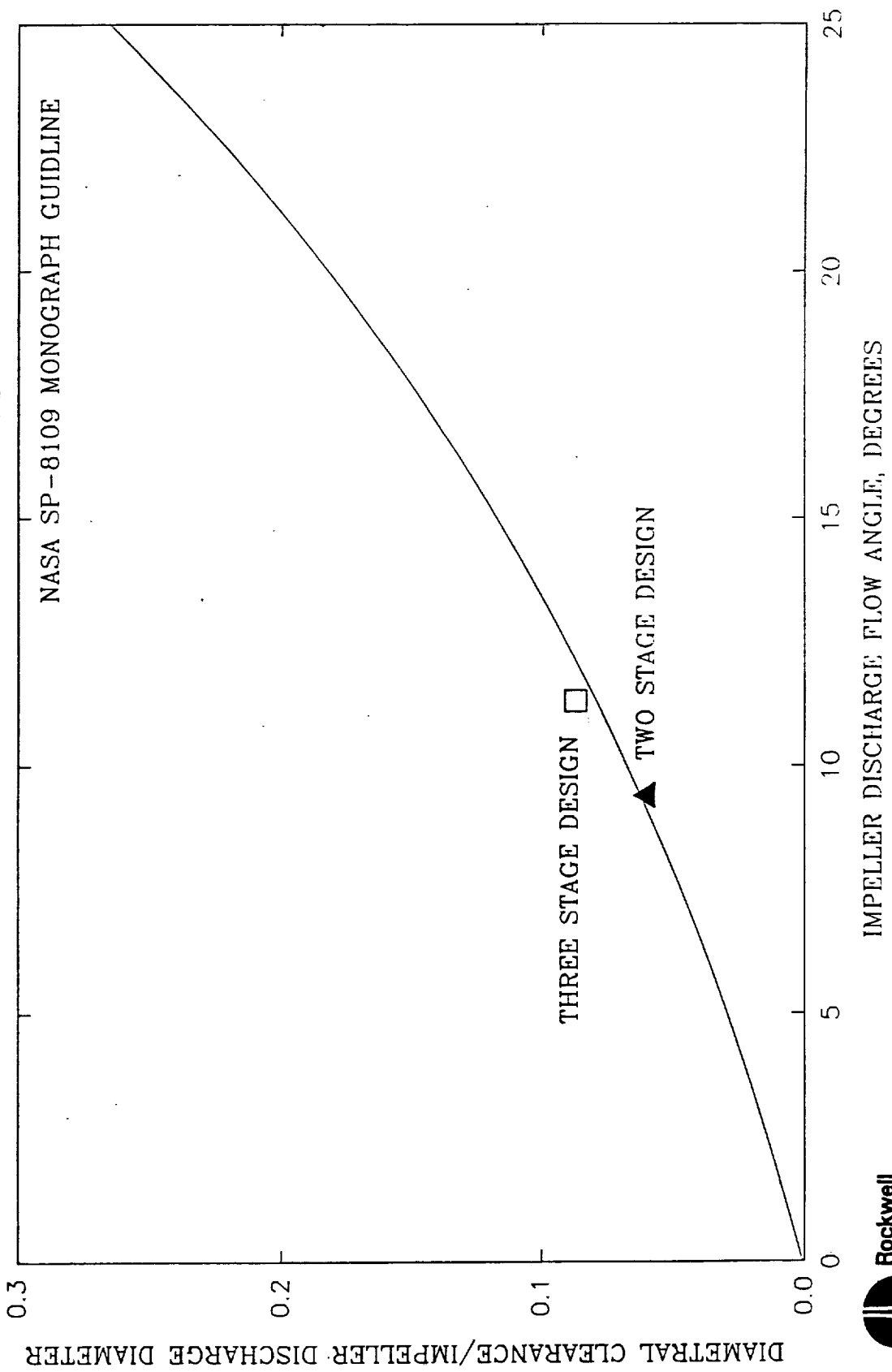

Figure 5

# CONSORTIUM PUMP STAGE PERFORMANCE

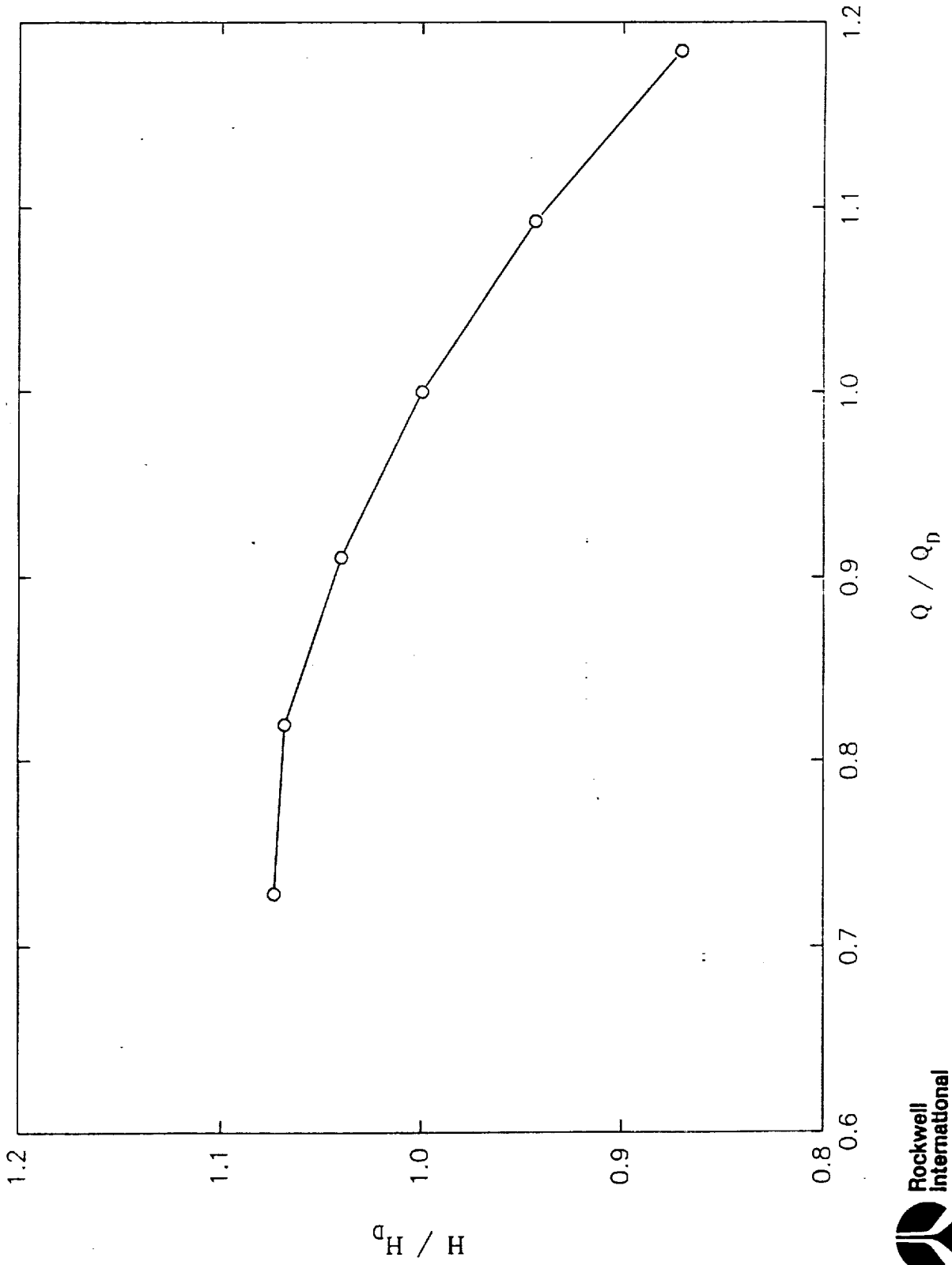

Figure 6

# CONSORTIUM PUMP STAGE PERFORMANCE

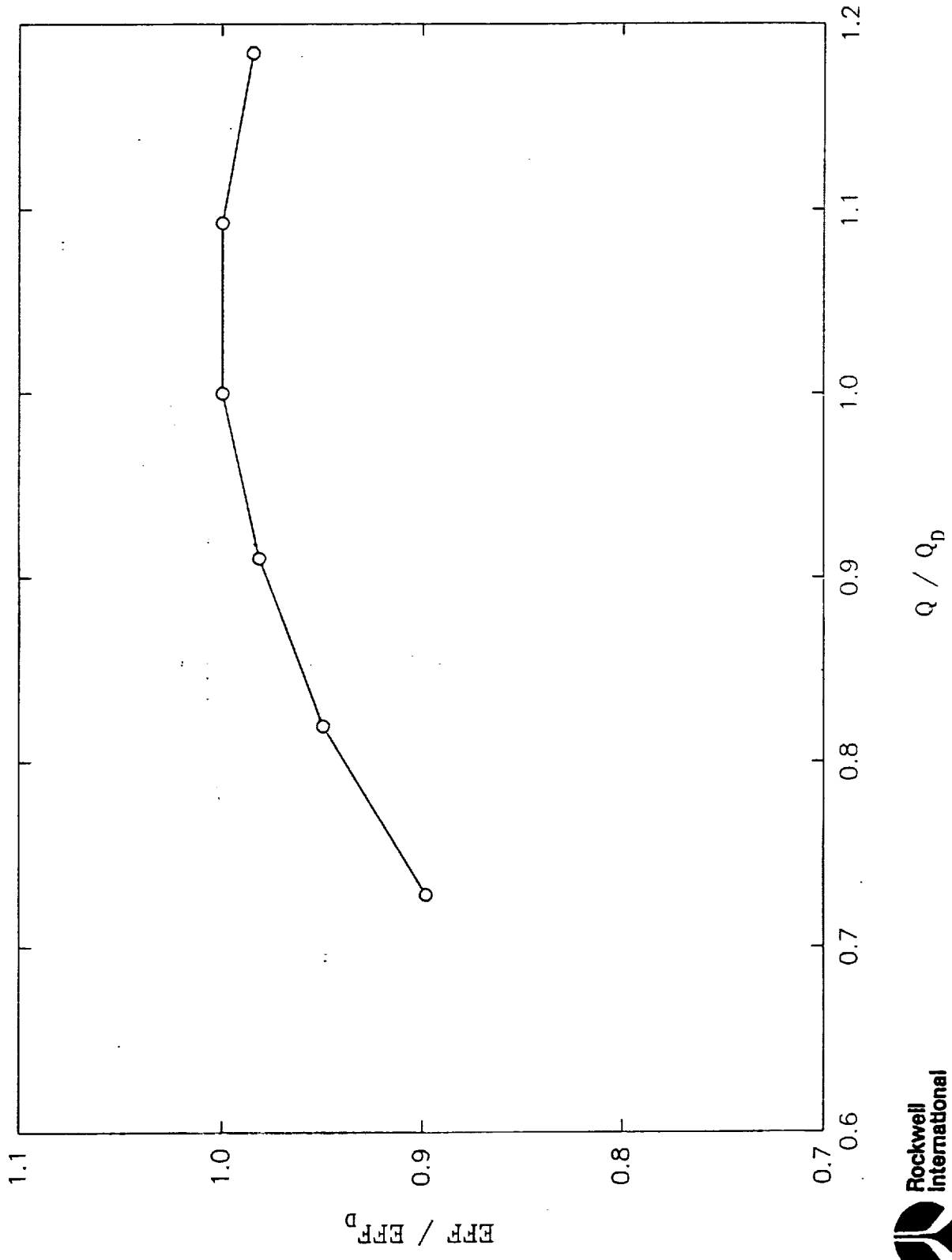

Figure 7

CONSORTIUM PUMP IMPELLER  
STREAMLINE DEFINITION ( ITERATION 22 )

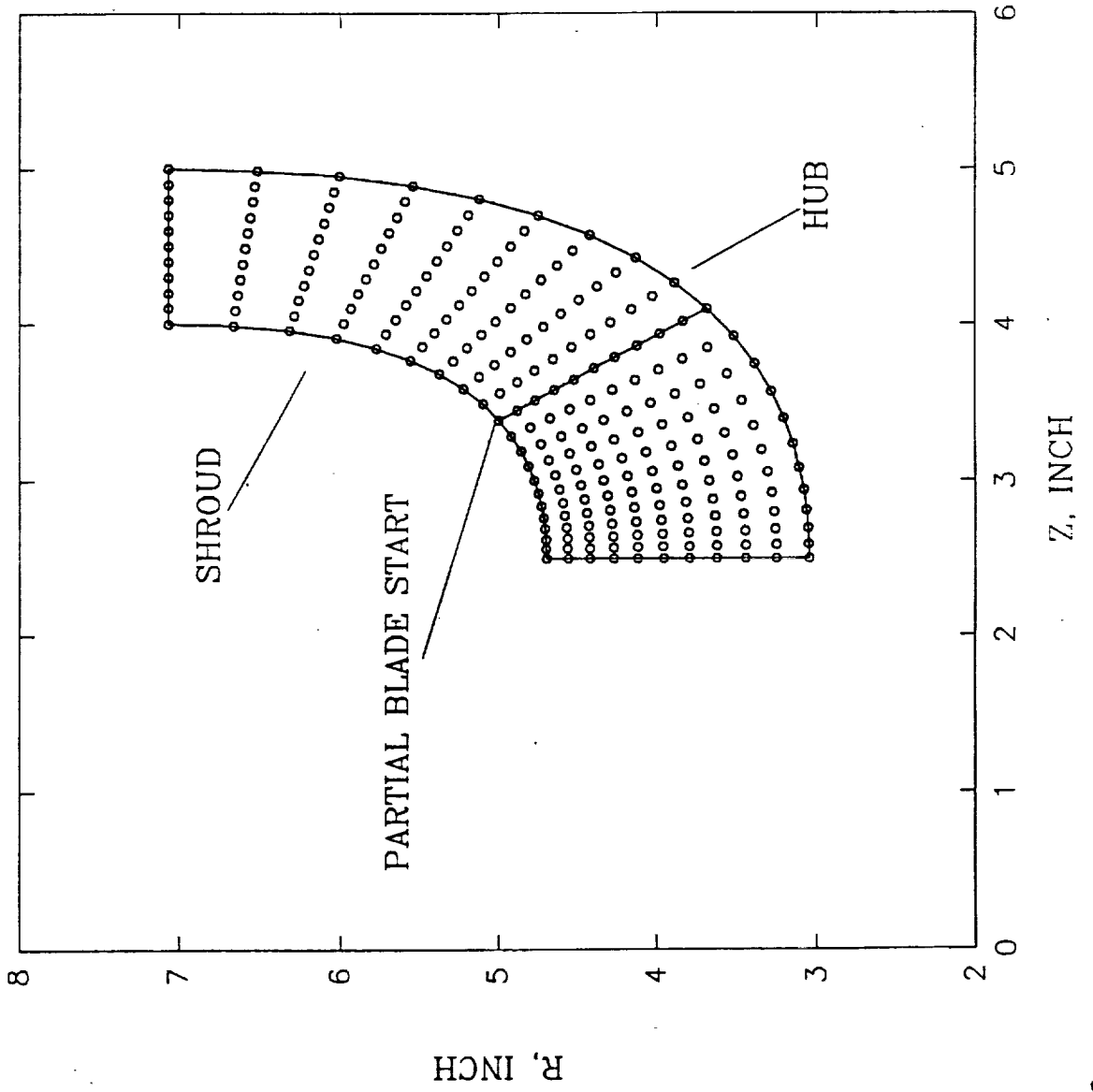

Figure 8

CONSORTIUM PUMP IMPELLER  
MEAN ( ITERATION 22 )

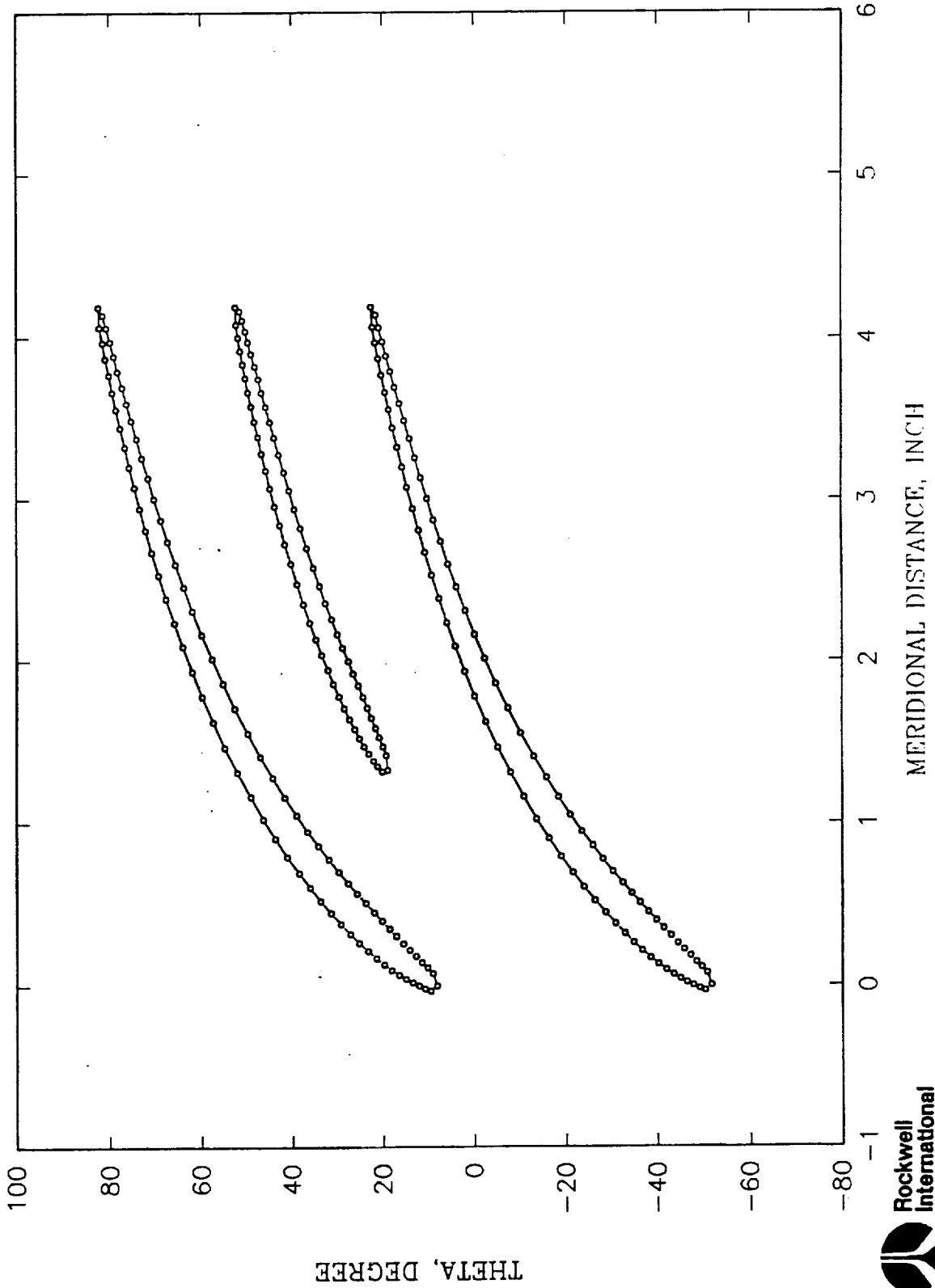

Figure 9



CONSORTIUM PUMP IMPELLER  
 R3DAP PREDICTION ( ITERATION 22 )

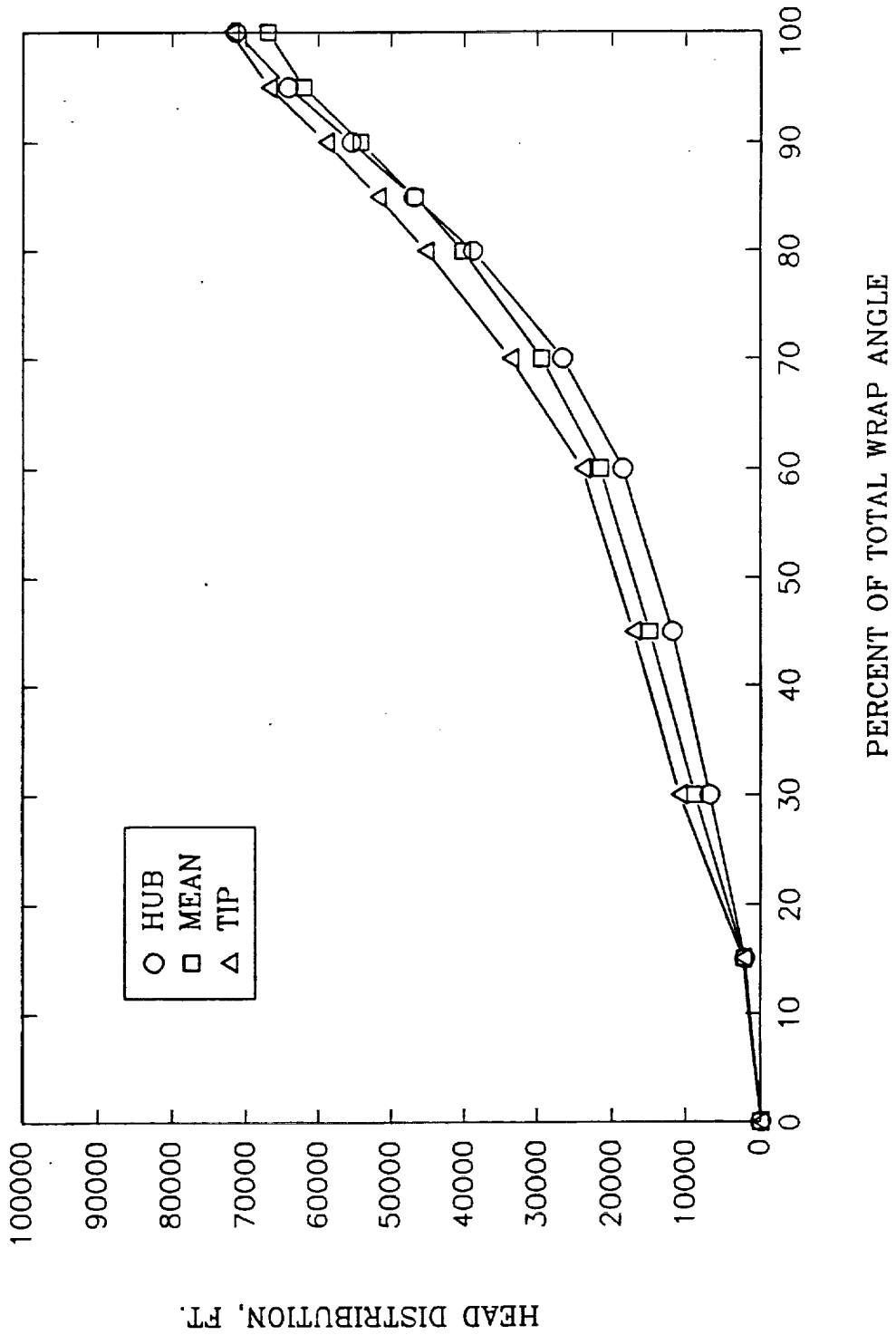

Figure 10

# CONSORTIUM 2STAGE FUEL PUMP IMPELLER MEAN FULL BLADE DISTRIBUTION

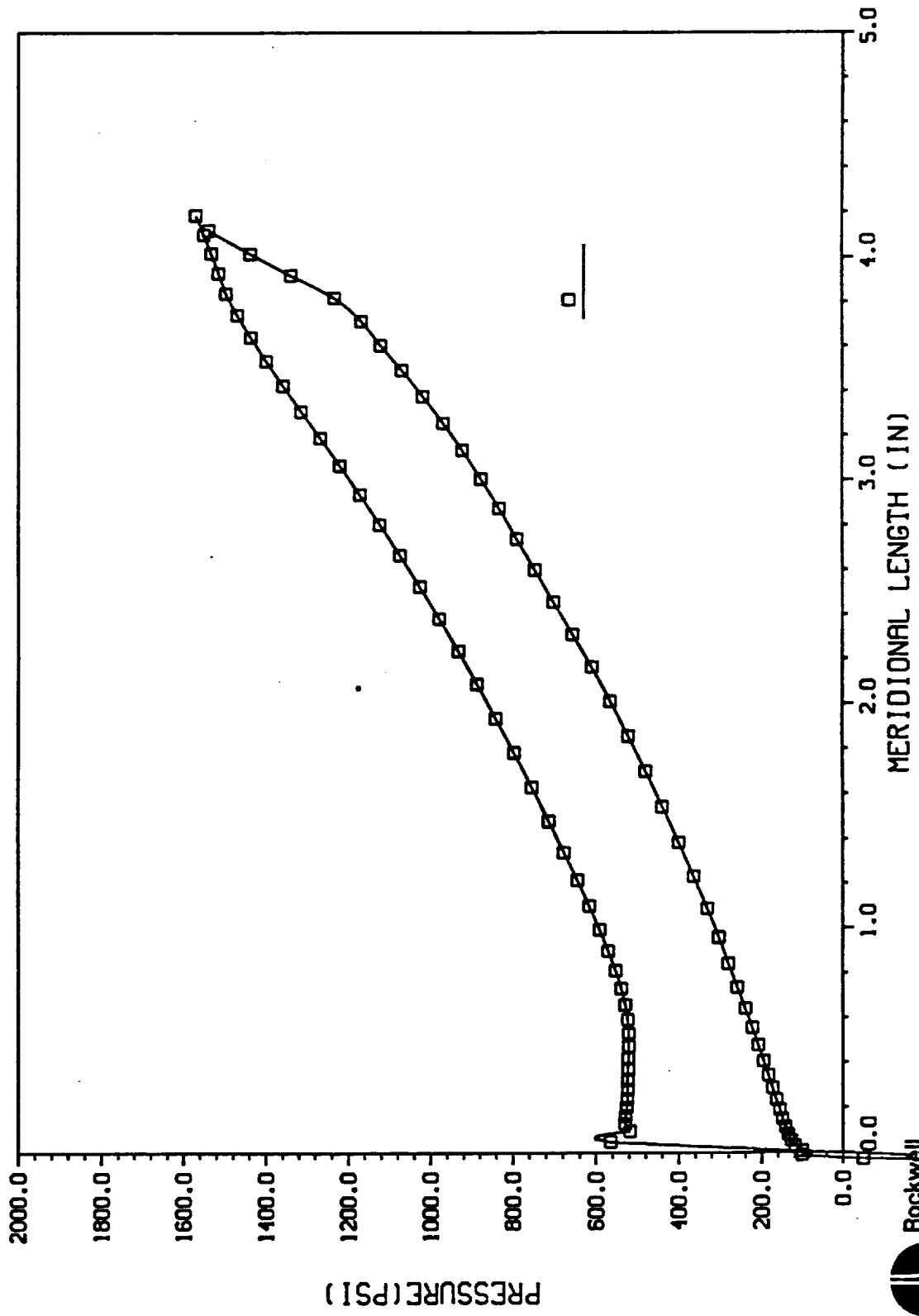

Figure 11

CONSORTIUM 2STAGE FUEL PUMP IMPELLER  
MEAN PARTIAL BLADE DISTRIBUTION

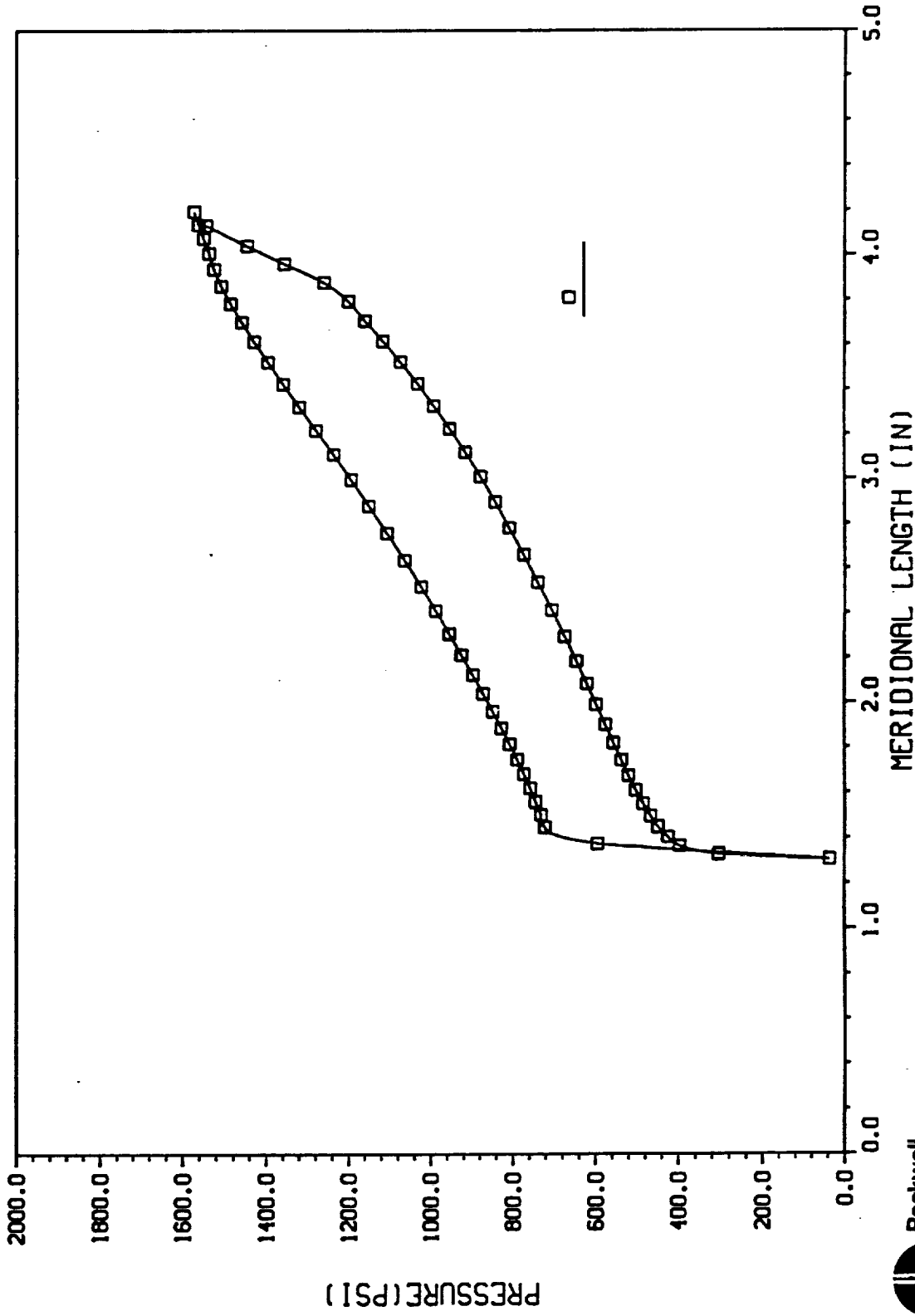
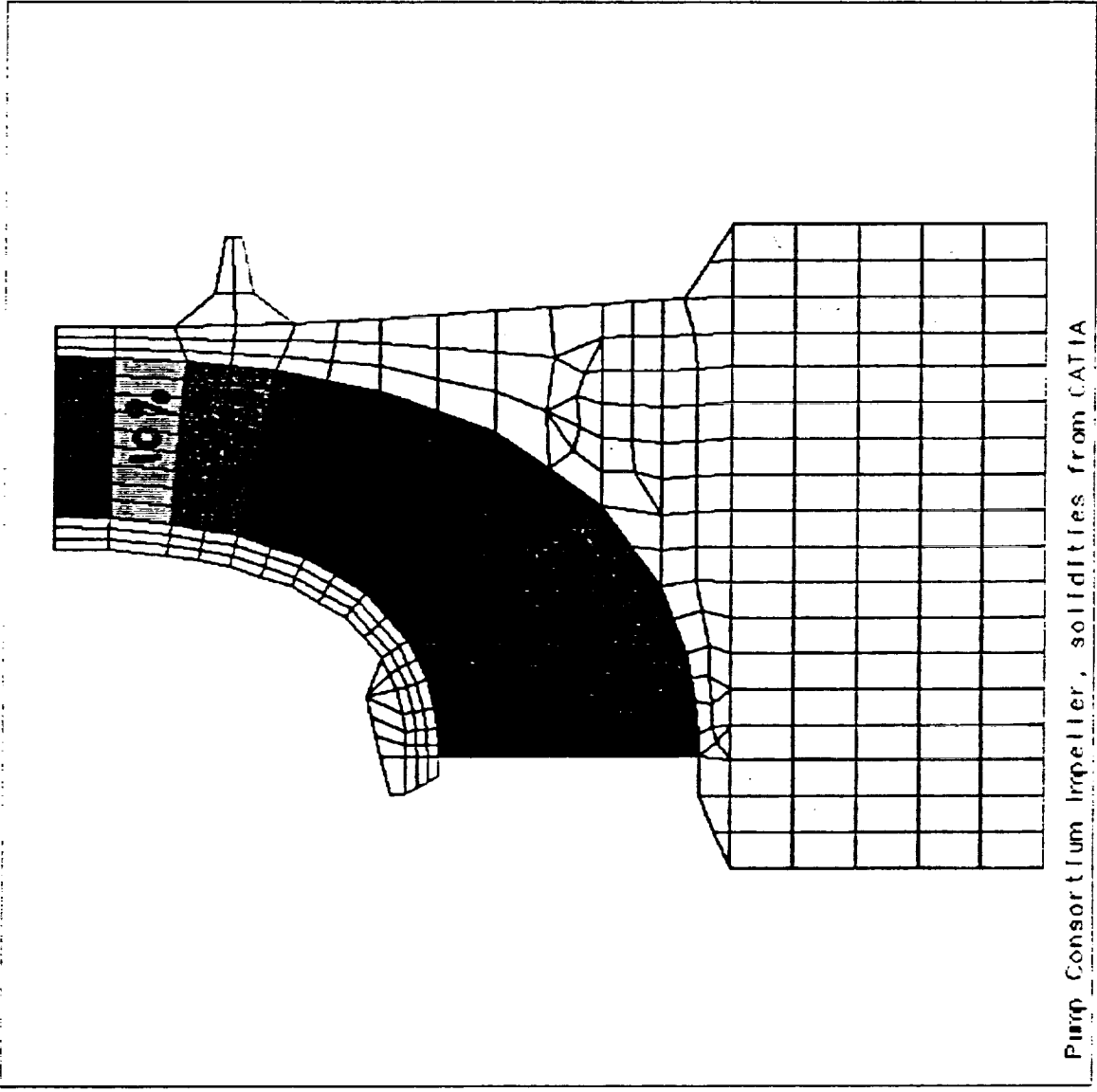

Figure 12

# BLADE STRUCTURAL SOLIDITY

ANSYS 4.4A  
APR 11 1991  
10:06:07  
POST1 ELEMENTS  
TYPE NUM  
ZV =-1  
DIST=3.394  
XF =3.985  
YF =3.82  
ANG7=-90



Pump Consortium Impeller, solidities from CATIA

Figure 13

# IMPELLER HUB AND SHROUD STRESS DISTRIBUTION

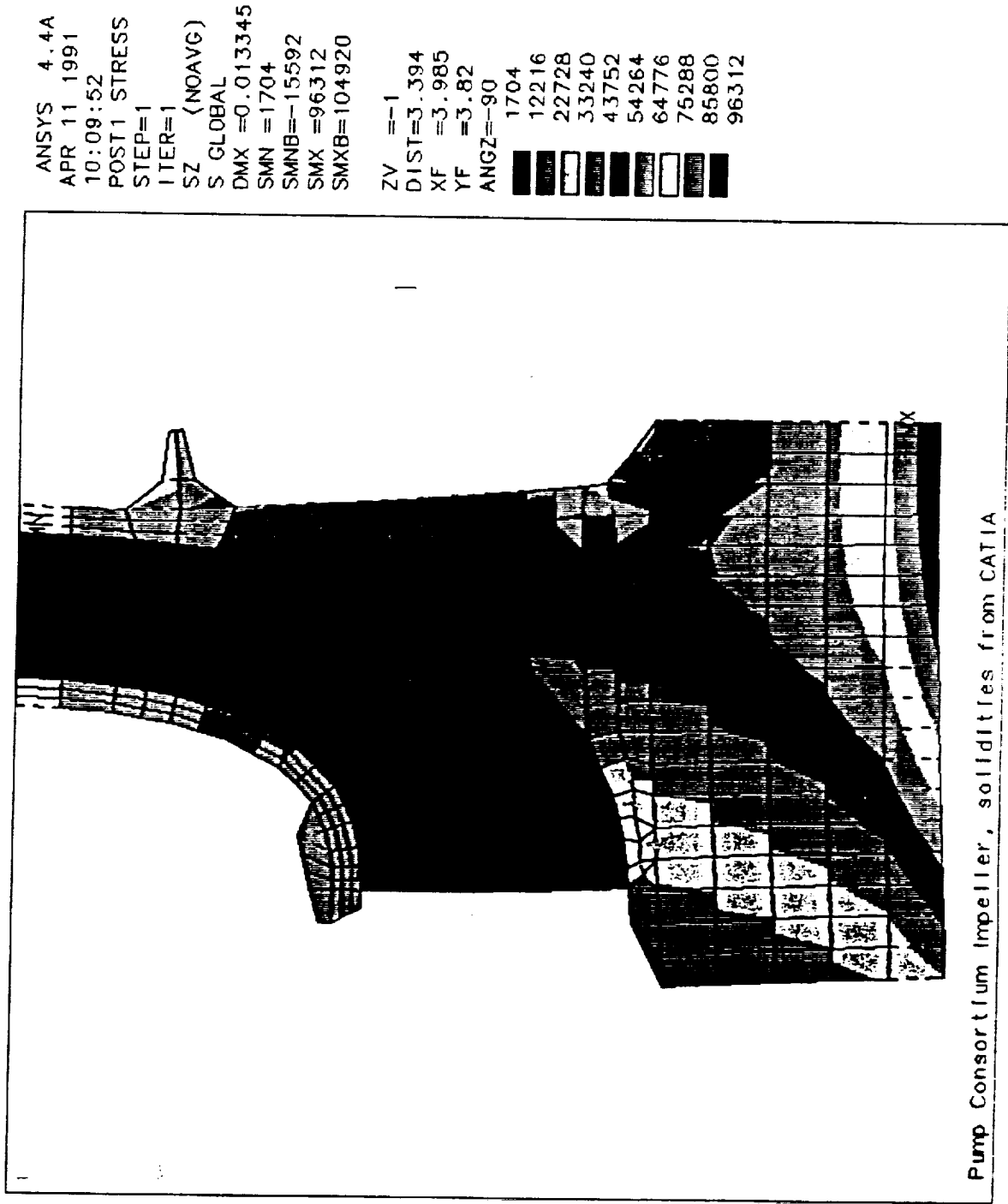
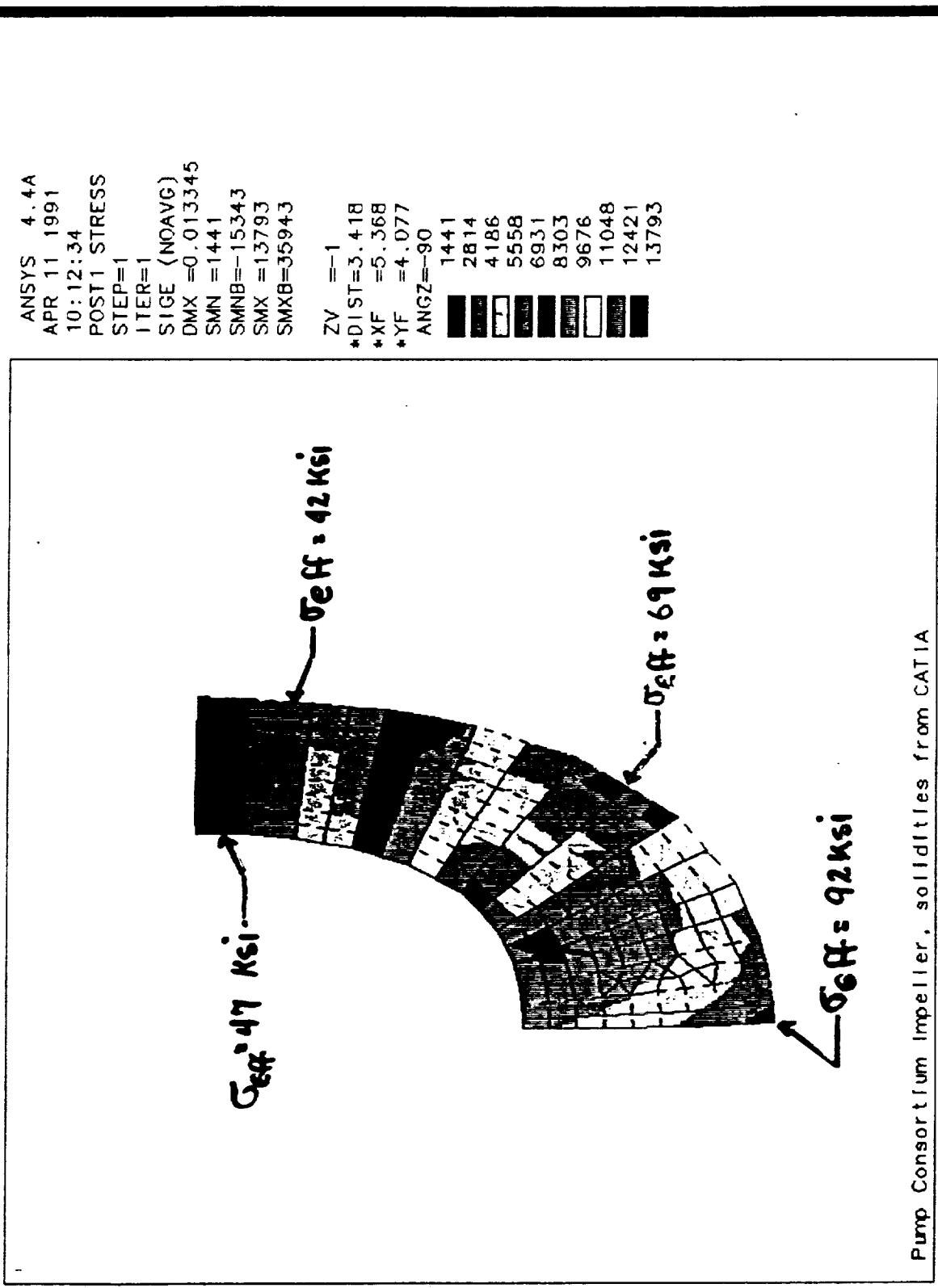

Figure 14

# IMPELLER BLADE STRESS DISTRIBUTION



Pump Consortium Impeller, solidities from CATIA

Figure 15

SURFACES

SOURCES

SURFACES

STANDARD

EXECUTE

SAVE

# ISOMETRIC VIEW OF IMPELLER



Figure 16

**VIEW OF IMPELLER WITH SHROUD REMOVED**



**Figure 17**

SOLIDWORKS  
SURFACES

STANDARD

EXECUTE

SAVE



PUMP CONSORTIUM INDUCER  
STREAMLINE NO. 1

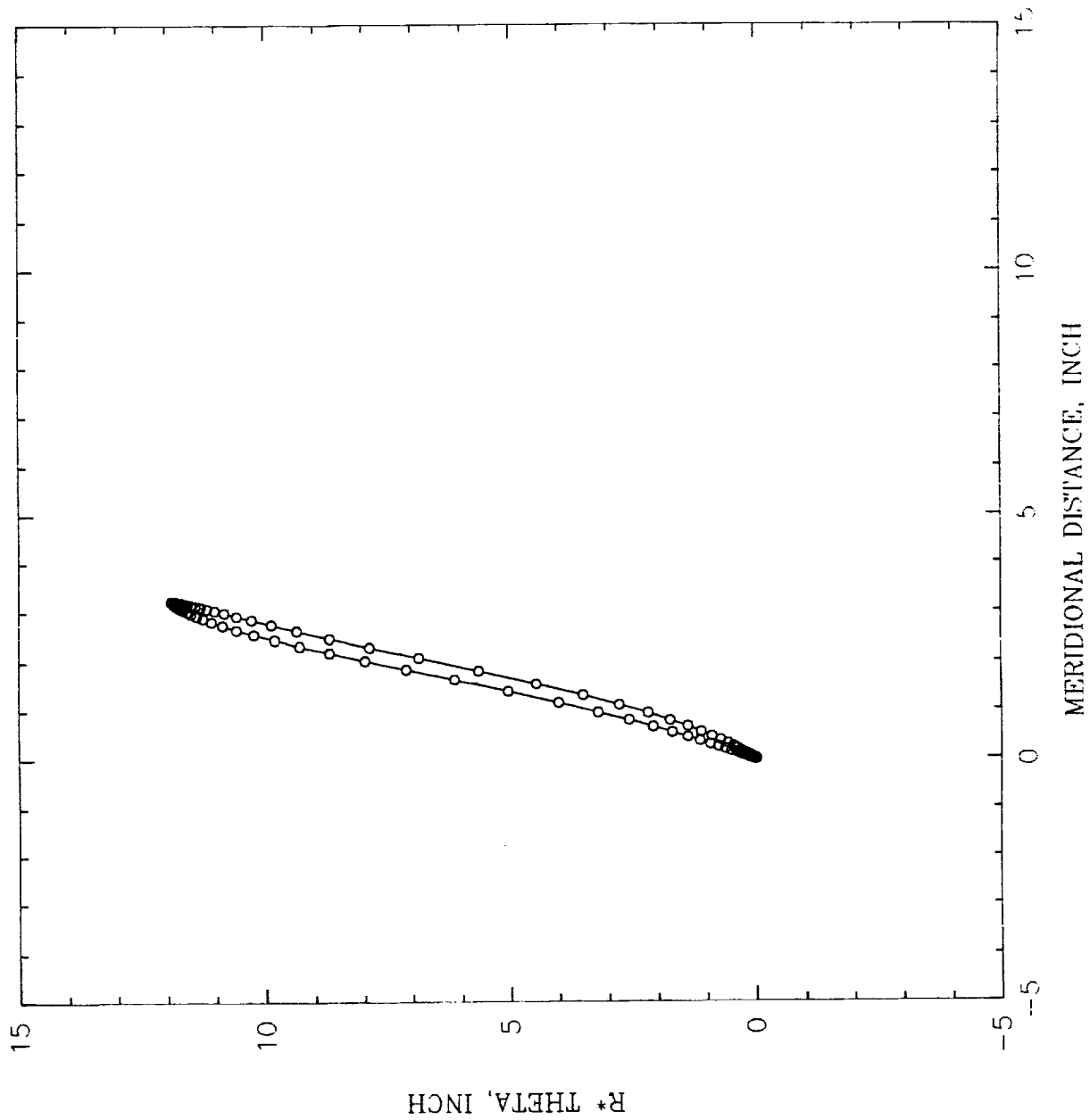

Figure 18

PUMP CONSORTIUM INDUCER  
STREAMLINE NO. 5

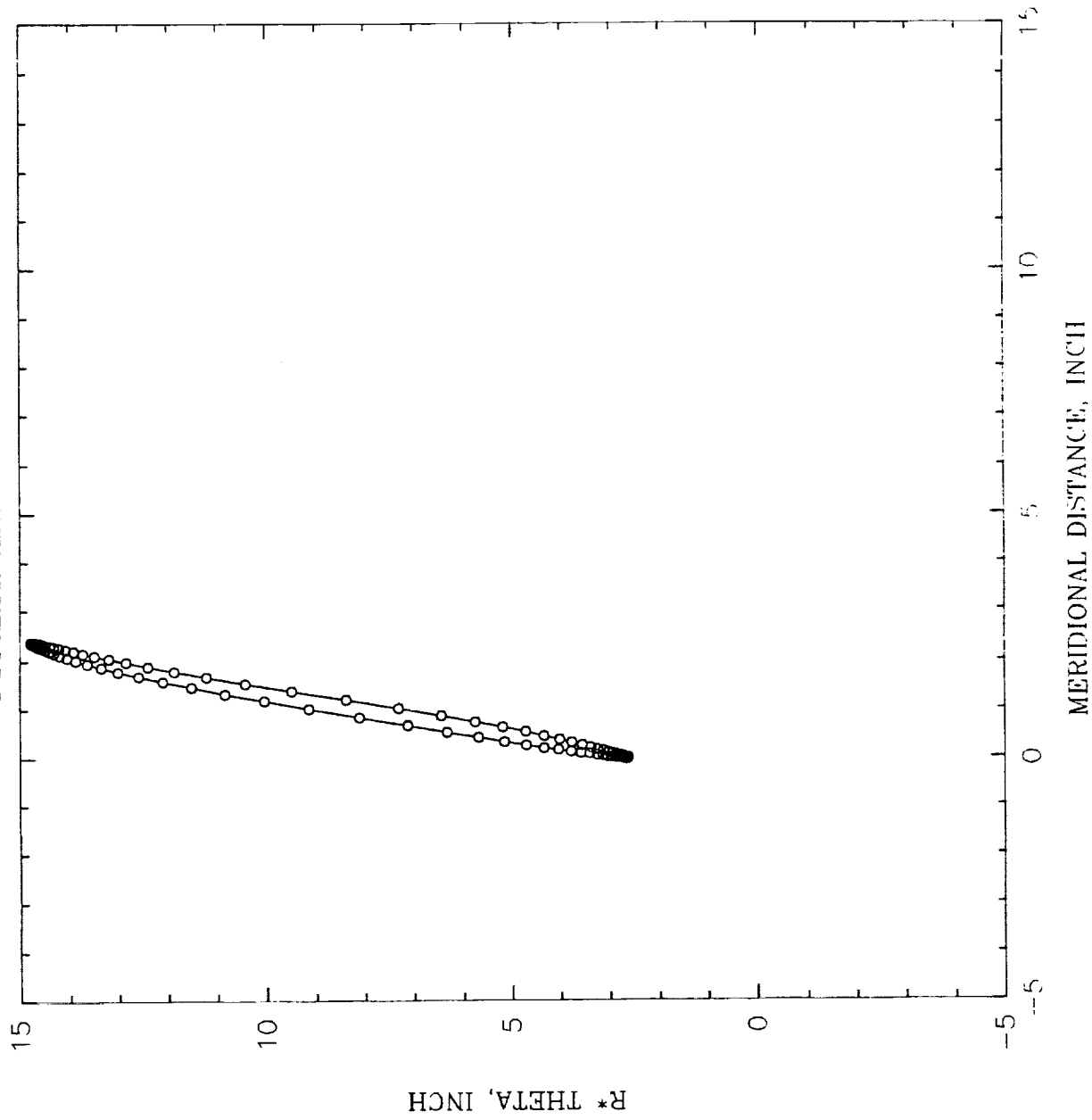

Figure 19

PUMP CONSORTIUM INDUCER  
STREAMLINE NO. 11

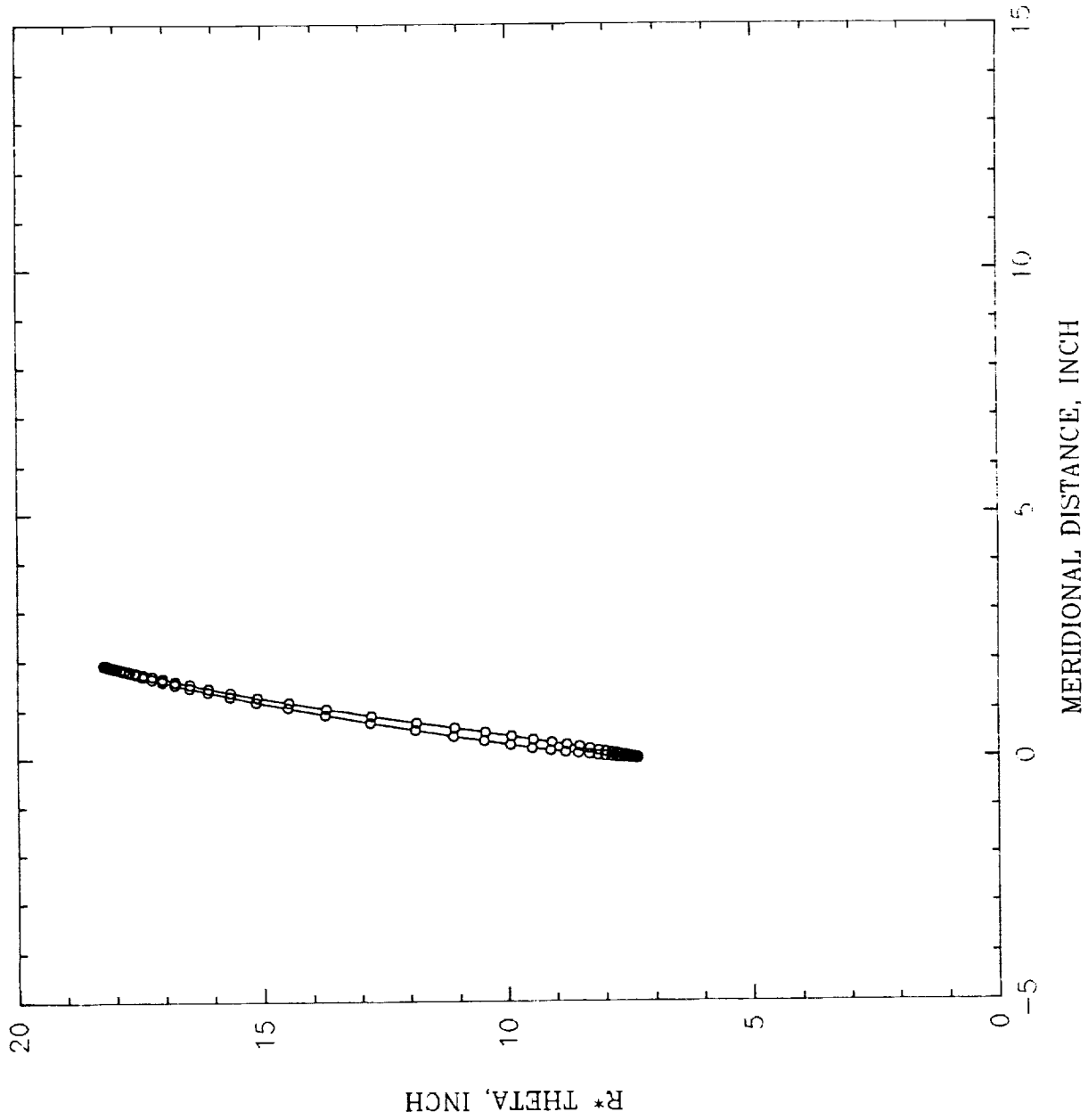
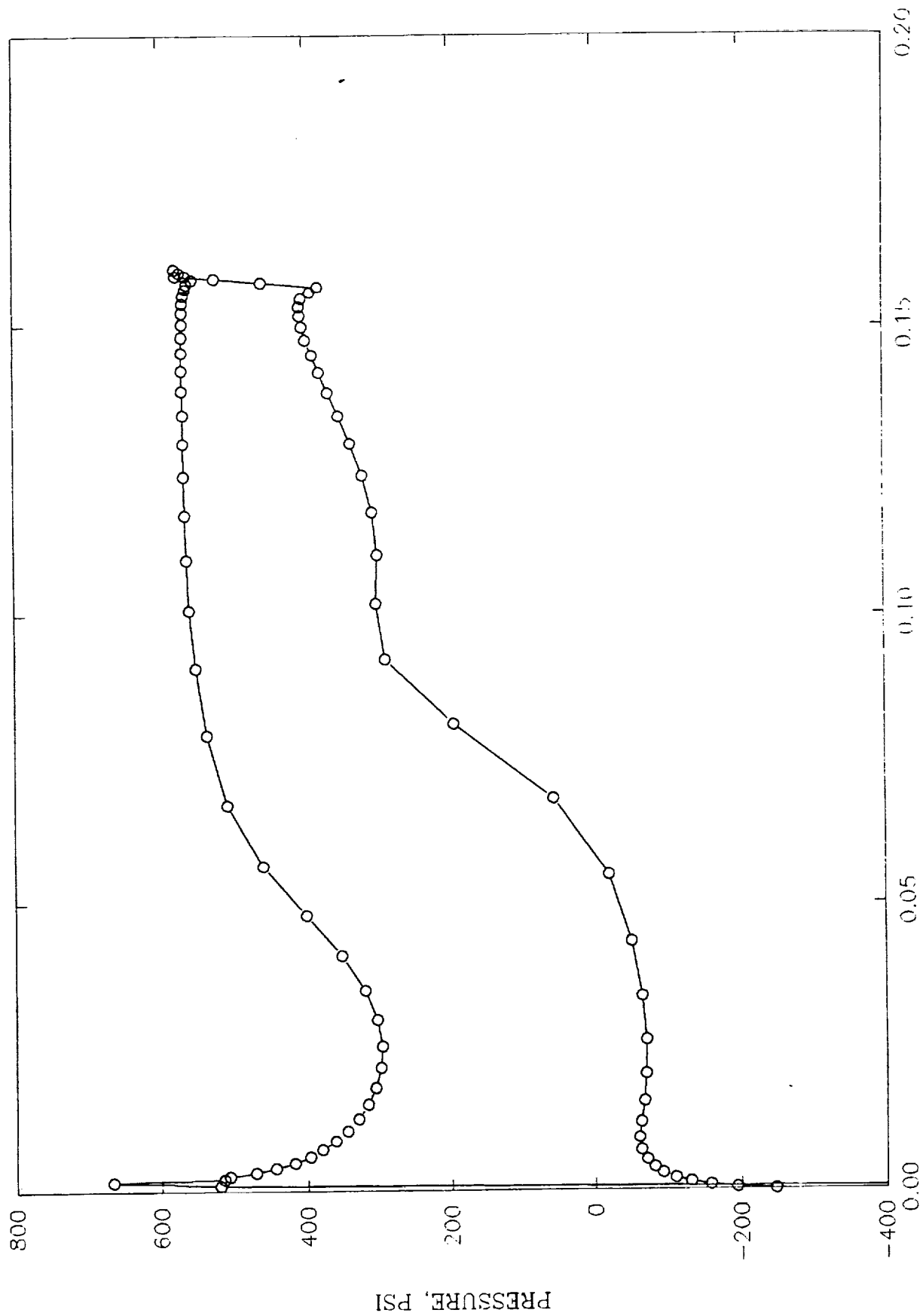

Figure 20

# TIP PRESSURE DISTRIBUTION



M, FT.

Figure 21

# RMS PRESSURE DISTRIBUTION

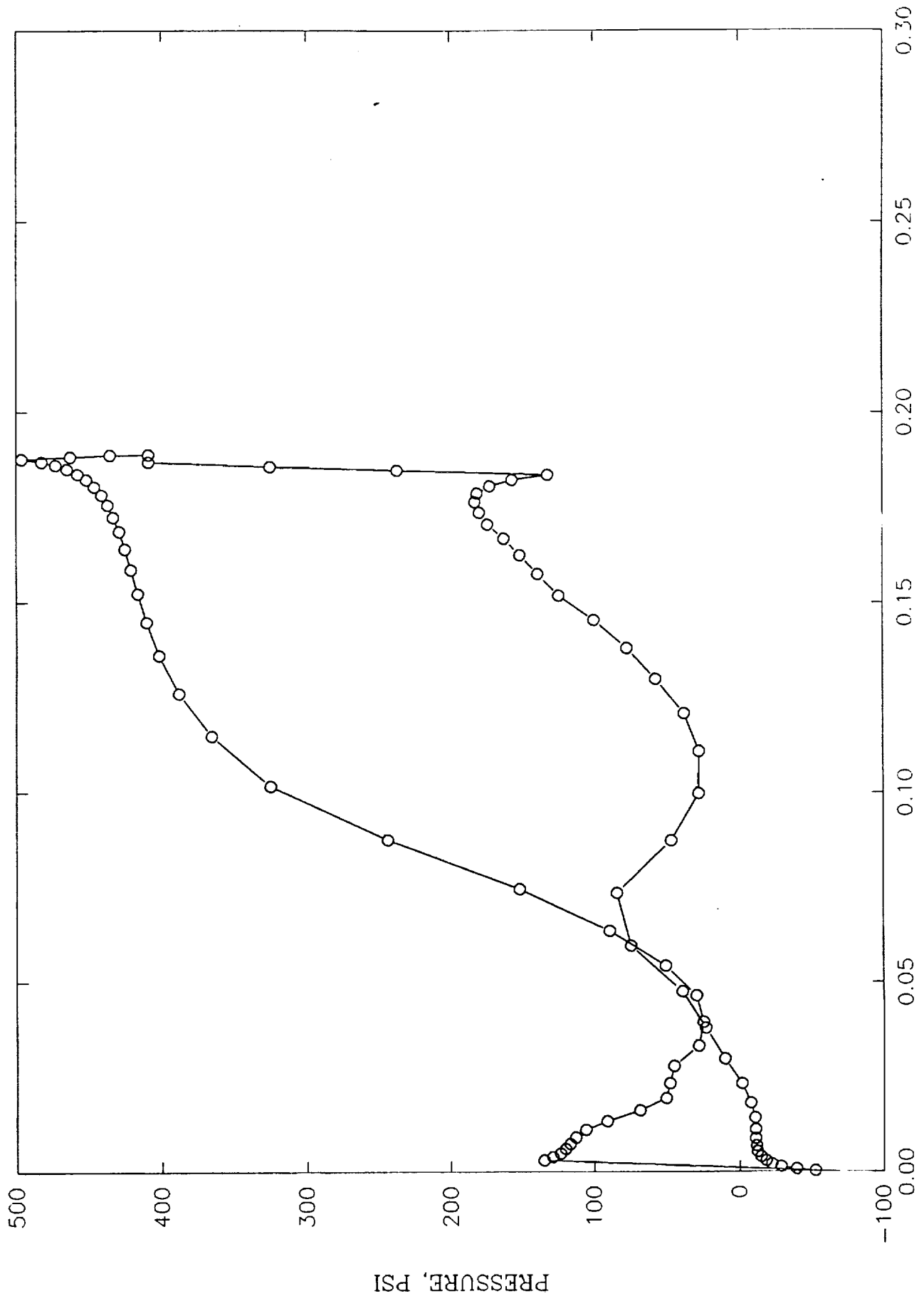

M, FT.

Figure 22

# HUB PRESSURE DISTRIBUTION

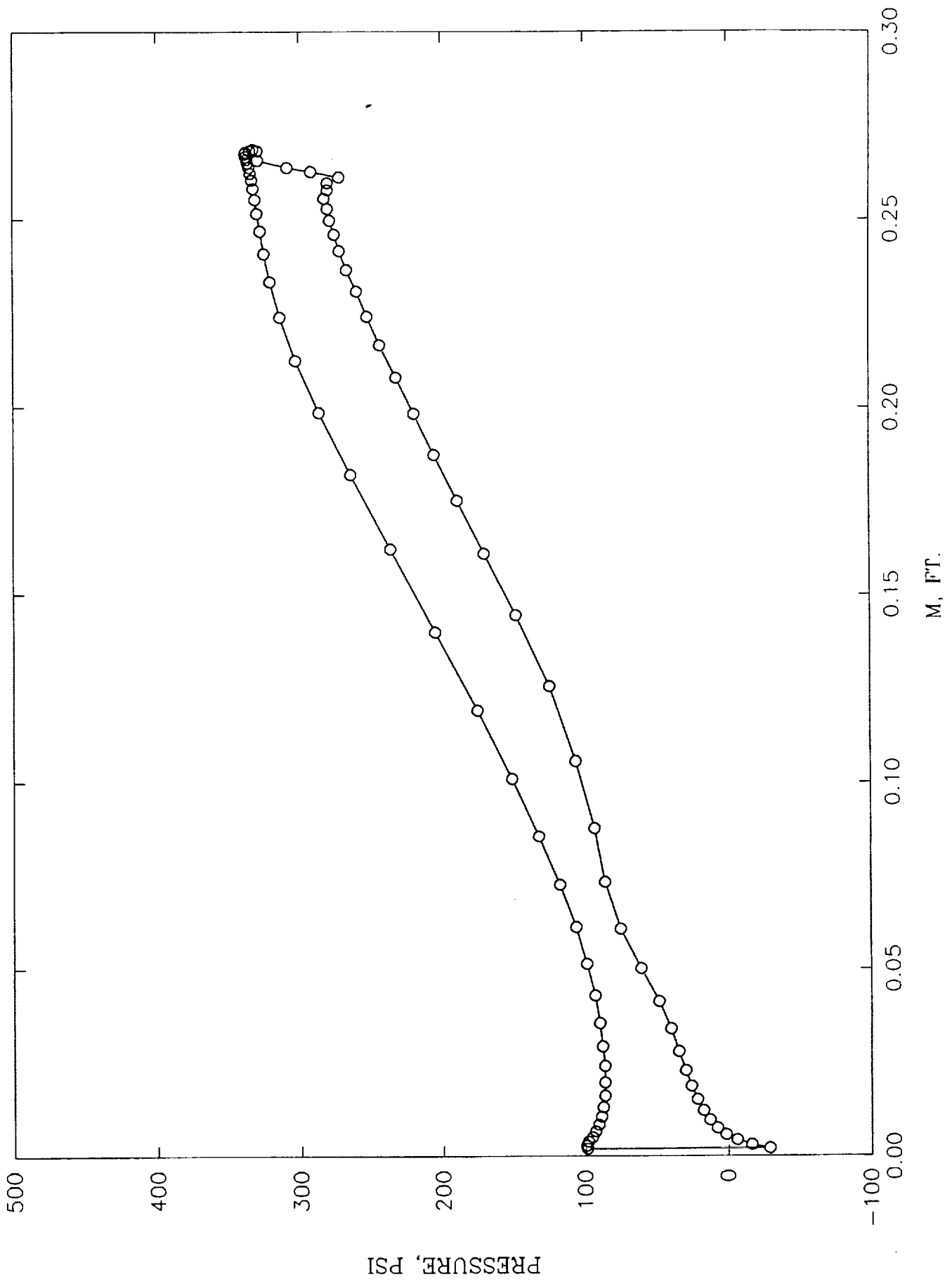

Figure 23

**TABLE 1: GENERIC FUEL PUMP DESIGN POINT  
REQUIREMENTS**

FLOW RATE, LB/SEC	214.2
INLET PRESSURE, PSIA	32
INLET TEMPERATURE, R	38
DISCHARGE PRESSURE, PSIA	4235

TABLE 2

# ALS FUEL TURBOPUMP

## Structural Design Groundrules

		<u>Rotating</u>	<u>Stationary</u>
● <b>Structural criteria</b>			
● Limit load factor	1.2		
● Primary stress factors			
● Yield	1.1		
● Ultimate	1.5		
● Life safety factors			
● LCF (Cycles)		4	4
● HCF (Endurance)		1.4	1.25
● Fatigue Crack growth			
● LC cycles		4	4
● HC cycles ( $\Delta K_{th} / \Delta K_{dyn}$ )		1.0	1.0
● Creep (time)		4	4



**TABLE 3**

**DESIGN PARAMETER SUMMARY**

GEOMETRIES	CASES	2 STAGE CASE A	2 STAGE CASE B	3 STAGE BASELINE
RPM		30108	30108	27550
IMPELLER INLET TIP D °		9.38	9.38	9.38
IMPELLER INLET HUB D		6.097	6.097	6.097
IMPELLER INLET β °		17.9	17.9	19.52
IMPELLER OUTLET D		13.8	14.14	13.8
IMPELLER OUTLET β		47.2	49.5	35.0
IMPELLER B <sub>2</sub> WIDTH		1.0	1.0	0.935
IMPELLER TIP SPEED		1813	1857	1659
IMPELLER SUCTION SPECIFIC SPEED		4591	4591	4962
IMPELLER SPECIFIC SPEED		1141	1141	1393
IMPELLER EYE TO TIP RATIO		0.68	0.66	0.68
IMPELLER W <sub>2</sub> /W <sub>1</sub>		0.61	0.70	0.86
IMPELLER C <sub>2</sub> /C <sub>1</sub>		3.9	3.8	3.1
IMPELLER CU <sub>2</sub> /U <sub>2</sub>		0.77	0.76	0.73
IMPELLER BLADE NUMBER		8+8	6+6	6+6
STAGE HEAD COEFFICIENT		0.6	0.572	0.49
ASPECT RATIO		2.71	3.70	3.863

D ° : DIAMETER IN INCH, β ° : RMS BLADE ANGLE FROM TANGENTIAL



Rockwell  
International  
Rocketdyne Division

## TABLE 4: INDUCER DESIGN REQUIREMENTS

FLOW RATE, GPM	22061
ROTATIONAL SPEED, RPM	30108
MINIMUM INLET NPSH, FT	462
TIP DIAMETER, INCH	9.38
INLET FLOW COEFFICIENT	0.091
HEAD, FT	9548
HEAD COEFFICIENT	0.2

**APPENDIX A**

**IMPELLER COORDINATES - WITH BLADE  
FILLET**

## PRESSURE SIDE

## FULL BLADE

## STREAMLINE 1

X	Y	Z	R	THETA	Z
3.0476	-0.0761	2.4428	3.0485	358.5694	2.4428
3.0473	-0.0860	2.4702	3.0485	358.3836	2.4702
3.0471	-0.0910	2.4989	3.0485	358.2897	2.4989
3.0473	-0.0909	2.5280	3.0487	358.2915	2.5280
3.0482	-0.0826	2.5708	3.0494	358.4482	2.5708
3.0498	-0.0656	2.6110	3.0505	358.7673	2.6110
3.0518	-0.0414	2.6473	3.0521	359.2235	2.6473
3.0538	-0.0114	2.6790	3.0539	359.7865	2.6790
3.0556	0.0226	2.7064	3.0557	0.4245	2.7064
3.0569	0.0594	2.7301	3.0575	1.1131	2.7301
3.0583	0.1354	2.7734	3.0613	2.5357	2.7734
3.0585	0.2113	2.8170	3.0658	3.9513	2.8170
3.0577	0.2868	2.8611	3.0711	5.3587	2.8611
3.0559	0.3621	2.9057	3.0773	6.7581	2.9057
3.0532	0.4371	2.9506	3.0844	8.1475	2.9506
3.0497	0.5119	2.9959	3.0924	9.5277	2.9959
3.0454	0.5863	3.0416	3.1014	10.8976	3.0416
3.0405	0.6605	3.0877	3.1114	12.2569	3.0877
3.0349	0.7345	3.1341	3.1226	13.6051	3.1341
3.0289	0.8082	3.1808	3.1349	14.9409	3.1808
3.0223	0.8818	3.2277	3.1484	16.2649	3.2277
3.0154	0.9552	3.2749	3.1631	17.5763	3.2749
3.0082	1.0285	3.3221	3.1792	18.8751	3.3221
3.0007	1.1017	3.3694	3.1965	20.1598	3.3694
2.9930	1.1748	3.4168	3.2153	21.4313	3.4168
2.9851	1.2480	3.4641	3.2354	22.6890	3.4641
2.9770	1.3213	3.5112	3.2570	23.9326	3.5112
2.9689	1.3946	3.5583	3.2801	25.1605	3.5583
2.9608	1.4680	3.6052	3.3047	26.3727	3.6052
2.9526	1.5416	3.6517	3.3308	27.5693	3.6517
2.9444	1.6154	3.6980	3.3585	28.7505	3.6980
2.9362	1.6895	3.7437	3.3876	29.9164	3.7437
2.9280	1.7640	3.7889	3.4183	31.0670	3.7889
2.9197	1.8388	3.8335	3.4504	32.2022	3.8335
2.9113	1.9140	3.8775	3.4841	33.3222	3.8775
2.9028	1.9896	3.9206	3.5192	34.4269	3.9206
2.8942	2.0656	3.9630	3.5557	35.5163	3.9630
2.8854	2.1421	4.0046	3.5936	36.5905	4.0046
2.8763	2.2190	4.0453	3.6328	37.6494	4.0453
2.8671	2.2964	4.0850	3.6734	38.6933	4.0850
2.8575	2.3742	4.1239	3.7152	39.7222	4.1239
2.8477	2.4525	4.1617	3.7582	40.7364	4.1617
2.8374	2.5312	4.1986	3.8023	41.7354	4.1986
2.8267	2.6103	4.2344	3.8476	42.7203	4.2344
2.8156	2.6897	4.2692	3.8939	43.6906	4.2692
2.8039	2.7696	4.3030	3.9412	44.6469	4.3030
2.7917	2.8498	4.3358	3.9894	45.5895	4.3358
2.7790	2.9303	4.3675	4.0385	46.5185	4.3675
2.7656	3.0111	4.3983	4.0884	47.4341	4.3983
2.7515	3.0922	4.4279	4.1391	48.3368	4.4279
2.7367	3.1735	4.4566	4.1906	49.2264	4.4566
2.7213	3.2551	4.4843	4.2427	50.1040	4.4843
2.7050	3.3368	4.5110	4.2955	50.9693	4.5110
2.6881	3.4187	4.5367	4.3489	51.8226	4.5367
2.6703	3.5007	4.5615	4.4029	52.6639	4.5615
2.6517	3.5828	4.5853	4.4574	53.4935	4.5853
2.6324	3.6650	4.6083	4.5124	54.3119	4.6083
2.6123	3.7472	4.6304	4.5679	55.1187	4.6304
2.5913	3.8294	4.6516	4.6238	55.9142	4.6516
2.5697	3.9117	4.6720	4.6802	56.6984	4.6720
2.5472	3.9940	4.6916	4.7371	57.4718	4.6916
2.5239	4.0762	4.7105	4.7943	58.2348	4.7105
2.4998	4.1583	4.7285	4.8518	58.9878	4.7285
2.4748	4.2404	4.7458	4.9097	59.7308	4.7458
2.4490	4.3223	4.7623	4.9679	60.4640	4.7623
2.4224	4.4041	4.7781	5.0264	61.1878	4.7781

2.3950	4.4858	4.7932	5.0851	61.9023	4.7932
2.3667	4.5673	4.8077	5.1441	62.6075	4.8077
2.3377	4.6487	4.8214	5.2033	63.3038	4.8214
2.3077	4.7299	4.8346	5.2628	63.9919	4.8346
2.2770	4.8108	4.8471	5.3225	64.6712	4.8471
2.2455	4.8916	4.8590	5.3823	65.3423	4.8590
2.2131	4.9721	4.8703	5.4424	66.0055	4.8703
2.1800	5.0523	4.8810	5.5026	66.6608	4.8810
2.1460	5.1323	4.8911	5.5629	67.3085	4.8911
2.1112	5.2119	4.9007	5.6233	67.9488	4.9007
2.0756	5.2913	4.9098	5.6839	68.5822	4.9098
2.0391	5.3704	4.9184	5.7445	69.2086	4.9184
2.0018	5.4492	4.9264	5.8053	69.8284	4.9264
1.9638	5.5276	4.9340	5.8660	70.4416	4.9340
1.9249	5.6056	4.9411	5.9269	71.0486	4.9411
1.8851	5.6833	4.9477	5.9878	71.6495	4.9477
1.8446	5.7605	4.9539	6.0487	72.2447	4.9539
1.8032	5.8374	4.9596	6.1096	72.8342	4.9596
1.7609	5.9138	4.9649	6.1704	73.4184	4.9649
1.7179	5.9898	4.9697	6.2313	73.9974	4.9697
1.6739	6.0654	4.9742	6.2921	74.5716	4.9742
1.6291	6.1404	4.9783	6.3529	75.1409	4.9783
1.5835	6.2150	4.9820	6.4135	75.7057	4.9820
1.5370	6.2890	4.9853	6.4741	76.2663	4.9853
1.4896	6.3625	4.9882	6.5346	76.8229	4.9882
1.4414	6.4355	4.9908	6.5949	77.3754	4.9908
1.3923	6.5078	4.9931	6.6551	77.9244	4.9931
1.3422	6.5795	4.9950	6.7150	78.4700	4.9950
1.2913	6.6506	4.9966	6.7748	79.0125	4.9966
1.2394	6.7211	4.9978	6.8344	79.5518	4.9978
1.1866	6.7908	4.9988	6.8937	80.0884	4.9988
1.1329	6.8599	4.9995	6.9528	80.6226	4.9995
1.0782	6.9282	4.9999	7.0115	81.1545	4.9999
1.0225	6.9957	5.0000	7.0700	81.6842	5.0000

STREAMLINE 2

X	Y	Z	R	THETA	Z
3.0719	-0.0052	2.4764	3.0719	359.9023	2.4764
3.0703	-0.0154	2.5032	3.0703	359.7127	2.5032
3.0706	-0.0138	2.5318	3.0707	359.7418	2.5318
3.0726	-0.0031	2.5584	3.0726	359.9429	2.5584
3.0771	0.0242	2.5914	3.0772	0.4508	2.5914
3.0815	0.0588	2.6170	3.0821	1.0924	2.6170
3.0842	0.0963	2.6384	3.0857	1.7887	2.6384
3.0842	0.1343	2.6591	3.0871	2.4940	2.6591
3.0837	0.1723	2.6799	3.0885	3.1976	2.6799
3.0830	0.2101	2.7008	3.0901	3.8989	2.7008
3.0806	0.2856	2.7430	3.0938	5.2973	2.7430
3.0771	0.3608	2.7857	3.0982	6.6885	2.7857
3.0725	0.4358	2.8289	3.1033	8.0720	2.8289
3.0670	0.5103	2.8725	3.1092	9.4468	2.8725
3.0606	0.5846	2.9165	3.1160	10.8132	2.9165
3.0534	0.6585	2.9610	3.1236	12.1697	2.9610
3.0455	0.7321	3.0058	3.1323	13.5165	3.0058
3.0369	0.8054	3.0510	3.1419	14.8533	3.0510
3.0278	0.8785	3.0965	3.1526	16.1796	3.0965
3.0181	0.9513	3.1423	3.1645	17.4947	3.1423
3.0080	1.0239	3.1883	3.1775	18.7981	3.1883
2.9975	1.0963	3.2345	3.1917	20.0898	3.2345
2.9868	1.1687	3.2808	3.2073	21.3694	3.2808
2.9757	1.2409	3.3272	3.2241	22.6365	3.3272
2.9645	1.3131	3.3736	3.2423	23.8910	3.3736
2.9531	1.3853	3.4200	3.2619	25.1317	3.4200
2.9416	1.4575	3.4663	3.2829	26.3578	3.4663
2.9300	1.5298	3.5125	3.3053	27.5692	3.5125
2.9183	1.6021	3.5585	3.3292	28.7661	3.5585
2.9067	1.6747	3.6042	3.3546	29.9486	3.6042
2.8950	1.7475	3.6496	3.3815	31.1164	3.6496
2.8832	1.8206	3.6945	3.4099	32.2696	3.6945
2.8715	1.8940	3.7388	3.4398	33.4080	3.7388

2.8597	1.9677	3.7826	3.4713	34.5314	3.7826
2.8478	2.0418	3.8257	3.5042	35.6399	3.8257
2.8359	2.1163	3.8681	3.5385	36.7331	3.8681
2.8238	2.1912	3.9097	3.5743	37.8106	3.9097
2.8117	2.2666	3.9506	3.6115	38.8733	3.9506
2.7993	2.3423	3.9906	3.6500	39.9204	3.9906
2.7868	2.4185	4.0297	3.6899	40.9529	4.0297
2.7740	2.4951	4.0680	3.7310	41.9701	4.0680
2.7609	2.5721	4.1053	3.7733	42.9723	4.1053
2.7475	2.6495	4.1416	3.8169	43.9595	4.1416
2.7337	2.7272	4.1770	3.8615	44.9318	4.1770
2.7196	2.8054	4.2114	3.9072	45.8901	4.2114
2.7050	2.8839	4.2448	3.9540	46.8339	4.2448
2.6899	2.9628	4.2772	4.0017	47.7637	4.2772
2.6743	3.0419	4.3086	4.0503	48.6797	4.3086
2.6581	3.1213	4.3390	4.0998	49.5823	4.3390
2.6414	3.2009	4.3684	4.1500	50.4713	4.3684
2.6240	3.2809	4.3968	4.2011	51.3478	4.3968
2.6059	3.3610	4.4242	4.2529	52.2116	4.4242
2.5872	3.4412	4.4507	4.3053	53.0629	4.4507
2.5678	3.5216	4.4762	4.3584	53.9018	4.4762
2.5478	3.6021	4.5008	4.4121	54.7286	4.5008
2.5270	3.6827	4.5245	4.4663	55.5435	4.5245
2.5055	3.7634	4.5473	4.5211	56.3466	4.5473
2.4833	3.8441	4.5693	4.5764	57.1379	4.5693
2.4604	3.9249	4.5905	4.6323	57.9179	4.5905
2.4367	4.0056	4.6108	4.6886	58.6868	4.6108
2.4123	4.0863	4.6303	4.7453	59.4451	4.6303
2.3871	4.1670	4.6490	4.8023	60.1930	4.6490
2.3612	4.2476	4.6670	4.8598	60.9308	4.6670
2.3345	4.3281	4.6842	4.9176	61.6586	4.6842
2.3070	4.4085	4.7007	4.9757	62.3767	4.7007
2.2788	4.4888	4.7164	5.0341	63.0853	4.7164
2.2497	4.5690	4.7315	5.0928	63.7846	4.7315
2.2199	4.6489	4.7459	5.1518	64.4748	4.7459
2.1894	4.7287	4.7596	5.2110	65.1562	4.7596
2.1580	4.8084	4.7726	5.2704	65.8294	4.7726
2.1259	4.8878	4.7851	5.3301	66.4940	4.7851
2.0929	4.9669	4.7969	5.3899	67.1506	4.7969
2.0592	5.0459	4.8082	5.4499	67.7993	4.8082
2.0248	5.1245	4.8188	5.5100	68.4405	4.8188
1.9895	5.2029	4.8289	5.5703	69.0743	4.8289
1.9534	5.2810	4.8384	5.6307	69.7008	4.8384
1.9166	5.3588	4.8474	5.6912	70.3207	4.8474
1.8789	5.4363	4.8559	5.7518	70.9338	4.8559
1.8404	5.5134	4.8639	5.8125	71.5405	4.8639
1.8012	5.5902	4.8714	5.8732	72.1410	4.8714
1.7611	5.6666	4.8783	5.9339	72.7355	4.8783
1.7202	5.7426	4.8849	5.9947	73.3245	4.8849
1.6785	5.8182	4.8909	6.0555	73.9078	4.8909
1.6359	5.8934	4.8965	6.1162	74.4859	4.8965
1.5926	5.9681	4.9017	6.1769	75.0589	4.9017
1.5484	6.0424	4.9064	6.2376	75.6272	4.9064
1.5033	6.1161	4.9108	6.2982	76.1908	4.9108
1.4574	6.1894	4.9147	6.3587	76.7500	4.9147
1.4107	6.2622	4.9182	6.4191	77.3051	4.9182
1.3630	6.3344	4.9214	6.4793	77.8561	4.9214
1.3145	6.4060	4.9242	6.5395	78.4038	4.9242
1.2651	6.4771	4.9266	6.5995	78.9478	4.9266
1.2149	6.5475	4.9286	6.6592	79.4885	4.9286
1.1637	6.6172	4.9303	6.7188	80.0264	4.9303
1.1115	6.6863	4.9317	6.7781	80.5614	4.9317
1.0585	6.7547	4.9328	6.8372	81.0939	4.9328
1.0045	6.8224	4.9335	6.8959	81.6240	4.9335
0.9496	6.8893	4.9339	6.9544	82.1521	4.9339
0.8936	6.9553	4.9340	7.0125	82.6789	4.9340
0.8365	7.0203	4.9340	7.0700	83.2049	4.9340

STREAMLINE 3

X	Y	Z	R	THETA	Z
-----	-----	-----	-----	-----	-----

3.1341	0.0431	2.5000	3.1344	0.7872	2.5000
3.1311	0.0401	2.5246	3.1313	0.7335	2.5246
3.1427	0.0564	2.5447	3.1432	1.0272	2.5447
3.1540	0.0769	2.5607	3.1549	1.3972	2.5607
3.1662	0.1121	2.5814	3.1682	2.0279	2.5814
3.1683	0.1498	2.6010	3.1718	2.7077	2.6010
3.1677	0.1877	2.6206	3.1732	3.3911	2.6206
3.1668	0.2255	2.6404	3.1748	4.0733	2.6404
3.1656	0.2632	2.6603	3.1765	4.7536	2.6603
3.1641	0.3009	2.6802	3.1784	5.4332	2.6802
3.1602	0.3761	2.7205	3.1825	6.7873	2.7205
3.1552	0.4510	2.7611	3.1873	8.1344	2.7611
3.1492	0.5256	2.8021	3.1927	9.4757	2.8021
3.1421	0.5999	2.8435	3.1989	10.8090	2.8435
3.1342	0.6739	2.8853	3.2059	12.1346	2.8853
3.1255	0.7476	2.9275	3.2136	13.4519	2.9275
3.1160	0.8210	2.9699	3.2223	14.7606	2.9699
3.1058	0.8941	3.0127	3.2320	16.0606	3.0127
3.0951	0.9670	3.0558	3.2426	17.3511	3.0558
3.0838	1.0397	3.0991	3.2544	18.6317	3.0991
3.0721	1.1122	3.1426	3.2672	19.9020	3.1426
3.0600	1.1846	3.1862	3.2813	21.1618	3.1862
3.0476	1.2567	3.2300	3.2965	22.4100	3.2300
3.0349	1.3289	3.2738	3.3131	23.6479	3.2738
3.0219	1.4010	3.3176	3.3308	24.8737	3.3176
3.0087	1.4731	3.3613	3.3499	26.0870	3.3613
2.9954	1.5452	3.4051	3.3704	27.2872	3.4051
2.9819	1.6173	3.4486	3.3923	28.4743	3.4486
2.9684	1.6896	3.4920	3.4156	29.6481	3.4920
2.9548	1.7620	3.5350	3.4403	30.8083	3.5350
2.9412	1.8347	3.5777	3.4665	31.9551	3.5777
2.9275	1.9075	3.6199	3.4941	33.0883	3.6199
2.9137	1.9807	3.6617	3.5232	34.2073	3.6617
2.8999	2.0542	3.7028	3.5538	35.3121	3.7028
2.8860	2.1280	3.7434	3.5857	36.4027	3.7434
2.8720	2.2021	3.7833	3.6191	37.4787	3.7833
2.8579	2.2766	3.8225	3.6539	38.5402	3.8225
2.8437	2.3514	3.8610	3.6900	39.5871	3.8610
2.8293	2.4266	3.8987	3.7274	40.6193	3.8987
2.8146	2.5022	3.9356	3.7661	41.6369	3.9356
2.7998	2.5781	3.9716	3.8060	42.6398	3.9716
2.7846	2.6544	4.0068	3.8471	43.6282	4.0068
2.7692	2.7310	4.0411	3.8893	44.6019	4.0411
2.7534	2.8080	4.0744	3.9327	45.5620	4.0744
2.7372	2.8852	4.1069	3.9770	46.5076	4.1069
2.7206	2.9628	4.1385	4.0224	47.4394	4.1385
2.7036	3.0406	4.1691	4.0687	48.3575	4.1691
2.6860	3.1186	4.1988	4.1159	49.2621	4.1988
2.6680	3.1969	4.2275	4.1640	50.1536	4.2275
2.6494	3.2755	4.2554	4.2128	51.0325	4.2554
2.6302	3.3541	4.2823	4.2624	51.8981	4.2823
2.6104	3.4330	4.3083	4.3127	52.7514	4.3083
2.5899	3.5119	4.3334	4.3636	53.5925	4.3334
2.5689	3.5910	4.3577	4.4152	54.4217	4.3577
2.5471	3.6702	4.3811	4.4674	55.2388	4.3811
2.5248	3.7494	4.4036	4.5202	56.0442	4.4036
2.5017	3.8286	4.4254	4.5735	56.8381	4.4254
2.4781	3.9079	4.4464	4.6273	57.6204	4.4464
2.4537	3.9871	4.4666	4.6817	58.3914	4.4666
2.4287	4.0664	4.4860	4.7365	59.1518	4.4860
2.4030	4.1456	4.5047	4.7917	59.9017	4.5047
2.3765	4.2247	4.5226	4.8473	60.6414	4.5226
2.3493	4.3038	4.5398	4.9033	61.3712	4.5398
2.3215	4.3828	4.5563	4.9596	62.0908	4.5563
2.2929	4.4616	4.5720	5.0163	62.8010	4.5720
2.2635	4.5403	4.5872	5.0733	63.5019	4.5872
2.2335	4.6189	4.6016	5.1306	64.1937	4.6016
2.2028	4.6973	4.6154	5.1881	64.8762	4.6154
2.1713	4.7755	4.6286	5.2460	65.5503	4.6286
2.1391	4.8536	4.6412	5.3040	66.2159	4.6412
2.1061	4.9314	4.6532	5.3623	66.8733	4.6532
2.0725	5.0090	4.6646	5.4208	67.5227	4.6646
2.0381	5.0863	4.6754	5.4794	68.1643	4.6754

2.0029	5.1634	4.6856	5.5383	68.7985	4.6856
1.9670	5.2403	4.6954	5.5973	69.4255	4.6954
1.9304	5.3168	4.7046	5.6564	70.0452	4.7046
1.8930	5.3930	4.7132	5.7156	70.6581	4.7132
1.8549	5.4689	4.7214	5.7749	71.2645	4.7214
1.8160	5.5445	4.7290	5.8344	71.8645	4.7290
1.7764	5.6198	4.7362	5.8939	72.4584	4.7362
1.7360	5.6947	4.7429	5.9534	73.0464	4.7429
1.6948	5.7692	4.7492	6.0130	73.6287	4.7492
1.6529	5.8433	4.7550	6.0725	74.2052	4.7550
1.6102	5.9170	4.7603	6.1321	74.7767	4.7603
1.5667	5.9902	4.7652	6.1917	75.3431	4.7652
1.5224	6.0630	4.7697	6.2512	75.9048	4.7697
1.4773	6.1354	4.7738	6.3107	76.4618	4.7738
1.4314	6.2072	4.7775	6.3701	77.0145	4.7775
1.3847	6.2786	4.7807	6.4295	77.5628	4.7807
1.3372	6.3494	4.7837	6.4887	78.1075	4.7837
1.2888	6.4197	4.7862	6.5478	78.6484	4.7862
1.2396	6.4894	4.7883	6.6067	79.1858	4.7883
1.1895	6.5585	4.7901	6.6655	79.7198	4.7901
1.1386	6.6270	4.7916	6.7241	80.2508	4.7916
1.0868	6.6948	4.7927	6.7824	80.7792	4.7927
1.0341	6.7619	4.7935	6.8406	81.3048	4.7935
0.9806	6.8284	4.7940	6.8984	81.8281	4.7940
0.9261	6.8941	4.7941	6.9560	82.3493	4.7941
0.8706	6.9589	4.7941	7.0132	82.8689	4.7941
0.8142	7.0230	4.7941	7.0700	83.3871	4.7941

STREAMLINE 4

X	Y	Z	R	THETA	Z
3.3817	0.1828	2.5000	3.3867	3.0939	2.5000
3.3822	0.1838	2.5273	3.3872	3.1102	2.5273
3.3818	0.1994	2.5504	3.3877	3.3751	2.5504
3.3810	0.2207	2.5686	3.3882	3.7349	2.5686
3.3792	0.2570	2.5897	3.3890	4.3493	2.5897
3.3769	0.2948	2.6081	3.3897	4.9893	2.6081
3.3743	0.3325	2.6266	3.3906	5.6283	2.6266
3.3713	0.3702	2.6451	3.3916	6.2663	2.6451
3.3681	0.4078	2.6638	3.3927	6.9034	2.6638
3.3646	0.4453	2.6825	3.3940	7.5396	2.6825
3.3568	0.5202	2.7201	3.3969	8.8093	2.7201
3.3479	0.5949	2.7580	3.4004	10.0750	2.7580
3.3381	0.6692	2.7962	3.4045	11.3363	2.7962
3.3273	0.7433	2.8347	3.4093	12.5927	2.8347
3.3156	0.8171	2.8735	3.4148	13.8437	2.8735
3.3030	0.8905	2.9126	3.4209	15.0888	2.9126
3.2896	0.9636	2.9521	3.4278	16.3275	2.9521
3.2755	1.0365	2.9918	3.4355	17.5593	2.9918
3.2607	1.1090	3.0319	3.4442	18.7839	3.0319
3.2454	1.1813	3.0723	3.4537	20.0008	3.0723
3.2296	1.2533	3.1129	3.4642	21.2096	3.1129
3.2132	1.3250	3.1537	3.4757	22.4099	3.1537
3.1964	1.3966	3.1948	3.4882	23.6013	3.1948
3.1793	1.4679	3.2360	3.5018	24.7837	3.2360
3.1618	1.5391	3.2773	3.5165	25.9568	3.2773
3.1440	1.6102	3.3188	3.5323	27.1194	3.3188
3.1260	1.6811	3.3604	3.5493	28.2715	3.3604
3.1077	1.7520	3.4019	3.5676	29.4127	3.4019
3.0894	1.8229	3.4435	3.5871	30.5428	3.4435
3.0709	1.8938	3.4849	3.6079	31.6617	3.4849
3.0523	1.9647	3.5262	3.6299	32.7691	3.5262
3.0336	2.0358	3.5673	3.6533	33.8647	3.5673
3.0148	2.1069	3.6082	3.6781	34.9483	3.6082
2.9960	2.1783	3.6487	3.7041	36.0198	3.6487
2.9771	2.2498	3.6888	3.7316	37.0790	3.6888
2.9581	2.3216	3.7285	3.7604	38.1256	3.7285
2.9391	2.3936	3.7677	3.7905	39.1596	3.7677
2.9200	2.4659	3.8063	3.8220	40.1806	3.8063
2.9009	2.5385	3.8443	3.8548	41.1888	3.8443
2.8816	2.6114	3.8817	3.8889	42.1841	3.8817



2.8622	2.6847	3.9185	3.9243	43.1662	3.9185
2.8427	2.7582	3.9545	3.9609	44.1354	3.9545
2.8230	2.8320	3.9897	3.9987	45.0914	3.9897
2.8031	2.9062	4.0242	4.0377	46.0345	4.0242
2.7830	2.9807	4.0579	4.0779	46.9647	4.0579
2.7626	3.0555	4.0907	4.1192	47.8820	4.0907
2.7419	3.1305	4.1227	4.1615	48.7866	4.1227
2.7208	3.2058	4.1538	4.2048	49.6786	4.1538
2.6994	3.2814	4.1840	4.2491	50.5581	4.1840
2.6777	3.3573	4.2133	4.2943	51.4253	4.2133
2.6555	3.4333	4.2418	4.3404	52.2804	4.2418
2.6328	3.5096	4.2693	4.3873	53.1234	4.2693
2.6097	3.5860	4.2960	4.4351	53.9546	4.2960
2.5862	3.6626	4.3218	4.4836	54.7736	4.3218
2.5622	3.7393	4.3467	4.5329	55.5812	4.3467
2.5376	3.8161	4.3708	4.5828	56.3774	4.3708
2.5126	3.8931	4.3940	4.6335	57.1620	4.3940
2.4870	3.9701	4.4164	4.6848	57.9352	4.4164
2.4609	4.0472	4.4379	4.7366	58.6976	4.4379
2.4343	4.1243	4.4587	4.7891	59.4494	4.4587
2.4070	4.2014	4.4786	4.8420	60.1909	4.4786
2.3792	4.2784	4.4978	4.8955	60.9221	4.4978
2.3508	4.3555	4.5162	4.9494	61.6434	4.5162
2.3217	4.4325	4.5338	5.0038	62.3548	4.5338
2.2921	4.5095	4.5508	5.0585	63.0567	4.5508
2.2618	4.5863	4.5669	5.1137	63.7492	4.5669
2.2309	4.6631	4.5824	5.1693	64.4326	4.5824
2.1994	4.7397	4.5972	5.2251	65.1070	4.5972
2.1672	4.8162	4.6114	5.2813	65.7728	4.6114
2.1344	4.8925	4.6248	5.3378	66.4302	4.6248
2.1010	4.9687	4.6377	5.3946	67.0794	4.6377
2.0669	5.0447	4.6499	5.4517	67.7206	4.6499
2.0321	5.1204	4.6615	5.5089	68.3541	4.6615
1.9966	5.1960	4.6725	5.5664	68.9802	4.6725
1.9605	5.2713	4.6829	5.6241	69.5990	4.6829
1.9237	5.3463	4.6927	5.6819	70.2108	4.6927
1.8861	5.4211	4.7020	5.7399	70.8159	4.7020
1.8479	5.4956	4.7108	5.7980	71.4145	4.7108
1.8090	5.5698	4.7191	5.8562	72.0068	4.7191
1.7694	5.6436	4.7268	5.9145	72.5930	4.7268
1.7290	5.7171	4.7340	5.9729	73.1734	4.7340
1.6879	5.7903	4.7408	6.0313	73.7482	4.7408
1.6461	5.8631	4.7471	6.0897	74.3177	4.7471
1.6035	5.9354	4.7529	6.1482	74.8819	4.7529
1.5602	6.0074	4.7583	6.2067	75.4413	4.7583
1.5161	6.0789	4.7633	6.2652	75.9959	4.7633
1.4713	6.1500	4.7678	6.3236	76.5459	4.7678
1.4257	6.2207	4.7719	6.3819	77.0917	4.7719
1.3793	6.2908	4.7757	6.4402	77.6333	4.7757
1.3321	6.3604	4.7791	6.4984	78.1712	4.7791
1.2841	6.4295	4.7820	6.5565	78.7053	4.7820
1.2353	6.4981	4.7847	6.6144	79.2361	4.7847
1.1857	6.5660	4.7870	6.6722	79.7636	4.7870
1.1353	6.6334	4.7889	6.7298	80.2883	4.7889
1.0839	6.7001	4.7905	6.7872	80.8102	4.7905
1.0318	6.7661	4.7918	6.8443	81.3298	4.7918
0.9787	6.8314	4.7928	6.9012	81.8471	4.7928
0.9247	6.8960	4.7935	6.9577	82.3624	4.7935
0.8699	6.9599	4.7939	7.0140	82.8758	4.7939
0.8142	7.0230	4.7941	7.0700	83.3872	4.7941

STREAMLINE 5

X	Y	Z	R	THETA	Z
3.6089	0.3323	2.5000	3.6241	5.2605	2.5000
3.6093	0.3342	2.5266	3.6247	5.2896	2.5266
3.6084	0.3501	2.5487	3.6253	5.5420	2.5487
3.6069	0.3712	2.5661	3.6259	5.8764	2.5661
3.6038	0.4069	2.5861	3.6267	6.4425	2.5861
3.6002	0.4442	2.6031	3.6275	7.0341	2.6031
3.5962	0.4815	2.6201	3.6283	7.6254	2.6201

3.5920	0.5187	2.6371	3.6293	8.2163	2.6371
3.5875	0.5558	2.6542	3.6303	8.8068	2.6542
3.5828	0.5929	2.6713	3.6315	9.3968	2.6713
3.5725	0.6670	2.7055	3.6342	10.5754	2.7055
3.5611	0.7408	2.7399	3.6374	11.7517	2.7399
3.5488	0.8144	2.7745	3.6411	12.9255	2.7745
3.5355	0.8878	2.8092	3.6453	14.0961	2.8092
3.5213	0.9609	2.8441	3.6501	15.2631	2.8441
3.5063	1.0337	2.8793	3.6555	16.4262	2.8793
3.4905	1.1062	2.9147	3.6616	17.5848	2.9147
3.4739	1.1785	2.9504	3.6683	18.7385	2.9504
3.4566	1.2504	2.9863	3.6759	19.8871	2.9863
3.4388	1.3221	3.0225	3.6841	21.0300	3.0225
3.4203	1.3935	3.0589	3.6932	22.1669	3.0589
3.4012	1.4646	3.0955	3.7032	23.2975	3.0955
3.3817	1.5355	3.1323	3.7140	24.4215	3.1323
3.3617	1.6062	3.1693	3.7257	25.5386	3.1693
3.3413	1.6767	3.2065	3.7384	26.6479	3.2065
3.3204	1.7470	3.2437	3.7519	27.7504	3.2437
3.2993	1.8171	3.2812	3.7666	28.8439	3.2812
3.2780	1.8871	3.3187	3.7824	29.9287	3.3187
3.2564	1.9570	3.3563	3.7992	31.0046	3.3563
3.2346	2.0268	3.3939	3.8171	32.0715	3.3939
3.2126	2.0966	3.4315	3.8362	33.1291	3.4315
3.1905	2.1664	3.4690	3.8565	34.1770	3.4690
3.1682	2.2362	3.5064	3.8779	35.2149	3.5064
3.1459	2.3061	3.5436	3.9006	36.2428	3.5436
3.1235	2.3761	3.5805	3.9245	37.2603	3.5805
3.1010	2.4462	3.6172	3.9497	38.2673	3.6172
3.0785	2.5164	3.6535	3.9761	39.2636	3.6535
3.0559	2.5869	3.6894	4.0038	40.2489	3.6894
3.0332	2.6575	3.7249	4.0327	41.2232	3.7249
3.0104	2.7284	3.7599	4.0629	42.1864	3.7599
2.9876	2.7995	3.7944	4.0942	43.1384	3.7944
2.9646	2.8708	3.8283	4.1268	44.0790	3.8283
2.9415	2.9424	3.8616	4.1605	45.0081	3.8616
2.9183	3.0142	3.8943	4.1955	45.9259	3.8943
2.8949	3.0862	3.9263	4.2315	46.8321	3.9263
2.8713	3.1586	3.9576	4.2686	47.7270	3.9576
2.8476	3.2311	3.9882	4.3068	48.6104	3.9882
2.8235	3.3039	4.0180	4.3461	49.4824	4.0180
2.7993	3.3769	4.0471	4.3863	50.3431	4.0471
2.7747	3.4501	4.0754	4.4275	51.1925	4.0754
2.7499	3.5235	4.1029	4.4696	52.0307	4.1029
2.7247	3.5971	4.1296	4.5126	52.8578	4.1296
2.6991	3.6709	4.1555	4.5564	53.6739	4.1555
2.6732	3.7448	4.1806	4.6011	54.4789	4.1806
2.6470	3.8189	4.2050	4.6465	55.2730	4.2050
2.6203	3.8930	4.2285	4.6927	56.0564	4.2285
2.5933	3.9673	4.2512	4.7397	56.8290	4.2512
2.5658	4.0416	4.2732	4.7873	57.5909	4.2732
2.5379	4.1161	4.2944	4.8356	58.3425	4.2944
2.5095	4.1905	4.3148	4.8845	59.0841	4.3148
2.4807	4.2650	4.3345	4.9340	59.8157	4.3345
2.4514	4.3395	4.3534	4.9840	60.5376	4.3534
2.4216	4.4139	4.3716	5.0346	61.2497	4.3716
2.3913	4.4884	4.3891	5.0856	61.9524	4.3891
2.3605	4.5628	4.4059	5.1372	62.6457	4.4059
2.3292	4.6371	4.4219	5.1892	63.3300	4.4219
2.2973	4.7114	4.4373	5.2416	64.0053	4.4373
2.2650	4.7855	4.4521	5.2945	64.6719	4.4521
2.2321	4.8596	4.4661	5.3477	65.3300	4.4661
2.1986	4.9335	4.4796	5.4012	65.9798	4.4796
2.1646	5.0073	4.4924	5.4551	66.6215	4.4924
2.1300	5.0809	4.5046	5.5093	67.2553	4.5046
2.0949	5.1544	4.5162	5.5638	67.8815	4.5162
2.0592	5.2276	4.5272	5.6186	68.5003	4.5272
2.0229	5.3007	4.5376	5.6736	69.1119	4.5376
1.9860	5.3735	4.5475	5.7288	69.7165	4.5475
1.9485	5.4461	4.5568	5.7842	70.3143	4.5568
1.9103	5.5185	4.5656	5.8398	70.9056	4.5656
1.8716	5.5905	4.5739	5.8955	71.4905	4.5739
1.8322	5.6623	4.5817	5.9514	72.0693	4.5817

1.7922	5.7338	4.5890	6.0074	72.6423	4.5890
1.7516	5.8050	4.5958	6.0635	73.2095	4.5958
1.7103	5.8759	4.6021	6.1197	73.7713	4.6021
1.6683	5.9464	4.6080	6.1760	74.3277	4.6080
1.6257	6.0165	4.6134	6.2323	74.8791	4.6134
1.5825	6.0863	4.6184	6.2886	75.4255	4.6184
1.5385	6.1556	4.6230	6.3450	75.9672	4.6230
1.4939	6.2246	4.6272	6.4013	76.5044	4.6272
1.4486	6.2931	4.6310	6.4577	77.0373	4.6310
1.4025	6.3612	4.6344	6.5140	77.5661	4.6344
1.3558	6.4288	4.6374	6.5702	78.0911	4.6374
1.3083	6.4959	4.6401	6.6264	78.6124	4.6401
1.2602	6.5625	4.6424	6.6824	79.1302	4.6424
1.2112	6.6286	4.6444	6.7384	79.6449	4.6444
1.1615	6.6941	4.6461	6.7941	80.1565	4.6461
1.1110	6.7590	4.6474	6.8497	80.6654	4.6474
1.0597	6.8233	4.6484	6.9051	81.1718	4.6484
1.0077	6.8870	4.6491	6.9603	81.6758	4.6491
0.9548	6.9500	4.6495	7.0153	82.1775	4.6495
0.9012	7.0123	4.6497	7.0700	82.6770	4.6497

STREAMLINE 6

X	Y	Z	R	THETA	Z
3.8292	0.4997	2.5001	3.8616	7.4343	2.5001
3.8295	0.5024	2.5260	3.8623	7.4742	2.5260
3.8280	0.5185	2.5471	3.8629	7.7144	2.5471
3.8257	0.5394	2.5637	3.8635	8.0250	2.5637
3.8214	0.5743	2.5828	3.8643	8.5471	2.5828
3.8165	0.6109	2.5986	3.8651	9.0942	2.5986
3.8113	0.6475	2.6142	3.8659	9.6417	2.6142
3.8058	0.6840	2.6299	3.8668	10.1892	2.6299
3.8000	0.7205	2.6455	3.8677	10.7366	2.6455
3.7940	0.7570	2.6611	3.8688	11.2838	2.6611
3.7813	0.8298	2.6924	3.8713	12.3779	2.6924
3.7675	0.9025	2.7236	3.8741	13.4709	2.7236
3.7528	0.9749	2.7549	3.8774	14.5626	2.7549
3.7372	1.0471	2.7862	3.8812	15.6526	2.7862
3.7208	1.1191	2.8176	3.8854	16.7404	2.8176
3.7035	1.1909	2.8492	3.8902	17.8256	2.8492
3.6854	1.2624	2.8809	3.8956	18.9079	2.8809
3.6665	1.3336	2.9128	3.9015	19.9869	2.9128
3.6470	1.4045	2.9448	3.9081	21.0623	2.9448
3.6268	1.4752	2.9771	3.9153	22.1337	2.9771
3.6059	1.5455	3.0095	3.9232	23.2007	3.0095
3.5844	1.6157	3.0421	3.9317	24.2632	3.0421
3.5624	1.6855	3.0749	3.9410	25.3207	3.0749
3.5399	1.7551	3.1079	3.9511	26.3731	3.1079
3.5169	1.8245	3.1411	3.9620	27.4199	3.1411
3.4934	1.8937	3.1744	3.9737	28.4608	3.1744
3.4696	1.9626	3.2078	3.9862	29.4952	3.2078
3.4455	2.0314	3.2414	3.9997	30.5230	3.2414
3.4210	2.1000	3.2752	4.0141	31.5439	3.2752
3.3963	2.1685	3.3089	4.0295	32.5576	3.3089
3.3714	2.2369	3.3428	4.0459	33.5639	3.3428
3.3462	2.3051	3.3766	4.0633	34.5623	3.3766
3.3209	2.3734	3.4105	4.0818	35.5528	3.4105
3.2954	2.4416	3.4442	4.1014	36.5350	3.4442
3.2698	2.5098	3.4779	4.1220	37.5088	3.4779
3.2442	2.5781	3.5113	4.1438	38.4739	3.5113
3.2184	2.6464	3.5446	4.1667	39.4302	3.5446
3.1925	2.7149	3.5776	4.1908	40.3773	3.5776
3.1666	2.7834	3.6104	4.2160	41.3153	3.6104
3.1406	2.8521	3.6427	4.2423	42.2439	3.6427
3.1145	2.9209	3.6748	4.2698	43.1629	3.6748
3.0883	2.9899	3.7064	4.2985	44.0723	3.7064
3.0620	3.0590	3.7375	4.3282	44.9719	3.7375
3.0357	3.1284	3.7681	4.3591	45.8617	3.7681
3.0092	3.1979	3.7982	4.3911	46.7414	3.7982
2.9826	3.2676	3.8278	4.4241	47.6113	3.8278
2.9558	3.3375	3.8568	4.4582	48.4710	3.8568

2.9289	3.4076	3.8851	4.4933	49.3206	3.8851
2.9018	3.4779	3.9128	4.5295	50.1601	3.9128
2.8745	3.5484	3.9398	4.5666	50.9895	3.9398
2.8470	3.6190	3.9662	4.6046	51.8088	3.9662
2.8192	3.6898	3.9919	4.6436	52.6180	3.9919
2.7912	3.7608	4.0168	4.6834	53.4171	4.0168
2.7630	3.8318	4.0411	4.7241	54.2062	4.0411
2.7345	3.9031	4.0647	4.7656	54.9851	4.0647
2.7056	3.9744	4.0875	4.8079	55.7543	4.0875
2.6765	4.0458	4.1096	4.8510	56.5135	4.1096
2.6471	4.1174	4.1311	4.8949	57.2628	4.1311
2.6173	4.1890	4.1518	4.9394	58.0025	4.1518
2.5872	4.2606	4.1718	4.9846	58.7326	4.1718
2.5567	4.3323	4.1911	5.0305	59.4533	4.1911
2.5258	4.4040	4.2097	5.0769	60.1646	4.2097
2.4946	4.4758	4.2276	5.1240	60.8667	4.2276
2.4629	4.5475	4.2448	5.1716	61.5598	4.2448
2.4309	4.6192	4.2614	5.2198	62.2438	4.2614
2.3984	4.6908	4.2773	5.2684	62.9191	4.2773
2.3656	4.7624	4.2925	5.3176	63.5858	4.2925
2.3323	4.8340	4.3071	5.3672	64.2440	4.3071
2.2985	4.9055	4.3211	5.4173	64.8939	4.3211
2.2643	4.9768	4.3345	5.4677	65.5357	4.3345
2.2297	5.0481	4.3472	5.5186	66.1696	4.3472
2.1946	5.1192	4.3594	5.5698	66.7957	4.3594
2.1590	5.1902	4.3709	5.6214	67.4143	4.3709
2.1229	5.2611	4.3819	5.6732	68.0255	4.3819
2.0863	5.3318	4.3924	5.7254	68.6296	4.3924
2.0492	5.4022	4.4022	5.7779	69.2267	4.4022
2.0117	5.4725	4.4116	5.8306	69.8171	4.4116
1.9735	5.5426	4.4204	5.8835	70.4008	4.4204
1.9349	5.6125	4.4287	5.9367	70.9782	4.4287
1.8958	5.6821	4.4365	5.9900	71.5495	4.4365
1.8560	5.7515	4.4439	6.0435	72.1147	4.4439
1.8158	5.8206	4.4507	6.0972	72.6741	4.4507
1.7750	5.8894	4.4571	6.1510	73.2279	4.4571
1.7336	5.9579	4.4630	6.2050	73.7763	4.4630
1.6916	6.0261	4.4685	6.2590	74.3195	4.4685
1.6491	6.0940	4.4736	6.3132	74.8576	4.4736
1.6060	6.1615	4.4782	6.3674	75.3908	4.4782
1.5623	6.2287	4.4824	6.4216	75.9193	4.4824
1.5180	6.2955	4.4863	6.4759	76.4433	4.4863
1.4731	6.3619	4.4897	6.5303	76.9630	4.4897
1.4276	6.4280	4.4928	6.5846	77.4786	4.4928
1.3814	6.4936	4.4955	6.6389	77.9903	4.4955
1.3346	6.5587	4.4979	6.6931	78.4983	4.4979
1.2871	6.6234	4.4999	6.7473	79.0027	4.4999
1.2390	6.6876	4.5016	6.8014	79.5039	4.5016
1.1902	6.7513	4.5029	6.8554	80.0020	4.5029
1.1407	6.8145	4.5040	6.9093	80.4972	4.5040
1.0905	6.8771	4.5047	6.9630	80.9897	4.5047
1.0396	6.9391	4.5051	7.0166	81.4795	4.5051
0.9880	7.0006	4.5053	7.0700	81.9668	4.5053

STREAMLINE 7

X	Y	Z	R	THETA	Z
4.0415	0.6843	2.5002	4.0990	9.6098	2.5002
4.0416	0.6876	2.5253	4.0997	9.6560	2.5253
4.0395	0.7038	2.5455	4.1003	9.8833	2.5455
4.0364	0.7243	2.5613	4.1009	10.1727	2.5613
4.0309	0.7584	2.5796	4.1016	10.6549	2.5796
4.0247	0.7941	2.5942	4.1023	11.1611	2.5942
4.0182	0.8298	2.6087	4.1030	11.6685	2.6087
4.0115	0.8656	2.6231	4.1038	12.1759	2.6231
4.0046	0.9013	2.6375	4.1047	12.6835	2.6375
3.9974	0.9369	2.6518	4.1057	13.1911	2.6518
3.9823	1.0082	2.6803	4.1079	14.2067	2.6803
3.9662	1.0792	2.7087	4.1104	15.2221	2.7087
3.9493	1.1502	2.7370	4.1134	16.2373	2.7370
3.9316	1.2209	2.7652	4.1168	17.2516	2.7652

3.9130	1.2915	2.7934	4.1206	18.2649	2.7934
3.8936	1.3618	2.8217	4.1249	19.2768	2.8217
3.8735	1.4318	2.8500	4.1296	20.2869	2.8500
3.8525	1.5016	2.8783	4.1349	21.2948	2.8783
3.8309	1.5712	2.9068	4.1406	22.3004	2.9068
3.8085	1.6405	2.9354	4.1468	23.3031	2.9354
3.7855	1.7095	2.9642	4.1536	24.3028	2.9642
3.7619	1.7782	2.9931	4.1610	25.2992	2.9931
3.7377	1.8467	3.0221	4.1690	26.2920	3.0221
3.7130	1.9148	3.0513	4.1777	27.2809	3.0513
3.6877	1.9828	3.0807	4.1870	28.2657	3.0807
3.6620	2.0505	3.1102	4.1970	29.2462	3.1102
3.6358	2.1179	3.1399	4.2077	30.2219	3.1399
3.6092	2.1852	3.1697	4.2192	31.1927	3.1697
3.5823	2.2522	3.1996	4.2315	32.1581	3.1996
3.5550	2.3191	3.2297	4.2446	33.1180	3.2297
3.5275	2.3858	3.2598	4.2586	34.0721	3.2598
3.4997	2.4524	3.2900	4.2734	35.0202	3.2900
3.4717	2.5188	3.3203	4.2892	35.9619	3.3203
3.4435	2.5852	3.3506	4.3059	36.8971	3.3506
3.4151	2.6514	3.3809	4.3235	37.8256	3.3809
3.3865	2.7177	3.4111	4.3422	38.7471	3.4111
3.3579	2.7839	3.4412	4.3618	39.6614	3.4412
3.3291	2.8502	3.4712	4.3825	40.5684	3.4712
3.3002	2.9165	3.5010	4.4042	41.4678	3.5010
3.2712	2.9828	3.5306	4.4270	42.3595	3.5306
3.2422	3.0492	3.5599	4.4508	43.2433	3.5599
3.2131	3.1157	3.5890	4.4757	44.1190	3.5890
3.1838	3.1824	3.6177	4.5016	44.9866	3.6177
3.1545	3.2491	3.6461	4.5285	45.8458	3.6461
3.1252	3.3159	3.6741	4.5565	46.6966	3.6741
3.0957	3.3829	3.7016	4.5856	47.5387	3.7016
3.0661	3.4501	3.7287	4.6156	48.3723	3.7287
3.0364	3.5174	3.7554	4.6467	49.1970	3.7554
3.0066	3.5848	3.7815	4.6787	50.0130	3.7815
2.9767	3.6524	3.8070	4.7117	50.8200	3.8070
2.9466	3.7201	3.8320	4.7457	51.6181	3.8320
2.9164	3.7879	3.8565	4.7805	52.4072	3.8565
2.8859	3.8559	3.8803	4.8163	53.1873	3.8803
2.8553	3.9241	3.9035	4.8530	53.9585	3.9035
2.8245	3.9923	3.9261	4.8904	54.7207	3.9261
2.7936	4.0607	3.9481	4.9288	55.4736	3.9481
2.7623	4.1291	3.9695	4.9679	56.2179	3.9695
2.7309	4.1976	3.9902	5.0078	56.9531	3.9902
2.6992	4.2663	4.0103	5.0484	57.6793	4.0103
2.6672	4.3350	4.0297	5.0898	58.3967	4.0297
2.6350	4.4037	4.0485	5.1318	59.1052	4.0485
2.6025	4.4725	4.0667	5.1746	59.8049	4.0667
2.5698	4.5413	4.0842	5.2180	60.4958	4.0842
2.5367	4.6101	4.1011	5.2620	61.1782	4.1011
2.5034	4.6790	4.1173	5.3066	61.8521	4.1173
2.4697	4.7478	4.1330	5.3517	62.5176	4.1330
2.4357	4.8166	4.1480	5.3974	63.1749	4.1480
2.4014	4.8854	4.1625	5.4437	63.8240	4.1625
2.3667	4.9541	4.1763	5.4904	64.4652	4.1763
2.3317	5.0228	4.1895	5.5376	65.0985	4.1895
2.2963	5.0914	4.2022	5.5852	65.7241	4.2022
2.2605	5.1598	4.2142	5.6333	66.3421	4.2142
2.2243	5.2282	4.2258	5.6817	66.9527	4.2258
2.1878	5.2965	4.2367	5.7306	67.5561	4.2367
2.1509	5.3647	4.2471	5.7798	68.1524	4.2471
2.1135	5.4327	4.2570	5.8293	68.7418	4.2570
2.0758	5.5005	4.2664	5.8792	69.3244	4.2664
2.0376	5.5682	4.2752	5.9293	69.9005	4.2752
1.9990	5.6357	4.2835	5.9797	70.4701	4.2835
1.9600	5.7030	4.2914	6.0304	71.0334	4.2914
1.9205	5.7701	4.2987	6.0813	71.5908	4.2987
1.8806	5.8370	4.3056	6.1325	72.1422	4.3056
1.8402	5.9037	4.3120	6.1838	72.6879	4.3120
1.7993	5.9701	4.3180	6.2353	73.2280	4.3180
1.7579	6.0362	4.3235	6.2870	73.7628	4.3235
1.7161	6.1021	4.3287	6.3388	74.2923	4.3287
1.6738	6.1677	4.3334	6.3908	74.8168	4.3334

1.6310	6.2330	4.3376	6.4429	75.3365	4.3376
1.5876	6.2980	4.3415	6.4950	75.8515	4.3415
1.5438	6.3627	4.3450	6.5473	76.3619	4.3450
1.4994	6.4270	4.3482	6.5996	76.8681	4.3482
1.4545	6.4909	4.3509	6.6519	77.3700	4.3509
1.4090	6.5545	4.3533	6.7043	77.8679	4.3533
1.3630	6.6177	4.3554	6.7566	78.3620	4.3554
1.3164	6.6805	4.3571	6.8090	78.8525	4.3571
1.2693	6.7429	4.3585	6.8613	79.3396	4.3585
1.2215	6.8048	4.3596	6.9136	79.8235	4.3596
1.1732	6.8663	4.3603	6.9658	80.3042	4.3603
1.1242	6.9273	4.3607	7.0179	80.7819	4.3607
1.0747	6.9878	4.3609	7.0700	81.2566	4.3609

STREAMLINE 8

X	Y	Z	R	THETA	Z
4.2448	0.8848	2.5001	4.3361	11.7745	2.5001
4.2446	0.8886	2.5245	4.3366	11.8240	2.5245
4.2418	0.9046	2.5438	4.3372	12.0391	2.5438
4.2380	0.9247	2.5588	4.3377	12.3088	2.5588
4.2313	0.9578	2.5762	4.3383	12.7551	2.5762
4.2239	0.9925	2.5899	4.3389	13.2236	2.5899
4.2162	1.0273	2.6032	4.3396	13.6940	2.6032
4.2083	1.0621	2.6165	4.3403	14.1646	2.6165
4.2002	1.0968	2.6297	4.3410	14.6354	2.6297
4.1919	1.1316	2.6429	4.3419	15.1065	2.6429
4.1746	1.2009	2.6690	4.3439	16.0493	2.6690
4.1565	1.2702	2.6948	4.3463	16.9928	2.6948
4.1376	1.3393	2.7203	4.3490	17.9366	2.7203
4.1179	1.4083	2.7457	4.3521	18.8803	2.7457
4.0974	1.4771	2.7710	4.3555	19.8238	2.7710
4.0761	1.5457	2.7962	4.3593	20.7667	2.7962
4.0540	1.6140	2.8213	4.3635	21.7086	2.8213
4.0312	1.6821	2.8465	4.3680	22.6493	2.8465
4.0076	1.7499	2.8717	4.3730	23.5885	2.8717
3.9834	1.8175	2.8969	4.3784	24.5258	2.8969
3.9585	1.8848	2.9222	4.3843	25.4610	2.9222
3.9330	1.9518	2.9477	4.3907	26.3938	2.9477
3.9069	2.0186	2.9732	4.3975	27.3240	2.9732
3.8802	2.0850	2.9989	4.4049	28.2515	2.9989
3.8530	2.1512	3.0248	4.4129	29.1760	3.0248
3.8253	2.2172	3.0507	4.4214	30.0974	3.0507
3.7971	2.2829	3.0767	4.4305	31.0154	3.0767
3.7684	2.3483	3.1029	4.4402	31.9297	3.1029
3.7394	2.4136	3.1292	4.4506	32.8402	3.1292
3.7099	2.4786	3.1557	4.4617	33.7464	3.1557
3.6802	2.5434	3.1823	4.4735	34.6483	3.1823
3.6501	2.6080	3.2089	4.4861	35.5456	3.2089
3.6197	2.6724	3.2357	4.4994	36.4381	3.2357
3.5891	2.7367	3.2625	4.5135	37.3255	3.2625
3.5583	2.8009	3.2894	4.5284	38.2076	3.2894
3.5273	2.8650	3.3163	4.5442	39.0843	3.3163
3.4961	2.9290	3.3432	4.5609	39.9554	3.3432
3.4648	2.9929	3.3700	4.5784	40.8206	3.3700
3.4333	3.0568	3.3968	4.5969	41.6797	3.3968
3.4017	3.1207	3.4235	4.6163	42.5327	3.4235
3.3700	3.1846	3.4500	4.6367	43.3793	3.4500
3.3382	3.2485	3.4764	4.6580	44.2193	3.4764
3.3064	3.3124	3.5025	4.6802	45.0526	3.5025
3.2744	3.3765	3.5284	4.7034	45.8790	3.5284
3.2424	3.4405	3.5541	4.7276	46.6985	3.5541
3.2102	3.5047	3.5794	4.7527	47.5107	3.5794
3.1780	3.5689	3.6045	4.7788	48.3157	3.6045
3.1458	3.6333	3.6291	4.8059	49.1132	3.6291
3.1134	3.6977	3.6534	4.8339	49.9033	3.6534
3.0810	3.7623	3.6773	4.8628	50.6857	3.6773
3.0484	3.8270	3.7007	4.8927	51.4604	3.7007
3.0158	3.8918	3.7237	4.9235	52.2272	3.7237
2.9830	3.9567	3.7461	4.9552	52.9863	3.7461
2.9502	4.0217	3.7681	4.9877	53.7375	3.7681

2.9171	4.0868	3.7896	5.0211	54.4808	3.7896
2.8840	4.1520	3.8105	5.0553	55.2160	3.8105
2.8507	4.2173	3.8309	5.0904	55.9434	3.8309
2.8172	4.2827	3.8508	5.1262	56.6628	3.8508
2.7835	4.3482	3.8700	5.1628	57.3739	3.8700
2.7498	4.4137	3.8888	5.2002	58.0769	3.8888
2.7158	4.4793	3.9069	5.2383	58.7718	3.9069
2.6817	4.5450	3.9245	5.2772	59.4585	3.9245
2.6473	4.6108	3.9415	5.3167	60.1372	3.9415
2.6128	4.6766	3.9580	5.3570	60.8079	3.9580
2.5781	4.7424	3.9739	5.3978	61.4706	3.9739
2.5431	4.8082	3.9892	5.4393	62.1254	3.9892
2.5079	4.8740	4.0039	5.4814	62.7724	4.0039
2.4724	4.9399	4.0181	5.5240	63.4118	4.0181
2.4367	5.0057	4.0317	5.5673	64.0435	4.0317
2.4008	5.0714	4.0448	5.6110	64.6676	4.0448
2.3645	5.1372	4.0573	5.6552	65.2844	4.0573
2.3280	5.2029	4.0692	5.7000	65.8938	4.0692
2.2912	5.2685	4.0807	5.7451	66.4960	4.0807
2.2542	5.3340	4.0915	5.7908	67.0912	4.0915
2.2168	5.3995	4.1019	5.8368	67.6794	4.1019
2.1791	5.4649	4.1118	5.8833	68.2607	4.1118
2.1411	5.5301	4.1211	5.9301	68.8354	4.1211
2.1027	5.5953	4.1299	5.9773	69.4035	4.1299
2.0641	5.6603	4.1383	6.0249	69.9651	4.1383
2.0251	5.7251	4.1461	6.0727	70.5205	4.1461
1.9857	5.7898	4.1535	6.1209	71.0698	4.1535
1.9460	5.8544	4.1604	6.1693	71.6131	4.1604
1.9059	5.9188	4.1669	6.2181	72.1506	4.1669
1.8655	5.9829	4.1729	6.2670	72.6823	4.1729
1.8247	6.0469	4.1785	6.3162	73.2086	4.1785
1.7835	6.1107	4.1837	6.3656	73.7295	4.1837
1.7419	6.1742	4.1885	6.4152	74.2452	4.1885
1.6998	6.2375	4.1928	6.4650	74.7559	4.1928
1.6574	6.3006	4.1967	6.5149	75.2616	4.1967
1.6146	6.3633	4.2003	6.5650	75.7627	4.2003
1.5713	6.4258	4.2035	6.6152	76.2591	4.2035
1.5276	6.4881	4.2063	6.6655	76.7511	4.2063
1.4835	6.5500	4.2087	6.7159	77.2389	4.2087
1.4388	6.6116	4.2108	6.7664	77.7225	4.2108
1.3938	6.6729	4.2126	6.8169	78.2022	4.2126
1.3482	6.7338	4.2140	6.8675	78.6781	4.2140
1.3022	6.7944	4.2151	6.9181	79.1504	4.2151
1.2557	6.8547	4.2159	6.9687	79.6191	4.2159
1.2087	6.9145	4.2164	7.0194	80.0844	4.2164
1.1612	6.9740	4.2165	7.0700	80.5463	4.2165

STREAMLINE 9

X	Y	Z	R	THETA	Z
4.3432	0.9912	2.5000	4.4548	12.8559	2.5000
4.3453	0.9955	2.5197	4.4579	12.9033	2.5197
4.3535	1.0150	2.5329	4.4702	13.1241	2.5329
4.3599	1.0364	2.5441	4.4814	13.3715	2.5441
4.3662	1.0702	2.5590	4.4954	13.7720	2.5590
4.3695	1.1052	2.5717	4.5072	14.1948	2.5717
4.3687	1.1408	2.5831	4.5152	14.6342	2.5831
4.3613	1.1753	2.5955	4.5169	15.0818	2.5955
4.3536	1.2098	2.6078	4.5186	15.5302	2.6078
4.3457	1.2443	2.6200	4.5203	15.9782	2.6200
4.3293	1.3133	2.6442	4.5241	16.8754	2.6442
4.3119	1.3822	2.6681	4.5280	17.7734	2.6681
4.2937	1.4510	2.6916	4.5322	18.6716	2.6916
4.2745	1.5196	2.7148	4.5366	19.5700	2.7148
4.2544	1.5880	2.7379	4.5411	20.4683	2.7379
4.2334	1.6562	2.7607	4.5459	21.3664	2.7607
4.2115	1.7242	2.7834	4.5508	22.2637	2.7834
4.1888	1.7919	2.8061	4.5559	23.1603	2.8061
4.1652	1.8593	2.8286	4.5613	24.0558	2.8286
4.1408	1.9265	2.8512	4.5670	24.9500	2.8512
4.1156	1.9934	2.8738	4.5729	25.8431	2.8738

4.0897	2.0599	2.8964	4.5792	26.7337	2.8964
4.0631	2.1262	2.9191	4.5858	27.6229	2.9191
4.0358	2.1922	2.9419	4.5928	28.5098	2.9419
4.0080	2.2579	2.9647	4.6002	29.3945	2.9647
3.9795	2.3233	2.9877	4.6081	30.2769	2.9877
3.9505	2.3884	3.0107	4.6164	31.1568	3.0107
3.9209	2.4532	3.0338	4.6251	32.0338	3.0338
3.8907	2.5178	3.0571	4.6344	32.9084	3.0571
3.8602	2.5821	3.0805	4.6442	33.7789	3.0805
3.8292	2.6462	3.1040	4.6545	34.6465	3.1040
3.7978	2.7100	3.1276	4.6655	35.5103	3.1276
3.7660	2.7735	3.1513	4.6771	36.3705	3.1513
3.7339	2.8369	3.1751	4.6894	37.2267	3.1751
3.7015	2.9001	3.1990	4.7023	38.0788	3.1990
3.6688	2.9632	3.2229	4.7160	38.9265	3.2229
3.6359	3.0260	3.2469	4.7304	39.7697	3.2469
3.6027	3.0888	3.2710	4.7455	40.6082	3.2710
3.5693	3.1514	3.2950	4.7615	41.4418	3.2950
3.5357	3.2140	3.3191	4.7782	42.2706	3.3191
3.5020	3.2764	3.3431	4.7957	43.0937	3.3431
3.4681	3.3388	3.3670	4.8141	43.9117	3.3670
3.4340	3.4011	3.3909	4.8332	44.7244	3.3909
3.3998	3.4634	3.4146	4.8532	45.5309	3.4146
3.3655	3.5257	3.4382	4.8741	46.3318	3.4382
3.3310	3.5880	3.4617	4.8959	47.1267	3.4617
3.2965	3.6503	3.4849	4.9185	47.9155	3.4849
3.2618	3.7126	3.5080	4.9419	48.6980	3.5080
3.2271	3.7749	3.5308	4.9663	49.4741	3.5308
3.1922	3.8373	3.5533	4.9915	50.2437	3.5533
3.1572	3.8998	3.5755	5.0176	51.0068	3.5755
3.1222	3.9623	3.5974	5.0445	51.7629	3.5974
3.0870	4.0248	3.6189	5.0724	52.5123	3.6189
3.0517	4.0875	3.6401	5.1010	53.2548	3.6401
3.0164	4.1502	3.6609	5.1306	53.9905	3.6609
2.9809	4.2129	3.6813	5.1609	54.7184	3.6813
2.9453	4.2758	3.7013	5.1920	55.4396	3.7013
2.9096	4.3387	3.7209	5.2240	56.1536	3.7209
2.8737	4.4017	3.7400	5.2567	56.8603	3.7400
2.8378	4.4647	3.7586	5.2902	57.5596	3.7586
2.8017	4.5278	3.7768	5.3246	58.2516	3.7768
2.7656	4.5910	3.7946	5.3596	58.9358	3.7946
2.7293	4.6543	3.8118	5.3955	59.6126	3.8118
2.6928	4.7176	3.8285	5.4320	60.2818	3.8285
2.6563	4.7809	3.8447	5.4693	60.9436	3.8447
2.6196	4.8443	3.8605	5.5072	61.5979	3.8605
2.5827	4.9078	3.8757	5.5459	62.2447	3.8757
2.5457	4.9712	3.8904	5.5851	62.8840	3.8904
2.5085	5.0347	3.9045	5.6250	63.5160	3.9045
2.4711	5.0982	3.9182	5.6656	64.1405	3.9182
2.4336	5.1617	3.9313	5.7067	64.7577	3.9313
2.3959	5.2253	3.9439	5.7484	65.3679	3.9439
2.3579	5.2888	3.9559	5.7906	65.9707	3.9559
2.3198	5.3523	3.9675	5.8334	66.5665	3.9675
2.2815	5.4157	3.9785	5.8766	67.1551	3.9785
2.2430	5.4791	3.9890	5.9204	67.7371	3.9890
2.2042	5.5425	3.9989	5.9647	68.3122	3.9989
2.1653	5.6058	4.0083	6.0094	68.8806	4.0083
2.1261	5.6690	4.0173	6.0546	69.4424	4.0173
2.0866	5.7321	4.0257	6.1001	69.9975	4.0257
2.0469	5.7952	4.0336	6.1461	70.5466	4.0336
2.0069	5.8582	4.0409	6.1924	71.0893	4.0409
1.9667	5.9210	4.0478	6.2391	71.6259	4.0478
1.9262	5.9837	4.0542	6.2861	72.1564	4.0542
1.8854	6.0463	4.0601	6.3334	72.6812	4.0601
1.8443	6.1087	4.0655	6.3811	73.2002	4.0655
1.8029	6.1710	4.0704	6.4290	73.7136	4.0704
1.7613	6.2331	4.0749	6.4772	74.2215	4.0749
1.7193	6.2951	4.0788	6.5256	74.7240	4.0788
1.6770	6.3568	4.0823	6.5743	75.2216	4.0823
1.6343	6.4184	4.0854	6.6232	75.7141	4.0854
1.5914	6.4797	4.0880	6.6723	76.2016	4.0880
1.5481	6.5408	4.0901	6.7215	76.6842	4.0901
1.5044	6.6017	4.0918	6.7710	77.1625	4.0918



1.4604	6.6624	4.0931	6.8205	77.6361	4.0931
1.4160	6.7227	4.0939	6.8703	78.1054	4.0939
1.3713	6.7829	4.0943	6.9201	78.5704	4.0943
1.3262	6.8427	4.0942	6.9700	79.0313	4.0942
1.2807	6.9022	4.0941	7.0200	79.4886	4.0941
1.2347	6.9614	4.0938	7.0700	79.9426	4.0938

STREAMLINE 10

X	Y	Z	R	THETA	Z
4.4933	1.0320	2.4998	4.6103	12.9354	2.4998
4.4967	1.0345	2.5229	4.6142	12.9560	2.5229
4.4993	1.0517	2.5404	4.6206	13.1568	2.5404
4.4995	1.0711	2.5559	4.6252	13.3900	2.5559
4.4977	1.1024	2.5760	4.6308	13.7712	2.5760
4.4946	1.1354	2.5927	4.6358	14.1774	2.5927
4.4881	1.1697	2.6056	4.6380	14.6072	2.6056
4.4802	1.2040	2.6174	4.6392	15.0426	2.6174
4.4720	1.2384	2.6291	4.6403	15.4785	2.6291
4.4637	1.2727	2.6408	4.6416	15.9144	2.6408
4.4464	1.3414	2.6637	4.6443	16.7872	2.6637
4.4282	1.4099	2.6863	4.6473	17.6609	2.6863
4.4092	1.4783	2.7086	4.6505	18.5353	2.7086
4.3894	1.5466	2.7305	4.6539	19.4098	2.7305
4.3687	1.6147	2.7522	4.6576	20.2849	2.7522
4.3472	1.6826	2.7736	4.6615	21.1595	2.7736
4.3248	1.7503	2.7949	4.6656	22.0342	2.7949
4.3017	1.8178	2.8160	4.6700	22.9085	2.8160
4.2777	1.8851	2.8370	4.6746	23.7822	2.8370
4.2530	1.9521	2.8579	4.6796	24.6545	2.8579
4.2275	2.0188	2.8788	4.6848	25.5260	2.8788
4.2014	2.0852	2.8997	4.6904	26.3963	2.8997
4.1745	2.1514	2.9207	4.6963	27.2650	2.9207
4.1470	2.2173	2.9416	4.7026	28.1320	2.9416
4.1189	2.2829	2.9627	4.7093	28.9971	2.9627
4.0902	2.3482	2.9837	4.7164	29.8606	2.9837
4.0609	2.4133	3.0049	4.7238	30.7219	3.0049
4.0310	2.4780	3.0261	4.7318	31.5805	3.0261
4.0006	2.5425	3.0474	4.7401	32.4372	3.0474
3.9697	2.6067	3.0688	4.7490	33.2913	3.0688
3.9383	2.6707	3.0904	4.7584	34.1424	3.0904
3.9064	2.7343	3.1120	4.7683	34.9904	3.1120
3.8742	2.7978	3.1337	4.7788	35.8350	3.1337
3.8416	2.8610	3.1555	4.7899	36.6768	3.1555
3.8087	2.9241	3.1774	4.8017	37.5148	3.1774
3.7754	2.9869	3.1994	4.8141	38.3490	3.1994
3.7418	3.0495	3.2215	4.8271	39.1793	3.2215
3.7080	3.1120	3.2436	4.8409	40.0056	3.2436
3.6739	3.1743	3.2657	4.8553	40.8276	3.2657
3.6396	3.2365	3.2879	4.8705	41.6449	3.2879
3.6051	3.2986	3.3100	4.8865	42.4581	3.3100
3.5704	3.3606	3.3322	4.9032	43.2664	3.3322
3.5355	3.4225	3.3542	4.9207	44.0696	3.3542
3.5005	3.4843	3.3762	4.9390	44.8677	3.3762
3.4653	3.5461	3.3982	4.9581	45.6610	3.3982
3.4299	3.6079	3.4200	4.9781	46.4486	3.4200
3.3945	3.6696	3.4416	4.9989	47.2307	3.4416
3.3589	3.7314	3.4631	5.0205	48.0070	3.4631
3.3232	3.7931	3.4844	5.0429	48.7775	3.4844
3.2875	3.8548	3.5055	5.0663	49.5418	3.5055
3.2516	3.9166	3.5263	5.0904	50.3004	3.5263
3.2156	3.9784	3.5469	5.1155	51.0527	3.5469
3.1796	4.0403	3.5671	5.1414	51.7985	3.5671
3.1434	4.1022	3.5871	5.1681	52.5378	3.5871
3.1072	4.1642	3.6067	5.1957	53.2705	3.6067
3.0709	4.2262	3.6259	5.2241	53.9964	3.6259
3.0345	4.2883	3.6448	5.2533	54.7160	3.6448
2.9980	4.3504	3.6633	5.2834	55.4285	3.6633
2.9614	4.4126	3.6814	5.3142	56.1339	3.6814
2.9247	4.4749	3.6991	5.3459	56.8325	3.6991
2.8879	4.5372	3.7164	5.3783	57.5239	3.7164

2.8510	4.5996	3.7332	5.4115	58.2081	3.7332
2.8140	4.6621	3.7496	5.4455	58.8851	3.7496
2.7769	4.7246	3.7655	5.4803	59.5547	3.7655
2.7398	4.7872	3.7810	5.5157	60.2171	3.7810
2.7025	4.8498	3.7959	5.5519	60.8722	3.7959
2.6650	4.9125	3.8104	5.5888	61.5199	3.8104
2.6275	4.9752	3.8245	5.6264	62.1604	3.8245
2.5898	5.0379	3.8380	5.6646	62.7937	3.8380
2.5520	5.1006	3.8510	5.7034	63.4197	3.8510
2.5141	5.1634	3.8635	5.7429	64.0385	3.8635
2.4759	5.2262	3.8756	5.7830	64.6506	3.8756
2.4376	5.2889	3.8871	5.8237	65.2552	3.8871
2.3992	5.3517	3.8982	5.8649	65.8529	3.8982
2.3606	5.4144	3.9088	5.9066	66.4436	3.9088
2.3218	5.4771	3.9188	5.9489	67.0275	3.9188
2.2828	5.5397	3.9284	5.9916	67.6046	3.9284
2.2436	5.6023	3.9375	6.0349	68.1750	3.9375
2.2042	5.6649	3.9461	6.0786	68.7389	3.9461
2.1646	5.7273	3.9542	6.1227	69.2963	3.9542
2.1248	5.7897	3.9619	6.1673	69.8473	3.9619
2.0847	5.8520	3.9691	6.2123	70.3921	3.9691
2.0444	5.9142	3.9758	6.2576	70.9308	3.9758
2.0039	5.9763	3.9821	6.3033	71.4634	3.9821
1.9631	6.0383	3.9879	6.3494	71.9901	3.9879
1.9221	6.1001	3.9933	6.3957	72.5110	3.9933
1.8807	6.1618	3.9983	6.4424	73.0263	3.9983
1.8392	6.2233	4.0028	6.4894	73.5361	4.0028
1.7973	6.2847	4.0069	6.5366	74.0406	4.0069
1.7551	6.3459	4.0106	6.5842	74.5398	4.0106
1.7127	6.4069	4.0138	6.6319	75.0338	4.0138
1.6699	6.4678	4.0167	6.6799	75.5229	4.0167
1.6268	6.5284	4.0191	6.7280	76.0072	4.0191
1.5835	6.5888	4.0212	6.7764	76.4867	4.0212
1.5397	6.6490	4.0229	6.8250	76.9616	4.0229
1.4957	6.7090	4.0242	6.8737	77.4321	4.0242
1.4513	6.7687	4.0251	6.9225	77.8983	4.0251
1.4065	6.8282	4.0256	6.9715	78.3603	4.0256
1.3615	6.8873	4.0258	7.0206	78.8178	4.0258
1.3162	6.9464	4.0257	7.0700	79.2706	4.0257

STREAMLINE 11

X	Y	Z	R	THETA	Z
4.5981	0.9242	2.4619	4.6900	11.3643	2.4619
4.5993	0.9180	2.4863	4.6900	11.2878	2.4863
4.5996	0.9166	2.5115	4.6900	11.2698	2.5115
4.5991	0.9207	2.5364	4.6904	11.3200	2.5364
4.5972	0.9353	2.5712	4.6914	11.5001	2.5712
4.5941	0.9576	2.6016	4.6928	11.7746	2.6016
4.5899	0.9852	2.6272	4.6944	12.1141	2.6272
4.5849	1.0159	2.6488	4.6961	12.4940	2.6488
4.5792	1.0486	2.6671	4.6977	12.8980	2.6671
4.5728	1.0827	2.6824	4.6993	13.3203	2.6824
4.5585	1.1530	2.7068	4.7020	14.1941	2.7068
4.5429	1.2238	2.7290	4.7049	15.0763	2.7290
4.5265	1.2945	2.7508	4.7080	15.9597	2.7508
4.5093	1.3652	2.7722	4.7114	16.8434	2.7722
4.4912	1.4357	2.7933	4.7150	17.7272	2.7933
4.4722	1.5061	2.8141	4.7190	18.6118	2.8141
4.4523	1.5763	2.8346	4.7231	19.4962	2.8346
4.4316	1.6464	2.8548	4.7276	20.3800	2.8548
4.4101	1.7163	2.8749	4.7323	21.2641	2.8749
4.3878	1.7859	2.8948	4.7373	22.1471	2.8948
4.3646	1.8553	2.9145	4.7426	23.0297	2.9145
4.3407	1.9245	2.9342	4.7482	23.9111	2.9342
4.3160	1.9935	2.9538	4.7541	24.7913	2.9538
4.2906	2.0621	2.9734	4.7604	25.6699	2.9734
4.2644	2.1306	2.9930	4.7670	26.5472	2.9930
4.2376	2.1987	3.0126	4.7740	27.4224	3.0126
4.2101	2.2666	3.0323	4.7814	28.2963	3.0323
4.1819	2.3341	3.0519	4.7892	29.1679	3.0519

4.1532	2.4015	3.0716	4.7975	30.0375	3.0716
4.1238	2.4685	3.0914	4.8061	30.9047	3.0914
4.0938	2.5352	3.1112	4.8152	31.7695	3.1112
4.0632	2.6017	3.1310	4.8248	32.6316	3.1310
4.0322	2.6679	3.1510	4.8349	33.4912	3.1510
4.0006	2.7339	3.1709	4.8455	34.3475	3.1709
3.9686	2.7996	3.1910	4.8567	35.2011	3.1910
3.9361	2.8651	3.2111	4.8684	36.0511	3.2111
3.9032	2.9304	3.2313	4.8808	36.8977	3.2313
3.8699	2.9954	3.2515	4.8937	37.7407	3.2515
3.8363	3.0602	3.2718	4.9073	38.5798	3.2718
3.8023	3.1249	3.2921	4.9216	39.4149	3.2921
3.7680	3.1894	3.3124	4.9366	40.2459	3.3124
3.7334	3.2537	3.3328	4.9522	41.0726	3.3328
3.6985	3.3179	3.3531	4.9686	41.8946	3.3531
3.6634	3.3819	3.3733	4.9858	42.7122	3.3733
3.6280	3.4459	3.3936	5.0037	43.5247	3.3936
3.5925	3.5097	3.4137	5.0223	44.3320	3.4137
3.5567	3.5735	3.4338	5.0418	45.1348	3.4338
3.5207	3.6371	3.4537	5.0620	45.9319	3.4537
3.4846	3.7008	3.4736	5.0831	46.7234	3.4736
3.4482	3.7643	3.4932	5.1050	47.5093	3.4932
3.4118	3.8279	3.5127	5.1277	48.2894	3.5127
3.3752	3.8914	3.5320	5.1512	49.0634	3.5320
3.3385	3.9549	3.5511	5.1756	49.8311	3.5511
3.3016	4.0184	3.5699	5.2008	50.5930	3.5699
3.2646	4.0820	3.5885	5.2269	51.3483	3.5885
3.2275	4.1455	3.6067	5.2538	52.0970	3.6067
3.1903	4.2091	3.6247	5.2815	52.8389	3.6247
3.1530	4.2727	3.6423	5.3101	53.5745	3.6423
3.1156	4.3363	3.6596	5.3395	54.3029	3.6596
3.0781	4.3999	3.6766	5.3697	55.0245	3.6766
3.0404	4.4636	3.6931	5.4008	55.7390	3.6931
3.0027	4.5274	3.7093	5.4326	56.4463	3.7093
2.9649	4.5911	3.7251	5.4652	57.1460	3.7251
2.9270	4.6549	3.7406	5.4987	57.8388	3.7406
2.8890	4.7188	3.7555	5.5329	58.5241	3.7555
2.8508	4.7827	3.7701	5.5679	59.2019	3.7701
2.8126	4.8466	3.7842	5.6036	59.8724	3.7842
2.7743	4.9106	3.7979	5.6401	60.5353	3.7979
2.7358	4.9746	3.8112	5.6772	61.1908	3.8112
2.6972	5.0385	3.8239	5.7151	61.8389	3.8239
2.6585	5.1026	3.8362	5.7536	62.4796	3.8362
2.6197	5.1666	3.8481	5.7928	63.1129	3.8481
2.5807	5.2306	3.8595	5.8326	63.7390	3.8595
2.5415	5.2946	3.8704	5.8730	64.3578	3.8704
2.5022	5.3586	3.8808	5.9140	64.9694	3.8808
2.4627	5.4225	3.8908	5.9556	65.5738	3.8908
2.4231	5.4864	3.9003	5.9977	66.1712	3.9003
2.3832	5.5503	3.9093	6.0403	66.7619	3.9093
2.3432	5.6141	3.9179	6.0835	67.3454	3.9179
2.3030	5.6778	3.9260	6.1271	67.9222	3.9260
2.2625	5.7415	3.9336	6.1712	68.4925	3.9336
2.2218	5.8050	3.9408	6.2157	69.0563	3.9408
2.1809	5.8685	3.9476	6.2606	69.6138	3.9476
2.1397	5.9318	3.9539	6.3060	70.1645	3.9539
2.0983	5.9951	3.9598	6.3517	70.7095	3.9598
2.0567	6.0582	3.9652	6.3978	71.2484	3.9652
2.0147	6.1211	3.9702	6.4442	71.7814	3.9702
1.9725	6.1839	3.9748	6.4909	72.3087	3.9748
1.9300	6.2466	3.9790	6.5379	72.8303	3.9790
1.8872	6.3090	3.9828	6.5852	73.3466	3.9828
1.8441	6.3713	3.9862	6.6328	73.8577	3.9862
1.8007	6.4334	3.9892	6.6806	74.3632	3.9892
1.7569	6.4952	3.9918	6.7287	74.8638	3.9918
1.7129	6.5569	3.9941	6.7769	75.3596	3.9941
1.6685	6.6183	3.9960	6.8254	75.8507	3.9960
1.6237	6.6795	3.9975	6.8740	76.3369	3.9975
1.5786	6.7404	3.9986	6.9228	76.8187	3.9986
1.5332	6.8010	3.9994	6.9717	77.2961	3.9994
1.4873	6.8614	3.9999	7.0208	77.7693	3.9999
1.4412	6.9216	4.0000	7.0700	78.2383	4.0000

SUCTION SIDE

FULL BLADE

STREAMLINE 1

X	Y	Z	R	THETA	Z
3.0476	-0.0761	2.4428	3.0485	358.5694	2.4428
3.0479	-0.0617	2.4169	3.0486	358.8406	2.4169
3.0482	-0.0434	2.3936	3.0486	359.1840	2.3936
3.0485	-0.0219	2.3732	3.0486	359.5886	2.3732
3.0485	0.0152	2.3488	3.0485	0.2862	2.3488
3.0480	0.0564	2.3320	3.0485	1.0594	2.3320
3.0469	0.0998	2.3225	3.0485	1.8754	2.3225
3.0451	0.1441	2.3197	3.0485	2.7091	2.3197
3.0427	0.1883	2.3228	3.0485	3.5421	2.3228
3.0397	0.2318	2.3318	3.0485	4.3600	2.3318
3.0319	0.3174	2.3547	3.0485	5.9766	2.3547
3.0219	0.4021	2.3800	3.0485	7.5790	2.3800
3.0095	0.4858	2.4077	3.0485	9.1687	2.4077
2.9951	0.5682	2.4377	3.0485	10.7428	2.4377
2.9785	0.6495	2.4701	3.0485	12.3009	2.4701
2.9600	0.7291	2.5051	3.0485	13.8382	2.5051
2.9400	0.8073	2.5425	3.0488	15.3552	2.5425
2.9186	0.8841	2.5821	3.0496	16.8529	2.5821
2.8962	0.9596	2.6235	3.0510	18.3321	2.6235
2.8727	1.0339	2.6666	3.0531	19.7933	2.6666
2.8484	1.1069	2.7111	3.0559	21.2363	2.7111
2.8234	1.1789	2.7571	3.0596	22.6621	2.7571
2.7978	1.2498	2.8043	3.0643	24.0708	2.8043
2.7717	1.3198	2.8527	3.0699	25.4620	2.8527
2.7453	1.3889	2.9021	3.0767	26.8354	2.9021
2.7187	1.4572	2.9525	3.0846	28.1915	2.9525
2.6919	1.5248	3.0038	3.0938	29.5293	3.0038
2.6651	1.5918	3.0559	3.1043	30.8488	3.0559
2.6384	1.6583	3.1087	3.1162	32.1499	3.1087
2.6119	1.7243	3.1621	3.1297	33.4317	3.1621
2.5856	1.7901	3.2160	3.1448	34.6954	3.2160
2.5597	1.8556	3.2702	3.1616	35.9400	3.2702
2.5341	1.9212	3.3247	3.1801	37.1662	3.3247
2.5090	1.9867	3.3794	3.2003	38.3736	3.3794
2.4843	2.0525	3.4340	3.2225	39.5624	3.4340
2.4601	2.1184	3.4886	3.2465	40.7321	3.4886
2.4364	2.1847	3.5430	3.2724	41.8833	3.5430
2.4131	2.2515	3.5970	3.3003	43.0153	3.5970
2.3904	2.3187	3.6507	3.3302	44.1285	3.6507
2.3681	2.3866	3.7037	3.3621	45.2230	3.7037
2.3462	2.4551	3.7562	3.3959	46.2985	3.7562
2.3248	2.5243	3.8078	3.4317	47.3554	3.8078
2.3037	2.5942	3.8586	3.4695	48.3938	3.8586
2.2830	2.6649	3.9085	3.5091	49.4138	3.9085
2.2625	2.7365	3.9573	3.5506	50.4163	3.9573
2.2422	2.8088	4.0049	3.5939	51.4007	4.0049
2.2219	2.8819	4.0514	3.6390	52.3682	4.0514
2.2017	2.9558	4.0966	3.6857	53.3183	4.0966
2.1815	3.0305	4.1406	3.7340	54.2515	4.1406
2.1612	3.1059	4.1833	3.7838	55.1681	4.1833
2.1407	3.1819	4.2246	3.8350	56.0681	4.2246
2.1200	3.2587	4.2646	3.8876	56.9530	4.2646
2.0990	3.3361	4.3032	3.9415	57.8221	4.3032
2.0777	3.4140	4.3405	3.9965	58.6763	4.3405
2.0559	3.4925	4.3764	4.0527	59.5157	4.3764
2.0337	3.5714	4.4109	4.1098	60.3406	4.4109
2.0110	3.6507	4.4441	4.1680	61.1520	4.4441
1.9878	3.7305	4.4760	4.2270	61.9494	4.4760
1.9640	3.8106	4.5067	4.2869	62.7335	4.5067
1.9396	3.8909	4.5360	4.3476	63.5044	4.5360
1.9145	3.9716	4.5642	4.4089	64.2629	4.5642
1.8888	4.0524	4.5911	4.4710	65.0094	4.5911
1.8625	4.1333	4.6168	4.5336	65.7441	4.6168
1.8354	4.2144	4.6414	4.5967	66.4669	4.6414
1.8076	4.2956	4.6649	4.6604	67.1789	4.6649

1.7791	4.3769	4.6874	4.7246	67.8797	4.6874
1.7499	4.4582	4.7088	4.7893	68.5695	4.7088
1.7199	4.5394	4.7292	4.8543	69.2487	4.7292
1.6893	4.6207	4.7486	4.9198	69.9179	4.7486
1.6579	4.7019	4.7671	4.9856	70.5768	4.7671
1.6259	4.7830	4.7846	5.0518	71.2258	4.7846
1.5931	4.8640	4.8013	5.1182	71.8652	4.8013
1.5596	4.9449	4.8172	5.1850	72.4952	4.8172
1.5254	5.0257	4.8322	5.2521	73.1159	4.8322
1.4905	5.1063	4.8464	5.3194	73.7276	4.8464
1.4550	5.1867	4.8598	5.3869	74.3304	4.8598
1.4187	5.2670	4.8724	5.4547	74.9245	4.8724
1.3818	5.3471	4.8844	5.5228	75.5101	4.8844
1.3443	5.4270	4.8956	5.5910	76.0874	4.8956
1.3061	5.5067	4.9062	5.6595	76.6564	4.9062
1.2674	5.5861	4.9161	5.7281	77.2173	4.9161
1.2280	5.6654	4.9253	5.7970	77.7702	4.9253
1.1880	5.7444	4.9340	5.8660	78.3153	4.9340
1.1475	5.8232	4.9420	5.9352	78.8523	4.9420
1.1064	5.9018	4.9494	6.0046	79.3818	4.9494
1.0648	5.9802	4.9563	6.0742	79.9036	4.9563
1.0227	6.0583	4.9626	6.1440	80.4179	4.9626
0.9801	6.1362	4.9684	6.2140	80.9247	4.9684
0.9371	6.2139	4.9736	6.2841	81.4240	4.9736
0.8936	6.2914	4.9784	6.3545	81.9161	4.9784
0.8497	6.3686	4.9826	6.4251	82.4005	4.9826
0.8054	6.4457	4.9864	6.4958	82.8778	4.9864
0.7607	6.5226	4.9897	6.5668	83.3477	4.9897
0.7157	6.5993	4.9925	6.6380	83.8105	4.9925
0.6704	6.6758	4.9948	6.7094	84.2658	4.9948
0.6247	6.7522	4.9967	6.7810	84.7139	4.9967
0.5788	6.8284	4.9982	6.8529	85.1548	4.9982
0.5327	6.9044	4.9992	6.9249	85.5885	4.9992
0.4863	6.9804	4.9998	6.9973	86.0152	4.9998
0.4399	7.0563	5.0000	7.0700	86.4329	5.0000

STREAMLINE 2

X	Y	Z	R	THETA	Z
3.0719	-0.0052	2.4764	3.0719	359.9023	2.4764
3.0750	0.0138	2.4550	3.0750	0.2579	2.4550
3.0789	0.0381	2.4398	3.0791	0.7096	2.4398
3.0831	0.0652	2.4304	3.0838	1.2114	2.4304
3.0888	0.1079	2.4255	3.0907	2.0012	2.4255
3.0923	0.1511	2.4284	3.0960	2.7981	2.4284
3.0923	0.1938	2.4365	3.0984	3.5867	2.4365
3.0899	0.2359	2.4474	3.0989	4.3653	2.4474
3.0869	0.2777	2.4589	3.0994	5.1404	2.4589
3.0834	0.3193	2.4711	3.0999	5.9121	2.4711
3.0746	0.4018	2.4971	3.1008	7.4457	2.4971
3.0637	0.4834	2.5253	3.1016	8.9657	2.5253
3.0507	0.5639	2.5555	3.1024	10.4716	2.5555
3.0358	0.6432	2.5879	3.1032	11.9622	2.5879
3.0194	0.7213	2.6223	3.1043	13.4363	2.6223
3.0016	0.7984	2.6586	3.1060	14.8944	2.6586
2.9827	0.8743	2.6966	3.1082	16.3364	2.6966
2.9628	0.9491	2.7362	3.1111	17.7623	2.7362
2.9420	1.0229	2.7771	3.1147	19.1727	2.7771
2.9203	1.0958	2.8194	3.1191	20.5674	2.8194
2.8979	1.1677	2.8629	3.1243	21.9468	2.8629
2.8749	1.2387	2.9075	3.1304	23.3099	2.9075
2.8513	1.3089	2.9531	3.1374	24.6577	2.9531
2.8274	1.3784	2.9996	3.1455	25.9898	2.9996
2.8032	1.4472	3.0470	3.1547	27.3066	3.0470
2.7787	1.5154	3.0951	3.1651	28.6062	3.0951
2.7542	1.5831	3.1439	3.1767	29.8901	3.1439
2.7296	1.6504	3.1933	3.1898	31.1581	3.1933
2.7052	1.7173	3.2431	3.2043	32.4086	3.2431
2.6808	1.7841	3.2933	3.2202	33.6437	3.2933
2.6567	1.8507	3.3437	3.2378	34.8612	3.3437
2.6328	1.9172	3.3943	3.2569	36.0625	3.3943

2.6091	1.9838	3.4450	3.2777	37.2471	3.4450
2.5858	2.0506	3.4957	3.3002	38.4152	3.4957
2.5627	2.1175	3.5462	3.3243	39.5656	3.5462
2.5400	2.1847	3.5965	3.3503	40.6997	3.5965
2.5176	2.2523	3.6464	3.3781	41.8161	3.6464
2.4956	2.3203	3.6959	3.4076	42.9156	3.6959
2.4739	2.3888	3.7449	3.4389	43.9979	3.7449
2.4524	2.4578	3.7933	3.4721	45.0631	3.7933
2.4313	2.5274	3.8410	3.5070	46.1105	3.8410
2.4104	2.5977	3.8879	3.5437	47.1410	3.8879
2.3898	2.6685	3.9339	3.5821	48.1542	3.9339
2.3692	2.7400	3.9789	3.6223	49.1505	3.9789
2.3488	2.8122	4.0230	3.6640	50.1301	4.0230
2.3285	2.8849	4.0660	3.7074	51.0928	4.0660
2.3081	2.9584	4.1079	3.7522	52.0390	4.1079
2.2877	3.0324	4.1487	3.7985	52.9689	4.1487
2.2671	3.1070	4.1884	3.8462	53.8828	4.1884
2.2464	3.1822	4.2268	3.8953	54.7808	4.2268
2.2255	3.2580	4.2641	3.9455	55.6634	4.2641
2.2043	3.3342	4.3002	3.9970	56.5308	4.3002
2.1828	3.4110	4.3350	4.0496	57.3833	4.3350
2.1609	3.4881	4.3687	4.1032	58.2213	4.3687
2.1386	3.5657	4.4011	4.1579	59.0452	4.4011
2.1159	3.6436	4.4324	4.2134	59.8552	4.4324
2.0927	3.7218	4.4624	4.2698	60.6517	4.4624
2.0690	3.8003	4.4914	4.3271	61.4348	4.4914
2.0448	3.8791	4.5191	4.3850	62.2049	4.5191
2.0200	3.9581	4.5458	4.4437	62.9628	4.5458
1.9946	4.0372	4.5714	4.5031	63.7085	4.5714
1.9685	4.1165	4.5960	4.5630	64.4425	4.5960
1.9419	4.1958	4.6194	4.6234	65.1647	4.6194
1.9146	4.2753	4.6419	4.6844	65.8762	4.6419
1.8866	4.3548	4.6634	4.7459	66.5766	4.6634
1.8580	4.4344	4.6840	4.8079	67.2662	4.6840
1.8287	4.5139	4.7036	4.8702	67.9452	4.7036
1.7988	4.5933	4.7223	4.9330	68.6140	4.7223
1.7682	4.6728	4.7402	4.9961	69.2730	4.7402
1.7369	4.7521	4.7572	5.0596	69.9222	4.7572
1.7050	4.8314	4.7734	5.1234	70.5618	4.7734
1.6724	4.9105	4.7888	5.1875	71.1922	4.7888
1.6392	4.9895	4.8035	5.2519	71.8135	4.8035
1.6053	5.0684	4.8174	5.3166	72.4258	4.8174
1.5707	5.1471	4.8306	5.3815	73.0295	4.8306
1.5356	5.2257	4.8430	5.4466	73.6244	4.8430
1.4998	5.3041	4.8548	5.5120	74.2114	4.8548
1.4633	5.3822	4.8660	5.5776	74.7901	4.8660
1.4263	5.4602	4.8765	5.6434	75.3607	4.8765
1.3887	5.5380	4.8864	5.7095	75.9233	4.8864
1.3504	5.6156	4.8957	5.7757	76.4782	4.8957
1.3117	5.6929	4.9044	5.8421	77.0253	4.9044
1.2723	5.7701	4.9125	5.9087	77.5652	4.9125
1.2324	5.8470	4.9201	5.9755	78.0975	4.9201
1.1920	5.9237	4.9272	6.0424	78.6224	4.9272
1.1511	6.0001	4.9338	6.1096	79.1400	4.9338
1.1097	6.0764	4.9398	6.1769	79.6504	4.9398
1.0678	6.1524	4.9454	6.2444	80.1536	4.9454
1.0255	6.2282	4.9505	6.3121	80.6496	4.9505
0.9828	6.3038	4.9551	6.3800	81.1388	4.9551
0.9396	6.3792	4.9592	6.4480	81.6210	4.9592
0.8961	6.4544	4.9630	6.5163	82.0963	4.9630
0.8521	6.5294	4.9662	6.5848	82.5645	4.9662
0.8079	6.6042	4.9691	6.6534	83.0258	4.9691
0.7633	6.6788	4.9715	6.7223	83.4802	4.9715
0.7184	6.7533	4.9736	6.7914	83.9277	4.9736
0.6732	6.8276	4.9752	6.8607	84.3686	4.9752
0.6278	6.9018	4.9764	6.9303	84.8024	4.9764
0.5822	6.9758	4.9772	7.0001	85.2294	4.9772
0.5363	7.0497	4.9777	7.0700	85.6499	4.9777

STREAMLINE 3

X                      Y                      Z                      R                      THETA                      Z

3.1341	0.0431	2.5000	3.1344	0.7872	2.5000
3.1516	0.0618	2.4873	3.1522	1.1226	2.4873
3.1687	0.0832	2.4789	3.1698	1.5039	2.4789
3.1839	0.1068	2.4729	3.1857	1.9213	2.4729
3.2010	0.1460	2.4689	3.2043	2.6108	2.4689
3.2088	0.1880	2.4720	3.2143	3.3531	2.4720
3.2077	0.2300	2.4815	3.2159	4.1010	2.4815
3.2057	0.2717	2.4919	3.2172	4.8448	2.4919
3.2031	0.3133	2.5028	3.2184	5.5862	2.5028
3.2001	0.3547	2.5143	3.2197	6.3245	2.5143
3.1923	0.4368	2.5389	3.2221	7.7916	2.5389
3.1823	0.5181	2.5655	3.2242	9.2470	2.5655
3.1702	0.5984	2.5941	3.2262	10.6891	2.5941
3.1561	0.6777	2.6245	3.2280	12.1188	2.6245
3.1401	0.7559	2.6568	3.2298	13.5349	2.6568
3.1227	0.8331	2.6906	3.2319	14.9386	2.6906
3.1040	0.9094	2.7260	3.2345	16.3289	2.7260
3.0841	0.9846	2.7628	3.2375	17.7057	2.7628
3.0632	1.0589	2.8010	3.2411	19.0698	2.8010
3.0413	1.1323	2.8404	3.2453	20.4208	2.8404
3.0187	1.2048	2.8809	3.2502	21.7580	2.8809
2.9953	1.2765	2.9225	3.2559	23.0820	2.9225
2.9713	1.3473	2.9651	3.2625	24.3920	2.9651
2.9468	1.4175	3.0086	3.2701	25.6891	3.0086
2.9220	1.4870	3.0530	3.2786	26.9717	3.0530
2.8968	1.5559	3.0981	3.2882	28.2410	3.0981
2.8714	1.6243	3.1439	3.2990	29.4958	3.1439
2.8459	1.6922	3.1902	3.3110	30.7362	3.1902
2.8203	1.7598	3.2370	3.3243	31.9632	3.2370
2.7948	1.8271	3.2843	3.3390	33.1750	3.2843
2.7693	1.8942	3.3318	3.3552	34.3728	3.3318
2.7440	1.9613	3.3796	3.3728	35.5556	3.3796
2.7188	2.0283	3.4274	3.3920	36.7235	3.4274
2.6939	2.0953	3.4753	3.4128	37.8759	3.4753
2.6692	2.1625	3.5232	3.4353	39.0138	3.5232
2.6448	2.2299	3.5709	3.4594	40.1357	3.5709
2.6206	2.2976	3.6184	3.4852	41.2425	3.6184
2.5968	2.3656	3.6655	3.5127	42.3333	3.6655
2.5732	2.4340	3.7121	3.5420	43.4080	3.7121
2.5499	2.5029	3.7582	3.5730	44.4672	3.7582
2.5269	2.5723	3.8038	3.6058	45.5102	3.8038
2.5041	2.6422	3.8486	3.6403	46.5369	3.8486
2.4816	2.7127	3.8926	3.6765	47.5474	3.8926
2.4592	2.7837	3.9358	3.7144	48.5417	3.9358
2.4370	2.8554	3.9781	3.7540	49.5196	3.9781
2.4149	2.9276	4.0195	3.7951	50.4816	4.0195
2.3928	3.0004	4.0598	3.8377	51.4273	4.0598
2.3708	3.0738	4.0991	3.8818	52.3574	4.0991
2.3486	3.1477	4.1374	3.9273	53.2713	4.1374
2.3264	3.2221	4.1745	3.9742	54.1700	4.1745
2.3040	3.2970	4.2106	4.0223	55.0534	4.2106
2.2814	3.3724	4.2455	4.0716	55.9216	4.2455
2.2586	3.4483	4.2792	4.1221	56.7755	4.2792
2.2355	3.5245	4.3118	4.1737	57.6144	4.3118
2.2120	3.6012	4.3433	4.2263	58.4395	4.3433
2.1882	3.6782	4.3736	4.2799	59.2508	4.3736
2.1640	3.7555	4.4028	4.3343	60.0485	4.4028
2.1393	3.8330	4.4309	4.3896	60.8332	4.4309
2.1142	3.9108	4.4580	4.4457	61.6045	4.4580
2.0886	3.9888	4.4840	4.5025	62.3633	4.4840
2.0624	4.0670	4.5089	4.5600	63.1102	4.5089
2.0356	4.1452	4.5328	4.6181	63.8453	4.5328
2.0083	4.2236	4.5557	4.6768	64.5688	4.5557
1.9804	4.3021	4.5777	4.7361	65.2814	4.5777
1.9520	4.3806	4.5987	4.7958	65.9824	4.5987
1.9229	4.4591	4.6187	4.8560	66.6729	4.6187
1.8932	4.5376	4.6379	4.9167	67.3529	4.6379
1.8629	4.6161	4.6563	4.9779	68.0229	4.6563
1.8320	4.6945	4.6738	5.0393	68.6823	4.6738
1.8005	4.7729	4.6905	5.1012	69.3323	4.6905
1.7683	4.8512	4.7064	5.1634	69.9727	4.7064
1.7355	4.9293	4.7216	5.2259	70.6038	4.7216

1.7021	5.0074	4.7360	5.2888	71.2260	4.7360
1.6681	5.0853	4.7498	5.3519	71.8390	4.7498
1.6335	5.1631	4.7628	5.4153	72.4432	4.7628
1.5983	5.2407	4.7752	5.4790	73.0390	4.7752
1.5625	5.3181	4.7869	5.5429	73.6264	4.7869
1.5261	5.3953	4.7980	5.6070	74.2057	4.7980
1.4892	5.4724	4.8085	5.6714	74.7769	4.8085
1.4517	5.5493	4.8184	5.7360	75.3402	4.8184
1.4136	5.6259	4.8277	5.8008	75.8958	4.8277
1.3749	5.7024	4.8365	5.8658	76.4437	4.8365
1.3358	5.7786	4.8448	5.9310	76.9840	4.8448
1.2961	5.8546	4.8525	5.9964	77.5169	4.8525
1.2559	5.9305	4.8598	6.0620	78.0427	4.8598
1.2153	6.0061	4.8666	6.1278	78.5611	4.8666
1.1741	6.0814	4.8729	6.1938	79.0723	4.8729
1.1326	6.1566	4.8787	6.2599	79.5765	4.8787
1.0905	6.2316	4.8841	6.3263	80.0736	4.8841
1.0481	6.3063	4.8891	6.3928	80.5637	4.8891
1.0053	6.3809	4.8936	6.4596	81.0469	4.8936
0.9621	6.4553	4.8978	6.5266	81.5233	4.8978
0.9185	6.5294	4.9015	6.5937	81.9928	4.9015
0.8746	6.6034	4.9048	6.6611	82.4555	4.9048
0.8304	6.6772	4.9078	6.7287	82.9113	4.9078
0.7858	6.7509	4.9103	6.7965	83.3605	4.9103
0.7410	6.8244	4.9125	6.8645	83.8029	4.9125
0.6960	6.8978	4.9143	6.9328	84.2385	4.9143
0.6507	6.9710	4.9158	7.0013	84.6674	4.9158
0.6051	7.0441	4.9169	7.0700	85.0899	4.9169

STREAMLINE 4

X	Y	Z	R	THETA	Z
3.3817	0.1828	2.5000	3.3867	3.0938	2.5000
3.3804	0.2021	2.4805	3.3864	3.4215	2.4805
3.3786	0.2286	2.4719	3.3863	3.8710	2.4719
3.3766	0.2564	2.4695	3.3863	4.3431	2.4695
3.3732	0.2981	2.4734	3.3863	5.0505	2.4734
3.3694	0.3390	2.4824	3.3864	5.7455	2.4824
3.3652	0.3797	2.4921	3.3866	6.4378	2.4921
3.3605	0.4203	2.5022	3.3867	7.1284	2.5022
3.3554	0.4606	2.5128	3.3869	7.8168	2.5128
3.3499	0.5008	2.5239	3.3871	8.5029	2.5239
3.3375	0.5806	2.5475	3.3876	9.8684	2.5475
3.3236	0.6596	2.5729	3.3884	11.2244	2.5729
3.3081	0.7377	2.6000	3.3894	12.5707	2.6000
3.2913	0.8149	2.6286	3.3907	13.9071	2.6286
3.2732	0.8914	2.6588	3.3924	15.2333	2.6588
3.2539	0.9669	2.6903	3.3945	16.5492	2.6903
3.2335	1.0416	2.7232	3.3971	17.8547	2.7232
3.2122	1.1154	2.7573	3.4003	19.1496	2.7573
3.1899	1.1885	2.7926	3.4041	20.4338	2.7926
3.1669	1.2607	2.8290	3.4086	21.7072	2.8290
3.1431	1.3322	2.8664	3.4137	22.9696	2.8664
3.1186	1.4029	2.9047	3.4196	24.2209	2.9047
3.0935	1.4730	2.9440	3.4263	25.4610	2.9440
3.0681	1.5424	2.9840	3.4340	26.6899	2.9840
3.0422	1.6113	3.0248	3.4426	27.9072	3.0248
3.0161	1.6796	3.0663	3.4522	29.1127	3.0663
2.9897	1.7475	3.1084	3.4630	30.3065	3.1084
2.9632	1.8150	3.1509	3.4749	31.4883	3.1509
2.9365	1.8822	3.1940	3.4880	32.6580	3.1940
2.9098	1.9491	3.2374	3.5023	33.8153	3.2374
2.8831	2.0158	3.2811	3.5179	34.9600	3.2811
2.8564	2.0823	3.3251	3.5348	36.0919	3.3251
2.8298	2.1488	3.3693	3.5531	37.2109	3.3693
2.8033	2.2152	3.4135	3.5729	38.3168	3.4135
2.7769	2.2817	3.4577	3.5941	39.4094	3.4577
2.7507	2.3483	3.5019	3.6167	40.4884	3.5019
2.7246	2.4151	3.5459	3.6409	41.5537	3.5459
2.6988	2.4821	3.5897	3.6667	42.6051	3.5897
2.6732	2.5494	3.6331	3.6939	43.6426	3.6331



2.6477	2.6170	3.6762	3.7228	44.6659	3.6762
2.6225	2.6850	3.7188	3.7532	45.6750	3.7188
2.5974	2.7534	3.7609	3.7852	46.6696	3.7609
2.5725	2.8222	3.8024	3.8187	47.6497	3.8024
2.5478	2.8914	3.8432	3.8538	48.6153	3.8432
2.5231	2.9611	3.8833	3.8903	49.5663	3.8833
2.4986	3.0313	3.9226	3.9284	50.5026	3.9226
2.4741	3.1020	3.9611	3.9678	51.4243	3.9611
2.4497	3.1731	3.9988	4.0087	52.3314	3.9988
2.4253	3.2447	4.0355	4.0509	53.2240	4.0355
2.4008	3.3168	4.0713	4.0945	54.1023	4.0713
2.3762	3.3893	4.1061	4.1393	54.9664	4.1061
2.3515	3.4622	4.1400	4.1853	55.8165	4.1400
2.3266	3.5356	4.1728	4.2324	56.6529	4.1728
2.3015	3.6093	4.2046	4.2806	57.4757	4.2046
2.2761	3.6833	4.2354	4.3298	58.2857	4.2354
2.2505	3.7577	4.2651	4.3801	59.0822	4.2651
2.2245	3.8324	4.2939	4.4312	59.8667	4.2939
2.1982	3.9073	4.3216	4.4832	60.6383	4.3216
2.1715	3.9824	4.3483	4.5360	61.3976	4.3483
2.1444	4.0578	4.3739	4.5896	62.1449	4.3739
2.1169	4.1334	4.3986	4.6439	62.8805	4.3986
2.0890	4.2091	4.4224	4.6989	63.6046	4.4224
2.0606	4.2849	4.4452	4.7546	64.3174	4.4452
2.0317	4.3608	4.4670	4.8108	65.0193	4.4670
2.0023	4.4368	4.4879	4.8677	65.7104	4.4879
1.9724	4.5128	4.5080	4.9250	66.3909	4.5080
1.9421	4.5889	4.5272	4.9829	67.0613	4.5272
1.9112	4.6649	4.5455	5.0412	67.7215	4.5455
1.8798	4.7409	4.5630	5.1000	68.3719	4.5630
1.8478	4.8169	4.5797	5.1592	69.0127	4.5797
1.8154	4.8929	4.5956	5.2188	69.6440	4.5956
1.7824	4.9688	4.6107	5.2788	70.2661	4.6107
1.7489	5.0446	4.6251	5.3391	70.8791	4.6251
1.7149	5.1203	4.6388	5.3998	71.4832	4.6388
1.6804	5.1959	4.6518	5.4608	72.0786	4.6518
1.6453	5.2713	4.6640	5.5221	72.6654	4.6640
1.6098	5.3467	4.6757	5.5838	73.2438	4.6757
1.5738	5.4219	4.6866	5.6457	73.8139	4.6866
1.5373	5.4969	4.6970	5.7078	74.3760	4.6970
1.5003	5.5719	4.7067	5.7703	74.9300	4.7067
1.4628	5.6466	4.7158	5.8330	75.4761	4.7158
1.4249	5.7212	4.7244	5.8960	76.0145	4.7244
1.3866	5.7956	4.7324	5.9592	76.5453	4.7324
1.3478	5.8699	4.7398	6.0226	77.0685	4.7398
1.3086	5.9440	4.7467	6.0863	77.5843	4.7467
1.2690	6.0179	4.7531	6.1502	78.0928	4.7531
1.2289	6.0917	4.7590	6.2144	78.5941	4.7590
1.1886	6.1652	4.7643	6.2788	79.0880	4.7643
1.1478	6.2387	4.7692	6.3434	79.5749	4.7692
1.1068	6.3119	4.7737	6.4082	80.0546	4.7737
1.0654	6.3850	4.7776	6.4733	80.5273	4.7776
1.0236	6.4580	4.7812	6.5386	80.9930	4.7812
0.9817	6.5308	4.7842	6.6042	81.4517	4.7842
0.9394	6.6035	4.7869	6.6700	81.9034	4.7869
0.8969	6.6760	4.7891	6.7360	82.3481	4.7891
0.8542	6.7485	4.7909	6.8023	82.7858	4.7909
0.8113	6.8208	4.7923	6.8689	83.2166	4.7923
0.7682	6.8930	4.7933	6.9357	83.6407	4.7933
0.7249	6.9651	4.7939	7.0027	84.0584	4.7939
0.6814	7.0371	4.7941	7.0700	84.4694	4.7941

STREAMLINE 5

X	Y	Z	R	THETA	Z
-----	-----	-----	-----	-----	-----
3.6089	0.3323	2.5000	3.6241	5.2604	2.5000
3.6068	0.3507	2.4805	3.6238	5.5543	2.4805
3.6041	0.3765	2.4717	3.6237	5.9635	2.4717
3.6011	0.4036	2.4688	3.6236	6.3947	2.4688
3.5963	0.4444	2.4713	3.6237	7.0440	2.4713
3.5913	0.4845	2.4791	3.6238	7.6834	2.4791

3.5858	0.5245	2.4875	3.6239	8.3211	2.4875
3.5799	0.5643	2.4962	3.6241	8.9573	2.4962
3.5736	0.6039	2.5055	3.6242	9.5919	2.5055
3.5669	0.6434	2.5151	3.6245	10.2249	2.5151
3.5524	0.7218	2.5356	3.6250	11.4861	2.5356
3.5364	0.7996	2.5576	3.6256	12.7403	2.5576
3.5190	0.8766	2.5812	3.6265	13.9875	2.5812
3.5003	0.9528	2.6061	3.6276	15.2274	2.6061
3.4803	1.0283	2.6324	3.6290	16.4599	2.6324
3.4591	1.1029	2.6600	3.6307	17.6847	2.6600
3.4369	1.1768	2.6888	3.6328	18.9018	2.6888
3.4137	1.2500	2.7187	3.6354	20.1110	2.7187
3.3895	1.3224	2.7498	3.6384	21.3122	2.7498
3.3646	1.3940	2.7818	3.6419	22.5053	2.7818
3.3388	1.4649	2.8148	3.6460	23.6902	2.8148
3.3123	1.5352	2.8488	3.6508	24.8666	2.8488
3.2852	1.6047	2.8835	3.6562	26.0346	2.8835
3.2575	1.6737	2.9191	3.6623	27.1939	2.9191
3.2294	1.7421	2.9554	3.6693	28.3443	2.9554
3.2009	1.8099	2.9924	3.6772	29.4856	2.9924
3.1721	1.8773	3.0301	3.6860	30.6178	3.0301
3.1430	1.9442	3.0682	3.6957	31.7406	3.0682
3.1136	2.0107	3.1069	3.7064	32.8539	3.1069
3.0841	2.0769	3.1461	3.7182	33.9574	3.1461
3.0545	2.1428	3.1857	3.7312	35.0509	3.1857
3.0248	2.2085	3.2256	3.7452	36.1341	3.2256
2.9951	2.2739	3.2658	3.7605	37.2069	3.2658
2.9654	2.3393	3.3062	3.7770	38.2690	3.3062
2.9357	2.4046	3.3467	3.7948	39.3203	3.3467
2.9061	2.4699	3.3873	3.8139	40.3604	3.3873
2.8767	2.5352	3.4280	3.8344	41.3893	3.4280
2.8474	2.6006	3.4686	3.8562	42.4065	3.4686
2.8182	2.6662	3.5090	3.8795	43.4120	3.5090
2.7892	2.7319	3.5492	3.9042	44.4056	3.5492
2.7604	2.7979	3.5892	3.9304	45.3870	3.5892
2.7318	2.8642	3.6288	3.9581	46.3561	3.6288
2.7033	2.9308	3.6681	3.9872	47.3127	3.6681
2.6750	2.9978	3.7068	4.0178	48.2566	3.7068
2.6469	3.0651	3.7450	4.0498	49.1877	3.7450
2.6189	3.1329	3.7826	4.0834	50.1059	3.7826
2.5911	3.2010	3.8196	4.1183	51.0110	3.8196
2.5634	3.2696	3.8559	4.1546	51.9029	3.8559
2.5358	3.3385	3.8915	4.1924	52.7818	3.8915
2.5082	3.4079	3.9262	4.2314	53.6475	3.9262
2.4806	3.4777	3.9602	4.2718	54.5003	3.9602
2.4530	3.5480	3.9933	4.3134	55.3401	3.9933
2.4254	3.6186	4.0255	4.3562	56.1672	4.0255
2.3977	3.6895	4.0568	4.4002	56.9818	4.0568
2.3698	3.7608	4.0871	4.4452	57.7844	4.0871
2.3417	3.8325	4.1165	4.4913	58.5744	4.1165
2.3135	3.9044	4.1450	4.5384	59.3521	4.1450
2.2850	3.9767	4.1725	4.5864	60.1181	4.1725
2.2563	4.0492	4.1991	4.6354	60.8721	4.1991
2.2273	4.1219	4.2247	4.6852	61.6145	4.2247
2.1981	4.1948	4.2494	4.7358	62.3455	4.2494
2.1685	4.2679	4.2732	4.7872	63.0653	4.2732
2.1386	4.3412	4.2960	4.8394	63.7741	4.2960
2.1083	4.4146	4.3180	4.8922	64.4720	4.3180
2.0777	4.4881	4.3390	4.9457	65.1593	4.3390
2.0466	4.5617	4.3592	4.9998	65.8363	4.3592
2.0152	4.6353	4.3785	5.0544	66.5030	4.3785
1.9834	4.7090	4.3970	5.1097	67.1597	4.3970
1.9512	4.7827	4.4147	5.1654	67.8066	4.4147
1.9185	4.8565	4.4316	5.2217	68.4438	4.4316
1.8854	4.9302	4.4477	5.2784	69.0716	4.4477
1.8520	5.0038	4.4630	5.3356	69.6901	4.4630
1.8181	5.0775	4.4776	5.3932	70.2994	4.4776
1.7837	5.1511	4.4915	5.4512	70.8999	4.4915
1.7490	5.2246	4.5046	5.5096	71.4915	4.5046
1.7138	5.2980	4.5171	5.5683	72.0744	4.5171
1.6783	5.3714	4.5289	5.6275	72.6488	4.5289
1.6423	5.4446	4.5401	5.6869	73.2149	4.5401
1.6059	5.5178	4.5506	5.7467	73.7727	4.5506

1.5692	5.5908	4.5605	5.8069	74.3223	4.5605
1.5320	5.6638	4.5698	5.8673	74.8640	4.5698
1.4945	5.7366	4.5785	5.9281	75.3977	4.5785
1.4566	5.8093	4.5866	5.9891	75.9236	4.5866
1.4184	5.8819	4.5942	6.0505	76.4418	4.5942
1.3799	5.9543	4.6013	6.1121	76.9524	4.6013
1.3410	6.0266	4.6078	6.1740	77.4555	4.6078
1.3018	6.0988	4.6138	6.2362	77.9511	4.6138
1.2623	6.1709	4.6193	6.2987	78.4393	4.6193
1.2225	6.2429	4.6243	6.3614	78.9201	4.6243
1.1825	6.3147	4.6288	6.4245	79.3938	4.6288
1.1422	6.3864	4.6329	6.4878	79.8602	4.6329
1.1016	6.4581	4.6365	6.5513	80.3194	4.6365
1.0609	6.5296	4.6396	6.6152	80.7715	4.6396
1.0200	6.6010	4.6423	6.6793	81.2164	4.6423
0.9788	6.6723	4.6446	6.7438	81.6542	4.6446
0.9376	6.7436	4.6464	6.8085	82.0849	4.6464
0.8961	6.8148	4.6479	6.8734	82.5086	4.6479
0.8546	6.8859	4.6489	6.9387	82.9255	4.6489
0.8128	6.9569	4.6495	7.0042	83.3358	4.6495
0.7710	7.0278	4.6497	7.0700	83.7395	4.6497

STREAMLINE 6

X	Y	Z	R	THETA	Z
3.8292	0.4997	2.5001	3.8616	7.4346	2.5001
3.8264	0.5172	2.4808	3.8612	7.6984	2.4808
3.8228	0.5421	2.4717	3.8611	8.0717	2.4717
3.8189	0.5685	2.4684	3.8610	8.4668	2.4684
3.8128	0.6082	2.4698	3.8611	9.0635	2.4698
3.8065	0.6474	2.4764	3.8612	9.6531	2.4764
3.7998	0.6865	2.4836	3.8613	10.2411	2.4836
3.7927	0.7254	2.4912	3.8614	10.8279	2.4912
3.7852	0.7642	2.4992	3.8616	11.4137	2.4992
3.7774	0.8028	2.5075	3.8618	11.9983	2.5075
3.7608	0.8796	2.5253	3.8623	13.1641	2.5253
3.7427	0.9557	2.5444	3.8628	14.3249	2.5444
3.7234	1.0312	2.5648	3.8636	15.4807	2.5648
3.7028	1.1061	2.5864	3.8645	16.6311	2.5864
3.6810	1.1802	2.6093	3.8656	17.7762	2.6093
3.6581	1.2536	2.6333	3.8670	18.9156	2.6333
3.6342	1.3263	2.6584	3.8686	20.0493	2.6584
3.6092	1.3983	2.6845	3.8706	21.1773	2.6845
3.5833	1.4696	2.7116	3.8730	22.2994	2.7116
3.5566	1.5402	2.7396	3.8757	23.4154	2.7396
3.5290	1.6101	2.7686	3.8790	24.5253	2.7686
3.5007	1.6795	2.7983	3.8827	25.6290	2.7983
3.4718	1.7481	2.8289	3.8871	26.7263	2.8289
3.4423	1.8162	2.8603	3.8920	27.8171	2.8603
3.4122	1.8837	2.8923	3.8976	28.9012	2.8923
3.3817	1.9507	2.9250	3.9040	29.9784	2.9250
3.3507	2.0172	2.9584	3.9110	31.0487	2.9584
3.3194	2.0832	2.9923	3.9189	32.1118	2.9923
3.2877	2.1488	3.0268	3.9276	33.1674	3.0268
3.2558	2.2139	3.0618	3.9372	34.2154	3.0618
3.2237	2.2787	3.0972	3.9478	35.2556	3.0972
3.1914	2.3433	3.1330	3.9593	36.2878	3.1330
3.1590	2.4075	3.1692	3.9718	37.3117	3.1692
3.1265	2.4716	3.2058	3.9854	38.3271	3.2058
3.0940	2.5355	3.2425	4.0002	39.3338	3.2425
3.0615	2.5992	3.2795	4.0161	40.3316	3.2795
3.0290	2.6629	3.3165	4.0331	41.3202	3.3165
2.9966	2.7266	3.3537	4.0514	42.2995	3.3537
2.9643	2.7904	3.3909	4.0710	43.2690	3.3909
2.9321	2.8542	3.4281	4.0919	44.2287	3.4281
2.9000	2.9181	3.4651	4.1141	45.1784	3.4651
2.8681	2.9823	3.5020	4.1376	46.1177	3.5020
2.8364	3.0466	3.5386	4.1625	47.0464	3.5386
2.8048	3.1112	3.5750	4.1888	47.9644	3.5750
2.7734	3.1760	3.6110	4.2165	48.8715	3.6110
2.7422	3.2412	3.6466	4.2456	49.7673	3.6466

2.7111	3.3067	3.6818	4.2760	50.6518	3.6818
2.6803	3.3726	3.7164	4.3079	51.5249	3.7164
2.6495	3.4388	3.7504	4.3411	52.3863	3.7504
2.6189	3.5054	3.7839	4.3756	53.2361	3.7839
2.5884	3.5723	3.8167	4.4115	54.0742	3.8167
2.5579	3.6396	3.8487	4.4486	54.9006	3.8487
2.5275	3.7074	3.8800	4.4870	55.7156	3.8800
2.4971	3.7754	3.9106	4.5265	56.5191	3.9106
2.4666	3.8438	3.9403	4.5672	57.3114	3.9403
2.4361	3.9126	3.9691	4.6090	58.0921	3.9691
2.4055	3.9816	3.9972	4.6518	58.8614	3.9972
2.3748	4.0510	4.0243	4.6958	59.6195	4.0243
2.3440	4.1206	4.0506	4.7406	60.3664	4.0506
2.3131	4.1905	4.0761	4.7865	61.1021	4.0761
2.2819	4.2606	4.1006	4.8332	61.8270	4.1006
2.2506	4.3309	4.1243	4.8808	62.5411	4.1243
2.2190	4.4015	4.1471	4.9292	63.2445	4.1471
2.1873	4.4721	4.1691	4.9784	63.9375	4.1691
2.1552	4.5430	4.1902	5.0283	64.6200	4.1902
2.1229	4.6139	4.2104	5.0789	65.2924	4.2104
2.0903	4.6850	4.2299	5.1302	65.9548	4.2299
2.0574	4.7561	4.2485	5.1821	66.6073	4.2485
2.0243	4.8274	4.2663	5.2346	67.2501	4.2663
1.9908	4.8986	4.2833	5.2877	67.8833	4.2833
1.9570	4.9699	4.2996	5.3413	68.5071	4.2996
1.9229	5.0412	4.3151	5.3955	69.1216	4.3151
1.8884	5.1125	4.3299	5.4502	69.7270	4.3299
1.8537	5.1838	4.3439	5.5053	70.3234	4.3439
1.8186	5.2551	4.3573	5.5609	70.9110	4.3573
1.7832	5.3264	4.3700	5.6170	71.4898	4.3700
1.7475	5.3976	4.3820	5.6734	72.0600	4.3820
1.7115	5.4687	4.3933	5.7303	72.6217	4.3933
1.6752	5.5398	4.4040	5.7876	73.1751	4.4040
1.6386	5.6109	4.4141	5.8453	73.7202	4.4141
1.6017	5.6819	4.4236	5.9033	74.2571	4.4236
1.5645	5.7528	4.4325	5.9617	74.7860	4.4325
1.5270	5.8236	4.4408	6.0205	75.3069	4.4408
1.4893	5.8944	4.4485	6.0796	75.8199	4.4485
1.4514	5.9651	4.4557	6.1391	76.3251	4.4557
1.4131	6.0357	4.4624	6.1989	76.8226	4.4624
1.3747	6.1062	4.4685	6.2590	77.3123	4.4685
1.3361	6.1766	4.4741	6.3195	77.7945	4.4741
1.2972	6.2470	4.4792	6.3803	78.2692	4.4792
1.2581	6.3173	4.4839	6.4414	78.7365	4.4839
1.2189	6.3876	4.4880	6.5028	79.1964	4.4880
1.1795	6.4577	4.4917	6.5646	79.6490	4.4917
1.1400	6.5278	4.4949	6.6266	80.0942	4.4949
1.1003	6.5979	4.4977	6.6890	80.5320	4.4977
1.0606	6.6679	4.5001	6.7517	80.9626	4.5001
1.0207	6.7379	4.5020	6.8148	81.3859	4.5020
0.9808	6.8079	4.5034	6.8781	81.8021	4.5034
0.9408	6.8778	4.5045	6.9418	82.2113	4.5045
0.9007	6.9476	4.5051	7.0058	82.6137	4.5051
0.8605	7.0175	4.5053	7.0700	83.0093	4.5053

STREAMLINE 7

X	Y	Z	R	THETA	Z
4.0382	0.7011	2.4811	4.0986	9.8487	2.4811
4.0338	0.7251	2.4719	4.0984	10.1908	2.4719
4.0291	0.7506	2.4682	4.0984	10.5532	2.4682
4.0217	0.7892	2.4687	4.0984	11.1025	2.4687
4.0141	0.8274	2.4741	4.0985	11.6469	2.4741
4.0062	0.8654	2.4804	4.0986	12.1898	2.4804
3.9980	0.9033	2.4870	4.0987	12.7318	2.4870
3.9894	0.9411	2.4939	4.0989	13.2730	2.4939
3.9805	0.9787	2.5011	4.0990	13.8135	2.5011
3.9617	1.0535	2.5164	4.0994	14.8919	2.5164
3.9417	1.1278	2.5329	4.0999	15.9668	2.5329
3.9205	1.2015	2.5505	4.1005	17.0381	2.5505
3.8981	1.2745	2.5692	4.1012	18.1056	2.5692

3.8746	1.3469	2.5889	4.1020	19.1692	2.5889
3.8500	1.4187	2.6096	4.1031	20.2288	2.6096
3.8244	1.4899	2.6313	4.1043	21.2843	2.6313
3.7978	1.5603	2.6539	4.1059	22.3356	2.6539
3.7703	1.6302	2.6775	4.1076	23.3826	2.6775
3.7420	1.6994	2.7018	4.1098	24.4252	2.7018
3.7128	1.7680	2.7270	4.1123	25.4632	2.7270
3.6830	1.8360	2.7529	4.1153	26.4967	2.7529
3.6525	1.9034	2.7796	4.1187	27.5254	2.7796
3.6213	1.9703	2.8070	4.1226	28.5493	2.8070
3.5896	2.0366	2.8350	4.1271	29.5683	2.8350
3.5573	2.1023	2.8637	4.1321	30.5821	2.8637
3.5246	2.1675	2.8930	4.1377	31.5908	2.8930
3.4914	2.2323	2.9228	4.1440	32.5942	2.9228
3.4577	2.2966	2.9532	4.1510	33.5920	2.9532
3.4238	2.3605	2.9841	4.1587	34.5839	2.9841
3.3896	2.4240	3.0154	4.1671	35.5699	3.0154
3.3551	2.4871	3.0473	4.1764	36.5496	3.0473
3.3204	2.5500	3.0795	4.1866	37.5229	3.0795
3.2856	2.6125	3.1121	4.1976	38.4896	3.1121
3.2506	2.6748	3.1450	4.2096	39.4495	3.1450
3.2156	2.7369	3.1782	4.2226	40.4024	3.1782
3.1805	2.7989	3.2116	4.2366	41.3480	3.2116
3.1454	2.8607	3.2453	4.2517	42.2862	3.2453
3.1103	2.9225	3.2790	4.2679	43.2166	3.2790
3.0753	2.9842	3.3129	4.2852	44.1390	3.3129
3.0404	3.0460	3.3468	4.3037	45.0532	3.3468
3.0055	3.1079	3.3807	4.3234	45.9590	3.3807
2.9708	3.1698	3.4145	4.3444	46.8561	3.4145
2.9363	3.2319	3.4482	4.3666	47.7444	3.4482
2.9019	3.2942	3.4817	4.3901	48.6234	3.4817
2.8676	3.3568	3.5150	4.4149	49.4931	3.5150
2.8336	3.4195	3.5480	4.4410	50.3532	3.5480
2.7997	3.4826	3.5807	4.4684	51.2034	3.5807
2.7660	3.5459	3.6129	4.4971	52.0438	3.6129
2.7325	3.6096	3.6447	4.5272	52.8740	3.6447
2.6991	3.6735	3.6760	4.5585	53.6940	3.6760
2.6658	3.7379	3.7067	4.5911	54.5038	3.7067
2.6326	3.8025	3.7369	4.6249	55.3033	3.7369
2.5996	3.8675	3.7663	4.6600	56.0927	3.7663
2.5665	3.9328	3.7951	4.6962	56.8718	3.7951
2.5335	3.9985	3.8232	4.7335	57.6405	3.8232
2.5006	4.0644	3.8506	4.7720	58.3987	3.8506
2.4676	4.1307	3.8772	4.8116	59.1465	3.8772
2.4346	4.1973	3.9031	4.8523	59.8839	3.9031
2.4016	4.2641	3.9282	4.8939	60.6110	3.9282
2.3685	4.3312	3.9525	4.9365	61.3278	3.9525
2.3354	4.3986	3.9759	4.9801	62.0345	3.9759
2.3021	4.4661	3.9986	5.0245	62.7310	3.9986
2.2687	4.5339	4.0204	5.0698	63.4176	4.0204
2.2351	4.6019	4.0415	5.1160	64.0942	4.0415
2.2014	4.6700	4.0618	5.1629	64.7610	4.0618
2.1675	4.7383	4.0812	5.2105	65.4181	4.0812
2.1335	4.8067	4.0999	5.2589	66.0655	4.0999
2.0992	4.8752	4.1178	5.3079	66.7035	4.1178
2.0648	4.9438	4.1350	5.3576	67.3321	4.1350
2.0301	5.0125	4.1514	5.4080	67.9513	4.1514
1.9952	5.0812	4.1671	5.4589	68.5614	4.1671
1.9602	5.1500	4.1820	5.5104	69.1624	4.1820
1.9249	5.2188	4.1962	5.5625	69.7544	4.1962
1.8894	5.2877	4.2098	5.6151	70.3376	4.2098
1.8536	5.3566	4.2226	5.6683	70.9120	4.2226
1.8177	5.4255	4.2348	5.7219	71.4777	4.2348
1.7815	5.4944	4.2463	5.7760	72.0349	4.2463
1.7452	5.5633	4.2572	5.8306	72.5835	4.2572
1.7086	5.6322	4.2675	5.8857	73.1238	4.2675
1.6719	5.7011	4.2772	5.9412	73.6558	4.2772
1.6349	5.7699	4.2863	5.9971	74.1796	4.2863
1.5978	5.8387	4.2947	6.0534	74.6952	4.2947
1.5605	5.9076	4.3027	6.1102	75.2028	4.3027
1.5231	5.9763	4.3100	6.1674	75.7023	4.3100
1.4855	6.0451	4.3168	6.2249	76.1939	4.3168
1.4478	6.1138	4.3231	6.2829	76.6777	4.3231

1.4099	6.1825	4.3289	6.3412	77.1537	4.3289
1.3719	6.2512	4.3341	6.4000	77.6221	4.3341
1.3338	6.3198	4.3389	6.4591	78.0829	4.3389
1.2956	6.3885	4.3432	6.5185	78.5361	4.3432
1.2573	6.4571	4.3469	6.5783	78.9817	4.3469
1.2189	6.5257	4.3503	6.6385	79.4197	4.3503
1.1805	6.5943	4.3531	6.6991	79.8502	4.3531
1.1421	6.6629	4.3555	6.7600	80.2732	4.3555
1.1037	6.7315	4.3575	6.8214	80.6888	4.3575
1.0652	6.8001	4.3590	6.8830	81.0970	4.3590
1.0268	6.8687	4.3600	6.9450	81.4980	4.3600
0.9883	6.9373	4.3607	7.0073	81.8920	4.3607
0.9498	7.0059	4.3609	7.0700	82.2791	4.3609

STREAMLINE 8

X	Y	Z	R	THETA	Z
4.2448	0.8848	2.5001	4.3361	11.7743	2.5001
4.2411	0.9009	2.4814	4.3357	11.9930	2.4814
4.2359	0.9241	2.4722	4.3356	12.3073	2.4722
4.2304	0.9488	2.4682	4.3355	12.6405	2.4682
4.2219	0.9861	2.4677	4.3355	13.1468	2.4677
4.2131	1.0232	2.4721	4.3356	13.6500	2.4721
4.2041	1.0600	2.4775	4.3357	14.1518	2.4775
4.1947	1.0968	2.4831	4.3358	14.6530	2.4831
4.1851	1.1334	2.4891	4.3359	15.1535	2.4891
4.1752	1.1699	2.4953	4.3360	15.6534	2.4953
4.1544	1.2426	2.5085	4.3363	16.6516	2.5085
4.1325	1.3147	2.5226	4.3366	17.6474	2.5226
4.1095	1.3862	2.5378	4.3370	18.6406	2.5378
4.0854	1.4573	2.5538	4.3375	19.6313	2.5538
4.0602	1.5277	2.5707	4.3381	20.6193	2.5707
4.0340	1.5975	2.5884	4.3389	21.6044	2.5884
4.0069	1.6668	2.6071	4.3397	22.5866	2.6071
3.9788	1.7355	2.6265	4.3408	23.5658	2.6265
3.9499	1.8036	2.6467	4.3422	24.5420	2.6467
3.9201	1.8711	2.6677	4.3438	25.5149	2.6677
3.8897	1.9380	2.6893	4.3457	26.4846	2.6893
3.8585	2.0044	2.7117	4.3480	27.4509	2.7117
3.8266	2.0702	2.7348	4.3507	28.4137	2.7348
3.7941	2.1355	2.7585	4.3538	29.3731	2.7585
3.7609	2.2002	2.7827	4.3572	30.3288	2.7827
3.7272	2.2645	2.8076	4.3611	31.2810	2.8076
3.6929	2.3282	2.8330	4.3655	32.2295	2.8330
3.6581	2.3914	2.8589	4.3705	33.1739	2.8589
3.6229	2.4542	2.8854	4.3759	34.1142	2.8854
3.5873	2.5165	2.9123	4.3820	35.0502	2.9123
3.5513	2.5785	2.9398	4.3887	35.9817	2.9398
3.5150	2.6400	2.9677	4.3960	36.9085	2.9677
3.4785	2.7011	2.9960	4.4041	37.8305	2.9960
3.4417	2.7620	3.0248	4.4129	38.7475	3.0248
3.4046	2.8225	3.0539	4.4225	39.6592	3.0539
3.3675	2.8828	3.0833	4.4329	40.5656	3.0833
3.3302	2.9428	3.1130	4.4442	41.4663	3.1130
3.2928	3.0027	3.1431	4.4563	42.3612	3.1431
3.2554	3.0624	3.1733	4.4695	43.2500	3.1733
3.2180	3.1220	3.2038	4.4836	44.1326	3.2038
3.1806	3.1815	3.2344	4.4987	45.0087	3.2344
3.1432	3.2410	3.2651	4.5149	45.8780	3.2651
3.1059	3.3006	3.2959	4.5321	46.7404	3.2959
3.0687	3.3601	3.3266	4.5505	47.5956	3.3266
3.0316	3.4198	3.3574	4.5701	48.4434	3.3574
2.9947	3.4796	3.3881	4.5908	49.2835	3.3881
2.9579	3.5395	3.4186	4.6127	50.1157	3.4186
2.9212	3.5997	3.4490	4.6359	50.9398	3.4490
2.8848	3.6600	3.4791	4.6602	51.7556	3.4791
2.8485	3.7207	3.5089	4.6858	52.5629	3.5089
2.8124	3.7815	3.5384	4.7127	53.3615	3.5384
2.7764	3.8427	3.5675	4.7408	54.1513	3.5675
2.7406	3.9042	3.5962	4.7701	54.9322	3.5962
2.7049	3.9659	3.6244	4.8006	55.7042	3.6244

2.6694	4.0280	3.6520	4.8322	56.4672	3.6520
2.6340	4.0904	3.6791	4.8651	57.2208	3.6791
2.5987	4.1531	3.7056	4.8991	57.9651	3.7056
2.5634	4.2161	3.7314	4.9343	58.7001	3.7314
2.5283	4.2794	3.7566	4.9705	59.4257	3.7566
2.4931	4.3430	3.7811	5.0078	60.1420	3.7811
2.4580	4.4069	3.8050	5.0461	60.8487	3.8050
2.4229	4.4711	3.8281	5.0854	61.5461	3.8281
2.3878	4.5355	3.8505	5.1256	62.2340	3.8505
2.3527	4.6001	3.8721	5.1668	62.9126	3.8721
2.3176	4.6650	3.8930	5.2089	63.5819	3.8930
2.2823	4.7301	3.9132	5.2519	64.2418	3.9132
2.2471	4.7953	3.9326	5.2957	64.8925	3.9326
2.2117	4.8607	3.9513	5.3403	65.5339	3.9513
2.1763	4.9263	3.9692	5.3856	66.1661	3.9692
2.1407	4.9921	3.9864	5.4317	66.7893	3.9864
2.1051	5.0579	4.0030	5.4785	67.4033	4.0030
2.0693	5.1239	4.0187	5.5260	68.0083	4.0187
2.0335	5.1900	4.0338	5.5742	68.6044	4.0338
1.9975	5.2562	4.0482	5.6230	69.1916	4.0482
1.9615	5.3225	4.0620	5.6724	69.7699	4.0620
1.9253	5.3888	4.0750	5.7224	70.3395	4.0750
1.8890	5.4552	4.0874	5.7730	70.9005	4.0874
1.8526	5.5217	4.0991	5.8242	71.4528	4.0991
1.8161	5.5882	4.1102	5.8759	71.9965	4.1102
1.7795	5.6548	4.1207	5.9282	72.5318	4.1207
1.7428	5.7214	4.1306	5.9809	73.0587	4.1306
1.7060	5.7880	4.1398	6.0342	73.5772	4.1398
1.6692	5.8547	4.1485	6.0880	74.0874	4.1485
1.6322	5.9214	4.1566	6.1423	74.5894	4.1566
1.5952	5.9882	4.1642	6.1970	75.0832	4.1642
1.5581	6.0549	4.1712	6.2522	75.5689	4.1712
1.5210	6.1217	4.1776	6.3079	76.0466	4.1776
1.4839	6.1886	4.1835	6.3640	76.5164	4.1835
1.4467	6.2554	4.1889	6.4205	76.9784	4.1889
1.4094	6.3223	4.1938	6.4775	77.4325	4.1938
1.3722	6.3892	4.1982	6.5348	77.8788	4.1982
1.3350	6.4561	4.2021	6.5927	78.3172	4.2021
1.2978	6.5231	4.2055	6.6509	78.7478	4.2055
1.2606	6.5901	4.2085	6.7096	79.1706	4.2085
1.2235	6.6572	4.2109	6.7687	79.5857	4.2109
1.1865	6.7243	4.2130	6.8282	79.9932	4.2130
1.1495	6.7914	4.2145	6.8880	80.3931	4.2145
1.1126	6.8587	4.2156	6.9483	80.7855	4.2156
1.0758	6.9259	4.2163	7.0090	81.1707	4.2163
1.0391	6.9932	4.2165	7.0700	81.5487	4.2165

STREAMLINE 9

X	Y	Z	R	THETA	Z
4.3432	0.9912	2.5000	4.4548	12.8559	2.5000
4.3543	1.0115	2.4895	4.4702	13.0781	2.4895
4.3650	1.0337	2.4827	4.4857	13.3238	2.4827
4.3741	1.0570	2.4773	4.5000	13.5853	2.4773
4.3838	1.0936	2.4712	4.5182	14.0073	2.4712
4.3898	1.1313	2.4676	4.5332	14.4514	2.4676
4.3938	1.1695	2.4667	4.5468	14.9043	2.4667
4.3892	1.2072	2.4697	4.5521	15.3779	2.4697
4.3797	1.2441	2.4743	4.5530	15.8573	2.4743
4.3700	1.2809	2.4792	4.5538	16.3362	2.4792
4.3497	1.3541	2.4896	4.5556	17.2920	2.4896
4.3283	1.4270	2.5009	4.5575	18.2464	2.5009
4.3058	1.4992	2.5131	4.5593	19.1979	2.5131
4.2820	1.5711	2.5261	4.5611	20.1480	2.5261
4.2571	1.6423	2.5399	4.5629	21.0955	2.5399
4.2310	1.7130	2.5546	4.5646	22.0412	2.5546
4.2037	1.7830	2.5699	4.5662	22.9842	2.5699
4.1754	1.8525	2.5861	4.5679	23.9252	2.5861
4.1459	1.9213	2.6030	4.5695	24.8635	2.6030
4.1154	1.9894	2.6206	4.5711	25.7996	2.6206
4.0839	2.0569	2.6390	4.5727	26.7328	2.6390

4.0514	2.1237	2.6582	4.5743	27.6635	2.6582
4.0181	2.1900	2.6779	4.5762	28.5918	2.6779
3.9840	2.2557	2.6983	4.5783	29.5175	2.6983
3.9492	2.3207	2.7192	4.5806	30.4406	2.7192
3.9137	2.3853	2.7408	4.5832	31.3611	2.7408
3.8774	2.4492	2.7629	4.5862	32.2785	2.7629
3.8406	2.5126	2.7856	4.5894	33.1934	2.7856
3.8031	2.5753	2.8088	4.5930	34.1045	2.8088
3.7651	2.6376	2.8326	4.5970	35.0128	2.8326
3.7265	2.6993	2.8570	4.6015	35.9176	2.8570
3.6875	2.7605	2.8818	4.6063	36.8190	2.8818
3.6480	2.8212	2.9072	4.6117	37.7167	2.9072
3.6082	2.8815	2.9331	4.6175	38.6106	2.9331
3.5680	2.9412	2.9595	4.6240	39.5005	2.9595
3.5274	3.0006	2.9864	4.6310	40.3862	2.9864
3.4866	3.0596	3.0137	4.6387	41.2677	3.0137
3.4456	3.1182	3.0414	4.6471	42.1443	3.0414
3.4044	3.1765	3.0696	4.6562	43.0164	3.0696
3.3630	3.2345	3.0981	4.6660	43.8835	3.0981
3.3216	3.2922	3.1270	4.6767	44.7454	3.1270
3.2801	3.3497	3.1563	4.6882	45.6019	3.1563
3.2385	3.4070	3.1858	4.7006	46.4529	3.1858
3.1969	3.4642	3.2157	4.7139	47.2980	3.2157
3.1554	3.5213	3.2457	4.7282	48.1371	3.2457
3.1139	3.5784	3.2760	4.7436	48.9699	3.2760
3.0726	3.6354	3.3064	4.7599	49.7962	3.3064
3.0313	3.6925	3.3369	4.7774	50.6162	3.3369
2.9902	3.7496	3.3674	4.7960	51.4285	3.3674
2.9493	3.8069	3.3980	4.8157	52.2341	3.3980
2.9086	3.8643	3.4284	4.8366	53.0323	3.4284
2.8680	3.9220	3.4588	4.8587	53.8230	3.4588
2.8277	3.9798	3.4890	4.8821	54.6060	3.4890
2.7876	4.0380	3.5189	4.9068	55.3812	3.5189
2.7477	4.0965	3.5486	4.9327	56.1482	3.5486
2.7081	4.1553	3.5778	4.9599	56.9070	3.5778
2.6687	4.2145	3.6067	4.9884	57.6573	3.6067
2.6295	4.2740	3.6352	5.0181	58.3993	3.6352
2.5904	4.3338	3.6631	5.0490	59.1323	3.6631
2.5516	4.3941	3.6906	5.0812	59.8567	3.6906
2.5129	4.4547	3.7174	5.1146	60.5724	3.7174
2.4744	4.5157	3.7435	5.1491	61.2792	3.7435
2.4360	4.5770	3.7691	5.1849	61.9770	3.7691
2.3977	4.6387	3.7939	5.2218	62.6657	3.7939
2.3596	4.7008	3.8180	5.2598	63.3453	3.8180
2.3215	4.7632	3.8413	5.2988	64.0158	3.8413
2.2836	4.8259	3.8639	5.3390	64.6767	3.8639
2.2457	4.8890	3.8858	5.3801	65.3285	3.8858
2.2079	4.9524	3.9068	5.4223	65.9712	3.9068
2.1702	5.0160	3.9271	5.4654	66.6042	3.9271
2.1325	5.0800	3.9466	5.5094	67.2281	3.9466
2.0948	5.1441	3.9653	5.5543	67.8427	3.9653
2.0572	5.2085	3.9832	5.6001	68.4480	3.9832
2.0195	5.2731	4.0004	5.6466	69.0441	4.0004
1.9819	5.3380	4.0168	5.6940	69.6312	4.0168
1.9442	5.4030	4.0324	5.7421	70.2092	4.0324
1.9065	5.4682	4.0473	5.7910	70.7782	4.0473
1.8689	5.5335	4.0615	5.8405	71.3381	4.0615
1.8312	5.5989	4.0750	5.8908	71.8895	4.0750
1.7934	5.6645	4.0877	5.9416	72.4319	4.0877
1.7557	5.7302	4.0998	5.9931	72.9656	4.0998
1.7179	5.7960	4.1112	6.0453	73.4903	4.1112
1.6802	5.8620	4.1219	6.0980	74.0067	4.1219
1.6424	5.9280	4.1320	6.1513	74.5145	4.1320
1.6046	5.9941	4.1414	6.2051	75.0138	4.1414
1.5667	6.0603	4.1502	6.2595	75.5052	4.1502
1.5289	6.1265	4.1584	6.3144	75.9882	4.1584
1.4910	6.1928	4.1661	6.3698	76.4631	4.1661
1.4531	6.2591	4.1731	6.4256	76.9298	4.1731
1.4152	6.3256	4.1797	6.4819	77.3888	4.1797
1.3774	6.3920	4.1857	6.5388	77.8398	4.1857
1.3395	6.4586	4.1911	6.5960	78.2827	4.1911
1.3017	6.5252	4.1961	6.6538	78.7180	4.1961
1.2640	6.5918	4.2005	6.7119	79.1453	4.2005



1.2263	6.6586	4.2044	6.7706	79.5648	4.2044
1.1887	6.7253	4.2078	6.8296	79.9764	4.2078
1.1512	6.7922	4.2107	6.8891	80.3807	4.2107
1.1137	6.8592	4.2131	6.9490	80.7773	4.2131
1.0764	6.9261	4.2150	7.0093	81.1663	4.2150
1.0391	6.9932	4.2165	7.0700	81.5483	4.2165

STREAMLINE 10

X	Y	Z	R	THETA	Z
4.4933	1.0320	2.4998	4.6103	12.9354	2.4998
4.5009	1.0443	2.4793	4.6204	13.0623	2.4793
4.5035	1.0636	2.4628	4.6274	13.2881	2.4628
4.5038	1.0854	2.4495	4.6328	13.5500	2.4495
4.5015	1.1209	2.4352	4.6390	13.9825	2.4352
4.4973	1.1579	2.4259	4.6439	14.4380	2.4259
4.4919	1.1955	2.4207	4.6483	14.9036	2.4207
4.4838	1.2329	2.4215	4.6502	15.3749	2.4215
4.4738	1.2697	2.4258	4.6505	15.8449	2.4258
4.4635	1.3064	2.4303	4.6508	16.3142	2.4303
4.4421	1.3795	2.4399	4.6514	17.2522	2.4399
4.4195	1.4521	2.4505	4.6519	18.1887	2.4505
4.3958	1.5242	2.4619	4.6525	19.1236	2.4619
4.3709	1.5958	2.4741	4.6531	20.0566	2.4741
4.3449	1.6668	2.4871	4.6536	20.9879	2.4871
4.3177	1.7372	2.5010	4.6541	21.9174	2.5010
4.2895	1.8071	2.5156	4.6546	22.8451	2.5156
4.2602	1.8764	2.5309	4.6551	23.7708	2.5309
4.2298	1.9450	2.5470	4.6556	24.6945	2.5470
4.1985	2.0130	2.5637	4.6561	25.6164	2.5637
4.1662	2.0805	2.5811	4.6568	26.5363	2.5811
4.1330	2.1473	2.5991	4.6575	27.4545	2.5991
4.0990	2.2136	2.6176	4.6585	28.3705	2.6176
4.0642	2.2793	2.6366	4.6598	29.2848	2.6366
4.0288	2.3445	2.6562	4.6613	30.1971	2.6562
3.9926	2.4092	2.6763	4.6631	31.1073	2.6763
3.9557	2.4732	2.6969	4.6652	32.0151	2.6969
3.9181	2.5368	2.7181	4.6677	32.9205	2.7181
3.8800	2.5997	2.7398	4.6704	33.8234	2.7398
3.8413	2.6622	2.7620	4.6736	34.7235	2.7620
3.8020	2.7241	2.7847	4.6771	35.6214	2.7847
3.7622	2.7855	2.8079	4.6811	36.5160	2.8079
3.7219	2.8464	2.8315	4.6856	37.4076	2.8315
3.6812	2.9068	2.8557	4.6905	38.2961	2.8557
3.6401	2.9668	2.8803	4.6959	39.1812	2.8803
3.5986	3.0263	2.9053	4.7019	40.0625	2.9053
3.5568	3.0854	2.9308	4.7086	40.9407	2.9308
3.5147	3.1442	2.9567	4.7158	41.8150	2.9567
3.4724	3.2026	2.9830	4.7238	42.6851	2.9830
3.4299	3.2606	3.0097	4.7324	43.5509	3.0097
3.3872	3.3184	3.0367	4.7418	44.4122	3.0367
3.3443	3.3760	3.0640	4.7520	45.2695	3.0640
3.3014	3.4333	3.0917	4.7631	46.1216	3.0917
3.2584	3.4904	3.1196	4.7750	46.9687	3.1196
3.2154	3.5474	3.1477	4.7878	47.8105	3.1477
3.1724	3.6044	3.1760	4.8016	48.6469	3.1760
3.1295	3.6612	3.2045	4.8165	49.4775	3.2045
3.0866	3.7181	3.2331	4.8323	50.3020	3.2331
3.0437	3.7750	3.2618	4.8492	51.1208	3.2618
3.0010	3.8319	3.2906	4.8672	51.9330	3.2906
2.9585	3.8890	3.3192	4.8864	52.7384	3.3192
2.9161	3.9462	3.3479	4.9067	53.5372	3.3479
2.8738	4.0036	3.3764	4.9283	54.3289	3.3764
2.8318	4.0612	3.4047	4.9510	55.1132	3.4047
2.7899	4.1192	3.4327	4.9751	55.8901	3.4327
2.7483	4.1774	3.4604	5.0004	56.6593	3.4604
2.7069	4.2359	3.4878	5.0269	57.4202	3.4878
2.6656	4.2947	3.5149	5.0547	58.1733	3.5149
2.6245	4.3539	3.5415	5.0837	58.9181	3.5415
2.5837	4.4133	3.5676	5.1140	59.6543	3.5676
2.5430	4.4731	3.5933	5.1455	60.3819	3.5933

2.5025	4.5333	3.6183	5.1781	61.1006	3.6183
2.4621	4.5939	3.6428	5.2120	61.8110	3.6428
2.4219	4.6547	3.6666	5.2471	62.5118	3.6666
2.3818	4.7159	3.6898	5.2833	63.2038	3.6898
2.3419	4.7775	3.7124	5.3206	63.8866	3.7124
2.3021	4.8394	3.7342	5.3591	64.5600	3.7342
2.2624	4.9016	3.7553	5.3986	65.2240	3.7553
2.2228	4.9642	3.7757	5.4391	65.8784	3.7757
2.1834	5.0270	3.7954	5.4807	66.5234	3.7954
2.1440	5.0901	3.8143	5.5232	67.1587	3.8143
2.1047	5.1535	3.8325	5.5668	67.7845	3.8325
2.0655	5.2172	3.8499	5.6112	68.4009	3.8499
2.0264	5.2811	3.8666	5.6565	69.0075	3.8666
1.9874	5.3452	3.8826	5.7027	69.6045	3.8826
1.9484	5.4095	3.8979	5.7497	70.1921	3.8979
1.9095	5.4741	3.9124	5.7975	70.7703	3.9124
1.8706	5.5388	3.9262	5.8461	71.3391	3.9262
1.8317	5.6037	3.9393	5.8955	71.8986	3.9393
1.7929	5.6687	3.9518	5.9455	72.4489	3.9518
1.7541	5.7340	3.9635	5.9963	72.9901	3.9635
1.7154	5.7993	3.9745	6.0477	73.5217	3.9745
1.6768	5.8648	3.9849	6.0998	74.0442	3.9849
1.6382	5.9304	3.9946	6.1525	74.5578	3.9946
1.5997	5.9962	4.0036	6.2059	75.0625	4.0036
1.5612	6.0621	4.0121	6.2599	75.5585	4.0121
1.5227	6.1280	4.0199	6.3144	76.0457	4.0199
1.4843	6.1941	4.0272	6.3694	76.5241	4.0272
1.4460	6.2602	4.0338	6.4251	76.9942	4.0338
1.4077	6.3265	4.0399	6.4812	77.4557	4.0399
1.3695	6.3928	4.0454	6.5379	77.9088	4.0454
1.3314	6.4593	4.0504	6.5951	78.3534	4.0504
1.2934	6.5258	4.0548	6.6528	78.7895	4.0548
1.2555	6.5925	4.0587	6.7110	79.2174	4.0587
1.2177	6.6592	4.0620	6.7697	79.6371	4.0620
1.1801	6.7261	4.0648	6.8288	80.0485	4.0648
1.1426	6.7930	4.0671	6.8884	80.4519	4.0671
1.1053	6.8601	4.0689	6.9485	80.8472	4.0689
1.0681	6.9272	4.0702	7.0091	81.2347	4.0702
1.0310	6.9944	4.0710	7.0700	81.6144	4.0710

STREAMLINE 11

X	Y	Z	R	THETA	Z
4.5981	0.9242	2.4619	4.6900	11.3643	2.4619
4.5959	0.9348	2.4377	4.6900	11.4966	2.4377
4.5930	0.9490	2.4154	4.6900	11.6735	2.4154
4.5894	0.9661	2.3955	4.6900	11.8878	2.3955
4.5830	0.9963	2.3703	4.6900	12.2646	2.3703
4.5755	1.0301	2.3508	4.6900	12.6883	2.3508
4.5672	1.0663	2.3362	4.6900	13.1410	2.3362
4.5583	1.1038	2.3261	4.6900	13.6118	2.3261
4.5488	1.1420	2.3200	4.6900	14.0926	2.3200
4.5390	1.1805	2.3171	4.6900	14.5786	2.3171
4.5183	1.2573	2.3208	4.6900	15.5500	2.3208
4.4965	1.3333	2.3304	4.6900	16.5162	2.3304
4.4734	1.4089	2.3411	4.6900	17.4815	2.3411
4.4491	1.4839	2.3527	4.6900	18.4445	2.3527
4.4236	1.5583	2.3653	4.6900	19.4065	2.3653
4.3968	1.6322	2.3787	4.6900	20.3660	2.3787
4.3689	1.7055	2.3930	4.6900	21.3242	2.3930
4.3399	1.7782	2.4082	4.6900	22.2801	2.4082
4.3097	1.8502	2.4241	4.6901	23.2343	2.4241
4.2784	1.9215	2.4407	4.6901	24.1864	2.4407
4.2459	1.9923	2.4581	4.6901	25.1370	2.4581
4.2123	2.0623	2.4759	4.6900	26.0859	2.4759
4.1776	2.1316	2.4943	4.6900	27.0332	2.4943
4.1418	2.2004	2.5130	4.6900	27.9801	2.5130
4.1052	2.2685	2.5322	4.6903	28.9251	2.5322
4.0676	2.3360	2.5519	4.6907	29.8686	2.5519
4.0293	2.4029	2.5721	4.6914	30.8103	2.5721
3.9901	2.4691	2.5928	4.6923	31.7500	2.5928

3.9501	2.5348	2.6140	4.6935	32.6881	2.6140
3.9095	2.5998	2.6357	4.6950	33.6237	2.6357
3.8681	2.6642	2.6580	4.6968	34.5577	2.6580
3.8261	2.7280	2.6807	4.6990	35.4891	2.6807
3.7834	2.7912	2.7039	4.7016	36.4180	2.7039
3.7402	2.8538	2.7276	4.7046	37.3443	2.7276
3.6964	2.9159	2.7518	4.7081	38.2679	2.7518
3.6521	2.9774	2.7765	4.7120	39.1885	2.7765
3.6074	3.0384	2.8017	4.7165	40.1061	2.8017
3.5623	3.0989	2.8273	4.7215	41.0205	2.8273
3.5167	3.1589	2.8534	4.7272	41.9313	2.8534
3.4709	3.2185	2.8799	4.7334	42.8389	2.8799
3.4248	3.2776	2.9067	4.7404	43.7421	2.9067
3.3783	3.3364	2.9340	4.7481	44.6422	2.9340
3.3317	3.3948	2.9617	4.7566	45.5377	2.9617
3.2849	3.4530	2.9897	4.7659	46.4287	2.9897
3.2380	3.5109	3.0180	4.7761	47.3152	3.0180
3.1910	3.5685	3.0466	4.7871	48.1968	3.0466
3.1439	3.6260	3.0755	4.7992	49.0733	3.0755
3.0968	3.6833	3.1045	4.8122	49.9444	3.1045
3.0497	3.7406	3.1338	4.8262	50.8100	3.1338
3.0026	3.7978	3.1631	4.8414	51.6694	3.1631
2.9556	3.8551	3.1926	4.8577	52.5231	3.1926
2.9087	3.9124	3.2221	4.8752	53.3703	3.2221
2.8620	3.9698	3.2517	4.8939	54.2107	3.2517
2.8154	4.0273	3.2811	4.9138	55.0441	3.2811
2.7689	4.0851	3.3104	4.9351	55.8702	3.3104
2.7227	4.1431	3.3396	4.9577	56.6887	3.3396
2.6767	4.2015	3.3685	4.9817	57.4993	3.3685
2.6309	4.2601	3.3971	5.0070	58.3014	3.3971
2.5854	4.3191	3.4255	5.0338	59.0950	3.4255
2.5401	4.3784	3.4534	5.0619	59.8798	3.4534
2.4951	4.4381	3.4810	5.0914	60.6552	3.4810
2.4503	4.4982	3.5080	5.1223	61.4219	3.5080
2.4057	4.5588	3.5346	5.1546	62.1787	3.5346
2.3614	4.6197	3.5605	5.1883	62.9258	3.5605
2.3173	4.6811	3.5858	5.2233	63.6628	3.5858
2.2735	4.7429	3.6105	5.2597	64.3897	3.6105
2.2299	4.8052	3.6345	5.2974	65.1060	3.6345
2.1865	4.8679	3.6578	5.3364	65.8121	3.6578
2.1433	4.9310	3.6803	5.3766	66.5072	3.6803
2.1003	4.9944	3.7020	5.4181	67.1915	3.7020
2.0576	5.0584	3.7230	5.4608	67.8653	3.7230
2.0150	5.1227	3.7432	5.5047	68.5280	3.7432
1.9726	5.1873	3.7626	5.5497	69.1796	3.7626
1.9303	5.2523	3.7812	5.5958	69.8206	3.7812
1.8883	5.3177	3.7989	5.6430	70.4502	3.7989
1.8464	5.3833	3.8159	5.6911	71.0691	3.8159
1.8046	5.4492	3.8320	5.7402	71.6772	3.8320
1.7629	5.5154	3.8473	5.7903	72.2748	3.8473
1.7213	5.5818	3.8618	5.8412	72.8614	3.8618
1.6798	5.6485	3.8755	5.8930	73.4379	3.8755
1.6385	5.7154	3.8885	5.9456	74.0038	3.8885
1.5972	5.7825	3.9006	5.9990	74.5594	3.9006
1.5560	5.8498	3.9119	6.0532	75.1043	3.9119
1.5150	5.9173	3.9225	6.1082	75.6392	3.9225
1.4740	5.9850	3.9324	6.1639	76.1643	3.9324
1.4332	6.0528	3.9415	6.2202	76.6790	3.9415
1.3924	6.1208	3.9499	6.2771	77.1842	3.9499
1.3517	6.1889	3.9576	6.3348	77.6798	3.9576
1.3111	6.2571	3.9646	6.3930	78.1658	3.9646
1.2706	6.3255	3.9710	6.4518	78.6422	3.9710
1.2302	6.3939	3.9767	6.5112	79.1094	3.9767
1.1899	6.4625	3.9817	6.5712	79.5670	3.9817
1.1498	6.5313	3.9862	6.6317	80.0155	3.9862
1.1098	6.6001	3.9899	6.6928	80.4548	3.9899
1.0700	6.6691	3.9931	6.7544	80.8852	3.9931
1.0304	6.7382	3.9956	6.8165	81.3061	3.9956
0.9909	6.8074	3.9976	6.8792	81.7182	3.9976
0.9516	6.8768	3.9989	6.9423	82.1216	3.9989
0.9125	6.9462	3.9997	7.0059	82.5160	3.9997
0.8736	7.0158	4.0000	7.0700	82.9018	4.0000

## PRESSURE SIDE

## PARTIAL BLADE

## STREAMLINE 1

X	Y	Z	R	THETA	Z
3.5053	0.9684	4.0490	3.6366	15.4446	4.0490
3.5179	0.9608	4.0591	3.6468	15.2758	4.0591
3.5309	0.9545	4.0698	3.6576	15.1274	4.0698
3.5441	0.9496	4.0809	3.6691	14.9998	4.0809
3.5642	0.9449	4.0982	3.6873	14.8478	4.0982
3.5844	0.9432	4.1159	3.7064	14.7424	4.1159
3.6045	0.9445	4.1337	3.7262	14.6837	4.1337
3.6243	0.9488	4.1515	3.7464	14.6703	4.1515
3.6434	0.9559	4.1690	3.7667	14.7002	4.1690
3.6619	0.9656	4.1860	3.7871	14.7714	4.1860
3.6958	0.9923	4.2180	3.8267	15.0286	4.2180
3.7244	1.0277	4.2466	3.8636	15.4258	4.2466
3.7484	1.0686	4.2721	3.8978	15.9116	4.2721
3.7720	1.1103	4.2966	3.9320	16.4027	4.2966
3.7951	1.1528	4.3203	3.9663	16.8963	4.3203
3.8179	1.1958	4.3433	4.0008	17.3917	4.3433
3.8402	1.2395	4.3655	4.0353	17.8883	4.3655
3.8621	1.2837	4.3870	4.0699	18.3864	4.3870
3.8836	1.3285	4.4078	4.1045	18.8843	4.4078
3.9047	1.3738	4.4280	4.1393	19.3832	4.4280
3.9253	1.4195	4.4475	4.1741	19.8814	4.4475
3.9455	1.4657	4.4664	4.2089	20.3792	4.4664
3.9652	1.5123	4.4848	4.2438	20.8761	4.4848
3.9846	1.5593	4.5026	4.2788	21.3719	4.5026
4.0035	1.6067	4.5199	4.3138	21.8664	4.5199
4.0219	1.6544	4.5366	4.3489	22.3593	4.5366
4.0400	1.7024	4.5529	4.3840	22.8503	4.5529
4.0576	1.7508	4.5687	4.4192	23.3390	4.5687
4.0748	1.7994	4.5840	4.4545	23.8261	4.5840
4.0917	1.8483	4.5989	4.4898	24.3104	4.5989
4.1081	1.8975	4.6134	4.5252	24.7923	4.6134
4.1242	1.9470	4.6275	4.5606	25.2715	4.6275
4.1398	1.9966	4.6412	4.5962	25.7478	4.6412
4.1552	2.0465	4.6545	4.6318	26.2212	4.6545
4.1701	2.0966	4.6674	4.6675	26.6915	4.6674
4.1847	2.1469	4.6800	4.7033	27.1587	4.6800
4.1990	2.1973	4.6922	4.7392	27.6228	4.6922
4.2129	2.2479	4.7041	4.7751	28.0835	4.7041
4.2265	2.2987	4.7157	4.8112	28.5409	4.7157
4.2398	2.3497	4.7270	4.8474	28.9952	4.7270
4.2527	2.4008	4.7379	4.8836	29.4460	4.7379
4.2653	2.4520	4.7486	4.9199	29.8934	4.7486
4.2776	2.5034	4.7589	4.9563	30.3378	4.7589
4.2896	2.5550	4.7690	4.9928	30.7787	4.7690
4.3012	2.6066	4.7788	5.0294	31.2165	4.7788
4.3125	2.6584	4.7883	5.0660	31.6512	4.7883
4.3235	2.7103	4.7975	5.1028	32.0827	4.7975
4.3341	2.7623	4.8065	5.1395	32.5110	4.8065
4.3444	2.8144	4.8152	5.1764	32.9361	4.8152
4.3545	2.8667	4.8236	5.2133	33.3580	4.8236
4.3641	2.9190	4.8318	5.2504	33.7768	4.8318
4.3735	2.9714	4.8397	5.2874	34.1924	4.8397
4.3826	3.0239	4.8474	5.3246	34.6053	4.8474
4.3913	3.0765	4.8548	5.3617	35.0152	4.8548
4.3997	3.1292	4.8620	5.3990	35.4221	4.8620
4.4077	3.1820	4.8690	5.4363	35.8260	4.8690
4.4155	3.2348	4.8758	5.4736	36.2271	4.8758
4.4229	3.2878	4.8823	5.5110	36.6252	4.8823
4.4300	3.3408	4.8886	5.5485	37.0210	4.8886
4.4368	3.3939	4.8948	5.5860	37.4138	4.8948
4.4432	3.4470	4.9007	5.6235	37.8038	4.9007
4.4493	3.5002	4.9064	5.6611	38.1912	4.9064
4.4551	3.5534	4.9119	5.6987	38.5760	4.9119
4.4606	3.6067	4.9172	5.7363	38.9582	4.9172
4.4657	3.6601	4.9223	5.7740	39.3379	4.9223

4.4706	3.7135	4.9272	5.8117	39.7150	4.9272
4.4750	3.7669	4.9319	5.8494	40.0896	4.9319
4.4792	3.8204	4.9364	5.8872	40.4617	4.9364
4.4830	3.8740	4.9408	5.9250	40.8315	4.9408
4.4865	3.9275	4.9450	5.9628	41.1989	4.9450
4.4897	3.9811	4.9490	6.0006	41.5640	4.9490
4.4926	4.0347	4.9528	6.0384	41.9268	4.9528
4.4951	4.0884	4.9565	6.0762	42.2875	4.9565
4.4972	4.1421	4.9600	6.1141	42.6461	4.9600
4.4990	4.1958	4.9633	6.1519	43.0027	4.9633
4.5005	4.2495	4.9664	6.1897	43.3573	4.9664
4.5016	4.3033	4.9694	6.2276	43.7098	4.9694
4.5023	4.3570	4.9723	6.2654	44.0605	4.9723
4.5027	4.4108	4.9750	6.3031	44.4095	4.9750
4.5027	4.4646	4.9775	6.3409	44.7567	4.9775
4.5023	4.5184	4.9799	6.3786	45.1024	4.9799
4.5015	4.5722	4.9821	6.4162	45.4465	4.9821
4.5002	4.6260	4.9842	6.4538	45.7893	4.9842
4.4986	4.6797	4.9861	6.4913	46.1307	4.9861
4.4965	4.7335	4.9879	6.5288	46.4708	4.9879
4.4940	4.7873	4.9896	6.5661	46.8099	4.9896
4.4910	4.8410	4.9911	6.6034	47.1480	4.9911
4.4875	4.8947	4.9925	6.6405	47.4853	4.9925
4.4835	4.9484	4.9938	6.6775	47.8218	4.9938
4.4790	5.0021	4.9949	6.7143	48.1577	4.9949
4.4739	5.0556	4.9960	6.7510	48.4931	4.9960
4.4683	5.1092	4.9968	6.7875	48.8283	4.9968
4.4621	5.1627	4.9976	6.8237	49.1631	4.9976
4.4553	5.2161	4.9983	6.8598	49.4979	4.9983
4.4478	5.2694	4.9988	6.8956	49.8329	4.9988
4.4396	5.3226	4.9993	6.9311	50.1682	4.9993
4.4308	5.3757	4.9996	6.9664	50.5039	4.9996
4.4212	5.4287	4.9998	7.0013	50.8401	4.9998
4.4109	5.4815	5.0000	7.0358	51.1771	5.0000
4.3997	5.5342	5.0000	7.0700	51.5151	5.0000

STREAMLINE 2

X	Y	Z	R	THETA	Z
3.5466	1.0462	4.0707	3.6977	16.4353	4.0707
3.5598	1.0399	4.0804	3.7086	16.2839	4.0804
3.5736	1.0363	4.0907	3.7208	16.1720	4.0907
3.5876	1.0356	4.1013	3.7341	16.1008	4.1013
3.6084	1.0394	4.1170	3.7551	16.0686	4.1170
3.6282	1.0486	4.1316	3.7767	16.1206	4.1316
3.6465	1.0629	4.1441	3.7982	16.2500	4.1441
3.6624	1.0813	4.1543	3.8186	16.4487	4.1543
3.6754	1.1019	4.1644	3.8370	16.6894	4.1644
3.6865	1.1224	4.1767	3.8536	16.9338	4.1767
3.7082	1.1636	4.2015	3.8865	17.4220	4.2015
3.7295	1.2055	4.2254	3.9195	17.9128	4.2254
3.7505	1.2480	4.2486	3.9527	18.4056	4.2486
3.7711	1.2911	4.2710	3.9860	18.8998	4.2710
3.7913	1.3347	4.2927	4.0194	19.3951	4.2927
3.8111	1.3789	4.3138	4.0528	19.8909	4.3138
3.8305	1.4235	4.3342	4.0864	20.3869	4.3342
3.8494	1.4686	4.3539	4.1201	20.8826	4.3539
3.8680	1.5141	4.3731	4.1538	21.3773	4.3731
3.8862	1.5600	4.3917	4.1876	21.8713	4.3917
3.9040	1.6062	4.4098	4.2215	22.3640	4.4098
3.9214	1.6529	4.4274	4.2555	22.8552	4.4274
3.9384	1.6998	4.4445	4.2896	23.3447	4.4445
3.9551	1.7471	4.4611	4.3237	23.8323	4.4611
3.9713	1.7946	4.4772	4.3579	24.3175	4.4772
3.9872	1.8424	4.4929	4.3923	24.8003	4.4929
4.0027	1.8904	4.5082	4.4267	25.2806	4.5082
4.0179	1.9387	4.5231	4.4612	25.7584	4.5231
4.0327	1.9873	4.5375	4.4958	26.2333	4.5375
4.0472	2.0360	4.5516	4.5304	26.7050	4.5516
4.0613	2.0849	4.5654	4.5652	27.1738	4.5654
4.0752	2.1340	4.5787	4.6001	27.6394	4.5787

4.0887	2.1833	4.5918	4.6351	28.1019	4.5918
4.1019	2.2328	4.6045	4.6702	28.5612	4.6045
4.1148	2.2825	4.6168	4.7054	29.0169	4.6168
4.1274	2.3322	4.6289	4.7408	29.4693	4.6289
4.1397	2.3822	4.6406	4.7762	29.9183	4.6406
4.1517	2.4323	4.6520	4.8117	30.3639	4.6520
4.1634	2.4825	4.6631	4.8474	30.8062	4.6631
4.1748	2.5329	4.6740	4.8831	31.2451	4.6740
4.1860	2.5834	4.6845	4.9189	31.6807	4.6845
4.1968	2.6340	4.6948	4.9549	32.1130	4.6948
4.2073	2.6847	4.7047	4.9909	32.5421	4.7047
4.2175	2.7356	4.7144	5.0270	32.9683	4.7144
4.2274	2.7865	4.7238	5.0632	33.3913	4.7238
4.2370	2.8376	4.7330	5.0994	33.8108	4.7330
4.2463	2.8887	4.7419	5.1358	34.2272	4.7419
4.2553	2.9400	4.7505	5.1722	34.6404	4.7505
4.2641	2.9914	4.7589	5.2087	35.0507	4.7589
4.2725	3.0428	4.7670	5.2453	35.4579	4.7670
4.2806	3.0943	4.7749	5.2819	35.8621	4.7749
4.2884	3.1460	4.7825	5.3186	36.2635	4.7825
4.2959	3.1976	4.7899	5.3554	36.6619	4.7899
4.3031	3.2494	4.7971	5.3922	37.0574	4.7971
4.3100	3.3013	4.8040	5.4291	37.4501	4.8040
4.3166	3.3532	4.8108	5.4660	37.8400	4.8108
4.3229	3.4051	4.8173	5.5030	38.2271	4.8173
4.3289	3.4572	4.8236	5.5400	38.6116	4.8236
4.3346	3.5093	4.8297	5.5771	38.9936	4.8297
4.3400	3.5614	4.8356	5.6142	39.3728	4.8356
4.3450	3.6137	4.8413	5.6513	39.7495	4.8413
4.3498	3.6659	4.8467	5.6885	40.1235	4.8467
4.3542	3.7182	4.8520	5.7258	40.4951	4.8520
4.3584	3.7706	4.8571	5.7630	40.8642	4.8571
4.3622	3.8229	4.8620	5.8003	41.2307	4.8620
4.3657	3.8754	4.8667	5.8376	41.5951	4.8667
4.3689	3.9278	4.8712	5.8750	41.9572	4.8712
4.3718	3.9804	4.8756	5.9123	42.3170	4.8756
4.3743	4.0329	4.8797	5.9497	42.6745	4.8797
4.3765	4.0855	4.8837	5.9871	43.0299	4.8837
4.3784	4.1380	4.8875	6.0245	43.3832	4.8875
4.3800	4.1907	4.8912	6.0618	43.7344	4.8912
4.3812	4.2433	4.8946	6.0992	44.0836	4.8946
4.3821	4.2959	4.8979	6.1366	44.4308	4.8979
4.3827	4.3486	4.9011	6.1740	44.7765	4.9011
4.3828	4.4013	4.9041	6.2113	45.1203	4.9041
4.3826	4.4540	4.9069	6.2486	45.4624	4.9069
4.3821	4.5067	4.9096	6.2859	45.8029	4.9096
4.3811	4.5593	4.9121	6.3231	46.1419	4.9121
4.3798	4.6120	4.9144	6.3603	46.4794	4.9144
4.3781	4.6647	4.9167	6.3974	46.8157	4.9167
4.3759	4.7174	4.9187	6.4345	47.1508	4.9187
4.3733	4.7701	4.9207	6.4714	47.4847	4.9207
4.3702	4.8227	4.9225	6.5083	47.8177	4.9225
4.3667	4.8753	4.9241	6.5450	48.1498	4.9241
4.3627	4.9279	4.9257	6.5816	48.4812	4.9257
4.3582	4.9804	4.9271	6.6181	48.8119	4.9271
4.3532	5.0330	4.9284	6.6544	49.1422	4.9284
4.3476	5.0854	4.9295	6.6905	49.4721	4.9295
4.3415	5.1378	4.9306	6.7265	49.8019	4.9306
4.3347	5.1901	4.9315	6.7622	50.1316	4.9315
4.3274	5.2424	4.9323	6.7977	50.4614	4.9323
4.3194	5.2945	4.9331	6.8329	50.7915	4.9331
4.3107	5.3465	4.9337	6.8679	51.1220	4.9337
4.3013	5.3985	4.9342	6.9025	51.4531	4.9342
4.2912	5.4502	4.9346	6.9368	51.7850	4.9346
4.2803	5.5019	4.9350	6.9708	52.1178	4.9350
4.2686	5.5533	4.9352	7.0043	52.4519	4.9352
4.2560	5.6045	4.9354	7.0374	52.7874	4.9354
4.2426	5.6556	4.9357	7.0700	53.1241	4.9357

STREAMLINE 3

X

Y

Z

R

THETA

Z

3.6104	1.1061	4.0455	3.7760	17.0330	4.0455
3.6251	1.1017	4.0531	3.7888	16.9044	4.0531
3.6413	1.1030	4.0584	3.8047	16.8530	4.0584
3.6574	1.1082	4.0615	3.8216	16.8570	4.0615
3.6806	1.1194	4.0617	3.8470	16.9167	4.0617
3.7023	1.1330	4.0589	3.8718	17.0150	4.0589
3.7201	1.1509	4.0616	3.8941	17.1904	4.0616
3.7306	1.1712	4.0735	3.9101	17.4292	4.0735
3.7410	1.1917	4.0852	3.9263	17.6687	4.0852
3.7514	1.2123	4.0967	3.9424	17.9089	4.0967
3.7719	1.2541	4.1192	3.9749	18.3909	4.1192
3.7919	1.2964	4.1408	4.0074	18.8747	4.1408
3.8116	1.3393	4.1618	4.0400	19.3597	4.1618
3.8309	1.3826	4.1821	4.0727	19.8456	4.1821
3.8497	1.4265	4.2018	4.1055	20.3320	4.2018
3.8681	1.4708	4.2209	4.1383	20.8182	4.2209
3.8862	1.5155	4.2394	4.1712	21.3042	4.2394
3.9037	1.5606	4.2573	4.2041	21.7896	4.2573
3.9209	1.6060	4.2748	4.2371	22.2741	4.2748
3.9377	1.6518	4.2917	4.2701	22.7574	4.2917
3.9540	1.6979	4.3082	4.3032	23.2393	4.3082
3.9700	1.7443	4.3242	4.3363	23.7196	4.3242
3.9855	1.7910	4.3398	4.3694	24.1981	4.3398
4.0007	1.8380	4.3550	4.4027	24.6748	4.3550
4.0155	1.8851	4.3698	4.4360	25.1487	4.3698
4.0299	1.9326	4.3843	4.4693	25.6205	4.3843
4.0439	1.9802	4.3983	4.5027	26.0897	4.3983
4.0576	2.0280	4.4120	4.5362	26.5563	4.4120
4.0710	2.0761	4.4254	4.5698	27.0201	4.4254
4.0840	2.1243	4.4384	4.6035	27.4811	4.4384
4.0968	2.1727	4.4511	4.6372	27.9390	4.4511
4.1092	2.2212	4.4635	4.6711	28.3939	4.4635
4.1212	2.2699	4.4756	4.7050	28.8456	4.4756
4.1330	2.3188	4.4874	4.7391	29.2941	4.4874
4.1446	2.3678	4.4989	4.7732	29.7396	4.4989
4.1558	2.4169	4.5102	4.8075	30.1815	4.5102
4.1667	2.4662	4.5211	4.8418	30.6202	4.5211
4.1774	2.5156	4.5318	4.8763	31.0558	4.5318
4.1877	2.5650	4.5421	4.9109	31.4879	4.5421
4.1978	2.6146	4.5523	4.9455	31.9168	4.5523
4.2076	2.6643	4.5621	4.9803	32.3427	4.5621
4.2172	2.7142	4.5717	5.0151	32.7654	4.5717
4.2264	2.7641	4.5810	5.0500	33.1850	4.5810
4.2354	2.8141	4.5901	5.0850	33.6014	4.5901
4.2441	2.8642	4.5989	5.1201	34.0147	4.5989
4.2525	2.9144	4.6075	5.1553	34.4248	4.6075
4.2606	2.9647	4.6158	5.1906	34.8320	4.6158
4.2685	3.0151	4.6239	5.2260	35.2364	4.6239
4.2760	3.0656	4.6317	5.2614	35.6374	4.6317
4.2833	3.1161	4.6394	5.2969	36.0356	4.6394
4.2904	3.1667	4.6468	5.3325	36.4309	4.6468
4.2971	3.2174	4.6539	5.3681	36.8235	4.6539
4.3035	3.2681	4.6609	5.4038	37.2132	4.6609
4.3097	3.3189	4.6677	5.4396	37.6002	4.6677
4.3156	3.3698	4.6742	5.4754	37.9843	4.6742
4.3212	3.4207	4.6805	5.5112	38.3658	4.6805
4.3265	3.4717	4.6866	5.5472	38.7446	4.6866
4.3315	3.5227	4.6926	5.5832	39.1208	4.6926
4.3363	3.5738	4.6983	5.6192	39.4944	4.6983
4.3407	3.6249	4.7038	5.6553	39.8654	4.7038
4.3449	3.6761	4.7092	5.6914	40.2339	4.7092
4.3488	3.7273	4.7143	5.7275	40.5999	4.7143
4.3524	3.7786	4.7193	5.7638	40.9638	4.7193
4.3557	3.8299	4.7240	5.8000	41.3249	4.7240
4.3587	3.8812	4.7286	5.8363	41.6837	4.7286
4.3614	3.9326	4.7330	5.8726	42.0402	4.7330
4.3639	3.9840	4.7373	5.9089	42.3945	4.7373
4.3660	4.0354	4.7413	5.9453	42.7465	4.7413
4.3678	4.0868	4.7452	5.9816	43.0965	4.7452
4.3693	4.1383	4.7489	6.0180	43.4443	4.7489
4.3706	4.1898	4.7525	6.0544	43.7902	4.7525
4.3715	4.2413	4.7559	6.0908	44.1340	4.7559

4.3720	4.2928	4.7591	6.1272	44.4760	4.7591
4.3723	4.3443	4.7622	6.1636	44.8160	4.7622
4.3722	4.3958	4.7651	6.2000	45.1544	4.7651
4.3718	4.4474	4.7678	6.2363	45.4909	4.7678
4.3710	4.4990	4.7704	6.2727	45.8263	4.7704
4.3699	4.5505	4.7729	6.3090	46.1599	4.7729
4.3684	4.6021	4.7752	6.3452	46.4921	4.7752
4.3665	4.6536	4.7774	6.3814	46.8230	4.7774
4.3642	4.7051	4.7794	6.4175	47.1527	4.7794
4.3615	4.7567	4.7813	6.4536	47.4812	4.7813
4.3584	4.8082	4.7831	6.4895	47.8088	4.7831
4.3549	4.8596	4.7847	6.5254	48.1355	4.7847
4.3508	4.9111	4.7862	6.5611	48.4614	4.7862
4.3463	4.9624	4.7876	6.5967	48.7866	4.7876
4.3414	5.0138	4.7889	6.6322	49.1116	4.7889
4.3358	5.0651	4.7901	6.6675	49.4360	4.7901
4.3298	5.1164	4.7911	6.7026	49.7601	4.7911
4.3232	5.1676	4.7921	6.7375	50.0845	4.7921
4.3159	5.2187	4.7930	6.7722	50.4088	4.7930
4.3081	5.2697	4.7938	6.8066	50.7333	4.7938
4.2996	5.3206	4.7945	6.8407	51.0583	4.7945
4.2904	5.3714	4.7951	6.8746	51.3838	4.7951
4.2806	5.4221	4.7956	6.9081	51.7101	4.7956
4.2699	5.4726	4.7961	6.9413	52.0373	4.7961
4.2585	5.5230	4.7966	6.9741	52.3655	4.7966
4.2464	5.5731	4.7970	7.0065	52.6949	4.7970
4.2333	5.6231	4.7975	7.0385	53.0256	4.7975
4.2195	5.6728	4.7981	7.0700	53.3576	4.7981

STREAMLINE 4

X	Y	Z	R	THETA	Z
3.7704	1.1946	3.9490	3.9552	17.5804	3.9490
3.7829	1.1892	3.9588	3.9654	17.4517	3.9588
3.7954	1.1884	3.9699	3.9771	17.3864	3.9699
3.8070	1.1924	3.9812	3.9894	17.3917	3.9812
3.8204	1.2068	3.9967	4.0064	17.5308	3.9967
3.8291	1.2267	4.0095	4.0208	17.7627	4.0095
3.8377	1.2468	4.0220	4.0352	17.9975	4.0220
3.8462	1.2670	4.0343	4.0495	18.2331	4.0343
3.8546	1.2875	4.0464	4.0640	18.4694	4.0464
3.8630	1.3080	4.0583	4.0784	18.7062	4.0583
3.8795	1.3496	4.0816	4.1075	19.1814	4.0816
3.8956	1.3916	4.1041	4.1367	19.6582	4.1041
3.9114	1.4342	4.1260	4.1660	20.1360	4.1260
3.9269	1.4771	4.1472	4.1955	20.6145	4.1472
3.9420	1.5206	4.1678	4.2251	21.0931	4.1678
3.9568	1.5644	4.1878	4.2549	21.5716	4.1878
3.9713	1.6085	4.2072	4.2847	22.0495	4.2072
3.9855	1.6530	4.2261	4.3147	22.5266	4.2261
3.9994	1.6979	4.2444	4.3449	23.0026	4.2444
4.0129	1.7430	4.2623	4.3751	23.4772	4.2623
4.0262	1.7884	4.2796	4.4055	23.9501	4.2796
4.0392	1.8340	4.2965	4.4360	24.4211	4.2965
4.0518	1.8799	4.3129	4.4667	24.8901	4.3129
4.0642	1.9261	4.3289	4.4975	25.3567	4.3289
4.0763	1.9724	4.3445	4.5285	25.8209	4.3445
4.0882	2.0190	4.3597	4.5596	26.2826	4.3597
4.0998	2.0657	4.3745	4.5908	26.7415	4.3745
4.1111	2.1126	4.3889	4.6222	27.1977	4.3889
4.1222	2.1597	4.4030	4.6537	27.6508	4.4030
4.1331	2.2070	4.4167	4.6854	28.1010	4.4167
4.1437	2.2544	4.4300	4.7173	28.5481	4.4300
4.1541	2.3019	4.4430	4.7493	28.9920	4.4430
4.1643	2.3496	4.4557	4.7814	29.4327	4.4557
4.1742	2.3974	4.4681	4.8137	29.8702	4.4681
4.1840	2.4453	4.4802	4.8462	30.3044	4.4802
4.1935	2.4934	4.4919	4.8787	30.7353	4.4919
4.2028	2.5416	4.5034	4.9115	31.1630	4.5034
4.2118	2.5899	4.5145	4.9444	31.5874	4.5145
4.2206	2.6382	4.5254	4.9774	32.0087	4.5254



4.2292	2.6867	4.5360	5.0105	32.4268	4.5360
4.2376	2.7353	4.5463	5.0437	32.8419	4.5463
4.2457	2.7840	4.5563	5.0771	33.2539	4.5563
4.2536	2.8328	4.5661	5.1106	33.6627	4.5661
4.2613	2.8817	4.5756	5.1442	34.0684	4.5756
4.2688	2.9307	4.5848	5.1779	34.4710	4.5848
4.2760	2.9797	4.5938	5.2118	34.8706	4.5938
4.2830	3.0288	4.6025	5.2457	35.2672	4.6025
4.2897	3.0780	4.6110	5.2797	35.6609	4.6110
4.2962	3.1273	4.6192	5.3139	36.0518	4.6192
4.3024	3.1766	4.6272	5.3481	36.4397	4.6272
4.3085	3.2261	4.6350	5.3824	36.8249	4.6350
4.3142	3.2755	4.6425	5.4168	37.2073	4.6425
4.3197	3.3251	4.6498	5.4513	37.5870	4.6498
4.3250	3.3747	4.6569	5.4858	37.9639	4.6569
4.3300	3.4243	4.6637	5.5204	38.3383	4.6637
4.3348	3.4740	4.6704	5.5551	38.7099	4.6704
4.3393	3.5238	4.6768	5.5899	39.0790	4.6768
4.3435	3.5736	4.6830	5.6247	39.4456	4.6830
4.3475	3.6235	4.6890	5.6596	39.8096	4.6890
4.3513	3.6734	4.6948	5.6945	40.1712	4.6948
4.3548	3.7233	4.7004	5.7295	40.5304	4.7004
4.3580	3.7733	4.7058	5.7645	40.8871	4.7058
4.3610	3.8233	4.7111	5.7996	41.2416	4.7111
4.3637	3.8734	4.7161	5.8348	41.5937	4.7161
4.3661	3.9235	4.7209	5.8700	41.9435	4.7209
4.3683	3.9736	4.7256	5.9052	42.2911	4.7256
4.3702	4.0237	4.7301	5.9404	42.6366	4.7301
4.3718	4.0739	4.7344	5.9757	42.9800	4.7344
4.3731	4.1241	4.7385	6.0110	43.3213	4.7385
4.3742	4.1743	4.7424	6.0463	43.6606	4.7424
4.3749	4.2245	4.7462	6.0817	43.9979	4.7462
4.3754	4.2748	4.7498	6.1170	44.3334	4.7498
4.3756	4.3250	4.7533	6.1524	44.6671	4.7533
4.3754	4.3753	4.7566	6.1877	44.9990	4.7566
4.3750	4.4256	4.7597	6.2230	45.3293	4.7597
4.3742	4.4759	4.7627	6.2584	45.6580	4.7627
4.3731	4.5261	4.7655	6.2937	45.9851	4.7655
4.3717	4.5764	4.7682	6.3289	46.3108	4.7682
4.3699	4.6267	4.7707	6.3641	46.6352	4.7707
4.3677	4.6770	4.7731	6.3993	46.9584	4.7731
4.3652	4.7273	4.7753	6.4344	47.2804	4.7753
4.3623	4.7775	4.7774	6.4695	47.6013	4.7774
4.3589	4.8277	4.7794	6.5044	47.9213	4.7794
4.3552	4.8779	4.7812	6.5393	48.2405	4.7812
4.3510	4.9281	4.7829	6.5740	48.5589	4.7829
4.3464	4.9783	4.7844	6.6086	48.8768	4.7844
4.3412	5.0284	4.7859	6.6431	49.1942	4.7859
4.3356	5.0784	4.7872	6.6774	49.5112	4.7872
4.3295	5.1284	4.7883	6.7116	49.8281	4.7883
4.3229	5.1783	4.7894	6.7455	50.1448	4.7894
4.3156	5.2282	4.7903	6.7793	50.4616	4.7903
4.3078	5.2779	4.7911	6.8128	50.7787	4.7911
4.2994	5.3276	4.7919	6.8461	51.0960	4.7919
4.2904	5.3772	4.7925	6.8791	51.4137	4.7925
4.2807	5.4266	4.7930	6.9118	51.7321	4.7930
4.2703	5.4759	4.7934	6.9441	52.0513	4.7934
4.2592	5.5250	4.7937	6.9762	52.3714	4.7937
4.2474	5.5740	4.7939	7.0078	52.6925	4.7939
4.2348	5.6228	4.7940	7.0391	53.0146	4.7940
4.2215	5.6713	4.7941	7.0700	53.3378	4.7941

STREAMLINE 5

X	Y	Z	R	THETA	Z
3.9386	1.2917	3.8465	4.1450	18.1576	3.8465
3.9506	1.2872	3.8563	4.1550	18.0468	3.8563
3.9625	1.2869	3.8671	4.1663	17.9924	3.8671
3.9734	1.2911	3.8781	4.1779	18.0010	3.8781
3.9858	1.3052	3.8931	4.1941	18.1319	3.8931
3.9935	1.3248	3.9051	4.2075	18.3524	3.9051

4.0008	1.3446	3.9169	4.2207	18.5769	3.9169
4.0081	1.3646	3.9285	4.2340	18.8020	3.9285
4.0152	1.3847	3.9398	4.2473	19.0278	3.9398
4.0223	1.4050	3.9510	4.2607	19.2542	3.9510
4.0363	1.4459	3.9729	4.2875	19.7085	3.9729
4.0500	1.4872	3.9941	4.3144	20.1644	3.9941
4.0633	1.5290	4.0146	4.3414	20.6214	4.0146
4.0763	1.5712	4.0345	4.3686	21.0790	4.0345
4.0890	1.6137	4.0538	4.3959	21.5369	4.0538
4.1014	1.6566	4.0726	4.4233	21.9948	4.0726
4.1134	1.6998	4.0908	4.4508	22.4522	4.0908
4.1252	1.7433	4.1085	4.4785	22.9090	4.1085
4.1367	1.7871	4.1257	4.5062	23.3648	4.1257
4.1479	1.8311	4.1425	4.5341	23.8194	4.1425
4.1588	1.8754	4.1588	4.5621	24.2725	4.1588
4.1695	1.9199	4.1747	4.5903	24.7240	4.1747
4.1799	1.9646	4.1901	4.6186	25.1736	4.1901
4.1901	2.0094	4.2052	4.6470	25.6212	4.2052
4.2000	2.0545	4.2199	4.6756	26.0666	4.2199
4.2097	2.0998	4.2342	4.7043	26.5097	4.2342
4.2191	2.1451	4.2481	4.7331	26.9504	4.2481
4.2283	2.1907	4.2617	4.7621	27.3886	4.2617
4.2374	2.2364	4.2750	4.7913	27.8241	4.2750
4.2462	2.2822	4.2879	4.8206	28.2569	4.2879
4.2548	2.3281	4.3006	4.8501	28.6868	4.3006
4.2632	2.3742	4.3129	4.8797	29.1139	4.3129
4.2714	2.4204	4.3249	4.9095	29.5380	4.3249
4.2795	2.4667	4.3366	4.9395	29.9592	4.3366
4.2873	2.5131	4.3481	4.9696	30.3773	4.3481
4.2950	2.5596	4.3592	4.9998	30.7924	4.3592
4.3025	2.6061	4.3701	5.0302	31.2045	4.3701
4.3098	2.6528	4.3807	5.0608	31.6135	4.3807
4.3169	2.6996	4.3911	5.0915	32.0196	4.3911
4.3239	2.7464	4.4011	5.1224	32.4229	4.4011
4.3306	2.7934	4.4109	5.1533	32.8233	4.4109
4.3371	2.8404	4.4205	5.1844	33.2208	4.4205
4.3435	2.8875	4.4298	5.2157	33.6154	4.4298
4.3496	2.9346	4.4389	5.2470	34.0070	4.4389
4.3556	2.9819	4.4477	5.2785	34.3958	4.4477
4.3614	3.0292	4.4563	5.3101	34.7817	4.4563
4.3670	3.0765	4.4646	5.3419	35.1648	4.4646
4.3724	3.1240	4.4728	5.3737	35.5452	4.4728
4.3775	3.1715	4.4806	5.4056	35.9228	4.4806
4.3825	3.2190	4.4883	5.4377	36.2978	4.4883
4.3873	3.2666	4.4958	5.4698	36.6701	4.4958
4.3919	3.3143	4.5030	5.5021	37.0397	4.5030
4.3962	3.3620	4.5100	5.5344	37.4068	4.5100
4.4004	3.4098	4.5168	5.5669	37.7713	4.5168
4.4043	3.4576	4.5234	5.5994	38.1333	4.5234
4.4081	3.5054	4.5298	5.6320	38.4927	4.5298
4.4116	3.5533	4.5360	5.6646	38.8498	4.5360
4.4149	3.6012	4.5419	5.6974	39.2043	4.5419
4.4180	3.6492	4.5477	5.7302	39.5565	4.5477
4.4209	3.6972	4.5533	5.7631	39.9063	4.5533
4.4235	3.7453	4.5588	5.7961	40.2538	4.5588
4.4259	3.7934	4.5640	5.8291	40.5989	4.5640
4.4282	3.8415	4.5690	5.8622	40.9419	4.5690
4.4302	3.8896	4.5739	5.8954	41.2826	4.5739
4.4319	3.9378	4.5786	5.9286	41.6211	4.5786
4.4335	3.9859	4.5831	5.9618	41.9574	4.5831
4.4348	4.0342	4.5874	5.9951	42.2917	4.5874
4.4358	4.0824	4.5916	6.0285	42.6240	4.5916
4.4367	4.1306	4.5956	6.0619	42.9542	4.5956
4.4373	4.1789	4.5994	6.0953	43.2825	4.5994
4.4376	4.2272	4.6031	6.1287	43.6089	4.6031
4.4377	4.2755	4.6066	6.1622	43.9335	4.6066
4.4375	4.3238	4.6099	6.1957	44.2563	4.6099
4.4371	4.3721	4.6131	6.2292	44.5774	4.6131
4.4364	4.4204	4.6162	6.2627	44.8969	4.6162
4.4354	4.4687	4.6191	6.2962	45.2148	4.6191
4.4341	4.5171	4.6218	6.3297	45.5312	4.6218
4.4325	4.5654	4.6244	6.3632	45.8462	4.6244
4.4306	4.6137	4.6269	6.3966	46.1599	4.6269

4.4284	4.6620	4.6292	6.4300	46.4723	4.6292
4.4258	4.7103	4.6314	6.4634	46.7837	4.6314
4.4229	4.7586	4.6334	6.4967	47.0939	4.6334
4.4197	4.8069	4.6353	6.5299	47.4032	4.6353
4.4160	4.8551	4.6371	6.5631	47.7117	4.6371
4.4120	4.9034	4.6387	6.5961	48.0194	4.6387
4.4076	4.9516	4.6402	6.6291	48.3264	4.6402
4.4027	4.9997	4.6416	6.6619	48.6330	4.6416
4.3974	5.0478	4.6429	6.6946	48.9391	4.6429
4.3917	5.0959	4.6440	6.7272	49.2450	4.6440
4.3854	5.1439	4.6451	6.7596	49.5507	4.6451
4.3787	5.1919	4.6460	6.7918	49.8564	4.6460
4.3714	5.2397	4.6468	6.8238	50.1622	4.6468
4.3636	5.2875	4.6475	6.8555	50.4683	4.6475
4.3552	5.3352	4.6481	6.8871	50.7747	4.6481
4.3462	5.3827	4.6486	6.9183	51.0816	4.6486
4.3366	5.4302	4.6490	6.9493	51.3890	4.6490
4.3263	5.4775	4.6493	6.9800	51.6972	4.6493
4.3154	5.5247	4.6495	7.0103	52.0062	4.6495
4.3038	5.5717	4.6496	7.0403	52.3162	4.6496
4.2915	5.6185	4.6497	7.0700	52.6270	4.6497

STREAMLINE 6

X	Y	Z	R	THETA	Z
4.1051	1.3923	3.7441	4.3347	18.7348	3.7441
4.1165	1.3885	3.7537	4.3444	18.6396	3.7537
4.1278	1.3887	3.7643	4.3552	18.5948	3.7643
4.1381	1.3931	3.7750	4.3662	18.6059	3.7750
4.1495	1.4069	3.7894	4.3815	18.7289	3.7894
4.1561	1.4260	3.8008	4.3939	18.9380	3.8008
4.1622	1.4455	3.8118	4.4061	19.1520	3.8118
4.1683	1.4652	3.8227	4.4183	19.3668	3.8227
4.1743	1.4849	3.8333	4.4305	19.5822	3.8333
4.1802	1.5048	3.8438	4.4428	19.7981	3.8438
4.1917	1.5449	3.8643	4.4674	20.2316	3.8643
4.2030	1.5854	3.8841	4.4920	20.6666	3.8841
4.2139	1.6263	3.9033	4.5168	21.1028	3.9033
4.2246	1.6675	3.9219	4.5417	21.5397	3.9219
4.2349	1.7090	3.9399	4.5667	21.9769	3.9399
4.2449	1.7509	3.9575	4.5918	22.4142	3.9575
4.2547	1.7930	3.9745	4.6170	22.8512	3.9745
4.2641	1.8353	3.9911	4.6423	23.2877	3.9911
4.2733	1.8779	4.0072	4.6678	23.7234	4.0072
4.2823	1.9208	4.0228	4.6933	24.1581	4.0228
4.2909	1.9638	4.0381	4.7190	24.5915	4.0381
4.2994	2.0070	4.0530	4.7447	25.0235	4.0530
4.3076	2.0504	4.0675	4.7707	25.4539	4.0675
4.3156	2.0939	4.0816	4.7967	25.8825	4.0816
4.3233	2.1376	4.0953	4.8229	26.3092	4.0953
4.3309	2.1814	4.1088	4.8493	26.7338	4.1088
4.3383	2.2254	4.1219	4.8758	27.1563	4.1219
4.3454	2.2695	4.1346	4.9024	27.5766	4.1346
4.3524	2.3137	4.1471	4.9292	27.9944	4.1471
4.3593	2.3580	4.1593	4.9561	28.4098	4.1593
4.3659	2.4024	4.1712	4.9832	28.8227	4.1712
4.3724	2.4469	4.1828	5.0105	29.2330	4.1828
4.3787	2.4916	4.1941	5.0380	29.6405	4.1941
4.3849	2.5363	4.2052	5.0656	30.0454	4.2052
4.3909	2.5810	4.2160	5.0933	30.4476	4.2160
4.3968	2.6259	4.2266	5.1213	30.8469	4.2266
4.4025	2.6709	4.2369	5.1494	31.2435	4.2369
4.4081	2.7159	4.2469	5.1776	31.6373	4.2469
4.4136	2.7610	4.2567	5.2060	32.0284	4.2567
4.4189	2.8061	4.2663	5.2346	32.4168	4.2663
4.4240	2.8513	4.2756	5.2633	32.8025	4.2756
4.4290	2.8966	4.2847	5.2921	33.1855	4.2847
4.4338	2.9420	4.2936	5.3211	33.5657	4.2936
4.4385	2.9874	4.3022	5.3502	33.9433	4.3022
4.4430	3.0329	4.3106	5.3794	34.3183	4.3106
4.4473	3.0784	4.3188	5.4088	34.6906	4.3188

4.4515	3.1240	4.3268	5.4383	35.0602	4.3268
4.4556	3.1696	4.3345	5.4680	35.4273	4.3345
4.4595	3.2153	4.3421	5.4977	35.7919	4.3421
4.4632	3.2610	4.3494	5.5276	36.1539	4.3494
4.4667	3.3068	4.3565	5.5576	36.5134	4.3565
4.4701	3.3526	4.3634	5.5876	36.8705	4.3634
4.4733	3.3985	4.3702	5.6178	37.2250	4.3702
4.4763	3.4444	4.3767	5.6481	37.5772	4.3767
4.4792	3.4903	4.3830	5.6785	37.9269	4.3830
4.4819	3.5363	4.3891	5.7090	38.2743	4.3891
4.4844	3.5823	4.3951	5.7396	38.6193	4.3951
4.4868	3.6284	4.4009	5.7703	38.9620	4.4009
4.4889	3.6744	4.4064	5.8010	39.3023	4.4064
4.4909	3.7206	4.4118	5.8319	39.6404	4.4118
4.4927	3.7667	4.4170	5.8628	39.9763	4.4170
4.4944	3.8128	4.4221	5.8938	40.3099	4.4221
4.4958	3.8590	4.4269	5.9249	40.6414	4.4269
4.4971	3.9052	4.4316	5.9561	40.9708	4.4316
4.4982	3.9515	4.4362	5.9873	41.2980	4.4362
4.4991	3.9977	4.4405	6.0186	41.6231	4.4405
4.4998	4.0440	4.4447	6.0499	41.9463	4.4447
4.5003	4.0903	4.4487	6.0814	42.2674	4.4487
4.5006	4.1366	4.4526	6.1128	42.5866	4.4526
4.5007	4.1829	4.4563	6.1443	42.9040	4.4563
4.5006	4.2292	4.4599	6.1759	43.2195	4.4599
4.5003	4.2756	4.4633	6.2075	43.5332	4.4633
4.4997	4.3219	4.4665	6.2391	43.8451	4.4665
4.4990	4.3682	4.4696	6.2707	44.1554	4.4696
4.4980	4.4146	4.4726	6.3024	44.4642	4.4726
4.4967	4.4610	4.4754	6.3341	44.7713	4.4754
4.4952	4.5073	4.4781	6.3658	45.0771	4.4781
4.4935	4.5537	4.4806	6.3975	45.3814	4.4806
4.4914	4.6001	4.4830	6.4291	45.6844	4.4830
4.4891	4.6464	4.4852	6.4608	45.9862	4.4852
4.4865	4.6927	4.4874	6.4924	46.2868	4.4874
4.4836	4.7391	4.4894	6.5240	46.5864	4.4894
4.4804	4.7854	4.4912	6.5555	46.8850	4.4912
4.4769	4.8317	4.4929	6.5869	47.1828	4.4929
4.4730	4.8780	4.4945	6.6183	47.4797	4.4945
4.4687	4.9242	4.4960	6.6496	47.7761	4.4960
4.4641	4.9704	4.4974	6.6808	48.0718	4.4974
4.4591	5.0166	4.4986	6.7119	48.3671	4.4986
4.4537	5.0627	4.4998	6.7429	48.6620	4.4998
4.4478	5.1088	4.5008	6.7737	48.9567	4.5008
4.4415	5.1548	4.5017	6.8043	49.2513	4.5017
4.4347	5.2008	4.5025	6.8348	49.5459	4.5025
4.4274	5.2467	4.5031	6.8651	49.8407	4.5031
4.4196	5.2925	4.5037	6.8951	50.1358	4.5037
4.4112	5.3382	4.5042	6.9249	50.4311	4.5042
4.4023	5.3838	4.5046	6.9545	50.7269	4.5046
4.3929	5.4293	4.5049	6.9838	51.0232	4.5049
4.3828	5.4746	4.5051	7.0129	51.3203	4.5051
4.3721	5.5198	4.5052	7.0416	51.6181	4.5052
4.3608	5.5649	4.5053	7.0700	51.9166	4.5053

STREAMLINE 7

X	Y	Z	R	THETA	Z
4.2697	1.4963	3.6418	4.5243	19.3128	3.6418
4.2806	1.4933	3.6513	4.5336	19.2318	3.6513
4.2912	1.4940	3.6616	4.5439	19.1951	3.6616
4.3008	1.4984	3.6720	4.5544	19.2081	3.6720
4.3114	1.5118	3.6859	4.5688	19.3238	3.6859
4.3169	1.5305	3.6966	4.5802	19.5216	3.6966
4.3219	1.5496	3.7069	4.5913	19.7252	3.7069
4.3268	1.5688	3.7170	4.6024	19.9295	3.7170
4.3316	1.5881	3.7270	4.6136	20.1345	3.7270
4.3364	1.6075	3.7367	4.6248	20.3401	3.7367
4.3457	1.6467	3.7558	4.6472	20.7527	3.7558
4.3546	1.6862	3.7742	4.6697	21.1669	3.7742
4.3633	1.7260	3.7921	4.6923	21.5822	3.7921

4.3716	1.7661	3.8094	4.7149	21.9984	3.8094
4.3797	1.8065	3.8262	4.7377	22.4150	3.8262
4.3875	1.8472	3.8426	4.7605	22.8317	3.8426
4.3950	1.8881	3.8584	4.7834	23.2484	3.8584
4.4022	1.9292	3.8738	4.8064	23.6646	3.8738
4.4092	1.9705	3.8888	4.8295	24.0803	3.8888
4.4160	2.0120	3.9034	4.8527	24.4951	3.9034
4.4225	2.0537	3.9176	4.8761	24.9089	3.9176
4.4288	2.0955	3.9314	4.8995	25.3215	3.9314
4.4349	2.1375	3.9449	4.9231	25.7327	3.9449
4.4408	2.1796	3.9581	4.9468	26.1424	3.9581
4.4464	2.2218	3.9709	4.9706	26.5504	3.9709
4.4520	2.2641	3.9835	4.9946	26.9567	3.9835
4.4573	2.3066	3.9957	5.0188	27.3611	3.9957
4.4625	2.3492	4.0077	5.0430	27.7634	4.0077
4.4675	2.3918	4.0193	5.0675	28.1637	4.0193
4.4724	2.4345	4.0307	5.0921	28.5617	4.0307
4.4771	2.4774	4.0419	5.1168	28.9575	4.0419
4.4817	2.5203	4.0528	5.1418	29.3509	4.0528
4.4862	2.5632	4.0634	5.1668	29.7420	4.0634
4.4906	2.6063	4.0738	5.1921	30.1306	4.0738
4.4948	2.6494	4.0840	5.2175	30.5167	4.0840
4.4989	2.6926	4.0939	5.2431	30.9004	4.0939
4.5029	2.7358	4.1037	5.2689	31.2814	4.1037
4.5068	2.7791	4.1131	5.2948	31.6600	4.1131
4.5106	2.8225	4.1224	5.3209	32.0360	4.1224
4.5143	2.8659	4.1315	5.3472	32.4094	4.1315
4.5179	2.9094	4.1403	5.3736	32.7804	4.1403
4.5213	2.9529	4.1489	5.4002	33.1488	4.1489
4.5247	2.9965	4.1573	5.4269	33.5148	4.1573
4.5279	3.0401	4.1655	5.4538	33.8784	4.1655
4.5309	3.0838	4.1735	5.4808	34.2395	4.1735
4.5339	3.1275	4.1813	5.5079	34.5982	4.1813
4.5367	3.1713	4.1889	5.5352	34.9545	4.1889
4.5394	3.2151	4.1963	5.5626	35.3084	4.1963
4.5420	3.2589	4.2034	5.5902	35.6599	4.2034
4.5444	3.3028	4.2104	5.6178	36.0090	4.2104
4.5467	3.3467	4.2172	5.6456	36.3558	4.2172
4.5489	3.3907	4.2239	5.6735	36.7003	4.2239
4.5509	3.4347	4.2303	5.7016	37.0425	4.2303
4.5528	3.4787	4.2365	5.7297	37.3823	4.2365
4.5546	3.5227	4.2426	5.7580	37.7199	4.2426
4.5563	3.5668	4.2485	5.7863	38.0551	4.2485
4.5578	3.6109	4.2542	5.8148	38.3882	4.2542
4.5592	3.6551	4.2597	5.8434	38.7190	4.2597
4.5604	3.6992	4.2651	5.8721	39.0476	4.2651
4.5615	3.7434	4.2702	5.9009	39.3741	4.2702
4.5625	3.7876	4.2753	5.9298	39.6984	4.2753
4.5633	3.8318	4.2801	5.9587	40.0206	4.2801
4.5640	3.8761	4.2848	5.9878	40.3406	4.2848
4.5645	3.9204	4.2893	6.0170	40.6586	4.2893
4.5649	3.9646	4.2937	6.0462	40.9746	4.2937
4.5651	4.0089	4.2979	6.0755	41.2886	4.2979
4.5652	4.0533	4.3020	6.1049	41.6006	4.3020
4.5651	4.0976	4.3059	6.1344	41.9107	4.3059
4.5649	4.1419	4.3096	6.1639	42.2189	4.3096
4.5645	4.1863	4.3132	6.1935	42.5253	4.3132
4.5639	4.2307	4.3166	6.2232	42.8299	4.3166
4.5632	4.2750	4.3199	6.2529	43.1327	4.3199
4.5622	4.3194	4.3231	6.2826	43.4339	4.3231
4.5611	4.3638	4.3261	6.3124	43.7334	4.3261
4.5598	4.4082	4.3290	6.3422	44.0314	4.3290
4.5583	4.4526	4.3317	6.3721	44.3279	4.3317
4.5566	4.4970	4.3343	6.4020	44.6229	4.3343
4.5546	4.5414	4.3368	6.4318	44.9166	4.3368
4.5524	4.5858	4.3391	6.4617	45.2089	4.3391
4.5500	4.6301	4.3413	6.4916	45.5000	4.3413
4.5473	4.6745	4.3434	6.5215	45.7900	4.3434
4.5444	4.7189	4.3453	6.5513	46.0790	4.3453
4.5412	4.7632	4.3471	6.5811	46.3669	4.3471
4.5377	4.8076	4.3488	6.6109	46.6539	4.3488
4.5339	4.8519	4.3504	6.6406	46.9402	4.3504
4.5298	4.8962	4.3518	6.6702	47.2257	4.3518

4.5254	4.9404	4.3531	6.6998	47.5107	4.3531
4.5206	4.9847	4.3544	6.7292	47.7951	4.3544
4.5154	5.0288	4.3555	6.7586	48.0791	4.3555
4.5099	5.0730	4.3564	6.7878	48.3629	4.3564
4.5040	5.1171	4.3573	6.8169	48.6464	4.3573
4.4976	5.1611	4.3581	6.8458	48.9299	4.3581
4.4908	5.2051	4.3588	6.8746	49.2134	4.3588
4.4836	5.2490	4.3594	6.9032	49.4969	4.3594
4.4758	5.2928	4.3598	6.9316	49.7807	4.3598
4.4676	5.3366	4.3602	6.9598	50.0648	4.3602
4.4589	5.3802	4.3605	6.9877	50.3495	4.3605
4.4496	5.4237	4.3607	7.0154	50.6346	4.3607
4.4398	5.4671	4.3609	7.0428	50.9203	4.3609
4.4295	5.5104	4.3609	7.0700	51.2064	4.3609

STREAMLINE 8

X	Y	Z	R	THETA	Z
4.4325	1.6038	3.5396	4.7138	19.8911	3.5396
4.4428	1.6015	3.5490	4.7227	19.8221	3.5490
4.4528	1.6025	3.5590	4.7323	19.7927	3.5590
4.4617	1.6070	3.5690	4.7422	19.8074	3.5690
4.4713	1.6201	3.5824	4.7558	19.9165	3.5824
4.4758	1.6382	3.5925	4.7662	20.1031	3.5925
4.4797	1.6568	3.6021	4.7763	20.2965	3.6021
4.4836	1.6755	3.6115	4.7864	20.4905	3.6115
4.4873	1.6943	3.6207	4.7965	20.6851	3.6207
4.4910	1.7132	3.6298	4.8066	20.8803	3.6298
4.4980	1.7512	3.6475	4.8269	21.2721	3.6475
4.5048	1.7895	3.6646	4.8473	21.6655	3.6646
4.5113	1.8282	3.6811	4.8677	22.0601	3.6811
4.5175	1.8671	3.6972	4.8881	22.4555	3.6972
4.5234	1.9063	3.7127	4.9087	22.8515	3.7127
4.5290	1.9456	3.7278	4.9293	23.2478	3.7278
4.5344	1.9852	3.7425	4.9499	23.6442	3.7425
4.5395	2.0249	3.7568	4.9707	24.0403	3.7568
4.5444	2.0649	3.7706	4.9915	24.4359	3.7706
4.5490	2.1049	3.7841	5.0124	24.8310	3.7841
4.5535	2.1452	3.7973	5.0335	25.2252	3.7973
4.5577	2.1855	3.8101	5.0546	25.6185	3.8101
4.5617	2.2260	3.8226	5.0759	26.0106	3.8226
4.5656	2.2665	3.8348	5.0972	26.4014	3.8348
4.5693	2.3072	3.8467	5.1187	26.7908	3.8467
4.5728	2.3480	3.8584	5.1404	27.1787	3.8584
4.5762	2.3888	3.8697	5.1622	27.5650	3.8697
4.5794	2.4298	3.8808	5.1841	27.9495	3.8808
4.5826	2.4708	3.8917	5.2062	28.3321	3.8917
4.5856	2.5119	3.9023	5.2285	28.7128	3.9023
4.5884	2.5530	3.9127	5.2509	29.0915	3.9127
4.5912	2.5942	3.9229	5.2734	29.4682	3.9229
4.5939	2.6355	3.9328	5.2962	29.8427	3.9328
4.5965	2.6768	3.9426	5.3191	30.2150	3.9426
4.5990	2.7182	3.9521	5.3422	30.5850	3.9521
4.6014	2.7596	3.9614	5.3655	30.9528	3.9614
4.6037	2.8011	3.9705	5.3889	31.3183	3.9705
4.6060	2.8427	3.9794	5.4126	31.6815	3.9794
4.6082	2.8843	3.9881	5.4364	32.0424	3.9881
4.6103	2.9259	3.9967	5.4603	32.4010	3.9967
4.6123	2.9675	4.0050	5.4845	32.7572	4.0050
4.6142	3.0093	4.0131	5.5088	33.1112	4.0131
4.6160	3.0510	4.0211	5.5332	33.4630	4.0211
4.6178	3.0928	4.0288	5.5578	33.8126	4.0288
4.6194	3.1346	4.0364	5.5826	34.1599	4.0364
4.6210	3.1765	4.0438	5.6075	34.5050	4.0438
4.6224	3.2184	4.0509	5.6325	34.8479	4.0509
4.6238	3.2603	4.0580	5.6577	35.1886	4.0580
4.6250	3.3023	4.0648	5.6830	35.5271	4.0648
4.6262	3.3443	4.0714	5.7084	35.8634	4.0714
4.6273	3.3863	4.0779	5.7340	36.1975	4.0779
4.6283	3.4284	4.0842	5.7598	36.5294	4.0842
4.6291	3.4705	4.0903	5.7856	36.8591	4.0903

4.6299	3.5126	4.0963	5.8116	37.1867	4.0963
4.6306	3.5547	4.1021	5.8377	37.5121	4.1021
4.6312	3.5969	4.1077	5.8639	37.8354	4.1077
4.6317	3.6391	4.1132	5.8903	38.1565	4.1132
4.6321	3.6813	4.1185	5.9168	38.4755	4.1185
4.6324	3.7235	4.1236	5.9434	38.7924	4.1236
4.6326	3.7658	4.1286	5.9701	39.1072	4.1286
4.6327	3.8080	4.1334	5.9969	39.4200	4.1334
4.6327	3.8503	4.1381	6.0239	39.7307	4.1381
4.6326	3.8926	4.1426	6.0509	40.0394	4.1426
4.6324	3.9349	4.1470	6.0780	40.3461	4.1470
4.6320	3.9773	4.1512	6.1053	40.6509	4.1512
4.6316	4.0196	4.1552	6.1326	40.9537	4.1552
4.6310	4.0620	4.1592	6.1600	41.2547	4.1592
4.6304	4.1043	4.1629	6.1876	41.5538	4.1629
4.6296	4.1467	4.1665	6.2152	41.8510	4.1665
4.6286	4.1891	4.1700	6.2428	42.1465	4.1700
4.6276	4.2315	4.1734	6.2706	42.4403	4.1734
4.6264	4.2739	4.1766	6.2984	42.7323	4.1766
4.6250	4.3163	4.1796	6.3262	43.0227	4.1796
4.6235	4.3587	4.1825	6.3542	43.3115	4.1825
4.6219	4.4012	4.1853	6.3821	43.5988	4.1853
4.6200	4.4436	4.1880	6.4102	43.8846	4.1880
4.6180	4.4860	4.1905	6.4382	44.1690	4.1905
4.6159	4.5284	4.1929	6.4663	44.4520	4.1929
4.6135	4.5708	4.1952	6.4944	44.7337	4.1952
4.6109	4.6132	4.1973	6.5225	45.0142	4.1973
4.6082	4.6556	4.1993	6.5506	45.2936	4.1993
4.6052	4.6980	4.2012	6.5787	45.5719	4.2012
4.6019	4.7404	4.2030	6.6068	45.8492	4.2030
4.5985	4.7828	4.2046	6.6348	46.1256	4.2046
4.5947	4.8251	4.2062	6.6628	46.4011	4.2062
4.5907	4.8675	4.2076	6.6908	46.6759	4.2076
4.5864	4.9098	4.2089	6.7187	46.9500	4.2089
4.5818	4.9520	4.2101	6.7466	47.2236	4.2101
4.5769	4.9943	4.2111	6.7743	47.4967	4.2111
4.5717	5.0365	4.2121	6.8020	47.7695	4.2121
4.5661	5.0787	4.2130	6.8295	48.0419	4.2130
4.5602	5.1208	4.2138	6.8569	48.3142	4.2138
4.5538	5.1628	4.2144	6.8842	48.5864	4.2144
4.5471	5.2048	4.2150	6.9113	48.8586	4.2150
4.5399	5.2468	4.2155	6.9383	49.1309	4.2155
4.5324	5.2886	4.2159	6.9650	49.4033	4.2159
4.5243	5.3304	4.2161	6.9916	49.6760	4.2161
4.5158	5.3721	4.2163	7.0180	49.9492	4.2163
4.5069	5.4137	4.2165	7.0441	50.2227	4.2165
4.4974	5.4551	4.2165	7.0700	50.4967	4.2165

STREAMLINE 9

X	Y	Z	R	THETA	Z
4.5263	1.6679	3.4802	4.8239	20.2278	3.4802
4.5360	1.6657	3.4896	4.8322	20.1645	3.4896
4.5472	1.6683	3.4971	4.8435	20.1476	3.4971
4.5585	1.6744	3.5019	4.8563	20.1691	3.5019
4.5745	1.6870	3.5048	4.8757	20.2436	3.5048
4.5891	1.7016	3.5044	4.8944	20.3441	3.5044
4.6015	1.7178	3.5033	4.9117	20.4715	3.5033
4.6063	1.7363	3.5107	4.9227	20.6540	3.5107
4.6097	1.7548	3.5193	4.9324	20.8405	3.5193
4.6131	1.7733	3.5277	4.9422	21.0275	3.5277
4.6195	1.8107	3.5442	4.9617	21.4031	3.5442
4.6256	1.8483	3.5600	4.9812	21.7806	3.5600
4.6313	1.8862	3.5754	5.0007	22.1599	3.5754
4.6366	1.9243	3.5902	5.0201	22.5398	3.5902
4.6416	1.9627	3.6047	5.0395	22.9209	3.6047
4.6462	2.0012	3.6187	5.0589	23.3024	3.6187
4.6506	2.0399	3.6323	5.0783	23.6844	3.6323
4.6546	2.0788	3.6456	5.0977	24.0665	3.6456
4.6583	2.1179	3.6585	5.1171	24.4486	3.6585
4.6617	2.1570	3.6711	5.1366	24.8304	3.6711

4.6649	2.1963	3.6834	5.1560	25.2118	3.6834
4.6678	2.2357	3.6955	5.1756	25.5925	3.6955
4.6704	2.2751	3.7072	5.1951	25.9724	3.7072
4.6729	2.3147	3.7188	5.2148	26.3516	3.7188
4.6751	2.3544	3.7301	5.2345	26.7294	3.7301
4.6772	2.3941	3.7411	5.2543	27.1063	3.7411
4.6791	2.4339	3.7520	5.2742	27.4817	3.7520
4.6808	2.4737	3.7626	5.2942	27.8557	3.7626
4.6823	2.5136	3.7730	5.3144	28.2282	3.7730
4.6838	2.5536	3.7833	5.3346	28.5991	3.7833
4.6851	2.5936	3.7933	5.3551	28.9683	3.7933
4.6863	2.6337	3.8032	5.3756	29.3357	3.8032
4.6874	2.6738	3.8129	5.3964	29.7012	3.8129
4.6884	2.7139	3.8224	5.4173	30.0649	3.8224
4.6894	2.7541	3.8318	5.4383	30.4263	3.8318
4.6902	2.7944	3.8410	5.4595	30.7858	3.8410
4.6910	2.8346	3.8500	5.4810	31.1433	3.8500
4.6918	2.8750	3.8588	5.5026	31.4987	3.8588
4.6924	2.9153	3.8675	5.5243	31.8520	3.8675
4.6931	2.9557	3.8759	5.5463	32.2028	3.8759
4.6936	2.9961	3.8843	5.5684	32.5517	3.8843
4.6941	3.0366	3.8924	5.5907	32.8986	3.8924
4.6946	3.0771	3.9004	5.6131	33.2433	3.9004
4.6949	3.1176	3.9082	5.6358	33.5860	3.9082
4.6952	3.1582	3.9158	5.6585	33.9266	3.9158
4.6954	3.1988	3.9233	5.6815	34.2653	3.9233
4.6956	3.2395	3.9305	5.7046	34.6016	3.9305
4.6957	3.2801	3.9376	5.7279	34.9359	3.9376
4.6957	3.3208	3.9446	5.7513	35.2680	3.9446
4.6957	3.3615	3.9513	5.7749	35.5981	3.9513
4.6956	3.4023	3.9579	5.7986	35.9260	3.9579
4.6954	3.4431	3.9643	5.8225	36.2519	3.9643
4.6952	3.4839	3.9706	5.8466	36.5756	3.9706
4.6949	3.5247	3.9767	5.8708	36.8972	3.9767
4.6946	3.5656	3.9826	5.8951	37.2168	3.9826
4.6942	3.6064	3.9884	5.9196	37.5342	3.9884
4.6937	3.6473	3.9940	5.9442	37.8495	3.9940
4.6932	3.6882	3.9994	5.9690	38.1627	3.9994
4.6926	3.7292	4.0047	5.9940	38.4739	4.0047
4.6920	3.7701	4.0098	6.0190	38.7828	4.0098
4.6913	3.8111	4.0148	6.0442	39.0898	4.0148
4.6905	3.8521	4.0196	6.0695	39.3948	4.0196
4.6896	3.8931	4.0242	6.0950	39.6978	4.0242
4.6887	3.9341	4.0287	6.1206	39.9988	4.0287
4.6877	3.9752	4.0330	6.1463	40.2978	4.0330
4.6867	4.0162	4.0372	6.1721	40.5947	4.0372
4.6855	4.0573	4.0412	6.1980	40.8900	4.0412
4.6843	4.0984	4.0450	6.2241	41.1834	4.0450
4.6830	4.1395	4.0487	6.2502	41.4749	4.0487
4.6815	4.1806	4.0523	6.2765	41.7645	4.0523
4.6800	4.2217	4.0557	6.3028	42.0523	4.0557
4.6784	4.2628	4.0589	6.3292	42.3386	4.0589
4.6767	4.3039	4.0620	6.3557	42.6231	4.0620
4.6749	4.3451	4.0650	6.3823	42.9060	4.0650
4.6729	4.3862	4.0678	6.4090	43.1873	4.0678
4.6708	4.4274	4.0704	6.4357	43.4671	4.0704
4.6686	4.4685	4.0730	6.4625	43.7454	4.0730
4.6662	4.5096	4.0753	6.4893	44.0223	4.0753
4.6637	4.5508	4.0776	6.5161	44.2978	4.0776
4.6610	4.5919	4.0797	6.5430	44.5721	4.0797
4.6582	4.6331	4.0816	6.5699	44.8452	4.0816
4.6551	4.6742	4.0835	6.5968	45.1171	4.0835
4.6519	4.7153	4.0852	6.6237	45.3879	4.0852
4.6484	4.7564	4.0868	6.6507	45.6578	4.0868
4.6448	4.7975	4.0882	6.6775	45.9265	4.0882
4.6409	4.8386	4.0895	6.7044	46.1948	4.0895
4.6367	4.8796	4.0908	6.7313	46.4622	4.0908
4.6323	4.9206	4.0919	6.7580	46.7288	4.0919
4.6276	4.9617	4.0928	6.7847	46.9952	4.0928
4.6226	5.0026	4.0937	6.8114	47.2609	4.0937
4.6173	5.0436	4.0945	6.8379	47.5263	4.0945
4.6117	5.0844	4.0952	6.8643	47.7915	4.0952
4.6057	5.1253	4.0958	6.8906	48.0565	4.0958



4.5993	5.1661	4.0963	6.9168	48.3215	4.0963
4.5926	5.2068	4.0967	6.9428	48.5865	4.0967
4.5854	5.2474	4.0970	6.9686	48.8517	4.0970
4.5779	5.2880	4.0973	6.9943	49.1171	4.0973
4.5699	5.3285	4.0977	7.0197	49.3828	4.0977
4.5614	5.3689	4.0980	7.0450	49.6490	4.0980
4.5525	5.4092	4.0984	7.0700	49.9155	4.0984

STREAMLINE 10

X	Y	Z	R	THETA	Z
4.6265	1.6798	3.3917	4.9220	19.9551	3.3917
4.6362	1.6765	3.4004	4.9300	19.8800	3.4004
4.6465	1.6756	3.4092	4.9394	19.8296	3.4092
4.6569	1.6773	3.4176	4.9498	19.8078	3.4176
4.6717	1.6844	3.4295	4.9661	19.8272	3.4295
4.6847	1.6957	3.4404	4.9821	19.8986	3.4404
4.6953	1.7100	3.4502	4.9970	20.0116	3.4502
4.7014	1.7273	3.4589	5.0087	20.1728	3.4589
4.7045	1.7455	3.4673	5.0179	20.3560	3.4673
4.7073	1.7638	3.4757	5.0269	20.5409	3.4757
4.7126	1.8007	3.4919	5.0449	20.9123	3.4919
4.7175	1.8379	3.5076	5.0629	21.2853	3.5076
4.7222	1.8753	3.5228	5.0809	21.6597	3.5228
4.7265	1.9130	3.5375	5.0990	22.0353	3.5375
4.7305	1.9509	3.5517	5.1170	22.4116	3.5517
4.7343	1.9890	3.5656	5.1351	22.7887	3.5656
4.7377	2.0272	3.5789	5.1532	23.1657	3.5789
4.7409	2.0656	3.5919	5.1713	23.5431	3.5919
4.7438	2.1042	3.6046	5.1895	23.9205	3.6046
4.7464	2.1429	3.6169	5.2077	24.2976	3.6169
4.7488	2.1816	3.6289	5.2260	24.6743	3.6289
4.7510	2.2205	3.6406	5.2443	25.0505	3.6406
4.7530	2.2595	3.6520	5.2627	25.4260	3.6520
4.7547	2.2986	3.6631	5.2812	25.8007	3.6631
4.7563	2.3377	3.6740	5.2998	26.1743	3.6740
4.7577	2.3770	3.6847	5.3185	26.5468	3.6847
4.7590	2.4163	3.6951	5.3373	26.9182	3.6951
4.7601	2.4557	3.7053	5.3562	27.2884	3.7053
4.7611	2.4950	3.7152	5.3752	27.6567	3.7152
4.7619	2.5345	3.7250	5.3944	28.0238	3.7250
4.7627	2.5740	3.7346	5.4138	28.3893	3.7346
4.7633	2.6136	3.7440	5.4332	28.7531	3.7440
4.7639	2.6532	3.7532	5.4529	29.1154	3.7532
4.7644	2.6929	3.7623	5.4727	29.4755	3.7623
4.7648	2.7325	3.7711	5.4927	29.8337	3.7711
4.7651	2.7723	3.7798	5.5129	30.1901	3.7798
4.7654	2.8120	3.7883	5.5332	30.5445	3.7883
4.7657	2.8518	3.7967	5.5538	30.8969	3.7967
4.7659	2.8917	3.8049	5.5745	31.2473	3.8049
4.7660	2.9315	3.8129	5.5954	31.5956	3.8129
4.7661	2.9714	3.8208	5.6165	31.9418	3.8208
4.7661	3.0114	3.8285	5.6378	32.2859	3.8285
4.7661	3.0513	3.8360	5.6592	32.6281	3.8360
4.7660	3.0913	3.8434	5.6808	32.9682	3.8434
4.7659	3.1314	3.8507	5.7026	33.3066	3.8507
4.7657	3.1714	3.8577	5.7245	33.6427	3.8577
4.7654	3.2115	3.8646	5.7466	33.9768	3.8646
4.7651	3.2516	3.8713	5.7688	34.3088	3.8713
4.7647	3.2917	3.8779	5.7912	34.6388	3.8779
4.7643	3.3319	3.8843	5.8138	34.9668	3.8843
4.7638	3.3721	3.8906	5.8365	35.2928	3.8906
4.7633	3.4123	3.8966	5.8594	35.6167	3.8966
4.7627	3.4525	3.9026	5.8825	35.9385	3.9026
4.7621	3.4928	3.9084	5.9057	36.2583	3.9084
4.7614	3.5330	3.9140	5.9290	36.5761	3.9140
4.7607	3.5733	3.9195	5.9525	36.8918	3.9195
4.7599	3.6136	3.9248	5.9762	37.2055	3.9248
4.7590	3.6540	3.9300	6.0000	37.5171	3.9300
4.7581	3.6943	3.9351	6.0239	37.8267	3.9351
4.7572	3.7347	3.9400	6.0480	38.1343	3.9400

4.7562	3.7751	3.9447	6.0722	38.4397	3.9447
4.7551	3.8155	3.9493	6.0966	38.7433	3.9493
4.7540	3.8559	3.9537	6.1211	39.0449	3.9537
4.7528	3.8963	3.9580	6.1457	39.3445	3.9580
4.7516	3.9367	3.9622	6.1705	39.6422	3.9622
4.7502	3.9772	3.9662	6.1954	39.9380	3.9662
4.7489	4.0176	3.9701	6.2204	40.2319	3.9701
4.7474	4.0581	3.9739	6.2455	40.5239	3.9739
4.7459	4.0986	3.9774	6.2707	40.8141	3.9774
4.7443	4.1391	3.9809	6.2961	41.1025	3.9809
4.7426	4.1796	3.9842	6.3215	41.3891	3.9842
4.7409	4.2201	3.9874	6.3470	41.6740	3.9874
4.7390	4.2606	3.9905	6.3727	41.9572	3.9905
4.7370	4.3011	3.9934	6.3984	42.2387	3.9934
4.7350	4.3416	3.9962	6.4241	42.5187	3.9962
4.7328	4.3822	3.9988	6.4500	42.7971	3.9988
4.7305	4.4227	4.0013	6.4759	43.0739	4.0013
4.7281	4.4632	4.0037	6.5019	43.3493	4.0037
4.7255	4.5038	4.0060	6.5280	43.6235	4.0060
4.7228	4.5443	4.0081	6.5540	43.8962	4.0081
4.7200	4.5848	4.0101	6.5802	44.1677	4.0101
4.7170	4.6253	4.0120	6.6063	44.4379	4.0120
4.7138	4.6658	4.0137	6.6325	44.7070	4.0137
4.7104	4.7063	4.0154	6.6586	44.9747	4.0154
4.7069	4.7468	4.0169	6.6848	45.2418	4.0169
4.7031	4.7873	4.0183	6.7110	45.5080	4.0183
4.6992	4.8277	4.0196	6.7371	45.7732	4.0196
4.6950	4.8682	4.0207	6.7633	46.0377	4.0207
4.6905	4.9086	4.0218	6.7893	46.3014	4.0218
4.6858	4.9490	4.0227	6.8154	46.5645	4.0227
4.6808	4.9893	4.0236	6.8413	46.8270	4.0236
4.6756	5.0296	4.0243	6.8672	47.0891	4.0243
4.6700	5.0699	4.0249	6.8930	47.3512	4.0249
4.6641	5.1102	4.0255	6.9187	47.6128	4.0255
4.6579	5.1504	4.0259	6.9442	47.8742	4.0259
4.6513	5.1905	4.0262	6.9697	48.1356	4.0262
4.6444	5.2306	4.0265	6.9949	48.3970	4.0265
4.6371	5.2706	4.0267	7.0201	48.6584	4.0267
4.6295	5.3105	4.0268	7.0451	48.9194	4.0268
4.6215	5.3504	4.0269	7.0700	49.1807	4.0269

STREAMLINE 11

X	Y	Z	R	THETA	Z
4.6715	1.5851	3.3079	4.9331	18.7426	3.3079
4.6805	1.5805	3.3173	4.9402	18.6589	3.3173
4.6897	1.5771	3.3271	4.9477	18.5874	3.3271
4.6988	1.5749	3.3372	4.9557	18.5290	3.3372
4.7125	1.5738	3.3528	4.9684	18.4677	3.3528
4.7259	1.5756	3.3685	4.9816	18.4386	3.3685
4.7387	1.5802	3.3842	4.9952	18.4420	3.3842
4.7508	1.5874	3.3994	5.0090	18.4767	3.3994
4.7619	1.5971	3.4140	5.0226	18.5409	3.4140
4.7719	1.6089	3.4278	5.0358	18.6324	3.4278
4.7880	1.6381	3.4523	5.0605	18.8874	3.4523
4.7985	1.6729	3.4723	5.0818	19.2199	3.4723
4.8045	1.7105	3.4887	5.0999	19.5971	3.4887
4.8097	1.7487	3.5042	5.1177	19.9797	3.5042
4.8146	1.7871	3.5192	5.1355	20.3638	3.5192
4.8191	1.8257	3.5336	5.1533	20.7491	3.5336
4.8233	1.8645	3.5476	5.1711	21.1351	3.5476
4.8271	1.9036	3.5611	5.1889	21.5221	3.5611
4.8307	1.9428	3.5742	5.2067	21.9092	3.5742
4.8339	1.9822	3.5869	5.2246	22.2968	3.5869
4.8369	2.0218	3.5992	5.2424	22.6842	3.5992
4.8396	2.0614	3.6111	5.2604	23.0714	3.6111
4.8421	2.1012	3.6227	5.2783	23.4582	3.6227
4.8443	2.1411	3.6340	5.2964	23.8443	3.6340
4.8463	2.1810	3.6450	5.3145	24.2298	3.6450
4.8481	2.2211	3.6557	5.3327	24.6144	3.6557
4.8497	2.2612	3.6662	5.3509	24.9979	3.6662

4.8511	2.3014	3.6764	5.3693	25.3802	3.6764
4.8523	2.3417	3.6864	5.3878	25.7616	3.6864
4.8534	2.3820	3.6961	5.4065	26.1413	3.6961
4.8544	2.4224	3.7057	5.4252	26.5198	3.7057
4.8552	2.4628	3.7150	5.4441	26.8966	3.7150
4.8559	2.5033	3.7242	5.4632	27.2718	3.7242
4.8565	2.5438	3.7331	5.4824	27.6453	3.7331
4.8571	2.5844	3.7419	5.5018	28.0170	3.7419
4.8575	2.6250	3.7505	5.5214	28.3868	3.7505
4.8578	2.6656	3.7590	5.5411	28.7547	3.7590
4.8581	2.7063	3.7673	5.5611	29.1203	3.7673
4.8584	2.7470	3.7754	5.5812	29.4844	3.7754
4.8585	2.7877	3.7833	5.6015	29.8463	3.7833
4.8587	2.8285	3.7911	5.6220	30.2060	3.7911
4.8587	2.8693	3.7988	5.6427	30.5635	3.7988
4.8588	2.9101	3.8063	5.6636	30.9188	3.8063
4.8587	2.9510	3.8136	5.6847	31.2724	3.8136
4.8587	2.9918	3.8208	5.7059	31.6236	3.8208
4.8585	3.0327	3.8279	5.7274	31.9726	3.8279
4.8584	3.0737	3.8348	5.7490	32.3196	3.8348
4.8581	3.1146	3.8415	5.7708	32.6646	3.8415
4.8578	3.1556	3.8481	5.7928	33.0075	3.8481
4.8574	3.1966	3.8545	5.8149	33.3480	3.8545
4.8570	3.2376	3.8607	5.8372	33.6868	3.8607
4.8565	3.2787	3.8668	5.8596	34.0235	3.8668
4.8560	3.3197	3.8728	5.8823	34.3581	3.8728
4.8554	3.3608	3.8786	5.9051	34.6906	3.8786
4.8547	3.4020	3.8842	5.9280	35.0209	3.8842
4.8540	3.4431	3.8897	5.9512	35.3491	3.8897
4.8533	3.4842	3.8951	5.9744	35.6752	3.8951
4.8524	3.5254	3.9003	5.9979	35.9991	3.9003
4.8516	3.5666	3.9053	6.0215	36.3210	3.9053
4.8507	3.6078	3.9103	6.0452	36.6407	3.9103
4.8497	3.6490	3.9150	6.0691	36.9587	3.9150
4.8486	3.6902	3.9197	6.0932	37.2743	3.9197
4.8476	3.7315	3.9242	6.1174	37.5879	3.9242
4.8464	3.7727	3.9285	6.1418	37.8994	3.9285
4.8452	3.8140	3.9328	6.1663	38.2089	3.9328
4.8439	3.8553	3.9368	6.1909	38.5164	3.9368
4.8426	3.8966	3.9408	6.2156	38.8219	3.9408
4.8412	3.9379	3.9446	6.2405	39.1254	3.9446
4.8397	3.9792	3.9482	6.2656	39.4269	3.9482
4.8382	4.0206	3.9518	6.2907	39.7267	3.9518
4.8366	4.0619	3.9552	6.3160	40.0244	3.9552
4.8349	4.1032	3.9584	6.3413	40.3202	3.9584
4.8331	4.1446	3.9616	6.3668	40.6142	3.9616
4.8313	4.1859	3.9646	6.3924	40.9065	3.9646
4.8293	4.2273	3.9674	6.4181	41.1971	3.9674
4.8272	4.2686	3.9702	6.4439	41.4857	3.9702
4.8251	4.3100	3.9728	6.4697	41.7728	3.9728
4.8228	4.3514	3.9753	6.4957	42.0583	3.9753
4.8204	4.3927	3.9776	6.5217	42.3421	3.9776
4.8179	4.4341	3.9798	6.5478	42.6245	3.9798
4.8153	4.4755	3.9819	6.5739	42.9054	3.9819
4.8125	4.5168	3.9839	6.6001	43.1849	3.9839
4.8095	4.5582	3.9858	6.6264	43.4630	3.9858
4.8065	4.5996	3.9875	6.6527	43.7399	3.9875
4.8032	4.6409	3.9891	6.6790	44.0155	3.9891
4.7998	4.6822	3.9906	6.7053	44.2899	3.9906
4.7961	4.7236	3.9920	6.7316	44.5632	3.9920
4.7923	4.7649	3.9932	6.7580	44.8355	3.9932
**	4.8062	3.9944	6.7843	45.1069	3.9944
4.7840	4.8474	3.9954	6.8106	45.3774	3.9954
4.7795	4.8887	3.9963	6.8369	45.6470	3.9963
4.7747	4.9299	3.9971	6.8631	45.9160	3.9971
4.7697	4.9711	3.9978	6.8893	46.1842	3.9978
4.7644	5.0123	3.9984	6.9154	46.4519	3.9984
4.7589	5.0534	3.9989	6.9414	46.7192	3.9989
4.7530	5.0945	3.9993	6.9674	46.9860	3.9993
4.7468	5.1355	3.9996	6.9932	47.2526	3.9996
4.7402	5.1765	3.9998	7.0189	47.5189	3.9998
4.7333	5.2174	4.0000	7.0445	47.7851	4.0000
4.7260	5.2583	4.0000	7.0700	48.0513	4.0000

## SUCTION SIDE

## PARTIAL BLADE

## STREAMLINE 1

X	Y	Z	R	THETA	Z
3.5053	0.9684	4.0490	3.6366	15.4446	4.0490
3.4928	0.9776	4.0393	3.6270	15.6368	4.0393
3.4807	0.9881	4.0304	3.6183	15.8484	4.0304
3.4693	0.9999	4.0224	3.6105	16.0774	4.0224
3.4534	1.0197	4.0122	3.6008	16.4511	4.0122
3.4393	1.0419	4.0046	3.5936	16.8541	4.0046
3.4271	1.0660	3.9997	3.5891	17.2777	3.9997
3.4173	1.0915	3.9978	3.5874	17.7130	3.9978
3.4100	1.1178	3.9991	3.5885	18.1497	3.9991
3.4054	1.1445	4.0034	3.5926	18.5768	4.0034
3.4046	1.1964	4.0204	3.6087	19.3613	4.0204
3.4103	1.2459	4.0431	3.6308	20.0696	4.0431
3.4165	1.2953	4.0661	3.6538	20.7639	4.0661
3.4232	1.3446	4.0892	3.6778	21.4449	4.0892
3.4302	1.3938	4.1124	3.7026	22.1126	4.1124
3.4378	1.4429	4.1356	3.7283	22.7683	4.1356
3.4457	1.4919	4.1588	3.7548	23.4112	4.1588
3.4540	1.5409	4.1819	3.7821	24.0425	4.1819
3.4627	1.5899	4.2050	3.8102	24.6622	4.2050
3.4717	1.6389	4.2278	3.8391	25.2707	4.2278
3.4810	1.6879	4.2505	3.8687	25.8685	4.2505
3.4906	1.7370	4.2729	3.8989	26.4560	4.2729
3.5005	1.7862	4.2951	3.9299	27.0336	4.2951
3.5106	1.8354	4.3170	3.9614	27.6017	4.3170
3.5209	1.8848	4.3386	3.9936	28.1607	4.3386
3.5313	1.9342	4.3598	4.0263	28.7109	4.3598
3.5419	1.9838	4.3807	4.0596	29.2529	4.3807
3.5526	2.0335	4.4012	4.0934	29.7870	4.4012
3.5633	2.0833	4.4213	4.1276	30.3134	4.4213
3.5741	2.1333	4.4410	4.1624	30.8326	4.4410
3.5849	2.1835	4.4604	4.1975	31.3449	4.4604
3.5957	2.2338	4.4793	4.2331	31.8506	4.4793
3.6064	2.2843	4.4977	4.2690	32.3499	4.4977
3.6171	2.3350	4.5158	4.3053	32.8432	4.5158
3.6277	2.3857	4.5334	4.3419	33.3304	4.5334
3.6383	2.4367	4.5506	4.3789	33.8124	4.5506
3.6487	2.4879	4.5674	4.4161	34.2887	4.5674
3.6589	2.5392	4.5838	4.4537	34.7596	4.5838
3.6690	2.5906	4.5997	4.4915	35.2252	4.5997
3.6790	2.6423	4.6153	4.5296	35.6860	4.6153
3.6889	2.6941	4.6304	4.5679	36.1415	4.6304
3.6985	2.7460	4.6451	4.6065	36.5918	4.6451
3.7080	2.7980	4.6595	4.6453	37.0374	4.6595
3.7173	2.8502	4.6734	4.6843	37.4786	4.6734
3.7264	2.9025	4.6870	4.7234	37.9155	4.6870
3.7352	2.9550	4.7002	4.7628	38.3479	4.7002
3.7439	3.0076	4.7130	4.8023	38.7763	4.7130
3.7523	3.0603	4.7254	4.8420	39.2005	4.7254
3.7604	3.1132	4.7375	4.8819	39.6206	4.7375
3.7684	3.1661	4.7493	4.9219	40.0365	4.7493
3.7761	3.2192	4.7606	4.9621	40.4483	4.7606
3.7836	3.2724	4.7717	5.0024	40.8562	4.7717
3.7908	3.3256	4.7824	5.0428	41.2602	4.7824
3.7978	3.3791	4.7928	5.0834	41.6606	4.7928
3.8046	3.4325	4.8028	5.1242	42.0571	4.8028
3.8111	3.4861	4.8126	5.1650	42.4499	4.8126
3.8173	3.5397	4.8220	5.2059	42.8391	4.8220
3.8233	3.5934	4.8311	5.2470	43.2248	4.8311
3.8291	3.6472	4.8399	5.2881	43.6067	4.8399
3.8345	3.7011	4.8484	5.3293	43.9856	4.8484
3.8398	3.7551	4.8567	5.3707	44.3611	4.8567
3.8447	3.8091	4.8646	5.4121	44.7332	4.8646
3.8494	3.8632	4.8723	5.4536	45.1021	4.8723
3.8539	3.9173	4.8797	5.4952	45.4678	4.8797

3.8580	3.9715	4.8868	5.5369	45.8303	4.8868
3.8619	4.0258	4.8937	5.5787	46.1897	4.8937
3.8656	4.0801	4.9003	5.6205	46.5461	4.9003
3.8690	4.1344	4.9067	5.6624	46.8993	4.9067
3.8721	4.1888	4.9128	5.7043	47.2496	4.9128
3.8750	4.2432	4.9186	5.7464	47.5969	4.9186
3.8777	4.2977	4.9243	5.7885	47.9409	4.9243
3.8801	4.3522	4.9297	5.8307	48.2820	4.9297
3.8823	4.4067	4.9348	5.8730	48.6201	4.9348
3.8843	4.4613	4.9398	5.9153	48.9552	4.9398
3.8860	4.5159	4.9445	5.9577	49.2871	4.9445
3.8876	4.5705	4.9490	6.0002	49.6159	4.9490
3.8890	4.6251	4.9533	6.0429	49.9415	4.9533
3.8902	4.6798	4.9574	6.0856	50.2640	4.9574
3.8913	4.7345	4.9613	6.1284	50.5830	4.9613
3.8922	4.7892	4.9649	6.1713	50.8988	4.9649
3.8930	4.8439	4.9684	6.2144	51.2112	4.9684
3.8938	4.8986	4.9717	6.2576	51.5197	4.9717
3.8944	4.9533	4.9748	6.3009	51.8248	4.9748
3.8950	5.0081	4.9777	6.3444	52.1260	4.9777
3.8956	5.0628	4.9805	6.3881	52.4234	4.9805
3.8962	5.1176	4.9830	6.4319	52.7167	4.9830
3.8968	5.1723	4.9854	6.4760	53.0058	4.9854
3.8975	5.2271	4.9876	6.5202	53.2909	4.9876
3.8982	5.2819	4.9896	6.5646	53.5715	4.9896
3.8990	5.3367	4.9914	6.6093	53.8477	4.9914
3.9000	5.3915	4.9931	6.6542	54.1193	4.9931
3.9012	5.4463	4.9945	6.6993	54.3857	4.9945
3.9026	5.5011	4.9958	6.7448	54.6472	4.9958
3.9042	5.5559	4.9969	6.7905	54.9036	4.9969
3.9061	5.6106	4.9979	6.8364	55.1546	4.9979
3.9082	5.6654	4.9986	6.8827	55.4005	4.9986
3.9106	5.7202	4.9992	6.9292	55.6411	4.9992
3.9133	5.7749	4.9997	6.9759	55.8768	4.9997
3.9161	5.8297	4.9999	7.0229	56.1083	4.9999
3.9190	5.8844	5.0000	7.0700	56.3363	5.0000

STREAMLINE 2

X	Y	Z	R	THETA	Z
3.5466	1.0462	4.0707	3.6977	16.4353	4.0707
3.5343	1.0552	4.0618	3.6885	16.6238	4.0618
3.5233	1.0667	4.0542	3.6813	16.8441	4.0542
3.5140	1.0804	4.0482	3.6763	17.0906	4.0482
3.5038	1.1042	4.0429	3.6737	17.4916	4.0429
3.4991	1.1302	4.0431	3.6771	17.9003	4.0431
3.4990	1.1561	4.0485	3.6850	18.2838	4.0485
3.5014	1.1808	4.0576	3.6952	18.6364	4.0576
3.5044	1.2051	4.0678	3.7059	18.9772	4.0678
3.5075	1.2294	4.0780	3.7167	19.3151	4.0780
3.5140	1.2778	4.0986	3.7391	19.9820	4.0986
3.5209	1.3260	4.1194	3.7623	20.6372	4.1194
3.5281	1.3742	4.1403	3.7863	21.2812	4.1403
3.5357	1.4223	4.1612	3.8111	21.9135	4.1612
3.5436	1.4704	4.1822	3.8366	22.5352	4.1822
3.5518	1.5184	4.2030	3.8628	23.1462	4.2030
3.5604	1.5664	4.2238	3.8897	23.7470	4.2238
3.5692	1.6144	4.2445	3.9173	24.3378	4.2445
3.5782	1.6624	4.2651	3.9455	24.9190	4.2651
3.5875	1.7105	4.2854	3.9744	25.4908	4.2854
3.5970	1.7586	4.3055	4.0039	26.0537	4.3055
3.6067	1.8067	4.3254	4.0339	26.6079	4.3254
3.6165	1.8550	4.3451	4.0645	27.1540	4.3451
3.6265	1.9033	4.3644	4.0956	27.6917	4.3644
3.6366	1.9517	4.3835	4.1272	28.2219	4.3835
3.6467	2.0002	4.4022	4.1593	28.7448	4.4022
3.6569	2.0489	4.4207	4.1918	29.2607	4.4207
3.6672	2.0976	4.4388	4.2247	29.7695	4.4388
3.6774	2.1465	4.4565	4.2580	30.2720	4.4565
3.6877	2.1955	4.4739	4.2917	30.7682	4.4739
3.6979	2.2447	4.4909	4.3258	31.2585	4.4909

X	Y	Z	R	THETA	Z
3.6104	1.1061	4.0455	3.7760	17.0330	4.0455
3.5999	1.1166	4.0371	3.7691	17.2328	4.0371
3.5948	1.1310	4.0294	3.7685	17.4652	4.0294
3.5942	1.1472	4.0236	3.7729	17.7022	4.0236
3.5982	1.1725	4.0211	3.7844	18.0480	4.0211
3.6015	1.1968	4.0286	3.7951	18.3825	4.0286
3.6041	1.2208	4.0379	3.8052	18.7124	4.0379
3.6068	1.2447	4.0473	3.8155	19.0395	4.0473
3.6096	1.2686	4.0567	3.8260	19.3641	4.0567
3.6125	1.2925	4.0662	3.8367	19.6859	4.0662
3.6185	1.3401	4.0852	3.8587	20.3219	4.0852
3.6248	1.3876	4.1045	3.8814	20.9476	4.1045
3.6315	1.4351	4.1238	3.9048	21.5629	4.1238
3.6385	1.4825	4.1431	3.9289	22.1685	4.1431
3.6457	1.5298	4.1625	3.9537	22.7642	4.1625
3.6533	1.5772	4.1818	3.9792	23.3505	4.1818
3.6610	1.6245	4.2010	4.0053	23.9277	4.2010
3.6691	1.6718	4.2202	4.0320	24.4959	4.2202
3.6773	1.7191	4.2392	4.0593	25.0554	4.2392
3.6858	1.7665	4.2580	4.0872	25.6065	4.2580
3.6945	1.8139	4.2767	4.1157	26.1495	4.2767
3.7033	1.8613	4.2951	4.1447	26.6847	4.2951
3.7122	1.9088	4.3133	4.1742	27.2125	4.3133
3.7212	1.9564	4.3313	4.2042	27.7328	4.3313
3.7304	2.0041	4.3490	4.2346	28.2464	4.3490
3.7396	2.0518	4.3664	4.2655	28.7529	4.3664
3.7488	2.0997	4.3835	4.2968	29.2531	4.3835
3.7581	2.1477	4.4003	4.3285	29.7471	4.4003
3.7674	2.1958	4.4168	4.3606	30.2351	4.4168
3.7766	2.2439	4.4330	4.3930	30.7173	4.4330
3.7858	2.2922	4.4488	4.4257	31.1940	4.4488
3.7950	2.3407	4.4643	4.4588	31.6653	4.4643
3.8041	2.3892	4.4795	4.4922	32.1316	4.4795
3.8131	2.4379	4.4943	4.5258	32.5925	4.4943
3.8220	2.4867	4.5088	4.5597	33.0486	4.5088
3.8308	2.5356	4.5230	4.5939	33.5000	4.5230
3.8395	2.5846	4.5369	4.6284	33.9467	4.5369
3.8481	2.6337	4.5504	4.6631	34.3888	4.5504
3.8565	2.6829	4.5636	4.6980	34.8257	4.5636
3.8648	2.7323	4.5764	4.7331	35.2588	4.5764
3.8730	2.7817	4.5890	4.7685	35.6868	4.5890
3.8810	2.8312	4.6012	4.8040	36.1111	4.6012
3.8889	2.8809	4.6132	4.8397	36.5314	4.6132
3.8965	2.9307	4.6248	4.8756	36.9481	4.6248
3.9040	2.9805	4.6361	4.9117	37.3604	4.6361
3.9113	3.0305	4.6471	4.9479	37.7688	4.6471
3.9183	3.0805	4.6579	4.9843	38.1735	4.6579
3.9253	3.1306	4.6683	5.0208	38.5745	4.6683
3.9320	3.1808	4.6784	5.0575	38.9718	4.6784
3.9385	3.2311	4.6883	5.0943	39.3655	4.6883
3.9448	3.2815	4.6979	5.1313	39.7557	4.6979
3.9509	3.3319	4.7072	5.1683	40.1421	4.7072
3.9568	3.3825	4.7163	5.2055	40.5252	4.7163
3.9625	3.4331	4.7251	5.2429	40.9049	4.7251
3.9680	3.4837	4.7337	5.2803	41.2813	4.7337
3.9733	3.5344	4.7419	5.3178	41.6544	4.7419
3.9784	3.5852	4.7500	5.3555	42.0243	4.7500
3.9832	3.6361	4.7578	5.3933	42.3912	4.7578
3.9879	3.6870	4.7654	5.4311	42.7548	4.7654
3.9923	3.7379	4.7727	5.4690	43.1153	4.7727
3.9965	3.7889	4.7798	5.5071	43.4728	4.7798
4.0004	3.8400	4.7867	5.5452	43.8274	4.7867
4.0042	3.8911	4.7933	5.5833	44.1791	4.7933
4.0077	3.9422	4.7998	5.6216	44.5279	4.7998
4.0110	3.9934	4.8060	5.6600	44.8739	4.8060
4.0141	4.0446	4.8120	5.6984	45.2171	4.8120
4.0169	4.0959	4.8178	5.7369	45.5576	4.8178
4.0195	4.1471	4.8234	5.7754	45.8952	4.8234
4.0219	4.1985	4.8289	5.8140	46.2301	4.8289
4.0241	4.2498	4.8341	5.8527	46.5623	4.8341
4.0261	4.3012	4.8391	5.8915	46.8917	4.8391

3.7080	2.2939	4.5076	4.3602	31.7429	4.5076
3.7181	2.3434	4.5239	4.3949	32.2217	4.5239
3.7280	2.3929	4.5398	4.4299	32.6952	4.5398
3.7379	2.4426	4.5554	4.4652	33.1634	4.5554
3.7477	2.4925	4.5706	4.5008	33.6265	4.5706
3.7573	2.5424	4.5854	4.5366	34.0847	4.5854
3.7668	2.5925	4.5999	4.5727	34.5379	4.5999
3.7761	2.6427	4.6140	4.6090	34.9862	4.6140
3.7853	2.6931	4.6277	4.6456	35.4297	4.6277
3.7944	2.7436	4.6412	4.6824	35.8688	4.6412
3.8033	2.7941	4.6542	4.7194	36.3033	4.6542
3.8120	2.8449	4.6670	4.7565	36.7336	4.6670
3.8205	2.8957	4.6794	4.7938	37.1595	4.6794
3.8288	2.9466	4.6914	4.8314	37.5818	4.6914
3.8369	2.9977	4.7032	4.8690	37.9999	4.7032
3.8447	3.0488	4.7146	4.9069	38.4141	4.7146
3.8524	3.1001	4.7257	4.9449	38.8243	4.7257
3.8598	3.1515	4.7365	4.9830	39.2306	4.7365
3.8671	3.2029	4.7470	5.0212	39.6332	4.7470
3.8741	3.2544	4.7572	5.0596	40.0319	4.7572
3.8809	3.3061	4.7671	5.0982	40.4270	4.7671
3.8875	3.3578	4.7767	5.1368	40.8185	4.7767
3.8938	3.4095	4.7860	5.1756	41.2064	4.7860
3.8999	3.4614	4.7950	5.2145	41.5908	4.7950
3.9058	3.5134	4.8037	5.2535	41.9721	4.8037
3.9115	3.5654	4.8122	5.2926	42.3498	4.8122
3.9169	3.6175	4.8204	5.3318	42.7242	4.8204
3.9221	3.6696	4.8284	5.3711	43.0952	4.8284
3.9270	3.7218	4.8361	5.4105	43.4633	4.8361
3.9317	3.7741	4.8435	5.4500	43.8282	4.8435
3.9362	3.8264	4.8507	5.4895	44.1901	4.8507
3.9404	3.8788	4.8577	5.5292	44.5489	4.8577
3.9443	3.9312	4.8644	5.5689	44.9048	4.8644
3.9480	3.9837	4.8709	5.6087	45.2576	4.8709
3.9515	4.0362	4.8771	5.6485	45.6075	4.8771
3.9548	4.0888	4.8831	5.6884	45.9546	4.8831
3.9578	4.1414	4.8889	5.7284	46.2987	4.8889
3.9605	4.1940	4.8945	5.7685	46.6401	4.8945
3.9630	4.2467	4.8999	5.8086	46.9788	4.8999
3.9653	4.2994	4.9051	5.8488	47.3146	4.9051
3.9674	4.3521	4.9100	5.8891	47.6475	4.9100
3.9693	4.4049	4.9148	5.9294	47.9776	4.9148
3.9710	4.4577	4.9193	5.9699	48.3049	4.9193
3.9724	4.5105	4.9237	6.0104	48.6293	4.9237
3.9737	4.5633	4.9279	6.0509	48.9507	4.9279
3.9748	4.6161	4.9319	6.0916	49.2694	4.9319
3.9757	4.6690	4.9357	6.1324	49.5851	4.9357
3.9765	4.7219	4.9393	6.1732	49.8977	4.9393
3.9771	4.7748	4.9428	6.2142	50.2073	4.9428
3.9777	4.8276	4.9461	6.2552	50.5137	4.9461
3.9781	4.8805	4.9492	6.2964	50.8168	4.9492
3.9784	4.9334	4.9522	6.3377	51.1166	4.9522
3.9787	4.9864	4.9550	6.3792	51.4133	4.9550
3.9789	5.0393	4.9576	6.4208	51.7063	4.9576
3.9792	5.0923	4.9601	6.4626	51.9956	4.9601
3.9794	5.1452	4.9624	6.5045	52.2812	4.9624
3.9796	5.1982	4.9646	6.5467	52.5630	4.9646
3.9799	5.2512	4.9666	6.5890	52.8410	4.9666
3.9803	5.3041	4.9685	6.6315	53.1151	4.9685
3.9807	5.3571	4.9702	6.6742	53.3848	4.9702
3.9813	5.4101	4.9717	6.7171	53.6503	4.9717
3.9821	5.4631	4.9731	6.7603	53.9112	4.9731
3.9831	5.5160	4.9743	6.8038	54.1674	4.9743
3.9843	5.5690	4.9754	6.8475	54.4189	4.9754
3.9857	5.6220	4.9764	6.8915	54.6655	4.9764
3.9874	5.6750	4.9772	6.9357	54.9072	4.9772
3.9893	5.7279	4.9778	6.9803	55.1440	4.9778
3.9915	5.7809	4.9783	7.0250	55.3761	4.9783
3.9939	5.8338	4.9785	7.0700	55.6042	4.9785

4.0279	4.3526	4.8440	5.9304	47.2187	4.8440
4.0295	4.4040	4.8487	5.9693	47.5428	4.8487
4.0309	4.4555	4.8532	6.0083	47.8641	4.8532
4.0321	4.5070	4.8575	6.0474	48.1828	4.8575
4.0332	4.5584	4.8617	6.0865	48.4986	4.8617
4.0340	4.6099	4.8657	6.1258	48.8117	4.8657
4.0348	4.6614	4.8695	6.1651	49.1217	4.8695
4.0353	4.7130	4.8732	6.2045	49.4292	4.8732
4.0358	4.7645	4.8768	6.2441	49.7337	4.8768
4.0361	4.8161	4.8802	6.2837	50.0351	4.8802
4.0364	4.8676	4.8834	6.3235	50.3335	4.8834
4.0365	4.9192	4.8865	6.3634	50.6288	4.8865
4.0366	4.9708	4.8895	6.4034	50.9209	4.8895
4.0367	5.0224	4.8924	6.4435	51.2097	4.8924
4.0367	5.0740	4.8951	6.4839	51.4950	4.8951
4.0368	5.1256	4.8977	6.5243	51.7769	4.8977
4.0368	5.1772	4.9002	6.5650	52.0551	4.9002
4.0369	5.2288	4.9026	6.6058	52.3296	4.9026
4.0371	5.2804	4.9048	6.6468	52.6007	4.9048
4.0373	5.3320	4.9069	6.6880	52.8676	4.9069
4.0376	5.3836	4.9088	6.7295	53.1306	4.9088
4.0381	5.4353	4.9107	6.7712	53.3895	4.9107
4.0388	5.4869	4.9124	6.8131	53.6439	4.9124
4.0397	5.5385	4.9140	6.8552	53.8937	4.9140
4.0408	5.5902	4.9155	6.8977	54.1391	4.9155
4.0421	5.6418	4.9168	6.9404	54.3798	4.9168
4.0437	5.6934	4.9180	6.9833	54.6159	4.9180
4.0456	5.7451	4.9191	7.0266	54.8474	4.9191
4.0477	5.7967	4.9199	7.0700	55.0744	4.9199

STREAMLINE 4

X	Y	Z	R	THETA	Z
3.7704	1.1946	3.9490	3.9552	17.5804	3.9490
3.7591	1.2040	3.9412	3.9472	17.7596	3.9412
3.7494	1.2165	3.9360	3.9418	17.9758	3.9360
3.7426	1.2316	3.9343	3.9401	18.2148	3.9343
3.7374	1.2555	3.9368	3.9426	18.5687	3.9368
3.7385	1.2790	3.9452	3.9512	18.8873	3.9452
3.7399	1.3025	3.9539	3.9602	19.2017	3.9539
3.7414	1.3259	3.9626	3.9694	19.5137	3.9626
3.7431	1.3493	3.9714	3.9788	19.8233	3.9714
3.7448	1.3727	3.9803	3.9884	20.1306	3.9803
3.7485	1.4193	3.9983	4.0082	20.7381	3.9983
3.7526	1.4658	4.0164	4.0287	21.3363	4.0164
3.7570	1.5123	4.0346	4.0500	21.9256	4.0346
3.7618	1.5586	4.0530	4.0719	22.5060	4.0530
3.7669	1.6050	4.0713	4.0946	23.0776	4.0713
3.7723	1.6513	4.0897	4.1179	23.6408	4.0897
3.7780	1.6976	4.1080	4.1418	24.1957	4.1080
3.7839	1.7438	4.1263	4.1664	24.7425	4.1263
3.7902	1.7901	4.1445	4.1916	25.2815	4.1445
3.7966	1.8364	4.1625	4.2174	25.8128	4.1625
3.8032	1.8827	4.1804	4.2437	26.3367	4.1804
3.8101	1.9291	4.1981	4.2706	26.8535	4.1981
3.8171	1.9755	4.2156	4.2980	27.3634	4.2156
3.8242	2.0220	4.2329	4.3258	27.8666	4.2329
3.8315	2.0685	4.2500	4.3542	28.3634	4.2500
3.8388	2.1151	4.2668	4.3829	28.8541	4.2668
3.8462	2.1618	4.2833	4.4121	29.3388	4.2833
3.8537	2.2086	4.2996	4.4417	29.8177	4.2996
3.8612	2.2555	4.3156	4.4717	30.2910	4.3156
3.8687	2.3025	4.3313	4.5021	30.7591	4.3313
3.8762	2.3496	4.3466	4.5327	31.2220	4.3466
3.8837	2.3968	4.3617	4.5637	31.6800	4.3617
3.8912	2.4441	4.3765	4.5951	32.1331	4.3765
3.8985	2.4915	4.3909	4.6267	32.5816	4.3909
3.9059	2.5390	4.4051	4.6585	33.0254	4.4051
3.9131	2.5866	4.4189	4.6907	33.4648	4.4189
3.9203	2.6343	4.4324	4.7231	33.8996	4.4324
3.9273	2.6821	4.4456	4.7558	34.3301	4.4456



3.9343	2.7300	4.4585	4.7887	34.7562	4.4585
3.9412	2.7780	4.4712	4.8219	35.1779	4.4712
3.9480	2.8260	4.4835	4.8553	35.5955	4.4835
3.9547	2.8742	4.4955	4.8888	36.0092	4.4955
3.9612	2.9225	4.5072	4.9226	36.4190	4.5072
3.9676	2.9709	4.5186	4.9566	36.8250	4.5186
3.9739	3.0193	4.5297	4.9908	37.2271	4.5297
3.9800	3.0678	4.5405	5.0251	37.6256	4.5405
3.9859	3.1165	4.5511	5.0596	38.0204	4.5511
3.9918	3.1651	4.5614	5.0943	38.4116	4.5614
3.9974	3.2139	4.5713	5.1292	38.7991	4.5713
4.0029	3.2627	4.5811	5.1642	39.1832	4.5811
4.0083	3.3117	4.5905	5.1993	39.5638	4.5905
4.0134	3.3606	4.5997	5.2347	39.9409	4.5997
4.0185	3.4097	4.6086	5.2701	40.3148	4.6086
4.0233	3.4588	4.6173	5.3057	40.6853	4.6173
4.0280	3.5080	4.6257	5.3414	41.0525	4.6257
4.0325	3.5572	4.6338	5.3772	41.4166	4.6338
4.0368	3.6065	4.6417	5.4132	41.7775	4.6417
4.0409	3.6558	4.6494	5.4492	42.1354	4.6494
4.0449	3.7052	4.6568	5.4854	42.4901	4.6568
4.0487	3.7546	4.6640	5.5217	42.8419	4.6640
4.0523	3.8041	4.6709	5.5581	43.1907	4.6709
4.0557	3.8536	4.6776	5.5946	43.5366	4.6776
4.0589	3.9032	4.6841	5.6312	43.8797	4.6841
4.0620	3.9528	4.6904	5.6678	44.2198	4.6904
4.0648	4.0025	4.6965	5.7046	44.5572	4.6965
4.0675	4.0522	4.7023	5.7415	44.8918	4.7023
4.0700	4.1019	4.7079	5.7784	45.2236	4.7079
4.0723	4.1516	4.7133	5.8155	45.5527	4.7133
4.0744	4.2014	4.7186	5.8526	45.8790	4.7186
4.0764	4.2512	4.7236	5.8898	46.2026	4.7236
4.0782	4.3011	4.7284	5.9271	46.5235	4.7284
4.0798	4.3509	4.7330	5.9645	46.8417	4.7330
4.0813	4.4008	4.7375	6.0020	47.1571	4.7375
4.0826	4.4507	4.7417	6.0396	47.4698	4.7417
4.0838	4.5006	4.7458	6.0773	47.7797	4.7458
4.0849	4.5506	4.7497	6.1150	48.0869	4.7497
4.0858	4.6005	4.7534	6.1529	48.3912	4.7534
4.0866	4.6505	4.7569	6.1909	48.6926	4.7569
4.0873	4.7005	4.7602	6.2290	48.9911	4.7602
4.0880	4.7504	4.7634	6.2672	49.2866	4.7634
4.0885	4.8005	4.7665	6.3056	49.5792	4.7665
4.0890	4.8505	4.7693	6.3441	49.8686	4.7693
4.0895	4.9005	4.7720	6.3827	50.1548	4.7720
4.0899	4.9505	4.7745	6.4215	50.4377	4.7745
4.0904	5.0006	4.7769	6.4604	50.7173	4.7769
4.0909	5.0506	4.7791	6.4995	50.9934	4.7791
4.0914	5.1007	4.7812	6.5388	51.2659	4.7812
4.0920	5.1507	4.7831	6.5783	51.5347	4.7831
4.0926	5.2008	4.7848	6.6180	51.7999	4.7848
4.0934	5.2509	4.7864	6.6579	52.0614	4.7864
4.0942	5.3009	4.7879	6.6980	52.3189	4.7879
4.0953	5.3510	4.7892	6.7383	52.5723	4.7892
4.0965	5.4011	4.7903	6.7788	52.8213	4.7903
4.0979	5.4511	4.7913	6.8197	53.0659	4.7913
4.0996	5.5012	4.7921	6.8608	53.3059	4.7921
4.1015	5.5513	4.7928	6.9021	53.5414	4.7928
4.1037	5.6013	4.7934	6.9437	53.7723	4.7934
4.1061	5.6514	4.7938	6.9856	53.9987	4.7938
4.1088	5.7014	4.7940	7.0277	54.2207	4.7940
4.1118	5.7514	4.7941	7.0700	54.4385	4.7941

STREAMLINE 5

X	Y	Z	R	THETA	Z
3.9386	1.2917	3.8465	4.1450	18.1576	3.8465
3.9274	1.3000	3.8385	4.1370	18.3149	3.8385
3.9174	1.3111	3.8325	4.1310	18.5043	3.8325
3.9101	1.3242	3.8298	4.1283	18.7094	3.8298
3.9040	1.3475	3.8316	4.1300	19.0422	3.8316

3.9037	1.3705	3.8389	4.1373	19.3451	3.8389
3.9039	1.3934	3.8466	4.1452	19.6426	3.8466
3.9043	1.4163	3.8545	4.1532	19.9380	3.8545
3.9047	1.4391	3.8625	4.1614	20.2314	3.8625
3.9052	1.4619	3.8705	4.1698	20.5228	3.8705
3.9065	1.5074	3.8868	4.1873	21.0994	3.8868
3.9082	1.5528	3.9033	4.2054	21.6682	3.9033
3.9103	1.5981	3.9200	4.2242	22.2291	3.9200
3.9127	1.6433	3.9368	4.2438	22.7823	3.9368
3.9154	1.6885	3.9538	4.2640	23.3279	3.9538
3.9185	1.7336	3.9708	4.2848	23.8660	3.9708
3.9218	1.7788	3.9878	4.3063	24.3968	3.9878
3.9255	1.8238	4.0048	4.3285	24.9205	4.0048
3.9294	1.8689	4.0218	4.3512	25.4372	4.0218
3.9335	1.9140	4.0387	4.3745	25.9472	4.0387
3.9379	1.9591	4.0555	4.3983	26.4506	4.0555
3.9425	2.0043	4.0722	4.4227	26.9475	4.0722
3.9473	2.0494	4.0887	4.4476	27.4382	4.0887
3.9523	2.0947	4.1051	4.4730	27.9230	4.1051
3.9574	2.1399	4.1213	4.4989	28.4019	4.1213
3.9626	2.1852	4.1372	4.5252	28.8752	4.1372
3.9679	2.2306	4.1529	4.5520	29.3431	4.1529
3.9734	2.2761	4.1684	4.5791	29.8058	4.1684
3.9789	2.3216	4.1837	4.6067	30.2634	4.1837
3.9844	2.3673	4.1987	4.6346	30.7160	4.1987
3.9899	2.4130	4.2134	4.6628	31.1639	4.2134
3.9955	2.4588	4.2278	4.6914	31.6073	4.2278
4.0011	2.5046	4.2420	4.7204	32.0462	4.2420
4.0066	2.5506	4.2559	4.7496	32.4807	4.2559
4.0121	2.5967	4.2695	4.7791	32.9110	4.2695
4.0176	2.6428	4.2828	4.8089	33.3371	4.2828
4.0230	2.6890	4.2958	4.8390	33.7591	4.2958
4.0284	2.7353	4.3086	4.8693	34.1770	4.3086
4.0337	2.7817	4.3211	4.8999	34.5908	4.3211
4.0390	2.8282	4.3333	4.9308	35.0006	4.3333
4.0442	2.8748	4.3452	4.9619	35.4065	4.3452
4.0493	2.9214	4.3568	4.9932	35.8086	4.3568
4.0544	2.9681	4.3681	5.0247	36.2071	4.3681
4.0593	3.0149	4.3792	5.0565	36.6018	4.3792
4.0642	3.0618	4.3900	5.0884	36.9929	4.3900
4.0689	3.1087	4.4005	5.1206	37.3805	4.4005
4.0735	3.1557	4.4108	5.1529	37.7645	4.4108
4.0781	3.2028	4.4208	5.1854	38.1450	4.4208
4.0825	3.2499	4.4305	5.2181	38.5221	4.4305
4.0868	3.2971	4.4400	5.2510	38.8958	4.4400
4.0910	3.3444	4.4492	5.2841	39.2662	4.4492
4.0950	3.3917	4.4582	5.3173	39.6333	4.4582
4.0990	3.4391	4.4669	5.3506	39.9971	4.4669
4.1028	3.4865	4.4754	5.3841	40.3578	4.4754
4.1065	3.5340	4.4836	5.4178	40.7153	4.4836
4.1100	3.5816	4.4916	5.4516	41.0698	4.4916
4.1134	3.6292	4.4993	5.4855	41.4212	4.4993
4.1167	3.6768	4.5068	5.5196	41.7696	4.5068
4.1198	3.7245	4.5141	5.5538	42.1151	4.5141
4.1228	3.7722	4.5211	5.5881	42.4576	4.5211
4.1256	3.8200	4.5280	5.6225	42.7972	4.5280
4.1283	3.8678	4.5346	5.6571	43.1340	4.5346
4.1308	3.9156	4.5409	5.6918	43.4680	4.5409
4.1332	3.9635	4.5471	5.7265	43.7991	4.5471
4.1355	4.0114	4.5531	5.7614	44.1275	4.5531
4.1376	4.0594	4.5588	5.7964	44.4532	4.5588
4.1396	4.1074	4.5644	5.8315	44.7761	4.5644
4.1414	4.1554	4.5697	5.8667	45.0964	4.5697
4.1431	4.2034	4.5748	5.9020	45.4139	4.5748
4.1447	4.2515	4.5798	5.9374	45.7287	4.5798
4.1461	4.2995	4.5845	5.9730	46.0408	4.5845
4.1474	4.3476	4.5891	6.0086	46.3501	4.5891
4.1486	4.3958	4.5935	6.0443	46.6568	4.5935
4.1497	4.4439	4.5977	6.0802	46.9607	4.5977
4.1507	4.4921	4.6017	6.1161	47.2618	4.6017
4.1516	4.5402	4.6055	6.1522	47.5602	4.6055
4.1524	4.5884	4.6092	6.1884	47.8557	4.6092
4.1532	4.6366	4.6127	6.2247	48.1483	4.6127

4.1538	4.6849	4.6160	6.2612	48.4381	4.6160
4.1545	4.7331	4.6192	6.2978	48.7248	4.6192
4.1551	4.7813	4.6222	6.3345	49.0086	4.6222
4.1557	4.8296	4.6250	6.3714	49.2892	4.6250
4.1563	4.8778	4.6277	6.4084	49.5667	4.6277
4.1569	4.9261	4.6302	6.4456	49.8408	4.6302
4.1575	4.9744	4.6326	6.4830	50.1117	4.6326
4.1582	5.0227	4.6348	6.5206	50.3791	4.6348
4.1590	5.0709	4.6368	6.5583	50.6429	4.6368
4.1598	5.1192	4.6387	6.5963	50.9031	4.6387
4.1608	5.1675	4.6405	6.6344	51.1597	4.6405
4.1619	5.2158	4.6421	6.6728	51.4125	4.6421
4.1631	5.2641	4.6435	6.7114	51.6615	4.6435
4.1645	5.3124	4.6448	6.7502	51.9065	4.6448
4.1661	5.3607	4.6459	6.7893	52.1471	4.6459
4.1680	5.4090	4.6469	6.8286	52.3835	4.6469
4.1701	5.4573	4.6478	6.8682	52.6154	4.6478
4.1725	5.5056	4.6484	6.9080	52.8428	4.6484
4.1751	5.5538	4.6490	6.9482	53.0657	4.6490
4.1781	5.6021	4.6494	6.9885	53.2842	4.6494
4.1813	5.6503	4.6496	7.0292	53.4982	4.6496
4.1847	5.6985	4.6497	7.0700	53.7083	4.6497

STREAMLINE 6

X	Y	Z	R	THETA	Z
4.1051	1.3923	3.7441	4.3347	18.7348	3.7441
4.0941	1.3996	3.7360	4.3267	18.8729	3.7360
4.0843	1.4099	3.7299	4.3208	19.0447	3.7299
4.0763	1.4227	3.7264	4.3175	19.2397	3.7264
4.0693	1.4446	3.7271	4.3181	19.5452	3.7271
4.0679	1.4669	3.7334	4.3243	19.8299	3.7334
4.0670	1.4891	3.7404	4.3311	20.1099	3.7404
4.0663	1.5113	3.7474	4.3380	20.3884	3.7474
4.0656	1.5334	3.7545	4.3452	20.6653	3.7545
4.0650	1.5556	3.7617	4.3525	20.9407	3.7617
4.0641	1.5998	3.7763	4.3676	21.4865	3.7763
4.0635	1.6439	3.7912	4.3834	22.0258	3.7912
4.0632	1.6879	3.8063	4.3999	22.5584	3.8063
4.0634	1.7319	3.8216	4.4170	23.0844	3.8216
4.0638	1.7758	3.8371	4.4349	23.6037	3.8371
4.0646	1.8196	3.8527	4.4533	24.1164	3.8527
4.0658	1.8634	3.8684	4.4724	24.6226	3.8684
4.0672	1.9072	3.8841	4.4922	25.1226	3.8841
4.0689	1.9509	3.8999	4.5125	25.6165	3.8999
4.0709	1.9947	3.9157	4.5333	26.1045	3.9157
4.0731	2.0385	3.9313	4.5547	26.5866	3.9313
4.0755	2.0823	3.9470	4.5767	27.0631	3.9470
4.0782	2.1261	3.9625	4.5991	27.5341	3.9625
4.0810	2.1699	3.9778	4.6221	27.9997	3.9778
4.0841	2.2138	3.9931	4.6455	28.4601	3.9931
4.0872	2.2577	4.0082	4.6693	28.9155	4.0082
4.0905	2.3017	4.0230	4.6936	29.3660	4.0230
4.0939	2.3457	4.0377	4.7183	29.8118	4.0377
4.0974	2.3898	4.0522	4.7434	30.2529	4.0522
4.1010	2.4340	4.0665	4.7689	30.6896	4.0665
4.1046	2.4782	4.0805	4.7947	31.1220	4.0805
4.1083	2.5225	4.0943	4.8209	31.5501	4.0943
4.1120	2.5669	4.1078	4.8474	31.9742	4.1078
4.1157	2.6114	4.1211	4.8743	32.3943	4.1211
4.1195	2.6559	4.1342	4.9014	32.8105	4.1342
4.1232	2.7005	4.1470	4.9288	33.2228	4.1470
4.1269	2.7452	4.1595	4.9566	33.6313	4.1595
4.1306	2.7899	4.1717	4.9845	34.0361	4.1717
4.1343	2.8347	4.1837	5.0128	34.4371	4.1837
4.1379	2.8796	4.1955	5.0413	34.8345	4.1955
4.1416	2.9246	4.2070	5.0701	35.2282	4.2070
4.1451	2.9696	4.2182	5.0991	35.6184	4.2182
4.1487	3.0147	4.2292	5.1283	36.0050	4.2292
4.1521	3.0599	4.2399	5.1578	36.3881	4.2399
4.1556	3.1051	4.2504	5.1875	36.7678	4.2504

4.1589	3.1504	4.2606	5.2174	37.1441	4.2606
4.1622	3.1958	4.2705	5.2476	37.5170	4.2705
4.1655	3.2412	4.2803	5.2779	37.8866	4.2803
4.1686	3.2866	4.2897	5.3084	38.2529	4.2897
4.1717	3.3322	4.2990	5.3391	38.6160	4.2990
4.1747	3.3777	4.3079	5.3700	38.9759	4.3079
4.1777	3.4234	4.3167	5.4011	39.3327	4.3167
4.1805	3.4690	4.3252	5.4324	39.6864	4.3252
4.1832	3.5148	4.3334	5.4638	40.0370	4.3334
4.1859	3.5605	4.3415	5.4954	40.3846	4.3415
4.1884	3.6063	4.3493	5.5271	40.7292	4.3493
4.1909	3.6522	4.3569	5.5590	41.0709	4.3569
4.1933	3.6981	4.3642	5.5910	41.4096	4.3642
4.1955	3.7441	4.3713	5.6232	41.7455	4.3713
4.1977	3.7900	4.3782	5.6555	42.0786	4.3782
4.1997	3.8361	4.3849	5.6880	42.4089	4.3849
4.2016	3.8821	4.3914	5.7205	42.7364	4.3914
4.2035	3.9282	4.3977	5.7533	43.0611	4.3977
4.2052	3.9743	4.4037	5.7861	43.3831	4.4037
4.2068	4.0205	4.4096	5.8191	43.7023	4.4096
4.2084	4.0666	4.4153	5.8522	44.0189	4.4153
4.2098	4.1128	4.4207	5.8854	44.3328	4.4207
4.2111	4.1591	4.4260	5.9187	44.6439	4.4260
4.2123	4.2053	4.4311	5.9522	44.9524	4.4311
4.2135	4.2516	4.4359	5.9858	45.2583	4.4359
4.2145	4.2979	4.4406	6.0195	45.5614	4.4406
4.2155	4.3442	4.4451	6.0533	45.8618	4.4451
4.2164	4.3906	4.4495	6.0873	46.1596	4.4495
4.2172	4.4369	4.4536	6.1213	46.4545	4.4536
4.2179	4.4833	4.4576	6.1556	46.7468	4.4576
4.2186	4.5297	4.4614	6.1899	47.0362	4.4614
4.2193	4.5761	4.4650	6.2244	47.3228	4.4650
4.2199	4.6225	4.4685	6.2590	47.6066	4.4685
4.2206	4.6689	4.4718	6.2938	47.8874	4.4718
4.2212	4.7154	4.4749	6.3287	48.1653	4.4749
4.2218	4.7618	4.4779	6.3638	48.4401	4.4779
4.2224	4.8083	4.4807	6.3991	48.7119	4.4807
4.2231	4.8547	4.4834	6.4345	48.9805	4.4834
4.2238	4.9012	4.4859	6.4701	49.2458	4.4859
4.2246	4.9477	4.4882	6.5059	49.5078	4.4882
4.2254	4.9942	4.4904	6.5419	49.7664	4.4904
4.2264	5.0407	4.4925	6.5781	50.0215	4.4925
4.2275	5.0872	4.4944	6.6145	50.2729	4.4944
4.2287	5.1337	4.4961	6.6511	50.5207	4.4961
4.2301	5.1802	4.4977	6.6879	50.7650	4.4977
4.2317	5.2267	4.4991	6.7250	51.0053	4.4991
4.2334	5.2732	4.5004	6.7623	51.2417	4.5004
4.2354	5.3197	4.5015	6.7998	51.4739	4.5015
4.2376	5.3661	4.5025	6.8376	51.7019	4.5025
4.2401	5.4126	4.5034	6.8757	51.9255	4.5034
4.2429	5.4591	4.5041	6.9140	52.1447	4.5041
4.2460	5.5055	4.5046	6.9527	52.3596	4.5046
4.2494	5.5519	4.5050	6.9915	52.5699	4.5050
4.2531	5.5983	4.5052	7.0307	52.7759	4.5052
4.2570	5.6447	4.5053	7.0700	52.9780	4.5053

STREAMLINE 7

X	Y	Z	R	THETA	Z
4.2697	1.4963	3.6418	4.5243	19.3128	3.6418
4.2591	1.5027	3.6335	4.5164	19.4334	3.6335
4.2494	1.5119	3.6271	4.5103	19.5856	3.6271
4.2412	1.5237	3.6231	4.5066	19.7612	3.6231
4.2331	1.5443	3.6225	4.5060	20.0433	3.6225
4.2305	1.5659	3.6278	4.5110	20.3115	3.6278
4.2286	1.5874	3.6338	4.5167	20.5757	3.6338
4.2267	1.6088	3.6399	4.5225	20.8383	3.6399
4.2250	1.6302	3.6461	4.5286	21.0996	3.6461
4.2233	1.6516	3.6525	4.5348	21.3593	3.6525
4.2203	1.6944	3.6655	4.5478	21.8745	3.6655
4.2177	1.7370	3.6788	4.5614	22.3841	3.6788

4.2154	1.7796	3.6924	4.5757	22.8880	3.6924
4.2135	1.8221	3.7063	4.5906	23.3862	3.7063
4.2119	1.8646	3.7203	4.6061	23.8789	3.7203
4.2106	1.9070	3.7346	4.6223	24.3660	3.7346
4.2096	1.9494	3.7490	4.6391	24.8477	3.7490
4.2090	1.9917	3.7634	4.6564	25.3241	3.7634
4.2086	2.0341	3.7780	4.6743	25.7951	3.7780
4.2085	2.0764	3.7925	4.6928	26.2610	3.7925
4.2086	2.1187	3.8071	4.7118	26.7219	3.8071
4.2090	2.1611	3.8216	4.7313	27.1778	3.8216
4.2096	2.2034	3.8361	4.7514	27.6288	3.8361
4.2104	2.2458	3.8505	4.7719	28.0752	3.8505
4.2113	2.2882	3.8648	4.7928	28.5169	3.8648
4.2125	2.3306	3.8790	4.8143	28.9542	3.8790
4.2138	2.3731	3.8930	4.8361	29.3872	3.8930
4.2152	2.4157	3.9069	4.8584	29.8159	3.9069
4.2168	2.4582	3.9206	4.8810	30.2405	3.9206
4.2185	2.5009	3.9341	4.9041	30.6611	3.9341
4.2202	2.5436	3.9474	4.9275	31.0777	3.9474
4.2221	2.5863	3.9605	4.9512	31.4906	3.9605
4.2239	2.6291	3.9734	4.9753	31.8997	3.9734
4.2259	2.6720	3.9861	4.9998	32.3052	3.9861
4.2278	2.7150	3.9986	5.0245	32.7072	3.9986
4.2298	2.7580	4.0108	5.0496	33.1056	4.0108
4.2318	2.8011	4.0228	5.0749	33.5006	4.0228
4.2339	2.8442	4.0346	5.1005	33.8921	4.0346
4.2359	2.8874	4.0461	5.1264	34.2802	4.0461
4.2380	2.9307	4.0574	5.1526	34.6649	4.0574
4.2400	2.9740	4.0685	5.1790	35.0463	4.0685
4.2420	3.0174	4.0793	5.2057	35.4244	4.0793
4.2441	3.0608	4.0899	5.2327	35.7991	4.0899
4.2461	3.1043	4.1003	5.2598	36.1706	4.1003
4.2481	3.1479	4.1104	5.2873	36.5388	4.1104
4.2500	3.1915	4.1203	5.3149	36.9039	4.1203
4.2520	3.2351	4.1300	5.3428	37.2657	4.1300
4.2539	3.2789	4.1394	5.3709	37.6245	4.1394
4.2558	3.3226	4.1486	5.3992	37.9801	4.1486
4.2577	3.3664	4.1576	5.4277	38.3326	4.1576
4.2595	3.4103	4.1663	5.4565	38.6822	4.1663
4.2612	3.4542	4.1748	5.4854	39.0287	4.1748
4.2629	3.4982	4.1831	5.5145	39.3722	4.1831
4.2646	3.5421	4.1912	5.5438	39.7128	4.1912
4.2662	3.5862	4.1991	5.5733	40.0506	4.1991
4.2677	3.6303	4.2067	5.6029	40.3855	4.2067
4.2692	3.6744	4.2141	5.6327	40.7175	4.2141
4.2707	3.7185	4.2213	5.6627	41.0467	4.2213
4.2720	3.7627	4.2283	5.6928	41.3731	4.2283
4.2733	3.8070	4.2351	5.7231	41.6968	4.2351
4.2745	3.8512	4.2417	5.7536	42.0178	4.2417
4.2757	3.8955	4.2480	5.7842	42.3360	4.2480
4.2768	3.9398	4.2542	5.8149	42.6515	4.2542
4.2778	3.9842	4.2602	5.8458	42.9644	4.2602
4.2788	4.0286	4.2659	5.8768	43.2746	4.2659
4.2797	4.0730	4.2715	5.9080	43.5821	4.2715
4.2805	4.1174	4.2769	5.9394	43.8870	4.2769
4.2813	4.1618	4.2821	5.9708	44.1893	4.2821
4.2820	4.2063	4.2871	6.0024	44.4889	4.2871
4.2827	4.2508	4.2919	6.0342	44.7858	4.2919
4.2833	4.2953	4.2966	6.0660	45.0800	4.2966
4.2839	4.3398	4.3010	6.0981	45.3715	4.3010
4.2845	4.3844	4.3053	6.1302	45.6604	4.3053
4.2850	4.4290	4.3094	6.1625	45.9466	4.3094
4.2855	4.4736	4.3134	6.1950	46.2300	4.3134
4.2860	4.5182	4.3171	6.2276	46.5106	4.3171
4.2865	4.5628	4.3208	6.2604	46.7885	4.3208
4.2869	4.6074	4.3242	6.2933	47.0634	4.3242
4.2875	4.6520	4.3275	6.3264	47.3355	4.3275
4.2880	4.6967	4.3306	6.3597	47.6045	4.3306
4.2886	4.7414	4.3336	6.3931	47.8706	4.3336
4.2892	4.7860	4.3364	6.4268	48.1336	4.3364
4.2899	4.8307	4.3390	6.4606	48.3934	4.3390
4.2907	4.8754	4.3415	6.4946	48.6500	4.3415
4.2916	4.9201	4.3438	6.5288	48.9033	4.3438

4.2926	4.9648	4.3460	6.5632	49.1532	4.3460
4.2937	5.0095	4.3481	6.5978	49.3995	4.3481
4.2950	5.0542	4.3500	6.6326	49.6423	4.3500
4.2965	5.0989	4.3517	6.6677	49.8815	4.3517
4.2981	5.1436	4.3533	6.7030	50.1171	4.3533
4.2999	5.1883	4.3547	6.7385	50.3489	4.3547
4.3020	5.2330	4.3560	6.7743	50.5767	4.3560
4.3043	5.2777	4.3571	6.8103	50.8005	4.3571
4.3069	5.3223	4.3581	6.8466	51.0200	4.3581
4.3097	5.3670	4.3590	6.8832	51.2353	4.3590
4.3129	5.4116	4.3597	6.9201	51.4463	4.3597
4.3164	5.4563	4.3602	6.9572	51.6529	4.3602
4.3202	5.5009	4.3606	6.9945	51.8553	4.3606
4.3243	5.5454	4.3608	7.0322	52.0532	4.3608
4.3286	5.5900	4.3609	7.0700	52.2475	4.3609

STREAMLINE 8

X	Y	Z	R	THETA	Z
4.4325	1.6038	3.5396	4.7138	19.8912	3.5396
4.4223	1.6092	3.5312	4.7060	19.9957	3.5312
4.4127	1.6175	3.5245	4.6998	20.1303	3.5245
4.4044	1.6281	3.5199	4.6957	20.2873	3.5199
4.3955	1.6474	3.5182	4.6941	20.5460	3.5182
4.3920	1.6681	3.5226	4.6981	20.7974	3.5226
4.3891	1.6888	3.5277	4.7028	21.0455	3.5277
4.3862	1.7095	3.5329	4.7076	21.2925	3.5329
4.3835	1.7301	3.5383	4.7126	21.5382	3.5383
4.3809	1.7507	3.5438	4.7177	21.7827	3.5438
4.3759	1.7919	3.5551	4.7286	22.2681	3.5551
4.3714	1.8329	3.5668	4.7401	22.7488	3.5668
4.3671	1.8740	3.5789	4.7522	23.2247	3.5789
4.3632	1.9149	3.5913	4.7649	23.6960	3.5913
4.3596	1.9559	3.6039	4.7783	24.1625	3.6039
4.3564	1.9967	3.6168	4.7922	24.6243	3.6168
4.3534	2.0376	3.6298	4.8067	25.0816	3.6298
4.3508	2.0784	3.6430	4.8217	25.5342	3.6430
4.3484	2.1192	3.6563	4.8373	25.9824	3.6563
4.3463	2.1600	3.6697	4.8535	26.4261	3.6697
4.3445	2.2008	3.6831	4.8701	26.8655	3.6831
4.3429	2.2416	3.6965	4.8873	27.3006	3.6965
4.3415	2.2824	3.7099	4.9049	27.7315	3.7099
4.3404	2.3232	3.7233	4.9230	28.1583	3.7233
4.3394	2.3641	3.7366	4.9416	28.5812	3.7366
4.3386	2.4049	3.7499	4.9606	29.0001	3.7499
4.3380	2.4459	3.7630	4.9800	29.4152	3.7630
4.3376	2.4868	3.7761	4.9999	29.8266	3.7761
4.3372	2.5278	3.7890	5.0201	30.2344	3.7890
4.3370	2.5688	3.8017	5.0407	30.6386	3.8017
4.3369	2.6099	3.8143	5.0617	31.0393	3.8143
4.3369	2.6511	3.8267	5.0830	31.4366	3.8267
4.3370	2.6923	3.8390	5.1047	31.8306	3.8390
4.3372	2.7335	3.8510	5.1267	32.2214	3.8510
4.3374	2.7748	3.8629	5.1491	32.6089	3.8629
4.3377	2.8162	3.8746	5.1717	32.9933	3.8746
4.3380	2.8576	3.8860	5.1946	33.3745	3.8860
4.3384	2.8991	3.8973	5.2179	33.7526	3.8973
4.3388	2.9406	3.9084	5.2414	34.1275	3.9084
4.3392	2.9822	3.9192	5.2652	34.4994	3.9192
4.3397	3.0238	3.9298	5.2893	34.8683	3.9298
4.3402	3.0655	3.9403	5.3137	35.2340	3.9403
4.3407	3.1073	3.9505	5.3383	35.5967	3.9505
4.3413	3.1491	3.9605	5.3632	35.9563	3.9605
4.3418	3.1909	3.9703	5.3883	36.3130	3.9703
4.3424	3.2328	3.9798	5.4137	36.6667	3.9798
4.3430	3.2748	3.9892	5.4393	37.0174	3.9892
4.3436	3.3167	3.9983	5.4651	37.3652	3.9983
4.3442	3.3588	4.0073	5.4912	37.7101	4.0073
4.3448	3.4009	4.0160	5.5175	38.0520	4.0160
4.3453	3.4430	4.0245	5.5440	38.3911	4.0245
4.3459	3.4851	4.0328	5.5707	38.7274	4.0328

4.3465	3.5273	4.0409	5.5977	39.0608	4.0409
4.3470	3.5696	4.0488	5.6248	39.3915	4.0488
4.3475	3.6119	4.0564	5.6521	39.7193	4.0564
4.3480	3.6542	4.0639	5.6797	40.0445	4.0639
4.3485	3.6966	4.0712	5.7074	40.3669	4.0712
4.3490	3.7390	4.0782	5.7353	40.6866	4.0782
4.3494	3.7814	4.0851	5.7634	41.0036	4.0851
4.3498	3.8238	4.0917	5.7916	41.3179	4.0917
4.3502	3.8663	4.0982	5.8200	41.6296	4.0982
4.3506	3.9088	4.1045	5.8486	41.9386	4.1045
4.3509	3.9514	4.1105	5.8774	42.2450	4.1105
4.3512	3.9940	4.1164	5.9063	42.5487	4.1164
4.3515	4.0366	4.1221	5.9354	42.8499	4.1221
4.3517	4.0792	4.1276	5.9647	43.1484	4.1276
4.3519	4.1218	4.1329	5.9941	43.4444	4.1329
4.3522	4.1645	4.1381	6.0236	43.7377	4.1381
4.3523	4.2072	4.1430	6.0534	44.0284	4.1430
4.3525	4.2499	4.1478	6.0833	44.3165	4.1478
4.3527	4.2926	4.1524	6.1133	44.6019	4.1524
4.3529	4.3354	4.1568	6.1435	44.8845	4.1568
4.3530	4.3781	4.1611	6.1739	45.1646	4.1611
4.3532	4.4209	4.1652	6.2044	45.4420	4.1652
4.3534	4.4637	4.1691	6.2351	45.7167	4.1691
4.3536	4.5065	4.1728	6.2660	45.9885	4.1728
4.3539	4.5494	4.1764	6.2971	46.2576	4.1764
4.3542	4.5922	4.1798	6.3283	46.5238	4.1798
4.3546	4.6350	4.1831	6.3597	46.7872	4.1831
4.3550	4.6779	4.1862	6.3913	47.0475	4.1862
4.3555	4.7208	4.1892	6.4231	47.3049	4.1892
4.3561	4.7637	4.1920	6.4551	47.5591	4.1920
4.3568	4.8066	4.1946	6.4872	47.8102	4.1946
4.3576	4.8495	4.1971	6.5196	48.0581	4.1971
4.3585	4.8924	4.1994	6.5522	48.3027	4.1994
4.3596	4.9353	4.2016	6.5851	48.5439	4.2016
4.3609	4.9782	4.2037	6.6181	48.7816	4.2037
4.3624	5.0211	4.2055	6.6514	49.0157	4.2055
4.3640	5.0640	4.2073	6.6850	49.2462	4.2073
4.3658	5.1069	4.2089	6.7187	49.4732	4.2089
4.3679	5.1498	4.2103	6.7527	49.6964	4.2103
4.3702	5.1927	4.2116	6.7870	49.9156	4.2116
4.3728	5.2356	4.2127	6.8215	50.1308	4.2127
4.3757	5.2785	4.2137	6.8563	50.3419	4.2137
4.3789	5.3213	4.2146	6.8914	50.5488	4.2146
4.3824	5.3641	4.2153	6.9267	50.7515	4.2153
4.3862	5.4061	4.2158	6.9617	50.9464	4.2158
4.3903	5.4489	4.2162	6.9976	51.1406	4.2162
4.3948	5.4917	4.2164	7.0337	51.3308	4.2164
4.3995	5.5344	4.2165	7.0700	51.5174	4.2165

STREAMLINE 9

X	Y	Z	R	THETA	Z
4.5263	1.6679	3.4802	4.8239	20.2278	3.4802
4.5188	1.6744	3.4702	4.8191	20.3318	3.4702
4.5136	1.6841	3.4614	4.8175	20.4615	3.4614
4.5110	1.6957	3.4538	4.8192	20.6015	3.4538
4.5122	1.7147	3.4445	4.8270	20.8078	3.4445
4.5138	1.7352	3.4417	4.8358	21.0285	3.4417
4.5100	1.7557	3.4462	4.8397	21.2701	3.4462
4.5064	1.7761	3.4509	4.8437	21.5107	3.4509
4.5028	1.7964	3.4557	4.8479	21.7503	3.4557
4.4992	1.8168	3.4607	4.8522	21.9889	3.4607
4.4923	1.8574	3.4712	4.8611	22.4630	3.4712
4.4856	1.8979	3.4822	4.8706	22.9330	3.4822
4.4792	1.9382	3.4938	4.8806	23.3988	3.4938
4.4731	1.9785	3.5058	4.8911	23.8605	3.5058
4.4672	2.0187	3.5183	4.9021	24.3179	3.5183
4.4616	2.0588	3.5311	4.9137	24.7712	3.5311
4.4562	2.0989	3.5442	4.9258	25.2203	3.5442
4.4511	2.1389	3.5576	4.9383	25.6654	3.5576
4.4462	2.1788	3.5712	4.9514	26.1064	3.5712

4.4416	2.2187	3.5850	4.9649	26.5434	3.5850
4.4372	2.2586	3.5990	4.9790	26.9765	3.5990
4.4331	2.2985	3.6131	4.9935	27.4057	3.6131
4.4292	2.3383	3.6273	5.0085	27.8314	3.6273
4.4255	2.3782	3.6415	5.0240	28.2531	3.6415
4.4220	2.4181	3.6557	5.0399	28.6713	3.6557
4.4186	2.4580	3.6699	5.0563	29.0859	3.6699
4.4155	2.4979	3.6841	5.0731	29.4971	3.6841
4.4126	2.5378	3.6983	5.0903	29.9049	3.6983
4.4098	2.5778	3.7123	5.1080	30.3094	3.7123
4.4072	2.6179	3.7263	5.1260	30.7106	3.7263
4.4047	2.6580	3.7401	5.1445	31.1086	3.7401
4.4023	2.6981	3.7538	5.1634	31.5034	3.7538
4.4001	2.7383	3.7674	5.1826	31.8953	3.7674
4.3980	2.7786	3.7807	5.2023	32.2838	3.7807
4.3961	2.8189	3.7940	5.2222	32.6695	3.7940
4.3942	2.8593	3.8070	5.2426	33.0523	3.8070
4.3924	2.8998	3.8198	5.2633	33.4317	3.8198
4.3908	2.9403	3.8325	5.2843	33.8083	3.8325
4.3892	2.9809	3.8450	5.3057	34.1820	3.8450
4.3877	3.0215	3.8572	5.3274	34.5526	3.8572
4.3863	3.0622	3.8693	5.3495	34.9203	3.8693
4.3850	3.1030	3.8811	5.3719	35.2850	3.8811
4.3838	3.1439	3.8927	5.3946	35.6467	3.8927
4.3826	3.1848	3.9042	5.4176	36.0057	3.9042
4.3815	3.2258	3.9153	5.4409	36.3613	3.9153
4.3805	3.2668	3.9263	5.4645	36.7141	3.9263
4.3795	3.3079	3.9370	5.4884	37.0639	3.9370
4.3786	3.3490	3.9475	5.5126	37.4109	3.9475
4.3778	3.3903	3.9578	5.5370	37.7550	3.9578
4.3770	3.4315	3.9679	5.5618	38.0963	3.9679
4.3762	3.4729	3.9777	5.5868	38.4347	3.9777
4.3755	3.5143	3.9873	5.6121	38.7703	3.9873
4.3748	3.5557	3.9966	5.6375	39.1027	3.9966
4.3742	3.5972	4.0058	5.6633	39.4325	4.0058
4.3736	3.6387	4.0147	5.6893	39.7596	4.0147
4.3729	3.6803	4.0234	5.7155	40.0839	4.0234
4.3724	3.7219	4.0318	5.7420	40.4055	4.0318
4.3718	3.7636	4.0401	5.7686	40.7243	4.0401
4.3713	3.8053	4.0481	5.7955	41.0404	4.0481
4.3707	3.8470	4.0559	5.8226	41.3536	4.0559
4.3702	3.8888	4.0635	5.8499	41.6644	4.0635
4.3697	3.9307	4.0709	5.8774	41.9725	4.0709
4.3692	3.9726	4.0780	5.9051	42.2780	4.0780
4.3686	4.0145	4.0850	5.9330	42.5807	4.0850
4.3682	4.0564	4.0917	5.9611	42.8808	4.0917
4.3677	4.0984	4.0983	5.9894	43.1781	4.0983
4.3672	4.1404	4.1046	6.0179	43.4731	4.1046
4.3667	4.1824	4.1108	6.0465	43.7652	4.1108
4.3662	4.2245	4.1167	6.0754	44.0548	4.1167
4.3658	4.2666	4.1225	6.1044	44.3417	4.1225
4.3653	4.3087	4.1281	6.1336	44.6259	4.1281
4.3649	4.3508	4.1335	6.1630	44.9075	4.1335
4.3645	4.3930	4.1387	6.1925	45.1863	4.1387
4.3641	4.4352	4.1437	6.2223	45.4625	4.1437
4.3638	4.4774	4.1486	6.2522	45.7360	4.1486
4.3635	4.5196	4.1533	6.2823	46.0067	4.1533
4.3633	4.5619	4.1578	6.3126	46.2746	4.1578
4.3631	4.6041	4.1622	6.3430	46.5396	4.1622
4.3629	4.6464	4.1664	6.3737	46.8019	4.1664
4.3629	4.6887	4.1704	6.4046	47.0613	4.1704
4.3629	4.7310	4.1743	6.4356	47.3176	4.1743
4.3631	4.7733	4.1780	6.4669	47.5710	4.1780
4.3633	4.8156	4.1816	6.4984	47.8213	4.1816
4.3637	4.8580	4.1851	6.5300	48.0684	4.1851
4.3641	4.9003	4.1884	6.5619	48.3123	4.1884
4.3648	4.9427	4.1915	6.5941	48.5529	4.1915
4.3656	4.9851	4.1945	6.6264	48.7901	4.1945
4.3666	5.0274	4.1974	6.6590	49.0239	4.1974
4.3678	5.0698	4.2001	6.6918	49.2541	4.2001
4.3692	5.1122	4.2027	6.7249	49.4810	4.2027
4.3708	5.1546	4.2051	6.7582	49.7040	4.2051
4.3726	5.1970	4.2074	6.7918	49.9234	4.2074



4.3747	5.2394	4.2095	6.8256	50.1390	4.2095
4.3771	5.2817	4.2115	6.8597	50.3505	4.2115
4.3798	5.3241	4.2134	6.8941	50.5579	4.2134
4.3828	5.3664	4.2150	6.9287	50.7613	4.2150
4.3861	5.4088	4.2165	6.9637	50.9606	4.2165
4.3897	5.4511	4.2178	6.9989	51.1557	4.2178
4.3937	5.4934	4.2190	7.0343	51.3466	4.2190
4.3979	5.5356	4.2198	7.0700	51.5337	4.2198

STREAMLINE 10

X	Y	Z	R	THETA	Z
4.6265	1.6798	3.3917	4.9220	19.9551	3.3917
4.6171	1.6855	3.3828	4.9151	20.0553	3.3828
4.6085	1.6932	3.3746	4.9097	20.1737	3.3746
4.6006	1.7024	3.3673	4.9055	20.3062	3.3673
4.5903	1.7183	3.3578	4.9014	20.5226	3.3578
4.5820	1.7363	3.3504	4.9000	20.7539	3.3504
4.5757	1.7563	3.3474	4.9012	20.9982	3.3474
4.5710	1.7768	3.3502	4.9042	21.2413	3.3502
4.5667	1.7971	3.3544	4.9075	21.4812	3.3544
4.5623	1.8174	3.3587	4.9110	21.7202	3.3587
4.5539	1.8580	3.3679	4.9184	22.1957	3.3679
4.5458	1.8985	3.3777	4.9263	22.6679	3.3777
4.5379	1.9389	3.3880	4.9348	23.1360	3.3880
4.5303	1.9793	3.3987	4.9438	23.6006	3.3987
4.5230	2.0196	3.4100	4.9534	24.0616	3.4100
4.5159	2.0598	3.4216	4.9635	24.5189	3.4216
4.5091	2.1000	3.4335	4.9741	24.9721	3.4335
4.5026	2.1401	3.4457	4.9853	25.4218	3.4457
4.4963	2.1802	3.4582	4.9970	25.8677	3.4582
4.4903	2.2202	3.4710	5.0092	26.3098	3.4710
4.4845	2.2603	3.4839	5.0219	26.7487	3.4839
4.4790	2.3003	3.4970	5.0352	27.1833	3.4970
4.4738	2.3403	3.5101	5.0489	27.6144	3.5101
4.4687	2.3803	3.5234	5.0631	28.0420	3.5234
4.4639	2.4203	3.5367	5.0778	28.4662	3.5367
4.4592	2.4603	3.5501	5.0929	28.8869	3.5501
4.4548	2.5004	3.5634	5.1085	29.3043	3.5634
4.4506	2.5405	3.5768	5.1246	29.7184	3.5768
4.4465	2.5805	3.5901	5.1411	30.1288	3.5901
4.4426	2.6207	3.6033	5.1580	30.5362	3.6033
4.4389	2.6609	3.6164	5.1754	30.9408	3.6164
4.4353	2.7011	3.6295	5.1931	31.3417	3.6295
4.4319	2.7414	3.6424	5.2112	31.7396	3.6424
4.4286	2.7818	3.6551	5.2298	32.1345	3.6551
4.4254	2.8222	3.6678	5.2487	32.5263	3.6678
4.4224	2.8626	3.6803	5.2680	32.9152	3.6803
4.4194	2.9031	3.6926	5.2877	33.3011	3.6926
4.4166	2.9437	3.7047	5.3077	33.6840	3.7047
4.4139	2.9844	3.7167	5.3281	34.0638	3.7167
4.4112	3.0250	3.7284	5.3488	34.4406	3.7284
4.4087	3.0658	3.7401	5.3699	34.8148	3.7401
4.4063	3.1066	3.7515	5.3913	35.1857	3.7515
4.4039	3.1475	3.7627	5.4131	35.5538	3.7627
4.4017	3.1885	3.7737	5.4352	35.9186	3.7737
4.3995	3.2295	3.7845	5.4576	36.2803	3.7845
4.3975	3.2705	3.7951	5.4803	36.6391	3.7951
4.3955	3.3116	3.8055	5.5034	36.9948	3.8055
4.3936	3.3528	3.8157	5.5267	37.3476	3.8157
4.3917	3.3940	3.8256	5.5504	37.6974	3.8256
4.3900	3.4353	3.8354	5.5743	38.0443	3.8354
4.3882	3.4766	3.8449	5.5985	38.3882	3.8449
4.3866	3.5180	3.8543	5.6230	38.7292	3.8543
4.3850	3.5594	3.8634	5.6478	39.0672	3.8634
4.3835	3.6009	3.8723	5.6729	39.4024	3.8723
4.3820	3.6425	3.8809	5.6982	39.7347	3.8809
4.3805	3.6840	3.8894	5.7237	40.0637	3.8894
4.3791	3.7256	3.8976	5.7495	40.3903	3.8976
4.3777	3.7673	3.9057	5.7756	40.7138	3.9057
4.3764	3.8090	3.9135	5.8018	41.0345	3.9135

4.3751	3.8507	3.9211	5.8284	41.3524	3.9211
4.3738	3.8925	3.9285	5.8551	41.6675	3.9285
4.3726	3.9343	3.9356	5.8821	41.9798	3.9356
4.3714	3.9762	3.9426	5.9093	42.2893	3.9426
4.3702	4.0181	3.9494	5.9367	42.5960	3.9494
4.3691	4.0600	3.9559	5.9643	42.8999	3.9559
4.3680	4.1020	3.9623	5.9921	43.2010	3.9623
4.3669	4.1439	3.9684	6.0202	43.4993	3.9684
4.3659	4.1860	3.9744	6.0484	43.7949	3.9744
4.3649	4.2280	3.9801	6.0768	44.0876	3.9801
4.3639	4.2701	3.9857	6.1055	44.3775	3.9857
4.3629	4.3122	3.9911	6.1343	44.6646	3.9911
4.3621	4.3543	3.9963	6.1634	44.9491	3.9963
4.3612	4.3965	4.0013	6.1927	45.2306	4.0013
4.3604	4.4386	4.0061	6.2221	45.5092	4.0061
4.3597	4.4808	4.0107	6.2518	45.7849	4.0107
4.3591	4.5230	4.0152	6.2817	46.0576	4.0152
4.3585	4.5653	4.0194	6.3117	46.3274	4.0194
4.3580	4.6075	4.0235	6.3420	46.5941	4.0235
4.3576	4.6498	4.0275	6.3725	46.8579	4.0275
4.3573	4.6921	4.0312	6.4032	47.1186	4.0312
4.3571	4.7343	4.0348	6.4342	47.3760	4.0348
4.3571	4.7766	4.0383	6.4653	47.6302	4.0383
4.3571	4.8190	4.0416	6.4967	47.8813	4.0416
4.3574	4.8613	4.0447	6.5283	48.1289	4.0447
4.3578	4.9037	4.0476	6.5602	48.3730	4.0476
4.3584	4.9460	4.0504	6.5923	48.6136	4.0504
4.3592	4.9884	4.0531	6.6247	48.8506	4.0531
4.3603	5.0307	4.0556	6.6573	49.0839	4.0556
4.3615	5.0731	4.0579	6.6902	49.3134	4.0579
4.3630	5.1155	4.0601	6.7234	49.5394	4.0601
4.3647	5.1578	4.0621	6.7567	49.7612	4.0621
4.3667	5.2002	4.0639	6.7904	49.9792	4.0639
4.3690	5.2426	4.0656	6.8244	50.1932	4.0656
4.3716	5.2849	4.0671	6.8587	50.4028	4.0671
4.3746	5.3272	4.0684	6.8932	50.6080	4.0684
4.3779	5.3695	4.0696	6.9280	50.8091	4.0696
4.3815	5.4118	4.0706	6.9632	51.0058	4.0706
4.3855	5.4541	4.0715	6.9985	51.1982	4.0715
4.3898	5.4963	4.0722	7.0342	51.3865	4.0722
4.3943	5.5385	4.0726	7.0700	51.5714	4.0726

STREAMLINE 11

X	Y	Z	R	THETA	Z
4.6715	1.5851	3.3079	4.9331	18.7426	3.3079
4.6619	1.5912	3.2981	4.9260	18.8458	3.2981
4.6525	1.5984	3.2890	4.9194	18.9606	3.2890
4.6433	1.6066	3.2804	4.9134	19.0854	3.2804
4.6299	1.6203	3.2688	4.9052	19.2887	3.2688
4.6172	1.6359	3.2587	4.8984	19.5094	3.2587
4.6052	1.6529	3.2502	4.8928	19.7442	3.2502
4.5939	1.6711	3.2434	4.8884	19.9896	3.2434
4.5834	1.6903	3.2383	4.8852	20.2433	3.2383
4.5737	1.7103	3.2349	4.8830	20.5026	3.2349
4.5570	1.7519	3.2335	4.8822	21.0291	3.2335
4.5444	1.7946	3.2395	4.8860	21.5490	3.2395
4.5339	1.8373	3.2489	4.8921	22.0591	3.2489
4.5237	1.8799	3.2590	4.8987	22.5659	3.2590
4.5136	1.9223	3.2697	4.9059	23.0692	3.2697
4.5038	1.9648	3.2809	4.9137	23.5690	3.2809
4.4942	2.0071	3.2926	4.9220	24.0653	3.2926
4.4848	2.0493	3.3048	4.9309	24.5578	3.3048
4.4758	2.0915	3.3174	4.9403	25.0466	3.3174
4.4669	2.1337	3.3304	4.9503	25.5317	3.3304
4.4583	2.1757	3.3436	4.9609	26.0130	3.3436
4.4500	2.2178	3.3572	4.9720	26.4906	3.3572
4.4419	2.2598	3.3710	4.9837	26.9643	3.3710
4.4341	2.3018	3.3850	4.9960	27.4343	3.3850
4.4265	2.3438	3.3991	5.0088	27.9005	3.3991
4.4192	2.3858	3.4134	5.0221	28.3630	3.4134

4.4121	2.4278	3.4278	5.0359	28.8218	3.4278
4.4052	2.4697	3.4423	5.0503	29.2767	3.4423
4.3986	2.5118	3.4568	5.0653	29.7283	3.4568
4.3922	2.5539	3.4713	5.0807	30.1761	3.4713
4.3860	2.5960	3.4858	5.0966	30.6203	3.4858
4.3800	2.6381	3.5002	5.1131	31.0610	3.5002
4.3742	2.6803	3.5146	5.1300	31.4981	3.5146
4.3685	2.7225	3.5289	5.1475	31.9318	3.5289
4.3631	2.7648	3.5431	5.1654	32.3619	3.5431
4.3578	2.8072	3.5572	5.1837	32.7884	3.5572
4.3527	2.8496	3.5711	5.2026	33.2119	3.5711
4.3478	2.8921	3.5849	5.2219	33.6317	3.5849
4.3430	2.9347	3.5985	5.2416	34.0483	3.5985
4.3384	2.9774	3.6119	5.2618	34.4613	3.6119
4.3339	3.0201	3.6252	5.2824	34.8710	3.6252
4.3295	3.0629	3.6382	5.3034	35.2772	3.6382
4.3253	3.1058	3.6511	5.3249	35.6800	3.6511
4.3213	3.1487	3.6638	5.3467	36.0792	3.6638
4.3173	3.1917	3.6762	5.3690	36.4749	3.6762
4.3136	3.2348	3.6884	5.3917	36.8670	3.6884
4.3099	3.2780	3.7004	5.4148	37.2554	3.7004
4.3064	3.3212	3.7122	5.4384	37.6405	3.7122
4.3030	3.3646	3.7237	5.4623	38.0220	3.7237
4.2998	3.4079	3.7350	5.4865	38.3999	3.7350
4.2966	3.4514	3.7461	5.5112	38.7742	3.7461
4.2936	3.4949	3.7569	5.5362	39.1450	3.7569
4.2907	3.5385	3.7675	5.5615	39.5123	3.7675
4.2878	3.5822	3.7778	5.5873	39.8765	3.7778
4.2851	3.6259	3.7879	5.6133	40.2370	3.7879
4.2824	3.6697	3.7977	5.6397	40.5940	3.7977
4.2798	3.7135	3.8073	5.6663	40.9476	3.8073
4.2773	3.7574	3.8166	5.6933	41.2978	3.8166
4.2749	3.8014	3.8257	5.7206	41.6447	3.8257
4.2726	3.8454	3.8345	5.7482	41.9881	3.8345
4.2703	3.8895	3.8431	5.7761	42.3285	3.8431
4.2680	3.9336	3.8514	5.8043	42.6652	3.8514
4.2659	3.9778	3.8595	5.8327	42.9985	3.8595
4.2638	4.0220	3.8673	5.8614	43.3287	3.8673
4.2617	4.0663	3.8749	5.8904	43.6555	3.8749
4.2597	4.1106	3.8822	5.9197	43.9792	3.8822
4.2578	4.1550	3.8893	5.9492	44.2996	3.8893
4.2559	4.1993	3.8961	5.9789	44.6164	3.8961
4.2541	4.2438	3.9027	6.0089	44.9301	3.9027
4.2524	4.2882	3.9091	6.0392	45.2405	3.9091
4.2507	4.3327	3.9152	6.0697	45.5476	3.9152
4.2491	4.3773	3.9211	6.1004	45.8513	3.9211
4.2475	4.4218	3.9268	6.1314	46.1518	3.9268
4.2461	4.4664	3.9322	6.1626	46.4488	3.9322
4.2447	4.5111	3.9374	6.1941	46.7425	3.9374
4.2434	4.5557	3.9424	6.2259	47.0327	3.9424
4.2422	4.6004	3.9472	6.2578	47.3194	3.9472
4.2412	4.6451	3.9517	6.2901	47.6027	3.9517
4.2402	4.6899	3.9561	6.3225	47.8823	3.9561
4.2394	4.7346	3.9602	6.3553	48.1584	3.9602
4.2388	4.7794	3.9641	6.3883	48.4306	3.9641
4.2383	4.8242	3.9678	6.4215	48.6991	3.9678
4.2380	4.8690	3.9713	6.4550	48.9637	3.9713
4.2379	4.9138	3.9746	6.4888	49.2244	3.9746
4.2379	4.9587	3.9777	6.5229	49.4810	3.9777
4.2383	5.0035	3.9806	6.5573	49.7335	3.9806
4.2389	5.0484	3.9833	6.5920	49.9818	3.9833
4.2397	5.0933	3.9858	6.6269	50.2259	3.9858
4.2407	5.1382	3.9881	6.6622	50.4658	3.9881
4.2421	5.1831	3.9902	6.6977	50.7010	3.9902
4.2438	5.2279	3.9921	6.7336	50.9318	3.9921
4.2459	5.2728	3.9938	6.7698	51.1576	3.9938
4.2483	5.3177	3.9953	6.8063	51.3788	3.9953
4.2511	5.3625	3.9965	6.8431	51.5950	3.9965
4.2542	5.4074	3.9976	6.8803	51.8062	3.9976
4.2578	5.4522	3.9985	6.9177	52.0125	3.9985
4.2617	5.4969	3.9992	6.9555	52.2140	3.9992
4.2660	5.5417	3.9996	6.9935	52.4108	3.9996
4.2704	5.5864	3.9999	7.0317	52.6048	3.9999

4.2750 5.6311 4.0000 7.0700 52.7956 4.0000

HUB COORDINATES

X	Y	Z	R	THETA	Z
0.0000	-3.0485	1.9974	3.0485	270.0000	1.9974
0.0000	-3.0485	2.0565	3.0485	270.0000	2.0565
0.0000	-3.0485	2.1156	3.0485	270.0000	2.1156
0.0000	-3.0485	2.1748	3.0485	270.0000	2.1748
0.0000	-3.0485	2.2339	3.0485	270.0000	2.2339
0.0000	-3.0485	2.2930	3.0485	270.0000	2.2930
0.0000	-3.0485	2.3522	3.0485	270.0000	2.3522
0.0000	-3.0485	2.4113	3.0485	270.0000	2.4113
0.0000	-3.0485	2.4704	3.0485	270.0000	2.4704
0.0000	-3.0486	2.5296	3.0486	270.0000	2.5296
0.0000	-3.0498	2.5887	3.0498	270.0000	2.5887
0.0000	-3.0521	2.6478	3.0521	270.0000	2.6478
0.0000	-3.0556	2.7068	3.0556	270.0000	2.7068
0.0000	-3.0604	2.7657	3.0604	270.0000	2.7657
0.0000	-3.0665	2.8246	3.0665	270.0000	2.8246
0.0000	-3.0739	2.8832	3.0739	270.0000	2.8832
0.0000	-3.0828	2.9417	3.0828	270.0000	2.9417
0.0000	-3.0930	2.9999	3.0930	270.0000	2.9999
0.0000	-3.1047	3.0579	3.1047	270.0000	3.0579
0.0000	-3.1179	3.1155	3.1179	270.0000	3.1155
0.0000	-3.1326	3.1728	3.1326	270.0000	3.1728
0.0000	-3.1489	3.2297	3.1489	270.0000	3.2297
0.0000	-3.1667	3.2860	3.1667	270.0000	3.2860
0.0000	-3.1862	3.3419	3.1862	270.0000	3.3419
0.0000	-3.2073	3.3971	3.2073	270.0000	3.3971
0.0000	-3.2300	3.4517	3.2300	270.0000	3.4517
0.0000	-3.2544	3.5056	3.2544	270.0000	3.5056
0.0000	-3.2803	3.5587	3.2803	270.0000	3.5587
0.0000	-3.3079	3.6110	3.3079	270.0000	3.6110
0.0000	-3.3371	3.6624	3.3371	270.0000	3.6624
0.0000	-3.3678	3.7130	3.3678	270.0000	3.7130
0.0000	-3.4001	3.7625	3.4001	270.0000	3.7625
0.0000	-3.4339	3.8110	3.4339	270.0000	3.8110
0.0000	-3.4693	3.8584	3.4693	270.0000	3.8584
0.0000	-3.5060	3.9047	3.5060	270.0000	3.9047
0.0000	-3.5442	3.9499	3.5442	270.0000	3.9499
0.0000	-3.5837	3.9939	3.5837	270.0000	3.9939
0.0000	-3.6244	4.0367	3.6244	270.0000	4.0367
0.0000	-3.6664	4.0784	3.6664	270.0000	4.0784
0.0000	-3.7096	4.1188	3.7096	270.0000	4.1188
0.0000	-3.7539	4.1580	3.7539	270.0000	4.1580
0.0000	-3.7992	4.1960	3.7992	270.0000	4.1960
0.0000	-3.8455	4.2328	3.8455	270.0000	4.2328
0.0000	-3.8927	4.2684	3.8927	270.0000	4.2684
0.0000	-3.9408	4.3028	3.9408	270.0000	4.3028
0.0000	-3.9897	4.3360	3.9897	270.0000	4.3360
0.0000	-4.0394	4.3681	4.0394	270.0000	4.3681
0.0000	-4.0898	4.3990	4.0898	270.0000	4.3990
0.0000	-4.1408	4.4288	4.1408	270.0000	4.4288
0.0000	-4.1925	4.4576	4.1925	270.0000	4.4576
0.0000	-4.2447	4.4853	4.2447	270.0000	4.4853
0.0000	-4.2975	4.5119	4.2975	270.0000	4.5119
0.0000	-4.3508	4.5376	4.3508	270.0000	4.5376
0.0000	-4.4046	4.5622	4.4046	270.0000	4.5622
0.0000	-4.4587	4.5859	4.4587	270.0000	4.5859
0.0000	-4.5133	4.6087	4.5133	270.0000	4.6087
0.0000	-4.5683	4.6305	4.5683	270.0000	4.6305
0.0000	-4.6235	4.6515	4.6235	270.0000	4.6515
0.0000	-4.6791	4.6716	4.6791	270.0000	4.6716
0.0000	-4.7350	4.6909	4.7350	270.0000	4.6909
0.0000	-4.7912	4.7094	4.7912	270.0000	4.7094
0.0000	-4.8476	4.7271	4.8476	270.0000	4.7271
0.0000	-4.9043	4.7441	4.9043	270.0000	4.7441
0.0000	-4.9611	4.7603	4.9611	270.0000	4.7603
0.0000	-5.0182	4.7759	5.0182	270.0000	4.7759
0.0000	-5.0754	4.7907	5.0754	270.0000	4.7907

0.0000	-5.1328	4.8049	5.1328	270.0000	4.8049
0.0000	-5.1904	4.8184	5.1904	270.0000	4.8184
0.0000	-5.2481	4.8313	5.2481	270.0000	4.8313
0.0000	-5.3060	4.8436	5.3060	270.0000	4.8436
0.0000	-5.3639	4.8553	5.3639	270.0000	4.8553
0.0000	-5.4220	4.8664	5.4220	270.0000	4.8664
0.0000	-5.4802	4.8770	5.4802	270.0000	4.8770
0.0000	-5.5384	4.8871	5.5384	270.0000	4.8871
0.0000	-5.5968	4.8966	5.5968	270.0000	4.8966
0.0000	-5.6553	4.9056	5.6553	270.0000	4.9056
0.0000	-5.7138	4.9141	5.7138	270.0000	4.9141
0.0000	-5.7724	4.9221	5.7724	270.0000	4.9221
0.0000	-5.8310	4.9297	5.8310	270.0000	4.9297
0.0000	-5.8897	4.9368	5.8897	270.0000	4.9368
0.0000	-5.9485	4.9434	5.9485	270.0000	4.9434
0.0000	-6.0073	4.9497	6.0073	270.0000	4.9497
0.0000	-6.0661	4.9555	6.0661	270.0000	4.9555
0.0000	-6.1250	4.9609	6.1250	270.0000	4.9609
0.0000	-6.1839	4.9660	6.1839	270.0000	4.9660
0.0000	-6.2429	4.9706	6.2429	270.0000	4.9706
0.0000	-6.3018	4.9749	6.3018	270.0000	4.9749
0.0000	-6.3608	4.9788	6.3608	270.0000	4.9788
0.0000	-6.4199	4.9823	6.4199	270.0000	4.9823
0.0000	-6.4789	4.9855	6.4789	270.0000	4.9855
0.0000	-6.5380	4.9884	6.5380	270.0000	4.9884
0.0000	-6.5971	4.9909	6.5971	270.0000	4.9909
0.0000	-6.6562	4.9931	6.6562	270.0000	4.9931
0.0000	-6.7153	4.9950	6.7153	270.0000	4.9950
0.0000	-6.7744	4.9965	6.7744	270.0000	4.9965
0.0000	-6.8335	4.9978	6.8335	270.0000	4.9978
0.0000	-6.8926	4.9988	6.8926	270.0000	4.9988
0.0000	-6.9517	4.9995	6.9517	270.0000	4.9995
0.0000	-7.0109	4.9999	7.0109	270.0000	4.9999
0.0000	-7.0700	5.0000	7.0700	270.0000	5.0000

SHROUD COORDINATES

X	Y	Z	R	THETA	Z
0.0000	-4.6900	1.9974	4.6900	270.0000	1.9974
0.0000	-4.6900	2.0346	4.6900	270.0000	2.0346
0.0000	-4.6900	2.0718	4.6900	270.0000	2.0718
0.0000	-4.6900	2.1090	4.6900	270.0000	2.1090
0.0000	-4.6900	2.1463	4.6900	270.0000	2.1463
0.0000	-4.6900	2.1835	4.6900	270.0000	2.1835
0.0000	-4.6900	2.2207	4.6900	270.0000	2.2207
0.0000	-4.6900	2.2579	4.6900	270.0000	2.2579
0.0000	-4.6900	2.2952	4.6900	270.0000	2.2952
0.0000	-4.6900	2.3324	4.6900	270.0000	2.3324
0.0000	-4.6900	2.3696	4.6900	270.0000	2.3696
0.0000	-4.6900	2.4068	4.6900	270.0000	2.4068
0.0000	-4.6900	2.4440	4.6900	270.0000	2.4440
0.0000	-4.6900	2.4813	4.6900	270.0000	2.4813
0.0000	-4.6901	2.5185	4.6901	270.0000	2.5185
0.0000	-4.6908	2.5557	4.6908	270.0000	2.5557
0.0000	-4.6923	2.5929	4.6923	270.0000	2.5929
0.0000	-4.6946	2.6301	4.6946	270.0000	2.6301
0.0000	-4.6977	2.6671	4.6977	270.0000	2.6671
0.0000	-4.7017	2.7042	4.7017	270.0000	2.7042
0.0000	-4.7065	2.7411	4.7065	270.0000	2.7411
0.0000	-4.7123	2.7778	4.7123	270.0000	2.7778
0.0000	-4.7190	2.8144	4.7190	270.0000	2.8144
0.0000	-4.7267	2.8509	4.7267	270.0000	2.8509
0.0000	-4.7353	2.8871	4.7353	270.0000	2.8871
0.0000	-4.7450	2.9230	4.7450	270.0000	2.9230
0.0000	-4.7557	2.9587	4.7557	270.0000	2.9587
0.0000	-4.7674	2.9940	4.7674	270.0000	2.9940
0.0000	-4.7802	3.0290	4.7802	270.0000	3.0290
0.0000	-4.7940	3.0635	4.7940	270.0000	3.0635
0.0000	-4.8089	3.0976	4.8089	270.0000	3.0976
0.0000	-4.8249	3.1312	4.8249	270.0000	3.1312
0.0000	-4.8419	3.1643	4.8419	270.0000	3.1643

0.0000	-4.8601	3.1969	4.8601	270.0000	3.1969
0.0000	-4.8792	3.2288	4.8792	270.0000	3.2288
0.0000	-4.8994	3.2600	4.8994	270.0000	3.2600
0.0000	-4.9206	3.2906	4.9206	270.0000	3.2906
0.0000	-4.9428	3.3205	4.9428	270.0000	3.3205
0.0000	-4.9659	3.3497	4.9659	270.0000	3.3497
0.0000	-4.9899	3.3781	4.9899	270.0000	3.3781
0.0000	-5.0149	3.4057	5.0149	270.0000	3.4057
0.0000	-5.0406	3.4326	5.0406	270.0000	3.4326
0.0000	-5.0672	3.4587	5.0672	270.0000	3.4587
0.0000	-5.0946	3.4839	5.0946	270.0000	3.4839
0.0000	-5.1226	3.5084	5.1226	270.0000	3.5084
0.0000	-5.1514	3.5320	5.1514	270.0000	3.5320
0.0000	-5.1807	3.5549	5.1807	270.0000	3.5549
0.0000	-5.2107	3.5770	5.2107	270.0000	3.5770
0.0000	-5.2412	3.5982	5.2412	270.0000	3.5982
0.0000	-5.2723	3.6188	5.2723	270.0000	3.6188
0.0000	-5.3039	3.6385	5.3039	270.0000	3.6385
0.0000	-5.3359	3.6575	5.3359	270.0000	3.6575
0.0000	-5.3683	3.6758	5.3683	270.0000	3.6758
0.0000	-5.4011	3.6933	5.4011	270.0000	3.6933
0.0000	-5.4343	3.7102	5.4343	270.0000	3.7102
0.0000	-5.4678	3.7263	5.4678	270.0000	3.7263
0.0000	-5.5017	3.7419	5.5017	270.0000	3.7419
0.0000	-5.5358	3.7567	5.5358	270.0000	3.7567
0.0000	-5.5702	3.7710	5.5702	270.0000	3.7710
0.0000	-5.6048	3.7846	5.6048	270.0000	3.7846
0.0000	-5.6397	3.7977	5.6397	270.0000	3.7977
0.0000	-5.6747	3.8102	5.6747	270.0000	3.8102
0.0000	-5.7100	3.8222	5.7100	270.0000	3.8222
0.0000	-5.7454	3.8336	5.7454	270.0000	3.8336
0.0000	-5.7810	3.8445	5.7810	270.0000	3.8445
0.0000	-5.8167	3.8550	5.8167	270.0000	3.8550
0.0000	-5.8526	3.8649	5.8526	270.0000	3.8649
0.0000	-5.8886	3.8744	5.8886	270.0000	3.8744
0.0000	-5.9247	3.8834	5.9247	270.0000	3.8834
0.0000	-5.9609	3.8920	5.9609	270.0000	3.8920
0.0000	-5.9972	3.9002	5.9972	270.0000	3.9002
0.0000	-6.0336	3.9079	6.0336	270.0000	3.9079
0.0000	-6.0701	3.9153	6.0701	270.0000	3.9153
0.0000	-6.1067	3.9222	6.1067	270.0000	3.9222
0.0000	-6.1433	3.9288	6.1433	270.0000	3.9288
0.0000	-6.1800	3.9351	6.1800	270.0000	3.9351
0.0000	-6.2168	3.9410	6.2168	270.0000	3.9410
0.0000	-6.2536	3.9465	6.2536	270.0000	3.9465
0.0000	-6.2904	3.9517	6.2904	270.0000	3.9517
0.0000	-6.3273	3.9567	6.3273	270.0000	3.9567
0.0000	-6.3643	3.9613	6.3643	270.0000	3.9613
0.0000	-6.4012	3.9656	6.4012	270.0000	3.9656
0.0000	-6.4382	3.9696	6.4382	270.0000	3.9696
0.0000	-6.4753	3.9733	6.4753	270.0000	3.9733
0.0000	-6.5123	3.9768	6.5123	270.0000	3.9768
0.0000	-6.5494	3.9800	6.5494	270.0000	3.9800
0.0000	-6.5865	3.9829	6.5865	270.0000	3.9829
0.0000	-6.6236	3.9856	6.6236	270.0000	3.9856
0.0000	-6.6608	3.9880	6.6608	270.0000	3.9880
0.0000	-6.6980	3.9902	6.6980	270.0000	3.9902
0.0000	-6.7351	3.9922	6.7351	270.0000	3.9922
0.0000	-6.7723	3.9939	6.7723	270.0000	3.9939
0.0000	-6.8095	3.9954	6.8095	270.0000	3.9954
0.0000	-6.8467	3.9967	6.8467	270.0000	3.9967
0.0000	-6.8839	3.9977	6.8839	270.0000	3.9977
0.0000	-6.9211	3.9985	6.9211	270.0000	3.9985
0.0000	-6.9583	3.9992	6.9583	270.0000	3.9992
0.0000	-6.9956	3.9996	6.9956	270.0000	3.9996
0.0000	-7.0328	3.9999	7.0328	270.0000	3.9999
0.0000	-7.0700	4.0000	7.0700	270.0000	4.0000

**APPENDIX B**

**IMPELLER COORDINATES - WITHOUT BLADE  
FILLET**

## FULL BLADE PRESSURE SIDE

## STREAMLINE 1

X	Y	Z	R	THETA	Z
3.0481	-0.0004	2.5007	3.0481	359.9917	2.5007
3.0484	0.0005	2.5290	3.0484	0.0101	2.5290
3.0488	0.0157	2.5534	3.0489	0.2959	2.5534
3.0491	0.0371	2.5729	3.0493	0.6973	2.5729
3.0491	0.0739	2.5959	3.0499	1.3876	2.5959
3.0486	0.1120	2.6167	3.0507	2.1032	2.6167
3.0478	0.1500	2.6376	3.0515	2.8174	2.6376
3.0467	0.1879	2.6586	3.0525	3.5300	2.6586
3.0453	0.2258	2.6798	3.0537	4.2410	2.6798
3.0436	0.2636	2.7011	3.0550	4.9502	2.7011
3.0394	0.3389	2.7441	3.0582	6.3630	2.7441
3.0342	0.4139	2.7876	3.0623	7.7680	2.7876
3.0280	0.4885	2.8316	3.0671	9.1645	2.8316
3.0209	0.5627	2.8761	3.0729	10.5521	2.8761
3.0130	0.6366	2.9210	3.0795	11.9302	2.9210
3.0042	0.7101	2.9665	3.0869	13.2982	2.9665
2.9945	0.7831	3.0123	3.0953	14.6559	3.0123
2.9844	0.8559	3.0586	3.1047	16.0029	3.0586
2.9736	0.9284	3.1051	3.1152	17.3390	3.1051
2.9624	1.0007	3.1520	3.1269	18.6639	3.1520
2.9508	1.0727	3.1991	3.1398	19.9770	3.1991
2.9389	1.1445	3.2463	3.1539	21.2780	3.2463
2.9266	1.2162	3.2938	3.1693	22.5664	3.2938
2.9141	1.2878	3.3412	3.1860	23.8421	3.3412
2.9014	1.3593	3.3888	3.2040	25.1037	3.3888
2.8885	1.4308	3.4364	3.2235	26.3514	3.4364
2.8755	1.5023	3.4839	3.2443	27.5848	3.4839
2.8625	1.5739	3.5312	3.2667	28.8037	3.5312
2.8494	1.6456	3.5784	3.2905	30.0079	3.5784
2.8363	1.7175	3.6253	3.3158	31.1976	3.6253
2.8231	1.7897	3.6717	3.3426	32.3725	3.6717
2.8099	1.8621	3.7178	3.3709	33.5324	3.7178
2.7966	1.9348	3.7633	3.4007	34.6773	3.7633
2.7833	2.0079	3.8083	3.4320	35.8069	3.8083
2.7700	2.0814	3.8526	3.4648	36.9213	3.8526
2.7566	2.1552	3.8962	3.4991	38.0201	3.8962
2.7431	2.2295	3.9391	3.5349	39.1033	3.9391
2.7295	2.3042	3.9812	3.5721	40.1710	3.9812
2.7157	2.3794	4.0225	3.6106	41.2231	4.0225
2.7018	2.4550	4.0629	3.6505	42.2596	4.0629
2.6876	2.5310	4.1023	3.6918	43.2806	4.1023
2.6732	2.6074	4.1409	3.7343	44.2862	4.1409
2.6585	2.6843	4.1785	3.7780	45.2765	4.1785
2.6435	2.7616	4.2151	3.8229	46.2518	4.2151
2.6281	2.8393	4.2507	3.8689	47.2121	4.2507
2.6123	2.9174	4.2852	3.9160	48.1577	4.2852
2.5960	2.9958	4.3188	3.9641	49.0889	4.3188
2.5793	3.0745	4.3513	4.0131	50.0060	4.3513
2.5620	3.1535	4.3828	4.0631	50.9090	4.3828
2.5442	3.2329	4.4133	4.1139	51.7984	4.4133
2.5257	3.3124	4.4428	4.1655	52.6743	4.4428
2.5067	3.3922	4.4712	4.2179	53.5371	4.4712
2.4871	3.4722	4.4987	4.2710	54.3868	4.4987
2.4668	3.5524	4.5252	4.3248	55.2238	4.5252
2.4458	3.6327	4.5508	4.3793	56.0482	4.5508



2.4242	3.7131	4.5754	4.4344	56.8599	4.5754
2.4020	3.7936	4.5991	4.4901	57.6593	4.5991
2.3790	3.8742	4.6219	4.5463	58.4470	4.6219
2.3554	3.9548	4.6438	4.6030	59.2228	4.6438
2.3310	4.0354	4.6649	4.6603	59.9876	4.6649
2.3059	4.1160	4.6851	4.7179	60.7415	4.6851
2.2800	4.1966	4.7045	4.7760	61.4849	4.7045
2.2534	4.2771	4.7231	4.8344	62.2178	4.7231
2.2260	4.3576	4.7408	4.8932	62.9407	4.7408
2.1978	4.4379	4.7579	4.9523	63.6537	4.7579
2.1689	4.5182	4.7742	5.0118	64.3572	4.7742
2.1392	4.5982	4.7897	5.0715	65.0513	4.7897
2.1087	4.6782	4.8045	5.1315	65.7363	4.8045
2.0774	4.7579	4.8187	5.1917	66.4126	4.8187
2.0454	4.8375	4.8322	5.2521	67.0803	4.8322
2.0126	4.9168	4.8450	5.3128	67.7397	4.8450
1.9789	4.9960	4.8572	5.3736	68.3911	4.8572
1.9445	5.0748	4.8688	5.4346	69.0348	4.8688
1.9093	5.1534	4.8797	5.4957	69.6710	4.8797
1.8732	5.2317	4.8901	5.5570	70.2999	4.8901
1.8364	5.3097	4.8999	5.6183	70.9219	4.8999
1.7987	5.3874	4.9091	5.6798	71.5371	4.9091
1.7602	5.4648	4.9178	5.7413	72.1459	4.9178
1.7209	5.5417	4.9260	5.8028	72.7484	4.9260
1.6808	5.6183	4.9337	5.8644	73.3450	4.9337
1.6398	5.6946	4.9409	5.9259	73.9359	4.9409
1.5979	5.7703	4.9476	5.9875	74.5213	4.9476
1.5553	5.8457	4.9538	6.0490	75.1015	4.9538
1.5117	5.9206	4.9596	6.1105	75.6767	4.9596
1.4673	5.9950	4.9649	6.1719	76.2471	4.9649
1.4220	6.0689	4.9698	6.2333	76.8131	4.9698
1.3758	6.1423	4.9743	6.2945	77.3748	4.9743
1.3287	6.2151	4.9783	6.3556	77.9325	4.9783
1.2807	6.2874	4.9820	6.4165	78.4864	4.9820
1.2318	6.3591	4.9853	6.4773	79.0368	4.9853
1.1820	6.4301	4.9883	6.5379	79.5839	4.9883
1.1313	6.5005	4.9908	6.5982	80.1278	4.9908
1.0796	6.5703	4.9931	6.6584	80.6688	4.9931
1.0269	6.6393	4.9950	6.7182	81.2073	4.9950
0.9733	6.7075	4.9966	6.7778	81.7435	4.9966
0.9187	6.7750	4.9978	6.8370	82.2778	4.9978
0.8630	6.8417	4.9988	6.8959	82.8104	4.9988
0.8064	6.9074	4.9995	6.9543	83.3416	4.9995
0.7486	6.9723	4.9999	7.0124	83.8714	4.9999
0.6899	7.0363	5.0000	7.0700	84.3998	5.0000

### STREAMLINE 2

X	Y	Z	R	THETA	Z
3.1604	0.0569	2.5000	3.1609	1.0317	2.5000
3.1608	0.0581	2.5281	3.1613	1.0539	2.5281
3.1609	0.0733	2.5522	3.1618	1.3279	2.5522
3.1609	0.0945	2.5714	3.1623	1.7128	2.5714
3.1602	0.1311	2.5937	3.1629	2.3760	2.5937
3.1592	0.1692	2.6137	3.1637	3.0649	2.6137
3.1578	0.2071	2.6338	3.1645	3.7528	2.6338
3.1560	0.2450	2.6540	3.1655	4.4394	2.6540
3.1540	0.2829	2.6742	3.1667	5.1246	2.6742
3.1517	0.3206	2.6946	3.1680	5.8085	2.6946
3.1463	0.3959	2.7358	3.1711	7.1718	2.7358

3.1399	0.4709	2.7773	3.1750	8.5287	2.7773
3.1324	0.5455	2.8193	3.1796	9.8788	2.8193
3.1241	0.6198	2.8616	3.1850	11.2216	2.8616
3.1149	0.6938	2.9045	3.1912	12.5564	2.9045
3.1048	0.7674	2.9477	3.1982	13.8828	2.9477
3.0938	0.8406	2.9913	3.2060	15.2002	2.9913
3.0823	0.9135	3.0353	3.2148	16.5086	3.0353
3.0701	0.9861	3.0797	3.2246	17.8073	3.0797
3.0575	1.0585	3.1243	3.2356	19.0959	3.1243
3.0444	1.1306	3.1692	3.2476	20.3740	3.1692
3.0309	1.2026	3.2143	3.2608	21.6413	3.2143
3.0171	1.2743	3.2595	3.2752	22.8974	3.2595
3.0029	1.3459	3.3049	3.2908	24.1419	3.3049
2.9885	1.4174	3.3503	3.3076	25.3744	3.3503
2.9739	1.4889	3.3959	3.3258	26.5941	3.3959
2.9592	1.5603	3.4414	3.3454	27.8006	3.4414
2.9444	1.6317	3.4868	3.3663	28.9939	3.4868
2.9294	1.7032	3.5321	3.3886	30.1739	3.5321
2.9144	1.7748	3.5772	3.4123	31.3404	3.5772
2.8994	1.8466	3.6220	3.4375	32.4932	3.6220
2.8842	1.9186	3.6664	3.4641	33.6322	3.6664
2.8691	1.9909	3.7104	3.4921	34.7572	3.7104
2.8539	2.0634	3.7539	3.5217	35.8680	3.7539
2.8386	2.1363	3.7969	3.5527	36.9645	3.7969
2.8233	2.2095	3.8393	3.5851	38.0464	3.8393
2.8079	2.2830	3.8810	3.6189	39.1137	3.8810
2.7924	2.3570	3.9220	3.6542	40.1664	3.9220
2.7768	2.4313	3.9622	3.6908	41.2043	3.9622
2.7611	2.5060	4.0017	3.7288	42.2275	4.0017
2.7452	2.5811	4.0403	3.7681	43.2361	4.0403
2.7290	2.6567	4.0781	3.8086	44.2299	7.0000
2.7127	2.7325	4.1149	3.8504	45.2093	4.1149
2.6960	2.8088	4.1509	3.8933	46.1742	4.1509
2.6790	2.8855	4.1859	3.9374	47.1249	4.1859
2.6617	2.9625	4.2199	3.9825	48.0615	4.2199
2.6439	3.0398	4.2530	4.0287	48.9842	4.2530
2.6257	3.1174	4.2851	4.0759	49.8932	4.2851
2.6071	3.1953	4.3162	4.1240	50.7887	4.3162
2.5880	3.2735	4.3463	4.1729	51.6710	4.3463
2.5683	3.3519	4.3755	4.2228	52.5403	4.3755
2.5481	3.4306	4.4037	4.2734	53.3967	4.4037
2.5273	3.5094	4.4309	4.3247	54.2405	4.4309
2.5059	3.5884	4.4572	4.3768	55.0718	4.4572
2.4840	3.6675	4.4826	4.4295	55.8908	4.4826
2.4614	3.7468	4.5070	4.4830	56.6974	4.5070
2.4382	3.8261	4.5306	4.5370	57.4921	4.5306
2.4144	3.9055	4.5533	4.5916	58.2751	4.5533
2.3900	3.9850	4.5751	4.6467	59.0466	4.5751
2.3649	4.0645	4.5961	4.7024	59.8072	4.5961
2.3391	4.1439	4.6162	4.7585	60.5571	4.6162
2.3126	4.2234	4.6355	4.8151	61.2966	4.6355
2.2853	4.3028	4.6541	4.8720	62.0257	4.6541
2.2574	4.3821	4.6718	4.9294	62.7449	4.6718
2.2288	4.4613	4.6888	4.9871	63.4542	4.6888
2.1994	4.5405	4.7051	5.0451	64.1541	4.7051
2.1694	4.6195	4.7206	5.1035	64.8447	4.7206
2.1386	4.6983	4.7354	5.1621	65.5263	4.7354
2.1070	4.7770	4.7496	5.2211	66.1991	4.7496
2.0747	4.8555	4.7631	5.2802	66.8633	4.7631
2.0417	4.9338	4.7759	5.3396	67.5194	4.7759

2.0079	5.0119	4.7881	5.3992	68.1674	4.7881
1.9734	5.0898	4.7997	5.4590	68.8077	4.7997
1.9381	5.1674	4.8106	5.5189	69.4405	4.8106
1.9021	5.2447	4.8210	5.5790	70.0661	4.8210
1.8652	5.3217	4.8309	5.6392	70.6847	4.8309
1.8276	5.3985	4.8401	5.6995	71.2966	4.8401
1.7893	5.4749	4.8488	5.7599	71.9019	4.8488
1.7501	5.5510	4.8571	5.8203	72.5010	4.8571
1.7101	5.6267	4.8647	5.8808	73.0941	4.8647
1.6694	5.7020	4.8719	5.9413	73.6815	4.8719
1.6278	5.7769	4.8787	6.0019	74.2634	4.8787
1.5854	5.8514	4.8849	6.0624	74.8400	4.8849
1.5422	5.9255	4.8907	6.1229	75.4115	4.8907
1.4982	5.9991	4.8960	6.1834	75.9782	4.8960
1.4533	6.0723	4.9010	6.2437	76.5404	4.9010
1.4076	6.1449	4.9055	6.3040	77.0982	4.9055
1.3610	6.2170	4.9096	6.3642	77.6520	4.9096
1.3135	6.2886	4.9133	6.4243	78.2018	4.9133
1.2652	6.3596	4.9166	6.4842	78.7481	4.9166
1.2160	6.4300	4.9195	6.5440	79.2909	4.9195
1.1659	6.4998	4.9221	6.6035	79.8304	4.9221
1.1149	6.5690	4.9244	6.6629	80.3670	4.9244
1.0630	6.6374	4.9263	6.7220	80.9009	4.9263
1.0102	6.7052	4.9279	6.7809	81.4324	4.9279
0.9564	6.7722	4.9292	6.8394	81.9619	4.9292
0.9016	6.8384	4.9301	6.8976	82.4894	4.9301
0.8458	6.9038	4.9308	6.9554	83.0153	4.9308
0.7891	6.9684	4.9312	7.0129	83.5396	4.9312
0.7314	7.0321	4.9314	7.0700	84.0622	4.9314

STREAMLINE 3

X	Y	Z	R	THETA	Z
3.2716	0.1182	2.4996	3.2738	2.0687	2.4996
3.2720	0.1196	2.5273	3.2742	2.0940	2.5273
3.2720	0.1347	2.5512	3.2747	2.3574	2.5512
3.2715	0.1558	2.5700	3.2753	2.7271	2.5700
3.2703	0.1923	2.5917	3.2760	3.3650	2.5917
3.2686	0.2302	2.6109	3.2767	4.0284	2.6109
3.2666	0.2681	2.6302	3.2776	4.6911	2.6302
3.2643	0.3059	2.6495	3.2786	5.3529	2.6495
3.2617	0.3436	2.6690	3.2797	6.0135	2.6690
3.2588	0.3813	2.6885	3.2810	6.6731	2.6885
3.2521	0.4564	2.7278	3.2840	7.9888	2.7278
3.2445	0.5313	2.7675	3.2877	9.2994	2.7675
3.2358	0.6058	2.8075	3.2921	10.6044	2.8075
3.2263	0.6801	2.8479	3.2972	11.9035	2.8479
3.2158	0.7540	2.8887	3.3030	13.1959	2.8887
3.2044	0.8276	2.9298	3.3095	14.4811	2.9298
3.1922	0.9008	2.9713	3.3168	15.7589	2.9713
3.1793	0.9738	3.0132	3.3251	17.0288	3.0132
3.1659	1.0464	3.0553	3.3343	18.2902	3.0553
3.1519	1.1188	3.0978	3.3445	19.5428	3.0978
3.1374	1.1909	3.1405	3.3558	20.7861	3.1405
3.1224	1.2628	3.1834	3.3681	22.0197	3.1834
3.1071	1.3345	3.2266	3.3815	23.2434	3.2266
3.0914	1.4060	3.2699	3.3961	24.4569	3.2699
3.0754	1.4774	3.3133	3.4118	25.6597	3.3133
3.0591	1.5487	3.3567	3.4288	26.8509	3.3567
3.0427	1.6199	3.4003	3.4471	28.0303	3.4003

3.0261	1.6911	3.4438	3.4666	29.1977	3.4438
3.0094	1.7623	3.4872	3.4875	30.3529	3.4872
2.9927	1.8336	3.5305	3.5097	31.4958	3.5305
2.9758	1.9050	3.5735	3.5333	32.6261	3.5735
2.9588	1.9765	3.6163	3.5583	33.7436	3.6163
2.9418	2.0483	3.6587	3.5846	34.8481	3.6587
2.9247	2.1202	3.7008	3.6124	35.9395	3.7008
2.9076	2.1925	3.7423	3.6416	37.0176	3.7423
2.8905	2.2650	3.7834	3.6722	38.0821	3.7834
2.8733	2.3378	3.8238	3.7042	39.1329	3.8238
2.8560	2.4109	3.8637	3.7375	40.1700	3.8637
2.8386	2.4844	3.9029	3.7722	41.1934	3.9029
2.8211	2.5582	3.9413	3.8083	42.2028	3.9413
2.8034	2.6324	3.9790	3.8456	43.1984	3.9790
2.7855	2.7069	4.0159	3.8842	44.1801	4.0159
2.7675	2.7818	4.0520	3.9240	45.1480	4.0520
2.7492	2.8571	4.0873	3.9649	46.1022	4.0873
2.7306	2.9326	4.1216	4.0071	47.0429	4.1216
2.7117	3.0085	4.1551	4.0503	47.9700	4.1551
2.6925	3.0847	4.1876	4.0945	48.8838	4.1876
2.6729	3.1612	4.2192	4.1398	49.7845	4.2192
2.6529	3.2380	4.2499	4.1860	50.6722	4.2499
2.6324	3.3150	4.2797	4.2331	51.5471	4.2797
2.6115	3.3923	4.3085	4.2811	52.4094	4.3085
2.5901	3.4697	4.3364	4.3298	53.2592	4.3364
2.5682	3.5474	4.3634	4.3794	54.0968	4.3634
2.5457	3.6252	4.3894	4.4297	54.9222	4.3894
2.5227	3.7031	4.4146	4.4807	55.7355	4.4146
2.4992	3.7812	4.4388	4.5325	56.5369	4.4388
2.4751	3.8593	4.4622	4.5848	57.3266	4.4622
2.4504	3.9375	4.4848	4.6378	58.1049	4.4848
2.4252	4.0158	4.5065	4.6913	58.8719	4.5065
2.3993	4.0941	4.5274	4.7454	59.6281	4.5274
2.3728	4.1724	4.5474	4.7999	60.3739	4.5474
2.3456	4.2507	4.5667	4.8549	61.1092	4.5667
2.3178	4.3289	4.5851	4.9104	61.8345	4.5851
2.2893	4.4071	4.6028	4.9663	62.5498	4.6028
2.2602	4.4852	4.6198	5.0225	63.2554	4.6198
2.2304	4.5632	4.6360	5.0791	63.9516	4.6360
2.1999	4.6411	4.6515	5.1361	64.6386	4.6515
2.1688	4.7189	4.6663	5.1934	65.3167	4.6663
2.1369	4.7965	4.6805	5.2510	65.9860	4.6805
2.1044	4.8739	4.6940	5.3088	66.6468	4.6940
2.0712	4.9511	4.7068	5.3669	67.2995	4.7068
2.0372	5.0282	4.7190	5.4252	67.9441	4.7190
2.0026	5.1050	4.7306	5.4837	68.5810	4.7306
1.9672	5.1816	4.7416	5.5425	69.2104	4.7416
1.9311	5.2579	4.7520	5.6013	69.8326	4.7520
1.8943	5.3340	4.7618	5.6604	70.4479	4.7618
1.8568	5.4097	4.7711	5.7195	71.0563	4.7711
1.8185	5.4852	4.7798	5.7788	71.6583	4.7798
1.7794	5.5603	4.7881	5.8381	72.2540	4.7881
1.7397	5.6351	4.7958	5.8975	72.8436	4.7958
1.6991	5.7095	4.8030	5.9570	73.4275	4.8030
1.6578	5.7836	4.8097	6.0165	74.0058	4.8097
1.6157	5.8572	4.8160	6.0760	74.5788	4.8160
1.5728	5.9305	4.8218	6.1355	75.1467	4.8218
1.5291	6.0033	4.8272	6.1949	75.7098	4.8272
1.4847	6.0756	4.8321	6.2544	76.2681	4.8321
1.4394	6.1475	4.8366	6.3137	76.8221	4.8366

1.3933	6.2189	4.8408	6.3730	77.3718	4.8408
1.3464	6.2897	4.8445	6.4322	77.9176	4.8445
1.2986	6.3600	4.8478	6.4913	78.4596	4.8478
1.2500	6.4298	4.8508	6.5502	78.9981	4.8508
1.2006	6.4990	4.8534	6.6090	79.5333	4.8534
1.1503	6.5675	4.8557	6.6675	80.0654	4.8557
1.0991	6.6355	4.8576	6.7259	80.5946	4.8576
1.0471	6.7027	4.8592	6.7840	81.1214	4.8592
0.9941	6.7692	4.8605	6.8418	81.6459	4.8605
0.9401	6.8350	4.8615	6.8994	82.1683	4.8615
0.8853	6.9000	4.8622	6.9566	82.6889	4.8622
0.8295	6.9642	4.8626	7.0135	83.2077	4.8626
0.7728	7.0277	4.8627	7.0700	83.7247	4.8627

STREAMLINE 4

X	Y	Z	R	THETA	Z
3.3817	0.1834	2.4993	3.3867	3.1035	2.4993
3.3821	0.1850	2.5268	3.3871	3.1315	2.5268
3.3818	0.2001	2.5503	3.3877	3.3855	2.5503
3.3810	0.2211	2.5688	3.3883	3.7413	2.5688
3.3792	0.2574	2.5898	3.3890	4.3556	2.5898
3.3769	0.2951	2.6083	3.3897	4.9946	2.6083
3.3742	0.3328	2.6268	3.3906	5.6332	2.6268
3.3713	0.3705	2.6454	3.3916	6.2711	2.6454
3.3681	0.4081	2.6640	3.3927	6.9082	2.6640
3.3646	0.4456	2.6827	3.3940	7.5444	2.6827
3.3568	0.5205	2.7203	3.3969	8.8142	2.7203
3.3479	0.5952	2.7582	3.4004	10.0801	2.7582
3.3381	0.6695	2.7963	3.4045	11.3414	2.7963
3.3273	0.7436	2.8348	3.4093	12.5979	2.8348
3.3155	0.8174	2.8736	3.4148	13.8488	2.8736
3.3029	0.8908	2.9128	3.4209	15.0938	2.9128
3.2895	0.9639	2.9522	3.4278	16.3324	2.9522
3.2754	1.0368	2.9920	3.4356	17.5642	2.9920
3.2607	1.1093	3.0321	3.4442	18.7887	3.0321
3.2453	1.1816	3.0724	3.4537	20.0054	3.0724
3.2295	1.2536	3.1130	3.4642	21.2141	3.1130
3.2132	1.3253	3.1539	3.4757	22.4143	3.1539
3.1964	1.3968	3.1949	3.4883	23.6057	3.1949
3.1792	1.4682	3.2362	3.5019	24.7880	3.2362
3.1617	1.5394	3.2775	3.5165	25.9609	3.2775
3.1439	1.6104	3.3190	3.5324	27.1235	3.3190
3.1259	1.6814	3.3605	3.5494	28.2755	3.3605
3.1077	1.7523	3.4021	3.5677	29.4166	3.4021
3.0893	1.8231	3.4436	3.5872	30.5466	3.4436
3.0708	1.8940	3.4851	3.6079	31.6654	3.4851
3.0522	1.9650	3.5264	3.6300	32.7727	3.5264
3.0335	2.0360	3.5675	3.6534	33.8682	3.5675
3.0147	2.1072	3.6083	3.6781	34.9518	3.6083
2.9959	2.1785	3.6488	3.7042	36.0232	3.6488
2.9770	2.2500	3.6889	3.7317	37.0823	3.6889
2.9581	2.3218	3.7286	3.7605	38.1288	3.7286
2.9391	2.3939	3.7678	3.7906	39.1627	3.7678
2.9200	2.4662	3.8064	3.8221	40.1837	3.8064
2.9008	2.5388	3.8444	3.8549	41.1918	3.8444
2.8816	2.6117	3.8818	3.8890	42.1869	3.8818
2.8622	2.6849	3.9186	3.9244	43.1690	3.9186
2.8427	2.7584	3.9546	3.9610	44.1381	3.9546
2.8230	2.8322	3.9898	3.9988	45.0941	3.9898

2.8030	2.9064	4.0243	4.0379	46.0371	4.0243
2.7829	2.9809	4.0580	4.0780	46.9673	4.0580
2.7625	3.0556	4.0908	4.1193	47.8845	4.0908
2.7418	3.1307	4.1228	4.1616	48.7890	4.1228
2.7208	3.2060	4.1538	4.2049	49.6809	4.1538
2.6994	3.2816	4.1841	4.2492	50.5603	4.1841
2.6776	3.3575	4.2134	4.2944	51.4275	4.2134
2.6554	3.4335	4.2418	4.3405	52.2824	4.2418
2.6328	3.5098	4.2694	4.3875	53.1254	4.2694
2.6097	3.5862	4.2960	4.4352	53.9565	4.2960
2.5861	3.6628	4.3218	4.4837	54.7755	4.3218
2.5621	3.7395	4.3468	4.5330	55.5829	4.3468
2.5376	3.8163	4.3708	4.5830	56.3789	4.3708
2.5125	3.8932	4.3940	4.6336	57.1634	4.3940
2.4870	3.9703	4.4164	4.6849	57.9367	4.4164
2.4609	4.0473	4.4380	4.7368	58.6990	4.4380
2.4342	4.1244	4.4587	4.7892	59.4507	4.4587
2.4070	4.2015	4.4787	4.8421	60.1920	4.4787
2.3792	4.2786	4.4978	4.8956	60.9232	4.4978
2.3507	4.3557	4.5162	4.9495	61.6444	4.5162
2.3217	4.4327	4.5339	5.0039	62.3558	4.5339
2.2920	4.5096	4.5508	5.0586	63.0576	4.5508
2.2618	4.5864	4.5670	5.1138	63.7501	4.5670
2.2309	4.6632	4.5825	5.1694	64.4334	4.5825
2.1994	4.7398	4.5973	5.2252	65.1079	4.5973
2.1672	4.8163	4.6114	5.2814	65.7736	4.6114
2.1344	4.8926	4.6249	5.3379	66.4310	4.6249
2.1009	4.9688	4.6377	5.3947	67.0801	4.6377
2.0668	5.0448	4.6499	5.4517	67.7213	4.6499
2.0320	5.1205	4.6615	5.5090	68.3548	4.6615
1.9966	5.1961	4.6725	5.5665	68.9809	4.6725
1.9604	5.2714	4.6829	5.6241	69.5997	4.6829
1.9236	5.3464	4.6928	5.6820	70.2115	4.6928
1.8861	5.4212	4.7021	5.7399	70.8166	4.7021
1.8479	5.4957	4.7108	5.7980	71.4151	4.7108
1.8090	5.5698	4.7191	5.8562	72.0074	4.7191
1.7693	5.6437	4.7268	5.9145	72.5936	4.7268
1.7290	5.7172	4.7340	5.9729	73.1739	4.7340
1.6879	5.7903	4.7408	6.0313	73.7487	4.7408
1.6460	5.8631	4.7471	6.0898	74.3181	4.7471
1.6035	5.9355	4.7529	6.1483	74.8824	4.7529
1.5602	6.0075	4.7583	6.2067	75.4417	4.7583
1.5161	6.0790	4.7633	6.2652	75.9962	4.7633
1.4713	6.1501	4.7678	6.3236	76.5463	4.7678
1.4256	6.2207	4.7719	6.3820	77.0920	4.7719
1.3793	6.2908	4.7757	6.4403	77.6336	4.7757
1.3321	6.3605	4.7791	6.4985	78.1714	4.7791
1.2841	6.4295	4.7820	6.5565	78.7056	4.7820
1.2353	6.4981	4.7847	6.6145	79.2363	4.7847
1.1857	6.5660	4.7870	6.6722	79.7638	4.7870
1.1352	6.6334	4.7889	6.7298	80.2884	4.7889
1.0839	6.7001	4.7905	6.7872	80.8104	4.7905
1.0317	6.7661	4.7918	6.8443	81.3299	4.7918
0.9787	6.8314	4.7928	6.9012	81.8472	4.7928
0.9247	6.8960	4.7935	6.9578	82.3625	4.7935
0.8699	6.9599	4.7939	7.0140	82.8758	4.7939
0.8142	7.0230	4.7941	7.0700	83.3872	4.7941

X	Y	Z	R	THETA	Z
3.6088	0.3333	2.4992	3.6241	5.2763	2.4992
3.6092	0.3354	2.5260	3.6247	5.3091	2.5260
3.6084	0.3504	2.5487	3.6254	5.5461	2.5487
3.6069	0.3712	2.5664	3.6259	5.8761	2.5664
3.6038	0.4071	2.5862	3.6267	6.4445	2.5862
3.6002	0.4443	2.6032	3.6275	7.0356	2.6032
3.5962	0.4815	2.6202	3.6283	7.6267	2.6202
3.5920	0.5187	2.6372	3.6293	8.2175	2.6372
3.5875	0.5559	2.6543	3.6303	8.8080	2.6543
3.5828	0.5930	2.6714	3.6315	9.3980	2.6714
3.5724	0.6671	2.7056	3.6342	10.5767	2.7056
3.5611	0.7409	2.7400	3.6374	11.7532	2.7400
3.5488	0.8145	2.7745	3.6411	12.9270	2.7745
3.5355	0.8879	2.8092	3.6453	14.0976	2.8092
3.5213	0.9610	2.8442	3.6501	15.2646	2.8442
3.5063	1.0338	2.8794	3.6555	16.4277	2.8794
3.4904	1.1063	2.9148	3.6616	17.5862	2.9148
3.4739	1.1785	2.9505	3.6683	18.7400	2.9505
3.4566	1.2505	2.9864	3.6759	19.8885	2.9864
3.4387	1.3222	3.0225	3.6842	21.0314	3.0225
3.4202	1.3936	3.0589	3.6932	22.1684	3.0589
3.4012	1.4647	3.0955	3.7032	23.2989	3.0955
3.3817	1.5356	3.1324	3.7140	24.4229	3.1324
3.3616	1.6063	3.1693	3.7257	25.5400	3.1693
3.3412	1.6767	3.2065	3.7384	26.6490	3.2065
3.3204	1.7470	3.2438	3.7520	27.7513	3.2438
3.2993	1.8172	3.2812	3.7666	28.8448	3.2812
3.2780	1.8872	3.3187	3.7824	29.9298	3.3187
3.2564	1.9571	3.3563	3.7992	31.0058	3.3563
3.2346	2.0269	3.3940	3.8171	32.0726	3.3940
3.2126	2.0967	3.4315	3.8362	33.1302	3.4315
3.1905	2.1665	3.4690	3.8565	34.1780	3.4690
3.1682	2.2363	3.5064	3.8780	35.2159	3.5064
3.1459	2.3061	3.5436	3.9006	36.2438	3.5436
3.1235	2.3761	3.5805	3.9246	37.2613	3.5805
3.1010	2.4462	3.6172	3.9497	38.2682	3.6172
3.0785	2.5165	3.6535	3.9762	39.2645	3.6535
3.0559	2.5870	3.6894	4.0038	40.2497	3.6894
3.0332	2.6576	3.7249	4.0327	41.2241	3.7249
3.0104	2.7285	3.7599	4.0629	42.1873	3.7599
2.9876	2.7995	3.7944	4.0943	43.1392	3.7944
2.9646	2.8709	3.8283	4.1268	44.0797	3.8283
2.9415	2.9424	3.8616	4.1606	45.0089	3.8616
2.9183	3.0142	3.8943	4.1955	45.9266	3.8943
2.8949	3.0863	3.9263	4.2315	46.8328	3.9263
2.8713	3.1586	3.9576	4.2687	47.7277	3.9576
2.8475	3.2312	3.9882	4.3069	48.6111	3.9882
2.8235	3.3040	4.0180	4.3461	49.4830	4.0180
2.7993	3.3770	4.0471	4.3863	50.3437	4.0471
2.7747	3.4502	4.0754	4.4275	51.1931	4.0754
2.7498	3.5236	4.1029	4.4696	52.0313	4.1029
2.7246	3.5972	4.1296	4.5126	52.8584	4.1296
2.6991	3.6709	4.1555	4.5564	53.6744	4.1555
2.6732	3.7449	4.1806	4.6011	54.4794	4.1806
2.6470	3.8189	4.2050	4.6466	55.2734	4.2050
2.6203	3.8931	4.2285	4.6928	56.0567	4.2285
2.5933	3.9673	4.2513	4.7397	56.8292	4.2513
2.5658	4.0417	4.2732	4.7873	57.5913	4.2732
2.5379	4.1161	4.2944	4.8356	58.3429	4.2944

2.5095	4.1906	4.3148	4.8845	59.0844	4.3148
2.4807	4.2650	4.3345	4.9340	59.8160	4.3345
2.4514	4.3395	4.3534	4.9840	60.5377	4.3534
2.4216	4.4140	4.3716	5.0346	61.2498	4.3716
2.3913	4.4884	4.3891	5.0857	61.9525	4.3891
2.3605	4.5628	4.4059	5.1372	62.6458	4.4059
2.3292	4.6371	4.4220	5.1892	63.3301	4.4220
2.2974	4.7114	4.4373	5.2417	64.0054	4.4373
2.2650	4.7856	4.4521	5.2945	64.6720	4.4521
2.2321	4.8596	4.4662	5.3477	65.3301	4.4662
2.1986	4.9335	4.4796	5.4013	65.9799	4.4796
2.1646	5.0073	4.4924	5.4552	66.6216	4.4924
2.1300	5.0809	4.5046	5.5094	67.2554	4.5046
2.0949	5.1544	4.5162	5.5638	67.8816	4.5162
2.0592	5.2277	4.5272	5.6186	68.5004	4.5272
2.0229	5.3007	4.5376	5.6736	69.1120	4.5376
1.9860	5.3735	4.5475	5.7288	69.7166	4.5475
1.9485	5.4461	4.5568	5.7842	70.3144	4.5568
1.9103	5.5185	4.5656	5.8398	70.9057	4.5656
1.8716	5.5906	4.5739	5.8955	71.4906	4.5739
1.8322	5.6624	4.5817	5.9514	72.0695	4.5817
1.7922	5.7338	4.5890	6.0074	72.6424	4.5890
1.7516	5.8050	4.5958	6.0635	73.2096	4.5958
1.7103	5.8759	4.6021	6.1197	73.7713	4.6021
1.6683	5.9464	4.6080	6.1760	74.3278	4.6080
1.6257	6.0165	4.6134	6.2323	74.8791	4.6134
1.5825	6.0863	4.6184	6.2886	75.4256	4.6184
1.5385	6.1556	4.6230	6.3450	75.9673	4.6230
1.4939	6.2246	4.6272	6.4014	76.5045	4.6272
1.4486	6.2931	4.6310	6.4577	77.0374	4.6310
1.4025	6.3612	4.6344	6.5140	77.5662	4.6344
1.3558	6.4288	4.6374	6.5702	78.0912	4.6374
1.3083	6.4959	4.6401	6.6264	78.6125	4.6401
1.2601	6.5625	4.6424	6.6824	79.1303	4.6424
1.2112	6.6286	4.6444	6.7384	79.6449	4.6444
1.1615	6.6941	4.6461	6.7941	80.1565	4.6461
1.1110	6.7590	4.6474	6.8497	80.6654	4.6474
1.0597	6.8233	4.6484	6.9051	81.1718	4.6484
1.0077	6.8870	4.6491	6.9603	81.6758	4.6491
0.9548	6.9500	4.6495	7.0153	82.1775	4.6495
0.9012	7.0123	4.6497	7.0700	82.6770	4.6497

STREAMLINE 6

X	Y	Z	R	THETA	Z
3.8291	0.5004	2.4995	3.8616	7.4461	2.4995
3.8294	0.5030	2.5256	3.8623	7.4829	2.5256
3.8281	0.5180	2.5475	3.8629	7.7063	2.5475
3.8258	0.5387	2.5643	3.8636	8.0143	2.5643
3.8215	0.5740	2.5828	3.8643	8.5415	2.5828
3.8165	0.6105	2.5985	3.8651	9.0888	2.5985
3.8113	0.6471	2.6141	3.8659	9.6363	2.6141
3.8058	0.6837	2.6298	3.8668	10.1837	2.6298
3.8001	0.7202	2.6454	3.8677	10.7312	2.6454
3.7941	0.7567	2.6610	3.8688	11.2785	2.6610
3.7813	0.8295	2.6922	3.8712	12.3727	2.6922
3.7676	0.9021	2.7235	3.8741	13.4659	2.7235
3.7529	0.9746	2.7547	3.8774	14.5577	2.7547
3.7373	1.0468	2.7861	3.8811	15.6477	2.7861
3.7208	1.1188	2.8175	3.8854	16.7355	2.8175



3.7035	1.1906	2.8491	3.8902	17.8208	2.8491
3.6855	1.2620	2.8808	3.8956	18.9032	2.8808
3.6666	1.3333	2.9126	3.9015	19.9823	2.9126
3.6471	1.4042	2.9447	3.9081	21.0577	2.9447
3.6268	1.4749	2.9769	3.9153	22.1292	2.9769
3.6060	1.5453	3.0094	3.9231	23.1963	3.0094
3.5845	1.6154	3.0420	3.9317	24.2588	3.0420
3.5625	1.6852	3.0748	3.9410	25.3165	3.0748
3.5400	1.7549	3.1078	3.9511	26.3689	3.1078
3.5170	1.8242	3.1409	3.9619	27.4158	3.1409
3.4935	1.8934	3.1742	3.9736	28.4567	3.1742
3.4697	1.9624	3.2077	3.9862	29.4913	3.2077
3.4455	2.0311	3.2413	3.9997	30.5192	3.2413
3.4211	2.0998	3.2750	4.0141	31.5402	3.2750
3.3964	2.1682	3.3088	4.0295	32.5539	3.3088
3.3714	2.2366	3.3426	4.0459	33.5603	3.3426
3.3463	2.3049	3.3765	4.0633	34.5588	3.3765
3.3210	2.3731	3.4103	4.0818	35.5494	3.4103
3.2955	2.4414	3.4441	4.1013	36.5317	3.4441
3.2699	2.5096	3.4777	4.1220	37.5055	3.4777
3.2442	2.5779	3.5112	4.1437	38.4708	3.5112
3.2185	2.6462	3.5445	4.1667	39.4271	3.5445
3.1926	2.7146	3.5775	4.1907	40.3743	3.5775
3.1667	2.7832	3.6102	4.2159	41.3124	3.6102
3.1406	2.8519	3.6426	4.2423	42.2410	3.6426
3.1146	2.9207	3.6747	4.2698	43.1602	3.6747
3.0884	2.9897	3.7063	4.2984	44.0696	3.7063
3.0621	3.0588	3.7374	4.3281	44.9693	3.7374
3.0357	3.1282	3.7680	4.3590	45.8591	3.7680
3.0092	3.1977	3.7982	4.3910	46.7390	3.7982
2.9826	3.2674	3.8277	4.4240	47.6089	3.8277
2.9559	3.3373	3.8567	4.4581	48.4687	3.8567
2.9289	3.4074	3.8850	4.4932	49.3184	3.8850
2.9018	3.4777	3.9127	4.5294	50.1579	3.9127
2.8745	3.5482	3.9397	4.5665	50.9874	3.9397
2.8470	3.6188	3.9661	4.6045	51.8068	3.9661
2.8193	3.6896	3.9918	4.6435	52.6160	3.9918
2.7913	3.7606	4.0168	4.6833	53.4152	4.0168
2.7630	3.8317	4.0410	4.7240	54.2043	4.0410
2.7345	3.9029	4.0646	4.7655	54.9834	4.0646
2.7057	3.9742	4.0875	4.8079	55.7524	4.0875
2.6766	4.0457	4.1096	4.8510	56.5116	4.1096
2.6471	4.1172	4.1310	4.8948	57.2612	4.1310
2.6174	4.1888	4.1517	4.9393	58.0008	4.1517
2.5873	4.2605	4.1717	4.9845	58.7310	4.1717
2.5568	4.3322	4.1910	5.0304	59.4517	4.1910
2.5259	4.4039	4.2096	5.0769	60.1631	4.2096
2.4947	4.4756	4.2275	5.1239	60.8652	4.2275
2.4630	4.5473	4.2448	5.1715	61.5583	4.2448
2.4310	4.6191	4.2613	5.2197	62.2424	4.2613
2.3985	4.6907	4.2772	5.2684	62.9178	4.2772
2.3656	4.7623	4.2925	5.3175	63.5845	4.2925
2.3323	4.8339	4.3071	5.3671	64.2427	4.3071
2.2986	4.9054	4.3211	5.4172	64.8927	4.3211
2.2644	4.9767	4.3344	5.4677	65.5346	4.3344
2.2297	5.0480	4.3472	5.5185	66.1685	4.3472
2.1946	5.1191	4.3593	5.5697	66.7947	4.3593
2.1590	5.1901	4.3709	5.6213	67.4134	4.3709
2.1229	5.2610	4.3819	5.6732	68.0247	4.3819
2.0864	5.3317	4.3923	5.7253	68.6288	4.3923

2.0493	5.4022	4.4022	5.7778	69.2260	4.4022
2.0117	5.4725	4.4116	5.8305	69.8164	4.4116
1.9736	5.5425	4.4204	5.8834	70.4002	4.4204
1.9350	5.6124	4.4287	5.9366	70.9776	4.4287
1.8958	5.6820	4.4365	5.9899	71.5489	4.4365
1.8561	5.7514	4.4439	6.0435	72.1141	4.4439
1.8158	5.8205	4.4507	6.0972	72.6736	4.4507
1.7750	5.8893	4.4571	6.1510	73.2275	4.4571
1.7336	5.9578	4.4630	6.2049	73.7759	4.4630
1.6917	6.0260	4.4685	6.2590	74.3191	4.4685
1.6491	6.0939	4.4736	6.3131	74.8572	4.4736
1.6060	6.1615	4.4782	6.3673	75.3904	4.4782
1.5623	6.2287	4.4824	6.4216	75.9190	4.4824
1.5180	6.2955	4.4863	6.4759	76.4430	4.4863
1.4731	6.3619	4.4897	6.5302	76.9628	4.4897
1.4276	6.4279	4.4928	6.5845	77.4784	4.4928
1.3814	6.4935	4.4955	6.6388	77.9901	4.4955
1.3346	6.5587	4.4979	6.6931	78.4981	4.4979
1.2871	6.6234	4.4999	6.7473	79.0026	4.4999
1.2390	6.6876	4.5016	6.8014	79.5038	4.5016
1.1902	6.7513	4.5029	6.8554	80.0019	4.5029
1.1407	6.8145	4.5040	6.9093	80.4971	4.5040
1.0905	6.8771	4.5047	6.9630	80.9897	4.5047
1.0396	6.9391	4.5051	7.0166	81.4795	4.5051
0.9880	7.0006	4.5053	7.0700	81.9668	4.5053

STREAMLINE 7

X	Y	Z	R	THETA	Z
4.0415	0.6845	2.5000	4.0990	9.6130	2.5000
4.0416	0.6875	2.5254	4.0997	9.6533	2.5254
4.0397	0.7025	2.5464	4.1003	9.8651	2.5464
4.0367	0.7229	2.5623	4.1009	10.1532	2.5623
4.0311	0.7575	2.5794	4.1016	10.6429	2.5794
4.0249	0.7933	2.5939	4.1023	11.1500	2.5939
4.0184	0.8290	2.6084	4.1030	11.6573	2.6084
4.0117	0.8648	2.6228	4.1038	12.1649	2.6228
4.0047	0.9005	2.6372	4.1047	12.6725	2.6372
3.9975	0.9362	2.6515	4.1057	13.1803	2.6515
3.9824	1.0074	2.6800	4.1079	14.1959	2.6800
3.9664	1.0785	2.7084	4.1104	15.2116	2.7084
3.9495	1.1494	2.7367	4.1134	16.2268	2.7367
3.9318	1.2202	2.7649	4.1168	17.2413	2.7649
3.9132	1.2907	2.7932	4.1206	18.2548	2.7932
3.8938	1.3611	2.8214	4.1249	19.2668	2.8214
3.8737	1.4311	2.8497	4.1296	20.2770	2.8497
3.8527	1.5010	2.8781	4.1348	21.2851	2.8781
3.8311	1.5705	2.9065	4.1405	22.2907	2.9065
3.8088	1.6398	2.9351	4.1468	23.2936	2.9351
3.7858	1.7088	2.9639	4.1536	24.2935	2.9639
3.7622	1.7776	2.9928	4.1609	25.2900	2.9928
3.7380	1.8460	3.0219	4.1689	26.2829	3.0219
3.7132	1.9142	3.0511	4.1776	27.2720	3.0511
3.6879	1.9822	3.0804	4.1869	28.2571	3.0804
3.6622	2.0499	3.1099	4.1969	29.2377	3.1099
3.6360	2.1174	3.1396	4.2076	30.2136	3.1396
3.6094	2.1846	3.1694	4.2191	31.1845	3.1694
3.5825	2.2517	3.1994	4.2314	32.1501	3.1994
3.5553	2.3186	3.2294	4.2445	33.1101	3.2294
3.5277	2.3853	3.2596	4.2584	34.0645	3.2596

3.4999	2.4518	3.2898	4.2733	35.0127	3.2898
3.4719	2.5183	3.3201	4.2890	35.9546	3.3201
3.4437	2.5846	3.3504	4.3057	36.8899	3.3504
3.4153	2.6509	3.3806	4.3234	37.8186	3.3806
3.3867	2.7172	3.4108	4.3420	38.7402	3.4108
3.3581	2.7835	3.4410	4.3617	39.6548	3.4410
3.3293	2.8497	3.4709	4.3824	40.5618	3.4709
3.3004	2.9160	3.5008	4.4041	41.4614	3.5008
3.2715	2.9824	3.5304	4.4268	42.3533	3.5304
3.2424	3.0488	3.5597	4.4506	43.2372	3.5597
3.2133	3.1153	3.5888	4.4755	44.1131	3.5888
3.1840	3.1819	3.6175	4.5014	44.9808	3.6175
3.1547	3.2486	3.6459	4.5284	45.8402	3.6459
3.1253	3.3155	3.6739	4.5564	46.6911	3.6739
3.0959	3.3825	3.7015	4.5854	47.5334	3.7015
3.0663	3.4497	3.7286	4.6154	48.3672	3.7286
3.0366	3.5169	3.7552	4.6465	49.1921	3.7552
3.0068	3.5844	3.7813	4.6785	50.0082	3.7813
2.9768	3.6520	3.8069	4.7115	50.8154	3.8069
2.9467	3.7197	3.8319	4.7455	51.6136	3.8319
2.9165	3.7876	3.8563	4.7803	52.4029	3.8563
2.8861	3.8556	3.8801	4.8161	53.1832	3.8801
2.8555	3.9237	3.9034	4.8528	53.9544	3.9034
2.8247	3.9919	3.9260	4.8902	54.7168	3.9260
2.7937	4.0603	3.9480	4.9286	55.4698	3.9480
2.7625	4.1288	3.9694	4.9677	56.2140	3.9694
2.7310	4.1973	3.9901	5.0076	56.9495	3.9901
2.6993	4.2659	4.0102	5.0482	57.6758	4.0102
2.6674	4.3346	4.0296	5.0896	58.3932	4.0296
2.6352	4.4034	4.0484	5.1317	59.1018	4.0484
2.6027	4.4722	4.0666	5.1744	59.8016	4.0666
2.5699	4.5410	4.0841	5.2178	60.4927	4.0841
2.5369	4.6099	4.1010	5.2618	61.1752	4.1010
2.5035	4.6787	4.1173	5.3064	61.8492	4.1173
2.4699	4.7475	4.1329	5.3516	62.5148	4.1329
2.4358	4.8164	4.1480	5.3973	63.1722	4.1480
2.4015	4.8851	4.1624	5.4435	63.8215	4.1624
2.3668	4.9539	4.1762	5.4902	64.4628	4.1762
2.3318	5.0225	4.1895	5.5374	65.0962	4.1895
2.2964	5.0911	4.2021	5.5851	65.7219	4.2021
2.2606	5.1596	4.2142	5.6331	66.3400	4.2142
2.2245	5.2280	4.2257	5.6816	66.9507	4.2257
2.1879	5.2963	4.2367	5.7304	67.5542	4.2367
2.1510	5.3645	4.2471	5.7796	68.1506	4.2471
2.1137	5.4325	4.2570	5.8292	68.7401	4.2570
2.0759	5.5003	4.2663	5.8790	69.3228	4.2663
2.0377	5.5680	4.2752	5.9292	69.8990	4.2752
1.9991	5.6355	4.2835	5.9796	70.4687	4.2835
1.9601	5.7029	4.2913	6.0303	71.0321	4.2913
1.9206	5.7700	4.2987	6.0812	71.5895	4.2987
1.8806	5.8369	4.3056	6.1324	72.1410	4.3056
1.8402	5.9035	4.3120	6.1837	72.6868	4.3120
1.7994	5.9700	4.3180	6.2352	73.2270	4.3180
1.7580	6.0361	4.3235	6.2869	73.7618	4.3235
1.7162	6.1020	4.3287	6.3387	74.2914	4.3287
1.6738	6.1676	4.3333	6.3907	74.8160	4.3333
1.6310	6.2329	4.3376	6.4428	75.3358	4.3376
1.5877	6.2979	4.3415	6.4950	75.8508	4.3415
1.5438	6.3626	4.3450	6.5472	76.3614	4.3450
1.4994	6.4269	4.3482	6.5995	76.8675	4.3482

1.4545	6.4909	4.3509	6.6518	77.3695	4.3509
1.4090	6.5545	4.3533	6.7042	77.8675	4.3533
1.3630	6.6177	4.3554	6.7566	78.3617	4.3554
1.3164	6.6805	4.3571	6.8090	78.8523	4.3571
1.2693	6.7429	4.3585	6.8613	79.3394	4.3585
1.2215	6.8048	4.3596	6.9136	79.8233	4.3596
1.1732	6.8663	4.3603	6.9658	80.3041	4.3603
1.1242	6.9273	4.3607	7.0179	80.7818	4.3607
1.0747	6.9878	4.3609	7.0700	81.2566	4.3609

STREAMLINE 8

X	Y	Z	R	THETA	Z
4.2448	0.8849	2.5003	4.3361	11.7752	2.5003
4.2447	0.8881	2.5250	4.3367	11.8175	2.5250
4.2422	0.9031	2.5451	4.3372	12.0180	2.5451
4.2384	0.9231	2.5601	4.3377	12.2875	2.5601
4.2315	0.9569	2.5761	4.3383	12.7423	2.5761
4.2241	0.9917	2.5896	4.3389	13.2123	2.5896
4.2164	1.0265	2.6029	4.3395	13.6826	2.6029
4.2085	1.0613	2.6162	4.3402	14.1533	2.6162
4.2004	1.0960	2.6294	4.3410	14.6242	2.6294
4.1921	1.1307	2.6426	4.3419	15.0954	2.6426
4.1748	1.2001	2.6687	4.3439	16.0383	2.6687
4.1567	1.2694	2.6945	4.3462	16.9819	2.6945
4.1379	1.3386	2.7200	4.3490	17.9258	2.7200
4.1182	1.4075	2.7455	4.3521	18.8697	2.7455
4.0976	1.4763	2.7707	4.3555	19.8134	2.7707
4.0763	1.5449	2.7959	4.3593	20.7563	2.7959
4.0542	1.6133	2.8211	4.3634	21.6984	2.8211
4.0314	1.6814	2.8462	4.3680	22.6392	2.8462
4.0079	1.7492	2.8714	4.3730	23.5785	2.8714
3.9836	1.8168	2.8966	4.3784	24.5160	2.8966
3.9588	1.8841	2.9220	4.3843	25.4513	2.9220
3.9333	1.9511	2.9474	4.3906	26.3843	2.9474
3.9071	2.0179	2.9730	4.3975	27.3147	2.9730
3.8805	2.0844	2.9987	4.4049	28.2423	2.9987
3.8533	2.1506	3.0245	4.4128	29.1670	3.0245
3.8255	2.2166	3.0504	4.4213	30.0885	3.0504
3.7973	2.2823	3.0765	4.4304	31.0067	3.0765
3.7687	2.3477	3.1027	4.4401	31.9212	3.1027
3.7396	2.4130	3.1290	4.4505	32.8318	3.1290
3.7102	2.4780	3.1554	4.4616	33.7382	3.1554
3.6804	2.5428	3.1820	4.4734	34.6403	3.1820
3.6504	2.6074	3.2087	4.4859	35.5377	3.2087
3.6200	2.6719	3.2355	4.4993	36.4303	3.2355
3.5894	2.7362	3.2623	4.5134	37.3179	3.2623
3.5586	2.8003	3.2892	4.5283	38.2002	3.2892
3.5276	2.8644	3.3161	4.5441	39.0771	3.3161
3.4964	2.9284	3.3430	4.5607	39.9483	3.3430
3.4650	2.9924	3.3698	4.5783	40.8136	3.3698
3.4336	3.0563	3.3966	4.5968	41.6729	3.3966
3.4020	3.1202	3.4232	4.6162	42.5260	3.4232
3.3703	3.1841	3.4498	4.6365	43.3728	3.4498
3.3385	3.2480	3.4762	4.6578	44.2130	3.4762
3.3066	3.3120	3.5023	4.6800	45.0464	3.5023
3.2746	3.3760	3.5282	4.7032	45.8730	3.5282
3.2426	3.4401	3.5539	4.7274	46.6926	3.5539
3.2105	3.5042	3.5793	4.7526	47.5050	3.5793
3.1783	3.5685	3.6043	4.7786	48.3102	3.6043

3.1460	3.6328	3.6290	4.8057	49.1079	3.6290
3.1136	3.6973	3.6532	4.8337	49.8981	3.6532
3.0812	3.7619	3.6771	4.8626	50.6807	3.6771
3.0486	3.8265	3.7005	4.8925	51.4556	3.7005
3.0160	3.8913	3.7235	4.9233	52.2226	3.7235
2.9832	3.9562	3.7460	4.9549	52.9818	3.7460
2.9503	4.0213	3.7680	4.9875	53.7331	3.7680
2.9173	4.0864	3.7895	5.0209	54.4765	3.7895
2.8841	4.1516	3.8104	5.0551	55.2120	3.8104
2.8509	4.2169	3.8308	5.0902	55.9393	3.8308
2.8174	4.2823	3.8507	5.1260	56.6589	3.8507
2.7837	4.3478	3.8700	5.1626	57.3701	3.8700
2.7499	4.4134	3.8887	5.2000	58.0732	3.8887
2.7160	4.4790	3.9069	5.2382	58.7682	3.9069
2.6819	4.5447	3.9245	5.2770	59.4550	3.9245
2.6475	4.6105	3.9415	5.3166	60.1338	3.9415
2.6130	4.6763	3.9579	5.3568	60.8046	3.9579
2.5782	4.7421	3.9738	5.3976	61.4674	3.9738
2.5433	4.8079	3.9891	5.4391	62.1224	3.9891
2.5080	4.8738	4.0039	5.4812	62.7695	4.0039
2.4726	4.9396	4.0181	5.5239	63.4090	4.0181
2.4369	5.0054	4.0317	5.5671	64.0408	4.0317
2.4009	5.0712	4.0447	5.6108	64.6651	4.0447
2.3647	5.1369	4.0572	5.6551	65.2820	4.0572
2.3282	5.2026	4.0692	5.6998	65.8915	4.0692
2.2914	5.2683	4.0806	5.7450	66.4939	4.0806
2.2543	5.3338	4.0915	5.7906	67.0891	4.0915
2.2169	5.3993	4.1019	5.8367	67.6774	4.1019
2.1792	5.4647	4.1117	5.8832	68.2589	4.1117
2.1412	5.5299	4.1211	5.9300	68.8337	4.1211
2.1028	5.5951	4.1299	5.9772	69.4019	4.1299
2.0642	5.6601	4.1382	6.0247	69.9636	4.1382
2.0252	5.7250	4.1461	6.0726	70.5191	4.1461
1.9858	5.7897	4.1535	6.1208	71.0684	4.1535
1.9461	5.8542	4.1604	6.1692	71.6118	4.1604
1.9060	5.9186	4.1669	6.2180	72.1494	4.1669
1.8656	5.9828	4.1729	6.2669	72.6812	4.1729
1.8248	6.0468	4.1785	6.3161	73.2076	4.1785
1.7835	6.1106	4.1837	6.3655	73.7285	4.1837
1.7419	6.1741	4.1884	6.4151	74.2443	4.1884
1.6999	6.2374	4.1928	6.4649	74.7551	4.1928
1.6575	6.3005	4.1967	6.5148	75.2609	4.1967
1.6146	6.3633	4.2003	6.5649	75.7620	4.2003
1.5714	6.4258	4.2035	6.6151	76.2585	4.2035
1.5276	6.4880	4.2063	6.6654	76.7506	4.2063
1.4835	6.5499	4.2087	6.7158	77.2384	4.2087
1.4389	6.6116	4.2108	6.7663	77.7221	4.2108
1.3938	6.6729	4.2126	6.8169	78.2019	4.2126
1.3483	6.7338	4.2140	6.8675	78.6778	4.2140
1.3022	6.7944	4.2151	6.9181	79.1502	4.2151
1.2557	6.8546	4.2159	6.9687	79.6190	4.2159
1.2087	6.9145	4.2164	7.0194	80.0843	4.2164
1.1612	6.9740	4.2165	7.0700	80.5463	4.2165

STREAMLINE 9

X	Y	Z	R	THETA	Z
4.3428	0.9909	2.5004	4.4544	12.8530	2.5004
4.3425	0.9942	2.5247	4.4548	12.8955	2.5247
4.3396	1.0090	2.5444	4.4553	13.0900	2.5444

4.3354	1.0288	2.5590	4.4558	13.3501	2.5590
4.3279	1.0621	2.5745	4.4563	13.7883	2.5745
4.3199	1.0964	2.5874	4.4568	14.2409	2.5874
4.3116	1.1306	2.6003	4.4574	14.6939	2.6003
4.3032	1.1649	2.6130	4.4581	15.1472	2.6130
4.2946	1.1991	2.6257	4.4588	15.6009	2.6257
4.2857	1.2333	2.6383	4.4597	16.0548	2.6383
4.2675	1.3017	2.6632	4.4616	16.9636	2.6632
4.2485	1.3700	2.6878	4.4639	17.8731	2.6878
4.2286	1.4382	2.7121	4.4665	18.7832	2.7121
4.2080	1.5062	2.7362	4.4694	19.6936	2.7362
4.1866	1.5740	2.7601	4.4727	20.6040	2.7601
4.1644	1.6416	2.7839	4.4762	21.5140	2.7839
4.1414	1.7089	2.8076	4.4801	22.4235	2.8076
4.1177	1.7761	2.8312	4.4844	23.3320	2.8312
4.0933	1.8430	2.8548	4.4891	24.2394	2.8548
4.0682	1.9096	2.8785	4.4941	25.1453	2.8785
4.0425	1.9760	2.9022	4.4996	26.0495	2.9022
4.0161	2.0420	2.9261	4.5054	26.9517	2.9261
3.9891	2.1078	2.9500	4.5118	27.8518	2.9500
3.9616	2.1734	2.9740	4.5186	28.7496	2.9740
3.9335	2.2386	2.9981	4.5259	29.6449	2.9981
3.9049	2.3036	3.0223	4.5338	30.5376	3.0223
3.8758	2.3683	3.0467	4.5421	31.4274	3.0467
3.8462	2.4328	3.0711	4.5511	32.3142	3.0711
3.8163	2.4971	3.0957	4.5606	33.1976	3.0957
3.7859	2.5611	3.1204	4.5708	34.0774	3.1204
3.7551	2.6248	3.1452	4.5816	34.9535	3.1452
3.7241	2.6884	3.1701	4.5931	35.8256	3.1701
3.6927	2.7518	3.1952	4.6052	36.6935	3.1952
3.6610	2.8150	3.2203	4.6182	37.5570	3.2203
3.6291	2.8781	3.2455	4.6318	38.4160	3.2455
3.5970	2.9410	3.2707	4.6463	39.2701	3.2707
3.5647	3.0038	3.2960	4.6616	40.1193	3.2960
3.5322	3.0666	3.3213	4.6777	40.9633	3.3213
3.4996	3.1292	3.3465	4.6946	41.8020	3.3465
3.4668	3.1918	3.3717	4.7124	42.6351	3.3717
3.4339	3.2544	3.3967	4.7311	43.4626	3.3967
3.4010	3.3170	3.4217	4.7507	44.2843	3.4217
3.3679	3.3796	3.4465	4.7712	45.0999	3.4465
3.3347	3.4422	3.4712	4.7926	45.9093	3.4712
3.3014	3.5049	3.4956	4.8149	46.7125	3.4956
3.2681	3.5676	3.5198	4.8382	47.5091	3.5198
3.2346	3.6304	3.5437	4.8624	48.2991	3.5437
3.2011	3.6932	3.5673	4.8874	49.0824	3.5673
3.1676	3.7561	3.5906	4.9135	49.8588	3.5906
3.1339	3.8192	3.6135	4.9404	50.6283	3.6135
3.1002	3.8823	3.6361	4.9682	51.3906	3.6361
3.0664	3.9455	3.6582	4.9970	52.1458	3.6582
3.0325	4.0088	3.6799	5.0266	52.8936	3.6799
2.9985	4.0722	3.7012	5.0571	53.6341	3.7012
2.9644	4.1357	3.7221	5.0884	54.3673	3.7221
2.9302	4.1993	3.7424	5.1206	55.0931	3.7424
2.8959	4.2630	3.7623	5.1536	55.8112	3.7623
2.8614	4.3267	3.7816	5.1873	56.5221	3.7816
2.8268	4.3906	3.8004	5.2219	57.2251	3.8004
2.7921	4.4545	3.8187	5.2573	57.9204	3.8187
2.7573	4.5186	3.8365	5.2934	58.6079	3.8365
2.7223	4.5827	3.8538	5.3303	59.2878	3.8538
2.6872	4.6468	3.8705	5.3678	59.9599	3.8705

2.6519	4.7110	3.8867	5.4061	60.6243	3.8867
2.6164	4.7752	3.9024	5.4450	61.2811	3.9024
2.5808	4.8395	3.9175	5.4846	61.9303	3.9175
2.5449	4.9038	3.9320	5.5248	62.5720	3.9320
2.5089	4.9681	3.9460	5.5656	63.2062	3.9460
2.4726	5.0324	3.9595	5.6070	63.8330	3.9595
2.4362	5.0966	3.9725	5.6489	64.4525	3.9725
2.3995	5.1609	3.9849	5.6914	65.0646	3.9849
2.3626	5.2251	3.9968	5.7344	65.6696	3.9968
2.3254	5.2893	4.0081	5.7779	66.2676	4.0081
2.2880	5.3534	4.0190	5.8219	66.8585	4.0190
2.2504	5.4175	4.0293	5.8663	67.4426	4.0293
2.2124	5.4815	4.0391	5.9111	68.0199	4.0391
2.1743	5.5454	4.0484	5.9564	68.5906	4.0484
2.1358	5.6092	4.0573	6.0021	69.1547	4.0573
2.0971	5.6729	4.0656	6.0481	69.7124	4.0656
2.0581	5.7365	4.0735	6.0945	70.2638	4.0735
2.0187	5.8000	4.0809	6.1412	70.8091	4.0809
1.9791	5.8633	4.0878	6.1883	71.3484	4.0878
1.9391	5.9265	4.0943	6.2356	71.8818	4.0943
1.8989	5.9895	4.1004	6.2833	72.4095	4.1004
1.8583	6.0523	4.1060	6.3312	72.9316	4.1060
1.8174	6.1150	4.1112	6.3793	73.4482	4.1112
1.7761	6.1774	4.1160	6.4277	73.9596	4.1160
1.7344	6.2397	4.1204	6.4763	74.4658	4.1204
1.6924	6.3017	4.1243	6.5251	74.9671	4.1243
1.6501	6.3636	4.1279	6.5740	75.4634	4.1279
1.6073	6.4251	4.1311	6.6231	75.9550	4.1311
1.5642	6.4865	4.1340	6.6724	76.4420	4.1340
1.5207	6.5475	4.1365	6.7218	76.9247	4.1365
1.4768	6.6083	4.1386	6.7713	77.4030	4.1386
1.4324	6.6688	4.1404	6.8209	77.8773	4.1404
1.3877	6.7290	4.1418	6.8706	78.3476	4.1418
1.3425	6.7889	4.1429	6.9204	78.8141	4.1429
1.2969	6.8485	4.1437	6.9702	79.2768	4.1437
1.2509	6.9077	4.1442	7.0201	79.7359	4.1442
1.2044	6.9667	4.1443	7.0700	80.1913	4.1443

STREAMLINE 10

X	Y	Z	R	THETA	Z
4.4380	1.1006	2.5003	4.5724	13.9285	2.5003
4.4375	1.1039	2.5242	4.5728	13.9698	2.5242
4.4342	1.1186	2.5436	4.5732	14.1583	2.5436
4.4297	1.1381	2.5579	4.5735	14.4087	2.5579
4.4216	1.1708	2.5729	4.5740	14.8309	2.5729
4.4131	1.2045	2.5853	4.5745	15.2669	2.5853
4.4043	1.2383	2.5977	4.5751	15.7032	2.5977
4.3953	1.2720	2.6099	4.5757	16.1400	2.6099
4.3862	1.3057	2.6220	4.5764	16.5771	2.6220
4.3769	1.3394	2.6341	4.5772	17.0146	2.6341
4.3577	1.4067	2.6578	4.5792	17.8904	2.6578
4.3378	1.4739	2.6812	4.5814	18.7672	2.6812
4.3171	1.5410	2.7043	4.5839	19.6447	2.7043
4.2955	1.6080	2.7272	4.5866	20.5227	2.7272
4.2732	1.6747	2.7498	4.5897	21.4009	2.7498
4.2502	1.7413	2.7722	4.5930	22.2790	2.7722
4.2264	1.8076	2.7945	4.5967	23.1567	2.7945
4.2019	1.8738	2.8167	4.6007	24.0338	2.8167
4.1766	1.9396	2.8389	4.6050	24.9101	2.8389

4.1508	2.0052	2.8611	4.6097	25.7852	2.8611
4.1242	2.0706	2.8833	4.6148	26.6590	2.8833
4.0971	2.1356	2.9055	4.6203	27.5312	2.9055
4.0693	2.2004	2.9279	4.6261	28.4017	2.9279
4.0410	2.2649	2.9502	4.6324	29.2703	2.9502
4.0121	2.3292	2.9727	4.6391	30.1369	2.9727
3.9826	2.3931	2.9952	4.6463	31.0012	2.9952
3.9527	2.4568	3.0179	4.6540	31.8632	3.0179
3.9223	2.5203	3.0406	4.6622	32.7226	3.0406
3.8915	2.5835	3.0635	4.6710	33.5791	3.0635
3.8602	2.6464	3.0865	4.6802	34.4326	3.0865
3.8286	2.7091	3.1096	4.6901	35.2829	3.1096
3.7966	2.7716	3.1328	4.7006	36.1298	3.1328
3.7643	2.8338	3.1562	4.7117	36.9730	3.1562
3.7317	2.8959	3.1796	4.7235	37.8125	3.1796
3.6988	2.9578	3.2031	4.7360	38.6480	3.2031
3.6657	3.0195	3.2267	4.7492	39.4793	3.2267
3.6324	3.0811	3.2504	4.7631	40.3062	3.2504
3.5988	3.1426	3.2740	4.7778	41.1287	3.2740
3.5651	3.2040	3.2977	4.7933	41.9465	3.2977
3.5313	3.2654	3.3214	4.8096	42.7594	3.3214
3.4973	3.3266	3.3450	4.8267	43.5673	3.3450
3.4632	3.3878	3.3685	4.8447	44.3700	3.3685
3.4290	3.4490	3.3919	4.8635	45.1673	3.3919
3.3946	3.5102	3.4152	4.8832	45.9592	3.4152
3.3602	3.5714	3.4384	4.9037	46.7454	3.4384
3.3257	3.6327	3.4613	4.9251	47.5258	3.4613
3.2911	3.6939	3.4841	4.9474	48.3002	3.4841
3.2565	3.7552	3.5066	4.9706	49.0685	3.5066
3.2218	3.8166	3.5288	4.9946	49.8306	3.5288
3.1870	3.8780	3.5508	5.0196	50.5864	3.5508
3.1522	3.9396	3.5724	5.0454	51.3356	3.5724
3.1173	4.0012	3.5937	5.0721	52.0783	3.5937
3.0823	4.0628	3.6146	5.0997	52.8143	3.6146
3.0472	4.1246	3.6351	5.1281	53.5435	3.6351
3.0121	4.1865	3.6553	5.1574	54.2658	3.6553
2.9768	4.2484	3.6750	5.1875	54.9813	3.6750
2.9415	4.3104	3.6942	5.2184	55.6898	3.6942
2.9060	4.3725	3.7130	5.2501	56.3913	3.7130
2.8705	4.4347	3.7313	5.2827	57.0856	3.7313
2.8349	4.4970	3.7492	5.3160	57.7726	3.7492
2.7992	4.5593	3.7666	5.3500	58.4523	3.7666
2.7634	4.6218	3.7834	5.3849	59.1247	3.7834
2.7274	4.6842	3.7998	5.4204	59.7898	3.7998
2.6913	4.7468	3.8157	5.4567	60.4476	3.8157
2.6551	4.8094	3.8311	5.4936	61.0981	3.8311
2.6188	4.8720	3.8460	5.5313	61.7412	3.8460
2.5823	4.9347	3.8603	5.5695	62.3772	3.8603
2.5457	4.9974	3.8741	5.6084	63.0058	3.8741
2.5089	5.0601	3.8875	5.6480	63.6274	3.8875
2.4719	5.1229	3.9003	5.6881	64.2417	3.9003
2.4347	5.1856	3.9126	5.7287	64.8490	3.9126
2.3974	5.2483	3.9244	5.7699	65.4493	3.9244
2.3599	5.3110	3.9357	5.8117	66.0427	3.9357
2.3221	5.3736	3.9464	5.8539	66.6291	3.9464
2.2842	5.4363	3.9567	5.8967	67.2089	3.9567
2.2461	5.4988	3.9665	5.9399	67.7819	3.9665
2.2077	5.5613	3.9758	5.9835	68.3484	3.9758
2.1691	5.6238	3.9846	6.0276	68.9084	3.9846
2.1303	5.6861	3.9930	6.0721	69.4620	3.9930



2.0912	5.7484	4.0008	6.1169	70.0093	4.0008
2.0519	5.8106	4.0083	6.1622	70.5505	4.0083
2.0123	5.8726	4.0152	6.2078	71.0857	4.0152
1.9724	5.9345	4.0217	6.2537	71.6150	4.0217
1.9323	5.9963	4.0278	6.3000	72.1386	4.0278
1.8919	6.0580	4.0335	6.3465	72.6565	4.0335
1.8512	6.1195	4.0387	6.3934	73.1689	4.0387
1.8102	6.1808	4.0435	6.4405	73.6759	4.0435
1.7690	6.2420	4.0479	6.4879	74.1774	4.0479
1.7274	6.3031	4.0519	6.5355	74.6738	4.0519
1.6855	6.3639	4.0555	6.5833	75.1653	4.0555
1.6433	6.4245	4.0588	6.6313	75.6519	4.0588
1.6008	6.4849	4.0617	6.6795	76.1338	4.0617
1.5579	6.5450	4.0642	6.7279	76.6112	4.0642
1.5147	6.6050	4.0663	6.7764	77.0842	4.0663
1.4711	6.6646	4.0681	6.8251	77.5529	4.0681
1.4271	6.7241	4.0696	6.8738	78.0175	4.0696
1.3828	6.7832	4.0707	6.9227	78.4781	4.0707
1.3381	6.8421	4.0715	6.9717	78.9346	4.0715
1.2930	6.9007	4.0720	7.0208	79.3873	4.0720
1.2476	6.9591	4.0722	7.0700	79.8361	4.0722

STREAMLINE 11

X	Y	Z	R	THETA	Z
4.5303	1.2140	2.5000	4.6901	15.0012	2.5000
4.5297	1.2172	2.5236	4.6904	15.0409	2.5236
4.5261	1.2315	2.5427	4.6907	15.2214	2.5427
4.5212	1.2506	2.5567	4.6910	15.4624	2.5567
4.5126	1.2828	2.5713	4.6914	15.8691	2.5713
4.5035	1.3160	2.5833	4.6919	16.2890	2.5833
4.4943	1.3492	2.5951	4.6924	16.7094	2.5951
4.4849	1.3823	2.6068	4.6931	17.1303	2.6068
4.4753	1.4155	2.6184	4.6938	17.5516	2.6184
4.4656	1.4486	2.6299	4.6947	17.9732	2.6299
4.4455	1.5149	2.6525	4.6965	18.8175	2.6525
4.4246	1.5810	2.6748	4.6986	19.6628	2.6748
4.4030	1.6470	2.6967	4.7009	20.5090	2.6967
4.3806	1.7128	2.7183	4.7036	21.3556	2.7183
4.3575	1.7785	2.7397	4.7065	22.2026	2.7397
4.3336	1.8440	2.7609	4.7096	23.0496	2.7609
4.3091	1.9092	2.7819	4.7131	23.8965	2.7819
4.2838	1.9742	2.8028	4.7168	24.7430	2.8028
4.2578	2.0390	2.8236	4.7209	25.5889	2.8236
4.2312	2.1035	2.8444	4.7253	26.4341	2.8444
4.2040	2.1678	2.8651	4.7300	27.2782	2.8651
4.1761	2.2318	2.8858	4.7350	28.1212	2.8858
4.1476	2.2955	2.9066	4.7404	28.9628	2.9066
4.1185	2.3590	2.9273	4.7462	29.8030	2.9273
4.0888	2.4221	2.9482	4.7524	30.6414	2.9482
4.0587	2.4850	2.9691	4.7590	31.4781	2.9691
4.0280	2.5476	2.9901	4.7660	32.3127	2.9901
3.9968	2.6100	3.0112	4.7735	33.1452	3.0112
3.9652	2.6721	3.0324	4.7815	33.9752	3.0324
3.9331	2.7339	3.0537	4.7900	34.8027	3.0537
3.9007	2.7954	3.0751	4.7989	35.6274	3.0751
3.8679	2.8568	3.0967	4.8085	36.4492	3.0967
3.8347	2.9179	3.1183	4.8186	37.2679	3.1183
3.8012	2.9788	3.1401	4.8293	38.0834	3.1401
3.7675	3.0395	3.1620	4.8407	38.8954	3.1620

3.7335	3.1000	3.1840	4.8527	39.7038	3.1840
3.6992	3.1604	3.2060	4.8654	40.5085	3.2060
3.6647	3.2206	3.2281	4.8788	41.3092	3.2281
3.6301	3.2807	3.2502	4.8929	42.1059	3.2502
3.5952	3.3407	3.2723	4.9077	42.8983	3.2723
3.5602	3.4006	3.2945	4.9233	43.6863	3.2945
3.5251	3.4604	3.3165	4.9397	44.4698	3.3165
3.4898	3.5202	3.3386	4.9569	45.2485	3.3386
3.4544	3.5800	3.3605	4.9748	46.0224	3.3605
3.4189	3.6397	3.3823	4.9936	46.7912	3.3823
3.3834	3.6994	3.4040	5.0133	47.5549	3.4040
3.3477	3.7591	3.4256	5.0337	48.3132	3.4256
3.3120	3.8189	3.4469	5.0550	49.0661	3.4469
3.2762	3.8787	3.4681	5.0772	49.8134	3.4681
3.2403	3.9385	3.4890	5.1002	50.5549	3.4890
3.2044	3.9984	3.5096	5.1240	51.2905	3.5096
3.1684	4.0584	3.5300	5.1487	52.0202	3.5300
3.1324	4.1184	3.5500	5.1743	52.7437	3.5500
3.0963	4.1785	3.5697	5.2007	53.4611	3.5697
3.0601	4.2387	3.5891	5.2279	54.1721	3.5891
3.0239	4.2989	3.6081	5.2559	54.8768	3.6081
2.9876	4.3592	3.6267	5.2848	55.5749	3.6267
2.9512	4.4196	3.6449	5.3144	56.2666	3.6449
2.9148	4.4801	3.6627	5.3449	56.9516	3.6627
2.8783	4.5407	3.6800	5.3761	57.6299	3.6800
2.8417	4.6013	3.6969	5.4081	58.3013	3.6969
2.8050	4.6620	3.7134	5.4408	58.9659	3.7134
2.7682	4.7228	3.7294	5.4743	59.6236	3.7294
2.7314	4.7837	3.7449	5.5086	60.2744	3.7449
2.6945	4.8446	3.7600	5.5435	60.9182	3.7600
2.6574	4.9056	3.7746	5.5791	61.5550	3.7746
2.6203	4.9666	3.7887	5.6154	62.1849	3.7887
2.5830	5.0277	3.8024	5.6524	62.8078	3.8024
2.5456	5.0888	3.8155	5.6900	63.4238	3.8155
2.5081	5.1499	3.8282	5.7282	64.0328	3.8282
2.4705	5.2110	3.8403	5.7670	64.6350	3.8403
2.4327	5.2722	3.8520	5.8064	65.2303	3.8520
2.3948	5.3333	3.8632	5.8463	65.8189	3.8632
2.3567	5.3945	3.8739	5.8868	66.4008	3.8739
2.3185	5.4556	3.8841	5.9278	66.9760	3.8841
2.2800	5.5167	3.8939	5.9693	67.5447	3.8939
2.2415	5.5778	3.9032	6.0113	68.1069	3.9032
2.2027	5.6388	3.9120	6.0537	68.6627	3.9120
2.1637	5.6997	3.9203	6.0966	69.2122	3.9203
2.1246	5.7606	3.9282	6.1399	69.7555	3.9282
2.0852	5.8214	3.9356	6.1836	70.2927	3.9356
2.0456	5.8822	3.9426	6.2277	70.8238	3.9426
2.0059	5.9428	3.9491	6.2722	71.3490	3.9491
1.9659	6.0034	3.9552	6.3170	71.8684	3.9552
1.9256	6.0638	3.9609	6.3622	72.3821	3.9609
1.8852	6.1241	3.9661	6.4077	72.8901	3.9661
1.8445	6.1843	3.9710	6.4535	73.3925	3.9710
1.8036	6.2444	3.9754	6.4997	73.8895	3.9754
1.7624	6.3043	3.9795	6.5461	74.3811	3.9795
1.7210	6.3641	3.9831	6.5927	74.8676	3.9831
1.6793	6.4237	3.9864	6.6396	75.3492	3.9864
1.6374	6.4832	3.9893	6.6868	75.8260	3.9893
1.5951	6.5424	3.9919	6.7341	76.2981	3.9919
1.5525	6.6015	3.9941	6.7816	76.7656	3.9941
1.5097	6.6603	3.9959	6.8293	77.2287	3.9959

1.4665	6.7189	3.9974
1.4230	6.7773	3.9985
1.3792	6.8355	3.9994
1.3351	6.8935	3.9998
1.2907	6.9512	4.0000

6.8771	77.6875	3.9974
6.9251	78.1421	3.9985
6.9733	78.5925	3.9994
7.0216	79.0387	3.9998
7.0700	79.4809	4.0000

FULL BLADE SUCTION SIDE

STREAMLIN 1

X	Y	Z	R	THETA	Z
3.0481	-0.0004	2.5007	3.0481	359.9917	2.5007
3.0479	0.0181	2.4794	3.0480	0.3405	2.4794
3.0476	0.0453	2.4702	3.0479	0.8510	2.4702
3.0470	0.0740	2.4693	3.0479	1.3919	2.4693
3.0457	0.1166	2.4767	3.0479	2.1917	2.4767
3.0439	0.1583	2.4877	3.0480	2.9774	2.4877
3.0415	0.1999	2.4994	3.0481	3.7602	2.4994
3.0386	0.2413	2.5117	3.0482	4.5396	2.5117
3.0353	0.2824	2.5246	3.0484	5.3156	2.5246
3.0314	0.3233	2.5381	3.0486	6.0880	2.5381
3.0222	0.4044	2.5668	3.0492	7.6218	2.5668
3.0113	0.4845	2.5976	3.0500	9.1406	2.5976
2.9987	0.5636	2.6303	3.0512	10.6444	2.6303
2.9847	0.6416	2.6649	3.0528	12.1325	2.6649
2.9693	0.7186	2.7012	3.0550	13.6050	2.7012
2.9528	0.7946	2.7391	3.0578	15.0618	2.7391
2.9352	0.8696	2.7785	3.0614	16.5028	2.7785
2.9168	0.9437	2.8192	3.0657	17.9281	2.8192
2.8976	1.0169	2.8612	3.0709	19.3375	2.8612
2.8777	1.0892	2.9043	3.0769	20.7310	2.9043
2.8571	1.1607	2.9484	3.0839	22.1085	2.9484
2.8360	1.2313	2.9936	3.0918	23.4700	2.9936
2.8144	1.3013	3.0396	3.1007	24.8154	3.0396
2.7925	1.3708	3.0864	3.1108	26.1449	3.0864
2.7705	1.4397	3.1338	3.1222	27.4581	3.1338
2.7483	1.5081	3.1819	3.1349	28.7548	3.1819
2.7262	1.5762	3.2304	3.1490	30.0350	3.2304
2.7040	1.6439	3.2794	3.1645	31.2985	3.2794
2.6818	1.7115	3.3287	3.1814	32.5454	3.3287
2.6598	1.7789	3.3782	3.1999	33.7755	3.3782
2.6379	1.8463	3.4278	3.2199	34.9888	3.4278
2.6162	1.9137	3.4775	3.2415	36.1851	3.4775
2.5947	1.9813	3.5271	3.2647	37.3645	3.5271
2.5735	2.0490	3.5766	3.2895	38.5267	3.5766
2.5524	2.1169	3.6258	3.3161	39.6719	3.6258
2.5316	2.1852	3.6747	3.3443	40.7997	3.6747
2.5111	2.2539	3.7231	3.3743	41.9102	3.7231
2.4908	2.3230	3.7711	3.4059	43.0033	3.7711
2.4707	2.3926	3.8184	3.4393	44.0792	3.8184
2.4509	2.4627	3.8650	3.4744	45.1376	3.8650
2.4311	2.5333	3.9109	3.5111	46.1787	3.9109
2.4116	2.6045	3.9560	3.5495	47.2026	3.9560
2.3921	2.6763	4.0002	3.5895	48.2092	4.0002
2.3727	2.7486	4.0434	3.6310	49.1989	4.0434
2.3532	2.8216	4.0857	3.6741	50.1716	4.0857
2.3337	2.8951	4.1269	3.7186	51.1276	4.1269
2.3142	2.9692	4.1671	3.7645	52.0671	4.1671
2.2945	3.0438	4.2061	3.8117	52.9905	4.2061

2.2746	3.1189	4.2441	3.8602	53.8978	4.2441
2.2544	3.1946	4.2809	3.9100	54.7895	4.2809
2.2340	3.2707	4.3166	3.9608	55.6657	4.3166
2.2132	3.3473	4.3511	4.0128	56.5269	4.3511
2.1921	3.4242	4.3845	4.0658	57.3732	4.3845
2.1706	3.5016	4.4167	4.1198	58.2050	4.4167
2.1487	3.5792	4.4478	4.1747	59.0226	4.4478
2.1263	3.6572	4.4778	4.2304	59.8267	4.4778
2.1033	3.7355	4.5067	4.2869	60.6175	4.5067
2.0799	3.8140	4.5345	4.3442	61.3953	4.5345
2.0558	3.8927	4.5611	4.4022	62.1604	4.5611
2.0312	3.9715	4.5868	4.4608	62.9132	4.5868
2.0060	4.0506	4.6114	4.5201	63.6539	4.6114
1.9801	4.1297	4.6350	4.5799	64.3829	4.6350
1.9536	4.2089	4.6576	4.6402	65.1004	4.6576
1.9265	4.2881	4.6793	4.7010	65.8068	4.6793
1.8988	4.3674	4.7000	4.7623	66.5024	4.7000
1.8703	4.4466	4.7198	4.8240	67.1874	4.7198
1.8412	4.5259	4.7387	4.8861	67.8622	4.7387
1.8115	4.6051	4.7568	4.9485	68.5269	4.7568
1.7811	4.6842	4.7741	5.0114	69.1818	4.7741
1.7500	4.7632	4.7905	5.0745	69.8272	4.7905
1.7182	4.8421	4.8061	5.1380	70.4632	4.8061
1.6858	4.9210	4.8210	5.2017	71.0902	4.8210
1.6527	4.9996	4.8351	5.2657	71.7082	4.8351
1.6189	5.0781	4.8485	5.3300	72.3176	4.8485
1.5845	5.1565	4.8612	5.3945	72.9184	4.8612
1.5495	5.2347	4.8732	5.4592	73.5108	4.8732
1.5138	5.3127	4.8846	5.5241	74.0951	4.8846
1.4776	5.3905	4.8953	5.5893	74.6713	4.8953
1.4407	5.4681	4.9054	5.6547	75.2396	4.9054
1.4032	5.5455	4.9149	5.7202	75.8001	4.9149
1.3651	5.6226	4.9238	5.7860	76.3530	4.9238
1.3265	5.6996	4.9322	5.8519	76.8983	4.9322
1.2873	5.7763	4.9400	5.9180	77.4362	4.9400
1.2476	5.8528	4.9472	5.9843	77.9668	4.9472
1.2073	5.9291	4.9540	6.0508	78.4902	4.9540
1.1666	6.0051	4.9602	6.1174	79.0064	4.9602
1.1253	6.0810	4.9659	6.1842	79.5155	4.9659
1.0836	6.1566	4.9711	6.2512	80.0176	4.9711
1.0414	6.2320	4.9759	6.3184	80.5127	4.9759
0.9988	6.3071	4.9802	6.3857	81.0010	4.9802
0.9558	6.3821	4.9841	6.4532	81.4825	4.9841
0.9124	6.4568	4.9875	6.5209	81.9572	4.9875
0.8686	6.5313	4.9905	6.5888	82.4250	4.9905
0.8244	6.6057	4.9930	6.6569	82.8859	4.9930
0.7800	6.6799	4.9952	6.7253	83.3399	4.9952
0.7352	6.7539	4.9969	6.7938	83.7871	4.9969
0.6902	6.8278	4.9983	6.8626	84.2276	4.9983
0.6449	6.9014	4.9992	6.9315	84.6615	4.9992
0.5993	6.9750	4.9998	7.0007	85.0890	4.9998
0.5535	7.0483	5.0000	7.0700	85.5101	5.0000

STREAMLINE 2

X	Y	Z	R	THETA	Z
3.1604	0.0569	2.5000	3.1609	1.0317	2.5000
3.1599	0.0750	2.4787	3.1607	1.3599	2.4787
3.1590	0.1019	2.4695	3.1607	1.8474	2.4695
3.1580	0.1304	2.4684	3.1607	2.3640	2.4684

3.1560	0.1726	2.4753	3.1607	3.1299	2.4753
3.1535	0.2141	2.4857	3.1608	3.8838	2.4857
3.1506	0.2554	2.4966	3.1609	4.6350	2.4966
3.1471	0.2966	2.5081	3.1610	5.3833	2.5081
3.1431	0.3375	2.5202	3.1612	6.1286	2.5202
3.1387	0.3782	2.5329	3.1614	6.8709	2.5329
3.1285	0.4590	2.5598	3.1620	8.3461	2.5598
3.1166	0.5388	2.5886	3.1628	9.8084	2.5886
3.1030	0.6177	2.6194	3.1639	11.2577	2.6194
3.0881	0.6956	2.6519	3.1654	12.6936	2.6519
3.0718	0.7725	2.6860	3.1674	14.1160	2.6860
3.0543	0.8485	2.7217	3.1700	15.5248	2.7217
3.0358	0.9235	2.7588	3.1732	16.9196	2.7588
3.0164	0.9976	2.7972	3.1771	18.3008	2.7972
2.9961	1.0709	2.8369	3.1818	19.6680	2.8369
2.9751	1.1433	2.8777	3.1872	21.0211	2.8777
2.9534	1.2149	2.9195	3.1935	22.3600	2.9195
2.9311	1.2857	2.9623	3.2007	23.6846	2.9623
2.9083	1.3559	3.0061	3.2088	24.9950	3.0061
2.8852	1.4254	3.0506	3.2181	26.2911	3.0506
2.8618	1.4944	3.0958	3.2285	27.5726	3.0958
2.8382	1.5629	3.1416	3.2401	28.8395	3.1416
2.8146	1.6310	3.1880	3.2530	30.0915	3.1880
2.7908	1.6987	3.2348	3.2672	31.3285	3.2348
2.7671	1.7663	3.2820	3.2827	32.5505	3.2820
2.7434	1.8336	3.3295	3.2997	33.7573	3.3295
2.7198	1.9008	3.3772	3.3182	34.9488	3.3772
2.6963	1.9680	3.4250	3.3382	36.1248	3.4250
2.6730	2.0352	3.4728	3.3597	37.2851	3.4728
2.6499	2.1026	3.5206	3.3827	38.4298	3.5206
2.6270	2.1701	3.5682	3.4074	39.5586	3.5682
2.6043	2.2378	3.6155	3.4337	40.6715	3.6155
2.5819	2.3059	3.6626	3.4617	41.7682	3.6626
2.5597	2.3743	3.7092	3.4913	42.8487	3.7092
2.5377	2.4432	3.7553	3.5226	43.9130	3.7553
2.5159	2.5125	3.8008	3.5556	44.9610	3.8008
2.4943	2.5822	3.8457	3.5902	45.9926	3.8457
2.4728	2.6525	3.8899	3.6264	47.0079	3.8899
2.4515	2.7233	3.9332	3.6642	48.0068	3.9332
2.4303	2.7947	3.9757	3.7036	48.9895	3.9757
2.4091	2.8666	4.0174	3.7445	49.9560	4.0174
2.3879	2.9390	4.0580	3.7868	50.9063	4.0580
2.3667	3.0120	4.0977	3.8306	51.8408	4.0977
2.3454	3.0855	4.1364	3.8757	52.7595	4.1364
2.3240	3.1595	4.1740	3.9222	53.6626	4.1740
2.3025	3.2340	4.2105	3.9699	54.5505	4.2105
2.2807	3.3089	4.2460	4.0188	55.4234	4.2460
2.2586	3.3843	4.2803	4.0688	56.2815	4.2803
2.2363	3.4601	4.3136	4.1199	57.1251	4.3136
2.2136	3.5363	4.3457	4.1719	57.9545	4.3457
2.1905	3.6128	4.3768	4.2250	58.7702	4.3768
2.1671	3.6896	4.4067	4.2789	59.5724	4.4067
2.1431	3.7667	4.4356	4.3337	60.3614	4.4356
2.1187	3.8440	4.4633	4.3893	61.1375	4.4633
2.0938	3.9216	4.4901	4.4456	61.9011	4.4901
2.0684	3.9993	4.5157	4.5026	62.6524	4.5157
2.0425	4.0772	4.5404	4.5602	63.3917	4.5404
2.0160	4.1553	4.5640	4.6185	64.1193	4.5640
1.9889	4.2334	4.5867	4.6773	64.8355	4.5867
1.9612	4.3115	4.6085	4.7366	65.5406	4.6085

1.9329	4.3897	4.6293	4.7964	66.2349	4.6293
1.9040	4.4680	4.6492	4.8567	66.9187	4.6492
1.8745	4.5462	4.6682	4.9175	67.5922	4.6682
1.8444	4.6244	4.6864	4.9786	68.2556	4.6864
1.8137	4.7025	4.7037	5.0401	68.9092	4.7037
1.7823	4.7805	4.7202	5.1020	69.5532	4.7202
1.7503	4.8585	4.7359	5.1642	70.1878	4.7359
1.7177	4.9364	4.7509	5.2267	70.8133	4.7509
1.6845	5.0141	4.7651	5.2895	71.4298	4.7651
1.6507	5.0917	4.7786	5.3526	72.0375	4.7786
1.6163	5.1692	4.7914	5.4160	72.6366	4.7914
1.5813	5.2465	4.8035	5.4796	73.2272	4.8035
1.5457	5.3237	4.8150	5.5435	73.8095	4.8150
1.5095	5.4006	4.8258	5.6076	74.3838	4.8258
1.4728	5.4774	4.8360	5.6720	74.9500	4.8360
1.4355	5.5540	4.8455	5.7365	75.5083	4.8455
1.3977	5.6304	4.8545	5.8013	76.0590	4.8545
1.3593	5.7066	4.8629	5.8663	76.6020	4.8629
1.3204	5.7826	4.8708	5.9314	77.1375	4.8708
1.2810	5.8584	4.8781	5.9968	77.6657	4.8781
1.2411	5.9340	4.8849	6.0624	78.1866	4.8849
1.2008	6.0093	4.8912	6.1281	78.7003	4.8912
1.1599	6.0845	4.8969	6.1941	79.2069	4.8969
1.1187	6.1595	4.9022	6.2602	79.7064	4.9022
1.0770	6.2342	4.9070	6.3265	80.1988	4.9070
1.0349	6.3088	4.9114	6.3931	80.6844	4.9114
0.9924	6.3831	4.9153	6.4598	81.1631	4.9153
0.9495	6.4573	4.9187	6.5267	81.6349	4.9187
0.9063	6.5313	4.9217	6.5938	82.0998	4.9217
0.8628	6.6051	4.9243	6.6612	82.5577	4.9243
0.8190	6.6787	4.9265	6.7288	83.0088	4.9265
0.7749	6.7523	4.9283	6.7966	83.4529	4.9283
0.7306	6.8256	4.9296	6.8646	83.8903	4.9296
0.6860	6.8988	4.9306	6.9329	84.3211	4.9306
0.6412	6.9719	4.9312	7.0013	84.7454	4.9312
0.5961	7.0448	4.9314	7.0700	85.1633	4.9314

STREAMLINE 3

X	Y	Z	R	THETA	Z
3.2716	0.1182	2.4996	3.2738	2.0687	2.4996
3.2707	0.1359	2.4782	3.2735	2.3788	2.4782
3.2694	0.1624	2.4689	3.2735	2.8434	2.4689
3.2679	0.1906	2.4677	3.2735	3.3376	2.4677
3.2652	0.2324	2.4741	3.2735	4.0714	2.4741
3.2621	0.2736	2.4838	3.2736	4.7948	2.4838
3.2586	0.3147	2.4940	3.2737	5.5161	2.4940
3.2545	0.3556	2.5048	3.2739	6.2349	2.5048
3.2500	0.3962	2.5161	3.2740	6.9512	2.5161
3.2450	0.4367	2.5280	3.2742	7.6649	2.5280
3.2337	0.5170	2.5531	3.2748	9.0842	2.5531
3.2208	0.5965	2.5802	3.2756	10.4925	2.5802
3.2063	0.6751	2.6091	3.2766	11.8897	2.6091
3.1904	0.7527	2.6396	3.2780	13.2752	2.6396
3.1733	0.8295	2.6716	3.2799	14.6490	2.6716
3.1549	0.9053	2.7052	3.2822	16.0110	2.7052
3.1354	0.9802	2.7401	3.2851	17.3609	2.7401
3.1150	1.0543	2.7764	3.2886	18.6987	2.7764
3.0938	1.1275	2.8138	3.2928	20.0243	2.8138
3.0717	1.1999	2.8523	3.2978	21.3376	2.8523

3.0489	1.2715	2.8919	3.3035	22.6383	2.8919
3.0255	1.3424	2.9325	3.3100	23.9265	2.9325
3.0016	1.4126	2.9739	3.3173	25.2019	2.9739
2.9772	1.4821	3.0162	3.3257	26.4646	3.0162
2.9526	1.5511	3.0592	3.3352	27.7144	3.0592
2.9277	1.6196	3.1028	3.3458	28.9509	3.1028
2.9026	1.6876	3.1470	3.3576	30.1743	3.1470
2.8774	1.7553	3.1917	3.3706	31.3843	3.1917
2.8522	1.8227	3.2368	3.3849	32.5807	3.2368
2.8269	1.8899	3.2823	3.4005	33.7633	3.2823
2.8017	1.9568	3.3280	3.4174	34.9321	3.3280
2.7766	2.0237	3.3739	3.4358	36.0867	3.3739
2.7516	2.0906	3.4199	3.4557	37.2271	3.4199
2.7267	2.1575	3.4659	3.4771	38.3531	3.4659
2.7020	2.2246	3.5119	3.5000	39.4646	3.5119
2.6775	2.2918	3.5577	3.5244	40.5613	3.5577
2.6532	2.3592	3.6032	3.5504	41.6431	3.6032
2.6292	2.4270	3.6485	3.5781	42.7099	3.6485
2.6053	2.4951	3.6933	3.6073	43.7615	3.6933
2.5817	2.5635	3.7376	3.6382	44.7980	3.7376
2.5582	2.6324	3.7814	3.6707	45.8191	3.7814
2.5349	2.7018	3.8246	3.7048	46.8248	3.8246
2.5118	2.7716	3.8671	3.7404	47.8150	3.8671
2.4888	2.8419	3.9088	3.7776	48.7898	3.9088
2.4659	2.9127	3.9497	3.8164	49.7492	3.9497
2.4430	2.9841	3.9897	3.8565	50.6931	3.9897
2.4202	3.0559	4.0289	3.8982	51.6217	4.0289
2.3973	3.1282	4.0671	3.9412	52.5352	4.0671
2.3744	3.2011	4.1043	3.9855	53.4336	4.1043
2.3514	3.2744	4.1405	4.0312	54.3171	4.1405
2.3282	3.3481	4.1757	4.0780	55.1861	4.1757
2.3048	3.4223	4.2098	4.1260	56.0407	4.2098
2.2812	3.4969	4.2429	4.1752	56.8812	4.2429
2.2573	3.5718	4.2749	4.2253	57.7078	4.2749
2.2331	3.6471	4.3058	4.2765	58.5211	4.3058
2.2086	3.7228	4.3357	4.3286	59.3211	4.3357
2.1836	3.7987	4.3645	4.3816	60.1080	4.3645
2.1583	3.8748	4.3923	4.4354	60.8823	4.3923
2.1325	3.9512	4.4190	4.4899	61.6441	4.4190
2.1062	4.0278	4.4447	4.5453	62.3937	4.4447
2.0795	4.1045	4.4694	4.6013	63.1314	4.4694
2.0523	4.1814	4.4931	4.6579	63.8575	4.4931
2.0246	4.2584	4.5158	4.7152	64.5723	4.5158
1.9963	4.3355	4.5376	4.7730	65.2760	4.5376
1.9675	4.4126	4.5585	4.8314	65.9689	4.5585
1.9381	4.4898	4.5785	4.8902	66.6512	4.5785
1.9082	4.5669	4.5976	4.9495	67.3233	4.5976
1.8777	4.6441	4.6159	5.0093	67.9853	4.6159
1.8466	4.7212	4.6333	5.0695	68.6375	4.6333
1.8150	4.7982	4.6499	5.1300	69.2800	4.6499
1.7828	4.8752	4.6657	5.1910	69.9131	4.6657
1.7500	4.9521	4.6808	5.2522	70.5370	4.6808
1.7167	5.0289	4.6951	5.3138	71.1519	4.6951
1.6828	5.1056	4.7087	5.3758	71.7579	4.7087
1.6483	5.1821	4.7216	5.4380	72.3553	4.7216
1.6133	5.2586	4.7338	5.5005	72.9441	4.7338
1.5778	5.3348	4.7453	5.5632	73.5246	4.7453
1.5417	5.4109	4.7562	5.6263	74.0968	4.7562
1.5050	5.4869	4.7665	5.6896	74.6611	4.7665
1.4679	5.5627	4.7761	5.7531	75.2173	4.7761

1.4303	5.6383	4.7852	5.8168	75.7658	4.7852
1.3922	5.7137	4.7937	5.8808	76.3065	4.7937
1.3535	5.7889	4.8016	5.9451	76.8398	4.8016
1.3145	5.8640	4.8090	6.0095	77.3655	4.8090
1.2749	5.9388	4.8158	6.0741	77.8839	4.8158
1.2349	6.0135	4.8221	6.1390	78.3952	4.8221
1.1945	6.0880	4.8280	6.2040	78.8992	4.8280
1.1537	6.1623	4.8333	6.2693	79.3960	4.8333
1.1125	6.2364	4.8381	6.3348	79.8857	4.8381
1.0709	6.3103	4.8425	6.4005	80.3685	4.8425
1.0289	6.3840	4.8465	6.4664	80.8443	4.8465
0.9866	6.4576	4.8499	6.5326	81.3131	4.8499
0.9440	6.5310	4.8530	6.5989	81.7750	4.8530
0.9012	6.6043	4.8556	6.6655	82.2300	4.8556
0.8580	6.6774	4.8578	6.7323	82.6779	4.8578
0.8146	6.7504	4.8596	6.7994	83.1190	4.8596
0.7710	6.8233	4.8610	6.8667	83.5532	4.8610
0.7271	6.8960	4.8619	6.9343	83.9807	4.8619
0.6831	6.9686	4.8625	7.0020	84.4018	4.8625
0.6388	7.0411	4.8627	7.0700	84.8164	4.8627

STREAMLINE 4

X	Y	Z	R	THETA	Z
3.3817	0.1834	2.4993	3.3867	3.1036	2.4993
3.3804	0.2006	2.4780	3.3864	3.3962	2.4780
3.3787	0.2268	2.4685	3.3863	3.8396	2.4685
3.3767	0.2546	2.4671	3.3863	4.3127	2.4671
3.3734	0.2961	2.4729	3.3863	5.0164	2.4729
3.3696	0.3370	2.4820	3.3864	5.7112	2.4820
3.3654	0.3777	2.4916	3.3865	6.4042	2.4916
3.3608	0.4183	2.5017	3.3867	7.0950	2.5017
3.3557	0.4587	2.5123	3.3869	7.7837	2.5123
3.3501	0.4989	2.5234	3.3871	8.4702	2.5234
3.3378	0.5787	2.5469	3.3876	9.8362	2.5469
3.3239	0.6577	2.5723	3.3884	11.1928	2.5723
3.3085	0.7359	2.5993	3.3894	12.5398	2.5993
3.2917	0.8132	2.6279	3.3907	13.8767	2.6279
3.2736	0.8896	2.6581	3.3923	15.2035	2.6581
3.2543	0.9652	2.6896	3.3945	16.5200	2.6896
3.2340	1.0399	2.7224	3.3971	17.8261	2.7224
3.2126	1.1138	2.7565	3.4002	19.1215	2.7565
3.1904	1.1869	2.7918	3.4040	20.4063	2.7918
3.1674	1.2592	2.8282	3.4085	21.6802	2.8282
3.1436	1.3307	2.8656	3.4136	22.9432	2.8656
3.1191	1.4015	2.9039	3.4195	24.1952	2.9039
3.0941	1.4716	2.9432	3.4262	25.4358	2.9432
3.0686	1.5410	2.9832	3.4338	26.6652	2.9832
3.0427	1.6099	3.0240	3.4424	27.8830	3.0240
3.0166	1.6783	3.0655	3.4520	29.0891	3.0655
2.9902	1.7462	3.1075	3.4628	30.2835	3.1075
2.9637	1.8137	3.1501	3.4746	31.4659	3.1501
2.9370	1.8809	3.1932	3.4877	32.6361	3.1932
2.9103	1.9478	3.2366	3.5020	33.7939	3.2366
2.8836	2.0145	3.2803	3.5176	34.9392	3.2803
2.8569	2.0811	3.3243	3.5345	36.0717	3.3243
2.8302	2.1476	3.3685	3.5528	37.1912	3.3685
2.8037	2.2141	3.4127	3.5725	38.2976	3.4127
2.7773	2.2806	3.4569	3.5937	39.3907	3.4569
2.7511	2.3472	3.5011	3.6163	40.4703	3.5011



2.7251	2.4140	3.5451	3.6405	41.5361	3.5451
2.6992	2.4810	3.5889	3.6662	42.5881	3.5889
2.6736	2.5483	3.6324	3.6935	43.6261	3.6324
2.6481	2.6159	3.6755	3.7223	44.6499	3.6755
2.6229	2.6839	3.7182	3.7527	45.6594	3.7182
2.5978	2.7523	3.7603	3.7847	46.6545	3.7603
2.5729	2.8211	3.8018	3.8182	47.6351	3.8018
2.5481	2.8904	3.8426	3.8532	48.6010	3.8426
2.5235	2.9601	3.8827	3.8898	49.5524	3.8827
2.4990	3.0303	3.9221	3.9278	50.4890	3.9221
2.4745	3.1010	3.9606	3.9673	51.4111	3.9606
2.4501	3.1722	3.9983	4.0082	52.3185	3.9983
2.4256	3.2438	4.0350	4.0504	53.2115	4.0350
2.4011	3.3158	4.0708	4.0939	54.0902	4.0708
2.3766	3.3884	4.1057	4.1387	54.9547	4.1057
2.3518	3.4613	4.1395	4.1847	55.8053	4.1395
2.3269	3.5347	4.1724	4.2318	56.6421	4.1724
2.3018	3.6084	4.2042	4.2800	57.4656	4.2042
2.2764	3.6824	4.2350	4.3293	58.2760	4.2350
2.2508	3.7568	4.2648	4.3795	59.0734	4.2648
2.2248	3.8315	4.2935	4.4306	59.8578	4.2935
2.1985	3.9064	4.3212	4.4826	60.6299	4.3212
2.1718	3.9816	4.3479	4.5354	61.3897	4.3479
2.1447	4.0570	4.3737	4.5890	62.1374	4.3737
2.1172	4.1326	4.3984	4.6433	62.8734	4.3984
2.0892	4.2083	4.4221	4.6983	63.5978	4.4221
2.0608	4.2841	4.4449	4.7540	64.3109	4.4449
2.0319	4.3600	4.4668	4.8103	65.0131	4.4668
2.0025	4.4360	4.4877	4.8671	65.7044	4.4877
1.9727	4.5121	4.5078	4.9245	66.3852	4.5078
1.9423	4.5882	4.5270	4.9823	67.0558	4.5270
1.9114	4.6642	4.5453	5.0407	67.7162	4.5453
1.8800	4.7403	4.5629	5.0995	68.3669	4.5629
1.8481	4.8163	4.5796	5.1587	69.0078	4.5796
1.8156	4.8923	4.5955	5.2183	69.6394	4.5955
1.7826	4.9682	4.6106	5.2783	70.2616	4.6106
1.7491	5.0440	4.6250	5.3387	70.8749	4.6250
1.7151	5.1197	4.6387	5.3994	71.4792	4.6387
1.6806	5.1953	4.6517	5.4604	72.0748	4.6517
1.6455	5.2708	4.6640	5.5217	72.6618	4.6640
1.6100	5.3462	4.6756	5.5834	73.2404	4.6756
1.5740	5.4214	4.6866	5.6453	73.8107	4.6866
1.5375	5.4965	4.6969	5.7075	74.3729	4.6969
1.5005	5.5714	4.7067	5.7700	74.9271	4.7067
1.4630	5.6462	4.7158	5.8327	75.4734	4.7158
1.4251	5.7208	4.7243	5.8957	76.0120	4.7243
1.3867	5.7953	4.7323	5.9589	76.5429	4.7323
1.3479	5.8696	4.7398	6.0224	77.0663	4.7398
1.3087	5.9437	4.7467	6.0861	77.5823	4.7467
1.2691	6.0176	4.7531	6.1500	78.0909	4.7531
1.2291	6.0914	4.7590	6.2142	78.5923	4.7590
1.1887	6.1650	4.7643	6.2786	79.0864	4.7643
1.1480	6.2385	4.7692	6.3432	79.5734	4.7692
1.1069	6.3117	4.7737	6.4081	80.0533	4.7737
1.0655	6.3849	4.7776	6.4731	80.5262	4.7776
1.0237	6.4578	4.7812	6.5385	80.9920	4.7812
0.9817	6.5307	4.7842	6.6040	81.4508	4.7842
0.9395	6.6034	4.7869	6.6699	81.9026	4.7869
0.8970	6.6759	4.7891	6.7359	82.3474	4.7891
0.8543	6.7484	4.7909	6.8023	82.7853	4.7909

0.8114	6.8208	4.7923
0.7682	6.8930	4.7933
0.7249	6.9651	4.7939
0.6814	7.0371	4.7941

6.8688	83.2162	4.7923
6.9357	83.6405	4.7933
7.0027	84.0582	4.7939
7.0700	84.4694	4.7941

STREAMLINE 5

X	Y	Z	R	THETA	Z
3.6088	0.3333	2.4992	3.6241	5.2763	2.4992
3.6069	0.3496	2.4779	3.6238	5.5357	2.4779
3.6042	0.3749	2.4681	3.6236	5.9381	2.4681
3.6012	0.4021	2.4661	3.6236	6.3704	2.4661
3.5965	0.4426	2.4709	3.6237	7.0164	2.4709
3.5915	0.4828	2.4788	3.6238	7.6557	2.4788
3.5860	0.5227	2.4871	3.6239	8.2936	2.4871
3.5801	0.5626	2.4959	3.6241	8.9300	2.4959
3.5739	0.6022	2.5051	3.6242	9.5648	2.5051
3.5672	0.6417	2.5147	3.6244	10.1981	2.5147
3.5527	0.7202	2.5351	3.6250	11.4596	2.5351
3.5367	0.7980	2.5571	3.6256	12.7143	2.5571
3.5194	0.8750	2.5807	3.6265	13.9620	2.5807
3.5006	0.9513	2.6056	3.6276	15.2023	2.6056
3.4807	1.0267	2.6319	3.6290	16.4352	2.6319
3.4596	1.1015	2.6595	3.6307	17.6605	2.6595
3.4374	1.1754	2.6882	3.6328	18.8780	2.6882
3.4142	1.2486	2.7182	3.6353	20.0876	2.7182
3.3900	1.3210	2.7492	3.6383	21.2893	2.7492
3.3650	1.3927	2.7812	3.6418	22.4828	2.7812
3.3393	1.4636	2.8142	3.6459	23.6681	2.8142
3.3128	1.5339	2.8481	3.6507	24.8450	2.8481
3.2857	1.6035	2.8829	3.6561	26.0138	2.8829
3.2580	1.6725	2.9185	3.6622	27.1735	2.9185
3.2299	1.7409	2.9548	3.6692	28.3243	2.9548
3.2014	1.8088	2.9918	3.6771	29.4660	2.9918
3.1726	1.8762	3.0294	3.6858	30.5986	3.0294
3.1435	1.9431	3.0676	3.6955	31.7219	3.0676
3.1141	2.0096	3.1063	3.7063	32.8356	3.1063
3.0846	2.0759	3.1455	3.7180	33.9396	3.1455
3.0550	2.1418	3.1850	3.7309	35.0335	3.1850
3.0252	2.2074	3.2250	3.7450	36.1172	3.2250
2.9955	2.2729	3.2651	3.7602	37.1904	3.2651
2.9658	2.3383	3.3056	3.7767	38.2529	3.3056
2.9361	2.4036	3.3461	3.7945	39.3046	3.3461
2.9066	2.4689	3.3867	3.8136	40.3449	3.3867
2.8771	2.5342	3.4274	3.8340	41.3742	3.4274
2.8478	2.5996	3.4680	3.8559	42.3918	3.4680
2.8186	2.6652	3.5084	3.8792	43.3978	3.5084
2.7896	2.7310	3.5487	3.9039	44.3918	3.5487
2.7608	2.7970	3.5886	3.9300	45.3736	3.5886
2.7321	2.8633	3.6283	3.9577	46.3431	3.6283
2.7037	2.9299	3.6675	3.9868	47.3001	3.6675
2.6754	2.9969	3.7063	4.0174	48.2444	3.7063
2.6473	3.0643	3.7445	4.0494	49.1758	3.7445
2.6193	3.1320	3.7822	4.0829	50.0943	3.7822
2.5915	3.2002	3.8192	4.1179	50.9997	3.8192
2.5637	3.2687	3.8555	4.1542	51.8920	3.8555
2.5361	3.3377	3.8911	4.1919	52.7712	3.8911
2.5085	3.4071	3.9258	4.2310	53.6373	3.9258
2.4810	3.4769	3.9598	4.2713	54.4904	3.9598
2.4534	3.5472	3.9929	4.3129	55.3306	3.9929

2.4257	3.6178	4.0251	4.3557	56.1580	4.0251
2.3980	3.6887	4.0564	4.3997	56.9730	4.0564
2.3701	3.7601	4.0868	4.4447	57.7758	4.0868
2.3420	3.8317	4.1162	4.4908	58.5662	4.1162
2.3137	3.9037	4.1447	4.5379	59.3444	4.1447
2.2853	3.9759	4.1723	4.5859	60.1107	4.1723
2.2566	4.0484	4.1988	4.6349	60.8651	4.1988
2.2276	4.1212	4.2245	4.6847	61.6078	4.2245
2.1983	4.1941	4.2492	4.7353	62.3392	4.2492
2.1687	4.2673	4.2730	4.7867	63.0592	4.2730
2.1388	4.3405	4.2958	4.8389	63.7683	4.2958
2.1085	4.4140	4.3178	4.8917	64.4665	4.3178
2.0779	4.4875	4.3388	4.9452	65.1540	4.3388
2.0468	4.5611	4.3590	4.9993	65.8312	4.3590
2.0154	4.6347	4.3784	5.0540	66.4981	4.3784
1.9836	4.7085	4.3969	5.1092	67.1551	4.3969
1.9514	4.7822	4.4146	5.1650	67.8021	4.4146
1.9187	4.8559	4.4315	5.2213	68.4396	4.4315
1.8857	4.9297	4.4476	5.2780	69.0675	4.4476
1.8522	5.0034	4.4629	5.3352	69.6862	4.4629
1.8183	5.0770	4.4775	5.3928	70.2957	4.4775
1.7839	5.1506	4.4914	5.4508	70.8963	4.4914
1.7492	5.2241	4.5045	5.5092	71.4881	4.5045
1.7140	5.2976	4.5170	5.5680	72.0712	4.5170
1.6784	5.3710	4.5288	5.6271	72.6458	4.5288
1.6425	5.4442	4.5400	5.6866	73.2120	4.5400
1.6061	5.5174	4.5505	5.7464	73.7700	4.5505
1.5693	5.5905	4.5604	5.8066	74.3198	4.5604
1.5322	5.6634	4.5697	5.8670	74.8616	4.5697
1.4947	5.7363	4.5785	5.9278	75.3955	4.5785
1.4568	5.8090	4.5866	5.9889	75.9216	4.5866
1.4186	5.8816	4.5942	6.0502	76.4399	4.5942
1.3800	5.9540	4.6013	6.1119	76.9507	4.6013
1.3411	6.0264	4.6078	6.1738	77.4539	4.6078
1.3019	6.0986	4.6138	6.2360	77.9496	4.6138
1.2624	6.1707	4.6193	6.2985	78.4379	4.6193
1.2226	6.2427	4.6243	6.3613	78.9188	4.6243
1.1826	6.3145	4.6288	6.4243	79.3926	4.6288
1.1423	6.3863	4.6329	6.4876	79.8591	4.6329
1.1017	6.4579	4.6365	6.5512	80.3185	4.6365
1.0610	6.5295	4.6396	6.6151	80.7707	4.6396
1.0200	6.6009	4.6423	6.6792	81.2157	4.6423
0.9789	6.6723	4.6446	6.7437	81.6536	4.6446
0.9376	6.7435	4.6464	6.8084	82.0845	4.6464
0.8962	6.8147	4.6479	6.8734	82.5083	4.6479
0.8546	6.8859	4.6489	6.9387	82.9253	4.6489
0.8129	6.9569	4.6495	7.0042	83.3357	4.6495
0.7710	7.0278	4.6497	7.0700	83.7394	4.6497

STREAMLINE 6

X	Y	Z	R	THETA	Z
3.8291	0.5004	2.4995	3.8616	7.4461	2.4995
3.8266	0.5158	2.4782	3.8612	7.6763	2.4782
3.8231	0.5402	2.4680	3.8610	8.0421	2.4680
3.8192	0.5666	2.4654	3.8610	8.4379	2.4654
3.8132	0.6061	2.4692	3.8610	9.0323	2.4692
3.8068	0.6454	2.4760	3.8612	9.6216	2.4760
3.8001	0.6844	2.4832	3.8613	10.2098	2.4832
3.7931	0.7234	2.4908	3.8614	10.7970	2.4908

3.7856	0.7621	2.4988	3.8616	11.3830	2.4988
3.7778	0.8008	2.5071	3.8618	11.9679	2.5071
3.7612	0.8776	2.5248	3.8622	13.1341	2.5248
3.7432	0.9538	2.5439	3.8628	14.2954	2.5439
3.7239	1.0293	2.5643	3.8636	15.4516	2.5643
3.7034	1.1042	2.5859	3.8645	16.6026	2.5859
3.6816	1.1783	2.6087	3.8656	17.7480	2.6087
3.6587	1.2518	2.6327	3.8669	18.8879	2.6327
3.6348	1.3245	2.6578	3.8686	20.0222	2.6578
3.6098	1.3966	2.6839	3.8706	21.1506	2.6839
3.5839	1.4679	2.7109	3.8729	22.2731	2.7109
3.5572	1.5386	2.7390	3.8757	23.3896	2.7390
3.5296	1.6086	2.7679	3.8789	24.5000	2.7679
3.5014	1.6779	2.7977	3.8827	25.6042	2.7977
3.4725	1.7466	2.8282	3.8870	26.7019	2.8282
3.4429	1.8147	2.8596	3.8919	27.7932	2.8596
3.4129	1.8823	2.8916	3.8975	28.8777	2.8916
3.3823	1.9493	2.9243	3.9038	29.9552	2.9243
3.3514	2.0158	2.9577	3.9109	31.0259	2.9577
3.3200	2.0818	2.9916	3.9187	32.0894	2.9916
3.2884	2.1474	3.0261	3.9274	33.1456	3.0261
3.2565	2.2126	3.0611	3.9370	34.1941	3.0611
3.2243	2.2774	3.0965	3.9475	35.2349	3.0965
3.1920	2.3420	3.1323	3.9590	36.2675	3.1323
3.1596	2.4063	3.1685	3.9716	37.2919	3.1685
3.1271	2.4703	3.2050	3.9852	38.3078	3.2050
3.0946	2.5343	3.2418	3.9999	39.3150	3.2418
3.0621	2.5980	3.2788	4.0157	40.3132	3.2788
3.0296	2.6618	3.3158	4.0328	41.3023	3.3158
2.9972	2.7255	3.3530	4.0511	42.2820	3.3530
2.9648	2.7892	3.3902	4.0706	43.2521	3.3902
2.9326	2.8531	3.4274	4.0915	44.2123	3.4274
2.9006	2.9170	3.4645	4.1137	45.1623	3.4645
2.8686	2.9812	3.5014	4.1372	46.1021	3.5014
2.8369	3.0455	3.5380	4.1621	47.0312	3.5380
2.8053	3.1101	3.5744	4.1884	47.9497	3.5744
2.7739	3.1750	3.6104	4.2161	48.8571	3.6104
2.7427	3.2402	3.6461	4.2451	49.7534	3.6461
2.7116	3.3057	3.6812	4.2756	50.6383	3.6812
2.6807	3.3716	3.7159	4.3074	51.5117	3.7159
2.6500	3.4378	3.7499	4.3406	52.3736	3.7499
2.6193	3.5044	3.7834	4.3751	53.2238	3.7834
2.5888	3.5714	3.8162	4.4110	54.0623	3.8162
2.5584	3.6387	3.8483	4.4481	54.8891	3.8483
2.5279	3.7064	3.8796	4.4864	55.7045	3.8796
2.4975	3.7745	3.9101	4.5260	56.5084	3.9101
2.4670	3.8429	3.9399	4.5666	57.3011	3.9399
2.4365	3.9117	3.9688	4.6084	58.0822	3.9688
2.4059	3.9807	3.9968	4.6513	58.8519	3.9968
2.3752	4.0501	4.0240	4.6952	59.6103	4.0240
2.3444	4.1198	4.0503	4.7401	60.3575	4.0503
2.3134	4.1897	4.0758	4.7859	61.0937	4.0758
2.2823	4.2598	4.1004	4.8327	61.8189	4.1004
2.2509	4.3301	4.1241	4.8803	62.5333	4.1241
2.2194	4.4007	4.1469	4.9287	63.2370	4.1469
2.1876	4.4714	4.1688	4.9778	63.9303	4.1688
2.1555	4.5423	4.1900	5.0278	64.6132	4.1900
2.1232	4.6132	4.2102	5.0784	65.2859	4.2102
2.0906	4.6843	4.2297	5.1297	65.9485	4.2297
2.0577	4.7555	4.2483	5.1816	66.6013	4.2483

2.0246	4.8267	4.2661	5.2341	67.2444	4.2661
1.9911	4.8980	4.2832	5.2872	67.8778	4.2832
1.9573	4.9693	4.2995	5.3409	68.5019	4.2995
1.9232	5.0406	4.3150	5.3951	69.1167	4.3150
1.8887	5.1120	4.3298	5.4497	69.7223	4.3298
1.8540	5.1833	4.3438	5.5049	70.3189	4.3438
1.8189	5.2546	4.3572	5.5605	70.9067	4.3572
1.7835	5.3259	4.3699	5.6166	71.4857	4.3699
1.7478	5.3971	4.3819	5.6731	72.0562	4.3819
1.7118	5.4683	4.3932	5.7299	72.6181	4.3932
1.6754	5.5394	4.4039	5.7872	73.1717	4.4039
1.6388	5.6105	4.4140	5.8449	73.7170	4.4140
1.6019	5.6815	4.4235	5.9030	74.2541	4.4235
1.5647	5.7524	4.4324	5.9614	74.7832	4.4324
1.5272	5.8233	4.4407	6.0202	75.3043	4.4407
1.4895	5.8940	4.4485	6.0793	75.8175	4.4485
1.4515	5.9647	4.4557	6.1388	76.3228	4.4557
1.4133	6.0354	4.4623	6.1986	76.8205	4.4623
1.3749	6.1059	4.4685	6.2588	77.3105	4.4685
1.3362	6.1764	4.4741	6.3193	77.7928	4.4741
1.2973	6.2468	4.4792	6.3801	78.2677	4.4792
1.2583	6.3171	4.4839	6.4412	78.7351	4.4839
1.2190	6.3874	4.4880	6.5027	79.1952	4.4880
1.1796	6.4576	4.4917	6.5644	79.6479	4.4917
1.1401	6.5277	4.4949	6.6265	80.0932	4.4949
1.1004	6.5978	4.4977	6.6889	80.5312	4.4977
1.0606	6.6678	4.5001	6.7517	80.9620	4.5001
1.0208	6.7378	4.5019	6.8147	81.3854	4.5019
0.9808	6.8078	4.5034	6.8781	81.8017	4.5034
0.9408	6.8777	4.5045	6.9418	82.2111	4.5045
0.9007	6.9476	4.5051	7.0057	82.6136	4.5051
0.8605	7.0175	4.5053	7.0700	83.0093	4.5053

STREAMLINE 7

X	Y	Z	R	THETA	Z
4.0415	0.6845	2.5000	4.0990	9.6130	2.5000
4.0385	0.6989	2.4789	4.0986	9.8184	2.4789
4.0342	0.7223	2.4682	4.0984	10.1509	2.4682
4.0295	0.7478	2.4649	4.0983	10.5140	2.4649
4.0222	0.7863	2.4679	4.0984	11.0618	2.4679
4.0147	0.8245	2.4737	4.0985	11.6057	2.4737
4.0068	0.8626	2.4799	4.0986	12.1489	2.4799
3.9986	0.9005	2.4865	4.0987	12.6912	2.4865
3.9900	0.9383	2.4933	4.0989	13.2328	2.4933
3.9812	0.9759	2.5005	4.0990	13.7735	2.5005
3.9624	1.0508	2.5158	4.0994	14.8525	2.5158
3.9425	1.1251	2.5322	4.0999	15.9280	2.5322
3.9213	1.1988	2.5498	4.1005	16.9998	2.5498
3.8989	1.2719	2.5685	4.1012	18.0679	2.5685
3.8754	1.3444	2.5882	4.1020	19.1321	2.5882
3.8509	1.4163	2.6089	4.1030	20.1923	2.6089
3.8253	1.4874	2.6306	4.1043	21.2484	2.6306
3.7987	1.5580	2.6532	4.1058	22.3002	2.6532
3.7712	1.6279	2.6767	4.1076	23.3478	2.6767
3.7429	1.6971	2.7010	4.1097	24.3909	2.7010
3.7138	1.7658	2.7262	4.1122	25.4296	2.7262
3.6840	1.8338	2.7521	4.1152	26.4636	2.7521
3.6535	1.9013	2.7787	4.1186	27.4929	2.7787
3.6223	1.9682	2.8061	4.1225	28.5174	2.8061

3.5906	2.0345	2.8341	4.1269	29.5369	2.8341
3.5583	2.1003	2.8628	4.1319	30.5513	2.8628
3.5256	2.1656	2.8921	4.1376	31.5606	2.8921
3.4923	2.2304	2.9219	4.1438	32.5645	2.9219
3.4587	2.2948	2.9523	4.1508	33.5629	2.9523
3.4248	2.3587	2.9832	4.1584	34.5554	2.9832
3.3905	2.4222	3.0145	4.1669	35.5420	3.0145
3.3561	2.4854	3.0463	4.1761	36.5223	3.0463
3.3214	2.5482	3.0786	4.1863	37.4962	3.0786
3.2865	2.6108	3.1112	4.1973	38.4636	3.1112
3.2515	2.6731	3.1441	4.2093	39.4241	3.1441
3.2165	2.7353	3.1773	4.2223	40.3775	3.1773
3.1814	2.7972	3.2108	4.2363	41.3236	3.2108
3.1463	2.8591	3.2444	4.2513	42.2624	3.2444
3.1112	2.9209	3.2782	4.2675	43.1934	3.2782
3.0762	2.9827	3.3121	4.2848	44.1164	3.3121
3.0412	3.0445	3.3460	4.3033	45.0312	3.3460
3.0064	3.1064	3.3799	4.3229	45.9376	3.3799
2.9716	3.1684	3.4137	4.3439	46.8353	3.4137
2.9371	3.2305	3.4474	4.3661	47.7241	3.4474
2.9026	3.2928	3.4810	4.3895	48.6037	3.4810
2.8684	3.3554	3.5143	4.4143	49.4739	3.5143
2.8343	3.4182	3.5473	4.4404	50.3345	3.5473
2.8004	3.4812	3.5800	4.4678	51.1853	3.5800
2.7667	3.5446	3.6122	4.4965	52.0262	3.6122
2.7332	3.6082	3.6440	4.5265	52.8570	3.6440
2.6997	3.6722	3.6754	4.5578	53.6775	3.6754
2.6665	3.7366	3.7061	4.5904	54.4879	3.7061
2.6333	3.8012	3.7363	4.6242	55.2879	3.7363
2.6002	3.8663	3.7658	4.6593	56.0778	3.7658
2.5671	3.9316	3.7946	4.6955	56.8574	3.7946
2.5341	3.9973	3.8227	4.7329	57.6266	3.8227
2.5012	4.0632	3.8501	4.7713	58.3853	3.8501
2.4682	4.1295	3.8768	4.8109	59.1336	3.8768
2.4352	4.1961	3.9027	4.8516	59.8715	3.9027
2.4022	4.2630	3.9278	4.8932	60.5990	3.9278
2.3691	4.3301	3.9521	4.9358	61.3164	3.9521
2.3359	4.3975	3.9756	4.9794	62.0235	3.9756
2.3026	4.4651	3.9983	5.0238	62.7205	3.9983
2.2692	4.5329	4.0201	5.0692	63.4075	4.0201
2.2356	4.6009	4.0412	5.1153	64.0845	4.0412
2.2019	4.6690	4.0615	5.1622	64.7517	4.0615
2.1680	4.7373	4.0810	5.2098	65.4092	4.0810
2.1339	4.8058	4.0997	5.2582	66.0570	4.0997
2.0997	4.8743	4.1176	5.3073	66.6954	4.1176
2.0652	4.9429	4.1348	5.3570	67.3243	4.1348
2.0305	5.0116	4.1512	5.4074	67.9439	4.1512
1.9957	5.0804	4.1669	5.4583	68.5543	4.1669
1.9606	5.1492	4.1818	5.5099	69.1557	4.1818
1.9253	5.2181	4.1961	5.5619	69.7480	4.1961
1.8897	5.2870	4.2096	5.6146	70.3315	4.2096
1.8540	5.3559	4.2225	5.6677	70.9062	4.2225
1.8181	5.4249	4.2347	5.7214	71.4722	4.2347
1.7819	5.4938	4.2463	5.7755	72.0296	4.2463
1.7455	5.5627	4.2572	5.8301	72.5786	4.2572
1.7090	5.6316	4.2674	5.8852	73.1192	4.2674
1.6722	5.7005	4.2771	5.9407	73.6514	4.2771
1.6352	5.7694	4.2862	5.9967	74.1755	4.2862
1.5981	5.8383	4.2947	6.0530	74.6914	4.2947
1.5608	5.9071	4.3026	6.1098	75.1992	4.3026

1.5233	5.9759	4.3100	6.1670	75.6990	4.3100
1.4857	6.0447	4.3168	6.2246	76.1910	4.3168
1.4480	6.1135	4.3231	6.2826	76.6751	4.3231
1.4101	6.1822	4.3289	6.3410	77.1513	4.3289
1.3721	6.2509	4.3341	6.3997	77.6200	4.3341
1.3339	6.3196	4.3389	6.4588	78.0810	4.3389
1.2957	6.3882	4.3431	6.5183	78.5344	4.3431
1.2574	6.4569	4.3469	6.5781	78.9802	4.3469
1.2190	6.5255	4.3502	6.6384	79.4185	4.3502
1.1806	6.5941	4.3531	6.6990	79.8492	4.3531
1.1422	6.6627	4.3555	6.7599	80.2723	4.3555
1.1037	6.7314	4.3575	6.8213	80.6881	4.3575
1.0653	6.8000	4.3590	6.8829	81.0965	4.3590
1.0268	6.8686	4.3600	6.9450	81.4977	4.3600
0.9883	6.9373	4.3607	7.0073	81.8919	4.3607
0.9498	7.0059	4.3609	7.0700	82.2791	4.3609

STREAMLINE 8

X	Y	Z	R	THETA	Z
4.2448	0.8849	2.5003	4.3361	11.7752	2.5003
4.2416	0.8985	2.4795	4.3357	11.9596	2.4795
4.2366	0.9208	2.4685	4.3355	12.2626	2.4685
4.2311	0.9455	2.4647	4.3355	12.5961	2.4647
4.2226	0.9828	2.4667	4.3355	13.1016	2.4667
4.2139	1.0198	2.4718	4.3356	13.6042	2.4718
4.2049	1.0567	2.4771	4.3357	14.1062	2.4771
4.1956	1.0935	2.4827	4.3358	14.6077	2.4827
4.1860	1.1301	2.4886	4.3359	15.1086	2.4886
4.1761	1.1667	2.4948	4.3360	15.6089	2.4948
4.1554	1.2394	2.5079	4.3363	16.6078	2.5079
4.1335	1.3116	2.5220	4.3366	17.6042	2.5220
4.1105	1.3832	2.5371	4.3370	18.5981	2.5371
4.0864	1.4543	2.5531	4.3375	19.5893	2.5531
4.0613	1.5248	2.5700	4.3381	20.5779	2.5700
4.0351	1.5947	2.5877	4.3388	21.5636	2.5877
4.0080	1.6640	2.6063	4.3397	22.5465	2.6063
3.9800	1.7327	2.6257	4.3408	23.5263	2.6257
3.9511	1.8009	2.6459	4.3421	24.5030	2.6459
3.9213	1.8684	2.6668	4.3437	25.4766	2.6668
3.8909	1.9354	2.6885	4.3456	26.4468	2.6885
3.8597	2.0019	2.7108	4.3480	27.4138	2.7108
3.8278	2.0677	2.7339	4.3506	28.3772	2.7339
3.7953	2.1331	2.7576	4.3536	29.3372	2.7576
3.7621	2.1979	2.7818	4.3571	30.2936	2.7818
3.7284	2.2621	2.8067	4.3610	31.2463	2.8067
3.6941	2.3259	2.8321	4.3654	32.1953	2.8321
3.6594	2.3892	2.8580	4.3703	33.1404	2.8580
3.6242	2.4520	2.8845	4.3757	34.0813	2.8845
3.5885	2.5144	2.9114	4.3818	35.0179	2.9114
3.5526	2.5763	2.9388	4.3884	35.9500	2.9388
3.5162	2.6379	2.9667	4.3957	36.8775	2.9667
3.4797	2.6991	2.9951	4.4038	37.8001	2.9951
3.4428	2.7600	3.0238	4.4126	38.7177	3.0238
3.4058	2.8206	3.0529	4.4221	39.6301	3.0529
3.3687	2.8809	3.0824	4.4325	40.5371	3.0824
3.3314	2.9410	3.1121	4.4438	41.4384	3.1121
3.2940	3.0009	3.1421	4.4560	42.3339	3.1421
3.2566	3.0606	3.1724	4.4691	43.2234	3.1724
3.2191	3.1202	3.2029	4.4831	44.1066	3.2029

3.1817	3.1798	3.2335	4.4982	44.9833	3.2335
3.1443	3.2393	3.2642	4.5144	45.8533	3.2642
3.1069	3.2989	3.2950	4.5316	46.7163	3.2950
3.0697	3.3585	3.3258	4.5500	47.5721	3.3258
3.0326	3.4182	3.3566	4.5695	48.4205	3.3566
2.9956	3.4780	3.3873	4.5902	49.2612	3.3873
2.9588	3.5380	3.4178	4.6121	50.0940	3.4178
2.9222	3.5981	3.4482	4.6353	50.9186	3.4482
2.8857	3.6585	3.4783	4.6596	51.7350	3.4783
2.8494	3.7192	3.5082	4.6852	52.5428	3.5082
2.8133	3.7801	3.5377	4.7120	53.3420	3.5377
2.7773	3.8413	3.5669	4.7401	54.1324	3.5669
2.7415	3.9027	3.5955	4.7694	54.9140	3.5955
2.7058	3.9645	3.6237	4.7999	55.6867	3.6237
2.6702	4.0266	3.6514	4.8315	56.4503	3.6514
2.6347	4.0890	3.6785	4.8644	57.2046	3.6785
2.5994	4.1518	3.7050	4.8984	57.9495	3.7050
2.5642	4.2148	3.7309	4.9335	58.6850	3.7309
2.5290	4.2782	3.7561	4.9697	59.4112	3.7561
2.4938	4.3418	3.7807	5.0070	60.1279	3.7807
2.4587	4.4057	3.8045	5.0453	60.8352	3.8045
2.4236	4.4699	3.8277	5.0846	61.5331	3.8277
2.3885	4.5343	3.8501	5.1249	62.2216	3.8501
2.3533	4.5990	3.8717	5.1661	62.9007	3.8717
2.3182	4.6639	3.8927	5.2082	63.5704	3.8927
2.2829	4.7290	3.9128	5.2512	64.2308	3.9128
2.2476	4.7942	3.9323	5.2950	64.8819	3.9323
2.2123	4.8597	3.9510	5.3396	65.5238	3.9510
2.1768	4.9253	3.9690	5.3849	66.1565	3.9690
2.1412	4.9911	3.9862	5.4310	66.7801	3.9862
2.1056	5.0570	4.0027	5.4778	67.3946	4.0027
2.0698	5.1230	4.0185	5.5253	68.0000	4.0185
2.0340	5.1891	4.0336	5.5735	68.5965	4.0336
1.9980	5.2553	4.0481	5.6223	69.1841	4.0481
1.9619	5.3216	4.0618	5.6718	69.7628	4.0618
1.9257	5.3880	4.0748	5.7218	70.3328	4.0748
1.8894	5.4545	4.0872	5.7724	70.8941	4.0872
1.8530	5.5210	4.0990	5.8236	71.4468	4.0990
1.8165	5.5875	4.1101	5.8754	71.9909	4.1101
1.7799	5.6541	4.1206	5.9277	72.5265	4.1206
1.7431	5.7208	4.1305	5.9804	73.0537	4.1305
1.7063	5.7874	4.1398	6.0338	73.5726	4.1398
1.6695	5.8542	4.1485	6.0876	74.0831	4.1485
1.6325	5.9209	4.1566	6.1418	74.5854	4.1566
1.5955	5.9877	4.1641	6.1966	75.0796	4.1641
1.5584	6.0545	4.1711	6.2518	75.5656	4.1711
1.5213	6.1213	4.1776	6.3075	76.0436	4.1776
1.4841	6.1882	4.1835	6.3636	76.5137	4.1835
1.4469	6.2550	4.1889	6.4202	76.9759	4.1889
1.4096	6.3219	4.1938	6.4772	77.4303	4.1938
1.3724	6.3889	4.1982	6.5346	77.8768	4.1982
1.3351	6.4558	4.2021	6.5924	78.3155	4.2021
1.2979	6.5228	4.2055	6.6507	78.7463	4.2055
1.2607	6.5899	4.2085	6.7094	79.1694	4.2085
1.2236	6.6570	4.2109	6.7685	79.5847	4.2109
1.1866	6.7241	4.2129	6.8280	79.9924	4.2129
1.1496	6.7913	4.2145	6.8880	80.3925	4.2145
1.1127	6.8586	4.2156	6.9483	80.7852	4.2156
1.0758	6.9259	4.2163	7.0090	81.1705	4.2163
1.0391	6.9932	4.2165	7.0700	81.5487	4.2165



STREAMLINE 9

X	Y	Z	R	THETA	Z
4.3428	0.9909	2.5004	4.4544	12.8530	2.5004
4.3394	1.0041	2.4797	4.4540	13.0285	2.4797
4.3341	1.0260	2.4687	4.4539	13.3182	2.4687
4.3283	1.0502	2.4646	4.4538	13.6379	2.4646
4.3192	1.0868	2.4663	4.4539	14.1237	2.4663
4.3100	1.1232	2.4709	4.4539	14.6070	2.4709
4.3004	1.1595	2.4759	4.4540	15.0898	2.4759
4.2906	1.1957	2.4811	4.4541	15.5722	2.4811
4.2804	1.2318	2.4865	4.4541	16.0540	2.4865
4.2700	1.2677	2.4922	4.4542	16.5354	2.4922
4.2483	1.3392	2.5043	4.4544	17.4967	2.5043
4.2256	1.4102	2.5174	4.4547	18.4560	2.5174
4.2017	1.4807	2.5313	4.4550	19.4131	2.5313
4.1768	1.5507	2.5460	4.4554	20.3681	2.5460
4.1509	1.6201	2.5616	4.4559	21.3208	2.5616
4.1240	1.6890	2.5780	4.4564	22.2712	2.5780
4.0962	1.7572	2.5951	4.4572	23.2191	2.5951
4.0674	1.8250	2.6130	4.4581	24.1646	2.6130
4.0379	1.8921	2.6317	4.4592	25.1074	2.6317
4.0075	1.9587	2.6510	4.4606	26.0476	2.6510
3.9765	2.0248	2.6710	4.4623	26.9850	2.6710
3.9447	2.0903	2.6917	4.4643	27.9196	2.6917
3.9122	2.1553	2.7130	4.4666	28.8512	2.7130
3.8791	2.2198	2.7350	4.4693	29.7799	2.7350
3.8453	2.2837	2.7575	4.4723	30.7056	2.7575
3.8109	2.3471	2.7805	4.4757	31.6282	2.7805
3.7760	2.4100	2.8040	4.4795	32.5476	2.8040
3.7406	2.4724	2.8281	4.4838	33.4637	2.8281
3.7047	2.5344	2.8526	4.4886	34.3763	2.8526
3.6683	2.5959	2.8777	4.4939	35.2851	2.8777
3.6316	2.6570	2.9032	4.4998	36.1902	2.9032
3.5945	2.7177	2.9292	4.5063	37.0912	2.9292
3.5572	2.7780	2.9557	4.5134	37.9881	2.9557
3.5195	2.8379	2.9825	4.5211	38.8806	2.9825
3.4816	2.8975	3.0097	4.5296	39.7686	3.0097
3.4435	2.9569	3.0373	4.5388	40.6519	3.0373
3.4053	3.0160	3.0652	4.5489	41.5304	3.0652
3.3669	3.0748	3.0934	4.5597	42.4037	3.0934
3.3285	3.1335	3.1219	4.5714	43.2718	3.1219
3.2900	3.1920	3.1506	4.5840	44.1343	3.1506
3.2515	3.2504	3.1795	4.5975	44.9911	3.1795
3.2129	3.3088	3.2086	4.6120	45.8419	3.2086
3.1744	3.3671	3.2378	4.6276	46.6866	3.2378
3.1360	3.4254	3.2670	4.6441	47.5249	3.2670
3.0977	3.4837	3.2964	4.6618	48.3565	3.2964
3.0595	3.5421	3.3257	4.6805	49.1813	3.3257
3.0214	3.6007	3.3549	4.7004	49.9990	3.3549
2.9835	3.6594	3.3840	4.7215	50.8094	3.3840
2.9458	3.7183	3.4130	4.7438	51.6122	3.4130
2.9082	3.7774	3.4418	4.7672	52.4074	3.4418
2.8708	3.8367	3.4703	4.7918	53.1946	3.4703
2.8335	3.8963	3.4985	4.8177	53.9738	3.4985
2.7964	3.9561	3.5263	4.8447	54.7448	3.5263
2.7595	4.0162	3.5537	4.8729	55.5076	3.5537
2.7227	4.0767	3.5807	4.9023	56.2620	3.5807
2.6861	4.1374	3.6072	4.9328	57.0077	3.6072

2.6496	4.1984	3.6332	4.9646	57.7446	3.6332
2.6132	4.2598	3.6586	4.9974	58.4727	3.6586
2.5769	4.3214	3.6834	5.0314	59.1920	3.6834
2.5407	4.3833	3.7076	5.0664	59.9024	3.7076
2.5046	4.4456	3.7311	5.1025	60.6038	3.7311
2.4685	4.5081	3.7540	5.1396	61.2963	3.7540
2.4324	4.5708	3.7762	5.1777	61.9798	3.7762
2.3964	4.6338	3.7977	5.2168	62.6542	3.7977
2.3604	4.6971	3.8185	5.2568	63.3197	3.8185
2.3244	4.7606	3.8386	5.2977	63.9761	3.8386
2.2883	4.8243	3.8580	5.3395	64.6235	3.8580
2.2522	4.8882	3.8767	5.3821	65.2619	3.8767
2.2161	4.9523	3.8946	5.4255	65.8914	3.8946
2.1800	5.0165	3.9119	5.4697	66.5119	3.9119
2.1438	5.0809	3.9284	5.5147	67.1234	3.9284
2.1076	5.1455	3.9443	5.5604	67.7261	3.9443
2.0713	5.2102	3.9595	5.6068	68.3199	3.9595
2.0349	5.2750	3.9740	5.6539	68.9048	3.9740
1.9985	5.3399	3.9878	5.7016	69.4810	3.9878
1.9620	5.4049	4.0009	5.7500	70.0485	4.0009
1.9255	5.4700	4.0134	5.7991	70.6073	4.0134
1.8889	5.5353	4.0253	5.8487	71.1575	4.0253
1.8523	5.6006	4.0365	5.8989	71.6991	4.0365
1.8156	5.6659	4.0471	5.9497	72.2322	4.0471
1.7789	5.7314	4.0571	6.0011	72.7568	4.0571
1.7421	5.7969	4.0665	6.0530	73.2730	4.0665
1.7053	5.8625	4.0753	6.1055	73.7808	4.0753
1.6685	5.9281	4.0835	6.1584	74.2804	4.0835
1.6317	5.9938	4.0911	6.2119	74.7716	4.0911
1.5948	6.0596	4.0982	6.2659	75.2547	4.0982
1.5580	6.1254	4.1048	6.3204	75.7296	4.1048
1.5211	6.1912	4.1108	6.3754	76.1965	4.1108
1.4843	6.2571	4.1163	6.4308	76.6555	4.1163
1.4474	6.3231	4.1212	6.4867	77.1064	4.1212
1.4107	6.3891	4.1257	6.5430	77.5494	4.1257
1.3739	6.4552	4.1297	6.5998	77.9844	4.1297
1.3373	6.5214	4.1331	6.6571	78.4114	4.1331
1.3007	6.5876	4.1361	6.7148	78.8306	4.1361
1.2643	6.6539	4.1387	6.7730	79.2418	4.1387
1.2279	6.7203	4.1407	6.8315	79.6453	4.1407
1.1917	6.7867	4.1423	6.8906	80.0412	4.1423
1.1555	6.8533	4.1434	6.9500	80.4294	4.1434
1.1195	6.9198	4.1441	7.0098	80.8102	4.1441
1.0836	6.9865	4.1443	7.0700	81.1840	4.1443

STREAMLINE 10

X	Y	Z	R	THETA	Z
4.4380	1.1006	2.5003	4.5724	13.9285	2.5003
4.4345	1.1135	2.4799	4.5722	14.0960	2.4799
4.4290	1.1350	2.4688	4.5721	14.3734	2.4688
4.4228	1.1587	2.4646	4.5720	14.6802	2.4646
4.4132	1.1947	2.4659	4.5721	15.1471	2.4659
4.4034	1.2304	2.4702	4.5721	15.6119	2.4702
4.3933	1.2661	2.4747	4.5721	16.0763	2.4747
4.3830	1.3016	2.4795	4.5722	16.5403	2.4795
4.3723	1.3371	2.4846	4.5722	17.0039	2.4846
4.3614	1.3724	2.4898	4.5723	17.4671	2.4898
4.3388	1.4427	2.5010	4.5724	18.3924	2.5010
4.3152	1.5125	2.5130	4.5726	19.3159	2.5130

4.2905	1.5818	2.5258	4.5728	20.2377	2.5258
4.2648	1.6506	2.5393	4.5731	21.1577	2.5393
4.2381	1.7188	2.5537	4.5734	22.0758	2.5537
4.2105	1.7866	2.5688	4.5739	22.9920	2.5688
4.1820	1.8538	2.5846	4.5745	23.9061	2.5846
4.1527	1.9204	2.6011	4.5752	24.8182	2.6011
4.1225	1.9865	2.6182	4.5762	25.7282	2.6182
4.0916	2.0521	2.6360	4.5774	26.6359	2.6360
4.0600	2.1172	2.6545	4.5789	27.5413	2.6545
4.0276	2.1818	2.6735	4.5806	28.4444	2.6735
3.9946	2.2458	2.6932	4.5826	29.3449	2.6932
3.9609	2.3093	2.7134	4.5849	30.2430	2.7134
3.9266	2.3723	2.7341	4.5875	31.1386	2.7341
3.8916	2.4347	2.7554	4.5905	32.0317	2.7554
3.8561	2.4967	2.7771	4.5938	32.9220	2.7771
3.8201	2.5582	2.7994	4.5976	33.8094	2.7994
3.7836	2.6193	2.8221	4.6017	34.6939	2.8221
3.7466	2.6799	2.8454	4.6064	35.5753	2.8454
3.7092	2.7400	2.8690	4.6115	36.4534	2.8690
3.6715	2.7998	2.8931	4.6172	37.3281	2.8931
3.6334	2.8591	2.9177	4.6234	38.1992	2.9177
3.5950	2.9181	2.9427	4.6302	39.0666	2.9427
3.5563	2.9767	2.9680	4.6377	39.9302	2.9680
3.5174	3.0351	2.9937	4.6458	40.7897	2.9937
3.4783	3.0931	3.0198	4.6547	41.6449	3.0198
3.4391	3.1509	3.0462	4.6643	42.4958	3.0462
3.3997	3.2085	3.0729	4.6747	43.3421	3.0729
3.3603	3.2659	3.0998	4.6859	44.1835	3.0998
3.3208	3.3231	3.1270	4.6979	45.0199	3.1270
3.2812	3.3802	3.1544	4.7109	45.8512	3.1544
3.2417	3.4372	3.1820	4.7247	46.6769	3.1820
3.2022	3.4942	3.2097	4.7396	47.4971	3.2097
3.1628	3.5512	3.2375	4.7554	48.3114	3.2375
3.1234	3.6083	3.2653	4.7723	49.1195	3.2653
3.0842	3.6654	3.2932	4.7903	49.9214	3.2932
3.0451	3.7226	3.3210	4.8094	50.7167	3.3210
3.0061	3.7799	3.3487	4.8296	51.5053	3.3487
2.9673	3.8374	3.3763	4.8509	52.2868	3.3763
2.9287	3.8952	3.4038	4.8734	53.0613	3.4038
2.8902	3.9531	3.4310	4.8970	53.8284	3.4310
2.8519	4.0113	3.4579	4.9218	54.5882	3.4579
2.8138	4.0697	3.4844	4.9477	55.3404	3.4844
2.7758	4.1284	3.5106	4.9749	56.0846	3.5106
2.7380	4.1874	3.5364	5.0031	56.8209	3.5364
2.7004	4.2467	3.5618	5.0326	57.5491	3.5618
2.6629	4.3063	3.5866	5.0631	58.2690	3.5866
2.6255	4.3662	3.6110	5.0948	58.9807	3.6110
2.5882	4.4264	3.6348	5.1276	59.6841	3.6348
2.5511	4.4869	3.6579	5.1614	60.3790	3.6579
2.5140	4.5477	3.6805	5.1963	61.0655	3.6805
2.4770	4.6087	3.7025	5.2322	61.7434	3.7025
2.4401	4.6700	3.7238	5.2691	62.4127	3.7238
2.4032	4.7316	3.7444	5.3069	63.0734	3.7444
2.3664	4.7934	3.7644	5.3457	63.7254	3.7644
2.3296	4.8554	3.7837	5.3854	64.3687	3.7837
2.2928	4.9177	3.8023	5.4260	65.0033	3.8023
2.2561	4.9802	3.8202	5.4674	65.6291	3.8202
2.2193	5.0429	3.8375	5.5096	66.2462	3.8375
2.1826	5.1057	3.8541	5.5527	66.8545	3.8541
2.1458	5.1687	3.8700	5.5965	67.4541	3.8700

2.1091	5.2319	3.8852	5.6410	68.0450	3.8852
2.0723	5.2953	3.8998	5.6863	68.6272	3.8998
2.0355	5.3588	3.9137	5.7324	69.2007	3.9137
1.9988	5.4224	3.9269	5.7791	69.7655	3.9269
1.9620	5.4862	3.9395	5.8264	70.3217	3.9395
1.9252	5.5500	3.9515	5.8745	70.8693	3.9515
1.8884	5.6140	3.9628	5.9231	71.4084	3.9628
1.8516	5.6781	3.9735	5.9724	71.9389	3.9735
1.8149	5.7423	3.9836	6.0223	72.4609	3.9836
1.7781	5.8066	3.9931	6.0728	72.9744	3.9931
1.7414	5.8710	4.0020	6.1238	73.4795	4.0020
1.7046	5.9355	4.0103	6.1754	73.9763	4.0103
1.6680	6.0001	4.0181	6.2276	74.4647	4.0181
1.6313	6.0648	4.0253	6.2803	74.9448	4.0253
1.5947	6.1295	4.0319	6.3336	75.4166	4.0319
1.5582	6.1943	4.0380	6.3873	75.8803	4.0380
1.5217	6.2593	4.0436	6.4416	76.3359	4.0436
1.4853	6.3243	4.0487	6.4963	76.7833	4.0487
1.4490	6.3894	4.0532	6.5516	77.2226	4.0532
1.4128	6.4545	4.0572	6.6073	77.6539	4.0572
1.3767	6.5198	4.0608	6.6636	78.0770	4.0608
1.3407	6.5852	4.0638	6.7203	78.4921	4.0638
1.3049	6.6507	4.0664	6.7775	78.8992	4.0664
1.2692	6.7162	4.0685	6.8351	79.2984	4.0685
1.2337	6.7819	4.0701	6.8932	79.6898	4.0701
1.1984	6.8477	4.0712	6.9517	80.0735	4.0712
1.1631	6.9135	4.0719	7.0107	80.4498	4.0719
1.1281	6.9794	4.0722	7.0700	80.8186	4.0722

STREAMLINE 11

X	Y	Z	R	THETA	Z
4.5303	1.2140	2.5000	4.6901	15.0012	2.5000
4.5268	1.2266	2.4798	4.6900	15.1616	2.4798
4.5210	1.2476	2.4689	4.6900	15.4277	2.4689
4.5145	1.2709	2.4646	4.6900	15.7223	2.4646
4.5044	1.3062	2.4656	4.6900	16.1711	2.4656
4.4941	1.3413	2.4696	4.6900	16.6181	2.4696
4.4835	1.3763	2.4737	4.6900	17.0649	2.4737
4.4727	1.4112	2.4781	4.6900	17.5114	2.4781
4.4616	1.4460	2.4827	4.6901	17.9575	2.4827
4.4502	1.4807	2.4875	4.6901	18.4033	2.4875
4.4267	1.5497	2.4978	4.6901	19.2939	2.4978
4.4022	1.6182	2.5088	4.6902	20.1831	2.5088
4.3767	1.6863	2.5205	4.6903	21.0709	2.5205
4.3503	1.7538	2.5330	4.6905	21.9571	2.5330
4.3229	1.8209	2.5462	4.6907	22.8418	2.5462
4.2946	1.8874	2.5601	4.6911	23.7249	2.5601
4.2655	1.9535	2.5746	4.6915	24.6064	2.5746
4.2356	2.0190	2.5897	4.6922	25.4861	2.5897
4.2049	2.0840	2.6055	4.6930	26.3641	2.6055
4.1735	2.1486	2.6218	4.6941	27.2403	2.6218
4.1413	2.2126	2.6387	4.6953	28.1146	2.6387
4.1084	2.2761	2.6562	4.6968	28.9869	2.6562
4.0749	2.3391	2.6742	4.6985	29.8572	2.6742
4.0407	2.4016	2.6928	4.7005	30.7254	2.6928
4.0058	2.4636	2.7118	4.7027	31.5915	2.7118
3.9704	2.5251	2.7314	4.7053	32.4555	2.7314
3.9343	2.5861	2.7514	4.7082	33.3171	2.7514
3.8978	2.6466	2.7719	4.7114	34.1764	2.7719

3.8607	2.7067	2.7929	4.7150	35.0332	2.7929
3.8232	2.7663	2.8143	4.7190	35.8873	2.8143
3.7853	2.8254	2.8361	4.7235	36.7387	2.8361
3.7469	2.8842	2.8584	4.7284	37.5872	2.8584
3.7082	2.9425	2.8811	4.7338	38.4327	2.8811
3.6692	3.0005	2.9042	4.7398	39.2750	2.9042
3.6298	3.0581	2.9278	4.7463	40.1141	2.9278
3.5902	3.1154	2.9516	4.7535	40.9497	2.9516
3.5504	3.1724	2.9759	4.7612	41.7816	2.9759
3.5104	3.2291	3.0004	4.7697	42.6098	3.0004
3.4702	3.2855	3.0253	4.7788	43.4340	3.0253
3.4299	3.3417	3.0505	4.7887	44.2541	3.0505
3.3895	3.3978	3.0760	4.7993	45.0698	3.0760
3.3490	3.4536	3.1017	4.8108	45.8810	3.1017
3.3085	3.5094	3.1276	4.8231	46.6874	3.1276
3.2681	3.5651	3.1537	4.8363	47.4888	3.1537
3.2276	3.6207	3.1799	4.8504	48.2851	3.1799
3.1872	3.6763	3.2063	4.8655	49.0761	3.2063
3.1469	3.7320	3.2327	4.8816	49.8614	3.2327
3.1067	3.7877	3.2591	4.8988	50.6410	3.2591
3.0666	3.8435	3.2856	4.9170	51.4145	3.2856
3.0267	3.8994	3.3119	4.9362	52.1818	3.3119
2.9869	3.9555	3.3382	4.9566	52.9427	3.3382
2.9473	4.0118	3.3643	4.9781	53.6970	3.3643
2.9078	4.0683	3.3902	5.0007	54.4445	3.3902
2.8686	4.1250	3.4159	5.0244	55.1851	3.4159
2.8294	4.1820	3.4413	5.0493	55.9187	3.4413
2.7905	4.2393	3.4663	5.0753	56.6449	3.4663
2.7518	4.2968	3.4910	5.1024	57.3636	3.4910
2.7132	4.3546	3.5152	5.1307	58.0746	3.5152
2.6747	4.4127	3.5390	5.1601	58.7781	3.5390
2.6365	4.4711	3.5623	5.1906	59.4737	3.5623
2.5983	4.5298	3.5851	5.2221	60.1615	3.5851
2.5602	4.5888	3.6073	5.2547	60.8414	3.6073
2.5223	4.6480	3.6289	5.2883	61.5131	3.6289
2.4845	4.7076	3.6500	5.3230	62.1767	3.6500
2.4467	4.7674	3.6704	5.3586	62.8321	3.6704
2.4091	4.8275	3.6902	5.3952	63.4792	3.6902
2.3715	4.8878	3.7094	5.4327	64.1179	3.7094
2.3340	4.9484	3.7279	5.4712	64.7482	3.7279
2.2966	5.0092	3.7458	5.5105	65.3700	3.7458
2.2592	5.0702	3.7631	5.5508	65.9833	3.7631
2.2218	5.1315	3.7796	5.5918	66.5882	3.7796
2.1846	5.1929	3.7956	5.6337	67.1845	3.7956
2.1473	5.2546	3.8108	5.6764	67.7722	3.8108
2.1101	5.3164	3.8254	5.7198	68.3514	3.8254
2.0730	5.3784	3.8394	5.7640	68.9220	3.8394
2.0359	5.4405	3.8528	5.8090	69.4840	3.8528
1.9988	5.5029	3.8655	5.8546	70.0375	3.8655
1.9618	5.5654	3.8775	5.9010	70.5824	3.8775
1.9248	5.6280	3.8890	5.9480	71.1188	3.8890
1.8879	5.6907	3.8998	5.9957	71.6467	3.8998
1.8510	5.7536	3.9100	6.0441	72.1661	3.9100
1.8142	5.8167	3.9196	6.0930	72.6770	3.9196
1.7775	5.8798	3.9286	6.1426	73.1795	3.9286
1.7409	5.9431	3.9371	6.1929	73.6734	3.9371
1.7043	6.0065	3.9450	6.2437	74.1590	3.9450
1.6679	6.0701	3.9523	6.2951	74.6360	3.9523
1.6315	6.1337	3.9590	6.3470	75.1047	3.9590
1.5953	6.1975	3.9652	6.3995	75.5651	3.9652

1.5591	6.2614	3.9709	6.4526	76.0173	3.9709
1.5231	6.3254	3.9760	6.5062	76.4611	3.9760
1.4873	6.3895	3.9806	6.5603	76.8967	3.9806
1.4516	6.4538	3.9848	6.6150	77.3241	3.9848
1.4160	6.5182	3.9884	6.6702	77.7432	3.9884
1.3807	6.5827	3.9915	6.7259	78.1541	3.9915
1.3455	6.6473	3.9941	6.7821	78.5569	3.9941
1.3106	6.7120	3.9962	6.8388	78.9516	3.9962
1.2758	6.7769	3.9979	6.8959	79.3385	3.9979
1.2412	6.8419	3.9991	6.9535	79.7176	3.9991
1.2068	6.9069	3.9998	7.0116	80.0894	3.9998
1.1725	6.9721	4.0000	7.0700	80.4536	4.0000

PARTIAL BLADE PRESSURE SIDE

STREAMLINE 1

X	Y	Z	R	THETA	Z
3.5281	1.0618	4.0954	3.6844	16.7492	4.0954
3.5411	1.0550	4.1052	3.6949	16.5899	4.1052
3.5545	1.0527	4.1165	3.7071	16.4977	4.1165
3.5671	1.0562	4.1283	3.7202	16.4945	4.1283
3.5813	1.0715	4.1443	3.7382	16.6571	4.1443
3.5919	1.0917	4.1582	3.7541	16.9052	4.1582
3.6023	1.1120	4.1718	3.7701	17.1550	4.1718
3.6127	1.1325	4.1851	3.7860	17.4056	4.1851
3.6229	1.1532	4.1983	3.8020	17.6569	4.1983
3.6331	1.1741	4.2112	3.8181	17.9089	4.2112
3.6532	1.2163	4.2365	3.8504	18.4145	4.2365
3.6730	1.2591	4.2611	3.8829	18.9217	4.2611
3.6925	1.3025	4.2849	3.9155	19.4299	4.2849
3.7116	1.3464	4.3079	3.9483	19.9386	4.3079
3.7304	1.3908	4.3304	3.9812	20.4473	4.3304
3.7488	1.4357	4.3521	4.0144	20.9557	4.3521
3.7669	1.4810	4.3732	4.0476	21.4632	4.3732
3.7846	1.5268	4.3937	4.0810	21.9697	4.3937
3.8020	1.5729	4.4137	4.1145	22.4747	4.4137
3.8191	1.6194	4.4331	4.1482	22.9779	4.4331
3.8358	1.6662	4.4519	4.1821	23.4791	4.4519
3.8522	1.7133	4.4702	4.2160	23.9782	4.4702
3.8682	1.7608	4.4881	4.2501	24.4748	4.4881
3.8840	1.8085	4.5054	4.2844	24.9687	4.5054
3.8994	1.8565	4.5223	4.3188	25.4598	4.5223
3.9144	1.9048	4.5387	4.3533	25.9480	4.5387
3.9292	1.9533	4.5547	4.3880	26.4331	4.5547
3.9437	2.0020	4.5703	4.4228	26.9150	4.5703
3.9579	2.0510	4.5855	4.4577	27.3935	4.5855
3.9717	2.1002	4.6002	4.4928	27.8687	4.6002
3.9853	2.1495	4.6146	4.5281	28.3404	4.6146
3.9986	2.1990	4.6286	4.5634	28.8086	4.6286
4.0116	2.2488	4.6423	4.5989	29.2732	4.6423
4.0244	2.2986	4.6556	4.6346	29.7342	4.6556
4.0368	2.3487	4.6685	4.6704	30.1916	4.6685
4.0490	2.3989	4.6811	4.7063	30.6454	4.6811
4.0609	2.4493	4.6934	4.7423	31.0956	4.6934
4.0725	2.4997	4.7053	4.7785	31.5423	4.7053
4.0838	2.5504	4.7169	4.8147	31.9854	4.7169
4.0948	2.6012	4.7282	4.8511	32.4250	4.7282
4.1055	2.6521	4.7392	4.8876	32.8613	4.7392
4.1160	2.7031	4.7499	4.9242	33.2940	4.7499

4.1262	2.7542	4.7603	4.9609	33.7233	4.7603
4.1360	2.8055	4.7704	4.9978	34.1492	4.7704
4.1456	2.8569	4.7802	5.0347	34.5718	4.7802
4.1549	2.9083	4.7897	5.0717	34.9910	4.7897
4.1639	2.9599	4.7990	5.1087	35.4071	4.7990
4.1726	3.0116	4.8080	5.1459	35.8200	4.8080
4.1810	3.0634	4.8167	5.1831	36.2298	4.8167
4.1891	3.1152	4.8252	5.2204	36.6365	4.8252
4.1969	3.1672	4.8334	5.2578	37.0402	4.8334
4.2043	3.2192	4.8414	5.2953	37.4409	4.8414
4.2115	3.2713	4.8491	5.3328	37.8387	4.8491
4.2184	3.3235	4.8565	5.3703	38.2337	4.8565
4.2249	3.3758	4.8638	5.4079	38.6258	4.8638
4.2311	3.4281	4.8708	5.4456	39.0151	4.8708
4.2370	3.4805	4.8775	5.4833	39.4016	4.8775
4.2426	3.5330	4.8841	5.5211	39.7855	4.8841
4.2479	3.5855	4.8904	5.5589	40.1667	4.8904
4.2529	3.6381	4.8965	5.5967	40.5452	4.8965
4.2575	3.6908	4.9024	5.6346	40.9213	4.9024
4.2619	3.7435	4.9081	5.6725	41.2948	4.9081
4.2659	3.7962	4.9135	5.7104	41.6658	4.9135
4.2696	3.8490	4.9188	5.7484	42.0344	4.9188
4.2729	3.9018	4.9239	5.7864	42.4006	4.9239
4.2760	3.9547	4.9288	5.8244	42.7645	4.9288
4.2787	4.0075	4.9335	5.8624	43.1261	4.9335
4.2810	4.0605	4.9380	5.9004	43.4855	4.9380
4.2830	4.1134	4.9423	5.9384	43.8427	4.9423
4.2847	4.1664	4.9464	5.9765	44.1979	4.9464
4.2861	4.2194	4.9504	6.0145	44.5510	4.9504
4.2871	4.2724	4.9541	6.0525	44.9022	4.9541
4.2877	4.3255	4.9577	6.0905	45.2515	4.9577
4.2879	4.3786	4.9612	6.1285	45.5990	4.9612
4.2878	4.4316	4.9644	6.1664	45.9448	4.9644
4.2873	4.4847	4.9675	6.2043	46.2889	4.9675
4.2865	4.5378	4.9705	6.2422	46.6314	4.9705
4.2852	4.5909	4.9732	6.2800	46.9725	4.9732
4.2835	4.6439	4.9759	6.3178	47.3123	4.9759
4.2813	4.6970	4.9783	6.3555	47.6507	4.9783
4.2788	4.7501	4.9807	6.3931	47.9880	4.9807
4.2758	4.8031	4.9828	6.4306	48.3243	4.9828
4.2723	4.8561	4.9848	6.4679	48.6597	4.9848
4.2683	4.9091	4.9867	6.5052	48.9942	4.9867
4.2638	4.9621	4.9885	6.5424	49.3280	4.9885
4.2588	5.0150	4.9901	6.5793	49.6613	4.9901
4.2533	5.0678	4.9916	6.6162	49.9942	4.9916
4.2472	5.1206	4.9929	6.6528	50.3268	4.9929
4.2405	5.1734	4.9941	6.6892	50.6593	4.9941
4.2332	5.2260	4.9952	6.7254	50.9918	4.9952
4.2253	5.2786	4.9962	6.7614	51.3244	4.9962
4.2167	5.3311	4.9970	6.7971	51.6574	4.9970
4.2074	5.3834	4.9977	6.8325	51.9908	4.9977
4.1974	5.4356	4.9984	6.8676	52.3248	4.9984
4.1866	5.4877	4.9989	6.9023	52.6597	4.9989
4.1750	5.5396	4.9993	6.9367	52.9956	4.9993
4.1627	5.5913	4.9996	6.9707	53.3327	4.9996
4.1495	5.6428	4.9998	7.0042	53.6709	4.9998
4.1354	5.6941	5.0000	7.0373	54.0104	5.0000
4.1205	5.7451	5.0000	7.0700	54.3512	5.0000

X	Y	Z	R	THETA	Z
3.6089	1.1052	4.0463	3.7744	17.0273	4.0463
3.6218	1.0989	4.0562	3.7848	16.8787	4.0562
3.6349	1.0970	4.0673	3.7968	16.7932	4.0673
3.6472	1.1005	4.0790	3.8096	16.7904	4.0790
3.6611	1.1155	4.0948	3.8273	16.9454	4.0948
3.6711	1.1355	4.1083	3.8427	17.1878	4.1083
3.6809	1.1558	4.1215	3.8581	17.4325	4.1215
3.6906	1.1763	4.1346	3.8736	17.6780	4.1346
3.7003	1.1969	4.1474	3.8890	17.9243	4.1474
3.7099	1.2177	4.1600	3.9046	18.1712	4.1600
3.7288	1.2597	4.1846	3.9358	18.6666	4.1846
3.7473	1.3023	4.2085	3.9672	19.1636	4.2085
3.7656	1.3454	4.2317	3.9987	19.6617	4.2317
3.7835	1.3891	4.2541	4.0304	20.1603	4.2541
3.8010	1.4332	4.2759	4.0622	20.6590	4.2759
3.8182	1.4777	4.2971	4.0942	21.1574	4.2971
3.8351	1.5227	4.3177	4.1263	21.6551	4.3177
3.8516	1.5680	4.3377	4.1586	22.1518	4.3377
3.8678	1.6138	4.3571	4.1910	22.6472	4.3571
3.8837	1.6598	4.3759	4.2235	23.1409	4.3759
3.8993	1.7062	4.3943	4.2562	23.6327	4.3943
3.9145	1.7529	4.4122	4.2890	24.1225	4.4122
3.9294	1.7999	4.4295	4.3220	24.6100	4.4295
3.9440	1.8471	4.4464	4.3551	25.0950	4.4464
3.9583	1.8946	4.4629	4.3883	25.5773	4.4629
3.9723	1.9423	4.4789	4.4217	26.0567	4.4789
3.9860	1.9902	4.4945	4.4552	26.5331	4.4945
3.9994	2.0384	4.5097	4.4889	27.0065	4.5097
4.0126	2.0867	4.5245	4.5227	27.4766	4.5245
4.0254	2.1353	4.5389	4.5567	27.9435	4.5389
4.0380	2.1840	4.5530	4.5908	28.4071	4.5530
4.0503	2.2329	4.5666	4.6250	28.8672	4.5666
4.0624	2.2819	4.5800	4.6594	29.3239	4.5800
4.0742	2.3312	4.5930	4.6940	29.7771	4.5930
4.0857	2.3805	4.6056	4.7286	30.2268	4.6056
4.0970	2.4300	4.6179	4.7635	30.6730	4.6179
4.1080	2.4797	4.6299	4.7984	31.1157	4.6299
4.1188	2.5294	4.6416	4.8335	31.5550	4.6416
4.1293	2.5793	4.6530	4.8687	31.9908	4.6530
4.1395	2.6294	4.6641	4.9040	32.4233	4.6641
4.1494	2.6795	4.6748	4.9394	32.8526	4.6748
4.1591	2.7298	4.6853	4.9749	33.2785	4.6853
4.1685	2.7802	4.6955	5.0106	33.7010	4.6955
4.1776	2.8306	4.7054	5.0463	34.1202	4.7054
4.1865	2.8812	4.7150	5.0822	34.5362	4.7150
4.1951	2.9319	4.7244	5.1181	34.9490	4.7244
4.2034	2.9827	4.7335	5.1541	35.3586	4.7335
4.2115	3.0335	4.7423	5.1903	35.7652	4.7423
4.2192	3.0845	4.7508	5.2265	36.1687	4.7508
4.2267	3.1355	4.7592	5.2628	36.5692	4.7592
4.2339	3.1866	4.7672	5.2991	36.9668	4.7672
4.2408	3.2378	4.7750	5.3355	37.3614	4.7750
4.2474	3.2891	4.7826	5.3720	37.7532	4.7826
4.2538	3.3404	4.7900	5.4086	38.1422	4.7900
4.2598	3.3918	4.7971	5.4452	38.5284	4.7971
4.2655	3.4433	4.8039	5.4819	38.9119	4.8039
4.2710	3.4948	4.8106	5.5186	39.2927	4.8106
4.2761	3.5464	4.8170	5.5554	39.6708	4.8170



4.2810	3.5981	4.8232	5.5922	40.0463	4.8232
4.2856	3.6498	4.8293	5.6291	40.4192	4.8293
4.2898	3.7015	4.8351	5.6660	40.7897	4.8351
4.2938	3.7533	4.8406	5.7030	41.1576	4.8406
4.2975	3.8052	4.8460	5.7400	41.5231	4.8460
4.3008	3.8570	4.8512	5.7770	41.8862	4.8512
4.3039	3.9090	4.8562	5.8141	42.2470	4.8562
4.3066	3.9609	4.8610	5.8511	42.6055	4.8610
4.3091	4.0129	4.8657	5.8882	42.9618	4.8657
4.3112	4.0649	4.8701	5.9254	43.3158	4.8701
4.3130	4.1170	4.8743	5.9625	43.6678	4.8743
4.3145	4.1690	4.8784	5.9996	44.0177	4.8784
4.3156	4.2211	4.8823	6.0368	44.3656	4.8823
4.3164	4.2732	4.8860	6.0739	44.7116	4.8860
4.3169	4.3253	4.8896	6.1110	45.0557	4.8896
4.3171	4.3775	4.8930	6.1481	45.3980	4.8930
4.3168	4.4296	4.8962	6.1852	45.7387	4.8962
4.3163	4.4818	4.8993	6.2223	46.0777	4.8993
4.3153	4.5339	4.9022	6.2593	46.4151	4.9022
4.3140	4.5861	4.9049	6.2962	46.7511	4.9049
4.3123	4.6382	4.9075	6.3332	47.0858	4.9075
4.3101	4.6904	4.9099	6.3700	47.4192	4.9099
4.3076	4.7425	4.9122	6.4068	47.7515	4.9122
4.3046	4.7946	4.9144	6.4435	48.0827	4.9144
4.3012	4.8467	4.9164	6.4800	48.4130	4.9164
4.2973	4.8988	4.9182	6.5165	48.7424	4.9182
4.2929	4.9508	4.9199	6.5528	49.0712	4.9199
4.2880	5.0028	4.9215	6.5890	49.3994	4.9215
4.2826	5.0548	4.9230	6.6251	49.7271	4.9230
4.2767	5.1067	4.9243	6.6610	50.0546	4.9243
4.2702	5.1585	4.9255	6.6966	50.3819	4.9255
4.2631	5.2102	4.9266	6.7321	50.7092	4.9266
4.2555	5.2619	4.9275	6.7673	51.0366	4.9275
4.2471	5.3135	4.9284	6.8023	51.3643	4.9284
4.2381	5.3649	4.9291	6.8370	51.6924	4.9291
4.2285	5.4163	4.9297	6.8714	52.0210	4.9297
4.2181	5.4675	4.9302	6.9055	52.3505	4.9302
4.2069	5.5185	4.9307	6.9392	52.6809	4.9307
4.1950	5.5694	4.9310	6.9725	53.0123	4.9310
4.1822	5.6201	4.9312	7.0054	53.3449	4.9312
4.1687	5.6705	4.9313	7.0379	53.6786	4.9313
4.1543	5.7207	4.9314	7.0700	54.0136	4.9314

STREAMLINE 3

X	Y	Z	R	THETA	Z
3.6895	1.1495	3.9973	3.8645	17.3044	3.9973
3.7022	1.1436	4.0072	3.8748	17.1658	4.0072
3.7151	1.1419	4.0182	3.8866	17.0864	4.0182
3.7271	1.1455	4.0297	3.8991	17.0843	4.0297
3.7406	1.1603	4.0454	3.9165	17.2326	4.0454
3.7501	1.1802	4.0585	3.9314	17.4693	4.0585
3.7592	1.2004	4.0714	3.9462	17.7090	4.0714
3.7684	1.2208	4.0841	3.9612	17.9496	4.0841
3.7774	1.2413	4.0965	3.9761	18.1910	4.0965
3.7863	1.2620	4.1088	3.9911	18.4329	4.1088
3.8040	1.3038	4.1328	4.0212	18.9181	4.1328
3.8214	1.3461	4.1560	4.0515	19.4050	4.1560
3.8384	1.3890	4.1785	4.0820	19.8931	4.1785
3.8551	1.4323	4.2004	4.1126	20.3816	4.2004

3.8714	1.4761	4.2216	4.1433	20.8704	4.2216
3.8874	1.5203	4.2422	4.1741	21.3589	4.2422
3.9031	1.5648	4.2622	4.2051	21.8468	4.2622
3.9185	1.6098	4.2816	4.2363	22.3338	4.2816
3.9335	1.6551	4.3005	4.2675	22.8196	4.3005
3.9482	1.7007	4.3189	4.2989	23.3038	4.3189
3.9626	1.7466	4.3367	4.3305	23.7863	4.3367
3.9767	1.7928	4.3541	4.3622	24.2668	4.3541
3.9905	1.8392	4.3710	4.3940	24.7451	4.3710
4.0040	1.8859	4.3875	4.4259	25.2210	4.3875
4.0172	1.9329	4.4035	4.4580	25.6943	4.4035
4.0301	1.9800	4.4191	4.4903	26.1649	4.4191
4.0428	2.0274	4.4343	4.5226	26.6327	4.4343
4.0552	2.0749	4.4491	4.5552	27.0975	4.4491
4.0673	2.1226	4.4636	4.5879	27.5593	4.4636
4.0791	2.1706	4.4776	4.6207	28.0179	4.4776
4.0908	2.2186	4.4913	4.6537	28.4733	4.4913
4.1021	2.2669	4.5047	4.6868	28.9254	4.5047
4.1132	2.3152	4.5177	4.7201	29.3742	4.5177
4.1241	2.3638	4.5304	4.7535	29.8196	4.5304
4.1347	2.4124	4.5428	4.7870	30.2616	4.5428
4.1451	2.4612	4.5548	4.8208	30.7003	4.5548
4.1553	2.5101	4.5665	4.8546	31.1356	4.5665
4.1652	2.5592	4.5780	4.8886	31.5675	4.5780
4.1748	2.6083	4.5891	4.9227	31.9962	4.5891
4.1843	2.6576	4.5999	4.9569	32.4216	4.5999
4.1934	2.7070	4.6105	4.9912	32.8438	4.6105
4.2023	2.7565	4.6207	5.0257	33.2628	4.6207
4.2110	2.8061	4.6307	5.0603	33.6785	4.6307
4.2194	2.8558	4.6404	5.0949	34.0911	4.6404
4.2275	2.9056	4.6498	5.1297	34.5005	4.6498
4.2354	2.9554	4.6590	5.1646	34.9067	4.6590
4.2431	3.0054	4.6679	5.1996	35.3100	4.6679
4.2505	3.0554	4.6766	5.2347	35.7102	4.6766
4.2576	3.1055	4.6850	5.2699	36.1074	4.6850
4.2645	3.1557	4.6931	5.3051	36.5018	4.6931
4.2711	3.2060	4.7010	5.3405	36.8932	4.7010
4.2774	3.2564	4.7087	5.3759	37.2818	4.7087
4.2835	3.3068	4.7162	5.4114	37.6676	4.7162
4.2893	3.3573	4.7234	5.4469	38.0506	4.7234
4.2948	3.4078	4.7303	5.4826	38.4310	4.7303
4.3001	3.4584	4.7371	5.5183	38.8086	4.7371
4.3050	3.5091	4.7437	5.5540	39.1836	4.7437
4.3098	3.5598	4.7500	5.5898	39.5560	4.7500
4.3142	3.6105	4.7561	5.6257	39.9259	4.7561
4.3183	3.6613	4.7620	5.6616	40.2932	4.7620
4.3222	3.7122	4.7677	5.6975	40.6580	4.7677
4.3258	3.7631	4.7732	5.7336	41.0204	4.7732
4.3291	3.8140	4.7785	5.7696	41.3804	4.7785
4.3322	3.8650	4.7836	5.8057	41.7381	4.7836
4.3349	3.9160	4.7886	5.8418	42.0935	4.7886
4.3374	3.9671	4.7933	5.8780	42.4466	4.7933
4.3396	4.0181	4.7978	5.9141	42.7975	4.7978
4.3414	4.0692	4.8022	5.9503	43.1463	4.8022
4.3430	4.1204	4.8064	5.9866	43.4930	4.8064
4.3443	4.1715	4.8104	6.0228	43.8376	4.8104
4.3452	4.2227	4.8143	6.0590	44.1803	4.8143
4.3459	4.2738	4.8179	6.0953	44.5211	4.8179
4.3462	4.3250	4.8214	6.1315	44.8601	4.8214
4.3462	4.3763	4.8248	6.1678	45.1972	4.8248

4.3459	4.4275	4.8280	6.2040	45.5327	4.8280
4.3452	4.4787	4.8310	6.2402	45.8666	4.8310
4.3442	4.5299	4.8338	6.2763	46.1990	4.8338
4.3428	4.5812	4.8365	6.3125	46.5299	4.8365
4.3411	4.6324	4.8391	6.3485	46.8595	4.8391
4.3389	4.6836	4.8415	6.3846	47.1878	4.8415
4.3364	4.7348	4.8438	6.4205	47.5150	4.8438
4.3334	4.7860	4.8459	6.4564	47.8411	4.8459
4.3301	4.8372	4.8479	6.4921	48.1663	4.8479
4.3262	4.8883	4.8497	6.5278	48.4907	4.8497
4.3220	4.9394	4.8514	6.5633	48.8143	4.8514
4.3172	4.9905	4.8530	6.5988	49.1374	4.8530
4.3120	5.0415	4.8544	6.6340	49.4601	4.8544
4.3062	5.0925	4.8557	6.6691	49.7824	4.8557
4.2999	5.1434	4.8569	6.7040	50.1045	4.8569
4.2930	5.1943	4.8580	6.7388	50.4265	4.8580
4.2856	5.2451	4.8589	6.7732	50.7487	4.8589
4.2775	5.2957	4.8598	6.8075	51.0711	4.8598
4.2688	5.3463	4.8605	6.8415	51.3939	4.8605
4.2595	5.3968	4.8611	6.8752	51.7171	4.8611
4.2494	5.4471	4.8616	6.9086	52.0411	4.8616
4.2387	5.4973	4.8620	6.9416	52.3659	4.8620
4.2271	5.5473	4.8623	6.9743	52.6918	4.8623
4.2149	5.5971	4.8625	7.0066	53.0186	4.8625
4.2018	5.6467	4.8627	7.0385	53.3466	4.8627
4.1880	5.6961	4.8627	7.0700	53.6757	4.8627

STREAMLINE 4

X	Y	Z	R	THETA	Z
3.7699	1.1945	3.9485	3.9546	17.5809	3.9485
3.7824	1.1891	3.9583	3.9649	17.4516	3.9583
3.7950	1.1877	3.9692	3.9765	17.3778	3.9692
3.8067	1.1912	3.9806	3.9887	17.3765	3.9806
3.8199	1.2058	3.9960	4.0057	17.5191	3.9960
3.8287	1.2256	4.0088	4.0201	17.7504	4.0088
3.8373	1.2457	4.0213	4.0344	17.9852	4.0213
3.8458	1.2660	4.0337	4.0488	18.2208	4.0337
3.8542	1.2864	4.0458	4.0632	18.4571	4.0458
3.8626	1.3070	4.0577	4.0777	18.6939	4.0577
3.8791	1.3485	4.0810	4.1068	19.1693	4.0810
3.8952	1.3906	4.1036	4.1360	19.6462	4.1036
3.9110	1.4331	4.1255	4.1653	20.1242	4.1255
3.9265	1.4761	4.1467	4.1948	20.6028	4.1467
3.9417	1.5195	4.1673	4.2244	21.0817	4.1673
3.9565	1.5633	4.1873	4.2541	21.5603	4.1873
3.9710	1.6075	4.2068	4.2840	22.0385	4.2068
3.9852	1.6520	4.2257	4.3140	22.5158	4.2257
3.9991	1.6968	4.2440	4.3442	22.9919	4.2440
4.0126	1.7420	4.2619	4.3744	23.4666	4.2619
4.0259	1.7874	4.2792	4.4048	23.9397	4.2792
4.0389	1.8330	4.2961	4.4354	24.4109	4.2961
4.0515	1.8789	4.3126	4.4660	24.8800	4.3126
4.0640	1.9251	4.3286	4.4969	25.3468	4.3286
4.0761	1.9714	4.3442	4.5278	25.8112	4.3442
4.0880	2.0180	4.3594	4.5589	26.2730	4.3594
4.0996	2.0647	4.3742	4.5902	26.7322	4.3742
4.1109	2.1117	4.3886	4.6216	27.1885	4.3886
4.1220	2.1588	4.4027	4.6531	27.6418	4.4027
4.1329	2.2060	4.4164	4.6848	28.0922	4.4164

4.1435	2.2534	4.4298	4.7167	28.5394	4.4298
4.1539	2.3010	4.4428	4.7487	28.9835	4.4428
4.1641	2.3487	4.4555	4.7808	29.4244	4.4555
4.1741	2.3965	4.4679	4.8131	29.8620	4.4679
4.1838	2.4445	4.4799	4.8456	30.2964	4.4799
4.1933	2.4925	4.4917	4.8782	30.7275	4.4917
4.2026	2.5407	4.5032	4.9109	31.1553	4.5032
4.2117	2.5890	4.5143	4.9438	31.5800	4.5143
4.2205	2.6374	4.5252	4.9768	32.0014	4.5252
4.2291	2.6859	4.5358	5.0099	32.4197	4.5358
4.2375	2.7345	4.5461	5.0432	32.8350	4.5461
4.2456	2.7832	4.5561	5.0766	33.2471	4.5561
4.2535	2.8320	4.5659	5.1101	33.6561	4.5659
4.2612	2.8809	4.5754	5.1437	34.0619	4.5754
4.2687	2.9299	4.5847	5.1774	34.4647	4.5847
4.2759	2.9790	4.5936	5.2113	34.8645	4.5936
4.2829	3.0281	4.6024	5.2452	35.2613	4.6024
4.2896	3.0773	4.6109	5.2792	35.6552	4.6109
4.2961	3.1266	4.6191	5.3134	36.0461	4.6191
4.3024	3.1759	4.6271	5.3476	36.4343	4.6271
4.3084	3.2254	4.6349	5.3819	36.8196	4.6349
4.3141	3.2749	4.6424	5.4163	37.2021	4.6424
4.3197	3.3244	4.6497	5.4508	37.5819	4.6497
4.3249	3.3740	4.6568	5.4854	37.9590	4.6568
4.3300	3.4237	4.6636	5.5200	38.3335	4.6636
4.3347	3.4734	4.6703	5.5547	38.7053	4.6703
4.3392	3.5232	4.6767	5.5894	39.0746	4.6767
4.3435	3.5730	4.6829	5.6243	39.4413	4.6829
4.3475	3.6229	4.6889	5.6592	39.8054	4.6889
4.3512	3.6728	4.6948	5.6941	40.1671	4.6948
4.3547	3.7228	4.7004	5.7291	40.5264	4.7004
4.3580	3.7728	4.7058	5.7642	40.8833	4.7058
4.3609	3.8228	4.7110	5.7993	41.2379	4.7110
4.3636	3.8729	4.7160	5.8344	41.5901	4.7160
4.3661	3.9230	4.7209	5.8696	41.9401	4.7209
4.3682	3.9731	4.7255	5.9048	42.2878	4.7255
4.3701	4.0233	4.7300	5.9401	42.6334	4.7300
4.3718	4.0734	4.7343	5.9754	42.9769	4.7343
4.3731	4.1236	4.7385	6.0107	43.3183	4.7385
4.3742	4.1739	4.7424	6.0460	43.6577	4.7424
4.3749	4.2241	4.7462	6.0814	43.9952	4.7462
4.3754	4.2744	4.7498	6.1167	44.3308	4.7498
4.3756	4.3246	4.7533	6.1521	44.6646	4.7533
4.3754	4.3749	4.7566	6.1874	44.9966	4.7566
4.3750	4.4252	4.7597	6.2228	45.3270	4.7597
4.3742	4.4755	4.7627	6.2581	45.6557	4.7627
4.3731	4.5258	4.7655	6.2934	45.9830	4.7655
4.3717	4.5761	4.7682	6.3287	46.3088	4.7682
4.3699	4.6264	4.7707	6.3639	46.6333	4.7707
4.3677	4.6767	4.7731	6.3991	46.9565	4.7731
4.3652	4.7270	4.7753	6.4342	47.2786	4.7753
4.3623	4.7772	4.7774	6.4693	47.5997	4.7774
4.3589	4.8275	4.7794	6.5042	47.9198	4.7794
4.3552	4.8777	4.7812	6.5391	48.2390	4.7812
4.3510	4.9279	4.7829	6.5739	48.5576	4.7829
4.3464	4.9781	4.7844	6.6085	48.8755	4.7844
4.3413	5.0282	4.7858	6.6430	49.1930	4.7858
4.3357	5.0782	4.7871	6.6773	49.5102	4.7871
4.3295	5.1282	4.7883	6.7115	49.8271	4.7883
4.3229	5.1782	4.7894	6.7454	50.1439	4.7894

4.3157	5.2280	4.7903	6.7792	50.4608	4.7903
4.3079	5.2778	4.7911	6.8127	50.7780	4.7911
4.2995	5.3275	4.7919	6.8460	51.0954	4.7919
4.2904	5.3771	4.7925	6.8790	51.4132	4.7925
4.2807	5.4265	4.7930	6.9117	51.7317	4.7930
4.2703	5.4758	4.7934	6.9441	52.0510	4.7934
4.2592	5.5250	4.7937	6.9761	52.3712	4.7937
4.2474	5.5740	4.7939	7.0078	52.6924	4.7939
4.2348	5.6228	4.7940	7.0391	53.0146	4.7940
4.2215	5.6713	4.7941	7.0700	53.3378	4.7941

STREAMLINE 5

X	Y	Z	R	THETA	Z
3.9381	1.2918	3.8460	4.1445	18.1611	3.8460
3.9501	1.2872	3.8558	4.1545	18.0493	3.8558
3.9620	1.2863	3.8665	4.1656	17.9861	3.8665
3.9731	1.2900	3.8775	4.1773	17.9870	3.8775
3.9854	1.3042	3.8924	4.1934	18.1205	3.8924
3.9931	1.3237	3.9045	4.2068	18.3406	3.9045
4.0004	1.3436	3.9163	4.2200	18.5650	3.9163
4.0077	1.3636	3.9279	4.2333	18.7901	3.9279
4.0149	1.3837	3.9392	4.2466	19.0160	3.9392
4.0220	1.4039	3.9505	4.2600	19.2424	3.9505
4.0360	1.4448	3.9723	4.2868	19.6968	3.9723
4.0496	1.4862	3.9935	4.3137	20.1528	3.9935
4.0630	1.5280	4.0141	4.3408	20.6099	4.0141
4.0760	1.5701	4.0340	4.3679	21.0677	4.0340
4.0887	1.6127	4.0534	4.3952	21.5258	4.0534
4.1011	1.6556	4.0721	4.4226	21.9838	4.0721
4.1132	1.6988	4.0904	4.4502	22.4414	4.0904
4.1249	1.7423	4.1081	4.4778	22.8983	4.1081
4.1364	1.7861	4.1253	4.5056	23.3543	4.1253
4.1477	1.8301	4.1421	4.5335	23.8090	4.1421
4.1586	1.8744	4.1584	4.5615	24.2623	4.1584
4.1693	1.9189	4.1743	4.5897	24.7139	4.1743
4.1797	1.9636	4.1898	4.6179	25.1637	4.1898
4.1899	2.0085	4.2049	4.6464	25.6114	4.2049
4.1998	2.0535	4.2196	4.6749	26.0570	4.2196
4.2095	2.0988	4.2339	4.7037	26.5003	4.2339
4.2189	2.1442	4.2478	4.7325	26.9412	4.2478
4.2282	2.1898	4.2615	4.7615	27.3795	4.2615
4.2372	2.2354	4.2747	4.7907	27.8152	4.2747
4.2460	2.2813	4.2877	4.8200	28.2481	4.2877
4.2546	2.3272	4.3003	4.8495	28.6782	4.3003
4.2630	2.3733	4.3127	4.8792	29.1054	4.3127
4.2713	2.4195	4.3247	4.9090	29.5297	4.3247
4.2793	2.4658	4.3364	4.9389	29.9510	4.3364
4.2872	2.5122	4.3479	4.9690	30.3693	4.3479
4.2949	2.5587	4.3590	4.9993	30.7846	4.3590
4.3024	2.6053	4.3699	5.0297	31.1969	4.3699
4.3097	2.6520	4.3805	5.0603	31.6062	4.3805
4.3168	2.6988	4.3909	5.0910	32.0126	4.3909
4.3237	2.7456	4.4010	5.1218	32.4160	4.4010
4.3305	2.7926	4.4108	5.1528	32.8165	4.4108
4.3370	2.8396	4.4204	5.1839	33.2141	4.4204
4.3434	2.8867	4.4297	5.2152	33.6088	4.4297
4.3496	2.9339	4.4387	5.2466	34.0006	4.4387
4.3555	2.9811	4.4476	5.2781	34.3895	4.4476
4.3613	3.0284	4.4562	5.3097	34.7755	4.4562

4.3669	3.0758	4.4645	5.3414	35.1588	4.4645
4.3723	3.1233	4.4726	5.3732	35.5394	4.4726
4.3775	3.1708	4.4805	5.4052	35.9172	4.4805
4.3825	3.2183	4.4882	5.4373	36.2923	4.4882
4.3872	3.2660	4.4957	5.4694	36.6647	4.4957
4.3918	3.3136	4.5029	5.5017	37.0345	4.5029
4.3962	3.3614	4.5099	5.5340	37.4018	4.5099
4.4003	3.4091	4.5167	5.5664	37.7664	4.5167
4.4043	3.4569	4.5233	5.5989	38.1286	4.5233
4.4080	3.5048	4.5297	5.6316	38.4882	4.5297
4.4115	3.5527	4.5359	5.6642	38.8453	4.5359
4.4149	3.6007	4.5419	5.6970	39.2000	4.5419
4.4179	3.6487	4.5477	5.7298	39.5524	4.5477
4.4208	3.6967	4.5533	5.7627	39.9023	4.5533
4.4235	3.7447	4.5587	5.7957	40.2499	4.5587
4.4259	3.7928	4.5639	5.8288	40.5952	4.5639
4.4281	3.8410	4.5690	5.8619	40.9382	4.5690
4.4301	3.8891	4.5738	5.8950	41.2791	4.5738
4.4319	3.9373	4.5785	5.9282	41.6177	4.5785
4.4334	3.9855	4.5830	5.9615	41.9542	4.5830
4.4348	4.0337	4.5874	5.9948	42.2886	4.5874
4.4358	4.0819	4.5915	6.0282	42.6209	4.5915
4.4367	4.1302	4.5955	6.0616	42.9513	4.5955
4.4373	4.1785	4.5994	6.0950	43.2797	4.5994
4.4376	4.2268	4.6030	6.1285	43.6062	4.6030
4.4377	4.2751	4.6066	6.1619	43.9309	4.6066
4.4375	4.3234	4.6099	6.1954	44.2538	4.6099
4.4371	4.3717	4.6131	6.2289	44.5750	4.6131
4.4364	4.4201	4.6162	6.2625	44.8946	4.6162
4.4354	4.4684	4.6190	6.2960	45.2126	4.6190
4.4341	4.5167	4.6218	6.3295	45.5291	4.6218
4.4325	4.5651	4.6244	6.3630	45.8442	4.6244
4.4306	4.6134	4.6269	6.3964	46.1580	4.6269
4.4284	4.6618	4.6292	6.4298	46.4705	4.6292
4.4259	4.7101	4.6313	6.4632	46.7819	4.6313
4.4230	4.7584	4.6334	6.4965	47.0922	4.6334
4.4197	4.8067	4.6353	6.5298	47.4016	4.6353
4.4161	4.8549	4.6371	6.5629	47.7101	4.6371
4.4121	4.9032	4.6387	6.5960	48.0179	4.6387
4.4076	4.9514	4.6402	6.6290	48.3250	4.6402
4.4028	4.9996	4.6416	6.6618	48.6317	4.6416
4.3975	5.0477	4.6429	6.6946	48.9379	4.6429
4.3917	5.0958	4.6440	6.7271	49.2439	4.6440
4.3855	5.1438	4.6451	6.7595	49.5497	4.6451
4.3787	5.1917	4.6460	6.7917	49.8555	4.6460
4.3714	5.2396	4.6468	6.8237	50.1615	4.6468
4.3636	5.2874	4.6475	6.8555	50.4675	4.6475
4.3552	5.3351	4.6481	6.8870	50.7740	4.6481
4.3462	5.3827	4.6486	6.9183	51.0810	4.6486
4.3366	5.4302	4.6490	6.9493	51.3886	4.6490
4.3263	5.4775	4.6493	6.9800	51.6969	4.6493
4.3154	5.5247	4.6495	7.0103	52.0061	4.6495
4.3038	5.5717	4.6496	7.0403	52.3161	4.6496
4.2915	5.6185	4.6497	7.0700	52.6270	4.6497

STREAMLINE 6

X	Y	Z	R	THETA	Z
4.1048	1.3926	3.7439	4.3346	18.7404	3.7439
4.1162	1.3888	3.7535	4.3442	18.6439	3.7535

4.1276	1.3883	3.7640	4.3548	18.5899	3.7640
4.1380	1.3921	3.7747	4.3659	18.5935	3.7747
4.1493	1.4061	3.7890	4.3811	18.7207	3.7890
4.1558	1.4253	3.8004	4.3934	18.9299	3.8004
4.1620	1.4448	3.8114	4.4056	19.1440	3.8114
4.1680	1.4644	3.8223	4.4178	19.3587	3.8223
4.1740	1.4842	3.8329	4.4301	19.5742	3.8329
4.1799	1.5041	3.8434	4.4423	19.7902	3.8434
4.1915	1.5441	3.8639	4.4669	20.2237	3.8639
4.2028	1.5846	3.8837	4.4916	20.6588	3.8837
4.2137	1.6255	3.9029	4.5164	21.0950	3.9029
4.2244	1.6667	3.9215	4.5413	21.5319	3.9215
4.2347	1.7083	3.9396	4.5663	21.9693	3.9396
4.2447	1.7501	3.9572	4.5914	22.4067	3.9572
4.2545	1.7923	3.9742	4.6166	22.8438	3.9742
4.2640	1.8346	3.9908	4.6419	23.2804	3.9908
4.2732	1.8772	4.0069	4.6673	23.7162	4.0069
4.2821	1.9201	4.0226	4.6929	24.1510	4.0226
4.2908	1.9631	4.0379	4.7185	24.5845	4.0379
4.2992	2.0063	4.0527	4.7443	25.0166	4.0527
4.3075	2.0497	4.0672	4.7703	25.4471	4.0672
4.3155	2.0932	4.0814	4.7963	25.8758	4.0814
4.3232	2.1369	4.0951	4.8225	26.3026	4.0951
4.3308	2.1808	4.1086	4.8489	26.7274	4.1086
4.3382	2.2247	4.1217	4.8754	27.1500	4.1217
4.3453	2.2688	4.1345	4.9020	27.5704	4.1345
4.3523	2.3130	4.1469	4.9288	27.9883	4.1469
4.3592	2.3574	4.1591	4.9558	28.4038	4.1591
4.3658	2.4018	4.1710	4.9829	28.8168	4.1710
4.3723	2.4463	4.1826	5.0101	29.2272	4.1826
4.3786	2.4909	4.1940	5.0376	29.6349	4.1940
4.3848	2.5357	4.2051	5.0652	30.0399	4.2051
4.3909	2.5804	4.2159	5.0930	30.4421	4.2159
4.3967	2.6253	4.2264	5.1209	30.8416	4.2264
4.4025	2.6703	4.2367	5.1490	31.2384	4.2367
4.4081	2.7153	4.2468	5.1773	31.6323	4.2468
4.4135	2.7604	4.2566	5.2057	32.0235	4.2566
4.4188	2.8056	4.2662	5.2342	32.4120	4.2662
4.4239	2.8508	4.2755	5.2629	32.7978	4.2755
4.4289	2.8961	4.2846	5.2918	33.1809	4.2846
4.4338	2.9415	4.2935	5.3207	33.5612	4.2935
4.4384	2.9869	4.3021	5.3499	33.9389	4.3021
4.4430	3.0324	4.3105	5.3791	34.3139	4.3105
4.4473	3.0779	4.3187	5.4085	34.6863	4.3187
4.4515	3.1235	4.3267	5.4380	35.0561	4.3267
4.4556	3.1691	4.3344	5.4677	35.4233	4.3344
4.4594	3.2148	4.3420	5.4974	35.7880	4.3420
4.4631	3.2606	4.3493	5.5273	36.1501	4.3493
4.4667	3.3063	4.3565	5.5573	36.5097	4.3565
4.4701	3.3522	4.3634	5.5874	36.8669	4.3634
4.4733	3.3980	4.3701	5.6175	37.2216	4.3701
4.4763	3.4440	4.3766	5.6478	37.5738	4.3766
4.4792	3.4899	4.3830	5.6782	37.9237	4.3830
4.4819	3.5359	4.3891	5.7087	38.2711	4.3891
4.4844	3.5819	4.3950	5.7393	38.6162	4.3950
4.4867	3.6280	4.4008	5.7700	38.9590	4.4008
4.4889	3.6741	4.4064	5.8008	39.2995	4.4064
4.4909	3.7202	4.4118	5.8316	39.6377	4.4118
4.4927	3.7663	4.4170	5.8626	39.9736	4.4170
4.4944	3.8125	4.4220	5.8936	40.3074	4.4220

4.4958	3.8587	4.4269	5.9247	40.6389	4.4269
4.4971	3.9049	4.4316	5.9558	40.9683	4.4316
4.4982	3.9511	4.4361	5.9871	41.2956	4.4361
4.4991	3.9974	4.4405	6.0184	41.6209	4.4405
4.4998	4.0437	4.4447	6.0497	41.9441	4.4447
4.5003	4.0900	4.4487	6.0812	42.2653	4.4487
4.5006	4.1363	4.4526	6.1126	42.5846	4.4526
4.5007	4.1826	4.4563	6.1441	42.9020	4.4563
4.5006	4.2289	4.4599	6.1757	43.2176	4.4599
4.5003	4.2753	4.4633	6.2073	43.5314	4.4633
4.4997	4.3216	4.4665	6.2389	43.8434	4.4665
4.4990	4.3680	4.4696	6.2706	44.1538	4.4696
4.4980	4.4144	4.4726	6.3023	44.4626	4.4726
4.4967	4.4607	4.4754	6.3339	44.7698	4.4754
4.4952	4.5071	4.4781	6.3656	45.0756	4.4781
4.4935	4.5535	4.4806	6.3973	45.3800	4.4806
4.4915	4.5999	4.4830	6.4290	45.6830	4.4830
4.4892	4.6462	4.4852	6.4606	45.9849	4.4852
4.4866	4.6926	4.4874	6.4923	46.2855	4.4874
4.4837	4.7389	4.4893	6.5239	46.5852	4.4893
4.4805	4.7852	4.4912	6.5554	46.8838	4.4912
4.4769	4.8315	4.4929	6.5869	47.1816	4.4929
4.4730	4.8778	4.4945	6.6183	47.4786	4.4945
4.4688	4.9241	4.4960	6.6496	47.7750	4.4960
4.4642	4.9703	4.4974	6.6808	48.0708	4.4974
4.4591	5.0165	4.4986	6.7119	48.3661	4.4986
4.4537	5.0626	4.4998	6.7428	48.6611	4.4998
4.4478	5.1087	4.5008	6.7736	48.9559	4.5008
4.4415	5.1547	4.5017	6.8043	49.2507	4.5017
4.4347	5.2007	4.5025	6.8348	49.5454	4.5025
4.4274	5.2466	4.5031	6.8651	49.8401	4.5031
4.4196	5.2924	4.5037	6.8951	50.1352	4.5037
4.4113	5.3381	4.5042	6.9249	50.4307	4.5042
4.4024	5.3837	4.5046	6.9545	50.7266	4.5046
4.3929	5.4292	4.5049	6.9838	51.0230	4.5049
4.3828	5.4746	4.5051	7.0129	51.3201	4.5051
4.3721	5.5198	4.5052	7.0416	51.6180	4.5052
4.3608	5.5649	4.5053	7.0700	51.9166	4.5053

STREAMLINE 7

X	Y	Z	R	THETA	Z
4.2697	1.4968	3.6419	4.5245	19.3191	3.6419
4.2806	1.4937	3.6514	4.5338	19.2360	3.6514
4.2914	1.4936	3.6616	4.5439	19.1907	3.6616
4.3011	1.4976	3.6720	4.5544	19.1971	3.6720
4.3114	1.5114	3.6857	4.5686	19.3191	3.6857
4.3168	1.5302	3.6964	4.5800	19.5179	3.6964
4.3218	1.5493	3.7067	4.5911	19.7215	3.7067
4.3267	1.5685	3.7168	4.6022	19.9259	3.7168
4.3315	1.5878	3.7268	4.6134	20.1309	3.7268
4.3363	1.6072	3.7365	4.6246	20.3365	3.7365
4.3456	1.6463	3.7556	4.6470	20.7491	3.7556
4.3545	1.6858	3.7741	4.6695	21.1633	3.7741
4.3632	1.7256	3.7919	4.6921	21.5786	3.7919
4.3716	1.7658	3.8093	4.7147	21.9948	3.8093
4.3796	1.8062	3.8261	4.7375	22.4114	3.8261
4.3874	1.8468	3.8424	4.7603	22.8282	3.8424
4.3949	1.8877	3.8583	4.7832	23.2449	3.8583
4.4022	1.9289	3.8737	4.8062	23.6612	3.8737



4.4092	1.9702	3.8887	4.8293	24.0769	3.8887
4.4159	2.0117	3.9033	4.8525	24.4918	3.9033
4.4224	2.0534	3.9175	4.8759	24.9056	3.9175
4.4287	2.0952	3.9313	4.8993	25.3183	3.9313
4.4348	2.1372	3.9448	4.9229	25.7295	3.9448
4.4407	2.1793	3.9580	4.9466	26.1393	3.9580
4.4464	2.2215	3.9709	4.9705	26.5474	3.9709
4.4519	2.2638	3.9834	4.9944	26.9537	3.9834
4.4573	2.3063	3.9956	5.0186	27.3581	3.9956
4.4624	2.3488	4.0076	5.0429	27.7605	4.0076
4.4675	2.3915	4.0193	5.0673	28.1608	4.0193
4.4723	2.4342	4.0307	5.0919	28.5589	4.0307
4.4771	2.4771	4.0418	5.1167	28.9548	4.0418
4.4817	2.5200	4.0527	5.1416	29.3483	4.0527
4.4862	2.5630	4.0634	5.1667	29.7394	4.0634
4.4905	2.6060	4.0738	5.1919	30.1280	4.0738
4.4948	2.6491	4.0839	5.2174	30.5142	4.0839
4.4989	2.6923	4.0939	5.2430	30.8979	4.0939
4.5029	2.7356	4.1036	5.2687	31.2790	4.1036
4.5068	2.7789	4.1131	5.2947	31.6576	4.1131
4.5106	2.8222	4.1224	5.3208	32.0337	4.1224
4.5143	2.8657	4.1314	5.3470	32.4072	4.1314
4.5179	2.9091	4.1402	5.3735	32.7782	4.1402
4.5213	2.9527	4.1489	5.4000	33.1467	4.1489
4.5246	2.9962	4.1573	5.4268	33.5127	4.1573
4.5278	3.0399	4.1655	5.4536	33.8763	4.1655
4.5309	3.0835	4.1735	5.4806	34.2375	4.1735
4.5339	3.1273	4.1812	5.5078	34.5962	4.1812
4.5367	3.1710	4.1888	5.5351	34.9526	4.1888
4.5394	3.2148	4.1962	5.5625	35.3065	4.1962
4.5419	3.2587	4.2034	5.5900	35.6581	4.2034
4.5444	3.3026	4.2104	5.6177	36.0073	4.2104
4.5467	3.3465	4.2172	5.6455	36.3541	4.2172
4.5489	3.3905	4.2238	5.6734	36.6986	4.2238
4.5509	3.4344	4.2303	5.7014	37.0408	4.2303
4.5528	3.4785	4.2365	5.7296	37.3807	4.2365
4.5546	3.5225	4.2426	5.7578	37.7183	4.2426
4.5563	3.5666	4.2484	5.7862	38.0537	4.2484
4.5578	3.6107	4.2541	5.8147	38.3868	4.2541
4.5591	3.6549	4.2597	5.8433	38.7176	4.2597
4.5604	3.6990	4.2650	5.8720	39.0463	4.2650
4.5615	3.7432	4.2702	5.9008	39.3728	4.2702
4.5625	3.7874	4.2752	5.9296	39.6971	4.2752
4.5633	3.8317	4.2801	5.9586	40.0193	4.2801
4.5640	3.8759	4.2848	5.9877	40.3394	4.2848
4.5645	3.9202	4.2893	6.0169	40.6575	4.2893
4.5649	3.9645	4.2937	6.0461	40.9735	4.2937
4.5651	4.0088	4.2979	6.0754	41.2875	4.2979
4.5652	4.0531	4.3019	6.1048	41.5996	4.3019
4.5651	4.0975	4.3058	6.1343	41.9097	4.3058
4.5649	4.1418	4.3096	6.1638	42.2179	4.3096
4.5645	4.1862	4.3132	6.1934	42.5244	4.3132
4.5639	4.2305	4.3166	6.2231	42.8290	4.3166
4.5632	4.2749	4.3199	6.2528	43.1319	4.3199
4.5622	4.3193	4.3231	6.2825	43.4331	4.3231
4.5611	4.3637	4.3261	6.3123	43.7327	4.3261
4.5598	4.4081	4.3290	6.3422	44.0307	4.3290
4.5583	4.4525	4.3317	6.3720	44.3272	4.3317
4.5566	4.4969	4.3343	6.4019	44.6222	4.3343
4.5546	4.5413	4.3368	6.4318	44.9159	4.3368

4.5524	4.5857	4.3391	6.4617	45.2083	4.3391
4.5500	4.6301	4.3413	6.4915	45.4994	4.3413
4.5474	4.6744	4.3434	6.5214	45.7894	4.3434
4.5444	4.7188	4.3453	6.5513	46.0784	4.3453
4.5412	4.7632	4.3471	6.5811	46.3663	4.3471
4.5377	4.8075	4.3488	6.6108	46.6534	4.3488
4.5339	4.8518	4.3504	6.6405	46.9397	4.3504
4.5298	4.8961	4.3518	6.6702	47.2252	4.3518
4.5254	4.9404	4.3531	6.6997	47.5102	4.3531
4.5206	4.9846	4.3544	6.7292	47.7946	4.3544
4.5154	5.0288	4.3555	6.7586	48.0787	4.3555
4.5099	5.0729	4.3564	6.7878	48.3625	4.3564
4.5040	5.1170	4.3573	6.8169	48.6461	4.3573
4.4976	5.1611	4.3581	6.8458	48.9297	4.3581
4.4908	5.2051	4.3588	6.8746	49.2131	4.3588
4.4836	5.2490	4.3594	6.9032	49.4966	4.3594
4.4759	5.2928	4.3598	6.9316	49.7805	4.3598
4.4676	5.3365	4.3602	6.9598	50.0647	4.3602
4.4589	5.3802	4.3605	6.9877	50.3494	4.3605
4.4496	5.4237	4.3607	7.0154	50.6345	4.3607
4.4398	5.4671	4.3609	7.0428	50.9202	4.3609
4.4295	5.5104	4.3609	7.0700	51.2064	4.3609

STREAMLINE 8

X	Y	Z	R	THETA	Z
4.4327	1.6043	3.5400	4.7141	19.8963	3.5400
4.4431	1.6018	3.5493	4.7230	19.8254	3.5493
4.4531	1.6022	3.5592	4.7326	19.7880	3.5592
4.4622	1.6062	3.5693	4.7425	19.7969	3.5693
4.4714	1.6198	3.5824	4.7558	19.9136	3.5824
4.4758	1.6381	3.5924	4.7661	20.1019	3.5924
4.4797	1.6567	3.6020	4.7762	20.2952	3.6020
4.4835	1.6754	3.6114	4.7863	20.4893	3.6114
4.4873	1.6942	3.6206	4.7964	20.6839	3.6206
4.4909	1.7130	3.6297	4.8066	20.8791	3.6297
4.4980	1.7511	3.6474	4.8268	21.2709	3.6474
4.5048	1.7894	3.6645	4.8472	21.6643	3.6645
4.5113	1.8281	3.6811	4.8676	22.0589	3.6811
4.5175	1.8670	3.6971	4.8881	22.4543	3.6971
4.5234	1.9061	3.7127	4.9086	22.8503	3.7127
4.5290	1.9455	3.7278	4.9292	23.2466	3.7278
4.5344	1.9851	3.7425	4.9499	23.6430	3.7425
4.5395	2.0248	3.7567	4.9706	24.0391	3.7567
4.5444	2.0647	3.7706	4.9915	24.4348	3.7706
4.5490	2.1048	3.7841	5.0124	24.8299	3.7841
4.5535	2.1450	3.7972	5.0334	25.2241	3.7972
4.5577	2.1854	3.8101	5.0545	25.6174	3.8101
4.5617	2.2258	3.8226	5.0758	26.0095	3.8226
4.5656	2.2664	3.8348	5.0972	26.4003	3.8348
4.5693	2.3071	3.8467	5.1187	26.7898	3.8467
4.5728	2.3479	3.8583	5.1403	27.1777	3.8583
4.5762	2.3887	3.8697	5.1621	27.5640	3.8697
4.5794	2.4297	3.8808	5.1841	27.9485	3.8808
4.5826	2.4707	3.8917	5.2061	28.3311	3.8917
4.5855	2.5117	3.9023	5.2284	28.7119	3.9023
4.5884	2.5529	3.9127	5.2508	29.0906	3.9127
4.5912	2.5941	3.9228	5.2734	29.4672	3.9228
4.5939	2.6354	3.9328	5.2961	29.8418	3.9328
4.5965	2.6767	3.9425	5.3191	30.2141	3.9425

4.5990	2.7181	3.9521	5.3422	30.5842	3.9521
4.6014	2.7596	3.9614	5.3654	30.9520	3.9614
4.6037	2.8010	3.9705	5.3889	31.3175	3.9705
4.6060	2.8426	3.9794	5.4125	31.6807	3.9794
4.6082	2.8842	3.9881	5.4363	32.0416	3.9881
4.6103	2.9258	3.9966	5.4603	32.4002	3.9966
4.6123	2.9675	4.0050	5.4844	32.7565	4.0050
4.6142	3.0092	4.0131	5.5087	33.1105	4.0131
4.6160	3.0509	4.0211	5.5332	33.4623	4.0211
4.6178	3.0927	4.0288	5.5578	33.8118	4.0288
4.6194	3.1346	4.0364	5.5825	34.1592	4.0364
4.6210	3.1764	4.0437	5.6074	34.5043	4.0437
4.6224	3.2183	4.0509	5.6324	34.8473	4.0509
4.6238	3.2603	4.0579	5.6576	35.1880	4.0579
4.6250	3.3022	4.0648	5.6829	35.5265	4.0648
4.6262	3.3442	4.0714	5.7084	35.8628	4.0714
4.6273	3.3863	4.0779	5.7340	36.1969	4.0779
4.6283	3.4283	4.0842	5.7597	36.5288	4.0842
4.6291	3.4704	4.0903	5.7856	36.8586	4.0903
4.6299	3.5125	4.0963	5.8115	37.1861	4.0963
4.6306	3.5547	4.1021	5.8377	37.5116	4.1021
4.6312	3.5968	4.1077	5.8639	37.8348	4.1077
4.6317	3.6390	4.1132	5.8903	38.1560	4.1132
4.6321	3.6812	4.1185	5.9167	38.4750	4.1185
4.6324	3.7235	4.1236	5.9433	38.7919	4.1236
4.6326	3.7657	4.1286	5.9701	39.1068	4.1286
4.6327	3.8080	4.1334	5.9969	39.4195	4.1334
4.6327	3.8503	4.1381	6.0238	39.7303	4.1381
4.6326	3.8926	4.1426	6.0509	40.0390	4.1426
4.6324	3.9349	4.1470	6.0780	40.3457	4.1470
4.6320	3.9772	4.1512	6.1053	40.6505	4.1512
4.6316	4.0196	4.1552	6.1326	40.9534	4.1552
4.6310	4.0619	4.1591	6.1600	41.2543	4.1591
4.6304	4.1043	4.1629	6.1875	41.5534	4.1629
4.6296	4.1467	4.1665	6.2151	41.8507	4.1665
4.6286	4.1891	4.1700	6.2428	42.1462	4.1700
4.6276	4.2315	4.1734	6.2705	42.4399	4.1734
4.6264	4.2739	4.1766	6.2984	42.7320	4.1766
4.6250	4.3163	4.1796	6.3262	43.0224	4.1796
4.6235	4.3587	4.1825	6.3541	43.3112	4.1825
4.6219	4.4011	4.1853	6.3821	43.5985	4.1853
4.6200	4.4435	4.1880	6.4101	43.8843	4.1880
4.6181	4.4860	4.1905	6.4382	44.1687	4.1905
4.6159	4.5284	4.1929	6.4663	44.4518	4.1929
4.6135	4.5708	4.1952	6.4944	44.7335	4.1952
4.6110	4.6132	4.1973	6.5225	45.0140	4.1973
4.6082	4.6556	4.1993	6.5506	45.2934	4.1993
4.6052	4.6980	4.2012	6.5787	45.5717	4.2012
4.6020	4.7404	4.2030	6.6068	45.8489	4.2030
4.5985	4.7828	4.2046	6.6348	46.1253	4.2046
4.5948	4.8251	4.2062	6.6628	46.4009	4.2062
4.5907	4.8674	4.2076	6.6908	46.6757	4.2076
4.5865	4.9097	4.2089	6.7187	46.9498	4.2089
4.5819	4.9520	4.2101	6.7466	47.2234	4.2101
4.5770	4.9943	4.2111	6.7743	47.4965	4.2111
4.5717	5.0365	4.2121	6.8020	47.7693	4.2121
4.5661	5.0786	4.2130	6.8295	48.0418	4.2130
4.5602	5.1208	4.2138	6.8569	48.3142	4.2138
4.5538	5.1628	4.2144	6.8842	48.5863	4.2144
4.5471	5.2048	4.2150	6.9113	48.8585	4.2150

4.5400	5.2468	4.2155	6.9383	49.1307	4.2155
4.5324	5.2886	4.2159	6.9650	49.4032	4.2159
4.5243	5.3304	4.2161	6.9916	49.6760	4.2161
4.5158	5.3721	4.2163	7.0180	49.9491	4.2163
4.5069	5.4137	4.2165	7.0441	50.2227	4.2165
4.4974	5.4551	4.2165	7.0700	50.4967	4.2165

STREAMLINE 8

X	Y	Z	R	THETA	Z
4.5134	1.6592	3.4889	4.8087	20.1837	3.4889
4.5234	1.6570	3.4982	4.8174	20.1185	3.4982
4.5332	1.6575	3.5080	4.8267	20.0847	3.5080
4.5419	1.6616	3.5179	4.8363	20.0947	3.5179
4.5506	1.6750	3.5307	4.8491	20.2080	3.5307
4.5545	1.6930	3.5404	4.8590	20.3910	3.5404
4.5579	1.7113	3.5496	4.8686	20.5792	3.5496
4.5612	1.7297	3.5587	4.8782	20.7681	3.5587
4.5644	1.7482	3.5676	4.8878	20.9576	3.5676
4.5675	1.7668	3.5763	4.8974	21.1476	3.5763
4.5736	1.8043	3.5933	4.9166	21.5292	3.5933
4.5793	1.8420	3.6098	4.9359	21.9122	3.6098
4.5848	1.8800	3.6257	4.9552	22.2965	3.6257
4.5899	1.9183	3.6411	4.9746	22.6817	3.6411
4.5948	1.9567	3.6560	4.9941	23.0675	3.6560
4.5994	1.9954	3.6705	5.0136	23.4536	3.6705
4.6037	2.0343	3.6846	5.0331	23.8398	3.6846
4.6078	2.0733	3.6983	5.0528	24.2259	3.6983
4.6116	2.1125	3.7116	5.0725	24.6117	3.7116
4.6153	2.1518	3.7245	5.0923	24.9969	3.7245
4.6187	2.1913	3.7372	5.1122	25.3814	3.7372
4.6219	2.2308	3.7495	5.1322	25.7650	3.7495
4.6250	2.2705	3.7615	5.1523	26.1476	3.7615
4.6279	2.3103	3.7732	5.1725	26.5290	3.7732
4.6306	2.3502	3.7847	5.1928	26.9091	3.7847
4.6331	2.3901	3.7958	5.2133	27.2879	3.7958
4.6356	2.4301	3.8068	5.2339	27.6651	3.8068
4.6379	2.4702	3.8174	5.2547	28.0407	3.8174
4.6401	2.5104	3.8279	5.2756	28.4145	3.8279
4.6421	2.5506	3.8381	5.2967	28.7866	3.8381
4.6441	2.5909	3.8481	5.3180	29.1568	3.8481
4.6460	2.6313	3.8579	5.3394	29.5250	3.8579
4.6478	2.6717	3.8675	5.3610	29.8912	3.8675
4.6495	2.7121	3.8769	5.3827	30.2553	3.8769
4.6512	2.7526	3.8861	5.4047	30.6174	3.8861
4.6528	2.7932	3.8951	5.4268	30.9773	3.8951
4.6543	2.8337	3.9039	5.4491	31.3350	3.9039
4.6557	2.8744	3.9126	5.4715	31.6906	3.9126
4.6571	2.9150	3.9210	5.4942	32.0439	3.9210
4.6584	2.9558	3.9293	5.5170	32.3951	3.9293
4.6597	2.9965	3.9373	5.5400	32.7441	3.9373
4.6608	3.0373	3.9452	5.5632	33.0909	3.9452
4.6619	3.0781	3.9529	5.5865	33.4356	3.9529
4.6629	3.1190	3.9605	5.6099	33.7781	3.9605
4.6639	3.1599	3.9678	5.6335	34.1186	3.9678
4.6647	3.2008	3.9750	5.6573	34.4570	3.9750
4.6655	3.2418	3.9820	5.6812	34.7932	3.9820
4.6662	3.2828	3.9888	5.7053	35.1273	3.9888
4.6668	3.3238	3.9954	5.7295	35.4593	3.9954
4.6673	3.3649	4.0019	5.7538	35.7892	4.0019

4.6678	3.4059	4.0082	5.7783	36.1170	4.0082
4.6682	3.4470	4.0144	5.8029	36.4426	4.0144
4.6685	3.4882	4.0204	5.8277	36.7662	4.0204
4.6687	3.5293	4.0262	5.8526	37.0876	4.0262
4.6688	3.5705	4.0318	5.8776	37.4070	4.0318
4.6689	3.6117	4.0373	5.9028	37.7242	4.0373
4.6689	3.6529	4.0427	5.9281	38.0394	4.0427
4.6688	3.6941	4.0479	5.9535	38.3526	4.0479
4.6686	3.7354	4.0529	5.9791	38.6636	4.0529
4.6684	3.7767	4.0578	6.0047	38.9727	4.0578
4.6680	3.8180	4.0625	6.0305	39.2797	4.0625
4.6676	3.8593	4.0671	6.0564	39.5848	4.0671
4.6671	3.9006	4.0715	6.0824	39.8879	4.0715
4.6665	3.9419	4.0758	6.1086	40.1890	4.0758
4.6658	3.9833	4.0799	6.1348	40.4882	4.0799
4.6650	4.0246	4.0839	6.1612	40.7855	4.0839
4.6641	4.0660	4.0877	6.1876	41.0810	4.0877
4.6631	4.1074	4.0914	6.2141	41.3746	4.0914
4.6620	4.1488	4.0950	6.2407	41.6664	4.0950
4.6608	4.1902	4.0984	6.2674	41.9565	4.0984
4.6595	4.2316	4.1017	6.2942	42.2449	4.1017
4.6580	4.2730	4.1049	6.3211	42.5315	4.1049
4.6565	4.3145	4.1079	6.3480	42.8166	4.1079
4.6548	4.3559	4.1108	6.3750	43.1001	4.1108
4.6529	4.3973	4.1135	6.4021	43.3821	4.1135
4.6510	4.4387	4.1161	6.4291	43.6626	4.1161
4.6488	4.4802	4.1186	6.4563	43.9416	4.1186
4.6465	4.5216	4.1210	6.4835	44.2194	4.1210
4.6441	4.5630	4.1232	6.5107	44.4958	4.1232
4.6414	4.6045	4.1253	6.5379	44.7710	4.1253
4.6386	4.6459	4.1273	6.5651	45.0451	4.1273
4.6355	4.6873	4.1292	6.5923	45.3181	4.1292
4.6323	4.7287	4.1309	6.6196	45.5900	4.1309
4.6288	4.7701	4.1326	6.6468	45.8611	4.1326
4.6251	4.8114	4.1341	6.6739	46.1313	4.1341
4.6211	4.8528	4.1355	6.7011	46.4007	4.1355
4.6169	4.8941	4.1368	6.7282	46.6694	4.1368
4.6124	4.9354	4.1379	6.7552	46.9376	4.1379
4.6076	4.9767	4.1390	6.7822	47.2053	4.1390
4.6025	5.0179	4.1400	6.8090	47.4725	4.1400
4.5971	5.0591	4.1408	6.8358	47.7395	4.1408
4.5913	5.1003	4.1416	6.8624	48.0062	4.1416
4.5852	5.1414	4.1423	6.8890	48.2728	4.1423
4.5787	5.1824	4.1428	6.9154	48.5392	4.1428
4.5718	5.2234	4.1433	6.9416	48.8058	4.1433
4.5645	5.2643	4.1437	6.9677	49.0724	4.1437
4.5568	5.3052	4.1440	6.9935	49.3393	4.1440
4.5487	5.3459	4.1442	7.0192	49.6065	4.1442
4.5401	5.3866	4.1443	7.0447	49.8740	4.1443
4.5311	5.4272	4.1443	7.0700	50.1418	4.1443

STREAMLINE 10

X	Y	Z	R	THETA	Z
4.5935	1.7147	3.4378	4.9031	20.4699	3.4378
4.6032	1.7128	3.4470	4.9116	20.4100	3.4470
4.6126	1.7136	3.4566	4.9206	20.3797	3.4566
4.6210	1.7177	3.4663	4.9299	20.3904	3.4663
4.6293	1.7308	3.4790	4.9423	20.4997	3.4790
4.6328	1.7485	3.4884	4.9517	20.6772	3.4884

4.6356	1.7665	3.4972	4.9608	20.8604	3.4972
4.6384	1.7846	3.5059	4.9699	21.0442	3.5059
4.6411	1.8028	3.5145	4.9790	21.2286	3.5145
4.6437	1.8211	3.5229	4.9880	21.4135	3.5229
4.6487	1.8579	3.5392	5.0063	21.7848	3.5392
4.6534	1.8950	3.5550	5.0245	22.1577	3.5550
4.6578	1.9324	3.5702	5.0428	22.5318	3.5702
4.6620	1.9699	3.5850	5.0611	22.9068	3.5850
4.6658	2.0077	3.5993	5.0794	23.2824	3.5993
4.6694	2.0457	3.6132	5.0979	23.6584	3.6132
4.6727	2.0838	3.6267	5.1163	24.0346	3.6267
4.6758	2.1221	3.6398	5.1348	24.4107	3.6398
4.6787	2.1605	3.6526	5.1534	24.7866	3.6526
4.6813	2.1991	3.6650	5.1721	25.1620	3.6650
4.6838	2.2377	3.6771	5.1909	25.5367	3.6771
4.6860	2.2765	3.6889	5.2097	25.9107	3.6889
4.6881	2.3154	3.7004	5.2287	26.2838	3.7004
4.6900	2.3543	3.7116	5.2478	26.6558	3.7116
4.6918	2.3933	3.7226	5.2670	27.0267	3.7226
4.6934	2.4325	3.7333	5.2863	27.3963	3.7333
4.6949	2.4716	3.7438	5.3058	27.7644	3.7438
4.6963	2.5109	3.7541	5.3254	28.1311	3.7541
4.6976	2.5502	3.7641	5.3452	28.4961	3.7641
4.6988	2.5895	3.7740	5.3651	28.8595	3.7740
4.6999	2.6289	3.7836	5.3852	29.2211	3.7836
4.7009	2.6684	3.7930	5.4054	29.5810	3.7930
4.7018	2.7079	3.8023	5.4259	29.9389	3.8023
4.7027	2.7475	3.8113	5.4465	30.2949	3.8113
4.7035	2.7871	3.8202	5.4672	30.6489	3.8202
4.7043	2.8267	3.8289	5.4882	31.0009	3.8289
4.7049	2.8664	3.8374	5.5093	31.3509	3.8374
4.7056	2.9061	3.8457	5.5306	31.6988	3.8457
4.7062	2.9458	3.8539	5.5521	32.0446	3.8539
4.7067	2.9856	3.8619	5.5738	32.3883	3.8619
4.7072	3.0255	3.8697	5.5956	32.7301	3.8697
4.7076	3.0653	3.8773	5.6176	33.0697	3.8773
4.7080	3.1052	3.8848	5.6398	33.4074	3.8848
4.7083	3.1451	3.8921	5.6621	33.7430	3.8921
4.7085	3.1851	3.8992	5.6846	34.0766	3.8992
4.7086	3.2251	3.9062	5.7072	34.4082	3.9062
4.7087	3.2651	3.9130	5.7300	34.7378	3.9130
4.7088	3.3051	3.9196	5.7529	35.0653	3.9196
4.7087	3.3452	3.9261	5.7760	35.3908	3.9261
4.7086	3.3853	3.9324	5.7992	35.7143	3.9324
4.7085	3.4254	3.9385	5.8226	36.0357	3.9385
4.7082	3.4655	3.9445	5.8461	36.3551	3.9445
4.7080	3.5057	3.9503	5.8698	36.6725	3.9503
4.7076	3.5459	3.9560	5.8936	36.9878	3.9560
4.7072	3.5861	3.9615	5.9176	37.3011	3.9615
4.7067	3.6263	3.9669	5.9417	37.6124	3.9669
4.7062	3.6665	3.9721	5.9659	37.9217	3.9721
4.7056	3.7068	3.9772	5.9903	38.2289	3.9772
4.7050	3.7471	3.9821	6.0148	38.5342	3.9821
4.7042	3.7874	3.9869	6.0394	38.8375	3.9869
4.7035	3.8277	3.9915	6.0641	39.1388	3.9915
4.7026	3.8680	3.9960	6.0890	39.4382	3.9960
4.7017	3.9084	4.0003	6.1140	39.7357	4.0003
4.7007	3.9487	4.0045	6.1391	40.0313	4.0045
4.6996	3.9891	4.0086	6.1644	40.3249	4.0086
4.6985	4.0295	4.0125	6.1897	40.6168	4.0125

4.6973	4.0699	4.0163	6.2151	40.9068	4.0163
4.6959	4.1103	4.0199	6.2407	41.1950	4.0199
4.6945	4.1507	4.0234	6.2663	41.4814	4.0234
4.6931	4.1911	4.0268	6.2921	41.7661	4.0268
4.6915	4.2315	4.0300	6.3179	42.0491	4.0300
4.6898	4.2719	4.0331	6.3438	42.3305	4.0331
4.6880	4.3124	4.0361	6.3698	42.6102	4.0361
4.6861	4.3528	4.0389	6.3958	42.8884	4.0389
4.6841	4.3933	4.0417	6.4219	43.1651	4.0417
4.6819	4.4337	4.0442	6.4481	43.4403	4.0442
4.6796	4.4742	4.0467	6.4743	43.7141	4.0467
4.6772	4.5146	4.0490	6.5006	43.9866	4.0490
4.6746	4.5550	4.0512	6.5269	44.2577	4.0512
4.6719	4.5955	4.0533	6.5532	44.5277	4.0533
4.6690	4.6359	4.0553	6.5796	44.7965	4.0553
4.6659	4.6763	4.0571	6.6059	45.0641	4.0571
4.6626	4.7168	4.0589	6.6323	45.3308	4.0589
4.6591	4.7572	4.0605	6.6587	45.5965	4.0605
4.6554	4.7975	4.0620	6.6850	45.8614	4.0620
4.6515	4.8379	4.0634	6.7113	46.1254	4.0634
4.6473	4.8783	4.0646	6.7376	46.3888	4.0646
4.6429	4.9186	4.0658	6.7638	46.6515	4.0658
4.6382	4.9589	4.0669	6.7900	46.9137	4.0669
4.6332	4.9992	4.0678	6.8160	47.1755	4.0678
4.6280	5.0394	4.0687	6.8420	47.4369	4.0687
4.6224	5.0796	4.0694	6.8679	47.6981	4.0694
4.6165	5.1197	4.0701	6.8937	47.9590	4.0701
4.6102	5.1598	4.0707	6.9194	48.2198	4.0707
4.6036	5.1999	4.0711	6.9449	48.4806	4.0711
4.5966	5.2398	4.0715	6.9703	48.7414	4.0715
4.5892	5.2797	4.0718	6.9955	49.0024	4.0718
4.5814	5.3196	4.0720	7.0205	49.2636	4.0720
4.5732	5.3593	4.0721	7.0453	49.5250	4.0721
4.5646	5.3990	4.0722	7.0700	49.7867	4.0722

STREAMLINE 11

X	Y	Z	R	THETA	Z
4.6730	1.7709	3.3865	4.9973	20.7543	3.3865
4.6824	1.7693	3.3956	5.0055	20.6995	3.3956
4.6914	1.7702	3.4052	5.0143	20.6725	3.4052
4.6995	1.7743	3.4147	5.0233	20.6837	3.4147
4.7075	1.7871	3.4272	5.0353	20.7878	3.4272
4.7105	1.8044	3.4363	5.0443	20.9594	3.4363
4.7129	1.8221	3.4448	5.0528	21.1376	3.4448
4.7151	1.8399	3.4531	5.0614	21.3164	3.4531
4.7173	1.8578	3.4613	5.0700	21.4958	3.4613
4.7195	1.8758	3.4694	5.0786	21.6758	3.4694
4.7235	1.9120	3.4850	5.0957	22.0370	3.4850
4.7272	1.9484	3.5001	5.1129	22.3998	3.5001
4.7306	1.9850	3.5148	5.1302	22.7638	3.5148
4.7337	2.0219	3.5289	5.1474	23.1287	3.5289
4.7365	2.0590	3.5426	5.1647	23.4943	3.5426
4.7391	2.0962	3.5559	5.1820	23.8603	3.5559
4.7415	2.1336	3.5688	5.1994	24.2265	3.5688
4.7436	2.1711	3.5813	5.2168	24.5927	3.5813
4.7455	2.2087	3.5935	5.2343	24.9587	3.5935
4.7472	2.2465	3.6054	5.2519	25.3244	3.6054
4.7487	2.2843	3.6170	5.2695	25.6895	3.6170
4.7500	2.3223	3.6283	5.2873	26.0539	3.6283

4.7511	2.3603	3.6393	5.3051	26.4175	3.6393
4.7521	2.3984	3.6500	5.3231	26.7802	3.6500
4.7530	2.4366	3.6605	5.3411	27.1417	3.6605
4.7537	2.4748	3.6708	5.3593	27.5021	3.6708
4.7543	2.5131	3.6809	5.3776	27.8612	3.6809
4.7548	2.5515	3.6907	5.3961	28.2190	3.6907
4.7552	2.5899	3.7003	5.4147	28.5752	3.7003
4.7555	2.6284	3.7098	5.4335	28.9300	3.7098
4.7557	2.6669	3.7190	5.4524	29.2831	3.7190
4.7558	2.7055	3.7281	5.4715	29.6345	3.7281
4.7559	2.7441	3.7370	5.4908	29.9841	3.7370
4.7560	2.7827	3.7457	5.5102	30.3320	3.7457
4.7559	2.8214	3.7542	5.5298	30.6780	3.7542
4.7559	2.8601	3.7626	5.5496	31.0221	3.7626
4.7558	2.8989	3.7708	5.5696	31.3644	3.7708
4.7556	2.9377	3.7788	5.5898	31.7047	3.7788
4.7554	2.9765	3.7867	5.6101	32.0430	3.7867
4.7552	3.0153	3.7944	5.6306	32.3794	3.7944
4.7549	3.0542	3.8020	5.6513	32.7140	3.8020
4.7545	3.0931	3.8093	5.6721	33.0465	3.8093
4.7542	3.1321	3.8166	5.6931	33.3772	3.8166
4.7537	3.1710	3.8236	5.7143	33.7059	3.8236
4.7532	3.2100	3.8305	5.7356	34.0327	3.8305
4.7527	3.2491	3.8373	5.7571	34.3576	3.8373
4.7521	3.2881	3.8439	5.7788	34.6805	3.8439
4.7515	3.3272	3.8503	5.8006	35.0015	3.8503
4.7508	3.3663	3.8566	5.8226	35.3205	3.8566
4.7501	3.4054	3.8628	5.8447	35.6376	3.8628
4.7493	3.4446	3.8687	5.8669	35.9527	3.8687
4.7485	3.4838	3.8746	5.8894	36.2658	3.8746
4.7476	3.5229	3.8803	5.9119	36.5770	3.8803
4.7467	3.5622	3.8858	5.9347	36.8862	3.8858
4.7458	3.6014	3.8912	5.9575	37.1935	3.8912
4.7448	3.6406	3.8964	5.9806	37.4988	3.8964
4.7437	3.6799	3.9015	6.0037	37.8022	3.9015
4.7426	3.7192	3.9065	6.0270	38.1037	3.9065
4.7415	3.7585	3.9113	6.0505	38.4032	3.9113
4.7403	3.7978	3.9160	6.0740	38.7008	3.9160
4.7391	3.8371	3.9205	6.0977	38.9965	3.9205
4.7378	3.8765	3.9249	6.1216	39.2902	3.9249
4.7364	3.9158	3.9292	6.1455	39.5822	3.9292
4.7351	3.9552	3.9333	6.1696	39.8722	3.9333
4.7336	3.9946	3.9372	6.1939	40.1604	3.9372
4.7321	4.0340	3.9411	6.2182	40.4468	3.9411
4.7305	4.0734	3.9448	6.2426	40.7314	3.9448
4.7289	4.1128	3.9484	6.2672	41.0142	3.9484
4.7272	4.1522	3.9518	6.2918	41.2953	3.9518
4.7254	4.1917	3.9551	6.3166	41.5747	3.9551
4.7235	4.2311	3.9583	6.3415	41.8525	3.9583
4.7216	4.2706	3.9614	6.3664	42.1285	3.9614
4.7196	4.3100	3.9643	6.3914	42.4030	3.9643
4.7174	4.3495	3.9671	6.4165	42.6760	3.9671
4.7152	4.3889	3.9698	6.4417	42.9474	3.9698
4.7129	4.4284	3.9723	6.4670	43.2174	3.9723
4.7104	4.4678	3.9747	6.4923	43.4860	3.9747
4.7079	4.5073	3.9771	6.5177	43.7532	3.9771
4.7052	4.5468	3.9792	6.5431	44.0191	3.9792
4.7023	4.5862	3.9813	6.5685	44.2838	3.9813
4.6993	4.6257	3.9832	6.5940	44.5473	3.9832
4.6962	4.6651	3.9851	6.6195	44.8097	3.9851



4.6929	4.7045	3.9868	6.6450	45.0711	3.9868
4.6894	4.7440	3.9884	6.6705	45.3315	3.9884
4.6857	4.7834	3.9899	6.6960	45.5910	3.9899
4.6818	4.8228	3.9912	6.7215	45.8497	3.9912
4.6777	4.8622	3.9925	6.7470	46.1077	3.9925
4.6734	4.9015	3.9937	6.7724	46.3650	3.9937
4.6688	4.9408	3.9947	6.7977	46.6217	3.9947
4.6639	4.9801	3.9957	6.8230	46.8780	3.9957
4.6588	5.0194	3.9965	6.8483	47.1339	3.9965
4.6534	5.0586	3.9973	6.8734	47.3895	3.9973
4.6476	5.0978	3.9979	6.8984	47.6448	3.9979
4.6416	5.1370	3.9985	6.9234	47.9000	3.9985
4.6352	5.1761	3.9990	6.9482	48.1551	3.9990
4.6285	5.2151	3.9993	6.9728	48.4102	3.9993
4.6215	5.2541	3.9996	6.9974	48.6653	3.9996
4.6140	5.2930	3.9998	7.0217	48.9205	3.9998
4.6062	5.3318	4.0000	7.0460	49.1759	4.0000
4.5980	5.3706	4.0000	7.0700	49.4314	4.0000

PARTIAL BLADE SUCTION SIDE

STREAMLINE 1

X	Y	Z	R	THETA	Z
3.5281	1.0618	4.0954	3.6844	16.7492	4.0954
3.5163	1.0721	4.0876	3.6761	16.9556	4.0876
3.5065	1.0855	4.0824	3.6706	17.2016	4.0824
3.4998	1.1016	4.0809	3.6691	17.4723	4.0809
3.4977	1.1271	4.0863	3.6748	17.8606	4.0863
3.5007	1.1513	4.0961	3.6851	18.2048	4.0961
3.5040	1.1754	4.1062	3.6959	18.5439	4.1062
3.5074	1.1995	4.1162	3.7068	18.8802	4.1162
3.5108	1.2235	4.1263	3.7179	19.2135	4.1263
3.5144	1.2476	4.1365	3.7293	19.5440	4.1365
3.5218	1.2955	4.1568	3.7525	20.1965	4.1568
3.5295	1.3434	4.1772	3.7766	20.8379	4.1772
3.5376	1.3912	4.1977	3.8013	21.4685	4.1977
3.5459	1.4390	4.2181	3.8268	22.0885	4.2181
3.5546	1.4868	4.2385	3.8530	22.6981	4.2385
3.5635	1.5345	4.2588	3.8798	23.2978	4.2588
3.5726	1.5823	4.2790	3.9073	23.8877	4.2790
3.5820	1.6300	4.2990	3.9355	24.4682	4.2990
3.5916	1.6778	4.3189	3.9642	25.0395	4.3189
3.6014	1.7257	4.3385	3.9935	25.6020	4.3385
3.6114	1.7736	4.3579	4.0234	26.1560	4.3579
3.6214	1.8215	4.3770	4.0538	26.7018	4.3770
3.6317	1.8696	4.3959	4.0846	27.2397	4.3959
3.6420	1.9177	4.4145	4.1160	27.7699	4.4145
3.6523	1.9660	4.4328	4.1479	28.2928	4.4328
3.6628	2.0143	4.4508	4.1801	28.8086	4.4508
3.6732	2.0628	4.4685	4.2128	29.3175	4.4685
3.6837	2.1114	4.4859	4.2459	29.8200	4.4859
3.6941	2.1601	4.5029	4.2793	30.3163	4.5029
3.7045	2.2089	4.5195	4.3131	30.8065	4.5195
3.7149	2.2579	4.5358	4.3472	31.2909	4.5358
3.7251	2.3070	4.5518	4.3816	31.7697	4.5518
3.7353	2.3562	4.5674	4.4163	32.2431	4.5674
3.7454	2.4055	4.5827	4.4513	32.7112	4.5827
3.7553	2.4550	4.5976	4.4866	33.1743	4.5976
3.7651	2.5046	4.6122	4.5221	33.6323	4.6122

3.7748	2.5544	4.6264	4.5579	34.0855	4.6264
3.7844	2.6042	4.6403	4.5938	34.5340	4.6403
3.7938	2.6542	4.6539	4.6301	34.9777	4.6539
3.8030	2.7043	4.6671	4.6665	35.4166	4.6671
3.8121	2.7545	4.6800	4.7031	35.8512	4.6800
3.8209	2.8049	4.6925	4.7399	36.2817	4.6925
3.8296	2.8553	4.7048	4.7769	36.7080	4.7048
3.8381	2.9059	4.7167	4.8140	37.1302	4.7167
3.8463	2.9566	4.7283	4.8514	37.5484	4.7283
3.8544	3.0073	4.7396	4.8888	37.9627	4.7396
3.8623	3.0582	4.7505	4.9264	38.3730	4.7505
3.8699	3.1092	4.7612	4.9642	38.7794	4.7612
3.8773	3.1603	4.7716	5.0021	39.1821	4.7716
3.8845	3.2114	4.7817	5.0401	39.5811	4.7817
3.8915	3.2627	4.7914	5.0783	39.9764	4.7914
3.8983	3.3140	4.8009	5.1166	40.3681	4.8009
3.9049	3.3654	4.8102	5.1550	40.7563	4.8102
3.9112	3.4169	4.8191	5.1935	41.1410	4.8191
3.9173	3.4684	4.8278	5.2321	41.5224	4.8278
3.9231	3.5200	4.8362	5.2708	41.9002	4.8362
3.9287	3.5717	4.8444	5.3096	42.2750	4.8444
3.9341	3.6235	4.8522	5.3485	42.6465	4.8522
3.9392	3.6753	4.8599	5.3875	43.0149	4.8599
3.9441	3.7272	4.8673	5.4266	43.3802	4.8673
3.9488	3.7791	4.8744	5.4658	43.7424	4.8744
3.9532	3.8311	4.8813	5.5050	44.1016	4.8813
3.9574	3.8832	4.8880	5.5443	44.4579	4.8880
3.9613	3.9353	4.8944	5.5837	44.8113	4.8944
3.9649	3.9874	4.9006	5.6232	45.1618	4.9006
3.9684	4.0396	4.9066	5.6627	45.5095	4.9066
3.9716	4.0918	4.9124	5.7023	45.8544	4.9124
3.9745	4.1441	4.9179	5.7420	46.1964	4.9179
3.9772	4.1964	4.9233	5.7817	46.5357	4.9233
3.9797	4.2487	4.9284	5.8215	46.8723	4.9284
3.9820	4.3010	4.9333	5.8613	47.2061	4.9333
3.9840	4.3534	4.9381	5.9012	47.5372	4.9381
3.9858	4.4058	4.9426	5.9412	47.8655	4.9426
3.9874	4.4583	4.9469	5.9813	48.1910	4.9469
3.9888	4.5107	4.9511	6.0214	48.5137	4.9511
3.9900	4.5632	4.9550	6.0616	48.8336	4.9550
3.9911	4.6157	4.9588	6.1019	49.1507	4.9588
3.9920	4.6682	4.9624	6.1423	49.4648	4.9624
3.9927	4.7207	4.9658	6.1828	49.7761	4.9658
3.9933	4.7732	4.9690	6.2233	50.0843	4.9690
3.9937	4.8258	4.9721	6.2640	50.3895	4.9721
3.9941	4.8783	4.9750	6.3048	50.6916	4.9750
3.9943	4.9309	4.9777	6.3457	50.9905	4.9777
3.9945	4.9835	4.9803	6.3868	51.2861	4.9803
3.9946	5.0360	4.9827	6.4280	51.5783	4.9827
3.9947	5.0886	4.9849	6.4693	51.8670	4.9849
3.9948	5.1412	4.9870	6.5108	52.1520	4.9870
3.9949	5.1938	4.9889	6.5525	52.4335	4.9889
3.9951	5.2464	4.9907	6.5944	52.7112	4.9907
3.9953	5.2990	4.9923	6.6364	52.9850	4.9923
3.9955	5.3516	4.9938	6.6787	53.2549	4.9938
3.9959	5.4043	4.9951	6.7211	53.5205	4.9951
3.9965	5.4569	4.9962	6.7638	53.7818	4.9962
3.9972	5.5095	4.9972	6.8068	54.0385	4.9972
3.9982	5.5621	4.9981	6.8500	54.2905	4.9981
3.9994	5.6147	4.9988	6.8935	54.5377	4.9988

4.0008	5.6673	4.9993
4.0025	5.7200	4.9997
4.0044	5.7725	4.9999
4.0066	5.8251	5.0000

6.9372	54.7802	4.9993
6.9812	55.0179	4.9997
7.0255	55.2508	4.9999
7.0700	55.4794	5.0000

STREAMLINE 2

X	Y	Z	R	THETA	Z
3.6089	1.1052	4.0463	3.7744	17.0273	4.0463
3.5972	1.1150	4.0384	3.7660	17.2218	4.0384
3.5873	1.1280	4.0330	3.7605	17.4558	4.0330
3.5805	1.1437	4.0313	3.7588	17.7151	4.0313
3.5778	1.1688	4.0363	3.7639	18.0908	4.0363
3.5802	1.1928	4.0456	3.7737	18.4266	4.0456
3.5828	1.2167	4.0552	3.7838	18.7575	4.0552
3.5856	1.2406	4.0648	3.7941	19.0857	4.0648
3.5884	1.2645	4.0745	3.8047	19.4112	4.0745
3.5913	1.2883	4.0842	3.8154	19.7340	4.0842
3.5975	1.3359	4.1038	3.8375	20.3717	4.1038
3.6039	1.3833	4.1234	3.8603	20.9989	4.1234
3.6108	1.4308	4.1431	3.8839	21.6158	4.1431
3.6179	1.4781	4.1629	3.9082	22.2227	4.1629
3.6253	1.5254	4.1826	3.9332	22.8199	4.1826
3.6330	1.5727	4.2023	3.9588	23.4075	4.2023
3.6410	1.6200	4.2218	3.9852	23.9858	4.2218
3.6492	1.6673	4.2413	4.0121	24.5551	4.2413
3.6577	1.7146	4.2606	4.0396	25.1158	4.2606
3.6664	1.7620	4.2797	4.0678	25.6680	4.2797
3.6752	1.8094	4.2986	4.0965	26.2120	4.2986
3.6842	1.8568	4.3173	4.1257	26.7482	4.3173
3.6933	1.9044	4.3357	4.1554	27.2768	4.3357
3.7026	1.9520	4.3539	4.1856	27.7980	4.3539
3.7119	1.9997	4.3718	4.2163	28.3123	4.3718
3.7213	2.0475	4.3894	4.2474	28.8197	4.3894
3.7307	2.0954	4.4067	4.2789	29.3208	4.4067
3.7402	2.1434	4.4237	4.3108	29.8156	4.4237
3.7497	2.1915	4.4404	4.3431	30.3043	4.4404
3.7591	2.2397	4.4567	4.3758	30.7873	4.4567
3.7685	2.2881	4.4727	4.4087	31.2646	4.4727
3.7778	2.3366	4.4884	4.4420	31.7366	4.4884
3.7871	2.3852	4.5037	4.4756	32.2034	4.5037
3.7962	2.4339	4.5187	4.5095	32.6651	4.5187
3.8053	2.4827	4.5334	4.5436	33.1219	4.5334
3.8143	2.5317	4.5477	4.5780	33.5739	4.5477
3.8231	2.5808	4.5617	4.6126	34.0211	4.5617
3.8318	2.6300	4.5754	4.6475	34.4637	4.5754
3.8404	2.6793	4.5887	4.6826	34.9016	4.5887
3.8489	2.7287	4.6018	4.7180	35.3347	4.6018
3.8572	2.7782	4.6145	4.7536	35.7636	4.6145
3.8653	2.8278	4.6268	4.7893	36.1885	4.6268
3.8733	2.8776	4.6389	4.8252	36.6093	4.6389
3.8811	2.9274	4.6507	4.8613	37.0262	4.6507
3.8887	2.9773	4.6621	4.8976	37.4391	4.6621
3.8961	3.0274	4.6732	4.9340	37.8482	4.6732
3.9033	3.0775	4.6841	4.9706	38.2534	4.6841
3.9103	3.1277	4.6946	5.0073	38.6549	4.6946
3.9172	3.1780	4.7048	5.0442	39.0526	4.7048
3.9238	3.2284	4.7148	5.0813	39.4467	4.7148
3.9303	3.2789	4.7245	5.1184	39.8372	4.7245
3.9365	3.3295	4.7339	5.1557	40.2242	4.7339

3.9425	3.3801	4.7430	5.1931	40.6077	4.7430
3.9484	3.4308	4.7518	5.2307	40.9878	4.7518
3.9540	3.4816	4.7604	5.2683	41.3645	4.7604
3.9594	3.5324	4.7687	5.3061	41.7378	4.7687
3.9646	3.5833	4.7768	5.3439	42.1080	4.7768
3.9695	3.6342	4.7846	5.3819	42.4750	4.7846
3.9743	3.6853	4.7922	5.4200	42.8389	4.7922
3.9788	3.7363	4.7995	5.4581	43.1997	4.7995
3.9831	3.7875	4.8066	5.4964	43.5575	4.8066
3.9872	3.8386	4.8134	5.5347	43.9123	4.8134
3.9911	3.8899	4.8201	5.5731	44.2642	4.8201
3.9947	3.9411	4.8264	5.6116	44.6132	4.8264
3.9981	3.9924	4.8326	5.6502	44.9594	4.8326
4.0013	4.0438	4.8385	5.6888	45.3027	4.8385
4.0043	4.0952	4.8442	5.7275	45.6432	4.8442
4.0070	4.1466	4.8498	5.7663	45.9810	4.8498
4.0095	4.1981	4.8551	5.8052	46.3159	4.8551
4.0119	4.2496	4.8601	5.8441	46.6482	4.8601
4.0140	4.3011	4.8650	5.8831	46.9777	4.8650
4.0159	4.3526	4.8697	5.9222	47.3045	4.8697
4.0176	4.4042	4.8742	5.9614	47.6286	4.8742
4.0191	4.4558	4.8785	6.0006	47.9498	4.8785
4.0204	4.5074	4.8826	6.0399	48.2683	4.8826
4.0216	4.5590	4.8866	6.0793	48.5840	4.8866
4.0226	4.6107	4.8903	6.1188	48.8968	4.8903
4.0235	4.6624	4.8939	6.1584	49.2068	4.8939
4.0242	4.7140	4.8973	6.1981	49.5138	4.8973
4.0248	4.7657	4.9005	6.2379	49.8179	4.9005
4.0253	4.8174	4.9035	6.2778	50.1189	4.9035
4.0257	4.8691	4.9064	6.3178	50.4168	4.9064
4.0260	4.9209	4.9091	6.3580	50.7115	4.9091
4.0263	4.9726	4.9117	6.3983	51.0029	4.9117
4.0266	5.0243	4.9141	6.4387	51.2910	4.9141
4.0268	5.0761	4.9163	6.4793	51.5755	4.9163
4.0270	5.1278	4.9184	6.5201	51.8564	4.9184
4.0273	5.1796	4.9203	6.5611	52.1337	4.9203
4.0276	5.2314	4.9221	6.6022	52.4073	4.9221
4.0280	5.2831	4.9237	6.6435	52.6770	4.9237
4.0285	5.3349	4.9251	6.6850	52.9428	4.9251
4.0291	5.3867	4.9264	6.7268	53.2044	4.9264
4.0299	5.4384	4.9276	6.7688	53.4616	4.9276
4.0309	5.4902	4.9286	6.8111	53.7143	4.9286
4.0321	5.5420	4.9294	6.8536	53.9623	4.9294
4.0335	5.5938	4.9301	6.8963	54.2057	4.9301
4.0352	5.6455	4.9307	6.9394	54.4443	4.9307
4.0372	5.6973	4.9310	6.9827	54.6782	4.9310
4.0394	5.7490	4.9313	7.0262	54.9075	4.9313
4.0418	5.8008	4.9314	7.0700	55.1325	4.9314

STREAMLINE 3

X	Y	Z	R	THETA	Z
3.6895	1.1495	3.9973	3.8645	17.3044	3.9973
3.6779	1.1588	3.9893	3.8561	17.4876	3.9893
3.6679	1.1713	3.9838	3.8504	17.7097	3.9838
3.6609	1.1865	3.9818	3.8484	17.9579	3.9818
3.6577	1.2112	3.9863	3.8530	18.3214	3.9863
3.6594	1.2350	3.9952	3.8622	18.6487	3.9952
3.6615	1.2587	4.0043	3.8718	18.9715	4.0043
3.6636	1.2824	4.0135	3.8815	19.2916	4.0135

3.6658	1.3060	4.0227	3.8915	19.6093	4.0227
3.6681	1.3296	4.0321	3.9017	19.9244	4.0321
3.6730	1.3767	4.0508	3.9226	20.5472	4.0508
3.6783	1.4238	4.0697	3.9442	21.1602	4.0697
3.6839	1.4707	4.0887	3.9666	21.7635	4.0887
3.6898	1.5176	4.1077	3.9897	22.3573	4.1077
3.6961	1.5645	4.1267	4.0135	22.9419	4.1267
3.7026	1.6113	4.1457	4.0380	23.5175	4.1457
3.7094	1.6581	4.1647	4.0631	24.0843	4.1647
3.7165	1.7049	4.1836	4.0889	24.6425	4.1836
3.7238	1.7517	4.2023	4.1153	25.1924	4.2023
3.7314	1.7985	4.2209	4.1422	25.7343	4.2209
3.7391	1.8454	4.2393	4.1697	26.2685	4.2393
3.7470	1.8924	4.2575	4.1978	26.7951	4.2575
3.7551	1.9393	4.2755	4.2263	27.3145	4.2755
3.7633	1.9864	4.2932	4.2553	27.8269	4.2932
3.7716	2.0335	4.3107	4.2848	28.3325	4.3107
3.7799	2.0808	4.3279	4.3148	28.8317	4.3279
3.7884	2.1281	4.3448	4.3452	29.3245	4.3448
3.7968	2.1755	4.3615	4.3759	29.8115	4.3615
3.8053	2.2230	4.3778	4.4070	30.2928	4.3778
3.8138	2.2706	4.3938	4.4385	30.7684	4.3938
3.8222	2.3183	4.4095	4.4704	31.2387	4.4095
3.8306	2.3662	4.4249	4.5025	31.7038	4.4249
3.8390	2.4142	4.4400	4.5350	32.1639	4.4400
3.8472	2.4622	4.4547	4.5677	32.6191	4.4547
3.8554	2.5104	4.4691	4.6007	33.0696	4.4691
3.8635	2.5587	4.4832	4.6340	33.5154	4.4832
3.8715	2.6071	4.4970	4.6675	33.9566	4.4970
3.8794	2.6556	4.5104	4.7013	34.3932	4.5104
3.8872	2.7042	4.5236	4.7353	34.8253	4.5236
3.8949	2.7529	4.5364	4.7696	35.2527	4.5364
3.9025	2.8017	4.5489	4.8041	35.6760	4.5489
3.9099	2.8507	4.5611	4.8388	36.0953	4.5611
3.9172	2.8997	4.5730	4.8736	36.5107	4.5730
3.9242	2.9488	4.5846	4.9087	36.9222	4.5846
3.9312	2.9980	4.5959	4.9439	37.3299	4.5959
3.9379	3.0473	4.6068	4.9793	37.7337	4.6068
3.9445	3.0967	4.6175	5.0148	38.1338	4.6175
3.9509	3.1461	4.6279	5.0506	38.5302	4.6279
3.9572	3.1957	4.6381	5.0864	38.9230	4.6381
3.9633	3.2453	4.6479	5.1224	39.3122	4.6479
3.9692	3.2950	4.6575	5.1586	39.6978	4.6575
3.9749	3.3448	4.6667	5.1949	40.0800	4.6667
3.9804	3.3946	4.6758	5.2313	40.4588	4.6758
3.9857	3.4445	4.6845	5.2679	40.8342	4.6845
3.9909	3.4945	4.6930	5.3046	41.2063	4.6930
3.9958	3.5445	4.7013	5.3414	41.5749	4.7013
4.0006	3.5946	4.7092	5.3783	41.9406	4.7092
4.0051	3.6448	4.7170	5.4153	42.3031	4.7170
4.0095	3.6950	4.7245	5.4525	42.6625	4.7245
4.0137	3.7453	4.7317	5.4897	43.0189	4.7317
4.0176	3.7956	4.7387	5.5270	43.3722	4.7387
4.0214	3.8460	4.7455	5.5644	43.7227	4.7455
4.0249	3.8964	4.7521	5.6019	44.0702	4.7521
4.0283	3.9468	4.7584	5.6395	44.4148	4.7584
4.0314	3.9973	4.7645	5.6772	44.7566	4.7645
4.0343	4.0478	4.7704	5.7150	45.0956	4.7704
4.0371	4.0984	4.7761	5.7528	45.4319	4.7761
4.0396	4.1490	4.7815	5.7907	45.7653	4.7815

4.0419	4.1996	4.7868	5.8287	46.0960	4.7868
4.0441	4.2503	4.7919	5.8668	46.4240	4.7919
4.0460	4.3010	4.7967	5.9050	46.7493	4.7967
4.0478	4.3517	4.8014	5.9432	47.0718	4.8014
4.0494	4.4024	4.8058	5.9815	47.3916	4.8058
4.0508	4.4532	4.8101	6.0200	47.7086	4.8101
4.0521	4.5039	4.8142	6.0585	48.0229	4.8142
4.0532	4.5547	4.8181	6.0971	48.3343	4.8181
4.0542	4.6055	4.8218	6.1357	48.6430	4.8218
4.0550	4.6564	4.8254	6.1745	48.9487	4.8254
4.0558	4.7072	4.8288	6.2134	49.2515	4.8288
4.0564	4.7580	4.8320	6.2524	49.5514	4.8320
4.0569	4.8089	4.8350	6.2916	49.8482	4.8350
4.0574	4.8598	4.8379	6.3308	50.1419	4.8379
4.0578	4.9107	4.8406	6.3702	50.4324	4.8406
4.0581	4.9615	4.8431	6.4098	50.7197	4.8431
4.0585	5.0124	4.8455	6.4495	51.0035	4.8455
4.0588	5.0633	4.8477	6.4893	51.2839	4.8477
4.0592	5.1142	4.8498	6.5294	51.5607	4.8498
4.0597	5.1652	4.8517	6.5696	51.8338	4.8517
4.0601	5.2161	4.8535	6.6100	52.1032	4.8535
4.0607	5.2670	4.8551	6.6506	52.3689	4.8551
4.0614	5.3180	4.8565	6.6914	52.6306	4.8565
4.0622	5.3689	4.8578	6.7325	52.8881	4.8578
4.0632	5.4198	4.8589	6.7738	53.1413	4.8589
4.0644	5.4707	4.8599	6.8153	53.3900	4.8599
4.0659	5.5217	4.8608	6.8571	53.6341	4.8608
4.0675	5.5726	4.8615	6.8992	53.8736	4.8615
4.0695	5.6235	4.8620	6.9415	54.1084	4.8620
4.0717	5.6744	4.8624	6.9841	54.3385	4.8624
4.0742	5.7253	4.8626	7.0269	54.5641	4.8626
4.0768	5.7762	4.8627	7.0700	54.7855	4.8627

STREAMLINE 4

X	Y	Z	R	THETA	Z
3.7699	1.1945	3.9485	3.9546	17.5809	3.9485
3.7583	1.2033	3.9403	3.9463	17.7531	3.9403
3.7483	1.2153	3.9346	3.9404	17.9635	3.9346
3.7411	1.2301	3.9324	3.9382	18.2009	3.9324
3.7373	1.2543	3.9363	3.9422	18.5526	3.9363
3.7384	1.2779	3.9448	3.9508	18.8715	3.9448
3.7399	1.3013	3.9534	3.9598	19.1861	3.9534
3.7414	1.3248	3.9622	3.9690	19.4982	3.9622
3.7430	1.3482	3.9710	3.9784	19.8080	3.9710
3.7447	1.3715	3.9799	3.9880	20.1155	3.9799
3.7484	1.4182	3.9979	4.0077	20.7234	3.9979
3.7525	1.4647	4.0160	4.0282	21.3221	4.0160
3.7569	1.5112	4.0342	4.0495	21.9118	4.0342
3.7617	1.5576	4.0526	4.0714	22.4925	4.0526
3.7668	1.6039	4.0709	4.0940	23.0646	4.0709
3.7722	1.6502	4.0893	4.1173	23.6281	4.0893
3.7779	1.6965	4.1076	4.1413	24.1833	4.1076
3.7838	1.7428	4.1259	4.1659	24.7305	4.1259
3.7900	1.7891	4.1441	4.1911	25.2697	4.1441
3.7964	1.8354	4.1621	4.2168	25.8014	4.1621
3.8031	1.8817	4.1800	4.2432	26.3256	4.1800
3.8099	1.9281	4.1977	4.2700	26.8427	4.1977
3.8169	1.9745	4.2153	4.2974	27.3529	4.2153
3.8240	2.0210	4.2326	4.3253	27.8564	4.2326

3.8313	2.0676	4.2496	4.3536	28.3535	4.2496
3.8387	2.1142	4.2665	4.3824	28.8443	4.2665
3.8461	2.1609	4.2830	4.4116	29.3292	4.2830
3.8536	2.2077	4.2993	4.4412	29.8086	4.2993
3.8611	2.2546	4.3153	4.4711	30.2823	4.3153
3.8686	2.3016	4.3310	4.5015	30.7506	4.3310
3.8761	2.3487	4.3464	4.5322	31.2137	4.3464
3.8836	2.3959	4.3614	4.5632	31.6719	4.3614
3.8910	2.4432	4.3762	4.5945	32.1252	4.3762
3.8984	2.4906	4.3907	4.6261	32.5739	4.3907
3.9057	2.5381	4.4048	4.6580	33.0179	4.4048
3.9130	2.5858	4.4187	4.6901	33.4574	4.4187
3.9201	2.6335	4.4322	4.7226	33.8925	4.4322
3.9272	2.6813	4.4454	4.7552	34.3232	4.4454
3.9342	2.7292	4.4583	4.7882	34.7494	4.4583
3.9411	2.7772	4.4710	4.8213	35.1712	4.4710
3.9479	2.8253	4.4833	4.8547	35.5888	4.4833
3.9546	2.8735	4.4953	4.8883	36.0026	4.4953
3.9612	2.9218	4.5070	4.9221	36.4125	4.5070
3.9676	2.9701	4.5184	4.9561	36.8186	4.5184
3.9738	3.0186	4.5296	4.9903	37.2210	4.5296
3.9799	3.0671	4.5404	5.0247	37.6196	4.5404
3.9859	3.1158	4.5510	5.0592	38.0145	4.5510
3.9917	3.1645	4.5612	5.0939	38.4059	4.5612
3.9974	3.2132	4.5712	5.1287	38.7936	4.5712
4.0029	3.2621	4.5810	5.1637	39.1778	4.5810
4.0082	3.3110	4.5904	5.1989	39.5586	4.5904
4.0134	3.3600	4.5996	5.2342	39.9359	4.5996
4.0184	3.4091	4.6085	5.2697	40.3099	4.6085
4.0233	3.4582	4.6172	5.3053	40.6806	4.6172
4.0279	3.5074	4.6256	5.3410	41.0480	4.6256
4.0324	3.5566	4.6337	5.3768	41.4121	4.6337
4.0368	3.6059	4.6416	5.4128	41.7732	4.6416
4.0409	3.6552	4.6493	5.4488	42.1311	4.6493
4.0449	3.7046	4.6567	5.4850	42.4861	4.6567
4.0487	3.7541	4.6639	5.5213	42.8380	4.6639
4.0523	3.8036	4.6709	5.5577	43.1869	4.6709
4.0557	3.8531	4.6776	5.5942	43.5330	4.6776
4.0589	3.9027	4.6841	5.6308	43.8761	4.6841
4.0620	3.9523	4.6903	5.6675	44.2164	4.6903
4.0648	4.0020	4.6964	5.7043	44.5539	4.6964
4.0675	4.0517	4.7022	5.7411	44.8886	4.7022
4.0700	4.1014	4.7079	5.7781	45.2205	4.7079
4.0723	4.1512	4.7133	5.8152	45.5497	4.7133
4.0744	4.2010	4.7185	5.8523	45.8762	4.7185
4.0764	4.2508	4.7235	5.8895	46.1999	4.7235
4.0782	4.3007	4.7284	5.9268	46.5209	4.7284
4.0798	4.3505	4.7330	5.9642	46.8392	4.7330
4.0813	4.4004	4.7374	6.0017	47.1548	4.7374
4.0826	4.4503	4.7417	6.0393	47.4676	4.7417
4.0838	4.5003	4.7458	6.0770	47.7776	4.7458
4.0849	4.5502	4.7496	6.1148	48.0848	4.7496
4.0858	4.6002	4.7533	6.1527	48.3892	4.7533
4.0866	4.6502	4.7569	6.1907	48.6908	4.7569
4.0873	4.7002	4.7602	6.2288	48.9894	4.7602
4.0880	4.7502	4.7634	6.2670	49.2850	4.7634
4.0885	4.8002	4.7664	6.3054	49.5776	4.7664
4.0890	4.8502	4.7693	6.3439	49.8671	4.7693
4.0895	4.9003	4.7720	6.3825	50.1534	4.7720
4.0900	4.9503	4.7745	6.4213	50.4364	4.7745

4.0904	5.0004	4.7769	6.4603	50.7161	4.7769
4.0909	5.0504	4.7791	6.4994	50.9923	4.7791
4.0914	5.1005	4.7812	6.5387	51.2649	4.7812
4.0920	5.1506	4.7831	6.5782	51.5339	4.7831
4.0926	5.2006	4.7848	6.6179	51.7992	4.7848
4.0934	5.2507	4.7864	6.6578	52.0607	4.7864
4.0942	5.3008	4.7879	6.6979	52.3183	4.7879
4.0952	5.3509	4.7892	6.7382	52.5718	4.7892
4.0965	5.4010	4.7903	6.7788	52.8209	4.7903
4.0979	5.4511	4.7913	6.8196	53.0656	4.7913
4.0996	5.5011	4.7921	6.8607	53.3058	4.7921
4.1015	5.5512	4.7928	6.9020	53.5414	4.7928
4.1037	5.6013	4.7934	6.9437	53.7724	4.7934
4.1061	5.6513	4.7938	6.9855	53.9988	4.7938
4.1088	5.7014	4.7940	7.0277	54.2207	4.7940
4.1118	5.7514	4.7941	7.0700	54.4385	4.7941

STREAMLINE 5

X	Y	Z	R	THETA	Z
3.9381	1.2918	3.8460	4.1445	18.1611	3.8460
3.9267	1.2995	3.8377	4.1361	18.3118	3.8377
3.9166	1.3103	3.8315	4.1300	18.4983	3.8315
3.9089	1.3241	3.8286	4.1271	18.7135	3.8286
3.9039	1.3474	3.8314	4.1298	19.0413	3.8314
3.9037	1.3703	3.8388	4.1373	19.3428	3.8388
3.9040	1.3932	3.8466	4.1451	19.6403	3.8466
3.9043	1.4161	3.8545	4.1532	19.9357	3.8545
3.9047	1.4389	3.8624	4.1614	20.2291	3.8624
3.9052	1.4617	3.8704	4.1698	20.5205	3.8704
3.9065	1.5072	3.8867	4.1872	21.0973	3.8867
3.9082	1.5526	3.9032	4.2053	21.6661	3.9032
3.9103	1.5979	3.9199	4.2242	22.2271	3.9199
3.9127	1.6432	3.9368	4.2437	22.7804	3.9368
3.9154	1.6883	3.9537	4.2639	23.3260	3.9537
3.9185	1.7335	3.9707	4.2848	23.8642	3.9707
3.9218	1.7786	3.9878	4.3063	24.3951	3.9878
3.9254	1.8237	4.0048	4.3284	24.9188	4.0048
3.9294	1.8688	4.0218	4.3511	25.4356	4.0218
3.9335	1.9139	4.0387	4.3744	25.9456	4.0387
3.9379	1.9590	4.0555	4.3983	26.4490	4.0555
3.9425	2.0041	4.0722	4.4227	26.9460	4.0722
3.9473	2.0493	4.0887	4.4476	27.4368	4.0887
3.9523	2.0945	4.1050	4.4730	27.9216	4.1050
3.9574	2.1398	4.1212	4.4988	28.4006	4.1212
3.9626	2.1851	4.1372	4.5251	28.8739	4.1372
3.9679	2.2305	4.1529	4.5519	29.3419	4.1529
3.9733	2.2760	4.1684	4.5790	29.8047	4.1684
3.9788	2.3215	4.1836	4.6066	30.2623	4.1836
3.9844	2.3672	4.1986	4.6345	30.7150	4.1986
3.9899	2.4129	4.2134	4.6628	31.1630	4.2134
3.9955	2.4587	4.2278	4.6914	31.6064	4.2278
4.0010	2.5045	4.2420	4.7203	32.0453	4.2420
4.0066	2.5505	4.2559	4.7495	32.4799	4.2559
4.0121	2.5966	4.2695	4.7790	32.9102	4.2695
4.0176	2.6427	4.2828	4.8088	33.3363	4.2828
4.0230	2.6889	4.2958	4.8389	33.7583	4.2958
4.0284	2.7352	4.3086	4.8692	34.1762	4.3086
4.0337	2.7816	4.3210	4.8998	34.5901	4.3210
4.0390	2.8281	4.3332	4.9307	34.9998	4.3332



4.0442	2.8747	4.3451	4.9618	35.4056	4.3451
4.0494	2.9213	4.3568	4.9931	35.8077	4.3568
4.0544	2.9680	4.3681	5.0247	36.2061	4.3681
4.0593	3.0148	4.3792	5.0564	36.6008	4.3792
4.0642	3.0617	4.3900	5.0884	36.9919	4.3900
4.0689	3.1086	4.4005	5.1205	37.3795	4.4005
4.0736	3.1556	4.4108	5.1529	37.7635	4.4108
4.0781	3.2027	4.4208	5.1854	38.1441	4.4208
4.0825	3.2499	4.4305	5.2181	38.5212	4.4305
4.0868	3.2971	4.4400	5.2510	38.8950	4.4400
4.0910	3.3443	4.4492	5.2840	39.2654	4.4492
4.0951	3.3917	4.4582	5.3172	39.6325	4.4582
4.0990	3.4390	4.4669	5.3506	39.9964	4.4669
4.1028	3.4865	4.4754	5.3841	40.3571	4.4754
4.1065	3.5340	4.4836	5.4178	40.7147	4.4836
4.1100	3.5815	4.4916	5.4516	41.0692	4.4916
4.1134	3.6291	4.4993	5.4855	41.4206	4.4993
4.1167	3.6767	4.5068	5.5196	41.7690	4.5068
4.1198	3.7244	4.5141	5.5538	42.1145	4.5141
4.1228	3.7722	4.5211	5.5881	42.4570	4.5211
4.1256	3.8199	4.5280	5.6225	42.7967	4.5280
4.1283	3.8677	4.5346	5.6571	43.1335	4.5346
4.1309	3.9156	4.5409	5.6917	43.4675	4.5409
4.1333	3.9635	4.5471	5.7265	43.7987	4.5471
4.1355	4.0114	4.5531	5.7614	44.1271	4.5531
4.1376	4.0593	4.5588	5.7964	44.4528	4.5588
4.1396	4.1073	4.5644	5.8315	44.7757	4.5644
4.1414	4.1553	4.5697	5.8667	45.0960	4.5697
4.1431	4.2034	4.5748	5.9020	45.4135	4.5748
4.1447	4.2514	4.5798	5.9374	45.7283	4.5798
4.1461	4.2995	4.5845	5.9730	46.0404	4.5845
4.1474	4.3476	4.5891	6.0086	46.3498	4.5891
4.1486	4.3957	4.5935	6.0443	46.6565	4.5935
4.1497	4.4439	4.5977	6.0802	46.9604	4.5977
4.1507	4.4920	4.6017	6.1161	47.2616	4.6017
4.1516	4.5402	4.6056	6.1522	47.5599	4.6056
4.1524	4.5884	4.6092	6.1884	47.8555	4.6092
4.1532	4.6366	4.6127	6.2247	48.1481	4.6127
4.1539	4.6848	4.6160	6.2612	48.4379	4.6160
4.1545	4.7331	4.6192	6.2978	48.7247	4.6192
4.1551	4.7813	4.6222	6.3345	49.0084	4.6222
4.1557	4.8296	4.6250	6.3714	49.2891	4.6250
4.1563	4.8778	4.6277	6.4084	49.5665	4.6277
4.1569	4.9261	4.6302	6.4456	49.8407	4.6302
4.1575	4.9744	4.6326	6.4830	50.1116	4.6326
4.1582	5.0227	4.6348	6.5206	50.3790	4.6348
4.1590	5.0709	4.6368	6.5583	50.6429	4.6368
4.1598	5.1192	4.6387	6.5963	50.9031	4.6387
4.1608	5.1675	4.6405	6.6344	51.1597	4.6405
4.1619	5.2158	4.6421	6.6728	51.4126	4.6421
4.1631	5.2641	4.6435	6.7114	51.6616	4.6435
4.1645	5.3124	4.6448	6.7502	51.9065	4.6448
4.1661	5.3607	4.6459	6.7893	52.1472	4.6459
4.1680	5.4090	4.6469	6.8286	52.3835	4.6469
4.1701	5.4573	4.6478	6.8682	52.6154	4.6478
4.1725	5.5056	4.6484	6.9081	52.8429	4.6484
4.1751	5.5539	4.6490	6.9482	53.0658	4.6490
4.1781	5.6021	4.6494	6.9886	53.2843	4.6494
4.1813	5.6503	4.6496	7.0292	53.4983	4.6496
4.1847	5.6986	4.6497	7.0700	53.7085	4.6497

STREAMLINE 6

X	Y	Z	R	THETA	Z
4.1048	1.3926	3.7439	4.3346	18.7404	3.7439
4.0937	1.3993	3.7354	4.3262	18.8717	3.7354
4.0835	1.4089	3.7288	4.3197	19.0358	3.7288
4.0754	1.4215	3.7251	4.3162	19.2291	3.7251
4.0691	1.4437	3.7266	4.3176	19.5340	3.7266
4.0678	1.4660	3.7331	4.3239	19.8181	3.7331
4.0669	1.4882	3.7400	4.3307	20.0988	3.7400
4.0661	1.5104	3.7469	4.3376	20.3778	3.7469
4.0654	1.5325	3.7540	4.3447	20.6550	3.7540
4.0648	1.5547	3.7612	4.3520	20.9305	3.7612
4.0639	1.5989	3.7758	4.3671	21.4765	3.7758
4.0633	1.6430	3.7907	4.3829	22.0157	3.7907
4.0631	1.6870	3.8059	4.3994	22.5482	3.8059
4.0633	1.7310	3.8212	4.4166	23.0740	3.8212
4.0638	1.7749	3.8367	4.4345	23.5933	3.8367
4.0646	1.8187	3.8524	4.4530	24.1061	3.8524
4.0657	1.8625	3.8681	4.4721	24.6125	3.8681
4.0672	1.9063	3.8838	4.4918	25.1127	3.8838
4.0689	1.9501	3.8996	4.5121	25.6069	3.8996
4.0709	1.9939	3.9153	4.5329	26.0951	3.9153
4.0731	2.0376	3.9310	4.5543	26.5774	3.9310
4.0755	2.0814	3.9467	4.5762	27.0541	3.9467
4.0782	2.1252	3.9622	4.5987	27.5253	3.9622
4.0810	2.1691	3.9776	4.6216	27.9912	3.9776
4.0840	2.2130	3.9928	4.6450	28.4518	3.9928
4.0872	2.2569	4.0079	4.6689	28.9074	4.0079
4.0904	2.3009	4.0228	4.6932	29.3581	4.0228
4.0939	2.3450	4.0375	4.7179	29.8041	4.0375
4.0973	2.3891	4.0520	4.7430	30.2454	4.0520
4.1009	2.4332	4.0662	4.7685	30.6823	4.0662
4.1046	2.4775	4.0803	4.7943	31.1148	4.0803
4.1082	2.5218	4.0941	4.8205	31.5432	4.0941
4.1120	2.5662	4.1076	4.8470	31.9674	4.1076
4.1157	2.6106	4.1209	4.8738	32.3876	4.1209
4.1194	2.6552	4.1340	4.9010	32.8039	4.1340
4.1231	2.6998	4.1468	4.9284	33.2164	4.1468
4.1269	2.7445	4.1593	4.9561	33.6250	4.1593
4.1306	2.7892	4.1716	4.9841	34.0299	4.1716
4.1342	2.8341	4.1836	5.0124	34.4311	4.1836
4.1379	2.8790	4.1953	5.0409	34.8287	4.1953
4.1415	2.9240	4.2068	5.0697	35.2226	4.2068
4.1451	2.9690	4.2181	5.0987	35.6129	4.2181
4.1486	3.0141	4.2290	5.1279	35.9996	4.2290
4.1521	3.0593	4.2398	5.1574	36.3829	4.2398
4.1555	3.1045	4.2502	5.1871	36.7627	4.2502
4.1589	3.1498	4.2605	5.2171	37.1391	4.2605
4.1622	3.1952	4.2704	5.2472	37.5122	4.2704
4.1654	3.2406	4.2801	5.2775	37.8819	4.2801
4.1686	3.2861	4.2896	5.3081	38.2484	4.2896
4.1717	3.3316	4.2988	5.3388	38.6116	4.2988
4.1747	3.3772	4.3078	5.3697	38.9716	4.3078
4.1776	3.4228	4.3166	5.4008	39.3285	4.3166
4.1805	3.4685	4.3251	5.4320	39.6823	4.3251
4.1832	3.5142	4.3333	5.4634	40.0330	4.3333
4.1859	3.5600	4.3414	5.4950	40.3808	4.3414
4.1884	3.6059	4.3492	5.5268	40.7255	4.3492

4.1909	3.6517	4.3568	5.5586	41.0673	4.3568
4.1932	3.6976	4.3641	5.5907	41.4062	4.3641
4.1955	3.7436	4.3713	5.6229	41.7422	4.3713
4.1976	3.7896	4.3782	5.6552	42.0754	4.3782
4.1997	3.8356	4.3849	5.6876	42.4057	4.3849
4.2016	3.8817	4.3914	5.7202	42.7333	4.3914
4.2035	3.9278	4.3976	5.7530	43.0581	4.3976
4.2052	3.9739	4.4037	5.7858	43.3802	4.4037
4.2068	4.0201	4.4096	5.8188	43.6996	4.4096
4.2083	4.0663	4.4152	5.8519	44.0162	4.4152
4.2098	4.1125	4.4207	5.8851	44.3302	4.4207
4.2111	4.1587	4.4259	5.9185	44.6415	4.4259
4.2123	4.2050	4.4310	5.9519	44.9501	4.4310
4.2134	4.2513	4.4359	5.9855	45.2560	4.4359
4.2145	4.2976	4.4406	6.0192	45.5592	4.4406
4.2155	4.3439	4.4451	6.0531	45.8597	4.4451
4.2163	4.3903	4.4494	6.0870	46.1576	4.4494
4.2172	4.4366	4.4536	6.1211	46.4526	4.4536
4.2179	4.4830	4.4576	6.1553	46.7449	4.4576
4.2186	4.5294	4.4614	6.1897	47.0345	4.4614
4.2193	4.5758	4.4650	6.2242	47.3212	4.4650
4.2199	4.6222	4.4685	6.2588	47.6050	4.4685
4.2206	4.6687	4.4718	6.2936	47.8859	4.4718
4.2212	4.7151	4.4749	6.3286	48.1638	4.4749
4.2218	4.7616	4.4779	6.3637	48.4388	4.4779
4.2224	4.8081	4.4807	6.3989	48.7106	4.4807
4.2231	4.8545	4.4834	6.4343	48.9793	4.4834
4.2238	4.9010	4.4859	6.4700	49.2447	4.4859
4.2246	4.9475	4.4882	6.5058	49.5068	4.4882
4.2254	4.9940	4.4904	6.5417	49.7654	4.4904
4.2264	5.0405	4.4925	6.5779	50.0206	4.4925
4.2275	5.0870	4.4943	6.6144	50.2721	4.4943
4.2287	5.1335	4.4961	6.6510	50.5200	4.4961
4.2301	5.1800	4.4977	6.6878	50.7643	4.4977
4.2317	5.2266	4.4991	6.7249	51.0047	4.4991
4.2334	5.2731	4.5004	6.7622	51.2411	4.5004
4.2354	5.3196	4.5015	6.7997	51.4734	4.5015
4.2377	5.3661	4.5025	6.8376	51.7013	4.5025
4.2402	5.4125	4.5034	6.8757	51.9250	4.5034
4.2430	5.4590	4.5041	6.9140	52.1442	4.5041
4.2461	5.5055	4.5046	6.9526	52.3590	4.5046
4.2494	5.5519	4.5050	6.9915	52.5695	4.5050
4.2531	5.5983	4.5052	7.0307	52.7756	4.5052
4.2570	5.6447	4.5053	7.0700	52.9780	4.5053

STREAMLINE 7

X	Y	Z	R	THETA	Z
4.2697	1.4968	3.6419	4.5245	19.3191	3.6419
4.2590	1.5026	3.6334	4.5163	19.4330	3.6334
4.2489	1.5110	3.6263	4.5096	19.5766	3.6263
4.2405	1.5224	3.6219	4.5055	19.7490	3.6219
4.2330	1.5433	3.6220	4.5056	20.0308	3.6220
4.2306	1.5648	3.6276	4.5108	20.2984	3.6276
4.2287	1.5863	3.6335	4.5164	20.5626	3.6335
4.2268	1.6078	3.6397	4.5223	20.8254	3.6397
4.2251	1.6292	3.6459	4.5283	21.0868	3.6459
4.2234	1.6506	3.6522	4.5345	21.3467	3.6522
4.2204	1.6934	3.6652	4.5474	21.8623	3.6652
4.2177	1.7360	3.6785	4.5611	22.3722	3.6785

4.2155	1.7786	3.6921	4.5753	22.8763	3.6921
4.2135	1.8212	3.7059	4.5902	23.3749	3.7059
4.2119	1.8636	3.7200	4.6058	23.8678	3.7200
4.2106	1.9061	3.7343	4.6219	24.3552	3.7343
4.2096	1.9484	3.7486	4.6387	24.8372	3.7486
4.2090	1.9908	3.7631	4.6560	25.3137	3.7631
4.2086	2.0331	3.7777	4.6739	25.7850	3.7777
4.2085	2.0755	3.7922	4.6924	26.2511	3.7922
4.2086	2.1178	3.8068	4.7114	26.7122	3.8068
4.2090	2.1602	3.8213	4.7309	27.1683	3.8213
4.2095	2.2025	3.8358	4.7509	27.6196	3.8358
4.2103	2.2449	3.8502	4.7714	28.0662	3.8502
4.2113	2.2873	3.8645	4.7924	28.5082	3.8645
4.2125	2.3298	3.8787	4.8138	28.9457	3.8787
4.2138	2.3723	3.8927	4.8357	29.3789	3.8927
4.2152	2.4148	3.9066	4.8579	29.8078	3.9066
4.2168	2.4574	3.9203	4.8806	30.2325	3.9203
4.2184	2.5001	3.9338	4.9036	30.6533	3.9338
4.2202	2.5428	3.9472	4.9270	31.0702	3.9472
4.2220	2.5855	3.9603	4.9508	31.4832	3.9603
4.2239	2.6284	3.9732	4.9749	31.8925	3.9732
4.2258	2.6713	3.9859	4.9993	32.2981	3.9859
4.2278	2.7142	3.9984	5.0241	32.7002	3.9984
4.2298	2.7572	4.0106	5.0491	33.0988	4.0106
4.2318	2.8003	4.0226	5.0745	33.4939	4.0226
4.2339	2.8435	4.0344	5.1001	33.8856	4.0344
4.2359	2.8867	4.0459	5.1260	34.2738	4.0459
4.2379	2.9300	4.0572	5.1522	34.6587	4.0572
4.2400	2.9733	4.0683	5.1786	35.0403	4.0683
4.2420	3.0167	4.0792	5.2053	35.4185	4.0792
4.2440	3.0601	4.0898	5.2322	35.7934	4.0898
4.2460	3.1037	4.1001	5.2594	36.1650	4.1001
4.2480	3.1472	4.1103	5.2869	36.5334	4.1103
4.2500	3.1908	4.1202	5.3145	36.8986	4.1202
4.2520	3.2345	4.1298	5.3424	37.2606	4.1298
4.2539	3.2782	4.1393	5.3705	37.6194	4.1393
4.2558	3.3220	4.1485	5.3988	37.9752	4.1485
4.2576	3.3658	4.1575	5.4274	38.3279	4.1575
4.2594	3.4097	4.1662	5.4561	38.6775	4.1662
4.2612	3.4536	4.1747	5.4850	39.0242	4.1747
4.2629	3.4976	4.1830	5.5141	39.3678	4.1830
4.2646	3.5416	4.1911	5.5434	39.7086	4.1911
4.2662	3.5856	4.1990	5.5729	40.0464	4.1990
4.2677	3.6297	4.2066	5.6025	40.3814	4.2066
4.2692	3.6739	4.2140	5.6324	40.7136	4.2140
4.2706	3.7180	4.2212	5.6624	41.0429	4.2212
4.2720	3.7622	4.2282	5.6925	41.3695	4.2282
4.2733	3.8065	4.2350	5.7228	41.6933	4.2350
4.2745	3.8507	4.2416	5.7533	42.0143	4.2416
4.2757	3.8950	4.2480	5.7839	42.3327	4.2480
4.2768	3.9394	4.2541	5.8146	42.6483	4.2541
4.2778	3.9837	4.2601	5.8455	42.9613	4.2601
4.2788	4.0281	4.2659	5.8766	43.2716	4.2659
4.2797	4.0725	4.2715	5.9077	43.5793	4.2715
4.2805	4.1170	4.2768	5.9391	43.8842	4.2768
4.2813	4.1615	4.2820	5.9705	44.1866	4.2820
4.2820	4.2059	4.2871	6.0022	44.4863	4.2871
4.2827	4.2504	4.2919	6.0339	44.7833	4.2919
4.2833	4.2950	4.2965	6.0658	45.0776	4.2965
4.2839	4.3395	4.3010	6.0978	45.3692	4.3010

4.2845	4.3841	4.3053	6.1300	45.6582	4.3053
4.2850	4.4287	4.3094	6.1623	45.9445	4.3094
4.2855	4.4733	4.3133	6.1948	46.2280	4.3133
4.2860	4.5179	4.3171	6.2274	46.5087	4.3171
4.2865	4.5625	4.3207	6.2602	46.7866	4.3207
4.2870	4.6071	4.3242	6.2931	47.0617	4.3242
4.2875	4.6518	4.3275	6.3262	47.3338	4.3275
4.2880	4.6964	4.3306	6.3595	47.6030	4.3306
4.2886	4.7411	4.3335	6.3930	47.8691	4.3335
4.2892	4.7858	4.3363	6.4266	48.1322	4.3363
4.2899	4.8305	4.3390	6.4604	48.3921	4.3390
4.2907	4.8752	4.3415	6.4944	48.6488	4.3415
4.2916	4.9199	4.3438	6.5286	48.9021	4.3438
4.2926	4.9646	4.3460	6.5630	49.1521	4.3460
4.2937	5.0093	4.3481	6.5977	49.3986	4.3481
4.2950	5.0540	4.3499	6.6325	49.6415	4.3499
4.2965	5.0987	4.3517	6.6676	49.8808	4.3517
4.2981	5.1435	4.3533	6.7029	50.1164	4.3533
4.2999	5.1882	4.3547	6.7384	50.3483	4.3547
4.3020	5.2329	4.3560	6.7742	50.5761	4.3560
4.3043	5.2776	4.3571	6.8103	50.7999	4.3571
4.3069	5.3223	4.3581	6.8466	51.0195	4.3581
4.3098	5.3669	4.3590	6.8832	51.2348	4.3590
4.3129	5.4116	4.3597	6.9200	51.4458	4.3597
4.3164	5.4562	4.3602	6.9571	51.6525	4.3602
4.3202	5.5008	4.3606	6.9945	51.8549	4.3606
4.3243	5.5454	4.3608	7.0322	52.0530	4.3608
4.3286	5.5900	4.3609	7.0700	52.2475	4.3609

STREAMLINE 8

X	Y	Z	R	THETA	Z
4.4327	1.6043	3.5400	4.7141	19.8963	3.5400
4.4224	1.6092	3.5313	4.7061	19.9949	3.5313
4.4126	1.6165	3.5240	4.6994	20.1202	3.5240
4.4040	1.6267	3.5190	4.6948	20.2733	3.5190
4.3956	1.6463	3.5178	4.6938	20.5320	3.5178
4.3922	1.6670	3.5223	4.6978	20.7833	3.5223
4.3892	1.6876	3.5274	4.7025	21.0314	3.5274
4.3864	1.7083	3.5327	4.7073	21.2784	3.5327
4.3837	1.7289	3.5380	4.7123	21.5241	3.5380
4.3811	1.7495	3.5435	4.7175	21.7688	3.5435
4.3761	1.7907	3.5548	4.7283	22.2544	3.5548
4.3715	1.8318	3.5665	4.7398	22.7353	3.5665
4.3672	1.8728	3.5786	4.7519	23.2115	3.5786
4.3633	1.9138	3.5909	4.7646	23.6829	3.5909
4.3597	1.9547	3.6036	4.7779	24.1496	3.6036
4.3565	1.9956	3.6164	4.7918	24.6116	3.6164
4.3535	2.0365	3.6295	4.8063	25.0690	3.6295
4.3509	2.0773	3.6426	4.8213	25.5218	3.6426
4.3485	2.1181	3.6559	4.8369	25.9701	3.6559
4.3464	2.1589	3.6693	4.8530	26.4140	3.6693
4.3445	2.1997	3.6827	4.8697	26.8536	3.6827
4.3429	2.2405	3.6962	4.8868	27.2888	3.6962
4.3416	2.2813	3.7096	4.9044	27.7199	3.7096
4.3404	2.3221	3.7230	4.9225	28.1469	3.7230
4.3394	2.3630	3.7363	4.9411	28.5699	3.7363
4.3386	2.4039	3.7495	4.9601	28.9890	3.7495
4.3380	2.4448	3.7627	4.9795	29.4042	3.7627
4.3376	2.4857	3.7757	4.9993	29.8158	3.7757

4.3372	2.5267	3.7886	5.0195	30.2237	3.7886
4.3370	2.5678	3.8014	5.0402	30.6280	3.8014
4.3369	2.6089	3.8140	5.0611	31.0289	3.8140
4.3369	2.6500	3.8264	5.0825	31.4263	3.8264
4.3370	2.6912	3.8387	5.1041	31.8205	3.8387
4.3372	2.7325	3.8507	5.1261	32.2113	3.8507
4.3374	2.7738	3.8626	5.1485	32.5989	3.8626
4.3377	2.8151	3.8743	5.1711	32.9834	3.8743
4.3380	2.8566	3.8858	5.1940	33.3647	3.8858
4.3384	2.8980	3.8970	5.2173	33.7429	3.8970
4.3388	2.9396	3.9081	5.2408	34.1180	3.9081
4.3392	2.9811	3.9189	5.2646	34.4900	3.9189
4.3397	3.0228	3.9296	5.2887	34.8590	3.9296
4.3402	3.0645	3.9400	5.3130	35.2248	3.9400
4.3407	3.1062	3.9502	5.3377	35.5876	3.9502
4.3413	3.1480	3.9602	5.3625	35.9474	3.9602
4.3418	3.1899	3.9700	5.3877	36.3041	3.9700
4.3424	3.2318	3.9796	5.4130	36.6579	3.9796
4.3430	3.2737	3.9890	5.4386	37.0088	3.9890
4.3436	3.3157	3.9981	5.4645	37.3566	3.9981
4.3442	3.3577	4.0070	5.4906	37.7016	4.0070
4.3447	3.3998	4.0158	5.5169	38.0437	4.0158
4.3453	3.4420	4.0243	5.5434	38.3829	4.0243
4.3459	3.4841	4.0326	5.5701	38.7192	4.0326
4.3465	3.5263	4.0407	5.5970	39.0528	4.0407
4.3470	3.5686	4.0486	5.6242	39.3835	4.0486
4.3475	3.6109	4.0563	5.6515	39.7115	4.0563
4.3480	3.6532	4.0637	5.6790	40.0367	4.0637
4.3485	3.6956	4.0710	5.7067	40.3592	4.0710
4.3490	3.7379	4.0781	5.7346	40.6790	4.0781
4.3494	3.7804	4.0849	5.7627	40.9961	4.0849
4.3498	3.8228	4.0916	5.7909	41.3105	4.0916
4.3502	3.8653	4.0981	5.8194	41.6223	4.0981
4.3506	3.9078	4.1043	5.8480	41.9314	4.1043
4.3509	3.9504	4.1104	5.8767	42.2379	4.1104
4.3512	3.9930	4.1163	5.9056	42.5417	4.1163
4.3515	4.0356	4.1220	5.9347	42.8430	4.1220
4.3517	4.0782	4.1275	5.9640	43.1416	4.1275
4.3519	4.1208	4.1328	5.9934	43.4376	4.1328
4.3522	4.1635	4.1379	6.0230	43.7310	4.1379
4.3524	4.2062	4.1429	6.0527	44.0218	4.1429
4.3525	4.2489	4.1477	6.0826	44.3100	4.1477
4.3527	4.2917	4.1523	6.1126	44.5955	4.1523
4.3529	4.3344	4.1567	6.1428	44.8782	4.1567
4.3530	4.3772	4.1610	6.1732	45.1584	4.1610
4.3532	4.4200	4.1651	6.2038	45.4358	4.1651
4.3534	4.4628	4.1690	6.2345	45.7106	4.1690
4.3536	4.5056	4.1727	6.2653	45.9825	4.1727
4.3539	4.5484	4.1763	6.2964	46.2517	4.1763
4.3542	4.5913	4.1798	6.3276	46.5180	4.1798
4.3546	4.6341	4.1830	6.3590	46.7814	4.1830
4.3550	4.6770	4.1861	6.3906	47.0419	4.1861
4.3555	4.7199	4.1891	6.4224	47.2993	4.1891
4.3561	4.7627	4.1919	6.4544	47.5537	4.1919
4.3567	4.8056	4.1945	6.4866	47.8049	4.1945
4.3576	4.8485	4.1970	6.5189	48.0529	4.1970
4.3585	4.8915	4.1994	6.5516	48.2975	4.1994
4.3596	4.9344	4.2016	6.5844	48.5388	4.2016
4.3609	4.9773	4.2036	6.6174	48.7766	4.2036
4.3623	5.0202	4.2055	6.6507	49.0109	4.2055

4.3640	5.0631	4.2073	6.6843	49.2415	4.2073
4.3658	5.1060	4.2088	6.7180	49.4685	4.2088
4.3679	5.1489	4.2103	6.7520	49.6918	4.2103
4.3702	5.1918	4.2116	6.7863	49.9112	4.2116
4.3728	5.2347	4.2127	6.8208	50.1265	4.2127
4.3757	5.2776	4.2137	6.8556	50.3377	4.2137
4.3789	5.3205	4.2146	6.8907	50.5447	4.2146
4.3824	5.3633	4.2153	6.9260	50.7475	4.2153
4.3862	5.4061	4.2158	6.9617	50.9460	4.2158
4.3904	5.4489	4.2162	6.9975	51.1403	4.2162
4.3948	5.4916	4.2164	7.0337	51.3304	4.2164
4.3995	5.5343	4.2165	7.0700	51.5170	4.2165

STREAMLINE 9

X	Y	Z	R	THETA	Z
4.5134	1.6592	3.4889	4.8087	20.1837	3.4889
4.5033	1.6636	3.4803	4.8008	20.2751	3.4803
4.4937	1.6705	3.4728	4.7941	20.3925	3.4728
4.4850	1.6802	3.4676	4.7894	20.5367	3.4676
4.4763	1.6990	3.4658	4.7879	20.7842	3.4658
4.4724	1.7192	3.4698	4.7914	21.0274	3.4698
4.4690	1.7395	3.4745	4.7956	21.2675	3.4745
4.4657	1.7597	3.4793	4.7999	21.5067	3.4793
4.4626	1.7799	3.4842	4.8044	21.7448	3.4842
4.4595	1.8001	3.4893	4.8091	21.9818	3.4893
4.4536	1.8404	3.4998	4.8189	22.4527	3.4998
4.4481	1.8807	3.5107	4.8293	22.9193	3.5107
4.4429	1.9209	3.5220	4.8404	23.3815	3.5220
4.4381	1.9611	3.5336	4.8520	23.8395	3.5336
4.4335	2.0012	3.5455	4.8643	24.2931	3.5455
4.4293	2.0412	3.5577	4.8771	24.7425	3.5577
4.4255	2.0813	3.5700	4.8904	25.1876	3.5700
4.4218	2.1213	3.5825	4.9044	25.6285	3.5825
4.4185	2.1613	3.5952	4.9188	26.0653	3.5952
4.4155	2.2013	3.6080	4.9338	26.4980	3.6080
4.4127	2.2413	3.6208	4.9492	26.9267	3.6208
4.4101	2.2813	3.6337	4.9652	27.3515	3.6337
4.4078	2.3213	3.6465	4.9817	27.7724	3.6465
4.4057	2.3613	3.6594	4.9986	28.1895	3.6594
4.4038	2.4013	3.6722	5.0159	28.6029	3.6722
4.4021	2.4414	3.6850	5.0337	29.0126	3.6850
4.4005	2.4815	3.6977	5.0519	29.4188	3.6977
4.3991	2.5216	3.7103	5.0706	29.8216	3.7103
4.3978	2.5618	3.7228	5.0896	30.2209	3.7228
4.3967	2.6020	3.7352	5.1090	30.6169	3.7352
4.3957	2.6422	3.7474	5.1287	31.0097	3.7474
4.3948	2.6825	3.7595	5.1488	31.3992	3.7595
4.3940	2.7229	3.7714	5.1693	31.7857	3.7714
4.3933	2.7633	3.7831	5.1901	32.1690	3.7831
4.3927	2.8038	3.7947	5.2112	32.5493	3.7947
4.3921	2.8443	3.8061	5.2326	32.9266	3.8061
4.3916	2.8848	3.8173	5.2543	33.3010	3.8173
4.3911	2.9254	3.8283	5.2764	33.6723	3.8283
4.3907	2.9661	3.8391	5.2987	34.0407	3.8391
4.3904	3.0068	3.8497	5.3213	34.4062	3.8497
4.3900	3.0476	3.8601	5.3442	34.7688	3.8601
4.3898	3.0884	3.8703	5.3674	35.1284	3.8703
4.3896	3.1293	3.8803	5.3908	35.4850	3.8803
4.3894	3.1702	3.8902	5.4145	35.8388	3.8902

4.3892	3.2112	3.8998	5.4385	36.1897	3.8998
4.3891	3.2522	3.9092	5.4627	36.5378	3.9092
4.3890	3.2933	3.9184	5.4871	36.8829	3.9184
4.3889	3.3344	3.9274	5.5118	37.2253	3.9274
4.3888	3.3755	3.9362	5.5368	37.5648	3.9362
4.3888	3.4167	3.9448	5.5620	37.9015	3.9448
4.3887	3.4580	3.9532	5.5873	38.2354	3.9532
4.3887	3.4993	3.9614	5.6130	38.5666	3.9614
4.3887	3.5406	3.9694	5.6388	38.8950	3.9694
4.3886	3.5819	3.9772	5.6648	39.2207	3.9772
4.3886	3.6233	3.9848	5.6911	39.5437	3.9848
4.3886	3.6648	3.9922	5.7175	39.8641	3.9922
4.3886	3.7062	3.9994	5.7442	40.1818	3.9994
4.3885	3.7477	4.0064	5.7710	40.4968	4.0064
4.3885	3.7893	4.0132	5.7980	40.8091	4.0132
4.3884	3.8308	4.0198	5.8252	41.1188	4.0198
4.3884	3.8724	4.0262	5.8526	41.4259	4.0262
4.3883	3.9140	4.0324	5.8802	41.7304	4.0324
4.3882	3.9557	4.0384	5.9080	42.0323	4.0384
4.3882	3.9974	4.0443	5.9359	42.3317	4.0443
4.3881	4.0391	4.0499	5.9640	42.6284	4.0499
4.3880	4.0808	4.0554	5.9923	42.9225	4.0554
4.3879	4.1225	4.0607	6.0207	43.2141	4.0607
4.3878	4.1643	4.0658	6.0493	43.5030	4.0658
4.3877	4.2061	4.0708	6.0781	43.7894	4.0708
4.3876	4.2479	4.0755	6.1071	44.0731	4.0755
4.3876	4.2898	4.0801	6.1362	44.3542	4.0801
4.3875	4.3316	4.0845	6.1654	44.6326	4.0845
4.3875	4.3735	4.0888	6.1949	44.9084	4.0888
4.3875	4.4153	4.0929	6.2246	45.1815	4.0929
4.3875	4.4572	4.0968	6.2544	45.4519	4.0968
4.3876	4.4992	4.1005	6.2844	45.7195	4.1005
4.3877	4.5411	4.1041	6.3145	45.9843	4.1041
4.3879	4.5830	4.1075	6.3449	46.2462	4.1075
4.3882	4.6250	4.1108	6.3755	46.5053	4.1108
4.3885	4.6670	4.1139	6.4062	46.7614	4.1139
4.3889	4.7089	4.1169	6.4372	47.0145	4.1169
4.3895	4.7509	4.1197	6.4683	47.2645	4.1197
4.3902	4.7929	4.1223	6.4997	47.5113	4.1223
4.3910	4.8349	4.1248	6.5313	47.7550	4.1248
4.3919	4.8769	4.1272	6.5631	47.9953	4.1272
4.3931	4.9190	4.1294	6.5951	48.2323	4.1294
4.3944	4.9610	4.1314	6.6274	48.4657	4.1314
4.3959	5.0030	4.1333	6.6599	48.6956	4.1333
4.3976	5.0450	4.1350	6.6926	48.9219	4.1350
4.3996	5.0870	4.1366	6.7256	49.1447	4.1366
4.4017	5.1290	4.1381	6.7588	49.3637	4.1381
4.4042	5.1710	4.1394	6.7923	49.5788	4.1394
4.4069	5.2130	4.1405	6.8261	49.7899	4.1405
4.4099	5.2549	4.1415	6.8602	49.9969	4.1415
4.4132	5.2969	4.1424	6.8945	50.1997	4.1424
4.4169	5.3388	4.1431	6.9291	50.3984	4.1431
4.4209	5.3807	4.1436	6.9639	50.5930	4.1436
4.4252	5.4226	4.1440	6.9990	50.7833	4.1440
4.4298	5.4644	4.1443	7.0344	50.9693	4.1443
4.4347	5.5062	4.1443	7.0700	51.1518	4.1443

STREAMLINE 10

X

Y

Z

R

THETA

Z



4.5935	1.7147	3.4378	4.9031	20.4699	3.4378
4.5837	1.7188	3.4291	4.8953	20.5549	3.4291
4.5742	1.7252	3.4216	4.8887	20.6648	3.4216
4.5656	1.7344	3.4162	4.8840	20.8008	3.4162
4.5566	1.7525	3.4139	4.8820	21.0374	3.4139
4.5522	1.7723	3.4175	4.8851	21.2725	3.4175
4.5485	1.7921	3.4217	4.8888	21.5048	3.4217
4.5448	1.8119	3.4261	4.8926	21.7362	3.4261
4.5412	1.8317	3.4306	4.8967	21.9666	3.4306
4.5377	1.8514	3.4352	4.9008	22.1961	3.4352
4.5309	1.8909	3.4449	4.9096	22.6523	3.4449
4.5245	1.9303	3.4550	4.9191	23.1047	3.4550
4.5184	1.9697	3.4655	4.9291	23.5531	3.4655
4.5127	2.0090	3.4764	4.9397	23.9976	3.4764
4.5073	2.0482	3.4875	4.9509	24.4383	3.4875
4.5022	2.0875	3.4990	4.9626	24.8750	3.4990
4.4974	2.1267	3.5107	4.9749	25.3079	3.5107
4.4929	2.1659	3.5225	4.9877	25.7369	3.5225
4.4887	2.2050	3.5346	5.0010	26.1622	3.5346
4.4847	2.2442	3.5467	5.0149	26.5837	3.5467
4.4810	2.2833	3.5589	5.0292	27.0015	3.5589
4.4775	2.3225	3.5712	5.0440	27.4158	3.5712
4.4742	2.3616	3.5836	5.0593	27.8264	3.5836
4.4712	2.4008	3.5959	5.0750	28.2336	3.5959
4.4684	2.4400	3.6082	5.0912	28.6373	3.6082
4.4657	2.4792	3.6205	5.1078	29.0377	3.6205
4.4632	2.5185	3.6328	5.1248	29.4348	3.6328
4.4609	2.5578	3.6449	5.1422	29.8286	3.6449
4.4588	2.5971	3.6570	5.1600	30.2193	3.6570
4.4567	2.6364	3.6689	5.1782	30.6069	3.6689
4.4548	2.6758	3.6808	5.1967	30.9915	3.6808
4.4530	2.7153	3.6925	5.2156	31.3731	3.6925
4.4514	2.7548	3.7040	5.2348	31.7518	3.7040
4.4498	2.7943	3.7155	5.2544	32.1275	3.7155
4.4483	2.8339	3.7267	5.2743	32.5005	3.7267
4.4469	2.8736	3.7378	5.2945	32.8705	3.7378
4.4455	2.9132	3.7487	5.3150	33.2378	3.7487
4.4442	2.9530	3.7594	5.3358	33.6023	3.7594
4.4430	2.9928	3.7700	5.3570	33.9640	3.7700
4.4418	3.0326	3.7804	5.3784	34.3230	3.7804
4.4408	3.0725	3.7906	5.4001	34.6790	3.7906
4.4397	3.1125	3.8006	5.4220	35.0323	3.8006
4.4387	3.1524	3.8104	5.4443	35.3828	3.8104
4.4378	3.1925	3.8200	5.4668	35.7305	3.8200
4.4369	3.2325	3.8294	5.4896	36.0755	3.8294
4.4361	3.2727	3.8387	5.5126	36.4177	3.8387
4.4353	3.3128	3.8478	5.5359	36.7572	3.8478
4.4345	3.3531	3.8566	5.5595	37.0939	3.8566
4.4338	3.3933	3.8653	5.5833	37.4279	3.8653
4.4331	3.4336	3.8738	5.6073	37.7592	3.8738
4.4324	3.4740	3.8820	5.6316	38.0879	3.8820
4.4318	3.5143	3.8901	5.6561	38.4138	3.8901
4.4312	3.5547	3.8980	5.6808	38.7371	3.8980
4.4306	3.5952	3.9057	5.7057	39.0577	3.9057
4.4300	3.6357	3.9132	5.7309	39.3757	3.9132
4.4294	3.6762	3.9205	5.7563	39.6912	3.9205
4.4289	3.7168	3.9276	5.7818	40.0040	3.9276
4.4283	3.7574	3.9346	5.8076	40.3142	3.9346
4.4278	3.7980	3.9413	5.8336	40.6218	3.9413
4.4273	3.8387	3.9479	5.8597	40.9268	3.9479

4.4268	3.8794	3.9542	5.8861	41.2293	3.9542
4.4263	3.9201	3.9604	5.9126	41.5292	3.9604
4.4258	3.9608	3.9664	5.9394	41.8265	3.9664
4.4253	4.0016	3.9722	5.9663	42.1213	3.9722
4.4249	4.0424	3.9778	5.9934	42.4135	3.9778
4.4244	4.0832	3.9833	6.0207	42.7032	3.9833
4.4240	4.1241	3.9885	6.0481	42.9903	3.9885
4.4236	4.1649	3.9936	6.0758	43.2748	3.9936
4.4232	4.2058	3.9986	6.1036	43.5568	3.9986
4.4229	4.2467	4.0033	6.1316	43.8361	4.0033
4.4225	4.2877	4.0079	6.1598	44.1129	4.0079
4.4222	4.3286	4.0123	6.1881	44.3868	4.0123
4.4220	4.3696	4.0165	6.2167	44.6583	4.0165
4.4218	4.4105	4.0206	6.2454	44.9270	4.0206
4.4216	4.4515	4.0245	6.2743	45.1931	4.0245
4.4216	4.4926	4.0282	6.3034	45.4563	4.0282
4.4216	4.5336	4.0318	6.3327	45.7168	4.0318
4.4216	4.5746	4.0353	6.3622	45.9744	4.0353
4.4218	4.6157	4.0385	6.3919	46.2291	4.0385
4.4221	4.6568	4.0416	6.4218	46.4809	4.0416
4.4224	4.6978	4.0446	6.4519	46.7296	4.0446
4.4229	4.7389	4.0474	6.4823	46.9753	4.0474
4.4236	4.7800	4.0501	6.5128	47.2178	4.0501
4.4244	4.8211	4.0526	6.5436	47.4571	4.0526
4.4254	4.8622	4.0549	6.5746	47.6931	4.0549
4.4265	4.9033	4.0571	6.6058	47.9256	4.0571
4.4279	4.9445	4.0592	6.6373	48.1548	4.0592
4.4295	4.9856	4.0611	6.6690	48.3803	4.0611
4.4313	5.0267	4.0628	6.7010	48.6023	4.0628
4.4333	5.0678	4.0644	6.7332	48.8207	4.0644
4.4355	5.1089	4.0659	6.7657	49.0354	4.0659
4.4381	5.1500	4.0672	6.7984	49.2463	4.0672
4.4409	5.1910	4.0684	6.8314	49.4532	4.0684
4.4440	5.2321	4.0694	6.8647	49.6561	4.0694
4.4475	5.2731	4.0702	6.8983	49.8548	4.0702
4.4513	5.3141	4.0709	6.9321	50.0495	4.0709
4.4554	5.3551	4.0715	6.9662	50.2399	4.0715
4.4599	5.3960	4.0719	7.0005	50.4261	4.0719
4.4647	5.4369	4.0721	7.0352	50.6080	4.0721
4.4697	5.4778	4.0722	7.0700	50.7867	4.0722

STREAMLINE 11

X	Y	Z	R	THETA	Z
4.6730	1.7709	3.3865	4.9973	20.7543	3.3865
4.6635	1.7746	3.3779	4.9897	20.8335	3.3779
4.6542	1.7807	3.3703	4.9832	20.9366	3.3703
4.6457	1.7894	3.3648	4.9784	21.0653	3.3648
4.6366	1.8069	3.3621	4.9762	21.2913	3.3621
4.6318	1.8262	3.3652	4.9788	21.5182	3.3652
4.6276	1.8455	3.3690	4.9820	21.7427	3.3690
4.6235	1.8649	3.3729	4.9854	21.9664	3.3729
4.6195	1.8842	3.3770	4.9890	22.1893	3.3770
4.6156	1.9035	3.3813	4.9927	22.4113	3.3813
4.6080	1.9420	3.3901	5.0005	22.8529	3.3901
4.6008	1.9806	3.3994	5.0090	23.2911	3.3994
4.5939	2.0191	3.4091	5.0180	23.7258	3.4091
4.5873	2.0575	3.4193	5.0276	24.1570	3.4193
4.5811	2.0959	3.4297	5.0378	24.5846	3.4297
4.5751	2.1343	3.4404	5.0484	25.0088	3.4404

4.5694	2.1726	3.4514	5.0596	25.4295	3.4514
4.5640	2.2109	3.4626	5.0713	25.8467	3.4626
4.5589	2.2492	3.4740	5.0836	26.2604	3.4740
4.5540	2.2875	3.4855	5.0963	26.6708	3.4855
4.5494	2.3258	3.4971	5.1095	27.0777	3.4971
4.5450	2.3641	3.5088	5.1231	27.4814	3.5088
4.5409	2.4024	3.5206	5.1372	27.8818	3.5206
4.5369	2.4407	3.5324	5.1518	28.2790	3.5324
4.5332	2.4791	3.5442	5.1668	28.6730	3.5442
4.5296	2.5174	3.5560	5.1822	29.0639	3.5560
4.5263	2.5558	3.5678	5.1980	29.4518	3.5678
4.5231	2.5942	3.5795	5.2142	29.8368	3.5795
4.5200	2.6327	3.5911	5.2308	30.2188	3.5911
4.5171	2.6712	3.6027	5.2478	30.5979	3.6027
4.5143	2.7097	3.6141	5.2651	30.9742	3.6141
4.5116	2.7483	3.6254	5.2828	31.3478	3.6254
4.5091	2.7869	3.6367	5.3008	31.7186	3.6367
4.5066	2.8255	3.6477	5.3191	32.0867	3.6477
4.5043	2.8642	3.6586	5.3378	32.4521	3.6586
4.5020	2.9030	3.6694	5.3568	32.8149	3.6694
4.4998	2.9418	3.6800	5.3761	33.1751	3.6800
4.4977	2.9806	3.6905	5.3957	33.5326	3.6905
4.4957	3.0195	3.7008	5.4156	33.8875	3.7008
4.4937	3.0585	3.7109	5.4358	34.2398	3.7109
4.4918	3.0975	3.7209	5.4563	34.5894	3.7209
4.4900	3.1365	3.7307	5.4770	34.9364	3.7307
4.4883	3.1756	3.7403	5.4981	35.2807	3.7403
4.4866	3.2147	3.7497	5.5194	35.6223	3.7497
4.4850	3.2539	3.7590	5.5410	35.9613	3.7590
4.4834	3.2931	3.7681	5.5629	36.2977	3.7681
4.4819	3.3324	3.7770	5.5850	36.6314	3.7770
4.4805	3.3717	3.7857	5.6074	36.9624	3.7857
4.4791	3.4110	3.7942	5.6301	37.2909	3.7942
4.4778	3.4504	3.8026	5.6530	37.6167	3.8026
4.4765	3.4899	3.8107	5.6761	37.9400	3.8107
4.4752	3.5293	3.8187	5.6995	38.2606	3.8187
4.4740	3.5688	3.8265	5.7231	38.5787	3.8265
4.4728	3.6084	3.8341	5.7469	38.8943	3.8341
4.4717	3.6480	3.8415	5.7709	39.2073	3.8415
4.4706	3.6876	3.8488	5.7952	39.5177	3.8488
4.4695	3.7272	3.8558	5.8197	39.8256	3.8558
4.4684	3.7669	3.8627	5.8444	40.1310	3.8627
4.4674	3.8066	3.8693	5.8693	40.4339	3.8693
4.4664	3.8464	3.8758	5.8944	40.7342	3.8758
4.4655	3.8862	3.8822	5.9197	41.0321	3.8822
4.4645	3.9260	3.8883	5.9452	41.3274	3.8883
4.4636	3.9658	3.8942	5.9709	41.6202	3.8942
4.4627	4.0057	3.9000	5.9968	41.9105	3.9000
4.4619	4.0455	3.9056	6.0229	42.1982	3.9056
4.4611	4.0855	3.9110	6.0492	42.4834	3.9110
4.4603	4.1254	3.9163	6.0756	42.7661	3.9163
4.4596	4.1654	3.9214	6.1023	43.0463	3.9214
4.4589	4.2053	3.9263	6.1291	43.3239	3.9263
4.4582	4.2453	3.9310	6.1562	43.5989	3.9310
4.4576	4.2854	3.9356	6.1834	43.8712	3.9356
4.4571	4.3254	3.9400	6.2109	44.1410	3.9400
4.4566	4.3655	3.9442	6.2385	44.4081	3.9442
4.4562	4.4055	3.9483	6.2663	44.6725	3.9483
4.4559	4.4456	3.9522	6.2943	44.9342	3.9522
4.4556	4.4858	3.9559	6.3225	45.1931	3.9559

4.4555	4.5259	3.9595	6.3510	45.4493	3.9595
4.4554	4.5660	3.9629	6.3796	45.7025	3.9629
4.4554	4.6062	3.9662	6.4084	45.9529	3.9662
4.4556	4.6463	3.9693	6.4375	46.2003	3.9693
4.4559	4.6865	3.9723	6.4667	46.4447	3.9723
4.4564	4.7267	3.9751	6.4962	46.6860	3.9751
4.4570	4.7669	3.9778	6.5260	46.9242	3.9778
4.4578	4.8071	3.9803	6.5559	47.1591	3.9803
4.4588	4.8473	3.9827	6.5861	47.3907	3.9827
4.4600	4.8875	3.9849	6.6166	47.6189	3.9849
4.4614	4.9277	3.9869	6.6473	47.8436	3.9869
4.4630	4.9679	3.9888	6.6782	48.0647	3.9888
4.4649	5.0081	3.9906	6.7094	48.2824	3.9906
4.4669	5.0483	3.9922	6.7409	48.4966	3.9922
4.4693	5.0885	3.9937	6.7726	48.7071	3.9937
4.4719	5.1287	3.9950	6.8045	48.9138	3.9950
4.4748	5.1689	3.9962	6.8368	49.1165	3.9962
4.4781	5.2090	3.9972	6.8693	49.3151	3.9972
4.4816	5.2491	3.9980	6.9021	49.5097	3.9980
4.4856	5.2892	3.9987	6.9351	49.7002	3.9987
4.4898	5.3293	3.9993	6.9685	49.8865	3.9993
4.4944	5.3693	3.9997	7.0021	50.0688	3.9997
4.4994	5.4093	3.9999	7.0360	50.2468	3.9999
4.5045	5.4492	4.0000	7.0700	50.4217	4.0000

**APPENDIX C**

**INDUCER COORDINATES - WITHOUT BLADE  
FILLET**

## PRESSURE SURFACE STREAMLINE 1

radius	wrap	axial
1.40700	0.37060	-0.00410
1.40700	0.20060	0.01100
1.40710	-0.38710	0.01890
1.40730	-1.09220	0.02840
1.40750	-1.93830	0.03980
1.40800	-2.95360	0.05340
1.40880	-4.17170	0.06970
1.41010	-5.63300	0.08920
1.41200	-7.38600	0.11250
1.41490	-9.48830	0.14040
1.41920	-12.00870	0.17350
1.42560	-15.02900	0.21300
1.43490	-18.64530	0.25970
1.44860	-22.97040	0.31470
1.46840	-28.13430	0.37910
1.49650	-34.28450	0.45360
1.53590	-41.58320	0.53890
1.58960	-50.19180	0.63470
1.66080	-60.27030	0.74020
1.75190	-71.95680	0.85450
1.86640	-85.31430	0.97840
2.01080	-100.36690	1.11730
2.18610	-117.13720	1.27320
2.38780	-135.65100	1.45140
2.58030	-152.60160	1.63260
2.72500	-165.74050	1.79100
2.83280	-176.09850	1.93400
2.91060	-184.37230	2.06360
2.96290	-191.07630	2.17600
2.99650	-196.57330	2.27010
3.01740	-201.12240	2.34670
3.03020	-204.90990	2.40830
3.03800	-208.07500	2.45750
3.04260	-210.72510	2.49660
3.04540	-212.94640	2.52770
3.04690	-214.80870	2.55240
3.04780	-216.36970	2.57220
3.04830	-217.67780	2.58810
3.04850	-218.77330	2.60080
3.04850	-219.69030	2.61110
3.04850	-220.45740	2.61940
3.04850	-221.09880	2.62610
3.04850	-221.63500	2.63160
3.04850	-222.08280	2.63610
3.04850	-222.45680	2.63980
3.04850	-222.76900	2.64290
3.04850	-223.39060	2.63020

## PRESSURE SURFACE STREAMLINE 2

radius	wrap	axial
1.99530	-15.78890	0.10730
1.99530	-16.01420	0.12350
1.99540	-16.47910	0.13010
1.99550	-17.03700	0.13810
1.99570	-17.70650	0.14760
1.99600	-18.51010	0.15900
1.99640	-19.47440	0.17270
1.99710	-20.63180	0.18900
1.99810	-22.02080	0.20860
1.99960	-23.68770	0.23210
2.00190	-25.68790	0.26010
2.00530	-28.08800	0.29350
2.01030	-30.96710	0.33330
2.01770	-34.42000	0.38040
2.02850	-38.56030	0.43610
2.04400	-43.52370	0.50130
2.06640	-49.46220	0.57700
2.09790	-56.55950	0.66360
2.14110	-65.00970	0.76060
2.19870	-75.01990	0.86740
2.27450	-86.79120	0.98530
2.37540	-100.45900	1.11970
2.50490	-116.17630	1.27190
2.66170	-134.04950	1.44430
2.81870	-150.86520	1.61970
2.94220	-164.13160	1.77140
3.03810	-174.71060	1.90850
3.11010	-183.22720	2.03340
3.16030	-190.15630	2.14280
3.19360	-195.84590	2.23560
3.21510	-200.55310	2.31260
3.22880	-204.46820	2.37550
3.23740	-207.73490	2.42650
3.24270	-210.46560	2.46780
3.24600	-212.75050	2.50120
3.24800	-214.66300	2.52820
3.24910	-216.26400	2.55010
3.24970	-217.60380	2.56780
3.25010	-218.72460	2.58210
3.25020	-219.66200	2.59390
3.25020	-220.44540	2.60340
3.25020	-221.10020	2.61130
3.25020	-221.64700	2.61770
3.25020	-222.10370	2.62300
3.25010	-222.48490	2.62730
3.25010	-222.80310	2.63090
3.25020	-223.33930	2.61850

## PRESSURE SURFACE STREAMLINE 3

radius	wrap	axial
2.44600	-28.18240	0.19290
2.44600	-28.40260	0.20950
2.44610	-28.80970	0.21550
2.44610	-29.29830	0.22280
2.44620	-29.88460	0.23140
2.44640	-30.58820	0.24190
2.44670	-31.43260	0.25430
2.44720	-32.44590	0.26930
2.44790	-33.66190	0.28710
2.44900	-35.12120	0.30850
2.45060	-36.87270	0.33410
2.45290	-38.97480	0.36460
2.45640	-41.49780	0.40090
2.46140	-44.52610	0.44410
2.46880	-48.16070	0.49520
2.47940	-52.52230	0.55520
2.49480	-57.75350	0.62510
2.51650	-64.02270	0.70560
2.54660	-71.52210	0.79670
2.58720	-80.47000	0.89750
2.64160	-91.10040	1.01030
2.71590	-103.60930	1.14030
2.81370	-118.23160	1.28880
2.93590	-135.15880	1.45700
3.06180	-151.37340	1.62650
3.16400	-164.34540	1.77210
3.24540	-174.79390	1.90300
3.30830	-183.26430	2.02240
3.35340	-190.18580	2.12720
3.38420	-195.88310	2.21690
3.40470	-200.60080	2.29220
3.41800	-204.52440	2.35450
3.42650	-207.79620	2.40570
3.43200	-210.52890	2.44760
3.43540	-212.81330	2.48190
3.43750	-214.72370	2.50990
3.43870	-216.32120	2.53270
3.43940	-217.65710	2.55140
3.43980	-218.77390	2.56670
3.44000	-219.70720	2.57920
3.44000	-220.48690	2.58950
3.44000	-221.13810	2.59800
3.44000	-221.68190	2.60490
3.44000	-222.13580	2.61070
3.43990	-222.51460	2.61540
3.43990	-222.83060	2.61940
3.44000	-223.29200	2.60750



## PRESSURE SURFACE STREAMLINE 4

radius	wrap	axial
2.82570	-38.65030	0.26460
2.82570	-38.82950	0.28170
2.82580	-39.19920	0.28740
2.82580	-39.64280	0.29420
2.82600	-40.17520	0.30230
2.82610	-40.81410	0.31210
2.82630	-41.58080	0.32370
2.82670	-42.50090	0.33780
2.82720	-43.60510	0.35450
2.82800	-44.93030	0.37460
2.82920	-46.52090	0.39850
2.83090	-48.42990	0.42710
2.83350	-50.72140	0.46110
2.83720	-53.47220	0.50150
2.84250	-56.77460	0.54930
2.85040	-60.73950	0.60560
2.86160	-65.49880	0.67130
2.87750	-71.20920	0.74700
2.89950	-78.05340	0.83290
2.92920	-86.24080	0.92890
2.96950	-96.01980	1.03690
3.02510	-107.60300	1.16300
3.09990	-121.26750	1.30810
3.19520	-137.27230	1.47260
3.29560	-152.79000	1.63780
3.37900	-165.33920	1.77850
3.44680	-175.52870	1.90420
3.50040	-183.83620	2.01820
3.53970	-190.65100	2.11850
3.56720	-196.27340	2.20480
3.58590	-200.93410	2.27780
3.59820	-204.81100	2.33880
3.60640	-208.04300	2.38950
3.61170	-210.74100	2.43140
3.61510	-212.99480	2.46600
3.61720	-214.87830	2.49440
3.61850	-216.45220	2.51780
3.61930	-217.76750	2.53710
3.61970	-218.86640	2.55300
3.61990	-219.78430	2.56600
3.62000	-220.55080	2.57680
3.62000	-221.19080	2.58570
3.62000	-221.72490	2.59310
3.62000	-222.17060	2.59920
3.62000	-222.54260	2.60420
3.61990	-222.85290	2.60840
3.62000	-223.24780	2.59710

## PRESSURE SURFACE STREAMLINE 5

radius	wrap	axial
3.16010	-47.80860	0.32840
3.16010	-48.00820	0.34520
3.16020	-48.34990	0.35050
3.16020	-48.76000	0.35700
3.16030	-49.25210	0.36470
3.16040	-49.84270	0.37400
3.16060	-50.55150	0.38500
3.16090	-51.40210	0.39830
3.16130	-52.42310	0.41420
3.16190	-53.64840	0.43310
3.16280	-55.11930	0.45580
3.16410	-56.88480	0.48280
3.16610	-59.00420	0.51500
3.16890	-61.54860	0.55320
3.17290	-64.60320	0.59840
3.17870	-68.27010	0.65160
3.18710	-72.67280	0.71360
3.19880	-77.95940	0.78520
3.21510	-84.30100	0.86670
3.23710	-91.90050	0.95800
3.26690	-100.99670	1.06160
3.30860	-111.81730	1.18350
3.36530	-124.65740	1.32500
3.43880	-139.80950	1.48650
3.51810	-154.63330	1.64830
3.58520	-166.71890	1.78540
3.64080	-176.59240	1.90680
3.68560	-184.68370	2.01650
3.71910	-191.34290	2.11270
3.74300	-196.84780	2.19570
3.75960	-201.41560	2.26650
3.77080	-205.21640	2.32610
3.77830	-208.38460	2.37600
3.78330	-211.02820	2.41760
3.78650	-213.23560	2.45210
3.78860	-215.07920	2.48080
3.78990	-216.61910	2.50450
3.79060	-217.90520	2.52410
3.79110	-218.97930	2.54030
3.79130	-219.87610	2.55380
3.79140	-220.62480	2.56490
3.79140	-221.24960	2.57410
3.79140	-221.77100	2.58170
3.79140	-222.20600	2.58810
3.79140	-222.56890	2.59330
3.79130	-222.87150	2.59770
3.79140	-223.21080	2.58720

## PRESSURE SURFACE STREAMLINE 6

radius	wrap	axial
3.46240	-56.11810	0.38570
3.46240	-56.30230	0.40230
3.46240	-56.62150	0.40740
3.46250	-57.00450	0.41360
3.46250	-57.46430	0.42090
3.46260	-58.01600	0.42970
3.46280	-58.67820	0.44030
3.46300	-59.47300	0.45290
3.46330	-60.42690	0.46810
3.46380	-61.57190	0.48610
3.46450	-62.94630	0.50770
3.46550	-64.59610	0.53330
3.46690	-66.57660	0.56390
3.46900	-68.95400	0.60010
3.47200	-71.80820	0.64300
3.47630	-75.23570	0.69320
3.48250	-79.35150	0.75190
3.49110	-84.29270	0.81980
3.50300	-90.22500	0.89730
3.51910	-97.34410	0.98430
3.54090	-105.86680	1.08340
3.57140	-116.03920	1.20090
3.61340	-128.15350	1.33850
3.66910	-142.52990	1.49710
3.73020	-156.68630	1.65600
3.78290	-168.29860	1.79050
3.82760	-177.83600	1.90880
3.86400	-185.68310	2.01480
3.89200	-192.16070	2.10770
3.91230	-197.52550	2.18790
3.92660	-201.98080	2.25660
3.93650	-205.68880	2.31480
3.94310	-208.77930	2.36390
3.94760	-211.35750	2.40500
3.95060	-213.50920	2.43950
3.95250	-215.30560	2.46820
3.95370	-216.80540	2.49210
3.95440	-218.05750	2.51200
3.95490	-219.10280	2.52850
3.95510	-219.97530	2.54220
3.95530	-220.70330	2.55360
3.95530	-221.31090	2.56310
3.95530	-221.81770	2.57100
3.95530	-222.24040	2.57750
3.95530	-222.59300	2.58290
3.95530	-222.88710	2.58750
3.95530	-223.17440	2.57780

## PRESSURE SURFACE STREAMLINE 7

radius	wrap	axial
3.74030	-63.75690	0.43830
3.74030	-63.92750	0.45460
3.74030	-64.22780	0.45950
3.74040	-64.58820	0.46540
3.74040	-65.02060	0.47250
3.74050	-65.53960	0.48090
3.74060	-66.16250	0.49100
3.74080	-66.91000	0.50310
3.74100	-67.80720	0.51750
3.74130	-68.88410	0.53470
3.74180	-70.17670	0.55520
3.74250	-71.72840	0.57970
3.74360	-73.59120	0.60870
3.74510	-75.82790	0.64310
3.74730	-78.51330	0.68370
3.75040	-81.73730	0.73130
3.75480	-85.60880	0.78680
3.76100	-90.25950	0.85100
3.76940	-95.84320	0.92450
3.78070	-102.54630	1.00720
3.79610	-110.57930	1.10220
3.81770	-120.18640	1.21490
3.84780	-131.65600	1.34840
3.88820	-145.32020	1.50380
3.93350	-158.84130	1.66050
3.97350	-169.98750	1.79290
4.00800	-179.18120	1.90880
4.03680	-186.77140	2.01220
4.05920	-193.05240	2.10250
4.07580	-198.26280	2.18040
4.08770	-202.59380	2.24720
4.09610	-206.19920	2.30420
4.10190	-209.20410	2.35250
4.10580	-211.71020	2.39320
4.10840	-213.80110	2.42750
4.11010	-215.54600	2.45620
4.11130	-217.00220	2.48030
4.11200	-218.21750	2.50040
4.11240	-219.23170	2.51710
4.11260	-220.07790	2.53110
4.11280	-220.78400	2.54280
4.11280	-221.37300	2.55250
4.11280	-221.86420	2.56060
4.11280	-222.27390	2.56730
4.11280	-222.61560	2.57290
4.11280	-222.90050	2.57760
4.11280	-223.14260	2.56880

## PRESSURE SURFACE STREAMLINE 8

radius	wrap	axial
3.99890	-70.86730	0.48740
3.99890	-71.02290	0.50320
3.99890	-71.30650	0.50790
3.99890	-71.64700	0.51350
3.99900	-72.05550	0.52030
3.99900	-72.54590	0.52830
3.99910	-73.13440	0.53800
3.99920	-73.84080	0.54950
3.99940	-74.68860	0.56320
3.99960	-75.70620	0.57960
3.99990	-76.92770	0.59920
4.00040	-78.39400	0.62240
4.00120	-80.15410	0.64990
4.00220	-82.26720	0.68250
4.00370	-84.80420	0.72090
4.00590	-87.85150	0.76590
4.00880	-91.51150	0.81830
4.01290	-95.90570	0.87910
4.01850	-101.18350	0.94860
4.02610	-107.52130	1.02730
4.03630	-115.12270	1.11780
4.05070	-124.22480	1.22590
4.07080	-135.11370	1.35460
4.09840	-148.12020	1.50700
4.12990	-161.04020	1.66130
4.15830	-171.73230	1.79220
4.18340	-180.58130	1.90680
4.20470	-187.90840	2.00810
4.22160	-193.98540	2.09640
4.23450	-199.03360	2.17270
4.24400	-203.23290	2.23810
4.25060	-206.72990	2.29400
4.25530	-209.64440	2.34160
4.25850	-212.07460	2.38190
4.26060	-214.10170	2.41610
4.26210	-215.79270	2.44480
4.26300	-217.20350	2.46900
4.26360	-218.38060	2.48930
4.26400	-219.36250	2.50630
4.26420	-220.18160	2.52050
4.26430	-220.86480	2.53230
4.26440	-221.43460	2.54220
4.26440	-221.90980	2.55050
4.26440	-222.30610	2.55740
4.26440	-222.63650	2.56310
4.26440	-222.91200	2.56790
4.26440	-223.11280	2.56020

## PRESSURE SURFACE STREAMLINE 9

radius	wrap	axial
4.24180	-77.53650	0.53350
4.24180	-77.68600	0.54860
4.24180	-77.95480	0.55310
4.24180	-78.27740	0.55840
4.24180	-78.66460	0.56490
4.24190	-79.12940	0.57260
4.24190	-79.68710	0.58180
4.24200	-80.35660	0.59280
4.24210	-81.16000	0.60590
4.24230	-82.12450	0.62150
4.24250	-83.28230	0.64010
4.24280	-84.67210	0.66220
4.24320	-86.34060	0.68830
4.24380	-88.34390	0.71910
4.24470	-90.74930	0.75520
4.24600	-93.63760	0.79770
4.24780	-97.10630	0.84720
4.25030	-101.27250	0.90440
4.25360	-106.27630	0.96990
4.25800	-112.28630	1.04450
4.26410	-119.50000	1.13070
4.27260	-128.14680	1.23380
4.28450	-138.50290	1.35790
4.30130	-150.90100	1.50660
4.32080	-163.25070	1.65890
4.33870	-173.50170	1.78890
4.35490	-182.00950	1.90230
4.36890	-189.07180	2.00220
4.38030	-194.94050	2.08910
4.38920	-199.82170	2.16420
4.39580	-203.88530	2.22870
4.40060	-207.27040	2.28380
4.40400	-210.09180	2.33090
4.40630	-212.44420	2.37100
4.40790	-214.40570	2.40500
4.40900	-216.04170	2.43380
4.40970	-217.40610	2.45810
4.41020	-218.54420	2.47850
4.41050	-219.49330	2.49570
4.41060	-220.28490	2.51010
4.41070	-220.94500	2.52210
4.41080	-221.49540	2.53220
4.41080	-221.95430	2.54060
4.41080	-222.33700	2.54770
4.41080	-222.65600	2.55360
4.41080	-222.92190	2.55850
4.41080	-223.08440	2.55850

PRESSURE SURFACE STREAMLINE 10

radius	wrap	axial
4.47150	-83.84940	0.57690
4.47150	-83.98720	0.59140
4.47150	-84.24260	0.59570
4.47150	-84.54900	0.60080
4.47150	-84.91690	0.60700
4.47150	-85.35830	0.61430
4.47160	-85.88820	0.62310
4.47160	-86.52420	0.63360
4.47160	-87.28750	0.64600
4.47170	-88.20390	0.66090
4.47180	-89.30390	0.67840
4.47200	-90.62450	0.69930
4.47220	-92.20980	0.72400
4.47250	-94.11310	0.75300
4.47290	-96.39830	0.78720
4.47340	-99.14240	0.82700
4.47420	-102.43790	0.87320
4.47530	-106.39580	0.92680
4.47680	-111.15030	0.98860
4.47880	-116.86230	1.05900
4.48150	-123.72100	1.14080
4.48520	-131.94890	1.23910
4.49060	-141.81550	1.35830
4.49820	-153.64290	1.50340
4.50710	-165.45280	1.65340
4.51570	-175.27820	1.78270
4.52350	-183.45110	1.89560
4.53030	-190.24880	1.99470
4.53610	-195.90720	2.08080
4.54070	-200.61940	2.15500
4.54430	-204.54490	2.21890
4.54690	-207.81620	2.27360
4.54870	-210.54300	2.32040
4.55000	-212.81620	2.36030
4.55090	-214.71140	2.39420
4.55150	-216.29160	2.42300
4.55190	-217.60920	2.44740
4.55220	-218.70780	2.46800
4.55230	-219.62390	2.48530
4.55250	-220.38760	2.49990
4.55250	-221.02440	2.51220
4.55260	-221.55520	2.52240
4.55260	-221.99770	2.53110
4.55260	-222.36670	2.53830
4.55260	-222.67420	2.54430
4.55260	-222.93050	2.54930
4.55260	-223.93510	2.54380

## PRESSURE SURFACE STREAMLINE 11

radius	wrap	axial
4.69000	-89.85420	0.61840
4.69000	-89.97980	0.63200
4.69000	-90.22270	0.63610
4.69000	-90.51430	0.64100
4.69000	-90.86420	0.64680
4.69000	-91.28420	0.65380
4.69000	-91.78830	0.66220
4.69000	-92.39340	0.67210
4.69000	-93.11980	0.68390
4.69000	-93.99170	0.69790
4.69000	-95.03850	0.71460
4.69000	-96.29510	0.73420
4.69000	-97.80370	0.75740
4.69000	-99.61480	0.78460
4.69000	-101.78910	0.81650
4.69000	-104.40020	0.85370
4.69000	-107.53640	0.89700
4.69000	-111.30330	0.94700
4.69000	-115.82880	1.00470
4.69000	-121.26600	1.07120
4.69000	-127.79620	1.14870
4.69000	-135.63530	1.24180
4.69000	-145.04510	1.35590
4.69000	-156.33790	1.49770
4.69000	-167.63210	1.64530
4.69000	-177.04660	1.77410
4.69000	-184.89220	1.88680
4.69000	-191.42910	1.98540
4.69000	-196.87720	2.07100
4.69000	-201.41860	2.14500
4.69000	-205.20500	2.20860
4.69000	-208.36170	2.26320
4.69000	-210.99300	2.30980
4.69000	-213.18640	2.34960
4.69000	-215.01490	2.38350
4.69000	-216.53920	2.41240
4.69000	-217.80990	2.43690
4.69000	-218.86920	2.45770
4.69000	-219.75230	2.47530
4.69000	-220.48840	2.49000
4.69000	-221.10200	2.50250
4.69000	-221.61350	2.51300
4.69000	-222.03980	2.52170
4.69000	-222.39520	2.52910
4.69000	-222.69130	2.53530
4.69000	-222.93820	2.54040
4.69000	-223.03210	2.53610



SUCTION SURFACE STREAMLINE			1
radius	wrap		axial
1.40700	0.37060	-0.00410	
1.40700	-0.20060	-0.01100	
1.40700	-0.83050	-0.00540	
1.40700	-1.58640	0.00130	
1.40700	-2.49340	0.00930	
1.40710	-3.58150	0.01890	
1.40730	-4.88690	0.03040	
1.40770	-6.45250	0.04400	
1.40830	-8.32980	0.06030	
1.40940	-10.57960	0.07970	
1.41110	-13.27460	0.10280	
1.41370	-16.49970	0.13030	
1.41770	-20.35440	0.16290	
1.42350	-24.95310	0.20140	
1.43220	-30.42480	0.24690	
1.44480	-36.91110	0.30060	
1.46320	-44.55870	0.36360	
1.48990	-53.51060	0.43760	
1.52860	-63.88860	0.52430	
1.58420	-75.76850	0.62580	
1.66150	-89.24270	0.74110	
1.76280	-104.44840	0.86710	
1.89440	-121.34680	1.00670	
2.06770	-139.79850	1.16860	
2.24890	-156.68700	1.32870	
2.40790	-169.66190	1.46910	
2.54150	-179.88030	1.59400	
2.65060	-188.05490	1.70610	
2.74070	-194.62020	1.81010	
2.81460	-199.92070	1.90770	
2.87420	-204.22310	1.99900	
2.92090	-207.73400	2.08360	
2.95660	-210.61270	2.16080	
2.98330	-212.98080	2.23010	
3.00290	-214.93340	2.29160	
3.01700	-216.54630	2.34540	
3.02710	-217.88030	2.39200	
3.03420	-218.98470	2.43220	
3.03920	-219.89990	2.46650	
3.04250	-220.65880	2.49580	
3.04480	-221.28850	2.52060	
3.04630	-221.81130	2.54160	
3.04730	-222.24550	2.55930	
3.04790	-222.60640	2.57410	
3.04820	-222.90630	2.58670	
3.04850	-223.15580	2.59720	
3.04850	-223.39060	2.63020	

SUCTION SURFACE STREAMLINE 2

radius	wrap	axial
1.99530	-15.78890	0.10730
1.99530	-16.24200	0.09870
1.99530	-16.73100	0.10270
1.99530	-17.31770	0.10740
1.99530	-18.02180	0.11310
1.99530	-18.86660	0.11990
1.99540	-19.88030	0.12810
1.99550	-21.09660	0.13780
1.99570	-22.55570	0.14950
1.99610	-24.30600	0.16350
1.99670	-26.40510	0.18020
1.99760	-28.92160	0.20010
1.99910	-31.93710	0.22400
2.00130	-35.54820	0.25250
2.00460	-39.86790	0.28670
2.00960	-45.02770	0.32770
2.01710	-51.17760	0.37690
2.02850	-58.48540	0.43630
2.04600	-67.13190	0.50870
2.07330	-77.29120	0.59760
2.11460	-89.17540	0.70320
2.17370	-103.00810	0.82340
2.25870	-118.92040	0.96220
2.38260	-136.91130	1.12870
2.52530	-153.79420	1.29500
2.65860	-167.03470	1.44080
2.77540	-177.57890	1.57020
2.87440	-186.06630	1.68570
2.95800	-192.91930	1.79240
3.02770	-198.47680	1.89230
3.08430	-203.00640	1.98560
3.12900	-206.71440	2.07170
3.16320	-209.76190	2.14990
3.18860	-212.27340	2.22010
3.20720	-214.34750	2.28200
3.22070	-216.06310	2.33610
3.23020	-217.48380	2.38290
3.23690	-218.66120	2.42320
3.24150	-219.63790	2.45760
3.24470	-220.44850	2.48680
3.24680	-221.12160	2.51160
3.24820	-221.68080	2.53260
3.24910	-222.14550	2.55030
3.24960	-222.53200	2.56510
3.25000	-222.85340	2.57760
3.25010	-223.12070	2.58810
3.25020	-223.33930	2.61850

SUCTION SURFACE STREAMLINE 3

radius	wrap	axial
2.44600	-28.18240	0.19290
2.44600	-28.56380	0.18290
2.44600	-28.98820	0.18610
2.44600	-29.49740	0.18990
2.44600	-30.10850	0.19450
2.44600	-30.84170	0.20000
2.44600	-31.72140	0.20660
2.44610	-32.77700	0.21450
2.44610	-34.04340	0.22400
2.44630	-35.56260	0.23530
2.44660	-37.38480	0.24890
2.44710	-39.57010	0.26530
2.44780	-42.19000	0.28490
2.44900	-45.32990	0.30860
2.45080	-49.09060	0.33720
2.45360	-53.59140	0.37180
2.45780	-58.97130	0.41390
2.46430	-65.39070	0.46570
2.47470	-73.02910	0.53000
2.49130	-82.08380	0.61050
2.51740	-92.78780	0.70840
2.55610	-105.40860	0.82190
2.61430	-120.17110	0.95610
2.70430	-137.21920	1.12120
2.81380	-153.53160	1.28890
2.92150	-166.52760	1.43740
3.01940	-176.98730	1.56870
3.10450	-185.46460	1.68570
3.17800	-192.35020	1.79340
3.24000	-197.96120	1.89380
3.29090	-202.55040	1.98710
3.33110	-206.31810	2.07270
3.36200	-209.42100	2.15020
3.38500	-211.98240	2.21940
3.40180	-214.10060	2.28040
3.41380	-215.85460	2.33350
3.42240	-217.30850	2.37940
3.42840	-218.51460	2.41880
3.43250	-219.51580	2.45250
3.43530	-220.34720	2.48110
3.43720	-221.03810	2.50530
3.43840	-221.61240	2.52570
3.43910	-222.08990	2.54300
3.43960	-222.48700	2.55750
3.43990	-222.81740	2.56960
3.44000	-223.09240	2.57980
3.44000	-223.29200	2.60750

SUCTION SURFACE	STREAMLINE	4
radius	wrap	axial
2.82570	-38.65030	0.26460
2.82570	-38.95490	0.25410
2.82570	-39.33800	0.25680
2.82570	-39.79780	0.26000
2.82570	-40.34940	0.26390
2.82570	-41.01140	0.26860
2.82570	-41.80560	0.27420
2.82570	-42.75870	0.28090
2.82580	-43.90200	0.28890
2.82590	-45.27380	0.29860
2.82610	-46.91920	0.31030
2.82640	-48.89280	0.32440
2.82680	-51.25960	0.34140
2.82750	-54.09690	0.36200
2.82860	-57.49710	0.38700
2.83030	-61.56950	0.41770
2.83300	-66.44300	0.45540
2.83720	-72.26810	0.50230
2.84410	-79.21760	0.56140
2.85540	-87.48820	0.63660
2.87350	-97.31580	0.72920
2.90090	-108.97830	0.83790
2.94300	-122.73720	0.96810
3.01010	-138.83350	1.13070
3.09440	-154.43170	1.29800
3.18010	-167.01320	1.44720
3.26010	-177.22330	1.57910
3.33110	-185.55070	1.69660
3.39360	-192.35120	1.80440
3.44680	-197.91750	1.90420
3.49080	-202.48470	1.99640
3.52570	-206.24360	2.08050
3.55250	-209.34510	2.15630
3.57250	-211.90940	2.22370
3.58700	-214.03230	2.28290
3.59740	-215.79210	2.33440
3.60480	-217.25170	2.37880
3.61000	-218.46350	2.41680
3.61350	-219.46980	2.44930
3.61590	-220.30600	2.47690
3.61750	-221.00100	2.50020
3.61860	-221.57890	2.51990
3.61920	-222.05960	2.53650
3.61960	-222.45960	2.55050
3.61990	-222.79240	2.56220
3.62000	-223.06950	2.57200
3.62000	-223.24780	2.59710

SUCTION SURFACE	STREAMLINE	5
radius	wrap	axial
3.16010	-47.80860	0.32840
3.16010	-48.11060	0.31700
3.16010	-48.46340	0.31940
3.16010	-48.88670	0.32220
3.16010	-49.39460	0.32550
3.16010	-50.00410	0.32960
3.16010	-50.73540	0.33440
3.16010	-51.61280	0.34030
3.16010	-52.66560	0.34740
3.16020	-53.92860	0.35590
3.16030	-55.44380	0.36620
3.16050	-57.26130	0.37870
3.16080	-59.44100	0.39390
3.16120	-62.05470	0.41240
3.16200	-65.18790	0.43500
3.16310	-68.94200	0.46290
3.16500	-73.43770	0.49760
3.16790	-78.81640	0.54120
3.17280	-85.24290	0.59680
3.18080	-92.90710	0.66830
3.19400	-102.04060	0.75720
3.21420	-112.91880	0.86260
3.24570	-125.82230	0.98990
3.29660	-141.03520	1.15030
3.36180	-155.91500	1.31670
3.42900	-168.02420	1.46570
3.49320	-177.91630	1.59740
3.55090	-186.02740	1.71480
3.60230	-192.68050	1.82170
3.64650	-198.14640	1.92010
3.68330	-202.64570	2.01050
3.71260	-206.35710	2.09260
3.73500	-209.42450	2.16610
3.75170	-211.96370	2.23120
3.76390	-214.06810	2.28820
3.77270	-215.81380	2.33770
3.77890	-217.26310	2.38020
3.78320	-218.46680	2.41670
3.78610	-219.46720	2.44770
3.78810	-220.29870	2.47400
3.78950	-220.99030	2.49630
3.79030	-221.56550	2.51510
3.79080	-222.04420	2.53090
3.79120	-222.44250	2.54420
3.79130	-222.77400	2.55540
3.79140	-223.05000	2.56470
3.79140	-223.21080	2.58720

SUCTION SURFACE	STREAMLINE	6
radius	wrap	axial
3.46240	-56.11810	0.38570
3.46240	-56.38830	0.37410
3.46240	-56.71690	0.37610
3.46240	-57.11110	0.37860
3.46240	-57.58410	0.38160
3.46240	-58.15170	0.38520
3.46240	-58.83270	0.38950
3.46240	-59.64980	0.39470
3.46240	-60.63020	0.40100
3.46240	-61.80640	0.40870
3.46250	-63.21750	0.41800
3.46260	-64.91020	0.42930
3.46280	-66.94050	0.44310
3.46310	-69.37530	0.46010
3.46360	-72.29460	0.48100
3.46440	-75.79340	0.50700
3.46570	-79.98490	0.53960
3.46780	-85.00270	0.58100
3.47130	-91.00350	0.63420
3.47720	-98.17130	0.70280
3.48700	-106.72820	0.78890
3.50220	-116.94310	0.89210
3.52600	-129.10600	1.01780
3.56470	-143.51390	1.17660
3.61460	-157.70320	1.34210
3.66670	-169.32910	1.49050
3.71680	-178.87730	1.62160
3.76250	-186.73700	1.73790
3.80340	-193.20980	1.84360
3.83880	-198.54520	1.94020
3.86840	-202.94850	2.02830
3.89200	-206.58840	2.10770
3.91010	-209.60180	2.17840
3.92360	-212.09920	2.24080
3.93340	-214.17090	2.29530
3.94040	-215.89080	2.34240
3.94530	-217.31950	2.38290
3.94880	-218.50680	2.41750
3.95110	-219.49400	2.44700
3.95270	-220.31490	2.47190
3.95370	-220.99790	2.49310
3.95440	-221.56620	2.51090
3.95480	-222.03920	2.52590
3.95510	-222.43290	2.53850
3.95520	-222.76070	2.54910
3.95530	-223.03360	2.55790
3.95530	-223.17440	2.57780

SUCTION SURFACE STREAMLINE			7
radius	wrap		axial
3.74030	-63.75690		0.43830
3.74030	-64.00010		0.42660
3.74030	-64.30830		0.42840
3.74030	-64.67820		0.43070
3.74030	-65.12200		0.43330
3.74030	-65.65460		0.43660
3.74030	-66.29360		0.44050
3.74030	-67.06030		0.44520
3.74030	-67.98010		0.45100
3.74030	-69.08370		0.45800
3.74040	-70.40750		0.46650
3.74050	-71.99560		0.47700
3.74060	-73.90040		0.48990
3.74080	-76.18470		0.50570
3.74110	-78.92370		0.52540
3.74170	-82.20700		0.55010
3.74260	-86.14140		0.58120
3.74410	-90.85380		0.62090
3.74660	-96.49400		0.67230
3.75090	-103.23670		0.73890
3.75820	-111.29710		0.82320
3.76940	-120.93640		0.92490
3.78730	-132.43960		1.04980
3.81610	-146.12010		1.20730
3.85360	-159.65620		1.37240
3.89270	-170.80470		1.51980
3.93050	-179.99910		1.65010
3.96520	-187.59390		1.76520
3.99630	-193.86900		1.86900
4.02350	-199.05560		1.96320
4.04620	-203.34610		2.04860
4.06430	-206.89940		2.12490
4.07820	-209.84530		2.19250
4.08850	-212.28940		2.25190
4.09600	-214.31870		2.30360
4.10140	-216.00470		2.34810
4.10520	-217.40610		2.38640
4.10780	-218.57140		2.41910
4.10960	-219.54060		2.44690
4.11080	-220.34710		2.47040
4.11160	-221.01810		2.49030
4.11220	-221.57670		2.50710
4.11250	-222.04160		2.52120
4.11270	-222.42880		2.53310
4.11280	-222.75120		2.54310
4.11280	-223.01970		2.55140
4.11280	-223.14260		2.56880

SUCTION SURFACE STREAMLINE 8

radius	wrap	axial
3.99890	-70.86730	0.48740
3.99890	-71.08540	0.47580
3.99890	-71.37600	0.47750
3.99890	-71.72470	0.47950
3.99890	-72.14310	0.48190
3.99890	-72.64510	0.48490
3.99890	-73.24740	0.48850
3.99890	-73.97010	0.49280
3.99890	-74.83710	0.49820
3.99890	-75.87740	0.50460
3.99890	-77.12530	0.51260
3.99900	-78.62230	0.52240
3.99910	-80.41800	0.53450
3.99920	-82.57150	0.54960
3.99940	-85.15400	0.56840
3.99980	-88.25000	0.59210
4.00040	-91.96070	0.62220
4.00150	-96.40620	0.66090
4.00330	-101.72880	0.71110
4.00640	-108.09910	0.77630
4.01150	-115.72220	0.85900
4.01960	-124.84640	0.96010
4.03240	-135.75510	1.08450
4.05300	-148.76800	1.24160
4.07970	-161.69120	1.40610
4.10740	-172.37510	1.55280
4.13430	-181.21720	1.68200
4.15910	-188.54210	1.79550
4.18140	-194.61000	1.89720
4.20070	-199.63740	1.98880
4.21690	-203.80500	2.07080
4.22990	-207.26200	2.14380
4.23990	-210.13180	2.20810
4.24720	-212.51530	2.26430
4.25260	-214.49610	2.31300
4.25640	-216.14310	2.35490
4.25910	-217.51290	2.39080
4.26090	-218.65250	2.42140
4.26220	-219.60070	2.44750
4.26300	-220.38990	2.46950
4.26360	-221.04700	2.48810
4.26400	-221.59390	2.50380
4.26420	-222.04930	2.51700
4.26430	-222.42860	2.52810
4.26440	-222.74460	2.53740
4.26440	-223.00760	2.54530
4.26440	-223.11280	2.56020



SUCTION SURFACE STREAMLINE 9

radius	wrap	axial
4.24180	-77.53650	0.53350
4.24180	-77.73980	0.52220
4.24180	-78.01470	0.52380
4.24180	-78.34460	0.52560
4.24180	-78.74030	0.52790
4.24180	-79.21520	0.53060
4.24180	-79.78490	0.53390
4.24180	-80.46850	0.53790
4.24180	-81.28860	0.54290
4.24180	-82.27250	0.54900
4.24180	-83.45290	0.55650
4.24190	-84.86870	0.56570
4.24190	-86.56710	0.57730
4.24200	-88.60390	0.59180
4.24210	-91.04650	0.61010
4.24240	-93.97510	0.63330
4.24280	-97.48590	0.66290
4.24350	-101.69320	0.70100
4.24460	-106.73340	0.75030
4.24660	-112.76820	0.81460
4.24990	-119.99540	0.89640
4.25510	-128.65370	0.99710
4.26340	-139.02070	1.12150
4.27670	-151.41670	1.27810
4.29380	-163.75980	1.44260
4.31150	-173.99740	1.58840
4.32860	-182.49200	1.71630
4.34430	-189.54640	1.82830
4.35850	-195.40300	1.92760
4.37080	-200.26570	2.01600
4.38100	-204.30420	2.09460
4.38920	-207.65910	2.16390
4.39550	-210.44750	2.22470
4.40010	-212.76590	2.27750
4.40350	-214.69420	2.32310
4.40580	-216.29860	2.36230
4.40750	-217.63380	2.39570
4.40870	-218.74510	2.42430
4.40940	-219.67030	2.44850
4.41000	-220.44050	2.46900
4.41030	-221.08190	2.48630
4.41050	-221.61600	2.50090
4.41070	-222.06080	2.51310
4.41070	-222.43140	2.52340
4.41080	-222.74000	2.53210
4.41080	-222.99710	2.53930
4.41080	-223.08440	2.55850

SUCTION SURFACE	STREAMLINE	10
radius	wrap	axial
4.47150	-83.84940	0.57690
4.47150	-84.03380	0.56600
4.47150	-84.29440	0.56740
4.47150	-84.60720	0.56920
4.47150	-84.98240	0.57130
4.47150	-85.43270	0.57380
4.47150	-85.97290	0.57700
4.47150	-86.62100	0.58080
4.47150	-87.39860	0.58550
4.47150	-88.33140	0.59140
4.47150	-89.45050	0.59860
4.47150	-90.79290	0.60760
4.47150	-92.40310	0.61890
4.47160	-94.33430	0.63310
4.47170	-96.65030	0.65100
4.47180	-99.42740	0.67390
4.47200	-102.75690	0.70320
4.47240	-106.74780	0.74100
4.47290	-111.53010	0.79010
4.47380	-117.25940	0.85370
4.47550	-124.12390	0.93470
4.47810	-132.35430	1.03550
4.48220	-142.22040	1.16010
4.48860	-154.03930	1.31670
4.49690	-165.83440	1.48100
4.50540	-175.64140	1.62600
4.51360	-183.79880	1.75260
4.52120	-190.58500	1.86280
4.52790	-196.23010	1.95960
4.53370	-200.92510	2.04480
4.53860	-204.83120	2.11980
4.54250	-208.08080	2.18530
4.54540	-210.78460	2.24220
4.54760	-213.03490	2.29150
4.54920	-214.90810	2.33380
4.55030	-216.46760	2.37010
4.55100	-217.76600	2.40110
4.55160	-218.84730	2.42750
4.55190	-219.74770	2.44990
4.55220	-220.49750	2.46880
4.55230	-221.12210	2.48480
4.55240	-221.64230	2.49820
4.55250	-222.07560	2.50950
4.55260	-222.43660	2.51900
4.55260	-222.73730	2.52700
4.55260	-222.98790	2.53370
4.55260	-223.93510	2.54380

SUCTION SURFACE STREAMLINE 11

radius	wrap	axial
4.69000	-89.85420	0.61840
4.69000	-90.02020	0.60800
4.69000	-90.26780	0.60930
4.69000	-90.56480	0.61100
4.69000	-90.92120	0.61300
4.69000	-91.34870	0.61540
4.69000	-91.86180	0.61840
4.69000	-92.47730	0.62200
4.69000	-93.21570	0.62660
4.69000	-94.10160	0.63220
4.69000	-95.16430	0.63930
4.69000	-96.43910	0.64810
4.69000	-97.96820	0.65920
4.69000	-99.80230	0.67320
4.69000	-102.00180	0.69110
4.69000	-104.63950	0.71390
4.69000	-107.80220	0.74320
4.69000	-111.59340	0.78110
4.69000	-116.13750	0.83010
4.69000	-121.58440	0.89330
4.69000	-128.11430	0.97410
4.69000	-135.94810	1.07490
4.69000	-145.34550	1.20030
4.69000	-156.62160	1.35680
4.69000	-167.89560	1.52100
4.69000	-177.28800	1.66500
4.69000	-185.11600	1.79010
4.69000	-191.63940	1.89860
4.69000	-197.07430	1.99280
4.69000	-201.60230	2.07470
4.69000	-205.37460	2.14580
4.69000	-208.51730	2.20730
4.69000	-211.13510	2.26040
4.69000	-213.31550	2.30590
4.69000	-215.13170	2.34500
4.69000	-216.64450	2.37840
4.69000	-217.90480	2.40690
4.69000	-218.95460	2.43110
4.69000	-219.82930	2.45160
4.69000	-220.55790	2.46890
4.69000	-221.16500	2.48360
4.69000	-221.67070	2.49590
4.69000	-222.09220	2.50630
4.69000	-222.44330	2.51500
4.69000	-222.73580	2.52230
4.69000	-222.97960	2.52840
4.69000	-223.03210	2.53610

## **APPENDIX D**

### **IMPELLER INLET FLOWFIELD DEFINITION**

# CONSORTIUM IMPELLER INLET CONDITIONS AND CAVITY DEFINITION

## IMPELLER INLET CONDITIONS

OPERATION IN LH<sub>2</sub>

STATOR EXIT FLOW DEFINED, RECIRC FLOWS DEFINED (MASS FLOW, DENSITY, VELOCITY COMPONENTS)

"MIXED OUT" FLOWFIELD DEFINED - MIXING OVER ENTIRE SPAN

STATOR AXIAL POSITION, AXIAL LOCATION OF RECIRC FLOWS DEFINED

COORD. SYSTEM SAME AS BLADE GEOMETRY

RETURN FLOWPATHS EXTENDED STRAIGHT AND PARALLEL (NOT RADIUSSED) TO DEFINE CORNER LOCATIONS AND TO CALCULATE VELOCITY COMPONENTS FOR RECIRC. FLOWS

OPERATION IN WATER

ADP INDUCER EXIT FLOW DEFINED, NO STATOR, ASSUMED NO RECIRC FLOWS

INDUCER POSITION AND DETAILS OF TESTER GEOME TRY TBD

## CAVITY DEFINITION

COMPLETE DEFINITION OF FRONT SHROUD AND HUB CAVITIES

Z IMPELLER BLADE = Z+12.1477

SURFACE POINTS IN 2 GEOMETRY FILES (CAVROT, CAVSTAT)

MASS FLOWS, DENSITIES, NECESSARY VELOCITIES ETC. DEFINED FROM BEST AVAILABLE ANALYSES

TURBOPUMP CONFIGURATION.

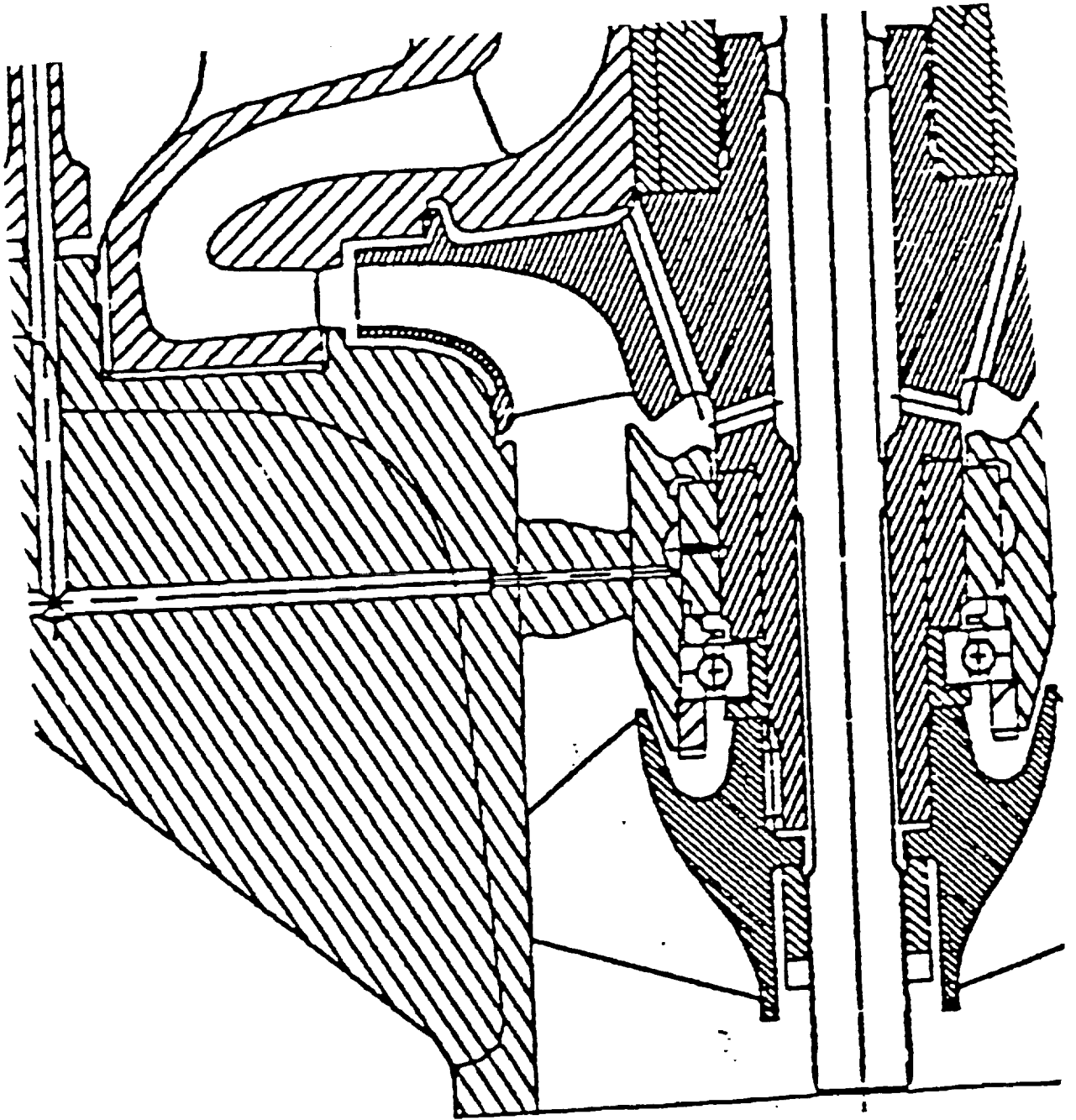

# CONSORTIUM FUEL PUMP IMPELLER INLET CONDITIONS FOR LH<sub>2</sub> OPERATION

- RECIRC. FLOWS SCALED FROM 3-STAGE THERMO MODEL
  - 6 LB/S FROM FRONT WEAR RING SEAL
  - 10 LB/S THROUGH HUB
- JET TANGENTIAL FLOW APPROXIMATED BY HALF WHEEL SPEED
- MIXED FLOW PROPERTIES DETERMINED BY TOTAL ENTHALPY MIXING
- ASSUME JET FLOW MIXED WITH MAIN FLOW OVER COMPLETE SPAN
  - FLOW CONTINUITY SATISFIED
  - FLOW ANGULAR MOMENTUM PRESERVED
  - FLOW RADIAL EQUILIBRIUM SATISFIED
  - MASS AVERAGE TOTAL PRESSURE CONSTANT

# CONSORTIUM PUMP IMPELLER

	MAIN STREAM	JET FROM TOP	JET FROM BOTTOM	MIXED FLOW
W (lb/s)	214.2	6.0	10.0	230.2
T (deg. R)	39.34	57.8	57.8	42.9
$\rho$ (lb/f <sup>3</sup> )	4.40	2.30	1.474	4.21
U (fps)		75.4	178	
V (fps)		-75.4	130	
W (fps)		616.0	400.5	



# CONSORTIUM JUMP IMPELLER COORDINATE DEFINITION

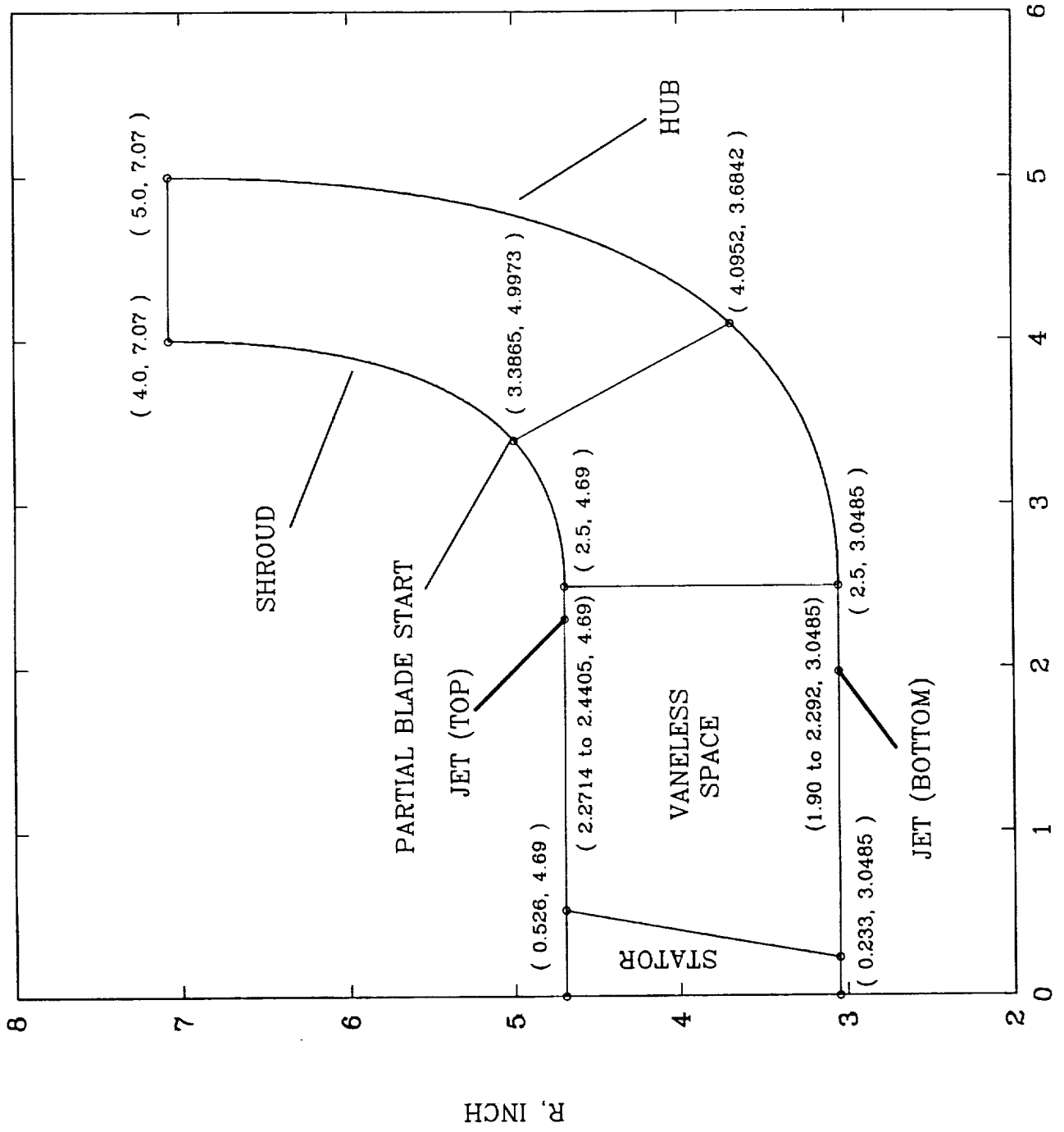

# PUMP CONSORTIUM IMPELLER DESIGN INLET BOUNDARY CONDITIONS

I	R	CM	CU	PS	PT	CMMIX	CUMIX	PSMIX	PTMIX
1	3.048	165.770	236.610	244.000	283.633	186.193	249.782	237.400	281.498
2	3.240	174.340	244.460	247.258	290.068	195.818	258.069	241.031	288.712
3	3.470	169.640	236.050	250.883	291.007	190.539	249.191	245.071	289.779
4	3.710	171.200	225.670	254.089	292.189	192.292	238.233	248.644	291.230
5	3.949	177.110	233.710	257.042	297.874	198.930	246.721	251.935	297.571
6	4.183	176.800	254.130	260.142	305.651	198.581	268.277	255.389	306.006
7	4.399	179.210	279.100	263.382	315.622	201.288	294.637	259.000	316.851
8	4.582	184.420	312.450	266.562	329.069	207.140	329.844	262.544	331.470
9	4.690	185.850	356.100	268.899	345.515	208.746	375.924	265.149	349.154

R(INCH): RADIUS

CM(FPS): MERIDIONAL VELOCITY BEFORE MIXING WITH JET

CU(FPS): TANGENTIAL VELOCITY BEFORE MIXING WITH JET

PS(PSI): STATIC PRESSURE BEFORE MIX WITH JET

PT(PSI): TOTAL PRESSURE BEFORE MIX WITH JET

CMMIX(FPS): MERIDIONAL VELOCITY AFTER MIXING WITH JET

CUMIX(FPS): TANGENTIAL VELOCITY AFTER MIXING WITH JET

PSMIX(PSI): STATIC PRESSURE AFTER MIX WITH JET

PTMIX(PSI): TOTAL PRESSURE AFTER MIX WITH JET

PUMP CONSORTIUM IMPELLER WATER TEST INLET CONDITIONS  
 ADP INDUCER, NO STATOR, NO RECIRC. FLOW

I	D	CM	CU	P <sub>T</sub>
1	3.90	20.74	47.12	61.83
2	4.11	26.90	41.49	61.83
3	4.32	27.41	39.19	61.83
4	4.53	27.30	37.45	61.83
5	4.74	27.15	35.90	61.83
6	4.95	26.72	34.70	61.83
7	5.16	25.97	33.86	61.83
8	5.37	24.29	33.77	61.83
9	5.58	21.24	34.31	61.83
10	5.79	15.87	35.64	61.83
11	6.00	13.88	39.38	61.83

WATER TESTER IMPELLER INLET TIP DIAMETER = 6 INCHES  
 SPEED = 6322 RPM  
 WATER DENSITY = 62.3 LB/F<sup>3</sup>  
 VOLUMETRIC FLOW = 1205 GPM

D (INCH) = DIAMETER  
 CM (FPS) = MERIDIONAL VELOCITY  
 CU (FPS) = TANGENTIAL VELOCITY  
 P<sub>T</sub> (PSI) = TOTAL PRESSURE

SURFACES DEFINED.

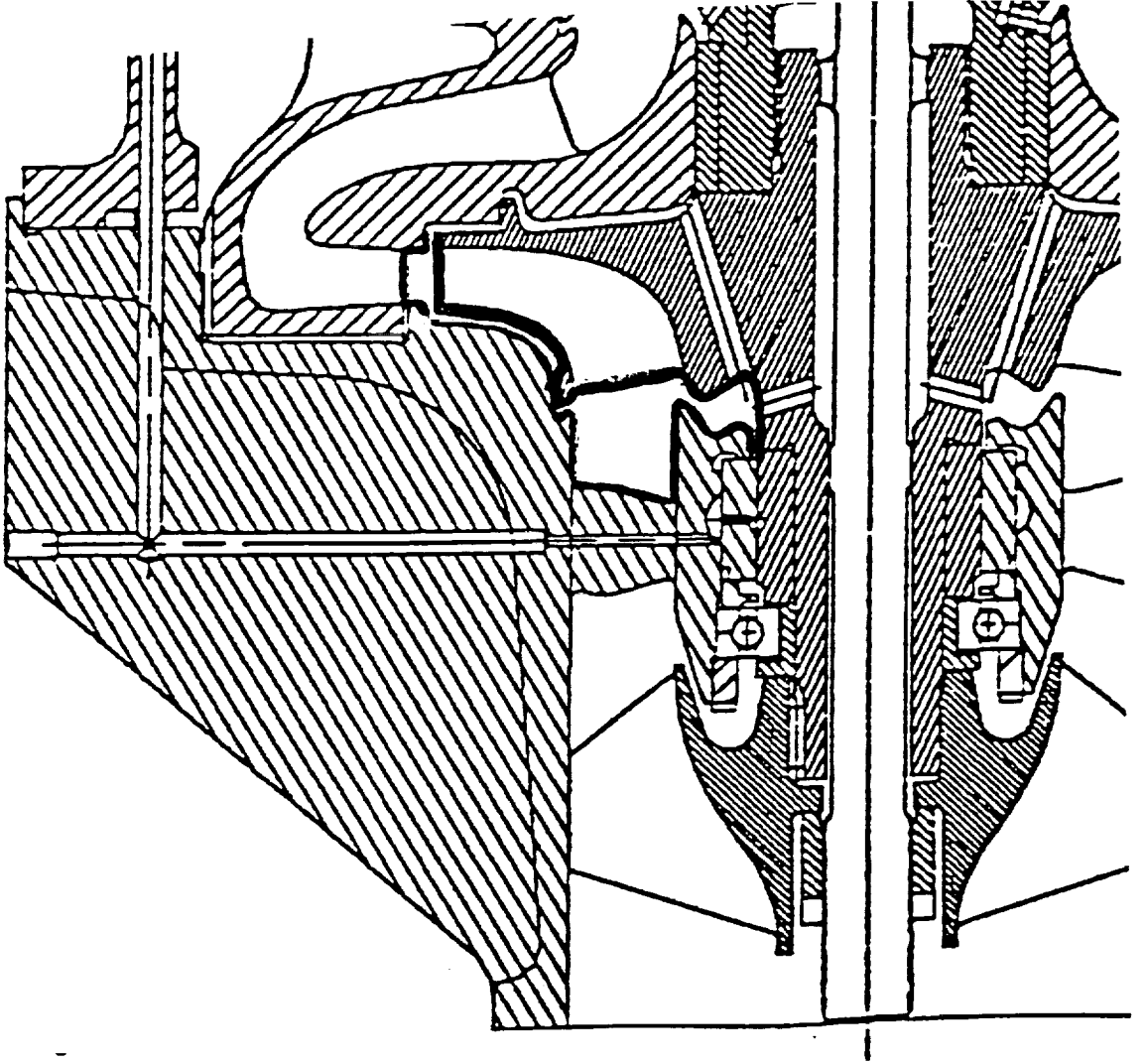



# CONSORTIUM IMPELLER CAVITY FLOWS.

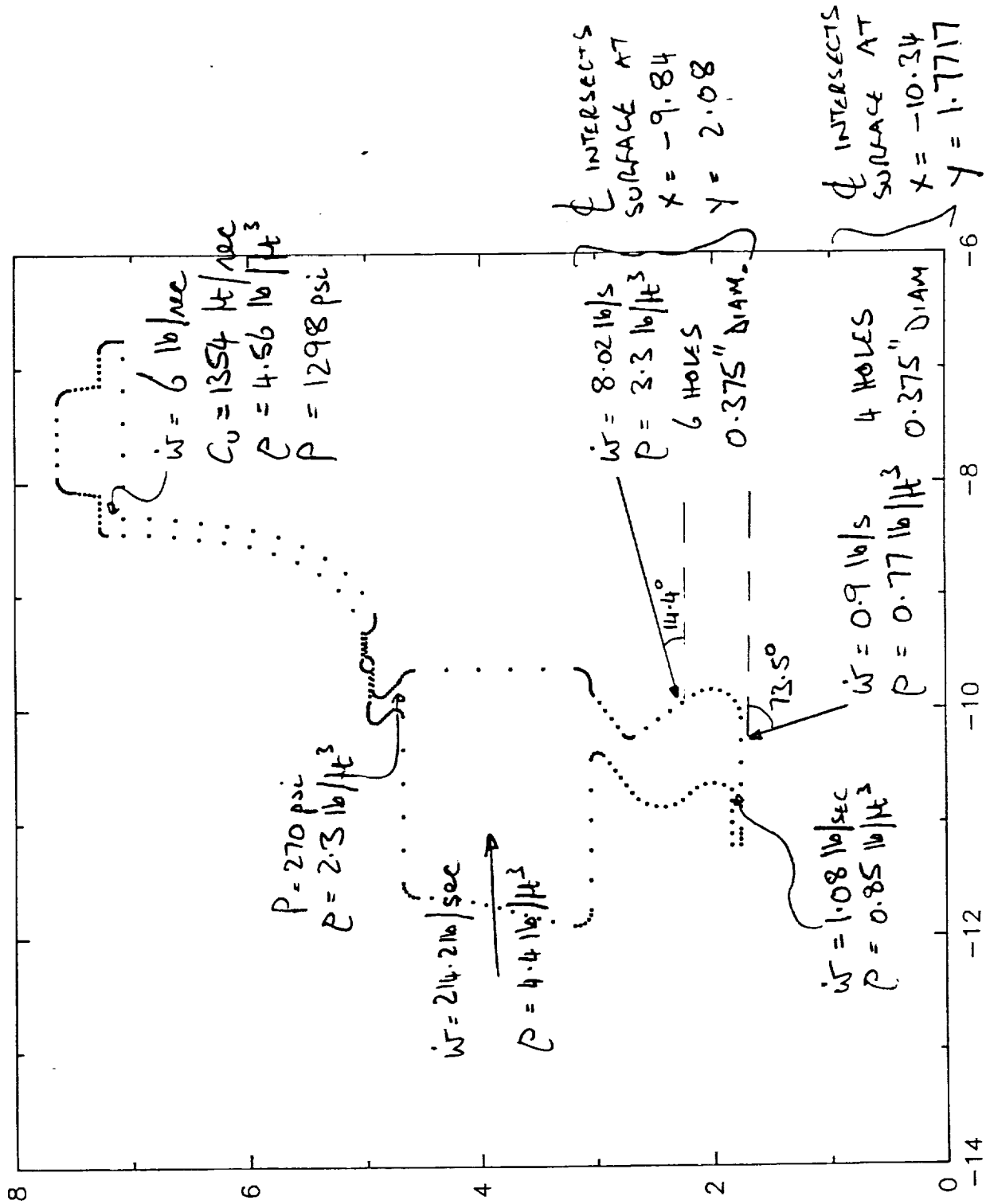

cavstat.dat

X	Y	Z
-11.1994	1.8467	0.0000
-11.1024	1.8467	0.0000
-11.0053	1.8467	0.0000
-10.9083	1.8467	0.0000
-10.8112	1.8467	0.0000
-10.7142	1.8467	0.0000
-10.6739	1.9145	0.0000
-10.6567	1.9914	0.0000
-10.6643	2.0698	0.0000
-10.6960	2.1419	0.0000
-10.7485	2.2007	0.0000
-10.8044	2.2598	0.0000
-10.8431	2.3313	0.0000
-10.8620	2.4104	0.0000
-10.8599	2.4917	0.0000
-10.8369	2.5697	0.0000
-10.7946	2.6392	0.0000
-10.7357	2.6953	0.0000
-10.6701	2.7434	0.0000
-10.6044	2.7914	0.0000
-10.5387	2.8395	0.0000
-10.4730	2.8875	0.0000
-10.4073	2.9356	0.0000
-10.3876	2.9595	0.0000

//r8/user/lin/eas/cavstat.dat

-10.3818	2.9900	0.0000
-10.3915	3.0196	0.0000
-10.4141	3.0408	0.0000
-10.4442	3.0485	0.0000
-10.7083	3.0485	0.0000
-10.9724	3.0485	0.0000
-11.2365	3.0485	0.0000
-11.5006	3.0485	0.0000
-11.7646	3.0485	0.0000
-11.8090	3.0502	0.0000
-11.8498	3.0680	0.0000
-11.8812	3.0994	0.0000
-11.8991	3.1401	0.0000
-11.9010	3.1845	0.0000
-11.8646	3.3806	0.0000
-11.8376	3.4980	0.0000
-11.8053	3.6141	0.0000
-11.7713	3.7297	0.0000
-11.7387	3.8456	0.0000
-11.7101	3.9627	0.0000
-11.6839	4.0803	0.0000
-11.6639	4.1991	0.0000
-11.6514	4.3189	0.0000
-11.6453	4.4392	0.0000
-11.6439	4.5597	0.0000
-11.6375	4.5981	0.0000



-11.6197	4.6327	0.0000
-11.5920	4.6601	0.0000
-11.5573	4.6777	0.0000
-11.5189	4.6837	0.0000
-11.2254	4.6837	0.0000
-10.9318	4.6837	0.0000
-10.6383	4.6837	0.0000
-10.3448	4.6837	0.0000
-10.0513	4.6837	0.0000
-10.0229	4.6905	0.0000
-10.0007	4.7095	0.0000
-9.9895	4.7364	0.0000
-9.9918	4.7655	0.0000
-10.0071	4.7904	0.0000
-10.0247	4.8080	0.0000
-10.0422	4.8256	0.0000
-10.0598	4.8431	0.0000
-10.0774	4.8607	0.0000
-10.0950	4.8783	0.0000
-10.1102	4.9032	0.0000
-10.1125	4.9323	0.0000
-10.1013	4.9592	0.0000
-10.0791	4.9782	0.0000
-10.0508	4.9850	0.0000
-10.0271	4.9850	0.0000

-10.0034	4.9850	0.0000
-9.9798	4.9850	0.0000
-9.9693	4.9844	0.0000
-9.9589	4.9825	0.0000
-9.9488	4.9795	0.0000
-9.9391	4.9753	0.0000
-9.9300	4.9700	0.0000
-9.8751	4.9700	0.0000
-9.8202	4.9700	0.0000
-9.7653	4.9700	0.0000
-9.7103	4.9700	0.0000
-9.6554	4.9700	0.0000
-9.6554	4.9742	0.0000
-9.6554	4.9783	0.0000
-9.6554	4.9825	0.0000
-9.6522	5.0025	0.0000
-9.6427	5.0204	0.0000
-9.6279	5.0343	0.0000
-9.6095	5.0427	0.0000
-9.5894	5.0449	0.0000
-9.5696	5.0405	0.0000
-9.5523	5.0300	0.0000
-9.5058	5.0300	0.0000
-9.4593	5.0300	0.0000
-9.4128	5.0300	0.0000
-9.3663	5.0300	0.0000

-9.3198	5.0300	0.0000
-9.1192	5.1096	0.0000
-8.9444	5.2360	0.0000
-8.8045	5.4005	0.0000
-8.6970	5.5880	0.0000
-8.6142	5.7876	0.0000
-8.5555	5.9957	0.0000
-8.5187	6.2088	0.0000
-8.4901	6.4232	0.0000
-8.4644	6.6379	0.0000
-8.4503	6.8537	0.0000
-8.4477	7.0700	0.0000
-8.4477	7.2113	0.0000
-8.4447	7.2306	0.0000
-8.4358	7.2481	0.0000
-8.4220	7.2619	0.0000
-8.4045	7.2708	0.0000
-8.3852	7.2738	0.0000
-8.3287	7.2738	0.0000
-8.2722	7.2738	0.0000
-8.2157	7.2738	0.0000
-8.1592	7.2738	0.0000
-8.1027	7.2738	0.0000
-8.0967	7.3155	0.0000
-8.0907	7.3571	0.0000

-8.0847	7.3988	0.0000
-8.0787	7.4404	0.0000
-8.0727	7.4820	0.0000
-8.0714	7.5130	0.0000
-8.0702	7.5301	0.0000
-8.0665	7.5468	0.0000
-8.0605	7.5628	0.0000
-8.0523	7.5779	0.0000
-8.0421	7.5916	0.0000
-8.0300	7.6037	0.0000
-8.0163	7.6139	0.0000
-8.0012	7.6222	0.0000
-7.9852	7.6281	0.0000
-7.9685	7.6318	0.0000
-7.9514	7.6330	0.0000
-7.8192	7.6330	0.0000
-7.6870	7.6330	0.0000
-7.5548	7.6330	0.0000
-7.4226	7.6330	0.0000
-7.2903	7.6330	0.0000
-7.2646	7.6302	0.0000
-7.2401	7.6220	0.0000
-7.2179	7.6087	0.0000
-7.1991	7.5910	0.0000
-7.1845	7.5696	0.0000
-7.1749	7.5456	0.0000

-7.1706	7.5201	0.0000
-7.1635	7.4709	0.0000
-7.1564	7.4216	0.0000
-7.1493	7.3723	0.0000
-7.1422	7.3231	0.0000
-7.1351	7.2738	0.0000
-7.0765	7.2738	0.0000
-7.0179	7.2738	0.0000
-6.9593	7.2738	0.0000
-6.9008	7.2738	0.0000
-6.8422	7.2738	0.0000
-6.8213	7.2715	0.0000
-6.8014	7.2645	0.0000
-6.7836	7.2533	0.0000
-6.7687	7.2384	0.0000
-6.7575	7.2206	0.0000
-6.7505	7.2007	0.0000
-6.7482	7.1798	0.0000
-6.7482	7.1432	0.0000
-6.7482	7.1066	0.0000
-6.7482	7.0700	0.0000

CAVROT.DAT

X	Y	Z
-11.1994	1.7717	0.0000
-11.1533	1.7717	0.0000
-11.1073	1.7717	0.0000
-11.0612	1.7717	0.0000
-10.8664	1.7717	0.0000
-10.6716	1.7717	0.0000
-10.4768	1.7717	0.0000
-10.2820	1.7717	0.0000
-10.0873	1.7717	0.0000
-10.0105	1.7837	0.0000
-9.9412	1.8188	0.0000
-9.8859	1.8734	0.0000
-9.8502	1.9424	0.0000
-9.8373	2.0190	0.0000
-9.8485	2.0959	0.0000
-9.8828	2.1656	0.0000
-9.9551	2.2683	0.0000
-10.0275	2.3710	0.0000
-10.0998	2.4738	0.0000
-10.1721	2.5765	0.0000
-10.2444	2.6793	0.0000
-10.2530	2.6966	0.0000
-10.2558	2.7157	0.0000
-10.2527	2.7348	0.0000

//r8/user/lin/eas/cavrot.dat

-10.2439	2.7520	0.0000
-10.2302	2.7657	0.0000
-10.1595	2.8174	0.0000
-10.0887	2.8692	0.0000
-10.0180	2.9209	0.0000
-9.9473	2.9727	0.0000
-9.8774	3.0244	0.0000
-9.8546	3.0376	0.0000
-9.8297	3.0457	0.0000
-9.8036	3.0485	0.0000
-9.7927	3.0485	0.0000
-9.7827	3.0485	0.0000
-9.7727	3.0485	0.0000
-9.7449	3.0516	0.0000
-9.7185	3.0609	0.0000
-9.6948	3.0758	0.0000
-9.6750	3.0956	0.0000
-9.6601	3.1193	0.0000
-9.6509	3.1457	0.0000
-9.6477	3.1735	0.0000
-9.6477	3.4563	0.0000
-9.6477	3.7391	0.0000
-9.6477	4.0219	0.0000
-9.6477	4.3047	0.0000
-9.6477	4.5875	0.0000

-9.6510	4.6158	0.0000
-9.6606	4.6427	0.0000
-9.6760	4.6667	0.0000
-9.6965	4.6865	0.0000
-9.7209	4.7012	0.0000
-9.7289	4.7052	0.0000
-9.7366	4.7098	0.0000
-9.7440	4.7149	0.0000
-9.7509	4.7205	0.0000
-9.7575	4.7266	0.0000
-9.7797	4.7488	0.0000
-9.8019	4.7710	0.0000
-9.8240	4.7932	0.0000
-9.8462	4.8154	0.0000
-9.8684	4.8376	0.0000
-9.8801	4.8540	0.0000
-9.8856	4.8733	0.0000
-9.8845	4.8933	0.0000
-9.8768	4.9119	0.0000
-9.8634	4.9269	0.0000
-9.8458	4.9366	0.0000
-9.8260	4.9400	0.0000
-9.7777	4.9400	0.0000
-9.7294	4.9400	0.0000
-9.6811	4.9400	0.0000
-9.6328	4.9400	0.0000

//r8/user/lin/eas/cavrot.dat



-9.5845	4.9400	0.0000
-9.5711	4.9415	0.0000
-9.5584	4.9459	0.0000
-9.5471	4.9531	0.0000
-9.5376	4.9626	0.0000
-9.5304	4.9740	0.0000
-9.5260	4.9866	0.0000
-9.5245	5.0000	0.0000
-9.4845	5.0000	0.0000
-9.4445	5.0000	0.0000
-9.4045	5.0000	0.0000
-9.3645	5.0000	0.0000
-9.3245	5.0000	0.0000
-9.3119	4.9741	0.0000
-9.2938	4.9518	0.0000
-9.2711	4.9343	0.0000
-9.2450	4.9223	0.0000
-9.2168	4.9167	0.0000
-9.1881	4.9176	0.0000
-9.1603	4.9251	0.0000
-8.9639	5.0289	0.0000
-8.7951	5.1732	0.0000
-8.6588	5.3488	0.0000
-8.5519	5.5439	0.0000
-8.4684	5.7501	0.0000

-8.4088	5.9644	0.0000
-8.3708	6.1837	0.0000
-8.3413	6.4043	0.0000
-8.3149	6.6254	0.0000
-8.3004	6.8474	0.0000
-8.2977	7.0700	0.0000
-8.0177	7.0700	0.0000
-7.7377	7.0700	0.0000
-7.4577	7.0700	0.0000
-7.1777	7.0700	0.0000
-6.8977	7.0700	0.0000



# Report Documentation Page

1. Report No. RI-RD-91-193		2. Government Accession No.		3. Recipient's Catalog No.	
4. Title and Subtitle FINAL TECHNICAL REPORT - HYDRODYNAMIC DESIGN OF GENERIC PUMP COMPONENTS				5. Report Date June 1991	
				6. Performing Organization Code	
7. Author(s) A. H. Eastland/H. Dodson				8. Performing Organization Report No.	
				10. Work Unit No.	
8. Performing Organization Name and Address Rocketdyne Division Rockwell International Corporation 6633 Canoga Ave. Canoga Park, CA 91303				11. Contract or Grant No. NAS 8-38863	
				13. Type of Report and Period Covered Final	
12. Sponsoring Agency Name and Address NASA Marshall Space Flight Center Huntsville, AL				14. Sponsoring Agency Code	
				15. Supplementary Notes	
16. Abstract Inducer and impeller blade geometries have been defined for a fuel pump for a generic generator cycle. Blade surface data and inlet flowfield definition is available in sufficient detail to allow CFD analysis of the two components.					
17. Key Words (Suggested by Author(s)) Pump Components			18. Distribution Statement		
19. Security Classif. (of this report) Unclassified		20. Security Classif. (of this page) Unclassified		21. No. of pages 150	22. Price