

N-05
00000
000

NASA Technical Memorandum 104125
AVSCOM Technical Report 91-B-019

FLAPPING INERTIA FOR SELECTED ROTOR BLADES

John D. Berry
Matthew J. May

November 1991

(NASA-TM-104125) FLAPPING INERTIA FOR
SELECTED ROTOR BLADES (NASA) 60 p USCL 01C

N92-13057

unclas
G3/05 0053060

NASA
National Aeronautics and
Space Administration
Langley Research Center
Hampton, Virginia 23665-5225



The use of trademarks or names of manufacturers in this report is for accurate reporting and does not constitute an official endorsement, either expressed or implied, of such products or manufacturers by the National Aeronautics and Space Administration.

Abstract

Aerodynamics of helicopter rotor systems cannot be investigated without consideration for the dynamics of the rotor. One of the principal properties of the rotor which affects the rotor dynamics is the inertia of the rotor blade about its root attachment. Previous aerodynamic investigations have been performed on rotor blades with a variety of planforms to determine the performance differences due to blade planform. The blades tested for this investigation have been tested on the US Army two-meter rotor test system (2MRTS) in the NASA Langley 14- by 22-foot Subsonic Tunnel for hover performance. This investigation was intended to provide fundamental information on the flapping inertia of five rotor blades with differing planforms. The inertia of the bare cuff and the cuff with a blade extension were also measured for comparison with the inertia of the blades. Inertia was determined using a swing-testing technique, using the period of oscillation to determine the effective flapping inertia. The effect of damping in the swing-test was measured and accounted for. A comparison of the flapping inertials for rectangular and tapered planform blades of approximately the same mass showed the tapered blades to have a lower inertia, as expected.

Introduction

Helicopter rotor aerodynamics cannot be investigated without consideration for rotor blade dynamics. One of the principal properties of a rotor which affects the rotor blade dynamics is the flapping inertia of the rotor blade. The amount of inertia affects the tendency of the rotor blades to "cone up" from the normal plane of rotation when producing thrust. A similar lead-lag inertia also affects the rotary inertia of the entire rotor system and contributes to the characteristics of the rotor during entry into and the final flare of an autorotation.

One aspect of rotor research at the NASA Langley 14- by 22-foot Subsonic Tunnel has been the evaluation of rotor systems designed with significant amounts of planform taper. Concern for the autorotative performance of these advanced rotors grew from these investigations. Rotational inertia (related directly to flapping inertia) is the principal measure of autorotative performance.

The US Army two-meter rotor test system (2MRTS, reference 1), developed for the NASA Langley 14- by 22-foot Subsonic Tunnel, was used in previous investigations to study the effect of planform taper on rotor performance (references 2 and 3 as examples.) This report documents the flapping inertia for several of these rotors.

Notation and Symbols

The physical quantities defined in this paper are given in the U.S. Customary Units. Measurements and calculations were made in the U.S. Customary Units with the exception of weight measurement which was made in grams. The conversion factor used from grams to pounds was obtained from reference 4.

f_d	damped frequency, Hz
f_n	natural frequency, Hz
g	gravitational constant, 386.112 in/sec ²
$I_{\theta\theta}$	flapping inertia, lb-in ²
m	mass, slugs
Q	Torque about flapping hinge, lb-in
r	length from flapping hinge axis to center of mass, in
S_x	uncertainty in x
T	damped period of oscillation, sec
t	time of oscillation, sec
X_1	amplitude of first oscillation, Volts
X_2	amplitude of second oscillation, Volts
δ	logarithmic decrement
ω_d	damped angular frequency, Hz
ω_n	natural angular frequency, Hz
θ	angular displacement about the flapping axis, rad
$\ddot{\theta}$	angular acceleration, rad/sec ²
ζ	damping constant

Theory

From torque equilibrium about the flapping hinge, the equation used to find the flapping inertia, $I_{\theta\theta}$, is:

$$Q = \ddot{\theta} I_{\theta\theta} = -mgr \sin \theta. \quad (1)$$

Assuming periodic displacement:

$$\theta = A \sin \omega t \quad (2)$$

$$\ddot{\theta} = -\omega^2 A \sin \omega t \quad (3)$$

and

$$\omega_n = 2\pi f_n. \quad (4)$$

By using a small angle assumption ($\sin \theta = \theta$) and combining the above equations, the flapping inertia is:

$$I_{\theta\theta} = \frac{mgr}{4\pi^2 f_n}. \quad (5)$$

This relation indicates that the flapping inertia can be determined by swinging the blade and measuring the period of oscillation. Unfortunately, in any experimental test of this nature there will be damping due to friction and air resistance which will affect the natural frequency. From reference 5 the effect of the damping can be determined and used to correct the measured frequency. The damped natural frequency, f_d , is related to the undamped natural frequency, f_n , by the relation:

$$f_d = \frac{f_n}{\sqrt{1 - \zeta^2}} \quad (6)$$

The logarithmic decrement, δ , of the system is defined as the natural logarithm of the ratio of any two consecutive amplitudes. From reference 5, the logarithmic decrement is related to the damping factor by:

$$\delta = \frac{2\pi\zeta}{\sqrt{1 - \zeta^2}}. \quad (7)$$

Therefore, by substituting and solving for ζ^2 , we have:

$$\zeta^2 = \frac{(\ln \frac{X_1}{X_2})^2}{4\pi^2 + (\ln \frac{X_1}{X_2})^2}. \quad (8)$$

Equation (8) can be substituted into equation (6) to find the natural frequency, and then the flapping inertia can be found by using equation (5). A general discussion of natural frequency, damping constant, and logarithmic decrement is given in reference 5.

Model and Apparatus

The model rotor blades which are described here have been used in several investigations (references 3-5). Although the geometry of the blades has been documented, the flapping response of the blades has not been previously documented. A photograph of the rotor blades used is shown in figure 1. Four of the five blades have a tapered planform, and the fifth blade is a baseline rectangular-planform rotor.

Two of these blades were designed to investigate the effect of the location of the initiation of taper on rotor performance. These two blades are similar in design with the primary difference being the radial location of the initiation of taper. These two blades are described in reference 3. The initiation of the taper starts at 50

percent radius for the XTR50 blade, while the initiation of the taper for the XTR75 is at 75 percent radius. Both the XTR50 and XTR75 have a 2.708 ft radius, -13 degrees of linear twist, and a thrust-weighted solidity of 0.0977. They also use a distribution of advanced rotorcraft airfoil sections. These airfoil sections were developed by researchers of the U.S. Army Aerostructures Directorate at the NASA Langley Research Center specifically for rotorcraft applications. The airfoils are RC(4)-10 (blade inboard section), RC(3)-10 (mid section), and RC(3)-08 (blade outboard sections). In the RC(x)-xx format, the RC indicates a rotorcraft airfoil, (x) designates a sequential number, and the xx is the thickness in percent of chord. The RC(3)-10 and the RC(3)-08 airfoils are documented in reference 6. The RC(4)-10 is documented in reference 7.

The rectangular blade (RECT) has been used in several investigations in the 14- by 22-foot Subsonic Tunnel (reference 8 as an example). The blade airfoil is the NACA 0012 with -8 degrees of linear twist from center of rotation to blade tip. The radius of this rotor is 2.823 ft. The thrust weighted solidity is 0.0981.

The AHIP blade is a 21% scale of the Army OH-58D helicopter prototype (reference 9). AHIP stands for the Army Helicopter Improvement Program, which resulted in the OH-58D model helicopter prototype. The blade has a radius of 3.675 ft, -16 degrees of twist, and a trust-weighted solidity of 0.0580. The taper ratio is 1.75/1. The airfoil for the rectangular section was a high performance rotor airfoil, similar to those used in the XTR50 and XTR75 blades.

A larger tapered rotor blade, the TR3, was also tested. This blade was tested for comparison with the AHIP blade (reference 9). The TR3 has a radius of 3.333 ft, -16 degrees of linear twist, and a thrust-weighted solidity of 0.0825. The NACA 0012 airfoil was used for this blade. The blade has a 3/1 taper ratio with taper starting at 80% of the basic radius. This blade was tested with a blade cuff extension so its radius would be equal to the AHIP blade.

All five blades used are of composite construction utilizing graphite prepreg cloth, polyurethane foam cores, fiberglass and epoxy external skins, and tungsten leading-edge balance weights. In the fabrication process, a graphite laminar spar is fabricated over a foam core and then cured in a mold. The trailing-edge core is then fabricated from low-density, self-skinning polyurethane foam and then bonded to the spar. The entire assemble is wrapped with fiberglass cloth and epoxy resin, placed in the mold, and cured under controlled conditions of temperature and pressure.

Since the rotor hub system used for testing of all of these blades is fully articulated with coincident flap and lag hinges, inertia in the chord-wise and flap-wise directions are equivalent. By including all of

the effective flapping hardware (blade, hub grip, and mounting bolts), the true flapping inertia of the blade can be correctly measured.

The blade cuff assembly is shown in figure 2. The cuff assembly used in this investigation is the same one in the basic rotor hub that was used in the 2MRTS. The cuff assembly is constructed almost entirely of 17-4 PH stainless steel. The blades were mounted in the blade cuffs by two close-tolerance bolts. This assembly is described in reference 1.

This investigation was conducted using an apparatus that allowed a rotor blade to hang from a pivot rod and swing freely. The rotor hub cuff grips the rotor blade and swings with the rotor blade. A Linear Variable Differential Transducer (LVDT) was attached to the cuff of the blade to measure the displacement of the blade. The LVDT sent a signal through an LVDT signal conditioner to a signal analyzer. The signal analyzer plotted the displacement as a function of LVDT volts vs. time. The signal analyzer also plotted volts vs. frequency. A sketch of the testing apparatus is presented in figure 3.

Test and Procedures

The flapping inertia of rotor blades can be determined by "swing" testing the blades. The blade and cuff assembly were swung by manually pulling the blade back and letting it go. The assembly then acts as a pendulum.

The test procedure consisted of two parts: determining the mass, and radial distance from the effective flapping axis to the center of gravity of the blade and cuff assembly; and determining the natural frequency.

The mass and location of the center of mass were found using an electronic balance. The radial length to the center of mass was found by multiplying the length of the blade as measured from the axis of the flapping hinge ratio of the weight measured at the tip end of the assembly to the total weight of the assembly. These weights were found by placing each end on a knife edge, and alternately setting each knife edge on the electronic balance.

The procedure for finding the natural frequency consisted of swinging the blade and blade cuff assembly. An LVDT measured the displacement of the blade and cuff assembly and then sent the signals through a signal conditioner to a signal analyzer. This procedure was repeated ten times, with the LVDT signal reset to zero each time. After ten tests, the signal analyzer output the average results in two plots: volts vs. time, and volts vs. frequency. The principal frequency given by the analyzer was checked by using a manual method of frequency determination.

A manual method of determining the frequency from the time history was used. The time between

consecutive peaks was measured to find the period of the oscillation. Then, the damped frequency was found from an average of the reciprocal of each of the periods throughout the oscillation. The voltage of the first two peaks was used to determine the logarithmic decrement and the damping constant of the system as described previously. This entire process was repeated five times for each rotor blade.

Results and Discussion

A summary of the results for this investigation is listed in Table I. A listing of the data for times from peak to peak, periods, and damped and natural frequencies for each blade, the blade cuff assembly, and the blade cuff with root extender are given in Tables II-VII. The plots of time history and frequency content from the signal analyzer are located in figures 4-10. The experimental uncertainty which is shown in Table I is described in Appendix A.

In figures 4-10 two plots per figure are shown as displayed on the signal analyzer. In these figures, the upper plot is the displacement (in LVDT volts) vs. time. In the lower plot the displacement is plotted vs. frequency. The coordinates of the first plot, volts vs. time, show the position of the first peak. The coordinates of the second plot, volts vs. frequency, are the coordinates of the approximate natural frequency of the system.

In the second plot there are times when there are a lot of extraneous lines towards the end of the plot, as in figure 7, test 1. These lines result from noise that the signal analyzer picked up from the system. There were also times when no "peak" could be seen in the second plot, as in figure 10, test 3. Although there was still a peak present, it was too low for the vertical scale.

Concluding Remarks

This investigation gives important information on the blade flapping inertia of several experimental model rotor blades. This inertia affects the tendency of the blades to "cone" up when producing thrust. The inertia is also important when determining the rotary inertia of the entire rotor system, which contributes to the characteristics of the rotor during entry into and final flare of an autorotation.

The results of this investigation provide essential data for dynamic analysis of blade response for the rotor systems tested. As expected, rotor blades of similar area and mass which have a chordwise taper show a significant reduction in flapping inertia.

NASA Langley Research Center
Hampton, VA 23665-5225
August 10, 1991

Appendix A — Uncertainty Analysis

The experimental accuracy for this investigation is affected by several factors. The effect of these factors on accuracy of the results will be estimated using an uncertainty analysis.

The LVDT used in this investigation is not made to measure radial displacement, it is made to measure linear displacement. This deviation is consistent with the small angle assumptions of the supporting "swing" test theory.

The core of the LVDT was attached to the cuff and blade, and therefore the pin moved in the same radial manner as did the cuff and blade. Because of the circular motion of the pin, the pin did not slide in and out of the core like it was supposed to. The pin rubbed against the inside of the core, and this caused friction. This friction damped the oscillations significantly. When examining a blade swinging on the rod without the LVDT attached, it can be seen that the blade will swing almost twice as long as when the LVDT was attached. The technique used to correct the measured frequency by the experimental damping factor should compensate for this effect.

Another possible error associated with this investigation is that each trial was not always exactly "zeroed". In other words, the end displacement of the blade was not always at zero. The end displacement voltage ranged from approximately ± 0.1 Volts. This would not cause an error in the damped frequency, but it would cause an error in the damping constant, and therefore in the natural frequency. Because the zeroing error was only as great as 0.1 Volts on a 10 Volt scale, the error caused by zeroing would be very close to negligible most of the time.

A description of this uncertainty analysis can be found in reference 10. For a given function

$$r = f(x, y, z) \quad (A1)$$

the uncertainty in r is:

$$S_r = \sqrt{\left(\frac{\partial r}{\partial x} S_x\right)^2 + \left(\frac{\partial r}{\partial y} S_y\right)^2 + \left(\frac{\partial r}{\partial z} S_z\right)^2} \quad (A2)$$

where x , y , and z are variables of r .

For this investigation the uncertainty in the flapping inertia is:

$$S_{I_{\theta\theta}} = \sqrt{\left(\frac{\partial I_{\theta\theta}}{\partial m} S_m\right)^2 + \left(\frac{\partial I_{\theta\theta}}{\partial r} S_r\right)^2 + \left(\frac{\partial I_{\theta\theta}}{\partial f_n} S_{f_n}\right)^2} \quad (A3)$$

where:

$$\frac{\partial I_{\theta\theta}}{\partial m} = \frac{gr}{4\pi^2 f_n^2} \quad (A4)$$

$$\frac{\partial I_{\theta\theta}}{\partial r} = \frac{mg}{4\pi^2 f_n^2} \quad (A5)$$

and

$$\frac{\partial I_{\theta\theta}}{\partial f_n} = \frac{-2mgr}{4\pi^2 f_n^3} \quad (A6)$$

The uncertainty in the mass, S_m , is 0.5 grams or 0.000101 pounds. The uncertainty in the measurement of the radial length, S_r , is 0.01 inches. The uncertainty of the natural frequency, S_{f_n} , is found from the standard deviation of the five different trials for each blade and the blade cuff assembly.

The resulting uncertainty ranged from 0.2% for the TR3 blade to 2.9% for the bare cuff. The specific uncertainties are tabulated in Table I with the experimental results.

References

1. Phelps, Arthur E. III and Berry, John D.: "Description of the U.S. Army Small Scale 2 Meter Rotor Test System." NASA TM 87762, AVSCOM TR 86-8-4, 1987.
2. Phelps, Arthur E. III and Althoff, Susan L.: "Effects of Planform Geometry on Hover Performance of a 2 Meter Diameter Model of a Four-Bladed Rotor." NASA TM-87607, AVSCOM TR 85-B-6, 1986.
3. Althoff, Susan L. and Noonan, Kevin W.: "Effect of Blade Planform Variation on a Small Scale 2-Meter Rotor Test System." NASA TM 4146, AVSCOM TR 89-8-009, 1990.
4. Beyer, William H.: *CRC Standard Mathematical Tables*. CRC Press, 1987, pp. 3.
5. Thompson, William L.: *Vibration Theory and Applications*. Prentice Hall, 1965, pp. 36-47, 159-200.
6. Noonan, Kevin W. and Bingham, Gene J.: "Aerodynamic Characteristics of Three Helicopter Rotor Airfoil Sections at Reynolds Numbers from Model Scale to Full Scale at Mach Numbers from 0.35 to 0.50." NASA TP-1701, AVRADCOM TR 80-8-5, 1980.
7. Noonan, Kevin W.: "High lift, Low Pitching Moment Airfoils." U.S. Patent No. 4,776,531, Oct. 11, 1988.
8. Elliott, Joe W. and Althoff, Susan L.: "Inflow Measurement made with a Laser Velocimeter on a Helicopter Model in Forward Flight, Volume I—Rectangular Planform Blades at an Advance Ratio of 0.15." NASA TM-100541, AVSCOM TM-88-B-004, 1988.
9. Phelps, Arthur E. III and Berry, John D.: "Wind-Tunnel Evaluation of a 21-Percent Scale Powered Model of a Prototype Advanced Scout Helicopter." NASA TP-2420, AVSCOM TR-85-B-2, 1985.
10. "Instruments and Apparatus, Part 1—Measurement Uncertainty." Supplement to ASME Performance Test Codes. ANSI/ASME PIC 19.1-1985, American Society of Mechanical Engineers, c.1986, pp.59.

TABLE I. Final Results

Blade	Mass (lb)	Radius to CG (in)	Natural Frequency (Hz)	Flapping Inertia (lb-in ²)	Percent Uncert. (%)
XTR50	2.030	5.160	0.89842	126.924±0.410	0.3 %
XTR75	1.969	5.320	0.86002	138.514±1.474	1.1 %
RECT	2.022	6.253	0.76085	213.613±1.173	0.5 %
AHIP	1.914	6.261	0.69257	244.350±0.641	0.3 %
TR3	2.370	8.283	0.67985	415.387±0.730	0.2 %
Bare Cuff	1.428	1.968	2.00283	6.825±0.201	2.9 %
Cuff w/ext.	1.691	2.541	1.60703	16.273±0.181	1.1 %

TABLE II. Data for XTR50 blade, Test 1

Peak	Time (sec)	Period (sec)	Damped Frequency (Hz)
1	0.31250		
2	1.40625	1.09375	0.91429
3	2.52344	1.11719	0.89510
4	3.63281	1.10937	0.90141
5	4.76563	1.13282	0.88275
6	5.89063	1.12500	0.88889
7	7.00000	1.10937	0.90141
8	8.08594	1.08594	0.92086
9	9.20313	1.11719	0.89510

Average Damped Frequency = 0.89998 Hz

$$X_1 = 4.436 \text{ Volts}$$

$$X_2 = 4.052 \text{ Volts}$$

$$\zeta^2 = 0.000207$$

Natural Frequency = 0.90035 Hz

TABLE II. Data for XTR50 blade (continued), Test 2

Peak	Time (sec)	Period (sec)	Damped Frequency (Hz)
1	0.27344		
2	1.39063	1.11719	0.89510
3	2.54688	1.15625	0.86486
4	3.64063	1.09375	0.91429
5	4.75781	1.11718	0.89511
6	5.88281	1.12500	0.88889
7	6.99219	1.10938	0.90140
8	8.10156	1.10937	0.90141
9	9.18750	1.08594	0.92086

Average Damped Frequency = 0.89774 Hz

$$X_1 = 4.492 \text{ Volts}$$

$$X_2 = 4.103 \text{ Volts}$$

$$\zeta^2 = 0.000207$$

Natural Frequency = 0.89783 Hz

TABLE II. Data for XTR50 blade (continued), Test 3

Peak	Time (sec)	Period (sec)	Damped Frequency (Hz)
1	0.26563		
2	1.40625	1.14062	0.87671
3	2.52344	1.11719	0.89510
4	3.65625	1.13281	0.88276
5	4.76563	1.10938	0.90140
6	5.88281	1.11718	0.89511
7	6.98438	1.10157	0.90780
8	8.09375	1.10937	0.90141
9	9.17188	1.07813	0.92753

Average Damped Frequency = 0.89848 Hz

$$X_1 = 4.385 \text{ Volts}$$

$$X_2 = 4.021 \text{ Volts}$$

$$\zeta^2 = 0.000190$$

Natural Frequency = 0.89857 Hz

TABLE II. Data for XTR50 blade (continued), Test 4

Peak	Time (sec)	Period (sec)	Damped Frequency (Hz)
1	0.21825		
2	1.40625	1.12500	0.88889
3	2.53906	1.13281	0.88276
4	3.65625	1.11719	0.89510
5	4.75781	1.10156	0.90780
6	5.89063	1.13282	0.88275
7	7.00000	1.10937	0.90141
8	8.10156	1.10156	0.90780
9	9.19531	1.09375	0.91429

Average Damped Frequency = 0.89760 Hz

$$X_1 = 4.578 \text{ Volts}$$

$$X_2 = 4.197 \text{ Volts}$$

$$\zeta^2 = 0.000191$$

Natural Frequency = 0.89769 Hz

TABLE II. Data for XTR50 blade (concluded), Test 5

Peak	Time (sec)	Period (sec)	Damped Frequency (Hz)
1	0.28906		
2	1.39844	1.10938	0.90141
3	2.52344	1.12500	0.88889
4	3.64844	1.12500	0.88889
5	4.76563	1.11719	0.89510
6	5.89063	1.12500	0.88889
7	7.00000	1.10937	0.90141
8	8.10938	1.10938	0.90140
9	9.20313	1.09375	0.91429

Average Damped Frequency = 0.89753 Hz

$$X_1 = 4.814 \text{ Volts}$$

$$X_2 = 4.367 \text{ Volts}$$

$$\zeta^2 = 0.000241$$

Natural Frequency = 0.89764 Hz

TABLE III. Data for XTR75 blade, Test 1

Peak	Time (sec)	Period (sec)	Damped Frequency (Hz)
1	0.28906		
2	1.41406	1.12500	0.88889
3	2.57031	1.15625	0.86486
4	3.77344	1.20313	0.83116
5	4.90625	1.13281	0.88276
6	6.10938	1.20313	0.83116

Average Damped Frequency = 0.85977 Hz

$$X_1 = 3.386 \text{ Volts}$$

$$X_2 = 2.620 \text{ Volts}$$

$$\zeta^2 = 0.00161$$

Natural Frequency = 0.86049 Hz

TABLE III. Data for XTR75 blade (continued), Test 2

Peak	Time (sec)	Period (sec)	Damped Frequency (Hz)
1	0.28906		
2	1.44531	1.15625	0.86487
3	2.62500	1.17967	0.84768
4	3.76563	1.14063	0.87671
5	4.92969	1.16406	0.85906
6	6.07813	1.14844	0.87075

Average Damped Frequency = 0.86381 Hz

$$X_1 = 3.389 \text{ Volts}$$

$$X_2 = 2.632 \text{ Volts}$$

$$\zeta^2 = 0.00162$$

Natural Frequency = 0.86451 Hz

TABLE III. Data for XTR75 blade (continued), Test 3

Peak	Time (sec)	Period (sec)	Damped Frequency (Hz)
1	0.25000		
2	1.41406	1.16406	0.85906
3	2.59375	1.17969	0.84768
4	3.75000	1.15625	0.86486
5	4.91406	1.16406	0.85906
6	6.10938	1.19532	0.83660

Average Damped Frequency = 0.85345 Hz

$$X_1 = 3.469 \text{ Volts}$$

$$X_2 = 2.629 \text{ Volts}$$

$$\zeta^2 = 0.00194$$

Natural Frequency = 0.85428 Hz

TABLE III. Data for XTR75 blade (continued), Test 4

Peak	Time (sec)	Period (sec)	Damped Frequency (Hz)
1	0.25781		
2	1.42188	1.16407	0.85906
3	2.60156	1.17968	0.84769
4	3.73438	1.13282	0.88275
5	4.92188	1.18750	0.84211
6	6.10156	1.17968	0.84768

Average Damped Frequency = 0.85586 Hz

$$X_1 = 4.243 \text{ Volts}$$

$$X_2 = 3.203 \text{ Volts}$$

$$\zeta^2 = 0.00200$$

Natural Frequency = 0.85671 Hz

TABLE III. Data for XTR75 blade (concluded), Test 5

Peak	Time (sec)	Period (sec)	Damped Frequency (Hz)
1	0.25781		
2	1.42969	1.17188	0.85333
3	2.60938	1.17969	0.84768
4	3.72656	1.11718	0.89511
5	4.92188	1.19532	0.83659
6	6.05468	1.13281	0.88276

Average Damped Frequency = 0.86310 Hz

$$X_1 = 4.170 \text{ Volts}$$

$$X_2 = 3.069 \text{ Volts}$$

$$\zeta^2 = 0.00237$$

Natural Frequency = 0.86413 Hz

TABLE IV. Data for RECT blade, Test 1

Peak	Time (sec)	Period (sec)	Damped Frequency (Hz)
1	0.31250		
2	1.61719	1.30469	0.76646
3	2.93750	1.32031	0.75740
4	4.23438	1.29668	0.77108
5	5.55469	1.32031	0.75740
6	6.86719	1.31250	0.76190
7	8.18750	1.32031	0.75740
8	9.50781	1.32031	0.75740
9	10.83594	1.32813	0.75249

Average Damped Frequency = 0.89753 Hz

Average Damped Frequency = 0.86310 Hz

$$X_1 = 4.814 \text{ Volts}$$

$$X_2 = 4.367 \text{ Volts}$$

$$\zeta^2 = 0.000241$$

Natural Frequency = 0.89764 Hz

TABLE IV. Data for RECT blade (continued), Test 2

Peak	Time (sec)	Period (sec)	Damped Frequency (Hz)
1	0.32031		
2	1.61719	1.29688	0.77108
3	2.92969	1.31250	0.76190
4	4.24219	1.31250	0.76190
5	5.55469	1.31250	0.76190
6	6.86719	1.31250	0.76190
7	8.17969	1.31250	0.76190
8	9.50000	1.32031	0.75740
9	10.79688	1.29688	0.77108

Average Damped Frequency = 0.76363 Hz

$$X_1 = 4.289 \text{ Volts}$$

$$X_2 = 3.877 \text{ Volts}$$

$$\zeta^2 = 0.000685$$

Natural Frequency = 0.76389 Hz

TABLE IV. Data for RECT blade (continued), Test 3

Peak	Time (sec)	Period (sec)	Damped Frequency (Hz)
1	0.75781		
2	2.07813	1.32032	0.75739
3	3.38281	1.30468	0.76647
4	4.69531	1.31250	0.76190
5	6.00781	1.31250	0.76190
6	7.32813	1.32032	0.75739
7	8.64844	1.32031	0.75740
8	9.95313	1.30469	0.76647
9	11.28125	1.32812	0.75294

Average Damped Frequency = 0.76023 Hz

$$X_1 = 4.729 \text{ Volts}$$

$$X_2 = 3.979 \text{ Volts}$$

$$\zeta^2 = 0.000755$$

Natural Frequency = 0.76052 Hz

TABLE IV. Data for RECT blade (continued), Test 4

Peak	Time (sec)	Period (sec)	Damped Frequency (Hz)
1	0.58594		
2	1.89063	1.30469	0.76646
3	3.21094	1.32031	0.75740
4	4.51563	1.30469	0.76646
5	5.82813	1.31250	0.76190
6	7.14063	1.31250	0.76190
7	8.45313	1.31250	0.76190
8	9.78125	1.32812	0.75294
9	11.10156	1.32031	0.75740

Average Damped Frequency = 0.76080 Hz

$$X_1 = 4.768 \text{ Volts}$$

$$X_2 = 4.045 \text{ Volts}$$

$$\zeta^2 = 0.000685$$

Natural Frequency = 0.76106 Hz

TABLE IV. Data for RECT blade (concluded), Test 5

Peak	Time (sec)	Period (sec)	Damped Frequency (Hz)
1	1.09375		
2	2.44531	1.35156	0.73989
3	3.75781	1.31250	0.76190
4	5.07031	1.31250	0.76190
5	6.38281	1.31250	0.76190
6	7.69531	1.31250	0.76190
7	9.01563	1.32032	0.75739
8	10.33594	1.32031	0.75740
9	11.64844	1.31250	0.76190

Average Damped Frequency = 0.75803 Hz

$$X_1 = 4.753 \text{ Volts}$$

$$X_2 = 4.019 \text{ Volts}$$

$$\zeta^2 = 0.000712$$

Natural Frequency = 0.75830 Hz

TABLE V. Data for AHIP blade, Test 1

Peak	Time (sec)	Period (sec)	Damped Frequency (Hz)
1	0.35156		
2	1.77344	1.42188	0.70330
3	3.23438	1.46094	0.68449
4	4.67188	1.43750	0.69565
5	6.10938	1.43750	0.69565
6	7.58594	1.47656	0.67725
7	9.01563	1.42969	0.69945
8	10.44531	1.42968	0.69946
9	11.89844	1.45313	0.68817
10	13.34375	1.44531	0.69189
11	14.79688	1.45313	0.68817
12	16.23438	1.43750	0.69565

Average Damped Frequency = 0.69265 Hz

$$X_1 = 4.316 \text{ Volts}$$

$$X_2 = 3.953 \text{ Volts}$$

$$\zeta^2 = 0.000195$$

Natural Frequency = 0.69292 Hz

TABLE V. Data for AHIP blade (continued), Test 2

Peak	Time (sec)	Period (sec)	Damped Frequency (Hz)
1	0.34375		
2	1.76563	1.42188	0.70330
3	3.25000	1.48437	0.67369
4	4.64844	1.39844	0.71508
5	6.10938	1.46094	0.68449
6	7.55469	1.44531	0.69189
7	9.00000	1.44531	0.69189
8	10.45313	1.45313	0.68817
9	11.89063	1.43750	0.69565
10	13.32813	1.43750	0.69565
11	14.78125	1.45312	0.68817
12	16.21875	1.43750	0.69565

Average Damped Frequency = 0.69306 Hz

$$X_1 = 4.128 \text{ Volts}$$

$$X_2 = 3.713 \text{ Volts}$$

$$\zeta^2 = 0.000284$$

Natural Frequency = 0.69316 Hz

TABLE V. Data for AIHP blade (continued), Test 3

Peak	Time (sec)	Period (sec)	Damped Frequency (Hz)
1	0.32813		
2	1.78125	1.45313	0.68817
3	3.23438	1.45313	0.68817
4	4.68750	1.45312	0.68817
5	6.12500	1.43750	0.69565
6	7.58031	1.44531	0.69189
7	8.99219	1.42188	0.70329
8	10.44531	1.45312	0.68817
9	11.89063	1.44532	0.69189
10	13.33594	1.44531	0.69189
11	14.78125	1.44531	0.69189
12	16.24219	1.46094	0.68449

Average Damped Frequency = 0.69125 Hz

$$X_1 = 4.753 \text{ Volts}$$

$$X_2 = 4.231 \text{ Volts}$$

$$\zeta^2 = 0.000343$$

Natural Frequency = 0.69137 Hz

TABLE V. Data for AHIP blade (continued), Test 4

Peak	Time (sec)	Period (sec)	Damped Frequency (Hz)
1	0.33594		
2	1.78906	1.45312	0.68817
3	3.25000	1.46094	0.68449
4	4.67188	1.42188	0.70329
5	6.10938	1.43750	0.69565
6	7.56250	1.45312	0.68817
7	9.00000	1.43750	0.69565
8	10.44531	1.44531	0.69189
9	11.89844	1.45313	0.68817
10	13.33594	1.43750	0.69565
11	14.78125	1.44531	0.69189
12	16.21875	1.43750	0.69565

Average Damped Frequency = 0.69261 Hz

$$X_1 = 4.048 \text{ Volts}$$

$$X_2 = 3.665 \text{ Volts}$$

$$\zeta^2 = 0.000250$$

Natural Frequency = 0.69270 Hz

TABLE V. Data for AHIP blade (concluded), Test 5

Peak	Time (sec)	Period (sec)	Damped Frequency (Hz)
1	0.36719		
2	1.79688	1.42969	0.69945
3	3.25781	1.46093	0.68450
4	4.68750	1.42969	0.69945
5	6.13281	1.44531	0.69189
6	7.56250	1.42969	0.69945
7	9.01563	1.45313	0.68817
8	10.46094	1.44531	0.69189
9	11.90625	1.44531	0.69189
10	13.35156	1.44531	0.69189
11	14.78125	1.42969	0.69945
12	16.25000	1.46875	0.68085

Average Damped Frequency = 0.69263 Hz

$$X_1 = 4.355 \text{ Volts}$$

$$X_2 = 3.960 \text{ Volts}$$

$$\zeta^2 = 0.000229$$

Natural Frequency = 0.69271 Hz

TABLE VI. Data for TR3 blade, Test 1

Peak	Time (sec)	Period (sec)	Damped Frequency (Hz)
1	0.34375		
2	1.82813	1.48438	0.67368
3	3.28906	1.46093	0.68449
4	4.77344	1.48438	0.67368
5	6.25000	1.47656	0.67725
6	7.71875	1.46875	0.68085
7	9.18750	1.46875	0.68085
8	10.66406	1.47656	0.67725
9	12.14063	1.47657	0.67724
10	13.60156	1.46093	0.68449
11	15.07031	1.46875	0.68085
12	16.53906	1.46875	0.68085
13	17.99219	1.45313	0.68817

Average Damped Frequency = 0.67997 Hz

$$X_1 = 4.951 \text{ Volts}$$

$$X_2 = 4.539 \text{ Volts}$$

$$\zeta^2 = 0.000191$$

Natural Frequency = 0.68004 Hz

TABLE VI. Data for TR3 blade (continued), Test 2

Peak	Time (sec)	Period (sec)	Damped Frequency (Hz)
1	0.34375		
2	1.82031	1.47656	0.67725
3	3.30469	1.48438	0.67368
4	4.77344	1.46875	0.68085
5	6.24219	1.46875	0.68085
6	7.71875	1.47656	0.67725
7	9.18750	1.46875	0.68085
8	10.66406	1.47656	0.67725
9	12.13281	1.46875	0.68085
10	13.59375	1.46094	0.68449
11	15.06250	1.46875	0.68085
12	16.53906	1.47656	0.67725
13	18.00781	1.46875	0.68085

Average Damped Frequency = 0.67936 Hz

$$X_1 = 4.626 \text{ Volts}$$

$$X_2 = 4.246 \text{ Volts}$$

$$\zeta^2 = 0.000186$$

Natural Frequency = 0.67942 Hz

TABLE VI. Data for TR3 blade (continued), Test 3

Peak	Time (sec)	Period (sec)	Damped Frequency (Hz)
1	1.82813		
2	3.29688	1.46875	0.68085
3	4.77344	1.47656	0.67725
4	6.25000	1.47656	0.67725
5	7.71094	1.46094	0.68449
6	9.19531	1.48437	0.67369
7	10.65625	1.46094	0.68449
8	12.13281	1.47656	0.67725
9	13.60156	1.46875	0.68085
10	15.07031	1.46875	0.68085
11	16.54688	1.47657	0.67725
12	18.00781	1.46093	0.68449
13	19.47656	1.46875	0.68085

Average Damped Frequency = 0.67996 Hz

$$X_1 = 5.000 \text{ Volts}$$

$$X_2 = 4.558 \text{ Volts}$$

$$\zeta^2 = 0.000217$$

Natural Frequency = 0.68003 Hz

TABLE VI. Data for TR3 blade (continued), Test 4

Peak	Time (sec)	Period (sec)	Damped Frequency (Hz)
1	0.35156		
2	1.82031	1.46875	0.68085
3	3.29688	1.47657	0.67725
4	4.77344	1.47656	0.67725
5	6.25781	1.48437	0.67369
6	7.71875	1.46094	0.68449
7	9.18750	1.46875	0.68085
8	10.67188	1.48438	0.67368
9	12.13281	1.46093	0.68449
10	13.60938	1.47651	0.67725
11	15.07031	1.46093	0.68449
12	16.53906	1.46875	0.68085
13	18.01563	1.47657	0.67724

Average Damped Frequency = 0.67937 Hz

$$X_1 = 4.902 \text{ Volts}$$

$$X_2 = 4.502 \text{ Volts}$$

$$\zeta^2 = 0.000184$$

Natural Frequency = 0.67943 Hz

TABLE VI. Data for TR3 blade (concluded), Test 5

Peak	Time (sec)	Period (sec)	Damped Frequency (Hz)
1	0.35156		
2	1.82031	1.46875	0.68085
3	3.29688	1.47657	0.67725
4	4.77344	1.47656	0.67725
5	6.24219	1.46875	0.68085
6	7.71094	1.46875	0.68085
7	9.18750	1.47656	0.67725
8	10.65625	1.46875	0.68085
9	12.12500	1.46875	0.68085
10	13.59375	1.46875	0.68085
11	15.06250	1.46875	0.68085
12	16.53906	1.47656	0.67725
13	17.99219	1.45313	0.68817

Average Damped Frequency = 0.68026 Hz

$$X_1 = 4.624 \text{ Volts}$$

$$X_2 = 4.209 \text{ Volts}$$

$$\zeta^2 = 0.000224$$

Natural Frequency = 0.68034 Hz

TABLE VII. Data for Bare Cuff, Test 1

Peak	Time (sec)	Period (sec)	Damped Frequency (Hz)
1	0.10156		
2	0.60938	0.50781	1.96923

$$X_1 = 2.346 \text{ Volts}$$

$$X_2 = 0.998 \text{ Volts}$$

$$\zeta^2 = 0.01826$$

$$\text{Natural Frequency} = 1.98746 \text{ Hz}$$

TABLE VII. Data for Bare Cuff (continued), Test 2

Peak	Time (sec)	Period (sec)	Damped Frequency (Hz)
1	0.10938		
2	0.60156	0.49219	2.03175

$$X_1 = 3.015 \text{ Volts}$$

$$X_2 = 1.377 \text{ Volts}$$

$$\zeta^2 = 0.01532$$

$$\text{Natural Frequency} = 2.04749 \text{ Hz}$$

TABLE VII. Data for Bare Cuff (continued), Test 3

Peak	Time (sec)	Period (sec)	Damped Frequency (Hz)
1	0.10938		
2	0.60938	0.50000	2.00000

$$X_1 = 2.703 \text{ Volts}$$

$$X_2 = 1.196 \text{ Volts}$$

$$\zeta^2 = 0.01656$$

$$\text{Natural Frequency} = 2.01677 \text{ Hz}$$

TABLE VII. Data for Bare Cuff (continued), Test 4

Peak	Time (sec)	Period (sec)	Damped Frequency (Hz)
1	0.10938		
2	0.61419	0.50781	1.96929

$$X_1 = 3.013 \text{ Volts}$$

$$X_2 = 1.489 \text{ Volts}$$

$$\zeta^2 = 0.01243$$

$$\text{Natural Frequency} = 1.98158 \text{ Hz}$$

TABLE VII. Data for Bare Cuff (concluded), Test 5

Peak	Time (sec)	Period (sec)	Damped Frequency (Hz)
1	0.10156		
2	0.60938	0.50781	1.96923

$$X_1 = 3.086 \text{ Volts}$$

$$X_2 = 1.558 \text{ Volts}$$

$$\zeta^2 = 0.01169$$

$$\text{Natural Frequency} = 1.98085 \text{ Hz}$$

TABLE VIII. Data for Cuff with Root Extender, Test 1

Peak	Time (sec)	Period (sec)	Damped Frequency (Hz)
1	0.13281		
2	0.76563	0.63281	1.58025
3	1.39063	0.62501	1.60000
4	2.00781	0.61718	1.62027

$$\text{Average Damped Frequency} = 1.60017 \text{ Hz}$$

$$X_1 = 4.634 \text{ Volts}$$

$$X_2 = 3.142 \text{ Volts}$$

$$\zeta^2 = 0.00381$$

$$\text{Natural Frequency} = 1.60323 \text{ Hz}$$

TABLE VIII. Data for Cuff with Root Extender (continued), Test 2

Peak	Time (sec)	Period (sec)	Damped Frequency (Hz)
1	0.14063		
2	0.76563	0.62500	1.60000
3	1.39063	0.62501	1.60000
4	2.00000	0.60937	1.64104

Average Damped Frequency = 1.61367 Hz

$$X_1 = 4.360 \text{ Volts}$$

$$X_2 = 2.793 \text{ Volts}$$

$$\zeta^2 = 0.00500$$

Natural Frequency = 1.61772 Hz

TABLE VIII. Data for Cuff with Root Extender (continued), Test 3

Peak	Time (sec)	Period (sec)	Damped Frequency (Hz)
1	0.14063		
2	0.76563	0.62500	1.60000
3	1.39063	0.62501	1.60000
4	2.00781	0.61718	1.62027

Average Damped Frequency = 1.60675 Hz

$$X_1 = 4.517 \text{ Volts}$$

$$X_2 = 2.671 \text{ Volts}$$

$$\zeta^2 = 0.00694$$

Natural Frequency = 1.61236 Hz

TABLE VIII. Data for Cuff with Root Extender (continued), Test 4

Peak	Time (sec)	Period (sec)	Damped Frequency (Hz)
1	0.13281		
2	0.76563	0.63281	1.58025
3	1.38281	0.61719	1.62026
4	2.00781	0.62500	1.60000

Average Damped Frequency = 1.60017 Hz

$$X_1 = 4.895 \text{ Volts}$$

$$X_2 = 3.886 \text{ Volts}$$

$$\zeta^2 = 0.00702$$

Natural Frequency = 1.60582 Hz

TABLE VIII. Data for Cuff with Root Extender (concluded), Test 5

Peak	Time (sec)	Period (sec)	Damped Frequency (Hz)
1	0.13281		
2	0.76563	0.63281	1.58025
3	1.39063	0.62501	1.60000
4	2.01563	0.62500	1.60000

Average Damped Frequency = 1.59341 Hz

$$X_1 = 4.668 \text{ Volts}$$

$$X_2 = 3.257 \text{ Volts}$$

$$\zeta^2 = 0.00327$$

Natural Frequency = 1.59602 Hz



L-91-7457

Figure 1. Photograph of Rotor Blades

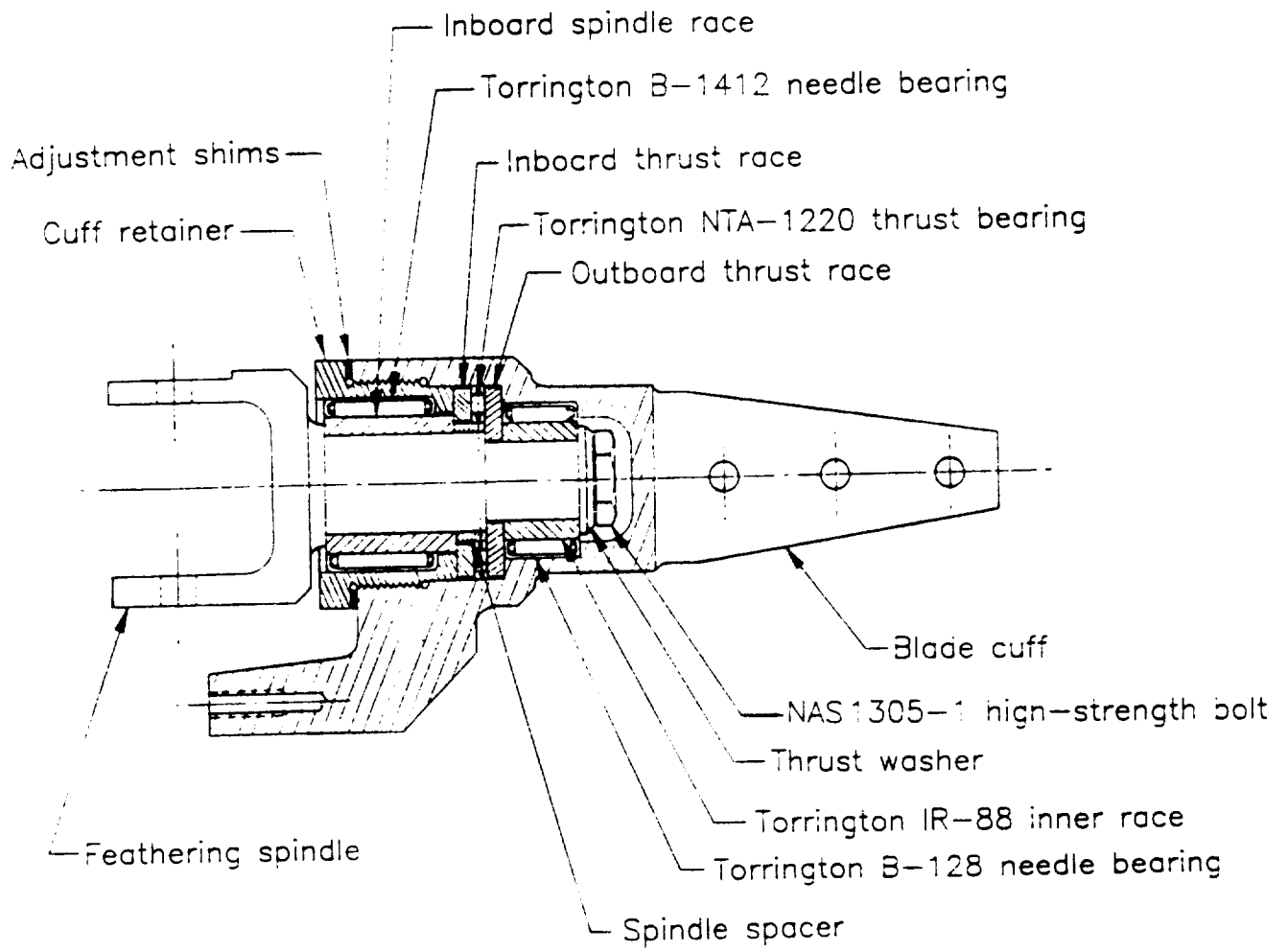

Figure 2. Sketch of Blade Cuff Assembly

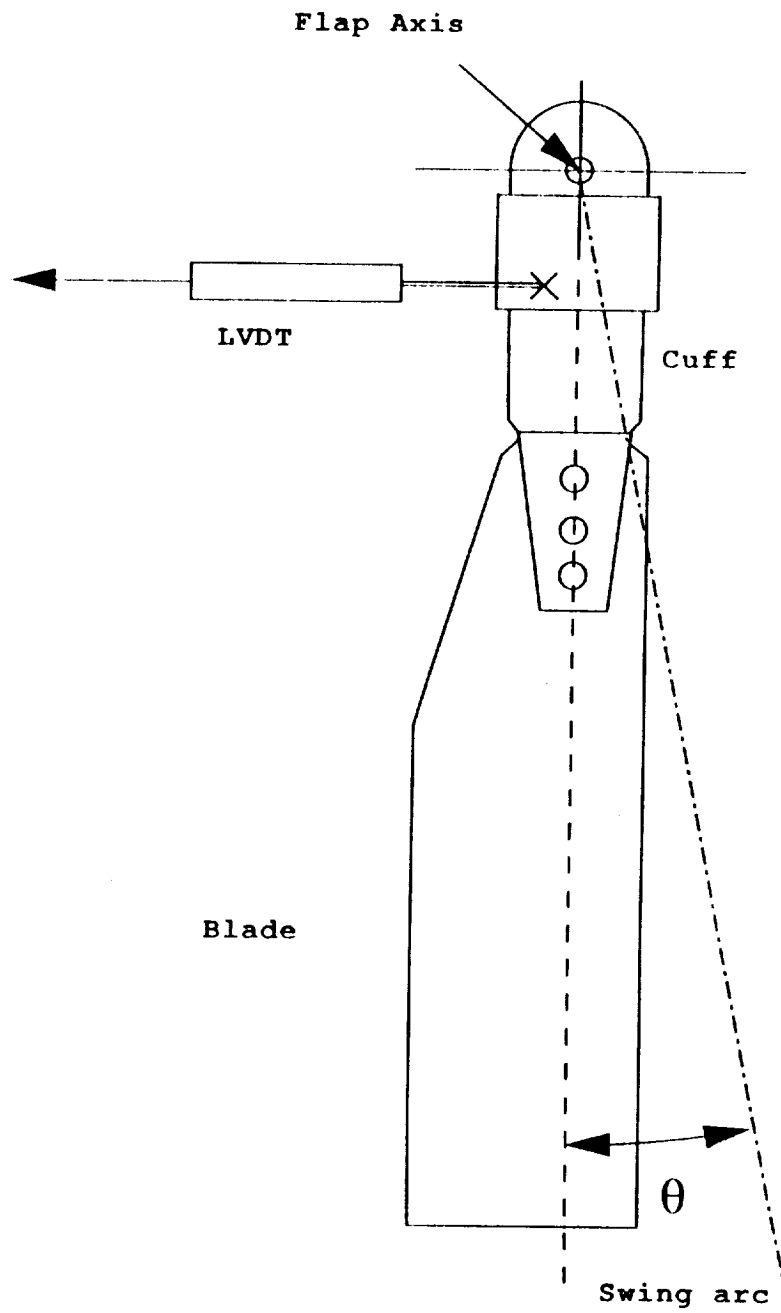
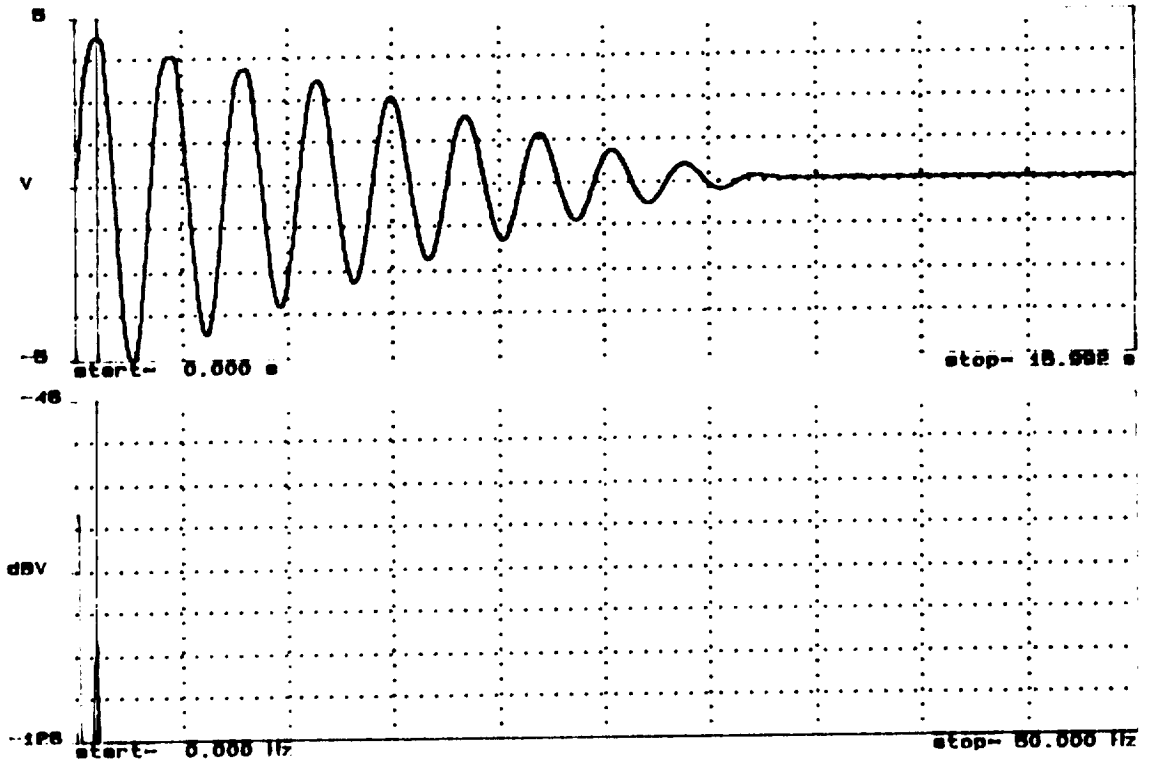

Figure 3. Apparatus Test Setup Sketch

312.50000ms 4.438 V TRA TIME CH1 REAL 91-08-05 11:12:26



875.00000mhz -103.07dBV TRF SPEC CH1 dB MAG 91-08-05 11:12:26

Test 1

279.43750ms 4.488 V TRA TIME CH1 REAL 91-08-05 12:22:48

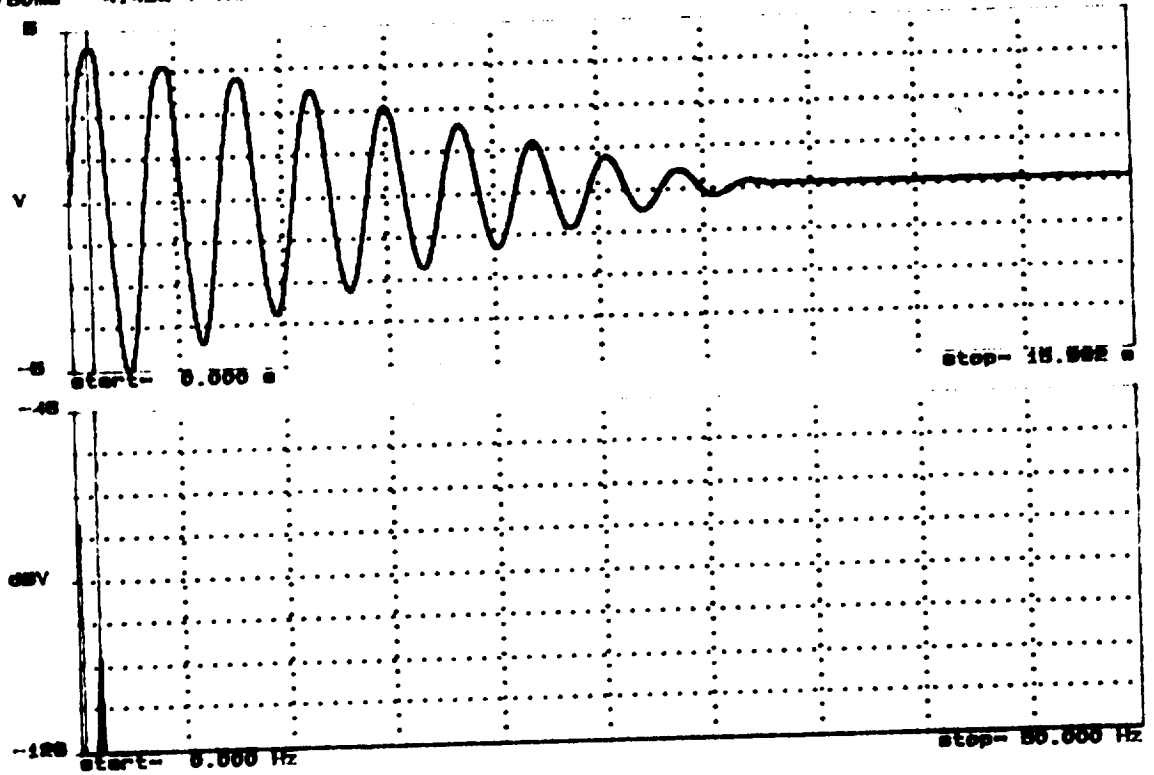

875.00000mhz -103.88dBV TRF SPEC CH1 dB MAG 91-08-05 12:22:48

Test 2

Figure 4. XTR50

265.62500ms 4.385 V TRA TIME CH1 REAL 01-05-05 12:42:38

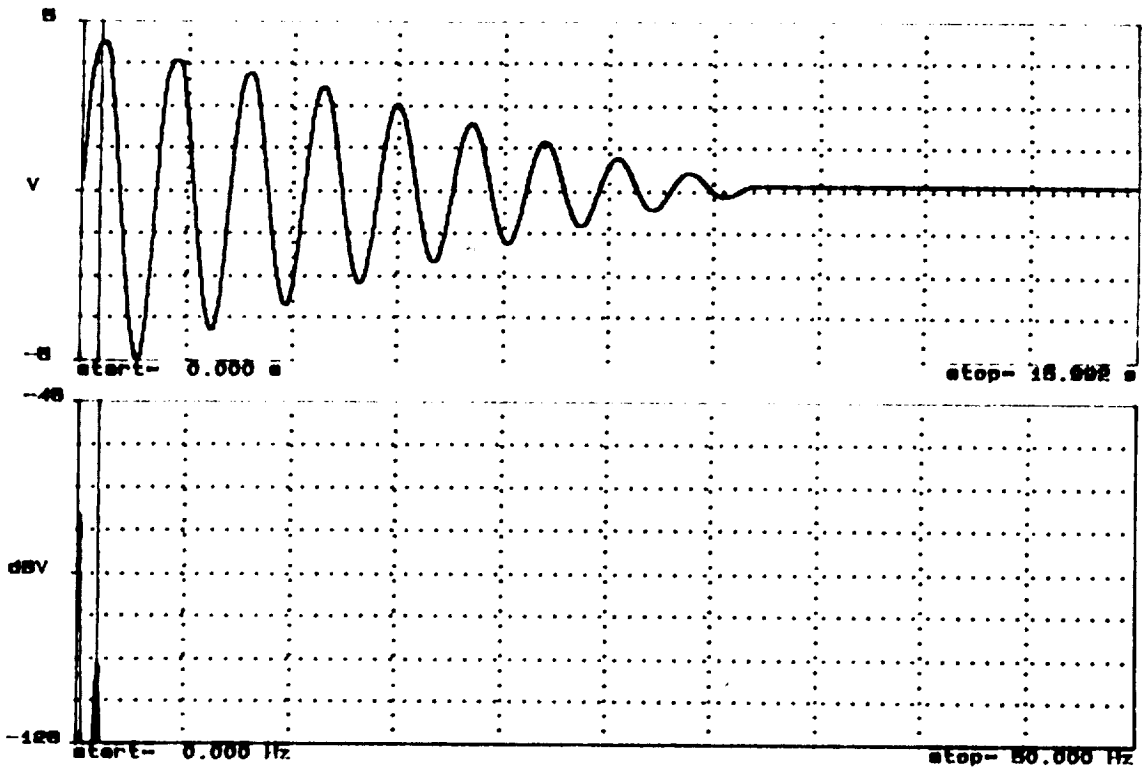

875.000000MHz -107.08dBV TR0 SPEC CH2 dB MAG 01-05-05 12:42:38

Test 3

261.25000ms 4.578 V TRA TIME CH1 REAL 01-05-05 13:22:42

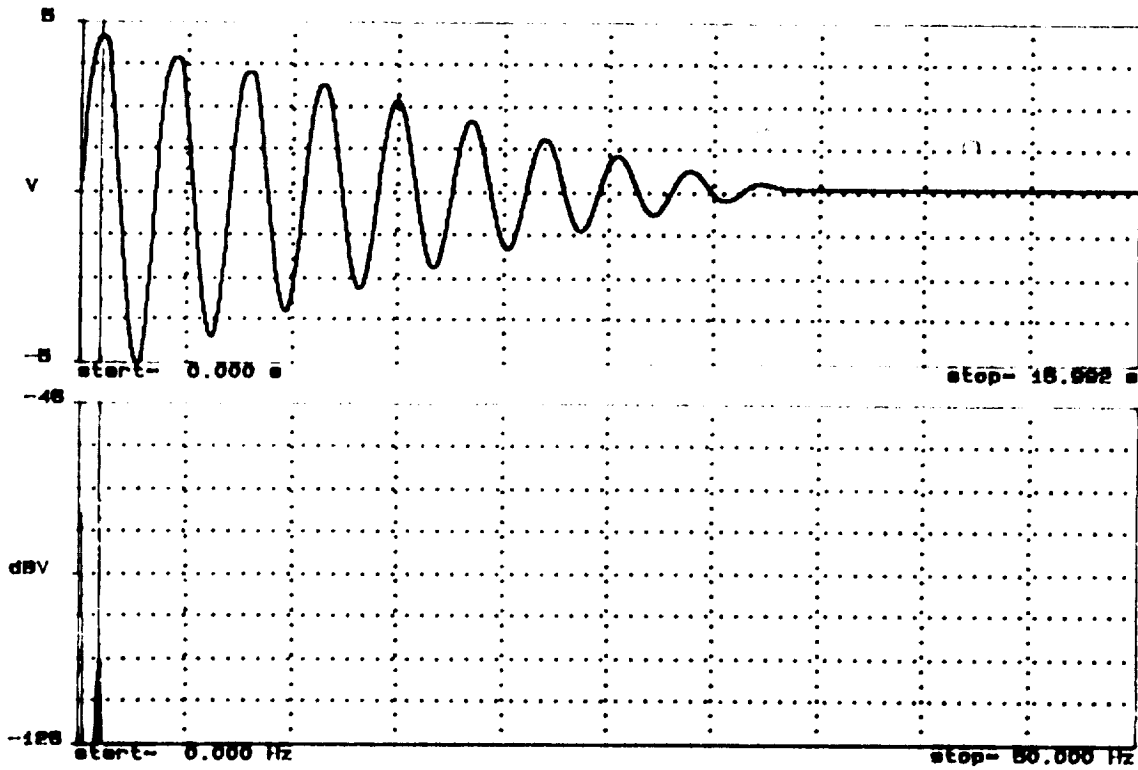

875.000000MHz -106.50dBV TR0 SPEC CH2 dB MAG 01-05-05 13:22:42

Test 4

Figure 4. XTR50 (continued)

200.0000ms 4.814 V TRA TIME CH1 REAL 01-08-08 13:08:30

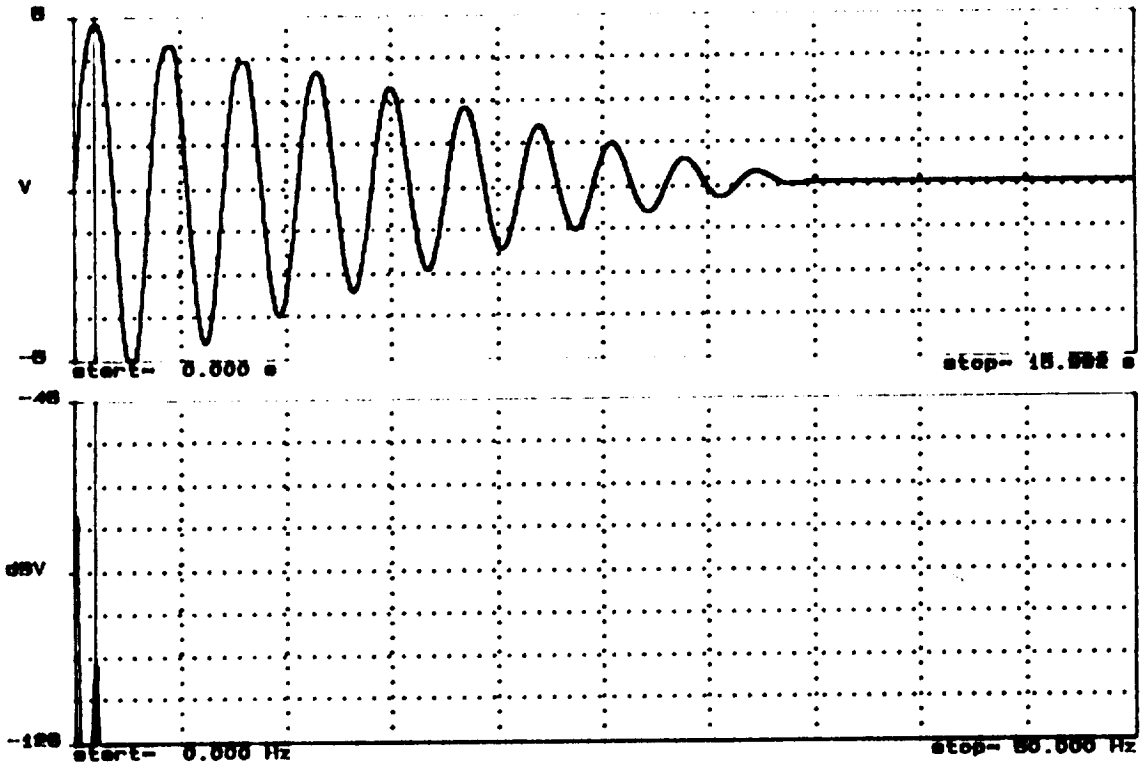

875.00000MHz -107.00dBV TRS SPEC CH2 dB MAX 01-08-08 13:08:30

Test 5

Figure 4. XTR50 (concluded)

200.06250ms 3.300 V TRA TIME CH1 REAL 01-06-06 11:31:53

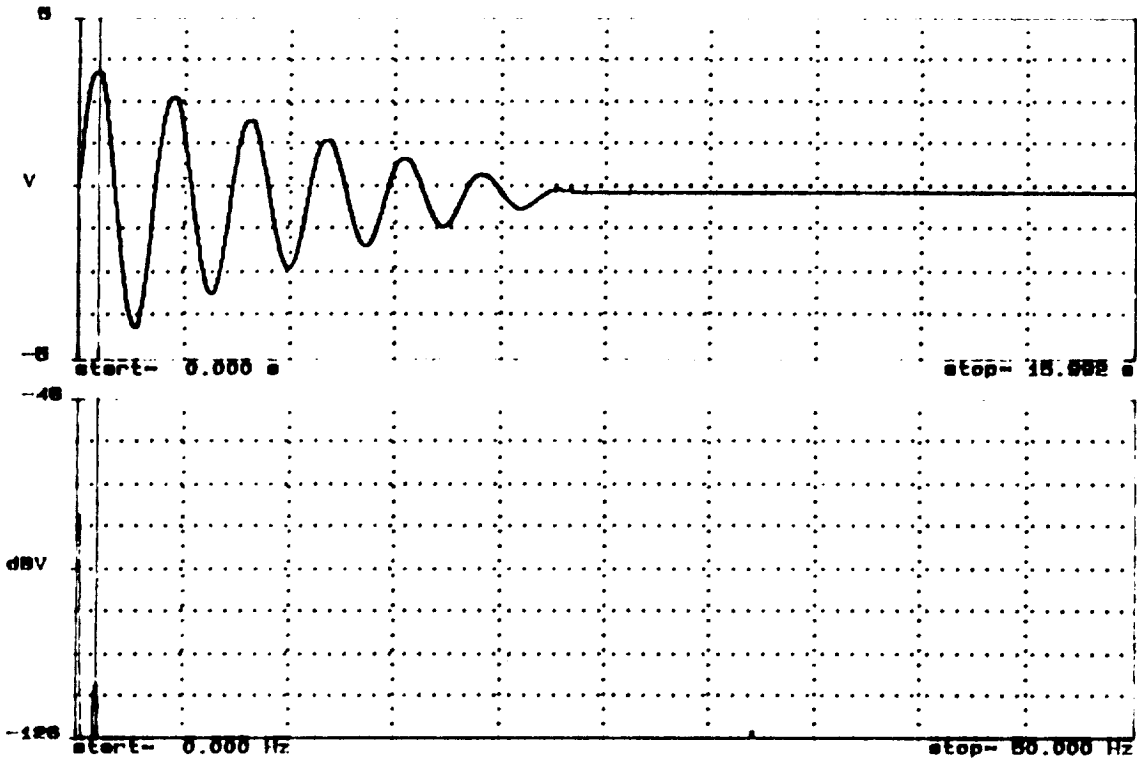

675.00000MHz -115.41dBV TR9 SPEC CH2 dB MAG 01-06-06 11:31:53

Test 1

200.06250ms 3.300 V TRA TIME CH1 REAL 01-06-06 11:33:31

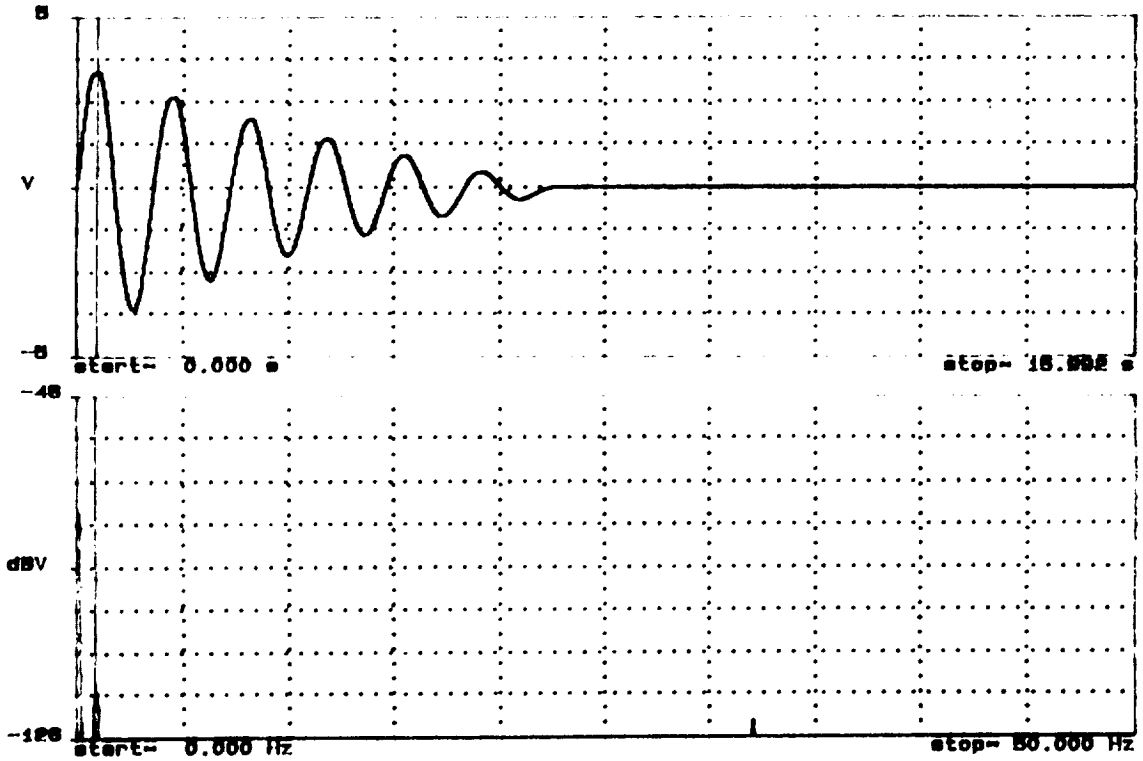

612.50000MHz -115.50dBV TR9 SPEC CH2 dB MAG 01-06-06 11:33:31

Test 2

Figure 5. XTR75

250.00000ms 3.489 V TRA TIME CH1 REAL 01-06-06 12:42:37

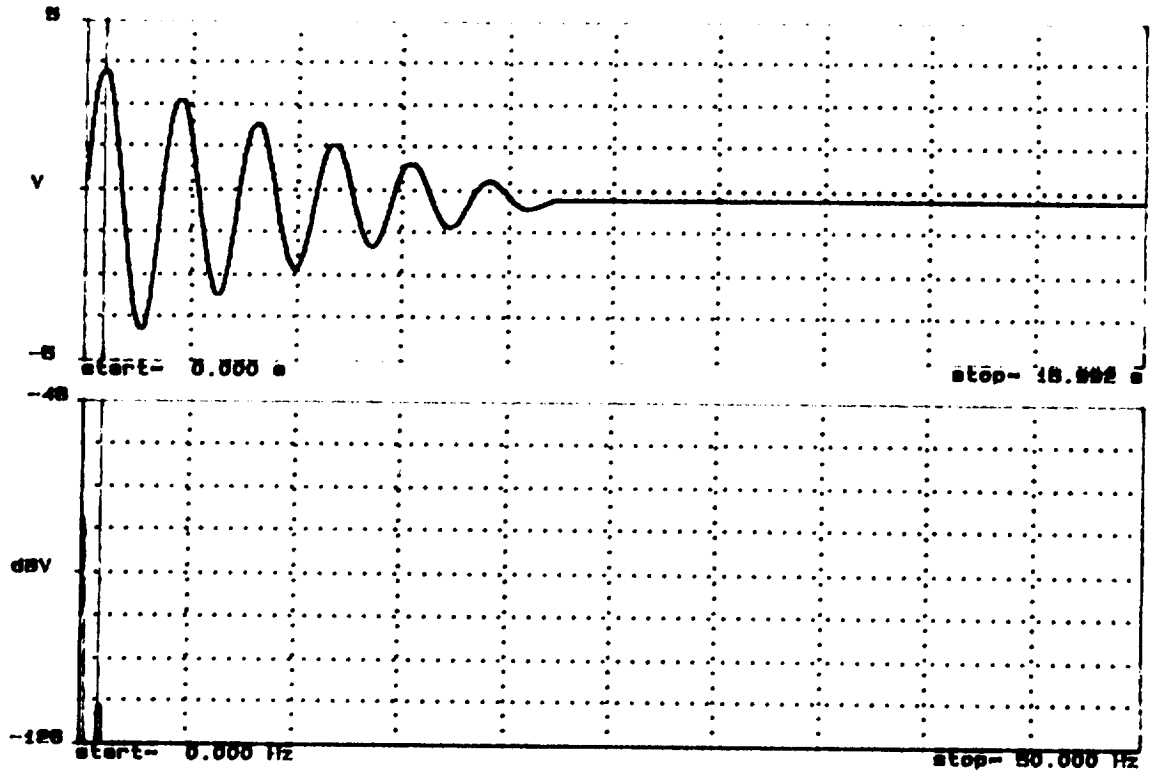

012.50000mhz -117.24dBV TRB SPEC CH2 dB MAG 01-06-06 12:42:37

Test 3

257.01250ms 4.249 V TRA TIME CH1 REAL 01-06-06 12:03:24

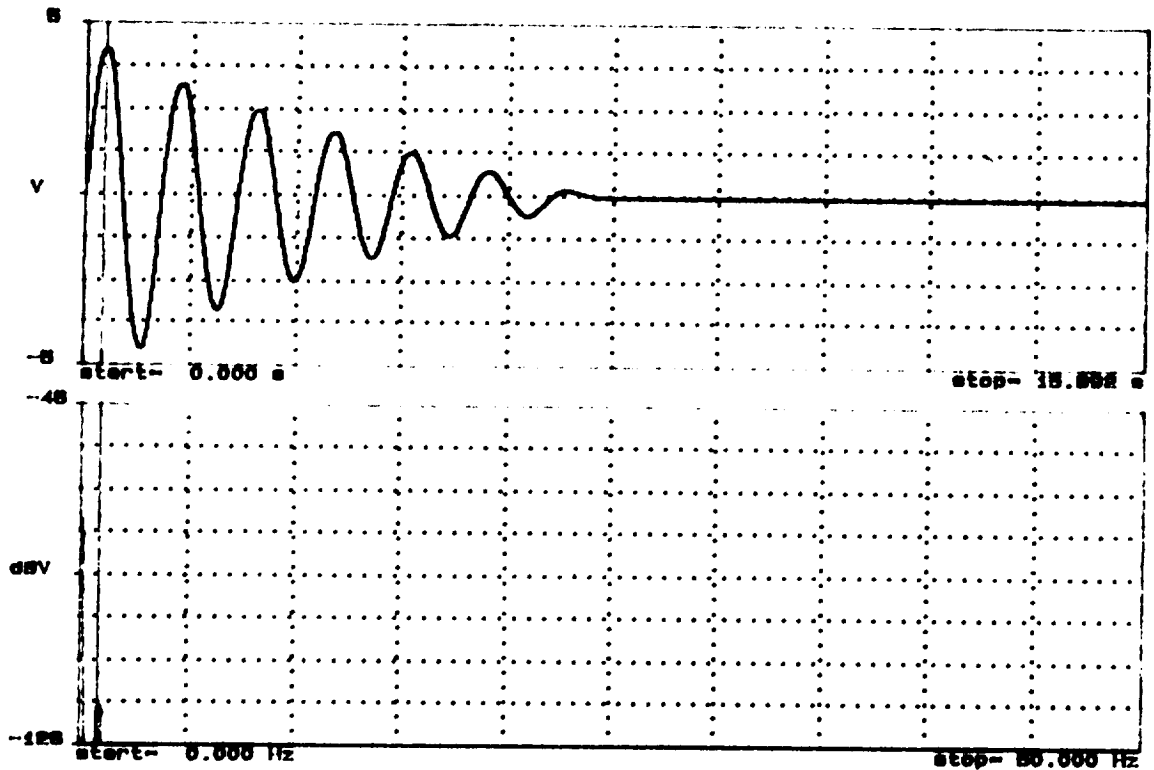

012.50000mhz -117.24dBV TRB SPEC CH2 dB MAG 01-06-06 12:03:24

Test 4

Figure 5. XTR75 (continued)

257.81250ms 4.170 V TRM TIME CH1 REAL 01-08-08 13:23:10

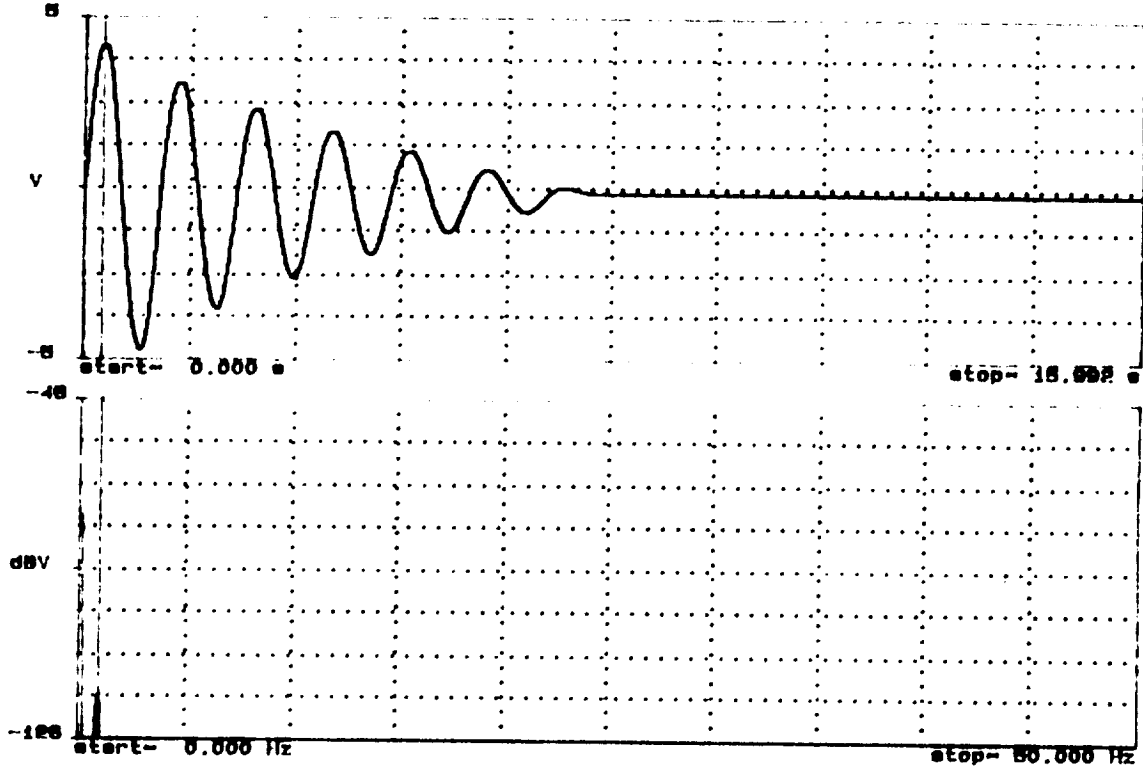

878.00000mhz --118.50dBV TRM SPEC CH2 dB MAG 01-08-08 13:23:10

Test 5

Figure 5. XTR75 (concluded)

ORIGINAL PAGE IS
OF POOR QUALITY

312.50000ms 3.977 V TRA TIME CH1 REAL 01-08-06 15:21:40

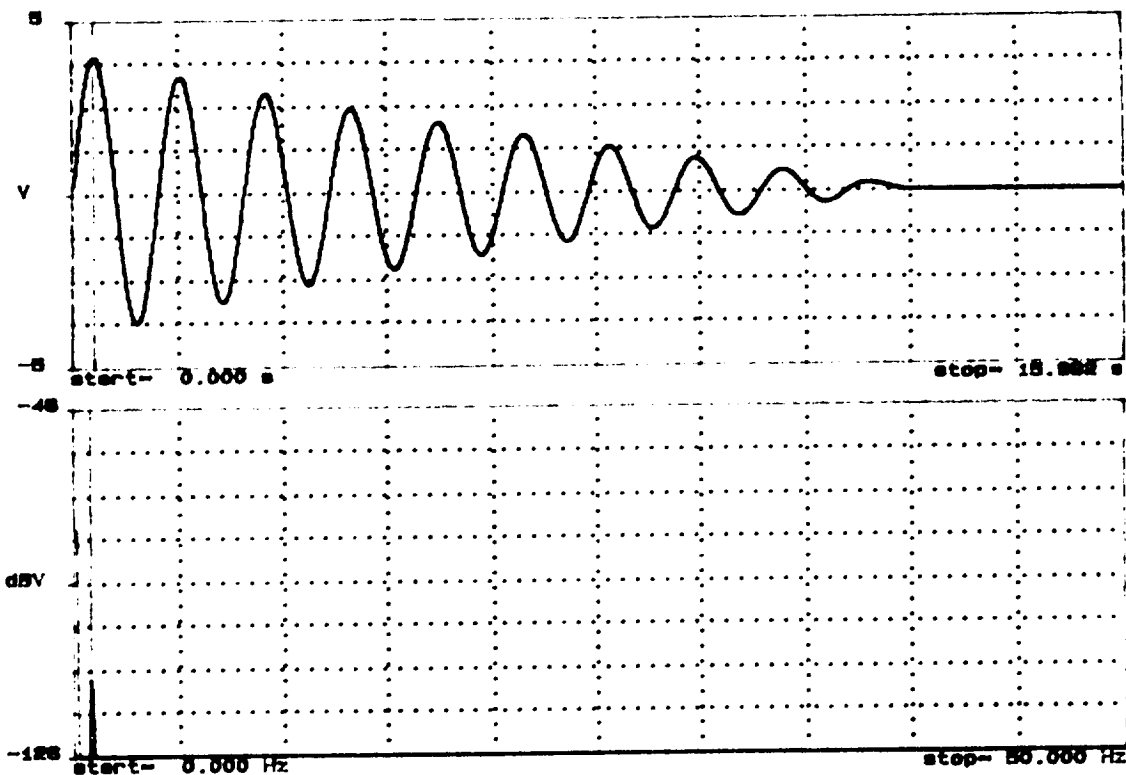

750.00000mHz -108.03dBV TRM SPEC CH2 dB MAG 01-08-06 15:21:40

Test 1

320.31250ms 3.877 V TRA TIME CH1 REAL 01-08-06 15:02:15

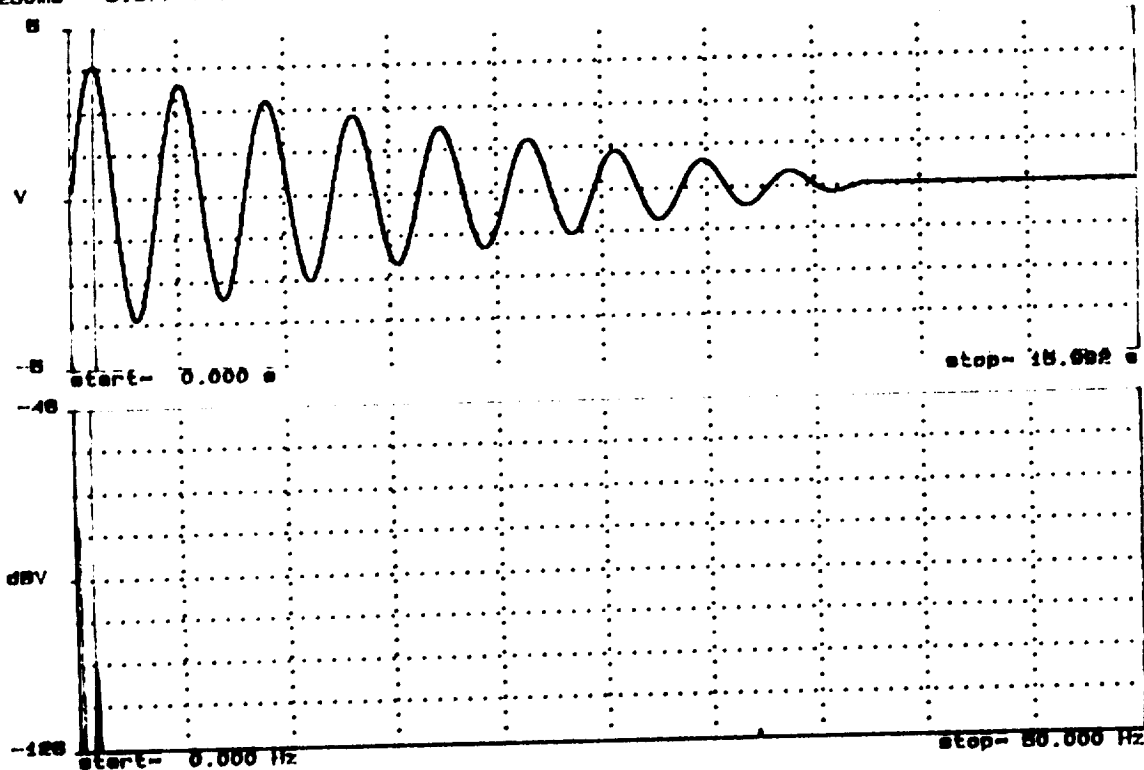

750.00000mHz -107.00dBV TRM SPEC CH2 dB MAG 01-08-06 15:02:15

Test 2

Figure 6. RECT

ORIGINAL PAGE IS
OF POOR QUALITY

757.81250ms 4.778 V TRA TIME CH1 REAL 01-08-06 15:39:28

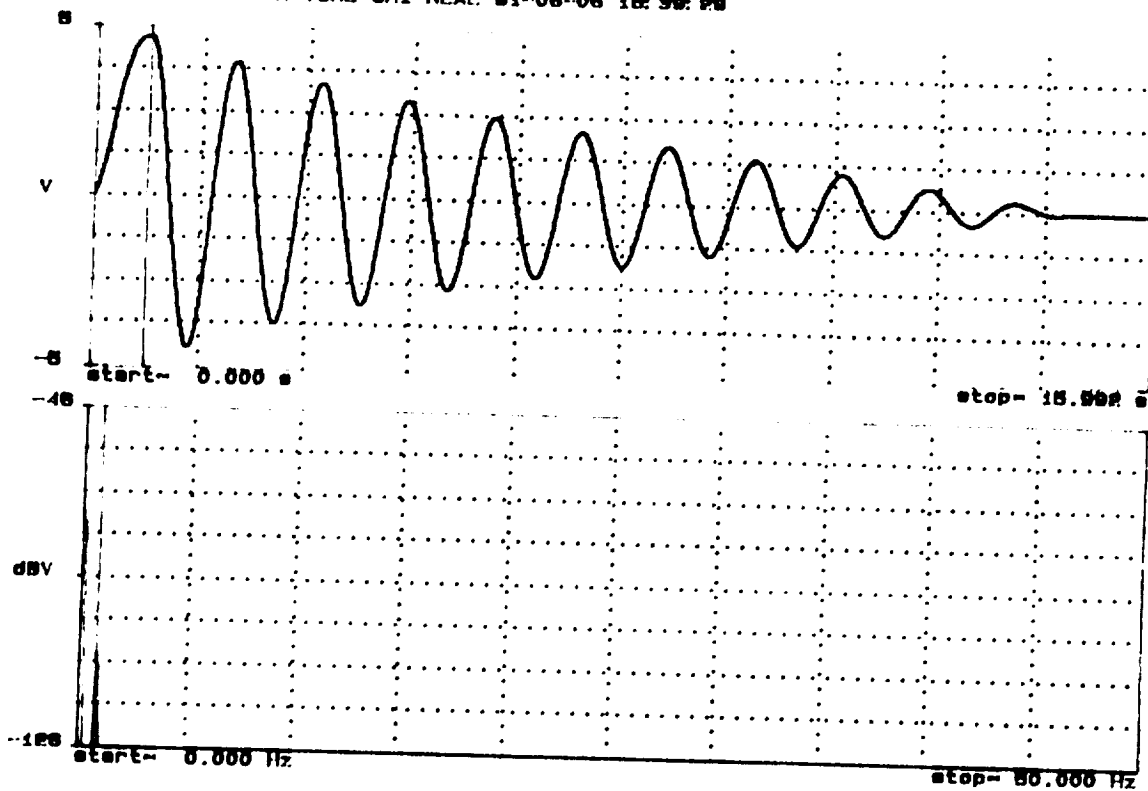

750.00000MHz -104.07dBV TR0 SPEC CH1 dB MAG 01-08-06 15:39:28

Test 3

588.83750ms 4.768 V TRA TIME CH1 REAL 01-08-06 16:14:38

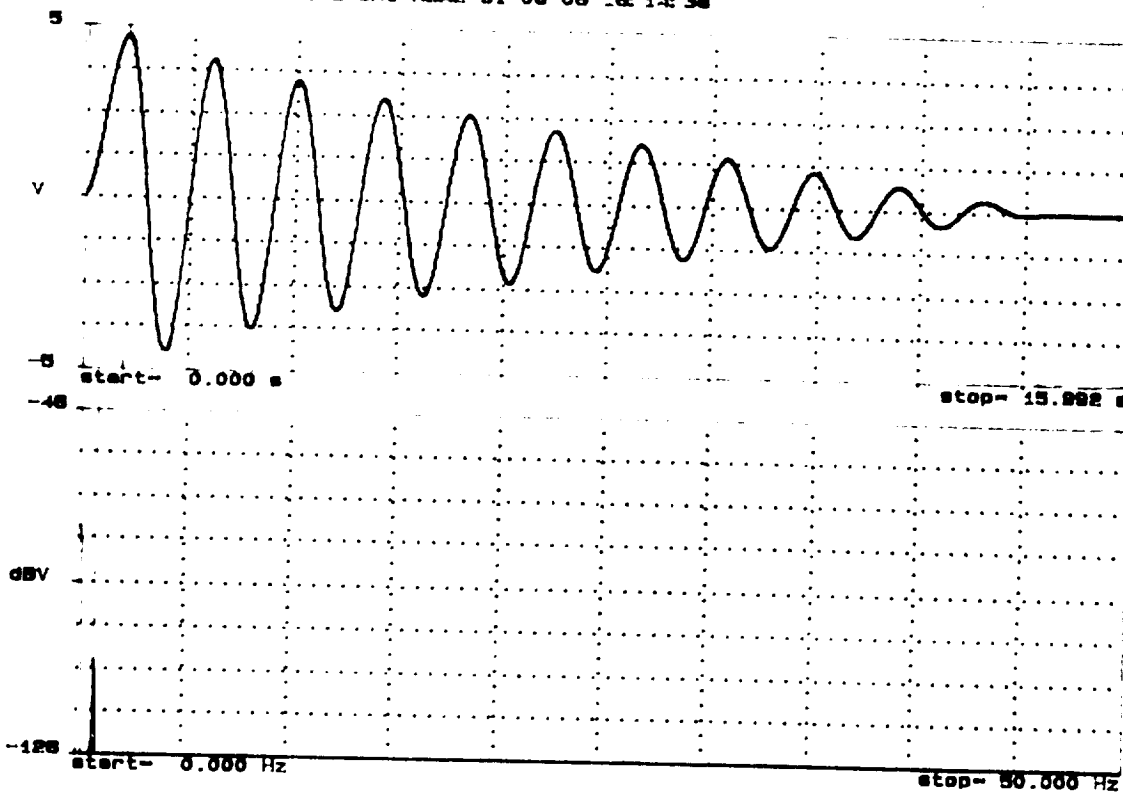

750.00000MHz -103.68dBV TR0 SPEC CH1 dB MAG 01-08-06 16:14:38

Test 4

Figure 6. RECT (continued)

ORIGINAL PAGE IS
OF POOR QUALITY

1.09375 s 4.753 V TRA TIME CH1 REAL 91-08-08 16:42:42

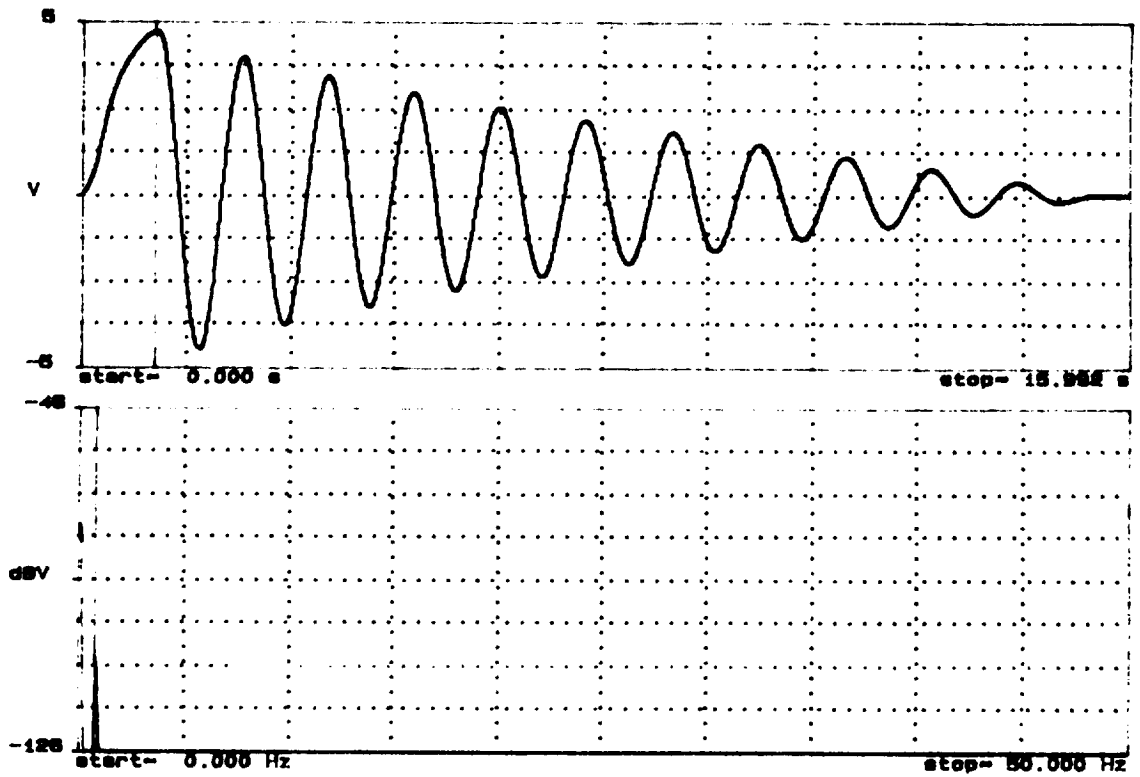

750.00000MHz -104.07dBV TRB SPEC CH2 dB MAX 91-08-08 16:42:42

Test 5

Figure 6. RECT (concluded)

ORIGINAL PAGE IS
OF POOR QUALITY

351.56250ms 4.316 V TRA TIME CH1 REAL 91-06-12 14:31:10

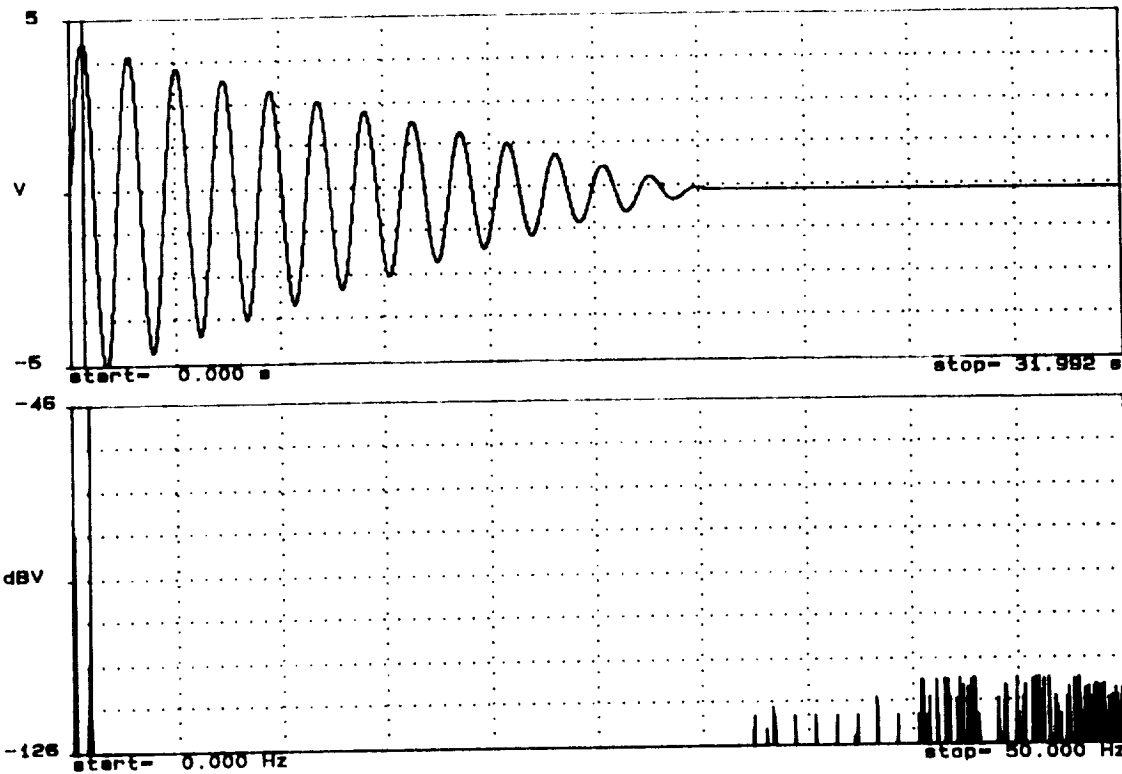

687.50000MHz -103.27dBV TRB SPEC CH2 dB MAG 91-06-12 14:31:10

Test 1

343.75000ms 4.128 V TRA TIME CH1 REAL 91-06-12 14:50:29

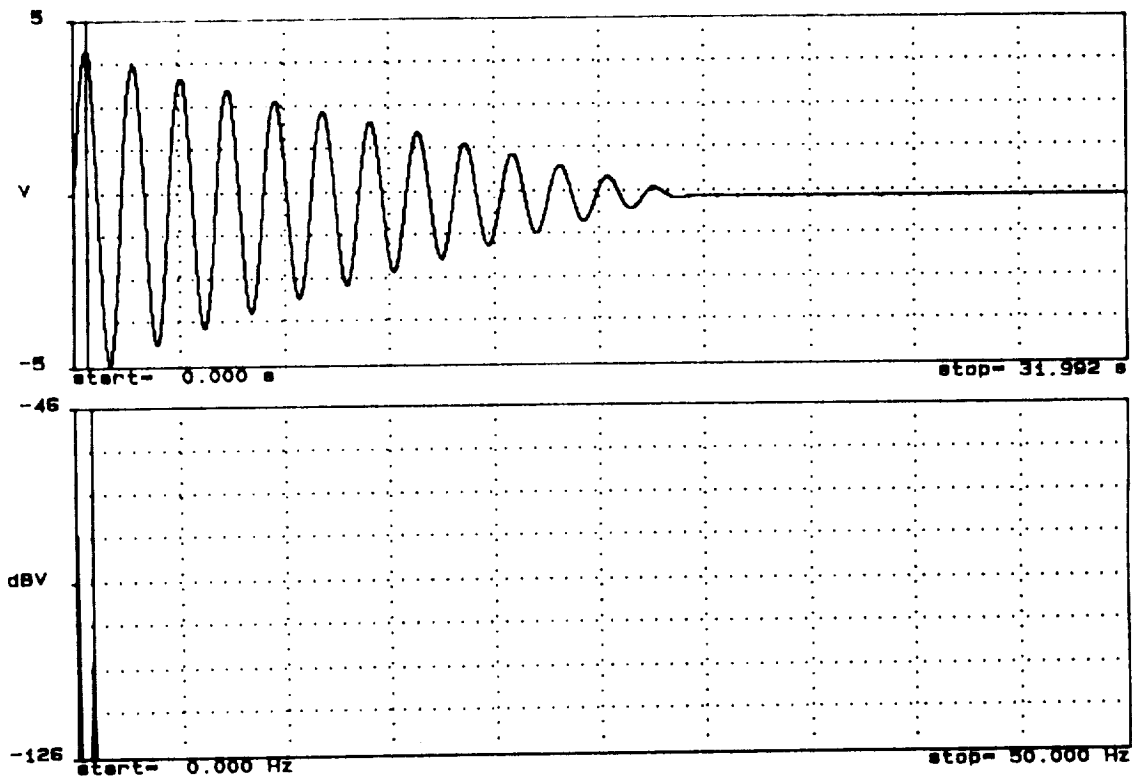

687.50000MHz -102.70dBV TRB SPEC CH2 dB MAG 91-06-12 14:50:29

Test 2

Figure 7. AHIP

328.12500ms 4.753 V TRA TIME CH1 REAL 91-06-12 15:07:51

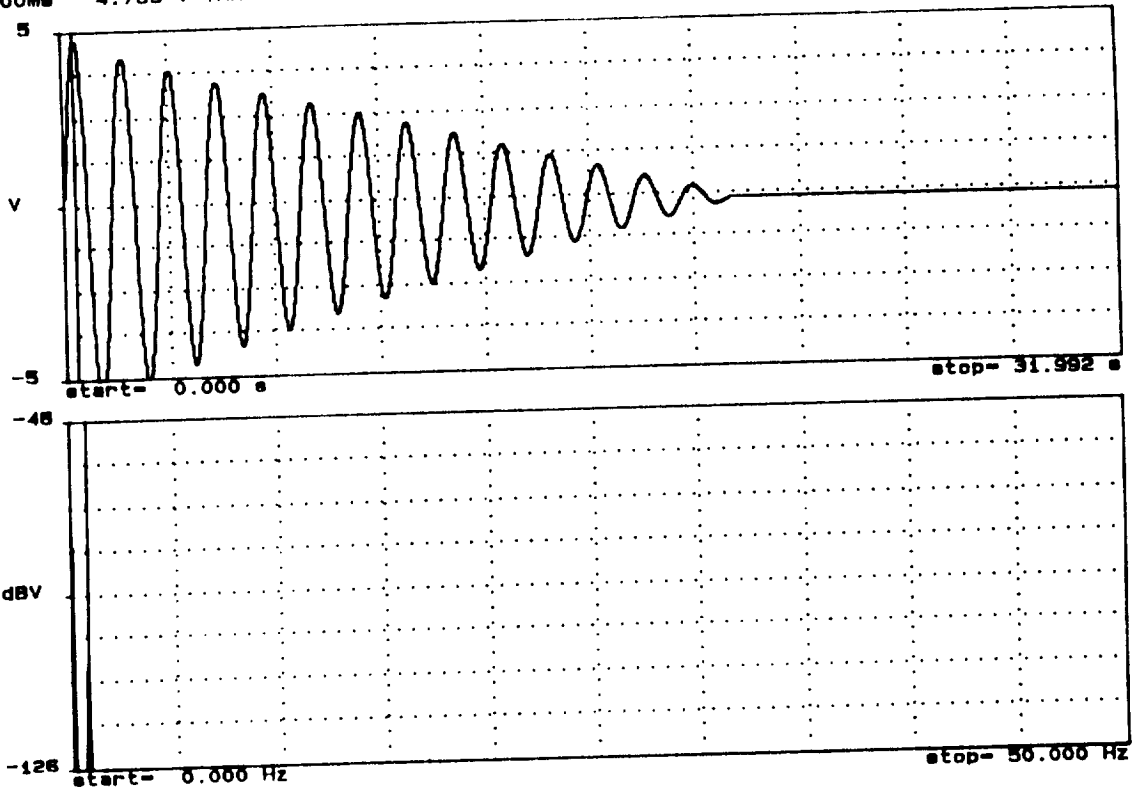

687.50000mHz -101.21dBV TRB SPEC CH2 dB MAG 91-06-12 15:07:51

Test 3

335.93750ms 4.048 V TRA TIME CH1 REAL 91-06-12 15:31:34

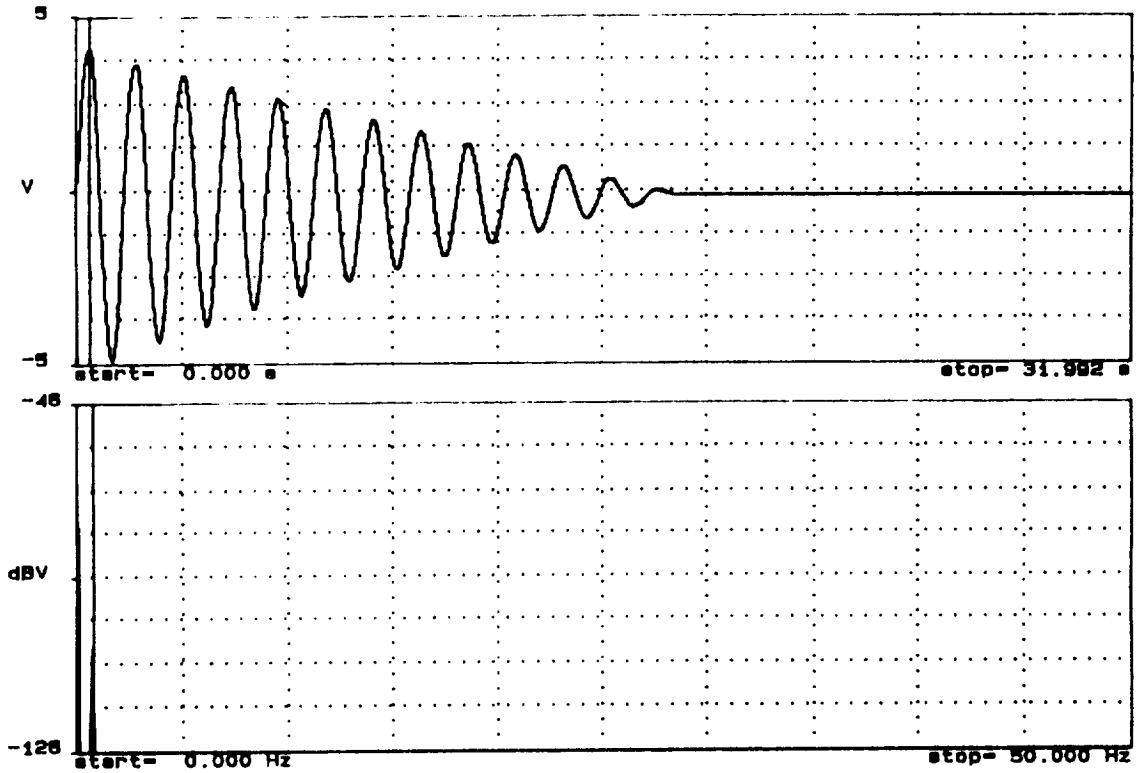

687.50000mHz -102.35dBV TRB SPEC CH2 dB MAG 91-06-12 15:31:34

Test 4

Figure 7. AHIP (continued)

ORIGINAL PAGE IS
OF POOR QUALITY

367.18750ms 4.355 V TRA TIME CH1 REAL 91-08-12 15:55:55

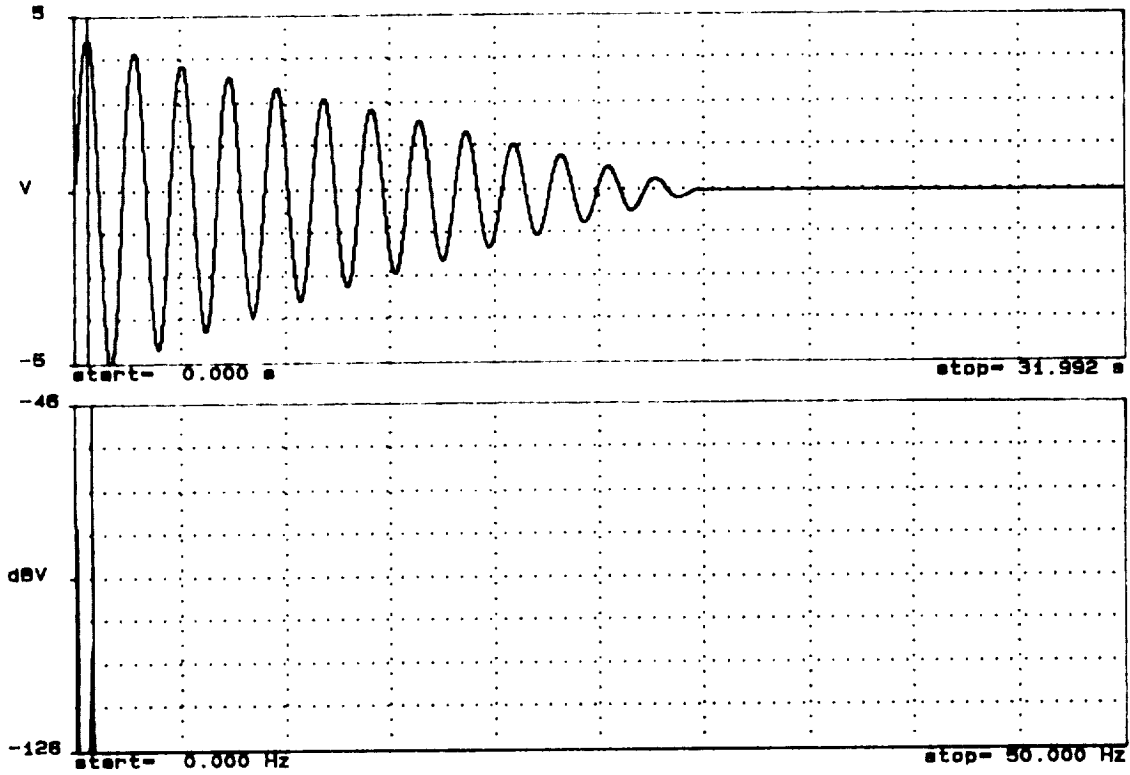

687.50000MHz -101.64dBV TRB SPEC CH2 dB MAG 91-08-12 15:55:55

Test 5

Figure 7. AHIP (concluded)

343.7500ms 4.981 V TRA TIME CH1 REAL 91-06-13 09:19:26

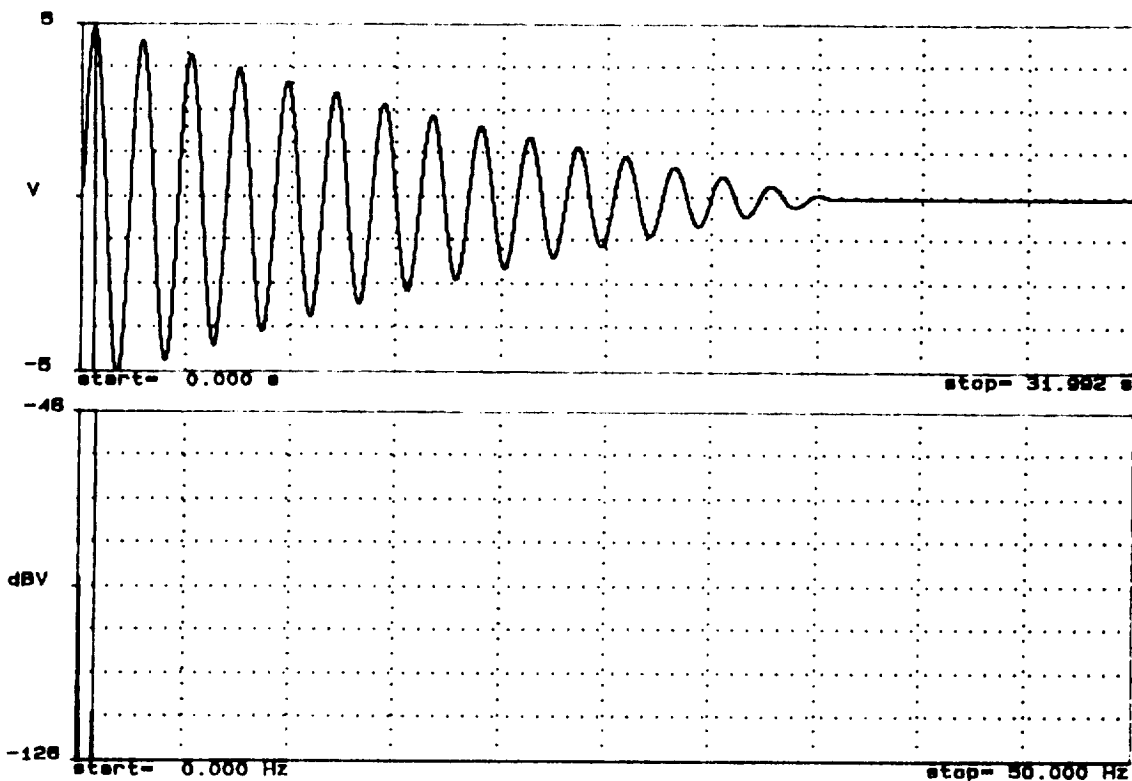

687.50000MHz -114.75dBV TRB SPEC CH2 dB MAG 91-06-13 09:19:26

Test 1

343.7500ms 4.826 V TRA TIME CH1 REAL 91-06-13 09:36:56

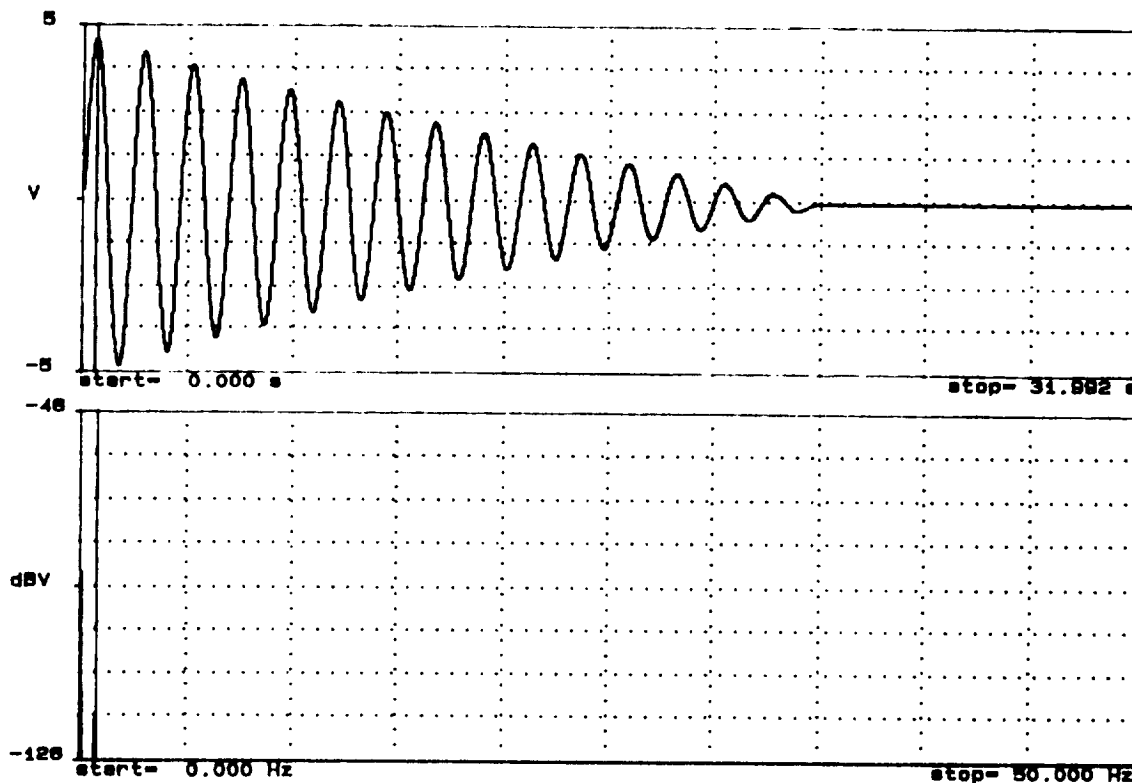

687.50000MHz -115.50dBV TRB SPEC CH2 dB MAG 91-06-13 09:36:56

Test 2

Figure 8. TR3

1.82613 5.000 V TRA TIME CH1 REAL 91-06-13 09:56:53

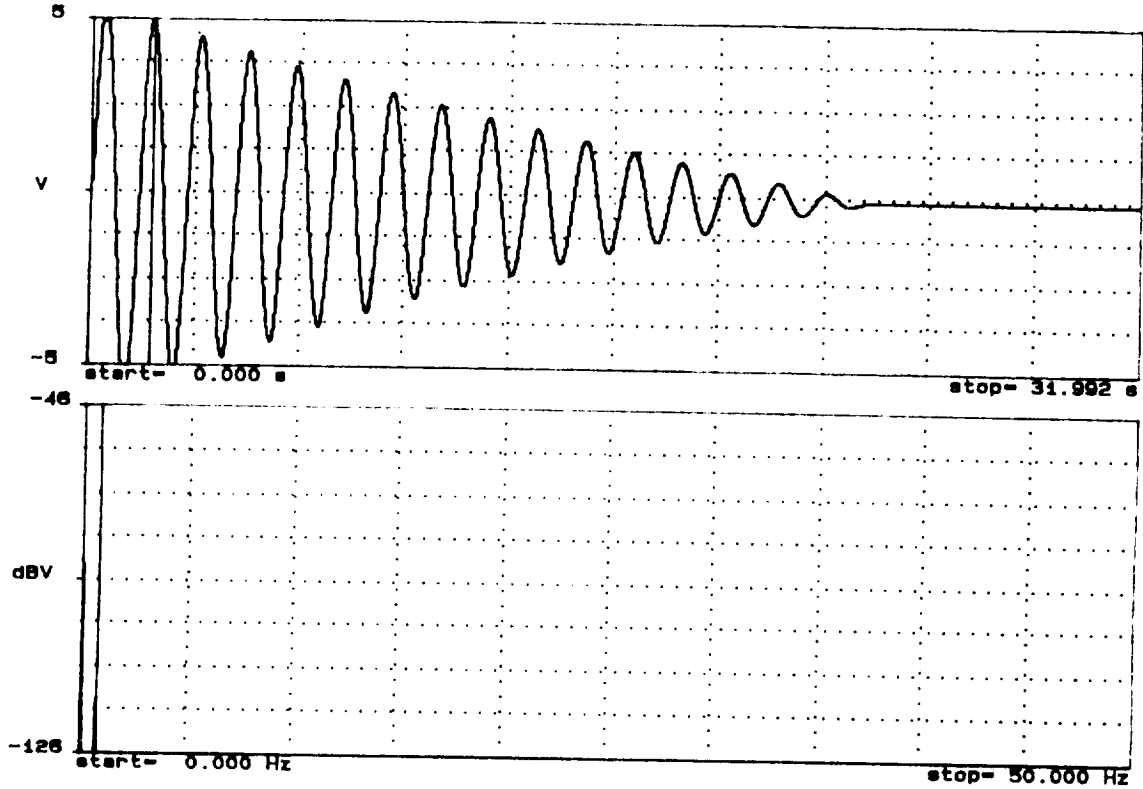

667.50000MHz -113.41dBV TRB SPEC CH2 dB MAG 91-06-13 09:56:53

Test 3

351.56250ms 4.902 V TRA TIME CH1 REAL 91-06-13 10:32:46

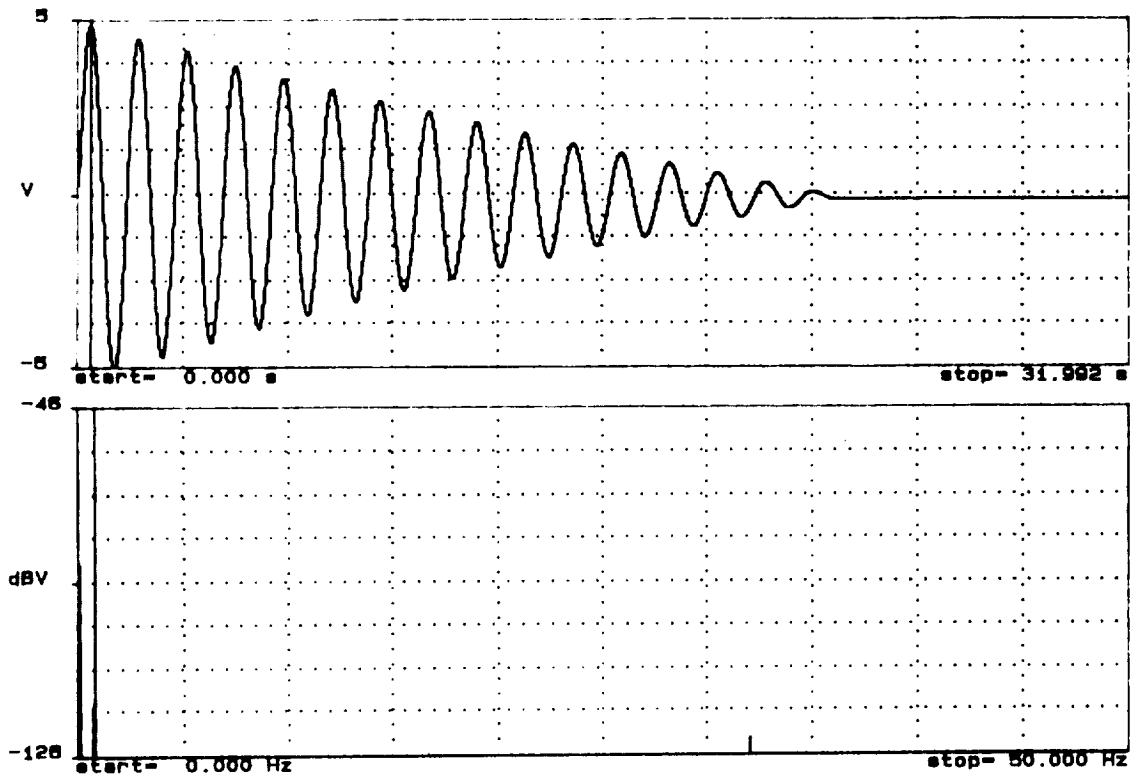

667.50000MHz -113.41dBV TRB SPEC CH2 dB MAG 91-06-13 10:32:46

Test 4

Figure 8. TR3 (continued)

351.56250ms 4.624 V TRA TIME CH1 REAL 91-06-13 10:15:23

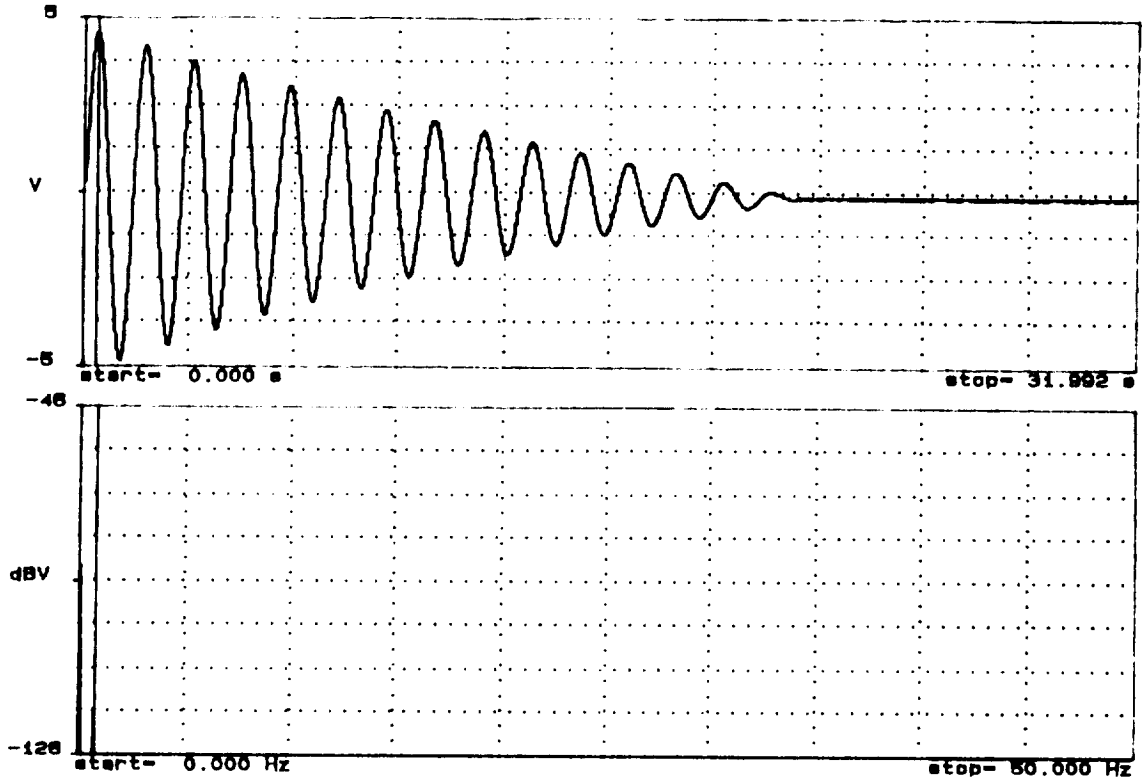

687.50000MHz -118.50dBV TRB SPEC CH2 dB MA0 91-06-13 10:15:23

Test 5

Figure 8. TR3 (concluded)

ORIGINAL FILED
OF POOR QUALITY

101.58250ms P.348 V TRA TIME CH1 REAL 91-06-07 08:27:40

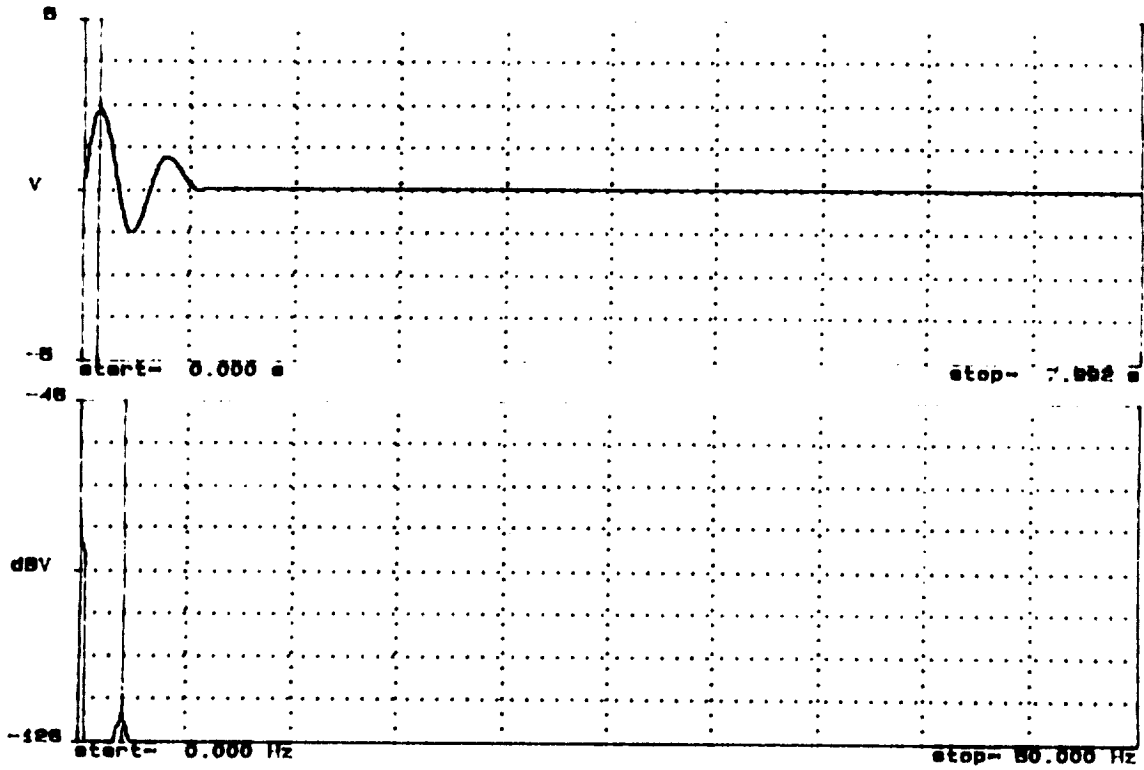

2.00000 Hz -119.43dBV TRB SPEC CH1 dB MAX 91-06-07 08:27:40

Test 1

109.37500ms 3.015 V TRA TIME CH1 REAL 91-06-07 08:12:08

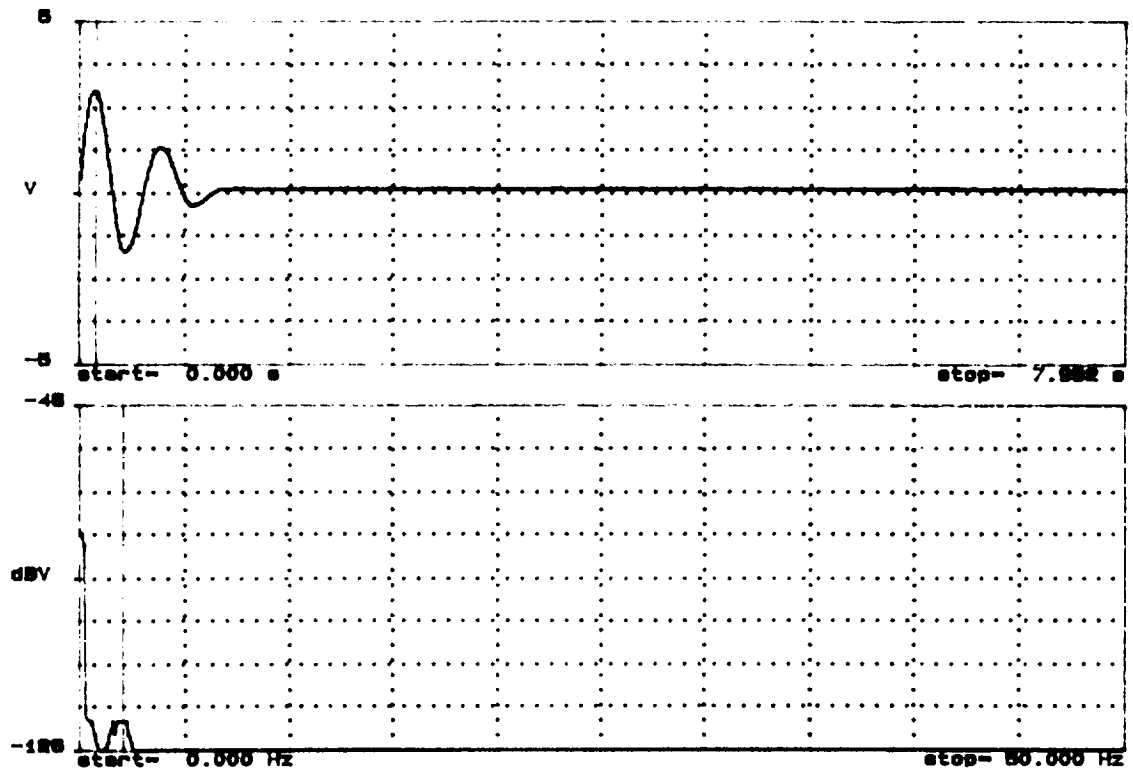

2.00000 Hz -119.43dBV TRB SPEC CH2 dB MAX 91-06-07 08:12:08

Test 2

Figure 9. Bare Cuff

ORIGINAL PAGE IS
OF POOR QUALITY

109.37500ms 2.703 V TRA TIME CH1 REAL 91-08-08 09:28:48

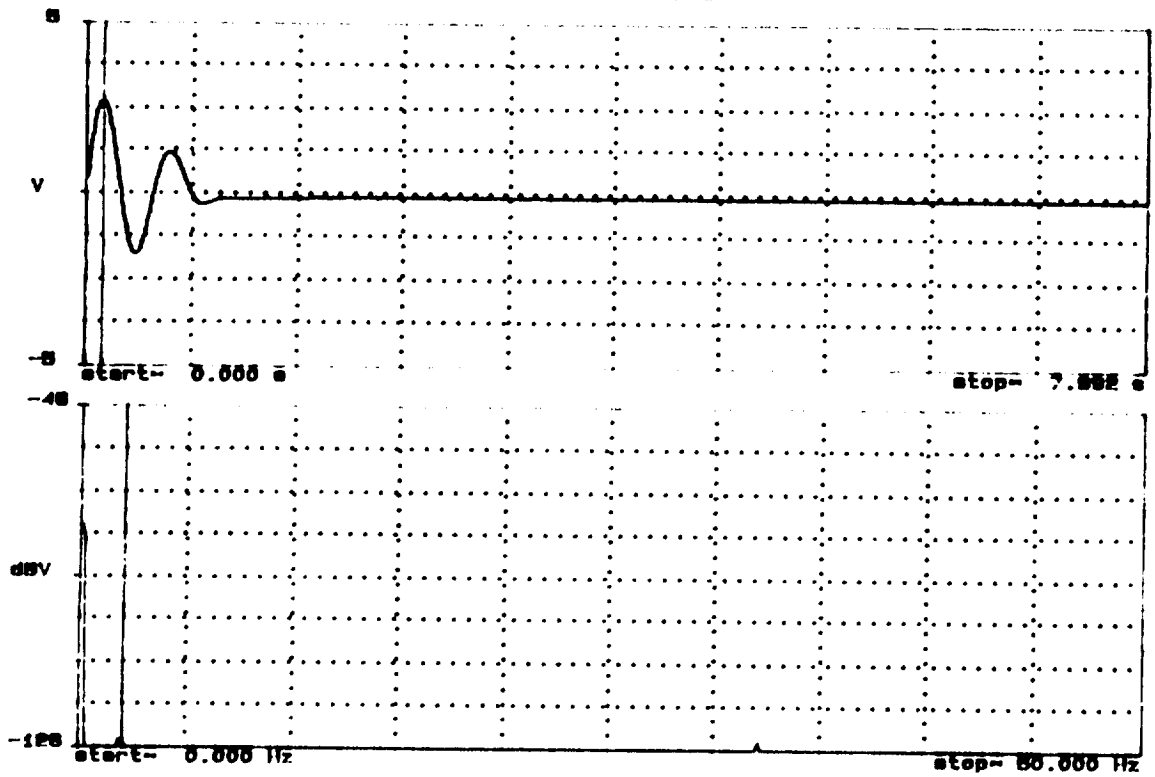

2.00000 Hz -124.29dBV TRS SPEC CH2 dB MAG 91-08-08 09:28:48

Test 3

109.37500ms 3.013 V TRA TIME CH1 REAL 91-08-08 09:40:43

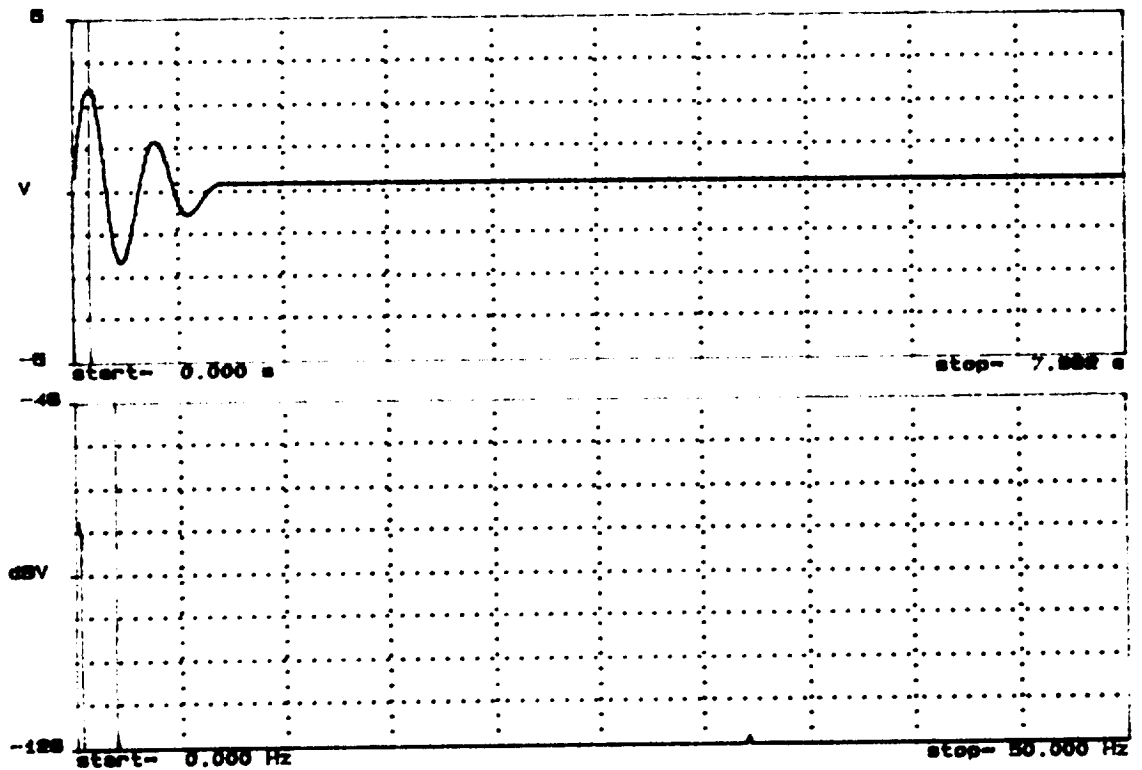

1.67500 Hz -124.29dBV TRS SPEC CH2 dB MAG 91-08-08 09:40:43

Test 4

Figure 9. Bare Cuff (continued)

101.56250ms 3.000 V TRM TIME CH1 REAL 01-08-06 09:57:00

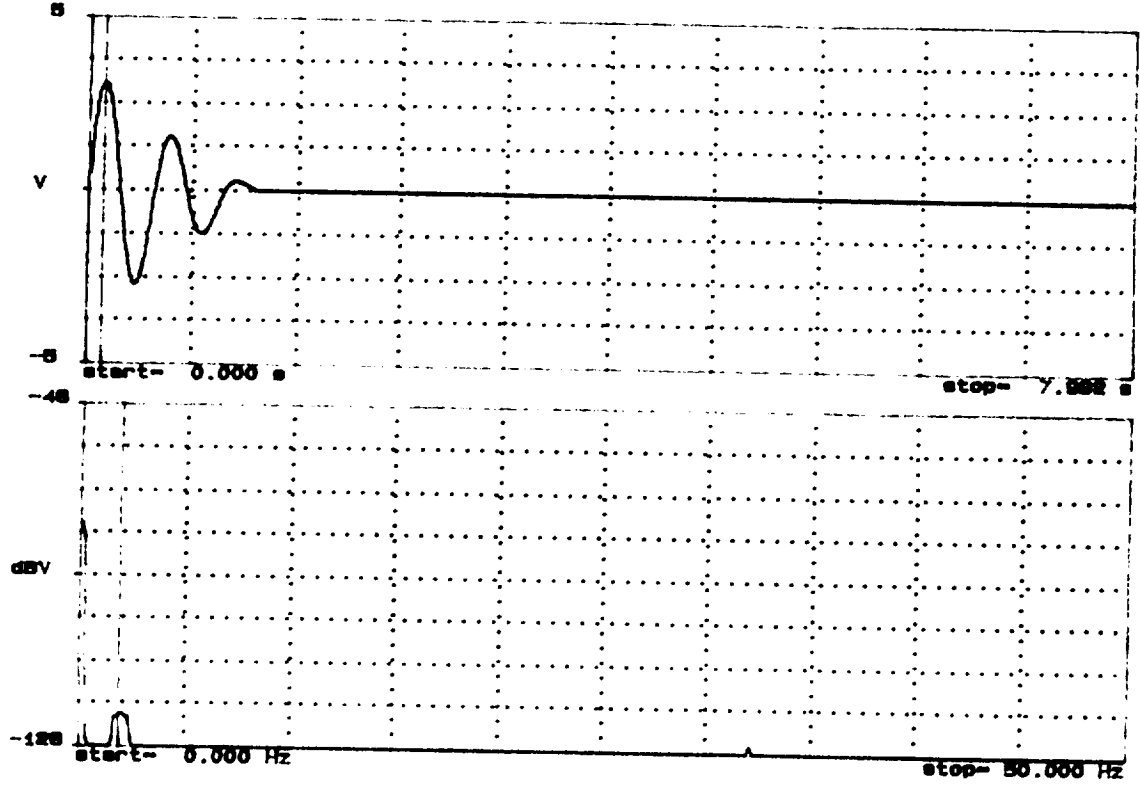

1.87500 Hz -118.27dBV TRM SPEC CH2 dB MAG 01-08-06 09:57:00

Test 5

Figure 9. Bare Cuff (concluded)

ORIGINAL PAGE IS
OF POOR QUALITY

132.81250ms 4.634 V TRA TIME CH1 REAL 91-08-13 10:53:55

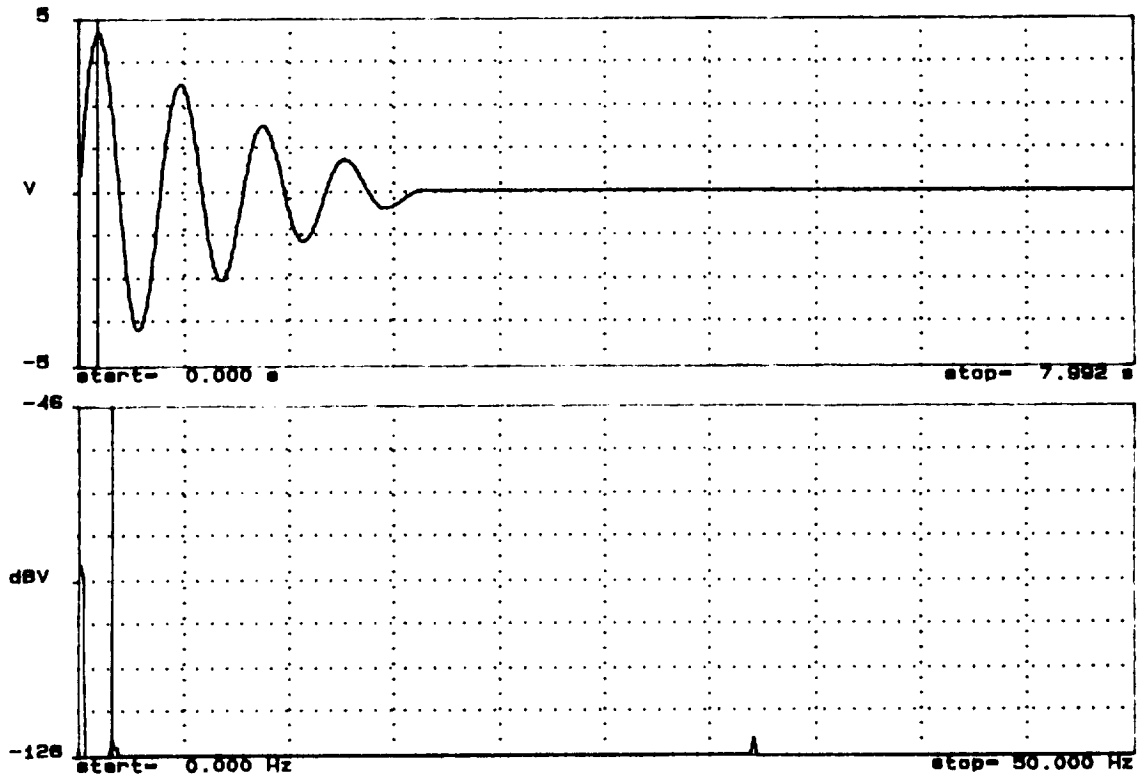

1.50000 Hz -122.35dBV TRB SPEC CH2 dB MAG 91-08-13 10:53:55

Test 1

140.62500ms 4.360 V TRA TIME CH1 REAL 91-08-13 11:03:52

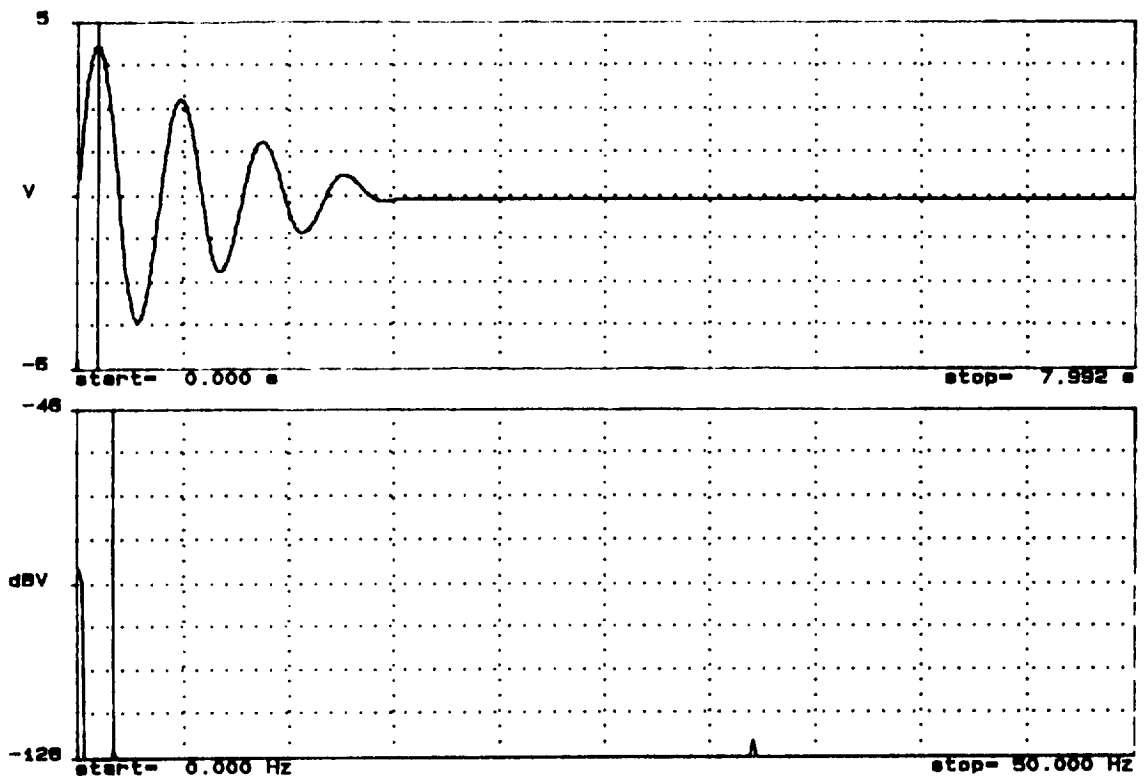

1.52500 Hz -124.29dBV TRB SPEC CH2 dB MAG 91-08-13 11:03:52

Test 2

Figure 10. Cuff with Blade Extender

ORIGINAL TABLE IS
OF POOR QUALITY

140.62500ms 4.517 V TRA TIME CH1 REAL 91-06-13 11:21:01

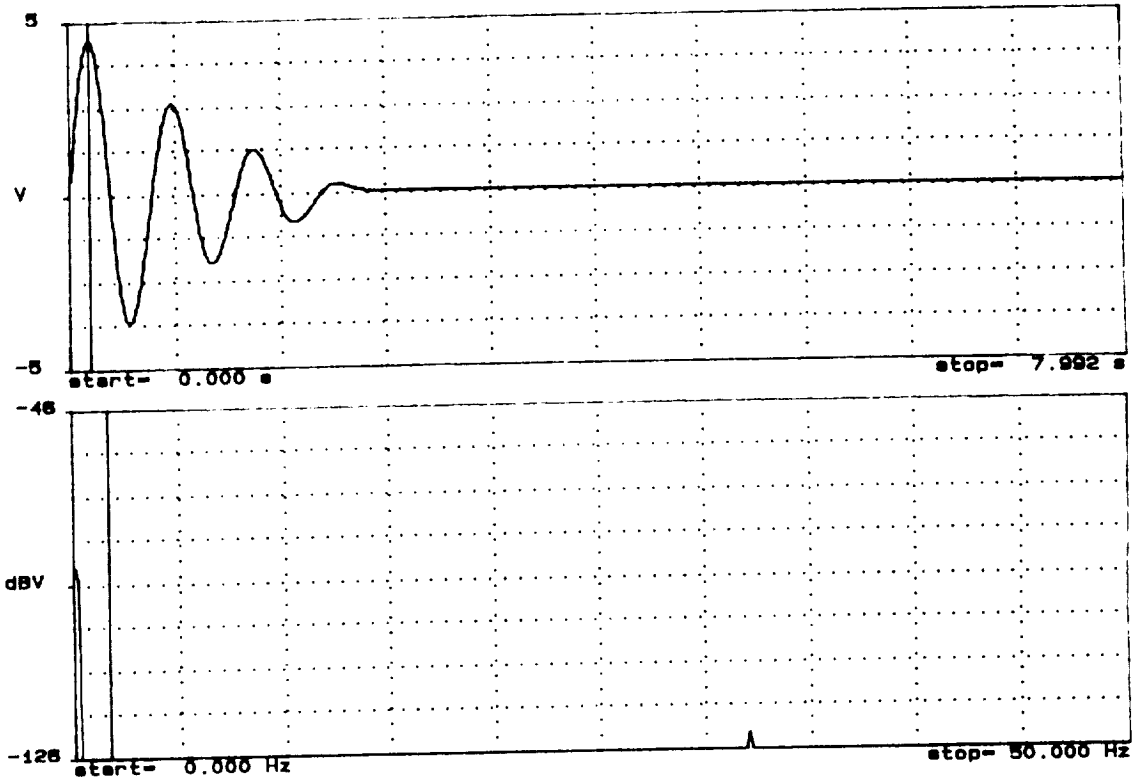

1.62500 Hz -130.31dBV TRB SPEC CH2 dB MAG 91-06-13 11:21:01

Test 3

132.81250ms 4.895 V TRA TIME CH1 REAL 91-06-13 11:29:18

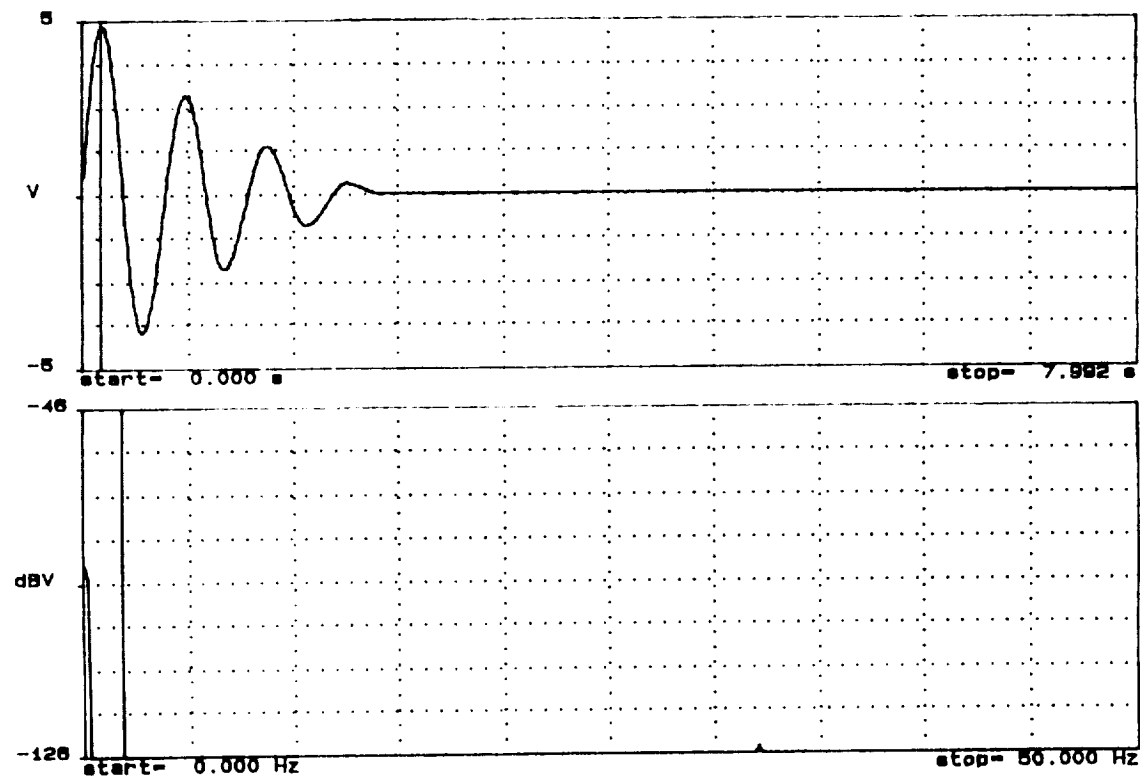

1.75000 Hz -130.31dBV TRB SPEC CH2 dB MAG 91-06-13 11:29:18

Test 4

Figure 10. Cuff with Blade Extender (continued)

ORIGINAL PAGE IS
OF POOR QUALITY

132.81250ms 4.868 V TRM TIME CH1 REAL 01-06-13 12:41:12

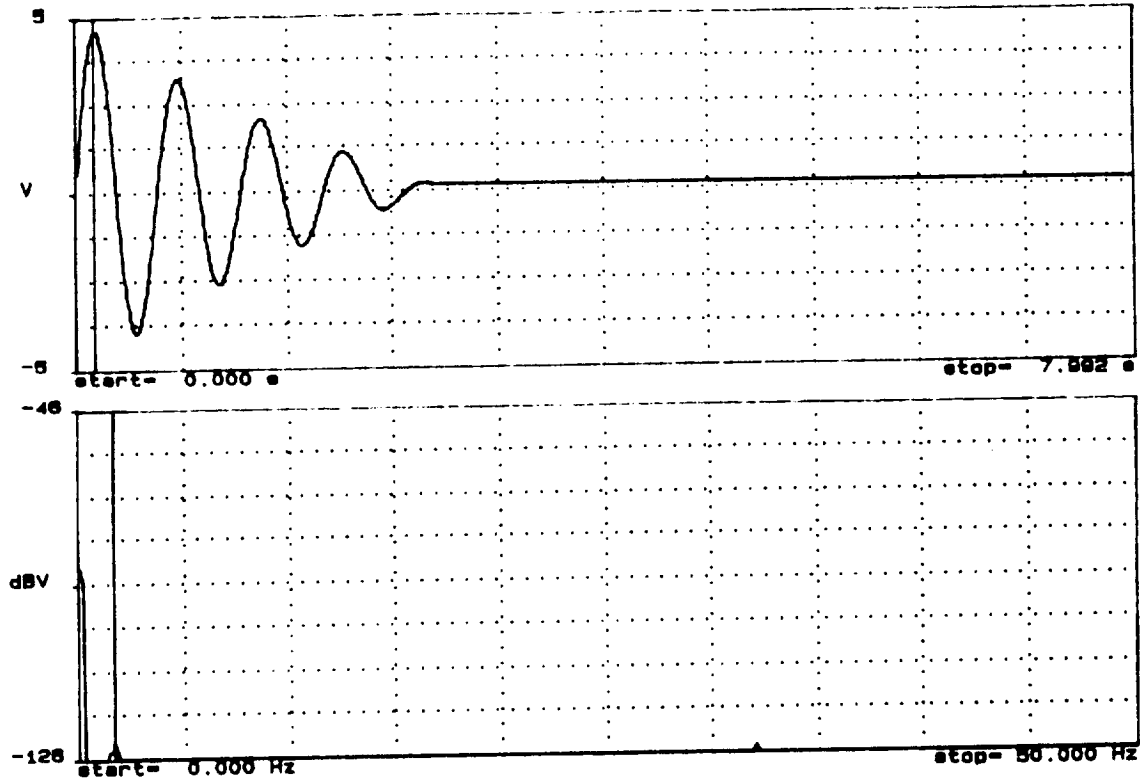

1.02800 Hz -122.36dBV TRM SPEC CH2 dB MAG 01-06-13 12:41:12

Test 5

Figure 10. Cuff with Blade Extender (concluded)

ORIGINAL COPY IS
OF POOR QUALITY

REPORT DOCUMENTATION PAGE

Form Approved
OMB No. 0704-0188

Public reporting burden for this collection of information is estimated to average 1 hour per response, including the time for reviewing instructions, searching existing data sources, gathering and maintaining the data needed, and completing and reviewing the collection of information. Send comments regarding this burden estimate or any other aspect of this collection of information, including suggestions for reducing this burden, to Washington Headquarters Services, Directorate for Information Operations and Reports, 1215 Jefferson Davis Highway, Suite 1204, Arlington, VA 22202-4302, and to the Office of Management and Budget, Paperwork Reduction Project (0704-0188), Washington, DC 20503.

1. AGENCY USE ONLY (Leave blank)	2. REPORT DATE November 1991	3. REPORT TYPE AND DATES COVERED Technical Memorandum	
4. TITLE AND SUBTITLE Flapping Inertia for Selected Rotor Blades		5. FUNDING NUMBERS WU 505-59-36-01	
6. AUTHOR(S) John D. Berry and Matthew J. May			
7. PERFORMING ORGANIZATION NAME(S) AND ADDRESS(ES) Aerostructures Directorate U.S. Army-AVSCOM Langley Research Center Hampton, VA 23665-5225		8. PERFORMING ORGANIZATION REPORT NUMBER	
9. SPONSORING / MONITORING AGENCY NAME(S) AND ADDRESS(ES) National Aeronautics and Space Administration Washington, DC 20546-0001 and U.S. Army Aviation Systems Command St. Louis, MO 63120-1798		10. SPONSORING / MONITORING AGENCY REPORT NUMBER NASA TM-104125 AVSCOM TR 91-B-019	
11. SUPPLEMENTARY NOTES Berry: Aerostructures Directorate, USA-AVSCOM, Hampton, VA. May: United States Military Academy, West Point, NY			
12a. DISTRIBUTION / AVAILABILITY STATEMENT Unclassified-Unlimited Subject Category 05		12b. DISTRIBUTION CODE	
13. ABSTRACT (Maximum 200 words) <p>Aerodynamics of helicopter rotor systems cannot be investigated without consideration for the dynamics of the rotor. One of the principal properties of the rotor which affects the rotor dynamics is the inertia of the rotor blade about its root attachment. Previous aerodynamic investigations have been performed on rotor blades with a variety of planforms to determine the performance differences due to blade planform. The blades tested for this investigation have been tested on the U.S. Army 2-meter rotor test system (2MRTS) in the NASA Langley 14- by 22-Foot Subsonic Tunnel for hover performance. This investigation was intended to provide fundamental information on the flapping inertia of five rotor blades with differing planforms. The inertia of the bare cuff and the cuff with a blade extension were also measured for comparison with the inertia of the blades. Inertia was determined using a swing-testing technique, using the period of oscillation to determine the effective flapping inertia. The effect of damping in the swing-test was measured and accounted for. A comparison of the flapping inertias for rectangular and tapered planform blades of approximately the same mass showed the tapered blades to have a lower inertia, as expected.</p>			
14. SUBJECT TERMS Rotor model; Flapping inertia; Rotor blade		15. NUMBER OF PAGES 58	
		16. PRICE CODE A04	
17. SECURITY CLASSIFICATION OF REPORT Unclassified	18. SECURITY CLASSIFICATION OF THIS PAGE Unclassified	19. SECURITY CLASSIFICATION OF ABSTRACT	20. LIMITATION OF ABSTRACT