

**NASA**  
Johnson Space Center  
Information Systems Directorate  
Information Technology Division

# INTELLIGENT COMPUTER-AIDED TRAINING (ICAT)

AUGUST 8, 1991

**ROBERT T. SARELY**  
NASA/JSC  
713-483-8105  
FTS 525-8105  
NASAMAIL: RSAVELY

**DR. R. BOWEN LOFTIN**  
UNIVERSITY OF HOUSTON  
AND NASA/JSC  
713-483-8070/FTS 525-8070  
NASAMAIL: BLOFTIN

2-23  
P-50



PRECEDING PAGE BLANK NOT FILMED

1105

4404

Software Technology Branch

RBL 8/8/91



Johnson Space Center  
Information Systems Directorate  
Information Technology Division

## INTELLIGENT COMPUTER-AIDED TRAINING

Since 1985 the Software Technology Branch at NASA/Johnson Space Center has been applying artificial intelligence technology to the development of autonomous, workstation-based training systems for use by astronauts, flight controllers, and other ground-support personnel. This activity has been under the management of Robert T. Savely (Chief, Software Technology Branch) and under the technical direction of Dr. R. Bowen Loftin (Professor, University of Houston-Downtown). A talented team of civil servants, contractors, and students has been assembled to support both the short and long range projects described herein.

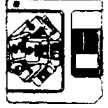

1106



**BACKGROUND:**

- TRAINING IS A MAJOR EFFORT AT ALL NASA CENTERS; DIRECT TRAINING COSTS ARE IN THE \$100M RANGE WHILE INDIRECT COSTS ARE FAR GREATER
- TRAINING TIME HAS A DIRECT IMPACT ON SCHEDULES
- LACK OF ADEQUATE TRAINING IN ALL PHASES OF SSF MISSION OPERATIONS CAN BE DETRIMENTAL TO SAFETY AND THE ACHIEVEMENT OF MISSION OBJECTIVES





Johnson Space Center  
Information Systems Directorate  
Information Technology Division

## INTELLIGENT COMPUTER-AIDED TRAINING

Historically, NASA has devoted extensive resources to training—especially the training of astronauts. Training costs represent a significant fraction of the budgets of operational centers, such as the Johnson Space Center. For example, the Shuttle Mission Simulator costs approximately \$30,000 per hour to operate. One unfortunate result of the high cost of sophisticated training is its scarcity. Astronauts receive far more training than most, if not all, ground-support personnel. The delivery of the best training via complex simulators severely restricts the time and quality of training received by novices.

Since training is an essential ingredient for a successful mission, the need to schedule adequate training has a direct impact on the scheduling of missions. Moreover, when the same resources (e.g., the Mission Control Center) are used for both training and mission operations, the impact of training on operations is obvious.

Crew performance is inevitably linked to training. Not only is adequate training preceding a mission necessary, but also training on-orbit may be needed, especially for infrequently-performed operations that are mission critical. In general, there is no such thing as too much training for personnel that support missions.





**BACKGROUND (continued):**

- CURRENT TRAINING METHODS THAT RELY ON LARGE-SCALE SIMULATORS MAY NOT BE COST EFFECTIVE VEHICLES FOR DELIVERING TRAINING TO ALL SSF MISSION OPERATIONS PERSONNEL
- SSF MISSION CONTROL CENTER WILL BE IN CONTINUOUS USE FOR OPERATIONS
- CURRENT TRAINING METHODS ARE NOT APPLICABLE TO THE SSF ON-ORBIT ENVIRONMENT

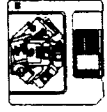



Johnson Space Center  
Information Systems Directorate  
Information Technology Division

## INTELLIGENT COMPUTER-AIDED TRAINING

Large-scale simulators are both expensive to build and expensive to maintain. The great expense of such simulation training environments clearly limits their numbers and, consequently, limits the training that can be delivered by such means. Intelligent Computer-Aided Training technology can, in some cases, replace and, in other cases, augment and make more effective such simulators. As a result more training can be delivered to more personnel in less time and with less expense.

Training for Apollo and Shuttle missions has been supported by use of the Mission Control Center for integrated simulations. With the advent of the Space Station Freedom and the eventual 24-hour utilization of the Space Station Control Center, such exclusive devotion of the facility to training will be eliminated.

Current simulators rely on physical mockups of the systems for which training is required in addition to significant computer resources and large numbers of training personnel. On-orbit training, deemed essential for Space Station Freedom, cannot be delivered in such a manner. The workstation-based nature of the ICAT technology permits the delivery of training systems for on-orbit use that can approach or match the efficacy of ground-based simulators.





**OBJECTIVES:**

THE APPLICATION OF ARTIFICIAL INTELLIGENCE TECHNOLOGY TO THE DEVELOPMENT OF AUTONOMOUS SYSTEMS FOR TRAINING PERSONNEL IN THE PERFORMANCE OF COMPLEX, PROCEDURAL TASKS ASSOCIATED WITH BOTH THE GROUND BASED AND ON-ORBIT OPERATIONS OF SPACE STATION FREEDOM

- DESIGN, DEVELOPMENT AND TESTING OF A GENERAL ARCHITECTURE FOR ICAT SYSTEMS THROUGH THE BUILDING OF SPECIFIC APPLICATIONS
- PRODUCTION OF A SOFTWARE DEVELOPMENT ENVIRONMENT FOR BUILDING ICAT SYSTEMS





Johnson Space Center  
Information Systems Directorate  
Information Technology Division

## INTELLIGENT COMPUTER-AIDED TRAINING

Recognizing that no one approach can successfully solve all training problems, ICAT technology has been specifically shaped to address training in complex, procedural tasks. Such tasks are common to the NASA environment and constitute the bulk of training requirements for mission operations personnel. This narrow focus has permitted the creation of a general architecture for ICAT systems that has been proven to be adaptable to a wide variety of training tasks.

In order for ICAT technology to become an essential element in the NASA training environment, two criteria must be met. First, substantial code reuse must be possible in order to reduce the time necessary to develop new ICAT applications. Secondly, software tools must be available that empower the training community to build new ICAT applications without, in large measure, the intervention of those in the software development community. The first of these criteria has been met through the development and refinement of the general ICAT architecture. The second criteria is being met through the development of an integrated set of workstation-based software tools, built for use by those lacking extensive programming experience.







## INTELLIGENT COMPUTER-AIDED TRAINING

### BENEFITS:

- ICAT SYSTEMS MAGNIFY THE EFFORTS OF TRAINERS TO DELIVER TRAINING, SERVE TO CAPTURE PERISHABLE TRAINING EXPERTISE, AND ENHANCE THE MAINTAINABILITY OF TRAINING SYSTEMS
- ICAT SYSTEMS PROVIDE UNIFORM AND VERIFIABLE TRAINING, ENHANCING SAFETY AND THE PROBABILITY OF MISSION SUCCESS
- ICAT SYSTEMS CAN SIGNIFICANTLY REDUCE THE TIME REQUIRED FOR TRAINEES TO ACHIEVE GIVEN LEVELS OF PROFICIENCY IN A TASK





Johnson Space Center  
Information Systems Directorate  
Information Technology Division

## INTELLIGENT COMPUTER-AIDED TRAINING

The very best trainers are always in short supply and often can personally serve only a fraction of those who are to be trained. An ICAT system can "capture" much of what makes an excellent trainer and deliver this to unlimited numbers of trainees, independent of schedule or location. High turnover rates among training personnel make it difficult to preserve corporate knowledge. Since an ICAT system captures the valuable knowledge and experience of one or more trainers, it can become a repository for much expertise that may be lost due to transfers or retirements. Most NASA training environments are dynamic. Both the systems for which personnel are being trained and the procedures appropriate to those systems may change frequently. ICAT technology provides both the structure ( a general architecture) and the means (software tools) to rapidly evolve training systems to keep pace with the operational environment.

When many personnel are involved in the delivery of training it is inevitable that the training will be uniform to a greater or lesser extent. Moreover, it is difficult to effectively verify that training delivered by more than one trainer is correct and has met all training objectives.

As the data provided below shows, the one-on-one nature of the ICAT system's interaction with trainees and its inherent ability to provide optimal training experiences for trainees with diverse skills and backgrounds lead to extraordinary performance gains.





**BENEFITS (continued):**

- ICAT SYSTEMS CAN BE USED FOR ON-ORBIT "REFRESHER" TRAINING, THEREBY REDUCING TIME REQUIRED FOR COMPLEX IVA AND EVA SSF ACTIVITIES
- ICAT SYSTEMS CAN BE DELIVERED IN BOTH GROUND-BASED AND ON-ORBIT ENVIRONMENT AND CAN AUGMENT SIMULATION-BASED TRAINING FACILITIES
- ICAT SYSTEMS HAVE APPLICABILITY THROUGHOUT NASA OPERATIONAL CENTERS, ALL GOVERNMENT AGENCIES, INDUSTRY, AND EDUCATIONAL INSTITUTIONS





Johnson Space Center  
Information Systems Directorate  
Information Technology Division

## INTELLIGENT COMPUTER-AIDED TRAINING

Astronauts have placed a high priority on the availability of on-orbit training, especially for mission critical tasks that are infrequently performed. Since Space Station Freedom will demand both lengthy periods of on-orbit duty and provide a extraordinary range of complex tasks for the crew to master, the availability of sophisticated workstation-based training systems in the on-orbit environment is essential for safety and mission success. ICAT technology provides a cost-effective way of delivery such on-orbit training.





Johnson Space Center  
Information Systems Directorate  
Information Technology Division

# INTELLIGENT COMPUTER-AIDED TRAINING

## AVERAGE NUMBER OF TOTAL ERRORS FOR TRAINEE GROUP USING PD/ICAT

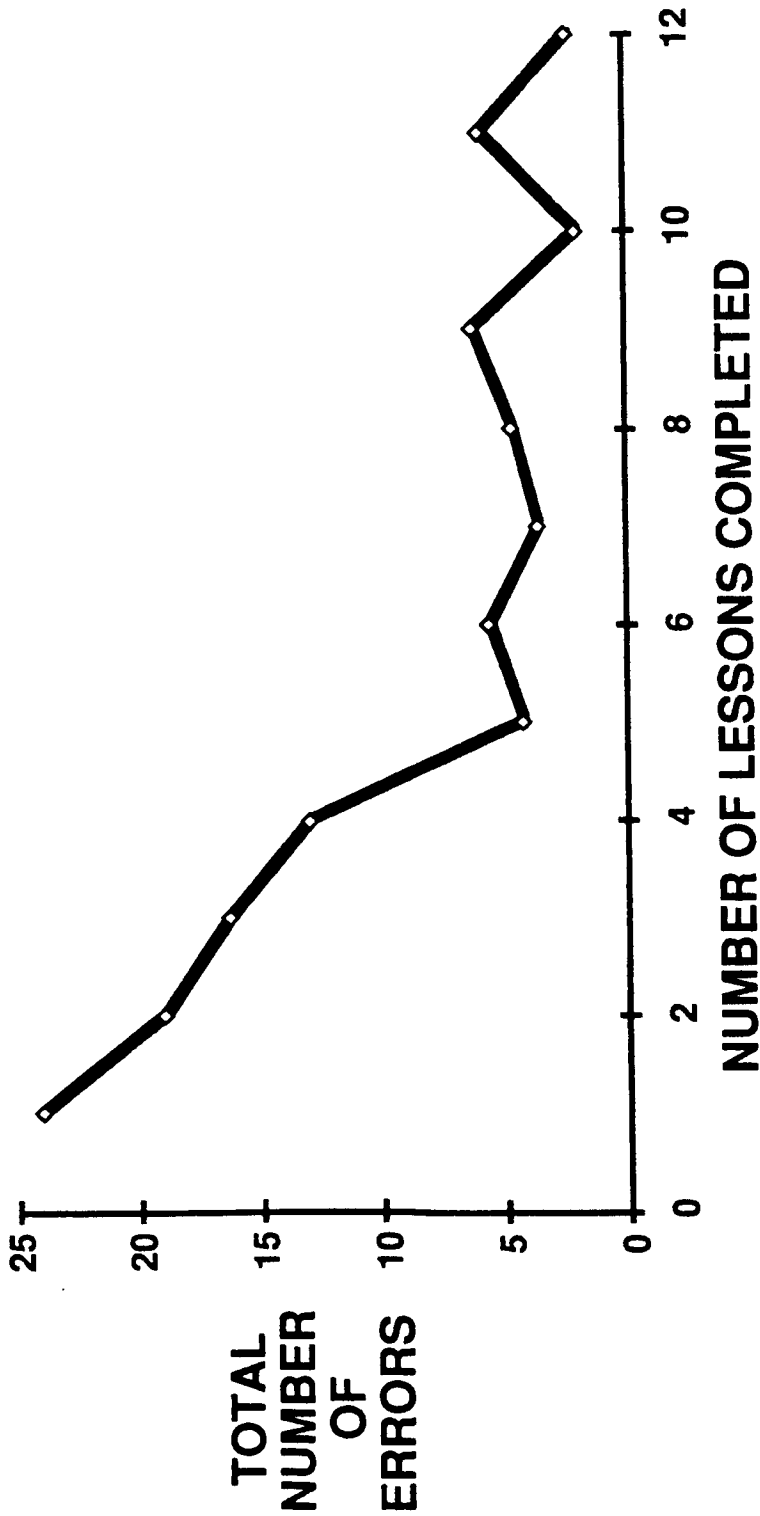



Johnson Space Center  
Information Systems Directorate  
Information Technology Division

## INTELLIGENT COMPUTER-AIDED TRAINING

The data shown in this graph was obtained from three novice Flight Dynamics Officers with very different backgrounds and prior knowledge of the task to be trained. The were each assigned to use the Payload-Assist-Module Deploys (PD)/ICAT system as often as they wished in order to master the nominal deployment task. The data clearly shows that they rapidly approached a low "error" rate. It is important to note that the error rate reported here is a "total" error rate. Those residual errors remaining after about the sixth training session were of a noncritical nature and generally involved failure to verify (manually) that correct parameters had been entered by "support personnel." The total time required for a given trainee to experience twelve sessions was approximately fifteen hours spread over three to five days. In order to experience a comparable number of deployments in the integrated simulation environment might have required as much as two years due to the limited availability of the Mission Control Center for non-Mission-specific training.

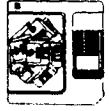



Johnson Space Center  
Information Systems Directorate  
Information Technology Division

# INTELLIGENT COMPUTER-AIDED TRAINING

## AVERAGE TASK COMPLETION TIME FOR TRAINEE GROUP USING PD/ICAT

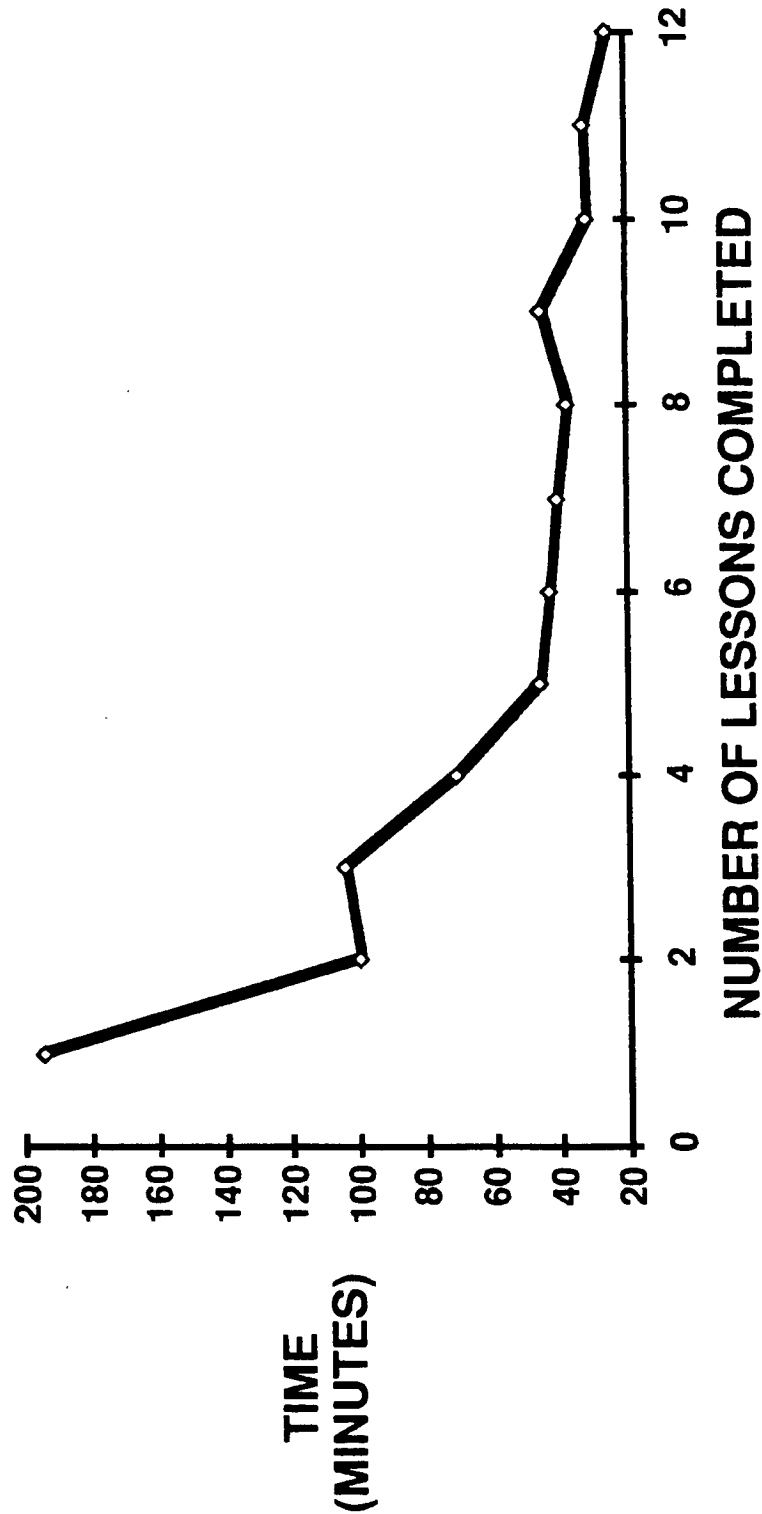



Johnson Space Center  
Information Systems Directorate  
Information Technology Division

## INTELLIGENT COMPUTER-AIDED TRAINING

The data shown in this graph was obtained from three novice Flight Dynamics Officers with very different backgrounds and prior knowledge of the task to be trained. They were each assigned to use the Payload-Assist-Module Deploys (PD)/ICAT system as often as they wished in order to master the nominal deployment task. The data clearly shows that the trainees were able to reach a reasonable performance time in about five sessions. The total time required for a given trainee to experience twelve sessions was approximately fifteen hours spread over three to five days. In order to experience a comparable number of deployments in the integrated simulation environment might have required as much as two years due to the limited availability of the Mission Control Center for non-Mission-specific training.







## ICAT ARCHITECTURE:

THE ICAT ARCHITECTURE PROVIDES THE TRAINEE WITH A SIMULATION OF THE TASK ENVIRONMENT, REAL-TIME COACHING, AND TRAINING EXERCISES THAT EVOLVE IN DIFFICULTY TOWARD THAT OF THE MOST COMPLEX TASK SCENARIO. THE ARCHITECTURE'S MAJOR COMPONENTS INCLUDE:

- EXPERT SYSTEMS THAT INCORPORATE SUCCESSFUL TRAINING METHODS AND THE TRAINING DOMAIN KNOWLEDGE
- HIGH FIDELITY USER INTERFACE





Johnson Space Center  
Information Systems Directorate  
Information Technology Division

## INTELLIGENT COMPUTER-AIDED TRAINING

The user of an ICAT application is presented with an interface that duplicates, to the extent possible, the task environment for which he or she is being prepared. The system examines the prior interactions, if any, of the trainee with the ICAT system (as embodied in a trainee model) and designs an appropriate training scenario for the session. As the scenario unfolds, the trainee's actions are monitored and compared to those of expert in the same context. When discrepancies between the expert's behavior and that of the trainee are detected, the ICAT system uses the trainee model of determine an appropriate response. The ICAT system can also provide context-sensitive help and hints in response to the trainee's request for such aid. At the conclusion of a training session, the trainee is provided with a trace of his or her actions that emphasizes those points where those actions differed from those of the expert. The next training session repeats this process and provides a new training scenario that will move the trainee closer to the ultimate training goals while testing the trainee's success in overcoming previously-identified weaknesses.

As will be more thoroughly explored below, the ICAT architecture includes rule-based expert systems that incorporate knowledge of the system and procedures to be trained, knowledge of how to train, and knowledge of how to structure new and ever more challenging training experiences.

The interface of an ICAT system consists of a "shell" of menus and text windows that provide for communication between the system and the. Other elements are usually unique to the system to be trained and may consist of formatted data displays, keyboards, keypads, control panels, indicators, and other elements.

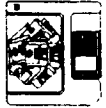

**ICAT ARCHITECTURE (continued):**

- MODELS OF TRAINEES THAT CONTAIN A KNOWLEDGE OF THEIR GENERAL BACKGROUNDS AND THEIR PREVIOUS INTERACTIONS WITH THE ICAT SYSTEM
- A TRAINING SCENARIO GENERATOR CAPABLE OF PRODUCING USEFUL AND REALISTIC TRAINING EXERCISES APPROPRIATE FOR A TRAINEE'S CURRENT LEVEL OF ACCOMPLISHMENT
- PRESENTATION OF PERFORMANCE DATA TO THE TRAINEE AND TRAINING PERSONNEL
- INTEGRATION OF THESE ELEMENTS, WHEN APPROPRIATE, WITH QUALITATIVE OR MATHEMATICAL SIMULATIONS





## INTELLIGENT COMPUTER-AIDED TRAINING

The trainee model is, at its most fundamental level, a compact trace of all that a trainee has done during the present and past interactions with the ICAT system. This basic data is organized in a hierarchical manner to facilitate its use in categorizing the trainee's demonstrated strengths and weaknesses. This model provides necessary input for the design of new training scenarios as well as for the handling of trainee errors during a training session.

The training scenario generator is a hybrid expert system that utilizes a knowledge base (in rules) and an object-oriented database to design and assemble unique training scenarios appropriate to a specific trainee's current needs.

At the conclusion of each training session the trainee is provided with a formatted trace of his or her actions during the sessions. Where those actions were not optimal or even correct, the action and that recommended by the expert are emphasized. In addition the trace notes instances when help was requested or provided. A training supervisor can, moreover, examine a trainee's record or can access summary data for a specific group of trainees.

Finally, many ICAT applications must also contain a quantitative or qualitative simulation that provides the actual scenario presented during the training session. In some cases these simulations may be created especially for the ICAT application while, in other cases, the ICAT application may make use of an existing simulation.





Johnson Space Center  
Information Systems Directorate  
Information Technology Division

# INTELLIGENT COMPUTER-AIDED TRAINING

## ICAT ARCHITECTURE SCHEMATIC

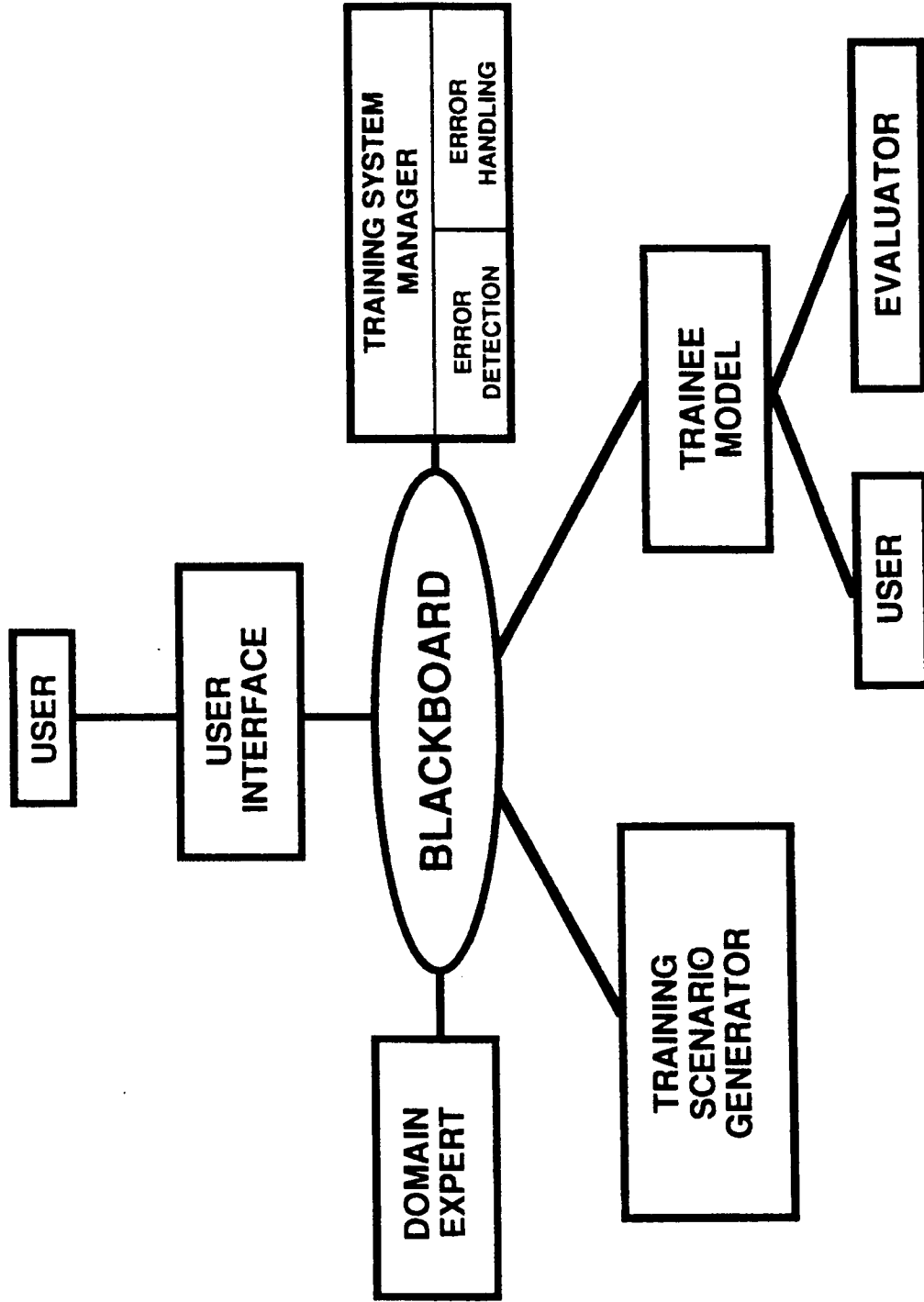



Johnson Space Center  
Information Systems Directorate  
Information Technology Division

## INTELLIGENT COMPUTER-AIDED TRAINING

In order to provide a robust and flexible architecture for the development of ICAT applications, domain-independent elements have been segregated from domain-dependent elements. The domain expert is a conventional rule-based expert system. The Training Session Manager consists of two rule-based expert systems—one for error detection and a second for error handling. The Training Scenario Generator is a hybrid system that uses a rule-base to decide on the general design of a new training scenario and then draws on an object-oriented database to provide the details of that scenario. The Trainee Model is a complex data structure that stores the history of each trainee's interaction with the ICAT application and organizes that data in a hierarchical manner to facilitate its use in identifying the strengths and weaknesses of the trainee. Both the trainee and a training supervisor can examine a trainee's model.

All elements of the ICAT architecture communicate via a blackboard approach. In this instance the blackboard is a common "factbase" that contains facts describing the current training environment as well as actions taken by the trainee and those that would be taken by an expert.





**SPACE STATION APPLICATIONS:**

- JOINTLY WITH SPACE STATION TRAINING OFFICE
- ACTIVE THERMAL CONTROL SYSTEM (ATCS) ICAT
- TRAINS CREW AND FLIGHT CONTROLLERS IN OPERATION OF THE SSF ACTIVE THERMAL CONTROL SYSTEM
- UNDER DEVELOPMENT BY MCDONNELL DOUGLAS USING IR&D FUNDS
- DEVELOPED USING COMPLETE ICAT ARCHITECTURE ON THE MACINTOSH
- SPANS TRAINING IN BOTH NOMINAL AND NONNOMINAL OPERATIONS





**Johnson Space Center**  
Information Systems Directorate  
Information Technology Division

## INTELLIGENT COMPUTER-AIDED TRAINING

A cooperative effort between the Software Technology Branch, the Space Station Training Office, and McDonnell Douglas Space Systems Company is directed at the development of an ICAT application for the Space Station Active Thermal Control System (ATCS). The ATCS/ICAT system is designed to train both crew members and ground-based flight controllers in the operation of the ATCS. The system will provide training in both the nominal operations of the ATCS and in anticipated nonnominal operations.

The ATCS/ICAT system utilizes the complete ICAT architecture as previously described. Its development is proceeding on a Macintosh platform with eventual goal of its delivery on the Macintosh, under Windows on PC platforms, and under X-Windows on unix platforms.







Johnson Space Center  
Information Systems Directorate  
Information Technology Division

## INTELLIGENT COMPUTER-AIDED TRAINING

### SPACE STATION APPLICATIONS (continued):

- VIRTUAL ENVIRONMENTS FOR ICAT SYSTEMS
- EVALUATE VIRTUAL ENVIRONMENT TECHNOLOGY FOR SPACE STATION TRAINING
- INTEGRATE VIRTUAL ENVIRONMENT AND ICAT TECHNOLOGY

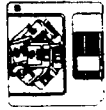



**Johnson Space Center**  
Information Systems Directorate  
Information Technology Division

## INTELLIGENT COMPUTER-AIDED TRAINING

Another activity pursued jointly by the Software Technology Branch and the Space Station Training Office is directed at exploring virtual environment (or reality or worlds) technology for Space Station training. In one instance virtual environment technology will be compared to dome and pancake window approaches to delivery graphically-generated sciences to trainees. In a second effort a virtual environment interface will be developed for an ICAT application directed at a Space Station training task.

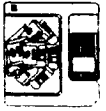



Johnson Space Center  
Information Systems Directorate  
Information Technology Division

## INTELLIGENT COMPUTER-AIDED TRAINING

### ICAT APPLICATION PROJECTS:

- PAYLOAD-ASSIST MODULE DEPLOY ICAT SYSTEM (PD/ICAT)
- VACUUM VENT LINE ICAT SYSTEM (VVL/ICAT)
- MAIN ENGINE PROPULSION SYSTEM ICAT SYSTEM (MPP/ICAT)
- INSTRUMENT POINTING SYSTEM ICAT SYSTEM (IPS/ICAT)





Johnson Space Center  
Information Systems Directorate  
Information Technology Division

## INTELLIGENT COMPUTER-AIDED TRAINING

PD/ICAT is a comprehensive intelligent computer-aided training system used by Flight Dynamics Officers in learning to deploy PAM (Payload-Assist Module) satellites from the Space Shuttle. This system was the first developed in the effort described in this paper and has served as a testbed for the development of a general architecture for ICAT systems. PD/ICAT is intended to train NASA flight controllers in performing the computations and other operations necessary to determine the time and proper Space Shuttle orientation for a satellite deployment. 13-16

VVL/ICAT is a limited, PC-based intelligent computer-aided training system for use by mission and payload specialists in learning to perform fault detection, isolation, and reconfiguration (FDIR) on the Spacelab VVL system. This system does not contain the full complement of student modelling, scenario generation, and trainee session management that is a part of the other systems described in this section.

MPP/ICAT is comprehensive intelligent computer-aided training system for use by test engineers at NASA/Kennedy Space Center in learning to perform testing of the Space Shuttle Main Propulsion Pneumatics system. This system utilizes the complete general ICAT architecture as found in PD/ICAT. The Firing Room console environment is duplicated in the MPP/ICAT interface, and training is provided in carrying out the Operations and Maintenance Instruction pertinent to the 750psi Helium pneumatics system that controls the Space Shuttle Main Propulsion System. In addition to training engineers in nominal test procedures, MPP/ICAT is ultimately intended to address the development and implementation of test procedures employed when faults are detected.

IPS/ICAT is intended for use by payload and mission specialists at NASA/Johnson Space Center and Marshall Space Flight Center in learning to utilize the IPS on Spacelab missions. The IPS is a platform used for mounting and pointing astronomical telescopes during the Astro series of Spacelab missions. The system provides a graphical representation of the Space Shuttle aft flight deck, from which one can access interactive, digitized images of relevant control panels as well as the displays used in operating the IPS. IPS/ICAT is designed to trainee astronauts in the activation, deactivation, and initial pointing of the IPS as well as in the final pointing of one of the instruments mounted on the IPS (the Hopkins Ultraviolet Telescope). The system uses the general ICAT architecture as found in PD/ICAT and MPP/ICAT.





Johnson Space Center  
Information Systems Directorate  
Information Technology Division

## INTELLIGENT COMPUTER-AIDED TRAINING

### ICAT APPLICATION PROJECTS (continued):

- CENTER INFORMATION SYSTEM COMPUTER OPERATIONS ICAT SYSTEM (CISCO/ICAT)
- SHUTTLE REMOTE MANIPULATOR ARM ICAT SYSTEM
- PROPULSION CONSOLE TRAINER
- SATELLITE OPERATIONS CONTROL LANGUAGE ICAT SYSTEM (GSFC)





Johnson Space Center  
Information Systems Directorate  
Information Technology Division

## INTELLIGENT COMPUTER-AIDED TRAINING

CISCO/ICAT addresses the training of mainframe computer operators within the context of the Johnson Space Center's Center Information System. Operators are provided, in a PC and Windows environment, with a console operator display as well as a "map" of the hardware locations. Utilizing these displays, trainees are instructed in standard operations, including power-up, power-down, and initial process load. Both console operations as well as physical interaction with devices are a part of the training regimen. CISCO/ICAT also uses the same ICAT architecture that is found in PD/ICAT, MPP/ICAT, and IPS/ICAT.

Through an SBIR (Phases I and II) project with Global Information Systems an ICAT system has been "married" to an existing kinematic simulation of the Shuttle Remote Manipulator System (RMS). The ICAT component of this system significantly enhances the utility of the simulation by providing appropriate goals, help/hints, and performance evaluation.

The U.S. Air strong laboratory has funded the development, by Southwest Research Institute, of an ICAT system for training flight controls in the operation of the propulsion console (Mission Control Center). The system specifically targets the development of automaticity on the part of the trainees.

Goddard Space Flight Center has utilized a portion of the general ICAT architecture in developing an ICAT system for training personnel in satellite control operations.





Johnson Space Center  
Information Systems Directorate  
Information Technology Division

## INTELLIGENT COMPUTER-AIDED TRAINING

### ICAT ANCILLARY PROJECTS:

- CLIPS INTELLIGENT TUTORING SYSTEM (CLIPSITS)
- INTELLIGENT PHYSICS TUTOR
- INTELLIGENT LITERACY TUTOR





Johnson Space Center  
Information Systems Directorate  
Information Technology Division

## INTELLIGENT COMPUTER-AIDED TRAINING

A PC-based intelligent tutoring system for the CLIPS language was developed and distributed with version 4.2 of CLIPS. This system, due to its delivery platform, has very limited student modeling capabilities but is capable of assisting students in acquiring a working knowledge of CLIPS syntax and proper programming style.

The ICAT project has also stimulated the development of an intelligent tutoring system (ITS) for use in a high school or introductory college physics course. The goal of this ITS is not the conveyance of facts and concepts but rather the transfer of problem solving skills to the student. Ultimately, this project will not only produce a useful teaching aid for students enrolled in high school or introductory college physics courses, but will also provide a development structure suitable for building additional intelligent tutors for other academic subjects which require the application of problem solving skills (e.g., mathematics, chemistry, and engineering). The tutor is in its final stages of development and will be licensed for commercial distribution in the near future.

The latest "spinoff" of ICAT technology is an intelligent tutoring system designed to aid adults in mastering literacy skills. The tutor uses the core of the intelligent physics tutor as well as extensive video, speech recognition, and speech generation facilities.

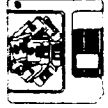





Johnson Space Center  
Information Systems Directorate  
Information Technology Division

## INTELLIGENT COMPUTER-AIDED TRAINING

### ICAT DEVELOPMENT ENVIRONMENT:

A SUITE OF SOFTWARE TOOLS TO AID TRAINING PERSONNEL IN APPLYING THE ICAT ARCHITECTURE TO SPECIFIC TRAINING TASKS.

- EVALUATION OF EXISTING TOOLS AND REQUIREMENTS DEVELOPMENT
- KNOWLEDGE ACQUISITION, KNOWLEDGE BASE EDITING, AND DATABASE DEVELOPMENT
- USER INTERFACE DEVELOPMENT
- TRAINEE MODELING





Johnson Space Center  
Information Systems Directorate  
Information Technology Division

## INTELLIGENT COMPUTER-AIDED TRAINING

In order to facilitate the rapid production and efficient maintenance of ICAT applications, a suite of software tools is under development. These software tools will aid both experienced programmers and those not proficient in computer programming in adapting the general ICAT architecture for specific applications and in modifying existing applications to address the evolution of the systems and procedures for which they were developed.

The approach followed has been (1) the identification of those areas for which tools should be available, (2) the evaluation of existing tools that address those areas, (3) the development of requirements for the tools needed, and (4) the development and/or adaptation of the needed tools.

The most serious "bottleneck" to the development of knowledge-based systems is the acquisition and maintenance of expert knowledge. The highest priority element of this project is the provision of a tool or tools for knowledge acquisition and the "editing" of existing knowledge bases. The building of databases to support training scenario generation has also been addressed in this manner.

The next most significant barrier to the efficient production of ICAT applications lies in the development of the user interface component.

Finally, the use of the ICAT architecture for widely diverse training tasks requires the ability to make some alterations in the trainee model element of the architecture.

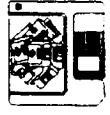



Johnson Space Center  
Information Systems Directorate  
Information Technology Division

## INTELLIGENT COMPUTER-AIDED TRAINING

### ICAT DEVELOPMENT ENVIRONMENT (continued):

- THE PRODUCTION, ADAPTATION, AND TESTING OF SPECIFIC TOOLS
- TOOL INTEGRATION INTO A COMPREHENSIVE DEVELOPMENT ENVIRONMENT ENVIRONMENT
- FULL-SCALE TESTING BY OPERATIONAL CENTERS
- INTEGRATION INTO SSF BASELINE





Johnson Space Center  
Information Systems Directorate  
Information Technology Division

## INTELLIGENT COMPUTER-AIDED TRAINING

Upon completion of an extensive evaluation and requirements development effort in the areas of knowledge acquisition and interface building, work began on the actual production of tools for these two areas.

Beta testing of these elements is now underway and their integration into a general purpose development environment (GPDE) will proceed following the testing phase. Finally, the integrated GPDE will be utilized at NASA operational centers for ICAT application development.

Through interaction with the Space Station Training Office and McDonnell Douglas Space Systems Company, progress is being made to demonstrate the applicability of ICAT technology for Space Station training and to encourage its incorporation, for both ground-based and on-orbit training, into the Space Station Freedom baseline.





**ICAT DEVELOPMENT ENVIRONMENT (continued):**

- KNOWLEDGE ACQUISITION TOOLS:
- TWENTY-TWO KNOWLEDGE ACQUISITION TOOLS WERE EVALUATED
- US NAVY VISTA PRODUCT SELECTED AS FUNCTIONAL PROTOTYPE
- DEVELOPMENT OF TASK ANALYSIS AND RULE GENERATION TOOL (TARGET) BEGAN 1/91
- CURRENT DEVELOPMENT IS BASED ON PC PLATFORM AND WINDOWS 3.0





Johnson Space Center  
Information Systems Directorate  
Information Technology Division

## INTELLIGENT COMPUTER-AIDED TRAINING

Following the evaluation of twenty-two existing tools for knowledge acquisition, a tool developed by the U.S. Navy Training Systems Center was selected for extensive use in the ICAT activity. The Visual Interactive System for Task Analysis (VISTA) was used as a vehicle to investigate knowledge acquisition modes specifically adapted to procedural knowledge. After extensive use of the VISTA tool a product, sharing some of its "look and feel" was designed. The Task Analysis and Rule Generation Tool (TARGET) permits an expert to visually describe complex procedural tasks and, from that description, automatically produces a task analysis and, upon completion, CLIPS rules representing the knowledge of how to perform the task. The version of TARGET now under development is based on the PC (386) and Microsoft Windows 3.0.





**ICAT DEVELOPMENT ENVIRONMENT (continued):**

- TARGET SUPPORTS KNOWLEDGE ACQUISITION, KNOWLEDGE REFINEMENT, KNOWLEDGE VALIDATION AND VERIFICATION, AND TRANSLATION OF KNOWLEDGE FROM A GRAPHIC TO A CLIPS REPRESENTATION
- TARGET V0.3 WAS RELEASED 6/91
- AUTOMATED GENERATION OF CLIPS PROCEDURAL CODE DEMONSTRATED 7/91; AUTOMATED RULE GENERATION PLANNED FOR 10/91
- FUTURE PLATFORMS INCLUDE MACINTOSH AND UNIX
- EXTENSION TO PASSIVE KNOWLEDGE ACQUISITION UNDERWAY





Johnson Space Center  
Information Systems Directorate  
Information Technology Division

## INTELLIGENT COMPUTER-AIDED TRAINING

TARGET provides an integrated environment in which complex procedural tasks can be represented in a three-dimensional graphical form. From this representation a standard task analysis chart can be generated. Ultimately, TARGET will also generate CLIPS rules or CLIPS procedural code from this representation. Editing any one of the three representations will automatically result in appropriate alterations of the other two representations. TARGET will ultimately be implemented in the Macintosh and unix environments also.

The use of TARGET will greatly facilitate the acquisition of knowledge from experts, the generation of expert consensus, the automatic creation of the domain-dependent knowledge bases required for ICAT applications, and the maintenance of ICAT knowledge bases.

In addition to its specific application to ICAT system development TARGET promises to be a versatile and robust tool for the creation of expert systems in general.







**ICAT DEVELOPMENT ENVIRONMENT (continued):**

- USER INTERFACE BUILDING TOOL:
- USER INTERFACE BUILDING TOOL ELEMENTS
  - ICAT INTERACTION SHELL
  - FORMATTED DATA DISPLAYS
  - TEXT WINDOWS
  - INTERACTIVE DIGITIZED IMAGES
  - KEYBOARDS/KEYPADS AND INDICATORS





Johnson Space Center  
Information Systems Directorate  
Information Technology Division

## INTELLIGENT COMPUTER-AIDED TRAINING

Since the creation of an appropriate user interface for an ICAT system can require a significant fraction of the total system development time, an interface building tool for ICAT applications is also under development. The interface builder addresses the creation and/or customization of the general ICAT interface shell (menus and text windows), formatted data displays, special text windows, interactive digitized images of hardware elements, and graphical representations of many commonly found input/output devices (for example, keyboards, keypads, gauges, switches, and a number of types of indicators).

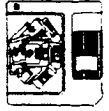



**ICAT DEVELOPMENT ENVIRONMENT (continued):**

- X-WINDOWS CURRENTLY SERVES AS THE BASIS FOR THE ICAT USER INTERFACE
- FORMATTED DATA DISPLAYS, TEXT WINDOWS, AND INTERACTIVE DIGITIZED IMAGES ELEMENTS HAVE BEEN DEMONSTRATED
- INTEGRATION OF DIGITAL VIDEO INTERACTIVE TECHNOLOGY
- TOOL FOR TRAINEE MODEL ADAPTATION PLANNED
- DATABASE DEVELOPMENT TOOL PLANNED





Johnson Space Center  
Information Systems Directorate  
Information Technology Division

## INTELLIGENT COMPUTER-AIDED TRAINING

The ICAT interface builder is currently under development in an X-Windows environment; it will ultimately be available for the Macintosh and Microsoft Windows as well.

Through an SBIR (Phase I) project with Betac Corporation the integration of Intel's Digital Video Interactive technology is also underway.

Two additional elements of a software tool suite for ICAT application development are also planned. The way in which basic trainee action can be organized and used to identify both skill/knowledge mastery and misconceptions/lack-of-knowledge can vary among task environments. A tool to facilitate the adaptation of the trainee model structure for specific task environments will greatly aid trainers in "molding" the trainee model to give a more detailed representation of trainee performance, thus enhancing the overall ability of an ICAT system to provide an optimal learning experience for the trainee. The object-oriented database used by the Training Scenario Generator to assemble a specific training scenario would also benefit from a tool designed to facilitate the entry of appropriate domain-specific data.

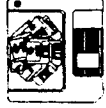



Johnson Space Center  
Information Systems Directorate  
Information Technology Division

# INTELLIGENT COMPUTER-AIDED TRAINING

## Project Schedule:

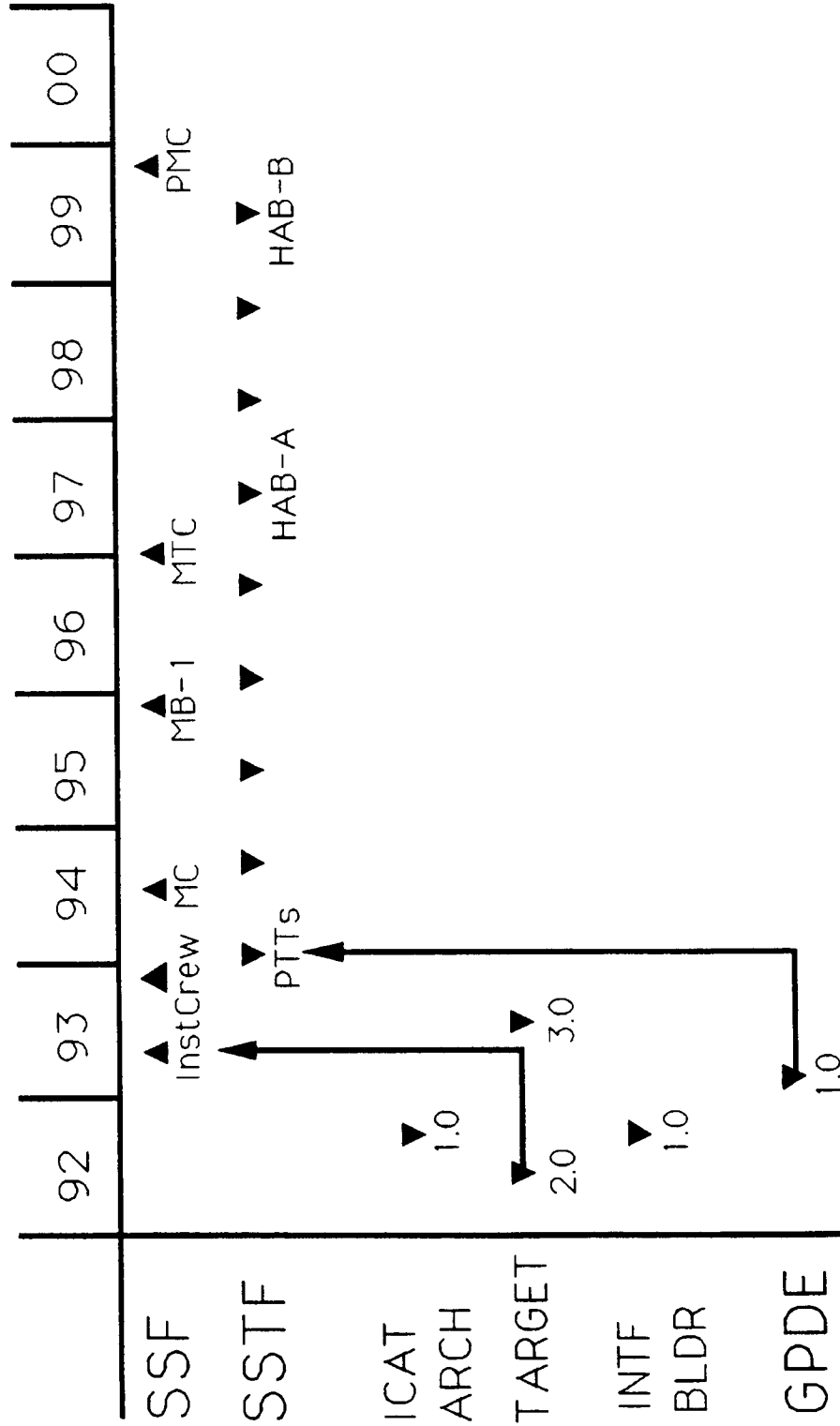



Johnson Space Center  
Information Systems Directorate  
Information Technology Division

## INTELLIGENT COMPUTER-AIDED TRAINING

The development of the general ICAT architecture and the General Purpose Development Environment for ICAT systems has been planned to coincide with milestones in the Space Station Freedom program. As the schedule shows, the general ICAT architecture and elements of the ICAT GPDE will be available for assessment and application development in advance of the assembly and training of instructor teams. The availability of TARGET can provide significant support to the Space Station Training Office in its analysis and development of procedures. The GPDE will be available for use in development part-task trainers and systems trainers.





**SUMMARY:**

- EFFECTIVE AUTONOMOUS ICAT SYSTEMS HAVE BEEN BUILT AND DELIVERED IN A WORKSTATION ENVIRONMENT
- A GENERAL ICAT ARCHITECTURE FOR PROCEDURAL TASKS HAS BEEN DEVELOPED AND USED TO CREATE SPECIFIC APPLICATIONS
- A SUITE OF SOFTWARE TOOLS THAT FACILITATE THE BUILDING OF SPECIFIC ICAT SYSTEMS FROM THE GENERAL ICAT ARCHITECTURE IS UNDER DEVELOPMENT



Johnson Space Center  
Information Systems Directorate  
Information Technology Division

## INTELLIGENT COMPUTER-AIDED TRAINING

The Software Technology Branch has developed and demonstrated a number of Intelligent Computer-Aided Training Systems for a variety of complex procedural tasks in the NASA operational environment. A general ICAT architecture has been developed and shown to be adaptable across this spectrum of tasks. Currently underway is the assembly of a suite of software tools that will permit the training community to rapidly develop and deploy ICAT systems for a variety of Space Station training tasks.







**SUMMARY (continued):**

- THE COST OF DEVELOPING, DELIVERING, AND MAINTAINING TRAINING SYSTEMS CAN BE SIGNIFICANTLY REDUCED
- AUTONOMOUS TRAINING SYSTEMS CAN BE DELIVERED FOR BOTH GROUND-BASED AND ON-ORBIT USE; SUCH SYSTEMS COULD SIGNIFICANTLY REDUCE EVA TIME AND CAN REFRESH PERSONNEL PRIOR TO PERFORMING INFREQUENT OPERATIONS
- TRAINING EFFICIENCY, UNIFORMITY, AND VERIFIABILITY CAN BE ENHANCED—INCREASING SAFETY AND THE PROBABILITY OF MISSION SUCCESS



Johnson Space Center  
Information Systems Directorate  
Information Technology Division

## INTELLIGENT COMPUTER-AIDED TRAINING

The use of ICAT technology for selected training applications within the Space Station Freedom program can significantly reduce the costs of training system development. Once developed ICAT systems can be more readily and efficiently evolved and maintained than many conventional training systems.

ICAT systems can be delivered for both ground-based and on-orbit training. The availability of sophisticated on-orbit training will serve to reduce EVA time and can be especially useful in preparing crew for the performance on infrequent, mission-critical tasks.

ICAT systems can deliver uniform but individualized training to large numbers of personnel in a workstation environment. Such training does not impact the use of operational systems and is subject to detailed verification. These features demonstrate that ICAT systems can enhance safety and increase the probability that mission goals are met in an optimal manner.

