

**N92-19746**

**CONICAL CUT RADAR CROSS SECTION CALCULATIONS  
FOR A THIN, PERFECTLY CONDUCTING PLATE**

furnished to

Dr. Alex Woo  
Mail Stop 227-6  
NASA Ames Research Center  
Moffet Field, CA 94035

submitted by

Raymond J. Luebbers and John H. Beggs  
Electrical and Computer Engineering Department  
The Pennsylvania State University  
University Park, PA 16802

(814) 865-2362

March 1991

## Abstract

Radar Cross Section (RCS) calculations for flat, perfectly conducting plates are readily available through the use of conventional frequency domain techniques such as the Method of Moments. However, if time domain scattering or wideband frequency domain results are desired, then the Finite Difference Time Domain (FDTD) technique is a suitable choice. In this paper, we present the application of the Finite Difference Time Domain (FDTD) technique to the problem of electromagnetic scattering and RCS calculations from a thin, perfectly conducting plate for a conical cut in the scattering angle  $\phi$ . RCS calculations versus angle  $\phi$  will be presented and discussed.

## I. Introduction

The Finite Difference Time Domain (FDTD) technique has become increasingly popular in recent years for modeling electromagnetic scattering problems. It is based upon the time domain form of Maxwell's equations, in which temporal and spatial derivatives are approximated by finite differences, and the electric and magnetic fields are interleaved spatially and temporally. Transient scattering behavior is easily examined and through the use of non-sinusoidal plane wave excitation, wideband frequency results can be obtained. The technique was first proposed by Yee [1] in 1966 and is inherently volumetric, which makes it ideal for modeling volumetric scatterers. Thin scatterers can easily be accommodated, and recently the technique has been expanded to include dispersive materials [2], plasmas [3], and chiral materials [4]. Through the use of a near to far zone transformation [5], far zone scattered fields (and thus RCS data) are readily available. This paper presents RCS calculations at several frequencies of a conical cut in scattering angle  $\phi$  for a  $3.5\lambda$  by  $2\lambda$  perfectly conducting plate. Results obtained with FDTD computations are compared with results obtained with the ESP4 electromagnetic code.

## II. Problem Description

This particular scattering problem first came to the authors' attention when Dr. Woo indicated he was obtaining significant discrepancies between measurements and numerical analyses using several Method of Moments electromagnetic codes. He then suggested that a scattering analysis by the Penn State FDTD code may provide some insight as to where problems may exist.

The scattering problem was a  $3.5\lambda$  by  $2\lambda$  (at 3 GHz) perfectly conducting plate that was oriented within the FDTD solution space as shown in Figure 1. The free space wavelength (at 3 GHz) is  $\lambda_0 = 10.0$  cm. The spatial increment (cell size) was chosen to be 1 cm, which provides a spatial resolution of 10 cells/ $\lambda_0$  in free space.

The problem space size was chosen to be 66 by 41 by 49 cells in the x, y and z directions respectively. The plate was centered within the problem space in the x and y directions. The plate was positioned low in the problem space in the z direction to allow any specular reflections multiple encounters with the outer radiation boundary condition (ORBC).

The plate was constructed with 35 by 20 by 0 cells in the x, y and z directions for the PEC plate. Thus the physical plate size was 35 cm by 20 cm. A 15 cell and 10 cell border on each side of the scatterer in the x and y directions provided adequate margin for the near to far zone transformation integration surface and for the ORBC.

A  $\phi$ -polarized, Gaussian pulse incident plane wave with a maximum amplitude of 1000 V/m and a total temporal width of 128 time steps was chosen. The time step was 0.0192 ns and the total number of time steps was 1024.

### III. Computations and Discussion

At the recommendation of Dr. Woo, calculations were made for  $\theta = 80.0$  degrees; and the angle  $\phi$  was varied from 0.0 to 10.0 degrees in steps of 0.5 degrees. The incidence angles  $\theta$  and  $\phi$  were taken from the +z and +x axes respectively and the incident field was  $\phi$ -polarized for all computations. The far field computations were for backscatter only. For each incidence angle, the  $\phi$ -polarized (co-pol) and  $\theta$ -polarized (cross-pol) scattered and incident fields were then transformed to the frequency domain via an FFT and RCS was determined. From each RCS data file, the  $\theta$ -polarized and  $\phi$ -polarized RCS at 3 GHz for each angle  $\phi$  were chosen and then entered into separate data files of RCS versus angle  $\phi$ . Each incidence angle computation required 1.5 hours on a 486/25 personal computer.

Figure 2 shows a sample time domain co-pol backscatter for  $\theta = 80.0$  degrees and  $\phi = 5.0$  degrees. Figure 3 shows a sample time domain cross-pol backscatter for  $\theta = 80.0$  degrees and  $\phi = 5.0$  degrees.

Figure 4 shows the co-pol radar cross section versus scattering angle  $\phi$ . Note the extreme disagreement between the FDTD result and the ESP4 result.

Figure 5 shows the cross-pol radar cross section versus scattering angle  $\phi$ . Note the change in scale of the cross section and the relatively good agreement between the FDTD result and the ESP4 result. Since the co-pol RCS results for FDTD and ESP4 were very much different and the cross-pol RCS results were similar, this indicates a possible problem with either the FDTD code or the ESP4 code.

#### IV. Investigation

The original calculations for ESP4 were made at 3 GHz with a plate size of 35 cm by 20 cm. These results were compared with FDTD RCS frequency domain data at 3 GHz. In order to gain some insight as to possible problems with the FDTD or ESP4 electromagnetic codes, three additional RCS computations were made with ESP4 at frequencies of 2.25 GHz, 2.47 GHz and 2.70 GHz with  $\theta = 80.0$  degrees and a  $\phi$ -polarized incident field. These frequencies were chosen as approximate frequencies for two peaks (2.25 and 2.70 GHz) and one null (2.47 GHz) in the co-pol frequency domain RCS from Figure 6. The data points from the resulting FDTD RCS files were chosen for each frequency and entered into a separate data file for comparison with ESP4 results.

Figure 6 shows the co-pol radar cross section versus frequency and incidence angle  $\phi$ . Figure 7 shows the cross-pol radar cross section versus frequency and incidence angle  $\phi$ .

Figures 8 and 9 show the co-pol and cross-pol radar cross section versus scattering angle  $\phi$  for both FDTD and ESP4 at 2.25 GHz. Note also the extreme disagreement between the co-polarized RCS results and the good agreement between the cross-polarized RCS results.

Figures 10 and 11 show the co-pol and cross-pol radar cross section versus scattering angle  $\phi$  for both FDTD and ESP4 at 2.47 GHz. Again, note the disagreement between the FDTD and ESP4 co-polarized RCS and the good agreement between the cross-polarized RCS results.

Figures 12 and 13 show the co-pol and cross-pol radar cross section versus scattering angle  $\phi$  for both FDTD and ESP4 at 2.7 GHz. Note the co-polarized RCS results are in slightly better agreement and the cross-polarized results again are in good agreement.

#### V. Conclusions

In this paper, the FDTD technique has been applied to model electromagnetic scattering in a conical cut from a perfectly conducting plate. Radar Cross Section versus scattering angle  $\phi$  was presented and discussed. The  $\phi$ -polarized FDTD and ESP4 RCS results were very dissimilar, while the  $\theta$ -polarized RCS results were in good agreement. Thus a problem may exist with one or both of the FDTD or ESP4 electromagnetic codes.

## References

- [1] K. S. Yee, "Numerical solution of initial boundary value problems involving Maxwell's equations in isotropic media," IEEE Trans. Antennas Propagat., vol. AP-14, pp. 302-307, May 1966.
- [2] R. J. Luebbers et al, "A frequency dependent Finite Difference Time Domain formulation for dispersive materials," IEEE Trans. Electromagn. Compat., vol. EMC-32, pp. 222-227, August 1990.
- [3] R. J. Luebbers et al, "A frequency dependent Finite Difference Time Domain formulation for transient propagation in plasmas," IEEE Trans. Antennas Propagat., accepted for publication.
- [4] F. P. Hunsberger, R. J. Luebbers and K. S. Kunz, "Application of the Finite-Difference Time-Domain method to electromagnetic scattering from 3-D chiral objects," Proc. IEEE AP-S Int. Symp., Dallas, TX, vol. 1, pp. 38-41, May 1990.
- [5] R. J. Luebbers et al, "A Finite Difference Time Domain near to far zone transformation," IEEE Trans. Antennas Propagat., accepted for publication.

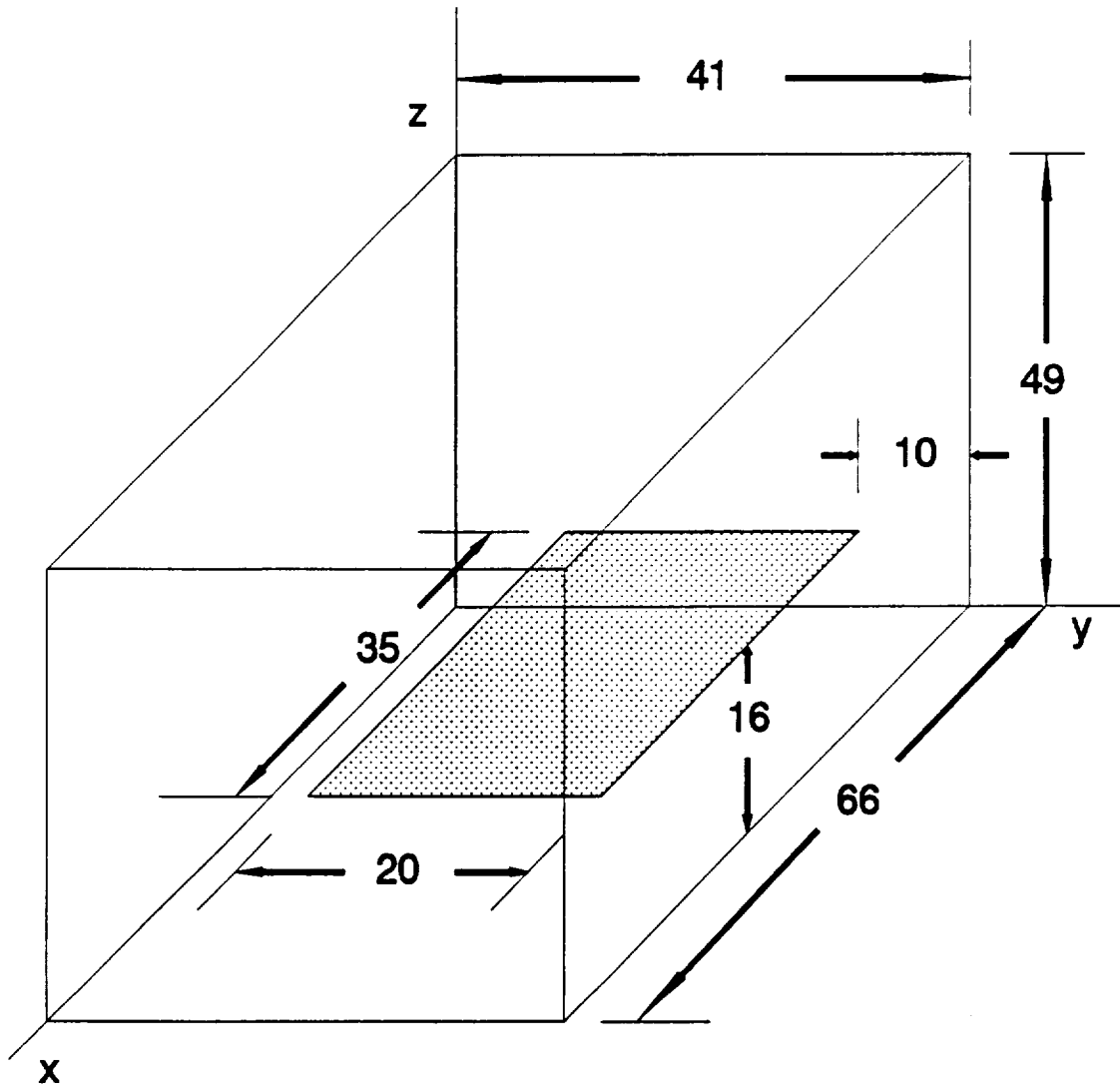

Figure 1. Problem geometry showing FDTD solution space size, and the size and spatial placement of the perfectly conducting plate. Dimensions are in cells, with each cell being a 1 cm cube.

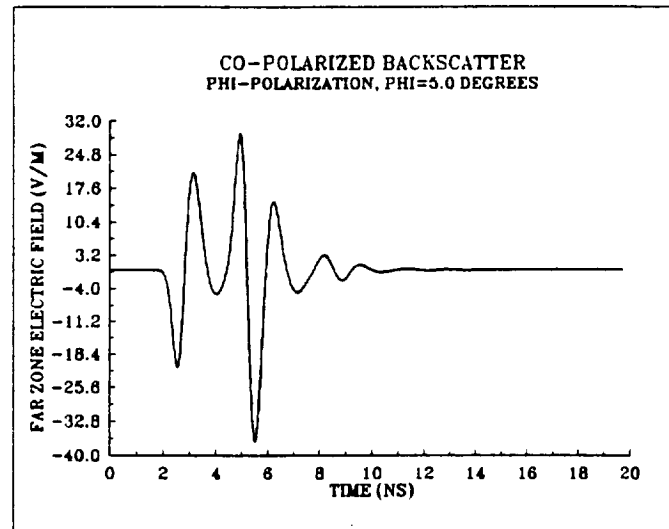

Figure 2. Sample time domain far zone, backscattered, co-polarized electric field from a 35 cm by 20 cm perfectly conducting plate. The scattering angles are  $\theta = 80.0$ ,  $\phi = 5.0$  degrees.

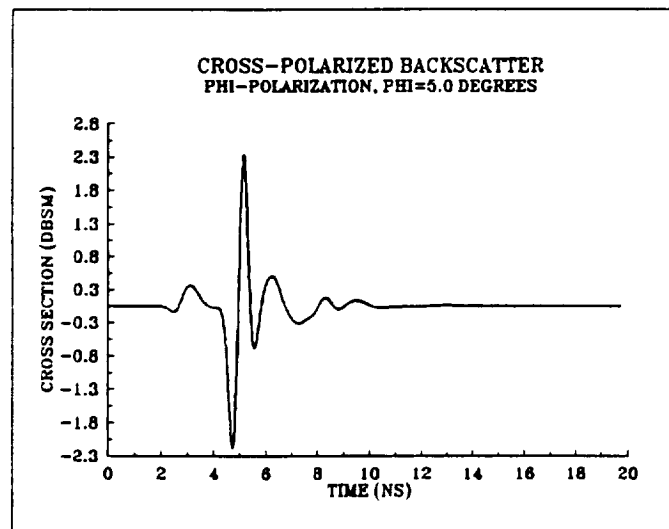

Figure 3. Sample time domain far zone, backscattered, cross-polarized electric field for a 35 cm by 20 cm perfectly conducting plate. The scattering angle is  $\theta = 80.0$ ,  $\phi = 5.0$  degrees.

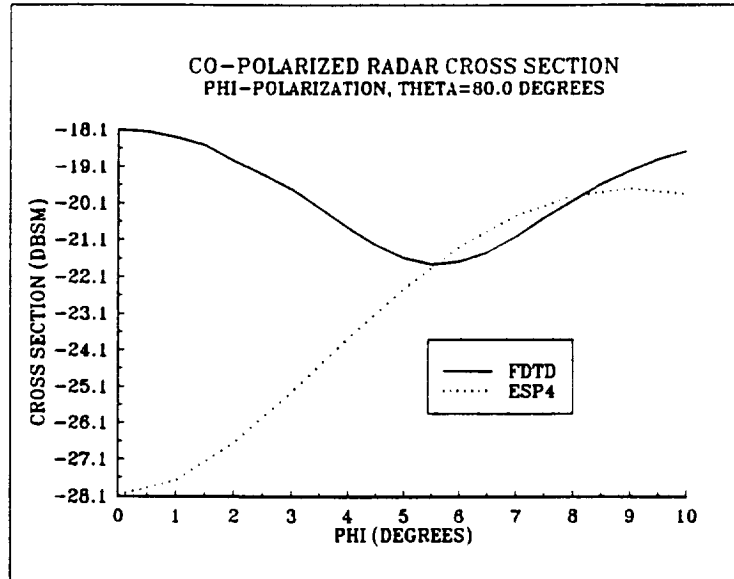

Figure 4. Co-polarized radar cross section versus angle  $\phi$  for a 35 cm by 20 cm perfectly conducting plate at 3.00 GHz using FDTD and ESP4.

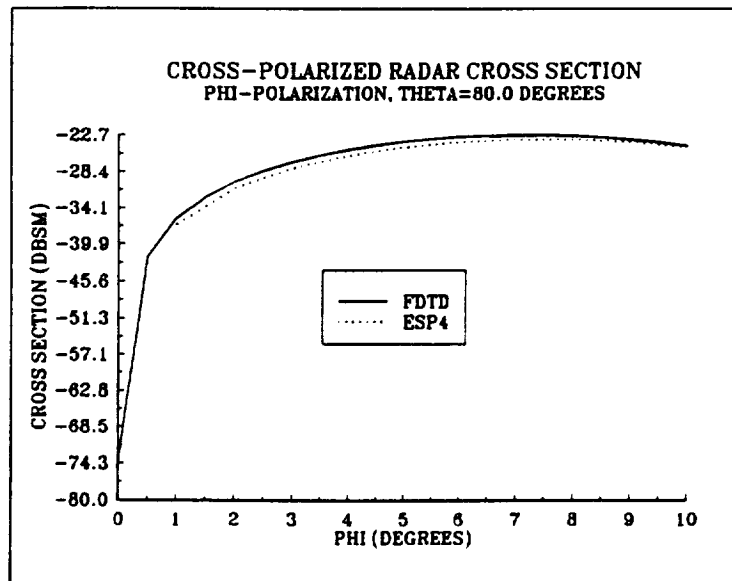

Figure 5. Cross-polarized radar cross section versus angle  $\phi$  for a 35 cm by 20 cm perfectly conducting plate at 3.00 GHz using FDTD and ESP4.



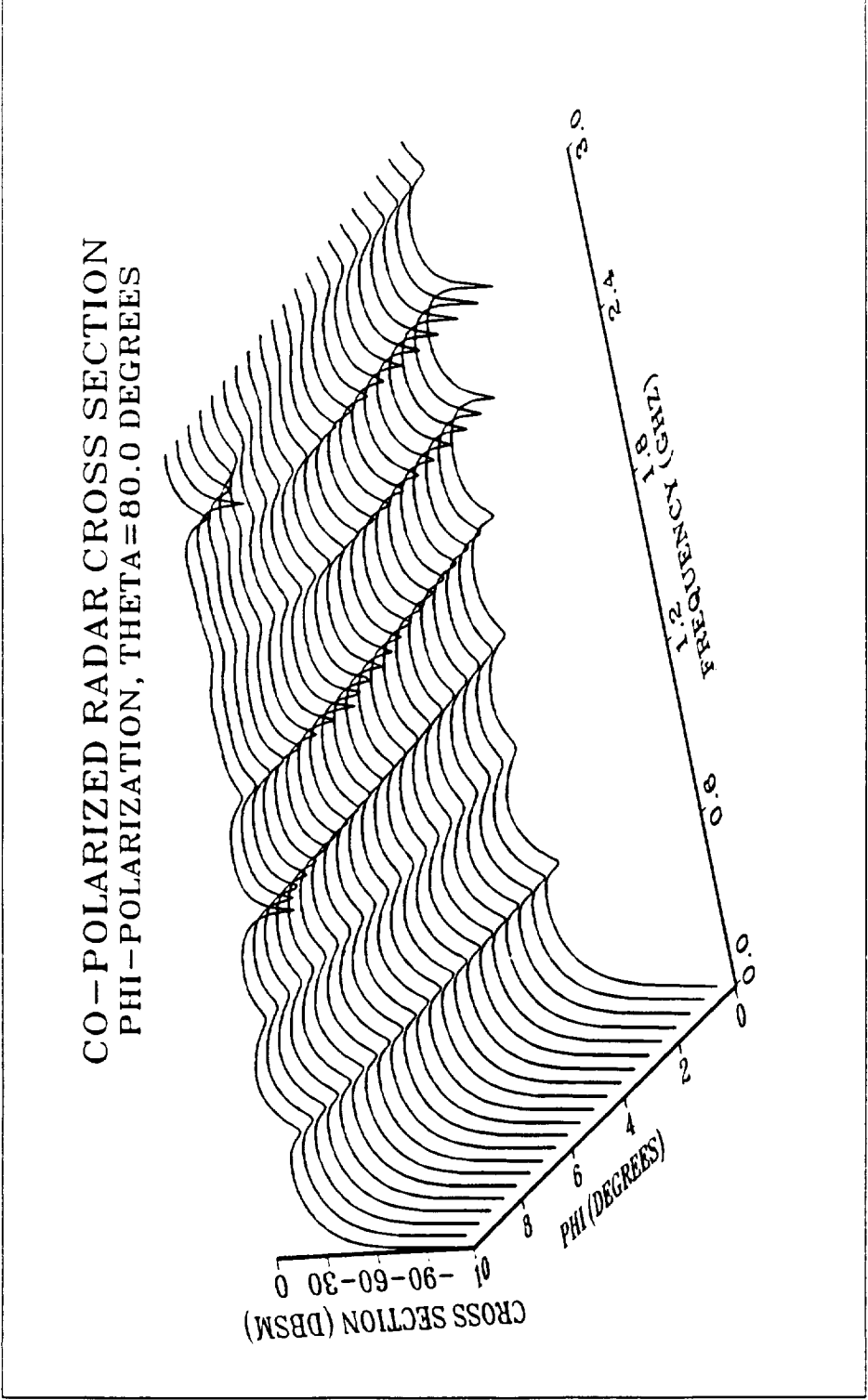

Figure 6. Co-polarized radar cross section versus frequency and incidence angle  $\phi$  from a 35 cm by 20 cm perfectly conducting plate using FDTD.

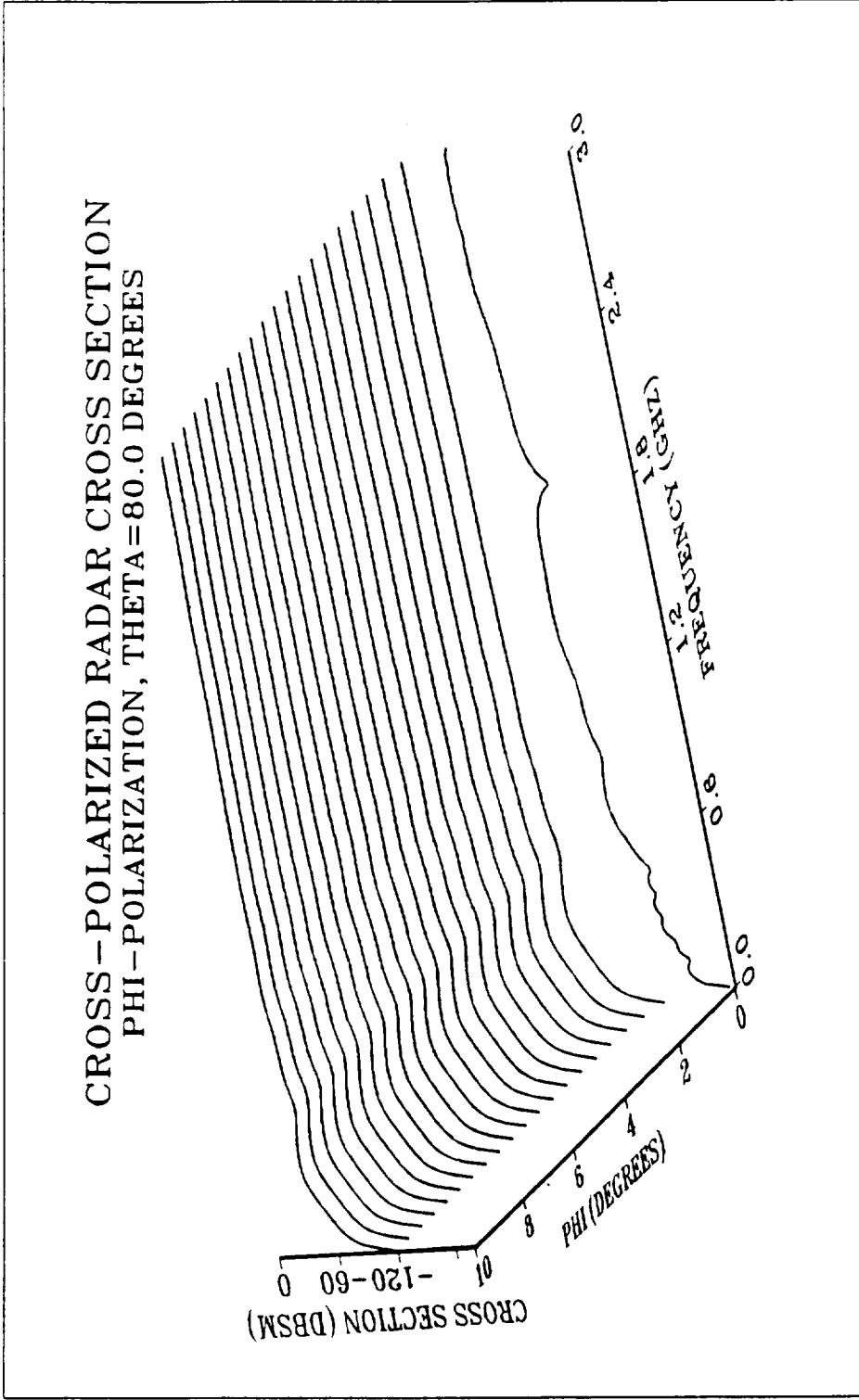

Figure 7. Cross-polarized radar cross section versus frequency and incidence angle  $\phi$  from a 35 cm by 20 cm perfectly conducting plate using FDTD.

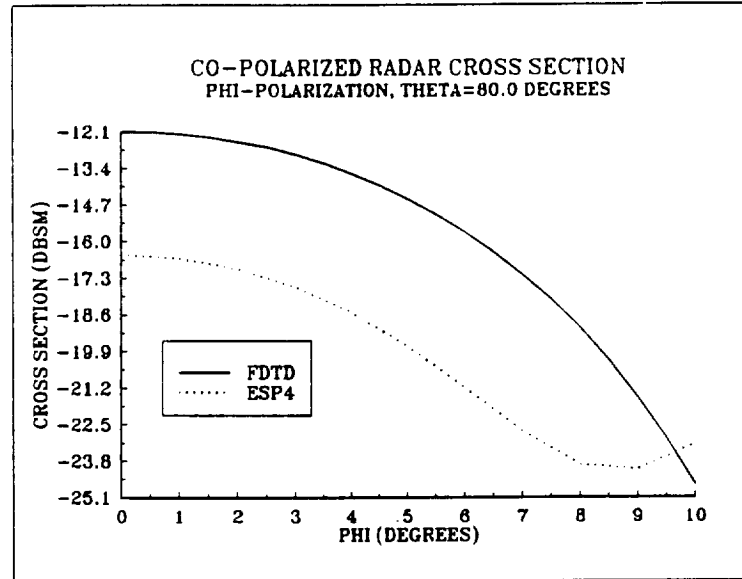

Figure 8. Co-polarized radar cross section versus angle  $\phi$  from a 35 cm by 20 cm perfectly conducting plate at 2.25 GHz using FDTD and ESP4.

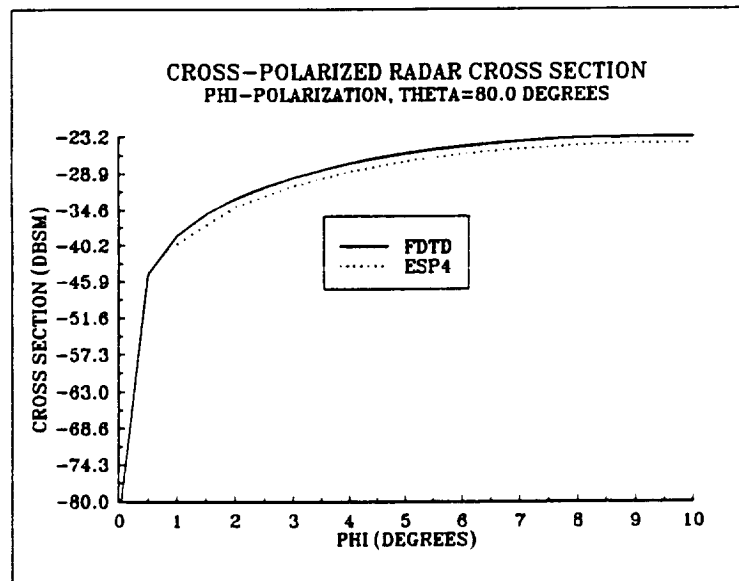

Figure 9. Cross-polarized radar cross section versus angle  $\phi$  from a 35 cm by 20 cm perfectly conducting plate at 2.25 GHz using FDTD and ESP4.

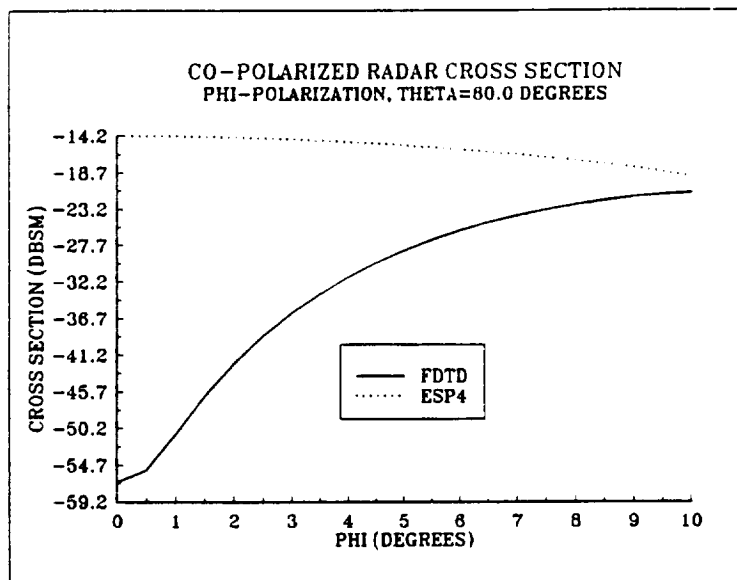

Figure 10. Co-polarized radar cross section versus angle  $\phi$  from a 35 cm by 20 cm perfectly conducting plate at 2.47 GHz using FDTD and ESP4.

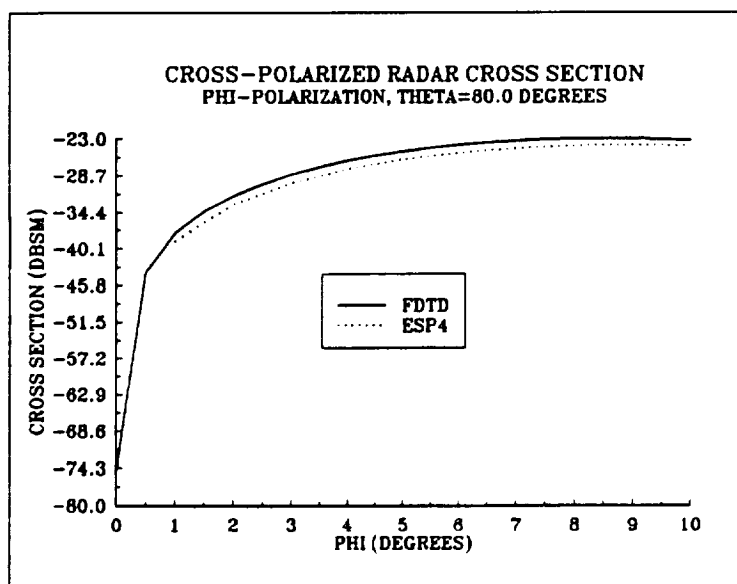

Figure 11. Cross-polarized radar cross section versus angle  $\phi$  from a 35 cm by 20 cm perfectly conducting plate at 2.47 GHz using FDTD and ESP4.

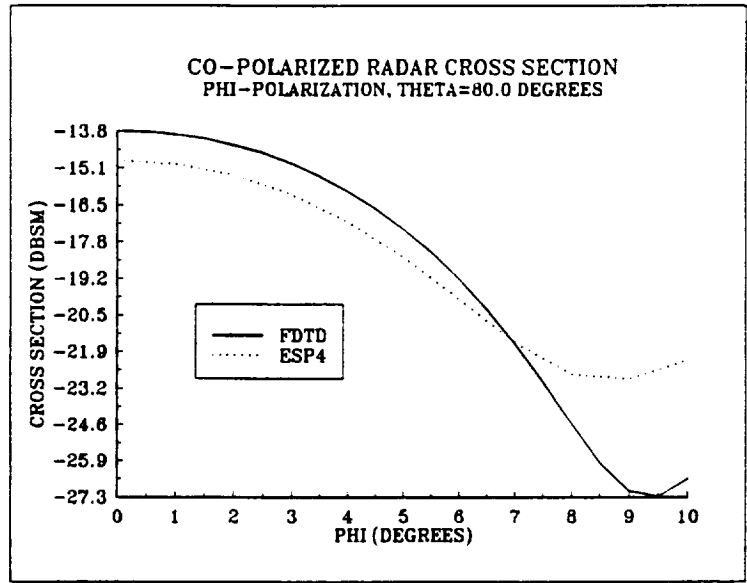

Figure 12. Co-polarized radar cross section versus angle  $\phi$  from a 35 cm by 20 cm at 2.70 GHz using FDTD and ESP4.

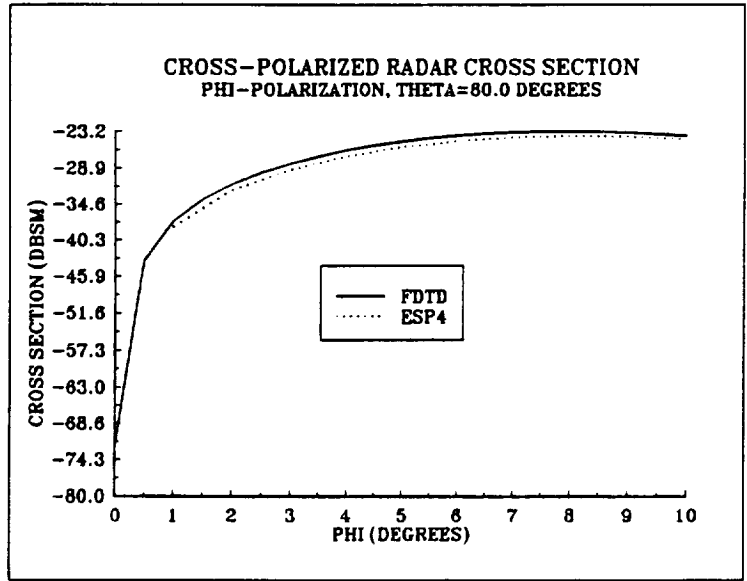

Figure 13. Cross-polarized radar cross section versus angle  $\phi$  from a 35 cm by 20 cm perfectly conducting plate at 2.70 GHz using FDTD and ESP4.