

14-54-CR
73 947
p.90

GENESIS II

ADVANCED LUNAR OUTPOST



Space Architecture Design Group
Written by Joseph P. Fieber, Janis Huebner-Moths, and
Kerry L. Paruleski
Edited by Gary T. Moore

Space Architecture Monograph Series, Vol. 4



UNIVERSITY
of WISCONSIN
MILWAUKEE

(NASA-CR-190027) SPACE ARCHITECTURE
MONOGRAPH SERIES. VOLUME 4: GENESIS 2:
ADVANCED LUNAR OUTPOST Final Report
(Wisconsin Univ.) 90 p

N92-20268

CSCL 06K

G3/54

Unclas
0073947

GENESIS II
ADVANCED LUNAR OUTPOST

Space Architecture Monograph, Vol. 4

design and illustrations by

Greg R. Buscher
Adam L. Demler
Peter J. Dewitt
Joseph P. Fieber
Peter Fruncek
Gregory S. Gorski
Janis Huebner-Moths
Deborah Kishony
Scott Maner
Kerry L. Paruleski
Keith Prudlow
Patrick Rebolz
Daniel Rhone
Curtis W. Schroeder
Christopher Trotier

report written by

Joseph P. Fieber
Janis Huebner-Moths
Kerry L. Paruleski
NASA/USRA Teaching Assistants

Edited By

Gary T. Moore
Project Director and Faculty Advisor

June 11, 1991

GENESIS II: ADVANCED LUNAR OUTPOST

Space Architecture Design Group; report written by Joseph P. Fieber, Janis Huebner-Moths, and Kerry L. Paruleski; edited by Gary T. Moore

ABSTRACT

This research and design study — the fourth in the Space Architecture Monograph Series — investigated advanced lunar habitats for astronauts and mission specialists on the Earth's moon. The work is based on design requirements and constrains set forth in previous monographs in this series (e.g., Cordes, 1989) and in research studies done especially for Genesis II, and supported by the development of the Genesis I Lunar Outpost (Hansmann & Moore, 1990). Design recommendations were based on environmental response to the lunar environment, human habitability (human factors and environment-behavior research), transportability (structural and materials systems with least mass), constructability (minimizing extravehicular time), construction dependability and resilience, and suitability for NASA lunar research missions in the early 21st century. The recommended design utilizes lunar lava tubes, with construction being a combination of Space Station Freedom-derived hard modules and light-weight Kevlar-laminate inflatable structures. The proposed habitat includes research laboratories and a biotron, crew quarters and crew support facility, mission control, health maintenance facility, maintenance work area and extravehicular chamber, storage and logistics facility, and special crew areas for psychological retreat, privacy, and contemplation. Furniture, specialized equipment, and lighting are included in the analysis and design. Drawings include base master plans, construction sequencing, overall architectural configuration, detailed floor plans, sections and axonometrics, interior perspectives, and construction details.

This study and report were supported by an Advanced Design Program grant from NASA/Universities Space Research Association (NASA/USRA) to the Regents of the University of Wisconsin System, University of Wisconsin-Milwaukee Center for Architecture and Urban Planning Research. USRA's Advanced Design Program operates under Grant NASW-4435 from the National Aeronautics and Space Administration.

OTHER MONOGRAPHS IN THE SPACE ARCHITECTURE MONOGRAPH SERIES

1. Space Architecture: Lunar Base Scenarios, by Anthony J. Schnarsky, Edwin G. Cordes, Thomas M. Crabb & Mark K. Jacobs (edited by Edwin G. Cordes, Gary T. Moore & Stephen J. Frahm). ISBN 0-938744-59-3, R88-1, 1988; pp. vi + 80, illus.; \$10.00.
2. Genesis Lunar Outpost: Program/Requirements Document for an Early Stage Lunar Outpost, by Dino J. Baschiera & 12 others (edited by Edwin G. Cordes). ISBN 0-938744-61-5, R89-1, 1989; pp. xix + 89, illus.; \$10.00.
3. Genesis Lunar Outpost: Criteria and Design, by Dino J. Baschiera, Joseph P. Fieber, Timothy L. Hansmann, Janis Huebner-Moths & Gary T. Moore (edited by Timothy L. Hansmann & Gary T. Moore). ISBN 0-938744-69-0, R90-1, 1990; pp. xii + 107, illus.; \$10.00.

PUBLICATIONS IN ARCHITECTURE AND URBAN PLANNING

Center for Architecture and Urban Planning Research
University of Wisconsin-Milwaukee
P.O. Box 413
Milwaukee, WI 53201-0413

Report No. R91-2
ISBN-0-938744-74-7

Additional Copies of this and other monographs in the series are available for \$10.00 prepaid by writing to the above address.

EXECUTIVE SUMMARY

The University of Wisconsin-Milwaukee Space Architecture Design Group undertook a designed a second generation advanced lunar outpost, called Genesis II, during the 1990-91 academic year. The design was based on internal and external critiques of the first generation lunar outpost developed in 1989-90, two internships at NASA/Johnson Space Center designing a full-scale mock-up of a lunar inflatable spherical design, three independent study projects conducted during the fall semester of 1990, followed by an integrative design studio in the spring of 1991. A series of experts—scientists, engineers, and architects—from NASA/JSC, Wisconsin aeronautical industry, and area universities—gave technical input and offered critiques at design reviews throughout the process. Students from architecture and engineering were involved and together explored the potential of developing a second generation lunar research and habitation base utilizing lunar lava tubes and inflatable and hard module construction.

In the after shock of the space shuttle Challenger disaster in 1986, scientists, professionals, and citizens around the world have been rethinking the role humans can and should play in space. Current discussion and planning has moved away from "one shot scenarios" and space transportation systems into the arena of long duration missions and issues of possible extraterrestrial habitation. Plans for the near future in space development include a permanently inhabited space station, an inhabited lunar colony, and a possible joint United States/Soviet Union mission to Mars.

Space Architecture

For the first time it has been realized by NASA that the long duration of these planned events requires the involvement of architects, interior designers, industrial designers, planners, and other environmental design professionals in order to ensure environments suitable for human habitation and performance. To date, space design has been the almost exclusive province of the engineer and that profession's highly technical orientation. Long-range planning, systems integration, construction sequencing, and interiors environmentally suitable for humans are all areas in which the design professions have demonstrable expertise and in which they can exercise a positive and much needed influence. Acknowledging this, engineers involved in shaping our future in space have begun to collaborate with architects and other environmental designers in the design process. Thus has evolved space architecture, as the field is becoming known.

This report summarizes the major design criteria and concepts which lead to the evolutionary development of Genesis II, including issues related to health and safety, psychological and social responses to living and working in a confined, isolated environment, habitability, underground architecture, interior architecture, construction technology, near term high technology materials, structural analyses and structural systems, site planning, and long-range master planning.

History

In the spring of 1991, a group of students under the direction of the authors researched and designed this second generation advanced lunar outpost, Genesis II. Genesis II is planned to provide housing, research space, mission control space, and all amenities for 11 astronauts to live on the moon for durations up to 20 months with normal change-outs of 6 to 9 months. It will serve as an evolutionary, long-term testbed for all materials, processes, and development strategies to be employed in a mature lunar colony for the next 20 years, and as a research and construction technology testbed for all processes to be employed in the exploration and settlement of Mars. At the present time, it is expected that the first lift-off for such a lunar outpost would be around 2005, with IOC (initial operating configuration) achieved by 2015.

Mission Objectives

As currently envisioned, a lunar outpost should include base master planning and habitat design for a mission that could be focused on five experimental systems:

- a. lunar mining and production analysis for lunar oxygen and helium³,
- b. lunar construction technology testbed,
- c. closed system ecological life support facility (biosphere),
- d. lunar far-side observatory, and
- e. human factors and environment-behavior research facility.

Methodology and Procedure

Development of the site plan and design for a second generation Genesis II focused on the central telerobotic command center running these mission operations, on the research facilities, on the crew support habitat, and on other ancillary spaces needed to assure quality of life.

Design issues considered included base master planning and phasing, human factors, psychological and social reactions to long-duration space missions, high-tech materials and construction technology, lighting, mechanical, and HVAC/ECLSS systems, energy systems, and overall design aesthetics. The design is based on a facility programming document produced by a group of undergraduate and graduate students in the fall of 1989 (Basciera & others, 1989), a final design document produced in the spring of 1990 based on first year study results (Hansmann & Moore, 1990; Moore, Basciera, Fieber & Moths, 1990), an intern report completed for NASA/JSC during the summer of 1990 (Connell, Fieber, Paruleski & Torres, 1990), and three independent study projects completed during the fall of 1990 (Fieber, 1990; Huebner-Moths, 1991; Paruleski, 1990).

Areas of detailed architectural and engineering (A/E) design investigation were conducted throughout the year as part of these reports and the final integrative design studio. These studies included, but were not limited to, the following: investigation of the implications of new, high-tech, light-weight, high strength materials especially elastomers and thin films; character of the lunar environment; extraction of design relevant information from previous space experience, analogous situations, and simulations, e.g. Mir and Skylab, Antarctica and Navy submarines, and Tekkitte; and human factors analysis of the minimum space requirements for different lunar habitation and research functions in 1/6th gravity.

The final integrative design studio was conducted as a professional team project, with the faculty advisory directing the project, and the three teaching assistants and other advanced students assuming the role of team leaders for various specialized functions. The class worked as one team, producing one final project, but were subdivided into various teams with specific tasks and deadlines as the semester unfolded.

The final design was summarized in a series of 30"x40" drawings, produced both in black-and-white for this report and subsequent technical papers and in color for slide presentations and exhibits. A model showing the final design proposal situated above and in a lunar lava tube was constructed.

Highlights of the Proposed Design for the Genesis II Lunar Base

The proposed design is situated in a lunar lava tube near the former Apollo 15 site, located at 3 degrees East by 25 degrees North, alongside Hadley Rille at Palus Putredinis (Marsh of Decay).

The master site plan is zoned such that the launch and landing facility is approximately 3 km to the south, the nuclear power facility is 1 km to the north, the mining facility and industrial zone 1.25 km to the west, and the

solar array field and heat-dissipation radiator field near the habitat. The habitat itself is over an opening—drilled and then sintered—to the safe confines of the lava tube (see Figure 3.3-1 ff. starting on p. 25 in the body of the report).

Following extensive telebotonic research and exploration, the base will be developed in three main stages spanning almost 10 years: (1) emplacement of an assembly facility and the erection of radiation protection truss-work with accompanying regolith covering; (2) integration phase during which the balance of base components are delivered, all surface facilities are constructed, the shaft to the lava tube is drilled, exploded, and sintered, and the structural truss-work and initial crew quarters are lowered through the opening and assembled on the base of the lava tube; and (3) final initial operation configuration during which two large, two-floor inflatables are lowered into the lava tube, inflated, and outfitted for expanded crew quarters and research space, with attendant reconfiguration of the rest of the base for the permanent 11-person base.

The design proposed to NASA is thus based on the use of Space Station Freedom-type hard modules, light-weight structural truss systems, and thin film elastomer inflatables. The habitat and research areas are situated in the safety of the lava tube, away from radiation, sharp temperature fluctuations, and deadly solar flares. Storage and vertical circulation to and from the surface occurs in a Shuttle-C type hard module installed in the sintered opening between the lava tube and the surface. Only logistics modules and the EVA chamber (for extra-vehicular activities) remain on the surface, thought protected by truss-work covered with a minimum of 0.5 m of lunar regolith. The basic configuration—a giant H on its side—can be seen in Figure 3.8.1-2 on p. 32 in the body of the report. Details—shown in a series of plans and axonometric drawings—of the two-story habitation and laboratory inflatables in the midst of the lava tube, the crew support module with mission operations and health maintenance facilities on the bottom of the lava tube, and the logistics and EVA modules on the lunar surface can be seen in Figures 3.8.1-3 ff. starting on p. 31 and are described in detail in the report. As considerable attention was placed on the quality of life, and the contribution which the designed environment can make to the overall quality of life, especially in confined quarters, more detailed designs are shown in larger scale drawings for individual spaces within the crew habitat areas (e.g., the wardroom/dining room, a game room, the exercise facility, several arrangements of the crew quarters, the personal hygiene facility, a small library, and several reading rooms and a conservatory providing places for retreat and renewal. Detailed designs were also developed, and are shown, for typical mission operations workstations, the operating theater of the health maintenance facility, and special furniture designs for 1/6th gravity body positions.

Technical engineering details are shown for wall sections, hatch connectors, the lighting system, and the structural space frame truss work.

Finally, as this second generation advanced lunar outpost may need to expand into a more mature lunar colony, expansion plans are shown in Figure 3.9-1 on p. 48 for expansion beyond IOC to accommodate increments of 5-6 additional astronauts and mission specialists up to the limit of the size of the cavern of the initially selected sub-surface lunar lava tube.

PREFACE AND ACKNOWLEDGEMENTS

This report presents the architectural requirements and design for an advanced lunar base habitat and research facility. This advanced lunar outpost, a second generation outpost, is planned for 11 astronauts and mission specialists at the former Apollo 15 site, located at 3 degrees East by 25 degrees North, alongside Hadley Rille at Palus Putredinis (Marsh of Decay). Construction would commence in 2005 with IOC (initial operating configuration) achieved by 2015. Design and construction will be led by a team of astronauts, scientists, architects, and engineers working together to build a permanently occupied habitat on the Moon.

Faculty and students of the University of Wisconsin-Milwaukee School of Architecture and Urban Planning (UW-Milwaukee/SARUP) have been actively involved in the research, analysis, and design of extraterrestrial environments since 1987. In 1987 the School began working with the Astronautics Corporation of America's, a world-wide aeronautics and aerospace company headquartered in Milwaukee, to define space design issues and criteria. In the fall of 1987, the Department of Architecture offered its first studio in "Space Architecture: Lunar Base Scenarios." The studio resulted in the first in our Space Architecture Monograph Series (Schnarsky, Cordes, Crabb & Jacobs, 1988). The School's Center for Architecture and Urban Planning Research (CAUPR) hosted a series of lectures and workshops by leading members of the aerospace industry and nationally recognized experts, made slide and video presentations at national meetings including the 3rd, 4th, and 5th Annual Summer Conferences of the Universities Space Research Association (e.g., Cordes, Moore & Hansmann, 1989), and wrote a series of articles about space research and design (e.g., Schnarsky, 1988).

In 1989 CAUPR was awarded a \$115,000, three-year grant from NASA/Universities Space Research Association (NASA/USRA) to conduct an Advanced Design Program in Space Architecture. Created as a result of that grant, the Space Architecture Design Group has been responsible for research and technical papers, lectures, talks, and exhibits at local, state, and national conferences, and has received six research and design awards (for a complete listing of available publications, exhibits, and awards, please see Appendix C).

Following on the results of our work in 1990-91 to develop an initial lunar base (Hansmann & Moore, 1990; Moore, Baschiera, Fieber & Moths, 1990), the current report summarizes the main performance requirements for a second generation lunar base, discusses the design criteria and issues, and presents a design proposal—called Genesis II—based on accumulated research and design trade studies.

The Space Architecture Design Group would like to express appreciation for the continued support, encouragement, and opportunities the Advanced Design Program has provided. We thank NASA and USRA for sponsoring the project, and Keith Henderson, our NASA/Johnson Space Center liaison. We would like to thank the following for critical feedback and suggestions during the project: Thomas Crabb, Orbital Technologies Corporation, Madison, Wisconsin; David Haberman, Astronautics Corporation of America, Milwaukee; John Cain, Kahler Slater Torphy Architects and Venture Architects, Milwaukee; Nancy Jaeger, graduate student in architecture and urban planning; Robert Weber, Marquette University Department of Mechanical Engineering; Wallace Fowler, University of Texas, Austin Department of Aerospace Engineering and Engineering Mechanics; and Profs. Douglas Ryhn and Anthony Schnarsky, Department of Architecture, Edward Beimborn, Department of Civil Engineering, and Mark Sothmann, Department of Human Kinetics at UW-Milwaukee. From NASA/Johnson Space Center, sincere appreciation for technical expertise is extended to Michael Roberts of Systems Engineering and John Connolly of Planet Surface Systems. Additionally, a special thank you to B.J. Bluth, NASA/Headquarters for her insight and most helpful critical commentary about confined environmental living conditions and lunar habitats. Finally, we would like to acknowledge the continuing support of local television, news media, and publications personnel. With their efforts, the Advanced Design Program has generated a greater enthusiasm for the space program and its benefits within academic and public audiences. The NASA/USRA Teaching Assistants and Faculty Advisor for 1990-1991 would also like to thank the students in the Spring Space Architecture Design Studio for their unending enthusiasm and diligence in design, creativity, and research toward the final product, Genesis II.

Joseph P. Fieber
Janis Huebner-Moths
Kerry L. Paruleski
NASA/USRA Teaching Assistants

Gary T. Moore
Faculty Advisor and Project Director

TABLE OF CONTENTS			
EXECUTIVE SUMMARY	iii		
PREFACE AND ACKNOWLEDGEMENTS	vii		
LIST OF FIGURES	xiii		
1 OBJECTIVES AND PROCEDURE	1		
1.1 Project Goals	1		
1.2 Objectives of an Advanced Lunar Base	1		
1.2.1 NASA Lunar Mission Objectives	1		
1.2.2 Key Research and Design Issues	2		
1.2.3 Principle Design Criteria	2		
1.3 Design Methodology	2		
1.3.1 <i>Genesis I</i> Lunar Outpost and Critique	2		
1.3.2 Fall 1990 Independent Research Studies	3		
1.3.2.1 Extraterrestrial Habitation: A Quest for Solutions	3		
1.3.2.2 An Investigation of Technological Options in Lunar Construction	3		
1.3.2.3 Environmental Conditions of the Moon and Mars: A Study of Two Worlds and their Ability to Foster Habitation and Experimentation	4		
1.3.2 Spring 1991 Design Studio	4		
2 DESIGN ISSUES AND REQUIREMENTS	5		
2.1 Character of the Lunar Environment	5		
2.1.1 Issues	5		
2.1.2 Findings	5		
2.1.3 Design Requirements/Recommendations	5		
2.2 Image and Symbolism Appropriate for a Lunar Outpost	6		
2.2.1 Issues	6		
2.2.2 Findings	6		
2.2.3 Design Requirements/Recommendations	6		
2.3 Site Planning Considerations	6		
2.3.1 Issues	6		
2.3.2 Findings	6		
2.3.3 Design Requirements/Recommendations	7		
2.4 Previous Space Experience, Analogous Situations, and Simulations	7		
2.4.1 Issues	7		
2.4.2 Findings	7		
2.4.3 Design Requirements/Recommendations	8		
2.5 Long-Term Effects of Reduced Gravity	8		
2.5.1 Issues	9		
2.5.2 Findings	9		
2.5.3 Design Requirements/Recommendations	9		
2.6 Spatial Allocation and Human Factors Analysis of Minimum Space Required for Lunar Habitation and Research Functions	10		
2.6.1 Issues	10		
2.6.2 Findings	11		
2.6.3 Design Requirements/Recommendations	11		
2.7 Design Requirements for all Functional Areas of an Advanced Lunar Outpost	11		
2.7.1 Base Operations	13		
2.7.2 Mission Operations	13		
2.7.3 Crew Support and Habitat	13		
2.8 Natural Light and Views	15		
2.8.1 Issues	15		
2.8.2 Findings	15		
2.8.3 Design Requirements/Recommendations	15		
2.9 Short- and Long-Term Habitability Effects of Underground, Windowless Architecture	15		
2.9.1 Issues	15		
2.9.2 Findings	15		
2.9.3 Design Requirements/Recommendations	16		
2.10 Expandability, Replacement, and Renovation	16		
2.10.1 Issues	16		
2.10.2 Findings	16		
2.10.3 Design Requirements/Recommendations	16		

2.11 Shielding	17	3 GENESIS II ADVANCED LUNAR	23
2.11.1 Issues	17	OUTPOST DESIGN	
2.11.2 Findings	17		
2.11.3 Design Requirements/Recommendations	17	3.1 Site Selection	23
2.12 Energy Considerations	17	3.2 Base Site Selection	24
2.12.1 Issues	17	3.3 Master Plan	24
2.12.2 Findings	17	3.4 Construction Sequencing	24
2.12.3 Design Requirements/Recommendations	18	3.5 Modular Panel and Rack Designs: A Kit of Parts	29
2.13 Biosphere Considerations	18	3.6 Phase I: Emplacement Phase	29
2.13.1 Issues	18	3.7 Phase II: Integration Phase	29
2.13.2 Findings	18	3.7.1 Surface Level 1	30
2.13.3 Design Requirements/Recommendations	18	3.7.2 Shuttle C Cylinder	30
2.14 Environmental Control Life Support System/Heating, Ventilating, and Air Conditioning Considerations	19	3.7.3 Lava Tube Level 5	30
2.14.1 Issues	19	3.8 Phase III: Initial Operating Configuration	31
2.14.2 Findings	19	3.8.1 Design Organization	31
2.14.3 Design Requirements/Recommendations	19	3.8.2 Entry and Logistics Facility	38
2.15 Construction Technologies	19	3.8.3 Storage	38
2.15.1 Issues	19	3.8.4 Crew Support Facility	38
2.15.2 Findings	19	3.8.4.1 Galley	38
2.15.3 Design Requirements/Recommendations	20	3.8.4.2 Wardroom and Dining	39
2.16 Lunar Structures	20	3.8.4.3 Group Recreation	39
2.16.1 Issues	20	3.8.4.4 Exercise Facility	40
2.16.2 Findings	20	3.8.5 Crew Quarters	40
2.16.3 Design Requirements/Recommendations	20	3.8.5.1 Personal Crew Quarters	40
2.17 Construction Materials	20	3.8.5.2 Personal Hygiene Facility	41
2.17.1 Issues	20	3.8.5.3 Laundry Facility	41
2.17.2 Findings	20	3.8.5.4 Library	42
2.17.3 Design Requirements/Recommendations	21	3.8.6 Research Laboratories	42
2.18 Construction Sequencing	21	3.8.7 Biotron	43
2.18.1 Issues	21	3.8.8 Quiet/Contemplation Areas	43
2.18.2 Findings	21	3.8.9 Mission Control and Specialized Facilities	44
2.18.3 Design Requirements/Recommendations	21	3.8.9.1 Mission Control	44
		3.8.9.2 Health Maintenance Facility	45
		3.8.9.3 Maintenance Work Area, Suit Storage, and EVA Chamber	45

3.8.10 Construction Technology	46
3.8.10.1 Space Frame	46
3.8.10.2 Inflatable Construction	47
3.8.10.3 Hatch and Connector Designs	47
3.8.10.4 Radiation Shielding	47
3.8.11 Furniture and Equipment	47
3.8.12 Lighting	47
3.8.13 Summary of Initial Operation Configuration	48
3.9 Expansion	48
4 SUMMARY AND CONCLUSIONS	49
4.1 Critical Design Features of <i>Genesis II</i>	49
4.2 Major Strengths and Limitations of the Design	50
4.3 Areas for Future Research and Design Development	51
APPENDICES	
Appendix A Space Architecture II Design Studio Syllabus	53
Appendix B Space Architecture Reader Contents	61
Appendix C Space Architecture Monographs and Other Publications	65
REFERENCES	71

LIST OF FIGURES

Figure 2.4.2-1.	The sleep compartment aboard Skylab was divided into three crew quarters each meant to allow personalization (Dalton, 1974).	7	Figure 2.7-4.	The hygiene facility aboard Skylab (Compton, 1983).	12
Figure 2.4.3-1.	Consideration, in regard to proximity between noisy and quiet areas, is important when designing an exotic base (Paruleski, 1990).	8	Figure 2.7-5.	Anticipated medical facility needs and support equipment (NASA STD-3000, 1987).	14
Figure 2.4.3-2.	Group blending could cause problems even if the habitat is designed well (Paruleski, 1990).	8	Figure 2.7-6.	Health maintenance facility diagnostic and treatment areas (SICSA, 1989).	14
Figure 2.5.3-1.	Bounding platforms rather than traditional stairs makes more sense in 1/6 gravity because of jumping abilities (Paruleski, 1991).	9	Figure 2.10.2-1.	An example of many different geometric configurations that could be adopted for a base layout (SICSA, 1989).	16
Figure 2.5.3-2.	Traction strips and carpeting will make the habitat safer and allow the crew to maneuver better through the base (Paruleski, 1991).	9	Figure 2.11.1-1.	An example of the harm that radiation has on humans (Haffner, 1967).	17
Figure 2.5.3-3.	The 1/6 gravity body position is different than that of the position on earth and in microgravity, therefore furniture and workstations must be designed accordingly (Capps, 1989).	10	Figure 2.12.2-1.	An example of a typical solar array structure (Bruckner, 1990).	18
Figure 2.6.1-1.	Proximities and adjacencies between spaces (Kishony, 1991).	10	Figure 2.13.2-1.	The regenerative process that a biosphere incorporates into it's day to day functioning (Cordes, n.d.).	18
Figure 2.6.3-1.	Zoning between work and living areas is important in relieving stress and allowing the crew to get away from work (Kishony, 1991).	11	Figure 2.14.2-1.	The method of recycling water for reuse in a lunar habitat (Buscher, 1991).	19
Figure 2.7-1.	The galley area aboard Skylab (Compton, 1983).	11	Figure 2.15.2-1.	An example of an inflatable structure proposed by NASA. Note the interior structure which must be erected and entirely self-supporting (Alred, 1989).	20
Figure 2.7-2.	An example of a workstation design aboard Skylab (Compton, 1983).	11	Figure 2.17.2-1.	An example of a foam-rigidized wall system (SICSA, 1988).	21
Figure 2.7-3.	The crew quarters on Skylab. Shown here are the small compartments used for leisure and	12	Figure 3.1-1.	Apollo 15 site.	23
			Figure 3.1-2.	A lunar map, including all of the Apollo landing sites.	23

Genesis II: Advanced Lunar Outpost

Figure 3.1-3	Apollo 15 site--Approach to <i>Genesis II</i> base location.	23	Figure 3.7.3-1.	Level 5 of the Integration Phase. This area is reconfigured as the base grows with additional galley, wardroom, suit maintenance, EVA chamber, exercise facility and hygiene facilities.	30
Figure 3.1-4.	The proposed <i>Genesis II</i> location.	24			
Figure 3.3-1.	<i>Genesis II</i> Base Master Plan--launch and landing facilities located to the right, habitation/laboratory areas near center, power facility to left, mining below.	25	Figure 3.7.3-2.	The plan of Level 5 of the Integration Phase. Medical and mission operations are complete.	31
Figure 3.4-1.	Emplacement phase: Equipment being landed for the construction of the base.	26	Figure 3.8.1-1.	The upper level of IOC on the surface of the moon, which houses the EVA module and the logistic modules.	31
Figure 3.4-2.	With the assembly facility in place, the hole is sintered into the roof of the lava tube.	26	Figure 3.8.1-2.	A section of the base, including the Shuttle-C module which connects the elements in the lava tube with the lunar surface.	32
Figure 3.4-3.	Integration phase: A crane lowers pieces of the space frame into the lava tube.	26	Figure 3.8.1-3	Shown on the left is the plan of the lower floor of the habitation inflatable, showing the galley, wardroom, exercise, limited hygiene facility, and a number of recreation areas. On the right, the laboratory inflatable is shown, including a general laboratory and a number of specialized laboratories.	33
Figure 3.4-4.	A Shuttle-C module is lowered into position through the hole in the lava tube's roof.	26			
Figure 3.4-5.	Initial Operation Configuration: The habitation inflatable is in place and the laboratory inflatable is being erected.	27	Figure 3.8.1-4	The interaction of areas on the lower level of the inflatables connected by circulation through the Shuttle-C central core.	34
Figure 3.4-6.	The base in it's completed form.	27			
Figure 3.5-1.	The Modular Construction Component System. This is the basis of the interior configuration, based on a grid system measurement of 1.2 meters.	28	Figure 3.8.1-5	Shown on the left is the upper floor of the habitation inflatable which includes crew quarters, personal hygiene and a small library. Shown on the right, the laboratory inflatable includes the biotron and several contemplation areas.	35
Figure 3.6-1.	The Assembly Facility used in the Emplacement Phase. This structure contains support facilities for a crew of four: crew quarters, hygiene, galley, and airlock with suit storage.	29	Figure 3.8.1-6	The left side of this axonometric shows the many variations in the crew quarters including single and double crew quarters and a possible larger single crew quarters for the mission commander. The right side shows	
Figure 3.7.1-1.	The surface level of the base allowing easy access to the lunar surface and efficient change-out of the logistics modules.	30			

Figure 3.8.1-7	the interaction between the contemplation areas and the biotron.	36	terminating the main translation path through the laboratory inflatable.	42
Figure 3.8.3-1.	Initial Operating Configuration Level 5, at the base of the lava-tube.	37	Figure 3.8.8-1.	The reading room allows the crew privacy to relax and read.
Figure 3.8.4-1.	Storage racks in the Shuttle-C module.	38	Figure 3.8.8-2.	The conservatory allowing a place to contemplate away from the activities of the base.
Figure 3.8.4.2-1.	The central translation platform, located in the center of the lower floor in the habitation inflatable, provides a means of bounding to the upper floor.	39	Figure 3.8.8-3.	The chapel in which the crew can practice their religious beliefs.
Figure 3.8.4.3-1.	A view of the wardroom. Note the raised table, shown in dotted lines, which lowers down over the three smaller tables when a large gathering takes place.	39	Figure 3.8.9.1-1.	Base activities can be monitored in the mission operations facility.
Figure 3.8.4.3-1.	The game room is one of the group recreation areas. Located between the wardroom and the group lounge, this space can be used for small group activities such as card or board games.	40	Figure 3.8.9.1-2.	A typical mission operations research workstation designed to accommodate the 1/6 gravity body position.
Figure 3.8.4.4-1.	A view of the exercise facility, which includes treadmills, stationary bicycles, stair-climbers, a punching bag, and a resistance machine.	40	Figure 3.8.9.2-1.	The health maintenance operating theatre protruding from the modular rack.
Figure 3.8.5.1-1.	A few of the possible arrangements for beds crew quarters. Note the overlapping of beds as seen in the right-most drawing.	41	Figure 3.8.9.2-2.	The health maintenance facility. All supplies and equipment are efficiently stored and easily reached.
Figure 3.8.5.2-1.	The personal hygiene facility includes three hygiene units and the laundry facility. Note the shared shower for two hygiene units.	41	Figure 3.8.9.3-1.	The maintenance facility in the level 5 module. Located in close proximity to the EVA module allows for efficiency and safety.
Figure 3.8.5.4-1.	A view of the library area, which will be a place of retreat, privacy, and contemplation for the crew.	42	Figure 3.8.10.1-1.	The space frame under construction.
Figure 3.8.6-1.	A view of the general labs shows the openness created by the half racks and the window	42	Figure 3.8.10.2-1.	A wall section through the inflatable structure inside the lava tube, including sections through both floor levels and through a window in the wall.
			Figure 3.8.10.3-1.	Front view and side views of the proposed hatch/connector to be used between all structural elements.

- Figure 3.8.11-1. Specially designed 1/6th gravity furniture used throughout the base. 48
- Figure 3.8.12-1. Specially designed lighting used throughout the base. 48
- Figure 3.9-1. Possible base expansion for *Genesis II* Advanced Lunar Outpost beyond IOC. 48
- Figure 4-1. The model of the *Genesis II* Advanced Lunar Outpost. The opening to the lava-tube is on the right. The dark paths on the surface are sintered roadways to help keep dust levels low. 49
- Figure 4-2. An overhead view of the modules on the lunar surface covered with a protective shielding. Note the coupola protruding at the apex of the configuration. 49
- Figure 4-3. The entry to the airlock on the lunar surface. The dust-off platform is just outside the airlock module, and the coupola can be seen in the background. 52
- Figure 4-4. Looking into the opening of the lava-tube. The space-frame supporting the inflatables can be seen in the darkness. 52

1 OBJECTIVES AND PROCEDURE

Genesis II, a second generation, or advanced, lunar outpost provides housing, research work space, mission control space, and all amenities for a permanent lunar settlement of 11 astronauts and mission specialists to live on the moon for durations up to 20 months. As well as providing the first or second permanent settlement on the moon, *Genesis II* is planned to serve as an evolutionary testbed for all materials, processes, and development strategies to be employed in a more mature lunar colony for the next 20 years, and as a testbed for procedures to be employed in the exploration and eventual settlement of Mars.

1.1 PROJECT GOALS

Genesis II is an advanced lunar base with anticipated construction commencing in the year 2005. *Genesis II* includes base master planning and design for a mission focused on five experimental systems:

- a. lunar mining and analysis for lunar oxygen and helium³,
- b. lunar construction technology test-bed,
- c. a closed system ecological life support facility (biotron),
- d. a lunar far-side observatory, and
- e. a human factors and environment-behavior research.

Design development focused on the division of work and rest environments. To provide continuity within the base master plan, an integrated, modular component system was developed to be applicable throughout the base.

Design issues considered included base master planning and phasing, human factors, psychological and social reactions to long-duration space missions, high-tech materials and construction technology, lighting, and mechanical systems, heating, ventilating, air conditioning, and environmental control life support systems (HVAC/ECLSS), energy systems, and overall design aesthetics.

1.2 OBJECTIVES OF AN ADVANCED LUNAR BASE

A mature base will benefit from previous, initial experimentation in living and technology. With a continuing commitment on behalf of government and industry, the base has the groundwork emplaced for advancement.

1.2.1 NASA LUNAR MISSION OBJECTIVES

The goals of the space program are clearly defined in the 1990 Report of the Advisory Committee on the Future of the U.S. Space Program (NASA, 1989). The basic imperatives of today's national civil space effort are, therefore, to:

- sustain our heritage to learn, explore, and discover;
- maintain our technological competitiveness in global markets;
- enhance the quality of life for all people on Earth.

In general, the definition of the human exploration initiative includes: to enrich the human spirit, to contribute to national pride and international prestige, to inspire America's youth, to unlock the secrets of the universe, and to strengthen our Nation's technological foundation. Human exploration of the Moon and Mars will fulfill all these aspirations. A permanent outpost on the Moon will support human presence for science and exploration (NASA, 1989).

Specifically, a lunar outpost will challenge technological and human capabilities, with advances in those areas being the goal. There will be research to counter the effects of reduced gravity, design of self-sufficient life support systems, development of hardware and software to engage and monitor the experiments, systems designed to lessen the differences between the atmospheres, and research to address the deep cold and radiation hazards.

In the area of human needs, the health, productivity, and safety of the crew members must be met. The outpost will increase the comprehension in the way humans adapt to the space environment. An important feature will be understanding of behavior, performance, and human factors in extraterrestrial situations.

Geology and geophysics, astronomy and astrophysics, human and plant biology, and evolutionary biology will all be advanced. Understanding the present as well as the past of planetary bodies will lead us to a knowledge of the origin of our own planet. The lunar base will utilize nuclear power systems, explore in-situ resource utilization, develop radiation protection systems, and advance automation and robotics. All these endeavors will inevitably lead to beneficial spin-offs for humans on Earth.

1.2.2 KEY RESEARCH AND DESIGN ISSUES

Based on a self-critique of the 1989-1990 UW-Milwaukee design work on *Genesis I*, and with the very helpful suggestions of James Burke, NASA-Jet Propulsion Laboratory, and Stephen Paddock, NASA-Goddard Space Flight Center, areas of detailed investigation included the following issues:

- a. Character of the lunar environment with design studies on implications of the lunar topography, atmosphere, radiation levels, solar flares, power sources, temperature extremes, and in-situ materials.
- b. Long-term effects of reduced gravity and design studies on different approaches to creatively design for 1/6th gravity.
- c. Extraction of design-relevant implications from previous space experience, analogous situations, and simulations, e.g., Mir and Skylab, Antarctica and Navy submarines, and Tektite.
- d. Space allocation studies including human factors analysis of minimum space required for different lunar habitation and research functions.
- e. Design trade studies of all different areas of a lunar habitat, e.g., health maintenance facility, exercise facility, crew quarters, air locks, workstations, etc.
- f. Design studies of different ways of getting natural light into a regolith-covered lunar habitat without admitting gamma ray particles, including partially covered cupolas, flexible light pipes, periscopes, etc.
- g. Secondary research and habitability design study of the short and long-term effects of underground, windowless architecture.
- h. Design replacement studies of how to replace/renovate/expand parts of a habitat without disturbing ongoing functions.
- i. Studies of alternative construction technologies including prefabrication modules, rigid structures, inflatables, and in-situ resource utilization.
- j. Design studies of the implication of new, high-technology materials especially elastomers and thin films, e.g., Kevlars, Mylars, Spectra, Nomex, aluminums, titaniums, rigidizing foams, and in-situ resource utilization of lunar regolith.
- k. Regolith depth studies of the minimum depth of regolith to protect lunar habitats from radiation and micrometeorites, and design studies of regolith containment systems, second-generation regolith bagging machines, and processes (including sequences) of habitat construction.

1.2.3 PRINCIPLE DESIGN CRITERIA

The Space Architecture Studio set forth a specific group of primary design criteria to guide in the final design of *Genesis II*. These were:

- habitability, human factors, and environment-behavior considerations;
- safety;
- using advanced near-term available technology;
- replaceability and modularity; and
- cost, i.e., minimizing volume and weight at lift-off.

1.3 DESIGN METHODOLOGY

A structured organization is a necessity to the planning process of the lunar base. Evaluation of past efforts was conducted and new topics studied in depth. The following sections review *Genesis I* (see Hansmann & Moore, 1990) and provide synopses of the independent research conducted to assist in the design of *Genesis II*.

1.3.1 GENESIS I LUNAR OUTPOST AND CRITIQUE

Genesis I was intended to be an initial outpost for the lunar surface. It was to contain the following components: three domed inflatables, each three floors; four-space station-derived common modules; one heavy life launch vehicle module; nodes; logistics modules and EVA modules.

The base, which housed 12 crew members, was meant to be an experimental test-bed for construction technology, mining, a lunar far-side observatory, experimental materials testing, CELSS (closed ecological life support system), and human factors and environmental behavior research.

The base combined both proven and experimental technologies. Prefabricated modules, transported and landed completely outfitted, made use of already proven technology derived from research on the proposed Space Station Freedom. The inflatable dome structures were suggested to introduce the use of fabric such as Kevlar in the design of living and working areas. By using these fabrics, weight and volume would be saved in the launch process, yet structures with large volumes could be possible on the lunar surface.

One of the important assets the base possessed was the variety of living and working environments. Open floor plans were designed for the group areas, yet personal spaces allowed for flexibility and expression of personality. Work environments were modular or open plan. It also provided for the viewing of the lunar surface from cupolas located in two areas.

One of the limitations was its size. For an initial outpost, the base was far too large. The nodes were found to be too numerous, as were the domes. Generally, there were too many functions dedicated to this base. Habitability should have been a priority for the initial operating configuration phase and sufficiently researched. Later phases could address the mining and far-side observatory objectives.

1.3.2 FALL 1990 INDEPENDENT RESEARCH STUDIES

Three students chose to undertake independent study courses in preparation for the Spring Design Studio. Summaries of these reports follow.

1.3.2.1 Extraterrestrial Habitation: A Quest for Solutions

The purpose of this study was to investigate what has already been learned about human behavior and adaptation to harsh environments and alien conditions, and to design elements that can help the adaptability process. This study focused particularly on studies of analogous situations, previous actual space exploration, simulated situation, and projects under development, in each case to look at their design implications.

In order to conduct this research, over 50 books and 200 journal articles were collected from the Technical Library and New Initiatives Library at NASA's Johnson Space Center, and from the Lunar and Planetary Institute in Houston. Materials were also found in the Space Architecture Design Group's collection of documents. Of these, 62 were found to be especially valuable and were used in the report. Members of NASA Johnson Space Center were also valuable in providing information for this project.

The important of the findings of this report are essential to the future designing of habitats in exotic environments. Stress from confined quarters - similar to that expected in any lunar habitat - was the main problem found in studies such as Space Station/Nuclear Submarine Analogs by B.J. Bluth. Solutions included, for example, a view to the outside, vital to the well being of not only the United States' Skylab crew, but to the Soviet cosmonauts serving on Salyut and Mir. It was found that they spent most of their leisure time gazing out of windows-amazed at the sight. This sets a major criterion for future extraterrestrial habitats. Another crucial finding deals with the need for private quarters where one can "get away" and establish personal territory (Dalton, 1974). Submarine, Antarctic and space crews have expressed their need for personal space. Without this space depression and group dissension will often occur.

In conclusion, it was discovered that of the four topics researched, the analogous situation section proved to be the most insightful. The habitats studied were small and the first exotic environment habitats will initially be small. The traffic patterns, storage compartments, and the dividing of spaces seem more applicable than those in the previous actual space exploration because the latter were designed for zero gravity. Information was found about the crew's reactions to the habitat in which he/she lived. With studies of this kind, the success of future habitat designs will be better designed (Paruleski, 1990).

1.3.2.2 An Investigation of Technological Options in Lunar Construction

The areas of space exploration and research have been dominated by engineers since the space programs beginning. Recently NASA has realized the importance of having architects involved in the design of many of their projects. Architects can add a new dimension in designing habitats to be placed on other moons or planets. Investigated were many previously proposed lunar structures, noting the advantages and disadvantages of each. Design recommendations are included which offer the best options of each of the proposals. The paper can be used as a guide for the non-engineering designer to derive the most useful structure for his or her needs.

While in Houston for an intern position in the summer of 1990, research was gathered from three technical libraries at NASA Johnson Space Center. People at NASA, and its contractors became useful in providing information or in locating needed resources. A small Space Architecture Library and the university library also became useful sources for a total of over 200 reports, articles and publications. These were then searched to find information directly related to the main topic, narrowing the number to approximately 60. These provided a sufficient background and sampling of the many different types of structures which need to be compared to any space architecture application.

Because all Earth derived materials must be transported to the Moon, with costs of up to \$1 million per pound, high strength and low weight are a must. One material that offers these benefits, Kevlar, can have a tensile strength 60% greater than that of steel. Kevlar can be made in thin, cloth-like sheets fabricated to create balloon-like tensile membrane structures which are relatively lightweight, and enclose large amounts of volume. Another material, structural foam, can be transported as a compact liquid which is injected into a form where it expands and hardens into a concrete. This process saves transportation costs and provides an almost endless supply of material.

Lunar structures that were found to be of great use included solid and collapsible options. Structures made of materials such as Kevlar can be compacted to fit in a U.S. Space Shuttle payload bay, and once deployed on the Moon, can be inflated into large enclosures. Metal structures similar in appearance to small submarines can be placed on the Moon with all systems needed to support life already on-board. Lunar forms such as lava tubes can even be used, by sealing them off and pressurizing the enclosures, saving in transport costs and construction time.

Through researching many options among materials and lunar structures, comparisons could be made between those proposed thus far, and conclusions drawn for the best options. In investigating materials, it became apparent that Kevlar and aluminum would be of great value for use in lunar habitats due to their high strength and low weight. Also of great importance will be lunar basalt and lunar concrete, which will save on the need to transport material to the lunar surface.

In comparing proposed lunar structures, best choices were made according to the general time period; initial structure, second generation, or third generation. The best initial structure was found to be the Space Station Freedom derived module, which would arrive fully outfitted. As a second generation structure, the inflatable Kevlar based structure will be large, and require only limited construction. A structure comprised of lunar concrete will be the best choice for a third generation structure, using easily obtainable resources (Fieber, 1990).

1.3.2.3. Environmental Conditions of the Moon and Mars: A Study of Two Worlds and Their Ability to Foster Habitation and Experimentation

There are exceptional environmental conditions that exist on the surfaces of the Moon and Mars. With the increasing participation of professional architects in the space program, the issues of habitability and human factors are being addressed, with resulting design parameters guiding the outcome of the structures. Without a comprehensive understanding of the atmospheric, or lack of atmospheric conditions in which those designs will exist, the architect will be at a disadvantage. This paper attempts to provide an overview of the conditions which will dictate design direction.

To obtain the necessary information, a three-week trip to the NASA-Johnson Space Center in Houston, Texas was taken. In the office of Planet Surface Systems and using the resources of the Technology Library at JSC, trade studies, mission architectures, geologic and geographic surveys were obtained. Several studies from the Lunar and Planetary Institute were rich in detail. In addition, the UW-Milwaukee Library and the Space Architecture Design Group collection provided needed information.

Critical in the design considerations of structures on the lunar surface is the intensity of the radiation due to the lack of a protective environment. Protection of crew and equipment must be obtained using materials which will impede radiation and any micrometeorite impacting, i.e., lunar regolith, regolith bagged within a material system, or burying the structures below the lunar surface.

Another concern is the extreme variation in the temperature of the surface. The range is 500 degrees from daylight to darkness. Structures and systems that can withstand those extremes must be utilized. Along with the temperature variations go the knowledge of the lunar day/night cycle. One lunar day is the equivalent of 14 Earth days. Similarly, one lunar night is 14 Earth days in length. This brings into question power utilization and the storage of backup power for the darker periods.

One unique feature which will be studied in detail is the lunar lava tube. These are natural caverns found in the lunar landscape. The principle interest in these geologic structures is their viability as a site for lunar base construction. The interior configuration of lava tubes on the Moon have yet to be investigated and mapped. If viable, the lava tube could provide excellent radiation shelter for inhabitants, an area preformed for base construction, and an environment where the temperature is fairly stable.

In conclusion, the major considerations for base design include the temperature variations, radiation and micrometeorite impacts, day/night cycles of the Moon, and the presence or absence of naturally occurring features capable of sustaining structures. As well, knowledge of what the surface compositions are may prove valuable for future in-situ resource utilization (Huebner-Moths, 1991).

1.3.2 SPRING 1991 DESIGN STUDIO

The spring design studio was structured into six segments, each providing an opportunity for the students to gain familiarity with the space program, space design, and utilizing the findings to generate *Genesis II*. It evolved in the following:

Part 1. Readings, slide talks, and individual sketch design explorations. Two weeks. Preliminary Design Review (PDR-1) university faculty.

Part 2. Research and design studies of different issues, e.g., lunar site design, 1/6 gravity, workstations, natural light, underground architecture, inflatable dome construction technology, high-technology materials like elastomers and thin films. 3-1/2 weeks. PDR-II.

Part 3. Preliminary design to develop and explore different parts. 1-1/2 weeks. PDR-III.

Part 4. Design development of different parts of overall lunar base. 2 weeks. Intermediate Design Review (IDR) with NASA scientists and engineers and national guests.

Part 5. Design integration to present final integrated design. 3-1/2 weeks. Not-quite-final Design Review (NQFDR).

Part 6. Presentation. 1-1/2 weeks. Final Design Review (FDR) with university faculty from several disciplines and local architects.

2 DESIGN ISSUES AND REQUIREMENTS

2.1 CHARACTER OF THE LUNAR ENVIRONMENT

The Moon is a unique environment, unlike any humans have inhabited before. This unique quality will develop living and working environments that combine this new technology with a certain amount of "humanness." What can be useful from Earth? What Earth-based, Earth-oriented technologies can apply to living on another world? What exceptional circumstances must be dealt with regarding the environment, geography, topography, and in-situ resources? These questions must be addressed prior to moving to the Moon.

2.1.1 ISSUES

The critical issue to be confronted on the Moon is a protective environment for crew members and equipment. Safety will receive a priority rating. Temperature extremes, reduced gravitational attraction, geographic and geologic composition, the ability to use the natural lunar resources, and adequate knowledge of the surface topography must be addressed.

2.1.2 FINDINGS

An analysis of the surface composition of the Moon shows formation occurred about 4.6 billion years ago. Plagioclase feldspar is predominant in the highland crust. Volcanic activity was occurring up to 4.1 billion years ago, depositing basaltic magmas with great quantities of potassium (K), the rare Earth elements (REE), and phosphorus (P). These elements have been nicknamed KREEP. Additional survey missions will locate areas that contain the necessary minerals to likely be used in the production of lunar hydrogen and oxygen as fuel for rockets; utilization of the quantities of oxygen, magnesium, aluminum, iron, silicon, and titanium; resources for manufacturing on the surface, formulation of lunar concrete; magma, ceramic, and fused adobe structures.

The safety issue occurs with the lack of a natural protective environment. There is no atmosphere to deter the radiation impacting the surface and any structure upon it. Micrometeorite impacting causes concern for the structures and personnel as well. Radiation itself isn't measurable, rather the ionization that is produced when radiation passes through a medium is measured. The type of radiation is important - most damaging are galactic cosmic rays (GCR's). These have the ability to penetrate the

surface of the Moon up to a few meters in depth. Additionally, humans may respond to radiation in various ways depending upon three sets of variables: radiation types, combinations of types, and the time-intensity relationship. One must also consider the condition of the crew member, his/her age, and separate medical factors with weightlessness, acceleration, and body temperature (Nicogassian & Parker, 1982).

The temperature on the Moon has an extreme range. Days can reach +250 degrees Fahrenheit, with the nights dropping to approximately -250 degrees Fahrenheit. The 500 degree range presents challenges for crews, equipment and structures.

The lunar landscape is composed of two major regions. The smooth, dark areas are called "maria" and the "terrae" are rugged, heavily cratered areas. The cratered highlands cover 83% of the surface and are located in higher elevations. These craters were formed by meteorite impact, are labeled simple or complex depending upon the impact strength and the strength of the material where the impact occurred. The maria regions are the result of basaltic lava deposits, leveling after the crater impacting occurred. One additional feature is the presence of lava channels, called rilles, from which the maria regions seem to have originated. Lunar soil, regolith, is comprised of fragments of debris and rock, minerals and glass. The average depth is 3 to 16 meters. Astronaut David Scott (Scott, 1973, pp. 326-329) described the lunar surface as covered with "A dark-grey Moon dust - its consistency seems to be somewhere between coal dust and talcum powder - mantles virtually every physical feature of the lunar surface. Our boots sink gently into it as we walk; we leave sharply chiseled footprints."

The Moon has a smaller gravitational pull than the Earth. It is calculated at approximately 1/6th that of Earth's gravity. In this environment, debris from launches and landings scatters further. The human mode of locomotion changes as distances can be covered in lesser amounts of time. Higher levels can be easily "bounded" to instead of the typical stair climbing. The Moon's gravity enables structures to have greater spans and can support greater loads.

2.1.3 DESIGN REQUIREMENTS/RECOMMENDATIONS

Site selection will be determined from the mission requirements. In this scenario, location will depend on the existence of a lunar lava tube. Additionally, in-situ resources will provide the opportunity for materials experimentation. Scientifically, the lunar environment will provide geologists the opportunity to test samples of the lunar soil and rock.

The construction of a lunar base must provide for radiation and micrometeorite impact protection. The materials utilized in the base must

withstand extreme temperature variations as well as the vacuum of the lunar environment. Provisions must be made for the event of an emergency, such as a solar flare, where heavily protected environments can be inhabited for short durations, containing food, water, and communication systems.

Additional requirements are the distances between base components. Locations between the inhabited areas and the more hazard-producing functions should be great enough to protect the crew and equipment.

2.2 IMAGE AND SYMBOLISM APPROPRIATE FOR A LUNAR OUTPOST

It is important that environmental issues be taken into consideration before any sort of habitat on the Moon is built. Planning for the long-term effects that living on the Moon will occur is something that should not be done after the fact.

2.2.1 ISSUES

An organization called the International Lunar Environmental Protection Agency (ILEPA) deals with the events that occur on and around the Moon. They deal with such issues as lunar zoning, waste disposal and recycling, surface mining, nuclear energy and radiation standards, surface transportation and natural landscape management, "Clean Skies" management (radio emissions, noise pollution, particle accumulations, orbital debris management, scientific activities/site concerns, and historic and aesthetic site preservation.)

2.2.2 FINDINGS

Of all the findings, keeping the Moon from being strip mined and environmentally destroyed is the most important concept in designing a lunar base. The main idea is to keep the landscape intact as much as possible. For example, any/all material taken to the Moon should be reusable or recyclable. Trying to keep the Moon as untouched as possible is highly recommended. Another reason has to do with her history. The early missions that included people, during the 1960's and the 1970's, is of extreme historical significance. Evidence of human presence, such as footprints, rover tracks, and flags would be the major areas of preservation. Like monuments preserved on earth, these sites will be protected for generations to come. These sites will be viewed as the Plymouth Rock of outer space.

2.2.3 DESIGN REQUIREMENTS/RECOMMENDATIONS

The most important recommendation that must be considered when understanding what the image and meaning of the Moon is that of planning before hand what is desired on the Moon and what is not.

2.3 SITE PLANNING CONSIDERATIONS

Planning what a lunar base should look like and how to make it work most efficiently is an important factor to consider when designing. This can be divided into two separate categories; natural and technological issues.

2.3.1 ISSUES

The natural issues address the problems of sound transmittal, geographic and topographic advantages, lava tubes and their potential for habitation, and the possible problems that arise with the fourteen day lunar night.

The technological side deals with transportation problems and methods, mining techniques, site layout, and landing pads.

2.3.2 FINDINGS

Sound is insignificant on the Moon because of the absence of atmosphere and the looseness of the regolith (regolith inhibits the travel of sound). The best way to take advantage of the topological features of the Moon is to use it for protection against the elements. Lava tubes, which are believed to exist below the surface of the Moon, could be considered an ideal place to situate a base. Finally, the 14 day lunar night has brought some concern. One of the main problems is that of being able to see when outside during the night. However, astronauts can see by the earth's light and no artificial lighting is really required.

Where the technological issues are concerned it was found that lighting the base wasn't really needed and therefore seeing tiny lights from earth won't cause possible ethical problems. Transportation could be in the form of lunar rovers or possibly a rail system. Much mining will be done on the Moon - at this point helium₃ could provide earth with years worth of energy. It was also found that a centrally located base would work better than a base that was spread out or randomly laid out.

2.3.3 DESIGN REQUIREMENTS/RECOMMENDATIONS

The ideal base might follow these guidelines: it would be centrally located, possibly situated in a lava tube, regolith covered structures would house mining equipment, with landing pads located downrange of the habitat, and unlit roads would connect all parts of the base.

2.4 PREVIOUS SPACE EXPERIENCE, ANALOGOUS SITUATIONS, AND SIMULATIONS

In order for humans to survive the unrelenting harshness of the "new frontier," it is imperative that architectural design elements be integrated into terrestrial habitation development. Without the addition of these elements, humans will not be able to adapt to a level in which they can physically live comfortably in an exotic environment in a mental state of comfort and safety. There is a need for apt personal space in which the crew can establish their own territory thus providing a release of some stress. The amount of space needed has yet to be fully established. Contact with plants and animals from our Mother Earth are critical. This provides a form of stress release in that the astronauts can care for them as they would do their families on earth. The astronauts also need space and equipment designed for their well-being, not "what will fit" the easiest and cheapest into the habitat. Beds are there for rest and relaxation. If they fit into the space but don't feel comfortable to the inhabitants what good will they do, except to cause anxiety? Through studying analogous situations, previous actual space exploration, simulated situations, and projects currently under construction, an essential ingredient will be reached: the understanding of human behavior and how that comprehension can be used to make the habitation of the Moon and other terrestrial environments "livable" (excerpt from Paruleski, 1990).

2.4.1 ISSUES

The effects of living in a harsh environment are extremely taxing on not only the body but the human psyche as well. In order for the human population to extend beyond the boundaries of earth, crucial factors must be conquered first. Issues such as what kind of stress is found inside the habitat as well as in the outside environment. Human factors such as crew make up and group behavior are important to consider when designing for extraterrestrial living. Also, the living and working conditions are vital to a mission's success. All of these issues can be studied in such places as Sealab, Tektite, and nuclear submarines.

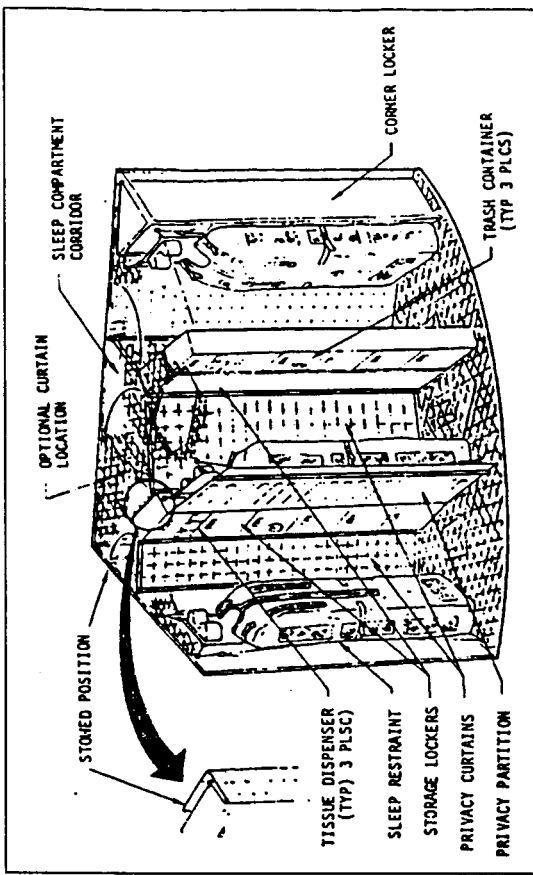

Figure 2.4.2-1. The sleep compartment aboard Skylab was divided into three crew quarters each meant to allow personalization. (Dalton, 1974).

2.4.2 FINDINGS

It has been found that without a concern about how humans are going to live in an extreme environment, the mission most likely won't be as successful as it would if the habitat would have been designed with the human in mind. For example, on Skylab the crew enjoyed having their own private quarters that they could personalize themselves (see Figure 2.4.2-1). However it was also noted that the proximity to the hygiene facility was found inappropriate because of the high noise factor (Dalton, 1974).

The constant threat of hostile outside forces has also been found to cause a large amount of stress to crews in extreme environments. For example, the crews on nuclear submarines find more relief in looking through a periscope, in order to view the outside, more reassuring than being told that they are safe (Paruleski, 1990). Designing for easy adaptation to the outside environment was found to be very difficult. For example, the crew on the Ben Franklin submersible found the high humidity in the habitat resulting from the cold water to be very uncomfortable. The habitat couldn't adapt to this thus leaving the crew in a less favorable atmosphere (Grumman Aerospace Corp., 1970).

It was found that the crew make up had a lot to do with how people behaved both individually and in groups (Paruleski, 1990). If enough testing and training were done to make the crew as harmonious as possible

there usually wasn't much trouble. However, missions have occurred where not as much thought went into it. For example, in the Antarctic bases, the civilian and the military groups often clash. High rates of sickness and inter-group fighting occur as a result of an exotic atmosphere and an unbalanced crew makeup (McKay, Anderson, Wharton, Rammel, in press).

The living and working spaces are important elements in the quest for a successful mission. Although space should be designed with economics and efficiency in mind, they shouldn't be driven by only these measures. Whether a person can tolerate working in a space that was only meant for equipment shouldn't be the weighing factor. Living in a hostile environment for a long period of time requires careful consideration of the spaces the crew is supposed to be living in. Not being able to sit up in a bunk space in order to read in a nuclear submarine caused much stress in the crew members (Bluth, 1983). This in turn lowered moral and thus prevented total concentration on the job at hand. With more consideration in what kind of spaces humans will be living in, the habitability of an extraterrestrial base doesn't seem so improbable.

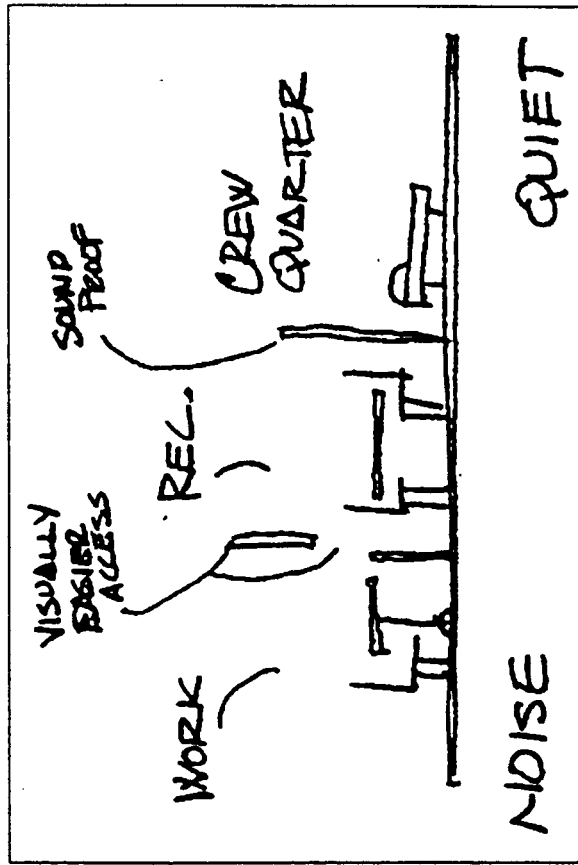

Figure 2.4.3-1. Consideration, in regard to proximity between noisy and quiet areas is important when designing an exotic base (Paruleski, 1990).

2.4.3 DESIGN REQUIREMENTS/RECOMMENDATIONS

Deciding proximities between spaces is an element that should take priority when designing for an exotic environment. Making sure the noisy functions aren't situated by the quiet ones is vital to the a habitat's success (see Figure 2.4.3-1). Crew selection is also a factor that must be considered (see Figure 2.4.3-2). Without this careful planning even the best designed habitat cannot be fully utilized. Designing for human habitation is crucial - people will be the ones that are running the equipment.

2.5 LONG-TERM EFFECTS OF REDUCED GRAVITY

When designers think about inhabiting the Moon, gravity is a critical issue to be considered. According to the New Merriam-Webster Dictionary (1989), gravity is defined as: "the gravitational attraction of the mass of a celestial object for bodies close to it" (p. 327). Albert Einstein's general theory of relativity states that space is curved and time is slowed down because of gravity. Gravity itself depends on the mass of a body and the distance it has to another body. The more massive the body the greater the attraction (Andino, 1990).

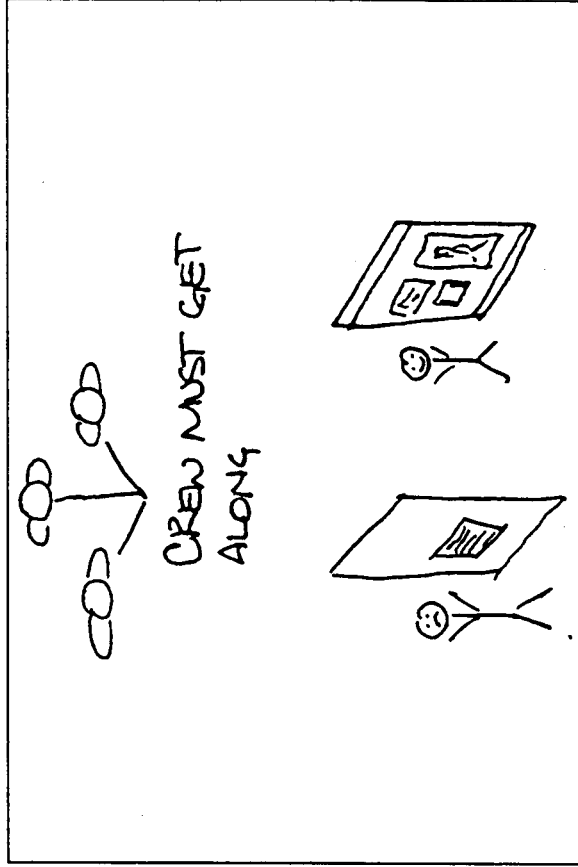

Figure 2.4.3-2. Group blending could cause problems even if the habitat is designed well (Paruleski, 1990).

The gravity on the Moon is 0.16 that of earth. This means all bodies appear lighter, materials stronger, and the time of distance traveled shorter since it takes less effort to get there (Paruleski, 1991).

2.5.1 ISSUES

The effects that partial have on humans is a critical issue to learn and conquer in order to design a livable habitat for the Moon. The anthropometrics and physiology of the individual is changed once lesser gravity is experienced for any length of time. The increase of height, the loss of body mass, muscular atrophy, cardiovascular changes, and fluid shifts are the major bodily changes. These changes, noticeable and subtle, effect the way astronauts function. Adjusting to bounding rather than walking is just one of the intricacies of living in an extraterrestrial environment (excerpt from Paruleski, 1991).

2.5.2 FINDINGS

Only with prevention and countermeasures can living on the Moon be feasible. With exercise, the effects of partial gravity such as muscular atrophy can be slowed down and hopefully stopped. "Gravity trousers" are also being used to keep the body from diminishing in health and strength. Artificial gravity is a solution that could all but eliminate the negative effects of exotic living. The way the interior is designed also has a lot to do with helping people succeed in living on the Moon (excerpt from Paruleski, 1991).

2.5.3 DESIGN REQUIREMENTS/RECOMMENDATIONS

Deciding whether it is better to have stairs or platforms in which to ascend to different levels is important (see Figure 2.5.3-1). Not only must it be economically feasible, but the choice must have the approval of whom ever will be living in the habitat. They must feel comfortable with the design. Bounding platforms are recommended because with the 1/6 gravity, traditional stairs are inefficient. An astronaut can easily jump to a surface one meter above the ground rather than take stairs with .33 meter risers (Paruleski, 1991).

Almost as important is the type of material that will be used on the floors in such places as corridors. There will be a lot of traffic here and it is important that it be as safe as possible. Rounded corners and traction strips is recommended throughout the base (Paruleski, 1991; see Figure 2.5.3-2).

The furniture and workstations that will be in the habitat must also be

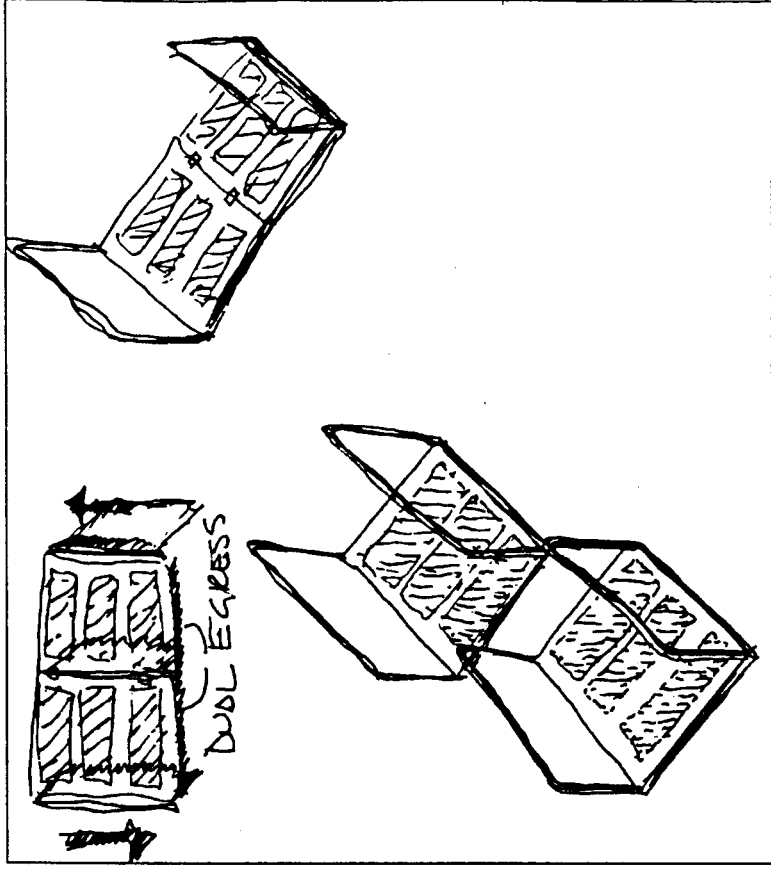

Figure 2.5.3-1. Bounding platforms rather than traditional stairs makes more sense in 1/6 gravity because of the jumping abilities (Paruleski, 1991).

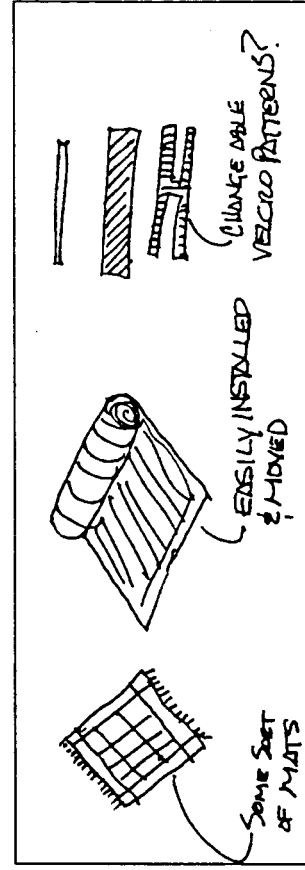

Figure 2.5.3-2. Traction strips and carpeting will make the habitat safer and allow the crew to maneuver better through the base (Paruleski, 1991).

safe. However, since the crew will have to use this equipment a fair amount of time, they should also feel comfortable in doing so. Designing the furniture and workstations to accommodate the 1/6 gravity body position is recommended (see Figure 2.5.3-3).

Finally, whether a lunar base should incorporate artificial gravity is a major decision. The whole lunar habitat could have this or just a part of it. Since it would be economically and practically more feasible, an artificial gravity simulation machine is recommended (Paruleski, 1991).

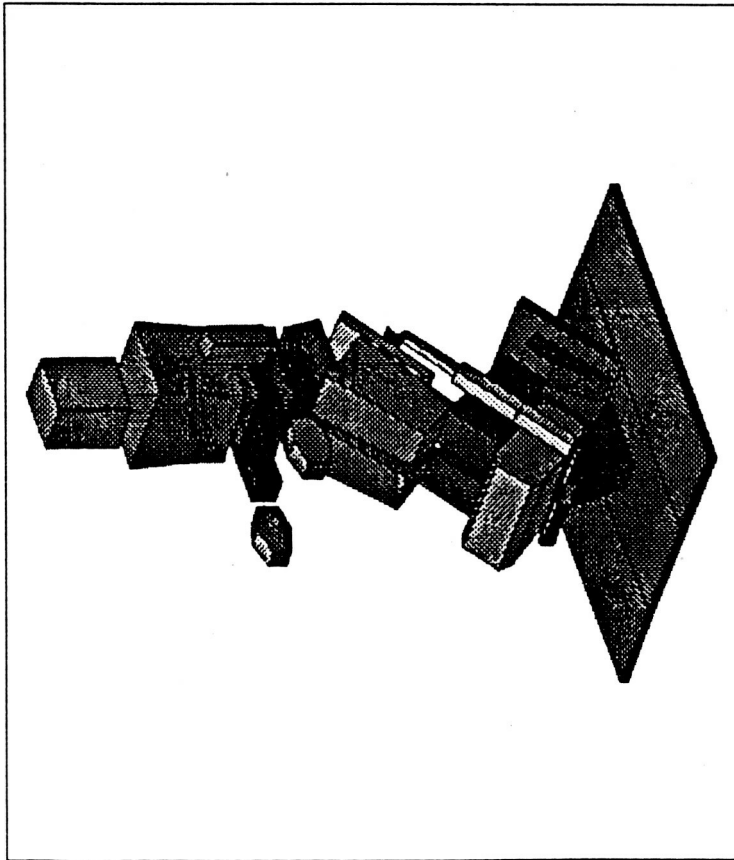

Figure 2.5.3-3. The 1/6 gravity body position is different than that of the position on earth and in micro-gravity, therefore furniture and workstations must be designed accordingly (Capps, 1989).

2.6 SPATIAL ALLOCATION AND HUMAN FACTORS ANALYSIS OF MINIMUM SPACE REQUIRED FOR LUNAR HABITATION AND RESEARCH FUNCTIONS

Human factors and social systems are important in the quest for habitable extraterrestrial bases. These habitats will not only want to house equipment comfortably but humans as well.

2.6.1 ISSUES

The following are some factors that need to be considered when establishing a "humane" base: dynamic anthropometrics, proximity, zoning, and translation/circulation paths. Since the crew will have to adapt to living in a 1/6 gravity environment, dynamic anthropometrics such as

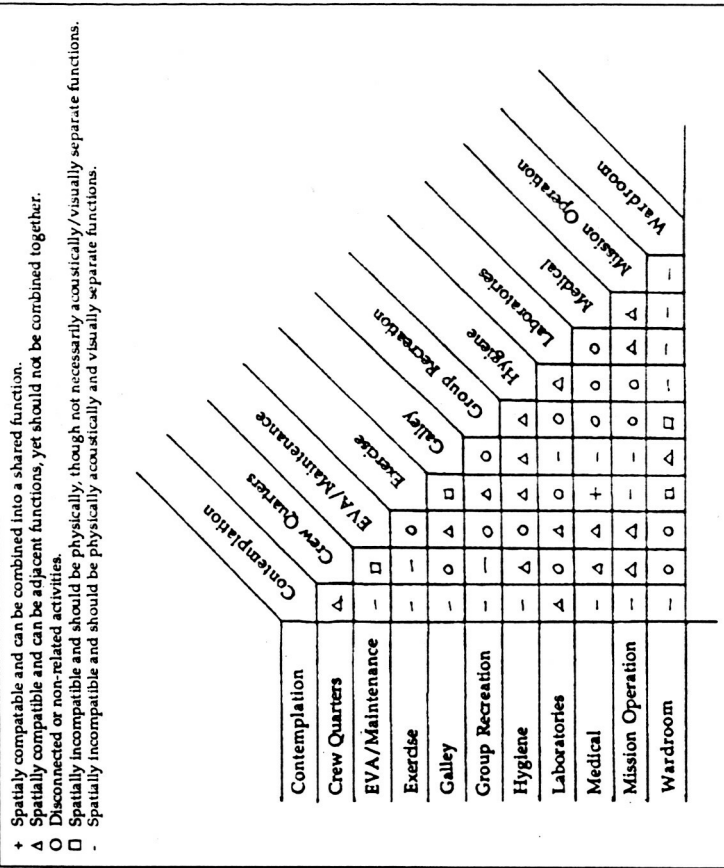

Figure 2.6.1-1. Proximities and adjacencies between spaces and what areas should be situated close to what (Kishony, 1991).

walking and running gaits, posture, and traction. Because the crew will be spending most of their time inside of the base, the proximity between noisy and quiet areas will have to be zoned off (see Figure 2.6.1-1). Translation and circulation paths will have to be designed carefully due to the 1/6 gravity.

2.6.2 FINDINGS

It has been found that the human body reacts differently in partial gravity. The gait is longer and the body appears to be "bounding" instead of just walking. As the body accelerates, traction is lost, therefore the translation/circulation paths must be open and clear of sharp obstructions. Designing to have buffer zones between noisy and quiet areas has been discovered to be important element in making the crew happy.

2.6.3 DESIGN REQUIREMENTS/RECOMMENDATIONS

Having rounded corners and hand holds located in the translation areas is recommended in making the habitat safe. Textured floor surfaces is also important in controlling the crew's bounding gait. Situating all the quiet living areas together and the noisy working areas together, apart from each other, will make living in the habitat more comfortable (Kishony, 1991; see Figure 2.6.3-1). Using these types of recommendations will help to allow the crew adapt to the harsh environment of the Moon.

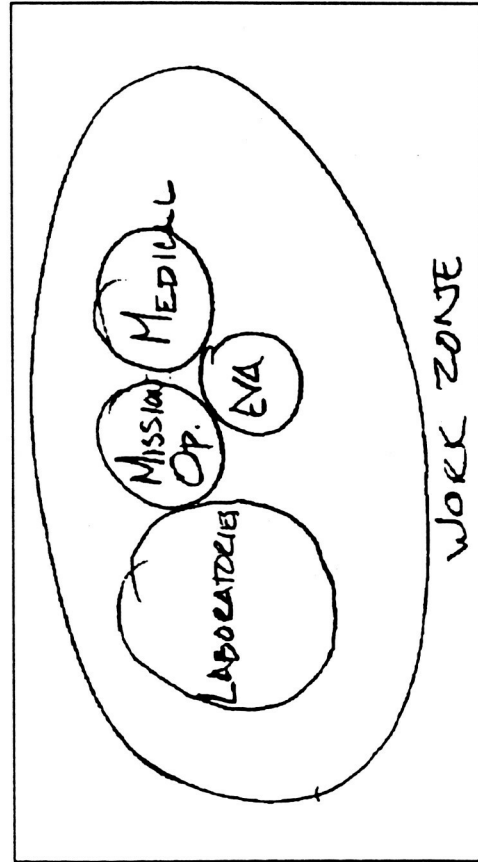

Figure 2.6.3-1. Zoning between work and living areas is important in relieving stress and allowing the crew to get away from work (Kishony, 1991).

2.7 DESIGN REQUIREMENTS FOR ALL FUNCTIONAL AREAS OF AN ADVANCED LUNAR OUTPOST

Genesis II is a base providing many areas for working and living. These areas have resulted from prior space habitation experience during the Mercury, Gemini and Apollo programs. Findings from the Spacelab and Space Shuttle programs continue to influence the design of vehicles and habitats for the future.

The first spacecraft were designed to be operated not inhabited. Due to the short periods of mission time, the discomforts of cramped quarters were tolerated. As the space program has matured, the length of the missions has grown. This has raised the issue of habitability. Engineers once felt their responsibilities included the composition and temperature of the atmosphere and light and noise levels. They also began to address housekeeping simplicity, easy personal hygiene, and exercise and relaxation areas.

Skylab and Spacelab were the programs which initiated the study of long-term living in space. The physiological response of the crew was given a priority in the design. It must be remembered that Skylab and Spacelab were microgravity environments. The physiological impact would not be the same in a lunar environment. As these programs were initial attempts at living in space, the different areas defined for work and living were small. Spaces such as the galley could accommodate crew members in close proximity.

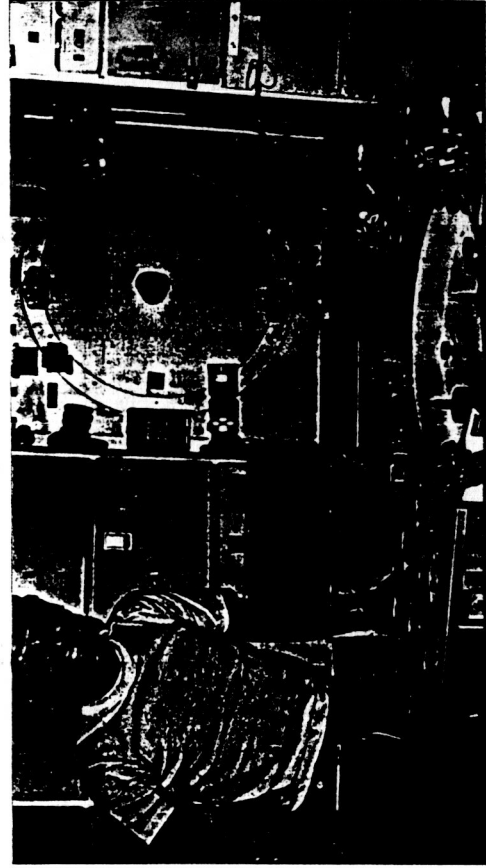

Figure 2.7-1. The galley area aboard Skylab (Compton, 1983).



Figure 2.7-2 . An example of workstation design aboard Skylab (Compton, 1983).

Workstations in the base operations and laboratory areas were cramped. Vast amounts of equipment supporting the experiments were compacted into small areas.

The crew quarters were compact, with virtually all space surfaces containing stowage and instrumentation.



Figure 2.7-3 . The crew quarters on Skylab. Shown here are the small compartments used for leisure and retreat. For sleeping, a restraining bag is attached to one wall (Compton, 1983).

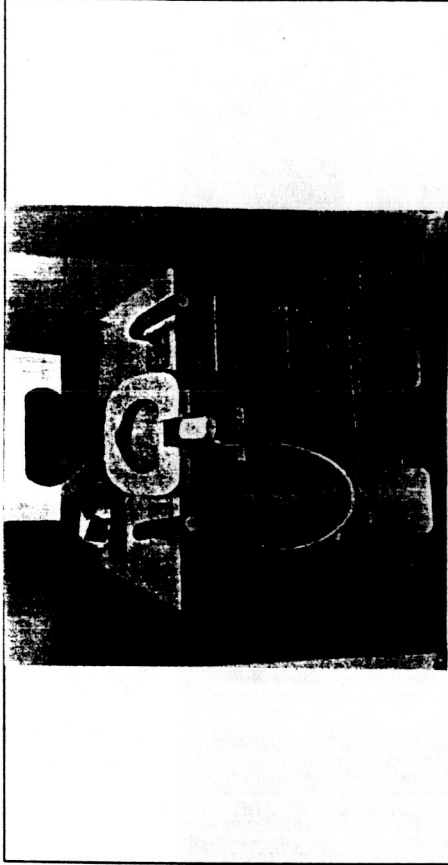

Figure 2.7-4 . The hygiene facility aboard Skylab (SICSA, 1989).

The same features are true for the hygiene facility. Space is a valuable commodity and only the necessities were designed into these spaces.

To determine the functional areas required on *Genesis II*, a priority list of the base requirements was compiled. Those areas included:

- Base Operations
- command center/communication systems
- logistics and storage
- safe-haven and emergency
- EVA module
- Mission Operations
- laboratories
- lunar surface mining
- construction technology
- CELSS research facility
- far-side observatory
- human factors and environment-behavior research facility
- Crew Support and Habitat
- personal quarters
- medical facility
- group recreation
- hygiene facilities
- meal/ meal preparation
- laundry facilities
- exercise facility

These activities were grouped into related areas and analyzed as separate components. The results of the analysis showed what was necessary in each of the functional areas.

2.7.1. BASE OPERATIONS

The primary use of this area of *Genesis II* will be to observe and control primary and secondary base systems and activities. The general systems include: life support, waste and water systems, communications, EVA systems, robotics and emergency backup. Base operations has the ability to also serve as a group telecommunications area and meeting facility for the crew.

On *Genesis II*, base operations will be specifically coordinating the command center and communications, logistics, safe-haven areas, and the EVA modules. Fixed equipment will be workstation monitors, screens, work surfaces, computer terminals and support stowage. It will require video screens, electronic communication capability and operational switchboards. Mobile equipment will be seating and wireless communications system.

Located within the base will be several safe-haven support facilities. This should be a specially colored coded component, equipped with emergency food, water, communications and medical supplies.

Logistics modules will be the method of resupply to the base. These should be easily transported between the landing facilities and the base nucleus.

Extravehicular activity modules will incorporate an airlock for passage to the surface of the Moon. Within these modules there should be pressure suit stowage for every member of the crew. A space to perform maintenance on the suits must also be designed. Additional stowage compartments for tools and equipment will be needed.

2.7.2. MISSION OPERATIONS

This area serves the function of overseeing all mission testing and experimentation. It will include the laboratories, lunar surface mining, construction technology, ECLSS research facility, a far-side observatory, and human factors and environment-behavior research facility. Those activities located within the base nucleus are the laboratories, human factors, and ECLSS.

The labs will conduct experiments in a general area, as well as biochemistry, microbiology, waste recycling and plant growth. The equipment for each area varies as does its demand for power and water. Each lab has the ability to conduct hazardous or contaminating experiments. This will require areas which can be isolated and/or specially vented. General stowage, equipment stowage, work surfaces (easily maintained and cleaned), communication link-up and computer terminals are needed.

General and task lighting need to be provided. An open floor plan can be utilized, but areas that can be isolated or quarantined must accompany the open spaces.

This will be a highly used environment. The crew must have clear and easy translation pathways around the lab, but not so as to interfere with other experimentation underway. Access to emergency hatches and different levels must be given priority in design. A general meeting area could be used for conferencing or relaxing.

The human factors facility will focus on the adaptation of humans to isolation and reduced gravity. The monitoring of the crew, specifically cardiovascular deconditioning, bone decalcification, and muscle atrophy will be overseen in the medical facility. Yet, station monitors will closely watch radiation, water quality, microbiology, toxicology and barothermal physiology (Basciera, 1989).

Outside the base nucleus, surface mining, construction and the far-side observatory will exist. There must be communication link-up and computer capability between those functions and the base. Monitoring can occur in the laboratories and /or in base operations.

2.7.3 CREW SUPPORT AND HABITAT

This expansive portion of the base must meet the needs of 11 crew members. It must be remembered the crew will include both genders and be multi-national in composition. The areas which crew support encompasses are:

- personal quarters
- hygiene facilities
- exercise facility
- laundry
- medical facility
- group recreation
- meal/meal preparation

Studies have shown (Paruleski, 1990) that the mental health of the crew depends in part on their ability to have control over certain spaces. This is the case in personal quarters. Required are a place to sleep, gear stowage, work surfaces and communications capability. Each crew member must have the opportunity for personalization. It can be accomplished through flexibility in room arrangement, and the adding of personal items to the environment. Considered should be the design of quarters which have the flexibility to expand into a room for married couples or those wishing roommates. It is important to remember that within the crew support and laboratory areas, the design of the individual operations must allow for the

Genesis II: Advanced Lunar Outpost

isolation of that particular area in the event of a failure. As well, the circulation pathways to emergency egress locations must be easily accessed and indicated.

Personal hygiene facilities must be designed to conserve water and space. The facility should address considerations of reliability and maintainability, ease of use, acceptance, number of facilities, and privacy (SICSA, 1989). As a design goal, the design should reflect usage time similar to Earth-based facilities (NASA, 1989). Full body cleansing requires a shower structure. To perform quicker hygiene tasks, half-bath facilities should be designed. One full facility is needed for every four crew members (SICSA, 1989). As a portion of the hygiene facility, a laundry can be incorporated. It may be impractical to dispose of clothing or carry enough to support a longer mission. The cleaning of clothes must be possible. One laundry will be necessary for every eight crew members. (SICSA, 1989).

The maintenance of the body will receive priority in the exercise facility. Due to the reduced gravity, the human body will begin to lose calcium and muscle tone. Studies are underway to determine the correct countermeasures, and exercise has become an integral component. Exercise machines can vary and may include bench presses, rowing machines, treadmills, and stationary bicycles. A major concern is the motivation factor for the crew to exercise. Although space is at a premium, some kind of environment should surround the equipment to entice the crew. This could be accomplished by using a near-technology virtual reality system. It could also be accomplished by using a video screen and various tapes.

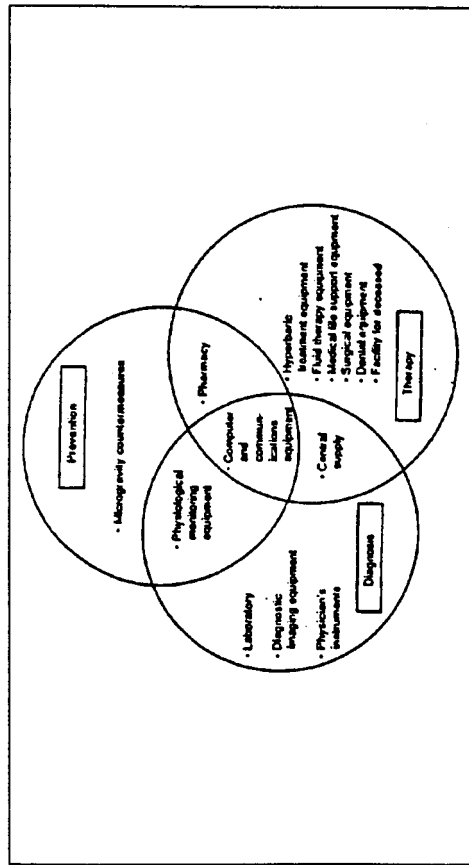

Figure 2.7-5. Anticipated medical facility needs and support equipment (NASA STD-3000, 1987).

The equipment itself could be stowable or stationary. This determination will be done based on the volume of space allocated for the exercise facility.

The medical facility must make provisions for the following functions: prevention, diagnosis and therapy. The chart below illustrates medical needs and support for the facility.

The main design concern will be that of creating stowage facilities for procedural equipment, and the spatial allocations for a minimum of two crew members - one in restraint and one performing treatment. Additional spatial considerations will involve a quarantine area, and a system for the care of deceased crew members. Below are shown two examples of health maintenance facilities.

An important part of the adaptation process to living on the surface of the Moon will be the interpersonal relations. There must be an area where the crew can go to relax and simply interact with one another. Anticipated are two different types of group recreation - active and passive. The active areas will demand a space that can accommodate two, three or more crew members. It will need seating, surfaces to work on, and stowage. There can be large screens for video viewing. With passive recreation, the activities anticipated are card playing, book reading, quiet conversation, and music listening. Needed will be seating and stowage for books, magazines, cassettes, and stereo equipment. One activity the astronauts have enjoyed in the past has been simply observing the Earth from space (Paruleski, 1990). It is anticipated that the crew members will also enjoy observing the activities on the surface of the Moon. To provide this, windows should be designed to allow viewing of the exterior environment wherever possible.

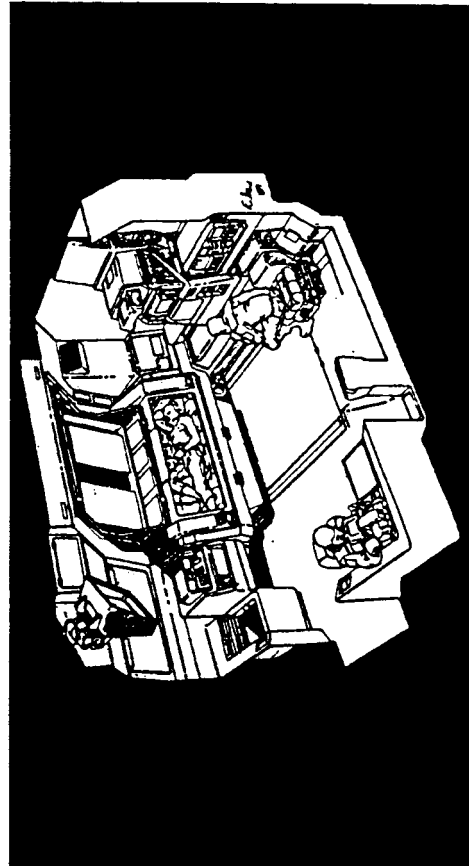

Figure 2.7-6. Health maintenance facility diagnostic and treatment areas (SICSA, 1989).

Another important facet to crew support is the meal preparation and dining areas. The galley must provide for the following: preservation, preparation, storage, dispensing and disposal of food and wastes (SICSA, 1989). Stowage, refrigeration, food inventory monitoring, microwave oven, trash compactor and water dispenser will be needed. An area for dishwashing and drying is also required.

Adjacent to the meal preparation area will be the wardroom. The combined galley/wardroom will be a center of activity. Equipment needed in this area will be seating and table facilities to seat the entire crew. This will be a dual function area for meetings. Stowage for utensils and serving pieces will be required as well as any conference equipment such as screens, monitors, and communications systems.

2.8 NATURAL LIGHT AND VIEWS

Natural lighting and views to the outside will be vitally important to a lunar base. For psychological reasons it is imperative that the crew have the ability to be able to see outside and have some form of natural lighting.

2.8.1 ISSUES

There are different kinds of viewing options to consider: video cameras and monitors, mirrors, windows, and cupolas.

Natural lighting is important to the success of an extraterrestrial habitat. It helps the crew psychologically, helps plant growth, sanitation, and in the applications occurring in the health and medical facilities.

2.8.2 FINDINGS

Although all of the possible options that could be utilized in viewing the outside some would work better than others. Video cameras and monitors could be used to see outside. However this type wouldn't stimulate the senses and would probably appear artificial. Using a series of mirrors to deflect harmful radiation could work but this would be like peering through a periscope. Here, the vision would be limited and still seem unnatural. The incorporation of windows seem to be a logical choice to fulfill the crew's need to see outside. The viewing is natural without mechanical devices taking away the pleasure of gazing outside. Finally, possibly the best option for viewing, is the cupola. This space should be surrounded by windows for the maximum viewing possible. A place to get away and connect with the outside world.

Because the environment is too severe to allow habitats open exposure to the outside, it is important to try to incorporate as many beneficial elements of the outside as possible. Natural lighting seems to be a viable solution (Maner, 1991).

Psychologically, the crew prospers from "real" illumination. One of the most enjoyable pastimes is sunbathing (two minutes is sufficient). Plant growth also thrives on natural lighting. Because natural illumination kills bacteria, sanitation processes can be made easier and more efficient. Oppositely, this light can also promote bacteria in assisting waste recycling. Finally, patient recovery can be increased with the use of natural lighting (Maner, 1991).

2.8.3 DESIGN REQUIREMENTS/RECOMMENDATIONS

It is recommended that cupolas and windows be used when ever possible. In the event that this is impossible, then any means to provide a view outside should be used. Psychologically the crew needs this form of relaxation even if it has to be done mechanically. It is also recommended that piping in light and using fiber optics it the most efficient means of getting natural light.

2.9 SHORT- AND LONG-TERM HABITABILITY EFFECTS OF UNDERGROUND, WINDOWLESS ARCHITECTURE

Through studying windowless, underground, or interior zones of conventional buildings one can gain a grasp of the kind of short and long-term psychological effects that are produced.

2.9.1 ISSUES

There are four major areas to be discussed in finding out what the effects of living in such unnatural settings: adjusting to the lack of natural light, designing views for stimulation, gaining a sense of place, and creating easy orientation and connection. All are essential in the success of windowless and underground buildings.

2.9.2 FINDINGS

One way to successfully design for an extraterrestrial base is to look at the results of studies of windowless and underground buildings. Natural

light not only promotes feelings of happiness but helps to prevent disease and fight bacteria (Ott, 1973; Wurtman, 1973). If a lunar base is to be designed this must be taken into account to make sure natural light or a sufficient replacement is used. Sensory deprivation has resulted in people who live or work in windowless environments (Dewitt, 1991). It might be fine in the work place where there is usually a lot of activities occurring at the same time but not in the living area, visual stimulation is very important. Fears associated with safety and claustrophobia have been found in people who live or work in underground buildings. These psychological problems must be addressed before living on the Moon commences. Orientation and wayfinding are crucial in underground environments as they will be on the Moon. Careful and deliberate designing must be done.

2.9.3 DESIGN REQUIREMENTS/RECOMMENDATIONS

By finding solutions to the problems that occur in windowless and underground building on earth, designing for the Moon can be made easier. By simply shifting the intensity of artificial lighting with the day and night cycle, variety and stimulation can happen (Scuri, 1990). Television screens, sculpture, pleasant color schemes, and different height spaces can help to create views for stimulation in windowless environments (Scuri, 1990). Being able to perceive changes in temperature, humidity and ventilation can assist in making the lunar inhabitants feel more comfortable in a habitat that is underground or windowless. Finally, icons, distinct architectural elements and signage can help to orient people in an unusual environment (Dewitt, 1991). Through using these types of solutions, habitats on the Moon can have a good start in becoming humane.

2.10 EXPANDABILITY, REPLACEMENT, AND RENOVATION

2.10.1 ISSUES

As the needs of the base grow, so will the size of the base. Because of this need, expansion must be kept in mind even at the beginning stages of the base. Even though the final layout of the base won't be known at these early stages, the ability to add on must be assured. This can be done by planning a number of possibilities for expansion which cover a broad spectrum of the future possibilities.

2.10.2 FINDINGS

The need for expansion of the base would suggest that the location of the base allow open space around it for other elements to be added. Access room will also be needed for the transporting of the new elements. Renovation and replacement will require elements to be interchangeable and easily movable. The layout of the base should allow geometric expansion, such as rectangular or triangular grid layouts, which provide ample expansion possibilities (see Figure 2.10.2-1).

2.10.3 DESIGN REQUIREMENTS/RECOMMENDATIONS

Because of the high cost of transporting items to the lunar surface, any structure we place on the Moon will need to be reusable once it's function is duplicated elsewhere. This would suggest that any structure, more importantly movable structures, must be modular so they can be placed elsewhere to serve other purposes. The base design should be geometric, allowing more than one possibility for expansion.

Modularity should also carry through on the interior of the structures. Any type of equipment or furnishings should be able to be movable to other locations if so desired. This will aid in the updating of the base, and will allow the inhabitants to change their environment more easily if they so desire. Modularity also aids in the replacement of outdated or damaged equipment, since the replacement piece will be of the same nature.

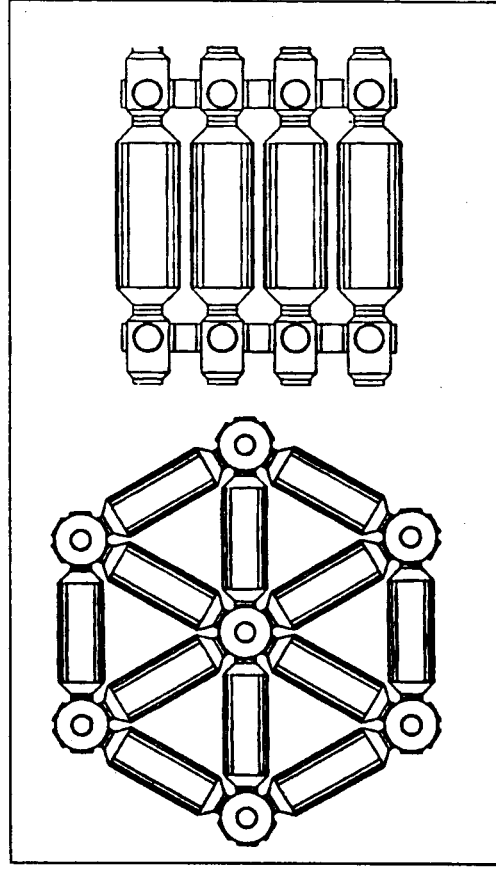

Figure 2.10.2-1. An example of different geometric configurations that could be adopted for a base layout (SICSA, 1989).

2.11 SHIELDING

2.11.1 ISSUES

Anything we build on the lunar surface will need protection from radiation, temperature fluctuations, and micrometeorites. Radiation, from cosmic rays, requires the largest amount of shielding, and will determine the minimum amount needed. This protection is provided to the Earth by our atmosphere, but the Moon has no atmosphere and will therefore require some other protection to be provided. This protection can be provided in a few ways, but most add up to the same conclusion-mass.

2.11.2 FINDINGS

Most scenarios for protection use the lunar regolith as a barrier for the structure. Since the main requirement for protection is simply mass, most any material could be used. Solid metal plates could be brought from Earth, requiring smaller shields, but the transportation costs would be so great that this option becomes infeasible. With the lunar regolith being plentiful, it becomes the most logical source for shielding.

2.11.3 DESIGN REQUIREMENTS/RECOMMENDATIONS

The regolith could be poured over the structure in a large pile. If access is required to the structure later, however, large amounts of regolith will need to be scooped away. The regolith could be put in sacks, much like sand bags, and piled on top of the structure. This makes access easier since only the bags around the affected area need be removed. Still another option is to build a structure to contain the regolith, and then pour the regolith into this structure. With this method, the regolith support structure can be built with a standoff from the structure being protected. Access becomes very easy, and EVA work will be done under the protection of the shielding. A final option would be the use of lava tubes found on the Moon. These lava tubes will provide all protection needed for any structures placed in them.

2.12 ENERGY CONSIDERATIONS

2.12.1 ISSUES

The energy requirements of a lunar base are not unlike those found here on Earth. The base will experience peak loads, and times when demand is low. A few options are available to provide power to the base, and these will most likely be used in combination to serve all needs of the base.

2.12.2 FINDINGS

The first option is solar power. By placing solar cells on the Moon, power can be generated and used. The major drawback to this method is that the Moon experiences a night period equal to 14 Earth days. This means some other form of power generation will be needed during this time.

Battery storage becomes a possibility for the needs of a lunar base. The batteries can be charged by the solar cells during the lunar day, and then power can be drawn off them during lunar night.

Nuclear power on the Moon is yet another option. By placing a relatively small nuclear generator on the Moon, much of our power needs will be met. Although nuclear power is a very attractive option, it also has side affects. The problem of what to do with the radioactive waste produced by the nuclear generator is one which is not easily solved, and must be considered.

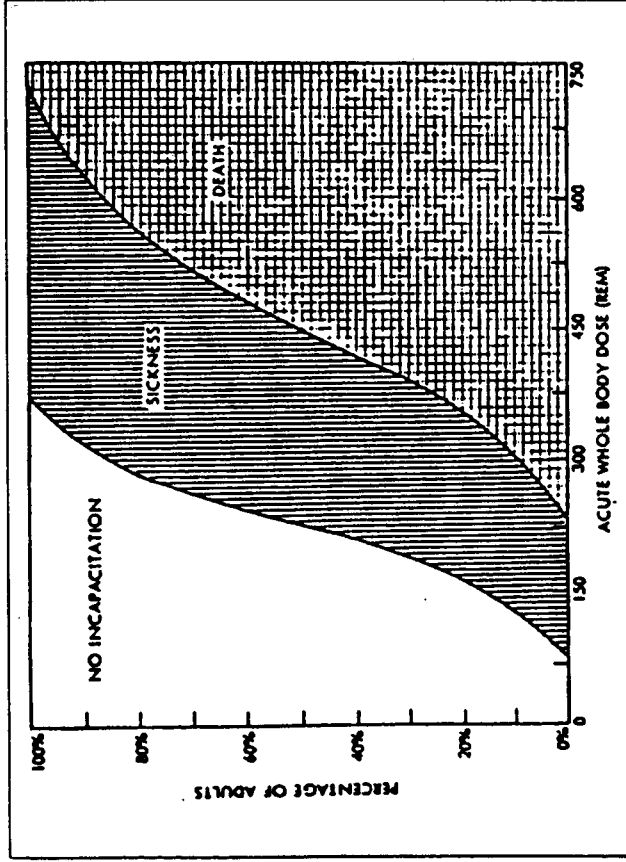

Figure 2.11.1-1. An example of the harm that radiation has on humans (Haffner, 1967).

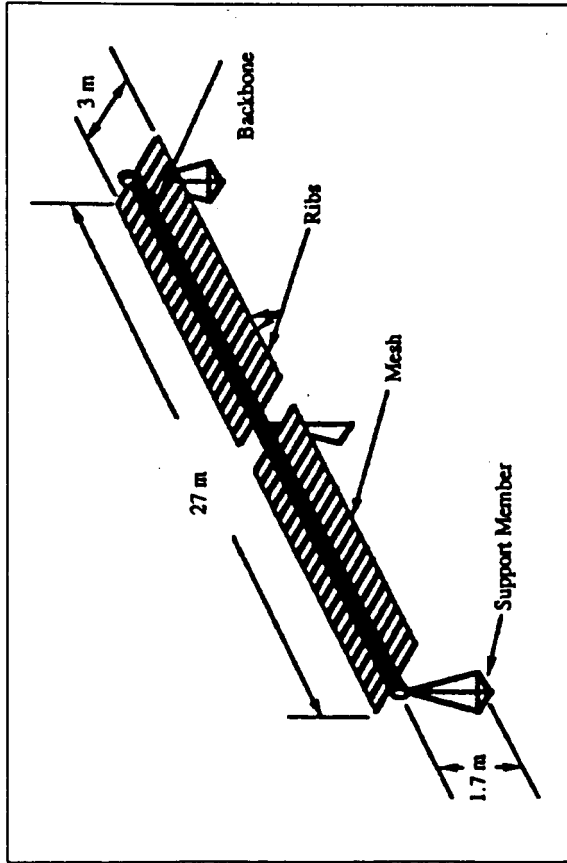

Figure 2.12.2-1. An example of a typical solar array structure (Bruckner, 1990).

2.12.3 DESIGN REQUIREMENTS/RECOMMENDATIONS

All three of the above mentioned options have benefits, but none of them will work alone. Instead, the three should be used in combination to support the energy needs of the base. Solar power should be used during of the lunar day to collect the free, clean power of the sun. The excess power collected by the solar arrays could be stored in batteries for later use during the lunar night. As of supplement to the batteries, a small nuclear generator should be used during the lunar night, or during peak hours during the lunar day. With these options working together, the benefits of all will be gained by the base.

2.13 BIOSPHERE CONSIDERATIONS

2.13.1 ISSUES

The driving force behind having a lunar base is that of experimentation. We will use the lunar base to conduct experiments which will further our knowledge in many areas. One of these areas is that of biospheres.

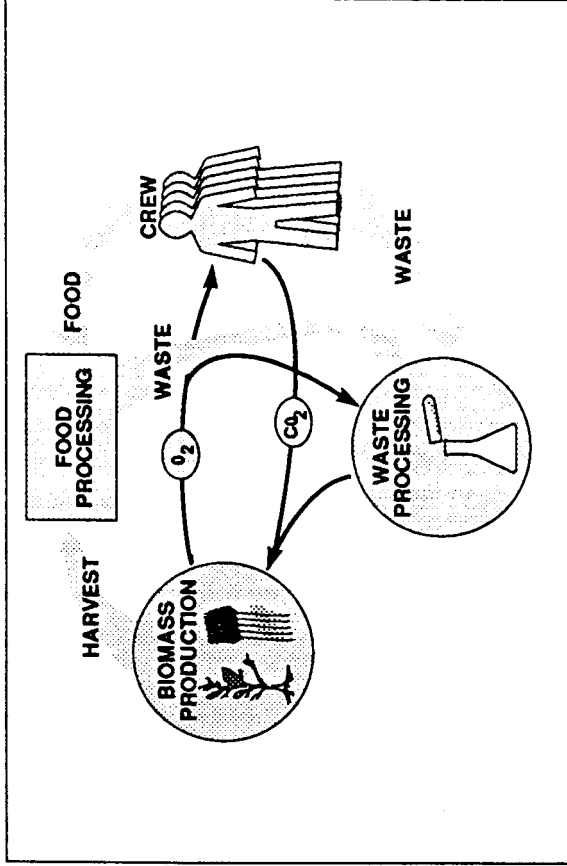

Figure 2.13.2-1. The regenerative process that a biosphere incorporates into it's day to day functioning (Cordes, nd.).

2.13.2 FINDINGS

By providing a means of experimenting with plant and animal growth in a simulated biosphere environment we will gain a better understanding of how to use these resources to their full potential. A properly functioning biosphere will help eliminate many of our resupply needs. Air, water, and waste products can be recycled, and food provided to the crew by a well designed biosphere. The biosphere could also become a tie to the Earth for crew members.

2.13.3 DESIGN REQUIREMENTS/RECOMMENDATIONS

A biosphere should be incorporated in the design of a lunar base. The biosphere will provide a place for testing the possibilities in plant growth, giving us insight into future potentials for habitats. A supplement to the food supply can also be provided by the growth of crops which can be used by the crew. Not only does the biosphere provide scientific benefits, but also psychological, becoming a place of contemplation for the crew, and providing possible hobbies.

2.14 ENVIRONMENTAL CONTROL LIFE SUPPORT SYSTEM/HEATING, VENTILATING, AND AIR CONDITIONING CONSIDERATIONS

2.14.1 ISSUES

With the entire base being sealed, the environmental control life support system (ECLSS) becomes extremely important. The functioning of the base will depend heavily on the condition of the atmosphere inside the habitat. If the air quality should drop, not only will productivity suffer, but the crew members health could also be in jeopardy.

2.14.2 FINDINGS

All movement and conditioning of air must be done mechanically since we no longer have windows open to the outside. The air which will reside in the structures will also need to be constantly recycled, filtering and reintroduced to the base, since the amount of air available will be limited.

Water will also be very limited in a lunar habitat. Any water there will need to be recycled, using filtering processes, and reintroduced into the system.

2.14.3 DESIGN REQUIREMENTS/RECOMMENDATIONS

With the many different types of areas in the base, the ECLSS system will need to deal with the complexities of the variations present. Smells from areas such as personal hygiene and exercise will not want to be allowed in adjoining areas, and must be dealt with in the ventilation system. Areas not being used for a number of hours may be kept a lower temperature to save in energy demands. Water will be recycled and reused many times. All of these factors must be considered when designing the ECLSS system.

2.15 CONSTRUCTION TECHNOLOGIES

2.15.1 ISSUES

Building a structure on the Moon is not a straight forward proposition. There are many different types of structures that can be constructed, and the type that is chosen depends on the situation at hand.

2.15.2 FINDINGS

Early lunar structures will most likely be built on Earth and transported to the Moon. These structures will probably be self contained elements such as those used in the proposed Space Station Freedom (SSF). Other structures which are bigger but still use this idea of a self contained, completely outfitted unit will also be used.

As time passes, and our experience on the Moon expands, we will begin building bigger structures using materials transported from Earth. A relatively new but promising technology is that of inflatable structures. A large membrane can be made into a number of different shapes which when inflated on the Moon, can provide shelter. These inflatable structures not only provide large open spaces, but are light weight to transport since they collapse down to a very small size.

Eventually enough knowledge will be gained of the Moon and it's resources to use these resources as building materials. The lunar regolith can be used in many different ways. It can be used much like concrete in the construction of anything from roads to walls in a building. Similar to concrete, the regolith can be melted and cast in forms in any number of shapes. Another option would be sintering, which is melting the upper layer of regolith to provide a continuous surface. An example the use of sintering would be in the creation of roads by melting the top layer of regolith to form a hard surface.

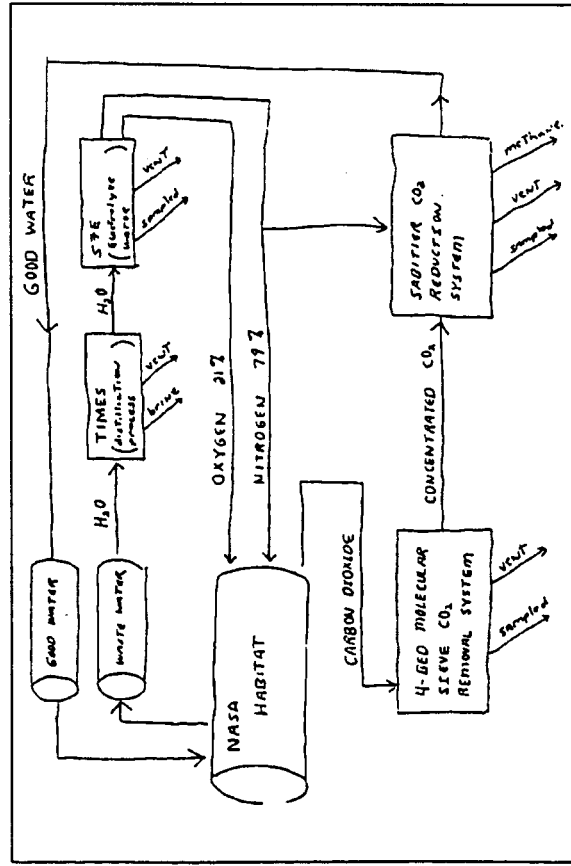

Figure 2.14.2-1. The method of recycling water for reuse in a lunar habitat (Buscher, 1991).

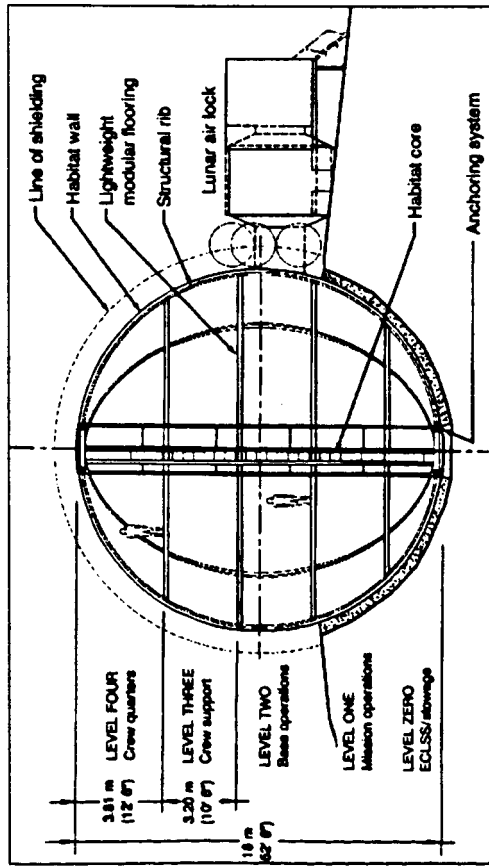

Figure 2.15.2-1. An example of an inflatable structure proposed by NASA. Note the interior structure which must be erected and entirely self-supporting (Alfred, Bufkin, Kennedy, Petro, Roberts, Stecklein, & Sturm, 1989).

2.15.3 DESIGN REQUIREMENTS/RECOMMENDATIONS

The construction of a lunar base will not be done all at once. It is a lengthy, difficult process involving many technologies. The first elements to be used should be small and self contained. These will be easy to transport and quickly utilized on the lunar surface. Larger Earth based structures, such as inflatables should be used next, providing much more space, but still using near term technology. Finally, lunar resources should be used to construct lunar structures, lessening a lunar bases dependence on the Earth.

2.16 LUNAR STRUCTURES

2.16.1 ISSUES

The actual structure to be used on the Moon will depend largely on the activity it will hold. Since crew members will be staying on the lunar surface for long periods of time, any activity that would be found on the Earth, could be found on the Moon. This means a large number of different structures will be required for the many different spaces which will exist.

2.16.2 FINDINGS

Whatever the structure, construction on the Moon differs from that on Earth. Any structure on the Moon that will contain an atmosphere is essentially a pressure vessel. This constraint directs the nature of the structure to a great extent. Also, with only 1/6th gravity, spans can be twice that found on Earth. Much less material is required since loads will not be as great. With just these two changes, it can be seen that a typical lunar structure will be far different than anything we are used to on Earth.

2.16.3 DESIGN REQUIREMENTS/RECOMMENDATION

Activities requiring a number of small spaces could be housed in a SSF type module, since it is small in size itself. Areas with larger space requirements, or a number of closely tied areas will need a larger space, where an inflatable type structure, which can be quite large in size, may be chosen. Even larger spaces may be created using lunar resources to construct large habitats. Any of the above options could also be combined to work together in providing the needed space for a lunar base.

2.17 CONSTRUCTION MATERIALS

2.17.1 ISSUES

A number of different materials show promise for use in construction on the Moon. A material which is to be used on the Moon should have the following characteristics: high strength, low weight, and high tolerance to temperature fluctuation.

2.17.2 FINDINGS

Of the metals which can be used, aluminum and titanium have properties which make them very desirable for use on the lunar surface. The SSF modules which could be used on the Moon are constructed of aluminum sheets,

A material which could be used for inflatable lunar structures is Kevlar. This material, which can take the form of a fabric like sheet, is extremely strong, and very light weight. It is used here on Earth for items such as bullet proof vests, but on the Moon could be used to form the membrane of an inflatable structure.

Structural foam will also play a part in lunar construction. It can be shipped very compactly, and expand to whatever shape is required on the

2.18.2 FINDINGS

Many tasks which must be done can be accomplished by using telerobotics. This allows the crew to control construction from the interior of the base, avoiding the dangers on the lunar surface. Robotics can also be programmed to do long, repetitive tasks easily. When human intervention is required, the tasks they are required to do should be well practiced, so no surprises are encountered while out on EVA. The way pieces go together should be well thought out to go together easily.

2.18.3 DESIGN REQUIREMENTS/RECOMMENDATIONS

Relatively simple tasks could be done using telerobotics. This keeps the astronauts from having to go out on EVA. In operations where a human must be present, construction needs to be simplified to be easy, safe, and quick.

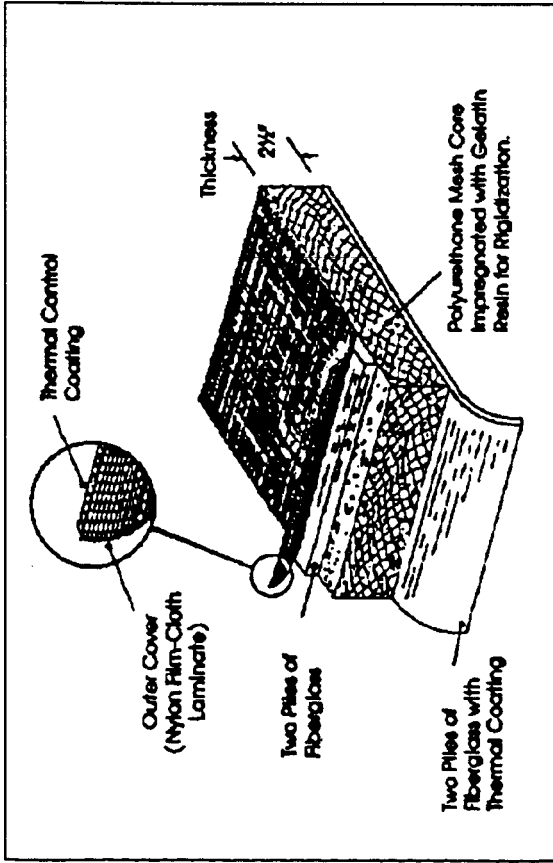

Figure 2.17.2-1. An example of a foam-rigidized wall system (SICSA, 1988).

site, and harden into its final form. Structural foam will most likely be used in combination with inflatable structures. When the foam is allowed to harden between two membranes in an inflatable structure, the resulting form will not only be air-tight, but will remain rigid even if the interior pressure should drop.

2.17.3 DESIGN REQUIREMENTS/RECOMMENDATIONS

All of the above mentioned materials will become very useful for lunar construction. Light, strong metals such as aluminum and titanium should be used for elements which require strength, and must be shipped in their final form. For larger structural elements, Kevlar and structural foam will become very useful. The elements can be transported in compacted form, and be erected to their final form once on the lunar surface.

2.18 CONSTRUCTION SEQUENCING

2.18.1 ISSUES

The sequence in which lunar construction is done needs to be well planned. Every minute spent on the lunar surface is expensive, and dangerous, so the less time spent, the better.

3 GENESIS II ADVANCED LUNAR OUTPOST DESIGN

3.1 SITE SELECTION

The purpose of site selection is to provide a geologically and geographically rich environment. Additionally, the surface features should be able to sustain roadways between the launch facilities, habitat, and surface operations. The Apollo 15 site contains features that range from flat expanses to cratered areas, from low hills to higher ridge areas. Hadley Rille, a sinuous geologic feature, also exists in this area. It suggests the presence of the lunar lava tube which is a volcanic lava channel beneath the lunar surface.

Genesis II will make use of the anticipated existence of a lunar lava tube. Precursor survey missions will define an optimal location for penetrating the roof of the lava tube. An anticipated collapsed section will allow egress from not only the surface portion of the base, but through the opening as well.

The site provides smoother areas for the construction of the launch and landing facilities, and protected areas in which the nuclear power plant can

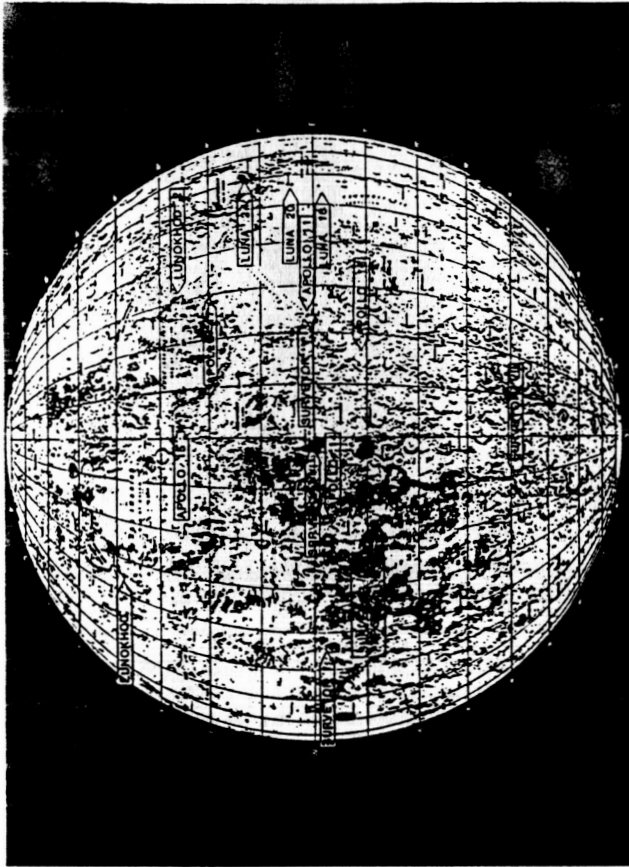

Figure 3.1-2. A lunar map, including all of the Apollo landing sites.

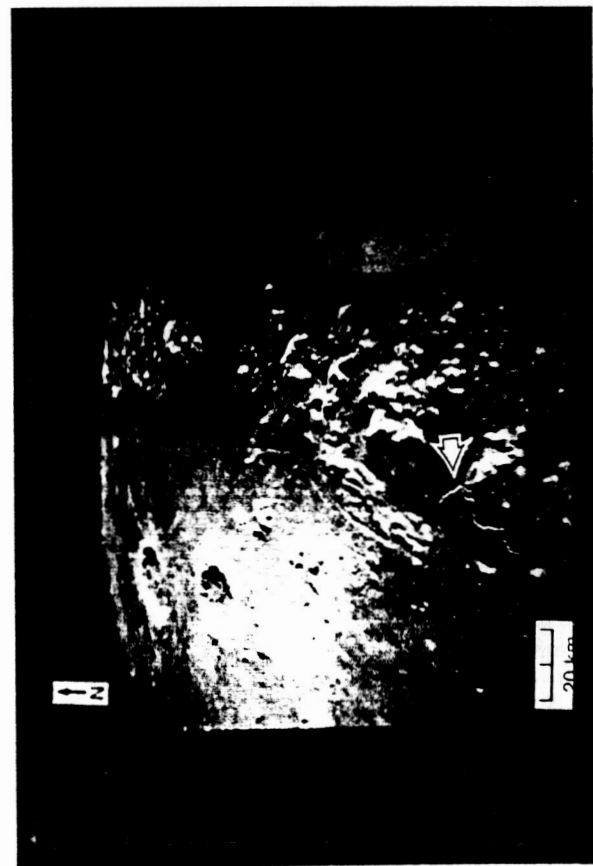

Figure 3.1-1. Apollo 15 site.

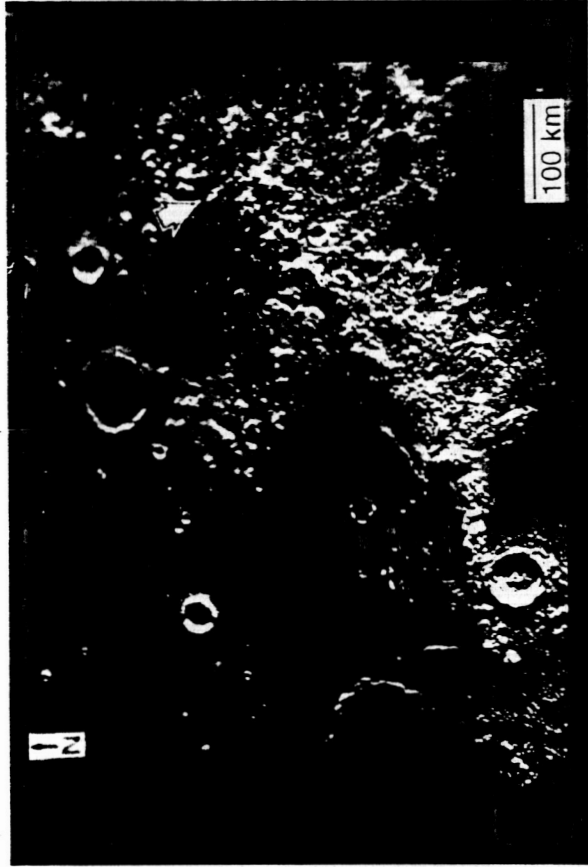

Figure 3.1-3. Apollo 15 site - Approach to Genesis II base location.

PRECEDING PAGE BLANK NOT FILMED

ORIGINAL PAGE IS
OF POOR QUALITY



Figure 3.1-4. The proposed Genesis II location.

be built. Near the base nucleus, the solar array field can be erected, protected from launch pad debris and clear of shadow-producing obstructions.

3.2 BASE SITE SELECTION

The Genesis II zoning is divided into three categories: industrial, hazard, and inhabited. These were selected as a result of the base and mission operations detailed for Genesis II.

The area included in the hazard zone is the nuclear power production facility. It's location will be no less than 1 kilometer away from the habitation and laboratory area. Located in the industrial zone are the launch and landing pads and the mining facility. The launch and landing facilities have been placed at the northern-most location of the base. This location provides for landings from eastern and westerly directions, and helps reduce the hazards from exhaust blasts or launch and landing failures. The distance between the launch area and the habitation area is approximately 3 kilometers, and between the habitation and the mining facilities is 1.25 kilometers. Lastly, the manned zone will contain the far-

side astronomical observatory, the solar power field, and the habitation and laboratory facilities. This area is more centrally located in Genesis II.

3.3 MASTER PLAN

The Genesis II base is designed in a linear fashion on a north-south axis, with the components consisting of the launch and landing facilities, solar power array field, mining facility, habitat and laboratory facilities, nuclear power generator, and a far-side astronomical observatory. The linear design provides safety for the base by prohibiting space vehicles from flying directly overhead. There will be transportation channels connecting these areas, observing the necessary safe distances between them. These distances are determined from the zoning requirements established due to the nature of the various activities occurring at the sites.

The zoning divisions are the result of an increased awareness of what effects will be produced by the living and working facilities on the Moon. This is an attempt to prevent damage, either intentional or unintentional, which may result. The effort is international in scope, with the International Lunar Environmental Protection Authority (ILEPA) being created from the Environmental Protection Agency model on Earth (Schroeder, 1990). It addresses the effects which will occur on the lunar surface, its subsurface, near surface and on-orbit environs. Suggested zones for a lunar base are:

- hazard zone (including nuclear power stations, bio-hazard areas, genetic engineering facilities and any activities that would be designated as extremely dangerous to humans or the lunar environment),
- industrial zone (mining operations, launch and landing, or other surface operations),
- inhabited zone (habitation areas, laboratories or frequently occupied pressure facilities),
- wilderness (areas to be saved from exploration, yet accessible),
- parks (those areas designated as historically, geologically, or scientifically significant).

3.4 CONSTRUCTION SEQUENCING

In order to understand the sequencing process, the components comprising Genesis II are as follows: on the surface of the Moon will be the assembly facility and protection truss-work. Below the surface, within the lava tube cavern, will be the truss-work, two space station-derived modules, an extravehicular activity (EVA) module, and two inflated structures.

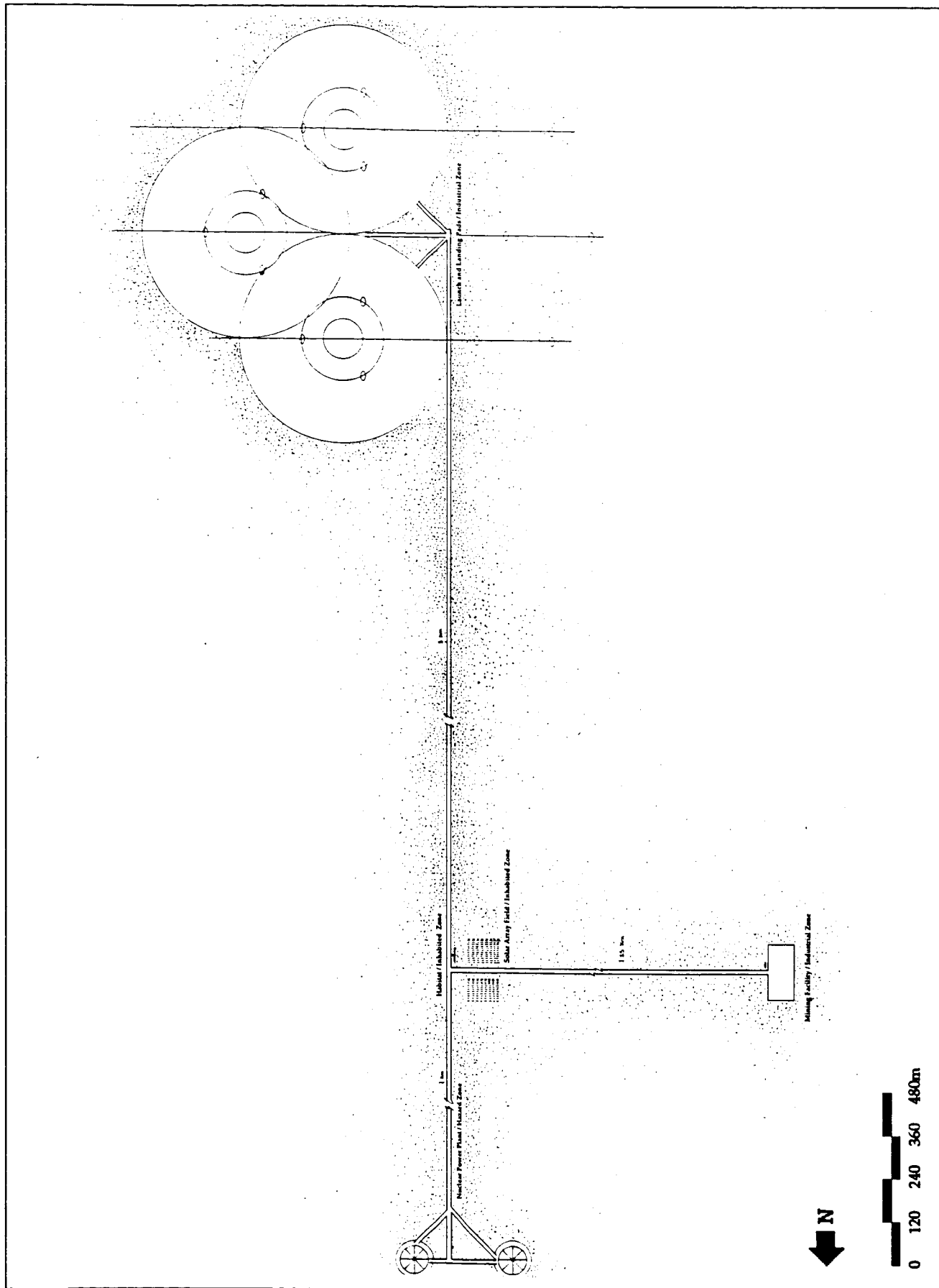

Fig. 3.3-1 The Genesis II Base Master Plan--launch and landing facilities located to the right, habitation/laboratory areas near center, power facility to left, mining facility to the left. (Note: North is to the left).

Genesis II: Advanced Lunar Outpost



Figure 3.4-1. Emplacement phase: Equipment being landed for the construction of the base.

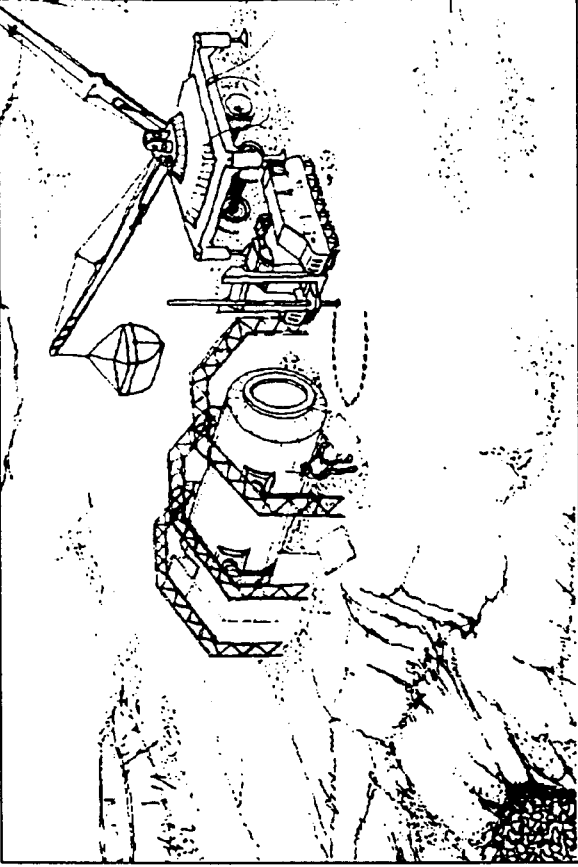

Figure 3.4-2. With the assembly facility in place, the hole is sintered into the roof of the lava tube.

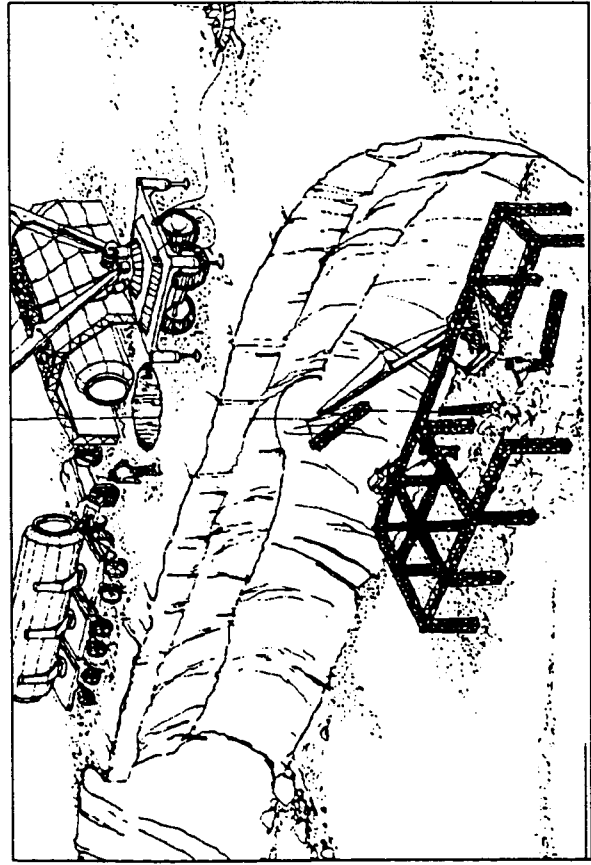

Figure 3.4-3. Integration phase: A crane lowers pieces of the space frame into the lava tube.

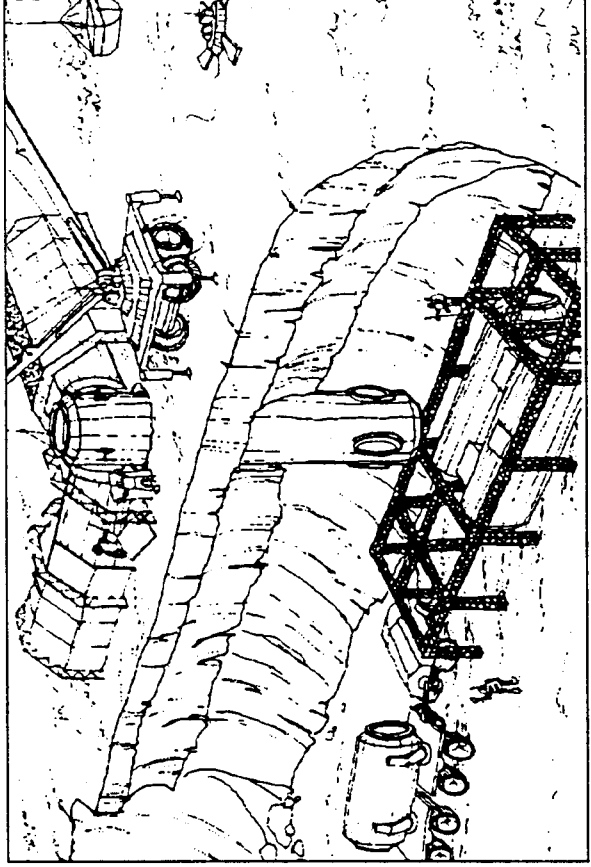

Figure 3.4-4. A Shuttle-C module is lowered into position through the hole in the lava tube's roof.

Connecting the surface to the base below will be a Shuttle-C derived module. At its initial operating configuration, Genesis II will see the assembly facility module moved to the mining area of the base, and in its place will be two logistics modules and an additional EVA module. Centered over the Shuttle-C module, and used as a connection point for the logistics and EVA units, will be an interconnect node.

The precursor missions to the lunar surface will have determined the optimal site, and robotic missions will bring the necessary equipment for site preparation (grading, leveling, bulldozing, lifting, and sintering). At that time as well, the module used as the assembly facility, fully out-fitted, will be landed. Once that equipment has arrived on the Moon, manned missions will begin the base construction sequencing.

The first task is the placement of the assembly facility and the erection of the radiation protection truss-work, with accompanying regolith covering. The crew members will proceed to cut through the roof of the lunar lava tube to access the cavity below. The process of cutting through the roof of the lava tube begins with a long rod, the length of which will be greater than that of the roof thickness. This rod is attached to a sintering vehicle. The rod is heated to 1400 degrees Celsius, and will melt through the lunar surface to the lava tube cavern below. This is repeated in a circular fashion creating a perforation. Small explosive charges will dislodge the center section. It is anticipated this section will drop to the cavern below and then is cleared away. Once the entrance to the lava tube is open, the crew must complete a clean-up process, removing rocks, regolith, and any additional debris which will impede construction. After site preparation, and the securing of any anticipated lava tube roof weaknesses, the truss-work will be lowered in through the opening to the floor below. A crane will be necessary to complete the truss construction, although it can be a smaller version.

The truss-work will be the supporting structure for the EVA module and the space-station modules, which will "hang" above the ground surface of the lava tube. Once they are secured, the Shuttle-C module can be lowered into position, connecting to the top section of the common module, and connected at the surface by the interconnect node. Inflation of the soft modules can commence, with construction of their interiors occurring as the logistics and EVA modules are delivered and set into position.

When all the components have been delivered, placed into position and secured, the actual interior configuring will commence. At the same time, any further clearing away of debris from the lava tube cavern will occur.

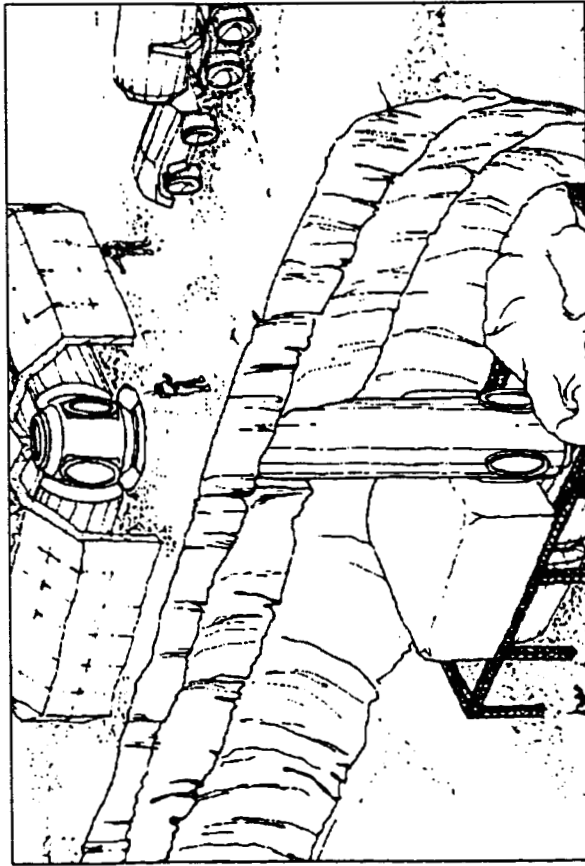

Figure 3.4-5. Initial Operating Configuration: The habitation inflatable is in place and the laboratory inflatable is being erected.

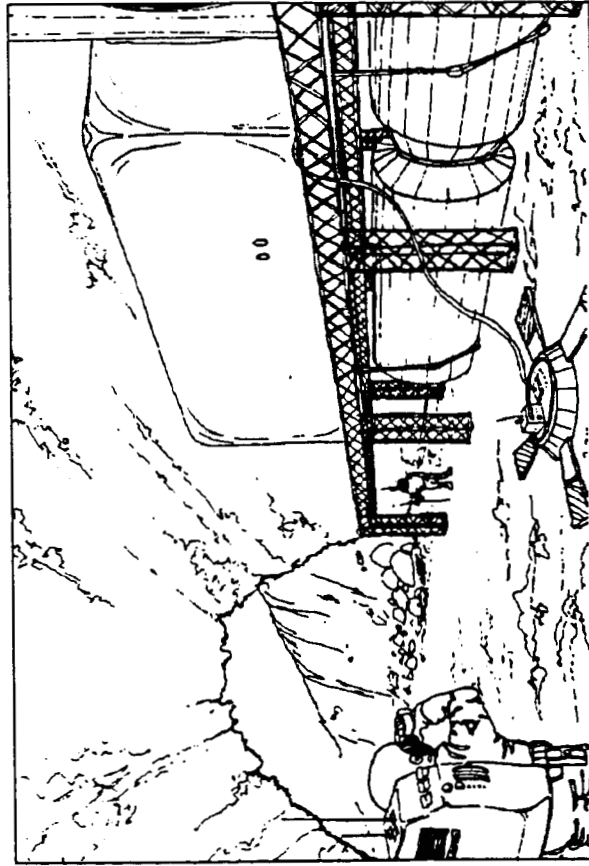

Figure 3.4-6. The base in its completed form.

Genesis II: Advanced Lunar Outpost

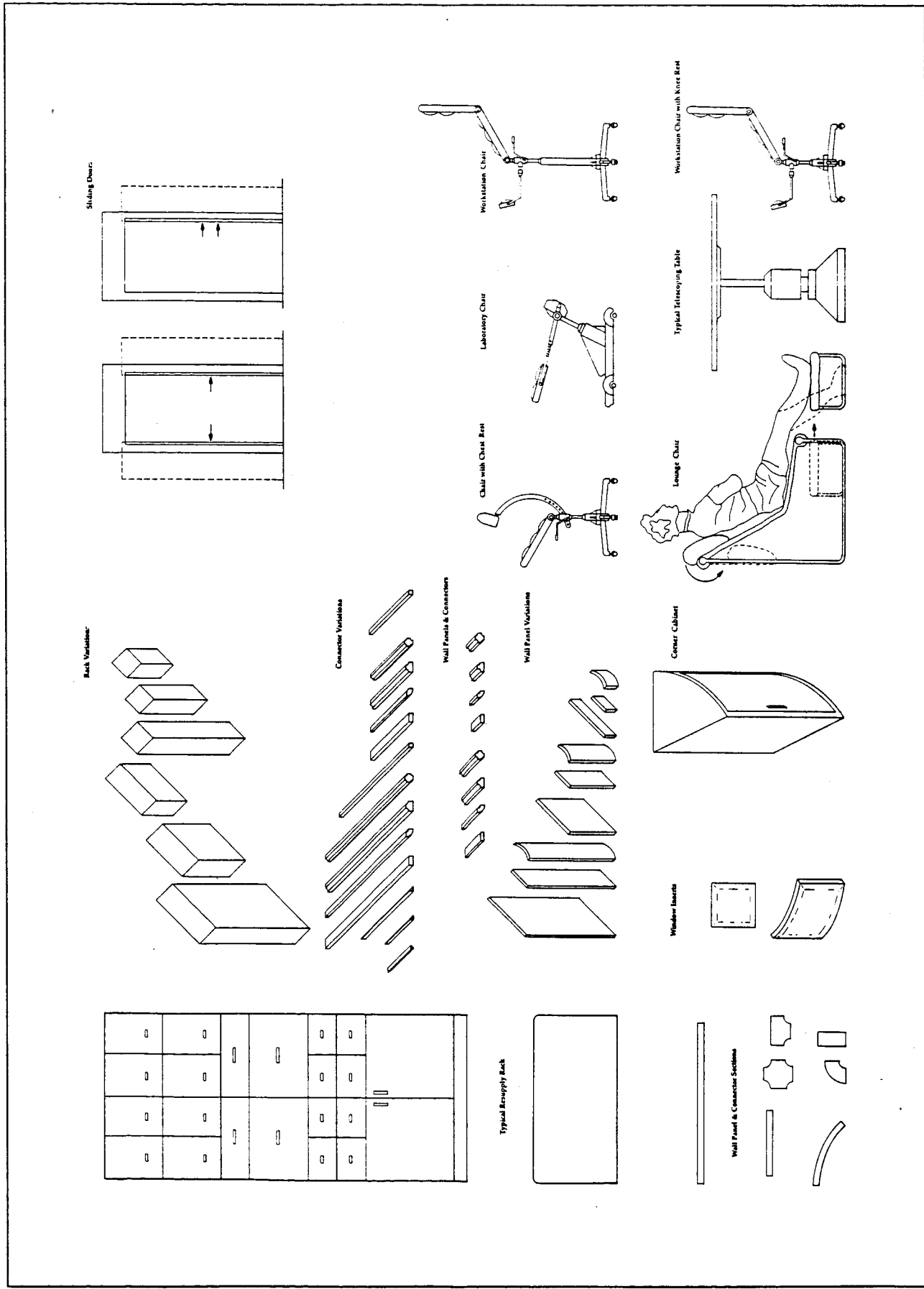

Fig. 3.5-1 The Modular Construction Component System. This is the basis of the interior configuration, based on a grid system measurement of 1.2 meters.

3.5 MODULAR PANEL AND RACK DESIGNS: A KIT OF PARTS

The design of this lunar base has been based on a system of modularity. Modular components utilize an easy system of emplacement and resupply. The pieces are sized to be transported through the hatches and be moved about the base from the logistics module on the surface. To address these requirements, a baseline measurement was determined. For the needs of the lunar base, both in transporting items, and responding to human anthropometrics, 1.2 meters was chosen. This corresponds with the human reach and the body position while in 1/6th gravity. Wherever possible, sizing of the pieces were designed within the 1.2 meter requirement, or a multiple thereof.

As in Space Station Freedom, a rack system has been chosen for the base. Not only does the rack system allow easy movement of items, making rearranging spaces easy, it also allows interchangeability in items, allowing the ability to switch around racks in the base. This also allows interchangeability when replacement is needed for things such as logistics, or if a rack should become damaged or inoperable.

The racks themselves will vary in height and width but will conform to the 1.2 meter system or its derivative. Connector variations allow wall systems to interconnect in any number of possible combinations. This reinforces the crew's ability to reconfigure personal spaces, as well as easily reconfigure areas as the base expands. Wall panels are designed with ease of maintenance in mind. Color will be easily applied to a surface either by manufacturing or by inserts, or simply with velcro-applied textural combinations.

3.6 PHASE I: EMPLACEMENT PHASE

The Emplacement Phase is the first manned mission phase. After the machinery necessary to prepare the site is landed, crew members will accompany the Assembly Facility to its proper location. This facility consists of a fully-outfitted pressure vessel, 13.6 meters long by 4.5 meters in diameter, constructed like the space station module model. The four crew members will oversee the base construction, on a mission rotation of approximately two weeks.

The Assembly Facility contains all life support necessities. It consists of an EVA (extravehicular activity) and pressure suit chamber, sleeping quarters, galley and wardroom, and hygiene facility. Within the modular rack system will be a "safe-haven" rack where medical supplies will be

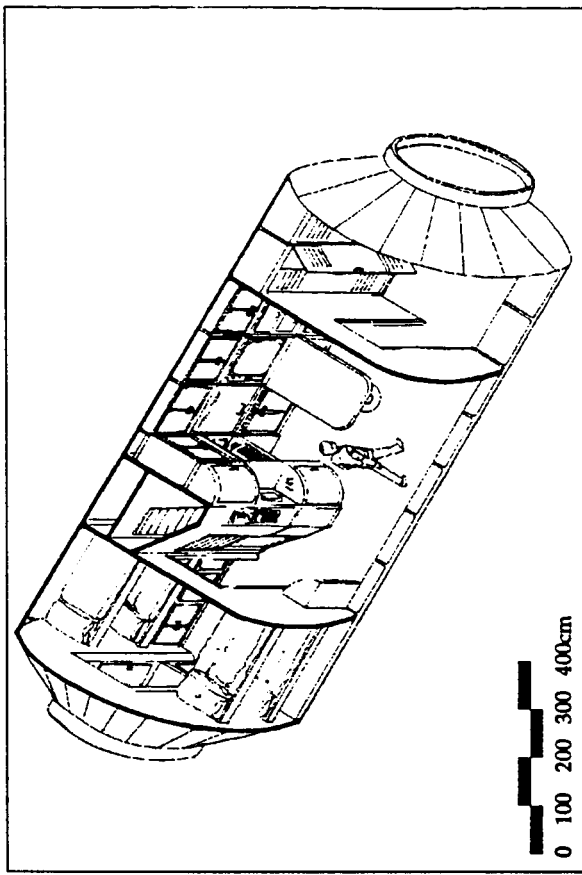

Fig. 3.6-1 The Assembly Facility used in the Emplacement Phase. This structure contains support facilities for a crew of four: crew quarters, hygiene, galley, and airlock with suit storage..

housed. Exercise performance will be minimal given the shorter mission durations.

This facility will be reconfigured when extended missions are performed, and a greater number of crew quarters are necessary. Once additional components for the base have been landed and brought to the site, the crew will begin the Integration Phase. The reconfiguring of the Assembly Facility will begin only after full crew support exists in other areas of the base. The final destination for the Assembly Facility will be adjacent to the mining field.

3.7 PHASE II: INTEGRATION PHASE

This phase of base construction is a reconfiguration phase. The base is expanding, yet is not mature, with all sections functioning. Integration will see the delivery of the balance of the base components, an increase in the size of the crew, and final construction of the surrounding surface facilities.

3.7.1 SURFACE LEVEL 1

Included on the surface of the base will be the temporary Assembly Facility, an interconnect node, EVA chamber and logistics module. It is during this phase that the actual lava tube roof penetration will occur. A description of the process is found in Section 3.4 Construction Sequencing. All these structures will be protected underneath truss-work incorporating a regolith infill system. This system provides for a double layer of Kevlar with expansion space between. Regolith is then introduced between the layers and fills to reach a width of .5 meters. The truss-work is enveloped in this protective covering, allowing the logistics module and Assembly Facility to be removed and replenished.

3.7.2 SHUTTLE-C CYLINDER

This structure will be dedicated for storage and translation core activities. The vertical movement will occur in the central portion of the 4.5 meter diameter. Around the perimeter, in a typical stowage level, eight modular racks can be installed. The translation core will permit mobility of the racks between levels and into the inflatable sections of the base.

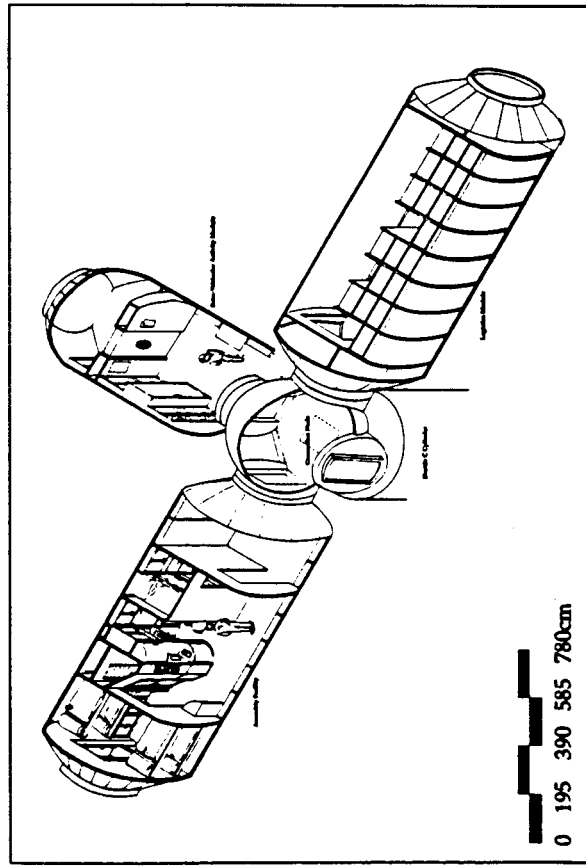

Figure 3.7.1-1. The surface level of the base allowing easy access to the lunar surface and efficient changeout of the logistic modules.

3.7.3 LAVA TUBE LEVEL 5

During the Integration Phase of construction, the base has expanded to support seven crew members. With a portion of the crew support facilities on the surface, the balance will be housed within the lava tube.

Within the Crew Support Module, there will be a limited exercise facility, a full hygiene facility, the mission operation's workstations and the health maintenance facility. This will be a module which will see some reconfiguration as the base matures. The Habitation Module has a number of combined activities. There will be galley, wardroom, passive and active recreation areas, pressure suit stowage, and wardroom stowage.

An EVA module will be connected to the habitation module, and it will provide additional suit stowage as well as access to the interior of the lava tube through the airlock.

As mention before, reconfiguration of the two larger modules will occur. Remaining will be the health maintenance facility and hygiene facility. Mission operations remain unchanged as well. The limited exercise facility will move into the inflatable crew support area. The space available will be dedicated to health maintenance stowage and general stowage for the mission operations sector.

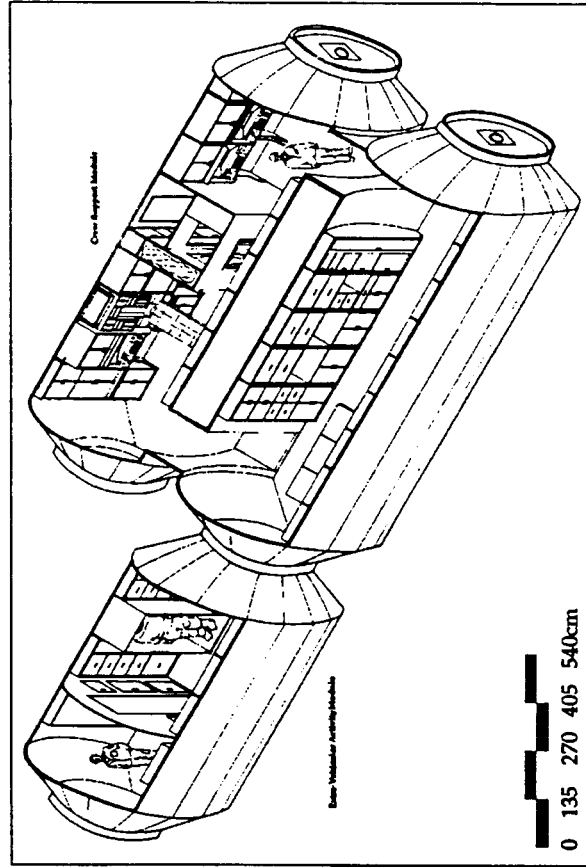

Fig. 3.7.3-1 Level 5 of the Integration Phase. This area is reconfigured as the base grows with additional galley, wardroom, suit maintenance, EVA chamber, exercise facility and hygiene facilities.

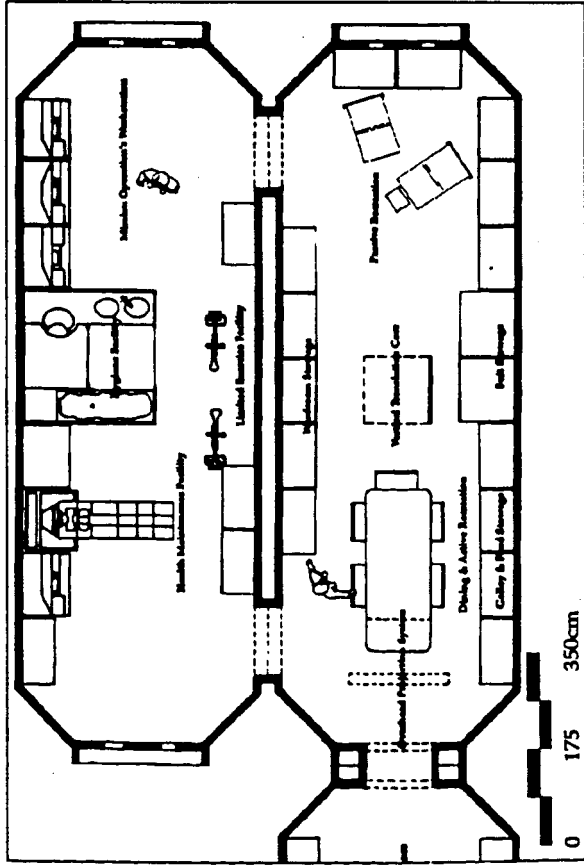

Fig. 3.7.3-2 The plan of Level 5 of the Integration Phase. medical and missions operations are complete.

The habitation module sees the greatest reconfiguration. It will house pressure suit stowage chambers and maintenance workstations for the suits.

3.8 PHASE III: INITIAL OPERATING CONFIGURATION

The initial operating configuration (IOC) will house eleven crew members. All of the components will be in place and functioning.

3.8.1 DESIGN ORGANIZATION

The overall image and organization of the Genesis II base is that of the separation of work and living. This is accomplished through an established set of criteria: safety, habitability/human factors/environment-behavior considerations, using advanced near term technology, and replaceability/modularity. The safety factor, a crucial element in the designing of a lunar base, is achieved through situating safe-havens throughout the base. A safe-haven is a modular rack supplied with all the necessary equipment

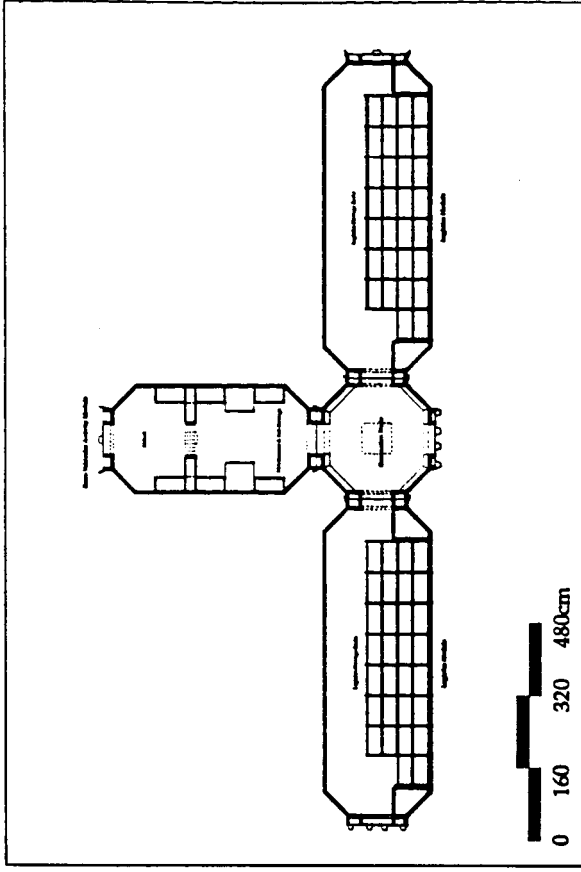

Figure 3.8.1-1. The upper level of IOC on the surface of the moon, which houses the EVA module and the logistic modules.

needed to neutralize an injury or hazardous situation. Dual egress, a vitally important element in the safety of the crew, is located at the top of the base on the surface of the Moon-and below where the roof collapsed. Habitability is derived by allowing the crew the ability to change or adjust anything undesirable to fit their needs. Using advanced near-term technology will give credibility to Genesis II in that it can be built without having to wait until the technology is developed. The kit of parts modular design allows replaceability and modularity. By giving the crew the opportunity to change anything undesirable, it will relieve possible stress. These criteria are used through out the entire five levels of the base.

The first level contains one of the two EVA modules which contains the suit stowage, maintenance, and airlocks. There are also logistic modules which can be attached and removed from the base as needed.

The Shuttle-C module (level 2), which is the spine connecting the top and the bottom parts of the base, is the vertical translation core and the main area for stowage (see Figure 3.8.1-1). The modular replaceable racks can be easily held here until needed.

The habitability inflatable is physically separated from the rest of the base, attached only through a connection node and an emergency hatch. It faces the entrance to the lava tube creating good views to the moonscape.

Genesis II: Advanced Lunar Outpost

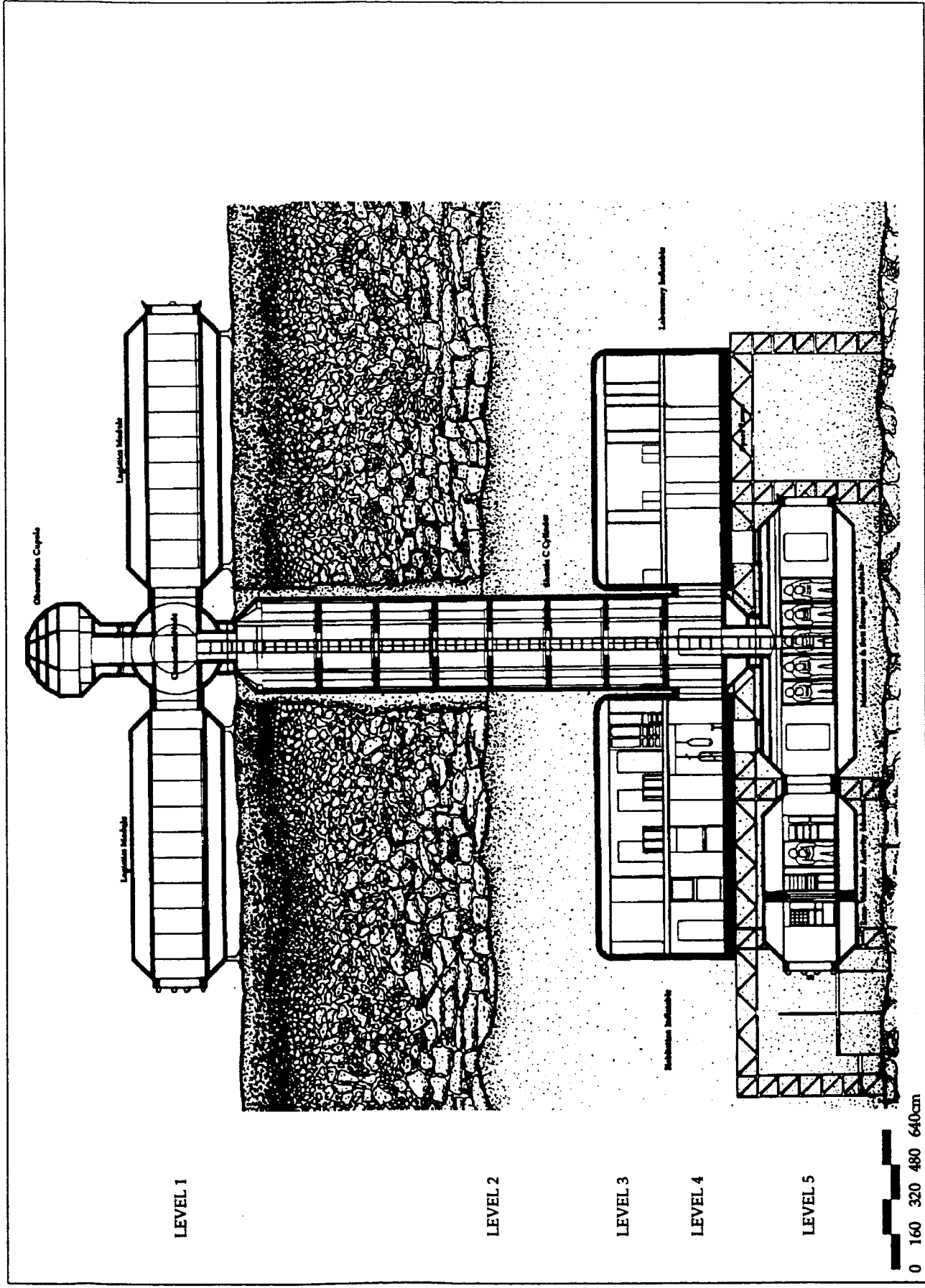

Figure 3.8.1-2. A section of the base, including the Shuttle-C module which connects the elements in the lava tube with the lunar surface.

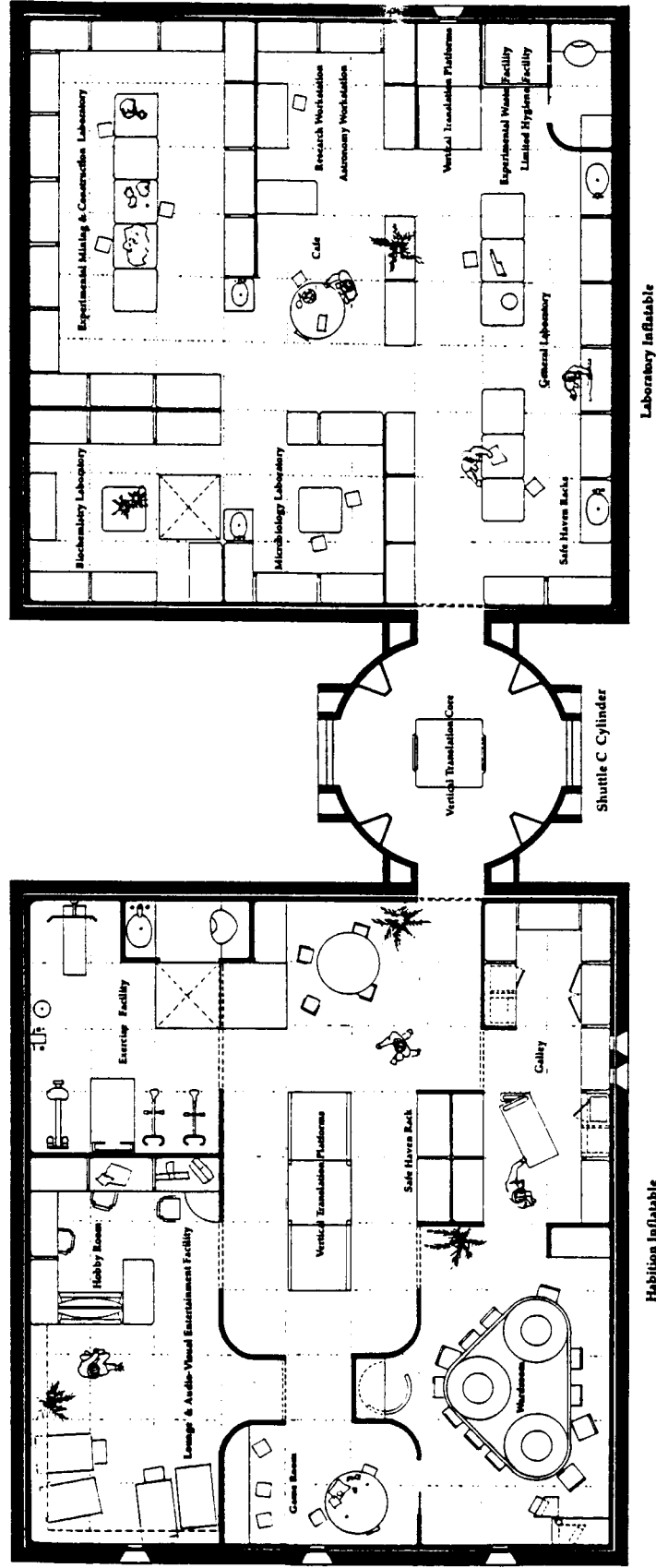

Figure 3.8.1-3. Shown on the left is the plan of the lower floor of the habitat inflatable, showing the galley, wardroom, exercise, limited hygiene facility, and a number of recreation areas. On the right, the laboratory inflatable is shown, including a general laboratory and a number of specialized laboratories.

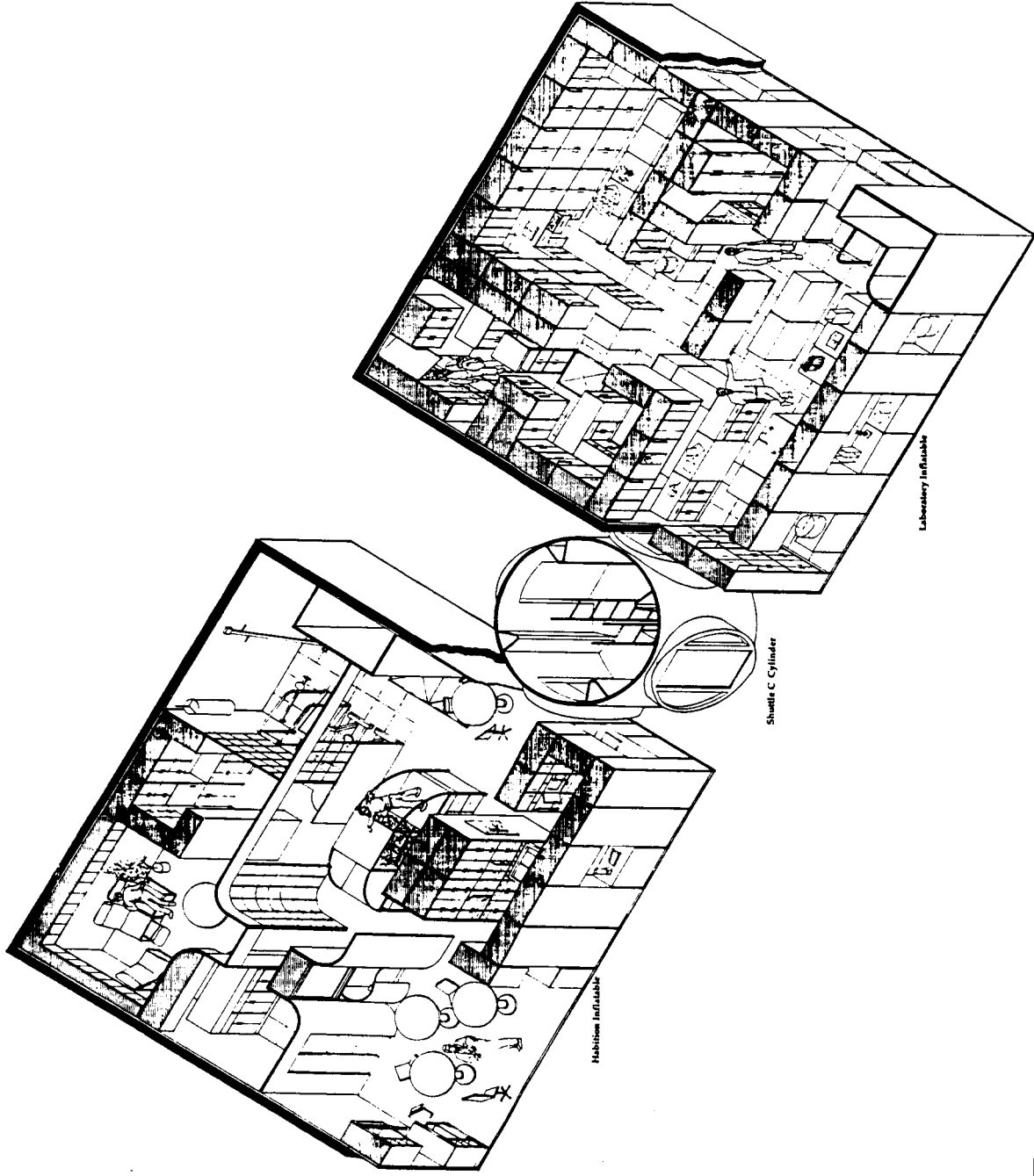
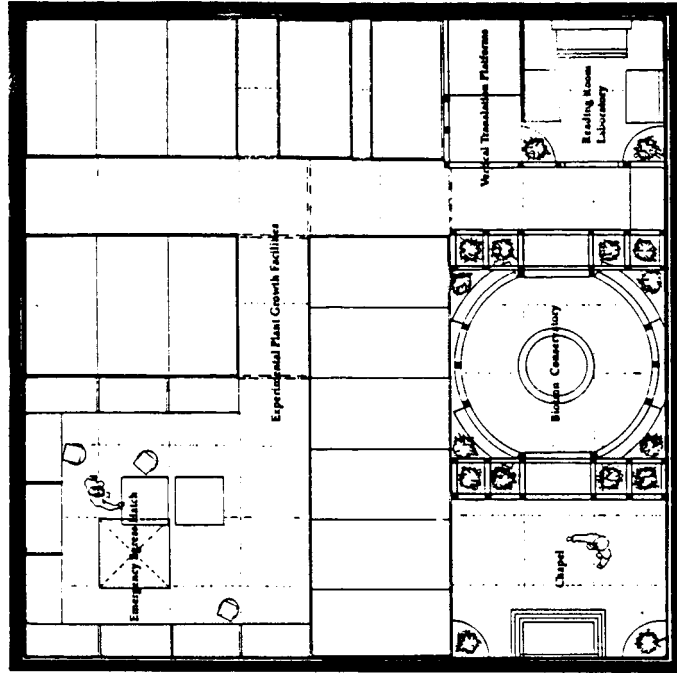
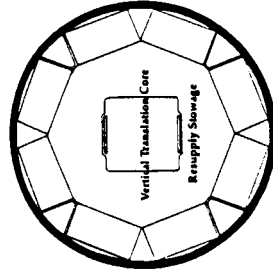

Figure 3.8.1-4. The interaction of areas on the lower level of the inflatables connected by circulation through the Shuttle-C central core..



Laboratory Inflatable



Shuttle C Cylinder

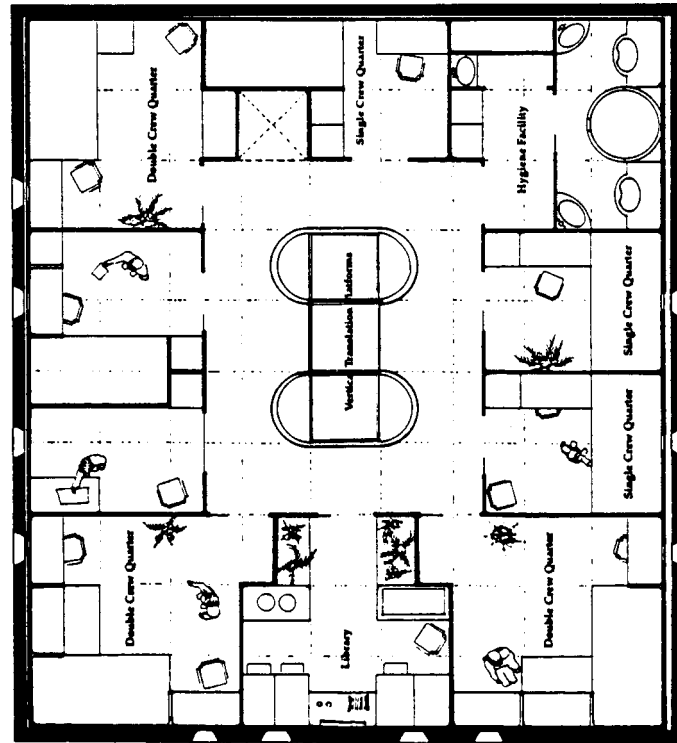

Habitation Inflatable



Figure 3.8.1-5. Shown on the left is the upper floor of the habitation inflatable which includes crew quarters, personal hygiene and a small library. Shown on the right, the laboratory inflatable includes the biotrom and several contemplation areas.

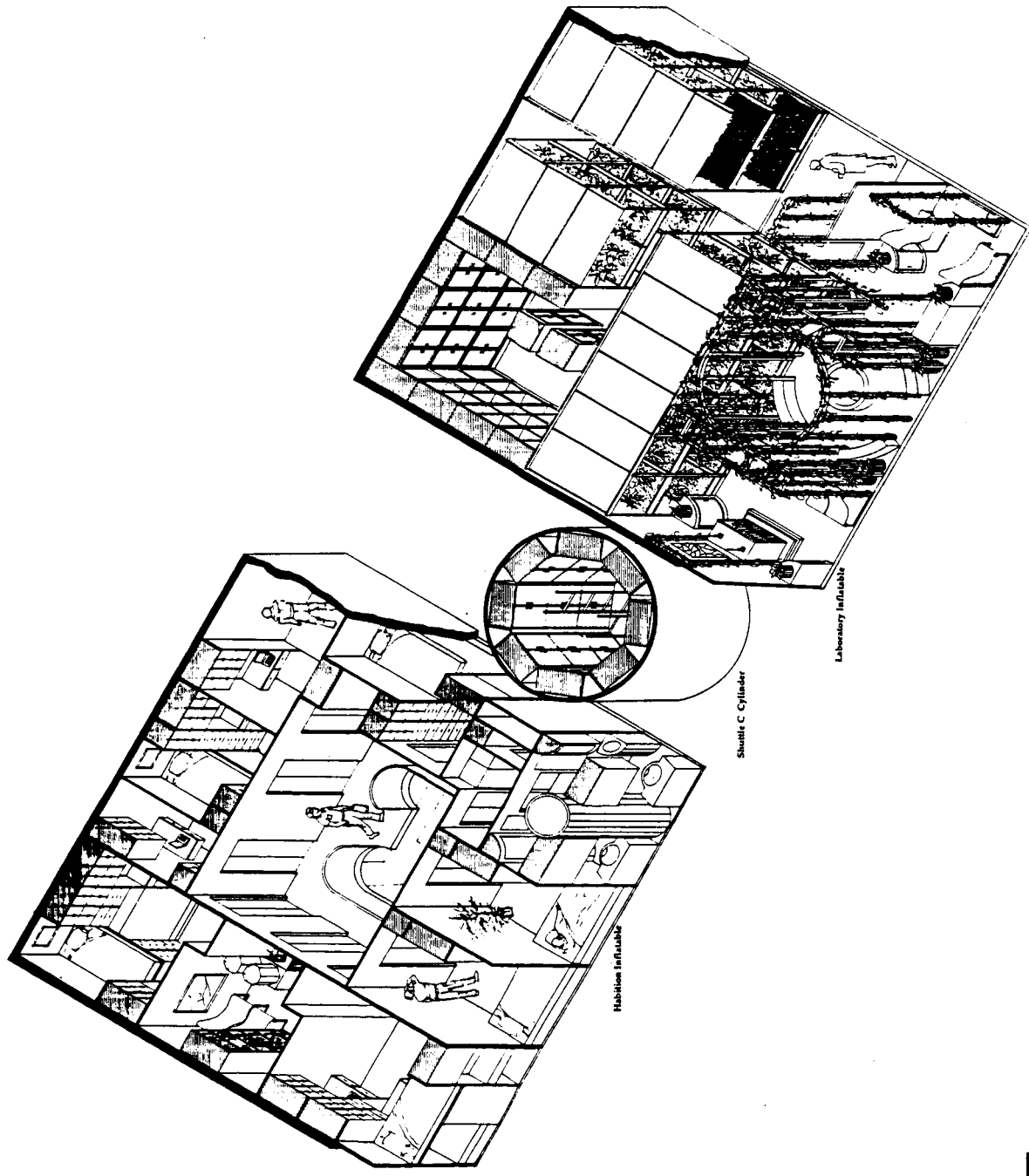

Figure 3.8.1-6. The left side of this axonometric shows the many variations in the crew quarters including single and double crew quarters and a possible larger single crew quarters for the mission commander. The right side shows the interaction between the contemplation areas and the biotron.

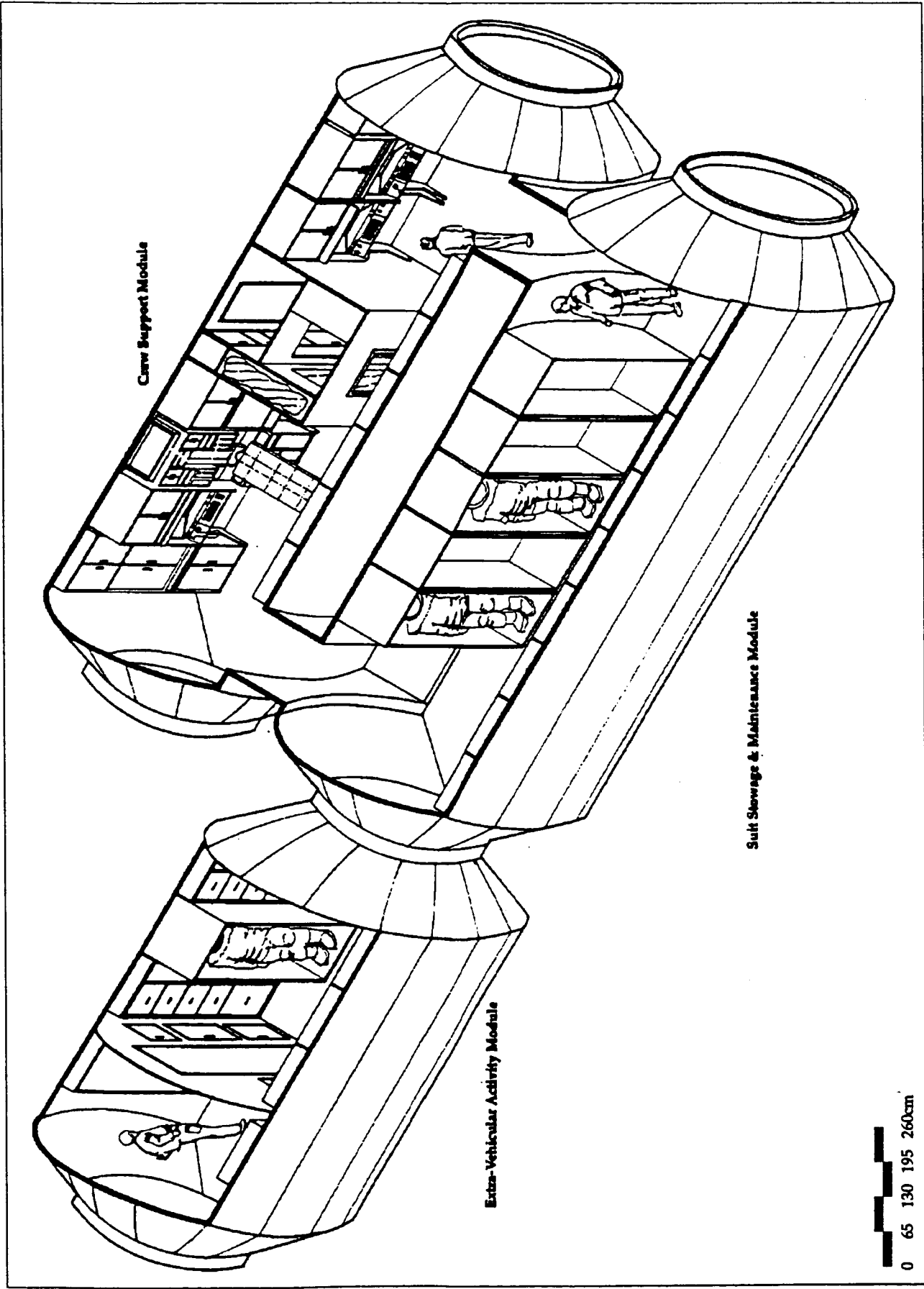

Fig. 3.8.1.7. Initial Operating Configuration Level 5 at the base of the larva-tube.

Genesis II: Advanced Lunar Outpost

Being almost totally isolated allows the crew to not only leave work mentally but physically as well. It is important to be able to get away and to go "home."

On the other side of the Shuttle-C modules is the laboratory inflatable. Here most of the scientific work will be done. This appendage faces into the lava tube thus allowing views to the lit interior.

Below this three modules are hung from the space frame. Medical and mission operations make up one 4.5 meter by 13.6 meter modules. An identical module holds suit stowage and maintenance. Attached to that is a 4.5 meter by 7 meter module containing the EVA chamber (see Figure 3.8.1-6).

Equipment, vehicles, and experiments will be stored inside of the lava tube. This will protect them from the harmful radiation and the irritation dustiness of regolith.

3.8.2 ENTRY AND LOGISTICS FACILITY

Because it is essential to have dual egress, there will be two entries located in the base. The main EVA chamber is situated on the surface of the moon, acting as the front door. Most of the activities will be occurring on the surface of the moon thus the need to have an entrance on top. The secondary entrance, or back door, is located in the lava tube. Because a lot of the outside equipment will be stored inside the lava tube it is important that it be easily and efficiently reached.

Both of the EVA chambers will be in modules 4.5 meters by 8 meters. They will contain an airlock, suit stowage (two suits), and a maintenance facility. The top module is covered with regolith for protection against the harsh lack of environment of the moon.

The logistics facilities are modules 4.5 meters by 13.6 meters and are located on the surface of the moon. They flank either side of the EVA module and are attached to a connection node. Regolith also covers the module for protection but allows them to be removed (i.e. one side is open). These facilities are temporary in that when emptied they will return to earth and be replaced by new ones (see Figure 3.8.1-1 on p. 31). The modules are sent with modular rack full of new supplies and equipment and are returned with the racks that aren't needed.

3.8.3 STOWAGE

Most of the stowage is located in the Shuttle-C module which also acts as the translation between the modules at the top of the base and the inflatables below, in the lava tube. Surrounding the vertical translation

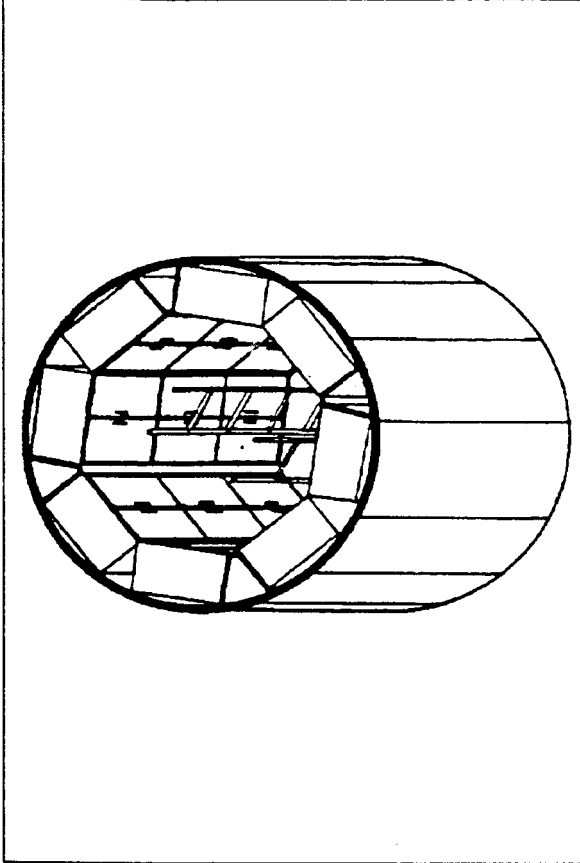

Figure 3.8.3-1. The storage racks in the Shuttle-C module.

core are modular racks meant solely for stowage. It acts as a weigh station between the logistic modules and the habitat elements.

3.8.4 CREW SUPPORT FACILITY

The Crew Support Facility, on the lower floor of the Habitat Inflatable (level 4), is where the crew will be spending most of their time. This is the crew's home, containing all the personal areas for day to day life. The inflatable contains both public and private areas and will service all needs of the crew.

3.8.4.1 Galley

The galley is what we refer to as the kitchen here on Earth. It is designed to be a facility for food preparation for the entire crew of 11. Included in the area are cooking and eating utensil stowage, food stowage, refrigeration units, cleaning facilities, and cooking facilities. Both convection ovens and microwave ovens will be used as well as a standard range top type cooking surface.

As in all other areas, the equipment and stowage in the galley area will use standard sized racks. Some of the racks, such as those containing sinks, refrigeration, or ovens will be more specialized than most standard racks, but will use the same overall dimensions and mechanical line inputs.

As an aid in preparing food, a movable working surface is included in the design. The surface is attached to a swinging, extending arm which allows the work area to be placed in a wide range of areas throughout the galley area. This feature will come in handy when cooking is being done for the entire crew at once, since a large amount of counter space will be required.

3.8.4.2 Wardroom and Dining

The wardroom/dining area is adjacent to the galley. The wardroom normally functions as a dining area for the crew, but is also a place to gather the entire group for meetings, communications with the Earth, and any other event requiring a large number of people to gather.

The seating in the wardroom is provided around three movable tables. The tables, which are round, will normally be in a triangular configuration, but can be rearranged to any suitable placement. In the event of a large group meeting, a triangular shaped working surface can be lowered from the ceiling to cover all three of the tables, making it one large table.

Three viewing screens are arranged such that any of the crew members can see at least one of the screens no matter where they are sitting. The screens will be used for conferences, casual viewing of television, and will be tied into the base informational systems.

3.8.4.3 Group Recreation

The group recreation area, located in a few areas on the first floor of the habitat, is dedicated to the well being of the crew. Group recreation is divided into three separate entities: the hobby room, the game room, and the audio/visual room.

The hobby room is a space dedicated to activities the crew may pursue for relaxation. This could include any number of activities, including but not limited to: model building, plant growth, puzzles, and drawing. With the variation of activities which will be taking place in this space, it will need to be flexible. Included in the space is a large amount of stowage, work surfaces, and a large video screen.

The game room is another recreation area for the relaxation of the crew. The space is designed to accommodate up to seven crew members in any game like activity. This could include board games, dice games, cards, etc. The space is flexible in design and can easily be reconfigured to accommodate other activities.

The audio/visual entertainment room is a place for the crew to gather and either watch television or listen to music. Comfortable, easily movable

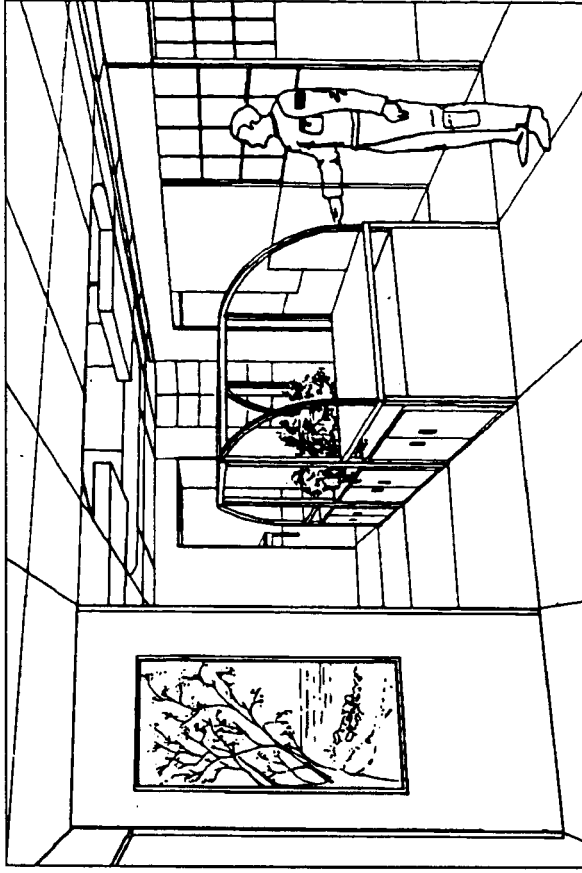

Figure 3.8.4.1. The central translation platform, located in the center of the lower floor in the habitation inflatable, provides a means of bounding to the upper floor.

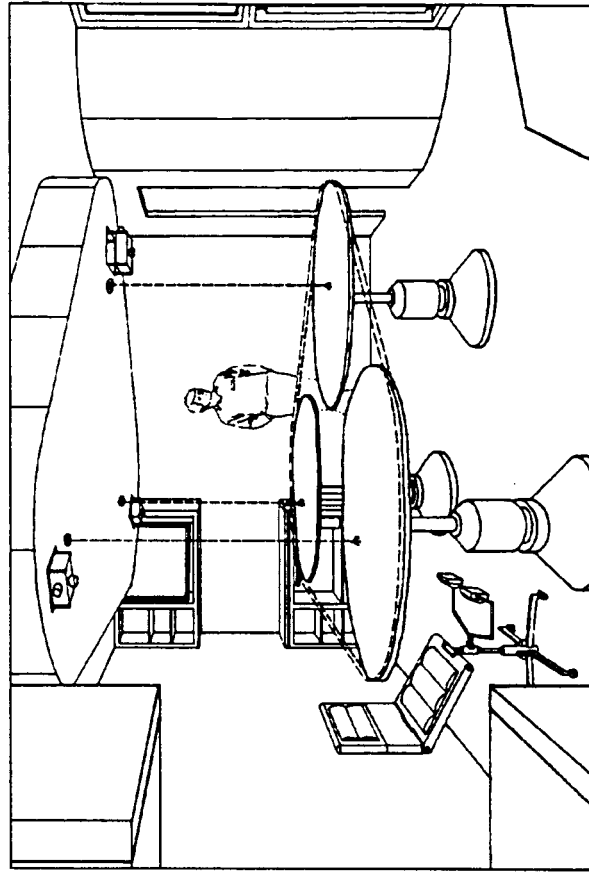

Figure 3.8.4.2-1. A view of the wardroom. Note the raised table, shown in dotted lines, which lowers down over the three smaller tables when a large gathering takes place.

Genesis II: Advanced Lunar Outpost

seating is provided for the crew to gather around the large video screen included in the area. The space is open to many of the other recreational spaces included on the floor so crew members can communicate between the spaces.

3.8.4.4 Exercise Facility

The exercise facility is an important space in the habitat. Because of the lessened gravity, their will be a degradation of the crew members' bodies over time. Not only will their muscles weaken in the lessened gravity, causing cardiovascular problems, but calcium will also leach from their systems, causing problems upon returning to Earth. By providing an exercise area, many of the health problems the crew may experience could be avoided. The exercise area includes exercise bikes, treadmills, a resistance machine, a rower, a stair climber, and a punching bag. All of the exercise equipment will be run through a computer management system. This system will connect to monitors or virtual reality units which allow the user to view stimulating scenes while they exercise. The system will also monitor the users vital signs which will be accessible from the medical center in the base.

3.8.5 CREW QUARTERS

The upper floor of the habitation inflatable (level 3) is a more private area dedicated to personal activities. The floor contains the 11 crew quarters, a multi-unit personal hygiene facility, a laundry facility, and a library. Access to the second floor is gained by bounding platforms located in the middle of the first floor. The opening in the upper floor not only allows passage on the platforms, but allows a view from floor to floor.

3.8.5.1 Personal Crew Quarters

The crew will spend more time in their quarters than any other single area in the base. This will be not only a place to sleep, but a place of retreat. Being confined to the base as they are, they will often desire to get away from others and have time to themselves. The crew quarters will need to accommodate functions such as studying and personal recreation as well as changing and sleeping.

The crew quarters, like all other areas, are designed with flexibility in mind. Part of the function of the crew quarters is to be an experimental testbed. Both double rooms and single rooms are included to test how the crew reacts to the different arrangements. If an arrangement is found unsuitable,

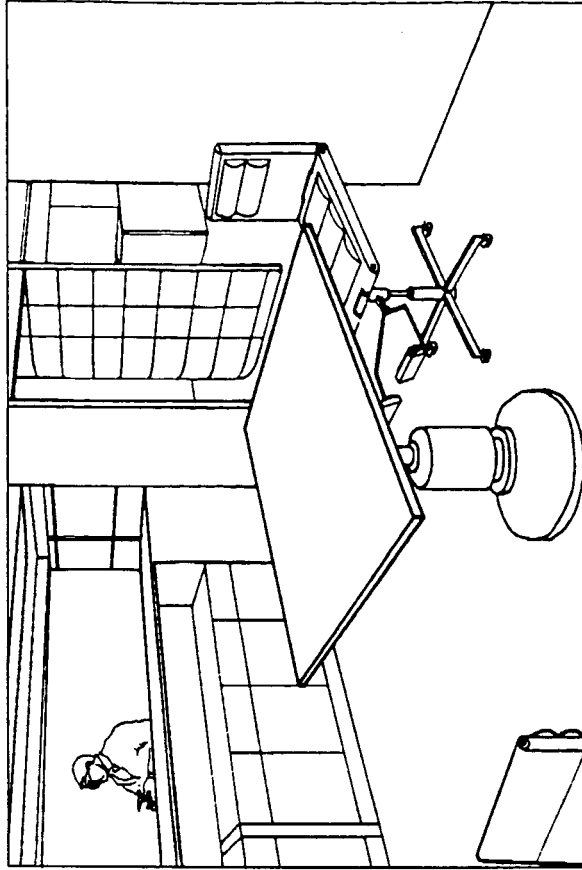

Figure 3.8.4.3-1. The game room is one of the group recreation areas. Located between the wardroom and the group lounge, this space can be used for small group activities, such as card or board games.

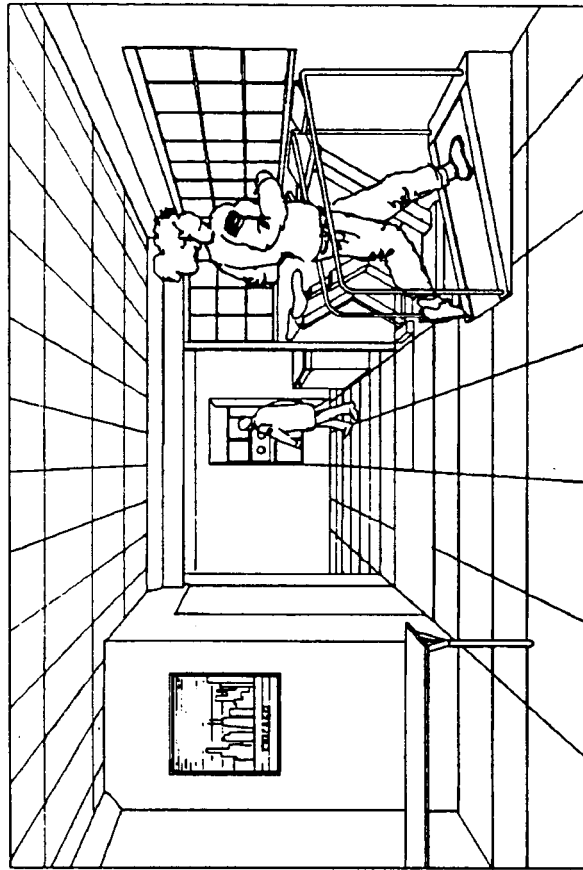

Figure 3.8.4.4-1. A view of the exercise facility, which includes treadmills, bicycles, stair-climbers, a punching bag, and a resistance machine..

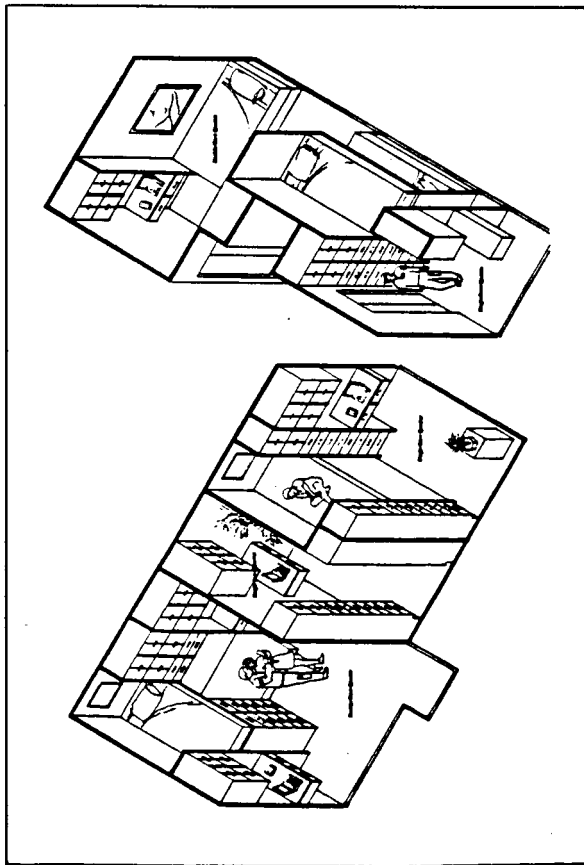

Figure 3.8.5.1-1. A few of the possible arrangements for the crew quarters. Note the overlapping of beds as seen in the right most drawing.

the walls and interior elements are modular and can easily take on a different form. The double rooms also allow married couples to stay together in the base.

Included in the crew quarters are a bed, a desk, stowage, and entertainment items. The beds in the crew quarters are often arranged so the bed of one quarter is placed over a bed of another quarter, with each bed being accessed from only its respective quarter. This arrangement saves space, allowing the crew more floor area in each quarter. Stowage for clothing and other accessories is provided in modular racks. The desk unit is also a modular unit which can be used for any number of personal activities. The room will include a small portable computer unit which can be used for games, telecommunications, and will double function as a television which can be placed anywhere in the room. Also included in each room is a window which will look out into the lava tube. The windows will help provide a place for the crew to contemplate and relax.

3.8.5.2 Personal Hygiene Facility

The base includes a number of personal hygiene facilities located on almost every floor. The main hygiene facility is located on the upper floor of the habitat inflatable. This location will service the crew mainly in the

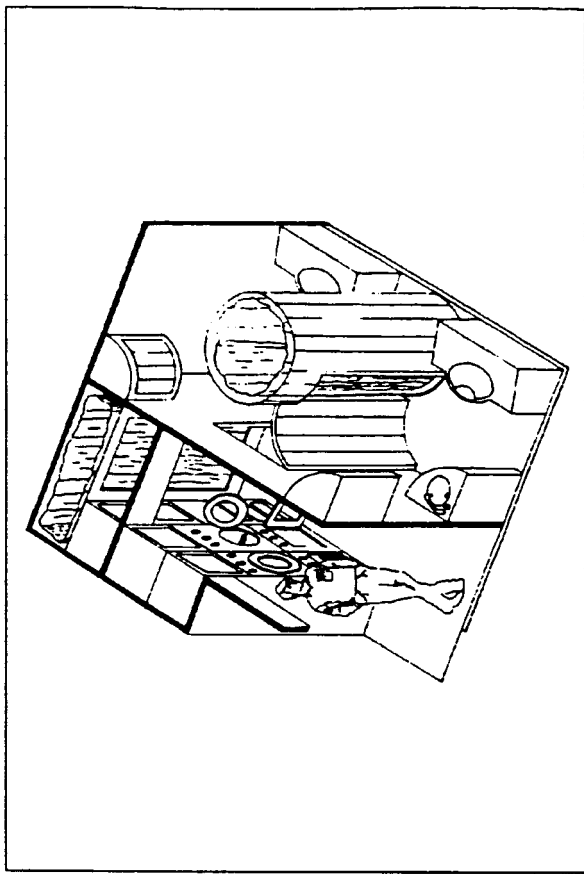

Figure 3.8.5.2-1. The personal hygiene facility includes three hygiene units, and the laundry facility. Note the shared shower for two hygiene units.

morning and the evening when the crew is showering and cleaning. The facility is split into four sections, three hygiene facilities, and a laundry facility.

The hygiene area is designed to provide showering, washing, and toilet facilities for the entire crew. The three hygiene facilities include two showers, two toilets, and three sinks. The first unit in the facility contains a shower unit and a sink. The other two units share one shower unit, and each contains a sink and toilet. The shower unit is designed to be entered from either of the two units, with a sliding door closing the shower off from the other unit so privacy is assured.

3.8.5.3 Laundry Facility

The laundry facility, included in the personal hygiene area on the upper floor of the habitat inflatable, will serve all of the crew member's clothes washing needs. The area includes two washers and two dryers. A small amount of stowage is also included for keeping of washing supplies. Small working platforms pull out of the washer dryer racks to provide a surface for folding cloths and other needs.

3.8.5.4 Library

The library area is located on the upper floor of the habitation inflatable and can be seen from the first floor through the vertical circulation opening in the floor. The area is meant to be a retreat for the crew, and includes book racks, aquariums, and comfortable, couch-like furniture. The library also includes two windows which look out towards the opening in the lava tube. This will make the library a pleasant place to go for relaxing and contemplating.

3.8.6 RESEARCH LABORATORIES

The research laboratories are located on the first floor of the laboratory inflatable (level 4). The space is designed to allow as much openness as possible. As one would enter the facility, a window would be seen as a focal point between the bounding platforms terminating the central translation path. The space opens up in the center allowing for a meeting place where daily activities can be discussed. Running along the perimeter of the inflatable, the laboratories are located (see Figure 3.8.1-2).

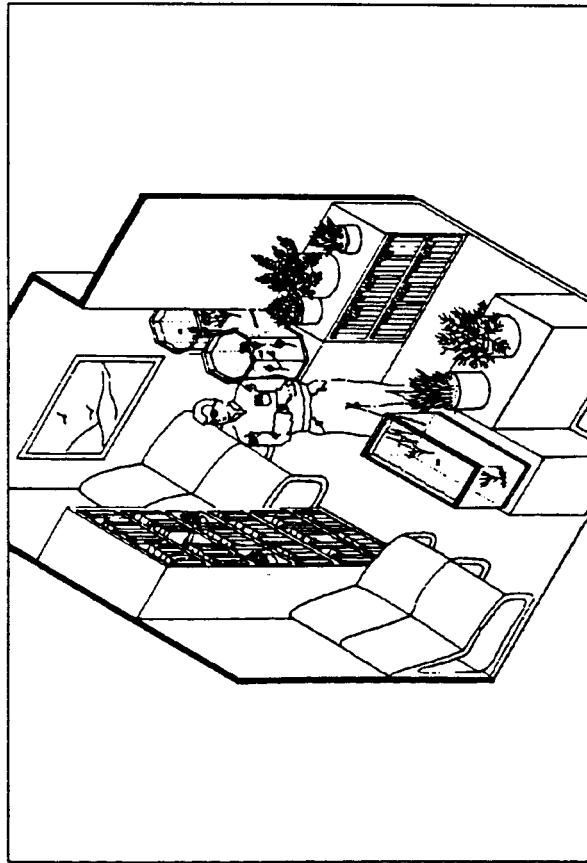

Figure 3.8.5.4-1. A view of the library area, which will be a place of contemplation for the crew.

There are six specific scientific functions that occur here: microbiology, biochemistry, experimental mining and construction, astronomy, environmental-behavior monitoring of the crew and habitat, and experimental waste recycling. In addition to these functions there is a general laboratory, a small cafe, and a half hygiene facility located on this floor (see Figure 3.8.1-2).

The aforementioned functions each have their own private work area. Here all the special equipment needed for each function is stored. All the shared equipment and most of the work space is located in the general laboratory. The specialized areas contain full sized and half sized modular racks. This is to allow as much space to be open as possible. Psychologically, the crew will be able to see and here each other most of the time. The areas can be isolated by pulling an accordion like curtain around the space. The cafe, being situated in the center, is designed to be a place where the crew can congregate comfortably during breaks without having to track all the way to the habitation inflatable in order to get a snack. The window that is located between the bounding platforms has a view into the lava tube. Here activities (experiments and maintenance) can be monitored. Since the lava tube will be illuminated the view should actually be quite stimulating (see Figure 3.8.6-3).

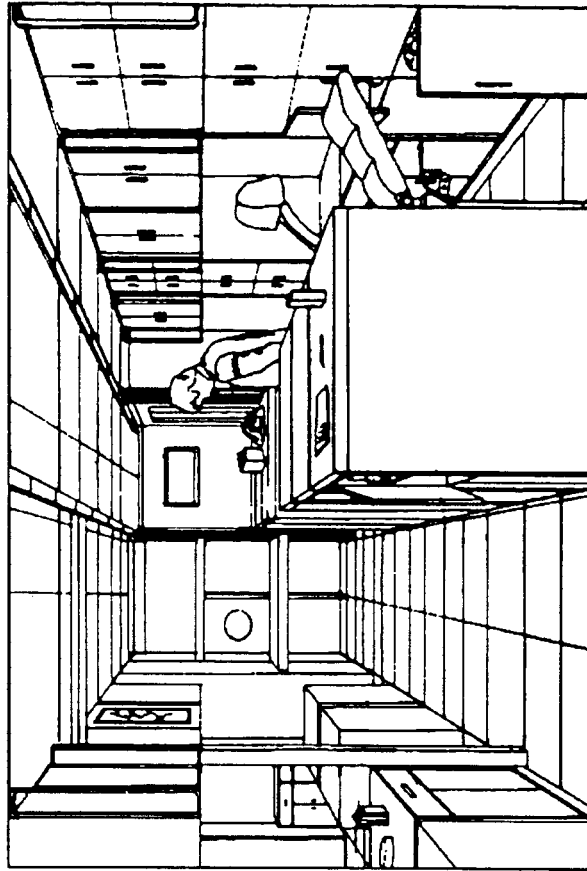

Figure 3.8.6-1. A view of the general labs shows the openness created by the half racks, the window terminating the main translation path through the laboratory inflatable.

3.8.7 BIOTRON

The biotron is located on the second floor of the laboratory inflatable. It is a plant growth experimentation facility. There will be expandable and contractible high density plant growing racks and a plant experimentation laboratory. Wheat, lettuce, carrots, soybeans, tomatoes, and cucumbers are just some of the plants that will be grown. Although most of the food consumed will be brought from earth, this experimental "garden" will supplement it. This facility is not only designed to experiment with biotrons but it is also meant to be a place where the crew can go to relieve stress.

The psychological benefits from the laboratory are plenty. For example, the crew has the opportunity to care for living organisms not unlike that of taking care of one's family. They also have the chance to cook with their own "home" grown food.

3.8.8 QUIET/CONTEMPLATION AREAS

Also located on the second floor of the laboratory inflatable is an area dedicated to reviving the inner self-a contemplation area. Being in close proximity to the pleasant scent of growing plants will stimulate the

olfactory senses while the sight is activated and soothed by the architectural elements in this area (see Figure 3.8.1-5).

The contemplation area is divided into three distinctly different spaces: the reading room, the biotron conservatory, and the chapel. Each space is large enough for just a few people in order to keep it as intimate as possible. As one bounds up from the work area below, plant life is immediately seen. To the left is the reading room. Here "real" books and couches are available in order to just get away and relax. Terminating the space is a window surrounded by colorful stained glass for viewing into the lava tube (see Figure 3.8.8-1).

To the right is the biotron conservatory. This space designed to be in the center, is formed by a trellis with vines winding around it. The seating curves around the periphery making the space circular. In the center is a reflecting pond holding experimental fish and plant life. One must walk through the space to reach the chapel (see Figure 3.8.8-2).

The chapel is a place that one can go to practice his/her belief in a private and personal setting. Since the crew will be an international one, there will be many religions practiced. In order not to favor any one faith the chapel is decorated only symbolically with plants, an altar, and stained glass. Again, there is only room for a few crew members as to keep the space as private as possible (see Figure 3.8.8-3).

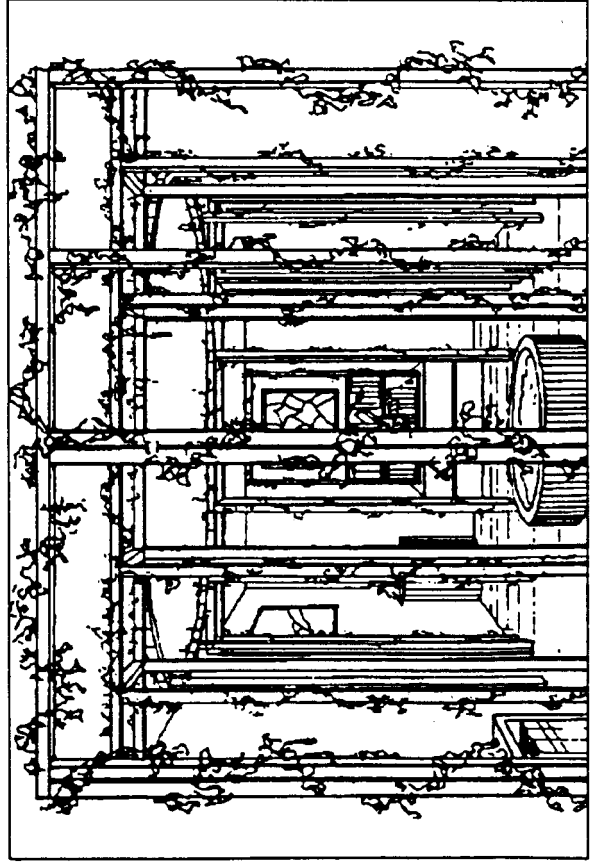

Figure 3.8.8-1. The reading room allows the crew privacy to relax and read.

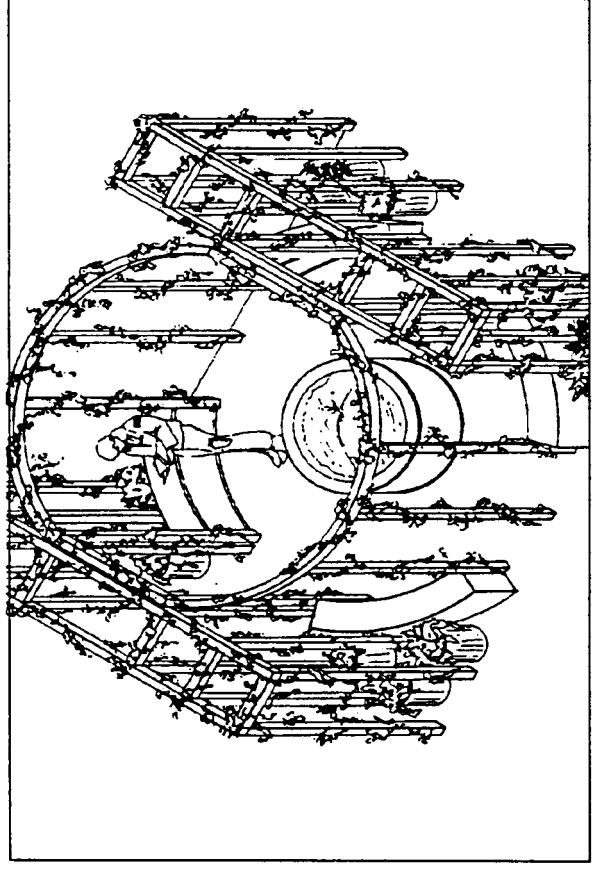

Figure 3.8.8-2. The conservatory allowing a place to contemplate away from the activities of the base.

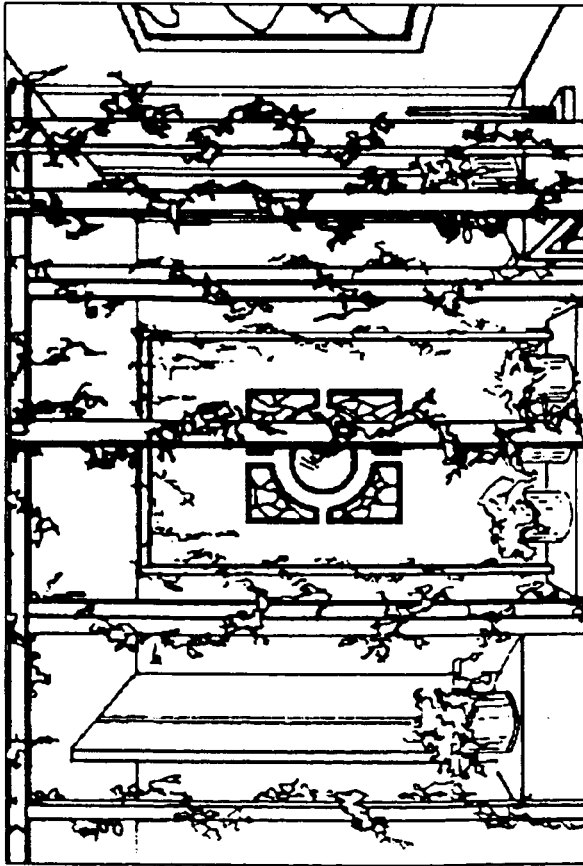

Figure 3.8.8-3. The chapel in which the crew can practice their religious beliefs.

3.8.9 MISSION CONTROL AND SPECIALIZED FACILITIES

This portion of *Genesis II* will oversee the base operations, surveillance all base functions, both internal and surface, and will allow the monitoring of the crew and their life support systems.

3.8.9.1 Mission Control

Mission and base operations will be housed within the lava tube. Additional communications stations will be located within the base. The purpose of the major workstations will be to monitor inter- and intra-base activities, any telerobotic activity on the lunar surface, the mining facility, power stations and launch facility (see Figure 3.8.9.1-1). The workstation itself is designed to fit within the modular system. The anthropometrics of the human body in 1/6th gravity has been considered in the placement of the monitor screens and controls. Additionally, the chair used at the workstation will address the altered body position (see Figure 3.8.9.1-2). It has been determined that three major workstations will suffice in overseeing the base functioning, and the supporting communications stations will provide any backup system necessary.

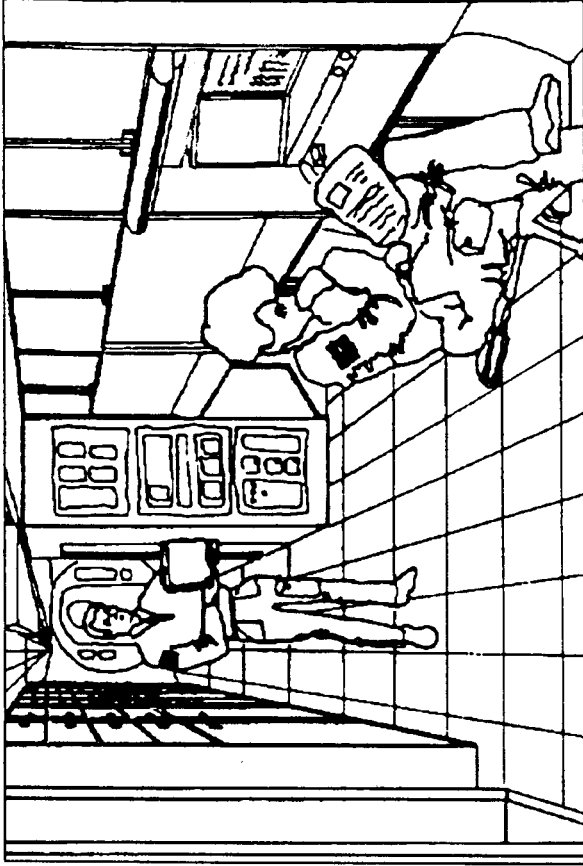

Figure 3.8.9.1-1. Base activities can be monitored in the mission operations facility.

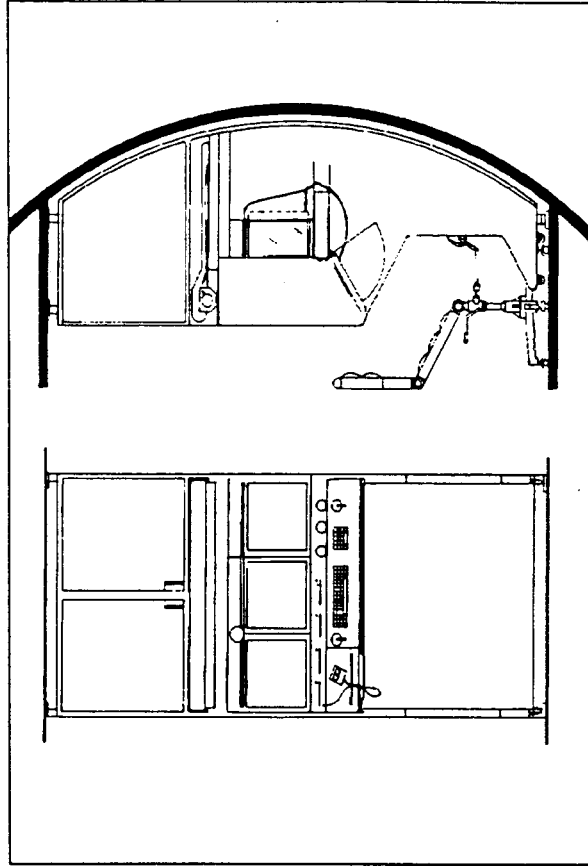

Figure 3.8.9.1-2. A typical mission operations research workstation, designed to accommodate the 1/6th gravity body position.

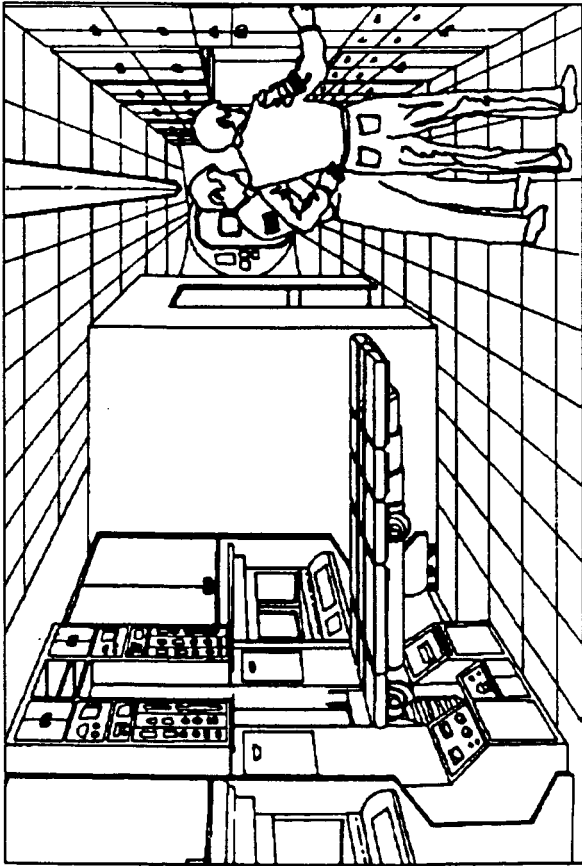

Figure 3.8.9.2-1. The health maintenance operating theatre protruding from the modular rack.

3.8.9.2 Health Maintenance Facility

This area of the base will provide health care and emergency medical aid. The core of this facility is the patient restraint table and supporting diagnostic equipment (see Figure 3.8.9.2-1). The table is especially designed to provide a wide range of movement, not only for the equipment but for the physician or medical personnel. All instrumentation is clearly visible, and accessibility to the necessary supplies is easy (see Figure 3.8.9.2-2). The equipment placed into the medical facility follows guidelines set by NASA and the proposed Space Station Freedom health maintenance facility (HMF) NASA-JSC Medical Sciences Space Station Working Group and the University of Houston College of Architecture/SICSA (SICSA, 1989).

3.8.9.3 Maintenance Work Area, Suit Stowage, and EVA Chamber

An entire common module has been dedicated to the stowage and maintaining of the pressure suits. Eight of the suits will be housed in this module along with six workstations. These six, in banks of three each, will allow the astronauts to lay out an entire suit for maintenance (see Figure 3.8.9.3-1). This module is adjacent to the EVA chamber and additional suits will be located there as well. The maintenance module is placed beneath

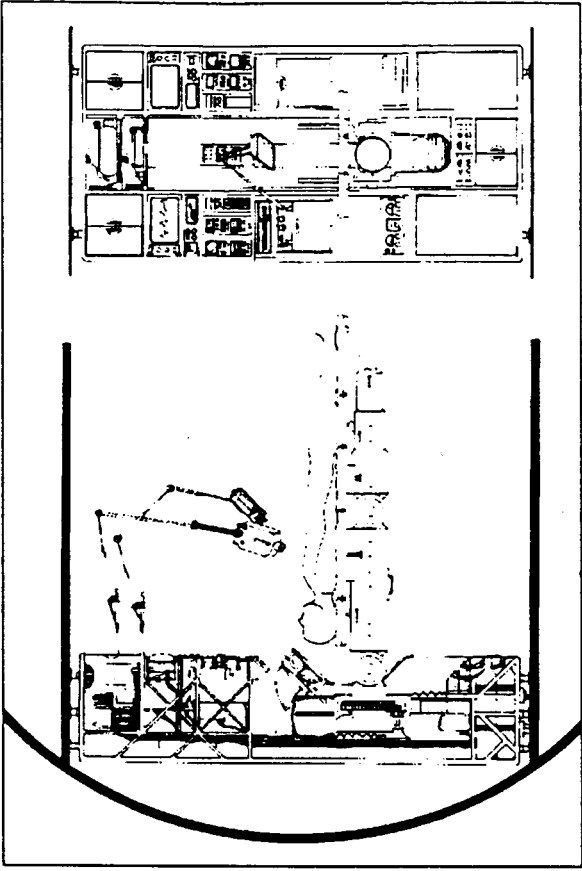

Figure 3.8.9.2-2. The health maintenance facility. All supplies and equipment are efficiently stored and easily reached.

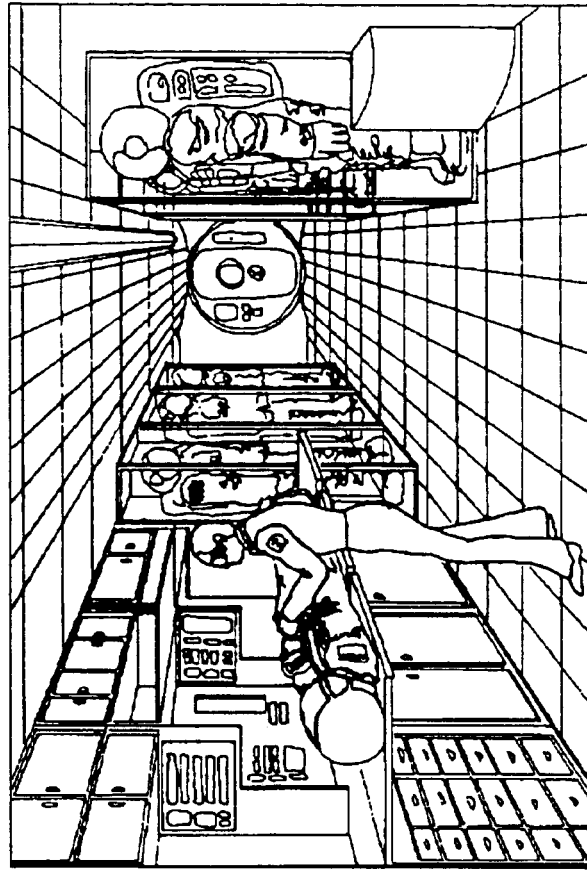

Figure 3.8.9.3-1. The maintenance facility in the Level 5 module. Located in close proximity to the EVA module allows for efficiency and safety.

the main translation path in the event of an emergency. For the day to day activities, the health maintenance facility and mission operations will not be in the way of traffic.

3.8.10 CONSTRUCTION TECHNOLOGY

The design of this lunar base includes many technical details. Although the architectural considerations of the base were concentrated on, some thought was given to the technical issues. These include: the space frame, the inflatables, hatches and connectors, and radiation shielding.

3.8.10.1 Space Frame

The space frame is a major element in the construction of the base. The frame is made of aluminum tubing, much like that of the proposed Space Station Freedom. It forms a platform measuring 13 meters wide, and 29 meters long. Basically, the space frame holds all of the bases structural elements in place, acting as a carrying system. It is needed due to the expected unevenness of the interior of the lava tube. The SSF modules can simply be hung from the frame, and the inflatables will have a flat, sturdy platform on which to rest.

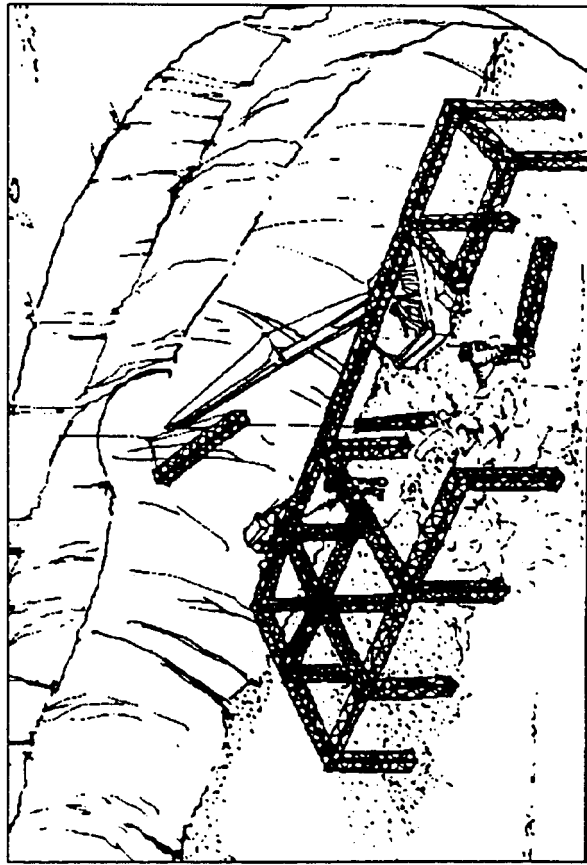

Figure 3.8.10.1-1. The space frame under construction.

The vertical trusses of the frame will use the tubing to form a square column, which is one meter square, and approximately six meters tall. The columns will include diagonal bracing and will rest on an adjustable footing. The horizontal elements of the frame are triangular trusses, measuring one meter across a side. These trusses also use triangulation in their construction.

Construction of the space frame in a relatively simple process. All of the trusses will be transported to the lunar surface preassembled. The entire space frame is comprised of three different sized trusses. These pieces will be lowered down through the opening created in the roof of the lava tube. The pieces will then easily connect together, forming a sturdy platform on which to build the base.

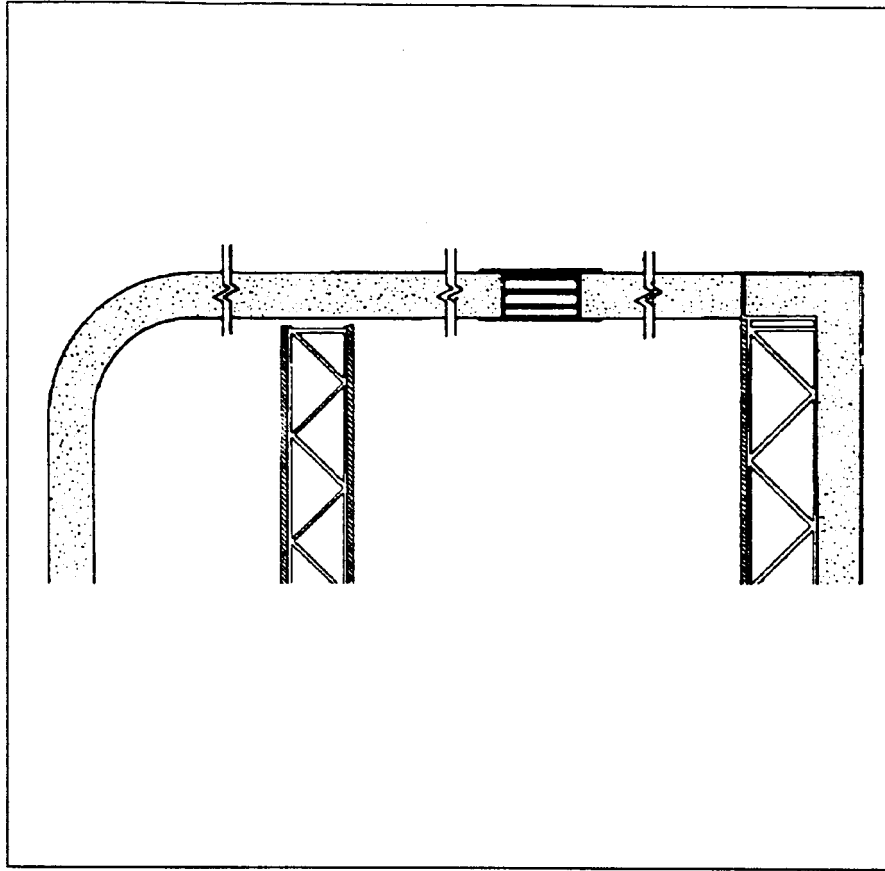

Figure 3.8.10.2-1. A wall section through the inflatable, including sections through both floor levels, and through a window in the wall.

3.8.10.2 Inflatable Construction

The habitation and laboratory modules in the base are constructed using inflatables. The structures are comprised of two membranes, one inside the other, which are based on the material Kevlar. Structural foam is inflated into the space between the two membranes, raising the structure to its final shape, and rigidizing to a hard form.

The internal framing of the inflatables uses lightweight trusses and panels. The base of the inflatable is formed by a rigid aluminum plate which folds for transport to the lunar surface. The base will then have an interior floor system which is raised up to allow space under floor for systems distribution.

The second floor system includes aluminum trusses which lie on the grid system with a depth of approximately 30 centimeters. These are supported by columns which fit on the grid system. The floor is then covered by 1.2 meter square panels which are made of a lightweight honeycomb material.

3.8.10.3 Hatch/Connector Designs

The hatches which connect all of the elements in the base are much like those proposed for Space Station Freedom. Their will be two basic hatch

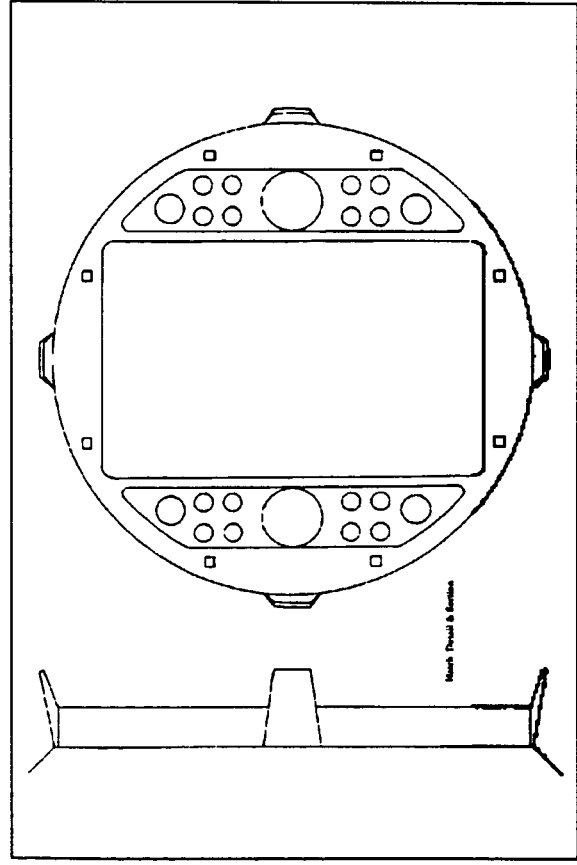

Figure 3.8.10.3-1. A front view and side view of the proposed hatch/connector to be used between all structural elements.

designs for the base, one for vertical translation, which has an opening of 1.25 meters square, and one for horizontal translation, which has an opening of 1.25 meters by 2 meters.

The connector is a collar, 2.5 meters in diameter, on the end of a SSF module, or attached to an inflatable. The collar includes alignment guides for attaching two connectors, securing devices which lock two connectors together, and a number of pass-throughs for the mechanical systems.

3.8.10.4 Radiation Shielding

The majority of the base will not need shielding for radiation or micrometeoroids since it lies under the lunar surface. The elements which are on the surface, however, will need this protection. To provide the needed protection, a space frame based system was used to hold regolith.

A space frame, 50 centimeters in depth, is used to form a frame with the shape of a half octagon. The interior of this frame is covered with aluminum panels. The outer portion of the frame is covered with Kevlar 149. Regolith is then dumped into the space in between these layers.

This protection not only stops radiation and micrometeoroids, but also has other benefits. Since it is the logistics modules which are on the surface, they will need to be removed and replaced. Using this system the replacement of logistics modules is very easy. Another benefit is that access to the modules is still possible since there is a large standoff between the protective structure and the modules.

3.8.11 FURNITURE AND EQUIPMENT

The furniture throughout the habitat is designed to fit the body in 1/6th gravity. It will be adjustable in order to accommodate the 5% female to the 95% male. It also will be able to be easily moved and stored. All of the furniture has rounded corners for safety reasons (see Figure 3.8.11-1 as well as Figures 3.8.4.2-1 on p. 39, 3.8.4.3-1 on p. 40, and 3.8.9.1-2 on p. 44).

3.8.12 LIGHTING

The lighting throughout the base will incorporate as much natural lighting as possible. By using fiber optics and piping it into the habitat both inside and out. Artificial lighting will supplement the natural and be used in emergencies.

The fixtures used are: ceiling application (45/45/90 degrees), corner application, track, and adjustable workstation task lighting. All will be easily adjusted and assembled (see Figure 3.8.12-1).

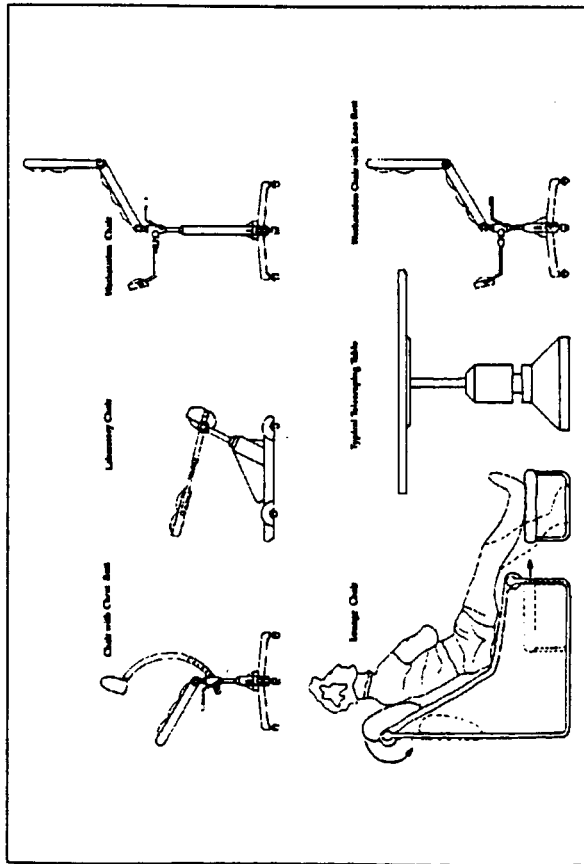

Figure 3.8.11-1. Specially designed 1/6th gravity furniture used throughout the base.

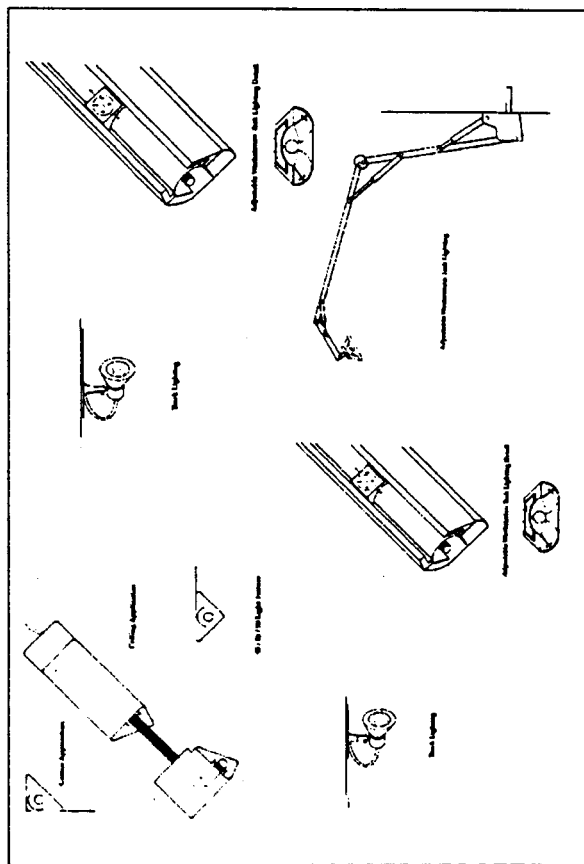

Figure 3.8.12-1. Specially designed lighting used throughout the base.

easily adjusted and assembled (see Figure 3.8.12-1).

3.8.13 SUMMARY OF INITIAL OPERATION CONFIGURATION

There are four main elements incorporated into *Genesis II*: safety, habitability/human factors/environment-behavior considerations, using advanced near term technology, and replaceability/modularity. By using these criteria, *Genesis II* won't just be a place for experimenting but a place where the astronauts can live comfortably.

3.9 EXPANSION

Future expansion of the base can be accomplished in a multitude of ways. Adding more inflatables width wise is an option to consider. However this would cut down on the space allowed for circulation. It can also grow into the lava tube extending deeper inside with another topside entrance. Here the lava tube is utilized while at the same time allowing enough room to circulate large equipment. Expansion could also be located on lunar surface however it would then have to be covered with regolith for protection thus creating more construction time being exposed to the moon's hostile environment (see Figure 3.9-1).

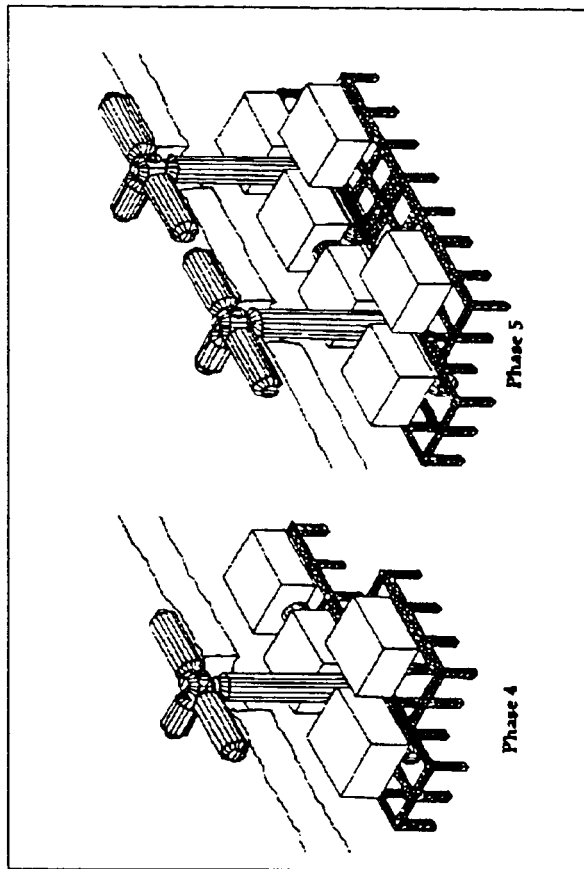

Figure 3.9-1. Possible base expansion that for *Genesis II* Advanced Lunar Outpost beyond IOC.

4 SUMMARY AND CONCLUSIONS

4.1 CRITICAL DESIGN FEATURES OF GENESIS II

The second-generation *Genesis II* lunar habitat and research facility incorporates many design features, some well established, others yet untried. The principle design criteria influencing the design included safety, using advanced yet near-term technology, replaceability and modularity, and cost, i.e., minimizing volume and weight at lift-off, yet the driving force in the design was habitability—human factors and environment-behavior considerations to provide a reasonable quality of life during long stays in an alien environment.

Habitability criteria affected the design in many ways, in many places. A separation was made between living and working spaces, the living spaces being in the inflatable habitation facility and the working spaces being in the inflatable laboratory facility and mission control on the lowest level of the lava tube. Movement through the Shuttle-C cylinder—the central circulation core—provides some transition between working and living spaces.

Furthermore, the character of the two types of spaces differs greatly. The laboratory inflatable is organized in a series of work bays with the

extensive biotron upstairs accessible from peripheral translation platforms, while the habitation inflatable is organized around a central mini-atrium and vertical translation platforms linking the two habitation floors. Thus within the research spaces an effort was made to separate the various research functions from each other, while in the habitation area an effort was made to provide considerable social and gathering space—as well as visual connections between all functions—in the central "atrium."

Balancing social interaction is the need for privacy. Upon advice of our consultants, and based on the research literature (cf. summary in Moore, 1990), the individual crew quarters were made larger than minimum and considerably larger than what would be suggested from current NASA standards for Space Station *Freedom* (e.g., NASA STD-3000, 1989). A variety of single or double crew quarters were designed to allow choice, and to allow the possibility of an environment/behavior post-occupancy evaluation (POE) of their impacts over extended time. The crew quarters were outfitted with sufficient persona amenities that a crew member can spend considerable time, if need be, away from fellow crew members.

To reinforce these private spaces, a number of small spaces were created throughout the habitat for individual or small group quiet activities, including the library and small games room in the habitation inflatable and the reading room, conservatory, and chapel borrowing from the natural living character of the biotron in the research facility.



Figure 4-1. The model of the *Genesis II* Advanced Lunar Outpost. The opening to the lava-tube is on the right. The dark paths on the surface are sintered roadways to help keep dust levels low.

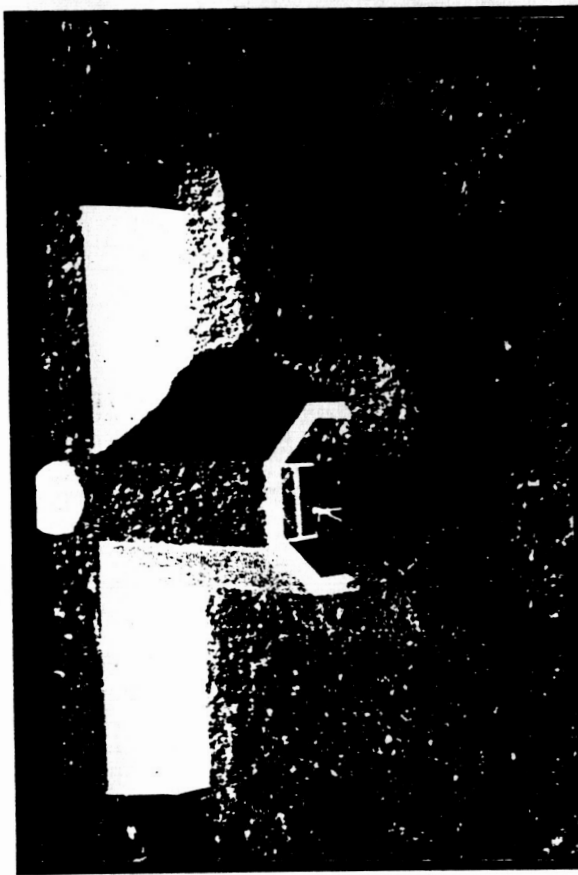

Figure 4-2. An overhead view of the modules on the lunar surface covered with a protective shielding. Note the coupola protruding at the apex of the configuration.

Safety influenced the design in many places, most notably in having dual means of egress from all points of the outpost, including two EVA chambers to allow egress to the surface and/or to the open-facing end of the lava tube and the provision of safe-haven racks throughout the structure.

The modularity of the design allows the crew to reconfigure the interior spaces to their liking. The modular kit of parts allows easy of emplacement, interchangeability, reconfiguration, and resupply. All pieces were sized to be transported thorough the hatches and moved from the logistics modules to all parts of the base. To provide maximum flexibility consistent with anthropometrically appropriate design, a module of 1.2 meters and variations thereof was chosen. The modular design also makes personalization of individual spaces—crew quarters and research laboratories—easy to accomplish.

Other important design constraints were the use of near-term technology and the minimization of volume and weight. The use of inflatable structures, using the latest in light-weight elastomer laminates, responded to both of these constraints. The technology needed to construct inflatables is not immediately available, but is near enough that it is practical and will be available prior to lift-off in 2005. Inflatables work as a testbed for experimentation. They also collapse for transportation, resulting in low mass and volume. Once expanded in the lava tube, the inflatable provides a very large volume for its weight.

4.2 MAJOR STRENGTHS AND LIMITATIONS OF THE DESIGN

There are advantages and limitations to the design of this lunar base. As in any design, alternatives that offered the greatest advantages were chosen over those with major limitations. Yet strengths and limitations remain. Since this design explored the impact of habitability criteria on lunar bases, design options that favored habitability considerations are favored over others that had major habitability limitations.

A major asset of the design is its location in side a lava tube. This protects the base and its inhabitants from solar flares, meteorites, radiation, and temperature fluctuations, allowing more flexibility in other aspects of the design. The extension of the habitat from the surface level to the base of the lava tube also allows two means of egress with exits on different levels. There are other advantages to the use of the lunar lava tubes. Use of the natural cavern of the lava tubes will prove cost effective relative to constructing space frames and moving great quantities of lunar regolith for protection. The constant temperature minimizes demands on the CELSS/HVAC system, also proving to be cost effective. EVA operations will be

easier, with no worries about cosmic radiation. Finally, expansion is facilitated by creating and linking another inflatable without having to remove regolith and provide additional regolith protection.

The natural zoning of the base can be seen as an advantage of this scenario, and a natural outgrowth of using the lava tubes. The sensitive habitat and research zones are protected and isolated from the hazard zone of launch and landing, from the industrial manufacturing zones, and from the potentially hazardous nuclear energy zone.

Inside the base, the articulated zoning between work and leisure, and between public and private, mirrors—albeit in a microcosm—the equivalent zoning of new—and old—towns on Earth. The use of both rigid and expandable structural systems provides a means of comparing the strengths and limitations of both, extending the experimental testbed function of the base.

The use of inflatables greatly reduces the cost of the base by minimizing mass and volume while providing large spaces easily subdivided according to functional criteria.

Another key design feature, the ability to easily personalize due to modularity, aids in the habitability and the quality of life of the base. As explained immediately above, the modular kit of parts also provides ease of emplacement, change-outs, reconfiguration, and resupply.

The furniture is potentially a real breakthrough in lunar design. While there are no published data on anthropometrics in 1/6th gravity, our interpolations between 1 g and 0 g suggest what we have been calling a “1/6th body position as shown in Figure 3.4-1 on page 28. Two members of the team have therefore designed a set of 1/6th gravity furniture for work and leisure, as shown in Figures 3.4-1, 3.8.4.2-1, 3.8.4.3-1, 3.8.5.4-1, 3.8.6-3, and 3.8.9.1-2, and summarized in Figure 3.8.11-1 on pages 28, 39, 40, 42, 44, and 48. An effort will be made to extend these designs and to test them in a 1/6th gravity chamber in the near future.

Lastly, we feel that the design of the base to have a variety of different situations and spaces, different in spatial size and configuration, and different in style and esthetics, as well as in flexibility to be able to be personalized, provides for the range of astronauts and mission specialists who will inhabit the base and for their different needs and personalities. Furthermore, the variety and flexibility are set up as an experimental system to enable POE and further refinement both on the lunar base and as input for Martian travel and Martian outposts.

Along with the assets inevitably come the limitations. As the limitations all suggest areas for future research and design development, we will discuss them in this light.

4.3 AREAS FOR FUTURE RESEARCH AND DESIGN DEVELOPMENT

Preliminary design reviews (PDRs) by NASA scientists and engineers, and reviews offered of the work at national conferences, including the annual USRA conference, have suggested the following limitations and areas for further research and design development:

1. The first limitation—or question for further research—is the location of a viable lava tube. Precursor survey missions must define the location, and subsequent exploration must determine their structural integrity. More information is needed on the location, size, and geologic nature of these forms. After confirmation of their existence, selection criteria will be developed depending on the size, nature, and mission requirements for the base.
2. Connected with the concern about the location of a viable lava tube is the question of how to stabilize the inner surfaces of the tube once found. Structural support systems may be devised that can be employed in an emergency.
3. Questions have been raised about the inflatable, about likely bowing or what is known as the "oil canning effect," and about pressure and stress on its corners in particular. Further study needs to be conducted—perhaps including computer simulations as well as laboratory tests—of the structural integrity of different inflatable shapes.
4. As mentioned above, further work will be done on furniture design for 1/6th gravity, and, with NASA's assistance, on testing the furniture for functional adequacy and static and dynamic anthropometrics in a 1/6th gravity chamber.
5. Some controversy surrounds the notion of safe havens as racks. Further exploration needs to be done on the relative advantages and disadvantages of safe havens as places versus as racks.
6. Questions could be raised about the modularity and relative openness of the plan. Some may question whether modularity leads to a sterile environment. Others may question whether modularity necessarily implies an open plan, as in the landscaped office plans of the 1950s through 70s. While there certainly is evidence in the office research literature that modularity is not the panacea that many thought it would be—few changes being made, open plans leading to increased noise and visual distractions—we feel that modularity and the possibilities of interchangeability are absolutely critical in an

extraterrestrial habitat and research facility. Once facility are in place, at considerable expense of launch and EVA construction time, it would seem unreasonable to assume no subsequent changes in functional needs, or if there were, that it would require entirely new construction with new parts being lifted-off from Earth. While the modular system may not be manipulated often by astronauts and mission specialists during a typical 9-month period, it also allows rapid change-outs as functional requirements change between crew change-outs (e.g., different crew compositions—men, women, couples; different mission research functions, etc.). Exploration does need to proceed, however, on the relative merits of different modular systems, e.g., hexagonal versus the current rectilinear system.

7. Concern has also been expressed about sound transmission and safety from research accidents in a relatively open plan research facility. Of special concern would be the possible transmission of odors or germs from animal research. Each of the research areas can be isolated from all others in a matter of moments, and could be closed if noise is a problem. Nevertheless, the questions raised about modularity deserve considerable further research and design investigation.
8. The exercise facility will undoubtedly require more sound proofing from the rest of the crew quarters and from the crew support areas in particular. Exercise machines cause noise and vibration, and require secure structural connections, neither of which has been adequately accounted for in the current design. New forms of NASA exercise counter-measure machines will be explored and incorporated in future work. A separate facility for group recreation may be needed. This will isolate excessive noise and vibrations from the ongoing base functions. Separating the exercise facility will enhance the activities psychologically, providing greater space and freedom to enjoy the reduced gravity.
9. Other vibrations may occur from the movement of personnel and the operation of equipment. These vibrations may cause structural problems, and the resulting noise may also lead to an increase in crew member stress.
10. The medical facility on the ground level of the lava tube, very close, but not immediately adjacent to the research areas, may cause some concern. Better emergency circulation connection between the two may be required.

11. Only some attention has been given so far to the equipment needed for construction (see Figures 3.4-1 through 3.4-6 on pages 26-27). Investigations need to be made of the relative merits of drilling, blowing, and laser cutting the hole between surface and tube. The reactions of the lava tube to vibrating machines during construction also needs careful exploration. Weight bearing features of the construction equipment relative to the strength of the lunar regolith especially over cavernous lava tubes needs careful exploration too. The details of the inflation of inflatables needs to be clarified. The exact equipment needed for construction, and the influence of this on the design itself, deserves further attention.
12. A number of mechanical engineering considerations were not investigated in this design, among them heat dissipation, the need for and amount of thermal radiators, ventilation systems, and a detailed mechanical analysis. Such analyses are not normally a part of design schematics, but would need to be explored in detail if this design were taken into detailed design development.
13. The extensive length of the Shuttle-C translation core between the surface of the moon and the lava tube itself presents cause

- for concern. It is true that considerable space is devoted to circulation. Movement between base locations must be efficient. In the event of an emergency, the crew must have easy access to the safe haven locations. Further investigation needs to be conducted to determine if this is the most efficient solution.
14. Question could also be raised about the advisability of combining inflatables and hard modules in the lava tube itself. Why not use all inflatables, one might ask, given they have such a great volume to mass ratio? In the spirit of initial exploration, and the lunar base being a testbed for Mars, this scenario explored the use of both inflatables and modules, and the necessary connectors between the two.
15. Lastly, further attention needs to be given to the overall image of the habitat and research facility. Does the design tell us what we value as humans?

Having mentioned these limitations and areas for further development, however, it is our firm belief that NASA should proceed with the Lunar/Mars Space Exploration Initiative (SEI) toward the eventual exploration and habitation of both the moon and Mars. First- and second-generation outposts will need to be developed. We offer these conceptual designs as beginnings on the path to the eventual habitation of our near planets.



Figure 4-3. The entry to the airlock on the lunar surface. The dust-off platform is just outside the airlock module, and the coupola can be seen in the background.



Figure 4-4. Looking into the opening of the lava-tube. The space-frame supporting the inflatables can be seen in the darkness.

APPENDIX A

**GENESIS II: ADVANCED LUNAR OUTPOST
SPACE ARCHITECTURE II DESIGN STUDIO**

Architecture 690 - Section 801

Department of Architecture
in cooperation with
College of Engineering and Applied Science
University of Wisconsin-Milwaukee

NASA/USRA Advanced Design Program in Space Architecture
in conjunction with
NASA/Johnson Space Center

Capstone Design Studio
Spring 1991

Robert Greenstreet, UW-Milwaukee School of
Architecture and Urban Planning

Nancy Jaeger, UW-Milwaukee Departments of
Architecture and Urban Planning

Mike Roberts, NASA Johnson Space Center,
Houston

Douglas C. Ryhn, UW-Milwaukee Department
of Architecture

Anthony J. Schnarsky, UW-Milwaukee Depart-
ment of Architecture

Mark Sothman, UW-Milwaukee Department of
Human Kinetics

Robert Webber, Marquette University Depart-
ment of Mechanical Engineering

Course Architecture 690 (U/G), La 801 (3 or 6 credits)

Location Engelmann 223; reviews and seminars in
Engelmann 128

Time Tuesdays and Thursdays 1:30-5:20 for 3 credit
students; 6 credit students will also meet Fridays
1:30-5:20; every one is expected to be present
during these times. There will be other required,
scheduled events for special guests, seminars,
and reviews. Additional time in studio is ex-
pected for individual work.

Office Hours Gary Moore / Eng 172 / T/Th 9:00-12:00
TAs / Eng 223 / during class times

Purpose Students at UW-Milwaukee may become involved
in an interdisciplinary design program to work with and present their ideas
to a real client—NASA, and to learn about areas of design related to health
and safety, psychological and social issues, habitability, underground
architecture, interior architecture, construction technology, hi-tech materi-

Instructor Gary T. Moore

**NASA/USRA
Teaching Assistants** Joseph P. Fieber
Janis Huebner-Moiths
Kerry L. Paruleski

Visiting Critics B.J. Bluth, NASA Headquarters
John Cain, Kahler Slater Architects, Milwaukee
John Connolly, NASA Johnson Space Center,
Houston

Thomas M. Crabb, Orbital Technologies Corpo-
ration, Madison
Wallace Fowler, University of Texas Depart-
ment of Mechanical Engineering

Genesis II: Advanced Lunar Outpost

als, mechanical systems, structural analyses and structural systems, energy systems, site planning, and long-range master planning.

Design Program The Department of Architecture, through its 3-year Advanced Design Program grant from NASA/USRA, is conducting a series of seminars (fall semester) and design studios (spring semester) on space architecture. The Department is one of only three architecture schools in the 41-university NASA/USRA Advanced Design Program. We are working in cooperation with the Departments of Mechanical and Civil Engineering who send us students and faculty advisors every year. The program stresses the systems approach to design in which we work together like an interdisciplinary A/E professional firm on a major real world project for NASA.

History Following criteria provided by consultants from NASA's Johnson Space Center (NASA/JSC) and one of its prime contractors, McDonnell Douglas in Houston, last spring's studio designed *Genesis I*, an early stage lunar outpost for the year 2005. The results were reported at the NASA/USRA meeting, in the USRA conference proceedings, and at one other national and one international conference.

Description In the spring of 1991 we will design an advanced lunar outpost, *Genesis II*, for the year 2005. *Genesis II* will provide housing, research space, mission control space, and all amenities for 11 astronauts to live on the moon for durations up to 20 months. It will serve as an evolutionary, long-term testbed for all materials, processes, and development strategies to be employed in a mature lunar colony for the next 20 years, and as a research and construction technology testbed for all processes to be employed in the exploration and settlement of Mars.

The lunar outpost will include base master planning and schematic design for a mission focused on five experimental systems:

- a. lunar mining and production analysis for lunar oxygen and helium,
- b. lunar construction technology testbed,
- c. a closed system ecological life support facility (biotron),
- d. a lunar far-side observatory,

- e. a human factors and environment-behavior research monitoring facility.

Design development will focus on the central telerobotic command center running these mission operations, on one of the research or manufacturing facilities, and on the crew support habitat.

Design issues to be considered will include base master planning and phasing, human factors, psychological and social reactions to long-duration space missions, high-tech materials and construction technology, lighting, mechanical, and HVAC/ECLSS systems, energy systems, and overall design aesthetics.

The design will be based on a programming document produced in Arch 390/790 Space Architecture Seminar offered in the fall of 1989, the final design document produced in Arch 690 Space Architecture Studio offered in the spring of 1990, and several independent study projects completed during the fall of 1990.

Structure and Schedule Studio will be structured in six segments:

1. Readings, slide talks, and individual sketch design explorations. 2 weeks. Preliminary Design Review (PDR-I) by NASA officials, university faculty, invited consultants.
2. Research and design studies of different issues, e.g., lunar site design, 1/6th gravity, workstations, natural light, underground architecture, inflatable dome construction, hi-tech materials like elastomers and thin films. 3-1/2 weeks. PDR-II.
3. Preliminary design to develop and explore different parti. 1-1/2 weeks. PDR-III.
4. Design development of different parts of overall lunar base. 2 weeks. Intermediate Design Review (IDR) with national guests.
5. Design integration to present final integrated design. 3-1/2 weeks. Not-quite-final Design Review (NQFDR).
6. Presentation. 1-1/2 weeks. Final Design Review/Final Jury (FDR).

Key A/E Design Issues Based on our self-critique of last year's work, and very helpful suggestions from James Burke, NASA/Jet Propulsion Laboratory, and Stephen Paddock, NASA/Goddard Space Flight Center, areas of detailed investigation will include, but not be limited to, the following:

- a. Character of the lunar environment with design studies on implications of the lunar topography, atmosphere, radiation levels, solar flares, power sources, temperature extremes, and in-situ materials.
- b. Long-term effects of reduced gravity and design studies on different approaches to creatively designing for 1/6th gravity.
- c. Extraction of design-relevant implications from previous space experience, analogous situations, and simulations, e.g., Mir and Skylab, Antarctica and Navy submarines, and Tektite.
- d. Space allocation studies including human factors analysis of the minimum space required for different lunar habitation and research functions.
- e. Design trade studies of different areas of a lunar habitat, e.g., health maintenance facility, exercise facility, crew quarters, air locks, and workstations; development studies of these areas including study perspectives and models.
- f. Design studies of different ways of getting natural light into a regolith-covered lunar habitat without admitting gamma ray particles, including partially covered cupolas, flexible light pipes, periscopes, etc.
- g. Habitability design study of the short- and long-term effects of underground, windowless architecture.
- h. Design replacement studies of how to replace/renovate parts of a habitat without disturbing ongoing functions.
- i. Design studies of construction technologies including prefabricated modules, rigid structures, inflatables, and in-situ resource utilization.

- j. Structural design studies and calculations for all structural members including inflatable domes.
- k. Design studies of the implications of new, hi-tech materials especially elastomers and thin films, e.g., Kevlars, Mylars, Spectra, Nomex, aluminums, titaniums, rigidizing foams, and in-situ resource utilization of lunar regolith.
- l. Mechanical design study of radiators to remove body and machinery heat from under-regolith.
- m. Regolith depth studies of the minimum depth of regolith to protect lunar habitats from radiation and micrometeoroids, and design studies of regolith containment systems, second-generation regolith bagging machines, and processes (including sequences) of habitat construction.
- n. Mass calculations, studies of ways to reduce mass, rough-order-of-magnitude (ROM) cost estimates, and analysis of total number of flights based on minimum mass calculations.

Eligibility/Prerequisites Students from architecture (undergraduate and graduate) and from engineering (especially mechanical, structural, and industrial/systems) are welcome to join this studio. It is not necessary to have taken the earlier space architecture seminars or studio. The most important prerequisite is a love for space and a commitment to aerospace studies. Specific prerequisites include a minimum of Arch 100, 101, 200, 202, and senior standing, or signed consent of the instructor. It is recommended to have also taken Arch 300, 301, 302, 303, and 400, 401, 402, or be a senior in Engineering. The course counts as studio credit in both the undergraduate and master's programs in the Department of Architecture, and as credit for the engineering capstone design requirement in the Departments of Mechanical and Civil Engineering (contact Prof. Ryoichi Amano in Mechanical Engineering and Profs. Al Chorbanoor, Fattah Shaikh, or Edward Beimbom in Civil Engineering for details on how to enroll). Students should enroll for Arch 166-690, Section 801, for 3 or 6 credits. If it is absolutely necessary to enroll for engineering credit, then it is required to also enroll formally for "Audit" status in 166-690.

Genesis II: Advanced Lunar Outpost

Instructor The instructor, Gary T. Moore, Ph.D., is Professor of Architecture and Project Director of the NASA/USRA Advanced Design Program in Space Architecture. (I am previously committed to several conferences this semester, and will be away as noted on the syllabus below). The TAs, Joe P. Fieber, Kerry L. Paruleski, and Janis Huebner-Moths, are advanced undergraduate or graduate students in the Department of Architecture and all have worked for the aerospace industry (Fieber/Paruleski at NASA/Johnson Space Center and Moths at Orbital Technologies in Madison). We will be joined by special guests and visiting critics selected from the above list from the Advanced Programs Office at NASA Johnson Space Center (NASA/JSC), NASA/USRA, McDonnell Douglas Astronautics Corporation in Houston, Astronautics Corporation of America, Orbital Technologies Corporation, and private A/E firms. Other faculty from the UW-Milwaukee Department of Architecture, Mechanical Engineering, and Civil Engineering will also serve as guest critics. Reviews at key milestones (preliminary, intermediate, and final design reviews) will be conducted by the studio faculty and these visiting critics.

Studio Everyone is expected to work in studio. Individual studio workstations will be provided. Computer graphics/CAD machines will be available in Engelmann 223 for exclusive use of the students enrolled in this studio.

Readings There are three required books for this studio:

Cordes, E.G., Hansmann, T., Fieber, J.P., Paruleski, K.L., Moths, J.H., & Moore, G.T. (Eds.) (1991). *Space architecture design seminar/workshop: Space architecture reader* (Rev. ed., 2 vols.). Milwaukee: University of Wisconsin-Milwaukee, NASA/USRA Advanced Design Program in Space Architecture. Pp. ca. 300/volume. Ca. \$10.00/volume — available from Clark's Graphics on Oakland Avenue. ("Reader" in the below assignments.)

Baschiera, D.J., Fieber, J.P., Moths, J.H., Paruleski, K.L., & others (1989). *Genesis Lunar Outpost: Program/requirements document for an early stage lunar outpost* (ed. by E.G. Cordes). Milwaukee: University of Wisconsin-Milwaukee, Center for Architecture and Urban Planning Research, Report R89-1. Pp. 91; figures, charts, tables. \$10.00 — available from CAUPR, Engelmann 158. ("Program" in the below assignments.)

Hansmann, T., & Moore, G.T. (Eds.) (1990). *Genesis Lunar Outpost: Criteria and design*. Milwaukee: University of Wisconsin-Milwaukee, Center for Architecture and Urban Planning Research, Report R90-1. Pp. xiv + 107; plans, illustrations, tables, references. \$10.00 — available from CAUPR, Engelmann 158. ("Final Design Report" in the below assignments.)

Please purchase these on the first day of class. Students who have not taken previous work in space architecture should immediately read as much as possible from the Space Architecture Reader. All students should read or review *Genesis Lunar Outpost: Program/Requirements Document for an Early Stage Lunar Outpost* and especially *Genesis Lunar Outpost: Criteria and Design*, within the first two weeks of the semester. Other hard-copy documents, papers, microfiche, and slides are available in the CAUPR Research Room, Engelmann 258, and in the studio. Other readings from these sources will be recommended as needed. All readings are to be done prior to the seminar or slide lecture at which they will be discussed.

Assignments The principle assignments will be one research and design project and three design projects including final presentation. Other assignments will include the required readings for each seminar or lecture.

Final Products The final products will be a set of design drawings, presentation boards suitable for exhibition, a model, a slide presentation, and a final written/graphic report. They will be presented to NASA/USRA and, like last year, at several regional, national, and perhaps international meetings. All costs associated with final presentations are underwritten by the NASA/USRA grant.

Conferences The final drawings and model will be presented by the students at the annual NASA/USRA Conference being held this year at NASA/Kennedy Space Center, June 17-21, 1991. Proposals for presentations at other national and international aerospace conferences are under review. We have already received an acceptance to present our work at the 10th annual International Space Development Conference of the National Space Society, San Antonio, Texas, May 22-27. In addition, there will be opportunities for the most advanced students to make presentations of our work at various other conferences and meetings locally and regionally.

GENESIS: LUNAR OUTPOST II

SPACE ARCHITECTURE II DESIGN STUDIO

Architecture 690 - Section 801

SYLLABUS

Spring 1991

Evaluation Evaluation will be based on how much you personally have developed over the semester, and will be based on evidenced knowledge of the material from the readings and lecture/seminars including seminar participation (20%), research and design study (PDR-II; 20%), parti development (PDR-III; 10%), design development (IDR; 15%), design integration (NQFDR; 15%), and contribution to the final presentation and product (FDR; 20%). While the TAs will advise on these matters, the final grades will be assigned by the instructor.

Funding The Advanced Design Program in Space Architecture is being underwritten by a three-year grant from NASA/USRA which supports the TAs and will pay for out-of-pocket expenses on the project and most of the travel expenses to the conferences for selected students. The best student will be invited to continue next year as the NASA/USRA sponsored TA for this studio following a paid training period this summer at the NASA Johnson Space Center.

Special Conditions For those of you familiar with studios, this will be a very different studio. For those of you from Engineering or earlier in your architecture career not familiar with studios, this will be a very different experience. I'll explain the differences at the first class, and answer your questions as best I can. But in a nutshell, this is a learning studio, a nationally funded project, and a group of aerospace nuts working and having fun together. My commitment is two-fold: to your education, and to the project and our client—NASA. Your commitment needs also to be two-fold: to your education, and to the project, and it needs to be a very real commitment. The project will be demanding, perhaps more so than any course or studio you have ever taken. But it will also be rewarding, and it should be fun. Already we have planned for you involvement in a regional conference that will include nationally recognized aerospace speakers (you'll have a chance to meet them over dinner, and to have them review your work at a late-night soiree). The best students will represent the class/project at the NASA/USRA conference at the Kennedy Space Center in June. Last year we were interviewed by radio, newspapers, and TV, and made presentations at a variety of local affairs—I hope you'll all have a chance to be involved in this way again this year. We prepared an exhibit of our work which was displayed twice in Wisconsin and once in Illinois—we still have the display and can prepare a second edition if called upon. The students received a special design commendation award from the Environmental Design Research Association (EDRA) for this work. We may do pot-lucks or other informal events, dinners at Kalt's, etc., when we have special guests in town. Other ideas are up to you.

Week / Date	Topic / Assignments / Readings / Reviews / Visiting Critics
--------------------	--

Part I The Space Environment: Readings, Slide Lectures, and Individual Sketch Design Explorations

1 / Jan 15 (T) Opening discussion: Purpose and objectives of the NASA/USRA Advanced Design Program in Space Architecture, Gary Moore, TAs, and class. Buy text books, set up studio, and begin reading.

Lecture: History of the Space Program, Jan Moths.
 Lecture: The Environment of the Moon, Jan Moths.

Jan 17 (R) Required reading: Reader — Section A (all):

- Sutphin (1988)
 - Higgins (1989)
 - Cordes (1988)
 - National Space Council (nd)
 - Cordes & Patton (1988)
- Section B (all):
- Moore (1989)
 - Weiss & Freiherr (1989)
- Section D (all):
- Crabb (1989)
 - Moths (1990)
 - Robinson (1989)

Genesis II: Advanced Lunar Outpost

Required reading: Program — Scenario, pp. 1-4. Skim rest of document so you'll know what's where for future reference.

Required reading: Final Design Report — Chapter 5, Introduction, pp. 1-10.

Skim Chapters 6-7, reading as much as you can. Chapter 7.2, Integrative Design, pp. 66-89.

All required reading is to be completed prior to class so that you can enter actively into the discussion, ask pertinent questions of the lecturers, etc.

1:30 Lecture: Design of an Inflatable Habitat for NASA's Proposed Lunar Base, Joe Fieber and Kerry Paruleski.

2:45 Lecture: *Genesis* Lunar Outpost: Criteria and Design. Description of last year's work, Gary Moore.

3:30-5:20 Self-critique of last year's work: *Genesis I* Lunar Outpost, based on your reading from the Reader, Program, and Final Design Report, and the week's lecture/seminars.

One-week Design Charette: Individual sketch designs for an overall lunar base. Problem statement handed out at end of class.

2 / Jan 22 (T)

Required reading: Reader — Section F:

Anonymous (nd)

Connors, Harrison & Akins (1985)

Moore (1988)

Section G:

Clearwater (1985)

Cranz, Eichold, Hottes, Jones & Weinstein (1985)

Lebedev (1989)

Connors et al. (1985)

Moore (1990)

1:30 Lecture: Human Factors—Anthropometric, Physiological, Medical, Health, and Safety Issues, Kerry Paruleski.

Desk crits of individual sketch designs by instructor and TAs.

4:30 Lecture: Environment-Behavior Factors—Psychological and Social Issues, Kerry Paruleski.

Preliminary Design Review: Individual Sketch Designs (PDR-I) — due Thursday, January 24, 1:30-4:30 p.m., Studio

Organization of issues and questions for further research and design studies. (Faculty and TA meeting every Thursday, 4:30-5:20, Room 172.)

Part II

Research and Design Studies

3 / Jan 29 (T)

Required readings: Reader —

Section E: Space Analogies, Simulations, and Previous Space Exploration

NASA (1989)

David (1988)

Required reading: K. Paruleski (1990), A comparative analysis of analogous situations, previous space exploration, simulated situations, and future conditions. Independent study report, Advanced Design Program in Space Architecture, Department of Architecture, University of Wisconsin-Milwaukee. Section on Previous Actual Space Exploration.

1:30 Lecture: Lessons from Previous Actual Space Exploration, Kerry Paruleski.

Selection/assignment in class of different issues and questions for research and design studies, e.g., lunar

Jan 31 (R)	<p>site design, 1/6th gravity, workstations, natural light, underground architecture, inflatable dome construction technology, hi-tech materials like elastomers and thin films, and others from PDR-I. Work individually or in pairs.</p> <p>Required reading: Reader — Section E: Klassi (1988) Johnson & Kingsley (1988) Stuster (1986)</p> <p>1:30 Lecture: Lessons from Analogous and Simulated Situations, Kerry Paruleski.</p> <p>Research and design studies. Work in studio and library. Desk crits by instructor and TAs. (If you're working in the library, please check in at the studio with the TAs or instructor before heading over.)</p> <p>Required reading: Reader — Section E: Anderson (1989) Space Biospheres Ventures (1990)</p> <p>1:30 Lecture: Lessons from "Future Conditions," Kerry Paruleski.</p>	6 / Feb 19 (T)	<p>Preliminary Design Review: Presentation of Research and Design Studies — oral, graphic, and written/graphic report (PDR-II) — due Tuesday, February 19, 1:30-4:30 p.m., Studio.</p>
4 / Feb 5 (T)	<p>Two-day Design Assignment: Individual sketch designs to identify a range of overall base design parti — minimum one parti per person; assignment at end of class.</p>		<p>Two-day Design Assignment: Individual sketch designs to identify a range of overall base design parti — minimum one parti per person; assignment at end of class.</p>
4 / Feb 5 (T)	<p>Required reading: Reader — Section E: Anderson (1989) Space Biospheres Ventures (1990)</p> <p>1:30 Lecture: Lessons from "Future Conditions," Kerry Paruleski.</p>		<p>Review of individual sketch design parti — due Thursday, February 21, 1:30 p.m., Studio.</p>
4 / Feb 5 (T)	<p>Required reading: Reader — Section E: Anderson (1989) Space Biospheres Ventures (1990)</p> <p>1:30 Lecture: Lessons from "Future Conditions," Kerry Paruleski.</p>		<p>One-week Design Charette: Preliminary sketch designs to explore and develop the most promising different parti. Work in teams (4-5 teams). Assigned at end of class.</p>
4 / Feb 5 (T)	<p>Required reading: Reader — Section E: Anderson (1989) Space Biospheres Ventures (1990)</p> <p>1:30 Lecture: Lessons from "Future Conditions," Kerry Paruleski.</p>		<p>Desk crits on preliminary sketch designs.</p> <p>(GTM @ University of Puerto Rico as visiting design critic on their Advanced Design Program in Space Architecture, February 22-27. TAs in charge.)</p>
Feb 7-8	<p>Desk crits by instructor and TAs.</p> <p>Continuation of research and design studies. Desk crits by instructor and TAs.</p>		<p>Preliminary Design Review: Design Parti (PDR-III) Thursday, February 28, 1:30-4:30 p.m., Engelmann 128.</p>
5 / Feb 12-15	<p>Completion of research and design studies. Desk crits by instructor and TAs.</p> <p>(GTM visiting lecturer @ Georgia Institute of Technology, and juror @ ACSA Student Research Competition, Kansas City, February 13-17.)</p> <p>Possible party, Friday, February 15.</p>		<p>Midterm</p>

Genesis II: Advanced Lunar Outpost

Part IV	Design Development	Spring Recess
8 / Mar 5-8	<p>Design development: Groups work on design development of different parts of the overall lunar base. One group per part (3-4 groups); TAs as team leaders for groups especially for overall master-plan/site design team.</p> <p>Readings from rest of Reader, Sections H, I, and J.</p> <p>Lectures on lunar construction technology, etc.</p>	Part V
9 / Mar 12-17	<p>Completion of design development.</p> <p>Wisconsin Aeronautics and Aerospace Conference Saturday-Sunday, March 16-17, 9:00 a.m.-5:00 p.m. (recommended).</p> <p>Dinner at Embassy Suites, Saturday, March 16, 7:30 p.m. (optional).</p> <p>Intermediate Design Review (IDR-Part 1). Saturday, March 16, 9:00 p.m., 2250 La Fontaine Ct., Brookfield</p> <p>Visiting Critics: John Connolly, NASA/JSC Mike Roberts, NASA/JSC Wallace Fowler, University of Texas, Austin Party with national aerospace guests following.</p> <p>(GTM @ Space Grant Conference, Huntsville, Alabama, March 9-17.)</p>	<p>Mar 21 (R) Full team design integration to prepare the final integrated design.</p> <p>11 / Apr 2-5 Design integration.</p> <p>12 / Apr 9 (T) Complete design integration.</p> <p>Apr 12 (R) Not-Quite-Final Design Review (NQFDR); Thursday, April 18, 1:30-4:30 p.m., Engelmann 128.</p>
10 / Mar 19 (T)	<p>IDR-Part 2: Preparation for design integration, review of comments from IDR, selection of best design concepts, and plans for integration Tuesday, March 19, 1:30-4:30 p.m., Studio.</p>	Part VI
		Presentation
		13 / Apr 16-18 Final presentation
		14 / Apr 23-26 Final presentation
		15 / Apr 30 (T) Final Design Review / Final Jury (FDR); Tuesday, April 30, 1:30-5:20 p.m., Engelmann 150. Party or at least drinks and dinner @ Kalt's following.
		May 22-27
		National Space Society 10th annual International Space Development Conference, San Antonio, Texas (optional — GTM and TAs have a paper accepted).
		May 31
		USRA Final Report completed by TAs — submitted to GTM.
		June 17-21
		USRA 7th annual Summer Conference, Kennedy Space Center, Florida (required for faculty, TAs, and next year's TA; optional for others — class will present paper and small exhibit).

APPENDIX B

**SPACE ARCHITECTURE READER
CONTENTS**

Department of Architecture
University of Wisconsin-Milwaukee

The History of the Space Program

G.T. Moore (1989). Why go to space: History, science, and exploration. From E.G. Cordes, G.T. Moore, & T. Hansmann, *Space architecture: A primer for the design of extraterrestrial environments*. Manuscript in preparation, Department of Architecture and Center for Architecture and Urban Planning Research, University of Wisconsin-Milwaukee, 20 pgs.

M. Weiss & G. Freiherr (1989). Lunar 2009. *Final Frontier*, 2(4), 52-53, 60-63.

The Future of Space Design

NASA (1989). Project pathfinder: NASA plans for man's next "giant leap." *NASA Tech Briefs*, July, 16-18.

J. Murphy (1987). An outward continuum: P/A profile, Michael Kalil, New York. *Progressive Architecture*, September, 136-142.

National Space Society (1989). Homesteading the space frontier. *National Space Society*, September 5, 16 pgs.

The Environment of the Moon

T.M. Crabb (1989). Introduction to the lunar environment and lunar base development issues. Unpublished class lecture notes, Department of Architecture, University of Wisconsin-Milwaukee, September 13, 9 pgs.

J.H. Moths (1990). The moon and Mars, too. Unpublished independent study paper, December, 17 pgs.

R. Robinson (1989). Constructor/astronauts will soon carry their own housing to the moon for shelter as they begin to build a more permanent habitat. *Civil Engineering*, January, 40-43.

Section B

Section C

Section D

Introduction: Why Architects are Involved in Space Design

S. Sutphin (1988). Designing for the future. *Space World*, April, 17-22, 31.

T. Higgins (1989). UWM architects win funds to explore the final frontier. *UWM News*, June 21, 10 pgs.

E.G. Cordes (1988). The history of space architecture design. From E.G. Cordes, G.T. Moore, & T. Hansmann, *Space architecture: A primer for the design of extraterrestrial environments*. Manuscript in preparation, Department of Architecture and Center for Architecture and Urban Planning Research, University of Wisconsin-Milwaukee, 8 pgs.

National Space Council (nd). *Careers in space: An education and career guide for America's space program*. Minneapolis: Final Frontier, 16 pgs.

E.G. Cordes & C.V. Patton (1988). Opportunities for designers and planners. From E.G. Cordes, G.T. Moore, & T. Hansmann, *Space architecture: A primer for the design of extraterrestrial environments*. Manuscript in preparation, Department of Architecture and Center for Architecture and Urban Planning Research, University of Wisconsin-Milwaukee, 8 pgs.

Section A

Section E

Space Analogies, Simulations, and Previous Space Exploration

NASA (1989). *Space Station Freedom program description*. Space Station Media Handbook. Washington, DC: Technical and Administrative Services Corporation, April, 22-47, 94-99.

L. David (1988). Living in space. *Space Station Freedom: A foothold on the future*. Washington, DC: NASA, Office of the Space Station, October, 16-19.

J. Klassi (1988). Comparisons between space facilities and earth-based analogues. *Lunar bases and space activities of the 21st century*. Houston: Lunar and Planetary Institute, 882-891.

R.W. Johnson & T. Kingsley (1988). Antarctic research and lunar exploration: Useful parallels. *Lunar bases and space activities of the 21st century*. Houston: Lunar and Planetary Institute, 892-903.

J.W. Stuster (1986). *Space Station habitability recommendations based on a systematic comparative analysis of analogous conditions*. Washington, DC: NASA Contractor Report 3943, September, 23 pgs.

I. Anderson (1989). Biosphere II: A world apart. *New Scientist*, March 18, 34-35.

Space Biospheres Ventures (1990). Biosphere II: A project to create a biosphere. *Space Biospheres Ventures*, February, No. 8, 3-10.

Section F

Human Factors: Anthropometric, Physiological, Medical, Health, and Safety Issues

Anonymous (nd). Making Skylab livable. *Industrial Design*, September, 20(7), 29-43.

Interiors Magazine (nd). *Interiors: Human dimensions*. New York: Interiors Magazine, 13 pgs.

NASA (1987). Anthropometry and biomechanics. *Man-system integration Standards—NASA-STD-3000*, Vol. 1. Washington, DC: NASA Headquarters, March, 3.0-1 to 3.0-12, 3.0-57 to 3.0-58, 4.0-1 to 4.0-8, and 8.6-1 to 8.8-5.

E.G. Cordes (1988). Safety: Problems and design issues. From E.G. Cordes, G.T. Moore, & T. Hansmann, *Space architecture: A primer for the design of extraterrestrial environments*. Manuscript in preparation, Department of Architecture and Center for Architecture and Urban Planning Research, University of Wisconsin-Milwaukee, 9 pgs.

M.M. Connors, A.A. Harrison, & F.R. Akins (1985). Behavioral and selection implications of biomedical changes. *Living aloft: Human requirements of extended space flight*. Washington, DC: NASA Scientific and Technical Information Branch, 19-56.

G.T. Moore (1988). Human factors and environment-behavior relations. From E.G. Cordes, G.T. Moore, & T. Hansmann, *Space architecture: A primer for the design of extraterrestrial environments*. Manuscript in preparation, Department of Architecture and Center for Architecture and Urban Planning Research, University of Wisconsin-Milwaukee, 39 pgs.

K. Boehler (1989). Lifeboat to safer shores. *Ad Astra*, March, 8-12.

Environment-Behavior Issues: People, Activities, Psychological, and Social Issues

Y. Clearwater (1985). A human place in outer space. *Psychology Today*, July, 34-43.

G. Cranz, A. Eichold, K. Hottes, K. Jones, & L. Weinstein (1985). Social factors in space station interiors. *Space Station Human Factors Research Review*. Washington, DC: NASA Conference Publication 2426, December, 165-189.

Section G

V. Lebedev (1989). *Diary of a cosmonaut: The loneliness of the long distance space traveler—excerpts from Diary of a cosmonaut: 211 days in space. Final Frontier*, February, 43-47.

M.M. Connors, A.A. Harrison, & F.R. Akins (1985). *Habitability. Living aloft: Human requirements of extended space flight*. Washington, DC: NASA Scientific and Technical Information Branch, 59-104.

G.T. Moore (1990). Psychological and social issues in the design of lunar habitats. Paper presented at the 11th biennial conference of the International Association for the Study of People and their Physical Surroundings, Ankara, Turkey, July, 24 pgs.

Section H

Energy and Natural Resources: Power, Thermal, and Hydraulic Systems

NASA (nd). *The space station power system*. Washington, DC: NASA Office of the Space Station, 10 pgs.

D. Buden & J.A. Anelo (1985). Nuclear energy: Key to lunar development. *Lunar bases and space activities of the 21st century*. Houston: Lunar and Planetary Institute, 85-98.

E.G. Cordes (1988). Natural resources and environmentally responsive design. From E.G. Cordes, G.T. Moore, & T. Hansmann, *Space architecture: A primer for the design of extraterrestrial environments*. Manuscript in preparation, Department of Architecture and Center for Architecture and Urban Planning Research, University of Wisconsin-Milwaukee, 10 pgs.

E.G. Cordes & S.J. Frahm (1988). Energy and its economics. From E.G. Cordes, G.T. Moore, & T. Hansmann, *Space architecture: A primer for the design of extraterrestrial environments*. Manuscript in preparation, Department of Architecture and Center for Architecture and Urban Planning Research, University of Wisconsin-Milwaukee, 15 pgs.

Section I

Lunar Construction Technology

L. Toups (nd). Lunar construction options. Unpublished presentation materials, Lockheed Company, NASA Contract No. NAS9-17900, 16 pgs.

P. Chow & T.Y. Lin (1988). Structures for the moon. *Lunar bases and space activities of the 21st century*. Houston: Lunar and Planetary Institute, 362-374.

A. Binder & L. Toups (1989). Astrotechnics: Construction requirements and methods in space. *SICSA Outreach*, June, 2(2), 12 pgs.

L. Bell (1988). Inflatable space structures. *SICSA Outreach*, May-June, 1(7), 16 pgs.

Section J

Space Biospheres, Controlled Ecological Life Support Systems (CELSS), and Environmentally Controlled Life Support Systems (ECLSS)

R.D. MacElroy, H.P. Klein, & M.M. Averter (1985). The evolution of CELSS for lunar bases. *Lunar bases and space activities of the 21st century*. Houston: Lunar and Planetary Institute, 621-633.

M.J. Mackowski (1988). Greening upon our act. *Space World*, October, 13-15.

P.J. Boston (1981). Life support workshop summary. *The case for Mars*. Space and Technology Series, Vol. 57. Washington, DC: American Astronautical Society, 184-188.

D.B. Reiber (1986). Life support: Flight versus surface systems. *The NASA Mars conference. Science and Technology Series*, Vol. 71. Washington, DC: American Astronautical Society, 487-507.

Section K

Bibliography

Space Architecture Design Group (1991). Publications, talks, and interviews on space architecture. Milwaukee: University of Wisconsin-Milwaukee, Department of Architecture and Center for Architecture and Urban Planning Research, January, 8 pgs.

APPENDIX C

PUBLICATIONS, TALKS, AND INTERVIEWS ON SPACE ARCHITECTURE¹

Space Architecture Design Group

Department of Architecture

and

Center for Architecture and Urban Planning Research
University of Wisconsin-Milwaukee

Books

Cordes, E.G., Moore, G.T., & Hansmann, T. (in preparation). Space architecture: A primer for the design of extraterrestrial environments. Manuscript in preparation, Center for Architecture and Urban Planning Research, University of Wisconsin-Milwaukee.

Research and Technical Reports

Schnarsky, A.J., Cordes, E.G., Crabb, T., & Jacobs, M. (1988). *Space architecture: Lunar base scenarios* (ed. by E.G. Cordes, G.T. Moore, & S.J. Frahm). Milwaukee: University of Wisconsin-Milwaukee, Center for Architecture and Urban Planning Research, Report R88-1. ISBN 0-938744-59-3. Pp. vi + 80; figures charts, and 8 design projects. \$10.00

Cordes, E.G. (1989). *Lunar base studies*. Unpublished M.Arch. thesis, School of Architecture and Urban Planning, University of Wisconsin-Milwaukee. Pp. iv. + 42; diagrams, plans, and computer-aided design illustrations.

Cordes, E.G. (1989). *Project Newton: A variable gravity research facility* (2 vols.). Strasbourg, France: International Space University/European Space Agency Publication.

Hansmann, T. (1989). *Inflatable lunar habitat mission operations level*. Final report prepared for the NASA/USRA Advanced Design Program, Johnson Space Center, Houston, Texas.

Baschiera, D.J., Fieber, J.P., Moths, J.H., Paruleski, K.L., & others (1989). *Genesis Lunar Outpost: Program/requirements documents for an early stage lunar outpost* (ed. by E.G. Cordes). Milwaukee: University of Wisconsin-Milwaukee, Center for Architecture and Urban Planning Research, Report R89-1. ISBN 0-938744-61-5. Pp. 91; figures, charts, tables. \$10.00.

Hansmann, T., & Moore, G.T. (Eds.) (1990). *Genesis Lunar Outpost: Criteria and design*. Milwaukee: University of Wisconsin-Milwaukee, Center for Architecture and Urban Planning Research, Report R90-1. ISBN 0-938744-69-0. Pp. xiv + 107; plans, illustrations, tables, references. \$10.00.

Connell, R.B., Fieber, J.P., Paruleski, K.L., & Torres, H.D. (1990). *Design of an inflatable habitat for NASA's proposed lunar base*. Final report prepared for Universities Space Research Association and NASA Johnson Space Center.

Cordes, E.G., Moore, G.T., Hansmann, T., Fieber, J.P., Paruleski, K.L., & Moths, J.H. (Eds.) (1991). *Space architecture design workshop/studio: Space architecture reader* (Rev. ed.). Milwaukee: University of Wisconsin-Milwaukee, Department of Architecture, Advanced Design Program in Space Architecture. Pp. ca. 300/volume. \$10.00/volume — students only.

Fieber, J.P. (1990). *An investigation of technological options in lunar construction*. Independent study report, Advanced Design Program in Space Architecture, Department of Architecture, University of Wisconsin-Milwaukee. Pp. xi + 47.

Paruleski, K.L. (1990). *Extra-terrestrial habitation: A quest for solutions*. Independent study report, Advanced Design Program in Space Architecture, Department of Architecture, University of Wisconsin-Milwaukee. Pp. vi + 56.

¹ The reports included on this list with prices indicated are available prepaid from the Center for Architecture and Urban Planning Research, University of Wisconsin-Milwaukee, P.O. Box 413, Milwaukee, WI 53201-0413. Other reports may be available by writing to the publisher indicated or directly to the author.

Genesis II: Advanced Lunar Outpost

Huebner-Moths, J. (1991). *Environmental conditions of the moon and Mars*. Independent study report, Advanced Design Program in Space Architecture, Department of Architecture, University of Wisconsin-Milwaukee.

Published Papers

Cordes, E.C. (1988). Computer-aided design and space architecture. *Academic Computing*, September, Vol. 3(2), Cover, 18-21, 49. \$1.00.

Schnarsky, A.J. (1988). CAD as a tool of change: Architecture a changing profession. *Academic Computing*, September, Vol. 3(2), 22-24. \$1.00.

Schnarsky, A.J. (1988). From the near side of the moon. *Wisconsin Architect*, July, 14-16. \$1.00.

Moore, G.T. (1990). Environment-behavior issues in extraterrestrial space. In H. Pamir, V. Imamoglu, & N. Teymur (Eds.), *Culture, space, history: Proceedings of the 11th international conference of the International Association for the Study of People and their Physical Surroundings*. Ankara, Turkey: Middle East Technical University Press. Vol. 5. pp. 387-403. \$1.00.

Moore, G.T. (1990). An evolutionary habitat for the moon. *Wisconsin Architect*, September-October. \$1.00.

Moore, G.T., Baschiera, D.J., Fieber, J.P., & Moths, J.H. (1990). *Genesis lunar outpost: An evolutionary lunar habitat*. In P. Thompson (Ed.), *NASA/USRA University Advanced Design Program: Proceedings of the 6th annual summer conference*. Houston: Universities Space Research Association and Lunar Planetary Institute. Pp. 241-254. \$1.00.

Moore, G.T. (1991). *Genesis lunar habitat*. In American Institute of Aeronautics and Astronautics, *Final Report to the Office of Aeronautics, Exploration, and Technology, National Aeronautics and Space Administration on Assessment of Technologies for the Space Exploration Initiative (SEI)*. Washington, DC: American Institute of Aeronautics and Astronautics. Log No. 284.

Moore, G.T., Fieber, J.P., Moths, J.H., & Paruleski, K.L. (in press). *Genesis advanced lunar outpost II: A progress report*. In J. Blackledge & S.

Seida (Eds.), *Space—A Call for Action: International Space Development Conference Proceedings Technical Papers*. Colorado Springs, CO: National Space Society. \$2.00.

Moore, G.T. (1991, in press). *Genesis II: Advanced lunar outpost*. In P. Thompson (Ed.), *NASA/USRA University Advanced Design Program: Proceedings of the 7th annual summer conference*. Houston: Lunar and Planetary Institute. \$2.00.

Moore, G.T. (under review). *Genesis: Psychological and social issues in the design of lunar habitats*. Submitted to the *Journal of Architecture and Planning Research*. \$2.00.

Symposia

Moore, G.T. (Chair). (1990). Architects explore the final frontier. Environmental Design Research Association 21st annual conference, Urbana, Illinois. \$1.00.

Moore, G.T. (Chair). (1990). Symposium on space architecture. International Association for the Study of People and their Physical Surroundings 11th biennial conference, METU Middle East Technical University, Ankara, Turkey. \$1.00.

Research / Major Proposals and Funded Projects

Advanced Design Program in Space Architecture. Funded by the National Aeronautics and Space Administration/Universities Space Research Association (\$115,000, G.T. Moore, PI, funded), 1989-1992.

Inflatable Habitable Modular Space Structure. Proposal submitted to the Lawrence Livermore National Laboratory in cooperation with Astronautics Corporation of America, Marquette University, Amalga Composites, Inc., Global Outpost, Inc., and Orbital Technologies Corporation (\$3.4 million, G.T. Moore, PI/PD, withdrawn), June 1990.

Wisconsin Space Grant Consortium. Funded by the National Aeronautics and Space Administration in cooperation with University of Wisconsin-Madison, Marquette University, Astronautics Corporation of America, Orbital Technologies Corporation, and Wisconsin Space Institute (\$600,000, G.T. Moore, PI/PD, funded), 1991-1995.

Lectures and Talks

- Bell, L. (1987). Space architecture: Its frontiers and opportunities for practice and research. School of Architecture and Urban Planning, University of Wisconsin-Milwaukee, November.
- Cordes, E.G., & Lovett, T.J. (1988). Lunar base designs. Video presentation. NASA/Universities Space Research Association 4th Annual Advanced Design Conference, Kennedy Space Center, Cocoa Beach, Florida, May.
- Cordes, E.G., & Moore, G.T. (1988). Space architecture and computer-aided design Applications. Video presentation. A/E/C Systems '88 Space Station Design and Development Conference, Chicago, May.
- Cordes, E.G., & Patton, C.V. (1988). Space exploration: Feasible roles for planners. Association of Collegiate Schools of Planning Conference, Buffalo, New York, October.
- Cordes, E.G. (1989). Lunar base studies. CAD-based video presentation. NASA/Universities Space Research Association 5th Annual Advanced Design Conference, Marshall Space Flight Center, Huntsville, Alabama, June.
- Kalil, M., & Veliz, C. (1989). Two approaches to space design (C. Veliz's work presented by G.T. Moore). School of Architecture and Urban Planning, University of Wisconsin-Milwaukee, September.
- Kalil, M. (1989). An outward continuum. Friday Afternoon Live Lecture. School of Architecture and Urban Planning, University of Wisconsin-Milwaukee, September.
- Cordes, E.G. (1989). Technology transfer for the human environment: Space systems design and the role of architects. Midwest Space Development Conference, West Lafayette, Indiana, October.
- Cordes, E.G. (1989). Design of lunar and Martian living quarters. Retired Men's Club of Whitefish Bay, Wisconsin, November.
- Moore, G.T. (1989). Industry/university cooperation in space architecture. Astronautics Corporation of America, Milwaukee, Wisconsin, November.
- Moore, G.T. (1989). Environment-behavior issues in extraterrestrial space. Escuela de Arquitectura, Universidad de Puerto Rico, San Juan, Puerto Rico, December.
- Moore, G.T., & Moths, J.H. (1990). Lunar space architecture. Greater Milwaukee Chapter of the Retired Officers Association, January.
- Moore, G.T., Moths, J.H., & Baschiera, D.J. (1990). Extraterrestrial habitats and how they will effect our futures. Wisconsin Young Astronauts Aviation and Aerospace Conference, Waukesha, Wisconsin, March.
- Neubek, D. (1990). Recent work of the University of Houston SICSA Space Architecture Program. School of Architecture and Urban Planning, University of Wisconsin-Milwaukee, March.
- Andino, A. (1990). Recent work of the University of Puerto Rico Space Architecture Program. School of Architecture and Urban Planning, University of Wisconsin-Milwaukee, April.
- Baschiera, D.J., Gruenberger, M., Moths, J.H., Paruleski, K.L., Schroeder, C.W., & Crabb, T.M. (1990). Architects explore the final frontier. Environmental Design Research Association 21st Annual Conference, Urbana-Champaign, Illinois, April.
- Baschiera, D.J., Fieber, J.P., Graff, P., Gruenberger, M., Kinde, M.R., Moss, S.E., Moths, J.H., Paruleski, K.L., Schleicher, S.A., & Schroeder, C.W. (1990). *Genesis* lunar outpost: Design project. Environmental Design Research Association 21st Annual Conference, Urbana-Champaign, Illinois, April.
- Baschiera, D.J., Schleicher, S.A., & Moore, G.T. (1990). Space architecture: The final frontier. University of Wisconsin-Milwaukee Guild for Learning in Retirement, April.
- Moths, J.H., Fieber, J.P., Gruenberger, M., & Paruleski, K.L. (1990). *Genesis* lunar outpost. National Aeronautics and Space Administration/Universities Space Research Association Advanced Design Program 6th annual summer conference, NASA Lewis Research Center, Cleveland, Ohio, June.
- Moore, G.T. (1990). Environment-behavior issues in extraterrestrial space. 11th biennial conference of the International Association for the

Genesis II: Advanced Lunar Outpost

- Study of People and their Physical Surroundings, METU Middle East Technical University, Ankara, Turkey, July.
- Moths, J.H. (1990). Space architecture: Update and future considerations. Milwaukee Chapter, American Association of University Women, Milwaukee, Wisconsin, November.
- Huebner-Moths, J. (1991). Space, astronauts, and future living. McKinley Elementary School, Wauwatosa, Wisconsin, January.
- Huebner-Moths, J. (1991). Space, astronauts, and future habitats. St. Agnes School, Menomonee Falls, Wisconsin, January.
- Moore, G.T. (1991). Space architecture. College of Architecture, Georgia Institute of Technology. Atlanta, February.
- Schroeder, C., & Huebner-Moths, J. (1991). Space and space architecture update. Shady Lane School, Menomonee Falls, Wisconsin, March.
- Schroeder, C., Huebner-Moths, J., & Paruleski, K.L. (1991). Space and space architecture update. Country Meadow School, Muskego, Wisconsin, March.
- Fieber, J.P., & Paruleski, K.L. (1991). *Genesis* lunar outpost: 1990 USRA project. Wisconsin Young Astronauts Aviation and Space Conference, Brookfield, Wisconsin, March.
- Bluth, B.J. (1991). The Soviet space stations and extraterrestrial space experience. Wisconsin Young Astronauts Aviation and Space Conference, Brookfield, Wisconsin, March.
- Moore, G.T., Fieber, J.P., Moths, J.H., & Paruleski, K.L. (1991). *Genesis* advanced lunar outpost II: A progress report. National Space Society 10th annual International Space Development Conference, San Antonio, Texas, May.
- Fieber, J.P., Huebner-Moths, J., Paruleski, K.L., and the students of Architecture 690 (1991). *Genesis II: Advanced Lunar Outpost*. National Aeronautics and Space Administration/Universities Space Research Association Advanced Design Program 7th Annual Summer Conference, NASA Kennedy Space Center, Florida, June.
- Huebner-Moths, J., Kishony, D., & Paruleski, K.L. (1991). *Genesis II* Advanced Lunar Outpost. Friday Afternoon Live, Department of Architecture, University of Wisconsin-Milwaukee, October (forthcoming).
- Moore, G.T., Fieber, J.P., Huebner-Moths, J., & Paruleski, K.L. (1991). *Genesis* advanced lunar outpost II. International Design for Extreme Environments Assembly, Houston, Texas, November (under review).
- ### Exhibits
- Space Architecture Design Group (1990). *Genesis: Space architecture*. Exhibit at the 1990 Aviation and Aerospace Conference, Brookfield and Waukesha, Wisconsin, March.
- Space Architecture Design Group (1990). Space architecture: Laboratory and habitation modules for the moon. Poster and exhibit at the Environmental Design Research Association 21st Annual Conference, Urbana-Champaign, Illinois, April.
- Space Architecture Design Group (1990). Recent work of the Space Architecture Design Group. Exhibit After Friday Afternoon Live, School of Architecture and Urban Planning, University of Wisconsin-Milwaukee, April.
- Space Architecture Design Group (1990). *Genesis* Lunar Outpost. Exhibit at the National Aeronautics and Space Administration/Universities Space Research Association Advanced Design Program 6th Annual Summer Conference, NASA/Lewis Research Center, Cleveland, Ohio, June.
- Space Architecture Design Group (1991). *Genesis II* Advanced Lunar Outpost. Exhibit at the National Aeronautics and Space Administration/Universities Space Research Association Advanced Design Program 7th Annual Summer Conference, NASA/Kennedy Space Center, Cocoa Beach, Florida, June.
- Space Architecture Design Group (1991). *Genesis I* Lunar Outpost and *Genesis II* Advanced Lunar Outpost. Exhibit at the Wisconsin Space Grant Consortium Annual Seminar, Regents' Conference Room, University of Wisconsin System, Madison, July.

Space Architecture Design Group (1991). *Genesis II Advanced Lunar Outpost. Exhibit After Friday Afternoon Live*, School of Architecture and Urban Planning. University of Wisconsin-Milwaukee, October (forthcoming).

Awards

Student Special Merit Award—Design for Genesis Lunar Outpost to the Space Architecture Design Group from the Environmental Design Research Association, April 1990.

National Student Research Award to Kerry L. Paruleski from the Association of Collegiate Schools of Architecture, February 1991.

National Student Research Honorable Mention to Joseph P. Fieber from the Association of Collegiate Schools of Architecture, February 1991.

Honorable Mention/Research—An Investigation of Technological Options in Lunar Construction to Joseph Fieber from the UW-Milwaukee School of Architecture and Urban Planning, May 1991.

Honorable Mention/Research—Extraterrestrial Habitation: A Quest for Solutions to Kerry Paruleski from the UW-Milwaukee School of Architecture and Urban Planning, May 1991.

Honorable Mention/Architectural Design to the Space Architecture Design Group from the UW-Milwaukee School of Architecture and Urban Planning, May 1991.

REFERENCES

- Adams, B., Alhadeff, S., Beard, S., Carlile, D., Cook, D., Douglas, C., Garcia, D., Gillespie, D., Golingo, R., Gonzalez, D., Gurevich, P., Hansen, C., Hopkins, W., Iacometti, J., Jardin, M., Lipscomb, T., Love, S., Montague, T., Nelson, J., Ritter, D. (1990). *Megawatt solar power systems for lunar base operations*. Seattle: University of Washington, Department of Aeronautics and Astronautics.
- Alred, J., Bufkin, A., Kennedy, K.J., Petro, A., Roberts, M., Stecklein, J., & Sturm, J. (1989). *Lunar Outpost*. Houston: NASA Johnson Space Center, Systems Definition Branch, Advanced Program Office.
- Boeing Aerospace Company (1983). *Space station/nuclear submarine analogs. U.S. Naval Submarine Interview Report*. Granada Hills, CA: National Behavior Systems.
- Buscher, G. (1991). ECLSS/HVAC life support systems. Paper prepared for Space Architecture 690, University of Wisconsin-Milwaukee, Department of Architecture, February.
- Compton, W. D., Benson, C. (1983). *Living and working in space. A History of Skylab*. NASA History Series, NASA SP-4208.
- Cordes, E.G., Moore, G.T., & Hansmann, T. (1989). *Space Architecture design workshop/studio: Space architecture reader (2 vols.)*. Milwaukee: University of Wisconsin-Milwaukee, Center for Architecture and Urban Planning Research.
- Cordes, E.G., Moore, G.T., & Hansmann, T. (in preparation). *Space architecture: A primer for the design of extraterrestrial environments*. Manuscript in preparation, Center for Architecture and Urban Planning Research, University of Wisconsin-Milwaukee.
- Dalton, M. (1974). *Architectural evaluation for sleeping quarters. Skylab Experience*, No. 3, Houston: National Aeronautics and Space Administration.
- Demler, A. (1991). *From one material world to another*. Paper prepared for Space Architecture 690, University of Wisconsin-Milwaukee, Department of Architecture, February.
- Dewitt, P. *Windowless Psychology*. Paper prepared for Space Architecture 690, University of Wisconsin-Milwaukee, Department of Architecture, February.
- Fieber, J.P. (1990). *An investigation of technological options in lunar construction*. Independent study report, Advanced Design Program in Space Architecture, Department of Architecture, University of Wisconsin-Milwaukee.
- Fieber, J.P. (1991). *The clarifier*. Paper prepared for Space Architecture 690, University of Wisconsin-Milwaukee, Department of Architecture, February.
- Fruncek, P. (1991). *Lunar habitat construction sequencing*. Paper prepared for Space Architecture 690, University of Wisconsin-Milwaukee, Department of Architecture, February.
- Gorski, G. (1991). *Radiation shielding and uses of lunar regolith*. Paper prepared for Space Architecture 690, University of Wisconsin-Milwaukee, Department of Architecture, February.
- Grumman Aerospace Corp. (1970). *Use of the Ben Franklin Submersible as a spacestation analog. Psychology and Physiology*. Vol. 2: NASA-CR-102831, Houston: National Aeronautics and Space Administration.
- Haffner, J.W. (1967). *Radiation and shielding in space*. New York: Academic Press.
- Hansmann, T., & Moore, G.T. (Eds.) (1990). *Genesis Lunar Outpost: Criteria and design*. Milwaukee: University of Wisconsin-Milwaukee, Center for Architecture and Urban Planning Research, Report R90-1. ISBN 0-938744-69-0. Pp. xiv + 107; plans, illustrations, tables, references.
- Huebner-Mothes, J. (1991). *Environmental conditions of the moon and Mars*. Independent study report, Advanced Design Program in Space Architecture, Department of Architecture, University of Wisconsin-Milwaukee.
- Kishony, D. (1991). *Partial Gravity: Human Factors which Effect Lunar Habitat Design*. Paper prepared for Space Architecture 690, University of Wisconsin-Milwaukee, Department of Architecture, February.

Genesis II: Advanced Lunar Outpost

- Maner, S. Natural Viewing and Lighting. Paper prepared for Space Architecture 690, University of Wisconsin-Milwaukee, Department of Architecture, February.
- McKay, C.P., Anderson, D.T., Wharton, R.A. Jr. & Rammel, J.D. (in press). An Antarctic outpost as a model for planetary exploration. *Journal of the British Interplanetary Society*.
- NASA (1989). *Man-Systems Integration Standards*. NASA Standard 3000, Vol. 1, Rev. A., Houston: Man-Systems Division.
- NASA (1989). *Report of the 90-Day Study on Human Exploration of the Moon and Mars*. Internal NASA report prepared for Administrator Richard H. Truly.
- Newkirk, R. (1977). Skylab: A chronology. *NASA History Series*, NASA SP-4011, Washington: Scientific & Technical Information Office.
- Nicogossian, A., Parker, J. (1982). *Space Physiology & Medicine*. NASA SP-447. Washington: Scientific & Technical Information Branch.
- Ott, J.N. (1973). On the psychology of earth covered buildings in Moorland, Florida. *Alternatives in Energy Conservation*. Fort Worth: pp.65-69.
- Paruleski, K.L. (1990). *A comparative analysis of analogous situations, previous space exploration, simulated situations, and future conditions*. Independent study report, Advanced Design Program in Space Architecture, Department of Architecture, University of Wisconsin-Milwaukee.
- Paruleski, K. (1991). 1/6 Gravity: An Understanding for the Design of a Lunar Base. Paper prepared for Space Architecture 690, University of Wisconsin-Milwaukee, Department of Architecture, February.
- Prudlow, K. (1991). Energy demands of a lunar habitat. Paper prepared for Space Architecture 690, University of Wisconsin-Milwaukee, Department of Architecture, February.
- Rebholz, P. (1991). A lunar biosphere, a total system. Paper prepared for Space Architecture 690, University of Wisconsin-Milwaukee, Department of Architecture, February.
- Rhone, D. (1991). Base and structural expandability. Paper prepared for Space Architecture 690, University of Wisconsin-Milwaukee, Department of Architecture, February.
- Sasakawa International Center for Space Architecture (1988). Inflatable space structures. *SICSA Outreach*. Vol. 1, No. 7. Houston: University of Houston.
- Sasakawa International Center for Space Architecture (1989). The manned lunar outpost (MLO): a NASA/USRA-sponsored study. *SICSA Outreach*. Vol. 2, No. 4. Houston: University of Houston.
- Schnarsky, A.J. (1988). From the near side of the moon. *Wisconsin Architect*, July, 14-16.
- Schnarsky, A.J., Cordes, E.G., Crabb, T., & Jacobs, M. (1988). *Space architecture: Lunarbase scenarios*. (ed. by E.G. Cordes, G.T. Moore, & S.J. Frahm). Milwaukee: University of Wisconsin-Milwaukee, Center for Architecture and Urban Planning Research, Report R88-1.
- Scott, D.R. (1973). What is it like to walk on the Moon? *National Geographic*, Vol. 3, No. 144, pp. 326-329.
- Scuri, P. (1990). Windowless environments and space habitats. *Journal of Architecture and Planning Research*. Dec.
- Wurtman, R.J. (1973). Biological implications of artificial illumination, *Illuminating Engineering*. Vol. 65, pp. 523-529.