

3-17-92  
E-6729

NASA Technical Memorandum 105355

# Properties Data for Opening the Galileo's Partially Unfurled Main Antenna

Kazuhisa Miyoshi and Stephen V. Pepper  
*Lewis Research Center*  
*Cleveland, Ohio*

February 1992

**NASA**

# PROPERTIES DATA FOR OPENING GALILEO'S

## PARTIALLY UNFURLED MAIN ANTENNA

Kazuhisa Miyoshi and Stephen V. Pepper  
National Aeronautics and Space Administration  
Lewis Research Center  
Cleveland, Ohio 44135

### SUMMARY

An investigation was conducted into the friction and wear behavior of both unlubricated and dry-film-lubricated (Tiolube 460) titanium alloy (Ti-6Al-4V) in contact with an uncoated high-nickel-content superalloy (Inconel 718) both in vacuum and in air. The acquisition of friction and wear data for this sliding couple was motivated by the need for input data for the "antenna stuck ribs model" effort to free Galileo's high gain antenna.

The results of the investigation indicate that galling occurred in the unlubricated system in vacuum and that the coefficient of friction increased to 1.2. The abnormally high friction (1.45) was observed when relatively large wear debris clogged at the sliding interface. The coefficient of friction for the dry-film-lubricated system in vacuum is 0.04, while the value in air is 0.13. The endurance life of the dry-film lubricant is about three orders of magnitude greater in vacuum than in air. The worn surfaces of the dry-film-lubricated Ti-6Al-4V pin and Inconel 718 disk first run in humid air and then rerun in vacuum was completely different from that of the pin and disk run only in vacuum. Galling occurred in the former conditions, while spalling occurred in the latter conditions. When galling occurred in the humid-air and vacuum contact, coefficient of friction rose to 0.32 when sliding in humid air and to 1.4 when sliding in vacuum. The galling was accompanied by severe surface damage and extensive transfer of the Ti-6Al-4V to the Inconel 718, or vice versa. When spalling occurred in the dry-film-lubricated Ti-6Al-4V pin run only in vacuum, the coefficient of friction rose to 0.36 or greater. The wear damage caused by spalling can self-heal when rerun in vacuum and, consequently, the coefficient of friction decreased to 0.05. The friction and wear data obtained can be used for the "antenna stuck ribs model" effort to free Galileo's high gain antenna.

### INTRODUCTION

NASA's Galileo Jupiter probe was deployed by the space shuttle Atlantis in October 1989. However, Galileo's main antenna remains only partially unfurled after its failure to open properly in April 1991. The latest analysis by NASA's Jet Propulsion Laboratory indicates that four of the antenna's 18 ribs are stuck in place. The alignment pins on those ribs were bent by the deployment motor during the first attempt to unfurl the device (ref. 1).

The Ti-6Al-4V pins were coated with an inorganic, bonded dry-film lubricant, Tiolube 460, which utilizes a molybdenum disulfide pigment to prevent galling and to increase pin wear life when sliding on Inconel 718 (private communication with John Repar and Tim O'Donnell of JPL). Because the lubricant may have failed on the spacecraft, the coefficient of friction of a bare pin-rib system will be used to determine whether a thermal excursion could generate forces (due to differential thermal expansion in the mechanism) large enough to free the galled parts.

The objective of the present investigation is to provide the Jet Propulsion Laboratory with friction and wear data, taken in vacuum, on the lubricated "rib-spoke interface of alignment pins," the galling



of which may be responsible for the antenna's failure to unfurl. Three sets of sliding friction experiments were conducted. In the first set unlubricated Ti-6Al-4V pins were slid on an unlubricated Inconel 718 disk at loads of 2.5 and 4 N in vacuum. In the second set dry-film-lubricated Ti-6Al-4V pins were slid on an Inconel 718 disk at a load of 8.5 N both in vacuum and in air. In the third set of experiments, the pins that had been run both in vacuum and in air during the second set of experiments were slid on the same track of their Inconel disk in vacuum and at two loads (8.5 and 2.5 N for average contact pressures of 0.95 to 1.5 GPa, respectively). The loads and environments were chosen to simulate the conditions that the rib-spoke interface of the antenna's alignment pins may have been experienced.

## EXPERIMENTAL

### Tribometer

The tribometer (vacuum friction apparatus) is shown in figure 1 (ref. 2). The apparatus consists of a pin-on-disk assembly mounted in an ultrahigh vacuum chamber, a drive system, and a friction force measuring system (also shown in fig. 1). All components within the vacuum chamber are compatible with oxidizing, inert, or reducing gases.

The disk specimen is mounted on a shaft that is driven by a gear motor connected to a rotary feedthrough with a ferrofluidic seal. The drive assembly provides rotation at various speeds, which are regulated by a dc-motor speed controller. During disk rotation, the pin scribed a circular wear track on the flat surface of the disk. The bellows assembly permits rotation at various track diameters. The pin specimen is mounted in a holder attached to one end of a stainless-steel beam. The beam is welded into a bellows assembly which is gimbal mounted to the vacuum-chamber wall. The gimbal mounting permits deadweight loading of the pin against the disk surface. At right angles to the deadweight loading, the beam containing the pin can move in two directions in the horizontal plane. Movement of the pin (with the disk as it rotates) is restrained by a cable which is attached to a beryllium-copper ring. The ring contains four sets of strain gauges to measure the friction force between the pin and disk specimens. The friction force can be continuously recorded by a strip chart recorder or by a computerized data acquisition system during friction experiments.

The vacuum system was evacuated for 12 to 15 hr without bakeout to a pressure in the  $10^{-7}$  Pa ( $10^{-9}$  torr) range using an oil-sealed mechanical pump, a turbomolecular vacuum pump, an ultraviolet lamp, and a titanium sublimation pump. Pressure is measured by a nude ionization gauge. Residual gas analysis is made before, during, and after the friction and wear experiment with a quadrupole gas analyzer.

### Friction and Wear Experiments

Friction and wear experiments were conducted with (1) unlubricated Ti-6Al-4V sliding against Inconel 718 and (2) dry-film-lubricated Ti-6Al-4V sliding against Inconel 718 (table I). The unlubricated Ti-6Al-4V sliding against Inconel 718 is given here for reference. The contacting surface of the Ti-6Al-4V specimens were hemispherical with a radius of curvature of 0.5 mm. The dry-film lubricant (25  $\mu$ m thick) was applied over Tiodize-treated Ti-6Al-4V pins (figs. 2 and 3) by the vendor of the lubricant. The coating thickness was determined by taking a cross section of a representative pin specimen (fig. 2 (b)). The contacting surface of Inconel 718 disk specimens was flat. The disk specimens were 25 mm in diameter and 5 mm thick. The average surface roughness of the Inconel

TABLE I.—EXPERIMENTS

(a) Materials

Materials		Pretreatment		Dry-film lubricant	
Pin	Disk	Pin	Disk	Pin	Disk
Ti-6Al-4V	Inconel 718 <sup>a</sup>	Bare	Bare	None	None
Ti-6Al-4V	Inconel 718 <sup>a</sup>	Tiodize	Bare	Tiolube 460	None

(b) Conditions

Load, N	2.5, 4, and 8.5
Disk rotating speed, rpm	1, 10, and 40
Track diameter, mm	12 to 20
Sliding velocity, mm/sec	0.5, 0.9, 8, and 36
Environment condition:	
Air	40% relative humidity
Vacuum	$10^{-7}$ Pa

<sup>a</sup>Composition, wt% (maximum unless shown as range): Ni, 50-55; Cr, 17-21; Fe, 12-23; Cb + Ta, 4.75-5.5; Mo, 2.8-3.3; Co, 1; Ti, 0.65-1.15; Al, 0.2-0.8; Si, 0.35; Mn, 0.35; Cu, 0.3; C, 0.08; S, 0.015; P, 0.015; B, 0.006.

718 disks, measured by surface profilometer, was 34 nm, root mean square, and 25 nm, center line average. The pin and disk specimens were provided by the Jet Propulsion Laboratory.

The as-received pin and disk specimens were positioned in the chamber. In this investigation, sliding friction experiments were conducted with the apparatus in two environments: (1) in vacuum and (2) in laboratory air (approximately 40-percent relative humidity). For the sliding friction experiments in vacuum, the system was evacuated to a pressure of approximately  $7 \times 10^{-7}$  Pa ( $5 \times 10^{-9}$  torr); all experiments in vacuum were conducted at this pressure.

In each experiment, a new pin specimen was used unless otherwise specified. The diameter of the wear track on the Inconel 718 disks ranged from approximately 12 to 20 mm. The loads used were 2.5 to 8.5 N (average contact pressure, 0.95 to 1.5 GPa).

## RESULTS AND DISCUSSION

### Unlubricated Ti-6Al-4V to Inconel 718 Contact

**Friction.**—Friction traces (plots of the coefficient of friction versus the number of disk revolutions) for the unlubricated system measured at 2.5 N are presented in figure 4. The traces for the first three or four disk revolutions are characterized by randomly fluctuating behavior, with only occasional evidence of stick-slip behavior (e.g., fig. 4(a)). The presence of oxides and contaminants on the surfaces of Ti-6Al-4V pin and Inconel 718 disk contributed to this relatively low coefficient of friction. Stick-slip behavior becomes dominant after five disk revolutions. The higher the number of disk revolutions, the greater the stick-slip behavior. The traces for 10 disk revolutions and above are primarily characterized by a continuous, marked stick-slip behavior, as shown by the representative section in figure 4(b). This type of friction is anticipated where strong metallic interactions occur at the interface due to the removal of the oxides and contaminants from the alloy surfaces by sliding action.



The coefficients of friction, calculated from the highest value and from the average value of the five highest values of friction within a given revolution, are presented in figure 5. Both coefficients of friction increased with increasing number of disk revolutions and reached equilibrium values (0.9 to 1.2) after 40 to 50 disk revolutions. The abnormally high coefficient of friction (1.45) at 80 disk revolutions is probably due to wear debris clogging the sliding interface.

Wear damage.—Scanning electron microscope (SEM) photographs and energy dispersion x-ray analysis (EDX) spectra of the damage produced on the pin and on the disk after 100 disk revolutions at a load of 2.5 N are presented in figures 6 to 9. Figure 6 shows that substantial plastic deformation occurred on the pin. Large wear debris particles formed by plastic deformation and ductile fracture of the Ti-6Al-4V pin are present around the wear scar. Also, plastically deformed grooves and clogged wear debris are present on the wear scar of the pin. Closer SEM examination and EDX analysis of the wear debris showed it to be composed primarily of elements from the Ti-6Al-4V pin (fig. 7) and of small amounts of chromium, iron, and nickel from the Inconel 718 disk.

Figures 8 and 9 show the Ti-6Al-4V patches on the wear track of Inconel 718 disk. The transferred patches occupied a quite large area fraction of the overall wear track. Thus, the severe damage, often referred to as galling, occurred in the unlubricated Ti-6Al-4V to Inconel 718 contact in vacuum (refs. 3 to 5).

Effect of dwell time on friction.—It is well known that, although the static coefficient of friction for metal contacts varies most markedly at short times of static contact (say, below 0.1 sec), at longer times the coefficient of friction depends only slightly on the duration of static loading (ref. 6). Since the contact surface of the Ti-6Al-4V pin was in a state of plasticity (fig. 6), it was expected that the static friction would not be sensitive to the duration of static loading (ref. 6).

Figure 10 presents friction traces (coefficient of friction as a function of number of disk revolutions) for a Ti-6Al-4V pin in contact with Inconel 718 disk. At 90 disk revolutions (fig. 10(a)) and at 95 disk revolutions (fig. 10(b)), the sliding motion was stopped, and conditions were held for 1/2 hr and for 2 hr, respectively. After the dwell time, sliding was restarted. The traces clearly show that dwell time had almost no effect on the static coefficient of friction, which was similar before and after the dwell time.

Effect of load.—Figure 11 presents the coefficients of friction measured at the load of 4 N. The coefficients of friction were calculated from highest value in friction traces. As might be expected, the friction behavior and the appearance of the galling was essentially the same as observed at 2.5 N.

#### Dry-Film-Lubricated Ti-6Al-4V to Inconel 718

Friction.—Sliding friction experiments were conducted with dry-film-lubricated (Tiolube 460) Ti-6Al-4V pins on Inconel 718 disks at a load of 8.5 N both in vacuum and in air. The results are presented in figures 12 to 14.

In vacuum, the coefficient of friction starts relatively high (0.23) but rapidly decreases and reaches an equilibrium value of about 0.04 (fig. 12). It remains constant for a long period of time. The friction trace fluctuated slightly with no evidence of stick-slip behavior (fig. 13). The sliding action finally caused the coefficient of friction to rapidly increase at 172 370 revolutions. Wear damage, which will be discussed later, caused the high friction at this stage.

In air, the coefficient of friction started high (approximately 0.30) in the first 23 revolutions, but decreased and reached an equilibrium value of about 0.1 (fig. 14). Continued sliding caused the coefficient of friction to increase at 270 revolutions. When the coefficient of friction reached an equilibrium value of about 0.3, the experiment stopped (at 700 disk revolutions). The friction trace with disk revolutions to 270 exhibited mild stick-slip behavior (as shown by the representative section in figs. 15(a) and (b)). After 270 disk revolutions, the friction trace exhibited greater stick-slip behavior (fig. 15(c)).

When compared with the coefficients of friction obtained in vacuum, the coefficients of friction obtained in air were much greater. The coefficient of friction for the dry-film lubricant in vacuum is 1/3 of the value in air. Further, the endurance life of the dry-film lubricant in vacuum (the number of disk revolutions before the onset of a marked increase in friction) is about three orders of magnitude longer than that in air.

#### Rerun in Vacuum with the Worn Pin and Disk

Worn in vacuum.—At 172 370 revolutions of sliding contact in vacuum (fig. 12), the sliding motion was stopped because of high friction (0.36 or greater) caused by the wear damage. After holding conditions for about 18 hr, the sliding was restarted. The result is presented in figure 16(a). The coefficient of friction after rerun became much lower. Further, the coefficient of friction generally decreased to about 0.05 with increasing number of disk revolutions. This result suggests that the wear damage in vacuum, which caused high friction at 172 370, can self-heal when rerun in vacuum.

After 50 revolutions of sliding contact, the sliding motion was stopped, and the load was changed from 8.5 N to 2.5 N. Contact was maintained for 30 sec, and then sliding was begun at the new load. The changing load from 8.5 N to 2.5 N did not affect the coefficient of friction, as shown in figure 16(b).

Worn in air and then rerun in vacuum.—After 700 disk revolutions in air (fig. 14), the worn surfaces were at rest, and loose wear particles on the Inconel 718 disk surface were blown off. Then the vacuum chamber was evacuated to  $10^{-7}$  Pa ( $10^{-9}$  torr). After dwelling for about 18 hr in contact, the sliding motion was restarted. The coefficients of friction for the pin and disk worn in humid air were much higher than those for the pin and disk worn in vacuum (as shown in fig. 16(a)). Further, the coefficient of friction generally increased with increasing number of disk revolutions.

After 50 revolutions of sliding contact in vacuum, the sliding motion was stopped, and the load was changed from 8.5 N to 2.5 N. Contact was maintained for 30 sec, and then sliding was begun at the new load. The coefficient of friction continued to increase with increasing number of disk revolutions (fig. 16(b)).

#### Wear Damage

Worn in vacuum.—SEM photographs of the worn surfaces of the dry-film-lubricated Ti-6Al-4V pin sliding against Inconel 718 disk in vacuum show surface smearing, tearing, and spalling of the dry-film lubricant (figs. 17 to 20). This type of wear damage, which results from fatigue of the dry-film lubricant, is often referred to as spalling (refs. 3 to 5).



Figure 17(a) shows the relatively smooth burnished surfaces in the upper and lower regions of the wear scar and the rougher surface at the center of the scar. Closer SEM examination and EDX analysis of the wear damage at the center of the wear scar showed that the flake-like wear debris (fig. 16(b)) resulted from surface smearing and tearing of the dry-film lubricant. EDX analysis of the flake-like debris indicated that it mainly contained the elements of the  $\text{MoS}_2$  lubricants. Figure 17(c) shows a crater (dark area) where fragments of the dry-film lubricant were removed and the Ti-6Al-4V substrate was exposed. The EDX analysis of the crater indicated that it mainly contained elements of the Ti-6Al-4V.

Interestingly, even with the spalling, the extent of removal and fragmentation of the dry-film lubricant was minimal. Still, the dry-film lubricant occupied the majority of the overall wear scar.

Figures 18 and 19 show a taper cross section of the worn surface of the dry-film-lubricated Ti-6Al-4V pin at an angle of  $45^\circ$  to the worn surface. The cross-section SEM photographs clearly indicate that most of the dry-film lubricant remains even after about 170 000 revolutions in vacuum. The film thickness of the remaining lubricant is about 15  $\mu\text{m}$ . Close SEM examination reveals dense, amorphous-like material in the area right underneath the worn surface (fig. 19 (a)).

Figure 20(a) shows the relatively smooth track of the Inconel 718 disk with transferred patches of the dry-film lubricant observed (even in the low magnification view) mainly at the center of the wear track. Closer SEM examination of the center and upper regions of the track shows the transferred wear particles to be in the form of flakes and powders (fig. 20(b) and (c)).

Worn in air and rerun in vacuum.—Scanning electron micrographs of the worn surfaces of the dry-film-lubricated Ti-6Al-4V pin and Inconel 718 disk run in air for 700 disk revolutions and then rerun in vacuum for 100 disk revolutions are shown in figures 21 to 27. Figure 21 shows that both plastic deformation and ductile fracture occurred in the dry-film-lubricated Ti-6Al-4V pin. The backscatter photograph (fig. 21(b)) reveals three different materials: (1) the light areas in the photomicrograph show where the transfer patches from the Inconel 718 disk stayed on the Ti-6Al-4V pin, (2) the grayer areas show the Ti-6Al-4V substrate with no dry-film lubricant present, and (3) the salt and pepper-like areas around the edge of wear scar show the dry-film lubricant. In addition to the major elements of Inconel 718, the transfer patches also contained elements such as molybdenum and sulfur from the lubricant (fig. 22(a)). On the other hand, the gray areas contained only the elements of Ti-6Al-4V (fig. 22(b)).

The large patches seen on the wear track of the Inconel 718 disk of figure 23 are also apparent in the backscatter photomicrograph of figure 23(b), which indicated the dark areas to be the transfer patches from the Ti-6Al-4V. Further, the EDX analysis (fig. 24(a)) of the transfer patch shows that it mainly contained elements of the Ti-6Al-4V with a small amount of elements from the dry-film lubricant. The rest of the areas in the wear track contained relatively smaller amounts of elements from the Ti-6Al-4V and dry-film lubricant (fig. 24(b)). Closer SEM examination (fig. 25) of the wear track reveals extensive plastic shearing of the Inconel 718 disk.

Figure 26, a taper cross section of the worn surface of the dry-film-lubricated Ti-6Al-4V pin shows clearly that the dry-film lubricant is not present on the worn surface. Further, in the overview photomicrograph, extrusion out of the wear scar and transferred patches of Inconel 718 are also well defined because of effective atomic number contrast. In figure 27 plastic deformation of the Ti-6Al-4V (extrusion out of the wear scar) and local solid-phase welding between Ti-6Al-4V and transfer patch of Inconel 718 (often referred to as scuffing) were well defined by the backscatter electron image SEM.

Thus, the worn surface of the pin and disk first run in humid air and then rerun in vacuum was completely different from that of the pin and disk run only in vacuum. The surface worn in humid air (figs. 21 and 23) exhibited galling accompanied by the severe surface damage and extensive transfer of the Ti-6Al-4V to the Inconel 718, or vice versa.

### SUMMARY OF RESULTS

1. Galling occurred in the unlubricated Ti-6Al-4V to Inconel 718 contact and increased the coefficient of friction to 1.2 in vacuum. Abnormally high friction (1.45) was observed when relatively large wear debris clogged the sliding interface. Dwell time had little effect on the static coefficient of friction.

2. The performance of the dry-film lubricant in air is poor compared with its performance in vacuum. The coefficient of friction for the dry-film-lubricated system in vacuum was about 0.04, while the value in air was 0.13. The endurance life of the dry-film lubricant was about three orders of magnitude greater in vacuum than in air.

3. The worn surfaces of the dry-film-lubricated Ti-6Al-4V pin and Inconel 718 disk first run in humid air and then rerun in vacuum were completely different from those of the pin and disk run only in vacuum. Galling occurred in the former conditions, while spalling occurred in the latter conditions.

4. When galling occurred in the dry-film-lubricated Ti-6Al-4V to Inconel 718 contact first run in humid air and then rerun in vacuum, the coefficient of friction rose to about 0.32 in humid air and to 1.4 in vacuum. The galling was accompanied by severe surface damage and extensive transfer of the Ti-6Al-4V to the Inconel 718, or vice versa.

5. When spalling occurred in the dry-film-lubricated Ti-6Al-4V pin run against Inconel 718 only in vacuum, the coefficient of friction rose to 0.36 or greater. The wear damage, however, self-healed when rerun in vacuum, and the coefficient of friction decreased to 0.05.

6. The friction and wear data obtained can be used for the "antenna stuck ribs model" effort to free Galileo's high gain antenna.

### ACKNOWLEDGMENT

The authors wish to thank Tim O'Donnell and John Repar, NASA Jet Propulsion Laboratory, for providing both pin and disk specimens and for their advice; Robert Fusaro, NASA Lewis Research Center, for his advice; and A. Korenyi-Both and R. Miller, NASA Lewis Research Center, for their help and advice.

### REFERENCES

1. Controllers Adjust Galileo For Future Gaspra Flyby. Space News, vol. 2, no. 25, July 15-28, 1991, p. 13.
2. Miyoshi, K., et al.: A Vacuum ( $10^{-9}$  torr) Friction Apparatus for Determining Friction and Endurance Life of MoS<sub>2</sub> Films. NASA TM-104478, 1991.



3. Glossary of Terms and Definitions in the Field of Friction, Wear and Lubrication. Research Group on Wear of Engineering Materials, Organization for Economic Cooperation and Development, Paris, France, 1969.
4. Glaeser, W.A.: High Strain Wear Mechanisms in Ferrous Alloys. *Wear of Materials 1987*, Vol. 1, K.C. Ludema, ed., ASME, 1987, pp. 155-162.
5. Sawa, M.; and Rigney, D.A.: Sliding Behavior of Dual Phase Steels in Vacuum and in Air. *Wear of Materials 1987*, Vol. 1, K.C. Ludema, ed., ASME, 1987, pp. 231-244.
6. Bowden, F.P.; and Tabor, D.: *The Friction and Lubrication of Solids, Part 2*, Clarendon Press, 1964, pp. 340-343.

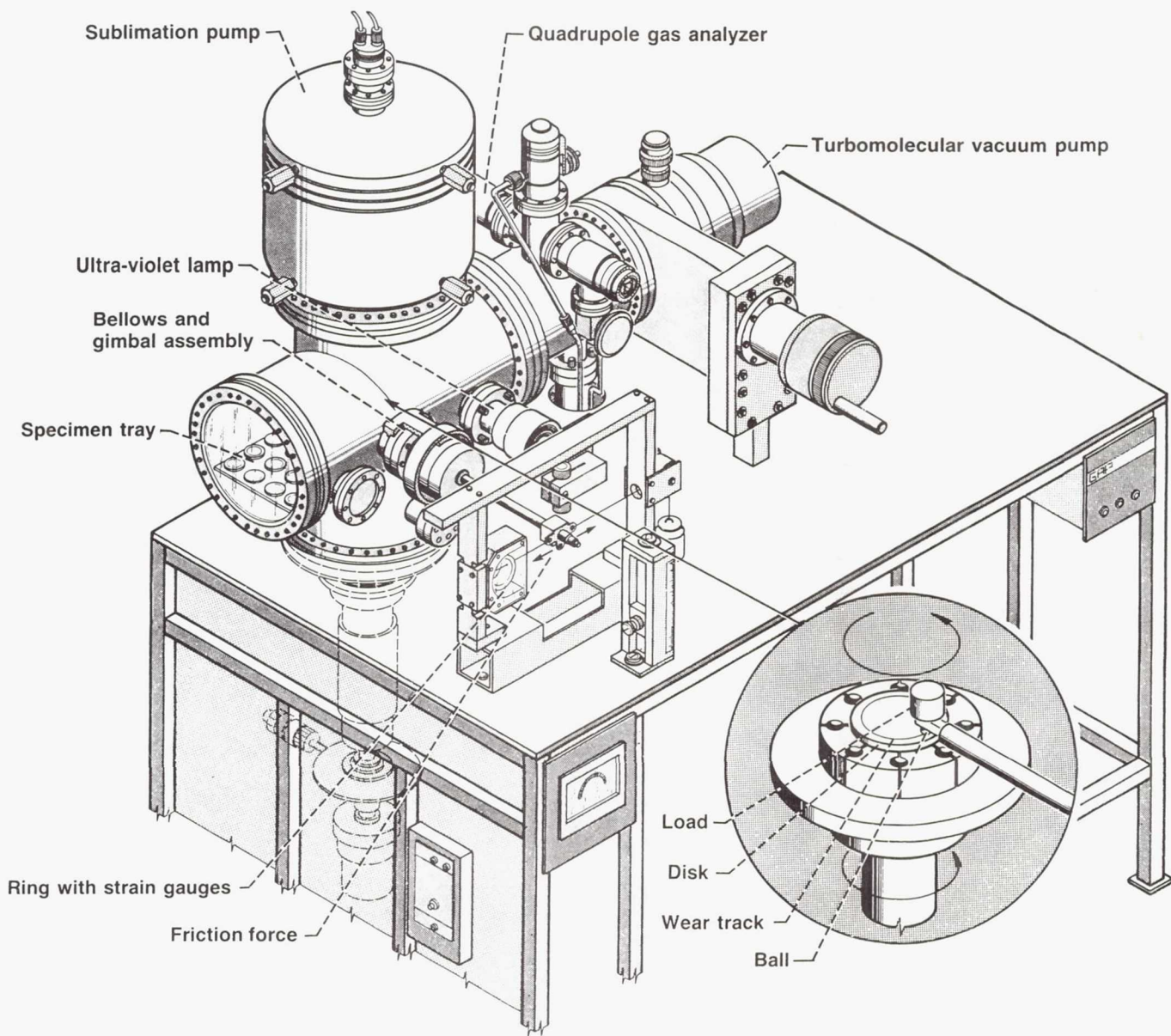
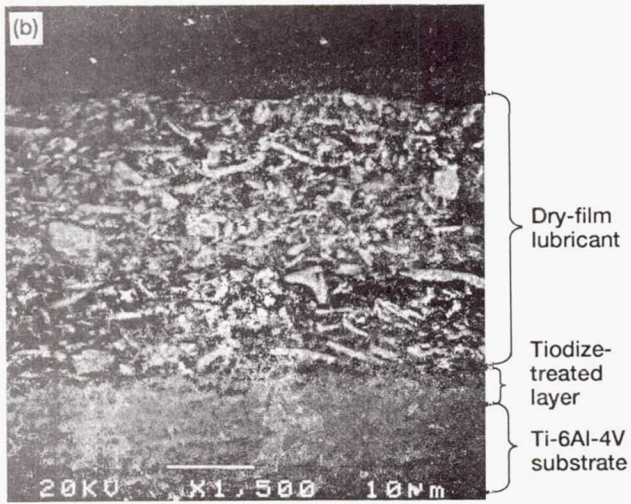
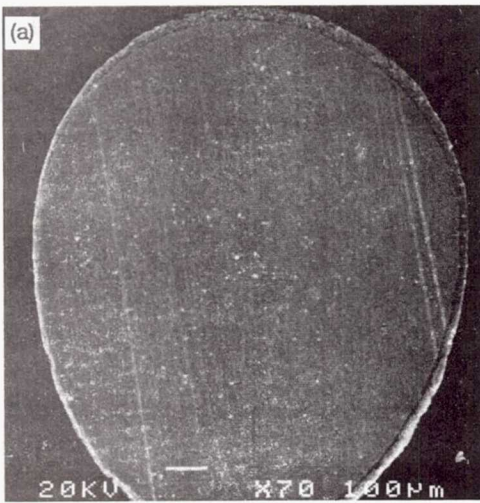

Figure 1.—Vacuum friction apparatus.





(a) Overview of pin.

(b) Details of dry-film lubricant, Tiodize treated layer, and Ti-6Al-4V substrate.

Figure 2.—Taper cross section of dry-film-lubricated Ti-6Al-4V pin at an angle of 45°.

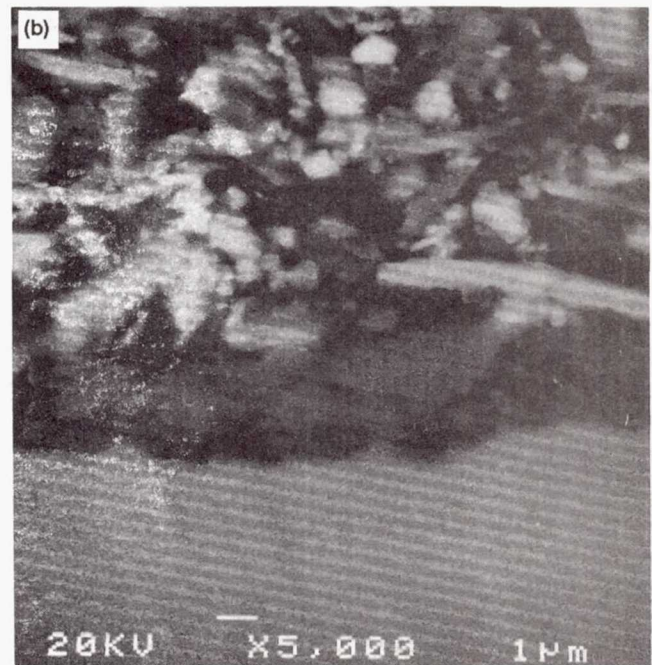
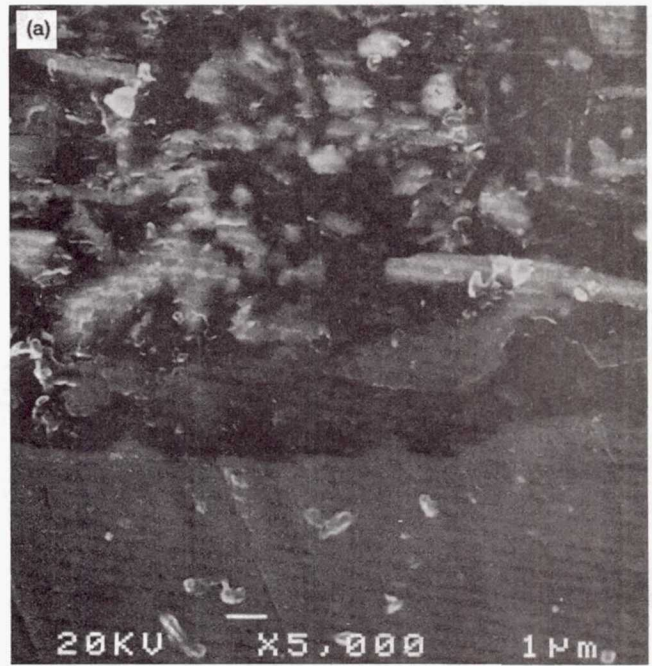

(a) Secondary electron image SEM.

(b) Backscatter electron image SEM.

Figure 3.—Structure of dry-film-lubricated Ti-6Al-4V pin.

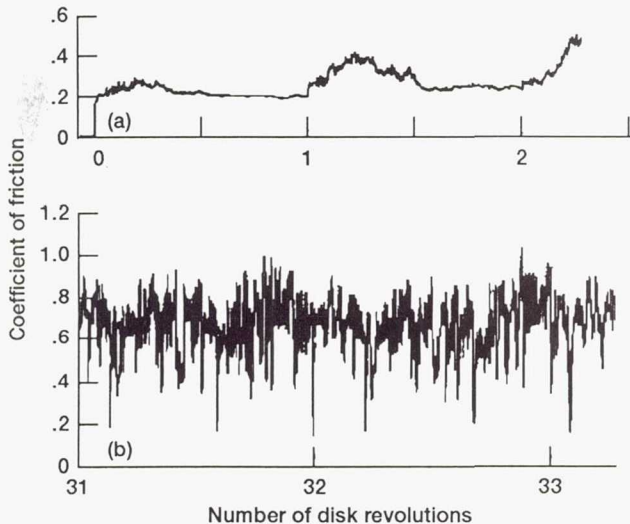

(a) At first and second revolution.  
 (b) At 31st and 32nd revolution.

Figure 4.—Friction trace for unlubricated Ti-6Al-4V pin sliding against Inconel 718 disk at 2.5 N in vacuum.

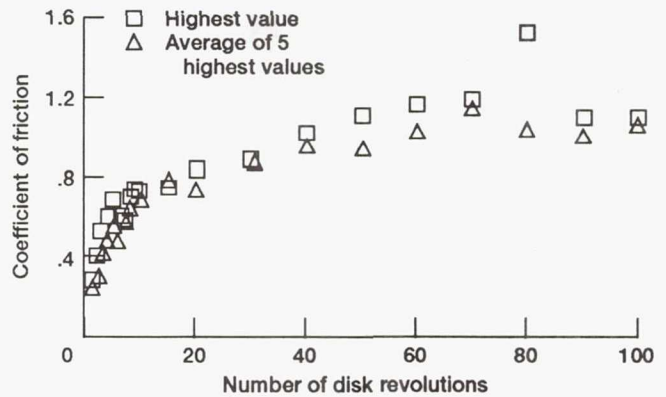

Figure 5.—Coefficients of friction for Ti-6Al-4V pin sliding against Inconel 718 disk as function of number of disk revolutions at 2.5 N in vacuum.

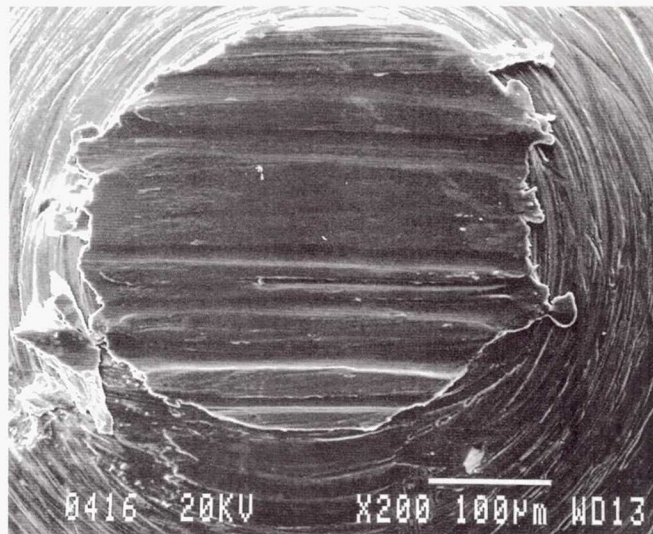
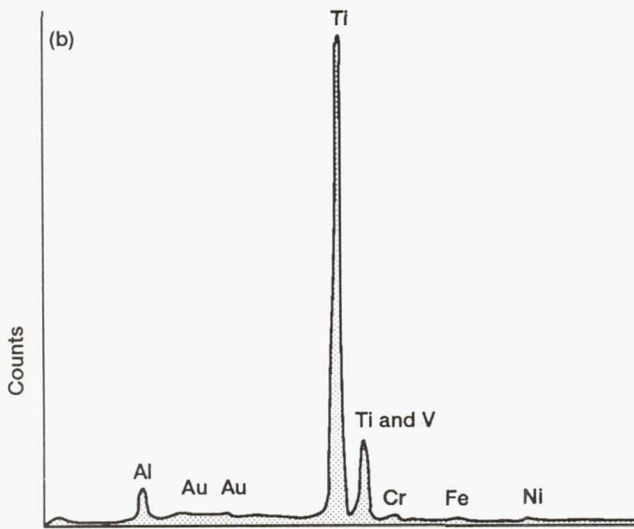
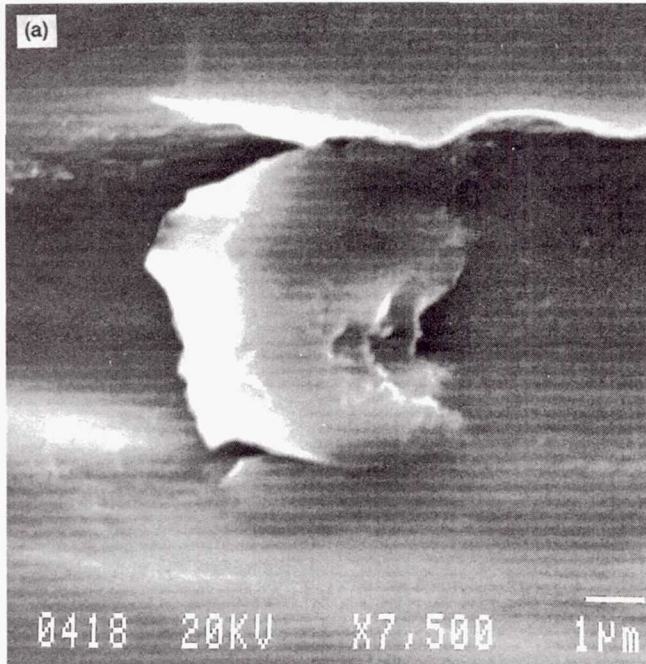

Figure 6.—Wear scar produced on unlubricated Ti-6Al-4V pin after sliding against Inconel 718 disk at 2.5 N in vacuum.





(a) Secondary electron image SEM of clogged wear debris.  
 (b) Spot EDX analysis of the clogged wear debris. The thin gold film used to reduce charging of the mount is responsible for the gold signal in the spectrum.

Figure 7.—Clogged wear debris on the wear scar of the pin.

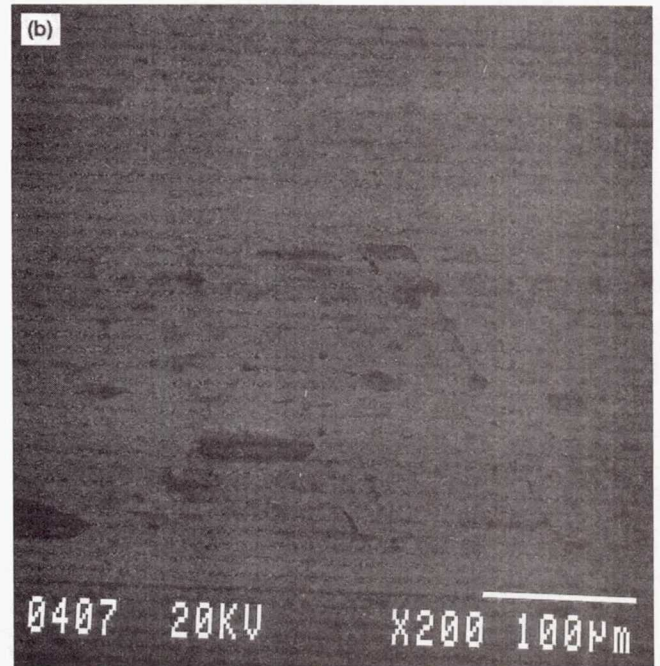
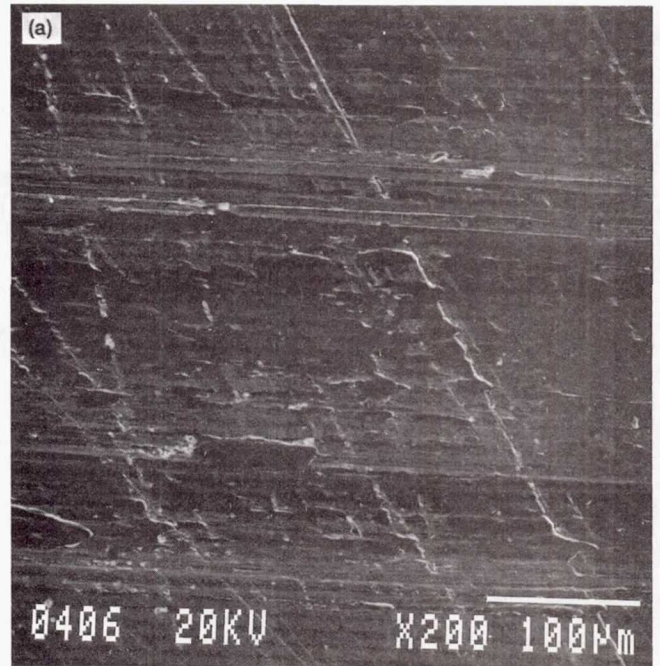

(a) Secondary electron image SEM.  
 (b) Backscatter electron image SEM.

Figure 8.—Wear track on Inconel 718 disk showing transfer patches of Ti-6Al-4V .

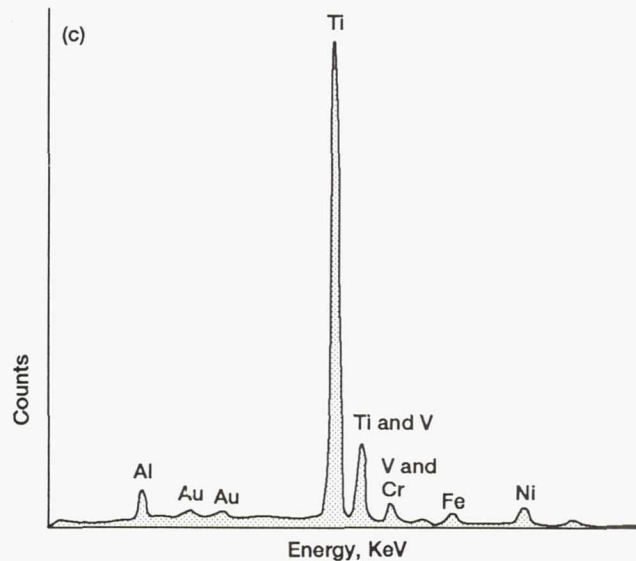
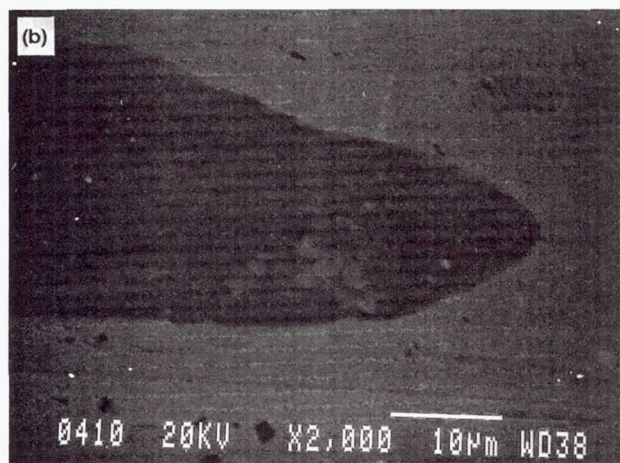
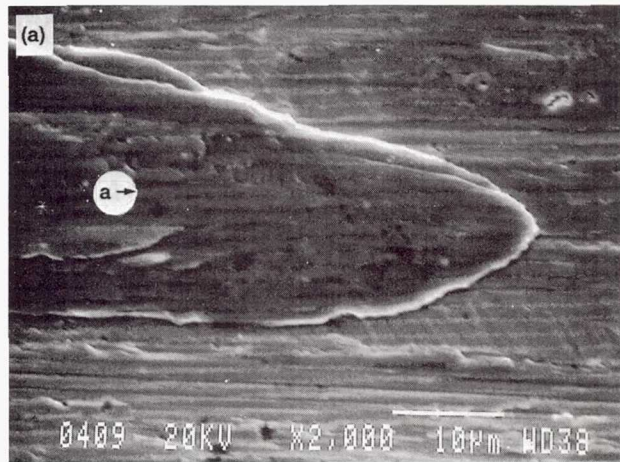

(a) Secondary electron image SEM.

(b) Backscatter electron image SEM.

(c) Energy dispersion X-ray analysis spectrum of transferred film on Inconel 718 disk. Data taken at point indicated in part (a). The thin gold film used to reduce charging of the mount is responsible for the gold signal in the spectrum.

Figure 9.—Large transfer patch of Ti-6Al-4V on Inconel 718 disk.



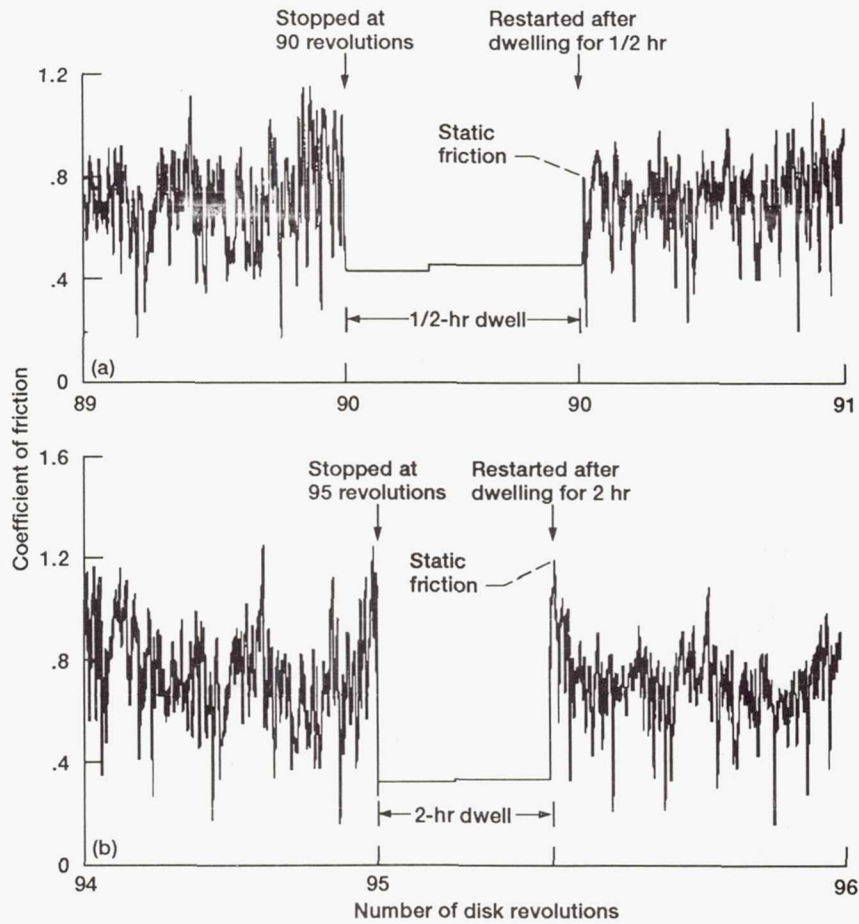

(a) Friction traces before and after dwelling for 1/2 hr.  
 (b) Friction traces before and after dwelling for 2 hr.  
 Figure 10.—Effect of dwelling on friction at 2.5 N in vacuum.

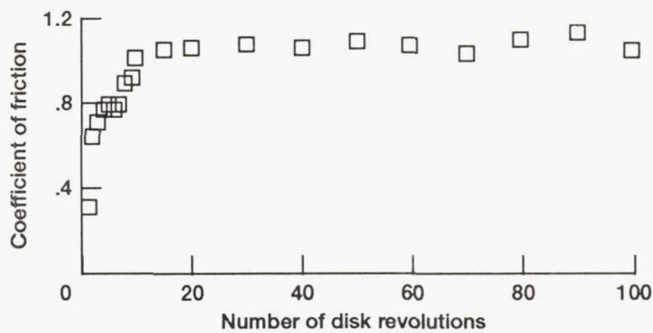

Figure 11.—Coefficients of friction (highest value) for unlubricated Ti-6Al-4V pin sliding against Inconel 718 disk as function of number of disk revolutions at 4 N in vacuum.

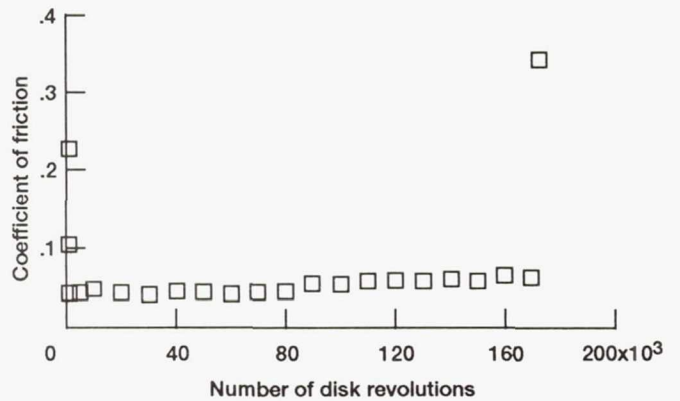

Figure 12.—Coefficients of friction for dry-film-lubricated Ti-6Al-4V pin sliding against Inconel 718 disk at 8.5 N in vacuum.

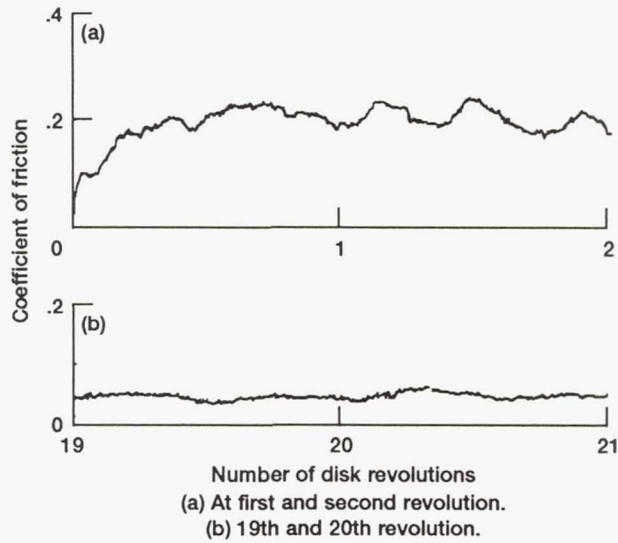

Figure 13.—Friction traces for dry-film-lubricated Ti-6Al-4V sliding against Inconel 718 at 8.5 N in vacuum.

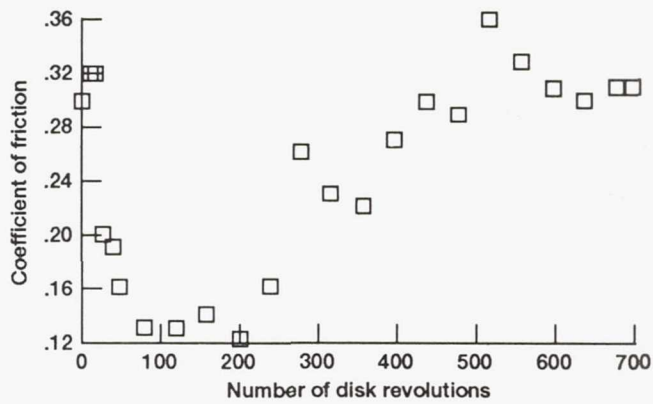

Figure 14.—Coefficients of friction for dry-film-lubricated Ti-6Al-4V pin sliding against Inconel 718 disk at 8.5 N in air.



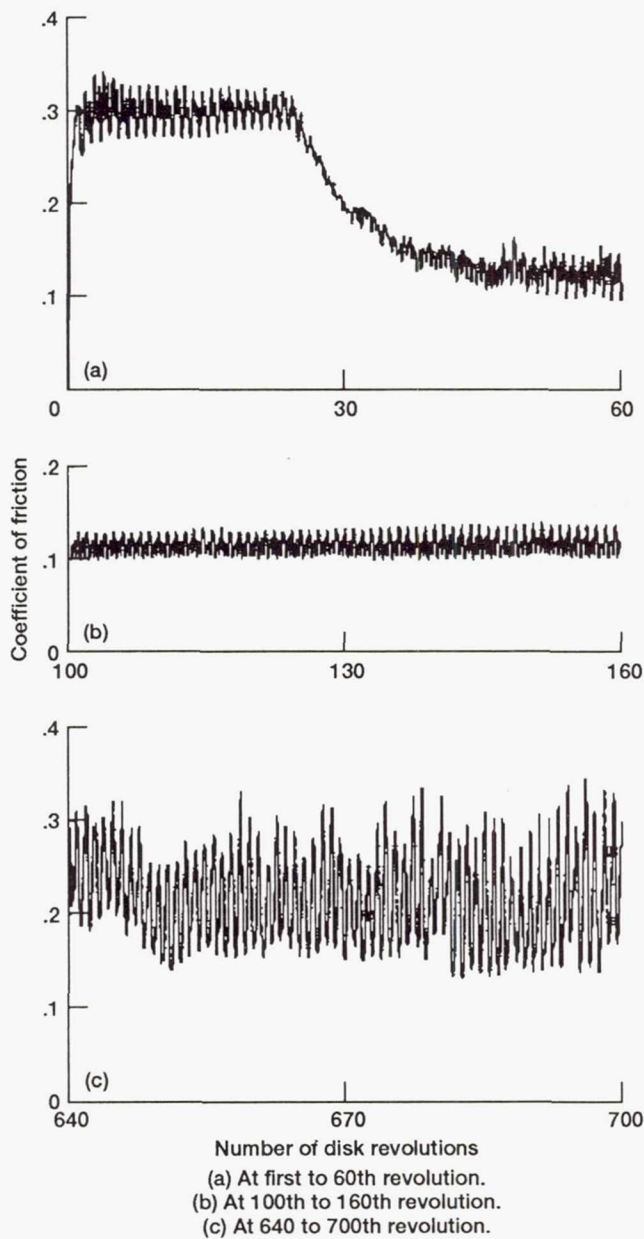

Figure 15.—Friction traces for Ti-6Al-4V pin sliding against Inconel 718 at 8.5 N in air.

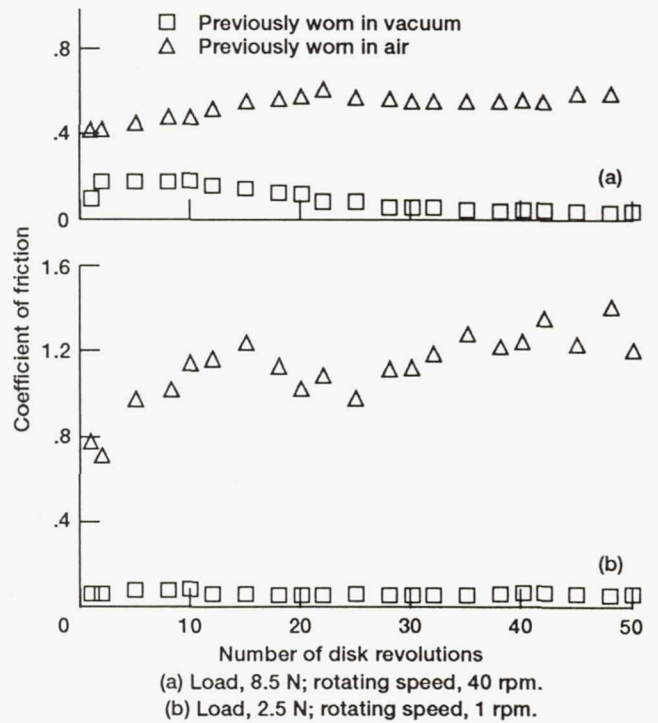
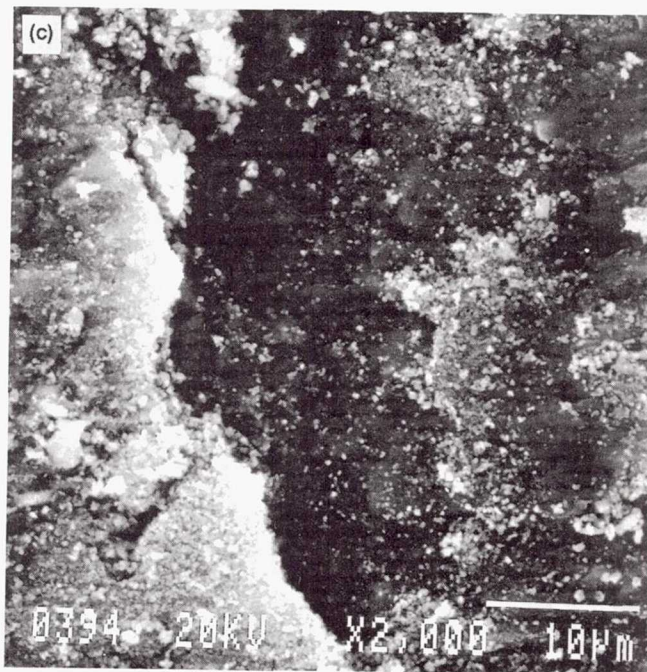
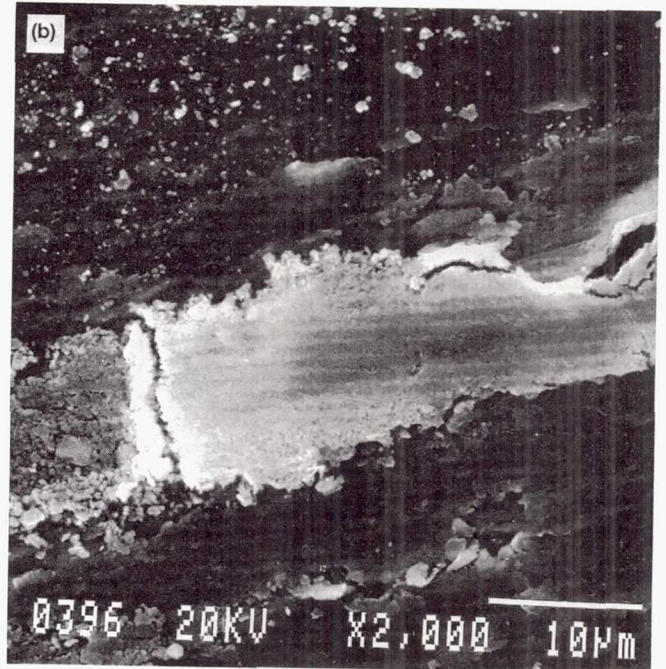
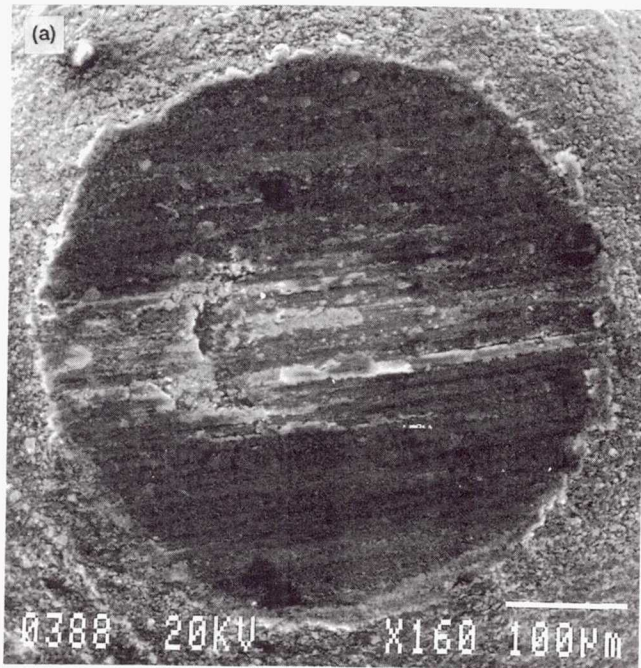

Figure 16.—Coefficients of friction for worn surfaces of dry-film-lubricated Ti-6Al-4V pin sliding against Inconel 718 disk when rerun in vacuum.



- (a) Low magnification overview showing relatively smooth surfaces at upper and lower areas of wear scar with spalling and tearing center.
- (b) Surface smearing and tearing at the center of wear scar resulting in separation of particles from surface in form of flakes.
- (c) Spalling at the center of wear scar.

Figure 17.—Wear scar produced in dry-film-lubricated Ti-6Al-4V pin after sliding against Inconel 718 disk in vacuum.



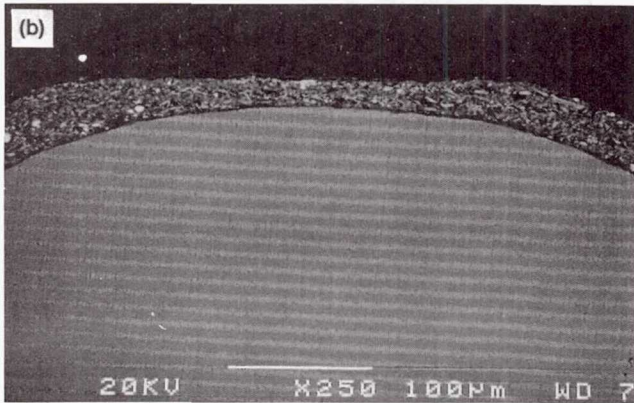
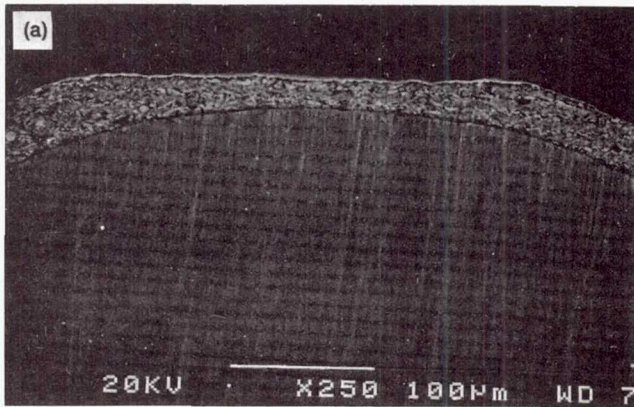

(a) Secondary electron image SEM.  
 (b) Backscatter electron image SEM.

Figure 18.—A taper cross section of the worn surface of dry-film-lubricated Ti-6Al-4V pin at angle of 45° to the worn surface.

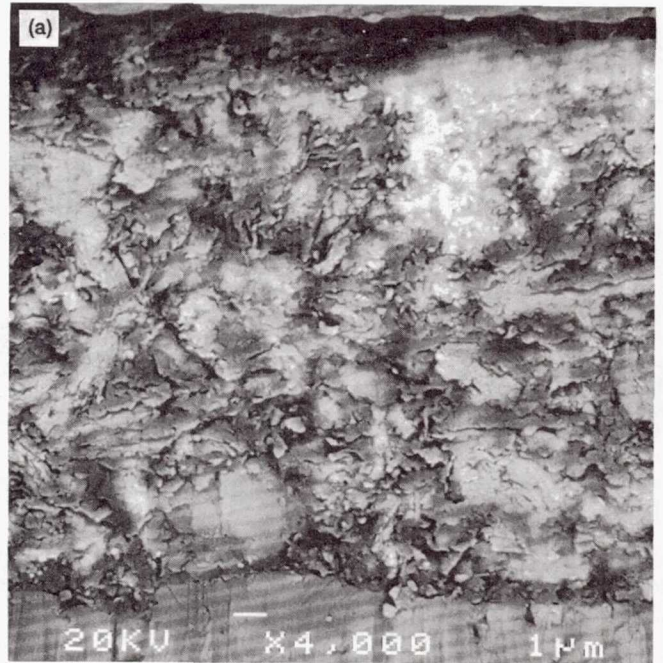

(a) Cross section of worn surface.  
 (b) Cross section of the as-coated area of dry-film-lubricant.

Figure 19.—Comparison of microstructures. Backscatter electron image SEM.



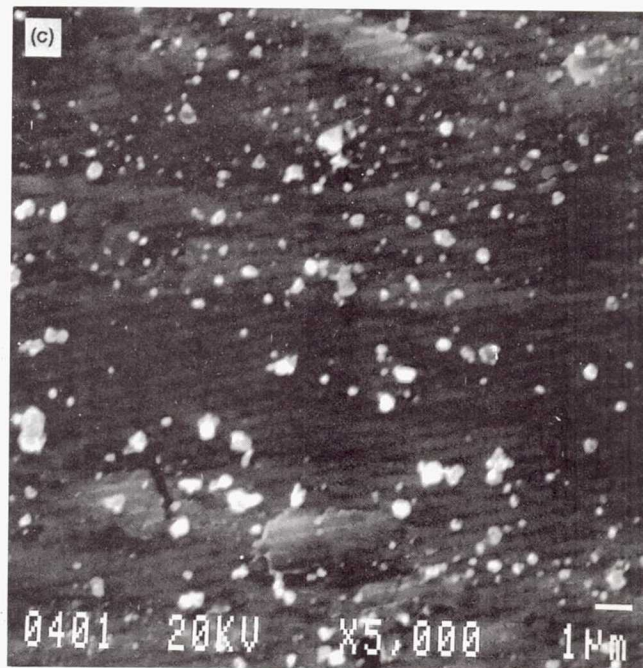
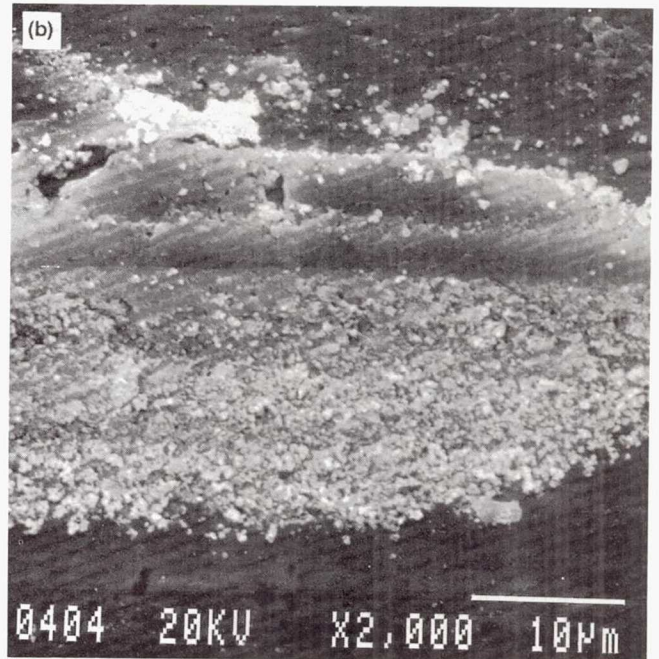
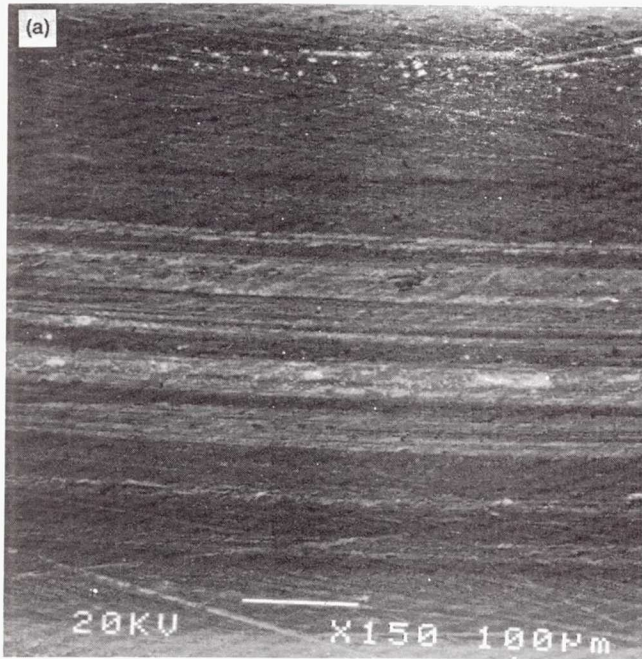

- (a) Low magnification overview of wear track.
- (b) Detailed view showing transfer patches at center of wear track.
- (c) Detailed view showing powder-like wear debris of dry-film lubricant.

Figure 20.—Wear scar produced on Inconel 718 disk after sliding against dry-film-lubricated Ti-6Al-4V pin in vacuum.



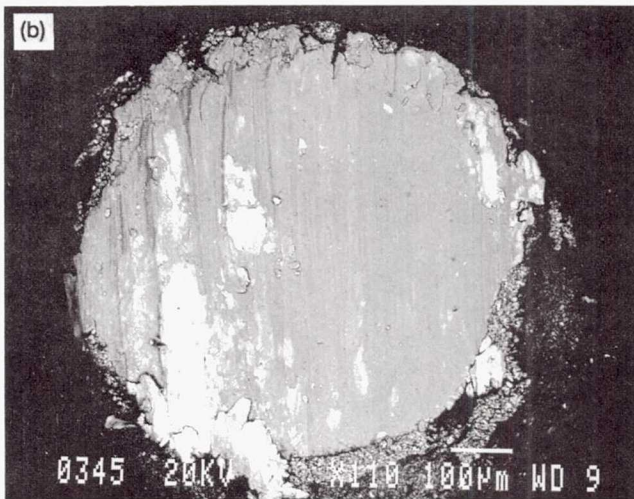
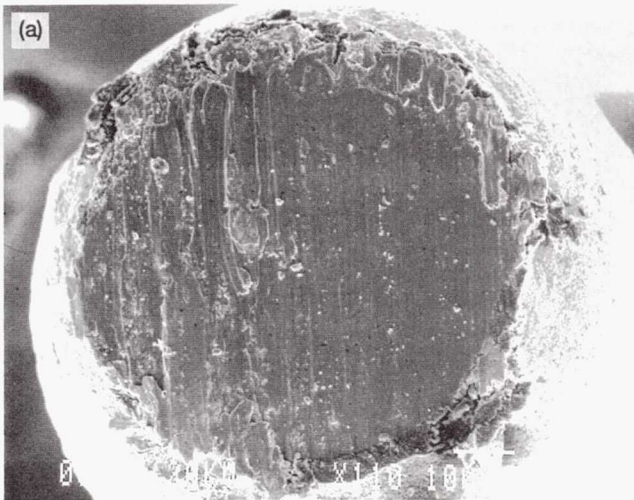

(a) Secondary electron image SEM.  
 (b) Backscatter electron image SEM.

Figure 21.—Wear track produced in dry-film-lubricated Ti-6Al-4V pin after sliding against Inconel 718 disk in air and then rerun in vacuum.

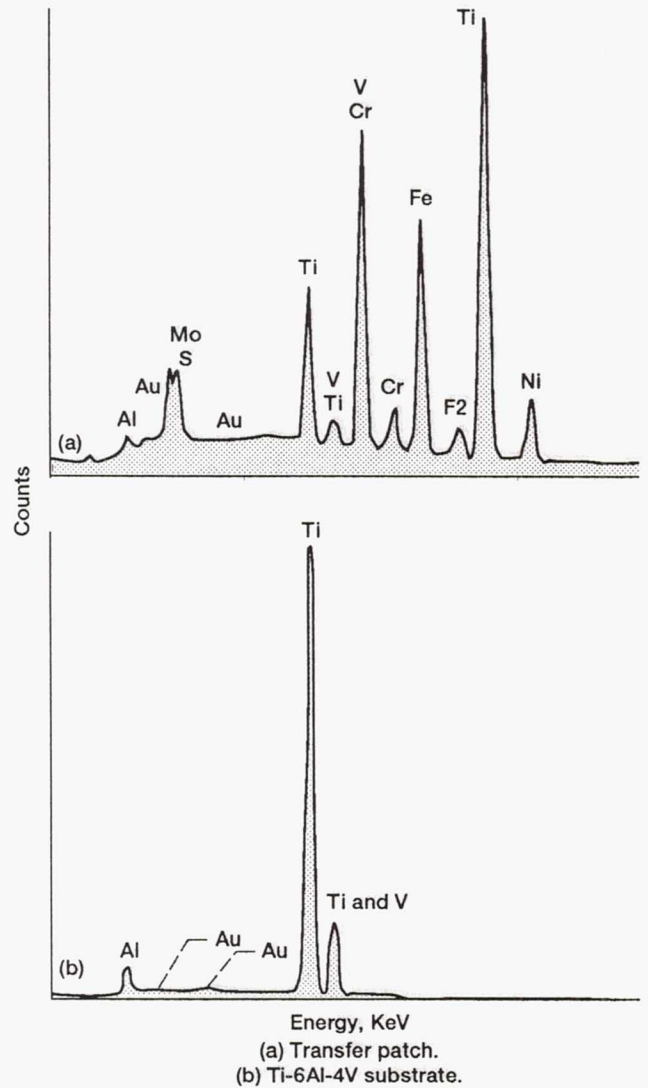
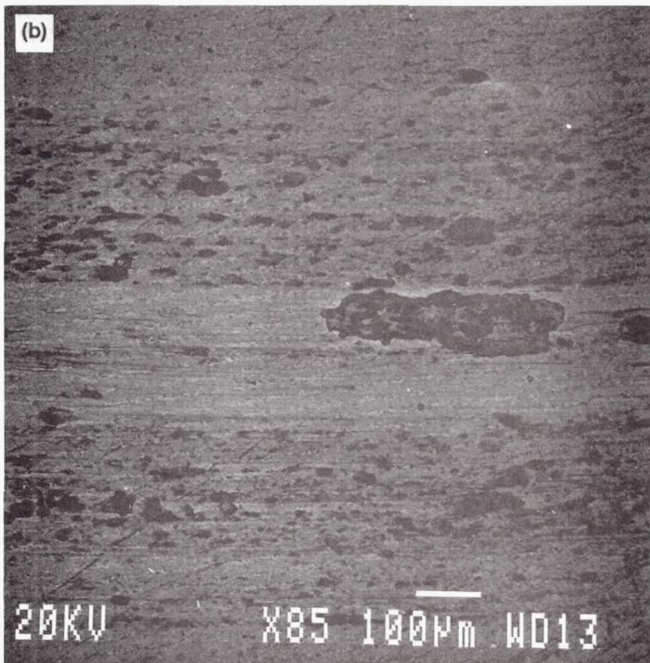
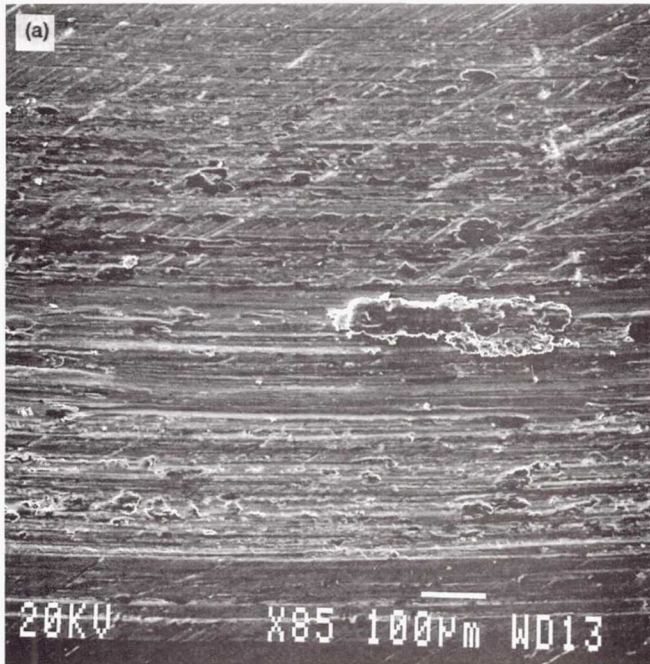
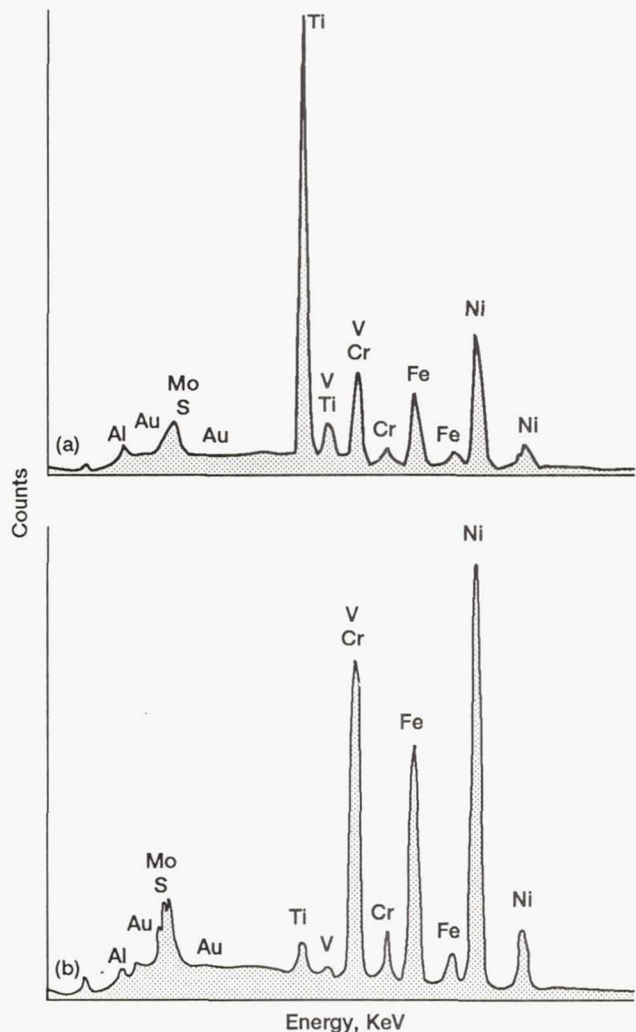

Figure 22.—EDX analysis of wear scar produced in dry-film-lubricated Ti-6Al-4V pin after sliding against Inconel 718 disk in air and then rerun in vacuum. The thin gold film used to reduce charging of the mount is responsible for the gold signal in the two spectra.



(a) Secondary electron image SEM.  
 (b) Backscatter electron image SEM.

Figure 23.—Wear track produced in Inconel 718 disk after sliding against dry-film-lubricated Ti-6Al-4V pin in air and then rerun in vacuum.



(a) Transfer patch of Ti-6Al-4V.  
 (b) Smear area.

Figure 24.—EDX analysis of wear track produced in Inconel 718 disk after sliding against dry-film-lubricated Ti-6Al-4V pin in air and then rerun in vacuum. The thin gold film used to reduce charging of the mount is responsible for the gold signal in the two spectra.



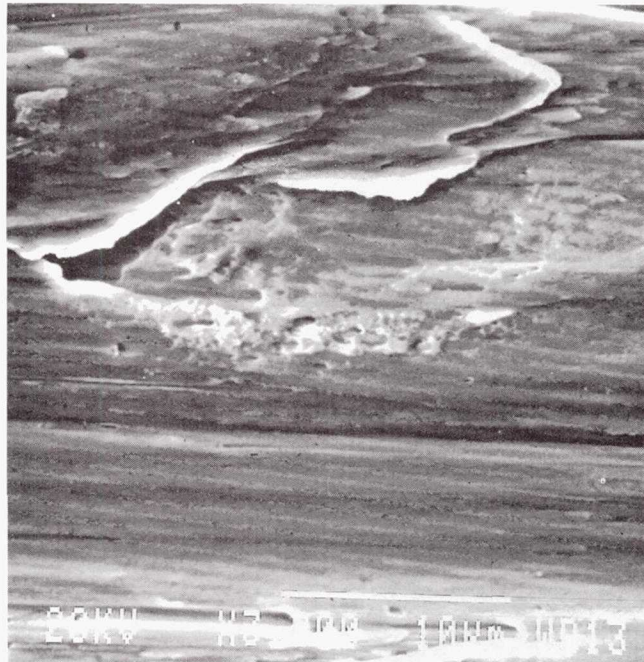

Figure 25.—SEM photomicrograph of wear track showing extensive plastic shearing in Inconel 718 disk after sliding against dry-film-lubricated Ti-6Al-4V pin in air then rerun in vacuum.

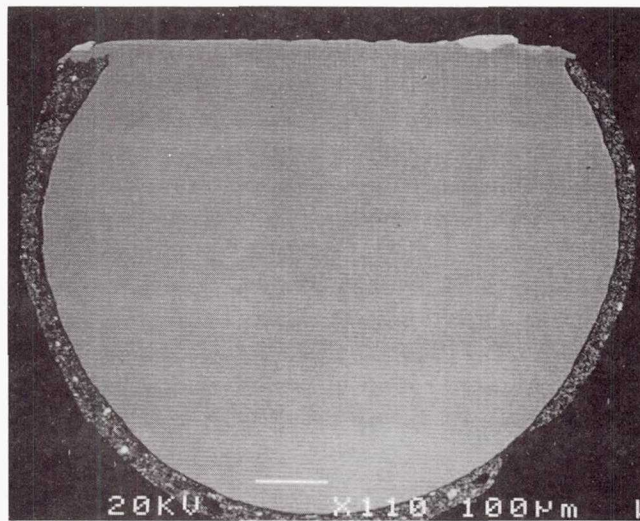
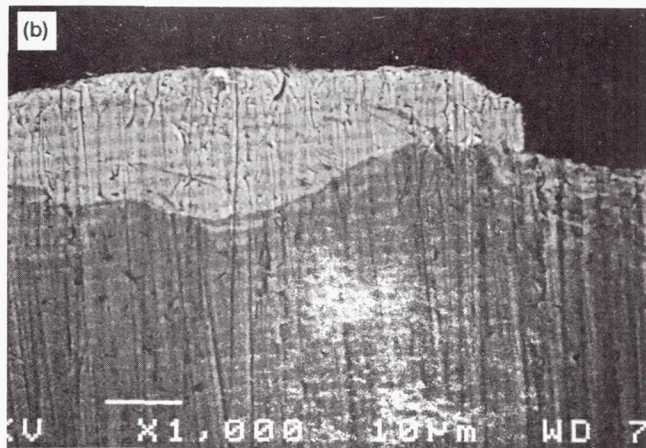
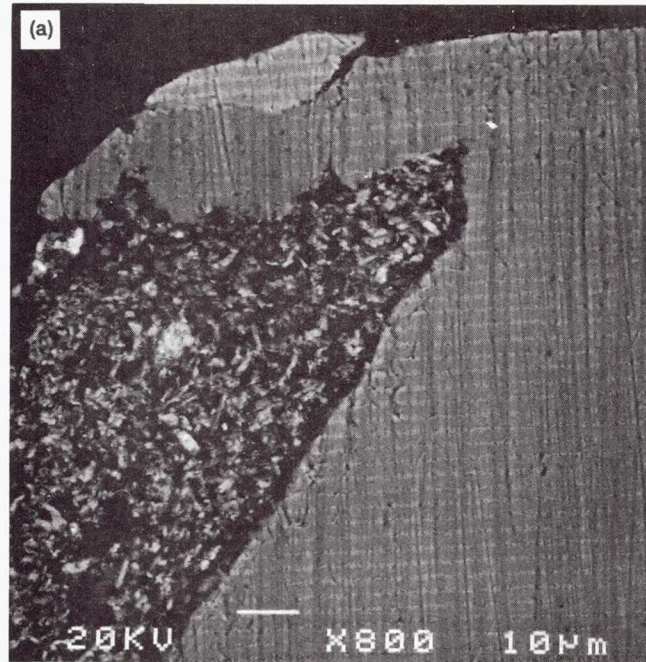

Figure 26.—A taper cross section of the worn surface of the dry-film-lubricated Ti-6Al-4V pin at an angle of 45° to the worn surface. Overview (backscatter electron image SEM) showing extrusion out of the wear scar, transferred patches of Inconel 718, and no presence of the dry-film lubricant on the worn surface.



(a) Backscatter electron image SEM showing extrusion out of the wear scar.

(b) Backscatter electron image SEM showing a transferred patch of Inconel 718 on the worn surface of Ti-6Al-4V pin.

Figure 27.—A taper cross section of the worn surface of the dry-film-lubricated Ti-6Al-4V pin.



# REPORT DOCUMENTATION PAGE

Form Approved  
OMB No. 0704-0188

Public reporting burden for this collection of information is estimated to average 1 hour per response, including the time for reviewing instructions, searching existing data sources, gathering and maintaining the data needed, and completing and reviewing the collection of information. Send comments regarding this burden estimate or any other aspect of this collection of information, including suggestions for reducing this burden, to Washington Headquarters Services, Directorate for Information Operations and Reports, 1215 Jefferson Davis Highway, Suite 1204, Arlington, VA 22202-4302, and to the Office of Management and Budget, Paperwork Reduction Project (0704-0188), Washington, DC 20503.

<b>1. AGENCY USE ONLY</b> (Leave blank)	<b>2. REPORT DATE</b> February 1992	<b>3. REPORT TYPE AND DATES COVERED</b> Technical Memorandum	
<b>4. TITLE AND SUBTITLE</b> Properties Data for Opening the Galileo's Partially Unfurled Main Antenna		<b>5. FUNDING NUMBERS</b>  WU-506-43-11	
<b>6. AUTHOR(S)</b> Kazuhisa Miyoshi and Stephen V. Pepper			
<b>7. PERFORMING ORGANIZATION NAME(S) AND ADDRESS(ES)</b> National Aeronautics and Space Administration Lewis Research Center Cleveland, Ohio 44135-3191		<b>8. PERFORMING ORGANIZATION REPORT NUMBER</b>  E-6729	
<b>9. SPONSORING/MONITORING AGENCY NAMES(S) AND ADDRESS(ES)</b> National Aeronautics and Space Administration Washington, D.C. 20546-0001		<b>10. SPONSORING/MONITORING AGENCY REPORT NUMBER</b>  NASA TM-105355	
<b>11. SUPPLEMENTARY NOTES</b> Responsible person, Kazuhisa Miyoshi, (216) 433-6078.			
<b>12a. DISTRIBUTION/AVAILABILITY STATEMENT</b>  Unclassified - Unlimited Subject Categories 26 and 27		<b>12b. DISTRIBUTION CODE</b>	
<b>13. ABSTRACT</b> (Maximum 200 words) An investigation was conducted into the friction and wear behavior of both unlubricated and dry-film-lubricated (Tiolube 460) titanium alloy (Ti-6Al-4V) in contact with an uncoated high-nickel-content superalloy (Inconel 718) both in vacuum and in air. The acquisition of friction and wear data for this sliding couple was motivated by the need for input data for the "antenna stuck ribs model" effort to free Galileo's High Gain Antenna. The results of the investigation indicate that galling occurred in the unlubricated system in vacuum and that the coefficient of friction increased to 1.2. The abnormally high friction (1.45) was observed when relatively large wear debris clogged at the sliding interface. The coefficient of friction for the dry-film-lubricated system in vacuum is 0.04, while the value in air is 0.13. The endurance life of the dry-film lubricant is about three orders of magnitude greater in vacuum than in air. The worn surfaces of the dry-film-lubricated Ti-6Al-4V pin and Inconel 718 disk first run in humid air and then rerun in vacuum was completely different from that of the pin and disk run only in vacuum. When galling occurred in the humid-air and vacuum contact, coefficient of friction rose to 0.32 when sliding in humid air and to 1.4 when sliding in vacuum. The galling was accompanied by severe surface damage and extensive transfer of the Ti-6Al-4V to the Inconel 718, or vice versa. When spalling occurred in the dry-film-lubricated Ti-6Al-4V pin run only in vacuum, the coefficient of friction rose to 0.36 or greater. The wear damage caused by spalling can self-heal when rerun in vacuum—the coefficient of friction decreased to 0.05. The friction and wear data obtained can be used for the "antenna stuck ribs model" effort to free Galileo's high gain antenna.			
<b>14. SUBJECT TERMS</b> Galling; Dry-film lubricated titanium alloys; Friction and wear			<b>15. NUMBER OF PAGES</b> 24
			<b>16. PRICE CODE</b> A03
<b>17. SECURITY CLASSIFICATION OF REPORT</b> Unclassified	<b>18. SECURITY CLASSIFICATION OF THIS PAGE</b> Unclassified	<b>19. SECURITY CLASSIFICATION OF ABSTRACT</b> Unclassified	<b>20. LIMITATION OF ABSTRACT</b>