

N 9 2 - 2 2 7 7 4

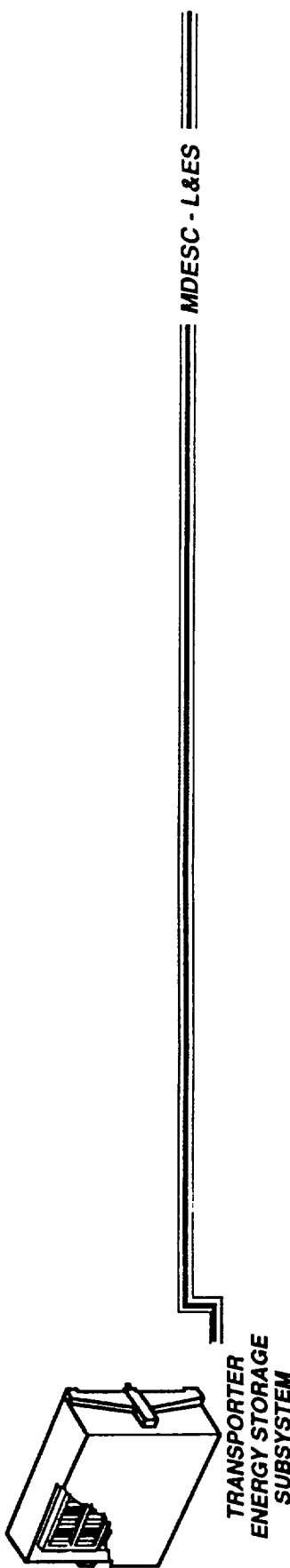

**NICKEL-HYDROGEN BATTERY DESIGN**

**FOR THE**

**TRANSPORTER ENERGY STORAGE SUBSYSTEM (TESS)**

**BY**

**JOHN R. LAPINSKI**                      **&**                      **DEBORAH S. BOURLAND**  
**MDESC-L&ES**    **NASA-JSC**

— **Space Station Freedom** —

McDonnell Douglas • GE • Honeywell • IBM • Lockheed

# SPACE STATION FREEDOM - PMC

MDESC - L&ES

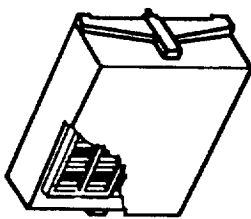

TRANSPORTER  
ENERGY STORAGE  
SUBSYSTEM

- TESS PROVIDES 120 VOLT POWER DURING TRANSLATION OF MOBILE SERVICING CENTER.
- TESS IS RECHARGED USING SPACE STATION 120 VOLT POWER AT BOTH WORK SITES AND HOME BASE.

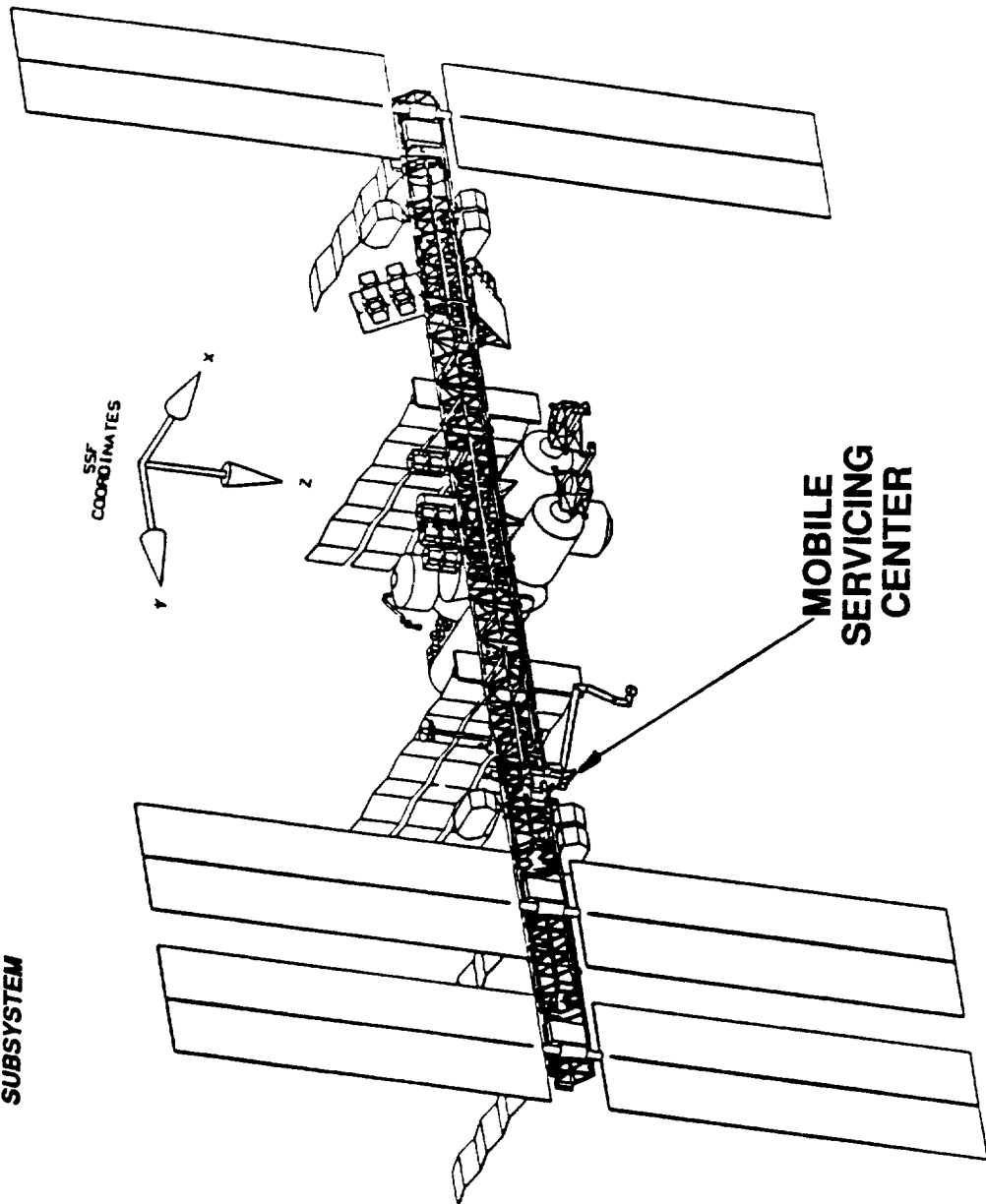

MOBILE  
SERVICING  
CENTER

# TESS IN LAUNCH CONFIGURATION

MDESC - L&ES

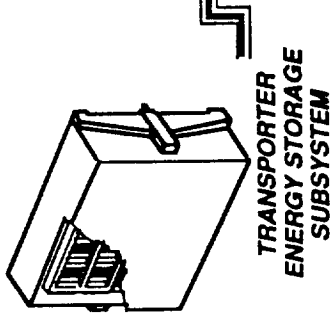

- TESS BATTERY LAUNCHED DISCHARGED AND OPEN CIRCUIT

- TESS REMAINS ON M1 SEGMENT FOR ABOUT 9 MONTHS

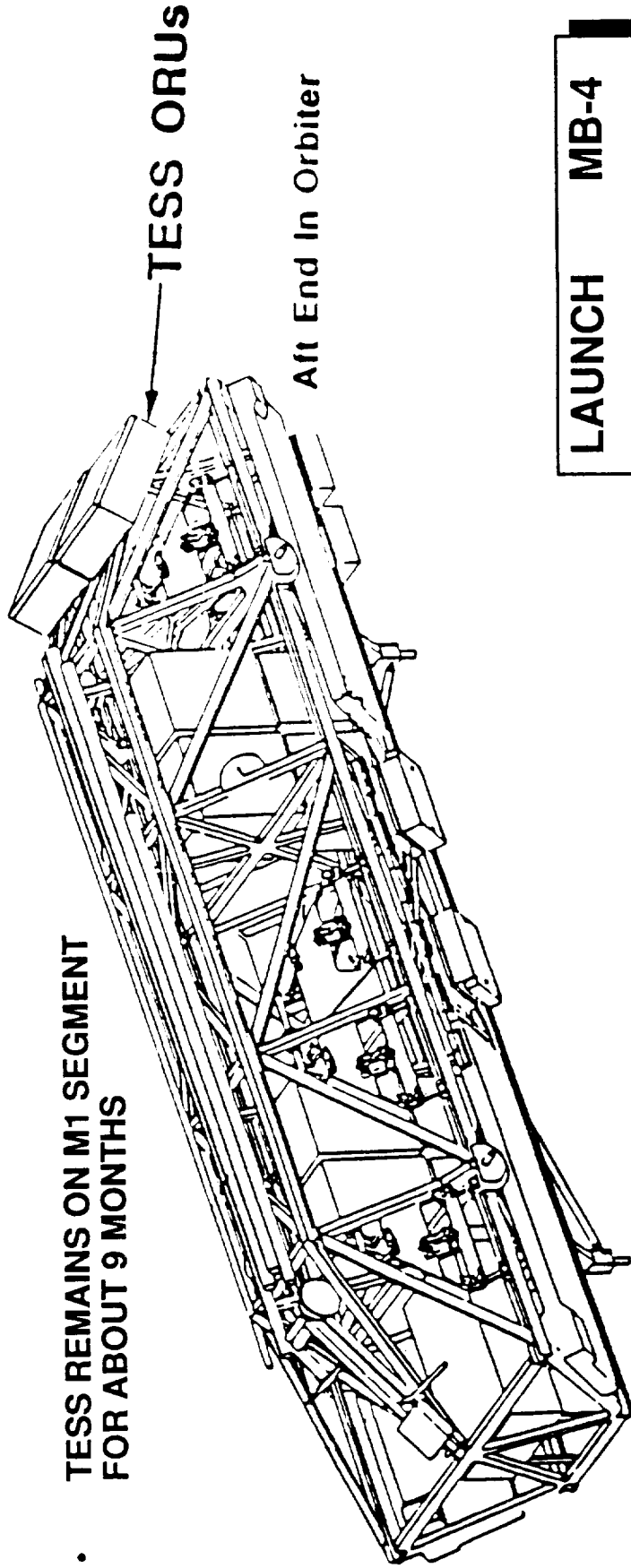

LAUNCH SEGMENT	MB-4 M1
----------------	---------

# TESS INSTALLED ON MOBILE SERVICING CENTER

MDESC - L&ES

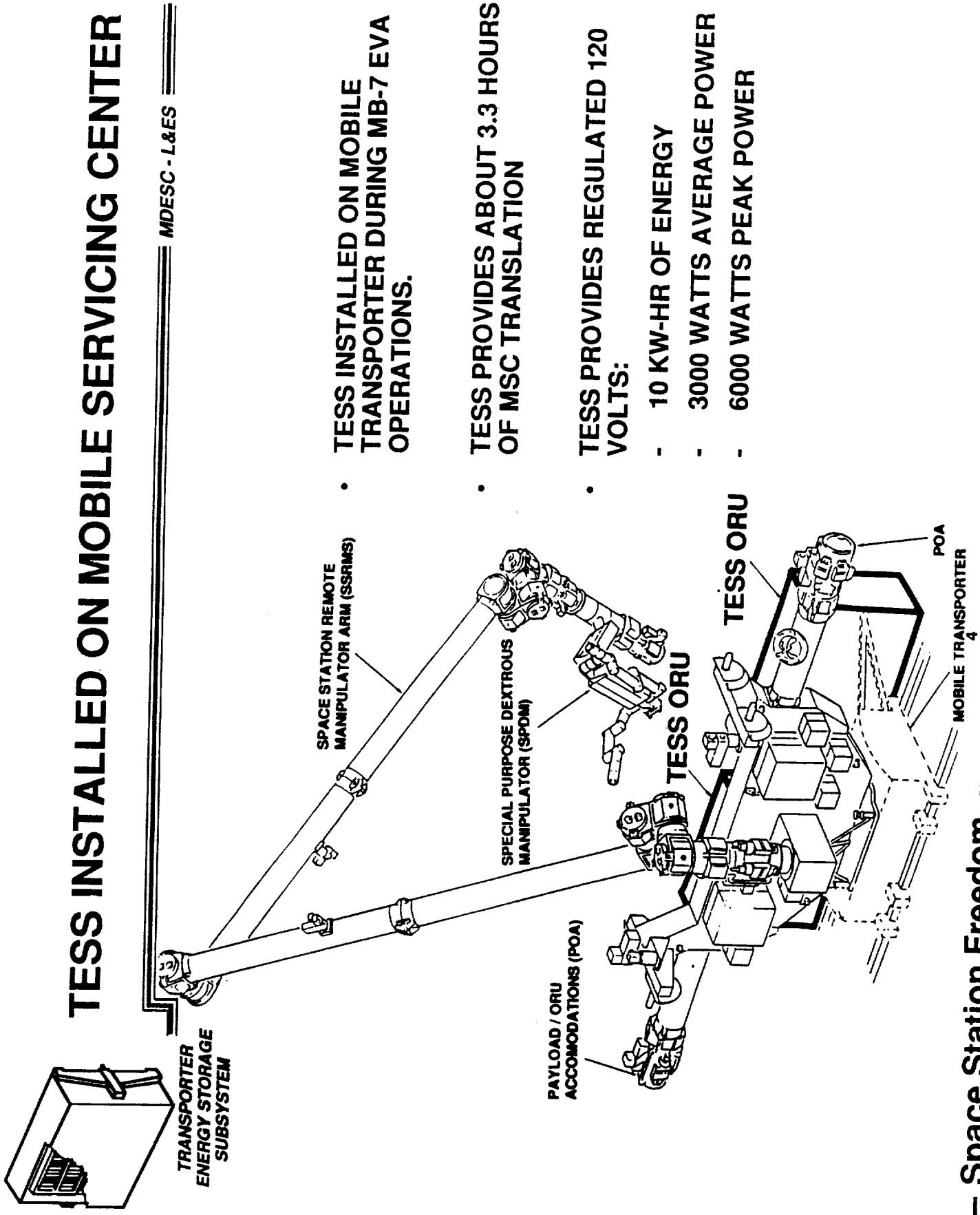

- TESS INSTALLED ON MOBILE TRANSPORTER DURING MB-7 EVA OPERATIONS.
- TESS PROVIDES ABOUT 3.3 HOURS OF MSC TRANSLATION
- TESS PROVIDES REGULATED 120 VOLTS:
  - 10 KW-HR OF ENERGY
  - 3000 WATTS AVERAGE POWER
  - 6000 WATTS PEAK POWER

## Space Station Freedom

McDonnell Douglas • GE • Honeywell • IBM • Lockheed

# TESS ORU LAYOUT

MDESC - L&ES

Envelope - 66x48x21in  
Spec Weight - 914 Lbs  
DOD - 77%

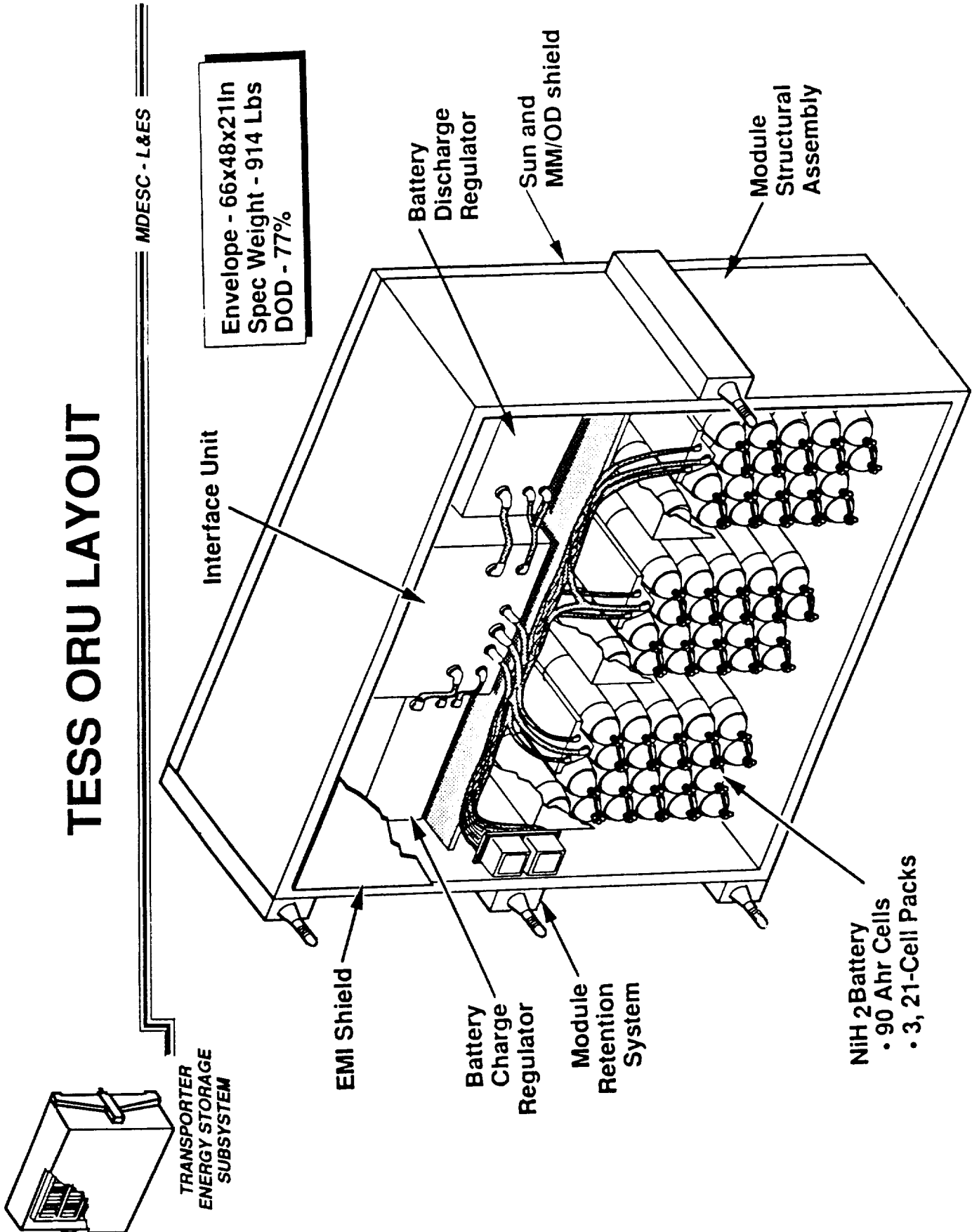

NiH<sub>2</sub> Battery  
• 90 Ahr Cells  
• 3, 21-Cell Packs

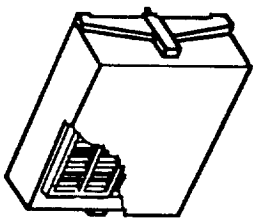

TRANSPORTER  
ENERGY STORAGE  
SUBSYSTEM

# BATTERY DESIGN REQUIREMENTS

MDESC - L&ES

- SUPPORT TESS/MT INTERFACE POWER & ENERGY REQUIREMENTS
  - 3000 WATTS OF AVERAGE OUTPUT POWER AT 120 VOLTS
  - 6000 WATTS OF PEAK OUTPUT POWER AT 120 VOLTS
  - 12,000 WATTS OF FAULT CLEARING POWER
  - 10 KILOWATT-HOURS OF MAXIMUM OUTPUT ENERGY AT 120 VOLTS
  - 7 KILOWATT-HOURS OF NOMINAL OUTPUT ENERGY AT 120 VOLTS
  
- OPERATIONAL LIFE OF 10 YEARS, THUS 2 REPLACEMENTS OVER SPACE STATION MISSION LIFE OF 30 YEARS.
  - 150 MOBILE SERVICING CENTER MISSIONS PER YEAR
  - 65 % AT NOMINAL ENERGY LEVEL (7 KW-HR), 35 % AT MAXIMUM
  
- SYSTEM REDUNDANCY, FAIL DEGRADE, FAIL SAFE



TRANSPORTER  
ENERGY STORAGE  
SUBSYSTEM

# BATTERY DESIGN REQUIREMENTS (CONTINUED)

MDESC - L&ES

- **STRUCTURAL, CELL PRESSURE VESSEL**
  - **PROOF PRESSURE: 1.5 x MAXIMUM OPERATING PRESSURE**
  - **ULTIMATE PRESSURE: 3 x MAXIMUM OPERATING PRESSURE**
  
- **THERMAL, PASSIVELY COOLED**
  - **OPERATING: 0 °C TO +25 °C**
  - **NON-OPERATING: -10 °C TO +35 °C**

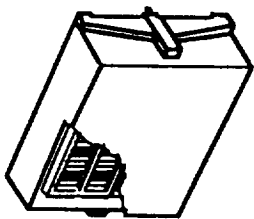

TRANSPORTER  
ENERGY STORAGE  
SUBSYSTEM

# TESS BATTERY DESIGN

MDESC - L&ES

- **TWO 63-CELL NICKEL HYDROGEN BATTERIES**
  - **THREE 21-CELL SUBASSEMBLIES, CONNECTED IN SERIES**
  - **90 AMP-HR HUBBLE SPACE TELESCOPE (HST) CELLS, MODIFIED**
- **21-CELL SUBASSEMBLY**
  - **WEIGHT: 149 LBS INCLUDING MM/OD COVERS**
  - **SIZE: 14.9 W x 23.7 L x 13.0 H (INCHES)**
  - **3 ELECTRICAL CONNECTORS: POWER, INSTRUMENTATION, AND TEST MONITOR**
  - **CELL ISOLATION: FIBERGLASS WRAP POTTED BETWEEN CELL AND COLLAR**
  - **BATTERY HOUSING, CELL COLLARS, AND BATTERY COVERS MADE OF ALUMINUM**



# TESS NICKEL-HYDROGEN BATTERY SUBASSEMBLY DESIGN

MDESC - L&ES



TRANSPORTER  
ENERGY STORAGE  
SUBSYSTEM

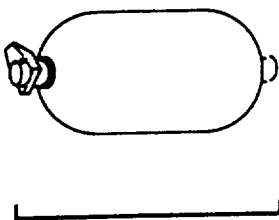

Cell Supplier = TBD

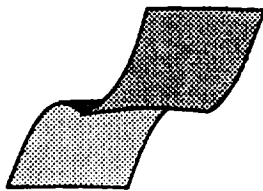

Fiberglass  
Wrap

+

+ CV-2942 RTV +

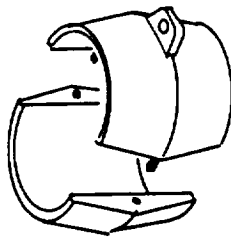

Cell Collars

X 21 + CV-2942 RTV +

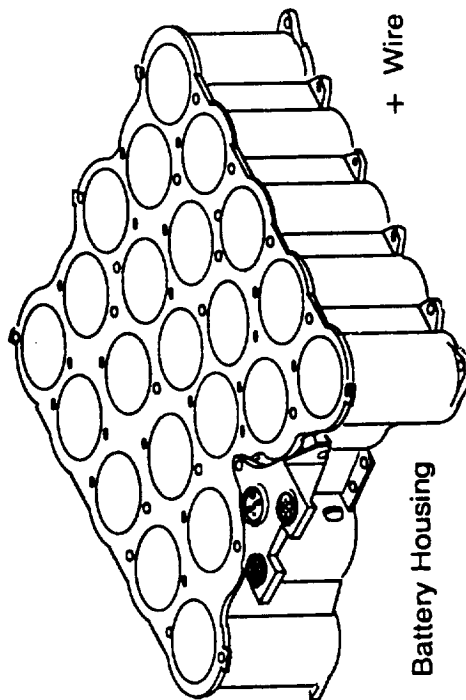

Battery Housing

+ Wire =

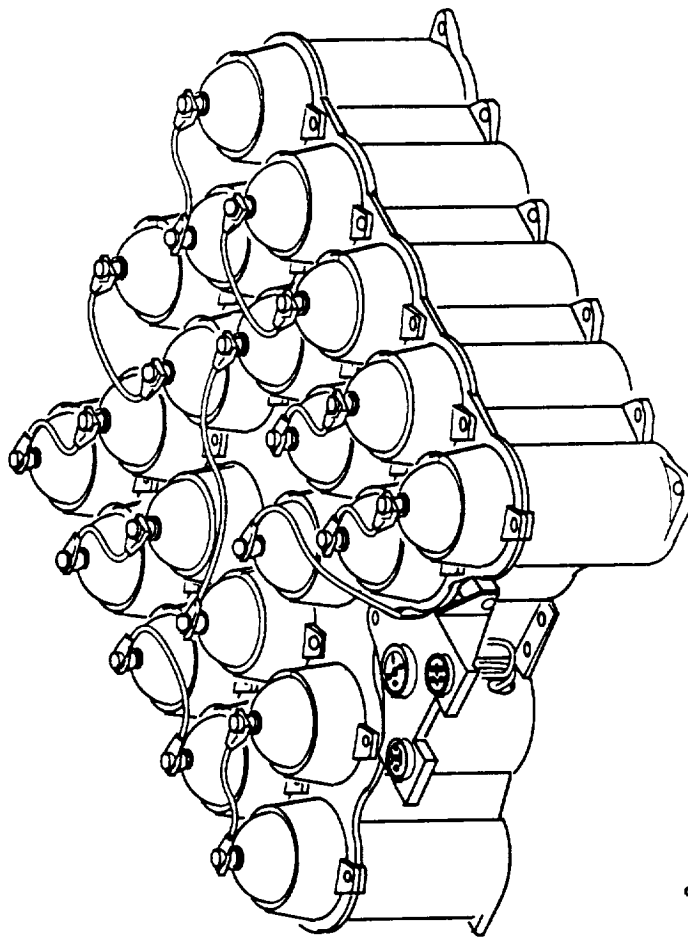

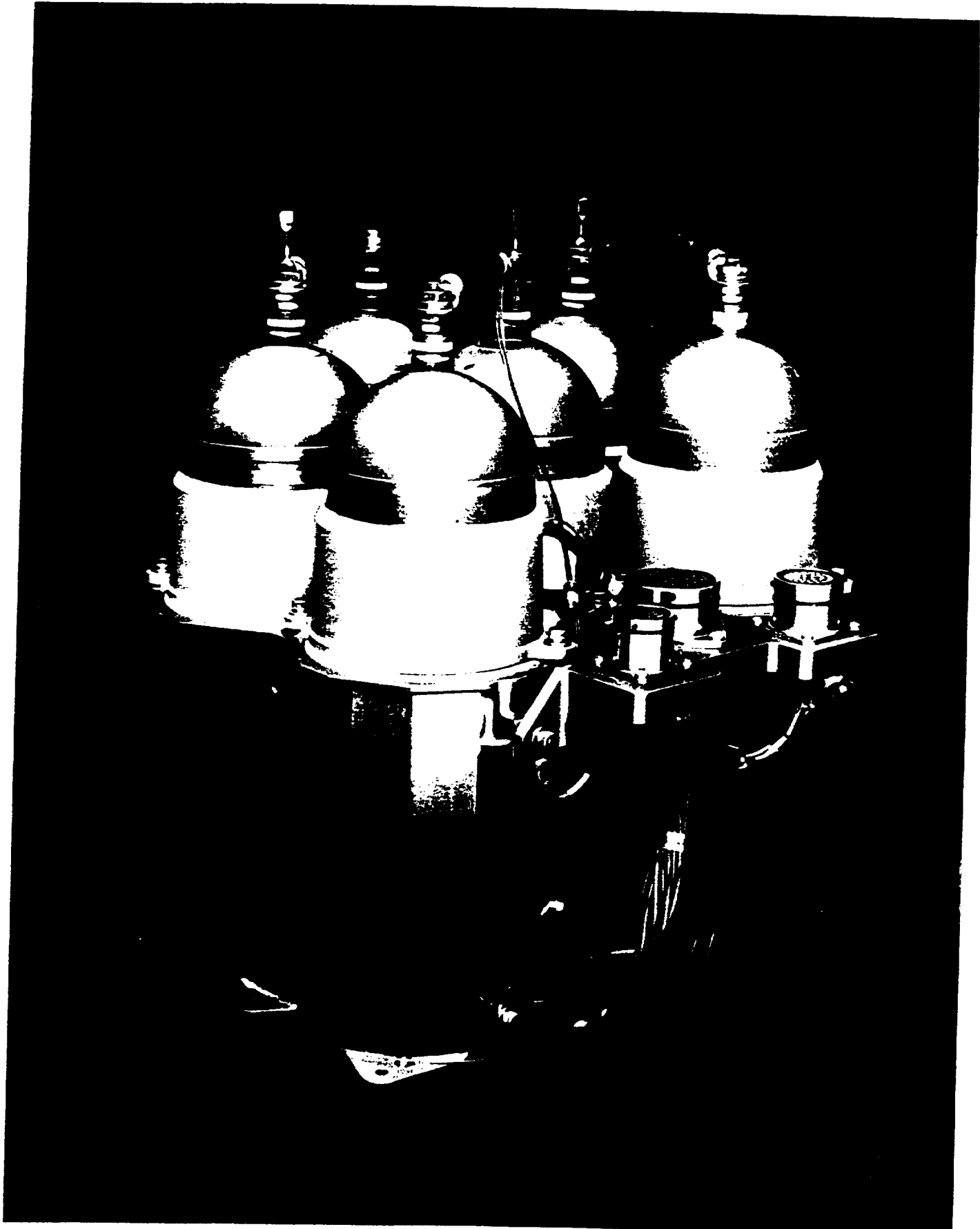



TRANSPORTER  
ENERGY STORAGE  
SUBSYSTEM

# PROOF-OF-PRINCIPLE TESTING OF 6-CELL BATTERY

MDESC - L&ES

- CELLS ARE USAF/HUGHES 50 AMP-HR DESIGN OF 1985 VINTAGE (40 AMP-HR.)
- ELECTRICAL CHARACTERISTIC TEST WILL NOT PROVIDE DATA RELATIVE TO TESS CELL/BATTERY.
- DISCHARGE EFFICIENCY TESTS WILL VERIFY THERMAL ANALYSIS AND PERFORMANCE OF BATTERY DESIGN AT 10 °C & 20 °C.
  - 1.9 °C GRADIENT ACROSS BATTERY CELL.
  - 1.7 °C GRADIENT FROM CELL TO CELL WITHIN BATTERY.
  - 9.7 °C GRADIENT FROM MIDDLE-OF-CELL (MOC) TO RADIATOR SURFACE (COLDPLATE)
  - TESS BATTERY WILL HAVE A LOWER BATTERY MOC TO RADIATOR GRADIENT DUE TO THE REDUCED HEIGHT (AXIAL/FILL TUBE)
- RANDOM VIBRATION TEST WILL VERIFY STRUCTURAL ANALYSIS AND INTEGRITY OF THIS BATTERY DESIGN.
  - TEST WILL BE CONDUCTED WEEK OF 4 NOVEMBER.

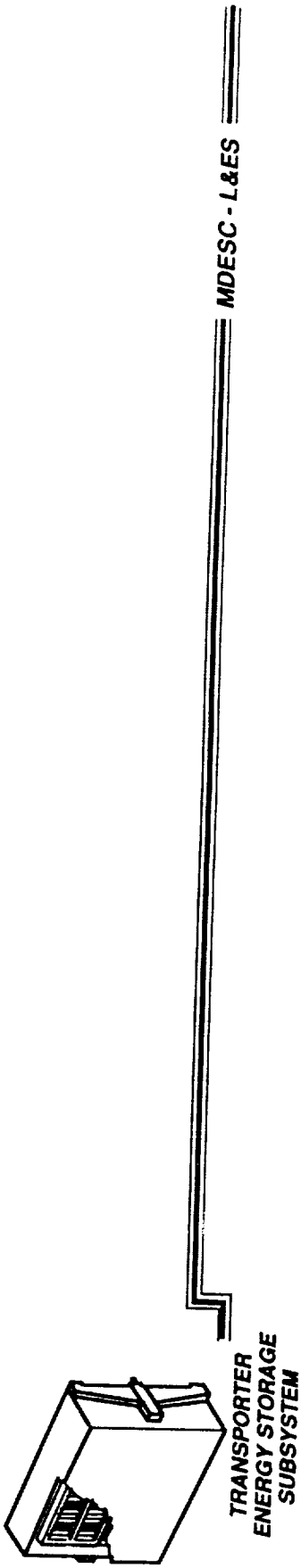

# POSSIBLE DOWNSIZING OF TESS TO SUPPORT MOBILE REMOTE SERVICER BASE SYSTEM (MBS) REDESIGN

# GROUNDRULES FOR DOWNSIZING TESS

MDESC - L&ES

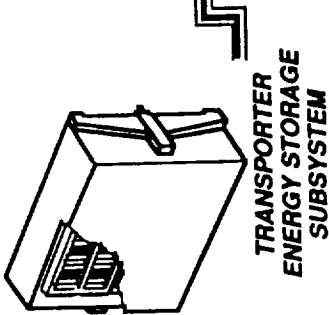

- DESIRED RESULT IS LOWER WEIGHT AND VOLUME OF TESS.
  - SINGLE ORU IS A DESIGN GOAL.
- OPERATIONAL SCENARIOS STILL UNDEFINED.
  - REDUCE OPERATIONAL CONSTRAINTS DURING EVA/EVR MISSIONS
- REDUCTION OF TESS POWER AND ENERGY IS REASONABLE.
 

	<u>WAS</u>	<u>NOW</u>
- ENERGY LEVEL	10 KWHR	3.4 KWHR
- NOMINAL POWER	3000 W	2300 W
- PEAK POWER	6000 W	3500 W
- TRANSLATION TIME	3.33 HRS	1.50 HRS
- NUMBER OF MISSIONS	150	50
- MAINTAIN CURRENT LEVEL OF TESS RELIABILITY.
  - FAIL DEGRADE, FAIL SAFE

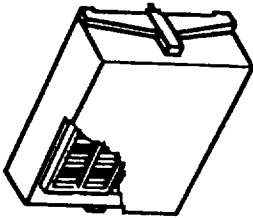

TRANSPORTER  
ENERGY STORAGE  
SUBSYSTEM

# TRAVEL DISTANCE FOR MT BASED ON TESS SIZE

MDESC - L&ES

BASED ON FAILED BATTERY CONDITION FOR AVERAGE & PEAK LOADS

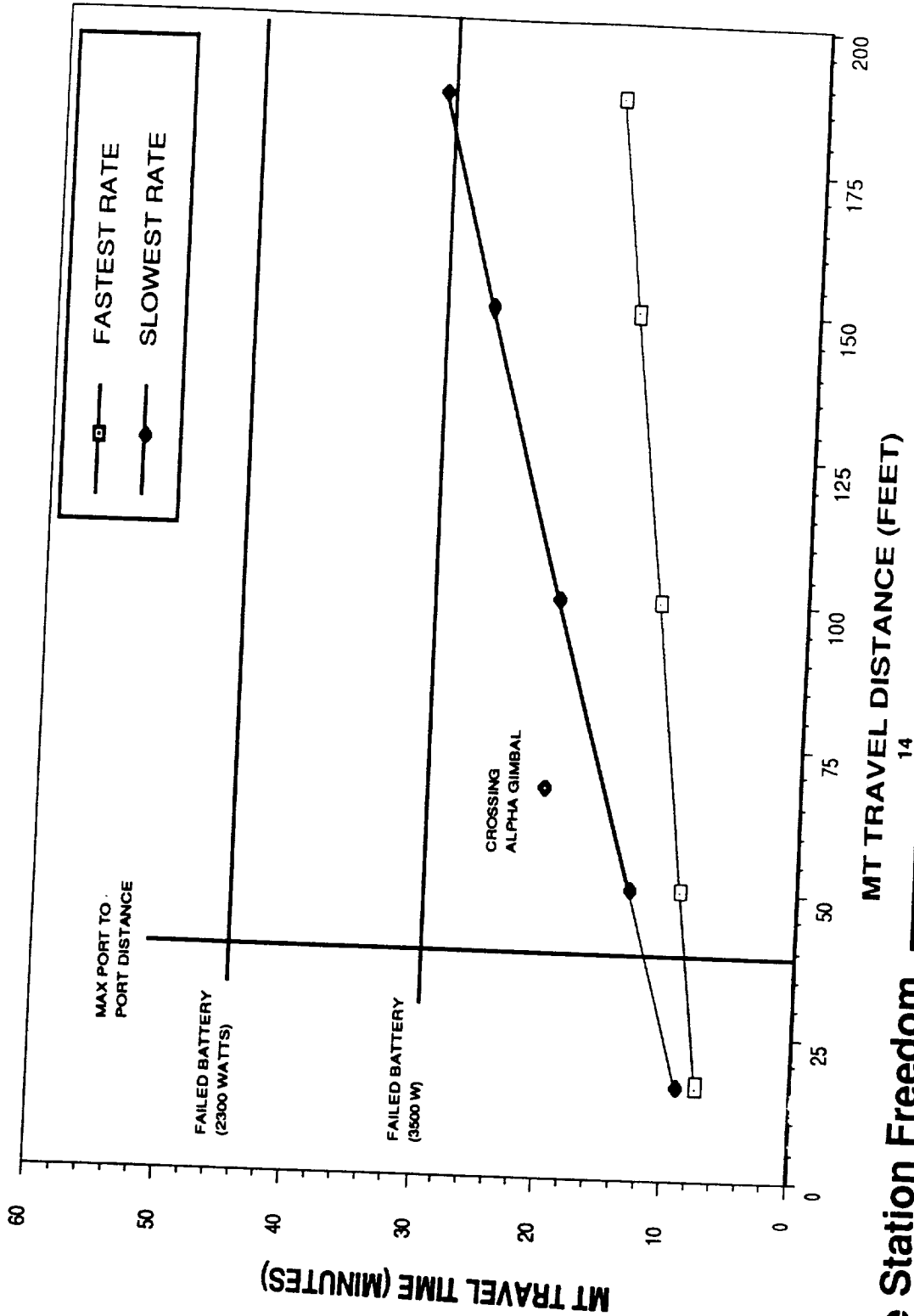

— Space Station Freedom



TRANSPORTER  
ENERGY STORAGE  
SUBSYSTEM

# TESS TRANSLATION OUTPUT CAPABILITY

MDESC - L&ES

ASSUMING ONE EVA/EVR MISSION PER DAY.

<b>TIMELINE - HOURS</b>		<b>24</b>
<b>0</b>	<b>6, 8, OR 12</b>	
<b>EVA/EVR MISSION</b>	<b>COOLDOWN/RECHARGE/ PREP FOR NEXT EVA/EVR</b>	
<p><b>TESS</b></p> <ul style="list-style-type: none"> <li>• SUPPLIES 1.5 HRS OF MT TRANSLATION.</li> <li>• SMALL AMOUNT OF COOLDOWN OR CHARGING DURING MBS OPERATIONS.</li> <li>• POSSIBLE INCREASE OF MT TRANSLATION TIME TO 2 HRS.</li> </ul>	<p><b>TESS</b></p> <ul style="list-style-type: none"> <li>• COOLS AND RECHARGES AS NECESSARY TO BE AVAILABLE FOR NEXT DAY'S ACTIVITIES.</li> </ul>	

NOTE: TRANSLATION TIMES WILL BE CUT IN HALF FOR FAILED BATTERY CONDITION

# BATTERY SIZING BASED ON MAXIMUM DOD

MDESC - L&ES

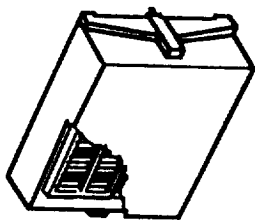

TRANSPORTER  
ENERGY STORAGE  
SUBSYSTEM

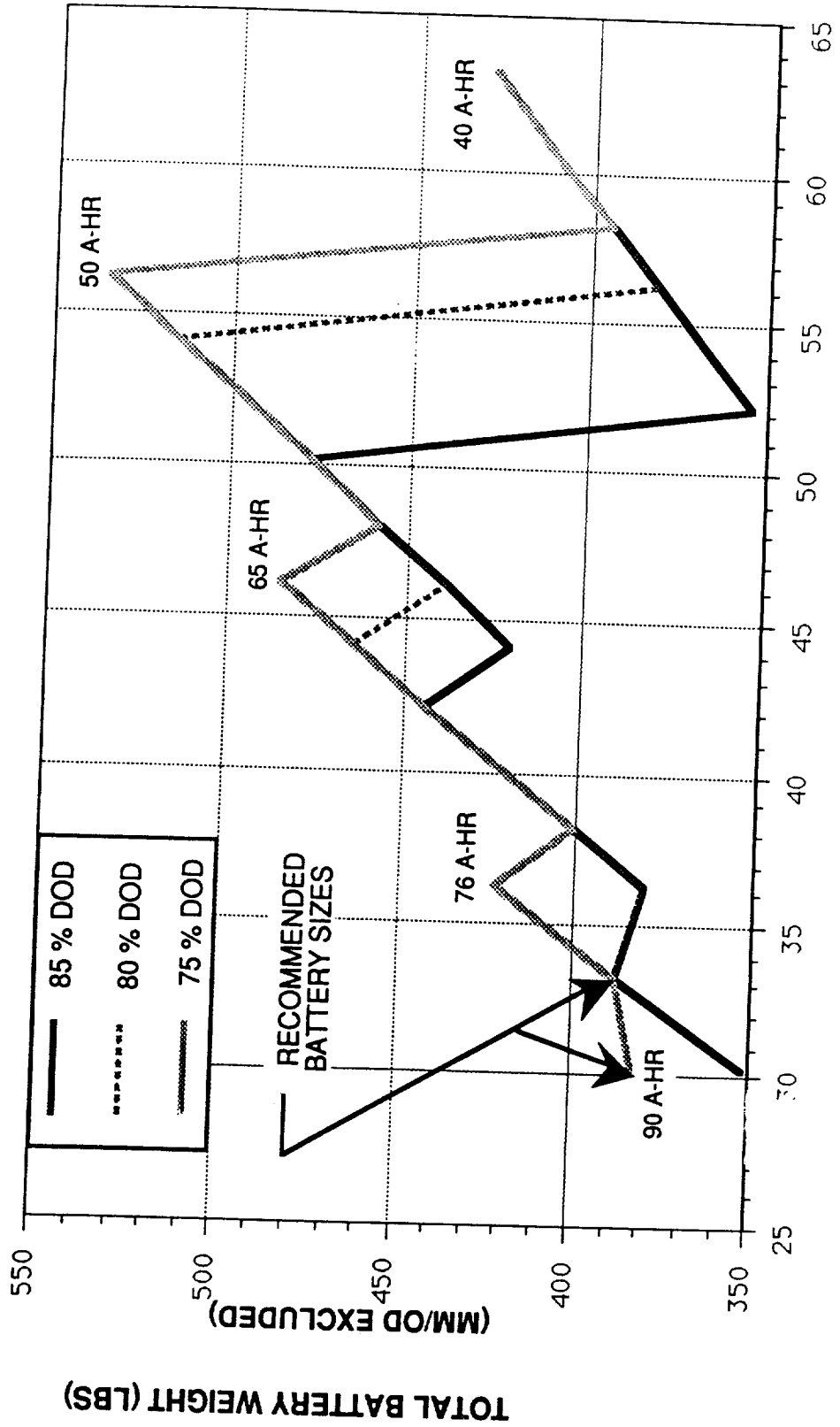

NUMBER OF NIH2 CELLS

Space Station Freedom

McDonnell Douglas • GE • Honeywell • IBM • Lockheed



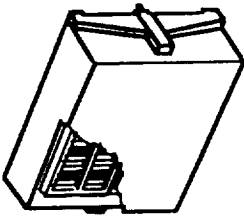

TRANSPORTER  
ENERGY STORAGE  
SUBSYSTEM

# TESS BATTERY WILL BE DISCHARGE RATE LIMITED

MDESC - L&ES

AVERAGE POWER 2300 W

PEAK POWER 3500 W

33 NIH2 CELL BATTERY

REQUIRED BATTERY CAPACITY (AMPHRS)

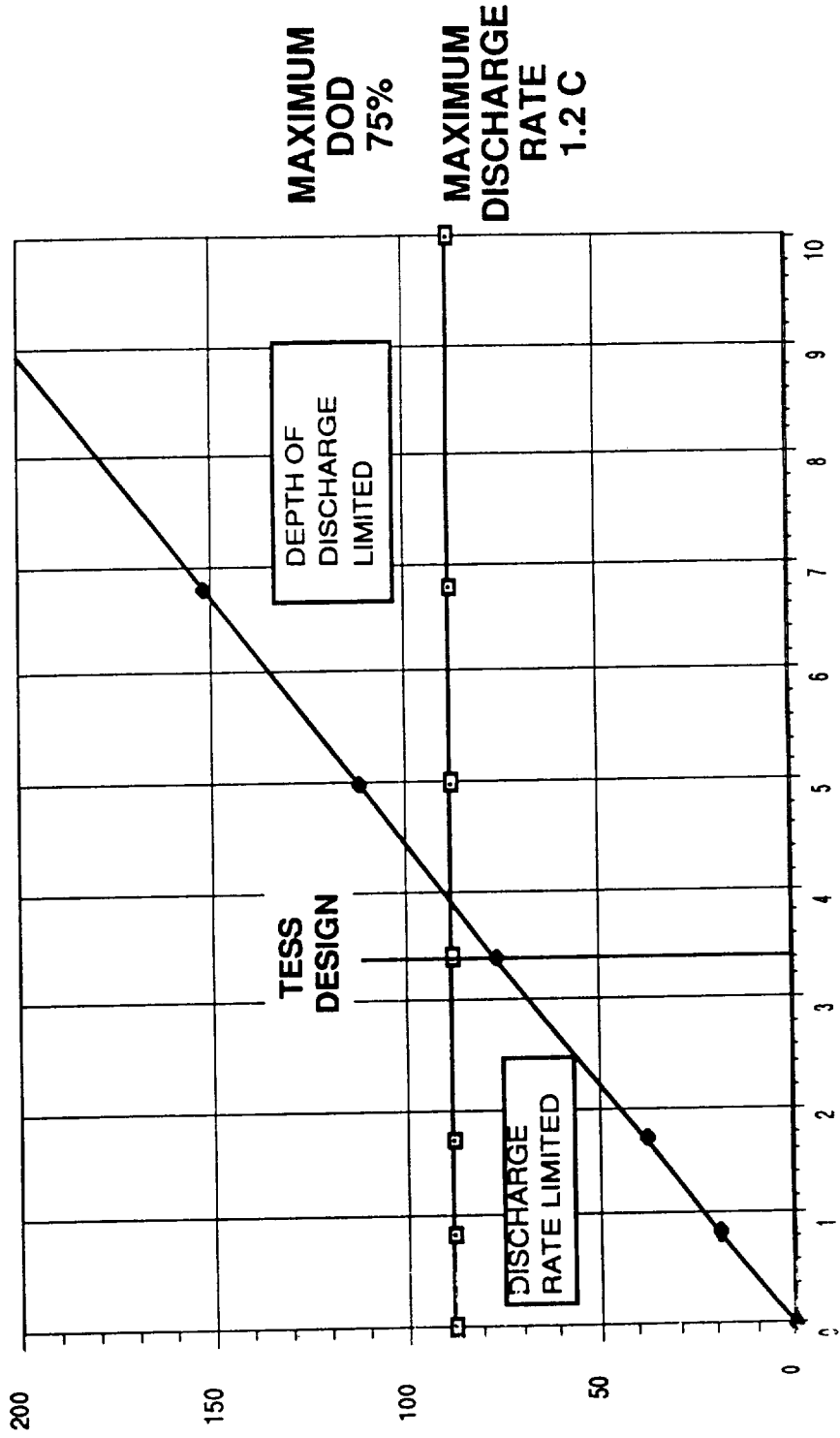

TESS BATTERY ENERGY (KW-HRS)

Space Station Freedom

McDonnell Douglas • GE • Honeywell • IBM • Lockheed

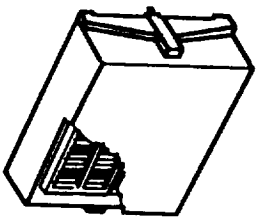

**TRANSPORTER  
ENERGY STORAGE  
SUBSYSTEM**

# **DOWNSIZED TESS SOLUTION FOR MBS REDESIGN**

**MDESC - L&ES**

- **REMOVE ONE TESS ORU**
- **REMOVE 63- CELL, 90 AMP-HR NIH2 BATTERY**
- **ADD TWO 33-CELL, 90 AMP-HR NIH2 BATTERIES**
- **CONNECT BATTERIES IN PARALLEL TO OBTAIN REDUNDANCY**

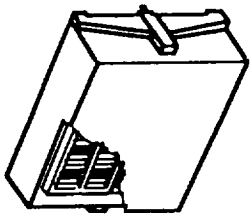

TRANSPORTER  
ENERGY STORAGE  
SUBSYSTEM

## RELATED NIH2 BATTERY CELL TESTING AT NASA-JSC

MDESC - L&ES

- OBTAINED 8 HUBBLE SPACE TELESCOPE CELLS FROM NASA-MARSHALL SPACE FLIGHT CENTER
- PAIR CELLS INTO FOUR, 2-CELL TEST PACKS
  - TWO PACKS FOR SSF ELECTRICAL POWER SYSTEM SCENARIOS
  - TWO PACKS FOR TESS SCENARIOS
- ESTABLISH TESS OPERATING SCENARIOS
  - DISCHARGE RATES AND DURATIONS
  - CHARGE RATES AND DURATIONS
  - STANDRY PERIODS OF CONSTANT TRICKLE CHARGE
- TEST PREPARATION IN PROGRESS

