

NASA Contractor Report 4442

Assessment of Flying-Quality Criteria for Air-Breathing Aerospacecraft

Duane T. McRuer, Thomas T. Myers,
Roger H. Hoh, Irving L. Ashkenas,
and Donald E. Johnston
Systems Technology, Inc.
Hawthorne, California

Prepared by
Systems Technology, Inc.,
under Subcontract ATD-88-STI-0221
to PRC Inc., for
Dryden Flight Research Facility
under Contract NAS2-12722



National Aeronautics and
Space Administration

Office of Management

Scientific and Technical
Information Program

1992



CONTENTS

ABSTRACT	1
NOMENCLATURE	1
INTRODUCTION	4
VEHICLE CHARACTERISTICS, DEFICIENCIES, AND IMPLICATIONS FOR CONTROL	5
General Issues	5
Dependence of Inlet Flows on Angle of Attack, Angle of Sideslip, and Mach Number	5
Boundary-Layer Transition	6
Thermal Management, Engine-Airframe Control, and Trajectory Consonance	6
Multimode, Multielement Propulsion System	6
Factors in Airframe-Propulsion-Flight-Control Integration	7
Bow-Shock Movement	7
Trim and Stability Effects of Engine	7
Wing Location	7
Control Power Considerations	7
Transition and Separation	8
Some Central Vehicle-Dynamic and Flight-Control Issues Affected by the Engine Array	8
System Uncertainties	8
Control-Based Limits on the Attainable Performance Envelope	9
MISSION-RELATED TASKS AND EXISTING FLYING-QUALITY SPECIFICATIONS	10
Missions and Tasks	10
Existing Flying Qualities as a Point of Departure	10
Throttling and Throttle Response Requirements	13
Engine-Airframe Dynamics Interaction Possibilities	13
Field of View and Definition of Flying-Quality Levels	14
Assessment of MIL-F-8785C for National Aero-Space Plane	14
SPACE SHUTTLE OPERATIONAL EXPERIENCE AND NATIONAL AERO-SPACE PLANE REQUIREMENTS FOR FLYING QUALITIES	15
Introduction	15
Flying-Quality Levels for National Aero-Space Plane	15
Review of Shuttle Orbiter Approach and Landing Characteristics	18
Entry Phases	18
The Approach and Landing Task	18
Shallow Glide and Final Flare	19
Ground Aids for Flightpath Control	19
Cockpit Display Aids	20
Examples of Orbiter Landing Performance and Pilot-Control Characteristics	21
Landing Performances	21
Pilot-Control Strategies	22
Approach and Landing Flying Qualities of the Shuttle Orbiter Based on Early Flights	24
TENTATIVE RECOMMENDATIONS FOR APPROACH AND LANDING FLYING QUALITIES FOR NATIONAL AERO-SPACE PLANE	26
Summary	26
Dynamic Response Considerations	28
Definitions of Response Types	28
Characteristics and Limitations of Rate Command, Attitude Hold	29

Characteristics and Limitations of Attitude Command, Attitude Hold Response Type and Flightpath Command, Flightpath Hold Response Type	30
Supporting Data	31
Flightpath and Attitude Bandwidth	31
Pitch Attitude Bandwidth and Phase Delay	33
Pilot Technique	33
Comparison of Attitude Command, Attitude Hold; Rate Command, Attitude Hold; and Conventional Airplane Response Types	34
Force as a Function of Position Input to Define Bandwidth and Phase Delay	35
Flightpath Angle Overshoot Criterion	35
RESULTS, CONCLUSIONS, AND RECOMMENDATIONS	37
Results and Conclusions	37
Recommendations	39
REFERENCES	40
TABLES	43
FIGURES	47

TABLES

1	Mission phase–task–handling quality criteria matrix.	43
2	Shuttle orbiter performance levels.	44
3	Competing response types for National Aero-Space Plane landings.	45
4	Recommendations.	46

FIGURES

1	Terminal area energy management guidance phases.	47
2	Nominal trajectory and airspeed variation for shuttle approach and landing.	48
3	Comparison between theoretical superaugmentation model and flight data.	49
4	Ball-bar shallow glide slope flightpath aid.	49
5	Steep glide precision approach path.	50
6	Head-up display approach and landing symbology.	51
7	Touchdown parameter summary chart.	52
8	Idealized altitude–sink rate phase plane trajectory for the shallow glide and flare assuming an exponential flare.	53
9	STS-6 preflare through touchdown time traces.	54
10	STS-6 preflare through touchdown hodograph.	55
11	STS-7 preflare through touchdown time traces.	56
12	STS-7 preflare through touchdown hodograph.	57
13	Comparison of pitch attitude responses in the shuttle landing flare.	58
14	Definition of bandwidth and phase delay.	59
15	Tentative requirements for attitude bandwidth to stick.	60
16	Tentative requirements for flightpath bandwidth-to-stick position.	61
17	Drop-back criterion for quasi-open-loop flying qualities.	62
18	Generic characteristics of three response types.	63
19	Generic loop closure characteristics.	64
20	Definitions of bandwidth and phase delay.	65
21	Correlation of pilot-rating data with flightpath and attitude bandwidth to stick position.	66
22	Correlation of pilot-rating data with attitude bandwidth and phase delay to stick position.	67
23	Pilot rating as a function of attitude bandwidth for rate command, attitude hold and attitude command, attitude hold response types.	68
24	Flight-test results showing effect of changing from rate to attitude response type (TIFS flared landing flight tests).	69
25	Correlation of pilot-rating data with attitude bandwidth and phase delay to stick force.	70
26	Correlation of pilot-rating data with flightpath and attitude bandwidth to stick force.	71

27	Correlation between flightpath bandwidth and flightpath angle overshoot.	72
28	Correlation between mean Cooper-Harper pilot rating and flightpath angle overshoot. .	72

ABSTRACT

A study of flying-quality requirements for air-breathing aerospacecraft gives special emphasis to the unusual operational requirements and characteristics of these aircraft, including operation at hypersonic speeds. The report considers distinguishing characteristics of these vehicles, including dynamic deficiencies and their implications for control. Particular emphasis is given to the interaction of the airframe and propulsion system, and the requirements for dynamic systems integration. Past operational missions are reviewed to define tasks and maneuvers to be considered for this class of aircraft. Areas of special concern with respect to vehicle dynamics and control are identified. Experience with the space shuttle orbiter is reviewed with respect to flight-control system mechanization and flight experience in approach and landing flying qualities for the National Aero-Space Plane (NASP).

NOMENCLATURE

a.c.	aerodynamic center
ACAH	attitude command, attitude hold (response type)
ACIP	aerodynamic coefficient identification package (shuttle)
AFCS	aircraft plus flight-control system
ALT	approach and landing test
c.g.	center of gravity
C_{m_u}	nondimensional pitch due to speed derivative
C_{m_α}	nondimensional pitch due to angle-of-attack derivative
C_{n_β}	nondimensional yaw due to sideslip derivative
c.p.	center of pressure
DLC	direct lift control
Drb	drop-back measure, deg
FCFH	flightpath command, flightpath hold (response type)
FCS	flight-control system
FOV	field of view
FQ	flying qualities
F_s	stick force, lb
g	gravitational unit
GM	gain margin, dB
GMT	Greenwich mean time
GPC	general-purpose computer (shuttle)
H	altitude, ft
\dot{H}	vertical speed perturbation, ft/sec
HAC	heading alignment cylinder

\dot{H}_{TD}	touchdown sink rate, ft/sec
HUD	head-up display
ICS	integrated control system
K	generic gain
K_q	pitch loop gain, deg/deg/sec
L/D	lift-drag ratio
M	Mach number
MMLE	modified maximum likelihood estimates
M_u	pitching moment due to speed derivative, 1/ft·sec
M_α	pitching moment due to angle-of-attack derivative, 1/ft ² ·sec ²
M_{δ_e}	elevator pitching moment effectiveness, rad/sec ² /rad
n	load factor, g
NASP	National Aero-Space Plane
N_δ^h	altitude to elevator numerator, ft/deg
N_δ^θ	pitch to elevator numerator
n_z	normal load factor, g
OFT	orbiter flight test
OGS	outer glide slope
PAPI	precision approach path indicator
PIO	pilot induced oscillation
PR	pilot rating
q	pitch rate, rad/sec
\bar{q}	dynamic pressure, lb/ft ²
q_c	pitch rate command, rad/sec
q_{peak}	maximum pitch rate, rad/sec
q_{ss}	steady state pitch rate, rad/sec
Q	pitch rate, rad/sec
RCAH	rate command, attitude hold (response type)
RHC	rotational hand controller (shuttle)
RJ	ramjet
SAS	stability augmentation system
SJ	scramjet
SSTO	single-stage-to-orbit
STI	Systems Technology, Inc., Hawthorne, CA
STS	Space Transportation System

TAEM	terminal area energy management
TIFS	total inflight simulator (USAF/Calspan)
T_q	pitch rate lead time constant, sec
T_ρ	density mode time constant, sec
$1/T_f$	flare inverse time constant, sec^{-1}
$1/T_{\theta 2}$	flightpath lag inverse time constant, sec^{-1}
UCE	usable cue environment
U_o	reference speed, ft/sec
VMS	vehicle management system
V_{TD}	touchdown speed, ft/sec
X_T	glide and flare distance, ft
α	angle of attack, deg
β	angle of sideslip, deg
γ	flightpath angle, deg
γ_o	initial flightpath angle, deg
δ_e	elevator deflection, deg
δ_{RHC}	rotational hand controller deflection, deg
δ_s	stick deflection, deg
ζ	damping ratio
θ	pitch attitude, deg
θ_{ss}	steady-state pitch attitude, deg
σ	singular value
τ_e	effective time delay, sec
τ_p	phase delay parameter, sec
Φ	phase margin, deg
ψ	heading, deg
ω'	closed loop natural frequency, rad/sec
ω_b	airplane bandwidth, rad/sec
ω_{BW}	aircraft bandwidth, rad/sec
ω_{BW_γ}	flightpath bandwidth, rad/sec
ω_d	dutch roll natural frequency, rad/sec
ω_{sp}	short-period natural frequency, rad/sec
ω_ϕ	roll-due-to-roll-control zero natural frequency, rad/sec

INTRODUCTION

An essential element of a sound and strong technical approach to the subject research area is the recognition that, quoting reference 1, “Air Breathing Aerospacecraft — are radically different in configuration, operational envelope, and complexity than any vehicle flown before, including the Space Shuttle.” These differences and complexities start with the airframe and engine, propagate through the integrated flight-propulsion control system, and finally impinge on flying qualities (FQ) and FQ criteria. The integrated control system (ICS) will have a major influence on the effective vehicle that the pilot is expected to either monitor and manage or manually control. Consequently, the forces and considerations that drive it must be thoroughly appreciated and understood, so that the development of new and the adaptation of existing FQ criteria can be meaningful and applicable.

The forces driving the ICS derive from the vehicle dynamic deficiencies, the variety of possible control effectors to deal with, and the precision missions to be flown. An ICS architecture is necessary to achieve the desired mission performance through weight and volume savings, dependent on the following:

- Unstable center of gravity (c.g.) location and control to minimize drag,
- Structural mode control as needed to permit the high bandwidth control of rigid body instabilities and allow reduced stiffness (leading to lower structural weight fractions),
- Possible active control of flutter to reduce or eliminate balance weight requirements,
- Control of the thermal system to actively cool the structure,
- Engine inlet normal shock and other controls to maximize thrust and minimize fuel usage,
- Control of c.g., slosh, thrust vector effects, unstart, restart, and
- Integrated flight-propulsion control ranging from thrust-aero effector blending through terminal operations, which minimize approach and touchdown parameters, thus reducing braking, tire, landing gear, and flap requirements.

Control system integration is also necessary to improve aircraft viability and reliability, and to cope with demanding, difficult to fly, time-critical profiles and missions. Such integration promises to provide relief for the demands presented by other technical disciplines and to permit a more balanced and efficient design. Integrated controls can impact on a broad range of features other than FQ — such as structures, loads, brake systems, tires, and aerodynamic performance. It is far more important and significant than conventional active control because of the absolute necessity for optimum overall design and operation to achieve even marginal path-restricted performance. Criteria for FQ must reflect this dependence on the nature of the ICS, and the reverse impact of FQ on certain control system details — e.g., control system command structure — must also be considered.

Within the foregoing context, our technical approach includes (1) the establishment and discussion of a list of dynamic stability and control deficiencies, which must be either accommodated by the pilot or corrected by integrated flight-propulsion control systems, (2) representative mission phase-task

structures (including maneuvers and environmental inputs) appropriate to a comprehensive set of air-breathing aerospace missions, (3) the assessment of existing FQ criteria, and (4) the identification of research needed to eliminate important gaps in these criteria.

In the following section, some of the expected vehicle characteristics and deficiencies, operational considerations, display and controller possibilities, ICS considerations, and FQ issues are outlined as pertinent background to our approach.

VEHICLE CHARACTERISTICS, DEFICIENCIES, AND IMPLICATIONS FOR CONTROL

Manned hypersonic aircraft offer a rich variety of uncertainties and unique features. Many of these have a major impact on the dynamics, stability, control, and FQ of the vehicle. Some of these are summarized in this report. The three general divisions treated are general issues, factors in airframe-propulsion-flight control integration, and control-based limits on the attainable performance envelope.

General Issues

Dependence of Inlet Flows on Angle of Attack, Angle of Sideslip, and Mach Number

At the supersonic and higher Mach numbers (M), the forebody is fundamentally part of the inlet. Boundary and entropy layers build up along the forebody to create stratified layers entering the inlet (unless diverted, e.g., by boundary layer gutters). Crossflows are also present, and are larger near the margins on either side. These and other effects create stratified inlet flows that can depend strongly on local angle of attack (α), angle of sideslip (β), and distance from the body even in ideal circumstances. Gusts, transitions, rogue shocks, and sudden atmospheric density changes can further complicate the picture.

Inlet flow fluctuations, when uncompensated by engine design or engine control actions, will be reflected and amplified in the exhaust flows. Because the forebody and afterbody forces are asymmetrically distributed by, and respond to, inlet-engine-nozzle flow, there is a resultant effect on the lift and moment balance as well as on the usual thrust-drag balance. In addition, the angle-of-attack and sideslip effects on the engine can contribute to the overall vehicle longitudinal and directional stability (e.g., C_{m_u} , C_{n_β} , and C_{m_α}).

The inlet flow conditions across distributed engine modules can also differ substantially if major asymmetries, especially as functions of angle of attack and angle of sideslip, are present. These effects lead directly to five major control issues:

- Need for completely integrated treatment of vehicle-propulsion-controls interactions,
- Emphasis on flight-control and propulsion systems which minimize sideslip in all maneuvers,
- Decoupling or compensating of exhaust from inlet fluctuations as a major function of the engine controls,

- Placement of constraints on allowable vehicle motions, flexible body deflections, and inlet flow conditions, and
- Need for positive control and initiation of all engine mode transitions.

Boundary-Layer Transition

The location of the transition region between laminar and turbulent boundary-layer flow on the forebody is an essential determinant of flow distribution conditions in the inlet, which then affect the subsequent combustion process and finally the thrust. The transition region between fully laminar and fully turbulent flow gets longer as Mach numbers increase, and is also a function of angle of attack. The flow at the inlet may be distorted by external environment or maneuver-induced shifts in the transition region, with a variety of consequences (e.g., reduced thrust and unstart). The control issues here relate to the need for the ICS to be tolerant of the uncertainties associated with changes in transition.

Thermal Management, Engine-Airframe Control, and Trajectory Consonance

The coordination of thermal management, propellant feed, and engine and flight controls is a central issue in hypersonic flight. For some conditions or for a single trajectory (e.g., single-stage-to-orbit (SSTO)) vehicle, the design can be managed in a straightforward way. When other flight conditions are considered, however, conflicts in requirements may occur. For instance, in constant Mach hypersonic cruise, entry, and perhaps other flight conditions flown as research objectives or during an envelope expansion, the conditions for thrust (defined by the trajectory and guidance) and cooling may be incompatible. In this case, cooling requirements would take precedence over achieving some desired flight conditions or trajectory. Inadmissible flight regimes are thereby created as new constraints on the attainable performance envelope.

Multimode, Multielement Propulsion System

As an overriding requirement, the ICS must be designed to cope with (1) thrust variations from engine to engine, including unstarts, regardless of cause, and (2) significant thrust changes when shifting from one mode to another. Because the force and moment changes can be quite diverse, this requirement (for unstart in particular) can be a major factor in setting control power and trim requirements for all control effectors.

The conversion from one engine mode to another can be demanding. For instance, in converting from ramjet (RJ) to scramjet (SJ) the normal shock and boundary layer must be suddenly ingested, thereby completely changing the internal conditions. Boundary-layer ingestion leads to large variations in the air density and stagnation pressure over the cross section of the inlet. Disturbances communicated through the boundary layer may result in unfavorable inlet conditions including possible inlet unstart. There must be no chance for fluctuations between RJ and SJ states. Marginal conversions may be especially sensitive to transient changes in the inlet flow that could be induced by variations in angle of attack, sideslip, or turbulence, which just happen to occur during the conversion process.

Factors in Airframe–Propulsion–Flight-Control Integration

Bow-Shock Movement

At lower supersonic Mach numbers, the bow shock will not intersect the vehicle; it will engulf the wing tips and begin to sweep across the wing surfaces, finally entering the engine cowls. The movement of the shock across the wings introduces shock-impingement phenomena. (Increased heating rates have received major attention, but changes in the stability derivatives have to be close behind.) Depending on the configuration details, the bow wave may have to be ingested into the inlet above some Mach number. All of these changes should have major effects on the derivatives, and the effects should also be strong functions of sideslip.

Trim and Stability Effects of Engine

With an underbody configuration, the engine provides a significant lift component from the inlet and exhaust streams. These will be modified by changes in throttle setting, angle of attack, angle of sideslip, and Mach number. The trim is consequently affected, and the several stability derivatives will be changed as well.

With a nozzle which comprises external expansion along the afterbody, there is an effective thrust vector angle. Typically this might vary from -8° at $M = 8$ to -2° for $M > 20$. Not only must this be trimmed out, but it will also add an increment to M_u .

Wing Location

Wing–engine relative positioning is a major issue in that wing-induced flow fields will affect the inlet flow, especially during maneuvers. Thus pullups and pushovers at those Mach numbers most critical for this kind of an effect will be important cases to consider in simulation and flight-test planning.

Control Power Considerations

The vehicle must have adequate control power to counter all possible inputs and failure states. Among the conditions of interest are

- Engine failure on takeoff (vertical tail size), and
- Engine unstart (vertical tail size for asymmetric conditions, but also roll control and pitch control power at hypersonic conditions where the unstart changes the engine-associated afterbody lift and location both laterally and longitudinally).

The engine array, with differential control of flow paths and adjustable engine-associated flaps, is a potentially important contributor to the total airplane control power resources.

Transition and Separation

Shock-induced boundary layer transition and separation and other factors can have a major impact on the effective aircraft stability parameters as well as on localized heating. Typical separation effects can occur in the region outboard of a fin, even at low angle of attack and high Mach cruise conditions.

Some Central Vehicle-Dynamic and Flight-Control Issues Affected by the Engine Array

- Longitudinal rigid body
 - Instabilities ($\omega_{sp^2} < 0$): either by design for performance, from center-of-pressure (c.p.) shifts, from aft travel of c.g. with fuel burn; from forebody and afterbody flow changes with flight conditions
 - Low frequency altitude mode $1/T_\rho$ introduced by density and temperature variations; sometimes negative (divergent)
 - Trim: travels of aerodynamic center (a.c.) with Mach number; c.g. with fuel depletion; engine-airframe forebody and afterbody flows
- Lateral-directional rigid body
 - Instabilities: dutch roll, ω_{d^2} ; roll numerator, $\omega_{\phi^2} < 0$
 - Reduced rudder control authority with Mach number increase
 - Engine-to-engine thrust asymmetry
- Body bending effects on
 - Vehicle management system (VMS) stability and control
 - Engine forebody and afterbody flows and associated lift and moment fluctuations
- Slosh effects on VMS stability and control
- Engine operations in maneuvers

System Uncertainties

The uncertainties in the VMS–engine system will include

- Aerodynamic coefficients and derivatives
- Engine-induced forebody and afterbody flow fluctuations and their effects on the aircraft stability and control parameters
- Flexible-to-rigid ratios, including heating effects
- Air and engine airflow data
- Structural mode shapes and frequencies

Control-Based Limits on the Attainable Performance Envelope

Severe limitations on the performance envelope are likely in certain Mach regions because of the combination of the open-loop instabilities, closed-loop instabilities governed by airplane zeros, and control power limitations. Uncontrollable divergences can always occur when the control effectors are at limit values, and the airplane-alone characteristics exhibit divergent characteristics. The basic and most conservative limits of this nature would be

- Longitudinal
 - Very long period divergence caused by the unstable height (density) mode,
 - Rapid divergence caused by the unstable short period, $\omega_{sp}^2 < 0$, and
- Lateral-directional
 - Rapid divergence caused by unstable dutch roll, $\omega_d^2 < 0$.

Performance boundaries based on these considerations alone would be hopelessly conservative. The unstable modes are not only expected but, in some cases, even desired. They will, of course, have to be stabilized by the primary flight-control system (FCS), because stabilization can be ensured only within the control power limits of the control effectors.

For the longitudinal system, the performance limits under aerodynamic control alone can be converted to angle-of-attack envelopes which provide boundaries of angle of attack within which the airplane can be trimmed and controlled. In elevon-controlled airplanes, establishing the envelopes can be complicated by lateral control needs, giving rise to more restricted angle-of-attack boundaries which may be strong functions of engine-out conditions. Considering the large actuator bandwidths required for stabilization of short-period divergences, the features of priority rate limiting assignments also enter. Thus, even in the relatively straightforward longitudinal aerodynamic effector case, the consideration of control-based performance limitations can be difficult and the actual performance boundaries severely restricted. Complicate the situation further with consideration of uncertainties in, for instance, M_α resulting from engine effects, and the performance boundaries narrow further still.

Lateral-directional control limits are more complicated. When the roll numerator zero $\omega_\phi^2 > 0$, correction of the directional divergence is similar to the longitudinal case. On the other hand, when rolling velocity reversal is present along with directional divergence, ω_ϕ must be corrected as well. Adequate directional control effectors are needed to accomplish these two functions. Aerodynamic effectors for this purpose are in short supply at hypersonic speeds, so some reliance on propulsion or reaction controls may be necessary. Thus, the effective lateral-directional control boundaries will be based on trimming engine-out conditions plus providing directional stability and correcting rolling velocity reversals. These features are described more fully in reference 6. Uncertainties again enter the issues, as do further complications because of the mix of needed control effectors.

Finally, the true control-oriented airplane performance envelope boundaries need to consider coupled longitudinal and lateral-directional characteristics at extreme trim values. Attainable performance will in many cases be adequate for mission-task requirements, but these need delineation to establish the proper context and framework for task-oriented FQ requirements, as discussed in the first part of the next section.

MISSION-RELATED TASKS AND EXISTING FLYING-QUALITY SPECIFICATIONS

Missions and Tasks

Table 1 defines the kind of information required and desired to relate FQ issues to particular mission phases. That is, when completed, this table will contain entries in all of the squares shown and will identify (on the far right side) critical handling-quality problems and issues which pertain to each of the various mission phases listed.

A partial treatment of the list in table 1 is given in reference 2, which sets a context of operational conditions, mission possibilities, and tasks to form a logical framework for the envelope expansion phases and other potential mission phases—tasks for any hypersonic aircraft. Five missions are defined and treated. The SSTO mission is not covered explicitly, although Mission V, Simulated Direct Boost (ref. 2), reproduces the early parts of an SSTO profile subject to a constraint of recovery within the continental U.S. In simulations conducted to support this effort, it was found that all five missions that were considered could be accomplished with relatively rudimentary displays, although the workload was often high. Coordination of dynamic pressure (\bar{q}), gravitational units (g), Mach number, and position required extensive cross checking, and turns were especially tough. Attempting to hold a constant dynamic pressure in boost was nearly as difficult. The most control-demanding maneuver encountered was maintaining $2 g$ and a constant dynamic pressure in descending turns while still achieving a proper ground track. This type of maneuver has several applications in hypersonic vehicles, including the setup of terminal conditions using a heading alignment cylinder (HAC) energy management feature.

The simulations used a rudimentary model for the aircraft and the display subsystem with incomplete (at best) effective vehicle and thrust dynamics. The five missions simulated constitute an excellent starting point, and should be used as parts of a more thorough simulation study of FQ for hypersonic vehicles. This would entail more realistic effective vehicle and display characteristics in a simulation program emphasizing and covering, in addition to the five missions defined, a full-fledged SSTO for nominal and perturbed conditions (perhaps eight mission conditions total).

Existing Flying Qualities as a Point of Departure

Reference 3 is an FQ requirement-like document which starts with MIL-F-8785C (ref. 4) or MIL-STD-1797 (ref. 5) and addresses the pertinence of these requirements to the National Aero-Space Plane (NASP). Several important points emerge from this, as summarized in the following (the pertinent paragraph from ref. 4 is noted parenthetically). The comments are a combination of Berry's (ref. 3) and other considerations arising during this project and noted as additions.

Pitch control variations during rapid speed change (3.2.1.1.2) are particularly important for NASP vehicles which spend "an unprecedented amount of time at a relatively high level of longitudinal acceleration." Changes in wording of the requirement to include supersonic and hypersonic speeds and other details are suggested.

The paragraph on flightpath stability (3.2.1.3) needs rethinking because

- Aerospacecraft approaches may not be at stabilized speeds,
- In unpowered low lift-drag ratio (L/D) landings, the vehicle may be decelerating during the approach,
- If power is held in reserve for a go-around capability, decelerating high-energy approaches similar to unpowered landings may be used to minimize the dead-man zone in case of a propulsion failure, and
- Reliable powered landings could have a significant impact on vehicle structural, landing gear, and braking characteristics by permitting lower landing speeds.

The sections on longitudinal maneuvering characteristics (3.2.2) including short-period responses (3.2.2.1), short-period frequency and acceleration sensitivity (3.2.2.1.1), and short-period damping (3.2.2.1.2) need more work to clarify the needs and remove ambiguities for aerospacecraft as well as aircraft in general.

Although Berry (ref. 3) does not comment on it, we should emphasize that there is little data to back up the existing requirements for Class III aircraft, including the sometimes marginal (from the specifications) characteristics of prominent civil transports which have excellent operational records.

In an attempt to bring more order to these requirements, STI has recently examined the existing database of recent USAF/Calspan Total Inflight Simulator (TIFS) studies, as shown in the following sections. Among other things, we have attempted to

- Determine the ideal task-tailored form of effective dynamics, and
- Assess whether an overall requirement on airplane bandwidth, ω_b , is the best way (in terms of proportion of the data correlated) to characterize the existing flight data.

We are now at the point where the criteria proposed later in “Tentative Recommendations for Approach and Landing Flying Qualities for National Aero-Space Plane” can be considered reliable for large aircraft which approach on normal glide slopes and land with conventional flares. Perhaps a limited simulation would be desirable to check points with degraded visibility or fields of view (FOV), but we feel confident that meeting the criteria proposed will result in an aircraft with excellent approach and landing characteristics.

While these correlations should apply to powered NASP landings, the unpowered craft approach and landing will be on different trajectories akin to the shuttle. Whether this imposes more severe requirements on the effective vehicle dynamics is dubious, because the effective required dynamics for powered approaches permit significant precise maneuvering. In fact, in terms of the criteria proposed later in this report, the shuttle is Level 2. It would be worthwhile to demonstrate that unpowered approaches and landings do not impose more severe requirements than are covered by these criteria.

Control forces in maneuvering flight (3.2.2.2.1) lack quantitative criteria for sidestick controllers. Such criteria are needed not only for hypersonic aircraft but for large aircraft in general.

The longitudinal pilot-induced oscillation (PIO) requirement (3.2.2.3) is primarily qualitative. The dynamic control forces in maneuvering flight criteria (3.2.2.3.1) provide a necessary but insufficient condition to ensure no PIO tendencies with respect to normal acceleration (but not necessarily well backed for Class III aircraft and sidesticks). Flightpath PIOs and control of vertical descent rate with bank angle in hypersonic turns, which have given some trouble on the shuttle, should be treated explicitly.

The paragraph on longitudinal control in landing (3.2.3.4) needs rewording to account for decelerating approaches for the unpowered landing conditions. The turn coordination requirement (3.3.2.6) needs to be modified to provide for very large bank angles in high-speed turns needed to achieve required ground tracks in the presence of centrifugal relief.

The section on roll performance for Class III airplanes (3.3.4.2) needs additional conditions based on hypersonic speeds. The importance of minimizing potential angle-of-attack and angle-of-sideslip excursions to avoid engine and heating limits should be noted.

Systems Technology, Inc., believes that a specific new requirement on sideslip excursions in maneuvering flight is needed, especially at high supersonic and hypersonic Mach numbers. Similar requirements may also be needed on angle-of-attack excursions. Limiting conditions should include avoidance of premature transition, engine unstart, and performance limits, etc.

The paragraph about roll control forces (3.3.4.3) needs requirements for sidestick controllers. The section on transient effects (3.3.9.3) is incomplete. Asymmetric loss of thrust should be reexamined with engine unstart in mind. Significant transients can occur in all axes for hypersonic vehicles. More quantitative criteria are needed for acceptable rates and accelerations.

The paragraph on dynamic characteristics (3.5.3) needs work. Effective time delay requirements are still ambiguous, e.g., task sensitive, feel system dependent, stick position, or stick force referenced. Recent data need to be examined, and the requirement needs to be updated. A possible major factor in connection with the effective time delay is the impact of structural and slosh mode stabilization factors on the potential effective time delay. This may have an effect in two ways:

- Structural mode filters needed for gain stabilization may introduce major components to the effective delay as seen by the pilot – some NASP structural modes are very low frequency. On the other hand, phase stabilization, which may be accomplished with no delay components caused by filtering, is not permissible under current specifications.
- The lower frequency bending mode(s) can result in what appears as a net lag to the pilot when an abrupt change is made (e.g., to change the pitch angle in the final flare of an unpowered landing). In this case the pilot may be better off using a pitch angle measured at the c.g. rather than relying on the visually observed pitch angle from a far forward cockpit location.

In addition to the noted military-specification criteria of possible applicability, similar auxiliary-complementary requirements and considerations deserve exposure, namely:

- Tameness criterion (based on a criterion used by Boeing (Boeing Company, Seattle, Washington) for transports). This requires that a pilot be able to react to an engine failure in the air shortly after

takeoff using wheel alone. Although this is not the total recommended response to an engine-out situation, it does ensure a basic level of directional stability and lateral control.

- Control under most adverse conditions. Fundamental levels of control should remain even under the most adverse circumstances. The maneuvers that could influence this minimum include the following:

- Takeoff rotation
- Landing flare
- Stall and stall recovery
- Tip-up at brake release
- Unpowered landing
- Flaps-up, slats-up landing

and such emergency–failure conditions as

- Control with partial hydraulic systems failed
- Control with all engines out
- Missing slat, flap
- Jammed stabilizer, body flap

Throttling and Throttle Response Requirements

A variety of flight conditions exists in which throttling requirements are especially important. These may include

- Low-speed operations – takeoff, landing, go-around
- Low-speed abort conditions – takeoff, go-around
- Trajectory following (guidance-based requirements)
- Very high speed flight – especially conditions where cooling dominates thrust requirements

In these conditions, there are three facets for requirements:

- Throttling range
- Thrust-setting accuracy
- Thrust response

Engine–Airframe Dynamics Interaction Possibilities

For hypersonic configurations, the engine control system is inevitably coupled with the aircraft dynamics. For the several frequency bands these include

was long ago rendered impossible by demands for, and technology permitting, higher performance at the expense of favorable aircraft-alone dynamics. The effective vehicle dynamics, comprising the aircraft plus minimum stability augmentation, became the characteristics which provide an FQ focus. In existing FQ specifications (ref. 4), the presumption has been that failures in the augmentation may change the properties of the effective vehicle dynamics. Three levels of FQ have accordingly been defined in reference 4.

- Level 1 – “Flying qualities clearly adequate for the mission Flight Phase.” (The effective vehicle dynamics and mission task environment for Level 1 are often associated with Cooper-Harper pilot ratings (PR) less than 3-1/2.)
- Level 2 – “Flying qualities adequate to accomplish the mission Flight Phase, but some increase in pilot workload or degradation in mission effectiveness, or both, exist. The probability of encountering Level 2 after failure within the operational flight envelope $< 10^{-2}$ per flight.” (Unofficially associated with effective vehicle dynamics and mission task environments with $3-1/2 < PR < 6-1/2$.)
- Level 3 – “Flying qualities such that the airplane can be controlled safely, but pilot workload is excessive or mission effectiveness is inadequate, or both. Category B and Category C (includes terminal flight phases of takeoff, approach, and landing) can be completed. The probability of encountering Level 3 after failure within the operational flight envelope $< 10^{-4}$ per flight and, within the service flight envelope $< 10^{-2}$ per flight.” (Usually associated with $PR > 6-1/2$.)

When multiple-redundant fail-operational, fly-by-wire SAS is the norm, failures can still occur in the parts of the FCS associated with stability augmentation, but the effective vehicle dynamics presented to the pilot will not change as a consequence of the first (or second, if fail operational–fail operational) failure. In general, for flight-critical situations on the shuttle orbiter or the NASP, the stability augmentation failure criteria are made sufficiently severe to reduce the probability of changing the effective vehicle dynamics from those present with no failures to negligible proportions. Thus, partial or total failure of elements within the control system does not play the same role as with ordinary aircraft. Further, because the vehicle-alone dynamics are unstable in some flight regimes, the SAS is a fairly high bandwidth controller. This means that the effective vehicle dynamics will be dominated by the aircraft and controller characteristics in the crossover region(s) of the SAS. Changes in these characteristics caused by tolerances, fluctuations, or uncertainties will be reflected directly into the effective vehicle dynamics.

Other important equipment with which the pilot interacts, e.g., guidance or display elements, does not have the same degree of redundancy as the integrated FCS. Failure in equipment may result in increased demands for the pilot’s attention. Other unexpected events also demanding attention may occur which the pilot must sort out. When the pilot is to perform manual control operations, the minimum level of divided attention permissible is established by the control tasks. The FQ for divided attention operations must be superior to those for full attention. Thus, as noted in reference 8, “When the task complex requires significant division of pilot attention between managerial and control roles, the

effective vehicle dynamics being controlled must be able to support very large pilot-vehicle system phase margins. As a corollary, the effective vehicle dynamics must possess dynamic properties that require little attention to control." Considered as a workload or attentional demand, index PR less than 3-1/2 corresponds roughly to control task attention level less than 1/3 (ref. 8.). Therefore, effective vehicle dynamics that may result in PR of better than 3-1/2 (classical Level 1) in normal situations may need to be improved to levels resulting in PR in the 1 to 2 range to provide sufficient margin for emergencies caused by failures of other equipment or major, perhaps unexpected, shifts in operational conditions.

A more profound change in perspective is probably as pertinent to the NASP as it was to the shuttle orbiter. This change of perspective is the lack of knowledge about the vehicle dynamics at unexplored flight conditions. In the case of the shuttle, there was no way to gradually build up to many flight conditions, and incomplete ground testing left the vehicle dynamic properties in a large Mach number region relatively uncertain. In spite of computational fluid dynamics and a planned envelope expansion flight program, similar uncertainties will exist with the NASP in the design phases. It follows from these considerations that the most important failure or FQ level designations should be associated with effective aircraft dynamics in the presence of tolerances and uncertainties in aircraft and controller properties, and with divided attention operations.

The FQ criteria levels developed for the shuttle orbiter pioneered this approach. The levels are shown in table 2, taken from reference 9. Because the principal sources of degraded effective vehicle dynamics stem from out-of-tolerance conditions or from vehicle-engine aerodynamic characteristics being considerably different from those predicted, the criteria emphasize the stability of the aircraft plus SAS. In establishing the details of application of these requirements, reference 10 shows the difference between Levels 1 and 2 to reside primarily in degradations caused by vehicle management system component 3σ out-of-tolerance buildup *combined* with large aerodynamic variations. Any lesser tolerance buildup or uncertainty levels must meet Level 1 requirements. An additional Level 1 constraint is that the FQ be rated 3 or better (or 6 or better for Level 2). Thus, each level requires a loop-by-loop stability margin within the FCS for all automatic functions and an additional FQ assessment of the effective vehicle dynamics presented to the pilot. Finally, FCS failure (i.e., multiple similar control system component failures which totally eliminate critical FCS functions) would result in loss of the vehicle. This is restricted in table 2 by the design assessment performance level.

This same type of level categorization could apply to the NASP. Divided attention considerations for coping with the unexpected might raise the actual PR levels a point or so (e.g., 2 to 2-1/2 for Level 1). The vehicle dynamic uncertainties might be approached in a somewhat different way by introducing structured uncertainties which focus on the most sensitive vehicle dynamic parameters, i.e., those which primarily govern the effective system dynamics (ref. 11). Finally, the phase and gain margins might be supplemented by such devices as generalized delay margins (ref. 11). In this way, some of the modern concepts of control system robustness assessments could be introduced, perhaps with profit, into the detailed definitions of FQ levels. Research should continue, and detailed recommendations about FQ levels for NASP along these lines should be considered.

Review of Shuttle Orbiter Approach and Landing Characteristics

Entry Phases

As the first vehicle to return from orbit and land as an aircraft, the shuttle orbiter provided its flight control designers with a formidable challenge. The complexity of the problem derived basically from the enormous range of flight conditions encountered in the entry and the pre-first-flight uncertainties in the vehicle dynamics, especially at the higher Mach numbers. To cope with these challenges required a sophisticated digital FCS, which employs both reaction jets and aerodynamic surfaces, and incorporates both automatic guidance and human pilots as essential elements in the system.

The return from orbit involves three phases: entry, terminal area energy management (TAEM), and approach and landing. Because the shuttle is a glider, energy management is a dominant concern throughout. The basic guidance activity in the entry phase involves modulation of a series of S-turns to keep the shuttle's total energy within an allowed "window." The TAEM phase begins at about 80,000 ft, and the major maneuver here is the HAC turn. The two HACs are imaginary cylinders (fig. 1) tangent to a vertical plane through the runway centerline. The shuttle may enter a HAC turn from any direction and then fly around its surface until the runway heading is reached. The major guidance activity in the TAEM is adjustment of the HAC diameter to put the shuttle within the correct energy window at the start of the approach and landing phase.

There have been challenging FCS design problems over the entire return from orbit (ref. 12). Like those for many previous aircraft, though, the primary FQ concerns for the orbiter have been in the landing phase, especially during the last few feet before touchdown including the final flare. To paraphrase an astronaut/pilot: the importance of FQ in the shuttle is inversely proportional to altitude. These concerns existed before the first orbiter flight test (OFT) flight, particularly after the PIO incident which occurred in the fifth approach and landing test (ALT) flight with Enterprise (ref. 13). Despite these concerns and a general recognition that the shuttle has unconventional and not entirely desirable handling qualities, the orbiter has now made a large number of successful manual landings. Furthermore, autoland flight testing, which was to have been a major activity beginning with OFT flight STS-3, has now been long postponed while confidence in manual landings has grown.

Because of the particular importance of the landing FCS design and FQ for NASP, this paper emphasizes orbiter experience in the landing phase. This is fundamentally a longitudinal maneuver, so we can concentrate on longitudinal dynamics and control.

The Approach and Landing Task

The basic technique for landing the shuttle as a glider was evolved over many years of experimentation with lifting body research aircraft. The maneuver basically consists of a steep outer glide followed by a pullup to a shallow inner glide slope.

Figure 2(a) shows a nominal trajectory for the orbiter approach and landing based on considerations of flight mechanics (ref. 14) and autoland system design data (ref. 15). Actual trajectories vary, depending on local conditions, pilot technique, and disturbances, etc.

The approach and landing phase begins with capture of the steep glide slope shortly after leveling the wings following the HAC turn — nominally at 15,000-ft altitude and approximately 40,000 ft from the runway threshold. The primary purpose of the steep glide slope is to set up and stabilize the vehicle to a constant equivalent airspeed (i.e., constant dynamic pressure). The steep flightpath angle is selected such that the gravity component balances the drag. Precise control of airspeed is then achieved through modulation of the speed brakes. Figure 2(b) shows a nominal airspeed variation. While the equivalent airspeed remains essentially constant during the equilibrium glide, true airspeed decreases because of variation of atmospheric density with altitude (ref. 14). Thus, adjustment of the airspeed on the outer glide slope with modulation of the speed brakes is the final major energy management operation before touchdown. At the end of the steep glide, the speed brakes are fixed, and no further active energy management is performed.

At an altitude of approximately 1700 ft, a preflare pullup maneuver is initiated which “circularizes” the trajectory. The pullup is terminated when the flightpath angle matches that for the shallow glide slope, nominally -1.5° . Speed change during the preflare pullup is slow until the flightpath angle departs significantly from the equilibrium value; therefore, the pullup may be considered a constant speed (either equivalent or true airspeed since the altitude change is small) maneuver to a first approximation.

Shallow Glide and Final Flare

In principle, the preflare pullup is followed by the $\gamma = -1.5^\circ$ shallow glide on the inner glide slope down to a final flare for touchdown. During the shallow glide the orbiter decelerates at a roughly constant $1/3$ to $1/4 g$, as indicated in figure 2(b). The shallow glide and final flare phase has been the focus of the greatest controversy concerning shuttle longitudinal FCS design, FQ, and design criteria. Further, there has been considerable variation in pilot technique for this maneuver. (For details of the flight mechanics, see references 7 or 14.)

Strictly speaking, the orbiter dynamics are time varying in the shallow glide. However, the variations in pitch and path response poles and zeros are small, and the scheduling of the FCS gains is such as to offset the time-varying effects, at least in the dominant mode. The effective vehicle dynamics as seen by the pilot are those of a rate-command, attitude-hold (RCAH) character. The pitching velocity per rotational hand controller response is shown in figure 3. In addition, the flightpath lag time constant, T_{θ_2} , is approximately 2 sec. The primary impact on pilot technique of the shuttle being a decelerating glider (rather than a conventional transport aircraft), is that the pilot has a finite time window in which to touch down to avoid exceeding maximum or minimum touchdown speed limits. Operational experience indicates that while this constraint exists for the shuttle in contrast to conventional aircraft, it is not restrictive enough to have caused problems that cannot be overcome by pilot training and skill.

Ground Aids for Flightpath Control

Ground aids for manual control of approach and landing have been steadily improved as the program progressed (ref. 16). For the first few flights, the principal ground aids consisted of steep and shallow glide aim markers on the dry lakebed at Edwards Air Force Base. Two aim markers were provided for the steep glide, one at 7500 ft before the runway threshold for nominal energy approaches and one at 6500 ft in case the shuttle should be at a low energy level. The shallow glide slope aim point is 1000 ft beyond the runway threshold.

An additional ground aid for the latter portion of the preflare pullup and shallow glide was then added (fig. 4). This consisted of a cluster of high-intensity white lights mounted on a pole on the left side of the runway near the runway threshold and a row of similar red lights, also on the left side but perpendicular to the runway at the shallow glide aim point. The height of the pole was selected so that a 1.5° glide slope is defined when the white light is superimposed on the red row of lights. This is called the ball-bar aid and is similar in function to the Fresnel lens optical landing aid employed on aircraft carriers.

With this ball-bar system, if the white ball appears to be below the red bar, the vehicle is high or on a steeper glide. If the ball is above the bar, the vehicle is below the desired 1.5° glide slope. Thus, this system provides a reference to guide the pilot to the correct termination of the preflare maneuver and to maintain the proper shallow glide in manually controlled flight. It would also provide a means of monitoring guidance and control performance for fully automatic landings.

Another ground-based optical aid for the steep glide slope was added following Mission 5. This consists of red and white high-intensity lights located at the steep glide aim point. These are aimed upward at differing angles such that specific glide slopes are defined by the number of red and white lights visible. This is called the precision approach path indicator (PAPI) and is represented in figure 5. The aircraft is on the correct 19° steep glide path when the crew can see two white and two red lights.

Cockpit Display Aids

A primary change in the orbiter vehicle occurred for STS-6 and STS-7 in which the flight-test vehicle, Columbia, was replaced by the operational vehicle, Challenger. Although there were no significant FCS changes affecting the final approach and landing, the Challenger introduced the head-up display (HUD).

For the first five landings, the principal onboard longitudinal path and energy references were head-down instruments: a flightpath flight director and airspeed and altimeter indicators for the steep glide phase (energy management setup), a pitch rate Q indicator and g -meter for preflare, and airspeed and altitude indicators for shallow glide and final flare. These were supported by pitch attitude display for inner loop control and out-the-window ground aim point references for path guidance.

One originally intended use of the HUD was as an adjunct to the autoland system. The HUD was to provide an initial check on guidance system accuracy at this terminal phase, to inform the crew when the approach path variables were within tolerances for engagement of the autoland, and then to help monitor performance of the autoland through approach and landing to flare (ref. 17). The HUD (fig. 6(a)) provided a computer-generated runway symbol which initially informs the crew that the guidance computer speed, distance, and so forth are good by way of the runway symbol being superimposed over the actual runway. A runway-extended centerline with an outer glide slope (OGS) aim point was also presented.

Other information displayed included velocity vector, flightpath angle reference, altitude, airspeed, speedbrake command and actual position, and the pitch-and-roll ladder (fig. 6(a)). This configuration provides so much information that declutter provisions were included for STS-8 and future flights

(ref. 16) to allow elimination of undesired or unnecessary data and symbology clutter as various phases of approach and landing are completed.

The symbology configuration of figure 6(a) would now be selected upon exiting the HAC for getting set up on the OGS path. Figure 6(a) depicts the vehicle approaching the OGS. When actually on the OGS aimpoint, the velocity vector symbol and PAPI light (out the window) would be superimposed and bracketed by the glide slope reference markers. The first declutter would then be selected to remove the runway symbology. This reduces the display to that of figure 6(b).

Just before preflare (1850-ft altitude) a second set of path reference markers comes into play and moves up from the bottom of the display. When these reach the OGS reference, it signals the start of preflare. One set of path markers then continues to move up while the second set disappears (ref. 17). This signifies the proper altitude and airspeed to initiate transition. The pilot then flies the velocity vector symbol to the path reference markers as they continue to move up the display. Preflare ends when the markers stop moving. The velocity vector should then be directed at the close end of the runway or between the close end and the shallow glide aim point. At this juncture, the shallow glide ground aid should also signify a 1.5° glide slope. The pilot should then accomplish a second declutter (fig. 6(c)) and keep the velocity vector symbol and ground glide slope reference steady until reaching the desired flare altitude.

As a result of these various ground and onboard landing aids becoming operational with successive flights, the control strategies (path control loop structure, gains, and so on), and hence workload, for preflare and shallow glide have varied somewhat from flight to flight. Path and landing performance have come closer to ideal or target values and become more uniform with each flight. Only the final flare has remained essentially the same unaided task for all landings. (An exception is HUD direct display of altitude and airspeed information on STS-6 and STS-7 in place of verbal callouts on previous flights.)

Variants of the ground aids and HUD features previously described would appear to be directly suitable for NASP. An internally generated display equivalent to the ground aids should be a useful surrogate if there is no external view from the cockpit.

Examples of Orbiter Landing Performance and Pilot-Control Characteristics

Landing Performances

Values of touchdown sink rate at the nose \dot{H}_{TD} , speed, V_{TD} , and glide and flare distance, X_T , derived from the STS-2 through STS-7 cinetheodolite data are summarized in reference 7. The distance is measured from the assumed end of preflare as identified from hodographs of \dot{H} as a function of H . In addition, touchdown sink rate at the nose was translated to the main gear based on vehicle geometry and pitch rate. Main gear sink rate, vehicle speed, and glide distance at touchdown are plotted in bar chart form in figure 7 for STS-2 through STS-7 landings. Various nominal values based on early autoland design goals (ref. 15) are also given. These do not necessarily reflect the latest shuttle mission policies, and more importantly, they do not necessarily drive the pilots who have their own internal criteria. However, they provide a consistent representative set for comparison.

The touchdown sink rate summary in figure 7(a) indicates that all landings were well within the 6 ft/sec (crosswind, table 4, ref. 7) sink rate limit, and only the STS-3 landing exceeded the assumed nominal region. However, that landing could have exceeded the 6 ft/sec limit if the vehicle had touched down about 1 sec earlier. All of the other landings have sink rates below 1.5 ft/sec, and tend to indicate a target value close to 1 ft/sec. Indeed, a major conclusion to be derived from the data is that the touchdown sink rate, when STS-3 is excluded, is remarkably uniform for all flights — mean $\dot{H}_{TD} \doteq 0.86$ ft/sec with a standard deviation of 0.38 ft/sec — and differs markedly from the autoland-based nominal.

The touchdown speed summary in figure 7(b) shows that the 225-kn touchdown speed limit was exceeded only in the STS-3 landing. Three flights were slightly higher and two slightly lower than the nominal 195 kn. One standard deviation in the achieved touchdown speed is less than the 30-kn difference between the upper limit and nominal V_{TD} values. If STS-3 is again excluded, the mean $V_{TD} \doteq 197$ kn/sec with a standard deviation of 13.3 kn.

Figure 7(c) compares the total distance traveled from the end of the preflare pullup (as identified in the hodographs) to touchdown. Establishing absolute constraints for distance is more difficult than for \dot{H}_{TD} and V_{TD} , since reference must be made to the runway threshold. Further, the effective distance constraints certainly vary more among the flights, especially between dry lakebed and runway landings.

The STS-2 was known to be low on energy, and this is reflected in both V_{TD} and X_T . Despite this (and with the exception of STS-3), touchdown performance is quite consistent and adequate with respect to the nominal goals. When it is recognized that this performance is attainable with either precognitive or tight closed-loop control of sink rate, this implies excellent and flexible performance for the pilot-vehicle system.

The data of figure 7 also tend to indicate that the highest importance is being attached to touchdown sink rate with touchdown velocity also being weighted heavily. The latter is consistent with reference 13, in which it was stated that the difficulty of runway landings was reduced by setting V_{TD} rather than X_{TD} criteria.

Pilot-Control Strategies

Ideal Characteristics—In the approach and landing task, the preflare, shallow approach, and flare are nominally individual segments which may involve different pilot control loop structures. The preflare is ideally a constant pitch rate maneuver. The orbiter effective vehicle dynamics exhibit a pitch RCH response (fig. 3), so pilot actuation of the rotational hand controller (RHC) directly commands vehicle pitch rate. During this flight segment, one would expect the time traces to show relatively constant RHC deflection, pitch rate, and normal acceleration.

For the shallow glide portion, the control task is more complicated in that pitch control becomes an inner loop to sink rate or flightpath control. The approximate short-term (quasi-steady speed) path to attitude transfer function is

$$\frac{\dot{H}}{\theta} = \frac{sN_{\delta}^h}{N_{\delta}^{\theta}} \doteq \frac{U_o}{(T_{\theta_2} s + 1)} \quad (1)$$

where the orbiter flightpath lag T_{θ_2} is about 2.0 sec.

The shallow glide and final flare control strategy may be identified from the altitude–sink rate phase plane (hodograph) shown hypothetically in figure 8. If the shallow glide region has a constant flightpath angle (γ_0), the phase plane trajectory will be a straight sloping line. If the sink rate is constant, the glide trajectory will be horizontal. In the final flare region, if sink rate is scheduled proportional to altitude (an exponential flare), the phase plane is a straight line with slope $-1/T_f$. The slope reflects the relative weighting given to arresting sink rate as altitude decreases and, therefore, can vary significantly. If any other relationship is employed, the flare phase plane will be curved.

Perhaps the easiest strategy for the final flare is to change pitch attitude in a stepwise manner, and let sink rate decay with the open-loop, 2-sec T_{θ_2} time constant noted in the previous figure. If sink rate should be controlled in a closed-loop manner as a function of altitude, flare response time constants greater than T_{θ_2} will result. Detection of either of these two path control strategies should be evident from the pilot's RHC inputs and by the flare time constant obtained from the hodograph, i.e., $T_f \doteq T_{\theta_2}$, and little or no RHC activity in the final seconds of the flare indicates precognitive control of sink rate; whereas a $T_f \neq T_{\theta_2}$ implies closed-loop piloted control of sink rate. Interpretation of the hodographs will be considered further in the following subsection.

Example Time Histories and Hodographs—To provide examples of limiting case strategies, time traces and altitude–sink rate hodographs for the STS-6 and STS-7 landings are presented in figures 9 through 12. The RHC, pitch rate, and normal acceleration time traces are from the modified maximum likelihood estimates (MMLE) database (ref. 18). Altitude and vertical speed are from the cinetheodolite database. The figures which contain only H , \dot{H} , and hydrograph plots are expanded scale data which cover only the final 10 to 15 sec of the landing. This generally includes the portion of flight which would encompass the end of preflare, shallow glide, and final flare, if such segments are identifiable. It should be noted in the hodographs that the altitude reference point (orbiter nose) is set to zero ground level at the touchdown point (to remove the 20- to 30-ft nose altitude biases seen in the altitude time histories). Similar data and detailed analyses for STS-2 through STS-7 are provided in reference 7.

The STS-6 flight landed on the runway at Edwards with the aid of the PAPI lights, ball–bar system, and HUD. It is relatively easy to identify preflare, shallow glide, and final flare in the time traces of figure 9. The preflare shows nearly steady average values of Q and δ_{RHC} with a neutrally damped pitch and δ_{RHC} oscillation developing near the end. There is then a distinct transition to pulse-type control for the shallow glide slope and landing. Essentially no RHC activity occurred for the last 5 sec prior to touchdown.

The time histories and hodograph of figure 10 also show very distinct segments for this landing. The shallow glide is held quite precisely at -10 ft/sec until final flare, which is initiated at a nose altitude of about 50 ft. The final flare is almost an ideal exponential with a time constant of 2 to 2.42 sec. In fact, this hodograph exhibits all the features of the idealized figure 8. The flare time constant, relative lack of RHC activity in the last few seconds, and nearly constant pitch attitude of figure 13 indicate that the pilot is behaving primarily as a precognitive or pursuit (largely open-loop) controller (ref. 8).

Flight STS-7 was diverted from landing at Kennedy Space Center to the dry lakebed at Edwards. The PAPI and ball–bar ground aids were available, and it was the second landing with the HUD. The

time traces of figure 11 show a gradual change in RHC activity from continuous rate command to a 3-cycle PIO (at about 4.2 rad/sec) and finally to the distinctly pulsatile type nearly continuous control. Thus, there is little to distinguish separate path segments. The time histories and hodograph of figure 12 provide additional clues to indicate a possible transition between (0) and (f) from the preflare to an apparent final flare. There is a large nose-up pulse which produces a hesitation at a sink rate of about -12 ft/sec and suggests start of shallow glide, but this is followed immediately by a flare with a time constant of 4.6 sec. Since this landing is on the dry lakebed where there is little concern for touchdown point and landing roll, it appears that the pilot was concentrating on achieving a specific touchdown sink rate (and possibly speed). The lightly damped path oscillation at about 2.3 rad/sec (also discernible in the Q of figure 11) and the rapid RHC pulsing suggests a rather tightly closed sink rate loop which results in an almost neutrally stable path mode. This terminal RHC activity and the $T_f \doteq 4.6$ sec flare time constant make it clear that the pilot was able to maintain sink rate proportional to altitude and was in closed-loop control throughout the flare. Interestingly, the neutrally damped closed-loop attitude and path modes demonstrated here are very close to those predicted in the analysis of reference 19.

These discussions for STS-6 and STS-7 concerning the landing hodograph shapes, flare time constants, etc., serve to illustrate two distinctly different pilot control flare techniques. An exponential flare is the only elementary strategy which produces a distinctly straight flare hodograph over a range of conditions with a flare time constant that can be other than T_{θ_2} . However, for sufficiently low altitude flares, open-loop "step θ " strategies will also approach straight-line hodographs with an indicated flare time constant close to T_{θ_2} (ref. 7 and fig. 14). By considering the effective flare time constant in conjunction with the amount of RHC activity, it has been possible to distinguish landings which appear to be largely precognitive from those which are largely closed loop. In the reference 7 examination of STS-2 to STS-7, the STS-5 and STS-6 landings appeared most strongly precognitive. They showed little RHC activity after flare initiation and flare time constants approaching $T_{\theta_2} \doteq 2$ sec. The four other landings showed more evidence of closed-loop control in flare. As seen above, STS-7 in particular showed distinct characteristics of a closed-loop exponential flare ($\dot{H} \propto H$) with continuous RHC activity and a flare time constant ($T_f = 4.6$ sec) much larger than T_{θ_2} .

Examination of pitch attitude time traces for these landings (fig. 13) further reinforces these conclusions. The step attitude change to initiate both shallow glide and final flare is apparent for STS-5 and STS-6, whereas a continuous, essentially exponential, change in pitch for flare is seen in STS-7. The trace for STS-4 reflects almost a doubled attitude change to initiate shallow glide, but this is then followed by a series of small-step pitch changes. In all cases, however, the final pitch attitude target appears to be about 8° , since this attitude is achieved some 3-4 sec prior to touchdown and then held constant until touchdown.

Approach and Landing Flying Qualities of the Shuttle Orbiter Based on Early Flights

The detailed studies of shuttle orbiter FQ reported in reference 7 resulted in a variety of conclusions which can be summarized as follows:

Pilot Control Strategy and Overall Performance

- Two basic flare strategies dominated the landings examined:
 - a precognitive step θ , or
 - closed-loop pilot operations making $\dot{H} \propto H$ or θ .
- Both strategies require precise control of the inner θ loop to achieve the desired path control.
- There is evidence (because of near PIO situations) that the pilots may be pushing the pitch response bandwidth limits.
 - Landing performance metrics show remarkably consistent touchdown values for sink rate, forward velocity, and distance from threshold despite widely varying conditions at the beginning of the shallow glide or flare initiation.
 - All landings met or exceeded reasonable touchdown performance goals regardless of visual aids.
 - Shallow glide and touchdown performance improved as path visual aids (ground based and HUD) were introduced to provide more information.

Flying Quality Dynamic Characteristics

(Note: These conclusions are not all covered in preceding discussions, but come in part from the referenced material.)

- The effective airplane pitch control bandwidth (1.3 rad/sec) is marginal at best (ref. 7, sec. V).
- The effective time delay, 0.15+ sec, is excessive for the two-step decelerating approach and landing (ref. 7, sec. V).
- The path time constant, 2 sec, is marginal (ref. 7, sec. V).
- The instantaneous center of rotation location with respect to the pilot is not located to minimize apparent path mode reversal or time lag response to flare commands (ref. 7, sec. V).
 - In pitch RCAH flight-control systems, the lead time constant, T_q , is not necessarily equal to the airplane's path control lag, T_{θ_2} . When $T_q < T_{\theta_2}$ a lag-lead is introduced into the transfer function relating path angle to pilot input. The path response to step elevon commands will exhibit an extra net lag, and this lag may also affect the pilot's impressions in closed-loop control (ref. 7, fig. 86).
 - The most desirable effective vehicle dynamics for the flare task, e.g., RCAH (actual orbiter system) or ACAH, are still to be determined (ref. 7, sec. 4B).

To some extent, the first group of conclusions may appear to contradict the second because adequate performance was always achieved in the landing task. Of course, the pilots were well trained (e.g., in the shuttle training aircraft) and highly experienced. Nonetheless, workload was very high on some landings, and, on most, the pilot activities in some closed-loop control phases pushed the pilot-vehicle

system to near limit values (e.g., the near-PIO conditions noted above). Although no PRs based on actual shuttle flights are available, it is clear that adequate performance does require considerable pilot compensation. Consequently, based on the excellent task performance, the apparent workload and high gain pilot activity, and a strict interpretation of the Cooper-Harper scale, the overall vehicle FQ would appear to be about 4 to 5.

TENTATIVE RECOMMENDATIONS FOR APPROACH AND LANDING FLYING QUALITIES FOR NATIONAL AERO-SPACE PLANE

The reference 7 study emphasized early shuttle landings and other data available before 1985. Since then many studies, both analytical and experimental, have been reported which bear on the questions left over from the conclusions previously cited. They also provide additional data and interpretations which are relevant to NASP. Some of this interpretive work is still going on as part of the NASP technology maturation effort. Enough has been accomplished, however, to provide some preliminary thoughts on possible FQ criteria for NASP based on both the earlier and subsequent studies and experiments. These will be addressed here as a snapshot report on work in progress. The emphasis will be on tentative criteria only, with the detailed technical backup to appear later. We should note, however, that the data, considerations, and interpretations in references 7 and 20 through 27 have entered into the formulation of the tentative criteria.

Summary

Good flying qualities for approach and landing depend on the selection of a proper response type, and the achievement of dynamic characteristics which fall in the desirable region of certain defined FQ criteria. The concept of response type has been developed to quantify the generic output and input characteristics of the aircraft plus flight-control system (ref. 22). Several response types applicable to the flared landing task include rate command, attitude hold; attitude command, attitude hold; and flightpath command, flightpath hold. Experience has shown that the following factors must be considered to achieve desirable approach and landing FQ for the flared landing task.

1. Precision control of pitch attitude.
2. Precision control of flightpath angle.
3. Consonance between flightpath angle and pitch attitude.
4. Proper control sensitivity.
5. Sufficient authority to change the flightpath with pitch attitude and with adequate margin for disturbances and pilot error.

As described in reference 22 and many previous papers, the aircraft bandwidth ω_{BW} and phase delay parameter τ_p are useful metrics to codify and predict FQ for tasks where small amplitude, precision, closed-loop tracking, or regulation is a primary requirement on the pilot-vehicle system. These quantities are defined for the case of airplane pitch response to elevator in figure 14. The 45°-phase margin

(-135° phase angle) point is usually the operative value, although the gain margin basis is occasionally needed. The bandwidth for path angle–elevator is defined using only the phase, since there is no long horizontal shelf in the amplitude ratio. (To avoid any possible confusion we should note that aircraft bandwidth differs somewhat from the control or communication engineers’ definition, i.e., the bandwidth of a low-pass system’s frequency response is the frequency at which the output/input amplitude ratio is 3 dB less than that of very low frequencies.) The airplane bandwidth is a meaningful indicator of closed-loop pilot–vehicle system dynamic performance potential in that it provides an indication of the maximum crossover frequency that a pure gain pilot can achieve with a reasonable stability margin. One major advantage of airplane bandwidth and phase delay metrics is that they correlate PR data from a large number of experiments better than other existing measures. That is, they can be used to define fairly clear and inclusive bounds on regions of data with PR which correspond to $1 < PR < 3-1/2$, $3-1/2 < PR < 6-1/2$, and $PR > 6-1/2$: the classical FQ Levels 1, 2, and 3, respectively.

With these definitions understood, we turn now to the listed factors and their associated tentative requirements. For precision pitch attitude control, the criterion shown in figure 15 is proposed. The shuttle characteristics from figure 3 are spotted on figure 15, indicating a clear cut Level 2 situation from this standpoint.

The figure 16 tentative criterion is intended to satisfy the requirements for precision flightpath control and attitude–flightpath consonance. The flightpath bandwidth for the shuttle is $\omega_{BW\gamma} = 0.4$ rad/sec. This reflects the additional lag caused by the $(1/T_q)/(1/T_{\theta_2}) = (1.5)/(0.5)$ dipole introduced by the FCS and described in reference 7. If the control system lead is adjusted to cancel the flightpath lag (as is done with the X-29 RCAH system), and it is assumed that the other characteristics are unchanged thereby, the flightpath bandwidth would be increased to $\omega_{BW\gamma} = 0.73$ rad/sec. Both values are spotted on figure 16. Both points are well outside the acceptable region. This is supplemented by the following criterion which is intended to ensure that the flightpath angle can be sufficiently modified with pitch attitude to accomplish the flare:

$$\frac{\Delta\gamma_{max}}{\Delta\theta_{ss}} \geq 0.7 \quad (2)$$

This criterion is based on in-flight landing studies conducted at NASA Ames Research Center (ref. 24).

There are no currently available criteria to ensure that the control sensitivity is satisfactory. Therefore, the control sensitivity must be experimentally optimized, preferably in a flight environment. In-flight simulation can be effective in this regard if the manipulator characteristics available are easily varied and sufficiently representative of the actual aircraft being simulated.

The criteria proposed above are based on analysis of the precision flared landing data in references 23 through 25, as are the following conclusions (also see ref. 22):

- The best response type for flare and landing is ACAH.
- The RCAH response type can yield desirable FQ for flare and landing, as long as the flightpath bandwidth meets the criterion in figure 16.

- The pitch attitude bandwidth and phase-delay parameters should fall within the Level 1 region noted in figure 15. There is some evidence that the minimum bandwidth can be reduced to 1.4 rad/sec for an ACAH response type (ref. 23).
- If an RCAH response type is employed, the dropback parameter defined in figure 17 should not exceed the limits shown. This is a requirement for good open loop and pursuit control.
- Airspeed control is more likely to be a problem for the RCAH response type than for ACAH or conventional airplanes.

Reference 24 reports the results of a study of flared landings for transport airplanes conducted on the USAF/Calspan Total Inflight Simulator (TIFS) in 1984. The results of a more recent (1986) TIFS flared landing experiment (ref. 25) are in general agreement with the reference 24 data, with some exceptions which are discussed later.

Consider now the question of response types. The shuttle orbiter and several other superaugmented aircraft (e.g., F-16 and X-29) have used RCAH systems with success. The shuttle FQ in approach and landing, as amply discussed above, could be significantly improved if the characteristics were modified to the Level 1 areas of the tentative criteria given here.

At this stage of its development, the NASP vehicle management systems have a great deal of possible flexibility so other kinds of response types should be considered seriously. Some of the advantages and disadvantages of three response types for the NASP approach and landing are summarized in table 3. A noted disadvantage of the RCAH response type is that additional feedbacks may be required if $1/T_{\theta_2}$ is low. This is not intuitively obvious, and is based on the fact that $1/T_q$ must be approximately equal to $1/T_{\theta_2}$ for good dynamics, and the ω' pole circles $1/T_q$. It can, therefore, be seen that if $1/T_{\theta_2}$ is low, $1/T_q$ must also be small, and increased values of ω' can only be achieved by way of some other feedback, such as normal acceleration.

Task-tailored controls, adjusted to optimize response type and FQ characteristics for each given mission phase, can easily be provided with existing technology. There is, however, the extremely important issue of transition between response types to make up the total mission-based system. This is a key factor in the selection of the proper FCS architecture.

Dynamic Response Considerations

Definitions of Response Types

The response types are defined in terms of the generic output–input relationships of an augmented or unaugmented airplane. The generic characteristics of the response types that were tested in references 23 to 25 are shown in figure 18. The fundamental properties of each of these response types are summarized in the following:

- Conventional airplane
 - Characteristic phugoid and short period modes which are well separated. Phugoid typically (but not necessarily) lightly damped.

- Flightpath frequency response is K/s from the phugoid mode to the short period mode.
 - Time response of pitch attitude increases monotonically to a step controller input in the short term (above phugoid frequency), and returns to trim when the control force is released.
- RCAH
 - Phugoid dynamics are eliminated
 - Attitude numerator defined by the controller lead $1/T_q$ instead of $1/T_{\theta_2}$.
 - Flightpath frequency response is K/s^2 between $1/T_{\theta_2}$ and $1/T_q$, when $1/T_q \gg 1/T_{\theta_2}$.
 - Time response of pitch attitude increases monotonically to a step controller input, and holds attitude at point of release.
 - ACAH
 - Attitude response is proportional to controller input with some lag (defined by ω' in fig. 18).
 - Steady flightpath change is proportional to controller input with lag defined by $1/T_{\theta_2}$.
 - Time response of pitch attitude to a step controller input is a constant attitude, which returns to trim when input is removed.

Characteristics and Limitations of Rate Command, Attitude Hold

Flightpath Control—The RCAH response type is most commonly mechanized using the loop structure shown in figure 19. The generic characteristics of the frequency response of the RCAH response type are shown for $1/T_q \gg 1/T_{\theta_2}$ in figure 18(b). The resulting region of K/s^2 (between $1/T_q$ and $1/T_{\theta_2}$) is undesirable for closed loop control. This region can be avoided by setting $1/T_q$ approximately equal to $1/T_{\theta_2}$, or by an alternative control system architecture to achieve a different response type. For example, the ACAH response type in figure 18(c) is seen to have an improved flightpath frequency response, i.e., there is no possibility for a K/s^2 slope and there are no low-frequency dynamics.

The existence of a long stretch of K/s^2 in the RCAH flightpath frequency response leads to a loss in phase margin, which is quantifiable by the bandwidth criterion, i.e., $\omega_{BW\gamma}$. As will be shown, a flightpath bandwidth of less than 0.6 rad/sec is a good indicator of poor FQ for the precision flare. Poor flightpath bandwidth can be improved, to a limited extent, by increased pitch-rate overshoot. This is accomplished by increasing the flat region of the attitude Bode plot between $1/T_q$ and ω' by further augmenting ω' to higher frequency. Experience has shown that excessive pitch-rate overshoot results in pilot complaints related to overly abrupt attitude control. The alternative is to use an additional control surface for direct lift control (DLC) to augment the flightpath response. This can also be overdone, which is the reason for the upper boundary of the figure 16 criterion. Configurations that fall above that boundary tend to receive pilot commentary related to poor consonance between pitch attitude and flightpath. This is discussed in further detail in the next subsection.

Pitch Attitude–Flightpath Consonance—The desired relationship between pitch attitude and flightpath angle has been the subject of considerable research. For example, reference 23 suggests the following limits on $1/T_{\theta_{2eff}}$:

$$0.38\omega' \leq (1/T_{\theta_{2eff}}) \leq 0.77\omega' \quad (3)$$

where $1/T_{\theta_{2\text{eff}}}$ is defined as the frequency where the flightpath response lags the pitch attitude response by 45° . The lower limit defines the maximum tolerable lag between pitch and path, whereas the upper limit represents a need for the flightpath to lag pitch attitude by some amount. The PR results from fixed-base simulations do not identify this upper limit, so it appears to be a motion induced limitation. The above criterion is based on flight-test results obtained by Deutsche Luftund Raumfahrt (DLR) using an HFB-320 in-flight simulator (ref. 26). The TIFS flared landing experiment conducted in 1986 (ref. 25) provides additional data regarding attitude-path consonance, since a number of the configurations were representative of aircraft with a DLC surface located forward of the tail (e.g., a canard or a DLC flap).¹ The upper boundary of the figure 16 criterion is based on that data, and has been found to be a better criterion than the upper limit on $1/T_{\theta_{2\text{eff}}}$ for the approach and landing task.

Airspeed Control—The nature of the RCAH response type is that it remains at approximately the attitude that exists when the cockpit controller input is removed (e.g., see figure 18(b)). As a result no trimming is required to change airspeed, and there are no tactile cues (i.e., force) to warn the pilot that the trim airspeed is not met. Therefore, airspeed changes that occur because of inadvertent pilot inputs, can only be detected by pilot visual scanning of the airspeed indicator. Experience has shown that this can be both an asset and a liability; it is convenient to make airspeed changes without having to retrim, but there is an increased possibility of inadvertent low airspeed excursions during periods of divided attention. An analysis of the data in the reference 25 experiments indicated that the pilot ratings for RCAH cases in the Level 1 regions of the figures 15 and 16 criteria showed some variability which could be traced to airspeed control problems in all but one case. A typical scenario for a configuration in the Level 1 region with some ratings worse than 3 was that most of the pilots rated the configuration as Level 1, whereas one or two pilots gave it a poor rating. In all but one case, those pilots who gave the poor rating complained of airspeed control problems, and those who rated the configuration as Level 1 did not. This never occurred with the conventional airplane or ACAH response types, where airspeed changes can be sensed by tactile force cues. For unpowered approaches, such as used on the shuttle, the constant deceleration during the final shallow approach segment would dictate a response type that would not require retrimming with changes in airspeed. This would rule out the conventional airplane response type, but not RCAH, ACAH, and FCFH.

Characteristics and Limitations of Attitude Command, Attitude Hold Response Type and Flightpath Command, Flightpath Hold Response Type

Attitude Command, Attitude Hold—The ACAH response type has some advantages and disadvantages which are summarized below.

- Advantages
 - The attitude response is very stable.
 - The flightpath response is also very stable, i.e., it is a pure gain below $1/T_{\theta_2}$ and K/s between $1/T_{\theta_2}$ and ω' .

¹The flightpath numerators of some configurations were consistent with DLC. Of course, with the TIFS, the flightpath response of all configurations was modified with the DLC flaps. DLC configurations are defined when the flightpath response is more rapid than would occur with the simulated value of $1/T_{\theta_2}$.

- Pitch attitude will always return to trim following a disturbance (inadvertent control input or a gust). Therefore, the aircraft tends to remain at its trim airspeed for constant airspeed approaches and at its trim attitude for a decelerating approach.
 - Increasing back pressure on the cockpit controller is required in the flare, a feature which is liked by pilots.
- Disadvantages
 - It is necessary to use a separate (trim) control to achieve a change in the equilibrium attitude or airspeed. This results in high pilot workload if the task requires large or frequent changes in the trim attitude. Note that the conventional airplane response type does not require retrimming if airspeed is held constant with power or a drag modulation device.
 - The ideal control sensitivities for precision attitude control result in attitude changes less than 20° at full cockpit control deflection. As a result, ACAH is perceived as being nonagile.

The TIFS flight-test experiments reported in references 24 and 25 indicate that pilots favored the ACAH response type for the precision flare and landing task. However, if ACAH is contemplated for an unpowered landing similar to the shuttle, the large trim change required at the transition between the steep and shallow glide path would probably offset this advantage.

Flightpath Command, Flightpath Hold (FCFH)—This response type has not been tested as extensively as RCAH and ACAH, but offers some potentially advantageous characteristics. The FCFH will have all the advantages of ACAH, and the aircraft will maintain its commanded flightpath in the presence of atmospheric gusts and wind shears with FCFH. However, FCFH will sacrifice airspeed control to hold flightpath unless a separate airspeed controller (thrust or drag modulation) is implemented. Actual piloted simulation or flight test is required to better understand the pros and cons of this response type.

Supporting Data

The figures 15 and 16 criteria are based on data for precision flared landings, i.e., refs. 23 through 25. Reference 24 reports the results of a study of flared landings for transport airplanes conducted on the USAF/Calspan Total Inflight Simulator (TIFS) in 1984. The results of a more recent (1986) flared landing experiment (ref. 25) are in general agreement with the reference 24 data with some exceptions, which are noted in the following discussions.

Flightpath and Attitude Bandwidth

The bandwidth criterion was developed as a generally applicable method to predict FQ for tasks in which small amplitude, precision, closed-loop tracking is a primary requirement. It is based on the crossover model developed in the early 1960s. The criterion is based on the premise that the maximum crossover frequency that a pure gain pilot can achieve without threatening stability is a valid figure of merit of the precision of control. On this basis, airplane attitude bandwidth is defined as the frequency in which the phase margin is 45° or the gain margin is less than 6 dB, as shown in figure 20. For precision landings, the pilot must be able to easily exercise precise control over both attitude and flightpath.

Therefore, we would expect to find that the pilot ratings would correlate with the bandwidth of pitch attitude and flightpath. The references 24 and 25 data are plotted on a grid of flightpath bandwidth as a function of pitch attitude bandwidth (to longitudinal cockpit controller position) in figure 21. The following observations are made regarding the data and boundaries in figure 21.

- The lower boundary on flightpath bandwidth is based on the analytically derived need for a K/s flightpath response. The numerical limit ($\omega_{BW\gamma} \geq 0.60$ rad/sec) is based on configurations 1-1-1, 6-1-1, and 8-3-5-1. (The apparent PR discrepancy between configurations 1-2-2 and 17 are discussed in the following.)

- The lower boundary on attitude bandwidth ($\omega_{BW\gamma} \geq 1.8$ rad/sec) is based primarily on configurations 5-2-2 and 8-1-5, both RCAH response types. A lower limit of approximately 1.4 rad/sec could be justified for the ACAH response type, based on configurations 8-3-5-1 and 8-2-5-1.

- The upper boundary on flightpath bandwidth is based on a need for some lag between pitch attitude and flightpath. The numerical limit is based on configurations 3, 5, 7, and 9, all RCAH response types. Configuration 1 falls above the boundary, is rated consistently Level 1 (4 pilots), and is an ACAH response type. Again, the ACAH response type appears to be more robust than RCAH.

- While a large majority of the PRs inside the figure 21 boundaries are Level 1, there are some Level 2 ratings. A review of the pilot commentary associated with all such rating points indicated that in nearly all cases, the pilot complained of airspeed control problems and the response type was RCAH.

- The figure 21 upper boundary has been found to correlate the reference 25 TIFS data better than the $1/T_{\theta_{2eff}}$ upper limit noted above, for the flared landing task (ref. 23).

Configurations 1-2-2 and 17 were intended to be identical (according to ref. 25), forming a link between the 1984 and 1986 experiments. As shown in figure 21, they are close in terms of flightpath and attitude bandwidth (albeit configuration 1-2-2 has a slightly lower attitude bandwidth). However, the PRs are seen to be consistently much worse for configuration 1-2-2 than for configuration 17. The pilot commentary supports the ratings in all cases, and does not offer a clue as to the source of this significant discrepancy. One pilot who flew configuration 1-2-2 on two occasions and 17 on one occasion was contacted but could not recall anything which would provide any insight. Given the consistency of the ratings and commentary within each of the respective experiments and the fact that the tasks were identical, it must be assumed that one configuration had a response characteristic which was not properly identified. Therefore, we have chosen to ignore both configurations in the analysis of the data. Configuration 17L/L was identical to 4-1-1 and the ratings were similar, so the problem is considered to be local rather than global between the two experiments. The flightpath bandwidth boundary at 0.60 rad/sec implicitly assumes that configuration 17 is correct.

As noted above, the Level 2 PR in the Level 1 region of figure 21 tends to be associated with airspeed control problems of an RCAH response type. The issue of airspeed control for RCAH has been under debate for a long time, and it centers about inadvertent airspeed excursions caused by pilot inattention (i.e., an inadequate scan). Such excursions would be caused by inadvertent pilot control inputs, since the attitude hold feature would handle gust upsets. Since division of attention is highly dependent on a large number of variables, it would be expected that the PR would be somewhat

unpredictable, and they are. In this context, the following conclusions can be drawn regarding the use of the RCAH response type for landing:

- Level 1 ratings are possible with RCAH, but require an efficient scan of airspeed.
- Airspeed control problems associated with RCAH are considered more important to some pilots than to others.
- Airspeed control problems are less of a problem with conventional or ACAH response types.

Pitch Attitude Bandwidth and Phase Delay

The data supporting the bandwidth-phase-delay boundaries in figure 15 are taken from the two TIFS flared landing experiments (refs. 24 and 25), and are plotted in figure 22. Configurations which have inadequate flightpath response characteristics (i.e., they fall outside the boundaries in fig. 21) are not plotted on the attitude requirement in figure 22. That is, configurations that have flightpath control problems are expected to have poor ratings regardless of their pitch attitude bandwidth. The remaining configurations are seen to show excellent correlation with attitude bandwidth and phase delay.

The phase delay parameter τ_p is a measure of the shape of the phase curve² above the bandwidth frequency. More specifically, it is the slope of the phase curve, which is weighted according to frequency (i.e., a given phase slope results in a larger τ_p as ω_{180} is decreased). The physical implications of the τ_p parameter are discussed in detail in reference 22. The phase delay parameter is calculated using the formula shown in figure 20.

It is well known that phase delay is only an important issue for tasks which involve precision *closed-loop* tracking. The landing is a terminal control task, and it is possible, therefore, to achieve good performance without closed-loop control on some landings and not on others with the same configuration. This may explain some of the surprisingly good ratings, along with very poor ratings, for very large τ_p in figure 22 (e.g., configurations 11, 24, and 25). A more detailed discussion of the effects of pilot technique follows.

Pilot Technique

As noted previously, a few of the configurations tested in references 24 and 25 exhibit some very large PR spreads (e.g., from 3 to 7). This is felt to result from different techniques that can be utilized to accomplish the task for a single configuration (one is related to airspeed control and is discussed above). The technique used to accomplish the flared landing task depends on

- External disturbances affecting the flightpath just prior to the flare (e.g., wind shear). Deviations from the desired flightpath on short final require the pilot to exercise closed-loop control.
- The steepness of the glide slope just prior to the flare. (Shallow glide slopes do not require a significant change in flightpath and tend to result in more open-loop precognitive pilot behavior.)

²For all practical purposes, the shape of the phase curve in the frequency region above ω_{180} is caused by high-frequency lags, and therefore can be approximated by $\Delta\phi = e^{-\tau s}$. This function plots as a straight line on a linear grid defined by $\Delta\phi$ as a function of ω .

- The required precision. If the required precision is high, the pilot is more likely to exhibit closed-loop behavior than if the runway is very long or the landing gear is very strong.
- Deviations in flightpath or airspeed (such as a last-minute offset) just before flare initiation. A destabilized approach requires the pilot to exhibit closed-loop behavior.
- Pilot background and training. Some pilots tend to be more aggressive and exhibit a higher degree of closed-loop behavior in the flare. For example, shuttle pilots are highly trained to be nonaggressive during the flare.

It can be seen that pilot behavior will vary from one landing to another depending on the conditions. If the landing can be accomplished with primarily open-loop or pursuit behavior, the closed-loop criteria noted above are of little importance, and can be replaced by the minimum value of $\Delta\gamma_{max}/\Delta\theta_{ss}$ noted above ($\Delta\gamma_{max}/\Delta\theta_{ss} \geq 0.70$). Wide variations in the PR may be expected for a configuration with poor closed-loop control characteristics; this is because one pilot may have been required to employ considerable closed-loop behavior, whereas another may have accomplished both landings with an essentially open-loop or pursuit technique. (Each pilot accomplished only two landings and sometimes only one landing per configuration in the ref. 24 and 25 experiments.) In general, the results between the two experiments are seen to be reasonably consistent (figs. 21 and 22). The exception was configuration 17, which was rated 8/9/5.5 in the reference 24 tests and 2/3/2/4/2 in the reference 25 tests (discussed previously).

Comparison of Attitude Command, Attitude Hold; Rate Command, Attitude Hold; and Conventional Airplane Response Types

Attitude Command, Attitude Hold Response Type—The ACAH response type is defined when the response to a constant cockpit controller force input is a constant attitude. This response type was highly desirable for flared landings in the TIFS experiments, as shown by the PR data in figure 23. Here it is seen that the ACAH response type is rated almost universally Level 1 down to an attitude bandwidth of 1.4 rad/sec, where the pilots began to notice attitude control problems. The PRs for the RCAH response type (fig. 23) exhibit more variation and a definite degradation for pitch attitude bandwidths below 1.8 rad/sec. Configuration 1, which falls above the upper boundary of the flightpath criterion, is rated Level 1 and is an ACAH response type. The value of the ACAH response type is further illustrated in figure 24. Here, the ratings for four configurations are shown, where the response type was changed from RCAH (with low (Level 2) attitude bandwidth) to ACAH by inserting a washout prefilter in the command path. This is seen to be accompanied by a dramatic improvement in the PR. Note that the ACAH response type has an inherently higher flightpath bandwidth, which helps to explain the improvement in rating. Nonetheless, the low attitude bandwidth of these configurations indicates that ACAH is inherently better than RCAH for the flared landing task.

Conventional Airplane Response Type—Few conventional airplane response type configurations were flown in the reference 24 and 25 experiments. However, all tested in the Level 1 region and were consistently rated Level 1. This response type bears a similarity to ACAH in that increasing back pressure is required as the airspeed bleeds off in the flare; so that the pilot never has to push, but simply releases back pressure when a negative attitude increment is required. Hence the benefits of ACAH noted above may also be available with the conventional response type. While there are no available

data to investigate this hypothesis, the analysis based on the generic characteristics shown in figure 18 predict that ACAH would provide better flightpath control (pilot does not have to damp the phugoid, and flightpath is proportional to control deflection at low frequency for ACAH).

Force as a Function of Position Input to Define Bandwidth and Phase Delay

There is currently considerable controversy as to whether the bandwidth and phase delay parameters should be obtained with respect to force or position inputs. For the references 23 through 25 experiments, the feel system was in series with the cockpit controller so that feel-system lags would lower the bandwidth and increase the phase-slope.³ The boundaries in figures 15, 16, 21, and 22 are with respect to stick position. The bandwidth and phase delay values that result from including feel-system lags which are in series with the pilot (i.e., from measuring bandwidth and phase delay as a function of force input) are shown in figures 25 and 26. There is some evidence that the pilot can compensate for feel-system lags independently of the airframe (ref. 28), while other data suggest that the feel system should be included as part of the plant (ref. 29). Until more is known, it is suggested that the bandwidth be calculated with respect to both force and position, and be required to meet the appropriate boundaries (figs. 15 and 16 for position, and figs. 25 and 26 for force). Some researchers have greater confidence in the position requirement at this time, since it is well known that pilots can use proprioceptive feedback very effectively. For example, helicopter pilots commonly fly with loose controls, which is a pure inertia (i.e., 180° of phase lag between force and position at all frequencies). These cases would have zero bandwidth based on force inputs.

In summary, the best way to guarantee good FQ is to minimize the feel-system lags so as to achieve values of bandwidth and phase delay based on force inputs that are well within the Level 1 region of the figure 15, 16, 25, and 26 boundaries.

Flightpath Angle Overshoot Criterion

A criterion which showed potential for correlating PR data for the flared landing task was presented in reference 30. The criterion is based on a step longitudinal controller input, which is removed after 5 sec. It is defined as the percentage increase in flightpath angle following the removal of the input.

$$\gamma \text{ peak overshoot (percent)} = \frac{\gamma_p - \gamma_R}{\gamma_R} 100$$

where γ_p = flightpath angle peak following control release, and

γ_R = flightpath angle at control release.

This metric is a measure of how quickly the flightpath angle follows the longitudinal control input, and hence is related to the flightpath bandwidth $\omega_{BW\gamma}$. (Recall that bandwidth is a general measure of how rapidly the output follows the input.) An indication of the degree to which the flightpath overshoot

³Stick position lags the pilot force input as long as the stick is damped (mechanically or electrically). If the input to the flight-control system is from stick position, this feel-system lag is in series with the pilot. If the input is from a stick force transducer, the lag is in parallel. However, experience has shown that such parallel feel systems require additional lags in series with the pilot to avoid overly abrupt responses.

is related to $\omega_{BW\gamma}$ is shown in figure 27 for configurations from the experiments in references 24 and 25. The correlation is very good for values of flightpath overshoot above 20 percent. As the flightpath bandwidth takes on values greater than one, the flightpath overshoot parameter is suppressed to the origin, i.e., values less than 10 percent. However, this is of small consequence since the FQ are generally good in this region. The exceptions are configurations 1, 3, 5, 7, and 9, which have a flightpath overshoot below 20 percent and fall well above the straight-line correlation in figure 27. Recall that these are the cases with excessive flightpath response for a given level of attitude response (i.e., poor path-attitude consonance); see figures 21 and 26.⁴ The flightpath overshoot parameter is plotted as a function of pilot rating in figure 28 (for the configurations in fig. 27). The following observations apply.

- A flightpath overshoot greater than 30 percent is a necessary and sufficient condition for average PR greater than 3.5.
- Flightpath overshoot less than 30 percent does not discriminate between good and poor PR (i.e., is necessary but not sufficient for good FQ).
- All configurations that have an average PR greater than 5.5 and flightpath overshoot less than 30 percent also have a very low (Level 2 or 3) attitude bandwidth (configurations 5, 11, 12, 13, and 8-2-5-1).
- Most configurations that have an average PR greater than 3.5 and a flightpath overshoot less than 30 percent also have a low (Level 2) attitude bandwidth or poor attitude-path consonance (configurations 3, 7, 9, and 14, in addition to those listed previously).

These results are attributed to the fact that pilots are sensitive to attitude and flightpath control in the landing flare. The flightpath overshoot parameter is a good predictor of an excessively sluggish flightpath response, but does not identify an excessively sluggish attitude response or the excessive flightpath response for cases with poor attitude-path consonance (i.e., configurations 3, 5, 7, and 9). It is interesting that a flightpath overshoot greater than 30 percent guarantees poor ratings (fig. 28), and corresponds closely to $\omega_{BW\gamma} = 0.60$ rad/sec (the lower limit in figs. 21 and 26).

In summary, the flightpath overshoot parameter is expected to be a good metric to identify excessively sluggish flightpath bandwidth, but should be used in conjunction with attitude bandwidth and phase delay to estimate the FQ for flare and landing. It has the advantage of being easily calculated from a simple time history, and is recommended as a rule-of-thumb measurement for initial estimates. Care must be taken to follow up with calculations of $\omega_{BW\gamma}$ to ensure adequate attitude-path consonance. Finally, it would be desirable to have a similar time response metric to estimate attitude bandwidth $\omega_{BW\theta}$ online. Rise time parameters have been shown to be successful in this regard. However, such metrics must be considered rough estimates, because they are sensitive to the shape of the input and because $\omega_{BW\theta}$ is not a unique function of rise time, depending also on damping ratio.

⁴Configuration 1 is an ACAH response type which appears to be less sensitive to path-attitude consonance than RCAH, and was rated Level 1.

RESULTS, CONCLUSIONS, AND RECOMMENDATIONS

Results and Conclusions

Based on the results of technical projections and surveys of existing applicable data, we have presented some expected problems and difficulties with the projected stability, control, and flying qualities of hypersonic air-breathing vehicles. These flying quality deficiencies are enumerated and discussed in a previous section and will not be repeated here. However, because flight control for this class of vehicles will necessarily be multiply redundant with two or more levels of fail-operational capability, the bare vehicle's deficiencies can be removed by augmentation, provided there is adequate control power in all axes for all desired flight conditions.

Thus, overcoming the natural deficiencies requires relatively accurate estimates of the trim and excess control power required and available, including power-on/off, aeroelastic, and thermal effects. But accurate knowledge of these effects and of vehicle-dynamic areas is not easily achieved. There will be a lack of information and data about the vehicle's characteristics at many unexplored flight conditions, as was the case for the shuttle (where there was no way to gradually build up to many flight conditions). Incomplete ground testing left the vehicle dynamic properties in a large Mach-number region relatively uncertain. In spite of computational fluid dynamics and a planned envelope expansion flight program, similar uncertainties will exist with the National Aero-Space Plane in the design phases. It follows from these considerations that the most important failure or flying quality level designations should be associated with aircraft characteristics in the presence of tolerances or uncertainties in aircraft and controller properties.

Obviously, the failure to provide sufficient control power to overcome extreme balance and upset conditions with adequate margin for uncertainties will constitute a general flight-control problem. The specification of flying quality requirements, assuming such control is available and properly disposed, is less uncertain because it depends on the foreseeable piloting tasks and the known piloting capabilities. For hypersonic cruiselike flight, the shuttle provides the only currently available specification base (ref. 6). Inflight piloting experience with the orbiter at hypersonic speeds is very limited, and primarily reflects the absence of negative or adverse opinion regarding the suitability of the shuttle flight-control system.

Relative to landing, the shuttle inflight experience is now more directly relevant for unpowered landing, while other data pertain to powered landing. For power-off landings, the elements of pilot control strategy, overall performance, and flying quality dynamics are as follows:

Pilot Control Strategy and Overall Performance

- Two basic flare strategies dominate the landings examined:
 - a precognitive step θ , or
 - closed-loop pilot operations making $\dot{H} \propto H$ or θ
- Both strategies require precise control of the inner θ loop to achieve the desired path control.

- There is evidence (because of near-pilot induced oscillation situations) that the pilots may be pushing the pitch response bandwidth limits.
- Landing performance metrics show remarkably consistent touchdown values for sink rate, forward velocity, and distance from threshold despite widely varying conditions at the beginning of the shallow glide or flare initiation.
- All landings meet or exceed reasonable touchdown performance goals regardless of visual aids.
- Shallow glide and touchdown performance improved as path visual aids (ground based and head-up display) were introduced to provide more information.

Flying Quality Dynamic Characteristics

- The effective airplane pitch control bandwidth — 1.3 rad/sec — is marginal, at best.
- The effective time delay — 0.15+ sec — is excessive for the two-step decelerating approach and landing.
- The path time constant — 2 sec — is marginal.
- The instantaneous center of rotation location with respect to the pilot is not located to minimize apparent path mode reversal or time lag response to flare commands.
- In pitch rate command, attitude hold flight-control systems, the lead time constant T_q in the control system is not necessarily equal to the airplane's path control lag T_{θ_2} . When $T_q < T_{\theta_2}$, this introduces a lag/lead into the transfer function relating path angle to pilot input. The path response to step elevon commands will exhibit an extra net lag, and this lag may also affect the pilot's impressions in closed-loop control.
- The most desirable effective vehicle dynamics for the flare task, e.g., rate command, attitude hold (actual orbiter system) or attitude command, attitude hold, are still to be determined.

To some extent, the first group of conclusions may appear to contradict the second, because adequate performance was always achieved in the landing task. Of course, the pilots were exceptionally well trained (e.g., in the shuttle training aircraft) and highly experienced. Nonetheless, workload was very high on some landings, and on most landings the pilot activities in some closed-loop control phases pushed the pilot-vehicle system to near limit values (e.g., the near-pilot induced oscillation conditions noted above). Although no pilot ratings based on actual shuttle flights are available, it is clear that adequate performance does require considerable pilot compensation. Consequently, based on the excellent task performance, the apparent workload and high gain pilot activity, and a strict interpretation of the Cooper-Harper scale, the overall vehicle flying qualities would appear to be about Level 4 to 5.

The above considerations are augmented for the powered-landing case by the considerable background and data given in a previous section, which leads to the following criteria-related conclusions:

- The best response type for flare and landing is attitude command, attitude hold.
- The rate command, attitude hold response type can yield desirable flying qualities for flare and landing, as long as the flightpath bandwidth meets the criterion in figure 16.
- The numerical values of the pitch attitude bandwidth and phase-delay parameters should fall within the Level 1 region noted in figure 15. There is some evidence that the minimum bandwidth can be reduced to 1.4 rad/sec for an attitude command, attitude hold response type.
- If a rate command, attitude hold response type is employed, the dropback parameter defined in figure 17 should not exceed the limits shown. This is a requirement for good open-loop and pursuit control.
- Airspeed control is more likely to be a problem for the rate command, attitude hold response type than for attitude command, attitude hold or conventional airplane response types.
- To ensure that the flightpath angle can be sufficiently modified with pitch attitude to accomplish the flare,

$$\frac{\Delta\gamma_{max}}{\Delta\theta_{ss}} \geq 0.7$$

Recommendations

The recommendations stemming from all the foregoing considerations, data, and discussions are contained in table 4. The first recommendation concerns possible restrictions on the vehicle because of control and flying-quality deficiencies. Particularly for flight conditions in which the control system is needed to redress aircraft-alone instabilities, the available control power may limit the angle-of-attack and angle-of-sideslip excursions for nominal trim and stability. These limits will be further reduced by maneuvering and aerothermoelastic effects, especially when multi-axis operations are considered. For instance, a given single-axis dynamic response may be quite acceptable, but when combined with other axes may result in an untenable flying situation, leading to more stringent restrictions on the flight envelope. The possibility of such multiple flight-control and flying-quality deficiencies and how they combine to limit usable flight situations should be studied, and generalized conclusions and criteria should be drawn from such studies.

Relative to criteria validation and verification, a first briefing of the airframe contractors has already occurred with good results. This practice should be continued to expedite information exchange on problems, proposed criteria, and possible simulation planning and testing.

Because the power approach and landing criteria appear to be in a fairly firm state and reflect a certain amount of partially applicable in-flight data, they are in a condition to be verified and validated with more specific flying in the total inflight simulator aircraft. As indicated, these new tests are conceived to be more hypersonic-vehicle oriented in terms of field-of-view limitations, a representative National Aero-Space Plane manipulator, ideal characteristics corresponding to some of the preceding graphs, and effective vehicle dynamics representative of the National Aero-Space Plane contractors, and include engine startup transients, thrust control dynamics, etc.

The final proposed stage in the validation and verification process would be to check the applicability of the proposed approach and landing criteria to the unpowered situations. The first step in such a check would be to compare the parameter values of the shuttle and shuttle training aircraft with the values of the parameters used to establish the criteria in the requirements. The final step would be to engage in an unpowered approach simulation to further check the data.

Relative to the development of lateral-directional criteria, a first step would be to develop feasible system architectures for superaugmented primary flight-control systems. That is, we would consider directionally unstable aircraft with a variety of key derivative combinations and uncertainties, and realistic sensor/equalization sets, to determine how such aircraft could best be stabilized and what might then be their resulting characteristics. Attention would be directed to determining which of the parameters were most significant from a flying qualities standpoint and to delineate, if possible, those that would become suitable criteria for establishing critical mission phase/task combinations. Such considerations would be based upon both analysis and correlations with existing data. The next step would be to develop simulation plans and conditions and establish a series of representative airframe and flight-control systems to provide the basis for the flight characteristics to be simulated, and finally to execute the verification experiments.

A somewhat abbreviated, but similar, process is contemplated for the development of throttle criteria: concern with startup, mode change, and throttle response requirements (e.g., as needed to support the primary flight-control system development and flying-quality requirements and needs). Finally, such criteria would be subjected to verification testing as for the lateral-directional criteria, in an expanded version, and other possible simulation testing.

The final recommendation is to initiate a primary flight-control and flying-quality criteria document that contains our current appreciation of hypersonic vehicle control and flying-quality problems, tentative criteria for manual control, major issues, and uncertainties; plan to continually update this document through discussions and contacts with National Aero-Space Plane contractors and through additional simulation and analysis programs.

REFERENCES

1. PRC System Services, ATD, "Air Breathing Aerospacecraft Flying Qualities Assessment," RFP 8822-1, Apr. 1988 (Unpublished Data).
2. Berry, Donald T., *National Aero-Space Plane Flying Qualities Task Definition Study*, NASA TM-100452, 1988.
3. Berry, Don, "NASP Flying Qualities Requirements," NASP Flight Systems Flash Data Report, 1988 (Unpublished Data).
4. "Flying Qualities of Piloted Airplanes," MIL-F-8785C, Nov. 1980.
5. "Flying Qualities of Piloted Vehicles," MIL-STD-1797, USAF, Mar. 1987.
6. McRuer, D.T., I.L. Ashkenas, and D.E. Johnston, *Flying Qualities and Control Issues/Features for Hypersonic Vehicles*, NASA CR-1063, 1989.

7. Myers, T.T., D.E. Johnston, and D.T. McRuer, *Space Shuttle Flying Qualities and Criteria Assessment*, NASA CR-4049, 1987.
8. McRuer, D.T., "Pilot Modeling," *Advances in Flying Qualities*, AGARD LS 157, May 1988, pp. 2-1 through 2-30.
9. Requirements/Definition Document, Flight Control, Part 1 Configuration, Performance and Functional Requirements, Rockwell International Space Division Report SD72-SH-0105, Vol. 1, Book 2, Part 1A, July 1977.
10. Ireland, R., and R. Woodle, "Entry Primary Flight Control System Analytic Verification Test Report," Honeywell, Inc., STS 81-0019, Feb. 1981.
11. McRuer, D.T., T.T. Myers, and P. M. Thompson, "Literal Singular-Value-Based Flight Control System Design Techniques," *J. Guidance, Control and Dynamics*, Vol. 12, No. 6, Nov-Dec 1989, pp. 913-919.
12. Arrington, J.P., and J.J. Jones (compilers), *Shuttle Performance: Lessons Learned*, NASA CP-2283, Part 1 and Part 2, 1983.
13. Powers, B.G., *Active Control Technology Experience with the Space Shuttle in the Landing Regime*, NASA TM-85910, 1984.
14. Myers, T.T., D.E. Johnston, and D.T. McRuer, *Space Shuttle Flying Qualities and Flight Control System Assessment Study, Phase II*, NASA CR-170406, 1983.
15. Tsikalas, G.M., "Space Shuttle Autoland Design," AIAA Paper No. 82-1604-CP, Aug. 1982.
16. Brand, V.D., "Space Shuttle Development Update," Society of Experimental Test Pilots Report to the Aerospace Profession, 28th Symposium, Sept. 1984, pp. 237-256.
17. Looney, B.J., "NASA Shuttle Autoland Support Program: Post-DETAC HUD Monitor Description," Sperry Autoland Memo 57, Sperry Flight System, Nov. 1980.
18. Myers, T.T., D.E. Johnston, and D.T. McRuer, *Space Shuttle Flying Qualities Criteria Assessment, Phase IV, Data Acquisition and Analysis*, NASA CR-166618, 1986.
19. Teper, G.L., R.J. DiMarco, I.L. Ashkenas, and R.H. Hoh, *Analyses of Shuttle Orbiter Approach and Landing Conditions*, NASA CR-163108, 1981.
20. Chalk, C.R., "Flying Qualities of Pitch Rate Command/Attitude Hold Control Systems for Landing," *J. Guidance, Control and Dynamics*, Vol. 9, No. 2, Sept./Oct. 1986, pp. 541-545.
21. McRuer, D.T., D.E. Johnston, and T.T. Myers, "A Perspective on Superaugmented Flight Control: Advantages and Problems," *J. Guidance, Control and Dynamics*, Vol. 9, No. 2, Sept./Oct. 1986, pp. 530-540.
22. Hoh, Roger H., "Unifying Concepts for Handling Qualities Criteria," AIAA Paper No. 88-4328, Aug. 1988.
23. Hoh, Roger H., and David G. Mitchell, "STOL Handling Qualities Criteria for Precision Landings," AFWAL-TR-86-3050, Nov. 1986.

24. Berthe, C.J., C.R. Chalk, and S. Sarrafian, *Pitch Rate Flight Control Systems in the Flared Landing Task and Design Criteria Development*, NASA CR-172491, 1984.
25. Weingarten, Norman C., Charles J. Berthe, Jr., Edmund G. Rynaski, and Shahank Sarrafian, *Flared Landing Approach Flying Qualities, Vol I, Experiment Design and Analysis*, NASA CR-178188, 1988.
26. Hanke, D., K. Wilhelm, and H.H. Lange, "Handling Qualities Aspects of CTOL Aircraft with Advanced Flight Controls, Criteria for Handling Qualities of Military Aircraft," AGARD CP-333, June 1982, pp. 10-1 through 10-17.
27. Gibson, J.C., "Piloted Handling Qualities Design Criteria for High Order Flight Control Systems," Criteria for Handling Qualities of Military Aircraft, AGARD CP-333, June 1982, pp. 4-1 through 4-15.
28. Smith, Rogers E., and Shahan K. Sarrafian, "Effect of Time Delay on Flying Qualities: An Update," *J. Guidance, Control, & Dynamics*, Vol. 9, No. 5, Sept-Oct 1986, pp. 578-584.
29. Bailey, Randall E., Bruce G. Powers, and Mary F. Shafer, "Interaction of Feel System and Flight Control System Dynamics on Lateral Flying Qualities," AIAA Paper No. 88-4327CP, Aug. 1988.
30. Berry, Donald T., and Shahan K. Sarrafian, "Validation of a New Flying Quality Criterion for the Landing Task," AIAA Paper No. 86-2126, Aug. 1986.

Table 1. Mission phase–task–handling quality criteria matrix.

Mission phases/tasks	Engine mode	Engine/aircraft control tasks	Disturbances	Critical HQ problems/issues
1. Pre-takeoff Pre-start Start Taxi				
2. Takeoff Accelerate Rotate Initial climb Abort				
3. Accelerate/climb Subsonic Accelerate Abort Transonic Accelerate Abort Low supersonic Accelerate Abort Transition to ram High supersonic Accelerate Abort Transition to scram Hypersonic Accelerate Abort				
4. Cruise Supersonic Hypersonic				
5. Loiter Supersonic Hypersonic				
6. Orbit Insertion Orbit De-orbit				
7. Reenter				
8. Unpowered decelerate/descend Hypersonic Supersonic Transonic Subsonic				

Table 1. Concluded.

Mission phases/tasks	Engine mode	Engine/aircraft control tasks	Disturbances	Critical HQ problems/issues
9. Restart engine Hypersonic Supersonic Subsonic				
10. Cross-range maneuvering Powered Unpowered				
11. Approach Powered Unpowered				
12. Go-around				
13. Landing Powered Unpowered				
14. Postlanding Taxi Shutdown				

Table 2. Shuttle orbiter performance levels.

<p>LEVEL 1</p> <ul style="list-style-type: none"> • Specified stability margins (typically 6 dB, 30°) & response criteria • Pilot rating (Cooper-Harper) – 3 or less <p>LEVEL 2</p> <ul style="list-style-type: none"> • Degraded stability margins (4 dB, 20°) • Large signal operation – stable • Degraded turn coordination (relaxed lateral acceleration & sideslip criteria) • Pilot rating – 6 or less <p>DESIGN ASSESSMENT</p> <ul style="list-style-type: none"> • No loss of vehicle

Table 3. Competing response types for National Aero-Space Plane landings.

Response type	Advantages	Disadvantages
Rate command, attitude hold (RCAH)	<p>No trimming required for a two segment glide slope</p> <p>Best response type for approach – no transition required to a new control mode for flare and landing.</p>	<p>Requires a higher bandwidth than ACAH</p> <p>May require additional feedback (such as n_z) if $1/T_{\theta_2}$ is low; see figure 19.</p> <p>Tendency for airspeed control problems (associated with division of attention).</p>
Attitude command, attitude hold (ACAH)	<p>Best response type for flared landing.</p>	<p>Requires large trim change for a two-segment approach.</p> <p>Not as good as RCAH for approach – would require a transition from RCAH prior to flare and landing, if RCAH is used for the approach.</p>
Flightpath command, flightpath hold (FCFH)	<p>Same as ACAH but better wind shear regulation.</p>	<p>Same as ACAH and may result in excessive airspeed bleedoff in a large wind shear for an unpowered approach.</p> <p>Sensing requirements more complex than RCAH or ACAH.</p> <p>Essentially untested.</p>

Table 4. Recommendations.

CONTROLS-BASED ENVELOPE RESTRICTIONS

Study flight condition limitations (performance envelope) caused by combined effects of multiple control and FQ deficiencies.

CRITERIA VALIDATION AND VERIFICATION

1. Continue to disseminate and exchange information on problems and proposed criteria with airframe contractors.
2. Conduct limited tests of the proposed Level 1 powered approach and landing criteria using the total in-flight simulation aircraft. Conditions examined should include
 - Field-of-view limitations representative of NASP
 - Representative NASP
 - Ideal (presumed Level 1, PR < 2.5) effective vehicle characteristics
 - Effective vehicle dynamics which are representative of the NASP contractors aircraft, including engine startup transients and thrust control dynamics.
3. Check proposed powered approach and landing criteria against unpowered situations, including
 - Comparison of the proposed criteria with those of the shuttle training aircraft
 - Examine existing RCAH simulation data to affirm criteria will apply to RCAH unpowered shuttlelike approaches
 - Consider a limited unpowered approach simulation program to further check the data.

DEVELOPMENT OF LATERAL-DIRECTIONAL CRITERIA

1. Establish feasible architectures for supraaugmented primary FCS.
2. Delineate governing FQ parameters and critical mission phase/task combinations.
3. Establish tentative (expected) criteria based on analysis and appropriate existing data.
4. Develop simulation plans, conditions, representative airframe, and flight control system data to verify and modify the tentative criteria.
5. Execute the verification experiments.

DEVELOPMENT OF THROTTLE CRITERIA

1. Using feasible architectures for supraaugmented longitudinal and lateral-directional primary FCS, delineate the governing engine startup, mode change, and throttle response requirements needed to support primary FCS and FQ needs.
2. Incorporate the tentative throttle criteria as entries in an expanded/extended version of the above simulation, and execute verification experiments.

Table 4. Continued.

PREPARATION OF PRELIMINARY PRIMARY FLIGHT-CONTROL AND FLYING-QUALITY CRITERIA DOCUMENT

1. Using the results of the current and preceding studies, prepare an initial FQ and preliminary FCS summary document and presentation that outlines
 - Key flight control and FQ problems associated with hypersonics controls,
 - Tentative criteria for effective vehicle dynamics for manual control modes, and
 - Major issues and uncertainties.
2. Present these results in a series of briefings to all the airframe companies involved in NASP.
3. Update the presentations and results periodically as results become available from the manned simulation and criteria validation programs.

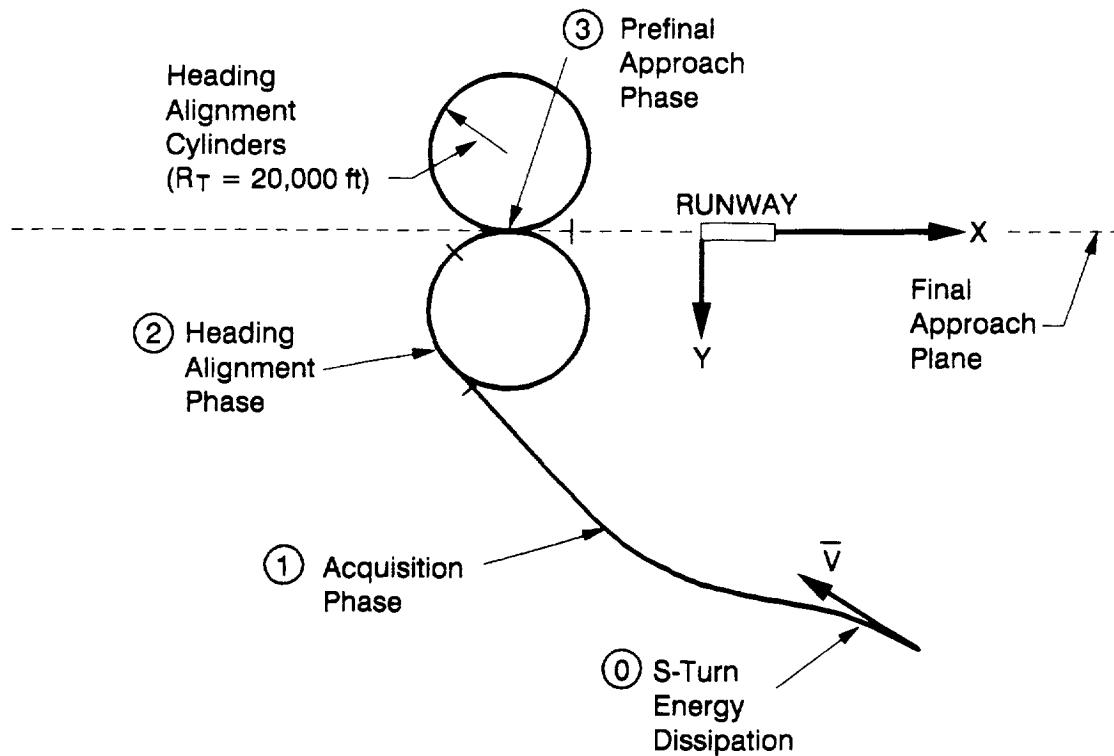
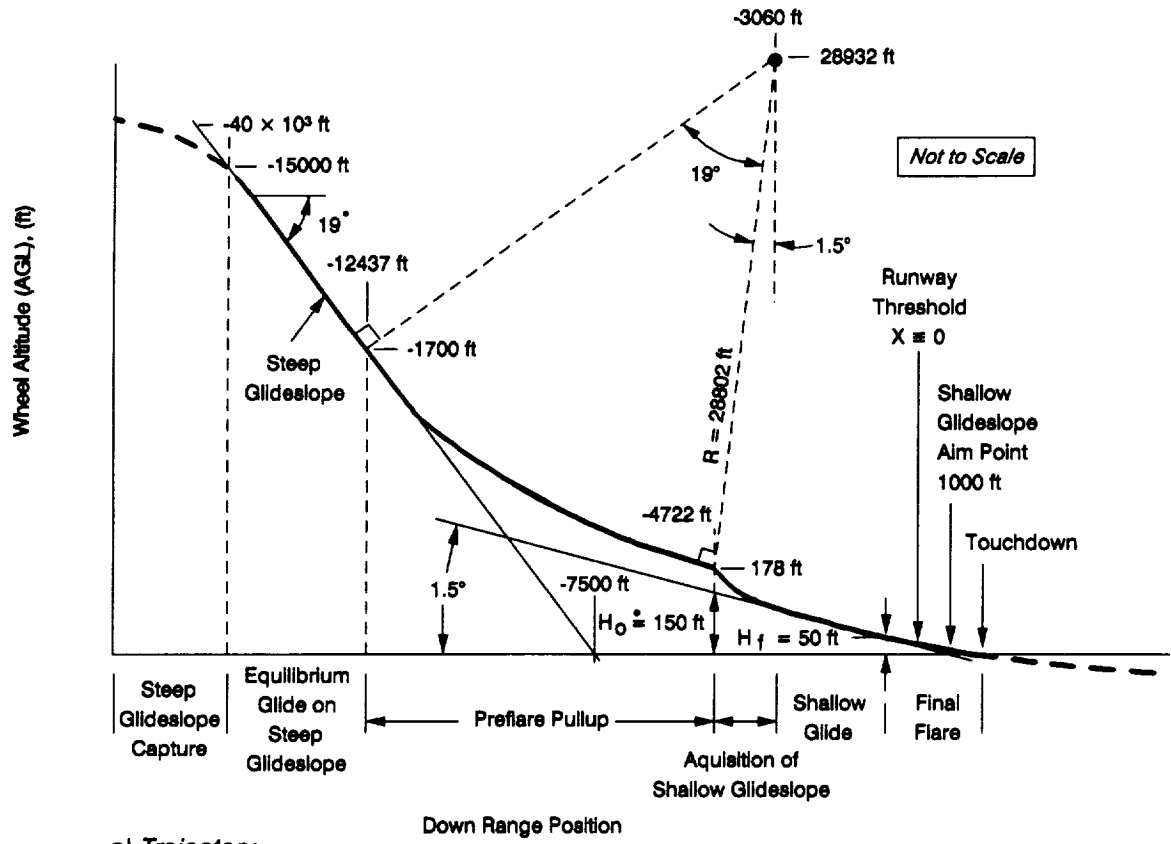
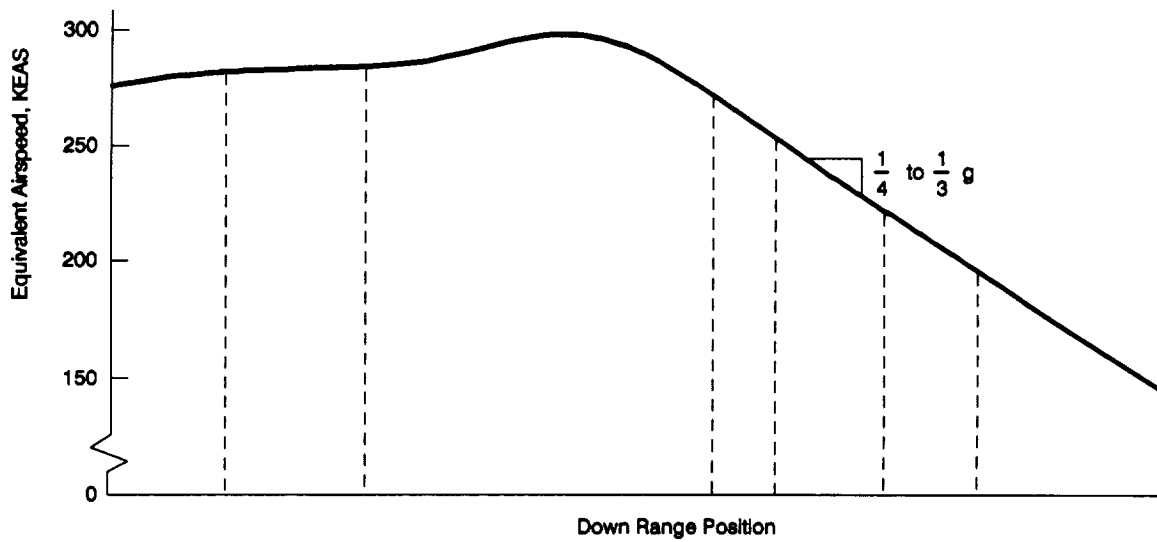

Figure 1. Terminal Area Energy Management Guidance Phases



a) Trajectory



b) Equivalent Airspeed Variation

Figure 2. Nominal Trajectory and Airspeed Variation for Shuttle Approach and Landing

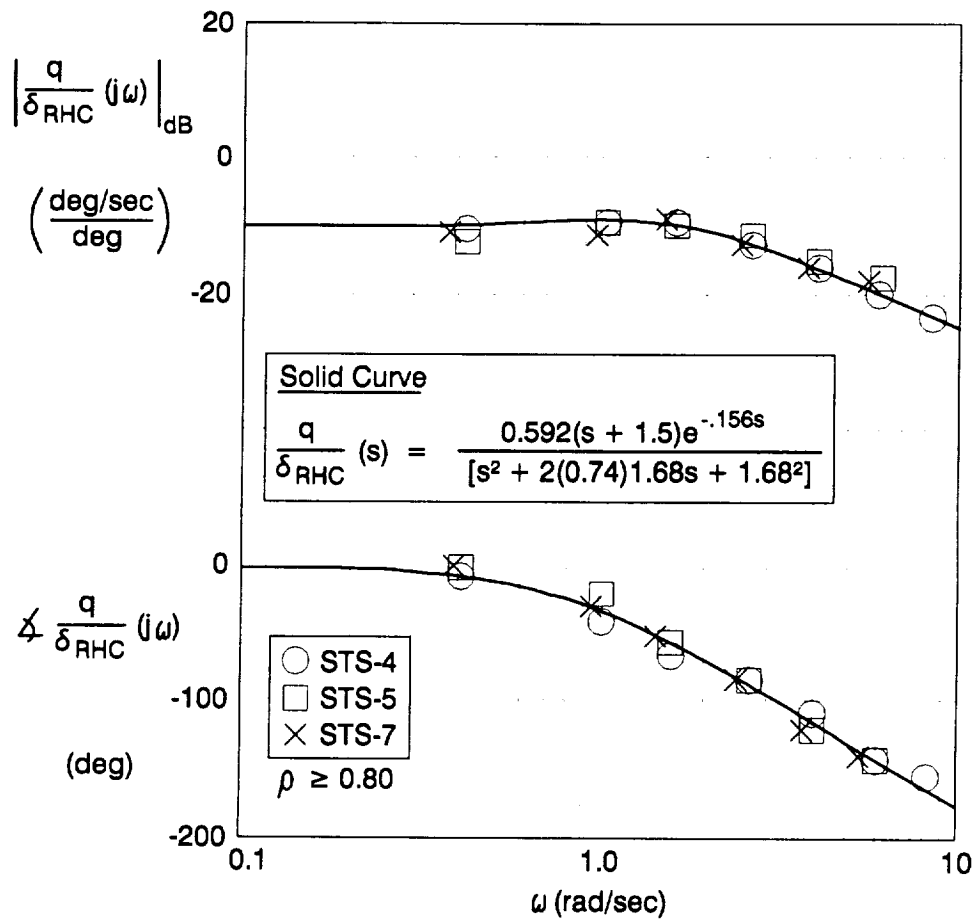

Figure 3. Comparison between Theoretical Superaugmentation Model and Flight Data

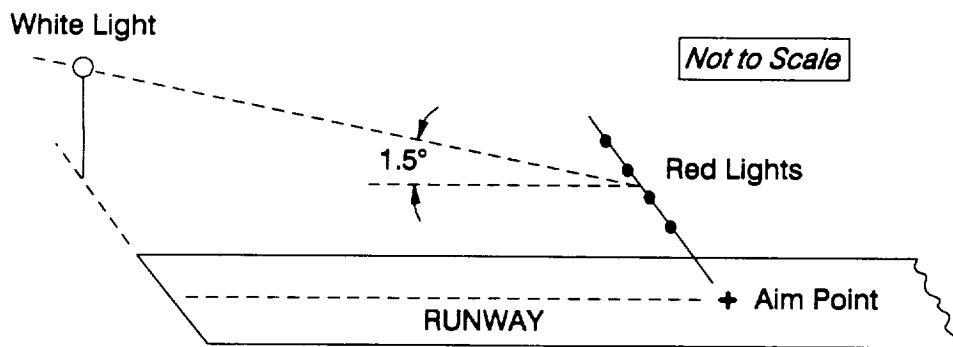

Figure 4. Ball-Bar Shallow Glide Slope Flight Path Aid

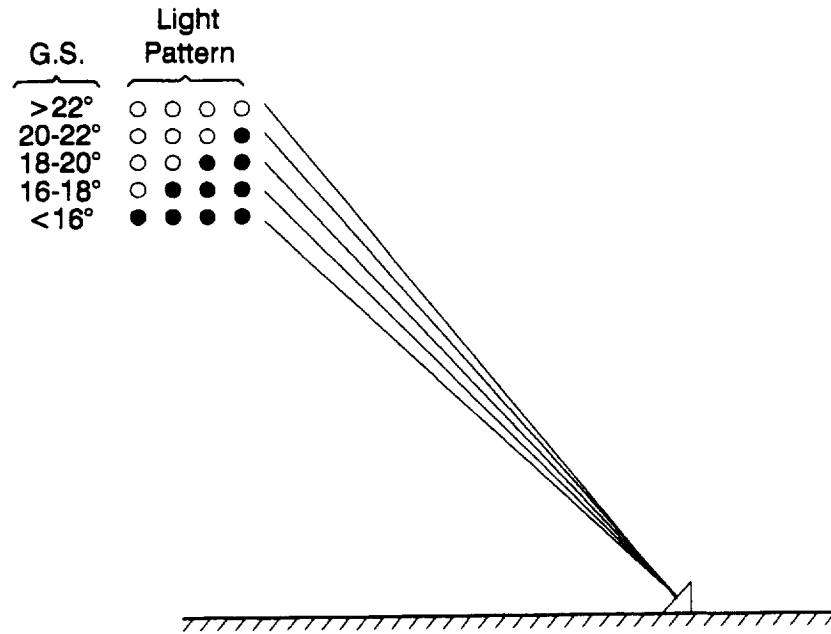
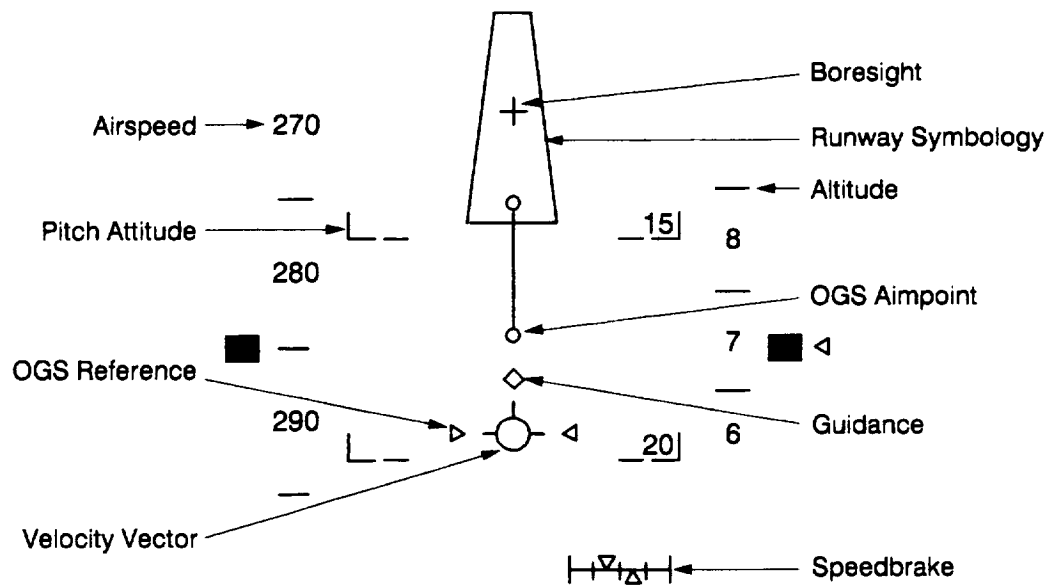
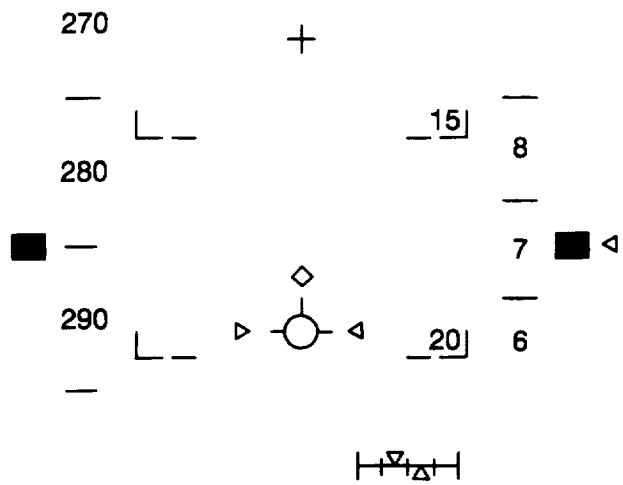

Figure 5. Steep Glide Precision Approach Path



a) No Declutter



b) First Declutter

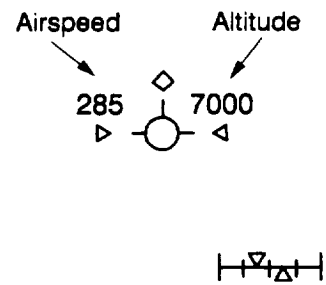

c) Second Declutter

Figure 6. HUD Approach and Landing Symbology

a) Touchdown Sink Rate Summary

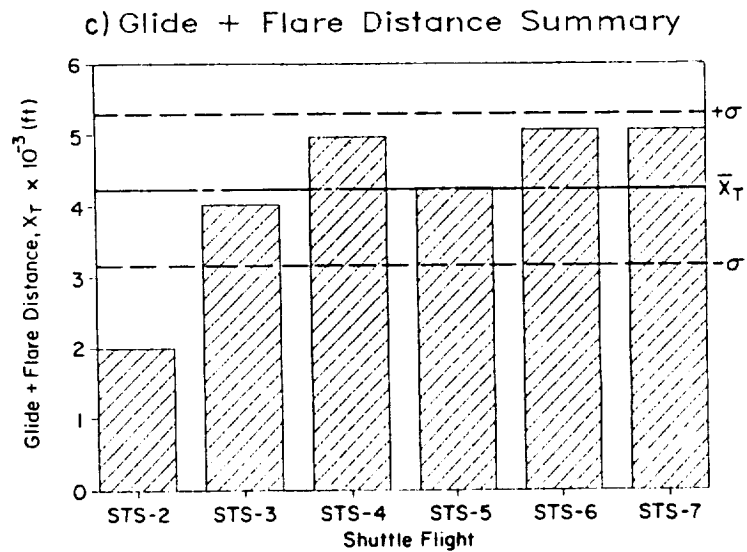
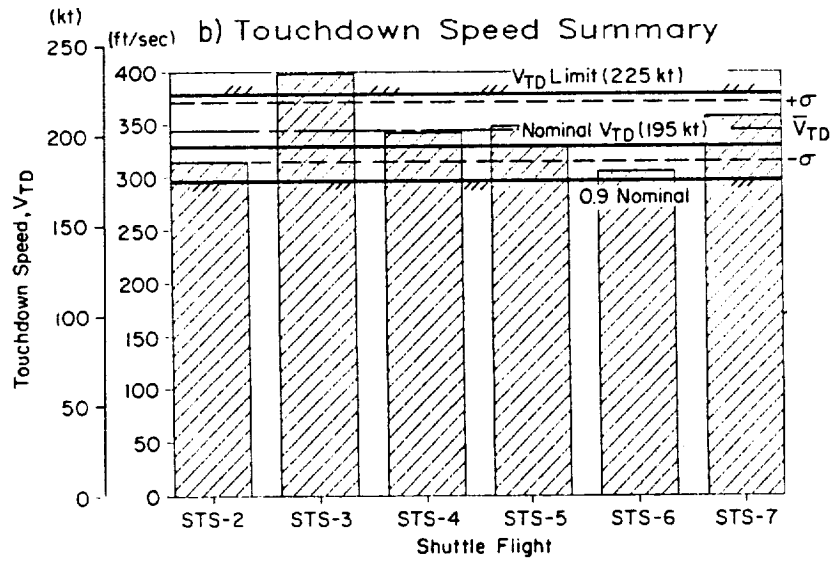
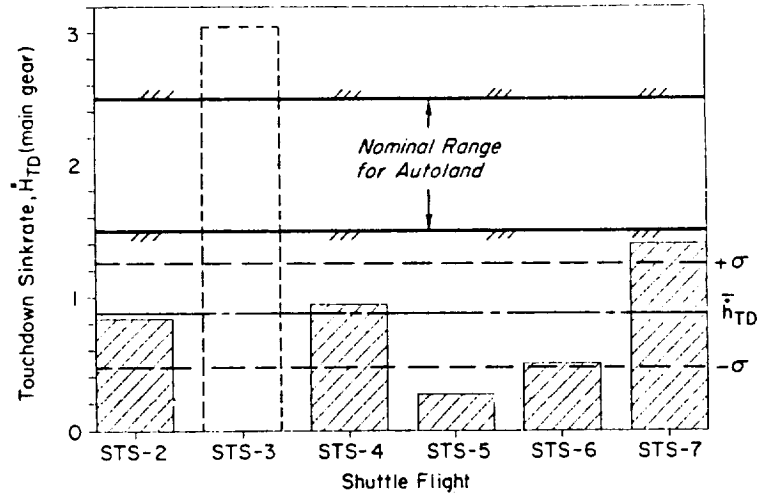

Figure 7. Touchdown Parameter Summary Chart

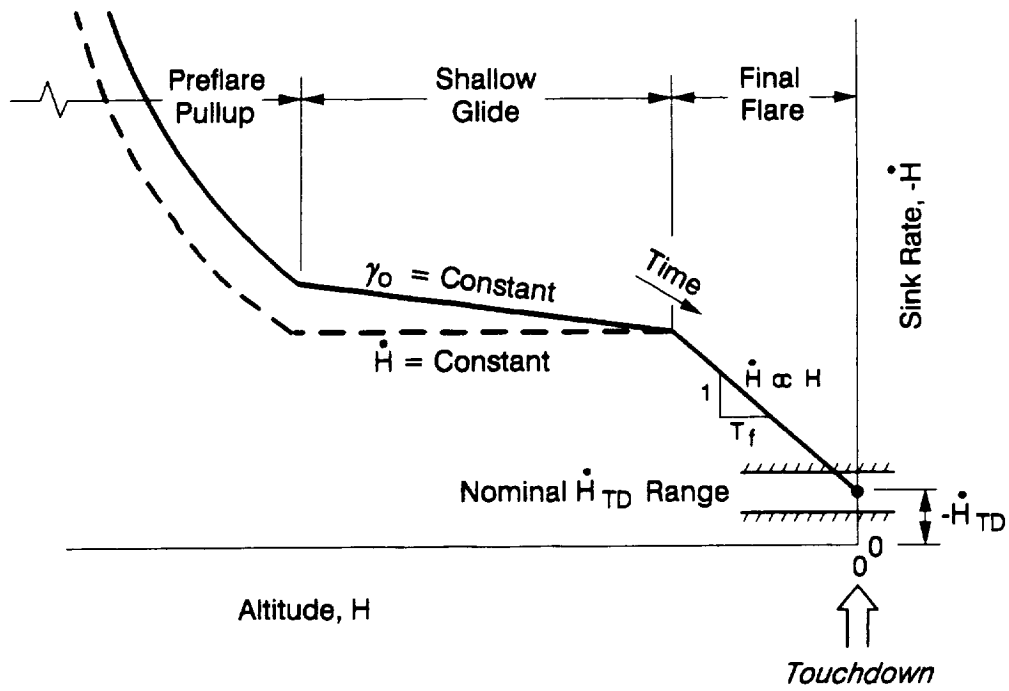

Figure 8. Idealized Altitude/Sink Rate Phase Plane Trajectory for the Shallow Glide and Flare Assuming an Exponential Flare

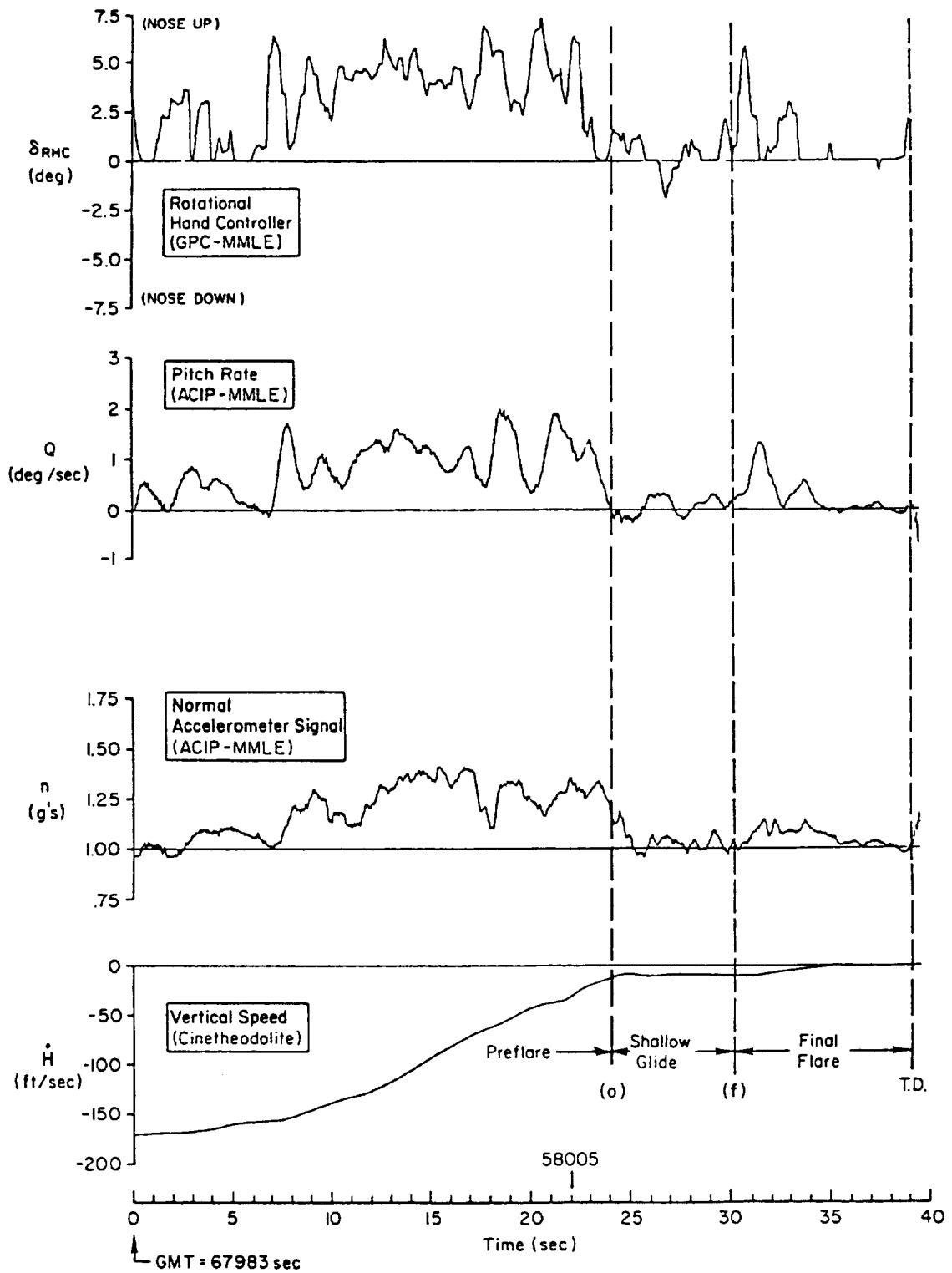
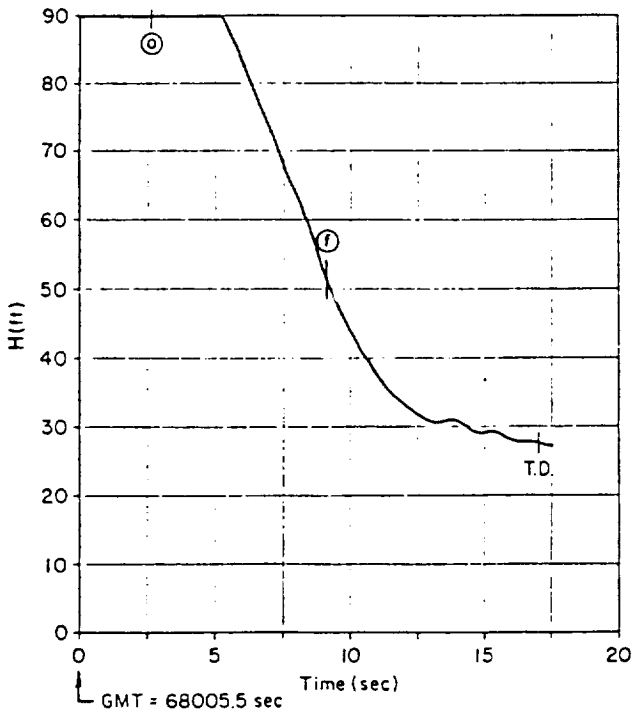
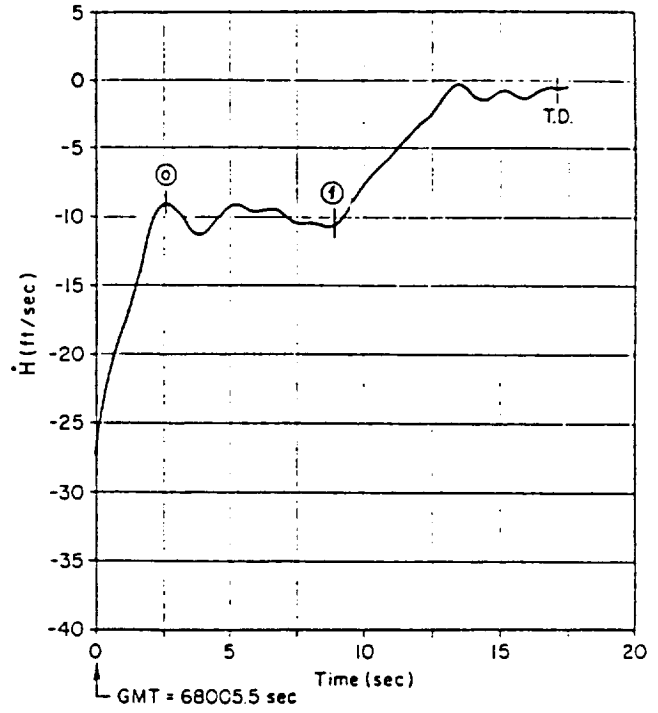

Figure 9. STS-6 Preflare Through Touchdown Time Traces



a) Altitude Time History



b) Vertical Speed Time History

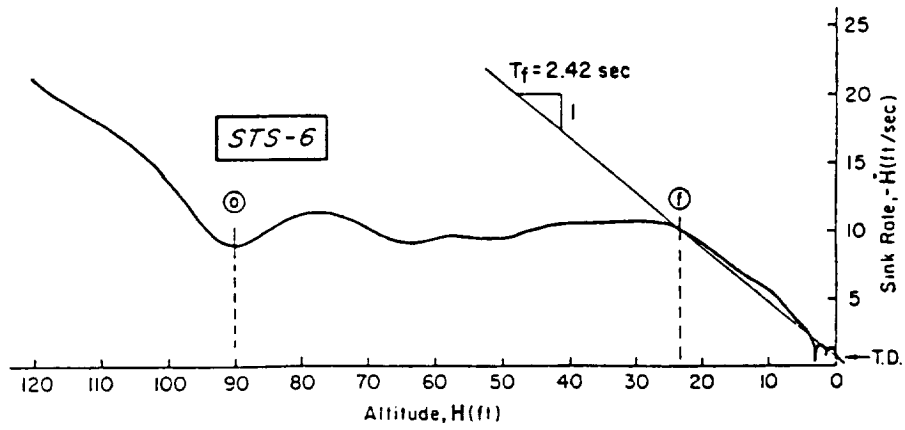

c) Hodograph

Figure 10. STS-6 Preflare Through Touchdown Hodograph

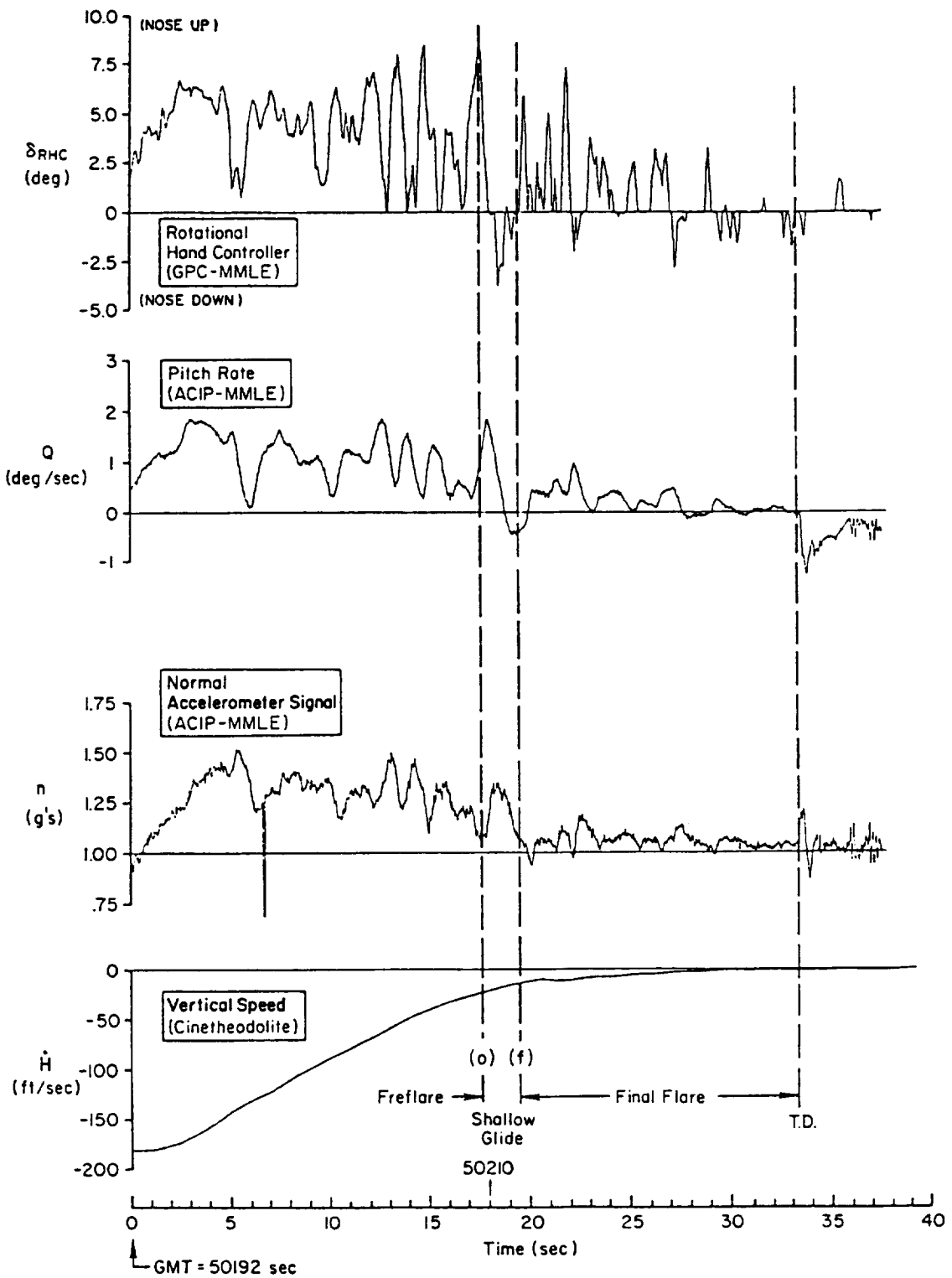
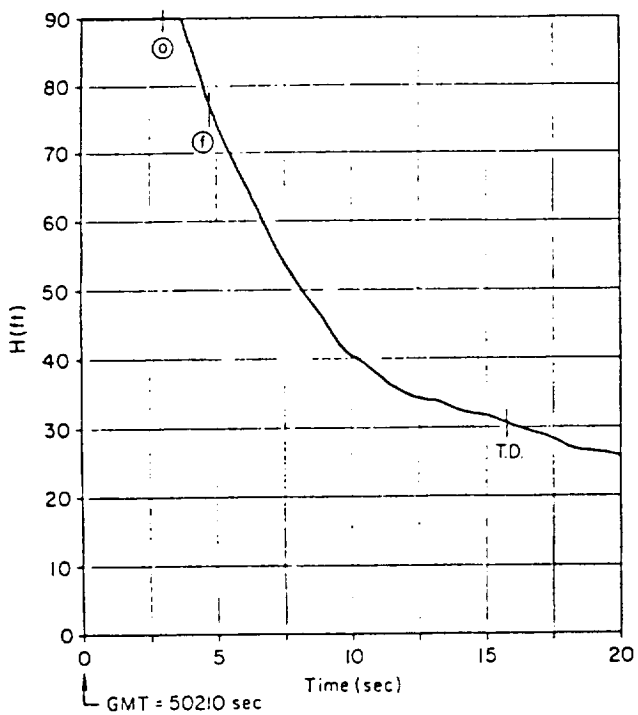
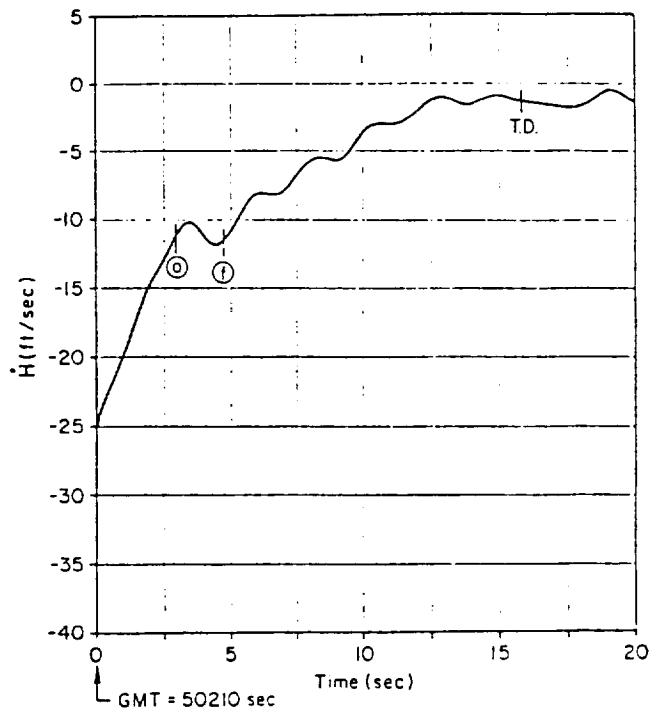

Figure 11. STS-7 Preflare Through Touchdown Time Traces



a) Altitude Time History



b) Vertical Speed Time History

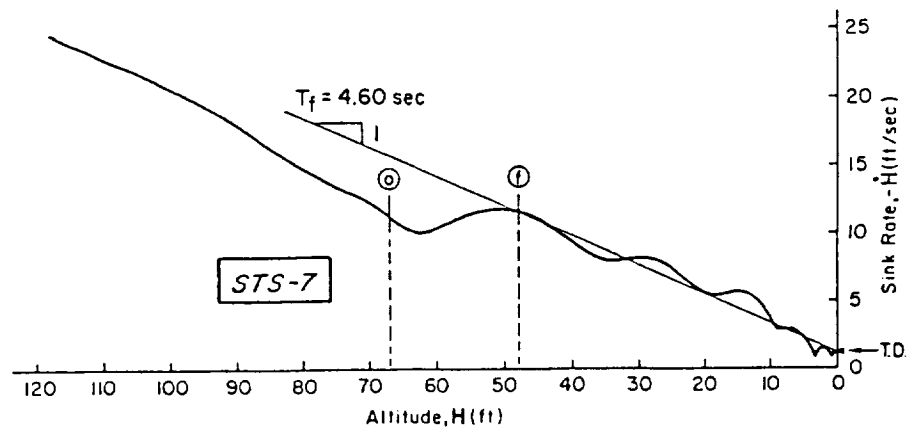

c) Hodograph

Figure 12. STS-7 Preflare Through Touchdown Hodograph

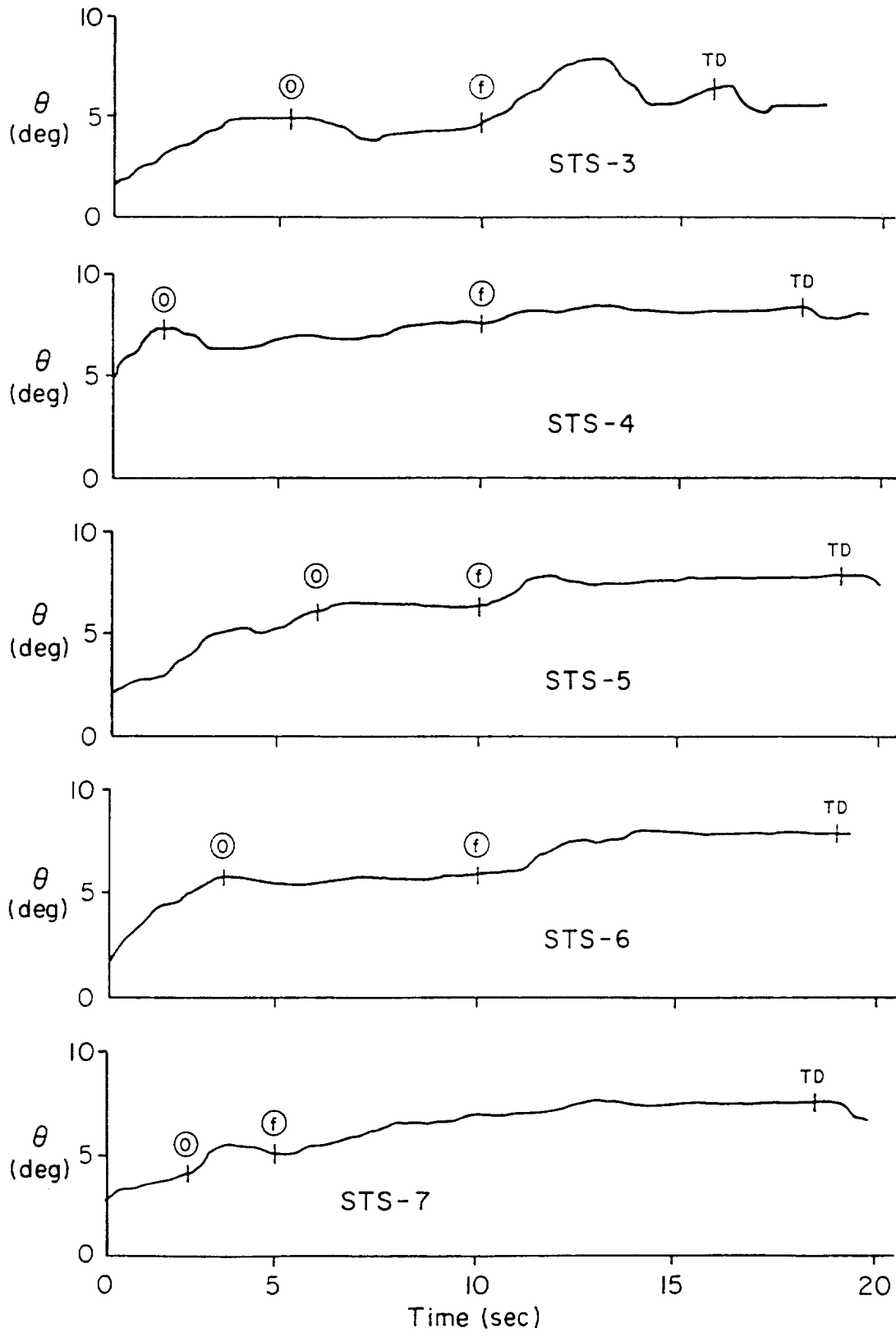
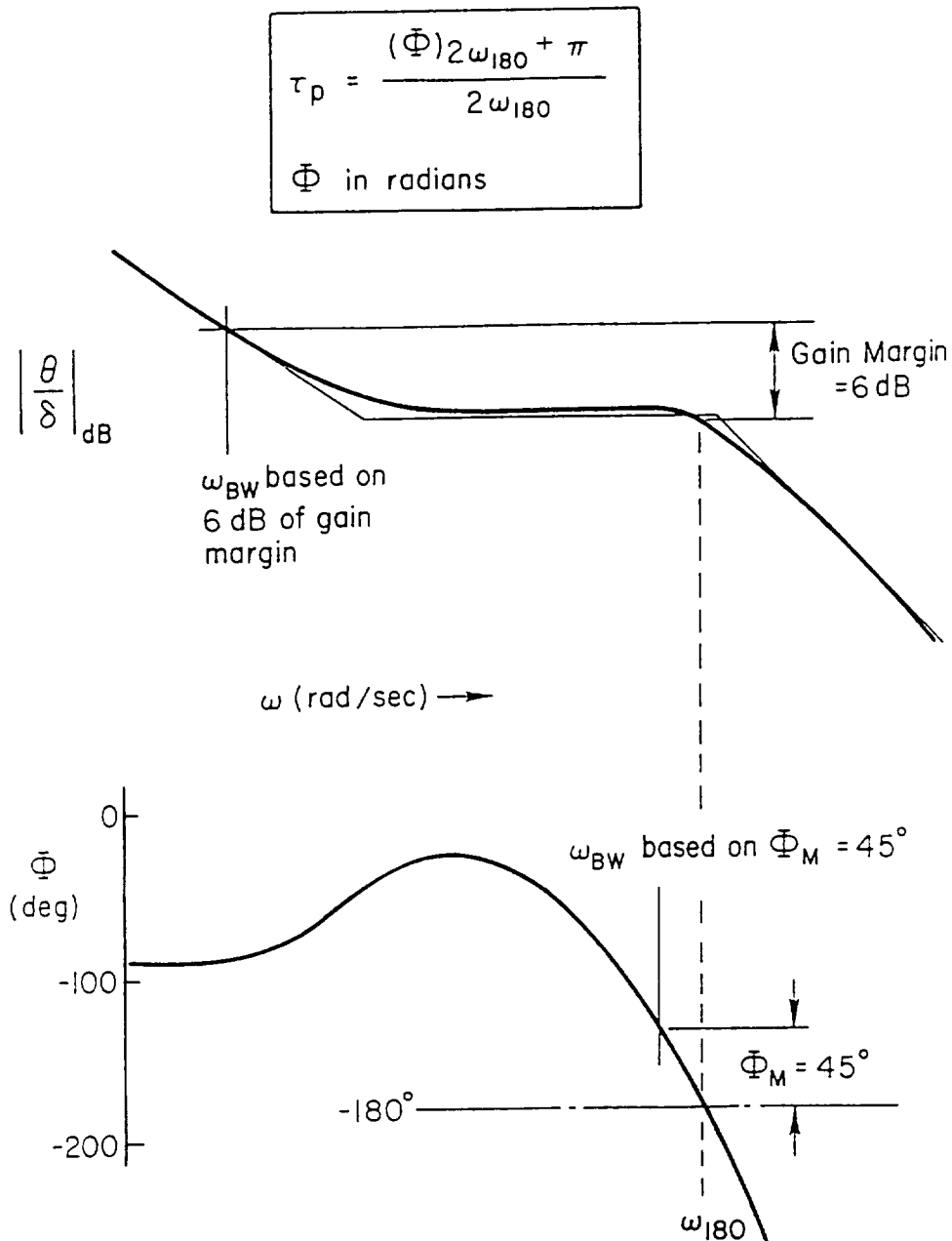

Figure 13. Comparison of Pitch Attitude Responses in the Shuttle Landing Flare



To Obtain Bandwidth:

1. Calculate ω_{BW} based on phase margin
2. Calculate ω_{BW} based on gain margin
3. Use lowest value

Figure 14. Definition of Bandwidth and Phase Delay

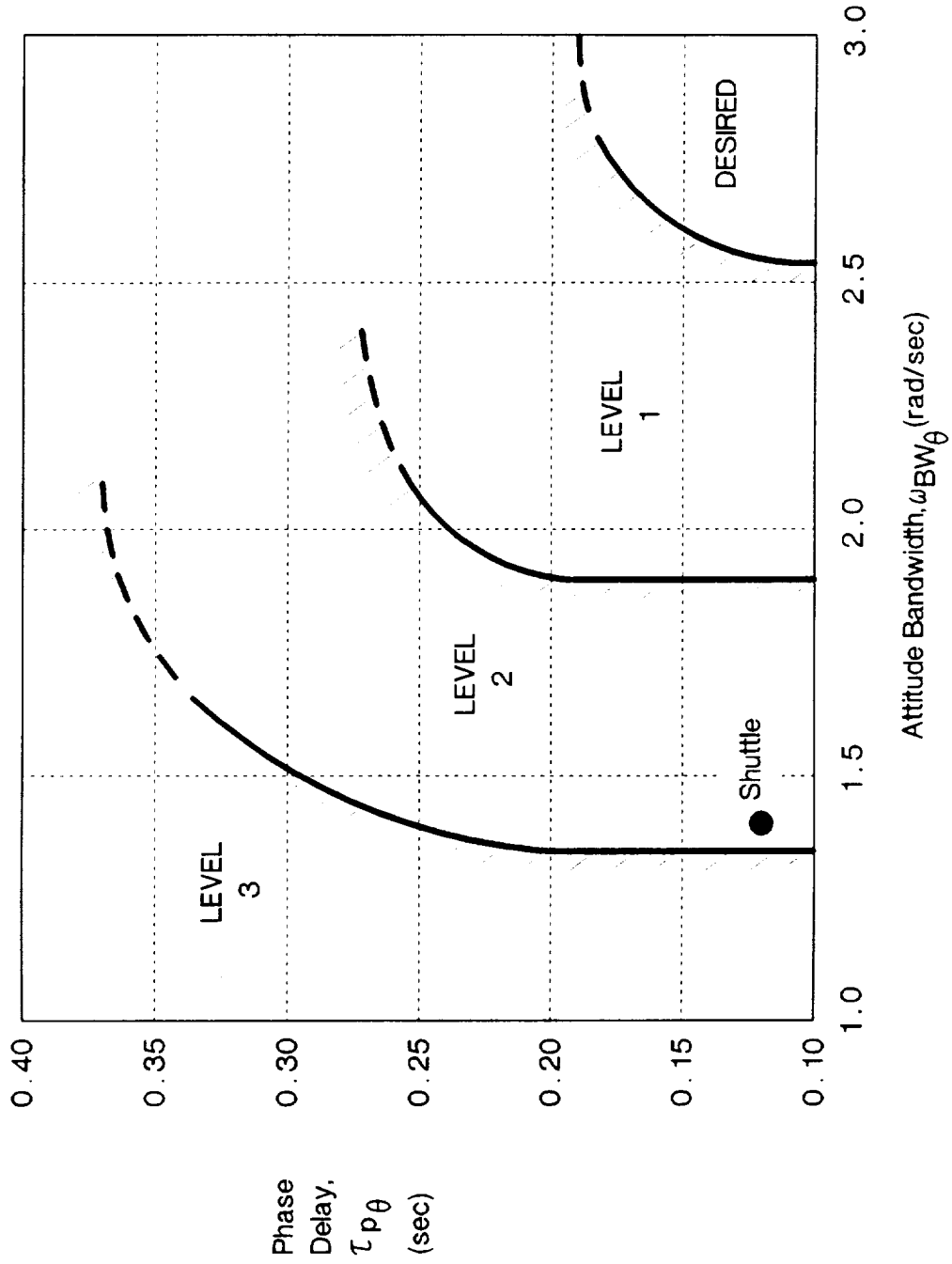

Figure 15. Tentative Requirements for Attitude Bandwidth to Stick

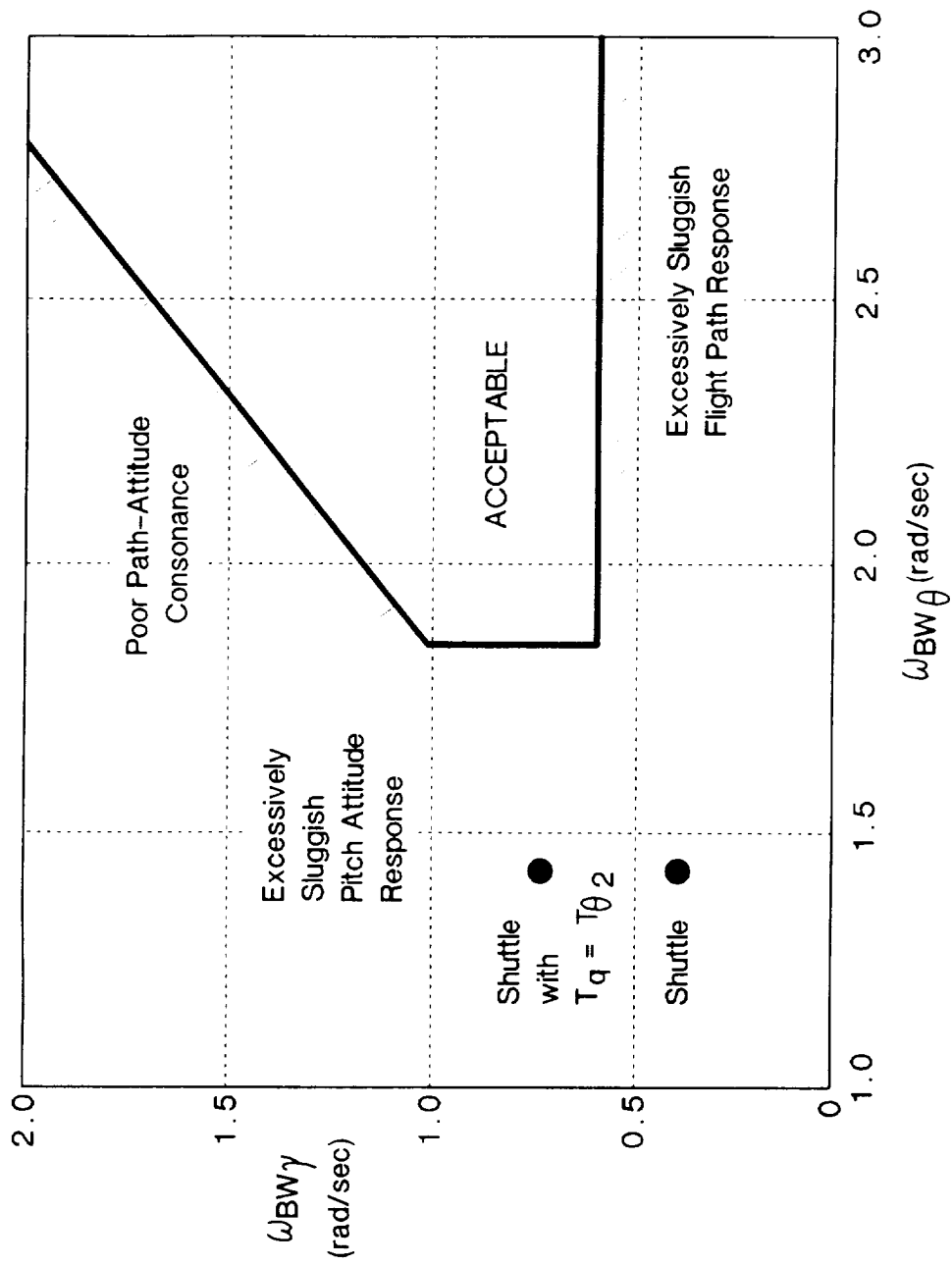
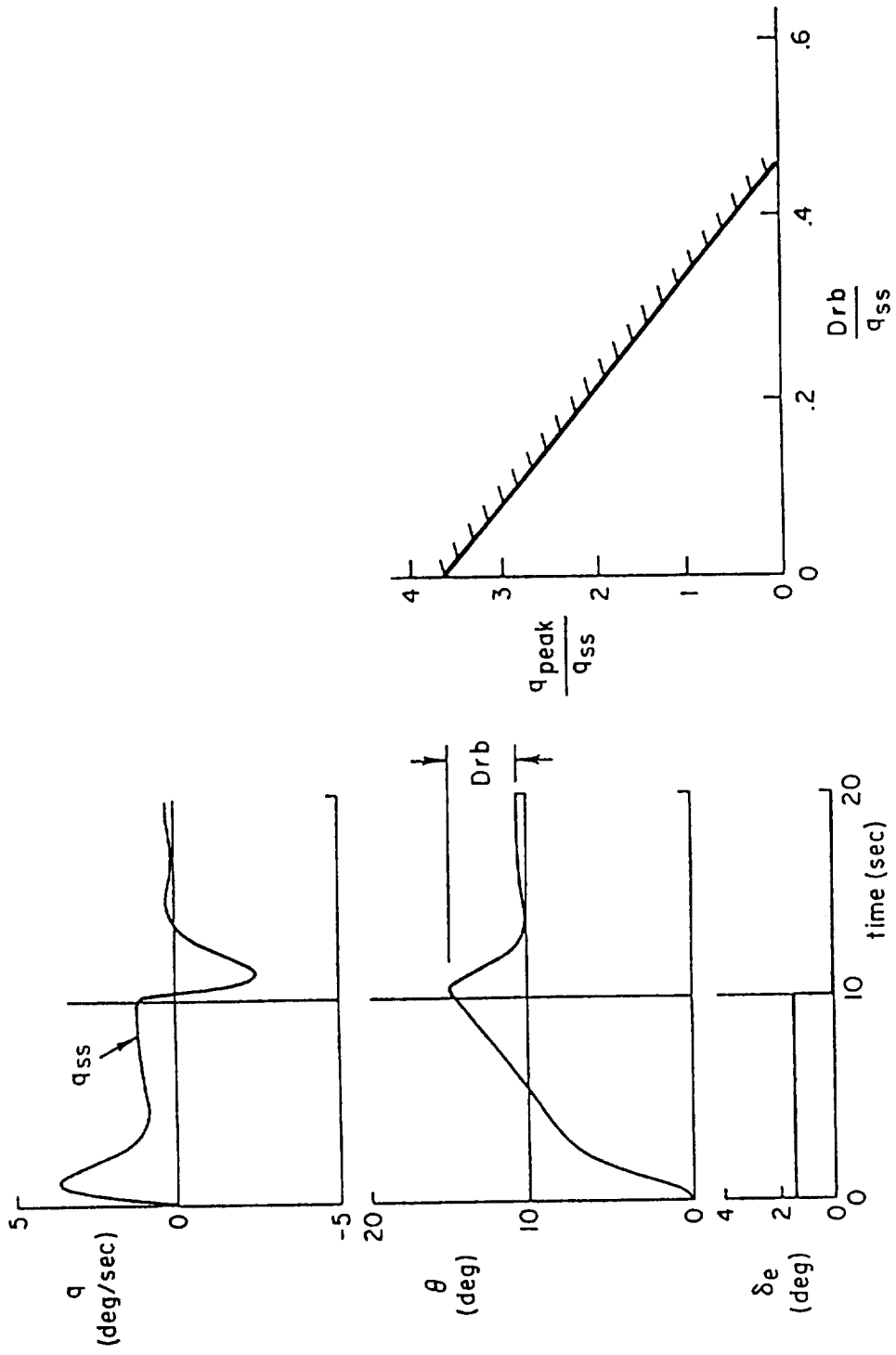

Figure 16. Tentative Requirements for Flight Path Bandwidth to Stick Position



b) Suggested Limit on Drop-Back from Reference 22

a) Definition of Attitude Drop-Back

Figure 17. Drop Back Criterion for Quasi-Open-Loop Flying Qualities

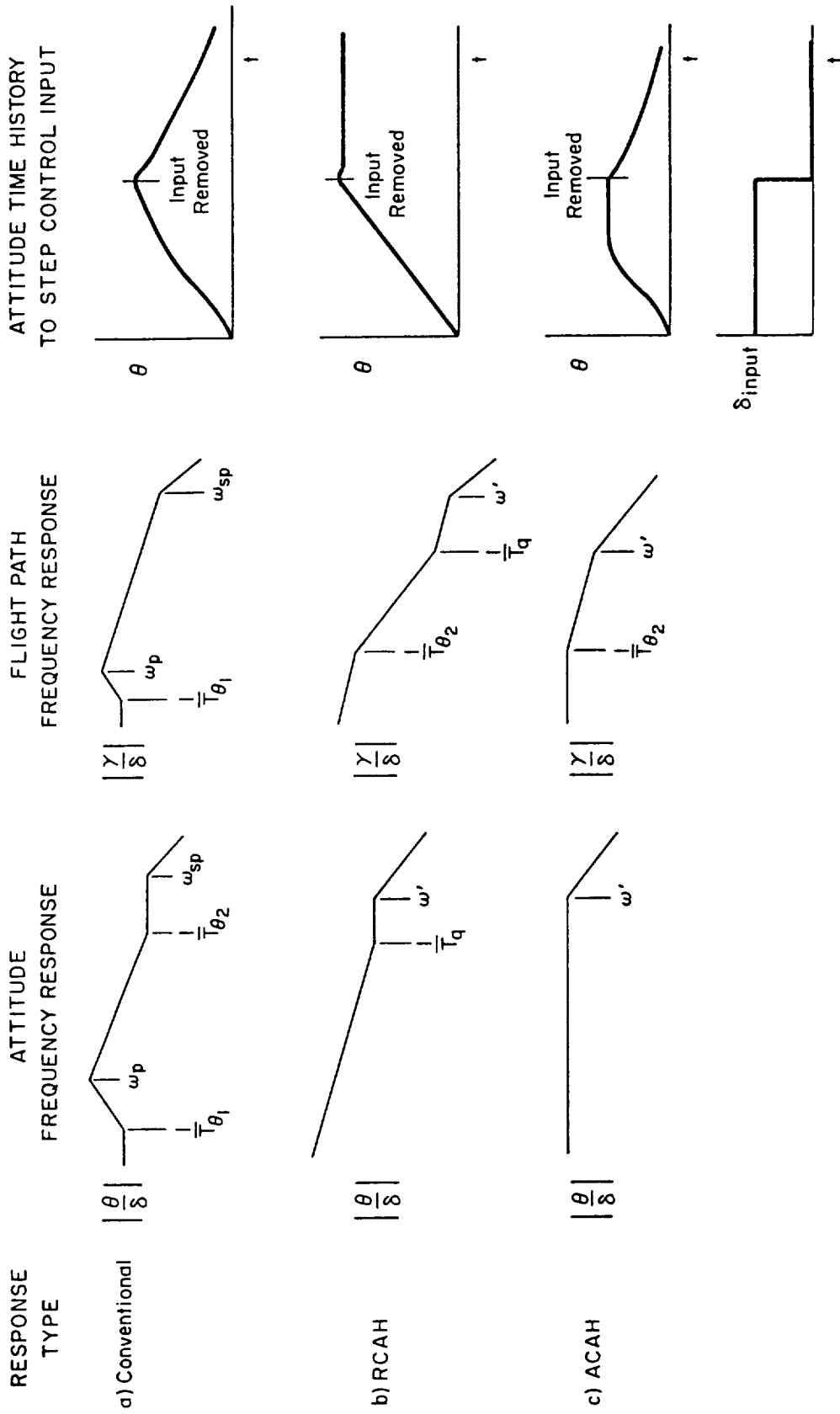
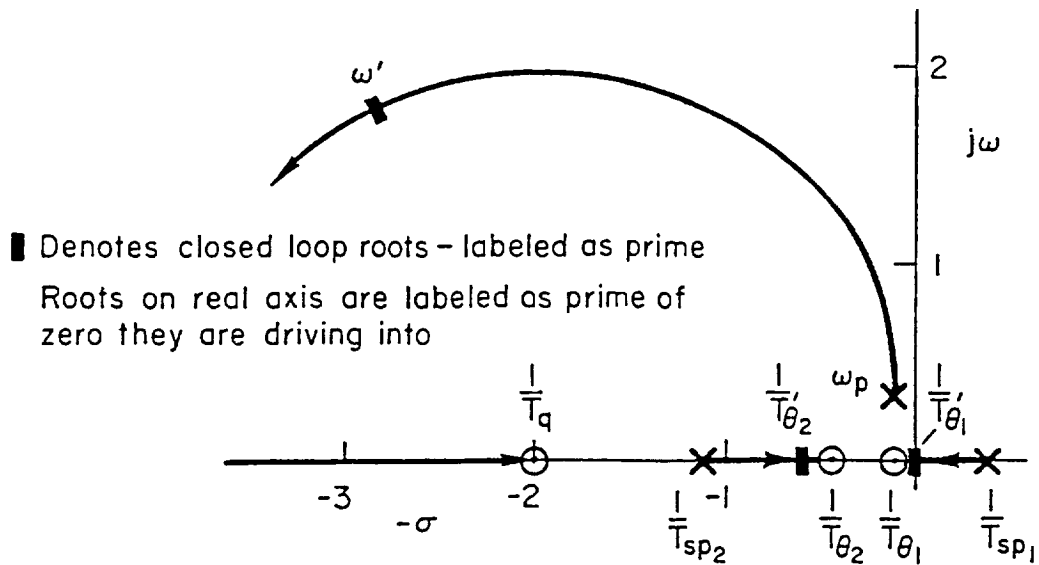
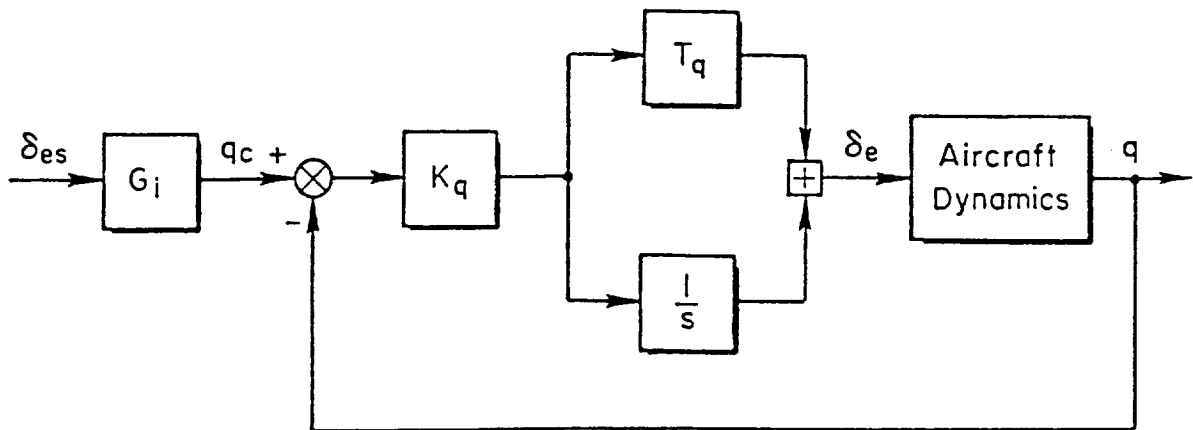

Figure 18. Generic Characteristics of Three Response-Types



For $G_i = K$:

$$\frac{q}{q_c} = \frac{K_q T_q M_{\delta_e} (1/T_{\theta_1})(1/T_{\theta_2})(1/T_q)}{(1/T_{\theta'_1})(1/T_{\theta'_2}) [\zeta' \omega']} = \frac{K_q T_q M_{\delta_e} (1/T_q)}{[\zeta' \omega']}$$

Shorthand Notation: $(1/T) \Rightarrow (s + 1/T)$

$$[\zeta \omega] \Rightarrow s^2 + 2\zeta\omega s + \omega^2$$

Figure 19. Generic Loop Closure Characteristics

Phase Delay:

$$\tau_p = \frac{\Delta\Phi_{2\omega_{180}}}{57.3(2\omega_{180})}$$

Notes: 1) if phase is nonlinear between ω_{180} and $2\omega_{180}$, τ_e shall be determined from a linear least squares fit to phase curve between ω_{180} and $2\omega_{180}$

CAUTION:

For ACAH, if $\omega_{BW_{gain}} < \omega_{BW_{phase}}$, or if $\omega_{BW_{gain}}$ is indeterminate, the aircraft may be PIO prone for super-precision tasks or aggressive pilot technique.

Rate and Conventional Response Types:

ω_{BW} is lesser of $\omega_{BW_{gain}}$ and $\omega_{BW_{phase}}$

Attitude Command/Attitude Hold Response Types (ACAH):

$\omega_{BW} \equiv \omega_{BW_{phase}}$

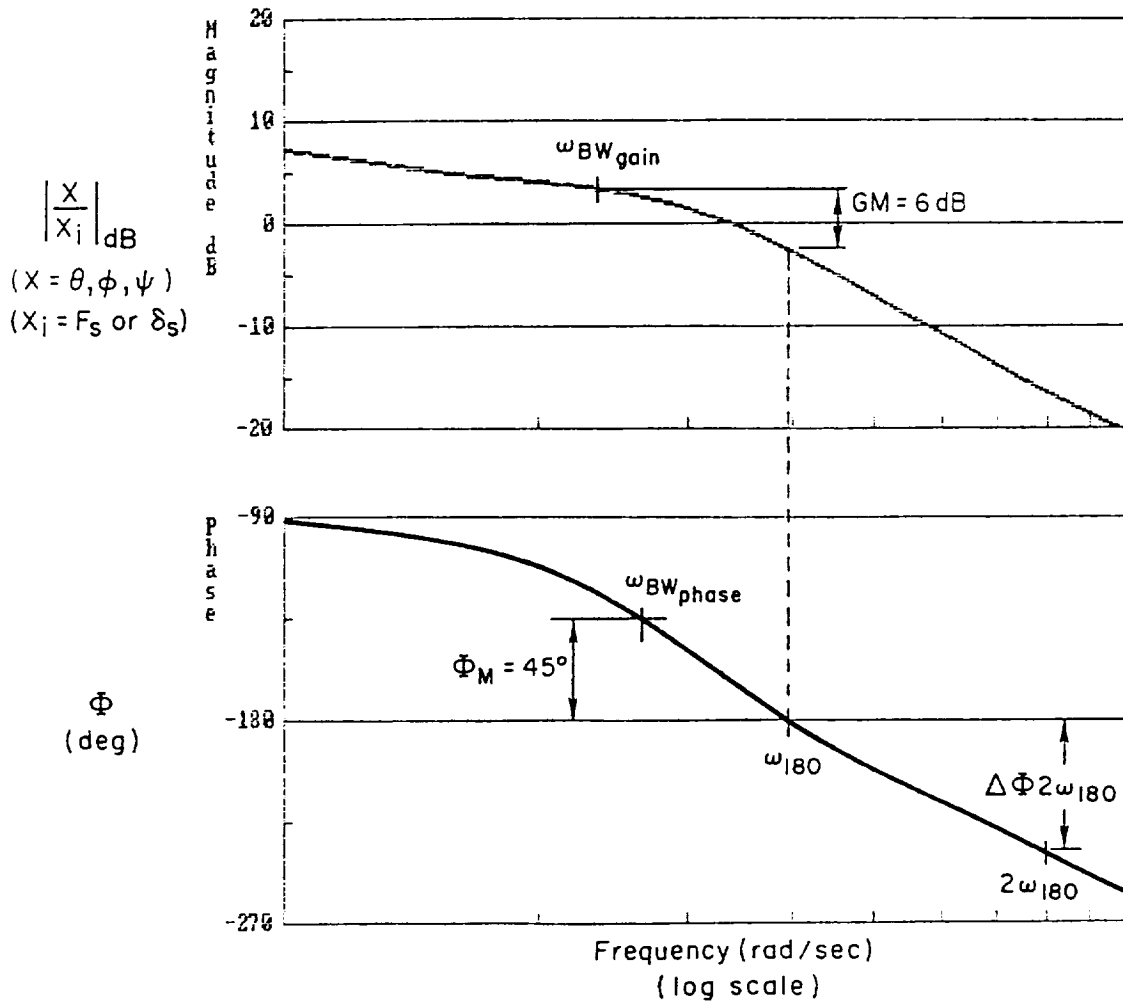

Figure 20. Definitions of Bandwidth and Phase Delay

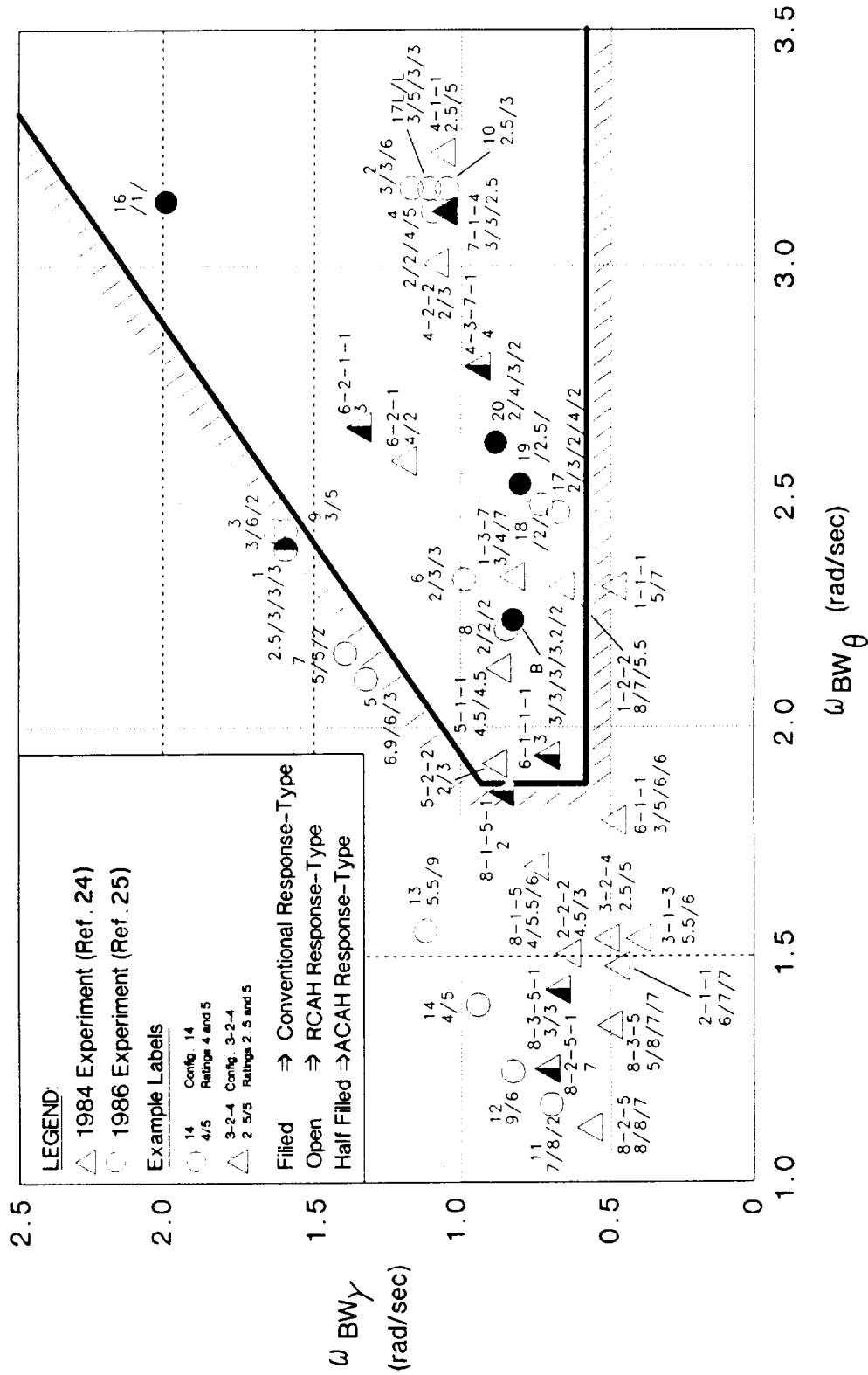

Figure 21. Correlation of Pilot Rating Data with Flight Path and Attitude Bandwidth to Stick Position

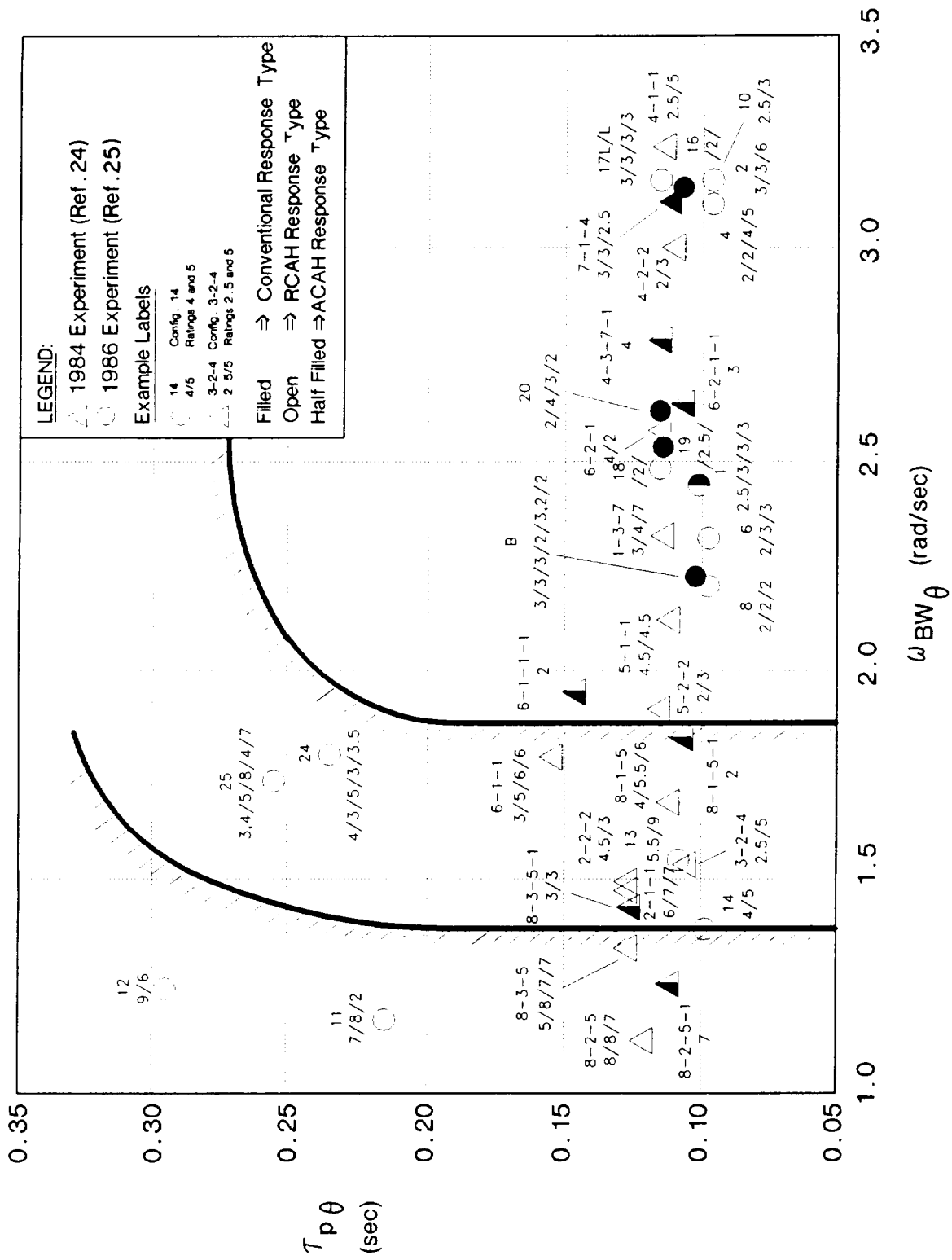
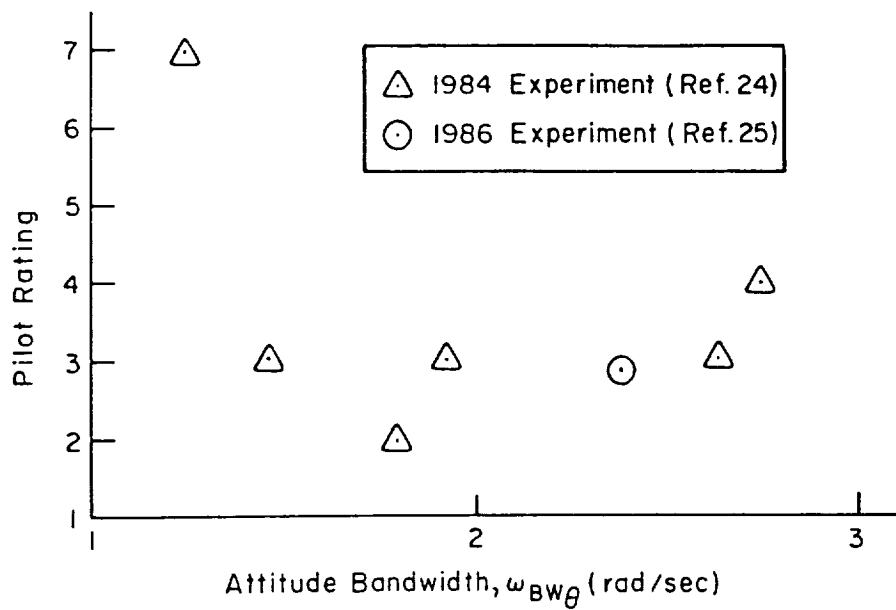
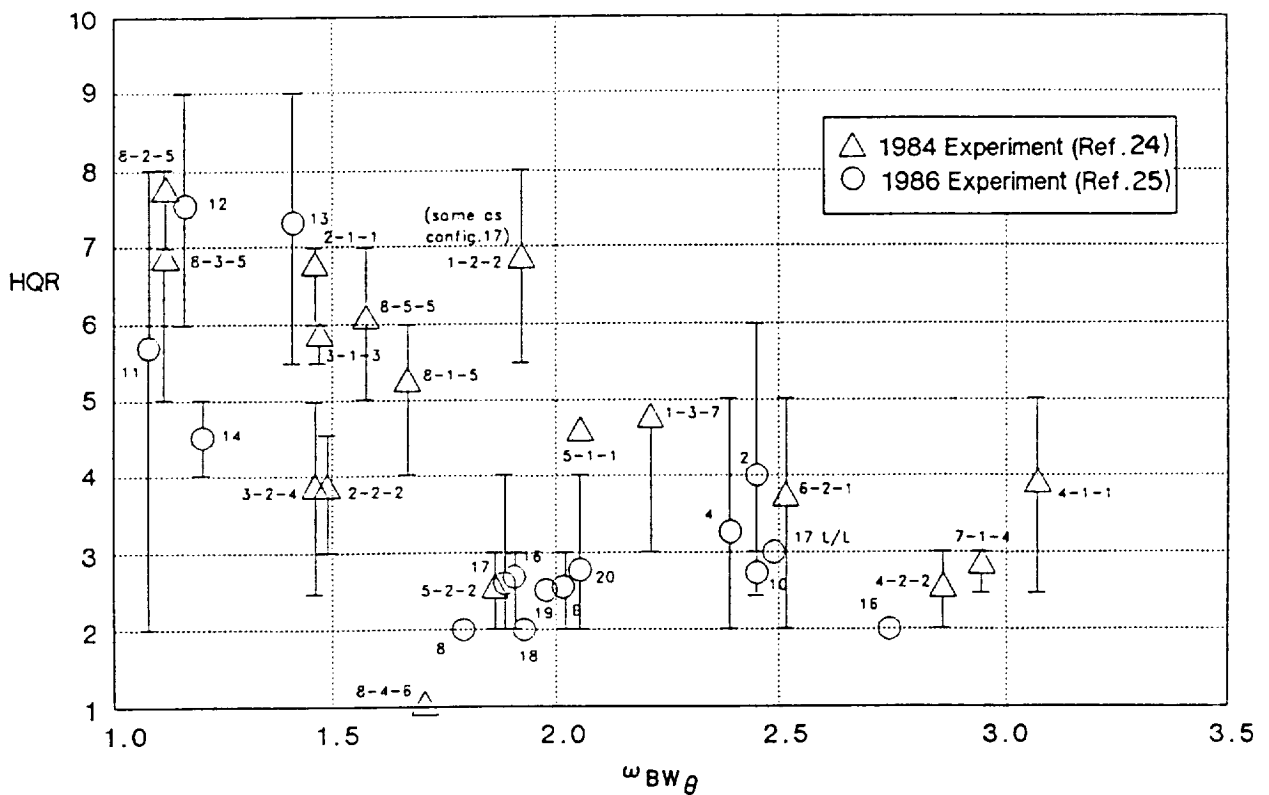

Figure 22. Correlation of Pilot Rating Data with Attitude Bandwidth and Phase Delay to Stick Position



a) ACAH Response Type Data



b) Rate Command, Attitude Hold Response Type
(all meet flight path control criterion boundary in Figure 16)

Figure 23. Pilot Ratings vs Attitude Bandwidth for RCAH and ACAH Response Types

Response Type	
○	RCAH
□	ACAH

CONFIG.	$\omega_{BW\theta}$ (rad/sec)	$\tau_{p\theta}$ (sec)
A	1.7	.13
B	1.2	.26
C	1.6	.18
D	1.8	.17

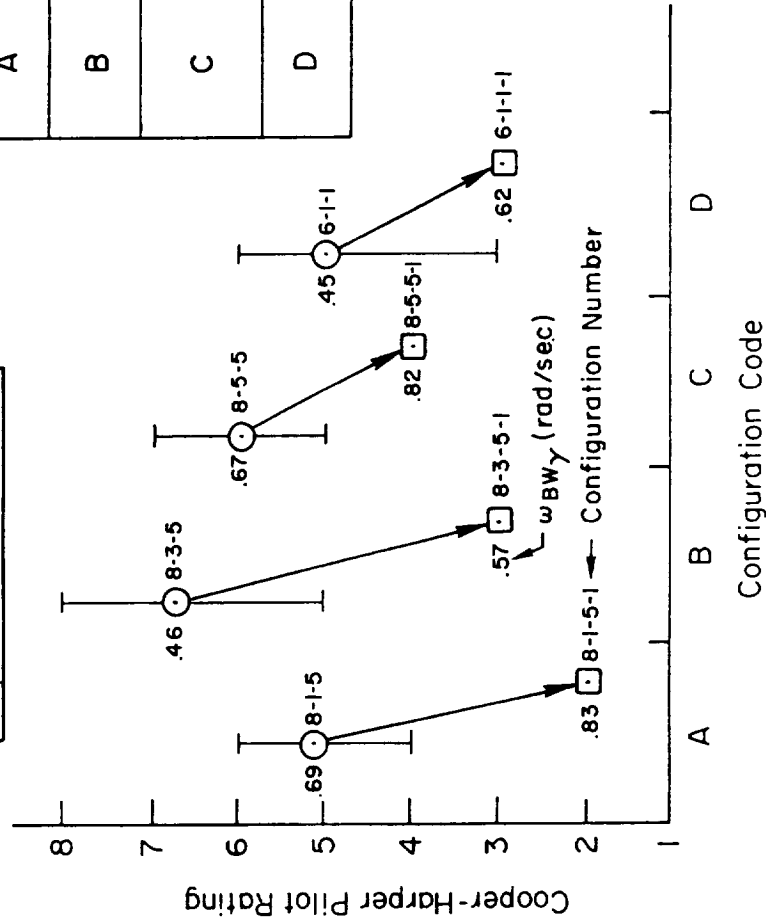

- NOTES:
- 1) BANDWIDTH AND PHASE DELAY WERE ESSENTIALLY UNCHANGED BETWEEN RATE AND ATTITUDE RESPONSE TYPES
 - 2) ATTITUDE WAS OBTAINED FROM RATE RESPONSE TYPE BY INSERTING A WASHOUT PRE-FILTER AT THE OUTPUT OF THE COCKPIT CONTROLLER (e.g., WASHOUT θ_c)
 - 3) TEST DESIGNED TO EVALUATE CONTROL LAWS FOR A GENERIC TRANSPORT (193,000 LB GROSS)

Figure 24. Flight Test Results Showing Effect of Changing From Rate to Attitude Response-Type (TIPS Flared Landing Flight Tests)

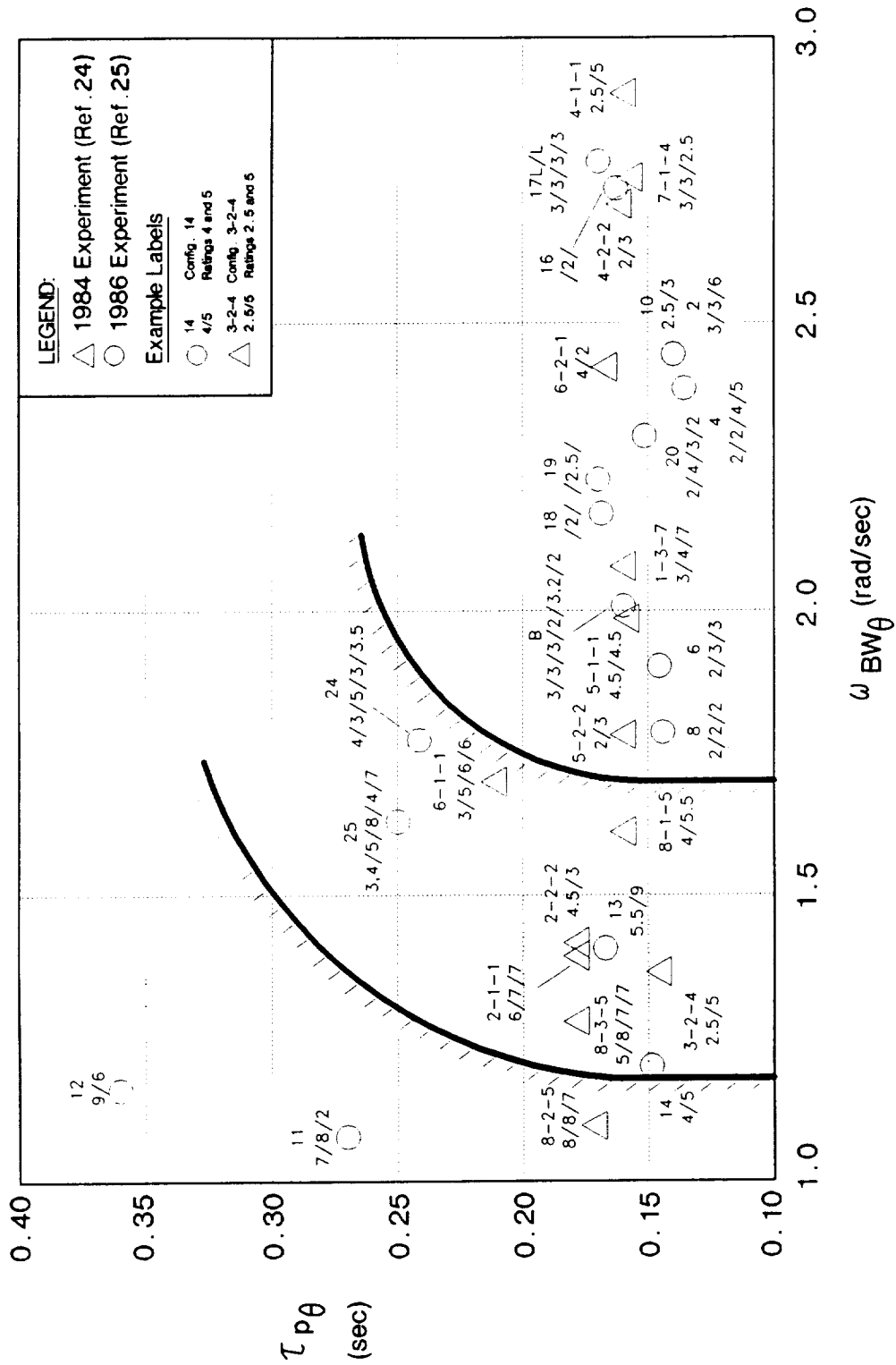

Figure 25. Correlation of Pilot Rating Data with Attitude Bandwidth and Phase Delay to Stick Force

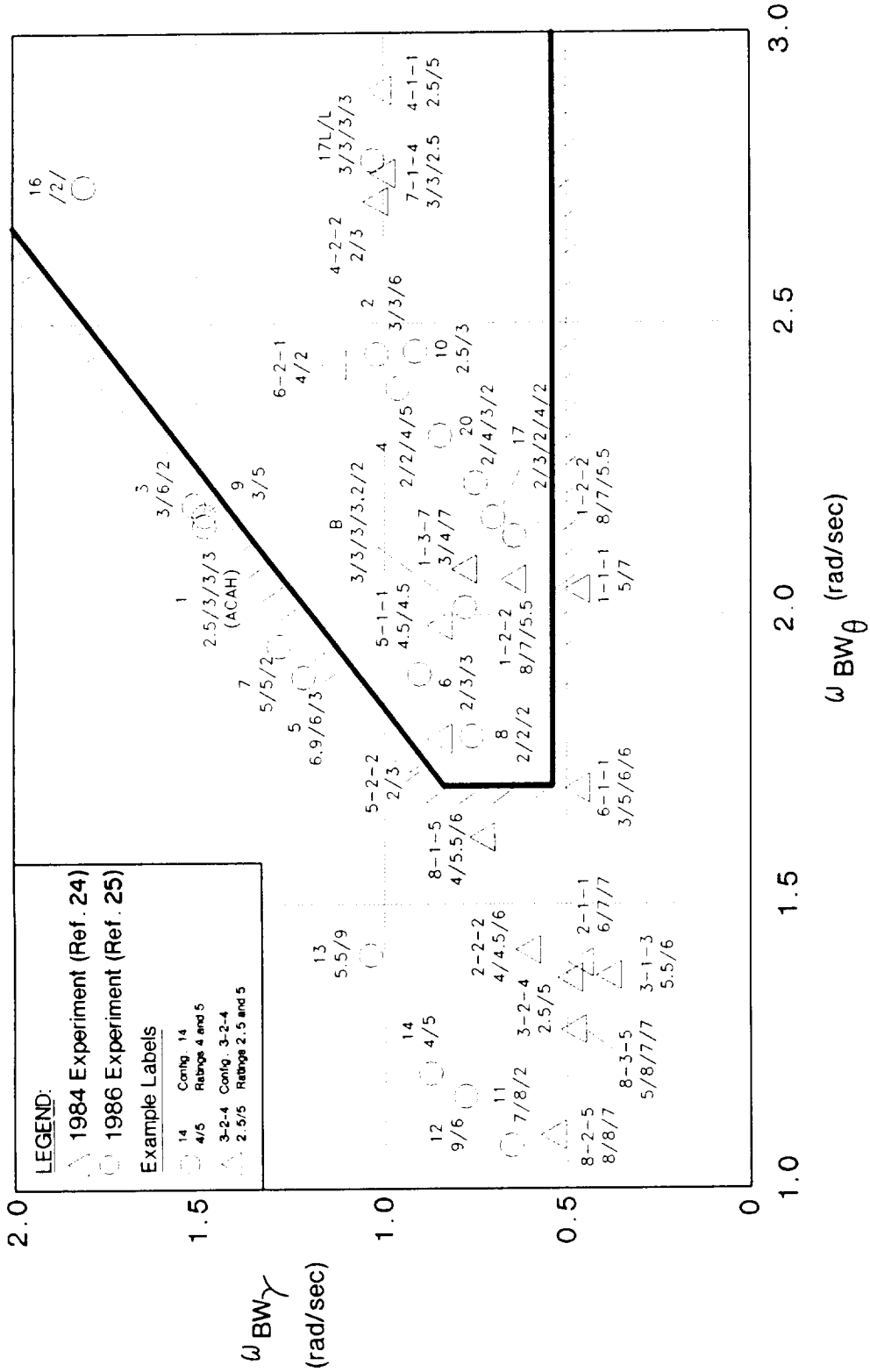

Figure 26. Correlation of Pilot Rating Data with Flight Path and Attitude Bandwidth to Stick Force

REPORT DOCUMENTATION PAGE			Form Approved OMB No. 0704-0188	
Public reporting burden for this collection of information is estimated to average 1 hour per response, including the time for reviewing instructions, searching existing data sources, gathering and maintaining the data needed, and completing and reviewing the collection of information. Send comments regarding this burden estimate or any other aspect of this collection of information, including suggestions for reducing this burden, to Washington Headquarters Services, Directorate for Information Operations and Reports, 1215 Jefferson Davis Highway, Suite 1204, Arlington, VA 22202-4302, and to the Office of Management and Budget, Paperwork Reduction Project (0704-0188), Washington, DC 20503.				
1. AGENCY USE ONLY (Leave blank)	2. REPORT DATE June 1992	3. REPORT TYPE AND DATES COVERED Contractor Report		
4. TITLE AND SUBTITLE Assessment of Flying-Quality Criteria for Air-Breathing Aerospacecraft		5. FUNDING NUMBERS C NAS2-12722 WU 505-64-40		
6. AUTHOR(S) Duane T. McRuer, Thomas T. Myers, Roger H. Hoh, Irving L. Ashkenas, and Donald E. Johnston				
7. PERFORMING ORGANIZATION NAME(S) AND ADDRESS(ES) Systems Technology, Inc. 13766 South Hawthorne Blvd. Hawthorne, CA 90250		8. PERFORMING ORGANIZATION REPORT NUMBER H-1758 STI-TR-2361-2		
9. SPONSORING/MONITORING AGENCY NAME(S) AND ADDRESS(ES) National Aeronautics and Space Administration Washington, DC 20546-0001		10. SPONSORING/MONITORING AGENCY REPORT NUMBER NASA CR-4442		
11. SUPPLEMENTARY NOTES NASA Technical Monitor: Mary Shafer, Dryden Flight Research Facility, Edwards, CA 93523-0273. Performed under Subcontract ATD-88-STI-0221 to PRC Inc., Edwards, CA 93523-0273.				
12a. DISTRIBUTION/AVAILABILITY STATEMENT Unclassified — Unlimited Subject Category 08 Final		12b. DISTRIBUTION CODE		
13. ABSTRACT (Maximum 200 words) A study of flying quality requirements for air-breathing aerospacecraft gives special emphasis to the unusual operational requirements and characteristics of these aircraft, including operation at hypersonic speeds. The report considers distinguishing characteristics of these vehicles, including dynamic deficiencies and their implications for control. Particular emphasis is given to the interaction of the airframe and propulsion system, and the requirements for dynamic systems integration. Past operational missions are reviewed to define tasks and maneuvers to be considered for this class of aircraft. Areas of special concern with respect to vehicle dynamics and control are identified. Experience with the space shuttle orbiter is reviewed with respect to flight control system mechanization and flight experience in approach and landing flying qualities for the National Aero-Space Plane (NASP).				
14. SUBJECT TERMS Air-breathing aerospacecraft; Approach and landing; Flying qualities criteria; NASP		15. NUMBER OF PAGES 80		16. PRICE CODE A05
17. SECURITY CLASSIFICATION OF REPORT Unclassified	18. SECURITY CLASSIFICATION OF THIS PAGE Unclassified	19. SECURITY CLASSIFICATION OF ABSTRACT Unclassified	20. LIMITATION OF ABSTRACT Unlimited	