

**NASA
Technical
Paper
3200**

June 1992

97841

P.19

Experimental Measurement of the Orbital Paths of Particles Sedimenting Within a Rotating Viscous Fluid as Influenced by Gravity

**David A. Wolf
and Ray P. Schwarz**

(NASA-TP-3200) EXPERIMENTAL MEASUREMENT OF
THE ORBITAL PATHS OF PARTICLES SEDIMENTING
WITHIN A ROTATING VISCOUS FLUID AS
INFLUENCED BY GRAVITY (NASA) 19 p

N92-29377

Unclass

H1/54 0097841



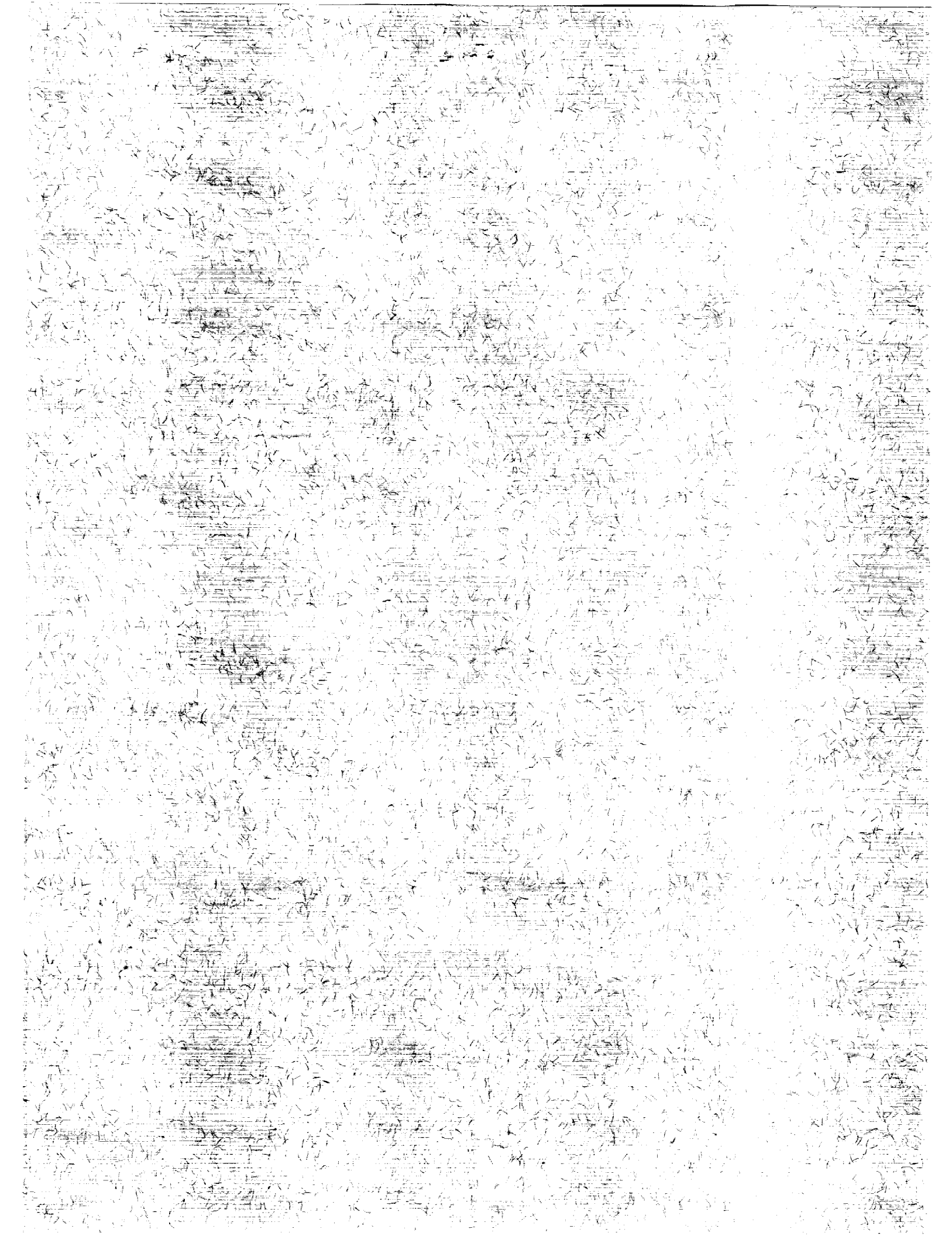

**NASA
Technical
Paper
3200**

1992

**Experimental Measurement
of the Orbital Paths of
Particles Sedimenting
Within a Rotating
Viscous Fluid as
Influenced by Gravity**

David A. Wolf
*Lyndon B. Johnson Space Center
Houston, Texas*

Ray P. Schwarz
*KRUG Life Sciences, Inc.
Houston, Texas*



National Aeronautics and
Space Administration
Office of Management
Scientific and Technical
Information Program



CONTENTS

I. Abstract	1
II. Methodology	1
III. General Particle Path Description (Unit Gravity)	2
IV. Particle Sedimentation Speed (in a Rotating Fluid)	5
V. Effect of Gravity on Particle Path	8
VI. Effect of Rotation Rate on Particle Path	11
VII. Effect of Initial Position on Particle Path	13
VIII. Conclusions and Error Analysis	14

TABLES

TABLE 1. COMPARISON OF LINEAR 1 G SEDIMENTATION RATE WITH PARTICLE SPEED IN ROTATING VESSEL	5
---	---

FIGURES

Figure 1. Particle Orbital Path General Shape	3
Figure 2. Rotating Reference Frame	4
Figure 3. Effect of Particle Sedimentation Rate on Particle Path	7
Figure 4. Effect of Gravitational Strength on Particle Path	8
Figure 5. "Zero" Gravity Particle Path	9
Figure 5A. "Zero" Gravity Particle Orbital Path as Observed from the Nonrotating External Reference Frame	10
Figure 6. Effect of Angular Rotation Rate on Particle Path	11
Figure 7. Effect of Angular Rotation Rate on Particle Path as Viewed from External Nonrotating Reference Frame	12
Figure 8. Effect of Initial Position on Particle Path	13



I. Abstract

Measurements were taken of the path of a simulated typical tissue segment, or particle, within a rotating fluid as a function of gravitational strength, fluid rotation rate, particle sedimentation rate, and particle initial position. Parameters were examined within the useful range for tissue cultures in the NASA rotating wall culture vessels. The particle moves through the fluid along a nearly circular path (as observed from the rotating reference frame of the fluid) at the same speed as its linear terminal sedimentation speed for the external gravitational field. This gravitationally induced motion causes an increasing deviation of the particle from its original position within the fluid for a decreased rotational rate, for a more rapidly sedimenting particle, and for an increased gravitational strength. Under low gravity conditions (<0.1 g), both the particle's motion through the fluid and its deviation from its original position become negligible. Under unit gravity conditions, large distortions (> 0.25 inch) occur even for particles with a slow sedimentation rate (< 1.0 cm/sec). The particle's motion is nearly independent of its initial position. Comparison with mathematically predicted particle paths show that a significant error in the mathematically predicted path occurs for large particle deviations. This results from a geometric approximation and a numerically accumulating error in the mathematical technique.

II. Methodology

A vessel for lateral visualization of the orbital path of particles suspended within water was constructed from clear lexan plastic. The vessel lateral wall was calibrated with radial lines at 5 degree increments and with concentric circles with a separation of 0.25 inch. This device was placed on the same rotator base used for cell cultures in the NASA Slow Turning Lateral Vessel (STLV) and mounted with a video camera and gravity meter on a pallet designed for the NASA KC-135 zero gravity airplane. This allows 25 seconds of gravity below 0.1 g. A simulated typical tissue consisting of a nearly spherical piece of sponge was placed within the water filled vessel. The linear terminal sedimentation speed of the particle within the water was measured 5 times with a stop watch and ruler. Videotapes of the rotating fluid-particle system were recorded for the various rotational rates, particle sedimentation rates, and gravitational conditions considered. The vessel rotational rate was measured by averaging the results of 5 time measurements, each consisting of 5 vessel rotations. Each digital video still frame was analyzed by measuring the particle's position against the calibrated vessel wall as a function of angular vessel position. The particle position was measured for 8 equally spaced vessel angular positions (45 degree increments) for a single vessel revolution. Data from 5 vessel revolutions was taken for each condition tested. In some cases only 4 revolutions of data were available. All measured data was averaged and standard deviations calculated. The speed of the particle motion through the fluid was experimentally determined by measuring the distance from the particle's initial point to the next point (45 degrees of vessel revolution) and dividing by the time for that motion. The formula for distance between two points in polar coordinates was applied directly to the particle position data. This produced 7 speed calculations for each vessel revolution. The 35 speed measurements (data from 4 or 5 revolutions) were then averaged and a standard deviation calculated. This will slightly underestimate the actual particle speed because the particle's true path between these points is actually slightly curved. These paths are nearly the chords of a circle defined by an octagon placed within that circle. A correction factor of 1.02 is applied which is the ratio of the circumference of a circle to the parameter of an octagon inscribed within that circle.

III. General Particle Path Description (Unit Gravity)

The paths of simulated tissue particles, which sediment at 0.84 cm/sec (SD = 0.04) and 4.6 cm/sec (SD = 0.54), were measured for the conditions which follow:

1.	Unit Gravity	High RPM	Low Radius	Low Sedimentation Rate
2.	High Gravity	Low RPM	Low Radius	Low Sedimentation Rate
3.	Unit Gravity	Low RPM	Low Radius	Low Sedimentation Rate
4.	Unit Gravity	High RPM	High Radius	Low Sedimentation Rate
5.	Zero Gravity	Low RPM	Low Radius	Low Sedimentation Rate
6.	Unit Gravity	High RPM	Low Radius	High Sedimentation Rate

These terms are defined as follows:

Unit Gravity	-	1.0 g
Zero Gravity	-	< 0.1 g (Obtained on NASA KC-135)
High Gravity	-	1.7 g (Obtained on NASA KC-135)
Low RPM	-	< 10 rpm
High RPM	-	> 15 rpm
Low Radius	-	(Initial Particle Radius = 1.5 inch)
High Radius	-	(Initial Particle Radius = 2.5 inch)
Low Sedimentation Rate	-	0.84 cm/sec (SD = 0.04)
High Sedimentation Rate	-	4.6 cm/sec (SD = 0.54)

In each case in which gravity is present the orbital path of the particle is of the same general shape. This path for condition 1 is shown in figure 1 as observed from the external nonrotating reference frame. In this reference frame the observer "sees" a fixed gravity vector and a rotating vessel. The "O" symbols are the measured particle positions. The standard deviation of the 4 or 5 measurements for each point falls within the "O" symbol. The "+" symbols are the corresponding points calculated from the mathematical model of particle motion. The plotted points correspond to the suspended particles' position at the times when the rotating vessel has transcribed 45 degree increments in angular position. The "trajectory variables" at the left of the figures are the input data for the mathematical model ("+" symbols). These trajectory variables match the corresponding values for the experimentally measured data.

The variables have the following meaning:

- Vsg - Particle Linear Unit Gravity Terminal and Sedimentation Rate
- gfac - Gravitational Field Ratio (Actual g/unit g)
- Rot # - Number of Rotations Modeled
- RPM - Fluid Angular Rotational Rate
- Rtissue - Initial Particle Radius
- Roves - Outer Vessel Wall Radius
- Rives - Inner Vessel Wall Radius

The smallest scale dimensions in the figures are half inches. Throughout the remainder of this document, when a variable is changed to determine its effect on particle motion, the other variables are held constant. One exception is the particle's initial radial position. The mathematical model and data presented in section VII of this document show that the absolute dimensions of the particle's motion are largely independent of this initial position. This is true for conditions under which centrifugation and coriolis forces are not major contributors to the particle's motion over a single revolution. This same constraint applies to the practical operating range of the NASA rotating wall vessel. The mathematical predictions are from the NASA TP 3143 titled "Analysis of Gravity Induced Particle and Fluid Perfusion Flow in the NASA Designed Rotating Zero Head Space Tissue Culture Vessel."

- Sedimentation Rate = 0.84 cm/sec
- Gravity = 1.1 g
- RPM (ω) = 2.2 rpm
- + mathematically predicted points
- o experimentally measured points

Trajectory Variables	
Vsg	0.840
gfac	1.100
Rot #	1.215
RPM	22.100
Rtissue	1.900
Roves	3.000
Rives	0.250

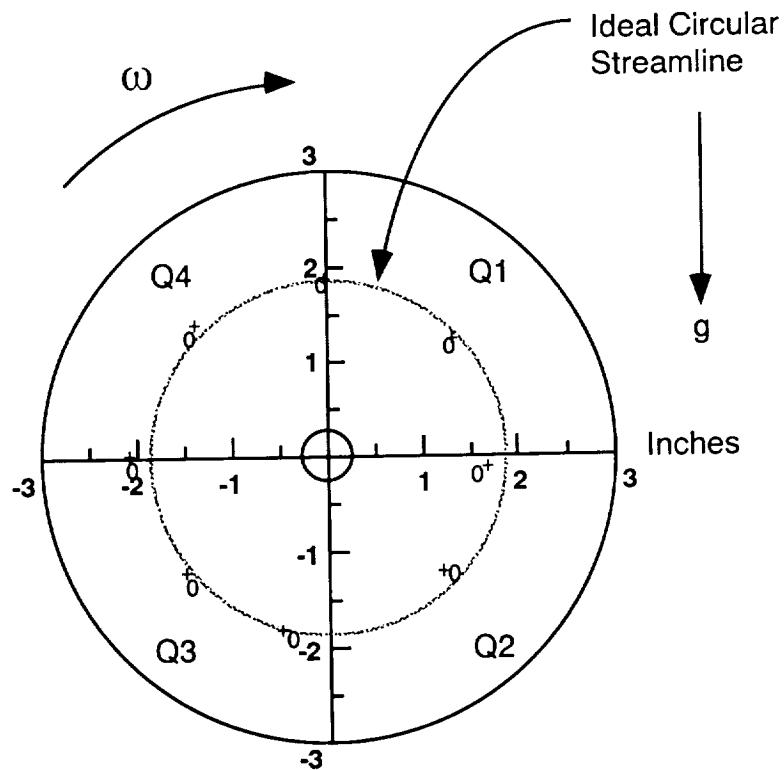

Figure 1. Particle Orbital Path General Shape.

In the first quadrant (Q1) of figure 1, the particle deviates inward and ahead of its original position in the rotating fluid. In the second quadrant (Q2), the particle advances further in phase and moves back radially outward toward its original radius. In the third quadrant (Q3), the particle phase lags nearly to its original angular position and moves radially outward beyond the original radius. In the fourth quadrant (Q4), the particle moves radially inward toward its original radius and lags slightly in phase from its original angular position in the fluid. Over the course of a single 360 degree revolution the particle deviates in position from the ideal circular streamline (dotted line) and returns nearly to its original position.

The particle path may be observed from the reference frame of the rotating fluid. Figure 2 is the same data as figure 1 plotted in this rotating reference frame from which the gravity vector appears to rotate. From this perspective the particle is seen to move through the fluid in a nearly circular path as its velocity tracks the rotating gravity vector. As in the nonrotating external reference frame, the particle returns nearly to its original position during a single 360 degree revolution.

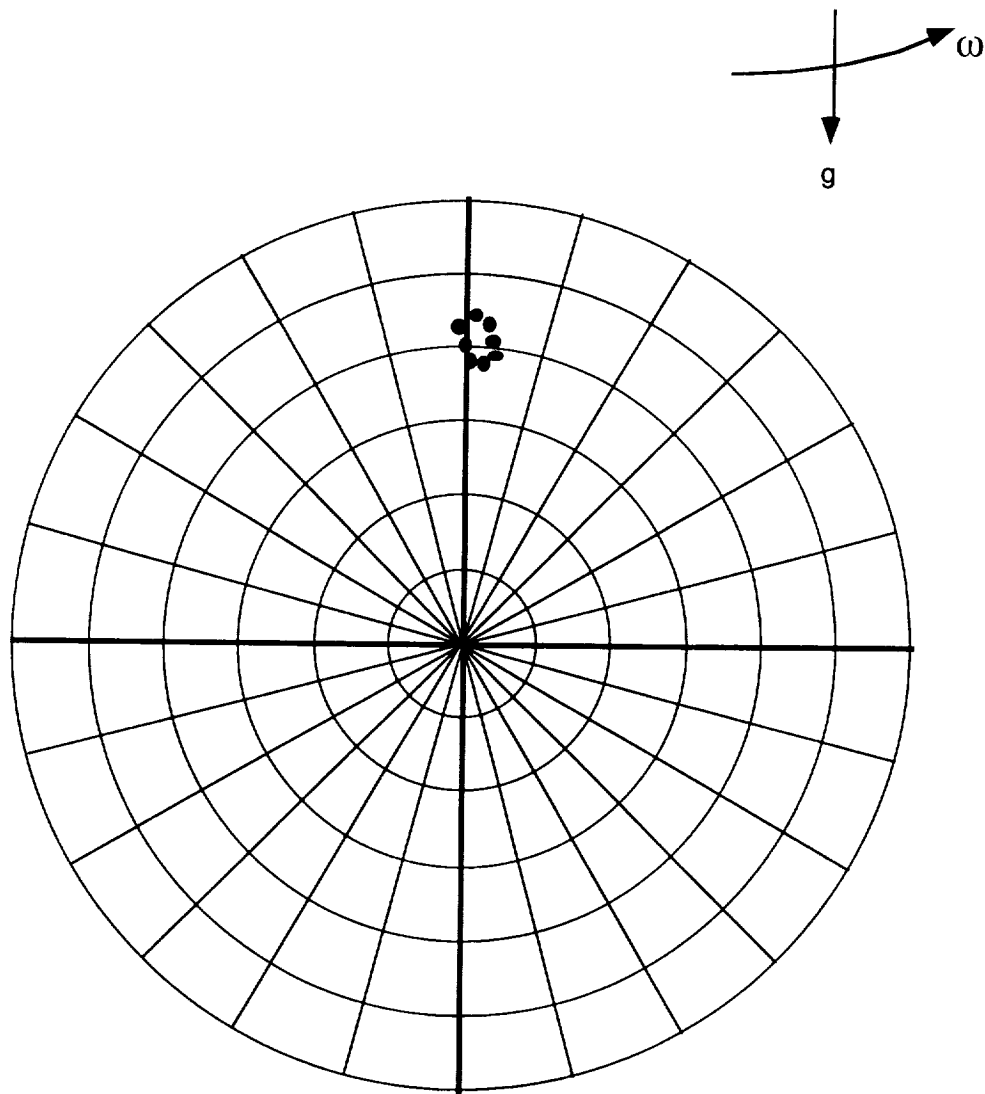

Figure 2. Rotating Reference Frame.

The particle path in figure 1 as observed from the fixed reference frame translates to the path in figure 2 when observed from the rotating reference frame of the fluid. The rest of this analysis will utilize the reference frame in which the effect under study is most readily observable. In general the rotating reference frame produces the simplest image of the deviation of the particle through the fluid medium.

IV. Particle Sedimentation Speed (in a Rotating Fluid)

Table 1 compares the unit gravity linear terminal sedimentation speed through water with the measured speed of the particle's motion through the rotating fluid. This is done to determine if the speed at which the typical tissue particle moves through the fluid medium is significantly altered by rotation at the useable angular rotation rates used during tissue culture with the NASA rotating wall culture vessels. Average particle speeds over 315 degrees of rotation are tabulated, with standard deviations for the measurements in parenthesis. The delta is the difference between the linear 1 g terminal sedimentation rate and the average speed in the rotating vessel. The percentage delta is the percentage change from the linear sedimentation rate. For the high g (1.7 g) and low g (zero g) cases the delta and percentage delta are not directly meaningful and are labeled N/A.

TABLE 1. COMPARISON OF LINEAR 1 G SEDIMENTATION RATE WITH PARTICLE SPEED IN ROTATING VESSEL

	Condition: RPM G	Linear 1 G Sedi- mentation Rate (SD)	Average Speed in Rotating Vessel (SD)	Delta	% Delta
1.	17.75 rpm 1.0 g	0.85 cm/sec (0.04)	0.85 cm/sec (0.28)	0.0	0.51 %
2.	22.13 rpm 1.7 g	0.84 (0.04)	1.46 (0.40)	N/A	N/A
3.	8.64 rpm 1.0 g	0.84 (0.04)	0.94 (0.21)	0.10	11.83
4.	17.94 rpm 1.0 g	0.85 (0.04)	0.92 (0.31)	0.07	8.64
5.	23.13 rpm 0 g	0.84 (0.04)	0.03 (0.12)	N/A	N/A
6.	23.24 rpm 1.0 g	4.6 (0.54)	5.47 (0.65)	0.86	18.79

Inspection of this data demonstrates that, within the precision of our measurements, the speed of the particle's motion through the rotating fluid medium is the same as its terminal sedimentation rate through a stationary fluid (in the same unit gravitational field). **Rotation, therefore, does not remove gravity-induced sedimentation of particles through the suspending media for the range of rotation rates and particle sedimentation rates within the operating range of the NASA rotating tissue culture systems.** Note that for the low g (zero g) case the particle speed through the rotating medium is negligible and for the high g (1.7 g) case there is the expected increase in the particle's speed by a 1.7 factor.

Particle sedimentation rate alters the path of the particle through the rotating medium. Figure 3 shows the path, in the rotating reference frame, of a particle with lower sedimentation rate on the left. The diameter of the nearly circular path is reduced for the lower sedimentation rate. This effect limits the maximum particle sedimentation rate which may be maintained without impacting the vessel wall (at a given angular rotation rate).

Rotating Reference Frame

$$\text{RPM } (\omega) = 22.5 \text{ rpm } (+/- 1.0)$$

$$\text{Gravity} = 1.05 \text{ g } (+/- 0.1)$$

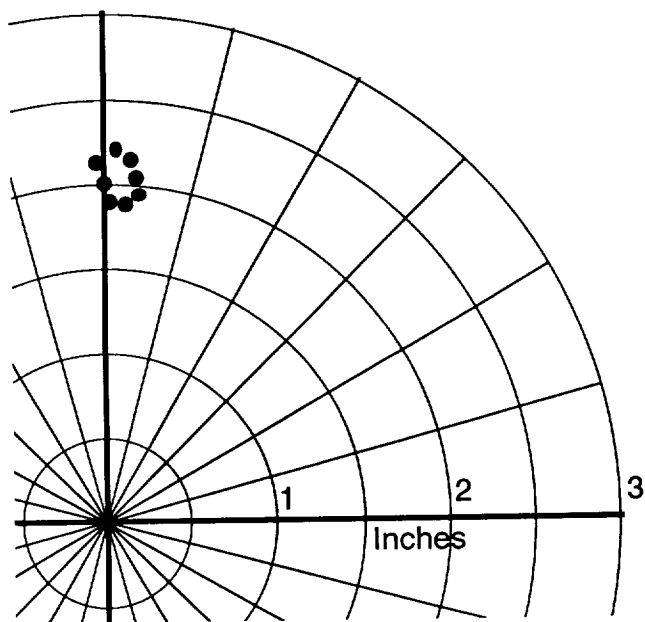
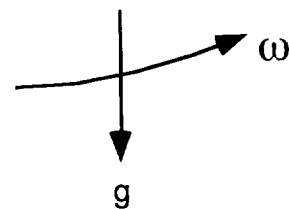

Low Sedimentation Rate
(0.84 cm/sec)

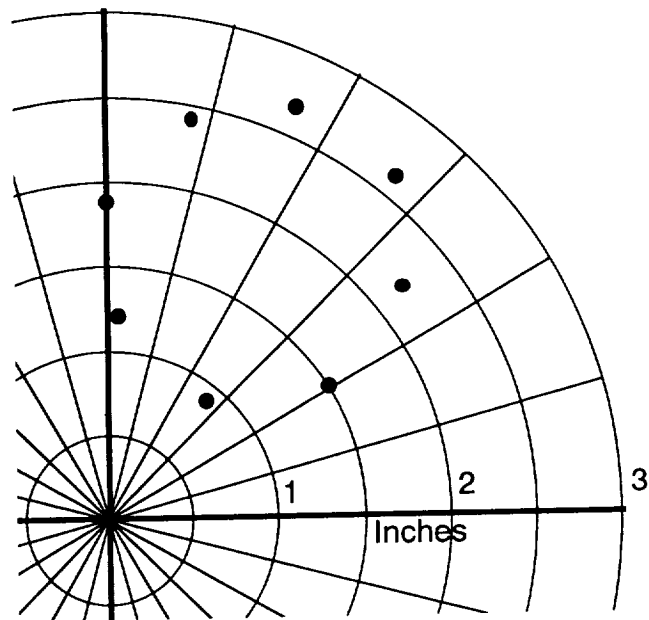

High Sedimentation Rate
(4.6 cm/sec)

Figure 3. Effect of Particle Sedimentation Rate on Particle Path.

V. Effect of Gravity on Particle Path

Figure 4 compares the path of the particles under conditions of 1 g (on the left) and 1.7 g (on the right) as observed from the rotating reference frame.

Rotating Reference Frame

RPM (ω) = 22.1 rpm (+/- 0.2)

Sedimentation Rate = 0.84 cm/sec (+/- 0.04)

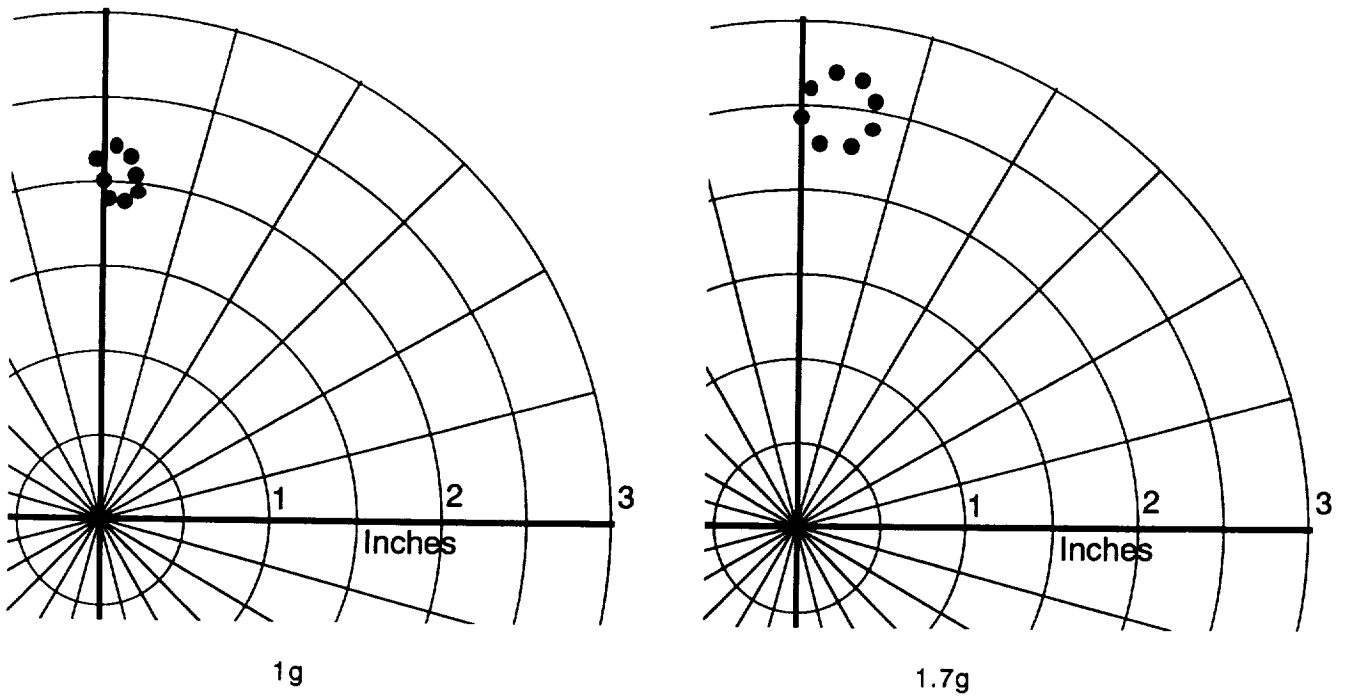
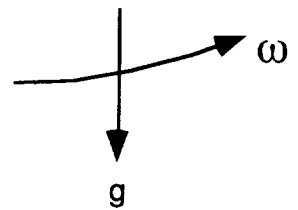

Figure 4. Effect of Gravitational Strength on Particle Path.

Increased gravitational acceleration increases the radius of the nearly circular particle path. This is similar to the effect observed for a particle with an increased sedimentation rate (at the same gravitational acceleration).

Figure 5 shows the path of the same particles from figure 4 during the low g phase (< 0.1 g) of the parabolic flight path within the NASA KC-135 zero gravity airplane.

Rotating Reference Frame

RPM (ω) = 22.1 rpm (+/- 0.2)

Sedimentation Rate = 0.84 cm/sec (+/- 0.04)

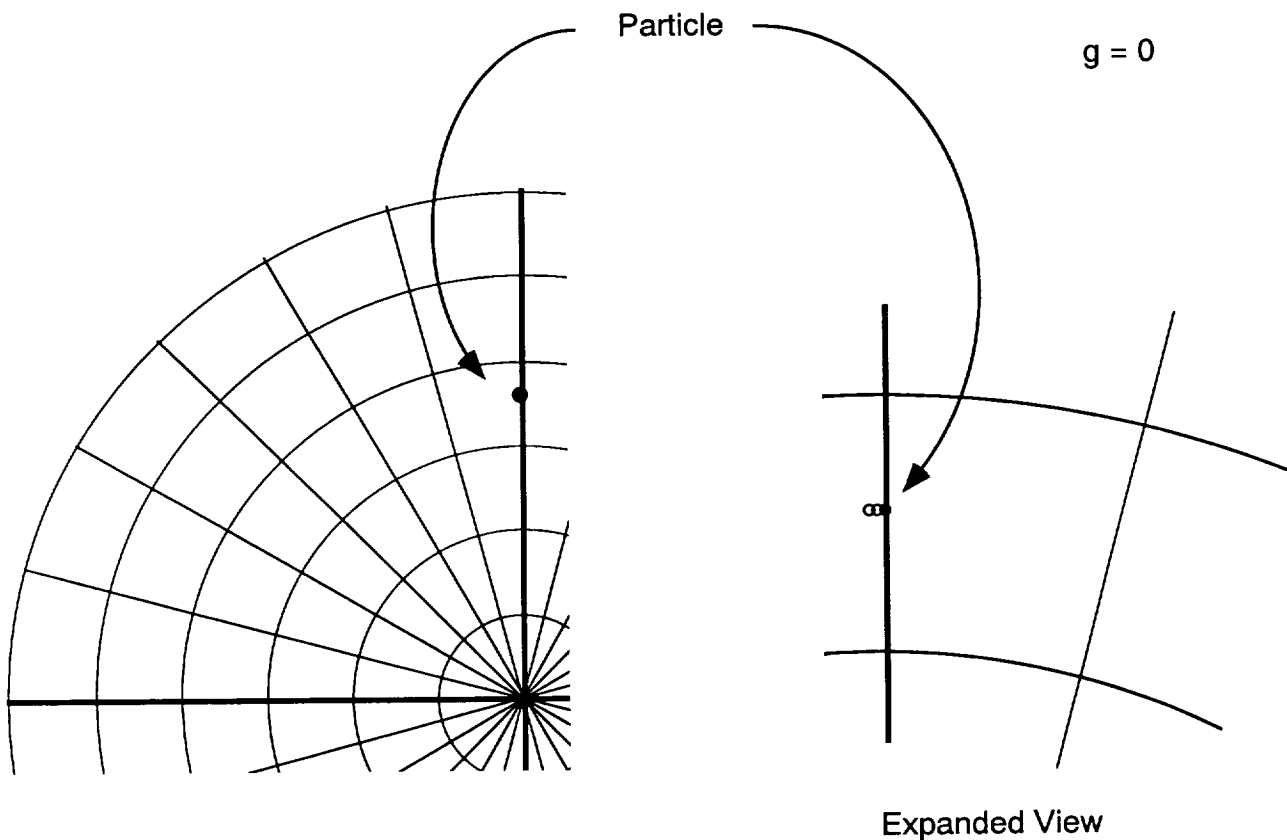

Figure 5. "Zero" Gravity Particle Path.

In this case the particle remains nearly stationary within the rotating fluid medium. The angular rotation rate is sufficiently low enough that minimal centrifugation occurs during a single 360 degree revolution. By reducing the external gravitational field, the speed that the particle moves through the rotating fluid is greatly reduced.

If the same data as that in figure 5 is plotted from the external nonrotating reference frame, we see negligible deviation of the particle from the ideal circular streamline (figure 5A).

External Nonrotating Reference Frame

RPM (ω) = 22.1 rpm (+/- 0.2)

Sedimentation Rate = 0.84 cm/sec (+/- 0.04)

Trajectory Variables	
Vsg	0.840
gfac	0.000
Rot #	1.215
RPM	22.100
Rtissue	1.600
Roves	3.000
Rives	0.250

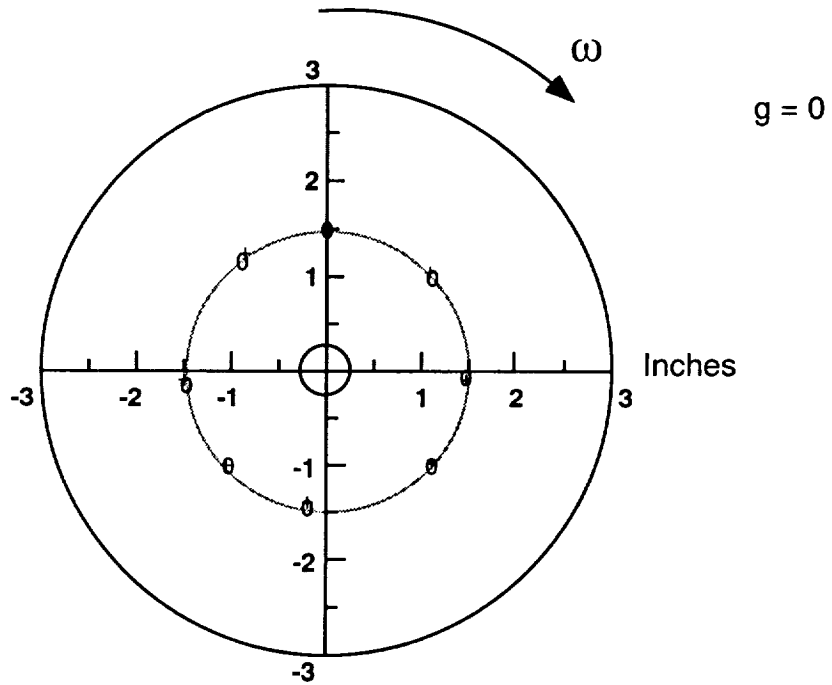

Figure 5A. "Zero" Gravity Particle Orbital Path as Observed from the Nonrotating External Reference Frame.

In this case, where negligible particle deviations occur, we see that the mathematically modeled points agree closely with the experimentally measured points. Therefore, the particle is not moving significantly through the fluid.

VI. Effect of Rotation Rate on Particle Path

Figure 6 shows the effect of the fluid's angular rotation rate on the path of the suspended particle (in unit gravity) as observed from the rotating reference frame. The lower rate is on the left and the higher rate is on the right. We restricted our observation to a single 360 degree rotation. Although these particles start at a different radial position, we see, in section VII, that this does not significantly effect the particle path.

Rotating Reference Frame

Sedimentation Rate = 0.84 cm/sec (+/- 0.04)
 Gravity = 1.0 g

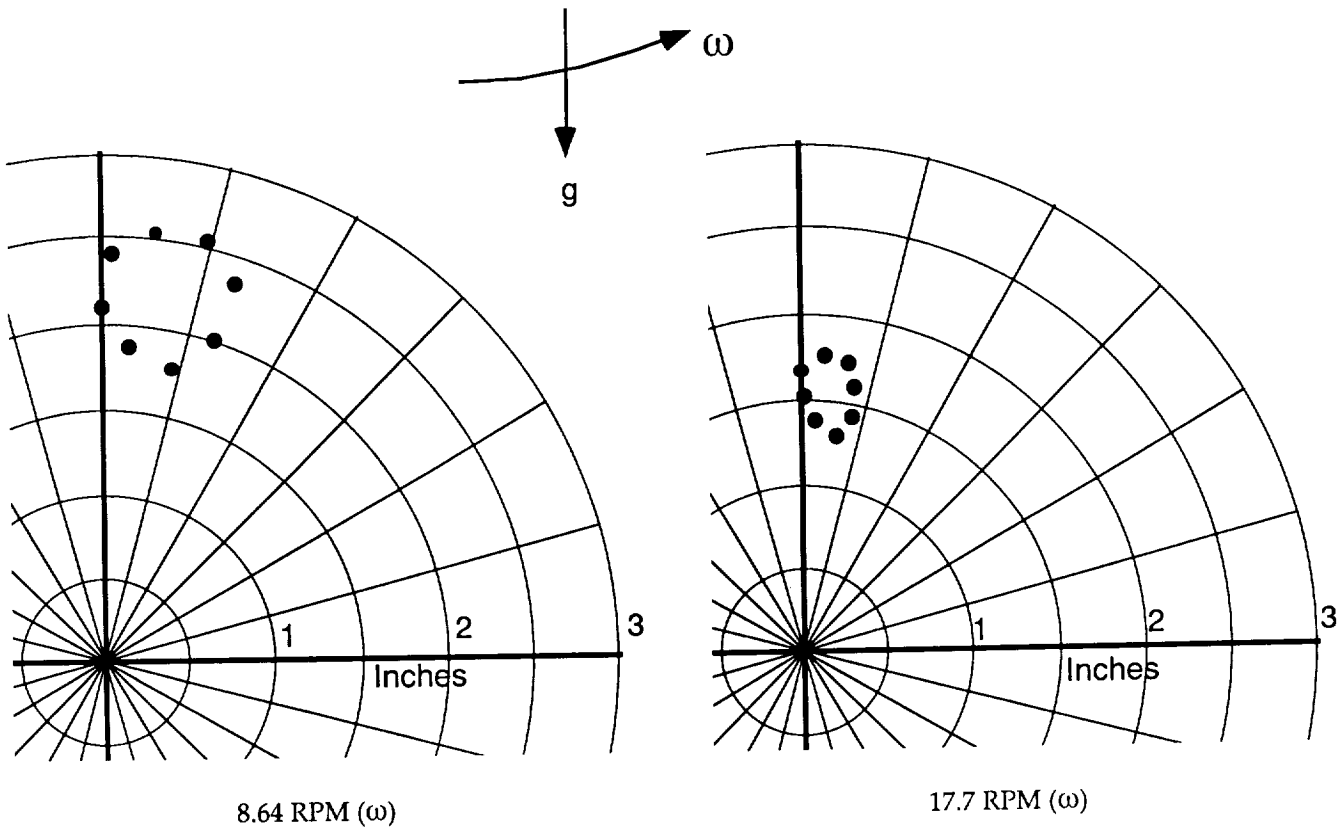

Figure 6. Effect of Angular Rotation Rate on Particle Path.

Figure 7 shows the same data plotted in the external nonrotating reference frame, "0". The mathematically predicted result is shown by the "+" symbol (below).

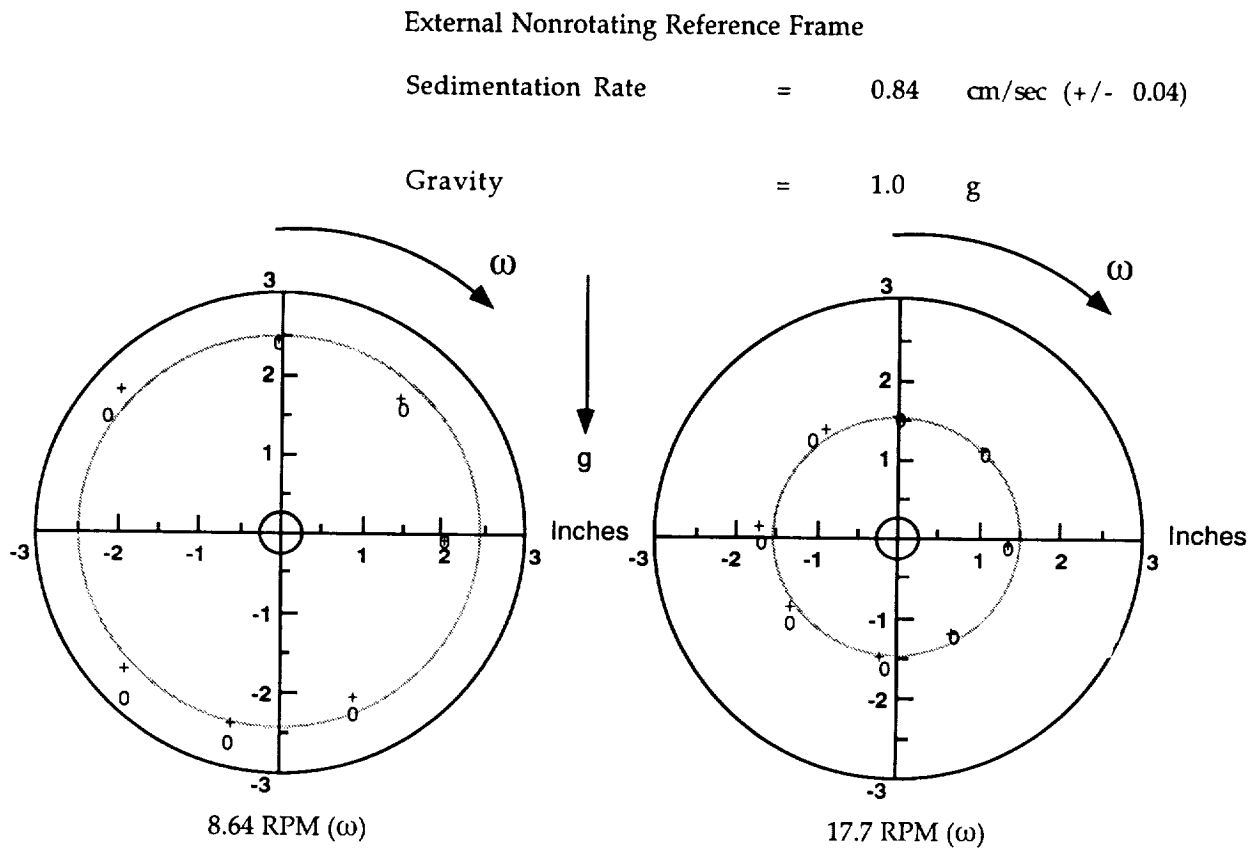

Figure 7. Effect of Angular Rotation Rate on Particle Path as Viewed from External Nonrotating Reference Frame.

Note that the predicted path corresponds better with the experimentally measured path for the higher rotation rate (right) where smaller deviations from the ideal circular streamline occur.

The effect of increased rotation rate is to reduce the deviation of the particle from the ideal circular streamline. In practice the maximum rotation rate is limited by mechanical constraints and by centrifugation of the cultured tissue to the outer wall.

VII. Effect of Initial Position on Particle Path

Figure 8 shows the effect of the initial radial position of a particle on the path of the particle through the fluid, as observed from the rotating reference frame. On the left is a low initial particle radius and on the right is a higher initial radius.

Rotating Reference Frame

Sedimentation Rate = 0.84 cm/sec (+/- 0.04)
 Gravity = 1.0 g
 RPM (ω) = 17.7 rpm (+/- 0.2)

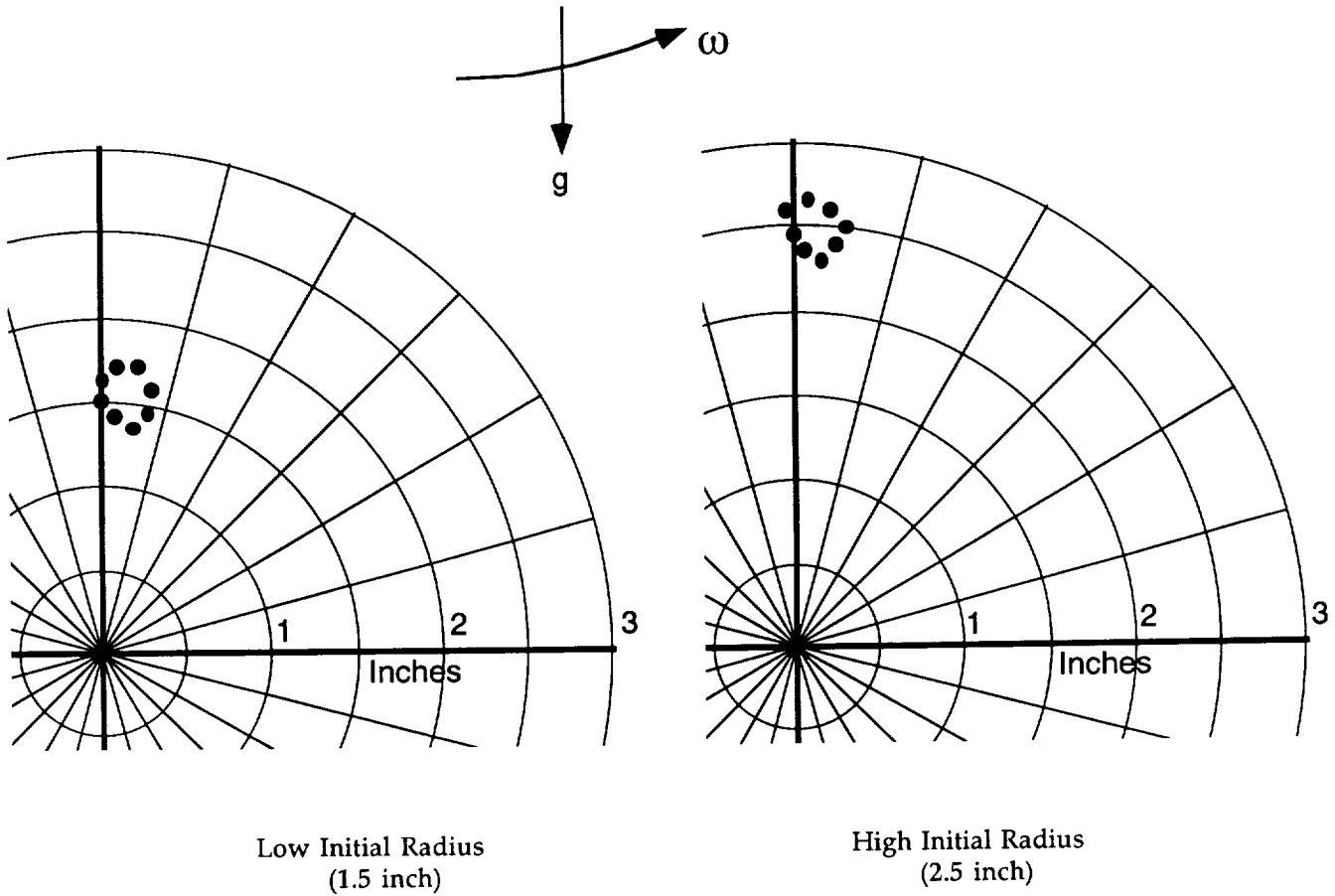

Figure 8. Effect of Initial Position on Particle Path.

VIII. Conclusions and Error Analysis

1. A single simulated section of tissue, or "particle," which sediments under the influence of gravity will deviate both radially and tangentially from its original position when suspended in a rotating fluid. For a constant angular rotation rate of the suspending fluid, the particle follows a nearly circular path as observed from the rotating reference frame of the rotating fluid (figure 2). The particle deviates from the ideal circular streamline when observed from the nonrotating external reference frame (figure 1).
2. The speed at which the particle travels through the rotating suspending fluid medium is not significantly reduced from the same particle's terminal sedimentation speed through the same fluid medium (at the same external gravitational field strength). This was measured for angular rotational rates up to 22.1 rpm and theoretically remains true through the whole useable range (0-80 rpm) of the NASA rotating tissue culture vessels.
3. The radius of the nearly circular particle paths, as observed from the rotating reference frame of the rotating suspending fluid, increases with increasing external gravitational field strength. At very low g levels (less than 0.1), the path reduces to nearly a point, indicating that the particle is nearly stationary with respect to the fluid medium. As observed from the nonrotating external reference frame, the particle is seen to increasingly deviate from the ideal circular streamline as the g level increases. At very low g, the particle closely follows the ideal circular streamline because insignificant gravity-induced deviations occur.
4. Increasing the angular rotation rate of the rotating suspending medium decreases the radius of the nearly circular path of the particle, as observed from the rotating reference frame, and decreases the deviation of the particle from the ideal circular streamline, as observed from the nonrotating external reference frame. This is true for the slow sedimenting particle at low rpm. At high rpm, or with rapidly sedimenting particles, the particle motion due to centrifugation is theoretically predicted to cause large deviations even at high rotational rates. This limitation results from the rotation required to suspend the particles within a gravitational field and defines a limit to unit gravity operation of the NASA rotating wall vessel in terms of maintaining a free suspension of increasingly rapidly sedimenting particles.
5. The initial radial position of the particle within the rotating fluid does not strongly influence the absolute dimensions of the motion of the suspended particle over the range of conditions evaluated.
6. Gravity-induced sedimentation limits the ability of a rotating fluid to freely suspend sedimenting particles without wall collisions.
7. Potential sources of experimental error are identified as
 - a. Irregularities in the rotator drive motor speed
 - b. Secondary fluid motions caused by the particle's motion
 - c. KC-135 aircraft motions (such as pilot-induced and turbulence)

- d. Precision of video measurements
 - e. Imperfect spherical shape of simulated tissue particle
8. A consistent discrepancy of the experimentally measured particle path from the mathematically predicted particle path is observed. It is observed primarily in the third quadrant of rotation and is characterized by an overestimation of the phase advance and an underestimation of the outward radial particle deviation. Increased error occurs for all cases which increase particle deviation. An analysis of the analytical and numerical method used in the mathematical prediction indicates two primary sources for this error. The model uses the gravity vectors for the original particle position within the rotating fluid to calculate the next incremental deviation vector. The particle is not actually at this position, so an error is introduced. The larger the deviation from the original position, the larger the error. Secondly, the numerical techniques integrate the deviation used velocities to obtain the deviated positions. This integration causes an accumulation of all previous error. The model also assumes that the particle is traveling through the rotating fluid medium at terminal velocity. This is true within the experimental error of our measurements; however a small reduction in this speed would be theoretically predicted because the particle must continuously accelerate as the gravity vector rotates. A number of modified approaches are under examination to remove these error sources.

REPORT DOCUMENTATION PAGE

Form Approved
OMB No. 0704-0188

Public reporting burden for this collection of information is estimated to average 1 hour per response, including the time for reviewing instructions, searching existing data sources, gathering and maintaining the data needed, and completing and reviewing the collection of information. Send comments regarding this burden estimate or any other aspect of this collection of information, including suggestions for reducing this burden, to Washington Headquarters Services, Directorate for Information Operations and Reports, 1215 Jefferson Davis Highway, Suite 1204, Arlington, VA 22202-4302, and to the Office of Management and Budget, Paperwork Reduction Project (0704-0188), Washington, DC 20503.

1. AGENCY USE ONLY (Leave blank)	2. REPORT DATE June 1992	3. REPORT TYPE AND DATES COVERED Technical Paper	
4. TITLE AND SUBTITLE Experimental Measurement of the Orbital Paths of Particles Sedimenting Within a Rotating Viscous Fluid as Influenced by Gravity		5. FUNDING NUMBERS VPN 694 01 23 05	
6. AUTHOR(S) David A. Wolf and Ray P. Schwarz			
7. PERFORMING ORGANIZATION NAME(S) AND ADDRESS(ES) Astronaut Office/CB NASA Lyndon B. Johnson Space Center Houston, Texas 77058		8. PERFORMING ORGANIZATION REPORT NUMBER S-668	
9. SPONSORING / MONITORING AGENCY NAME(S) AND ADDRESS(ES) National Aeronautics and Space Administration Washington, D.C. 20546		10. SPONSORING / MONITORING AGENCY REPORT NUMBER NASA TP-3200	
11. SUPPLEMENTARY NOTES David A. Wolf: Lyndon B. Johnson Space Center, Houston, Texas. Ray P. Schwarz: KRUG Life Sciences, Inc., Houston, Texas.			
12a. DISTRIBUTION / AVAILABILITY STATEMENT Unclassified-Unlimited Subject Category 54		12b. DISTRIBUTION CODE	
13. ABSTRACT (Maximum 200 words) Measurements were taken of the path of a simulated typical tissue segment or "particle" within a rotating fluid as a function of gravitational strength, fluid rotation rate, particle sedimentation rate, and particle initial position. Parameters were examined within the useful range for tissue culture in the NASA rotating wall culture vessels. The particle moves along a nearly circular path through the fluid (as observed from the rotating reference frame of the fluid) at the same speed as its linear terminal sedimentation speed for the external gravitational field. This gravitationally induced motion causes an increasing deviation of the particle from its original position within the fluid for a decreased rotational rate, for a more rapidly sedimenting particle, and for an increased gravitational strength. Under low gravity conditions (< 0.1 G), the particle's motion through the fluid and its deviation from its original position become negligible. Under unit gravity conditions, large distortions (> 0.25 inch) occur even for particles of slow sedimentation rate (< 1.0 cm/sec). The particle's motion is nearly independent of the particle's initial position. Comparison with mathematically predicted particle paths show that a significant error in the mathematically predicted path occurs for large particle deviations. This results from a geometric approximation and numerically accumulating error in the mathematical technique.			
14. SUBJECT TERMS KC 135, clinostat, bioreactor, cell culture, tissue culture, shear stress, hydrodynamic stress, 3-dimensional, microgravity, simulated gravity, fluid mechanics		15. NUMBER OF PAGES 20	16. PRICE CODE A03
17. SECURITY CLASSIFICATION OF REPORT Unclassified	18. SECURITY CLASSIFICATION OF THIS PAGE Unclassified	19. SECURITY CLASSIFICATION OF ABSTRACT Unclassified	20. LIMITATION OF ABSTRACT Unlimited

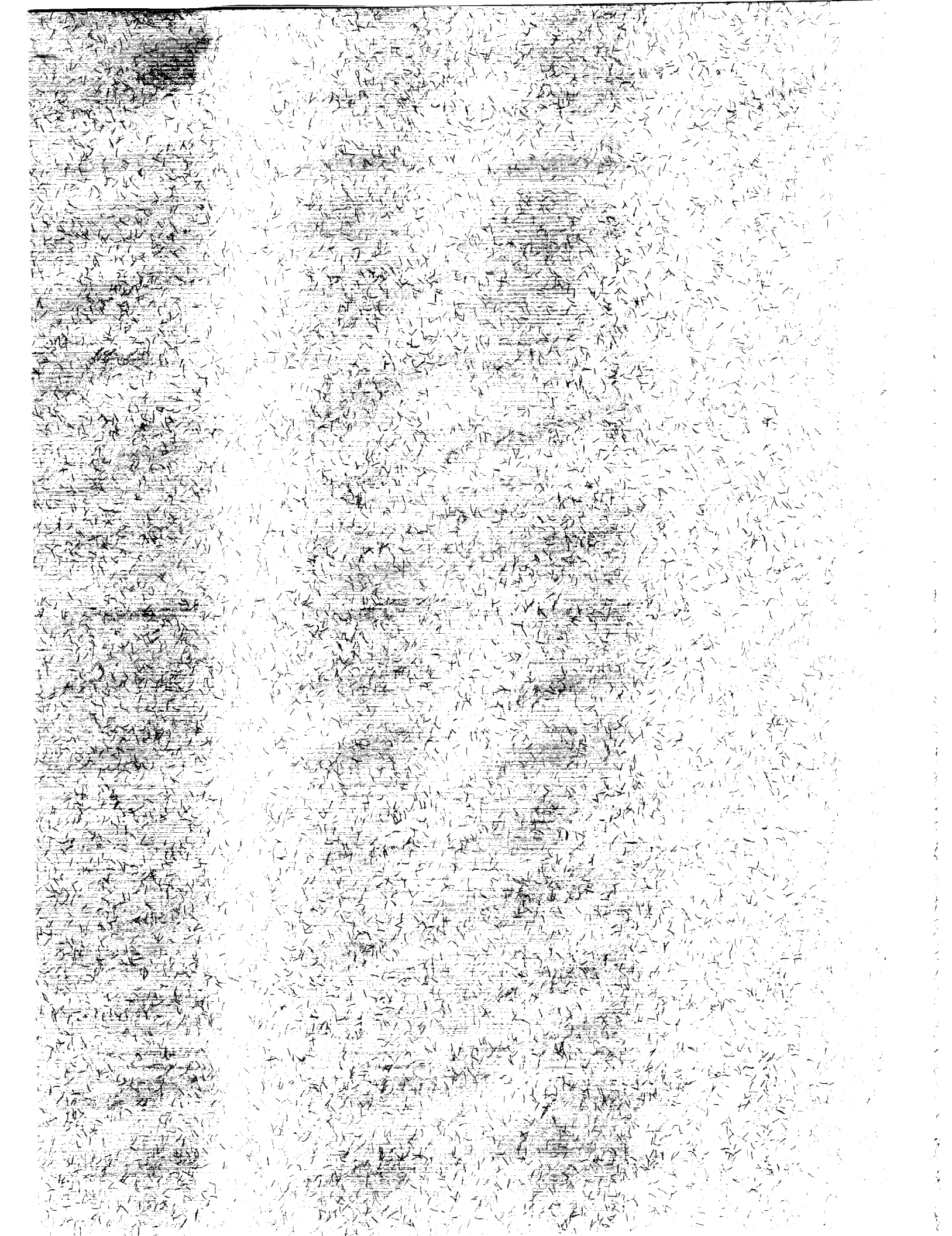

National Aeronautics and
Space Administration
Code JTT
Washington, D.C.
20546-0001
Official Business
Penalty for Private Use, \$300

BULK RATE
POSTAGE & FEES PAID
NASA
Permit No. G-27

NASA

POSTMASTER: If Undeliverable (Section 158
Postal Manual) Do Not Return
