

276  
P. 111

**NASA  
Reference  
Publication  
1279**

**August 1992**

**Mission Description  
and In-Flight Operations  
of ERBE Instruments  
on ERBS, NOAA 9, and  
NOAA 10 Spacecraft**

*February 1986 Through January 1987*

William L. Weaver,  
Kathryn A. Bush,  
Keith T. Degnan,  
Clayton E. Howerton,  
and Carol J. Tolson

(NASA-RP-1279) MISSION DESCRIPTION  
AND IN-FLIGHT OPERATIONS OF ERBE  
INSTRUMENTS ON ERBS, NOAA 9, AND  
NOAA 10 SPACECRAFT Report, Feb.  
1986 - Jan. 1987 (NASA) 217 p

N92-32127

Unclas

H1/43 0117470



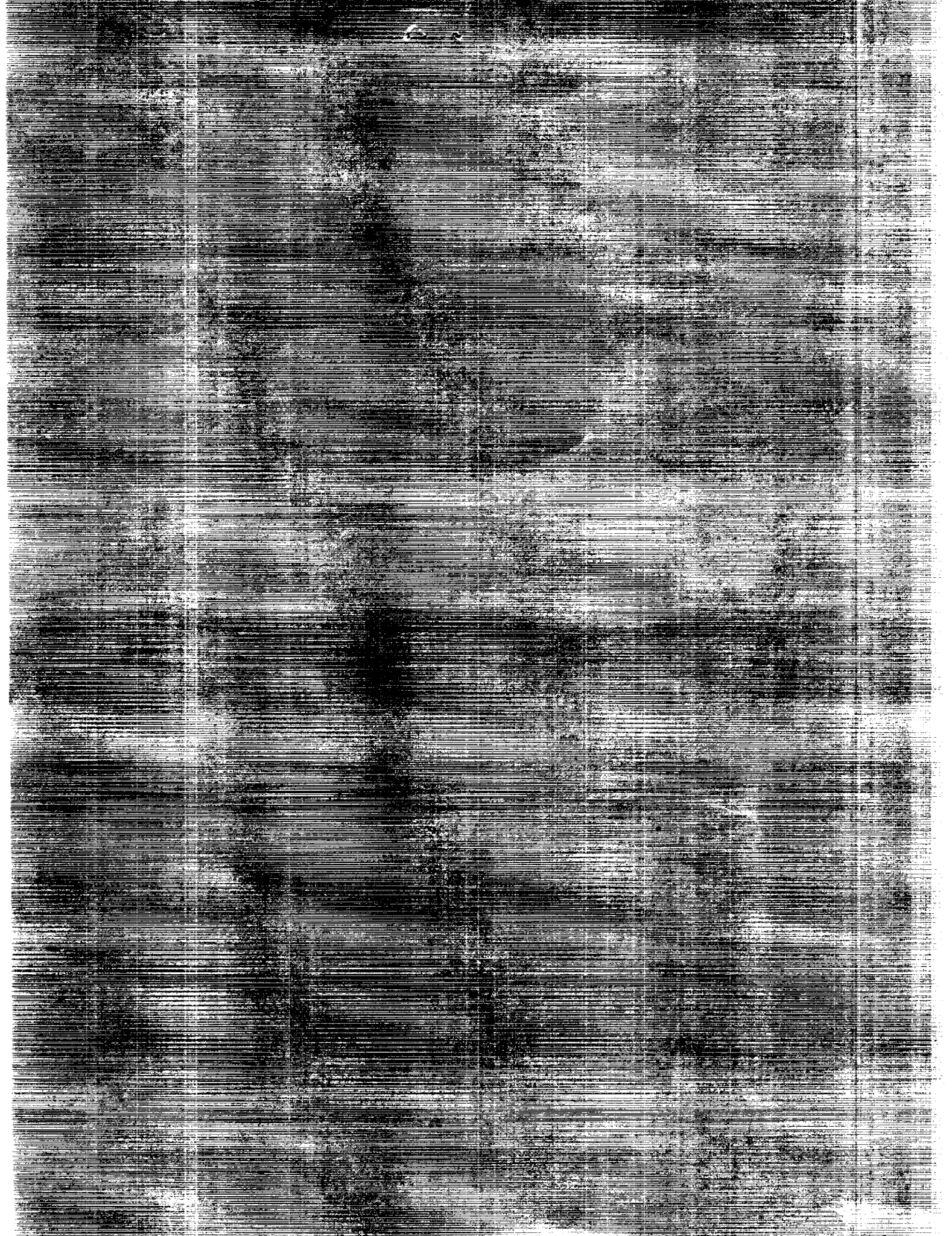

**NASA  
Reference  
Publication  
1279**

1992

**Mission Description  
and In-Flight Operations  
of ERBE Instruments  
on ERBS, NOAA 9, and  
NOAA 10 Spacecraft**

*February 1986 Through January 1987*

William L. Weaver  
*Langley Research Center  
Hampton, Virginia*

Kathryn A. Bush,  
Keith T. Degnan,  
Clayton E. Howerton,  
and Carol J. Tolson  
*ST Systems Corporation (STX)  
Hampton, Virginia*



National Aeronautics and  
Space Administration  
Office of Management  
Scientific and Technical  
Information Program

## Figures

Figure 1. Overview of ERBE data processing . . . . .	167
Figure 2. Diagram of ERBE instruments illustrating coordinate axes . . . . .	168
Figure 3. Spacecraft coordinate systems and alignment of axes with instrument axes . . . . .	169
Figure 4. Alignment between spacecraft and their local horizon coordinates . . . . .	170
Figure 5. Beta angles ( $\beta$ ) for ERBS, NOAA 9, and NOAA 10 spacecraft orbits . . . . .	171
Figure 6. Beta angles ( $\beta$ ) for ERBS, NOAA 9, and NOAA 10 spacecraft orbits for each month . . . . .	173
Figure 7. Daily values of minimum, mean, and maximum scan angles of elevation beam on scanner instrument . . . . .	178
Figure 8. Daily values of minimum, mean, and maximum housekeeping measurements from nonscanner instrument on ERBS spacecraft . . . . .	181
Figure 9. Daily values of minimum, mean, and maximum housekeeping measurements from scanner instrument on ERBS spacecraft . . . . .	187
Figure 10. Daily values of minimum, mean, and maximum housekeeping measurements from nonscanner instrument on NOAA 9 spacecraft . . . . .	191
Figure 11. Daily values of minimum, mean, and maximum housekeeping measurements from scanner instrument on NOAA 9 spacecraft . . . . .	197
Figure 12. Daily values of minimum, mean, and maximum housekeeping measurements from nonscanner instrument on NOAA 10 spacecraft . . . . .	201
Figure 13. Daily values of minimum, mean, and maximum housekeeping measurements from scanner instrument on NOAA 10 spacecraft . . . . .	207

## Abstract

*Instruments of the Earth Radiation Budget Experiment (ERBE) are operating on three different Earth-orbiting spacecraft. The Earth Radiation Budget Satellite (ERBS) is operated by the National Aeronautics and Space Administration (NASA), and the NOAA 9 and NOAA 10 weather satellites are operated by the National Oceanic and Atmospheric Administration (NOAA). This paper is the second in a series that describes the ERBE mission, in-orbit environments, instrument design and operational features, and data processing and validation procedures. This paper describes the spacecraft and instrument operations for the second full year of in-orbit operations, which extend from February 1986 through January 1987. Validation and archival of radiation measurements made by ERBE instruments during this second year of operation were completed in July 1991. This period includes the only time, November 1986 through January 1987, during which all ERBE instruments aboard the ERBS, NOAA 9, and NOAA 10 spacecraft were simultaneously operational. This paper covers normal and special operations of the spacecraft and instruments, operational anomalies, and the responses of the instruments to in-orbit and seasonal variations in the solar environment.*

## Introduction

The objective of the Earth Radiation Budget Experiment (ERBE) is to deduce long-term trends in monthly averages of the Earth's longwave and shortwave radiation fields. To accomplish this objective, ERBE instruments were launched into Earth orbits aboard the Earth Radiation Budget Satellite (ERBS) (operated by NASA) in October 1984 and aboard the NOAA 9 and NOAA 10 spacecraft (operated by the National Oceanic and Atmospheric Administration) in December 1984 and September 1986, respectively. Validation and archival of data from the first 15 months of instrument operation, November 1984 through January 1986, were completed in March 1990. Reference 1 describes mission strategy and operation of the ERBE instruments aboard the ERBS and NOAA spacecraft during that 15-month period. Reference 1 also gives the overview of the ERBE mission, the design and operational features of the ERBE instruments, and a description of the ERBE science data processing.

Validation and archival of data from the ERBE instruments for the period from February 1986 through January 1987 were completed in July 1991. From February 1, 1986, until October 24, 1986, data are available only from the instruments aboard the ERBS and NOAA 9 spacecraft. On October 24 both instruments aboard the NOAA 10 spacecraft became operational. Thus began a period during which ERBE instruments were operational on ERBS, NOAA 9, and NOAA 10. The overlap period for measurements from the three scanners was cut short

by the failure of the scanner instrument on the NOAA 9 spacecraft on January 20, 1987. The period of overlap of scanner data was further shortened by operational problems with the scanner instrument on the NOAA 10 spacecraft during November and December 1986.

This paper describes the in-orbit operation of the ERBE instruments during their second full year of operation, from February 1986 through January 1987. The discussion includes normal and special spacecraft and instrument operations, operational anomalies, and the responses of the instruments to in-orbit and seasonal variations in the solar environment.

## Nomenclature

### Acronyms and Abbreviations

ACR	active cavity radiometer
AVHRR	Advanced Very High Resolution Radiometer
BB	blackbody
CAL	calibration
CPU	Central Processing Unit
DAC	digital-to-analog converter
Det	detector
ERBE	Earth Radiation Budget Experiment
ERBS	Earth Radiation Budget Satellite
FOV	field of view

FOVL	FOV limiter
GSFC	Goddard Space Flight Center
Hex	hexadecimal
HK	housekeeping
HIRS	High-Resolution Infrared Radiometer Sounder
INT	internal
IVT	Instrument Validation Tape
LaRC	Langley Research Center
LW	longwave
MAM	Mirror Attenuator Mosaic
MFOV	medium field of view
NASA	National Aeronautics and Space Administration
NESDIS	National Environmental Satellite and Data Information Service
NOAA	National Oceanic and Atmospheric Administration
NS	nonscanner
NSSDC	National Space Science Data Center
PAT	Processed Archival Tape
POCC	Payload Operations and Control Center
QC	quality control
RAT	Raw Archival Tape
SAGE	Stratospheric Aerosol and Gas Experiment
SAS	solar aspect sensor
SBUV	Solar Backscatter Ultraviolet
SC	scanner
SMA	Solar Monitor Assembly (on non- scanner instrument)
SOCC	Satellite Operations and Control Center
SW	shortwave
SWICS	Shortwave Internal Calibration Source
TDRSS	Tracking and Data Relay Satellite System
temp.	temperature
TOA	top of atmosphere

TOT	total
UT	universal time
WFOV	wide field of view

### Symbols

A,B	azimuth positions, deg
$\hat{N}$	unit vector in direction of orbit angu- lar momentum
$V$	unit vector in direction of spacecraft velocity
$X, Y, Z$	coordinate axes
$\alpha$	azimuth angle, deg
$\beta$	beta angle (angle between Sun and orbit angular momentum vectors), deg
$\phi$	elevation (scan) angle, deg
Subscripts:	
$E$	ERBS
$LH$	local horizon
$N$	NOAA
$NS$	nonscanner
$SC$	scanner
$\alpha$	azimuth angle
$\phi$	elevation angle

### Mission Overview

The goal of the Earth Radiation Budget Experiment is to produce monthly averages of longwave and shortwave radiation parameters on the Earth at regional to global scales using radiation measurements obtained from three sets of nearly identical instruments flying on three separate spacecraft. These three spacecraft are the ERBS spacecraft, operated by the Goddard Space Flight Center (GSFC), and the NOAA 9 and NOAA 10 spacecraft, operated by the National Oceanic and Atmospheric Administration (NOAA).

The ERBS spacecraft was launched by the Space Shuttle *Challenger* in October 1984 and was the first spacecraft to carry ERBE instruments into orbit. The second and third sets of ERBE instruments were launched aboard the NOAA 9 and NOAA 10 operational meteorological satellites in December 1984 and September 1986, respectively. The Payload Operations and Control Center (POCC) at GSFC directs operations of the ERBS spacecraft and its

ERBE and Stratospheric Aerosol and Gas Experiment (SAGE) II instruments using both ground stations and the Tracking and Data Relay Satellite System (TDRSS) network. The Information Processing Division at GSFC receives and processes spacecraft and telemetry data from ERBS and provides that data to the Langley Research Center (LaRC) for further processing. GSFC also provides LaRC with ephemeris data for all three spacecraft. The Satellite Operations and Control Center (SOCC) at the National Environmental Satellite and Data Information Service (NESDIS) operates the NOAA spacecraft and their ERBE instruments, provides decommutation processing of the telemetry data, and generates ERBE data tapes for LaRC.

### **Data Processing, Validation, and Distribution of Science Data Products**

The Langley Research Center has the responsibility of processing and validating all science data from the ERBE mission and of distributing the resulting data products to the science community. The ERBE data processing system at LaRC uses modular software subsystems to process the ERBE data, starting with the input telemetry and ephemeris data from GSFC and NOAA and ending with the production of the required science data products.

Figure 1 shows the major steps in the science data processing, together with the primary input and output data products. These steps are discussed in detail in reference 1. Major data products are the Raw Archival Tape (RAT) and the Instrument Validation Tape (IVT) from the Merge/Field of View Count Conversion subsystem, the Processed Archival Tape (PAT) from the Inversion subsystem, and monthly averages from the Monthly Time/Space Averaging subsystem. Additional data products produced at the final processing stage include a nested averages product, a solar monitor data product, and a scene validation product. All archival data products are distributed first to the ERBE Science Team for review and validation and then to the National Space Science Data Center (NSSDC) for archival.

Table 1 presents summary information about the RAT and PAT archival products for each spacecraft for each month of operation covered in this paper. The information includes the percentage of data output to the RAT and to the PAT, the date of archival at NSSDC, and a notation on special operational events during the month.

### **Instrument Design and Operational Capabilities**

Instrument design is discussed in detail in references 1, 2, and 3. The ERBE nonscanner and scanner instruments (fig. 2) have several important design features in common. Both instruments have rotating azimuth and elevation beams that give them the capability to rotate the optical axes of the detectors in two degrees of freedom. Both instruments can perform two different types of in-flight calibrations: solar calibrations using the Sun as the calibration source, and internal calibrations using temperature-controlled blackbodies and special Shortwave Internal Calibration Sources (SWICS). Both instruments have microprocessors that process and execute ground-commanded or stored commands to direct and control their operation.

The nonscanner instrument (fig. 2(a)) consists of four Earth-viewing detectors located on the head assembly. The solar monitor assembly (SMA) houses the solar monitor detector and is attached to the head assembly at an angle of  $78^\circ$  from nadir. The four Earth-viewing detectors are unchopped active cavity radiometers (ACR's), whereas the solar monitor is an unfiltered chopped ACR designed to measure direct solar radiation for calibrating the Earth-viewing detectors. Two of these detectors have wide field-of-view (WFOV) apertures allowing the detectors to view the entire disk of the Earth; the other two detectors have medium field-of-view (MFOV) apertures allowing the detectors to view an area about 1100 km in diameter. Two of the Earth-viewing detectors, one WFOV and one MFOV, and the solar monitor detector measure total radiation, whereas the other two Earth-viewing detectors measure shortwave radiation. The spectral characteristics of the five nonscanner detectors are listed in table 2(a). The total radiation detectors are unfiltered, and the shortwave spectral bands are achieved by use of fused silica dome filters placed over the detectors.

The scanner instrument (fig. 2(b)) has three coaligned detectors, each consisting of an active and a compensating thermistor bolometer flake. These detectors are essentially identical in design except for optical filters on two of the detectors that restrict their spectral ranges. (See ref. 3 for more detail.) The spectral characteristics of the three scanner detectors are listed in table 2(b). The Mirror Attenuator Mosaic (MAM) assembly of the scanner instrument directs attenuated, diffuse solar energy to the instrument as the Sun passes through the field of view of the detector during solar calibrations.

Both the nonscanner and the scanner instruments can operate in several different modes so that radiometric measurements can be made over a wide range of operational conditions. Each instrument has its own microprocessor to control and direct the various operations. Table 3 lists the operational and pulse discrete commands for both instruments, which are discussed in detail in reference 1. Both instruments can operate at azimuth angles between  $0^\circ$  and  $180^\circ$ . The nonscanner instrument can operate at fixed elevation-beam positions of  $0^\circ$  (nadir),  $78^\circ$  (solar ports), and  $180^\circ$  (stow or internal calibration position). The scanner instrument has three Earth scan modes (normal, short, and nadir), a stow mode, and a solar calibration (or MAM) scan mode. Table 4 lists the scan elevation-angle positions and views (Earth, space, MAM, and internal calibration source) for each of the 74 radiometric measurements in a 4-second scan cycle for the normal Earth scan mode, the short scan mode, and the solar calibration or MAM scan mode.

The ERBE nonscanner instrument output consists of a complete cycle of radiometric and housekeeping measurements every 16 seconds, and the scanner instrument output consists of four 4-second cycles of radiometric and housekeeping measurements during the same 16-second period. A list of the data output by both instruments in a 16-second record is shown in table 5, which also indicates the specific instrument data that are included on the RAT and PAT archival products and the units of each data quantity. Note that the RAT contains all the data output by each instrument and that most of the housekeeping measurements have been converted to engineering units. The PAT, on the other hand, contains the converted values of the radiometric measurements and none of the housekeeping data.

## Coordinate Systems and In-Flight Geometry

A familiarity with Earth-Sun-spacecraft geometry and associated in-flight coordinate systems is helpful in understanding in-flight operations and instrument data output. Pertinent coordinate systems and in-flight geometry are described here, beginning with a description of the instrument coordinate axes. An additional description of the general Earth-Sun-spacecraft geometry is given in appendix B of reference 1, which illustrates the important role that the Sun plays in Earth radiation measurement missions.

When discussing detector pointing vectors, it is convenient to assume that the origin of a set of coordinate axes is at the focal point of the detector of interest. Figures 2(a) and 2(b) illustrate the fixed and

rotating axes systems of the nonscanner and scanner instruments, respectively. The fixed axes of the nonscanner instrument are noted by the subscript  $NS$ , and the fixed axes of the scanner instrument are noted by the subscript  $SC$ . The axes of the rotating azimuth beam are noted by the subscript  $\alpha$ , and the axes of the rotating elevation beam are noted by the subscript  $\phi$ .

The azimuth beam of each instrument has a single degree of freedom relative to the fixed axes, thus permitting the entire head assembly (the structure below the pedestal) to rotate about the fixed  $X$ -axis. The rotating  $\alpha$ -axes are aligned with the fixed axes when the rotation angle  $\alpha$  is zero. A positive rotation (clockwise) about the fixed  $X$ -axis of either instrument produces a positive azimuth angle  $\alpha$  that is measured from the fixed  $Z$ -axis. The azimuth beam of either instrument can rotate between angles of  $0^\circ$  and  $180^\circ$ .

The nonscanner elevation beam can rotate in one degree of freedom relative to the azimuth beam, thus permitting the optical axes of the four Earth-viewing detectors to rotate about the  $Y_\alpha$ -axis. Figure 2(a) shows the alignment of the rotating  $\phi$ -axes with the fixed axes and rotating  $\alpha$ -axes of the nonscanner instrument when the elevation angle  $\phi$  is zero. A negative (counterclockwise) rotation about the rotating  $Y_\alpha$ -axis of the nonscanner instrument produces a positive elevation angle  $\phi$  that is measured from the fixed  $X$ -axis. The elevation beam operates only at three elevation positions:  $0^\circ$  (nadir),  $78^\circ$  (solar ports), and  $180^\circ$  (internal calibration source). The optical axis of the solar monitor is fixed on the azimuth beam at an elevation angle of  $78^\circ$ , which is  $12^\circ$  down from the spacecraft horizon.

Like its counterpart on the nonscanner instrument, the elevation or scanner beam of the scanner instrument shown in figure 2(b) can rotate in one degree of freedom relative to the azimuth beam, thus permitting the optical axes of the three Earth-viewing detectors to rotate about the  $Y_\alpha$ -axis. A positive rotation (clockwise) about the rotating  $Y_\alpha$ -axis produces an increase in scan (elevation) angle  $\phi$  that is measured from the rotating  $Z_\alpha$ -axis. Figure 2(b) shows the alignment of the rotating  $\phi$ -axes when the elevation or scan angle is  $90^\circ$ . The  $Z_\phi$ -axis is aligned with the optical axes of the Earth-viewing detectors and is, therefore, aligned with the rotating  $Z_\alpha$ -axis when the angle  $\phi$  is  $0^\circ$ . The scanner elevation beam can rotate between angles of  $14^\circ$  (the space-look position for Earth scan modes) and  $233^\circ$  (the position of MAM). The optical axis of the MAM assembly is fixed on the azimuth beam at an elevation angle of  $11^\circ$  down from the  $Y_{SC}Z_{SC}$ -plane.



Figure 3 illustrates how the fixed axes of the ERBE instruments are aligned with the axes of the spacecraft on which they are mounted. The ERBS spacecraft axes have the subscript notation  $E$  (ERBS), and NOAA spacecraft axes have the subscript notation  $N$  (NOAA). NOAA 9 and NOAA 10 have the same coordinate system. As in figure 2,  $NS$  refers to *nonscanner instrument* and  $SC$  refers to *scanner instrument*. Note that only the orientation of these axis systems relative to each other is important, not the locations of their origins. The positive  $Y$ -axis of the ERBS spacecraft is in the direction in which the solar panels are tilted, and the positive  $Z$ -axis of both NOAA spacecraft is parallel to the axis of the boom that supports the spacecraft solar panel.

Figure 4 illustrates how the axes of the two types of spacecraft are aligned with their respective in-flight local horizon axes, and on which side of the orbit the Sun is positioned relative to the orbit plane and spacecraft velocity vector. Here,  $\mathbf{V}_{LH}$  is the component of the spacecraft velocity vector in the local horizon plane,  $\hat{\mathbf{N}}$  is the orbit angular momentum vector, and  $\mathbf{X}_{LH}$  and  $\mathbf{Z}_{LH}$  are local nadir vectors for NOAA and ERBS spacecraft, respectively. Shown also in figure 4 is the position of the instrument azimuth beam ( $\alpha$ -axes system) relative to the local horizon system when the rotating azimuth axes are aligned with the fixed axes.

The attitude or orientation angles of a spacecraft, which are provided in the telemetry data, are defined relative to the specific local horizon system in which the spacecraft operates. The spacecraft attitude angles and the azimuth and elevation angles of the instruments are used to compute the pointing vectors of the primary radiometric detectors, as well as those of the solar monitor and MAM, in the appropriate local horizon system of figure 4. The pointing vectors for the ERBS spacecraft of figure 4(a) are then transformed into the NOAA local horizon system of figure 4(b) so that all pointing vectors will have a common local horizon system. The pointing vectors in this common axis system are used to compute the Earth locations of the primary radiometric measurements. A detailed description of how the pointing vectors and the Earth locations of the scanner detector measurements are computed is given in reference 4.

When the ERBS spacecraft is flying  $X$ -axis forward (i.e., the positive  $X$ -axis is in the direction of the positive spacecraft velocity vector), the Sun is normally on the right side of the ERBS orbit (looking downrange or down the velocity vector). When the Sun crosses the ERBS orbit plane from right to

left, the spacecraft is yawed (i.e., rotated about the nadir or  $Z_E$ -axis)  $180^\circ$  to reposition the solar panels so that they tilt to the left side of the orbit. About 36 days later, when the Sun again crosses the orbit plane, this time from left to right, the spacecraft is again rotated  $180^\circ$ . The NOAA spacecraft are in approximate Sun-synchronous orbits, and the spacecraft always fly with their  $Y$ -axes in the direction of the negative velocity vector with the Sun on the left side of the orbit.

Appendix B in reference 1 describes the local-horizon coordinate axis systems in which the Sun's position is normally calculated. The azimuth and elevation angles of the Sun in this system can be related directly to the Sun angles in the instrument axes systems of the ERBE nonscanner and scanner instruments described earlier in this section.

## General Discussion and Analysis of Mission and Instrument Operations

This section presents a discussion of the instruments aboard each spacecraft separately, beginning with a brief description of operational responsibilities and procedures. An overview of calibrations and normal Earth-viewing operations is then presented; this is followed by discussions of the effects of the solar environment on instrument operations, of operational anomalies, and of instrument housekeeping measurements.

### ERBS Spacecraft

The ERBS spacecraft and the ERBE instruments aboard it are controlled and operated by NASA at its Payload Operations and Control Center (POCC) at the Goddard Space Flight Center, Greenbelt, Maryland. The LaRC ERBE personnel are responsible for planning changes in the instrument operation, and the plans are coordinated with POCC personnel who implement the changes. The operational status of the instruments and housekeeping measurements is monitored directly at the ERBS POCC during real-time passes. A telecommunication link between LaRC and the ERBS spacecraft via the POCC has permitted LaRC personnel to do limited real-time monitoring of the ERBE instrument operations and housekeeping data. This communication link has proven particularly valuable when the resolution of spacecraft or instrument problems has required participation by LaRC personnel.

### *In-Flight Operations*

Table 6 lists the operational modes in which the instruments normally operated between

February 1986 and January 1987 and shows the temperature values for those commands that require input data. Changes from the normal operational modes were required to obtain calibration data. Tables 7(a) and 7(b) list the operational mode commands executed by the nonscanner and scanner instruments, respectively, aboard the ERBS spacecraft during the period of this paper. (Tables 8(a) and 8(b) and tables 9(a) and 9(b) list the same information for the instruments on the NOAA 9 and NOAA 10 spacecraft, respectively.) The tables list each mode command executed, its hexadecimal command code, and the date and time of command execution (in hours, minutes, and seconds of universal time (UT) and in minutes of universal day). Spacecraft yaw maneuvers of the ERBS spacecraft are also noted in table 7.

The nonscanner instrument on ERBS operated at an azimuth-beam position of  $0^\circ$  and an elevation-beam position of  $0^\circ$  (nadir). In this configuration the solar monitor assembly was normally on the Sun's side of the orbit. The scanner instrument operated at an azimuth angle of  $180^\circ$  and in the normal Earth-scan mode. In this operational configuration, the detectors were positioned to view space on the dark side of the orbit at the beginning of each scan cycle. Appendix C in reference 1 presents a discussion of the normal Earth scan mode of operation.

All heaters and calibration sources on the spacecraft that are controlled by mode commands remained off during normal operations, except for the nonscanner detector heaters and the solar port heaters. Table 6 lists the normal status or positions of the power relays for both instruments (On = Closed; Off = Open). The positions of these relays, except for those marked with "a" under "Bi-Level Switch Indicators," are controlled by pulse discrete commands. (See table 3.) The instrument power and either the pulse A or pulse B switches must be on for an instrument to respond to mode commands and produce output data. The nonscanner calibration power must be on for the detector calibration mode command to activate the calibration heaters, and thus the detector calibration power switch remained on at all times. On the other hand, the scanner blackbody calibration heater is controlled directly by a pulse discrete command. Therefore, the pulse discrete commands of the scanner heater were inserted into the scanner internal calibration sequences to turn the scanner blackbody heaters on and off at the times required. (See table A1 in ref. 1.)

Power to the azimuth and elevation motors is controlled through the motor power bus relay by the azimuth and elevation mode commands, respectively. The azimuth motor power for either instrument is

turned on when a new azimuth mode command is executed and is turned off when the rotation is completed. The elevation motor power for an instrument is turned on and off in the same way by elevation mode commands. The elevation motor power of the scanner instrument on the ERBS spacecraft remained on at all times. The azimuth motor power for both instruments and the elevation motor power for the nonscanner instrument are turned on when the azimuth and elevation mode commands are executed.

Most of the in-flight instrument operational mode commands were associated with instrument calibrations. (See table 7.) Internal calibrations of both instruments and solar calibrations of the nonscanner instrument normally were all performed at approximately the same time every other Wednesday. Appendix A in reference 1 describes the preprogrammed, or automated, instrument calibration sequences used for the instruments on the ERBS spacecraft and how these sequences have been combined with additional commands to facilitate in-flight calibrations. Solar calibrations of the scanner instrument were discontinued in October 1985 because of problems experienced on October 19 and 20, 1985, in conjunction with the pitch maneuver. (See ref. 1.)

Table 10(a) lists some important characteristics of the ERBS spacecraft orbit on January 1, 1985, 1986, and 1987. Tables 10(b) and 10(c) list the orbit characteristics for the NOAA 9 and NOAA 10 spacecraft, respectively. The 1985 data are included to provide a continuity with the first year of operation. Although the ERBS spacecraft orbit is slightly elliptical, the resulting differences in minimum and maximum altitudes have not impacted the ERBE instrument data collection or mission operations. The rotation rate of  $-3.95^\circ$  per day of the right ascension of the ascending node of the ERBS orbit produces a range of beta angles ( $\beta$ ) during the year from  $10^\circ$  to  $170^\circ$ . (See fig. 5(a).) This variation in  $\beta$  produces a wide range of heating conditions for the instruments. The effects of  $\beta$  on the ERBS mission operations and on the instrument housekeeping temperatures are discussed later in the section entitled "Monitoring and Analysis of Instrument Housekeeping Measurements." Figures 5(a), 5(b), and 5(c) show the annual variation in  $\beta$  angle for the orbits of the ERBS, NOAA 9, and NOAA 10 spacecraft, respectively. Figures 6(a), 6(b), and 6(c) show the orbit  $\beta$  angles for each month of the year for the ERBS, NOAA 9, and NOAA 10 spacecraft, respectively. A more general description of how  $\beta$  affects Sun angles at the spacecraft and on the Earth is given in appendix B in reference 1.

When the  $\beta$  angle of the ERBS orbit is between  $10^\circ$  and  $90^\circ$ , the Sun is on the left side of the orbit, looking downrange. Figure 4(a) (where the  $X$ -axis is backward) presents an illustration of the geometry for this case. The spacecraft positive  $X$ -axis points uprange along the negative velocity vector, and the scanner instrument elevation beam rotates from right to left as one looks down the velocity vector from behind the spacecraft. When  $\beta$  is between  $90^\circ$  and  $170^\circ$ , the Sun is on the right side of the orbit ( $X$ -axis forward), as illustrated in figure 4(a). In this case, the spacecraft positive  $X$ -axis is pointed downrange, and the elevation beam scans from left to right. When  $\beta$  approaches  $90^\circ$  from either direction, the ERBS spacecraft is yawed (rotated about the  $Z$ - or nadir axis)  $180^\circ$  to reposition the spacecraft solar panels to tilt to the Sun's side of the orbit. This occurs about every 36 days. The dates and times of the  $180^\circ$  yaw turns are indicated in table 7. During these turns both instruments continued to operate in their normal modes. However, data acquired during the yaw turns are not included in the science data products because the locations of the measurements on the Earth are questionable.

When the ERBS spacecraft operates in full-Sun conditions, the scanner instrument operates at an azimuth position of  $145^\circ$  to prevent the detectors from directly scanning the Sun. Full-Sun orbits occurred in June and August 1986 when  $\beta$  was less than  $24^\circ$ , and in February and December 1986 when  $\beta$  was greater than  $156^\circ$  (see figs. 5(a) and 6(a)) and the ERBS spacecraft was in sunlight continuously. Regularly scheduled calibrations were not performed during the full-Sun periods; instead, a set of calibrations was performed immediately prior to and after the full-Sun periods. Because the Sun terminator is continuously in the limb-to-limb view of the Earth during these periods, the nonscanner WFOV detectors do not view any regions of the Earth that are totally illuminated or totally dark. The azimuth-beam rotations that occurred before and after full-Sun conditions were the only scanner instrument azimuth-beam rotations that were performed from February 1986 through January 1987. These rotations were all normal.

The elevation beam of the scanner instrument on the ERBS spacecraft continued to exhibit some effects of the rotational anomaly that started in 1985. However, no actual hang-ups (malfunctions) of the beam like those that occurred during May 1985 were observed. (See ref. 1.) An analysis of the scanner elevation-beam anomaly was reported in reference 5. Figures 7(a), 7(b), and 7(c) show daily values for the mean, minimum, and maximum scan angles for the

scanner instruments aboard the ERBS, NOAA 9, and NOAA 10 spacecraft, respectively. Unedited average values are based on all scan angles, and edited averages include only angles that passed rigorous range and rate-of-change edit tests. The average expected scan angle is about  $87.9^\circ$  when scan beam rotations are completely uniform in the normal Earth scan mode.

Figure 7(a) shows that the unedited mean scan angles varied significantly during the year covered by this paper. Most of the variation in the mean scan angle is caused by a skewing of the Earth scan portion of a scan cycle (measurements 9 through 70 in table 4). Lower averages mean that the measurements are skewed toward the space-look side of the scan. Even with this skewing, the scan pattern was normal and the pointing angles of the detector were correctly determined. Most of the time the edited and unedited values of the mean scan angle were about the same, indicating that the skewing of the scan pattern did not result in the rejection of scan angles during editing. Variations in the mean scan angle from the expected mean value are correlated with variations in  $\beta$  (figs. 5(a) and 6(a)). The difference between the actual and expected averages is generally smaller when  $\beta$  angles are near their extreme values, which is also when the instrument housekeeping temperatures are highest. (See the next section.) The  $\beta$  angle correlation is apparent during the entire year, but the large swings in mean scan angle become less pronounced after the first few months.

Another effect of the elevation-beam anomaly was a misalignment of the radiometric detectors with the internal calibration sources at a scan angle of  $190^\circ$ . This misalignment resulted in a nonuniform response of the shortwave detectors to the output of the internal calibration sources during internal calibrations. The effect was most pronounced at measurement 71, the first of the four measurements at the position of the internal calibration sources. The angular misalignments of the detectors at the internal calibration sources were not usually large enough to be rejected by the editing process and, therefore, did not significantly affect the mean scan angles of figure 7(a). However, the misalignments still invalidated many of the shortwave measurements made during internal calibrations for most of the period of this paper.

#### *Monitoring and Analysis of Instrument Housekeeping Measurements*

Instrument housekeeping measurements are monitored during real-time communication contacts with

the spacecraft to ensure that the instruments are functioning normally. Since the ERBS spacecraft orbit produced a wide range of  $\beta$  angles, causing the ERBE instruments onboard to experience large variations in heating and requiring changes in normal operational modes, the monitoring of housekeeping measurements of these instruments is particularly important. In the real-time monitoring procedure, the housekeeping measurements are checked against both yellow limits, which indicate that an instrument may be approaching a critical condition, and red limits, which indicate that the instrument is at risk of being damaged.

An analysis of instrument housekeeping measurements has also been performed during the ERBE science data processing. This processing produces a complete history of the actual measured values of all housekeeping temperatures and voltages, and it accumulates the minimum, mean, and maximum values of all housekeeping measurements for each day. The processing includes testing the value of every housekeeping measurement to determine if the value is within specified limits and if its rate of change is less than a specified value. Values used to test the magnitudes and rate changes of selected housekeeping measurements of the instruments on the ERBS spacecraft are listed in table 11. These edit limits are significantly more restrictive than those employed in the real-time monitoring process mentioned above. The more restrictive limits are employed because the output of the radiometric detectors may be affected by temperature or voltage changes before the health of the instrument is actually threatened. The processing procedures identify (flag) the data values that exceed the expected input limits.

Figures 8 and 9 are plots of the daily minimum, mean, and maximum values for selected housekeeping measurements of the ERBE instruments aboard the ERBS spacecraft. The plots cover the period from February 1986 through January 1987. The nonscanner heat sink and aperture temperatures and the scanner detector temperatures are computed to a higher resolution than the plotted values, and this difference accounts for the unusual appearance of the plotted values of these parameters. The computed resolutions of the nonscanner heat sink and aperture temperatures are  $0.013^{\circ}\text{C}$  and  $0.010^{\circ}\text{C}$ , respectively, and the computed resolution of the scanner detector temperature is  $0.001^{\circ}\text{C}$ . Differences in the minimum, mean, and maximum values of a given housekeeping measurement on a given day were primarily due to in-orbit variations in Sun angles.

Changes from day to day in values of the housekeeping measurements are primarily due to changes in the  $\beta$  angle. In general, housekeeping temperatures increased as  $\beta$  approached minimum and maximum extremes. When  $\beta$  is greater than  $156^{\circ}$  or less than  $24^{\circ}$ , the spacecraft is in continuous sunlight. At the specific  $\beta$  angle of  $156^{\circ}$ , or at its supplement,  $24^{\circ}$ , the Sun is at the Earth's limb as viewed from the spacecraft and the spacecraft will experience maximum heating conditions. Two separate geometries occur for these full-Sun conditions for the ERBS spacecraft. During February and August,  $\beta$  stays near  $156^{\circ}$  (or  $24^{\circ}$ ). During the full-Sun periods of June and December,  $\beta$  passes quickly through  $156^{\circ}$  (or  $24^{\circ}$ ), both before and after attaining extreme values of  $10^{\circ}$  (or  $170^{\circ}$ ). During these periods there is a distinct dog-ear (double maximum) appearance to plots of the heating effects. These heating effects are seen both in the nonscanner instrument (see, for example, fig. 8(c) for the field-of-view limiter temperatures) and in the scanner instrument (see, for example, fig. 9(c) for the blackbody temperatures). A description of  $\beta$  is given in appendix B of reference 1.

The heat sink, aperture, and field-of-view limiter temperatures of the nonscanner instruments (see figs. 8(a), 8(b), and 8(c), respectively) all affect the radiometric output of the Earth-viewing detectors. The heat sink and aperture temperatures of the Earth-viewing detectors are tightly controlled, and therefore their effects are not modeled in the radiometric data-conversion algorithms. However, when values of these measurements are flagged because they fail the edit limit tests, the corresponding radiometric data are rejected from further science data processing.

The heat sink temperatures varied only about  $0.1^{\circ}\text{C}$  during the time period covered by this paper (fig. 8(a)). The spikes usually indicate calibrations. Aperture temperatures varied by less than  $0.6^{\circ}\text{C}$ , with peaks occurring during periods of minimum or maximum  $\beta$  angles (fig. 8(b)). Temperatures of the solar monitor heat sinks and apertures (fig. 8(d)) are not controlled, and their values are more variable than those of the Earth-viewing detectors. Therefore, the effects of the variations of the solar monitor temperatures are modeled in the radiometric data-conversion algorithms during processing of the data acquired during solar calibrations. However, because of the extreme heating conditions, calibrations are not performed during these full-Sun periods.

Temperatures of the FOV limiters of the nonscanner instrument are not controlled, but their values are accurately measured and are included in the

radiometric data-conversion algorithms. These temperatures are very sensitive to  $\beta$  (fig. 8(c)). The maximum values occur when  $\beta \approx 24^\circ$  or  $156^\circ$  (when the Sun is very near the limb of the Earth). Some FOV limiter temperatures approached their upper limit values when  $\beta \approx 24^\circ$  or  $156^\circ$  in February, June, August, and December 1986.

The nonscanner blackbodies are used primarily during internal calibrations of the instruments, and variations in their temperatures do not affect the output of the radiometric detectors during normal operation (fig. 8(e)). The nonscanner electronic slice 3 and power converter temperatures (fig. 8(f)) are used primarily in the real-time data monitoring procedures. They are called passive measurements because these temperatures are available in the telemetry data stream even if the ERBE instruments are powered down. These housekeeping temperatures are very sensitive to variations in  $\beta$ , and like the FOV limiter temperatures, their maximum values on ERBS correlate with the periods of  $\beta$  that produce full-Sun conditions (fig. 6).

The temperatures of the scanner detectors varied by  $0.3^\circ\text{C}$  during the time period of this paper, and the largest variations are correlated with the periods of minimum and maximum  $\beta$  (fig. 9(a)). The effects of the detector temperatures are modeled in the radiometric data-conversion algorithms of the scanner instruments. The digital-to-analog converter (DAC) voltages all drifted gradually during the period of this paper (fig. 9(b)). However, the gradual changes in the values of these output voltages have not affected the output of the scanner radiometric detectors, and thus edit-limit values are not shown in table 11. The instantaneous rate of change in the values of the DAC voltages affects the output of the detectors, and the effects of the rate changes are modeled in the radiometric data-conversion algorithms.

Values of the temperatures of the blackbodies and the two passive analog temperatures from the scanner instrument (figs. 9(c) and 9(d)) are included for comparison with the corresponding measurements on the nonscanner instrument (figs. 8(e) and 8(f)). These temperatures exhibit behavior similar to that for corresponding time periods of the nonscanner instrument and correlate with variations in the  $\beta$  angle of the ERBS orbit. The sharp upward spikes in the blackbody temperatures occur when the blackbody heaters are turned on during internal calibrations.

### NOAA 9 Spacecraft

The NOAA 9 spacecraft and the ERBE instruments aboard it are controlled and operated by

the NOAA Satellite Operations and Control Center (SOCC) located in Suitland, Maryland. The operational status of the instruments and housekeeping measurements is monitored during real-time contacts with the spacecraft by SOCC personnel. A telecommunication link between LaRC and NOAA 9 spacecraft via the SOCC has permitted LaRC personnel to do limited real-time monitoring of the ERBE instrument operations and housekeeping data. This communication link has been very helpful, particularly when the resolution of spacecraft or instrument problems has required participation by LaRC personnel.

### *In-Flight Operations*

During the second year of operation, the ERBE instruments aboard the NOAA 9 spacecraft took Earth-viewing radiation measurements continuously, except during calibrations. Tables 8(a) and 8(b) list the operational mode commands executed by the ERBE nonscanner and scanner instruments, respectively, on the NOAA 9 spacecraft from February 1986 through January 1987.

The NOAA 9 orbit was nearly Sun-synchronous (see table 10), and  $\beta$  varied only about  $16^\circ$  during the year (fig. 5(b)). The resulting in-orbit solar environment was more benign and much less variable than that for the ERBS spacecraft. There were no periods during the year when the spacecraft was in full-Sun orbits, and no special spacecraft or instrument operations were required to be performed because of the solar environment. However,  $\beta$  was about  $6^\circ$  less on January 1, 1987, than it was a year earlier. Also, the local time of the ascending node is 37 minutes later on January 1, 1987, than it was a year earlier. These differences result from a faster-than-nominal rate of change in the right ascension of the ascending node of the orbit, that is, faster than one that would maintain a Sun-synchronous orbit.

Table 6 lists the operational modes in which the instruments aboard NOAA 9 normally operated between February 1986 and January 1987 and shows the temperature values for those commands that require input data. All heaters and calibration sources controlled by mode commands remained off during normal operation, except for the nonscanner detector heaters and solar port heaters. Table 6 lists the normal status of the power relays for both instruments on the NOAA 9 spacecraft, which are the same as those for the instruments on the ERBS spacecraft.

The nonscanner instrument on the NOAA 9 spacecraft was expected to operate at an azimuth angle of  $170^\circ$  to prevent Sun-glint interference with the Solar Backscatter Ultraviolet (SBUV) instrument. In

fact, the problem with the azimuth-beam rotation resulted in operation at an azimuth angle of  $180^\circ$  at all times, except during solar calibrations. The non-scanner instrument operated normally at the Earth-viewing or nadir-pointing elevation-beam position. The scanner instrument normally operated at the cross-track azimuth-beam position of  $0^\circ$  and in the normal Earth scan mode. Like the scanner instrument on the ERBS spacecraft, the scanner instrument detectors on the NOAA 9 spacecraft viewed space on the dark side of the orbit and scanned the Earth from dark to sunlit regions.

All in-flight instrument operational mode commands were associated with instrument calibrations. (See table 8.) Appendix A in reference 1 describes the preprogrammed, or automated, instrument calibration sequences used for the ERBE instruments and how these sequences have been combined with auxiliary commands to facilitate in-flight calibrations. Internal and solar calibrations of both instruments were normally performed every other Wednesday from February 1986 through January 1987.

The azimuth-beam rotation anomaly of the non-scanner instrument on the NOAA 9 spacecraft, which was first observed in 1985 (see ref. 1), continued in 1986. Operation of the azimuth beam during solar calibrations was usually normal and the calibrations were usually performed successfully. However, after the solar calibrations, the azimuth beam rotated to the  $180^\circ$  position instead of the commanded position of  $170^\circ$ . The result was that the instrument operated at an azimuth angle of  $180^\circ$  instead of the desired operating angle of  $170^\circ$ . The position of azimuth beam is shown on the RAT as  $170^\circ$  when, in fact, the beam was actually positioned at  $180^\circ$ . The Earth locations of the nonscanner measurements were calculated using the erroneous position of  $170^\circ$ . However, this error does not affect the accuracy of the locations of the measurements because the detectors are nadir-pointing during normal operation.

The elevation-beam rotation anomaly of the scanner instrument, which was discussed in reference 1, continued in 1986. However, no actual hang-ups of the beam were observed during the time period of this paper. Figure 7(b) shows the edited and unedited values of the mean scan angle for each day during the period of this paper. Unedited average values are based on all scan angles, and edited average values include only those angles that passed rigorous range and rate-of-change edit tests. The spikes in the data show the effect of MAM scan operations during solar calibrations.

The  $\beta$  angle of the NOAA 9 orbit is much less variable than that of the ERBS orbit (fig. 5), and figure 7(b) does not show the periodic variation in values of the mean scan angle seen in the ERBS data of figure 7(a). During most of the time, the unedited values of the mean scan angle are equal to or only slightly lower than the expected value of  $87.9^\circ$ . Another difference between the data of figures 7(a) and 7(b) is that the edited and unedited values of the mean scan angle for NOAA 9 are not as close together during some time periods as they were for the case of ERBS. The edited and unedited mean values of the scan angles that are lower than expected are generally correlated with periods when some scanner housekeeping temperatures are higher than normal. During these periods, the differences between the edited and unedited mean values are more pronounced.

Although values of the scan angles for the ERBS scanner were influenced more by the Earth-viewing portion of the scan, the mean scan angles for the NOAA 9 scanner were influenced more by variations in beam angles near the internal calibration sources. The Earth-viewing portion of the scan for the case of NOAA 9 was normally symmetrical, but the variation of the scan angle at the expected position of  $190^\circ$  varied more than was the case for ERBS. The significantly lower values for the edited mean scan angles were generally due to out-of-limit scan angles being rejected at the internal calibration sources. The larger detector misalignments at the internal calibration sources affected the shortwave detector measurements during internal calibrations more than those of ERBS. As was the case with ERBS, the effect was most pronounced at measurement 71, the first of four measurements made at the internal calibration sources.

At 18:49 UT on January 20, 1987, the elevation beam of the scanner instrument stopped scanning and all primary data from the instrument showed zeros. Several attempts were made to restore the instrument to operational status, but they were unsuccessful. The instrument would not respond to Central Processing Unit (CPU) reset commands, and the primary data were never restored to valid values. The cause of the failure could not be determined, although it was believed to be related to a timing problem between the instrument and the spacecraft.

#### *Monitoring and Analysis of Instrument Housekeeping Measurements*

Instrument housekeeping measurements are monitored during real-time communication contacts with

the spacecraft to ensure that the instruments are functioning normally. In the real-time monitoring procedure, the housekeeping measurements are checked against both yellow limits, which indicate that an instrument may be approaching a critical condition, and red limits, which indicate that the instrument is at risk of being damaged.

Table 11 shows the values used in the science data processing at LaRC to test the magnitudes and rates of change of selected key housekeeping measurements of the instruments on the NOAA 9 spacecraft. As was the case with ERBS, these limits are much more restrictive than those used in the real-time monitoring.

Figures 10 and 11 are plots of the minimum, mean, and maximum values of key housekeeping measurements for the instruments on the NOAA 9 spacecraft for each day from February 1986 through January 1987. Differences in the minimum and maximum values of the housekeeping measurements during a given day are about the same as those for the instruments on the ERBS spacecraft, and they are due to in-orbit variation (figs. 8 and 9). However, day-to-day variations in the values of the measurements are not nearly as large as those for the instruments on the ERBS spacecraft because of the smaller variation in the values of  $\beta$  (figs. 5 and 6).

Only small variations ( $0.10^{\circ}\text{C}$ ) occurred in the heat sink temperatures (fig. 10(a)) of the non-scanner instrument on NOAA 9, and the aperture temperatures varied only about  $0.20^{\circ}\text{C}$  (fig. 10(b)). The behavior of these controlled temperatures was about the same as that for the instruments on the ERBS spacecraft (figs. 8(a) and 8(b)). The mean values of the solar monitor heat sink and aperture temperatures (fig. 10(d)) were nearly constant for  $\beta > 52^{\circ}$ , and the maximum values of the temperatures occurred near the minimum value of  $\beta$  (fig. 5(b)).

Only slight changes occurred in the day-to-day values of the non-scanner field-of-view limiter, blackbody, and passive analog temperatures (figs. 10(c), 10(e), and 10(f)), and the highest values occurred near minimum  $\beta$  (figs. 5 and 6). The spikes in these housekeeping measurements correspond to the periods when the blackbodies were turned on during internal calibrations.

Little ( $0.1^{\circ}\text{C}$ ) or no variation was seen in the detector temperatures for the NOAA 9 scanner instrument (fig. 11(a)) prior to its failure on January 20, 1987. This variation is about one-third the variation observed for the scanner detectors on the ERBS spacecraft (fig. 9(a)). Detector temperatures

are modeled in the radiometric data-conversion algorithms of the scanner instruments. The DAC voltages (fig. 11(b)), like those for the instrument on the ERBS spacecraft, all drifted during the period of this paper. The blackbody temperatures (fig. 11(c)) show only small day-to-day variations in temperature, but internal calibration events are observed in the plots as tall spikes.

All plots of housekeeping measurements from the NOAA 9 scanner instrument (fig. 11) reflect its failure in January 1987. The plots of detector temperatures (fig. 11(a)), DAC voltages (fig. 11(b)), and blackbody temperatures (fig. 11(c)) show no data following the scanner failure on January 20. However, the electronic slice 3 and box beam temperatures (fig. 11(d)) are transmitted in spacecraft housekeeping channels and are considered valid after the scanner failed. These passive measurements increased after the scanner failure, and then they dropped following a CPU reset.

### NOAA 10 Spacecraft

The NOAA 10 spacecraft was launched into orbit September 17, 1986. The spacecraft and the ERBE instruments aboard it are monitored and controlled by NOAA in the same manner as that described for NOAA 9 in the previous section. From launch until October 24, 1986, the instruments were checked out and evaluated, and internal and solar calibrations of the non-scanner instrument and internal calibrations of the scanner instrument were performed. The archival period for RAT data from the NOAA 10 spacecraft began on October 24, the day during which the contamination covers of the scanner instrument were released, and both instruments made Earth-viewing science measurements in their normal operating modes for part of the day. The archival period for PAT data from the NOAA 10 spacecraft began on October 25, the first full day during which both instruments made Earth-viewing science measurements in their normal operating modes.

#### *In-Flight Operations*

The NOAA 10 orbit was nearly Sun-synchronous and had a mean local time of about 7:30 a.m. at the ascending node. The orbit resulted in relatively low  $\beta$  angles (see fig. 5(c)) that caused the spacecraft to be near or in full-Sun orbits during the operational period of the NOAA 10 spacecraft covered by this paper (October 1986 through January 1987). During that entire time period, the scanner instrument operated at an azimuth-beam position of  $35^{\circ}$  instead of the cross-track azimuth angle of  $0^{\circ}$  to prevent the scanner detectors from directly viewing the Sun.

During most of the operational period, the ERBE instruments aboard the NOAA 10 spacecraft operated in their normal modes and made Earth-viewing radiation measurements. However, changes in mode operation have been required to obtain calibration data. Also, an anomaly during an attempted solar calibration of the scanner instrument on November 12, 1986, resulted in the scanner instrument being stowed from November 18 until December 5, 1986. Tables 9(a) and 9(b) list the operational mode commands executed by the ERBE non-scanner and scanner instruments, respectively, on the NOAA 10 spacecraft from October 24, 1986, through January 31, 1987.

Table 6 lists the modes in which the ERBE instruments aboard the NOAA 10 spacecraft normally operated for each operational category, together with the data values used during the period for the mode commands that required input data.

The nonscanner instrument operated at an azimuth angle of  $180^\circ$  and in the normal Earth-viewing elevation mode except during periods of calibration. The scanner instrument normally operated at an azimuth-beam position of  $35^\circ$  and in the normal Earth scan mode. Like the scanner instruments on the ERBS and NOAA 9 spacecraft, the scanner instrument detectors on the NOAA 10 spacecraft viewed space on the dark side of the orbit and scanned the Earth from dark to sunlit regions.

All heaters and calibration sources controlled by mode commands remained off during normal operation, except for the nonscanner detector heaters and solar port heaters. Table 6 lists the normal status of the power relays for both instruments on the NOAA 10 spacecraft. The normal positions of the relays are the same as those for the instruments on the ERBS spacecraft.

Most of the operational mode commands of the in-flight instruments were associated with instrument calibrations. (See table 9.) Appendix A in reference 1 describes the preprogrammed, or automated, instrument calibration sequences of the instruments and how these sequences have been combined with auxiliary commands to facilitate in-flight calibrations. During the operational period of NOAA 10 covered by this paper, a set of instrument calibrations was normally performed on alternate Wednesdays. This set of calibrations included internal and solar calibrations of the nonscanner instrument and internal calibrations of the scanner instrument. No solar calibrations of the scanner instrument were attempted after the azimuth-beam anomaly on November 12, 1986.

After the scanner solar calibration on November 12, 1986, the azimuth position sensor indicated that the azimuth beam rotated to  $180^\circ$  instead of the desired angle of  $35^\circ$ . Since the spacecraft was operating in full-Sun orbits during this period, the instrument was commanded to the stow position on November 18 to prevent the detectors from scanning the Sun at the cross-track azimuth position of  $180^\circ$ . An analysis showed later that the azimuth beam had rotated correctly to  $35^\circ$  on November 12. The instrument was commanded back to the normal Earth scan mode on December 5, 1986, and it operated in that mode and at the azimuth angle of  $35^\circ$  through January 1987. No more azimuth-beam rotations were attempted during the period of this paper, and hence no more solar calibrations were performed.

Some misalignment of the detectors at the internal calibration sources was observed during most of the internal calibrations of the scanner instrument through December 1986. However, elevation-beam rotation was generally smooth with no significant sluggishness until near the end of December 1986. (See fig 7(c).) The gap in the mean scan angle plot reflects the period from November 18 until December 5 during which the scanner was stowed. Rotational motion of the elevation beam became erratic in January, and sluggishness and hang-up problems were more severe than had been observed with the scanner instruments on the ERBS and NOAA 9 spacecraft. New software for science data processing was developed to process and edit the data during the periods of severe rotation problems. This software separated good and bad elevation-beam position data during periods of elevation-beam problems and correctly computed pointing vectors of the detectors.

#### *Monitoring and Analysis of Instrument Housekeeping Measurements*

Instrument housekeeping measurements are monitored during real-time communication contacts with the spacecraft to ensure that the instruments are functioning normally. In the real-time monitoring procedure, the housekeeping measurements are checked against both yellow limits, which indicate that an instrument may be approaching a critical condition, and red limits, which indicate that the instrument is at risk of being damaged.

Table 11 shows the values used in the science data processing at LaRC to test the magnitudes and rates of change of selected key housekeeping measurements of the instruments on the NOAA 10 spacecraft. As was the case with ERBS and NOAA 9, these limits are much more restrictive than those used in the real-time monitoring.



Figures 12 and 13 are plots of the minimum, mean, and maximum values of key housekeeping measurements for the instruments on the NOAA 10 spacecraft for each day from the first day of archived data (October 24, 1986) through January 1987. Note that the abscissa for these figures starts at February 1986, not October 1986. This is to provide a comparison on the same scale among the three spacecraft discussed in this paper. Day-to-day variations in the values of the measurements are not nearly as large as those for the instruments on the ERBS spacecraft because of the smaller variation in the values of  $\beta$ , but they are larger than the variation seen in the NOAA 9 values.

Almost no variation occurred in the values of the heat sink temperatures of the nonscanner instrument on NOAA 10, and the aperture temperatures varied by no more than 0.30°C (figs. 12(a) and 12(b)). The solar monitor temperature changes, as well as changes seen in the day-to-day values of the nonscanner field-of-view limiter, blackbody, and passive analog temperatures (figs. 12(c) 12(f)), were in response to changes in  $\beta$  (fig. 5(c)). These changes in temperature with  $\beta$  are similar to changes seen on the ERBS spacecraft. (See, for example, figs. 8(d), 8(e), and 8(f).) The spikes in these housekeeping measurements correspond to nonscanner calibration events.

The temperatures of the scanner detectors on the NOAA 10 spacecraft varied by no more than 0.2°C (fig. 13(a)). The DAC voltages (fig. 13(b)), like those for the instruments on the ERBS and NOAA 9 spacecraft, all drifted during the period of this paper. The blackbody (fig. 13(c)) and passive analog (fig. 13(d)) temperatures show day-to-day variations that are related to changes in  $\beta$ . The spikes in the data correspond to instrument calibrations.

## Discussion and Analysis of Operations Month by Month

### Introduction

This section discusses spacecraft and instrument operations for the ERBS, NOAA 9, and NOAA 10 spacecraft separately for each month, beginning with February 1986 and continuing through January 1987. During most of this time the instruments were in their normal operating modes. The discussion addresses the percentage of data archived (see table 1),  $\beta$  angles (see figs. 5 and 6), spacecraft maneuvers (see tables 1, 7, 8, and 9), instrument calibrations (see tables 1, 7, 8, and 9), and other instrument operations (see tables 1, 7, 8, and 9).

Table 1 summarizes spacecraft and instrument operations for each spacecraft for each month, and

it also gives the percentage of data archived to both the RAT and PAT products. The percentage of data archived is actually the percentage of 16-second records archived. An archived record can contain fill data and/or poor quality data that are flagged as bad. However, the percentage of data archived is usually a good approximation of the percentage of usable data, particularly for data from the ERBS spacecraft.

Differences between the RAT and PAT data percentages arise because of data quality problems and because of constraints imposed on the data archived to the PAT. Data quality problems are rarely encountered in the ERBS data, and this is reflected in the small differences, generally less than 1 percent, between the percentages of data archived to the ERBS RAT and PAT products. On calibration days the differences are generally on the order of 3 percent, since some data collected during calibrations do not meet the constraints discussed below. On days when spacecraft yaw maneuvers are performed on the ERBS spacecraft, differences are generally greater than 3 percent, again because some data collected during these maneuvers do not meet the constraints discussed below. Data recovery was nearly always greater from the ERBS spacecraft than from the NOAA spacecraft. The losses in data recovery, as well as the larger differences between the NOAA 9 and NOAA 10 RAT and PAT data percentages, occur because of less efficient data processing procedures at NOAA. The less efficient procedures at NOAA reflect the fact that the NOAA spacecraft are operational weather satellites, whereas ERBS is dedicated to the ERBE and SAGE II instruments.

The following constraints in chart A must be met if data archived to the RAT are to be included on the PAT:

Chart A

Nonscanner	Scanner
Instrument power on	Instrument power on
Nadir (Earth-viewing) elevation	Azimuth motor power off
Not in solar calibration mode	Not in solar calibration mode
Not in internal calibration mode	In Earth-viewing scan mode

In addition, certain quality indicator flags for both the nonscanner and scanner instrument data must be set if the data are to be included on the PAT. These constraints ensure that no record is written to the PAT that does not contain at least one good scanner or nonscanner measurement. If the scanner

instrument is in stow for an entire day, no data are archived to the PAT for that day.

All the operational mode commands executed by the nonscanner and scanner instruments on the ERBS and NOAA 9 spacecraft from February 1986 through January 1987 are listed in Tables 7 and 8, respectively. Table 9 lists all operational mode commands executed by the nonscanner and scanner instruments on the NOAA 10 spacecraft from October 1986, the first month for which data from these instruments were archived, through January 1987. These tables are based on the command echo word from the telemetry data processing, which is an echo of the last command executed by the instrument. Occasionally, a data dropout will obscure a command that was actually received and executed by the instrument; thus the commands listed in tables 7, 8, and 9 may not exactly reflect instrument operations. When this occurs, it will be noted in the text and tables. Figures 5 and 6 show the  $\beta$  angles for ERBS, NOAA 9, and NOAA 10 for the entire year and for each month covered in this discussion. Figure 7 shows the daily mean scan angle for all three scanner instruments, whereas figures 8-13 show the responses of instrument housekeeping temperatures and voltages to the operations discussed in this section, as well as the effects of changes in Earth-Sun-spacecraft geometry.

Since elevation-beam motion problems were seen throughout the year on the ERBS and NOAA 9 scanner instruments, these problems are not discussed in the subsequent month-by-month sections. Elevation-beam anomalies are discussed in the section entitled "General Discussion and Analysis of Mission and Instrument Operations" on page 5.

The nonscanner instrument aboard the NOAA 9 spacecraft was intended to operate at an azimuth position of  $170^\circ$ , except during solar calibrations, to avoid interference with the SBUV instrument on that spacecraft. However, continuing problems with the nonscanner azimuth-beam rotation (see ref. 1) resulted in nonscanner operation at an azimuth position of  $180^\circ$  for the entire year except during solar calibrations. During this period, the instrument was commanded to an azimuth position of  $170^\circ$  and reported its azimuth position as being  $170^\circ$ . However, analysis of the data indicated that the instrument azimuth beam was actually at  $180^\circ$ . Since the nonscanner instrument is nadir-pointing in its normal Earth-viewing operational mode, this discrepancy in azimuth position did not affect the calculation of nonscanner view vectors.

Medium field-of-view (MFOV) data from the non-scanner instrument aboard the NOAA 10 spacecraft were not included in the PAT product because analyses revealed significant discrepancies between the NOAA 10 nonscanner MFOV data and the scanner data. At present, these data are set to a default value and the associated flags indicate bad data. These data may be archived at a later date after corrections have been made to the processing algorithms.

### *ERBS Spacecraft Operations*

*ERBS spacecraft February 1986.* In February 1986 the percentage of data archived to the RAT was 99.98 and to the PAT was 99.89. (See table 1(a).) The  $\beta$  angle increased from about  $91^\circ$  on February 1 to about  $158^\circ$  on February 21, the maximum for the month, and then it decreased to about  $140^\circ$  by the end of the month. (See figs. 5(a) and 6(a).) From February 18 through February 24, the spacecraft was in sunlight continuously during every orbit, and both the scanner and nonscanner instruments experienced above-normal heating from February 18 through February 24. The spacecraft operated with its  $X$ -axis positive for the entire month. Since  $\beta$  never reached  $90^\circ$ , no yaw maneuvers were performed in February 1986.

The nonscanner instrument operated in the normal nadir or Earth-viewing elevation mode and at the normal azimuth position of  $0^\circ$  during the month except during the internal and solar calibrations performed on February 5, 15, and 26. As mentioned above, the nonscanner instrument experienced above-normal heating during the full-Sun period, but instrument health was never endangered.

The scanner instrument operated in the normal Earth scan mode during the entire month of February. The azimuth operated at  $180^\circ$  for most of the month; however, the azimuth beam was rotated to  $145^\circ$  from 15:54 UT on February 16 until 21:06 UT on February 25 to prevent the scanner detectors from scanning the Sun as the spacecraft orbit approached full-Sun conditions. Successful internal calibrations were performed on February 5, 15, and 26. No scanner solar calibrations were performed in February. Solar calibrations were discontinued for the ERBS scanner following problems encountered in changing scan modes during the pitch maneuver performed on October 19, 1985. (See ref. 1.)

*ERBS spacecraft—March 1986.* In March 1986 the percentage of data archived to the RAT was 99.94 and to the PAT was 99.71. (See table 1(b).) The  $\beta$  angle decreased from about  $137^\circ$  on March 1 to about  $29^\circ$  on March 31. (See figs. 5(a) and 6(a).)

Both instruments showed increased heating toward the end of the month because of low  $\beta$  angle, although the spacecraft was never in full sunlight during March. The spacecraft was configured with its  $X$ -axis positive until about 15:07 UT on March 12 when a  $180^\circ$  yaw maneuver was performed. The spacecraft operated with its  $X$ -axis negative for the remainder of the month.

The nonscanner instrument operated in the normal Earth-viewing elevation mode and at the normal azimuth position of  $0^\circ$  the entire month except during calibrations. Successful internal and solar calibrations were performed on March 5 and 19.

The scanner instrument operated in the normal Earth scan mode and at the normal azimuth position of  $180^\circ$  for the entire month. Successful internal calibrations were performed on March 5 and 19.

*ERBS spacecraft April 1986.* In April 1986 the percentage of data archived to the RAT was nearly 100 and to the PAT was 99.73. (See table 1(c).) The  $\beta$  angle increased from about  $30^\circ$  on April 1 to about  $125^\circ$  on April 30. (See figs. 5(a) and 6(a).) Both instruments experienced higher than normal temperatures during the first few days of April because of the low  $\beta$  angle, although the spacecraft orbit never entered full sunlight for a complete orbit. The spacecraft was configured with its  $X$ -axis negative until April 18 at 16:17 UT when the spacecraft performed a  $180^\circ$  yaw turn. The spacecraft operated with its  $X$ -axis positive for the remainder of the month.

The nonscanner instrument operated in the normal Earth-viewing elevation mode and at the normal azimuth position of  $0^\circ$  the entire month except during calibrations. Successful internal and solar calibrations were performed on April 2, 16, and 30.

The scanner instrument operated in the normal Earth scan mode and at the normal azimuth position of  $180^\circ$  for the entire month. Successful internal calibrations were performed on April 2, 16, and 30.

*ERBS spacecraft May 1986.* In May 1986 the percentage of data archived to the RAT was 99.98 and to the PAT was 99.77. (See table 1(d).) The  $\beta$  angle increased from about  $127^\circ$  on May 1 to about  $130^\circ$  on May 5. The  $\beta$  angle then decreased to about  $50^\circ$  by the end of the month. (See figs. 5(a) and 6(a).) The spacecraft was configured with its  $X$ -axis positive until 14:48 UT on May 21 when the spacecraft executed a  $180^\circ$  yaw turn. The spacecraft operated with its  $X$ -axis negative for the remainder of the month.

The nonscanner instrument operated in the normal Earth-viewing elevation mode and at the normal azimuth position of  $0^\circ$  the entire month except during calibrations. Successful internal and solar calibrations were performed on May 14 and 28.

The scanner instrument operated in the normal Earth scan mode and at the normal azimuth position of  $180^\circ$  for the entire month. Successful internal calibrations were performed on May 14 and 28.

*ERBS spacecraft June 1986.* In June 1986 the percentage of data archived to the RAT was 99.99 and to the PAT was 99.79. (See table 1(e).) The  $\beta$  angle decreased from about  $46^\circ$  on June 1 to  $10^\circ$  on June 11, its lowest value of the year. The  $\beta$  angle then increased to about  $81^\circ$  by the end of the month. (See figs. 5(a) and 6(a).) The low  $\beta$  angle during this month caused the spacecraft to be continuously in sunlight during every orbit from about June 6 through June 17. As discussed previously, when  $\beta$  is near  $156^\circ$  or  $24^\circ$ , both ERBE instruments experience above-normal heating. Since  $\beta$  passes through  $24^\circ$  both before and after reaching  $10^\circ$  on June 11, there is a dog-car or double maxima pattern in the temperatures on both instruments. (See, for example, fig. 8(d) for nonscanner solar heat sink and aperture temperatures and fig. 9(c) for scanner blackbody temperatures.) Since  $\beta$  never reached  $90^\circ$ , no yaw turn was performed in June, and the spacecraft operated with its  $X$ -axis negative during the entire month.

The nonscanner instrument operated in the normal Earth-viewing elevation mode with its azimuth at the normal position of  $0^\circ$  the entire month except during calibrations. Some housekeeping temperatures exceeded their normal values during the full-Sun period, but the health of the instrument was not threatened. Maximum temperatures were seen on June 6 through 9 and again on June 14 through 17. Internal and solar calibrations were performed successfully on June 4, 19, and 25. On June 4 the address and data commands for azimuth angle A were sent twice. No apparent reason exists for this occurrence, and the calibration was not affected.

The scanner instrument operated in the normal Earth scan mode for the entire month. The scanner azimuth operated at the normal azimuth position of  $180^\circ$  until June 4 at 16:45 UT when the azimuth beam was rotated to  $145^\circ$  to prevent the detectors from scanning the Sun while in full-Sun conditions. The azimuth beam was rotated back to  $180^\circ$  following the full-Sun period on June 18 at 15:20 UT and remained at  $180^\circ$  through the end of the month. Some scanner temperatures were higher during the

full-Sun period with peaks on June 6 through 8 and June 14 through 16. Scanner internal calibrations were performed on June 4, 19, and 25.

*ERBS spacecraft—July 1986.* In July 1986 the percentage of data archived to the RAT was nearly 100 and to the PAT was 99.85. (See table 1(f).) The  $\beta$  angle increased from about  $85^\circ$  on July 1 to about  $126^\circ$  on July 18, and then it decreased to about  $97^\circ$  by the end of the month. (See figs. 5(a) and 6(a).) The spacecraft was configured with its  $X$ -axis negative until 15:24 UT on July 2 when the spacecraft executed a  $180^\circ$  yaw turn. The spacecraft operated with its  $X$ -axis positive for the remainder of the month.

The nonscanner instrument operated in the normal Earth-viewing elevation mode and at the normal azimuth position of  $0^\circ$  the entire month except during calibrations. Successful internal and solar calibrations were performed on July 9 and 23.

The scanner instrument operated in the normal Earth scan mode and at the normal azimuth position of  $180^\circ$  for the entire month. Scanner internal calibrations were performed on July 9 and 23.

*ERBS spacecraft August 1986.* In August 1986 the percentage of data archived to the RAT was 99.94 and to the PAT was 99.68. (See table 1(g).) The  $\beta$  angle decreased from about  $95^\circ$  on August 1 to about  $21^\circ$  on August 23, and then it increased to about  $45^\circ$  by August 31. (See figs. 5(a) and 6(a).) The low  $\beta$  angle caused the spacecraft to be continuously in sunlight every orbit from about August 19 through August 26. This condition is similar to the one seen in February, but with a single peak centered on August 23. Heating effects can be observed in both instruments. (See, for example, fig. 8(d) for solar monitor heat sink and aperture temperatures and fig. 9(c) for scanner blackbody temperatures.) The spacecraft operated with its  $X$ -axis positive until 14:55 UT on August 1 when a  $180^\circ$  yaw turn was performed. The spacecraft operated with its  $X$ -axis negative for the remainder of the month.

The nonscanner instrument operated in the normal Earth-viewing elevation mode, and its azimuth operated at the normal azimuth position of  $0^\circ$  for the entire month except during calibrations. Some housekeeping temperatures were higher than normal during the full-Sun period, but the health of the instrument was not threatened. Internal and solar calibrations were performed on August 6, 17, and 28. All calibrations were successful except for the solar calibration on August 6 when the azimuth beam was rotated at the wrong time during the orbit, and thus

the Sun never passed through the field of view of the detectors.

The scanner instrument operated in the normal Earth scan mode during the entire month. The azimuth operated at  $180^\circ$  from the beginning of the month until August 18 at 16:00 UT when the azimuth was rotated to  $145^\circ$ . The azimuth was rotated back to  $180^\circ$  on August 27 at 18:10 UT where it remained for the balance of the month. Scanner temperatures were higher during the full-Sun period, but the health of the instrument was unaffected. Successful internal calibrations were performed on August 6, 17, and 28.

*ERBS spacecraft—September 1986.* In September 1986 the percentage of data archived to the RAT was 99.90 and to the PAT was 99.72. (See table 1(h).) The  $\beta$  angle increased from about  $48^\circ$  on September 1 to about  $150^\circ$  on September 30. (See figs. 5(a) and 6(a).) Both instruments exhibited increased heating at the end of the month, but the spacecraft was never continuously in full sunlight during an orbit. The spacecraft was configured with its  $X$ -axis negative from the beginning of the month until 13:31 UT on September 11 when the spacecraft performed a  $180^\circ$  yaw turn. The spacecraft operated with its  $X$ -axis positive for the remainder of the month.

The nonscanner instrument operated in the normal Earth-viewing elevation mode, and the azimuth operated at  $0^\circ$  for the entire month except during calibrations. Nonscanner housekeeping and analog temperatures were higher at the end of the month, but they never threatened the health of the instrument. Successful internal and solar calibrations were performed on September 3 and 17.

The scanner instrument operated in the normal Earth scan mode with its azimuth at  $180^\circ$  for the entire month. Scanner housekeeping and analog temperatures were higher at the end of the month, but the instrument health was never threatened. Successful internal calibrations were performed on September 3 and 17.

*ERBS spacecraft—October 1986.* In October 1986 the percentage of data archived to the RAT was 99.98 and to the PAT was 99.83. (See table 1(i).) The  $\beta$  angle decreased from about  $149^\circ$  on October 1 to about  $52^\circ$  on October 31. (See figs. 5(a) and 6(a).) The spacecraft was configured with its  $X$ -axis positive from the beginning of the month until October 17 at 14:28 UT when the spacecraft executed a  $180^\circ$  yaw turn. The spacecraft operated with its  $X$ -axis negative for the remainder of the month.

The nonscanner instrument operated in the normal Earth-viewing mode, and the azimuth operated

at  $0^\circ$  for the entire month except during calibrations. Successful internal and solar calibrations were performed on October 1, 15, and 29.

The scanner instrument operated in the normal Earth scan mode with its azimuth at  $180^\circ$  for the entire month. Successful internal calibrations were performed on October 1, 15, and 29.

*ERBS spacecraft November 1986.* In November 1986 the percentage of data archived to the RAT was 99.97 and to the PAT was 99.84. (See table 1(j).) The  $\beta$  angle decreased from about  $51^\circ$  on November 1 to about  $49^\circ$  on November 4. The  $\beta$  angle then increased to about  $131^\circ$  by November 30. (See figs. 5(a) and 6(a).) The spacecraft was configured with its  $X$ -axis negative from the beginning of the month until 14:56 UT on November 20 when the spacecraft performed a  $180^\circ$  yaw maneuver. The spacecraft operated with its  $X$ -axis positive for the remainder of the month.

The nonscanner instrument operated in the normal Earth-viewing elevation mode with its azimuth operating at  $0^\circ$  for the entire month except during calibrations. Internal and solar calibrations were performed on November 12 and 26. These calibrations were successful.

The scanner instrument operated in the normal Earth scan mode for the entire month. The scanner azimuth operated at  $180^\circ$  for the entire month. Successful internal calibrations were performed on November 12 and 26.

*ERBS spacecraft December 1986.* In December 1986 the percentage of data archived to the RAT was 99.98 and to the PAT was 99.68. (See table 1(k).) The  $\beta$  angle increased from about  $133^\circ$  on December 1 to almost  $170^\circ$  on December 11, the maximum value for the year. The  $\beta$  angle then decreased to about  $91^\circ$  by December 31. (See figs. 5(a) and 6(a).) The spacecraft operated in continuous sunlight from December 6 through 16 because of the high  $\beta$  during this period. Since  $\beta$  passes quickly through the maximum heating conditions at  $\beta \approx 154^\circ$ , this period of full sunlight resembles the one seen in June that exhibited a dog-ear pattern (double maxima) of temperature values. Heating effects can be seen in both instruments. (For example, see fig. 8(d) for nonscanner solar heat sink and aperture temperatures and fig. 9(c) for scanner blackbody temperatures.) The spacecraft was configured with its  $X$ -axis positive from the beginning of the month until 15:15 UT on December 31 when the spacecraft performed a  $180^\circ$  yaw maneuver. The spacecraft operated with its  $X$ -axis negative for the remainder of the day.

The nonscanner instrument operated in the normal Earth-viewing elevation mode with its azimuth operating at  $0^\circ$  for the entire month except during calibrations. Some housekeeping temperatures were higher than normal during the full-Sun period. Temperatures never exceeded the established safety limits for the instrument. Successful internal and solar calibrations were performed on December 4, 18, and 24.

The scanner instrument operated in the normal Earth scan mode for the entire month. The scanner azimuth operated at  $180^\circ$  until 20:07 UT on December 4 when the azimuth beam was rotated to  $145^\circ$  to prevent the detectors from scanning the Sun. The azimuth beam was rotated back to  $180^\circ$  on December 17 at 16:47 UT and remained there for the rest of the month. Scanner housekeeping temperatures were higher during the full-Sun period, but most data involved in radiometric conversion were not adversely affected. Successful internal calibrations were performed on December 4, 18, and 24.

*ERBS spacecraft January 1987.* In January 1987 the percentage of data archived to the RAT was 99.98 and to the PAT was 99.74. (See table 1(l).) The  $\beta$  angle decreased from about  $89^\circ$  on January 1 to about  $54^\circ$  on January 16, and then it increased to  $91^\circ$  on January 31. (See figs. 5(a) and 6(a).) The spacecraft flew with its  $X$ -axis negative from the beginning of the month until January 30 at 14:45 UT when the spacecraft performed a  $180^\circ$  yaw maneuver. The spacecraft operated with its  $X$ -axis positive for the remainder of the month.

The nonscanner instrument operated in the normal Earth-viewing mode, and the azimuth operated at  $0^\circ$  for the entire month except during calibrations. Successful internal and solar calibrations were performed on January 7 and 21.

The scanner instrument operated in the normal Earth scan mode with its azimuth at  $180^\circ$  for the entire month. Successful internal calibrations were performed on January 7 and 21.

#### *NOAA 9 Spacecraft Operations*

*NOAA 9 spacecraft February 1986.* In February 1986 the percentage of data archived to the RAT was 89.42 and to the PAT was 86.98. (See table 1(a).) The  $\beta$  angle decreased from about  $53.0^\circ$  at the beginning of the month to about  $52.6^\circ$  at the end of the month.

The nonscanner instrument operated in its normal Earth-viewing elevation mode and at an azimuth position of  $180^\circ$  for the entire month except during calibrations. Successful internal and solar calibrations were performed on February 5 and 19.

The scanner instrument operated in the normal Earth scan mode and at the normal  $0^\circ$  azimuth position for the entire month except during calibrations. Internal and solar calibrations of the scanner instrument were performed on February 5 and 19. These calibrations were successful, although there was some misalignment of the detectors with the internal calibration sources.

*NOAA 9 spacecraft—March 1986.* In March 1986 the percentage of data archived to the RAT was 87.74 and to the PAT was 86.97. (See table 1(b).) No data tapes were received from NOAA for March 14 and 15. Excluding these 2 days, the percentages of data archived were 93.79 to the RAT and 92.96 to the PAT. The  $\beta$  angle decreased from about  $52.6^\circ$  at the beginning of the month to about  $52.1^\circ$  at the end of the month.

The nonscanner instrument operated in its normal Earth-viewing elevation mode and at an azimuth position of  $180^\circ$  for the entire month except during calibrations. Successful nonscanner internal and solar calibrations were performed on March 5 and 19.

Scanner internal and solar calibrations were performed on March 5 and 19. The solar calibration on March 5 was lost because of a data dropout; the other calibrations performed in March were successful. The scanner instrument operated in the normal Earth scan mode and at the normal  $0^\circ$  azimuth position except during calibrations.

*NOAA 9 spacecraft—April 1986.* In April 1986 the percentage of data archived to the RAT was 96.31 and to the PAT was 95.61. (See table 1(c).) The  $\beta$  angle increased from about  $52.1^\circ$  at the beginning of the month to about  $53.6^\circ$  at the end of the month.

The nonscanner instrument operated in its normal Earth-viewing elevation mode for the entire month except during calibrations. The instrument azimuth beam operated at  $180^\circ$  for the entire month except during solar calibrations. Successful nonscanner internal and solar calibrations were performed on April 2 and 30. Internal and solar calibrations were also performed on April 16, but a data dropout obscured all internal and most solar calibration commands. The data dropout occurred just after the blackbody heaters were turned on during the precalibration sequence and continued until a few minutes after the SMA shutter was turned on during the solar calibration. (See table 8(a).) This solar calibration appears normal and all radiometric data look good.

The scanner instrument operated in the normal Earth scan mode and at the normal azimuth

position of  $0^\circ$  for the entire month except during calibrations. Successful scanner internal and solar calibrations were performed on April 2, 16, and 30.

*NOAA 9 spacecraft—May 1986.* In May 1986 the percentage of data archived to the RAT was 96.39 and to the PAT was 94.90. (See table 1(d).) The  $\beta$  angle increased from about  $53.7^\circ$  at the beginning of the month to about  $56.2^\circ$  at the end of the month.

The nonscanner instrument operated in its normal Earth-viewing elevation mode and at an azimuth position of  $180^\circ$  throughout the month except during calibrations. Successful internal and solar calibrations were performed on May 14 and 28.

The scanner instrument operated in the normal Earth scan mode and at the normal  $0^\circ$  azimuth position for the entire month except during calibrations. Successful internal and solar calibrations were performed on May 14 and 28.

*NOAA 9 spacecraft—June 1986.* In June 1986 the percentage of data archived to the RAT was 98.77 and to the PAT was 95.42. (See table 1(e).) The  $\beta$  angle increased from about  $56.3^\circ$  at the beginning of the month to about  $57.8^\circ$  at the end of the month. This was the maximum  $\beta$  angle for the year.

The nonscanner instrument operated in its normal Earth-viewing elevation mode and at an azimuth position of  $180^\circ$  throughout the month except during calibrations. Successful internal and solar calibrations were performed on June 11 and 25.

The scanner instrument operated in its normal Earth scan mode and at its normal  $0^\circ$  azimuth position for the entire month except during calibrations. Successful scanner internal and solar calibrations were performed on June 11 and 25.

*NOAA 9 spacecraft—July 1986.* In July 1986 the percentage of data archived to the RAT was 96.63 and to the PAT was 93.39. (See table 1(f).) The  $\beta$  angle decreased from  $57.8^\circ$  on the first of the month, its maximum value for the year, to about  $55.7^\circ$  at the end of the month.

The nonscanner instrument operated in its normal Earth-viewing elevation mode and at an azimuth position of  $180^\circ$  throughout the month except during calibrations. Successful nonscanner internal and solar calibrations were performed on July 9 and 23.

The scanner instrument operated in its normal Earth scan mode and at its normal  $0^\circ$  azimuth position for the entire month except during calibrations. Successful scanner internal calibrations were performed on July 9 and 23. A successful solar calibration was performed on July 23, but the solar

calibration attempted on July 9 was obscured by a data dropout.

*NOAA 9 spacecraft—August 1986.* In August 1986 the percentage of data archived to the RAT was 97.28 and to the PAT was 95.67. (See table 1(g).) The  $\beta$  angle decreased from about  $55.6^\circ$  to about  $50.1^\circ$  during August.

Nonscanner internal and solar calibrations were successfully performed on August 6 and 20. The nonscanner instrument operated in its normal Earth-viewing elevation mode and at an azimuth position of  $180^\circ$  during the entire month except during calibrations.

The scanner instrument operated in the normal Earth scan mode and at its normal azimuth position of  $0^\circ$  for the entire month except during solar calibrations. Successful scanner internal and solar calibrations were performed on August 6 and 20.

*NOAA 9 spacecraft—September 1986.* In September 1986 the percentage of data archived to the RAT was 99.15 and to the PAT was 98.05. (See table 1(h).) The  $\beta$  angle decreased from about  $50.0^\circ$  to about  $44.1^\circ$  during September.

The nonscanner instrument operated in its normal Earth-viewing elevation mode and at an azimuth position of  $180^\circ$  for the entire month except during calibrations. Successful nonscanner internal and solar calibrations were performed on September 3 and 17.

The scanner instrument operated in its normal Earth scan mode and at its normal azimuth position of  $0^\circ$  for the entire month except during calibrations. Successful internal and solar calibrations were performed on September 3 and 17.

*NOAA 9 spacecraft—October 1986.* In October 1986 the percentage of data archived to the RAT was 98.74 and to the PAT was 97.87. (See table 1(i).) The  $\beta$  angle decreased from about  $44.0^\circ$  to about  $41.1^\circ$  during the month.

The nonscanner instrument operated in the normal Earth-viewing elevation mode and at an azimuth position of  $180^\circ$  for the entire month except during calibrations. Nonscanner internal calibrations were successfully performed on October 1, 15, and 29. Successful solar calibrations were performed on October 15 and 29. A solar calibration attempted on October 1 was unsuccessful because azimuth-beam rotation problems prevented the instrument from rotating to the correct Sun azimuth position.

The scanner instrument operated in the normal Earth scan mode and at the normal  $0^\circ$  azimuth po-

sition for the entire month except during calibrations. Scanner internal and solar calibrations were successfully performed on October 1, 15, and 29.

*NOAA 9 spacecraft November 1986.* In November 1986 the percentage of data archived to the RAT was 98.25 and to the PAT was 97.62. (See table 1(j).) The  $\beta$  angle reached its minimum value for the year of about  $41.1^\circ$  on November 1 and then increased to about  $42.8^\circ$  by the end of the month.

Except during calibrations, the nonscanner instrument operated in the normal Earth-viewing elevation mode and at an azimuth position of  $180^\circ$  for the entire month. Successful nonscanner internal and solar calibrations were performed on November 12 and 26.

Successful internal and solar calibrations of the scanner instrument were performed on November 12 and 26. Except during solar calibrations, the scanner instrument operated in the normal Earth scan mode and at the normal cross-track azimuth angle of  $0^\circ$  for the entire month.

*NOAA 9 spacecraft December 1986.* In December 1986 the percentage of data archived to the RAT was 98.18 and to the PAT was 97.37. (See table 1(k).) The  $\beta$  angle increased from about  $42.8^\circ$  to about  $45.7^\circ$  during December.

The nonscanner instrument operated in its normal Earth-viewing elevation mode and at an azimuth position of  $180^\circ$  for the entire month except during calibrations. Nonscanner internal calibrations were successfully performed on December 10 and 24. Solar calibrations attempted on these days were unsuccessful because azimuth rotation problems left the instrument at  $180^\circ$  during both solar calibration attempts.

Except during periods of calibration, the scanner instrument operated in the normal Earth scan mode and at the normal cross-track azimuth-beam position of  $0^\circ$ . Scanner internal and solar calibrations were successfully performed on December 10 and 24.

*NOAA 9 spacecraft—January 1987.* In January 1987 the percentage of data archived to the RAT was 98.30 and to the PAT was 63.48. (See table 1(l).) Because of the scanner instrument failure, data were archived to the PAT for only the first 20 days of the month. For this period, 98.39 percent of the data were archived to the PAT. The  $\beta$  angle increased from about  $45.8^\circ$  to about  $46.9^\circ$  during January.

Successful internal and solar calibrations of the nonscanner instrument were performed on January 21. The instrument operated in the nadir, or Earth-viewing, elevation mode and at an azimuth

position of  $180^\circ$  during the entire month except during calibrations.

The scanner instrument operated in the normal Earth scan mode and at the normal cross-track azimuth position of  $0^\circ$  until the instrument failed at 18:49 UT on January 20. No scanner calibrations were performed during January. A calibration scheduled for January 21 was not performed because the instrument failed on January 20.

#### *NOAA 10 Spacecraft Operations*

*NOAA 10 spacecraft October 1986.* The NOAA 10 spacecraft was launched into a Sun-synchronous orbit on September 17, 1986. This spacecraft carried the third and final set of ERBE scanner and nonscanner instruments. Data were archived to the RAT for the period of October 24–31, although scanner data are available for only the period after approximately 17:25 UT on October 24. Data were archived to the PAT for only the period of October 25–31 when both the nonscanner and scanner instruments were making Earth-viewing measurements. No data were archived to the PAT for October 24. The percentage of data archived to the RAT was 97.34 and to the PAT was 96.79 for their respective archival periods. (See table 1(i).)

The NOAA 10 spacecraft orbit was in full Sun when  $\beta$  was less than  $28^\circ$  or greater than  $152^\circ$ . (See appendix B of ref. 1.) The Sun's  $\beta$  angle increased from about  $26.4^\circ$  on October 24 to about  $26.8^\circ$  on October 31. Thus, the spacecraft was in a full-Sun orbit for the month of October. During the month the scanner azimuth beam operated at  $35^\circ$  instead of the cross-track azimuth position to prevent the scanner detectors from scanning the Sun.

The nonscanner instrument was uncaged on September 25. The instrument contamination covers were deployed and the instrument began normal Earth-viewing operations on October 20. At 12:28 UT on October 24, the instrument was commanded to stow in preparation for the release of the contamination covers of the scanner instrument; at 20:46 UT on this day, it was commanded to the nadir position and resumed normal Earth-viewing measurements. The instrument continued to operate in the normal Earth-viewing elevation mode for the remainder of the month except during calibrations. The azimuth beam operated at  $180^\circ$  during the entire month except during solar calibrations. Nonscanner internal and solar calibrations were successfully performed on October 25 and 29.

The scanner instrument was uncaged on September 30. The instrument was stowed at about

12:29 UT on October 24. (See table 9(b).) While the instrument was in stow on this day, the contamination covers were deployed and the azimuth beam was rotated to  $35^\circ$ . Normal Earth-viewing operations began at about 17:25 UT on October 24. From that time through the end of the month, the instrument operated in the normal Earth scan mode and the azimuth beam operated at  $35^\circ$ . Scanner internal calibrations were performed on October 24, 25, and 29. The elevation beam rotated smoothly during this month. No scanner solar calibrations were performed in October.

*NOAA 10 spacecraft November 1986.* November 1986 was the first full month of ERBE data collection on the NOAA 10. This was also the first month during which the ERBE instruments on all three satellites (ERBS, NOAA 9, and NOAA 10) were concurrently operational. The percentage of data archived to the RAT was 97.45 for the entire month and to the PAT was 97.72 for the period of November 1–18. (See table 1(j).) The PAT product was not archived for the period of November 19–30 because the scanner instrument was in stow and did not acquire Earth-viewing data during this period.

The Sun's  $\beta$  angle increased from about  $26.8^\circ$  at the beginning of the month to about  $27.9^\circ$  by the end of the month. Since the spacecraft orbit was in full sunlight for the entire month, the scanner instrument operated at an azimuth position of  $35^\circ$  to prevent the detectors from directly scanning the Sun.

Successful internal and solar calibrations of the nonscanner instrument were performed on November 1, 5, 12, and 26. The instrument operated in the normal Earth-viewing elevation mode and at an azimuth position of  $180^\circ$  for the entire month except during calibrations.

Successful scanner internal calibrations were performed on November 1, 5, and 12. A successful solar calibration was performed on November 12 although the full automated calibration sequence was not used. (See table 9(b).) A successful caged internal calibration was performed on November 26 while the instrument was in stow.

The scanner instrument operated in the normal Earth scan mode from the beginning of the month until November 18 except during the solar calibration on November 12 and from 16:52 UT to 18:33 UT on November 13 when it was in stow. At 18:24 UT on November 18, the scanner instrument was placed in stow where it remained through the end of the month. This was done because the instrument indicated that it was operating at an azimuth position of



180° instead of the expected 35° after the solar calibration on November 12. Further analysis (ref. 4) revealed that the instrument was actually at the correct 35° azimuth position. On November 19 azimuth load commands were sent up for angle A (35°) and angle B (154.65°). These were the same angles that had been sent up on November 11 in preparation for the solar calibration. On November 20 while still in stow, the scanner instrument was commanded to azimuth position B and then to A. (See table 9(b).)

*NOAA 10 spacecraft—December 1986.* The percentage of data archived to the RAT was 97.90 for the entire month of December 1986 and to the PAT was 98.00 for the period of December 5–31. (See table 1(k).) The PAT product was not archived for the period of December 1–4 when the scanner instrument was in stow. The  $\beta$  angle decreased from about 27.9° at the beginning of the month to about 25.8° at the end of the month. Because the spacecraft orbit was in full sunlight during the entire month, the azimuth beam of the scanner instrument continued to operate at an off-track position of 35° to prevent the detectors from directly scanning the Sun.

The nonscanner instrument operated in the normal Earth-viewing elevation mode throughout the month except during calibrations. The instrument operated at an azimuth-beam position of 180° during the entire month except during solar calibrations. Successful internal and solar calibrations were performed on December 10 and 24.

The scanner instrument was in stow for the first 5 days of December. On December 4, while still in stow, the instrument was commanded to an azimuth position of 0° and then to an azimuth position of 35°. Normal Earth scan operations were resumed at 15:36 UT on December 5. The instrument had been placed in stow on November 18 because it appeared to have been operating at an azimuth position of 180°, which would have put it at risk of scanning the Sun. Analysis (ref. 4) indicated that the scanner was actually operating at the proper azimuth position of 35° during this time. The instrument operated in the normal Earth scan mode from the time that it came out of stow on December 5 until the end of the month. The scanner instrument operated at an azimuth position of 35° for the entire month to prevent the detectors from scanning the Sun during this full-Sun period.

Scanner elevation-beam operation was very good during most of the month, but it became irregular during the last 2 days of the month. Successful

internal calibrations were performed on December 10 and 24. Because of the problems encountered with the November 12 solar calibration, scanner solar calibrations on the NOAA 10 instrument were discontinued.

*NOAA 10 spacecraft January 1987.* In January 1987 the percentage of data archived to the RAT was 96.43 and to the PAT was 95.82. (See table 1(l).) The  $\beta$  angle decreased from about 25.8° at the beginning of the month to about 21.2° by the end of the month. The spacecraft orbit was in full sunlight during this time. Because of this, the scanner instrument continued to operate at an off-track azimuth position of 35° to prevent the detectors from directly scanning the Sun.

The nonscanner instrument operated in the normal Earth scan elevation mode for the entire month except during calibrations. The instrument operated at an azimuth-beam position of 180° for the entire month except during solar calibrations. Successful internal and solar calibrations were performed on January 21.

The scanner instrument operated in the normal Earth scan mode and at an azimuth position of 35° for the entire month. The scanner instrument experienced severe elevation-beam motion problems throughout the month. (See fig. 7(c).) These problems first occurred on January 1 and worsened throughout the month. This was the first time since launch that elevation-beam rotation problems were encountered with the NOAA 10 scanner instrument. These problems were much more severe than any associated with the ERBS and NOAA 9 scanner instruments.

A scanner internal calibration was performed on January 21. Because of the severe elevation-beam motion problems experienced by the instrument, the detectors were not aligned with the internal calibration sources at the proper times and the calibration was unsuccessful.

## Concluding Remarks

In-flight operations and data acquisition have been discussed for the second full year of operation of the Earth Radiation Budget Experiment (ERBE) instruments. During this period the third and final set of ERBE instruments was launched into Sun-synchronous orbit aboard the NOAA 10 spacecraft. These instruments became operational on October 24, 1986, thus initiating a period of concurrent

measurements from all three sets of ERBE instruments. On January 20, 1987, the scanner instrument aboard the NOAA 9 spacecraft failed. All subsequent attempts to communicate with the instrument have been unsuccessful. As a result, no scanner data were obtained from this instrument after January 20, 1987. Thus, the period of simultaneous operation of three ERBE scanners that began on October 24, 1986, ended on January 20, 1987. This period of simultaneous operation was further shortened by problems with the NOAA 10 scanner instrument that resulted in that instrument being stowed from November 18 through December 5, 1986.

### Data Coverage and Archival

Data coverage for the ERBE scanner and non-scanner instruments on the Earth Radiation Budget Satellite (ERBS) and NOAA 9 spacecraft spans the entire year from February 1986 through January 1987. For the instruments on the NOAA 10 spacecraft, the collection of ERBE science data began in October 1986 and continued through January 1987. The first NOAA 10 data were archived to the Raw Archival Tape (RAT) in October 1990 and to the Processed Archival Tape (PAT) in January 1991. Archival to the RAT of the second year of ERBE data from all three spacecraft was completed in January 1991, and archival to the PAT was completed in July 1991.

The monthly average archival rate for ERBE data from the instruments aboard the ERBS spacecraft was nearly 100 percent for both the RAT and PAT products. More data losses occurred and the data coverage was somewhat more variable for the ERBE instruments aboard the NOAA 9 spacecraft. The monthly average rate of NOAA 9 data archived to the RAT was 97 percent, with a minimum of 89 percent in February 1986 and a maximum of 99 percent in September 1986. The monthly average rate of NOAA 9 data archived to the PAT was 96 percent, with a minimum of 87 percent in February 1986 and a maximum of 98 percent in January 1987. These rates were somewhat higher and less variable than those obtained during the first year of operation of the ERBE instruments aboard the NOAA 9. The monthly average archival rate of data from the ERBE instruments aboard the NOAA 10 spacecraft was 97 percent for both the RAT and PAT products. The minimum archival rate to the RAT was 96 percent in January 1987, and the maximum was 98 percent in December 1986. The minimum archival rate to the PAT was 96 percent in January 1987, and the maximum was 98 percent in December 1986. These

percentages do not include days for which no data were archived.

### Operations During Normal Earth-Viewing Measurements

For more than 98 percent of the 1-year time period covered by this paper, both ERBE instruments on the ERBS and NOAA 9 spacecraft made Earth-viewing science measurements. The non-scanner instrument on the NOAA 10 spacecraft made Earth-viewing measurements over 97 percent of the time during the period from October 25, 1986, through January 31, 1987. The period of the Earth-viewing measurements of the scanner instrument on NOAA 10 was reduced because the scanner was stowed from November 18 until December 5, 1986.

The non-scanner instruments operated in the nadir (Earth-viewing) elevation mode, and the Solar Monitor Assembly (SMA) shutters remained off during normal operation. The detector and solar port heaters remained on, but all other non-scanner instrument heaters, including the ones that control the output of the calibration sources, remained off. The temperatures of the heat sinks and apertures of the Earth-viewing detectors on all three non-scanner instruments were controlled to nearly constant values during normal operation.

The scanner instruments on the three spacecraft normally operated in the normal Earth scan mode, and the instruments on the ERBS and NOAA 9 spacecraft normally operated at a cross-track azimuth position. Because of full-Sun conditions, the instrument on the NOAA 10 spacecraft operated continuously at an azimuth position of  $35^\circ$ , and the instrument on the ERBS spacecraft periodically operated at an azimuth position of  $145^\circ$ .

### Calibrations

Internal and solar calibrations of both the non-scanner and scanner instruments on all three spacecraft were generally performed on Wednesdays at 14-day intervals during the time period of this paper. Additional calibrations of the ERBE instruments aboard the NOAA 10 spacecraft were performed during the first few months after launch. The normal calibration schedule for the instruments on the ERBS spacecraft was altered during full-Sun periods. During these periods, regularly scheduled calibrations were not performed. Instead, a set of calibrations was normally performed immediately prior to and after the full-Sun periods.

During the second year of operation of the ERBE instruments aboard the ERBS spacecraft, 30 successful internal calibrations were performed on the scanner instrument. No scanner solar calibrations were performed during that period. On the nonscanner instrument, 30 successful internal calibrations and 29 successful solar calibrations were performed. All but one of the attempted calibrations during the second year of operation were successful. A nonscanner solar calibration was unsuccessful because the instrument was rotated to the calibration position at the wrong time during the orbit; as a result, the Sun did not pass through the field of view of the detectors.

During the second year of operation of the ERBE instruments aboard the NOAA 9 spacecraft, 24 successful internal calibrations and 22 successful solar calibrations were performed on the scanner instrument. In addition, 24 successful internal and 22 successful solar calibrations were performed on the nonscanner instrument. As with the instruments on the ERBS spacecraft, almost all calibrations attempted were successful. Data from two scanner solar calibrations and one nonscanner internal calibration were lost because of data dropouts. Three nonscanner solar calibrations were unsuccessful because problems with azimuth-beam rotation resulted in the instrument being at the incorrect azimuth position for the calibration.

During the first 4 months of operation of the ERBE instruments aboard the NOAA 10 spacecraft, nine successful internal and solar calibrations were performed on the nonscanner instrument. In addition, nine successful internal calibrations and one successful caged internal calibration were performed on the scanner instrument. A single scanner solar calibration was successfully performed although the full automated calibration sequence was not used. All calibrations attempted on the NOAA 10 instruments during this time period were successful.

### **Solar Environment and Its Effect on the Response and Operation of Instruments**

The precession rate of the ERBS orbit produces variations in the Sun's  $\beta$  angle from  $10^\circ$  to  $170^\circ$  over a 72-day period (where  $\beta$  denotes the angle between the Sun and the orbit angular momentum vectors). The orbit plane crosses the Sun about every 36 days, and the spacecraft is in full-Sun orbits near the two extremes of  $\beta$ . Solar heating increases during the full-Sun periods, and housekeeping temperature measurements on both instruments increase significantly.

When the orbit plane crosses the Sun, the ERBS spacecraft is yawed  $180^\circ$  about the nadir axis to reposition the solar panels to tilt to the Sun's side of the orbit. The yaw rotation also has the effect of reorienting the scanner instrument so that the primary Earth scan motion is always from the dark side to the Sun's side of the orbit. During full-Sun periods, the scanner instrument operates at an azimuth position of  $145^\circ$  to prevent the detectors from directly viewing the Sun.

The precession rate of the ascending node of the NOAA 9 orbit continues to increase and to make the orbit less Sun synchronous. This effect has caused the local time of the ascending node of the orbit to increase by more than 50 minutes between January 1, 1985, and January 1, 1987. The  $\beta$  angle varied from about  $41^\circ$  to  $58^\circ$  during the time period of this paper, and the resulting solar environment was more benign and less variable than that of the ERBS orbit. No periods occurred when the spacecraft was in full Sun continuously, and no changes in the operation of the instrument were required because of changing orbit conditions.

The  $\beta$  angle of the Sun-synchronous orbit of the NOAA 10 spacecraft varied between  $21^\circ$  and  $28^\circ$  from October 1986 to January 1987. Variations in instrument housekeeping temperatures during this period were larger than those for the same period on the NOAA 9 spacecraft, and they were significantly lower than those on the ERBS spacecraft. The spacecraft was in full Sun continuously, and the scanner instrument operated at an azimuth angle of  $35^\circ$  to prevent the detectors from scanning the Sun.

### **Anomalies in the Operation of the Azimuth and Elevation Beams**

The problem with the azimuth position sensor of the nonscanner instrument on the NOAA 9 spacecraft continued during the time period of this paper, which caused the azimuth beam to operate much of the time at a position of  $180^\circ$  instead of the desired position of  $170^\circ$ . After a solar calibration on November 12, 1986, an erroneous output by the azimuth position sensor of the NOAA 10 scanner instrument caused ERBE support personnel to have doubts about the actual azimuth position. For this reason, the instrument was stowed from November 18 until December 5, 1986. Because of this problem, solar calibrations of the scanner instrument on the NOAA 10 spacecraft were discontinued.

Problems continued with the rotation of the elevation beams of the scanner instruments on the ERBS and NOAA 9 spacecraft. Sluggishness in beam rotation continued, but no serious hang-ups (malfunctions) in beam rotation, like those that occurred in 1985, were observed. The primary effect of the sluggishness was misalignment of the detectors with the internal calibration sources.

Rotation of the elevation beam of the scanner instrument on the NOAA 10 spacecraft was very smooth until near the end of December 1986. Rotation problems increased in January with serious hang-ups of the beam. Beam hang-up problems were more severe than any observed with the elevation beams of instruments on the ERBS and NOAA 9 spacecraft. New software was developed to process and edit the data to ensure correct computation of detector pointing vectors during periods of elevation-beam rotation anomalies.

### Acknowledgments

The authors wish to thank the following people from ST Systems Corporation (STX) whose support contributed to the success of this paper: Chris J. Harris, who provided many of the figures and invaluable advise in analyzing the housekeeping measurements; Frank E. Martino III, who generated many of the

tables; and Suzanne L. Huston, who assisted with the tables.

NASA Langley Research Center  
Hampton, VA 23681-0001  
May 18, 1992

### References

1. Weaver, William L.; Bush, Kathryn A.; Harris, Chris J.; Howerton, Clayton E.; and Tolson, Carol J.: *Mission Description and In-Flight Operations of ERBE Instruments on ERBS and NOAA 9 Spacecraft - November 1984 Through January 1986*. NASA RP-1256, 1991.
2. Luther, M. R.; Cooper, J. E.; and Taylor, G. R.: The Earth Radiation Budget Experiment Nonscanning Instrument. *Reviews Geophys.*, vol. 24, no. 2, May 1986, pp. 391-399.
3. Kopia, Leonard P.: The Earth Radiation Budget Experiment Scanning Instrument. *Reviews Geophys.*, vol. 24, no. 2, May 1986, pp. 400-406.
4. Hoffman, Lawrence H.; Weaver, William L.; and Kibler, James F.: *Calculation and Accuracy of ERBE Scanner Measurement Locations*. NASA TP-2670, 1987.
5. Watson, N. D.; Miller, J. B.; Taylor, L. V.; Lovell, J. B.; Cox, J. W.; Fedors, J. C.; Kopia, L. P.; Holloway, R. M.; and Bradley, O. H.: *Earth Radiation Budget Experiment (ERBE) Scanner Instrument Anomaly Investigation*. NASA TM-87636, 1985.

Table 1. Summary Information for RAT and PAT Tapes Archived at the NSSDC\*

[For explanation of abbreviations, see "Nomenclature" on p. 1]

(a) February 1986<sup>a</sup>

ERBS spacecraft			Day of month	NOAA 9 spacecraft			
Percentage of data on		Special events		Percentage of data on		Special events	
RAT	PAT			RAT	PAT		
99.67	98.24	SC INT, all NS CAL's	1	99.44	99.07	All CAL's	
99.98	99.96		2	93.07	92.70		
100.00	100.00		3	98.57	91.20		
100.00	100.00		4	93.11	63.44		
100.00	99.98		5	99.87	98.69		
99.98	99.98		6	81.50	75.94		
100.00	99.98		7	38.70	37.61		
100.00	99.98		8	51.24	49.93		
100.00	100.00		9	56.96	56.78		
100.00	100.00		10	55.80	55.50		
100.00	100.00		11	100.00	99.17		
99.96	99.94		12	100.00	98.00		
99.91	99.80		13	92.76	91.72		
99.96	99.94		14	99.94	99.67		
100.00	99.72	SC INT, all NS CAL's	15	100.00	99.39	All CAL's	
100.00	99.78		16	93.28	92.48		
100.00	99.98		17	93.24	93.02		
100.00	100.00		18	99.87	99.06		
100.00	99.98		19	91.87	91.00		
100.00	100.00		20	93.56	92.93		
100.00	99.96		21	99.94	99.02		
100.00	99.98		22	98.56	98.07		
100.00	99.98		23	96.09	90.15		
100.00	99.98		24	99.85	98.31		
100.00	100.00		25	99.96	98.80		
100.00	99.70		SC INT, all NS CAL's	26	84.28		82.37
99.98	99.93			27	99.94		99.50
100.00	100.00			28	92.24		91.70

ERBS                      NOAA 9

<sup>a</sup>Percentage of data for all days in month on

RAT . . . . . 99.98                      89.42  
 PAT . . . . . 99.89                      86.98

Percentage of data for days in month with data on

RAT . . . . . 99.98                      89.42  
 PAT . . . . . 99.89                      86.98

Date on which tape was archived at the NSSDC:

RAT . . . . . June 1989                      Dec. 1989  
 PAT . . . . . Sept. 1989                      Apr. 1990

Table 1. Continued

(b) March 1986<sup>a</sup>

ERBS spacecraft			Day of month	NOAA 9 spacecraft		
Percentage of data on		Special events		Percentage of data on		Special events
RAT	PAT			RAT	PAT	
100.00	100.00	SC INT, all NS CAL's	1	99.39	99.22	SC INT, all NS CAL's
100.00	100.00		2	93.83	93.57	
100.00	100.00		3	100.00	99.59	
100.00	99.96		4	99.98	98.81	
100.00	99.83		5	82.85	82.17	
99.78	99.63		6	95.02	94.33	
99.87	99.74		7	79.70	77.98	
99.43	99.37		8	100.00	99.61	
99.96	99.93		9	98.61	96.76	
99.81	99.70		10	92.83	92.48	
99.96	99.94	11	92.56	92.04		
100.00	98.19	Yaw turn (+) to (-)	12	100.00	99.02	All CAL's
100.00	99.96	13	97.52	96.48		
99.87	99.28	14	0.00	0.00		
99.98	99.83	15	0.00	0.00		
99.98	99.93	16	87.44	86.33		
99.74	99.50	17	67.20	65.93		
99.89	99.78	18	99.80	97.39		
99.96	99.61	SC INT, all NS CAL's	19	98.65	97.48	
99.98	99.96	20	84.52	84.30		
100.00	99.94	21	99.76	99.35		
100.00	98.96	22	94.19	93.35		
100.00	99.72	23	94.07	93.43		
100.00	99.69	24	93.54	92.93		
100.00	99.74	25	96.98	96.15		
100.00	99.76	26	93.37	91.50		
100.00	99.89	27	93.72	93.07		
100.00	99.91	28	93.15	92.74		
100.00	99.76	29	92.46	92.30		
100.00	99.74	30	100.00	99.70		
99.98	99.74	31	98.81	97.91		

	<u>ERBS</u>	<u>NOAA 9</u>
<sup>a</sup> Percentage of data for all days in month on		
RAT . . . . .	99.94	87.74
PAT . . . . .	99.71	86.97
Percentage of data for days in month with data on		
RAT . . . . .	99.94	93.79
PAT . . . . .	99.71	92.96
Date on which tape was archived at the NSSDC:		
RAT . . . . .	Sept. 1989	Jan. 1990
PAT . . . . .	Nov. 1989	May 1990

Table 1. Continued

(c) April 1986<sup>a</sup>

ERBS spacecraft			Day of month	NOAA 9 spacecraft		
Percentage of data on---		Special events		Percentage of data on		Special events
RAT	PAT			RAT	PAT	
100.00	99.94	SC INT, all NS CAL's	1	90.15	89.54	All CAL's
99.94	99.44		2	99.94	99.30	
100.00	99.76		3	93.19	92.91	
100.00	99.76		4	99.63	97.89	
100.00	99.85		5	99.98	99.78	
100.00	99.67		6	97.63	97.07	
100.00	99.44		7	99.57	99.07	
100.00	99.85		8	100.00	99.69	
100.00	100.00		9	97.24	96.50	
100.00	99.87		10	100.00	99.24	
100.00	99.80		11	99.91	99.28	
100.00	99.96		12	99.98	99.80	
100.00	99.61		13	98.80	97.22	
100.00	99.83		14	93.35	93.20	
99.98	99.93		15	91.61	90.72	
100.00	99.59	16	87.56	86.26		
100.00	99.70	17	93.57	92.41		
100.00	97.81	18	85.43	85.04		
100.00	99.87	19	99.39	99.00		
100.00	99.80	20	99.98	98.74		
100.00	99.85	21	96.50	96.04		
100.00	99.85	22	93.81	93.41		
100.00	99.78	23	98.76	97.26		
100.00	99.87	24	97.85	97.57		
100.00	99.69	25	97.65	97.13		
100.00	99.96	26	98.80	98.04		
100.00	99.91	27	93.61	93.17		
100.00	99.89	28	97.50	96.26		
100.00	100.00	29	94.83	94.31		
100.00	99.61	30	93.04	92.37	All CAL's	

	<u>ERBS</u>	<u>NOAA 9</u>
<sup>a</sup> Percentage of data for all days in month on		
RAT . . . . .	100.00	96.31
PAT . . . . .	99.73	95.61
Percentage of data for days in month with data on		
RAT . . . . .	100.00	96.31
PAT . . . . .	99.73	95.61
Date on which tape was archived at the NSSDC:		
RAT . . . . .	Sept. 1989	May 1990
PAT . . . . .	Dec. 1989	June 1990

Table 1. Continued

(d) May 1986<sup>a</sup>

ERBS spacecraft			Day of month	NOAA 9 spacecraft		
Percentage of data on —		Special events		Percentage of data on—		Special events
RAT	PAT			RAT	PAT	
100.00	99.89		1	95.87	94.61	
100.00	99.96		2	96.74	96.13	
100.00	99.94		3	95.41	94.56	
100.00	99.98		4	97.54	96.76	
100.00	99.93		5	96.13	94.46	
100.00	99.87		6	99.44	97.09	
100.00	99.93		7	98.02	96.63	
100.00	99.81		8	99.94	99.13	
100.00	99.91		9	94.48	93.67	
100.00	99.93		10	99.94	99.28	
100.00	99.83		11	97.96	96.06	
100.00	99.78		12	99.94	99.33	
100.00	99.87		13	86.24	83.57	
100.00	99.46	SC INT, all NS CAL's	14	99.91	98.72	All CAL's
100.00	99.67		15	99.33	97.54	
100.00	99.96		16	100.00	98.33	
100.00	99.98		17	100.00	99.50	
100.00	99.93		18	94.63	93.63	
100.00	99.85		19	99.98	99.43	
100.00	99.96		20	99.94	98.93	
100.00	98.17	Yaw turn (+) to (-)	21	99.94	98.00	
100.00	99.50		22	58.39	57.83	
99.76	99.35		23	99.94	99.24	
100.00	100.00		24	93.15	92.57	
100.00	99.85		25	96.39	95.37	
100.00	99.98		26	99.85	98.61	
100.00	99.93		27	99.98	98.69	
100.00	99.61	SC INT, all NS CAL's	28	99.67	97.85	All CAL's
99.48	99.33		29	99.67	98.28	
100.00	99.87		30	95.26	91.59	
100.00	99.81		31	94.48	86.43	

	<u>ERBS</u>	<u>NOAA 9</u>
"Percentage of data for all days in month on		
RAT . . . . .	99.98	96.39
PAT . . . . .	99.77	94.90
Percentage of data for days in month with data on		
RAT . . . . .	99.98	96.39
PAT . . . . .	99.77	94.90
Date on which tape was archived at the NSSDC:		
RAT . . . . .	Sept. 1989	Apr. 1990
PAT . . . . .	Mar. 1990	June 1990



Table 1. Continued

(e) June 1986<sup>a</sup>

ERBS spacecraft		Special events	Day of month	NOAA 9 spacecraft		Special events
Percentage of data on				Percentage of data on		
RAT	PAT			RAT	PAT	
100.00	99.96	SC INT, all NS CAL's	1	100.00	92.63	All CAL's
100.00	99.80		2	99.28	91.52	
99.76	99.31		3	98.83	93.91	
100.00	99.57		4	97.33	95.91	
100.00	99.87		5	99.98	98.81	
100.00	99.87		6	99.87	97.85	
100.00	99.44		7	100.00	89.35	
100.00	99.89		8	94.98	85.15	
100.00	99.59		9	95.81	87.22	
100.00	99.78		10	99.87	97.37	
100.00	99.61	11	99.91	98.13	All CAL's	
100.00	99.76	12	100.00	98.26		
100.00	99.85	13	99.98	98.02		
100.00	99.96	14	100.00	97.65		
100.00	99.94	15	99.76	97.70		
100.00	99.50	16	99.91	98.00		
100.00	99.80	17	100.00	97.94		
100.00	99.83	18	95.89	93.85		
100.00	99.46	19	100.00	97.93		
100.00	99.98	20	99.63	97.26		
100.00	99.93	21	93.46	91.81	All CAL's	
100.00	99.94	22	99.89	97.96		
100.00	99.67	23	98.70	96.54		
100.00	99.93	24	100.00	97.46		
100.00	99.76	25	100.00	97.63		
100.00	100.00	26	100.00	97.93		
99.89	99.74	27	99.48	96.33		
100.00	99.94	28	100.00	97.04		
100.00	99.96	29	91.74	88.93		
100.00	99.94	30	98.70	96.59		

ERBS                      NOAA 9

<sup>a</sup>Percentage of data for all days in month on

RAT . . . . .	99.99	98.77
PAT . . . . .	99.79	95.42
Percentage of data for days in month with data on		
RAT . . . . .	99.99	98.77
PAT . . . . .	99.79	95.42
Date on which tape was archived at the NSSDC:		
RAT . . . . .	Dec. 1989	May 1990
PAT . . . . .	Mar. 1990	June 1990

Table 1. Continued

(f) July 1986<sup>a</sup>

ERBS spacecraft			Day of month	NOAA 9 spacecraft			
Percentage of data on-		Special events		Percentage of data on-		Special events	
RAT	PAT			RAT	PAT		
99.98	99.87	Yaw turn (-) to (+)	1	99.63	97.43		
99.93	98.07		2	99.94	96.93		
100.00	100.00		3	99.94	98.07		
100.00	99.83		4	99.94	97.28		
100.00	99.61		5	99.94	97.04		
100.00	100.00		6	85.09	82.39		
100.00	100.00		7	96.83	91.04		
100.00	100.00		8	94.39	85.96		
100.00	99.93		9	93.24	89.59		SC INT, all NS CAL's
100.00	100.00		10	92.70	89.87		
100.00	99.96		11	95.22	92.54		
100.00	100.00		12	98.85	91.96		
100.00	99.98		13	97.69	93.20		
100.00	99.76		14	98.52	88.11		
100.00	99.70	15	83.78	80.46			
100.00	99.85	16	93.31	90.94			
100.00	100.00	17	99.98	97.48			
100.00	99.87	18	98.54	96.15			
100.00	99.94	19	99.11	97.30	All CAL's		
100.00	100.00	20	85.94	82.28			
100.00	100.00	21	99.87	97.83			
100.00	99.78	22	99.94	97.69			
100.00	99.72	23	99.94	97.93			
100.00	100.00	24	97.94	96.02			
100.00	100.00	25	96.67	94.09			
100.00	99.94	26	100.00	98.28			
100.00	99.98	27	93.15	90.83			
100.00	99.96	28	96.46	93.78			
100.00	99.80	29	99.81	97.15			
100.00	99.96	30	99.98	97.35			
100.00	99.87	31	99.22	98.13			

	ERBS	NOAA 9
"Percentage of data for all days in month on		
RAT . . . . .	100.00	96.63
PAT . . . . .	99.85	93.39
Percentage of data for days in month with data on		
RAT . . . . .	100.00	96.63
PAT . . . . .	99.85	93.39
Date on which tape was archived at the NSSDC:		
RAT . . . . .	Dec. 1989	May 1990
PAT . . . . .	Apr. 1990	June 1990

Table 1. Continued

(g) August 1986<sup>a</sup>

ERBS spacecraft			Day of month	NOAA 9 spacecraft		
Percentage of data on		Special events		Percentage of data on		Special events
RAT	PAT			RAT	PAT	
100.00	98.15	Yaw turn (+) to (-)	1	97.50	95.67	All CAL's
100.00	99.93		2	99.93	98.24	
98.74	98.48		3	92.15	90.33	
100.00	99.30		4	98.93	96.94	
100.00	99.93		5	100.00	98.57	
100.00	99.52	SC INT, NS INT	6	89.67	88.33	
100.00	99.67		7	100.00	99.13	
100.00	99.87		8	98.61	97.96	
100.00	99.98		9	98.89	97.43	
99.98	99.67		10	100.00	99.39	
100.00	99.98		11	100.00	99.28	
100.00	99.93		12	99.63	97.94	
100.00	99.93		13	89.94	87.96	
100.00	99.78		14	99.93	99.41	
100.00	99.61		15	96.06	95.41	
100.00	100.00		16	99.94	97.09	
99.93	99.63	SC INT, all NS CAL's	17	92.78	92.15	
99.83	99.61		18	99.54	92.43	
100.00	99.94		19	100.00	98.94	
100.00	99.76		20	91.35	89.98	
100.00	99.94		21	97.54	89.93	
100.00	99.76		22	96.02	95.31	
100.00	100.00		23	99.94	98.94	
100.00	100.00		24	93.56	92.59	
100.00	99.98		25	94.17	93.44	
99.89	99.20		26	99.80	99.19	
99.91	99.76		27	93.89	92.87	
100.00	99.76	SC INT, all NS CAL's	28	98.41	96.94	
100.00	99.50		29	100.00	97.31	
100.00	99.72		30	97.44	97.15	
100.00	99.89		31	100.00	99.57	

	ERBS	NOAA 9
"Percentage of data for all days in month on		
RAT . . . . .	99.94	97.28
PAT . . . . .	99.68	95.67
Percentage of data for days in month with data on		
RAT . . . . .	99.94	97.28
PAT . . . . .	99.68	95.67
Date on which tape was archived at the NSSDC:		
RAT . . . . .	Mar. 1990	Mar. 1990
PAT . . . . .	May 1990	June 1990

Table 1. Continued

(h) September 1986<sup>a</sup>

ERBS spacecraft			Day of month	NOAA 9 spacecraft		
Percentage of data on--		Special events		Percentage of data on--		Special events
RAT	PAT			RAT	PAT	
100.00	100.00		1	95.11	94.15	
100.00	99.98		2	99.87	96.04	
100.00	99.52	SC INT, all NS CAL's	3	99.83	94.85	All CAL's
100.00	99.63		4	99.91	99.61	
100.00	99.46		5	99.44	99.00	
100.00	99.98		6	99.81	98.33	
100.00	99.91		7	100.00	93.94	
100.00	99.76		8	99.94	99.78	
100.00	99.94		9	96.91	96.19	
98.61	98.54		10	100.00	98.61	
100.00	97.37	Yaw turn (-) to (+)	11	98.63	98.00	
100.00	99.78		12	99.94	99.19	
100.00	100.00		13	99.83	99.50	
100.00	100.00		14	99.80	99.24	
100.00	99.94		15	99.85	98.96	
100.00	99.98		16	100.00	99.56	
99.83	99.52	SC INT, all NS CAL's	17	97.80	96.87	All CAL's
100.00	99.98		18	98.91	98.63	
98.63	98.54		19	98.76	96.94	
100.00	99.98		20	100.00	99.83	
100.00	100.00		21	99.46	99.11	
100.00	99.96		22	99.94	99.69	
100.00	99.98		23	99.96	99.63	
99.96	99.89		24	97.61	97.15	
100.00	99.93		25	93.78	93.15	
100.00	99.98		26	99.93	99.22	
100.00	99.98		27	99.94	98.93	
100.00	99.98		28	99.94	99.26	
100.00	100.00		29	99.91	98.96	
100.00	99.96		30	99.81	99.20	

	<u>ERBS</u>	<u>NOAA 9</u>
<sup>a</sup> Percentage of data for all days in month on --		
RAT . . . . .	99.90	99.15
PAT . . . . .	99.72	98.05
Percentage of data for days in month with data on		
RAT . . . . .	99.90	99.15
PAT . . . . .	99.72	98.05
Date on which tape was archived at the NSSDC:		
RAT . . . . .	May 1990	May 1990
PAT . . . . .	July 1990	Dec. 1990

Table 1. Continued

(i) October 1986<sup>a</sup>

ERBS spacecraft			Day of month	NOAA 9 spacecraft			Day of month	NOAA 10 spacecraft			
Percentage of data on		Special events		Percentage of data on		Special events		Percentage of data on		Special events	
RAT	PAT			RAT	PAT			RAT	PAT		
100.00	99.96	SC INT. all NS CAL's	1	99.30	97.78	All SC CAL's, NS INT	1	0.00	0.00		
100.00	99.96		2	99.87	99.37		2	0.00	0.00		
100.00	99.94		3	99.76	99.57		3	0.00	0.00		
100.00	99.96		4	100.00	98.52		4	0.00	0.00		
100.00	100.00		5	99.94	99.85		5	0.00	0.00		
100.00	99.67		6	99.94	99.76		6	0.00	0.00		
100.00	99.96		7	96.04	94.56		7	0.00	0.00		
100.00	99.80		8	94.74	90.33		8	0.00	0.00		
100.00	99.96		9	94.76	94.04		9	0.00	0.00		
100.00	99.89		10	98.00	96.93		10	0.00	0.00		
100.00	99.74		11	93.33	92.61		11	0.00	0.00		
100.00	99.96		12	99.81	99.04		12	0.00	0.00		
100.00	99.98		13	100.00	98.80		13	0.00	0.00		
100.00	100.00		14	100.00	99.54		14	0.00	0.00		
100.00	99.96	SC INT. all NS CAL's	15	99.87	98.98	All CAL's	15	0.00	0.00		
100.00	99.89		16	96.69	96.07		16	0.00	0.00		
100.00	98.19		Yaw turn (+) to (-)	17	99.94		99.20	17	0.00		0.00
100.00	99.98			18	100.00		99.09	18	0.00		0.00
100.00	99.80		19	98.72	97.48		19	0.00	0.00		
100.00	99.94		20	99.98	99.72		20	0.00	0.00		
100.00	99.76		21	99.87	99.20		21	0.00	0.00		
100.00	99.93		22	99.15	98.24		22	0.00	0.00		
100.00	99.78		23	94.74	94.00		23	0.00	0.00		
100.00	99.94		24	98.52	96.96		24	95.74	0.00		SC INT
100.00	99.93	25	99.94	99.43	25	99.98	97.57	SC INT. all NS CAL's			
99.67	99.44	26	99.91	99.46	26	95.91	95.46				
99.83	99.67	27	99.76	99.24	27	99.30	98.67				
100.00	99.94	28	98.91	98.19	28	99.35	98.44				
100.00	99.94	SC INT. all NS CAL's	29	100.00	99.44	All CAL's	29	98.74	98.39	SC INT. all NS CAL's	
100.00	99.98		30	99.74	99.63		30	95.91	95.59		
100.00	99.96		31	99.67	98.85		31	93.81	93.43		

<sup>a</sup>Percentage of data for all days in month on

	ERBS	NOAA 9	NOAA 10
RAT . . . . .	99.98	98.74	25.12
PAT . . . . .	99.83	97.87	21.86
Percentage of data for days in month with data on			
RAT . . . . .	99.98	98.74	97.34
PAT . . . . .	99.83	97.87	96.79
Date on which tape was archived at the NSSDC:			
RAT . . . . .	Aug. 1988	Nov. 1988	Nov. 1990
PAT . . . . .	Apr. 1989	May 1989	June 1991

Table 1. Continued

(j) November 1986<sup>a</sup>

ERBS spacecraft			Day of month	NOAA 9 spacecraft			Day of month	NOAA 10 spacecraft		
Percentage of data on		Special events		Percentage of data on		Special events		Percentage of data on		Special events
RAT	PAT			RAT	PAT			RAT	PAT	
100.00	99.80		1	98.56	98.00	1	99.37	98.87	SC INT, all NS CAL's	
100.00	99.87		2	100.00	99.35	2	99.78	99.72		
100.00	99.85		3	96.48	96.20	3	99.98	99.80		
100.00	99.96		4	97.83	97.72	4	99.85	99.81		
99.76	99.59		5	89.81	88.91	5	99.93	99.87	SC INT, all NS CAL's	
99.56	99.37		6	99.94	99.65	6	89.85	88.52		
100.00	100.00		7	99.94	99.63	7	98.30	98.24		
100.00	99.96		8	99.72	98.93	8	99.98	99.81		
100.00	99.98		9	99.80	99.31	9	99.98	99.81		
100.00	99.93		10	99.85	99.61	10	94.15	93.87		
100.00	100.00		11	99.78	98.78	11	93.22	93.20		
100.00	99.91	SC INT, all NS CAL's	12	99.94	98.85	All CAL's	99.96	99.59	All CAL's	
100.00	99.83		13	99.74	99.56		98.52	98.43		
100.00	99.96		14	99.83	99.11		100.00	99.93		
100.00	99.98		15	99.94	97.72		99.98	99.89		
100.00	99.96		16	99.52	98.67		99.80	99.69		
99.93	99.85		17	95.46	94.98		99.93	99.69		
99.93	99.69		18	92.76	92.24		90.37	90.19		
99.91	99.85		19	93.20	92.65		82.44	0.00		
100.00	98.17	Yaw turn (-) to (+)	20	100.00	99.31		92.83	0.00		
100.00	99.98		21	100.00	99.67		99.87	0.00		
100.00	99.96		22	97.02	96.44		99.96	0.00		
100.00	99.98		23	99.83	99.35		99.93	0.00		
100.00	99.96		24	100.00	99.44		88.00	0.00		
99.93	99.89		25	100.00	98.48		99.52	0.00		
100.00	99.98	SC INT, all NS CAL's	26	96.30	95.87	All CAL's	99.41	0.00	All NS CAL's	
100.00	100.00		27	99.59	99.02		99.98	0.00		
100.00	99.94		28	97.31	96.63		100.00	0.00		
100.00	100.00		29	95.19	94.87		99.91	0.00		
100.00	99.98		30	99.98	99.70		98.63	0.00		

	ERBS	NOAA 9	NOAA 10
<sup>a</sup> Percentage of data for all days in month on			
RAT . . . . .	99.97	98.25	97.45
PAT . . . . .	99.84	97.62	58.63
Percentage of data for days in month with data on			
RAT . . . . .	99.97	98.25	97.45
PAT . . . . .	99.84	97.62	97.72
Date on which tape was archived at the NSSDC:			
RAT . . . . .	Jan. 1990	May 1990	Jan. 1991
PAT . . . . .	May 1990	Aug. 1990	June 1991

Table 1. Continued

(k) December 1986<sup>a</sup>

ERBS spacecraft			Day of month	NOAA 9 spacecraft			Day of month	NOAA 10 spacecraft		
Percentage of data on		Special events		Percentage of data on		Special events		Percentage of data on		Special events
RAT	PAT			RAT	PAT			RAT	PAT	
100.00	99.96	SC INT, all NS CAL's	1	99.81	99.56	All SC CAL's. NS INT	1	100.00	0.00	SC INT, all NS CAL's
100.00	99.96		2	96.57	95.15		2	88.43	0.00	
100.00	99.96		3	93.30	92.19		3	92.72	0.00	
100.00	100.00		4	99.87	99.30		4	99.65	0.00	
100.00	99.98		5	99.91	99.69		5	99.72	99.48	
100.00	99.96		6	100.00	99.61		6	99.98	99.39	
100.00	99.93		7	99.94	99.04		7	99.98	99.67	
100.00	99.98		8	98.81	97.76		8	100.00	99.91	
100.00	100.00		9	94.56	93.44		9	100.00	99.91	
100.00	93.67		10	97.17	96.44		10	100.00	99.19	
100.00	99.94	11	92.20	91.87	11	99.94	99.46			
100.00	99.98	12	100.00	98.98	12	92.69	92.39			
100.00	99.98	13	100.00	99.72	13	99.72	99.67			
100.00	100.00	14	99.89	99.37	14	99.94	99.67			
100.00	99.98	15	100.00	99.61	15	93.83	93.80			
99.56	99.50	16	99.91	99.56	16	100.00	99.87			
100.00	99.98	17	99.31	98.52	17	100.00	99.85			
100.00	99.94	SC INT, all NS CAL's	18	98.69	97.96	18	100.00	99.57		
100.00	100.00	19	99.98	99.37	19	99.87	99.69			
100.00	99.93	20	99.94	99.35	20	100.00	99.87			
100.00	99.94	21	99.91	98.94	21	98.94	98.61			
100.00	99.94	22	99.91	99.15	22	99.59	99.28			
100.00	99.89	23	100.00	98.98	23	92.89	92.78			
100.00	99.96	SC INT, all NS CAL's	24	93.22	92.31	All SC CAL's. NS INT	24	100.00	99.52	SC INT, all NS CAL's
100.00	99.94	25	99.98	99.35	25	92.52	91.98			
100.00	100.00	26	97.48	96.43	26	94.06	93.93			
100.00	99.87	27	94.89	94.28	27	97.46	97.17			
100.00	100.00	28	99.81	99.02	28	100.00	99.72			
100.00	100.00	29	92.69	90.74	29	99.83	99.02			
99.96	99.85	30	100.00	97.63	30	99.43	99.37			
100.00	98.06	Yaw turn (+) to (-)	31	95.74	95.22	31	93.78	93.37		

ERBS NOAA 9 NOAA 10

<sup>a</sup>Percentage of data for all days in month on

RAT . . . . .	99.98	98.18	97.90
PAT . . . . .	99.68	97.37	85.36
Percentage of data for days in month with data on			
RAT . . . . .	99.98	98.18	97.90
PAT . . . . .	99.68	97.37	98.00
Date on which tape was archived at the NSSDC:			
RAT . . . . .	Feb. 1988	Sept. 1988	Oct. 1990
PAT . . . . .	July 1989	July 1989	June 1991

Table 1. Concluded

(1) January 1987<sup>a</sup>

ERBS spacecraft			Day of month	NOAA 9 spacecraft			Day of month	NOAA 10 spacecraft		
Percentage of data on		Special events		Percentage of data on		Special events		Percentage of data on		Special events
RAT	PAT			RAT	PAT			RAT	PAT	
100.00	99.93	SC INT, all NS CAL's	1	90.26	89.89	All NS CAL's	1	78.00	77.85	SC INT, all NS CAL's
100.00	99.94		2	100.00	99.56		2	100.00	99.72	
100.00	99.93		3	100.00	99.74		3	100.00	99.80	
100.00	99.81		4	99.85	98.85		4	100.00	99.89	
100.00	99.83		5	99.80	99.30		5	74.83	74.81	
99.98	99.67		6	99.87	97.54		6	100.00	99.96	
99.52	99.06		7	99.98	98.91		7	99.17	99.06	
100.00	99.89		8	99.80	99.35		8	99.94	99.61	
100.00	99.72		9	100.00	99.52		9	100.00	99.96	
100.00	99.96		10	100.00	99.52		10	93.69	93.52	
100.00	99.69		11	100.00	99.37		11	100.00	99.63	
100.00	99.81		12	100.00	99.57		12	100.00	99.74	
100.00	99.85		13	99.87	99.35		13	98.61	98.24	
99.94	99.33		14	99.63	98.59		14	99.57	99.17	
100.00	99.89		15	99.93	99.35		15	99.98	99.89	
100.00	99.93		16	99.94	99.63		16	99.98	99.89	
100.00	99.89		17	99.94	99.80		17	99.91	98.67	
100.00	99.80		18	93.31	93.07		18	99.98	99.96	
100.00	99.78		19	99.98	99.22		19	93.13	92.96	
100.00	99.91	20	98.46	97.65	20	100.00	99.93			
99.93	99.48	21	96.91	0.00	21	99.98	90.91			
100.00	99.65	22	93.28	0.00	22	93.17	92.74			
100.00	100.00	23	96.24	0.00	23	100.00	99.80			
100.00	99.50	24	94.78	0.00	24	96.28	95.07			
100.00	99.83	25	99.91	0.00	25	99.98	99.70			
100.00	99.93	26	94.00	0.00	26	77.41	77.02			
100.00	99.94	27	99.91	0.00	27	99.74	99.06			
100.00	99.91	28	93.41	0.00	28	89.30	88.26			
100.00	99.96	29	98.22	0.00	29	96.72	96.56			
100.00	98.11	Yaw turn (-) to (+)	30	99.91	0.00	30	100.00	99.78		
100.00	99.98		31	100.00	0.00	31	100.00	99.41		

	ERBS	NOAA 9	NOAA 10
<sup>a</sup> Percentage of data for all days in month on			
RAT . . . . .	99.98	98.30	96.43
PAT . . . . .	99.74	63.48	95.82
Percentage of data for days in month with data on			
RAT . . . . .	99.98	98.30	96.43
PAT . . . . .	99.74	98.39	95.82
Date on which tape was archived at the NSSDC:			
RAT . . . . .	May 1990	Oct. 1990	Oct. 1990
PAT . . . . .	Nov. 1990	Feb. 1991	July 1991



Table 2. Spectral Characteristics of ERBE Instrument Detectors

(a) Nonscanner detectors

Detector	Spectral range, $\mu\text{m}$
Medium field of view:	
Shortwave . . . . .	0.2 to 5.0
Total . . . . .	0.2 to >50.0
Wide field of view:	
Shortwave . . . . .	0.2 to 5.0
Total . . . . .	0.2 to >50.0
Solar monitor . . . . .	0.2 to >50.0

(b) Scanner detectors

Detector	Spectral range, $\mu\text{m}$
Shortwave . . . . .	0.2 to 4.9
Longwave . . . . .	5.0 to 50.0
Total . . . . .	0.2 to >50.0

Table 3. Operational and Pulse Discrete Commands for Instruments

(a) Nonscanner instrument

1. Mode commands

Command description	Hex value
Azimuth to 0° position	811
Azimuth to 90° position	812
Azimuth to 180° position	813
Azimuth to position A	814
Elevation to internal source (stow)	821
Elevation to solar ports	822
Elevation to nadir (Earth view)	823
SMA shutter cycle on	831
SMA shutter cycle off	832
Detector heaters on	841
Detector heaters off	842
Solar port heaters on	851
Solar port heaters off	852
WFOV blackbody heater off	861
WFOV blackbody heater to temperature 1	862
WFOV blackbody heater to temperature 2	863
MFOV blackbody heater off	871
MFOV blackbody heater to temperature 1	872
MFOV blackbody heater to temperature 2	873
Detector calibration heater off	881
Detector calibration heater to level 1	882
Detector calibration heater to level 2	883
Detector calibration heater to level 3	884
SWICS off	891
SWICS to level 1	892
SWICS to level 2	893
SWICS to level 3	894
Internal calibration sequence	8A1
Solar calibration sequence	8A2

Table 3. Continued

(a) Concluded

2. Data storage commands

Command description	Hex value
Address for azimuth position A	419
Address for MFOV total heat sink temperature	422
Address for MFOV SW heat sink temperature	42B
Address for WFOV total heat sink temperature	434
Address for WFOV SW heat sink temperature	43D
Address for solar port temperature	446
Address for MFOV blackbody temperature 1	461
Address for MFOV blackbody temperature 2	463
Address for WFOV blackbody temperature 1	465
Address for WFOV blackbody temperature 2	467
Data, most significant byte	2xx
Data, least significant byte	1xx

3. Pulse discrete commands

Command description
Turn on instrument power
Turn off instrument power
Turn on standby heater 2 power (pedestal)
Turn off standby heater 2 power (pedestal)
Turn on pulse bus series relay
Turn off pulse bus series relay
Turn on pulse load bus A power
Turn off pulse load bus A power
Turn on pulse load bus B power
Turn off pulse load bus B power
Turn on standby heater 1 power (head)
Turn off standby heater 1 power (head)
Turn on instrument heater bus power
Turn off instrument heater bus power
Turn on blackbody heater bus power
Turn off blackbody heater bus power
Turn on motor bus
Turn off motor bus
CPU command load
CPU reset

Table 3. Continued

(b) Scanner instrument

1. Mode commands

Command description	Hex value
Azimuth to 0° position	811
Azimuth to 90° position	812
Azimuth to 180° position	813
Azimuth to position A	814
Azimuth to position B	815
Azimuth scan between 0° and position A	816
Scan to stow position	821
Normal Earth scan	822
Nadir Earth scan	823
Short Earth scan	824
MAM scan	825
SWICS off	891
SWICS to level 3	892
SWICS to level 3—modulated	893
SWICS to level 2	894
SWICS to level 2—modulated	895
SWICS to level 1	896
SWICS to level 1—modulated	897
Internal calibration sequence	8A1
Solar calibration sequence	8A2

2. Data storage commands

Command description	Hex value
Address for azimuth position A	419
Address for azimuth position B	41B
Data, most significant byte	2xx
Data, least significant byte	1xx

Table 3. Concluded

(b) Concluded

3. Pulse discrete commands

Command description
Turn on instrument power
Turn off instrument power
Turn on standby heater power (pedestal)
Turn off standby heater power (pedestal)
Turn on pulse bus series relay
Turn off pulse bus series relay
Turn on pulse load bus A power
Turn off pulse load bus A power
Turn on pulse load bus B power
Turn off pulse load bus B power
Turn on standby heater power (head)
Turn off standby heater power (head)
Turn on blackbody heater bus power
Turn off blackbody heater bus power
CPU command load
CPU reset

Table 4. Scan Profiles of Scanner Instrument<sup>a</sup>

[Footnotes are given at end of table]

Scan position	Normal Earth mode		Short Earth mode		MAM scan mode	
	Scan angle, deg	View	Scan angle, deg	View	Scan angle, deg	View
1	14.00	Space	14.0	Space	163.00	Space
2	↓	↓	↓	↓	↓	↓
3	↓	↓	↓	↓	↓	↓
4	↓	↓	↓	↓	↓	↓
5	↓	↓	↓	↓	↓	↓
6	↓	↓	↓	↓	↓	↓
7	↓	↓	↓	↓	↓	↓
8	↓	↓	↓	↓	↓	↓
9	23.00	Earth	23.00	Earth	(b)	Transit
10	25.22	↓	25.22	↓	↓	↓
11	27.45	↓	27.45	↓	↓	↓
12	29.67	↓	29.67	↓	↓	↓
13	31.89	↓	31.89	↓	↓	↓
14	34.12	↓	34.12	↓	↓	↓
15	36.34	↓	36.34	↓	↓	↓
16	38.56	↓	38.56	↓	↓	↓
17	40.79	↓	40.79	↓	↓	↓
18	43.01	↓	43.01	↓	233.00	MAM
19	45.23	↓	45.23	↓	↓	↓
20	47.46	↓	47.46	↓	↓	↓
21	49.68	↓	49.68	↓	↓	↓
22	51.90	↓	51.90	↓	↓	↓
23	54.13	↓	54.13	↓	↓	↓
24	56.35	↓	56.35	↓	↓	↓
25	58.57	↓	58.57	↓	↓	↓
26	60.80	↓	60.80	↓	↓	↓
27	63.02	↓	63.02	↓	↓	↓
28	65.24	↓	65.24	↓	↓	↓
29	67.47	↓	67.47	↓	↓	↓
30	69.69	↓	69.69	↓	↓	↓
31	71.91	↓	71.91	↓	↓	↓
32	74.14	↓	74.14	↓	↓	↓
33	76.36	↓	76.36	↓	↓	↓
34	78.58	↓	78.58	↓	↓	↓
35	80.81	↓	80.81	↓	↓	↓
36	83.03	↓	83.03	↓	↓	↓
37	85.25	↓	85.25	↓	↓	↓
38	87.48	↓	87.48	↓	↓	↓
39	89.70	↓	89.70	↓	↓	↓
40	91.92	↓	91.92	↓	↓	↓
41	94.15	↓	94.15	↓	↓	↓
42	96.37	↓	96.37	↓	↓	↓
43	98.59	↓	98.59	↓	↓	↓
44	100.82	↓	100.82	↓	↓	↓

Table 4. Concluded

Scan position	Normal Earth mode		Short Earth mode		MAM scan mode	
	Scan angle, deg	View	Scan angle, deg	View	Scan angle, deg	View
45	103.04	Earth	103.04	Earth	233.00	MAM
46	105.26	↓	105.26	↓	↓	↓
47	107.49	↓	107.49	↓	↓	↓
48	109.71	↓	109.71	↓	↓	↓
49	111.93	↓	111.93	↓	↓	↓
50	114.16	↓	114.16	↓	↓	↓
51	116.38	↓	116.38	↓	↓	↓
52	118.60	↓	118.60	↓	↓	↓
53	120.83	↓	120.83	↓	↓	↓
54	123.05	↓	123.05	↓	↓	↓
55	125.27	↓	125.27	↓	↓	↓
56	127.50	↓	127.50	↓	↓	↓
57	129.72	↓	129.72	↓	↓	↓
58	131.94	↓	131.94	↓	↓	↓
59	134.17	↓	134.17	↓	↓	↓
60	136.39	↓	136.39	↓	↓	↓
61	138.61	↓	138.61	↓	↓	↓
62	140.84	↓	140.84	↓	↓	↓
63	143.06	↓	142.00	↓	↓	↓
64	145.28	↓	↓	↓	↓	↓
65	147.51	↓	↓	↓	(b)	Transit
66	149.73	↓	↓	↓	↓	↓
67	151.95	↓	↓	↓	↓	↓
68	154.18	↓	↓	↓	↓	↓
69	156.40	↓	↓	↓	↓	↓
70	158.62	↓	↓	↓	↓	↓
71	190.00	INT CAL	142.00	Earth	190.00	INT CAL
72	↓	↓	↓	↓	↓	↓
73	↓	↓	↓	↓	↓	↓
74	↓	↓	↓	↓	↓	↓

<sup>a</sup>Scan angle is the elevation angle  $\phi$  defined in the "Coordinate Systems and In-flight Geometry" section (p. 4) and is shown in figure 2(b).

<sup>b</sup>Not calculated.

Table 5. List of Data Output by Instruments

(a) Nonscanner instrument

Data description	RAT units	PAT units	Measurement interval, sec	Measurements per 16 sec
WFOV total radiometric	Counts	$W/m^2$	0.8	20
WFOV SW radiometric	↓	↓	↓	↓
MFOV total radiometric	↓	↓	↓	↓
MFOV SW radiometric	↓	Not on PAT	↓	↓
Solar monitor radiometric	↓	↓	16	1
Command echo	↓	↓	↓	↓
Instrument status	↓	↓	↓	↓
Elevation drive position	deg	↓	↓	↓
MFOV total aperture temperature	°C	↓	↓	↓
MFOV SW aperture temperature	↓	↓	↓	↓
Solar monitor heat sink temperature	↓	↓	↓	↓
WFOV total aperture temperature	↓	↓	↓	↓
WFOV SW aperture temperature	↓	↓	↓	↓
MFOV total FOV limiter temperature	↓	↓	↓	↓
MFOV SW limiter temperature	↓	↓	↓	↓
Calibration heater voltage	V	↓	↓	↓
Solar monitor aperture temperature	°C	↓	↓	↓
WFOV total FOV limiter temperature	↓	↓	↓	↓
WFOV SW FOV limiter temperature	↓	↓	↓	↓
Beam electronics board temperature	↓	↓	↓	↓
Solar monitor baffle temperature	↓	↓	↓	↓
Azimuth drive position	deg	↓	8	2
WFOV total heat sink temperature	°C	↓	↓	↓
WFOV SW heat sink temperature	↓	↓	↓	↓
MFOV total heat sink temperature	↓	↓	↓	↓
MFOV SW heat sink temperature	↓	↓	↓	↓
WFOV blackbody temperature	↓	↓	↓	↓
MFOV blackbody temperature	↓	↓	↓	↓
WFOV solar port temperature	↓	↓	↓	↓
MFOV solar port temperature	↓	↓	↓	↓
SWICS photodiode temperature	↓	↓	↓	↓
SWICS amplifier output	V	↓	↓	↓
Temperature reference voltage	V	↓	↓	↓
SAS azimuth sine	Counts	↓	4	4
SAS azimuth cosine	↓	↓	↓	↓
SAS elevation sine	↓	↓	↓	↓
SAS elevation cosine	↓	↓	↓	↓
SAS coarse data	↓	↓	↓	↓



Table 5. Concluded

(b) Scanner instrument

Data description	RAT units	PAT units	Measurement interval, sec	Measurements per 16 sec
Total radiometric	Counts	W/m <sup>2</sup> /sr	0.033	296
LW radiometric	↓	↓	↓	↓
SW radiometric	↓	↓	↓	↓
Scan position	deg	Not on PAT	↓	↓
Command echo	Counts		4	4
Instrument status	Counts		↓	↓
Azimuth position	deg		↓	↓
Total detector temperature	°C		↓	↓
LW detector temperature	↓		↓	↓
SW detector temperature	↓		↓	↓
Total blackbody temperature	↓		↓	↓
LW blackbody temperature	↓		↓	↓
SWICS photodiode temperature	↓		↓	↓
Detector positive bias voltage	V		↓	↓
Detector negative bias voltage	↓		↓	↓
Total drift balance DAC voltage	↓		↓	↓
LW drift balance DAC voltage	↓		↓	↓
SW drift balance DAC voltage	↓		↓	↓
Temperature reference voltage 1	↓		↓	↓
Temperature reference voltage 2	↓		↓	↓
SW MAM temperature	°C		↓	↓
Total MAM baffle temperature	↓		↓	↓
SW MAM baffle temperature	↓		↓	↓
Total MAM temperature	↓		↓	↓
SWICS amplifier output (1)	V		↓	↓
SWICS amplifier output (2)	↓		↓	↓
SWICS amplifier output (3)	↓		↓	↓

Table 7. List of Operational Commands Executed by Instruments on ERBS Spacecraft

(a) Nonscanner commands

Date	Universal time		Hex command	Event description
	hr:min:sec	Minutes of day		
Begin azimuth angle load commands for solar calibration				
02/05/86	01:42:40	103	419	Address azimuth position A
	01:43:12	103	2xx	Data command, high byte
	01:44:16	104	1xx	Data command, low byte
End azimuth angle load commands (A = 72.38°).				
Begin preinternal calibration sequence				
02/05/86	10:02:56	603	821	Elevate to internal source (stow)
	10:03:28	603	862	WFOV BB heater on at temp. 1
	10:04:00	604	872	MFOV BB heater on at temp. 1
	11:40:00	700	823	Elevate to nadir (Earth)
End preinternal calibration sequence.				
Begin internal calibration sequence				
02/05/86	11:41:04	701	8A1	Begin internal calibration
	11:41:36	702	881	Detector bias heater off
	11:42:08	702	852	Solar port heaters off
	11:42:40	703	821	Elevate to internal source (stow)
	11:43:12	703	851	Solar port heaters on
	11:45:20	705	882	Detector bias heater on at level 1
	11:47:28	707	892	SWICS on at level 3
	11:50:40	711	881	Detector bias heater off
	11:54:24	714	862	WFOV BB heater on at temp. 1
	11:54:56	715	872	MFOV BB heater on at temp. 1
	11:56:00	716	891	SWICS off
	12:09:20	729	883	Detector bias heater on at level 2
	12:11:28	731	893	SWICS on at level 2
	12:14:40	735	881	Detector bias heater off
	12:18:24	738	863	WFOV BB heater on at temp. 2
	12:18:56	739	873	MFOV BB heater on at temp. 2
	12:20:00	740	891	SWICS off
	12:33:20	753	884	Detector bias heater on at level 3
	12:35:28	755	894	SWICS on at level 1
	12:37:36	758	881	Detector bias heater off
	12:40:16	760	852	Solar port heaters off
	12:41:20	761	861	WFOV BB heater off
	12:41:52	762	871	MFOV BB heater off
	12:42:24	762	851	Solar port heaters on
12:42:56	763	891	SWICS off	
End internal calibration sequence				
02/05/86	12:49:52	770	823	Elevate to nadir (Earth)
Begin modified solar calibration sequence				
02/05/86	12:56:48	777	822	Elevate to solar ports (Sun)
	12:57:20	777	814	Azimuth to position A
	12:57:52	778	883	Detector bias heater on at level 2
	13:08:00	788	831	SMA shutter cycle on

Table 7. Continued

(a) Continued

Date	Universal time		Hex command	Event description
	hr:min:sec	Minutes of day		
02/05/86	13:38:56	819	832	SMA shutter cycle off
	13:40:00	820	811	Azimuth to 0°
	13:40:32	821	881	Detector bias heater off
	13:50:08	830	823	Elevate to nadir (Earth)
End modified solar calibration sequence.				
Begin azimuth angle load commands for solar calibration				
02/15/86	00:53:04	53	419	Address azimuth position A
	00:53:36	54	2xx	Data command, high byte
	00:54:40	55	1xx	Data command, low byte
End azimuth angle load commands (A = 32.4°).				
Begin preinternal calibration sequence				
02/15/86	08:50:24	530	821	Elevate to internal source (stow)
	08:51:28	531	862	WFOV BB heater on at temp. 1
	08:52:00	532	872	MFOV BB heater on at temp. 1
	10:27:28	627	823	Elevate to nadir (Earth)
End preinternal calibration sequence.				
Begin internal calibration sequence				
02/15/86	10:28:32	629	8A1	Begin internal calibration
	10:29:04	629	881	Detector bias heater off
	10:29:36	630	852	Solar port heaters off
	10:30:08	630	821	Elevate to internal source (stow)
	10:30:40	631	851	Solar port heaters on
	10:32:48	633	882	Detector bias heater on at level 1
	10:34:56	635	892	SWICS on at level 3
	10:38:08	638	881	Detector bias heater off
	10:41:52	642	862	WFOV BB heater on at temp. 1
	10:42:24	642	872	MFOV BB heater on at temp. 1
	10:43:28	643	891	SWICS off
	10:56:48	657	883	Detector bias heater on at level 2
	10:58:56	659	893	SWICS on at level 2
	11:02:08	662	881	Detector bias heater off
	11:05:52	666	863	WFOV BB heater on at temp. 2
	11:06:24	666	873	MFOV BB heater on at temp. 2
	11:07:28	667	891	SWICS off
	11:20:48	681	884	Detector bias heater on at level 3
	11:22:56	683	894	SWICS on at level 1
	11:25:04	685	881	Detector bias heater off
	11:27:44	688	852	Solar port heaters off
	11:28:48	689	861	WFOV BB heater off
	11:29:20	689	871	MFOV BB heater off
	11:29:52	690	851	Solar port heaters on
11:30:24	690	891	SWICS off	
End internal calibration sequence				
02/15/86	11:37:52	698	823	Elevate to nadir (Earth)

Table 7. Continued

(a) Continued

Date	Universal time		Hex command	Event description
	hr:min:sec	Minutes of day		
Begin modified solar calibration sequence				
02/15/86	11:44:48	705	822	Elevate to solar ports (Sun)
	11:45:20	705	814	Azimuth to position A
	11:45:52	706	883	Detector bias heater on at level 2
	11:56:00	716	831	SMA shutter cycle on
	12:26:56	747	832	SMA shutter cycle off
	12:28:00	748	811	Azimuth to 0°
	12:28:32	749	881	Detector bias heater off
	12:38:08	758	823	Elevate to nadir (Earth)
End modified solar calibration sequence.				
Begin azimuth angle load commands for solar calibration				
02/26/86	01:47:28	107	419	Address azimuth position A
	01:48:00	108	2xx	Data command, high byte
	01:48:32	109	1xx	Data command, low byte
End azimuth angle load commands (A = 30.83°).				
Begin preinternal calibration sequence				
02/26/86	09:37:52	578	821	Elevate to internal source (stow)
	09:38:24	578	862	WFOV BB heater on at temp. 1
	09:38:56	579	872	MFOV BB heater on at temp. 1
	11:14:56	675	823	Elevate to nadir (Earth)
End preinternal calibration sequence.				
Begin internal calibration sequence				
02/26/86	11:16:00	676	8A1	Begin internal calibration
	11:16:32	677	881	Detector bias heater off
	11:17:04	677	852	Solar port heaters off
	11:17:36	678	821	Elevate to internal source (stow)
	11:18:08	678	851	Solar port heaters on
	11:20:16	680	882	Detector bias heater on at level 1
	11:22:24	682	892	SWICS on at level 3
	11:25:36	686	881	Detector bias heater off
	11:29:20	689	862	WFOV BB heater on at temp. 1
	11:29:52	690	872	MFOV BB heater on at temp. 1
	11:30:56	691	891	SWICS off
	11:44:16	704	883	Detector bias heater on at level 2
	11:46:24	706	893	SWICS on at level 2
	11:49:36	710	881	Detector bias heater off
	11:53:20	713	863	WFOV BB heater on at temp. 2
	11:53:52	714	873	MFOV BB heater on at temp. 2
	11:54:56	715	891	SWICS off
	12:08:16	728	884	Detector bias heater on at level 3
	12:10:24	730	894	SWICS on at level 1
	12:12:32	733	881	Detector bias heater off
12:15:12	735	852	Solar port heaters off	
12:16:16	736	861	WFOV BB heater off	

Table 7. Continued

(a) Continued

Date	Universal time		Hex command	Event description
	hr:min:sec	Minutes of day		
02/26/86	12:16:48	737	871	MFOV BB heater off
	12:17:20	737	851	Solar port heaters on
	12:17:52	738	891	SWICS off
End internal calibration sequence				
02/26/86	12:24:48	745	823	Elevate to nadir (Earth)
Begin modified solar calibration sequence				
02/26/86	12:32:16	752	822	Elevate to solar ports (Sun)
	12:32:48	753	814	Azimuth to position A
	12:33:20	753	883	Detector bias heater on at level 2
	12:43:28	763	831	SMA shutter cycle on
	13:24:32	805	832	SMA shutter cycle off
	13:25:36	806	811	Azimuth to 0°
	13:26:08	806	881	Detector bias heater off
	13:35:44	816	823	Elevate to nadir (Earth)
End modified solar calibration sequence.				
Begin azimuth angle load commands for solar calibration				
03/05/86	01:01:20	61	419	Address azimuth position A
	01:01:36	62	2xx	Data command, high byte
	01:02:40	63	1xx	Data command, low byte
End azimuth angle load commands (A = 59.4°).				
Begin preinternal calibration sequence				
03/05/86	09:22:56	563	821	Elevate to internal source (stow)
	09:23:28	563	862	WFOV BB heater on at temp. 1
	09:24:00	564	872	MFOV BB heater on at temp. 1
	11:00:00	660	823	Elevate to nadir (Earth)
End preinternal calibration sequence.				
Begin internal calibration sequence				
03/05/86	11:01:04	661	8A1	Begin internal calibration
	11:01:36	662	881	Detector bias heater off
	11:02:08	662	852	Solar port heaters off
	11:02:40	663	821	Elevate to internal source (stow)
	11:03:12	663	851	Solar port heaters on
	11:05:20	665	882	Detector bias heater on at level 1
	11:07:28	667	892	SWICS on at level 3
	11:10:40	671	881	Detector bias heater off
	11:14:24	674	862	WFOV BB heater on at temp. 1
	11:14:56	675	872	MFOV BB heater on at temp. 1
	11:16:00	676	891	SWICS off
	11:29:20	689	883	Detector bias heater on at level 2
	11:31:28	691	893	SWICS on at level 2
	11:34:40	695	881	Detector bias heater off
	11:38:24	698	863	WFOV BB heater on at temp. 2
	11:38:56	699	873	MFOV BB heater on at temp. 2
	11:40:00	700	891	SWICS off

Table 7. Continued

(a) Continued

Date	Universal time		Hex command	Event description
	hr:min:sec	Minutes of day		
03/05/86	11:53:20	713	884	Detector bias heater on at level 3
	11:55:28	715	894	SWICS on at level 1
	11:57:36	718	881	Detector bias heater off
	12:00:16	720	852	Solar port heaters off
	12:01:20	721	861	WFOV BB heater off
	12:01:52	722	871	MFOV BB heater off
	12:02:24	722	851	Solar port heaters on
	12:02:56	723	891	SWICS off
End internal calibration sequence				
03/05/86	12:09:52	730	823	Elevate to nadir (Earth)
Begin modified solar calibration sequence				
03/05/86	12:17:20	737	822	Elevate to solar ports (Sun)
	12:17:52	738	814	Azimuth to position A
	12:18:24	738	883	Detector bias heater on at level 2
	12:28:32	749	831	SMA shutter cycle on
	13:09:36	790	832	SMA shutter cycle off
	13:10:40	791	811	Azimuth to 0°
	13:11:12	791	881	Detector bias heater off
	13:20:48	801	823	Elevate to nadir (Earth)
End modified solar calibration sequence				
03/12/86	15:07:11			Yaw maneuver to X-axis negative
Begin azimuth angle load commands for solar calibration				
03/19/86	04:34:24	274	419	Address azimuth position A
	04:34:56	275	2xx	Data command, high byte
	04:36:00	276	1xx	Data command, low byte
End azimuth angle load commands (A = 59.78°).				
Begin preinternal calibration sequence				
03/19/86	09:32:32	573	821	Elevate to internal source (stow)
	09:33:04	573	862	WFOV BB heater on at temp. 1
	09:33:36	574	872	MFOV BB heater on at temp. 1
	11:09:04	669	823	Elevate to nadir (Earth)
End preinternal calibration sequence.				
Begin internal calibration sequence				
03/19/86	11:10:08	670	8A1	Begin internal calibration
	11:10:40	671	881	Detector bias heater off
	11:11:12	671	852	Solar port heaters off
	11:11:44	672	821	Elevate to internal source (stow)
	11:12:16	672	851	Solar port heaters on
	11:14:24	674	882	Detector bias heater on at level 1
	11:16:32	677	892	SWICS on at level 3
	11:19:44	680	881	Detector bias heater off
	11:23:28	683	862	WFOV BB heater on at temp. 1
	11:24:00	684	872	MFOV BB heater on at temp. 1
	11:25:04	685	891	SWICS off

Table 7. Continued

(a) Continued

Date	Universal time		Hex command	Event description
	hr:min:sec	Minutes of day		
03/19/86	11:38:24	698	883	Detector bias heater on at level 2
	11:40:32	701	893	SWICS on at level 2
	11:43:44	704	881	Detector bias heater off
	11:47:28	707	863	WFOV BB heater on at temp. 2
	11:48:00	708	873	MFOV BB heater on at temp. 2
	11:49:04	709	891	SWICS off
	12:02:24	722	884	Detector bias heater on at level 3
	12:04:32	725	894	SWICS on at level 1
	12:06:40	727	881	Detector bias heater off
	12:09:20	729	852	Solar port heaters off
	12:10:24	730	861	WFOV BB heater off
	12:10:56	731	871	MFOV BB heater off
	12:11:28	731	851	Solar port heaters on
	12:12:00	732	891	SWICS off
End internal calibration sequence				
03/19/86	12:19:28	739	823	Elevate to nadir (Earth)
Begin modified solar calibration sequence				
03/19/86	12:26:24	746	822	Elevate to solar ports (Sun)
	12:26:56	747	814	Azimuth to position A
	12:27:28	747	883	Detector bias heater on at level 2
	12:37:36	758	831	SMA shutter cycle on
	13:18:40	799	832	SMA shutter cycle off
	13:19:44	800	811	Azimuth to 0°
	13:20:16	800	881	Detector bias heater off
	13:29:52	810	823	Elevate to nadir (Earth)
End modified solar calibration sequence.				
Begin azimuth angle load commands for solar calibration				
04/02/86	02:20:00	140	419	Address azimuth position A
	02:20:32	141	2xx	Data command, high byte
	02:21:04	141	1xx	Data command, low byte
End azimuth angle load commands (A = 28.88°).				
Begin preinternal calibration sequence				
04/02/86	09:14:24	554	821	Elevate to internal source (stow)
	09:14:56	555	862	WFOV BB heater on at temp. 1
	09:15:28	555	872	MFOV BB heater on at temp. 1
	10:51:28	651	823	Elevate to nadir (Earth)
End preinternal calibration sequence.				
Begin internal calibration sequence				
04/02/86	10:52:32	653	8A1	Begin internal calibration
	10:53:04	653	881	Detector bias heater off
	10:53:36	654	852	Solar port heaters off
	10:54:08	654	821	Elevate to internal source (stow)
	10:54:40	655	851	Solar port heaters on
	10:56:48	657	882	Detector bias heater on at level 1

Table 7. Continued

(a) Continued

Date	Universal time		Hex command	Event description
	hr:min:sec	Minutes of day		
04/02/86	10:58:56	659	892	SWICS on at level 3
	11:02:08	662	881	Detector bias heater off
	11:05:52	666	862	WFOV BB heater on at temp. 1
	11:06:24	666	872	MFOV BB heater on at temp. 1
	11:07:28	667	891	SWICS off
	11:20:48	681	883	Detector bias heater on at level 2
	11:22:56	683	893	SWICS on at level 2
	11:26:08	686	881	Detector bias heater off
	11:29:52	690	863	WFOV BB heater on at temp. 2
	11:30:24	690	873	MFOV BB heater on at temp. 2
	11:31:28	691	891	SWICS off
	11:44:48	705	884	Detector bias heater on at level 3
	11:46:56	707	894	SWICS on at level 1
	11:49:04	709	881	Detector bias heater off
	11:51:44	712	852	Solar port heaters off
	11:52:48	713	861	WFOV BB heater off
	11:53:20	713	871	MFOV BB heater off
	11:53:52	714	851	Solar port heaters on
	11:54:24	714	891	SWICS off
End internal calibration sequence				
04/02/86	12:01:20	721	823	Elevate to nadir (Earth)
Begin modified solar calibration sequence				
04/02/86	12:08:16	728	822	Elevate to solar ports (Sun)
	12:08:48	729	814	Azimuth to position A
	12:09:20	729	883	Detector bias heater on at level 2
	12:19:28	739	831	SMA shutter cycle on
	13:00:32	781	832	SMA shutter cycle off
	13:01:36	782	811	Azimuth to 0°
	13:02:08	782	881	Detector bias heater off
	13:11:44	792	823	Elevate to nadir (Earth)
End modified solar calibration sequence.				
Begin azimuth angle load commands for solar calibration				
04/16/86	03:43:44	224	419	Address azimuth position A
	03:44:16	224	2xx	Data command, high byte
	03:45:20	225	1xx	Data command, low byte
End azimuth angle load commands (A = 78.0°).				
Begin preinternal calibration sequence				
04/16/86	08:54:08	534	821	Elevate to internal source (stow)
	08:54:40	535	862	WFOV BB heater on at temp. 1
	08:55:12	535	872	MFOV BB heater on at temp. 1
	10:30:40	631	823	Elevate to nadir (Earth)
End preinternal calibration sequence				



Table 7. Continued

(a) Continued

Date	Universal time		Hex command	Event description
	hr:min:sec	Minutes of day		
Begin internal calibration sequence				
04/16/86	10:31:44	632	8A1	Begin internal calibration
	10:32:16	632	881	Detector bias heater off
	10:32:48	633	852	Solar port heaters off
	10:33:20	633	821	Elevate to internal source (stow)
	10:33:52	634	851	Solar port heaters on
	10:36:00	636	882	Detector bias heater on at level 1
	10:38:08	638	892	SWICS on at level 3
	10:41:20	641	881	Detector bias heater off
	10:45:04	645	862	WFOV BB heater on at temp. 1
	10:45:36	646	872	MFOV BB heater on at temp. 1
	10:46:40	647	891	SWICS off
	11:00:00	660	883	Detector bias heater on at level 2
	11:02:08	662	893	SWICS on at level 2
	11:05:20	665	881	Detector bias heater off
	11:09:04	669	863	WFOV BB heater on at temp. 2
	11:09:36	670	873	MFOV BB heater on at temp. 2
	11:10:40	671	891	SWICS off
	11:24:00	684	884	Detector bias heater on at level 3
	11:26:08	686	894	SWICS on at level 1
	11:28:16	688	881	Detector bias heater off
11:30:56	691	852	Solar port heaters off	
11:32:00	692	861	WFOV BB heater off	
11:32:32	693	871	MFOV BB heater off	
11:33:04	693	851	Solar port heaters on	
11:33:36	694	891	SWICS off	
End internal calibration sequence				
04/16/86	11:41:04	701	823	Elevate to nadir (Earth)
Begin modified solar calibration sequence				
04/16/86	11:48:00	708	822	Elevate to solar ports (Sun)
	11:48:32	709	814	Azimuth to position A
	11:49:04	709	883	Detector bias heater on at level 2
	11:59:12	719	831	SMA shutter cycle on
	12:40:16	760	832	SMA shutter cycle off
	12:41:20	761	811	Azimuth to 0°
	12:41:52	762	881	Detector bias heater off
	12:51:28	771	823	Elevate to nadir (Earth)
End modified solar calibration sequence				
04/18/86	16:17:19			Yaw maneuver to X-axis positive
Begin azimuth angle load commands for solar calibration				
04/30/86	03:01:36	182	419	Address azimuth position A
	03:02:08	182	2xx	Data command, high byte
	03:02:40	183	1xx	Data command, low byte
End azimuth angle load commands (A = 54.23°)				

Table 7. Continued

(a) Continued

Date	Universal time		Hex command	Event description
	hr:min:sec	Minutes of day		
Begin preinternal calibration sequence				
04/30/86	09:21:52	562	821	Elevate to internal source (stow)
	09:22:24	562	862	WFOV BB heater on at temp. 1
	09:22:56	563	872	MFOV BB heater on at temp. 1
	10:58:56	659	823	Elevate to nadir (Earth)
End preinternal calibration sequence.				
Begin internal calibration sequence				
04/30/86	11:00:00	660	8A1	Begin internal calibration
	11:00:32	661	881	Detector bias heater off
	11:01:04	661	852	Solar port heaters off
	11:01:36	662	821	Elevate to internal source (stow)
	11:02:08	662	851	Solar port heaters on
	11:04:16	664	882	Detector bias heater on at level 1
	11:06:24	666	892	SWICS on at level 3
	11:09:36	670	881	Detector bias heater off
	11:13:20	673	862	WFOV BB heater on at temp. 1
	11:13:52	674	872	MFOV BB heater on at temp. 1
	11:14:56	675	891	SWICS off
	11:28:16	688	883	Detector bias heater on at level 2
	11:30:24	690	893	SWICS on at level 2
	11:33:36	694	881	Detector bias heater off
	11:37:20	697	863	WFOV BB heater on at temp. 2
	11:37:52	698	873	MFOV BB heater on at temp. 2
	11:38:56	699	891	SWICS off
	11:52:16	712	884	Detector bias heater on at level 3
	11:54:24	714	894	SWICS on at level 1
	11:56:32	717	881	Detector bias heater off
	11:59:12	719	852	Solar port heaters off
	12:00:16	720	861	WFOV BB heater off
	12:00:48	721	871	MFOV BB heater off
	12:01:20	721	851	Solar port heaters on
12:01:52	722	891	SWICS off	
End internal calibration sequence				
04/30/86	12:08:48	729	823	Elevate to nadir (Earth)
Begin modified solar calibration sequence				
04/30/86	12:16:16	736	822	Elevate to solar ports (Sun)
	12:16:48	737	814	Azimuth to position A
	12:17:20	737	883	Detector bias heater on at level 2
	12:27:28	747	831	SMA shutter cycle on
	13:08:32	789	832	SMA shutter cycle off
	13:09:36	790	811	Azimuth to 0°
	13:10:08	790	881	Detector bias heater off
	13:19:44	800	823	Elevate to nadir (Earth)
End modified solar calibration sequence				

Table 7. Continued

(a) Continued

Date	Universal time		Hex command	Event description
	hr:min:sec	Minutes of day		
Begin azimuth angle load commands for solar calibration				
05/14/86	01:24:32	85	419	Address azimuth position A
	01:25:04	85	2xx	Data command, high byte
	01:26:08	86	1xx	Data command, low byte
End azimuth angle load commands (A = 63.6°).				
Begin preinternal calibration sequence				
05/14/86	09:01:04	541	821	Elevate to internal source (stow)
	09:01:36	542	862	WFOV BB heater on at temp. 1
	09:02:08	542	872	MFOV BB heater on at temp. 1
	10:38:08	638	823	Elevate to nadir (Earth)
End preinternal calibration sequence.				
Begin internal calibration sequence				
05/14/86	10:39:12	639	8A1	Begin internal calibration
	10:39:44	640	881	Detector bias heater off
	10:40:16	640	852	Solar port heaters off
	10:40:48	641	821	Elevate to internal source (stow)
	10:41:20	641	851	Solar port heaters on
	10:43:28	643	882	Detector bias heater on at level 1
	10:45:36	646	892	SWICS on at level 3
	10:48:48	649	881	Detector bias heater off
	10:52:32	653	862	WFOV BB heater on at temp. 1
	10:53:04	653	872	MFOV BB heater on at temp. 1
	10:54:08	654	891	SWICS off
	11:07:28	667	883	Detector bias heater on at level 2
	11:09:36	670	893	SWICS on at level 2
	11:12:48	673	881	Detector bias heater off
	11:16:32	677	863	WFOV BB heater on at temp. 2
	11:17:04	677	873	MFOV BB heater on at temp. 2
	11:18:08	678	891	SWICS off
	11:31:28	691	884	Detector bias heater on at level 3
	11:33:36	694	894	SWICS on at level 1
	11:35:44	696	881	Detector bias heater off
	11:38:24	698	852	Solar port heaters off
	11:39:28	699	861	WFOV BB heater off
	11:40:00	700	871	MFOV BB heater off
	11:40:32	701	851	Solar port heaters on
11:41:04	701	891	SWICS off	
End internal calibration sequence				
05/14/86	11:48:00	708	823	Elevate to nadir (Earth)
Begin modified solar calibration sequence				
05/14/86	11:55:28	715	822	Elevate to solar ports (Sun)
	11:56:00	716	814	Azimuth to position A
	11:56:32	717	883	Detector bias heater on at level 2
	12:06:40	727	831	SMA shutter cycle on

Table 7. Continued

(a) Continued

Date	Universal time		Hex command	Event description
	hr:min:sec	Minutes of day		
05/14/86	12:47:12	767	832	SMA shutter cycle off
	12:48:16	768	811	Azimuth to 0°
	12:48:48	769	881	Detector bias heater off
	12:58:24	778	823	Elevate to nadir (Earth)
End modified solar calibration sequence				
05/21/86	14:48:15			Yaw maneuver to X-axis negative
Begin azimuth angle load commands for solar calibration				
05/28/86	02:20:32	141	419	Address azimuth position A
	02:21:04	141	2xx	Data command, high byte
	02:22:40	143	1xx	Data command, low byte
End azimuth angle load commands (A = 62.03°).				
Begin preinternal calibration sequence				
05/28/86	09:11:12	551	821	Elevate to internal source (stow)
	09:11:44	552	862	WFOV BB heater on at temp. 1
	09:12:48	553	872	MFOV BB heater on at temp. 1
	10:48:16	648	823	Elevate to nadir (Earth)
End preinternal calibration sequence.				
Begin internal calibration sequence				
05/28/86	10:49:20	649	8A1	Begin internal calibration
	10:49:52	650	881	Detector bias heater off
	10:50:24	650	852	Solar port heaters off
	10:50:56	651	821	Elevate to internal source (stow)
	10:51:28	651	851	Solar port heaters on
	10:53:36	654	882	Detector bias heater on at level 1
	10:55:44	656	892	SWICS on at level 3
	10:58:56	659	881	Detector bias heater off
	11:02:40	663	862	WFOV BB heater on at temp. 1
	11:03:12	663	872	MFOV BB heater on at temp. 1
	11:04:16	664	891	SWICS off
	11:17:36	678	883	Detector bias heater on at level 2
	11:19:44	680	893	SWICS on at level 2
	11:22:56	683	881	Detector bias heater off
	11:26:40	687	863	WFOV BB heater on at temp. 2
	11:27:12	687	873	MFOV BB heater on at temp. 2
	11:28:16	688	891	SWICS off
	11:41:36	702	884	Detector bias heater on at level 3
	11:43:44	704	894	SWICS on at level 1
	11:45:52	706	881	Detector bias heater off
	11:48:32	709	852	Solar port heaters off
	11:49:36	710	861	WFOV BB heater off
	11:50:08	710	871	MFOV BB heater off
11:50:40	711	851	Solar port heaters on	
11:51:12	711	891	SWICS off	
End internal calibration sequence				

Table 7. Continued

(a) Continued

Date	Universal time		Hex command	Event description
	hr:min:sec	Minutes of day		
05/28/86	11:58:08	718	823	Elevate to nadir (Earth)
Begin modified solar calibration sequence				
05/28/86	12:05:36	726	822	Elevate to solar ports (Sun)
	12:06:08	726	814	Azimuth to position A
	12:06:40	727	883	Detector bias heater on at level 2
	12:16:48	737	831	SMA shutter cycle on
	12:57:52	778	832	SMA shutter cycle off
	12:58:56	779	811	Azimuth to 0°
	12:59:28	779	881	Detector bias heater off
	13:09:04	789	823	Elevate to nadir (Earth)
End modified solar calibration sequence.				
Begin azimuth angle load commands for solar calibration				
06/04/86	02:07:44	128	419	Address azimuth position A
	02:08:16	128	2xx	Data command, high byte
	02:11:28	131	1xx	Data command, low byte
End azimuth angle load commands (A = 31.2°).				
Begin azimuth angle load commands for solar calibration				
06/04/86	05:39:28	339	419	Address azimuth position A
	05:40:00	340	2xx	Data command, high byte
	05:40:32	341	1xx	Data command, low byte
End azimuth angle load commands (A = 31.2°).				
Begin preinternal calibration sequence				
06/04/86	08:53:04	533	821	Elevate to internal source (stow)
	08:53:36	534	862	WFOV BB heater on at temp. 1
	08:54:40	535	872	MFOV BB heater on at temp. 1
	10:30:08	630	823	Elevate to nadir (Earth)
End preinternal calibration sequence.				
Begin internal calibration sequence				
06/04/86	10:31:12	631	8A1	Begin internal calibration
	10:31:44	632	881	Detector bias heater off
	10:32:16	632	852	Solar port heaters off
	10:32:48	633	821	Elevate to internal source (stow)
	10:33:20	633	851	Solar port heaters on
	10:35:28	635	882	Detector bias heater on at level 1
	10:37:36	638	892	SWICS on at level 3
	10:40:48	641	881	Detector bias heater off
	10:44:32	645	862	WFOV BB heater on at temp. 1
	10:45:04	645	872	MFOV BB heater on at temp. 1
	10:46:08	646	891	SWICS off
	10:59:28	659	883	Detector bias heater on at level 2
	11:01:36	662	893	SWICS on at level 2
	11:04:48	665	881	Detector bias heater off
	11:08:32	669	863	WFOV BB heater on at temp. 2
	11:09:04	669	873	MFOV BB heater on at temp. 2

Table 7. Continued

(a) Continued

Date	Universal time		Hex command	Event description
	hr:min:sec	Minutes of day		
06/04/86	11:10:08	670	891	SWICS off
	11:23:28	683	884	Detector bias heater on at level 3
	11:25:36	686	894	SWICS on at level 1
	11:27:44	688	881	Detector bias heater off
	11:30:24	690	852	Solar port heaters off
	11:31:28	691	861	WFOV BB heater off
	11:32:00	692	871	MFOV BB heater off
	11:32:32	693	851	Solar port heaters on
	11:33:04	693	891	SWICS off
End internal calibration sequence				
06/04/86	11:40:00	700	823	Elevate to nadir (Earth)
Begin modified solar calibration sequence				
06/04/86	11:47:28	707	822	Elevate to solar ports (Sun)
	11:48:00	708	814	Azimuth to position A
	11:48:32	709	883	Detector bias heater on at level 2
	11:58:40	719	831	SMA shutter cycle on
	12:39:44	760	832	SMA shutter cycle off
	12:40:48	761	811	Azimuth to 0°
	12:41:20	761	881	Detector bias heater off
	12:50:56	771	823	Elevate to nadir (Earth)
End modified solar calibration sequence.				
Begin azimuth angle load commands for solar calibration				
06/19/86	00:14:08	14	419	Address azimuth position A
	00:14:40	15	2xx	Data command, high byte
	00:16:48	17	1xx	Data command, low byte
End azimuth angle load commands (A = 33.68°).				
Begin preinternal calibration sequence				
06/19/86	09:07:28	547	821	Elevate to internal source (stow)
	09:08:00	548	862	WFOV BB heater on at temp. 1
	09:08:32	549	872	MFOV BB heater on at temp. 1
	10:44:32	645	823	Elevate to nadir (Earth)
End preinternal calibration sequence.				
Begin internal calibration sequence				
06/19/86	10:45:36	646	8A1	Begin internal calibration
	10:46:08	646	881	Detector bias heater off
	10:46:40	647	852	Solar port heaters off
	10:47:12	647	821	Elevate to internal source (stow)
	10:47:44	648	851	Solar port heaters on
	10:49:52	650	882	Detector bias heater on at level 1
	10:52:00	652	892	SWICS on at level 3
	10:55:12	655	881	Detector bias heater off
	10:58:56	659	862	WFOV BB heater on at temp. 1
	10:59:28	659	872	MFOV BB heater on at temp. 1
	11:00:32	661	891	SWICS off

Table 7. Continued

(a) Continued

Date	Universal time		Hex command	Event description
	hr:min:sec	Minutes of day		
06/19/86	11:13:52	674	883	Detector bias heater on at level 2
	11:16:00	676	893	SWICS on at level 2
	11:19:12	679	881	Detector bias heater off
	11:22:56	683	863	WFOV BB heater on at temp. 2
	11:23:28	683	873	MFOV BB heater on at temp. 2
	11:24:32	685	891	SWICS off
	11:37:52	698	884	Detector bias heater on at level 3
	11:40:00	700	894	SWICS on at level 1
	11:42:08	702	881	Detector bias heater off
	11:44:48	705	852	Solar port heaters off
	11:45:52	706	861	WFOV BB heater off
	11:46:24	706	871	MFOV BB heater off
	11:46:56	707	851	Solar port heaters on
	11:47:28	707	891	SWICS off
End internal calibration sequence				
06/19/86	11:54:24	714	823	Elevate to nadir (Earth)
Begin modified solar calibration sequence				
06/19/86	12:01:52	722	822	Elevate to solar ports (Sun)
	12:02:24	722	814	Azimuth to position A
	12:02:56	723	883	Detector bias heater on at level 2
	12:13:04	733	831	SMA shutter cycle on
	12:54:08	774	832	SMA shutter cycle off
	12:55:12	775	811	Azimuth to 0°
	12:55:44	776	881	Detector bias heater off
	13:05:20	785	823	Elevate to nadir (Earth)
End modified solar calibration sequence.				
Begin azimuth angle load commands for solar calibration				
06/25/86	03:27:12	207	419	Address azimuth position A
	03:27:44	208	2xx	Data command, high byte
	03:28:16	208	1xx	Data command, low byte
End azimuth angle load commands (A = 59.78°).				
Begin preinternal calibration sequence				
06/25/86	08:42:24	522	821	Elevate to internal source (stow)
	08:42:56	523	862	WFOV BB heater on at temp. 1
	08:43:28	523	872	MFOV BB heater on at temp. 1
	10:18:56	619	823	Elevate to nadir (Earth)
End preinternal calibration sequence.				
Begin internal calibration sequence				
06/25/86	10:20:00	620	8A1	Begin internal calibration
	10:20:32	621	881	Detector bias heater off
	10:21:04	621	852	Solar port heaters off
	10:21:36	622	821	Elevate to internal source (stow)
	10:22:08	622	851	Solar port heaters on
	10:24:16	624	882	Detector bias heater on at level 1

Table 7. Continued

(a) Continued

Date	Universal time		Hex command	Event description
	hr:min:sec	Minutes of day		
06/25/86	10:26:24	626	892	SWICS on at level 3
	10:29:36	630	881	Detector bias heater off
	10:33:20	633	862	WFOV BB heater on at temp. 1
	10:33:52	634	872	MFOV BB heater on at temp. 1
	10:34:56	635	891	SWICS off
	10:48:16	648	883	Detector bias heater on at level 2
	10:50:24	650	893	SWICS on at level 2
	10:53:36	654	881	Detector bias heater off
	10:57:20	657	863	WFOV BB heater on at temp. 2
	10:57:52	658	873	MFOV BB heater on at temp. 2
	10:58:56	659	891	SWICS off
	11:12:16	672	884	Detector bias heater on at level 3
	11:14:24	674	894	SWICS on at level 1
	11:16:32	677	881	Detector bias heater off
	11:19:12	679	852	Solar port heaters off
	11:20:16	680	861	WFOV BB heater off
	11:20:48	681	871	MFOV BB heater off
	11:21:20	681	851	Solar port heaters on
11:21:52	682	891	SWICS off	
End internal calibration sequence				
06/25/86	11:29:20	689	823	Elevate to nadir (Earth)
Begin modified solar calibration sequence				
06/25/86	11:36:16	696	822	Elevate to solar ports (Sun)
	11:36:48	697	814	Azimuth to position A
	11:37:20	697	883	Detector bias heater on at level 2
	11:47:28	707	831	SMA shutter cycle on
	12:28:32	749	832	SMA shutter cycle off
	12:29:36	750	811	Azimuth to 0°
	12:30:08	750	881	Detector bias heater off
	12:39:44	760	823	Elevate to nadir (Earth)
End modified solar calibration sequence				
07/02/86	15:24:15			Yaw maneuver to X-axis positive
Begin azimuth angle load commands for solar calibration				
07/09/86	01:09:36	70	419	Address azimuth position A
	01:10:08	70	2xx	Data command, high byte
	01:13:20	73	1xx	Data command, low byte
End azimuth angle load commands (A = 67.28°).				
Begin preinternal calibration sequence				
07/09/86	09:06:56	547	821	Elevate to internal source (stow)
	09:07:28	547	862	WFOV BB heater on at temp. 1
	09:08:00	548	872	MFOV BB heater on at temp. 1
	10:44:00	644	823	Elevate to nadir (Earth)
End preinternal calibration sequence				



Table 7. Continued

(a) Continued

Date	Universal time		Hex command	Event description
	hr:min:sec	Minutes of day		
Begin internal calibration sequence				
07/09/86	10:44:32	645	8A1	Begin internal calibration
	10:45:04	645	881	Detector bias heater off
	10:45:36	646	852	Solar port heaters off
	10:46:08	646	821	Elevate to internal source (stow)
	10:46:40	647	851	Solar port heaters on
	10:48:48	649	882	Detector bias heater on at level 1
	10:50:56	651	892	SWICS on at level 3
	10:54:08	654	881	Detector bias heater off
	10:57:52	658	862	WFOV BB heater on at temp. 1
	10:58:24	658	872	MFOV BB heater on at temp. 1
	10:59:28	659	891	SWICS off
	11:12:48	673	883	Detector bias heater on at level 2
	11:14:56	675	893	SWICS on at level 2
	11:18:08	678	881	Detector bias heater off
	11:21:52	682	863	WFOV BB heater on at temp. 2
	11:22:24	682	873	MFOV BB heater on at temp. 2
	11:23:28	683	891	SWICS off
	11:36:48	697	884	Detector bias heater on at level 3
	11:38:56	699	894	SWICS on at level 1
	11:41:04	701	881	Detector bias heater off
11:43:44	704	852	Solar port heaters off	
11:44:48	705	861	WFOV BB heater off	
11:45:20	705	871	MFOV BB heater off	
11:45:52	706	851	Solar port heaters on	
11:46:24	706	891	SWICS off	
End internal calibration sequence				
07/09/86	11:53:52	714	823	Elevate to nadir (Earth)
Begin modified solar calibration sequence				
07/09/86	12:00:48	721	822	Elevate to solar ports (Sun)
	12:01:20	721	814	Azimuth to position A
	12:01:52	722	883	Detector bias heater on at level 2
	12:12:00	732	831	SMA shutter cycle on
	12:53:04	773	832	SMA shutter cycle off
	12:54:08	774	811	Azimuth to 0°
	12:54:40	775	881	Detector bias heater off
13:04:16	784	823	Elevate to nadir (Earth)	
End modified solar calibration sequence.				
Begin azimuth angle load commands for solar calibration				
07/23/86	00:31:12	31	419	Address azimuth position A
	00:31:44	32	2xx	Data command, high byte
	00:32:16	32	1xx	Data command, low byte
End azimuth angle load commands (A = 58.88°)				

Table 7. Continued

(a) Continued

Date	Universal time		Hex command	Event description
	hr:min:sec	Minutes of day		
Begin preinternal calibration sequence				
07/23/86	10:22:08	622	821	Elevate to internal source (stow)
	10:22:40	623	862	WFOV BB heater on at temp. 1
	10:23:12	623	872	MFOV BB heater on at temp. 1
	11:59:12	719	823	Elevate to nadir (Earth)
End preinternal calibration sequence.				
Begin internal calibration sequence				
07/23/86	11:59:44	720	8A1	Begin internal calibration
	12:00:16	720	881	Detector bias heater off
	12:00:48	721	852	Solar port heaters off
	12:01:20	721	821	Elevate to internal source (stow)
	12:01:52	722	851	Solar port heaters on
	12:04:00	724	882	Detector bias heater on at level 1
	12:06:08	726	892	SWICS on at level 3
	12:09:20	729	881	Detector bias heater off
	12:13:04	733	862	WFOV BB heater on at temp. 1
	12:13:36	734	872	MFOV BB heater on at temp. 1
	12:14:40	735	891	SWICS off
	12:28:00	748	883	Detector bias heater on at level 2
	12:30:08	750	893	SWICS on at level 2
	12:33:20	753	881	Detector bias heater off
	12:37:04	757	863	WFOV BB heater on at temp. 2
	12:37:36	758	873	MFOV BB heater on at temp. 2
	12:38:40	759	891	SWICS off
	12:52:00	772	884	Detector bias heater on at level 3
	12:54:08	774	894	SWICS on at level 1
	12:56:16	776	881	Detector bias heater off
12:58:56	779	852	Solar port heaters off	
13:00:00	780	861	WFOV BB heater off	
13:00:32	781	871	MFOV BB heater off	
13:01:04	781	851	Solar port heaters on	
13:01:36	782	891	SWICS off	
End internal calibration sequence				
07/23/86	13:09:04	789	823	Elevate to nadir (Earth)
Begin modified solar calibration sequence				
07/23/86	13:16:00	796	822	Elevate to solar ports (Sun)
	13:16:32	797	814	Azimuth to position A
	13:17:04	797	883	Detector bias heater on at level 2
	13:27:12	807	831	SMA shutter cycle on
	14:08:16	848	832	SMA shutter cycle off
	14:09:20	849	811	Azimuth to 0°
	14:09:52	850	881	Detector bias heater off
14:19:28	859	823	Elevate to nadir (Earth)	
End modified solar calibration sequence				

Table 7. Continued

(a) Continued

Date	Universal time		Hex command	Event description
	hr:min:sec	Minutes of day		
08/01/86	14:55:11			Yaw maneuver to X-axis negative
Begin azimuth angle load commands for solar calibration				
08/06/86	01:29:20	89	419	Address azimuth position A
	01:29:52	90	2xx	Data command, high byte
	01:30:56	91	1xx	Data command, low byte
End azimuth angle load commands ( $A = 74.63^\circ$ ).				
Begin preinternal calibration sequence				
08/06/86	08:16:16	496	821	Elevate to internal source (stow)
	08:16:48	497	862	WFOV BB heater on at temp. 1
	08:17:52	498	872	MFOV BB heater on at temp. 1
	09:53:20	593	823	Elevate to nadir (Earth)
End preinternal calibration sequence.				
Begin internal calibration sequence				
08/06/86	09:54:24	594	8A1	Begin internal calibration
	09:54:56	595	881	Detector bias heater off
	09:55:28	595	852	Solar port heaters off
	09:56:00	596	821	Elevate to internal source (stow)
	09:56:32	597	851	Solar port heaters on
	09:58:40	599	882	Detector bias heater on at level 1
	10:00:48	601	892	SWICS on at level 3
	10:04:00	604	881	Detector bias heater off
	10:07:44	608	862	WFOV BB heater on at temp. 1
	10:08:16	608	872	MFOV BB heater on at temp. 1
	10:09:20	609	891	SWICS off
	10:22:40	623	883	Detector bias heater on at level 2
	10:24:48	625	893	SWICS on at level 2
	10:28:00	628	881	Detector bias heater off
	10:31:44	632	863	WFOV BB heater on at temp. 2
	10:32:16	632	873	MFOV BB heater on at temp. 2
	10:33:20	633	891	SWICS off
	10:46:40	647	884	Detector bias heater on at level 3
	10:48:48	649	894	SWICS on at level 1
	10:50:56	651	881	Detector bias heater off
10:53:36	654	852	Solar port heaters off	
10:54:40	655	861	WFOV BB heater off	
10:55:12	655	871	MFOV BB heater off	
10:55:44	656	851	Solar port heaters on	
10:56:16	656	891	SWICS off	
End internal calibration sequence				
08/06/86	11:03:12	663	823	Elevate to nadir (Earth)
Begin modified solar calibration sequence				
08/06/86	11:10:40	671	822	Elevate to solar ports (Sun)
	11:11:12	671	814	Azimuth to position A
	11:11:44	672	883	Detector bias heater on at level 2

Table 7. Continued

(a) Continued

Date	Universal time		Hex command	Event description
	hr:min:sec	Minutes of day		
08/06/86	11:21:52	682	831	SMA shutter cycle on
	12:02:56	723	832	SMA shutter cycle off
	12:04:00	724	811	Azimuth to 0°
	12:04:32	725	881	Detector bias heater off
	12:14:08	734	823	Elevate to nadir (Earth)
End modified solar calibration sequence.				
Begin azimuth angle load commands for solar calibration				
08/17/86	00:55:44	56	419	Address azimuth position A
	00:56:16	56	2xx	Data command, high byte
	00:56:48	57	1xx	Data command, low byte
End azimuth angle load commands (A = 30.6°).				
Begin preinternal calibration sequence				
08/17/86	09:29:20	569	821	Elevate to internal source (stow)
	09:29:52	570	862	WFOV BB heater on at temp. 1
	09:30:24	570	872	MFOV BB heater on at temp. 1
	11:05:52	666	823	Elevate to nadir (Earth)
End preinternal calibration sequence.				
Begin internal calibration sequence				
08/17/86	11:06:56	667	8A1	Begin internal calibration
	11:07:28	667	881	Detector bias heater off
	11:08:00	668	852	Solar port heaters off
	11:08:32	669	821	Elevate to internal source (stow)
	11:09:04	669	851	Solar port heaters on
	11:11:12	671	882	Detector bias heater on at level 1
	11:13:20	673	892	SWICS on at level 3
	11:16:32	677	881	Detector bias heater off
	11:20:16	680	862	WFOV BB heater on at temp. 1
	11:20:48	681	872	MFOV BB heater on at temp. 1
	11:21:52	682	891	SWICS off
	11:35:12	695	883	Detector bias heater on at level 2
	11:37:20	697	893	SWICS on at level 2
	11:40:32	701	881	Detector bias heater off
	11:44:16	704	863	WFOV BB heater on at temp. 2
	11:44:48	705	873	MFOV BB heater on at temp. 2
	11:45:52	706	891	SWICS off
	11:59:12	719	884	Detector bias heater on at level 3
	12:01:20	721	894	SWICS on at level 1
	12:03:28	723	881	Detector bias heater off
	12:06:08	726	852	Solar port heaters off
	12:07:12	727	861	WFOV BB heater off
	12:07:44	728	871	MFOV BB heater off
	12:08:16	728	851	Solar port heaters on
12:08:48	729	891	SWICS off	
End internal calibration sequence				

Table 7. Continued

(a) Continued

Date	Universal time		Hex command	Event description
	hr:min:sec	Minutes of day		
08/17/86	12:16:16	736	823	Elevate to nadir (Earth)
Begin modified solar calibration sequence				
08/17/86	12:23:12	743	822	Elevate to solar ports (Sun)
	12:23:44	744	814	Azimuth to position A
	12:24:16	744	883	Detector bias heater on at level 2
	12:34:24	754	831	SMA shutter cycle on
	13:15:28	795	832	SMA shutter cycle off
	13:16:32	797	811	Azimuth to 0°
	13:17:04	797	881	Detector bias heater off
	13:26:40	807	823	Elevate to nadir (Earth)
End modified solar calibration sequence.				
Begin azimuth angle load commands for solar calibration				
08/28/86	01:45:20	105	419	Address azimuth position A
	01:45:52	106	2xx	Data command, high byte
	01:48:00	108	1xx	Data command, low byte
End azimuth angle load commands (A = 30.83°).				
Begin preinternal calibration sequence				
08/28/86	10:21:36	622	821	Elevate to internal source (stow)
	10:22:08	622	862	WFOV BB heater on at temp. 1
	10:22:40	623	872	MFOV BB heater on at temp. 1
	11:58:40	719	823	Elevate to nadir (Earth)
End preinternal calibration sequence.				
Begin internal calibration sequence				
08/28/86	11:59:44	720	8A1	Begin internal calibration
	12:00:16	720	881	Detector bias heater off
	12:00:48	721	852	Solar port heaters off
	12:01:20	721	821	Elevate to internal source (stow)
	12:01:52	722	851	Solar port heaters on
	12:04:00	724	882	Detector bias heater on at level 1
	12:06:08	726	892	SWICS on at level 3
	12:09:20	729	881	Detector bias heater off
	12:13:04	733	862	WFOV BB heater on at temp. 1
	12:13:36	734	872	MFOV BB heater on at temp. 1
	12:14:40	735	891	SWICS off
	12:28:00	748	883	Detector bias heater on at level 2
	12:30:08	750	893	SWICS on at level 2
	12:33:20	753	881	Detector bias heater off
	12:37:04	757	863	WFOV BB heater on at temp. 2
	12:37:36	758	873	MFOV BB heater on at temp. 2
	12:38:40	759	891	SWICS off
	12:52:00	772	884	Detector bias heater on at level 3
	12:54:08	774	894	SWICS on at level 1
	12:56:16	776	881	Detector bias heater off
12:58:56	779	852	Solar port heaters off	

Table 7. Continued

(a) Continued

Date	Universal time		Hex command	Event description
	hr:min:sec	Minutes of day		
08/28/86	13:00:00	780	861	WFOV BB heater off
	13:00:32	781	871	MFOV BB heater off
	13:01:04	781	851	Solar port heaters on
	13:01:36	782	891	SWICS off
End internal calibration sequence				
08/28/86	13:08:32	789	823	Elevate to nadir (Earth)
Begin modified solar calibration sequence				
08/28/86	13:16:00	796	822	Elevate to solar ports (Sun)
	13:16:32	797	814	Azimuth to position A
	13:17:04	797	883	Detector bias heater on at level 2
	13:27:12	807	831	SMA shutter cycle on
	14:07:44	848	832	SMA shutter cycle off
	14:08:48	849	811	Azimuth to 0°
	14:09:20	849	881	Detector bias heater off
	14:18:56	859	823	Elevate to nadir (Earth)
End modified solar calibration sequence.				
Begin azimuth angle load commands for solar calibration				
09/03/86	01:23:28	83	419	Address azimuth position A
	01:24:00	84	2xx	Data command, high byte
	01:25:04	85	1xx	Data command, low byte
End azimuth angle load commands (A = 55.28°).				
Begin preinternal calibration sequence				
09/03/86	09:59:12	599	821	Elevate to internal source (stow)
	09:59:44	600	862	WFOV BB heater on at temp. 1
	10:00:16	600	872	MFOV BB heater on at temp. 1
	11:35:44	696	823	Elevate to nadir (Earth)
End preinternal calibration sequence.				
Begin internal calibration sequence				
09/03/86	11:36:48	697	8A1	Begin internal calibration
	11:37:20	697	881	Detector bias heater off
	11:37:52	698	852	Solar port heaters off
	11:38:24	698	821	Elevate to internal source (stow)
	11:38:56	699	851	Solar port heaters on
	11:41:04	701	882	Detector bias heater on at level 1
	11:43:12	703	892	SWICS on at level 3
	11:46:24	706	881	Detector bias heater off
	11:50:08	710	862	WFOV BB heater on at temp. 1
	11:50:40	711	872	MFOV BB heater on at temp. 1
	11:51:44	712	891	SWICS off
	12:05:04	725	883	Detector bias heater on at level 2
	12:07:12	727	893	SWICS on at level 2
	12:10:24	730	881	Detector bias heater off
	12:14:08	734	863	WFOV BB heater on at temp. 2
	12:14:40	735	873	MFOV BB heater on at temp. 2

Table 7. Continued

(a) Continued

Date	Universal time		Hex command	Event description
	hr:min:sec	Minutes of day		
09/03/86	12:15:44	736	891	SWICS off
	12:29:04	749	884	Detector bias heater on at level 3
	12:31:12	751	894	SWICS on at level 1
	12:33:20	753	881	Detector bias heater off
	12:36:00	756	852	Solar port heaters off
	12:37:04	757	861	WFOV BB heater off
	12:37:36	758	871	MFOV BB heater off
	12:38:08	758	851	Solar port heaters on
	12:38:40	759	891	SWICS off
End internal calibration sequence				
09/03/86	12:46:08	766	823	Elevate to nadir (Earth)
Begin modified solar calibration sequence				
09/03/86	12:53:04	773	822	Elevate to solar ports (Sun)
	12:53:36	774	814	Azimuth to position A
	12:54:08	774	883	Detector bias heater on at level 2
	13:04:16	784	831	SMA shutter cycle on
	13:45:20	825	832	SMA shutter cycle off
	13:46:24	826	811	Azimuth to 0°
	13:46:56	827	881	Detector bias heater off
	13:56:32	837	823	Elevate to nadir (Earth)
End modified solar calibration sequence				
09/11/86	13:31:11			Yaw maneuver to X-axis positive
Begin azimuth angle load commands for solar calibration				
09/17/86	00:57:20	57	419	Address azimuth position A
	00:57:52	58	2xx	Data command, high byte
	00:58:24	58	1xx	Data command, low byte
End azimuth angle load commands (A = 64.43°).				
Begin preinternal calibration sequence				
09/17/86	08:46:08	526	821	Elevate to internal source (stow)
	08:46:40	527	862	WFOV BB heater on at temp. 1
	08:47:12	527	872	MFOV BB heater on at temp. 1
	10:23:12	623	823	Elevate to nadir (Earth)
End preinternal calibration sequence.				
Begin internal calibration sequence				
09/17/86	10:24:16	624	8A1	Begin internal calibration
	10:24:48	625	881	Detector bias heater off
	10:25:20	625	852	Solar port heaters off
	10:25:52	626	821	Elevate to internal source (stow)
	10:26:24	626	851	Solar port heaters on
	10:28:32	629	882	Detector bias heater on at level 1
	10:30:40	631	892	SWICS on at level 3
	10:33:52	634	881	Detector bias heater off
	10:37:36	638	862	WFOV BB heater on at temp. 1
	10:38:08	638	872	MFOV BB heater on at temp. 1

Table 7. Continued

(a) Continued

Date	Universal time		Hex command	Event description
	hr:min:sec	Minutes of day		
09/17/86	10:39:12	639	891	SWICS off
	10:52:32	653	883	Detector bias heater on at level 2
	10:54:40	655	893	SWICS on at level 2
	10:57:52	658	881	Detector bias heater off
	11:01:36	662	863	WFOV BB heater on at temp. 2
	11:02:08	662	873	MFOV BB heater on at temp. 2
	11:03:12	663	891	SWICS off
	11:16:32	677	884	Detector bias heater on at level 3
	11:18:40	679	894	SWICS on at level 1
	11:20:48	681	881	Detector bias heater off
	11:23:28	683	852	Solar port heaters off
	11:24:32	685	861	WFOV BB heater off
	11:25:04	685	871	MFOV BB heater off
	11:25:36	686	851	Solar port heaters on
11:26:08	686	891	SWICS off	
End internal calibration sequence				
09/17/86	11:33:04	693	823	Elevate to nadir (Earth)
Begin modified solar calibration sequence				
09/17/86	11:40:32	701	822	Elevate to solar ports (Sun)
	11:41:04	701	814	Azimuth to position A
	11:41:36	702	883	Detector bias heater on at level 2
	11:51:44	712	831	SMA shutter cycle on
	12:32:16	752	832	SMA shutter cycle off
	12:33:20	753	811	Azimuth to 0°
	12:33:52	754	881	Detector bias heater off
	12:43:28	763	823	Elevate to nadir (Earth)
End modified solar calibration sequence.				
Begin azimuth angle load commands for solar calibration				
10/01/86	02:14:40	135	419	Address azimuth position A
	02:15:12	135	2xx	Data command, high byte
	02:16:16	136	1xx	Data command, low byte
End azimuth angle load commands (A = 29.03°).				
Begin preinternal calibration sequence				
10/01/86	08:31:12	511	821	Elevate to internal source (stow)
	08:31:44	512	862	WFOV BB heater on at temp. 1
	08:32:16	512	872	MFOV BB heater on at temp. 1
	10:08:16	608	823	Elevate to nadir (Earth)
End preinternal calibration sequence.				
Begin internal calibration sequence				
10/01/86	10:09:20	609	8A1	Begin internal calibration
	10:09:52	610	881	Detector bias heater off
	10:10:24	610	852	Solar port heaters off
	10:10:56	611	821	Elevate to internal source (stow)
	10:11:28	611	851	Solar port heaters on



Table 7. Continued

(a) Continued

Date	Universal time		Hex command	Event description
	hr:min:sec	Minutes of day		
10/01/86	10:13:36	614	882	Detector bias heater on at level 1
	10:15:44	616	892	SWICS on at level 3
	10:18:56	619	881	Detector bias heater off
	10:22:40	623	862	WFOV BB heater on at temp. 1
	10:23:12	623	872	MFOV BB heater on at temp. 1
	10:24:16	624	891	SWICS off
	10:37:36	638	883	Detector bias heater on at level 2
	10:39:44	640	893	SWICS on at level 2
	10:42:56	643	881	Detector bias heater off
	10:46:40	647	863	WFOV BB heater on at temp. 2
	10:47:12	647	873	MFOV BB heater on at temp. 2
	10:48:16	648	891	SWICS off
	11:01:36	662	884	Detector bias heater on at level 3
	11:03:44	664	894	SWICS on at level 1
	11:05:52	666	881	Detector bias heater off
	11:08:32	669	852	Solar port heaters off
	11:09:36	670	861	WFOV BB heater off
	11:10:08	670	871	MFOV BB heater off
	11:10:40	671	851	Solar port heaters on
11:11:12	671	891	SWICS off	
End internal calibration sequence				
10/01/86	11:18:08	678	823	Elevate to nadir (Earth)
Begin modified solar calibration sequence				
10/01/86	11:25:36	686	822	Elevate to solar ports (Sun)
	11:26:08	686	814	Azimuth to position A
	11:26:40	687	883	Detector bias heater on at level 2
	11:36:48	697	831	SMA shutter cycle on
	12:17:52	738	832	SMA shutter cycle off
	12:18:56	739	811	Azimuth to $0^\circ$
	12:19:28	739	881	Detector bias heater off
	12:29:04	749	823	Elevate to nadir (Earth)
End modified solar calibration sequence.				
Begin azimuth angle load commands for solar calibration				
10/15/86	02:55:12	175	419	Address azimuth position A
	02:55:44	176	2xx	Data command, high byte
	02:56:16	176	1xx	Data command, low byte
End azimuth angle load commands ( $A = 75.3^\circ$ ).				
Begin preinternal calibration sequence				
10/15/86	09:42:40	583	821	Elevate to internal source (stow)
	09:43:44	584	862	WFOV BB heater on at temp. 1
	09:44:16	584	872	MFOV BB heater on at temp. 1
	11:19:44	680	823	Elevate to nadir (Earth)
End preinternal calibration sequence				

Table 7. Continued

(a) Continued

Date	Universal time		Hex command	Event description
	hr:min:sec	Minutes of day		
Begin internal calibration sequence				
10/15/86	11:20:48	681	8A1	Begin internal calibration
	11:21:20	681	881	Detector bias heater off
	11:21:52	682	852	Solar port heaters off
	11:22:24	682	821	Elevate to internal source (stow)
	11:22:56	683	851	Solar port heaters on
	11:25:04	685	882	Detector bias heater on at level 1
	11:27:12	687	892	SWICS on at level 3
	11:30:24	690	881	Detector bias heater off
	11:34:08	694	862	WFOV BB heater on at temp. 1
	11:34:40	695	872	MFOV BB heater on at temp. 1
	11:35:44	696	891	SWICS off
	11:49:04	709	883	Detector bias heater on at level 2
	11:51:12	711	893	SWICS on at level 2
	11:54:24	714	881	Detector bias heater off
	11:58:08	718	863	WFOV BB heater on at temp. 2
	11:58:40	719	873	MFOV BB heater on at temp. 2
	11:59:44	720	891	SWICS off
	12:13:04	733	884	Detector bias heater on at level 3
	12:15:12	735	894	SWICS on at level 1
	12:17:20	737	881	Detector bias heater off
12:20:00	740	852	Solar port heaters off	
12:21:04	741	861	WFOV BB heater off	
12:21:36	742	871	MFOV BB heater off	
12:22:08	742	851	Solar port heaters on	
12:22:40	743	891	SWICS off	
End internal calibration sequence				
10/15/86	12:30:08	750	823	Elevate to nadir (Earth)
Begin modified solar calibration sequence				
10/15/86	12:37:04	757	822	Elevate to solar ports (Sun)
	12:37:36	758	814	Azimuth to position A
	12:38:08	758	883	Detector bias heater on at level 2
	12:48:16	768	831	SMA shutter cycle on
	13:29:20	809	832	SMA shutter cycle off
	13:30:24	810	811	Azimuth to 0°
	13:30:56	811	881	Detector bias heater off
	13:40:32	821	823	Elevate to nadir (Earth)
End modified solar calibration sequence				
10/17/86	14:28:15			Yaw maneuver to X-axis negative
Begin azimuth angle load commands for solar calibration				
10/29/86	01:21:52	82	419	Address azimuth position A
	01:22:24	82	2xx	Data command, high byte
	01:22:56	83	1xx	Data command, low byte
End azimuth angle load commands (A = 55.43°)				

Table 7. Continued

(a) Continued

Date	Universal time		Hex command	Event description
	hr:min:sec	Minutes of day		
Begin preinternal calibration sequence				
10/29/86	08:18:56	499	821	Elevate to internal source (stow)
	08:19:28	499	862	WFOV BB heater on at temp. 1
	08:20:32	501	872	MFOV BB heater on at temp. 1
	09:56:00	596	823	Elevate to nadir (Earth)
End preinternal calibration sequence.				
Begin internal calibration sequence				
10/29/86	09:57:04	597	8A1	Begin internal calibration
	09:57:36	598	881	Detector bias heater off
	09:58:08	598	852	Solar port heaters off
	09:58:40	599	821	Elevate to internal source (stow)
	09:59:12	599	851	Solar port heaters on
	10:01:20	601	882	Detector bias heater on at level 1
	10:03:28	603	892	SWICS on at level 3
	10:06:40	607	881	Detector bias heater off
	10:10:24	610	862	WFOV BB heater on at temp. 1
	10:10:56	611	872	MFOV BB heater on at temp. 1
	10:12:00	612	891	SWICS off
	10:25:20	625	883	Detector bias heater on at level 2
	10:27:28	627	893	SWICS on at level 2
	10:30:40	631	881	Detector bias heater off
	10:34:24	634	863	WFOV BB heater on at temp. 2
	10:34:56	635	873	MFOV BB heater on at temp. 2
	10:36:00	636	891	SWICS off
	10:49:20	649	884	Detector bias heater on at level 3
	10:51:28	651	894	SWICS on at level 1
	10:53:36	654	881	Detector bias heater off
	10:56:16	656	852	Solar port heaters off
	10:57:20	657	861	WFOV BB heater off
	10:57:52	658	871	MFOV BB heater off
10:58:24	658	851	Solar port heaters on	
10:58:56	659	891	SWICS off	
End internal calibration sequence				
10/29/86	11:05:52	666	823	Elevate to nadir (Earth)
Begin modified solar calibration sequence				
10/29/86	11:13:20	673	822	Elevate to solar ports (Sun)
	11:13:52	674	814	Azimuth to position A
	11:14:24	674	883	Detector bias heater on at level 2
	11:24:32	685	831	SMA shutter cycle on
	12:05:36	726	832	SMA shutter cycle off
	12:06:40	727	811	Azimuth to 0°
	12:07:12	727	881	Detector bias heater off
	12:16:48	737	823	Elevate to nadir (Earth)
End modified solar calibration sequence				

Table 7. Continued

(a) Continued

Date	Universal time		Hex command	Event description
	hr:min:sec	Minutes of day		
Begin azimuth angle load commands for solar calibration				
11/12/86	01:05:52	66	419	Address azimuth position A
	01:06:24	66	2xx	Data command, high byte
	01:07:28	67	1xx	Data command, low byte
End azimuth angle load commands (A = 60.68°).				
Begin preinternal calibration sequence				
11/12/86	09:38:56	579	821	Elevate to internal source (stow)
	09:39:28	579	862	WFOV BB heater on at temp. 1
	09:40:00	580	872	MFOV BB heater on at temp. 1
	11:16:00	676	823	Elevate to nadir (Earth)
End preinternal calibration sequence.				
Begin internal calibration sequence				
11/12/86	11:17:04	677	8A1	Begin internal calibration
	11:17:36	678	881	Detector bias heater off
	11:18:08	678	852	Solar port heaters off
	11:18:40	679	821	Elevate to internal source (stow)
	11:19:12	679	851	Solar port heaters on
	11:21:20	681	882	Detector bias heater on at level 1
	11:23:28	683	892	SWICS on at level 3
	11:26:40	687	881	Detector bias heater off
	11:30:24	690	862	WFOV BB heater on at temp. 1
	11:30:56	691	872	MFOV BB heater on at temp. 1
	11:32:00	692	891	SWICS off
	11:45:20	705	883	Detector bias heater on at level 2
	11:47:28	707	893	SWICS on at level 2
	11:50:40	711	881	Detector bias heater off
	11:54:24	714	863	WFOV BB heater on at temp. 2
	11:54:56	715	873	MFOV BB heater on at temp. 2
	11:56:00	716	891	SWICS off
	12:09:20	729	884	Detector bias heater on at level 3
	12:11:28	731	894	SWICS on at level 1
	12:13:36	734	881	Detector bias heater off
	12:16:16	736	852	Solar port heaters off
	12:17:20	737	861	WFOV BB heater off
	12:17:52	738	871	MFOV BB heater off
	12:18:24	738	851	Solar port heaters on
12:18:56	739	891	SWICS off	
End internal calibration sequence				
11/12/86	12:25:52	746	823	Elevate to nadir (Earth)
Begin modified solar calibration sequence				
11/12/86	12:30:08	750	822	Elevate to solar ports (Sun)
	12:30:40	751	814	Azimuth to position A
	12:31:12	751	883	Detector bias heater on at level 2
	12:41:20	761	831	SMA shutter cycle on

Table 7. Continued

(a) Continued

Date	Universal time		Hex command	Event description	
	hr:min:sec	Minutes of day			
11/12/86	13:22:24	802	832	SMA shutter cycle off	
	13:23:28	803	811	Azimuth to 0°	
	13:24:00	804	881	Detector bias heater off	
	13:33:36	814	823	Elevate to nadir (Earth)	
End modified solar calibration sequence					
11/20/86	14:56:15			Yaw maneuver to X-axis positive	
Begin azimuth angle load commands for solar calibration					
11/26/86	03:55:28	235	419	Address azimuth position A	
	03:56:00	236	2xx	Data command, high byte	
	03:57:04	237	1xx	Data command, low byte	
End azimuth angle load commands (A = 65.03°).					
Begin preinternal calibration sequence					
11/26/86	10:00:48	601	821	Elevate to internal source (stow)	
	10:01:20	601	862	WFOV BB heater on at temp. 1	
	10:01:52	602	872	MFOV BB heater on at temp. 1	
	11:37:52	698	823	Elevate to nadir (Earth)	
End preinternal calibration sequence.					
Begin internal calibration sequence					
11/26/86	11:38:56	699	8A1	Begin internal calibration	
	11:39:28	699	881	Detector bias heater off	
	11:40:00	700	852	Solar port heaters off	
	11:40:32	701	821	Elevate to internal source (stow)	
	11:41:04	701	851	Solar port heaters on	
	11:43:12	703	882	Detector bias heater on at level 1	
	11:45:20	705	892	SWICS on at level 3	
	11:48:32	709	881	Detector bias heater off	
	11:52:16	712	862	WFOV BB heater on at temp. 1	
	11:52:48	713	872	MFOV BB heater on at temp. 1	
	11:53:52	714	891	SWICS off	
	12:07:12	727	883	Detector bias heater on at level 2	
	12:09:20	729	893	SWICS on at level 2	
	12:12:32	733	881	Detector bias heater off	
	12:16:16	736	863	WFOV BB heater on at temp. 2	
	12:16:48	737	873	MFOV BB heater on at temp. 2	
	12:17:52	738	891	SWICS off	
	12:31:12	751	884	Detector bias heater on at level 3	
	12:33:20	753	894	SWICS on at level 1	
	12:35:28	755	881	Detector bias heater off	
	12:38:08	758	852	Solar port heaters off	
	12:39:12	759	861	WFOV BB heater off	
	12:39:44	760	871	MFOV BB heater off	
	12:40:16	760	851	Solar port heaters on	
	12:40:48	761	891	SWICS off	
	End internal calibration sequence				

Table 7. Continued

(a) Continued

Date	Universal time		Hex command	Event description
	hr:min:sec	Minutes of day		
11/26/86	12:47:44	768	823	Elevate to nadir (Earth)
Begin modified solar calibration sequence				
11/26/86	12:55:12	775	822	Elevate to solar ports (Sun)
	12:55:44	776	814	Azimuth to position A
	12:56:16	776	883	Detector bias heater on at level 2
	13:06:24	786	831	SMA shutter cycle on
	13:47:28	827	832	SMA shutter cycle off
	13:48:32	829	811	Azimuth to 0°
	13:49:04	829	881	Detector bias heater off
	13:58:40	839	823	Elevate to nadir (Earth)
End modified solar calibration sequence.				
Begin azimuth angle load commands for solar calibration				
12/04/86	00:31:12	31	419	Address azimuth position A
	00:31:44	32	2xx	Data command, high byte
	00:32:48	33	1xx	Data command, low byte
End azimuth angle load commands (A = 30.53°).				
Begin preinternal calibration sequence				
12/04/86	03:32:00	212	821	Elevate to internal source (stow)
	03:32:32	213	862	WFOV BB heater on at temp. 1
	03:33:36	214	872	MFOV BB heater on at temp. 1
	05:09:04	309	823	Elevate to nadir (Earth)
End preinternal calibration sequence.				
Begin internal calibration sequence				
12/04/86	05:10:08	310	8A1	Begin internal calibration
	05:10:40	311	881	Detector bias heater off
	05:11:12	311	852	Solar port heaters off
	05:11:44	312	821	Elevate to internal source (stow)
	05:12:16	312	851	Solar port heaters on
	05:14:24	314	882	Detector bias heater on at level 1
	05:16:32	317	892	SWICS on at level 3
	05:19:44	320	881	Detector bias heater off
	05:23:28	323	862	WFOV BB heater on at temp. 1
	05:24:00	324	872	MFOV BB heater on at temp. 1
	05:25:04	325	891	SWICS off
	05:38:24	338	883	Detector bias heater on at level 2
	05:40:32	341	893	SWICS on at level 2
	05:43:44	344	881	Detector bias heater off
	05:47:28	347	863	WFOV BB heater on at temp. 2
	05:48:00	348	873	MFOV BB heater on at temp. 2
	05:49:04	349	891	SWICS off
	06:02:24	362	884	Detector bias heater on at level 3
	06:04:32	365	894	SWICS on at level 1
	06:06:40	367	881	Detector bias heater off

Table 7. Continued

(a) Continued

Date	Universal time		Hex command	Event description
	hr:min:sec	Minutes of day		
12/04/86	06:09:20	369	852	Solar port heaters off
	06:10:24	370	861	WFOV BB heater off
	06:10:56	371	871	MFOV BB heater off
	06:11:28	371	851	Solar port heaters on
	06:12:00	372	891	SWICS off
End internal calibration sequence				
12/04/86	06:18:56	379	823	Elevate to nadir (Earth)
Begin modified solar calibration sequence				
12/04/86	06:26:24	386	822	Elevate to solar ports (Sun)
	06:26:56	387	814	Azimuth to position A
	06:27:28	387	883	Detector bias heater on at level 2
	06:37:36	398	831	SMA shutter cycle on
	07:18:40	439	832	SMA shutter cycle off
	07:19:44	440	811	Azimuth to 0°
	07:20:16	440	881	Detector bias heater off
07:29:52	450	823	Elevate to nadir (Earth)	
End modified solar calibration sequence.				
Begin azimuth angle load commands for solar calibration				
12/18/86	00:06:08	6	419	Address azimuth position A
	00:06:40	7	2xx	Data command, high byte
	00:08:16	8	1xx	Data command, low byte
End azimuth angle load commands (A = 31.8°).				
12/18/86	08:24:16	504	821	Elevate to internal source (stow)
	08:24:48	505	862	WFOV BB heater on at temp. 1
	08:25:20	505	872	MFOV BB heater on at temp. 1
	10:01:20	601	823	Elevate to nadir (Earth)
Begin internal calibration sequence.				
Begin preinternal calibration sequence				
12/18/86	10:02:24	602	8A1	Begin internal calibration
	10:02:56	603	881	Detector bias heater off
	10:03:28	603	852	Solar port heaters off
	10:04:00	604	821	Elevate to internal source (stow)
End preinternal calibration sequence				
12/18/86	10:04:32	605	851	Solar port heaters on
	10:06:40	607	882	Detector bias heater on at level 1
	10:08:48	609	892	SWICS on at level 3
	10:12:00	612	881	Detector bias heater off
	10:15:44	616	862	WFOV BB heater on at temp. 1
	10:16:16	616	872	MFOV BB heater on at temp. 1
	10:17:20	617	891	SWICS off
	10:30:40	631	883	Detector bias heater on at level 2
	10:32:48	633	893	SWICS on at level 2
	10:36:00	636	881	Detector bias heater off
	10:39:44	640	863	WFOV BB heater on at temp. 2

Table 7. Continued

(a) Continued

Date	Universal time		Hex command	Event description
	hr:min:sec	Minutes of day		
12/18/86	10:40:16	640	873	MFOV BB heater on at temp. 2
	10:41:20	641	891	SWICS off
	10:54:40	655	884	Detector bias heater on at level 3
	10:56:48	657	894	SWICS on at level 1
	10:58:56	659	881	Detector bias heater off
	11:01:36	662	852	Solar port heaters off
	11:02:40	663	861	WFOV BB heater off
	11:03:12	663	871	MFOV BB heater off
	11:03:44	664	851	Solar port heaters on
11:04:16	664	891	SWICS off	
End internal calibration sequence				
12/18/86	11:11:12	671	823	Elevate to nadir (Earth)
Begin modified solar calibration sequence				
12/18/86	11:18:40	679	822	Elevate to solar ports (Sun)
	11:19:12	679	814	Azimuth to position A
	11:19:44	680	883	Detector bias heater on at level 2
	11:29:52	690	831	SMA shutter cycle on
	12:10:56	731	832	SMA shutter cycle off
	12:12:00	732	811	Azimuth to 0°
	12:12:32	733	881	Detector bias heater off
	12:22:08	742	823	Elevate to nadir (Earth)
End modified solar calibration sequence.				
Begin azimuth angle load commands for solar calibration				
12/24/86	01:33:36	94	419	Address azimuth position A
	01:34:08	94	2xx	Data command, high byte
	01:35:12	95	1xx	Data command, low byte
End azimuth angle load commands (A = 58.5°).				
Begin preinternal calibration sequence				
12/24/86	09:32:00	572	821	Elevate to internal source (stow)
	09:32:32	573	862	WFOV BB heater on at temp. 1
	09:33:04	573	872	MFOV BB heater on at temp. 1
	11:08:32	669	823	Elevate to nadir (Earth)
End preinternal calibration sequence.				
Begin internal calibration sequence				
12/24/86	11:09:36	670	8A1	Begin internal calibration
	11:10:08	670	881	Detector bias heater off
	11:10:40	671	852	Solar port heaters off
	11:11:12	671	821	Elevate to internal source (stow)
	11:11:44	672	851	Solar port heaters on
	11:13:52	674	882	Detector bias heater on at level 1
	11:16:00	676	892	SWICS on at level 3
	11:19:12	679	881	Detector bias heater off
	11:22:56	683	862	WFOV BB heater on at temp. 1



Table 7. Continued

(a) Continued

Date	Universal time		Hex command	Event description
	hr:min:sec	Minutes of day		
12/24/86	11:23:28	683	872	MFOV BB heater on at temp. 1
	11:24:32	685	891	SWICS off
	11:37:52	698	883	Detector bias heater on at level 2
	11:40:00	700	893	SWICS on at level 2
	11:43:12	703	881	Detector bias heater off
	11:46:56	707	863	WFOV BB heater on at temp. 2
	11:47:28	707	873	MFOV BB heater on at temp. 2
	11:48:32	709	891	SWICS off
	12:01:52	722	884	Detector bias heater on at level 3
	12:04:00	724	894	SWICS on at level 1
	12:06:08	726	881	Detector bias heater off
	12:08:48	729	852	Solar port heaters off
	12:09:52	730	861	WFOV BB heater off
	12:10:24	730	871	MFOV BB heater off
12:10:56	731	851	Solar port heaters on	
12:11:28	731	891	SWICS off	
End internal calibration sequence				
12/24/86	12:18:56	739	823	Elevate to nadir (Earth)
Begin modified solar calibration sequence				
12/24/86	12:25:52	746	822	Elevate to solar ports (Sun)
	12:26:24	746	814	Azimuth to position A
	12:26:56	747	883	Detector bias heater on at level 2
	12:37:04	757	831	SMA shutter cycle on
	13:18:08	798	832	SMA shutter cycle off
	13:19:12	799	811	Azimuth to 0°
	13:19:44	800	881	Detector bias heater off
	13:29:20	809	823	Elevate to nadir (Earth)
End modified solar calibration sequence				
12/31/86	15:15:11			Yaw maneuver to X-axis negative
Begin azimuth angle load commands for solar calibration				
01/07/87	01:11:12	71	419	Address azimuth position A
	01:11:44	72	2xx	Data command, high byte
	01:12:48	73	1xx	Data command, low byte
End azimuth angle load commands (A = 67.58°).				
Begin preinternal calibration sequence				
01/07/87	09:41:36	582	821	Elevate to internal source (stow)
	09:42:40	583	862	WFOV BB heater on at temp. 1
	09:43:12	583	872	MFOV BB heater on at temp. 1
	11:18:40	679	823	Elevate to nadir (Earth)
End preinternal calibration sequence.				
Begin internal calibration sequence				
01/07/87	11:19:44	680	8A1	Begin internal calibration
	11:20:16	680	881	Detector bias heater off
	11:20:48	681	852	Solar port heaters off

Table 7. Continued

(a) Continued

Date	Universal time		Hex command	Event description
	hr:min:sec	Minutes of day		
01/07/87	11:21:20	681	821	Elevate to internal source (stow)
	11:21:52	682	851	Solar port heaters on
	11:24:00	684	882	Detector bias heater on at level 1
	11:26:08	686	892	SWICS on at level 3
	11:29:20	689	881	Detector bias heater off
	11:33:04	693	862	WFOV BB heater on at temp. 1
	11:33:36	694	872	MFOV BB heater on at temp. 1
	11:34:40	695	891	SWICS off
	11:48:00	708	883	Detector bias heater on at level 2
	11:50:08	710	893	SWICS on at level 2
	11:53:20	713	881	Detector bias heater off
	11:57:04	717	863	WFOV BB heater on at temp. 2
	11:57:36	718	873	MFOV BB heater on at temp. 2
	11:58:40	719	891	SWICS off
	12:12:00	732	884	Detector bias heater on at level 3
	12:14:08	734	894	SWICS on at level 1
	12:16:16	736	881	Detector bias heater off
	12:18:56	739	852	Solar port heaters off
	12:20:00	740	861	WFOV BB heater off
	12:20:32	741	871	MFOV BB heater off
12:21:04	741	851	Solar port heaters on	
12:21:36	742	891	SWICS off	
End internal calibration sequence				
01/07/87	12:29:04	749	823	Elevate to nadir (Earth)
Begin modified solar calibration sequence				
01/07/87	12:36:00	756	822	Elevate to solar ports (Sun)
	12:36:32	757	814	Azimuth to position A
	12:37:04	757	883	Detector bias heater on at level 2
	12:47:12	767	831	SMA shutter cycle on
	13:28:16	808	832	SMA shutter cycle off
	13:29:20	809	811	Azimuth to 0°
	13:29:52	810	881	Detector bias heater off
13:39:28	819	823	Elevate to nadir (Earth)	
End modified solar calibration sequence.				
Begin azimuth angle load commands for solar calibration				
01/21/87	02:28:00	148	419	Address azimuth position A
	02:28:32	149	2xx	Data command, high byte
	02:29:36	150	1xx	Data command, low byte
End azimuth angle load commands (A = 58.88°).				
Begin preinternal calibration sequence				
01/21/87	09:19:44	560	821	Elevate to internal source (stow)
	09:20:16	560	862	WFOV BB heater on at temp. 1

Table 7. Continued

(a) Concluded

Date	Universal time		Hex command	Event description
	hr:min:sec	Minutes of day		
01/21/87	09:20:48	561	872	MFOV BB heater on at temp. 1
	10:56:48	657	823	Elevate to nadir (Earth)
End preinternal calibration sequence.				
Begin internal calibration sequence				
01/21/87	10:57:52	658	8A1	Begin internal calibration
	10:58:24	658	881	Detector bias heater off
	10:58:56	659	852	Solar port heaters off
	10:59:28	659	821	Elevate to internal source (stow)
	11:00:00	660	851	Solar port heaters on
	11:02:08	662	882	Detector bias heater on at level 1
	11:04:16	664	892	SWICS on at level 3
	11:07:28	667	881	Detector bias heater off
	11:11:12	671	862	WFOV BB heater on at temp. 1
	11:11:44	672	872	MFOV BB heater on at temp. 1
	11:12:48	673	891	SWICS off
	11:26:08	686	883	Detector bias heater on at level 2
	11:28:16	688	893	SWICS on at level 2
	11:31:28	691	881	Detector bias heater off
	11:35:12	695	863	WFOV BB heater on at temp. 2
	11:35:44	696	873	MFOV BB heater on at temp. 2
	11:36:48	697	891	SWICS off
	11:50:08	710	884	Detector bias heater on at level 3
	11:52:16	712	894	SWICS on at level 1
	11:54:24	714	881	Detector bias heater off
11:57:04	717	852	Solar port heaters off	
11:58:08	718	861	WFOV BB heater off	
11:58:40	719	871	MFOV BB heater off	
11:59:12	719	851	Solar port heaters on	
11:59:44	720	891	SWICS off	
End internal calibration sequence				
01/21/87	12:06:40	727	823	Elevate to nadir (Earth)
Begin modified solar calibration sequence				
01/21/87	12:13:36	734	822	Elevate to solar ports (Sun)
	12:14:08	734	814	Azimuth to position A
	12:14:40	735	883	Detector bias heater on at level 2
	12:24:48	745	831	SMA shutter cycle on
	13:05:52	786	832	SMA shutter cycle off
	13:06:56	787	811	Azimuth to 0°
	13:07:28	787	881	Detector bias heater off
13:17:04	797	823	Elevate to nadir (Earth)	
End modified solar calibration sequence				
01/30/87	14:45:19			Yaw maneuver to X-axis positive

Table 7. Continued

## (b) Scanner commands

Date	Universal time		Hex command	Event description
	hr:min:sec	Minutes of day		
Begin internal calibration sequence				
02/05/86	11:41:04	701	8A1	Begin internal calibration
	11:41:36	702	897	SWICS on at level 1 modulated
	11:43:12	703	895	SWICS on at level 2 modulated
	11:44:48	705	893	SWICS on at level 3 modulated
	11:46:24	706	891	SWICS off
	11:49:36	710	897	SWICS on at level 1 modulated
	11:51:12	711	895	SWICS on at level 2 modulated
	11:52:48	713	893	SWICS on at level 3 modulated
	11:54:24	714	891	SWICS off
	12:13:36	734	897	SWICS on at level 1 modulated
	12:15:12	735	895	SWICS on at level 2 modulated
	12:16:48	737	893	SWICS on at level 3 modulated
	12:18:24	738	891	SWICS off
	End internal calibration sequence.			
Begin azimuth angle load commands for Sun avoidance angles				
02/14/86	16:24:48	985	419	Address azimuth position A
	16:25:20	985	2xx	Data command, high byte
	16:26:24	986	1xx	Data command, low byte
	16:27:28	987	41B	Address azimuth position B
	16:28:00	988	2xx	Data command, high byte
	16:29:04	989	1xx	Data command, low byte
End azimuth angle load commands (A = 179°, B = 145°).				
Begin internal calibration sequence				
02/15/86	10:28:32	629	8A1	Begin internal calibration
	10:29:04	629	897	SWICS on at level 1 modulated
	10:30:40	631	895	SWICS on at level 2 modulated
	10:32:16	632	893	SWICS on at level 3 modulated
	10:33:52	634	891	SWICS off
	10:37:04	637	897	SWICS on at level 1 modulated
	10:38:40	639	895	SWICS on at level 2 modulated
	10:40:16	640	893	SWICS on at level 3 modulated
	10:41:52	642	891	SWICS off
	11:01:04	661	897	SWICS on at level 1 modulated
	11:02:40	663	895	SWICS on at level 2 modulated
	11:04:16	664	893	SWICS on at level 3 modulated
	11:05:52	666	891	SWICS off
End internal calibration sequence.				
Begin Sun avoidance operation				
02/16/86	15:54:24	954	815	Azimuth to position B
02/25/86	21:05:52	1266	813	Azimuth to 180°
End Sun avoidance operation				

Table 7. Continued

(b) Continued

Date	Universal time		Hex command	Event description
	hr:min:sec	Minutes of day		
Begin internal calibration sequence				
02/26/86	11:16:00	676	8A1	Begin internal calibration
	11:16:32	677	897	SWICS on at level 1 modulated
	11:18:08	678	895	SWICS on at level 2 modulated
	11:19:44	680	893	SWICS on at level 3 modulated
	11:21:20	681	891	SWICS off
	11:24:32	685	897	SWICS on at level 1 modulated
	11:26:08	686	895	SWICS on at level 2 modulated
	11:27:44	688	893	SWICS on at level 3 modulated
	11:29:20	689	891	SWICS off
	11:48:32	709	897	SWICS on at level 1 modulated
	11:50:08	710	895	SWICS on at level 2 modulated
	11:51:44	712	893	SWICS on at level 3 modulated
	11:53:20	713	891	SWICS off
End internal calibration sequence.				
Begin internal calibration sequence				
03/05/86	11:01:04	661	8A1	Begin internal calibration
	11:01:36	662	897	SWICS on at level 1 modulated
	11:03:12	663	895	SWICS on at level 2 modulated
	11:04:48	665	893	SWICS on at level 3 modulated
	11:06:24	666	891	SWICS off
	11:09:36	670	897	SWICS on at level 1 modulated
	11:11:12	671	895	SWICS on at level 2 modulated
	11:12:48	673	893	SWICS on at level 3 modulated
	11:14:24	674	891	SWICS off
	11:33:36	694	897	SWICS on at level 1 modulated
	11:35:12	695	895	SWICS on at level 2 modulated
	11:36:48	697	893	SWICS on at level 3 modulated
	11:38:24	698	891	SWICS off
End internal calibration sequence				
03/12/86	15:07:11			Yaw maneuver to X-axis negative
Begin internal calibration sequence				
03/19/86	11:10:08	670	8A1	Begin internal calibration
	11:10:40	671	897	SWICS on at level 1 modulated
	11:12:16	672	895	SWICS on at level 2 modulated
	11:13:52	674	893	SWICS on at level 3 modulated
	11:15:28	675	891	SWICS off
	11:18:40	679	897	SWICS on at level 1 modulated
	11:20:16	680	895	SWICS on at level 2 modulated
	11:21:52	682	893	SWICS on at level 3 modulated
	11:23:28	683	891	SWICS off
	11:42:40	703	897	SWICS on at level 1 modulated
	11:44:16	704	895	SWICS on at level 2 modulated

Table 7. Continued

(b) Continued

Date	Universal time		Hex command	Event description
	hr:min:sec	Minutes of day		
03/19/86	11:45:52	706	893	SWICS on at level 3 modulated
	11:47:28	707	891	SWICS off
End internal calibration sequence.				
Begin internal calibration sequence				
04/02/86	10:52:32	653	8A1	Begin internal calibration
	10:53:04	653	897	SWICS on at level 1 modulated
	10:54:40	655	895	SWICS on at level 2 modulated
	10:56:16	656	893	SWICS on at level 3 modulated
	10:57:52	658	891	SWICS off
	11:01:04	661	897	SWICS on at level 1 modulated
	11:02:40	663	895	SWICS on at level 2 modulated
	11:04:16	664	893	SWICS on at level 3 modulated
	11:05:52	666	891	SWICS off
	11:25:04	685	897	SWICS on at level 1 modulated
	11:26:40	687	895	SWICS on at level 2 modulated
	11:28:16	688	893	SWICS on at level 3 modulated
	11:29:52	690	891	SWICS off
End internal calibration sequence.				
Begin internal calibration sequence				
04/16/86	10:31:44	632	8A1	Begin internal calibration
	10:32:16	632	897	SWICS on at level 1 modulated
	10:33:52	634	895	SWICS on at level 2 modulated
	10:35:28	635	893	SWICS on at level 3 modulated
	10:37:04	637	891	SWICS off
	10:40:16	640	897	SWICS on at level 1 modulated
	10:41:52	642	895	SWICS on at level 2 modulated
	10:43:28	643	893	SWICS on at level 3 modulated
	10:45:04	645	891	SWICS off
	11:04:16	664	897	SWICS on at level 1 modulated
	11:05:52	666	895	SWICS on at level 2 modulated
	11:07:28	667	893	SWICS on at level 3 modulated
	11:09:04	669	891	SWICS off
End internal calibration sequence				
04/18/86	16:17:19			Yaw maneuver to X-axis positive
Begin internal calibration sequence				
04/30/86	11:00:00	660	8A1	Begin internal calibration
	11:00:32	661	897	SWICS on at level 1 modulated
	11:02:08	662	895	SWICS on at level 2 modulated
	11:03:44	664	893	SWICS on at level 3 modulated
	11:05:20	665	891	SWICS off
	11:08:32	669	897	SWICS on at level 1 modulated
	11:10:08	670	895	SWICS on at level 2 modulated
	11:11:44	672	893	SWICS on at level 3 modulated
11:13:20	673	891	SWICS off	

Table 7. Continued

(b) Continued

Date	Universal time		Hex command	Event description
	hr:min:sec	Minutes of day		
04/30/86	11:32:32	693	897	SWICS on at level 1 modulated
	11:34:08	694	895	SWICS on at level 2 modulated
	11:35:44	696	893	SWICS on at level 3 modulated
	11:37:20	697	891	SWICS off
End internal calibration sequence.				
Begin internal calibration sequence				
05/14/86	10:39:12	639	8A1	Begin internal calibration
	10:39:44	640	897	SWICS on at level 1 modulated
	10:41:20	641	895	SWICS on at level 2 modulated
	10:42:56	643	893	SWICS on at level 3 modulated
	10:44:32	645	891	SWICS off
	10:47:44	648	897	SWICS on at level 1 modulated
	10:49:20	649	895	SWICS on at level 2 modulated
	10:50:56	651	893	SWICS on at level 3 modulated
	10:52:32	653	891	SWICS off
	11:11:44	672	897	SWICS on at level 1 modulated
	11:13:20	673	895	SWICS on at level 2 modulated
	11:14:56	675	893	SWICS on at level 3 modulated
	11:16:32	677	891	SWICS off
End internal calibration sequence				
05/21/86	14:48:15			Yaw manuever to <i>X</i> -axis negative
Begin internal calibration sequence				
05/28/86	10:49:20	649	8A1	Begin internal calibration
	10:49:52	650	897	SWICS on at level 1 modulated
	10:51:28	651	895	SWICS on at level 2 modulated
	10:53:04	653	893	SWICS on at level 3 modulated
	10:54:40	655	891	SWICS off
	10:57:52	658	897	SWICS on at level 1 modulated
	10:59:28	659	895	SWICS on at level 2 modulated
	11:01:04	661	893	SWICS on at level 3 modulated
	11:02:40	663	891	SWICS off
	11:21:52	682	897	SWICS on at level 1 modulated
	11:23:28	683	895	SWICS on at level 2 modulated
	11:25:04	685	893	SWICS on at level 3 modulated
	11:26:40	687	891	SWICS off
End internal calibration sequence.				
Begin internal calibration sequence				
06/04/86	10:31:12	631	8A1	Begin internal calibration
	10:31:44	632	897	SWICS on at level 1 modulated
	10:33:20	633	895	SWICS on at level 2 modulated
	10:34:56	635	893	SWICS on at level 3 modulated
	10:36:32	637	891	SWICS off
	10:39:44	640	897	SWICS on at level 1 modulated
	10:41:20	641	895	SWICS on at level 2 modulated

Table 7. Continued

(b) Continued

Date	Universal time		Hex command	Event description
	hr:min:sec	Minutes of day		
06/04/86	10:42:56	643	893	SWICS on at level 3 modulated
	10:44:32	645	891	SWICS off
	11:03:44	664	897	SWICS on at level 1 modulated
	11:05:20	665	895	SWICS on at level 2 modulated
	11:06:56	667	893	SWICS on at level 3 modulated
	11:08:32	669	891	SWICS off
End internal calibration sequence. Begin azimuth angle load commands for Sun avoidance angles				
06/04/86	14:08:16	848	419	Address azimuth position A
	14:08:48	849	2xx	Data command, high byte
	14:09:20	849	1xx	Data command, low byte
	14:10:24	850	41B	Address azimuth position B
	14:10:56	851	2xx	Data command, high byte
	14:12:00	852	1xx	Data command, low byte
End azimuth angle load commands ( $A = 179^\circ$ , $B = 145^\circ$ ). Begin Sun avoidance operation				
06/04/86	16:45:04	1005	815	Azimuth to position B
06/18/86	15:20:16	920	813	Azimuth to $180^\circ$
End Sun avoidance operation. Begin internal calibration sequence				
06/19/86	10:45:36	646	8A1	Begin internal calibration
	10:46:08	646	897	SWICS on at level 1 modulated
	10:47:44	648	895	SWICS on at level 2 modulated
	10:49:20	649	893	SWICS on at level 3 modulated
	10:50:56	651	891	SWICS off
	10:54:08	654	897	SWICS on at level 1 modulated
	10:55:44	656	895	SWICS on at level 2 modulated
	10:57:20	657	893	SWICS on at level 3 modulated
	10:58:56	659	891	SWICS off
	11:18:08	678	897	SWICS on at level 1 modulated
	11:19:44	680	895	SWICS on at level 2 modulated
	11:21:20	681	893	SWICS on at level 3 modulated
	11:22:56	683	891	SWICS off
End internal calibration sequence. Begin internal calibration sequence				
06/25/86	10:20:00	620	8A1	Begin internal calibration
	10:20:32	621	897	SWICS on at level 1 modulated
	10:22:08	622	895	SWICS on at level 2 modulated
	10:23:44	624	893	SWICS on at level 3 modulated
	10:25:20	625	891	SWICS off
	10:28:32	629	897	SWICS on at level 1 modulated
	10:30:08	630	895	SWICS on at level 2 modulated
	10:31:44	632	893	SWICS on at level 3 modulated



Table 7. Continued

(b) Continued

Date	Universal time		Hex command	Event description
	hr:min:sec	Minutes of day		
06/25/86	10:33:20	633	891	SWICS off
	10:52:32	653	897	SWICS on at level 1 modulated
	10:54:08	654	895	SWICS on at level 2 modulated
	10:55:44	656	893	SWICS on at level 3 modulated
	10:57:20	657	891	SWICS off
End internal calibration sequence				
07/02/86	15:24:15			Yaw maneuver to <i>X</i> -axis positive
Begin internal calibration sequence				
07/09/86	10:45:04	645	8A1	Begin internal calibration
	10:45:36	646	897	SWICS on at level 1 modulated
	10:47:12	647	895	SWICS on at level 2 modulated
	10:48:48	649	893	SWICS on at level 3 modulated
	10:50:24	650	891	SWICS off
	10:53:36	654	897	SWICS on at level 1 modulated
	10:55:12	655	895	SWICS on at level 2 modulated
	10:56:48	657	893	SWICS on at level 3 modulated
	10:58:24	658	891	SWICS off
	11:17:36	678	897	SWICS on at level 1 modulated
	11:19:12	679	895	SWICS on at level 2 modulated
	11:20:48	681	893	SWICS on at level 3 modulated
	11:22:24	682	891	SWICS off
End internal calibration sequence.				
Begin internal calibration sequence				
07/23/86	12:00:16	720	8A1	Begin internal calibration
	12:00:48	721	897	SWICS on at level 1 modulated
	12:02:24	722	895	SWICS on at level 2 modulated
	12:04:00	724	893	SWICS on at level 3 modulated
	12:05:36	726	891	SWICS off
	12:08:48	729	897	SWICS on at level 1 modulated
	12:10:24	730	895	SWICS on at level 2 modulated
	12:12:00	732	893	SWICS on at level 3 modulated
	12:13:36	734	891	SWICS off
	12:32:48	753	897	SWICS on at level 1 modulated
	12:34:24	754	895	SWICS on at level 2 modulated
	12:36:00	756	893	SWICS on at level 3 modulated
	12:37:36	758	891	SWICS off
End internal calibration sequence				
08/01/86	14:55:11			Yaw maneuver to <i>X</i> -axis negative
Begin internal calibration sequence				
08/06/86	09:54:24	594	8A1	Begin internal calibration
	09:54:56	595	897	SWICS on at level 1 modulated
	09:56:32	597	895	SWICS on at level 2 modulated
	09:58:08	598	893	SWICS on at level 3 modulated
	09:59:44	600	891	SWICS off

Table 7. Continued

(b) Continued

Date	Universal time		Hex command	Event description
	hr:min:sec	Minutes of day		
08/06/86	10:02:56	603	897	SWICS on at level 1 modulated
	10:04:32	605	895	SWICS on at level 2 modulated
	10:06:08	606	893	SWICS on at level 3 modulated
	10:07:44	608	891	SWICS off
	10:26:56	627	897	SWICS on at level 1 modulated
	10:28:32	629	895	SWICS on at level 2 modulated
	10:30:08	630	893	SWICS on at level 3 modulated
	10:31:44	632	891	SWICS off
End internal calibration sequence. Begin internal calibration sequence				
08/17/86	11:06:56	667	8A1	Begin internal calibration
	11:07:28	667	897	SWICS on at level 1 modulated
	11:09:04	669	895	SWICS on at level 2 modulated
	11:10:40	671	893	SWICS on at level 3 modulated
	11:12:16	672	891	SWICS off
	11:15:28	675	897	SWICS on at level 1 modulated
	11:17:04	677	895	SWICS on at level 2 modulated
	11:18:40	679	893	SWICS on at level 3 modulated
	11:20:16	680	891	SWICS off
	11:39:28	699	897	SWICS on at level 1 modulated
	11:41:04	701	895	SWICS on at level 2 modulated
	11:42:40	703	893	SWICS on at level 3 modulated
	11:44:16	704	891	SWICS off
End internal calibration sequence. Begin azimuth angle load commands for Sun avoidance angles				
08/17/86	16:37:04	997	419	Address azimuth position A
	16:38:40	999	2xx	Data command, high byte
	16:39:44	1000	1xx	Data command, low byte
	16:40:48	1001	41B	Address azimuth position B
	16:42:24	1002	2xx	Data command, high byte
	16:43:28	1003	1xx	Data command, low byte
End azimuth angle load commands (A = 179°, B = 145°) Begin Sun avoidance operation				
08/18/86	16:00:16	960	815	Azimuth to position B
08/27/86	18:10:24	1090	813	Azimuth to 180°
End Sun avoidance operation. Begin internal calibration sequence				
08/28/86	11:59:44	720	8A1	Begin internal calibration
	12:00:16	720	897	SWICS on at level 1 modulated
	12:01:52	722	895	SWICS on at level 2 modulated
	12:03:28	723	893	SWICS on at level 3 modulated
	12:05:04	725	891	SWICS off
	12:08:16	728	897	SWICS on at level 1 modulated

Table 7. Continued

(b) Continued

Date	Universal time		Hex command	Event description
	hr:min:sec	Minutes of day		
08/28/86	12:09:52	730	895	SWICS on at level 2 modulated
	12:11:28	731	893	SWICS on at level 3 modulated
	12:13:04	733	891	SWICS off
	12:32:16	752	897	SWICS on at level 1 modulated
	12:33:52	754	895	SWICS on at level 2 modulated
	12:35:28	755	893	SWICS on at level 3 modulated
	12:37:04	757	891	SWICS off
End internal calibration sequence.				
Begin internal calibration sequence				
09/03/86	11:36:48	697	8A1	Begin internal calibration
	11:37:20	697	897	SWICS on at level 1 modulated
	11:38:56	699	895	SWICS on at level 2 modulated
	11:40:32	701	893	SWICS on at level 3 modulated
	11:42:08	702	891	SWICS off
	11:45:20	705	897	SWICS on at level 1 modulated
	11:46:56	707	895	SWICS on at level 2 modulated
	11:48:32	709	893	SWICS on at level 3 modulated
	11:50:08	710	891	SWICS off
	12:09:20	729	897	SWICS on at level 1 modulated
	12:10:56	731	895	SWICS on at level 2 modulated
	12:12:32	733	893	SWICS on at level 3 modulated
	12:14:08	734	891	SWICS off
	End internal calibration sequence			
09/11/86	13:31:11			Yaw maneuver to X-axis positive
Begin internal calibration sequence				
09/17/86	10:24:16	624	8A1	Begin internal calibration
	10:24:48	625	897	SWICS on at level 1 modulated
	10:26:24	626	895	SWICS on at level 2 modulated
	10:28:00	628	893	SWICS on at level 3 modulated
	10:29:36	630	891	SWICS off
	10:32:48	633	897	SWICS on at level 1 modulated
	10:34:24	634	895	SWICS on at level 2 modulated
	10:36:00	636	893	SWICS on at level 3 modulated
	10:37:36	638	891	SWICS off
	10:56:48	657	897	SWICS on at level 1 modulated
	10:58:24	658	895	SWICS on at level 2 modulated
	11:00:00	660	893	SWICS on at level 3 modulated
	11:01:36	662	891	SWICS off
	End internal calibration sequence.			
Begin internal calibration sequence				
10/01/86	10:09:20	609	8A1	Begin internal calibration
	10:09:52	610	897	SWICS on at level 1 modulated
	10:11:28	611	895	SWICS on at level 2 modulated
	10:13:04	613	893	SWICS on at level 3 modulated

Table 7. Continued

(b) Continued

Date	Universal time		Hex command	Event description
	hr:min:sec	Minutes of day		
10/01/86	10:14:40	615	891	SWICS off
	10:17:52	618	897	SWICS on at level 1 modulated
	10:19:28	619	895	SWICS on at level 2 modulated
	10:21:04	621	893	SWICS on at level 3 modulated
	10:22:40	623	891	SWICS off
	10:41:52	642	897	SWICS on at level 1 modulated
	10:43:28	643	895	SWICS on at level 2 modulated
	10:45:04	645	893	SWICS on at level 3 modulated
	10:46:40	647	891	SWICS off
End internal calibration sequence. Begin internal calibration sequence				
10/15/86	11:20:48	681	8A1	Begin internal calibration
	11:21:20	681	897	SWICS on at level 1 modulated
	11:22:56	683	895	SWICS on at level 2 modulated
	11:24:32	685	893	SWICS on at level 3 modulated
	11:26:08	686	891	SWICS off
	11:29:20	689	897	SWICS on at level 1 modulated
	11:30:56	691	895	SWICS on at level 2 modulated
	11:32:32	693	893	SWICS on at level 3 modulated
	11:34:08	694	891	SWICS off
	11:53:20	713	897	SWICS on at level 1 modulated
	11:54:56	715	895	SWICS on at level 2 modulated
	11:56:32	717	893	SWICS on at level 3 modulated
11:58:08	718	891	SWICS off	
End internal calibration sequence				
10/17/86	14:28:15			Yaw maneuver to X-axis negative
Begin internal calibration sequence				
10/29/86	09:57:04	597	8A1	Begin internal calibration
	09:57:36	598	897	SWICS on at level 1 modulated
	09:59:12	599	895	SWICS on at level 2 modulated
	10:00:48	601	893	SWICS on at level 3 modulated
	10:02:24	602	891	SWICS off
	10:05:36	606	897	SWICS on at level 1 modulated
	10:07:12	607	895	SWICS on at level 2 modulated
	10:08:48	609	893	SWICS on at level 3 modulated
	10:10:24	610	891	SWICS off
	10:29:36	630	897	SWICS on at level 1 modulated
	10:31:12	631	895	SWICS on at level 2 modulated
	10:32:48	633	893	SWICS on at level 3 modulated
10:34:24	634	891	SWICS off	
End internal calibration sequence. Begin internal calibration sequence				
11/12/86	11:17:04	677	8A1	Begin internal calibration
	11:17:36	678	897	SWICS on at level 1 modulated

Table 7. Continued

(b) Continued

Date	Universal time		Hex command	Event description
	hr:min:sec	Minutes of day		
11/12/86	11:19:12	679	895	SWICS on at level 2 modulated
	11:20:48	681	893	SWICS on at level 3 modulated
	11:22:24	682	891	SWICS off
	11:25:36	686	897	SWICS on at level 1 modulated
	11:27:12	687	895	SWICS on at level 2 modulated
	11:28:48	689	893	SWICS on at level 3 modulated
	11:30:24	690	891	SWICS off
	11:49:36	710	897	SWICS on at level 1 modulated
	11:51:12	711	895	SWICS on at level 2 modulated
	11:52:48	713	893	SWICS on at level 3 modulated
	11:54:24	714	891	SWICS off
End internal calibration sequence				
11/20/86	14:56:15			Yaw maneuver to X-axis positive
Begin internal calibration sequence				
11/26/86	11:38:56	699	8A1	Begin internal calibration
	11:39:28	699	897	SWICS on at level 1 modulated
	11:41:04	701	895	SWICS on at level 2 modulated
	11:42:40	703	893	SWICS on at level 3 modulated
	11:44:16	704	891	SWICS off
	11:47:28	707	897	SWICS on at level 1 modulated
	11:49:04	709	895	SWICS on at level 2 modulated
	11:50:40	711	893	SWICS on at level 3 modulated
	11:52:16	712	891	SWICS off
	12:11:28	731	897	SWICS on at level 1 modulated
	12:13:04	733	895	SWICS on at level 2 modulated
	12:14:40	735	893	SWICS on at level 3 modulated
	12:16:16	736	891	SWICS off
End internal calibration sequence.				
Begin internal calibration sequence				
12/04/86	05:10:08	310	8A1	Begin internal calibration
	05:10:40	311	897	SWICS on at level 1 modulated
	05:12:16	312	895	SWICS on at level 2 modulated
	05:13:52	314	893	SWICS on at level 3 modulated
	05:15:28	315	891	SWICS off
	05:18:40	319	897	SWICS on at level 1 modulated
	05:20:16	320	895	SWICS on at level 2 modulated
	05:21:52	322	893	SWICS on at level 3 modulated
	05:23:28	323	891	SWICS off
	05:42:40	343	897	SWICS on at level 1 modulated
	05:44:16	344	895	SWICS on at level 2 modulated
	05:45:52	346	893	SWICS on at level 3 modulated
	05:47:28	347	891	SWICS off
End internal calibration sequence				

Table 7. Continued

(b) Continued

Date	Universal time		Hex command	Event description
	hr:min:sec	Minutes of day		
Begin azimuth angle load commands for Sun avoidance angles				
12/04/86	14:45:04	885	419	Address azimuth position A
	14:45:36	886	2xx	Data command, high byte
	14:46:40	887	1xx	Data command, low byte
	14:47:44	888	41B	Address azimuth position B
	14:48:16	888	2xx	Data command, high byte
	14:49:20	889	1xx	Data command, low byte
End azimuth angle load commands (A = 179°, B = 145°).				
Begin Sun avoidance operation				
12/04/86	20:07:12	1207	815	Azimuth to position B
12/17/86	16:47:12	1007	813	Azimuth to 180°
End Sun avoidance operation.				
Begin internal calibration sequence				
12/18/86	10:02:24	602	8A1	Begin internal calibration
	10:02:56	603	897	SWICS on at level 1 modulated
	10:04:32	605	895	SWICS on at level 2 modulated
	10:06:08	606	893	SWICS on at level 3 modulated
	10:07:44	608	891	SWICS off
	10:10:56	611	897	SWICS on at level 1 modulated
	10:12:32	613	895	SWICS on at level 2 modulated
	10:14:08	614	893	SWICS on at level 3 modulated
	10:15:44	616	891	SWICS off
	10:34:56	635	897	SWICS on at level 1 modulated
	10:36:32	637	895	SWICS on at level 2 modulated
	10:38:08	638	893	SWICS on at level 3 modulated
	10:39:44	640	891	SWICS off
	End internal calibration sequence.			
Begin internal calibration sequence				
12/24/86	11:09:36	670	8A1	Begin internal calibration
	11:10:08	670	897	SWICS on at level 1 modulated
	11:11:44	672	895	SWICS on at level 2 modulated
	11:13:20	673	893	SWICS on at level 3 modulated
	11:14:56	675	891	SWICS off
	11:18:08	678	897	SWICS on at level 1 modulated
	11:19:44	680	895	SWICS on at level 2 modulated
	11:21:20	681	893	SWICS on at level 3 modulated
	11:22:56	683	891	SWICS off
	11:42:08	702	897	SWICS on at level 1 modulated
	11:43:44	704	895	SWICS on at level 2 modulated
	11:45:20	705	893	SWICS on at level 3 modulated
	11:46:56	707	891	SWICS off
	End internal calibration sequence			
12/31/86	15:15:11			Yaw maneuver to X-axis negative

Table 7. Concluded

(b) Concluded

Date	Universal time		Hex command	Event description
	hr:min:sec	Minutes of day		
Begin internal calibration sequence				
01/07/87	11:19:44	680	8A1	Begin internal calibration
	11:20:16	680	897	SWICS on at level 1 modulated
	11:21:52	682	895	SWICS on at level 2 modulated
	11:23:28	683	893	SWICS on at level 3 modulated
	11:25:04	685	891	SWICS off
	11:28:16	688	897	SWICS on at level 1 modulated
	11:29:52	690	895	SWICS on at level 2 modulated
	11:31:28	691	893	SWICS on at level 3 modulated
	11:33:04	693	891	SWICS off
	11:52:16	712	897	SWICS on at level 1 modulated
	11:53:52	714	895	SWICS on at level 2 modulated
	11:55:28	715	893	SWICS on at level 3 modulated
	11:57:04	717	891	SWICS off
End internal calibration sequence.				
Begin internal calibration sequence				
01/21/87	10:57:52	658	8A1	Begin internal calibration
	10:58:24	658	897	SWICS on at level 1 modulated
	11:00:00	660	895	SWICS on at level 2 modulated
	11:01:36	662	893	SWICS on at level 3 modulated
	11:03:12	663	891	SWICS off
	11:06:24	666	897	SWICS on at level 1 modulated
	11:08:00	668	895	SWICS on at level 2 modulated
	11:09:36	670	893	SWICS on at level 3 modulated
	11:11:12	671	891	SWICS off
	11:30:24	690	897	SWICS on at level 1 modulated
	11:32:00	692	895	SWICS on at level 2 modulated
	11:33:36	694	893	SWICS on at level 3 modulated
	11:35:12	695	891	SWICS off
End internal calibration sequence				
01/30/87	14:45:19			Yaw maneuver to X-axis positive

Table 8. List of Operational Commands Executed by Instruments on NOAA 9 Spacecraft

(a) Nonscanner commands

Date	Universal time		Hex command	Event description
	hr:min:sec	Minutes of day		
Begin preinternal calibration sequence				
02/05/86	09:48:21	588	821	Elevate to internal source (stow)
	09:48:53	589	862	WFOV BB heater on at temp. 1
	10:04:21	604	872	MFOV BB heater on at temp. 1
	11:31:17	691	823	Elevate to nadir (Earth)
End preinternal calibration sequence.				
Begin internal calibration sequence				
02/05/86	11:31:49	692	8A1	Begin internal calibration
	11:32:21	692	881	Detector bias heater off
	11:32:53	693	852	Solar port heaters off
	11:33:25	693	821	Elevate to internal source (stow)
	11:33:57	694	851	Solar port heaters on
	11:36:05	696	882	Detector bias heater on at level 1
	11:38:13	698	892	SWICS on at level 3
	11:41:25	701	881	Detector bias heater off
	11:45:09	705	862	WFOV BB heater on at temp. 1
	11:45:41	706	872	MFOV BB heater on at temp. 1
	11:46:45	707	891	SWICS off
	12:00:05	720	883	Detector bias heater on at level 2
	12:02:13	722	893	SWICS on at level 2
	12:05:25	725	881	Detector bias heater off
	12:09:09	729	863	WFOV BB heater on at temp. 2
	12:09:41	730	873	MFOV BB heater on at temp. 2
	12:10:45	731	891	SWICS off
	12:24:05	744	884	Detector bias heater on at level 3
	12:26:13	746	894	SWICS on at level 1
	12:28:21	748	881	Detector bias heater off
	12:31:01	751	852	Solar port heaters off
	12:32:05	752	861	WFOV BB heater off
	12:32:37	753	871	MFOV BB heater off
	12:33:09	753	851	Solar port heaters on
12:33:41	754	891	SWICS off	
End internal calibration sequence.				
Begin azimuth angle load commands for solar calibration				
02/05/86	12:36:21	756	419	Address azimuth position A
	12:36:53	757	2xx	Data command, high byte
	12:37:25	757	1xx	Data command, low byte
End azimuth angle load commands (A = 128.03°).				
Begin solar calibration sequence				
02/05/86	12:37:57	758	8A2	Begin solar calibration
	12:38:29	758	852	Solar port heaters off
	12:39:01	759	822	Elevate to solar ports (Sun)
	12:39:33	760	814	Azimuth to position A
	12:40:05	760	882	Detector bias heater on at level 1



Table 8. Continued

(a) Continued

Date	Universal time		Hex command	Event description
	hr:min:sec	Minutes of day		
02/05/86	12:49:41	770	851	Solar port heaters on
	12:50:13	770	831	SMA shutter cycle on
	13:21:09	801	832	SMA shutter cycle off
	13:21:41	802	852	Solar port heaters off
	13:22:13	802	813	Azimuth to 180°
	13:22:45	803	881	Detector bias heater off
	13:32:21	812	823	Elevate to nadir (Earth)
	13:32:53	813	851	Solar port heaters on
End solar calibration sequence.				
Begin azimuth angle load commands for 170°				
02/05/86	13:38:13	818	419	Address azimuth position A
	13:38:45	819	2xx	Data command, high byte
	13:39:17	819	1xx	Data command, low byte
End azimuth angle load commands (A = 170°)				
02/05/86	13:39:49	820	814	Azimuth to position A
Begin preinternal calibration sequence				
02/19/86	10:42:13	642	821	Elevate to internal source (stow)
	10:42:45	643	862	WFOV BB heater on at temp. 1
	10:58:13	658	872	MFOV BB heater on at temp. 1
	12:25:09	745	823	Elevate to nadir (Earth)
End preinternal calibration sequence.				
Begin internal calibration sequence				
02/19/86	12:25:41	746	8A1	Begin internal calibration
	12:26:13	746	881	Detector bias heater off
	12:26:45	747	852	Solar port heaters off
	12:27:17	747	821	Elevate to internal source (stow)
	12:27:49	748	851	Solar port heaters on
	12:29:57	750	882	Detector bias heater on at level 1
	12:32:05	752	892	SWICS on at level 3
	12:35:17	755	881	Detector bias heater off
	12:39:01	759	862	WFOV BB heater on at temp. 1
	12:39:33	760	872	MFOV BB heater on at temp. 1
	12:40:37	761	891	SWICS off
	12:53:57	774	883	Detector bias heater on at level 2
	12:56:05	776	893	SWICS on at level 2
	12:59:17	779	881	Detector bias heater off
	13:03:01	783	863	WFOV BB heater on at temp. 2
	13:03:33	784	873	MFOV BB heater on at temp. 2
	13:04:37	785	891	SWICS off
	13:17:57	798	884	Detector bias heater on at level 3
	13:20:05	800	894	SWICS on at level 1
	13:22:13	802	881	Detector bias heater off
	13:24:53	805	852	Solar port heaters off
	13:25:57	806	861	WFOV BB heater off

Table 8. Continued

(a) Continued

Date	Universal time		Hex command	Event description
	hr:min:sec	Minutes of day		
02/19/86	13:26:29	806	871	MFOV BB heater off
	13:27:01	807	851	Solar port heaters on
	13:27:33	808	891	SWICS off
End internal calibration sequence.				
Begin azimuth angle load commands for solar calibration				
02/19/86	13:30:13	810	419	Address azimuth position A
	13:30:45	811	2xx	Data command, high byte
	13:31:17	811	1xx	Data command, low byte
End azimuth angle load commands (A = 128.18°)				
Begin solar calibration sequence				
02/19/86	13:31:49	812	8A2	Begin solar calibration
	13:32:21	812	852	Solar port heaters off
	13:32:53	813	822	Elevate to solar ports (Sun)
	13:33:25	813	814	Azimuth to position A
	13:33:57	814	882	Detector bias heater on at level 1
	13:43:33	824	851	Solar port heaters on
	13:44:05	824	831	SMA shutter cycle on
	14:15:01	855	832	SMA shutter cycle off
	14:15:33	856	852	Solar port heaters off
	14:16:05	856	813	Azimuth to 180°
	14:16:37	857	881	Detector bias heater off
	14:26:13	866	823	Elevate to nadir (Earth)
	14:26:45	867	851	Solar port heaters on
End solar calibration sequence.				
Begin azimuth angle load commands for 170°				
02/19/86	14:32:05	872	419	Address azimuth position A
	14:32:37	873	2xx	Data command, high byte
	14:33:09	873	1xx	Data command, low byte
End azimuth angle load commands (A = 170°)				
02/19/86	14:33:41	874	814	Azimuth to position A
Begin preinternal calibration sequence				
03/05/86	09:54:13	594	821	Elevate to internal source (stow)
	09:54:45	595	862	WFOV BB heater on at temp. 1
	10:10:13	610	872	MFOV BB heater on at temp. 1
	11:37:09	697	823	Elevate to nadir (Earth)
End preinternal calibration sequence.				
Begin internal calibration sequence				
03/05/86	11:37:41	698	8A1	Begin internal calibration
	11:38:13	698	881	Detector bias heater off
	11:38:45	699	852	Solar port heaters off
	11:39:17	699	821	Elevate to internal source (stow)
	11:39:49	700	851	Solar port heaters on
	11:41:57	702	882	Detector bias heater on at level 1
	11:44:05	704	892	SWICS on at level 3

Table 8. Continued

(a) Continued

Date	Universal time		Hex command	Event description
	hr:min:sec	Minutes of day		
03/05/86	11:47:17	707	881	Detector bias heater off
	11:51:01	711	862	WFOV BB heater on at temp. 1
	11:51:33	712	872	MFOV BB heater on at temp. 1
	11:52:37	713	891	SWICS off
	12:05:57	726	883	Detector bias heater on at level 2
	12:08:05	728	893	SWICS on at level 2
	12:11:17	731	881	Detector bias heater off
	12:15:01	735	863	WFOV BB heater on at temp. 2
	12:15:33	736	873	MFOV BB heater on at temp. 2
	12:16:37	737	891	SWICS off
	12:29:57	750	884	Detector bias heater on at level 3
	12:32:05	752	894	SWICS on at level 1
	12:34:13	754	881	Detector bias heater off
	12:36:53	757	852	Solar port heaters off
	12:37:57	758	861	WFOV BB heater off
	12:38:29	758	871	MFOV BB heater off
12:39:01	759	851	Solar port heaters on	
12:39:33	760	891	SWICS off	
End internal calibration sequence.				
Begin azimuth angle load commands for solar calibration				
03/05/86	12:42:13	762	419	Address azimuth position A
	12:42:45	763	2xx	Data command, high byte
	12:43:17	763	1xx	Data command, low byte
End azimuth angle load commands (A = 128.55°).				
Begin solar calibration sequence				
03/05/86	12:43:49	764	8A2	Begin solar calibration
	12:44:21	764	852	Solar port heaters off
	12:44:53	765	822	Elevate to solar ports (Sun)
	12:45:25	765	814	Azimuth to position A
	12:45:57	766	882	Detector bias heater on at level 1
	12:55:33	776	851	Solar port heaters on
	12:56:05	776	831	SMA shutter cycle on
	13:27:01	807	832	SMA shutter cycle off
	13:27:33	808	852	Solar port heaters off
	13:28:05	808	813	Azimuth to 180°
	13:28:37	809	881	Detector bias heater off
	13:38:13	818	823	Elevate to nadir (Earth)
	13:38:45	819	851	Solar port heaters on
End solar calibration sequence.				
Begin azimuth angle load commands for 170°				
03/05/86	13:44:05	824	419	Address azimuth position A
	13:44:37	825	2xx	Data command, high byte
	13:45:09	825	1xx	Data command, low byte
End azimuth angle load commands (A = 170°)				

Table 8. Continued

(a) Continued

Date	Universal time		Hex command	Event description
	hr:min:sec	Minutes of day		
03/05/86	13:45:41	826	814	Azimuth to position A
Begin preinternal calibration sequence				
03/19/86	10:48:37	649	821	Elevate to internal source (stow)
	10:49:09	649	862	WFOV BB heater on at temp. 1
	11:04:37	665	872	MFOV BB heater on at temp. 1
	12:31:33	752	823	Elevate to nadir (Earth)
End preinternal calibration sequence.				
Begin internal calibration sequence				
03/19/86	12:32:05	752	8A1	Begin internal calibration
	12:32:37	753	881	Detector bias heater off
	12:33:09	753	852	Solar port heaters off
	12:33:41	754	821	Elevate to internal source (stow)
	12:34:13	754	851	Solar port heaters on
	12:36:21	756	882	Detector bias heater on at level 1
	12:38:29	758	892	SWICS on at level 3
	12:41:41	762	881	Detector bias heater off
	12:45:25	765	862	WFOV BB heater on at temp. 1
	12:45:57	766	872	MFOV BB heater on at temp. 1
	12:47:01	767	891	SWICS off
	13:00:21	780	883	Detector bias heater on at level 2
	13:02:29	782	893	SWICS on at level 2
	13:05:41	786	881	Detector bias heater off
	13:09:25	789	863	WFOV BB heater on at temp. 2
	13:09:57	790	873	MFOV BB heater on at temp. 2
	13:11:01	791	891	SWICS off
	13:24:21	804	884	Detector bias heater on at level 3
	13:26:29	806	894	SWICS on at level 1
	13:28:37	809	881	Detector bias heater off
	13:31:17	811	852	Solar port heaters off
	13:32:21	812	861	WFOV BB heater off
	13:32:53	813	871	MFOV BB heater off
	13:33:25	813	851	Solar port heaters on
13:33:57	814	891	SWICS off	
End internal calibration sequence.				
Begin azimuth angle load commands for solar calibration				
03/19/86	13:36:37	817	419	Address azimuth position A
	13:37:09	817	2xx	Data command, high byte
	13:37:41	818	1xx	Data command, low byte
End azimuth angle load commands (A = 128.78°).				
Begin solar calibration sequence				
03/19/86	13:38:13	818	8A2	Begin solar calibration
	13:38:45	819	852	Solar port heaters off
	13:39:17	819	822	Elevate to solar ports (Sun)
	13:39:49	820	814	Azimuth to position A

Table 8. Continued

(a) Continued

Date	Universal time		Hex command	Event description
	hr:min:sec	Minutes of day		
03/19/86	13:40:21	820	882	Detector bias heater on at level 1
	13:49:57	830	851	Solar port heaters on
	13:50:29	830	831	SMA shutter cycle on
	14:21:25	861	832	SMA shutter cycle off
	14:21:57	862	852	Solar port heaters off
	14:22:29	862	813	Azimuth to 180°
	14:23:01	863	881	Detector bias heater off
	14:32:37	873	823	Elevate to nadir (Earth)
	14:33:09	873	851	Solar port heaters on
End solar calibration sequence. Begin azimuth angle load commands for 170°				
03/19/86	14:38:29	878	419	Address azimuth position A
	14:39:01	879	2xx	Data command, high byte
	14:39:33	880	1xx	Data command, low byte
End azimuth angle load commands (A = 170°)				
03/19/86	14:40:05	880	814	Azimuth to position A
Begin preinternal calibration sequence				
04/02/86	10:00:37	601	821	Elevate to internal source (stow)
	10:01:09	601	862	WFOV BB heater on at temp. 1
	10:16:37	617	872	MFOV BB heater on at temp. 1
	11:43:33	704	823	Elevate to nadir (Earth)
End preinternal calibration sequence. Begin internal calibration sequence				
04/02/86	11:44:05	704	8A1	Begin internal calibration
	11:44:37	705	881	Detector bias heater off
	11:45:09	705	852	Solar port heaters off
	11:45:41	706	821	Elevate to internal source (stow)
	11:46:13	706	851	Solar port heaters on
	11:48:21	708	882	Detector bias heater on at level 1
	11:50:29	710	892	SWICS on at level 3
	11:53:41	714	881	Detector bias heater off
	11:57:25	717	862	WFOV BB heater on at temp. 1
	11:57:57	718	872	MFOV BB heater on at temp. 1
	11:59:01	719	891	SWICS off
	12:12:21	732	883	Detector bias heater on at level 2
	12:14:29	734	893	SWICS on at level 2
	12:17:41	738	881	Detector bias heater off
	12:21:25	741	863	WFOV BB heater on at temp. 2
	12:21:57	742	873	MFOV BB heater on at temp. 2
	12:23:01	743	891	SWICS off
	12:36:21	756	884	Detector bias heater on at level 3
	12:38:29	758	894	SWICS on at level 1
	12:40:37	761	881	Detector bias heater off
	12:43:17	763	852	Solar port heaters off

Table 8. Continued

(a) Continued

Date	Universal time		Hex command	Event description
	hr:min:sec	Minutes of day		
04/02/86	12:44:21	764	861	WFOV BB heater off
	12:44:53	765	871	MFOV BB heater off
	12:45:25	765	851	Solar port heaters on
	12:45:57	766	891	SWICS off
End internal calibration sequence. Begin azimuth angle load commands for solar calibration				
04/02/86	12:48:37	769	419	Address azimuth position A
	12:49:09	769	2xx	Data command, high byte
	12:49:41	770	1xx	Data command, low byte
End azimuth angle load commands (A = 128.78°). Begin solar calibration sequence				
04/02/86	12:50:13	770	8A2	Begin solar calibration
	12:50:45	771	852	Solar port heaters off
	12:51:17	771	822	Elevate to solar ports (Sun)
	12:51:49	772	814	Azimuth to position A
	12:52:21	772	882	Detector bias heater on at level 1
	13:01:57	782	851	Solar port heaters on
	13:02:29	782	831	SMA shutter cycle on
	13:33:25	813	832	SMA shutter cycle off
	13:33:57	814	852	Solar port heaters off
	13:34:29	814	813	Azimuth to 180°
	13:35:01	815	881	Detector bias heater off
	13:44:37	825	823	Elevate to nadir (Earth)
	13:45:09	825	851	Solar port heaters on
	End solar calibration sequence. Begin azimuth angle load commands for 170°			
04/02/86	13:50:29	830	419	Address azimuth position A
	13:51:01	831	2xx	Data command, high byte
	13:51:33	832	1xx	Data command, low byte
End azimuth angle load commands (A = 170°)				
04/02/86	13:52:05	832	814	Azimuth to position A
Begin preinternal calibration sequence				
04/16/86	09:12:37	553	821	Elevate to internal source (stow)
	09:13:09	553	862	WFOV BB heater on at temp. 1
	09:28:37	569	872	MFOV BB heater on at temp. 1
Data dropout				
04/16/86	12:16:37	737	831	SMA shutter cycle on
	12:45:25	765	832	SMA shutter cycle off
	12:45:57	766	852	Solar port heaters off
	12:46:29	766	813	Azimuth to 180°
	12:47:01	767	881	Detector bias heater off
	12:56:37	777	823	Elevate to nadir (Earth)
	12:57:09	777	851	Solar port heaters on

Table 8. Continued

(a) Continued

Date	Universal time		Hex command	Event description
	hr:min:sec	Minutes of day		
Begin azimuth angle load commands for 170°				
04/16/86	13:02:29	782	419	Address azimuth position A
	13:03:01	783	2xx	Data command, high byte
	13:03:33	784	1xx	Data command, low byte
End azimuth angle load commands (A = 170°)				
04/16/86	13:04:05	784	814	Azimuth to position A
Begin preinternal calibration sequence				
04/30/86	10:05:57	606	821	Elevate to internal source (stow)
	10:06:29	606	862	WFOV BB heater on at temp. 1
	10:21:57	622	872	MFOV BB heater on at temp. 1
	11:48:53	709	823	Elevate to nadir (Earth)
End preinternal calibration sequence.				
Begin internal calibration sequence				
04/30/86	11:49:25	709	8A1	Begin internal calibration
	11:49:57	710	881	Detector bias heater off
	11:50:29	710	852	Solar port heaters off
	11:51:01	711	821	Elevate to internal source (stow)
	11:51:33	712	851	Solar port heaters on
	11:53:41	714	882	Detector bias heater on at level 1
	11:55:49	716	892	SWICS on at level 3
	11:59:01	719	881	Detector bias heater off
	12:02:45	723	862	WFOV BB heater on at temp. 1
	12:03:17	723	872	MFOV BB heater on at temp. 1
	12:04:21	724	891	SWICS off
	12:17:41	738	883	Detector bias heater on at level 2
	12:19:49	740	893	SWICS on at level 2
	12:23:01	743	881	Detector bias heater off
	12:26:45	747	863	WFOV BB heater on at temp. 2
	12:27:17	747	873	MFOV BB heater on at temp. 2
	12:28:21	748	891	SWICS off
	12:41:41	762	884	Detector bias heater on at level 3
	12:43:49	764	894	SWICS on at level 1
	12:45:57	766	881	Detector bias heater off
	12:48:37	769	852	Solar port heaters off
	12:49:41	770	861	WFOV BB heater off
	12:50:13	770	871	MFOV BB heater off
	12:50:45	771	851	Solar port heaters on
	12:51:17	771	891	SWICS off
	End internal calibration sequence.			
Begin azimuth angle load commands for solar calibration				
04/30/86	12:53:57	774	419	Address azimuth position A
	12:54:29	774	2xx	Data command, high byte
	12:55:01	775	1xx	Data command, low byte
End azimuth angle load commands (A = 127.43°)				

Table 8. Continued

(a) Continued

Date	Universal time		Hex command	Event description
	hr:min:sec	Minutes of day		
Begin internal calibration sequence				
05/28/86	11:53:42	714	8A1	Begin internal calibration
	11:54:14	714	881	Detector bias heater off
	11:54:46	715	852	Solar port heaters off
	11:55:18	715	821	Elevate to internal source (stow)
	11:55:50	716	851	Solar port heaters on
	11:57:58	718	882	Detector bias heater on at level 1
	12:00:06	720	892	SWICS on at level 3
	12:03:18	723	881	Detector bias heater off
	12:07:02	727	862	WFOV BB heater on at temp. 1
	12:07:34	728	872	MFOV BB heater on at temp. 1
	12:08:38	729	891	SWICS off
	12:21:58	742	883	Detector bias heater on at level 2
	12:24:06	744	893	SWICS on at level 2
	12:27:18	747	881	Detector bias heater off
	12:31:02	751	863	WFOV BB heater on at temp. 2
	12:31:34	752	873	MFOV BB heater on at temp. 2
	12:32:38	753	891	SWICS off
	12:45:58	766	884	Detector bias heater on at level 3
	12:48:06	768	894	SWICS on at level 1
	12:50:14	770	881	Detector bias heater off
	12:52:54	773	852	Solar port heaters off
12:53:58	774	861	WFOV BB heater off	
12:54:30	775	871	MFOV BB heater off	
12:55:02	775	851	Solar port heaters on	
12:55:34	776	891	SWICS off	
End internal calibration sequence.				
Begin azimuth angle load commands for solar calibration				
05/28/86	12:58:14	778	419	Address azimuth position A
	12:58:46	779	2xx	Data command, high byte
	12:59:18	779	1xx	Data command, low byte
End azimuth angle load commands (A = 115.2°).				
Begin solar calibration sequence				
05/28/86	12:59:50	780	8A2	Begin solar calibration
	13:00:22	780	852	Solar port heaters off
	13:00:54	781	822	Elevate to solar ports (Sun)
	13:01:26	781	814	Azimuth to position A
	13:01:58	782	882	Detector bias heater on at level 1
	13:11:34	792	851	Solar port heaters on
	13:12:06	792	831	SMA shutter cycle on
	13:43:02	823	832	SMA shutter cycle off
	13:43:34	824	852	Solar port heaters off
	13:44:06	824	813	Azimuth to 180°
	13:44:38	825	881	Detector bias heater off



Table 8. Continued

(a) Continued

Date	Universal time		Hex command	Event description
	hr:min:sec	Minutes of day		
05/28/86	13:54:14	834	823	Elevate to nadir (Earth)
	13:54:46	835	851	Solar port heaters on
End solar calibration sequence.				
Begin azimuth angle load commands for 170°				
05/28/86	14:00:06	840	419	Address azimuth position A
	14:00:38	841	2xx	Data command, high byte
	14:01:10	841	1xx	Data command, low byte
End azimuth angle load commands (A = 170°)				
05/28/86	14:01:42	842	814	Azimuth to position A
Begin preinternal calibration sequence				
06/11/86	09:20:38	561	821	Elevate to internal source (stow)
	09:21:10	561	862	WFOV BB heater on at temp. 1
	09:36:38	577	872	MFOV BB heater on at temp. 1
	11:03:34	664	823	Elevate to nadir (Earth)
End preinternal calibration sequence.				
Begin internal calibration sequence				
06/11/86	11:04:06	664	8A1	Begin internal calibration
	11:04:38	665	881	Detector bias heater off
	11:05:10	665	852	Solar port heaters off
	11:05:42	666	821	Elevate to internal source (stow)
	11:06:14	666	851	Solar port heaters on
	11:08:22	668	882	Detector bias heater on at level 1
	11:10:30	671	892	SWICS on at level 3
	11:13:42	674	881	Detector bias heater off
	11:17:26	677	862	WFOV BB heater on at temp. 1
	11:17:58	678	872	MFOV BB heater on at temp. 1
	11:19:02	679	891	SWICS off
	11:32:22	692	883	Detector bias heater on at level 2
	11:34:30	695	893	SWICS on at level 2
	11:37:42	698	881	Detector bias heater off
	11:41:26	701	863	WFOV BB heater on at temp. 2
	11:41:58	702	873	MFOV BB heater on at temp. 2
	11:43:02	703	891	SWICS off
	11:56:22	716	884	Detector bias heater on at level 3
	11:58:30	719	894	SWICS on at level 1
	12:00:38	721	881	Detector bias heater off
	12:03:18	723	852	Solar port heaters off
	12:04:22	724	861	WFOV BB heater off
	12:04:54	725	871	MFOV BB heater off
	12:05:26	725	851	Solar port heaters on
12:05:58	726	891	SWICS off	
End internal calibration sequence				

Table 8. Continued

(a) Continued

Date	Universal time		Hex command	Event description
	hr:min:sec	Minutes of day		
Begin azimuth angle load commands for solar calibration				
06/11/86	12:08:38	729	419	Address azimuth position A
	12:09:10	729	2xx	Data command, high byte
	12:09:42	730	1xx	Data command, low byte
End azimuth angle load commands (A = 123.75°).				
Begin solar calibration sequence				
06/11/86	12:10:14	730	8A2	Begin solar calibration
	12:10:46	731	852	Solar port heaters off
	12:11:18	731	822	Elevate to solar ports (Sun)
	12:11:50	732	814	Azimuth to position A
	12:12:22	732	882	Detector bias heater on at level 1
	12:21:58	742	851	Solar port heaters on
	12:22:30	743	831	SMA shutter cycle on
	12:53:26	773	832	SMA shutter cycle off
	12:53:58	774	852	Solar port heaters off
	12:54:30	775	813	Azimuth to 180°
	12:55:02	775	881	Detector bias heater off
	13:04:38	785	823	Elevate to nadir (Earth)
13:05:10	785	851	Solar port heaters on	
End solar calibration sequence.				
Begin azimuth angle load commands for 170°				
06/11/86	13:10:30	791	419	Address azimuth position A
	13:11:02	791	2xx	Data command, high byte
	13:11:34	792	1xx	Data command, low byte
End azimuth angle load commands (A = 170°)				
06/11/86	13:12:06	792	814	Azimuth to position A
Begin preinternal calibration sequence				
06/25/86	10:12:22	612	821	Elevate to internal source (stow)
	10:12:54	613	862	WFOV BB heater on at temp. 1
	10:28:22	628	872	MFOV BB heater on at temp. 1
	11:55:18	715	823	Elevate to nadir (Earth)
End preinternal calibration sequence.				
Begin internal calibration sequence				
06/25/86	11:55:50	716	8A1	Begin internal calibration
	11:56:22	716	881	Detector bias heater off
	11:56:54	717	852	Solar port heaters off
	11:57:26	717	821	Elevate to internal source (stow)
	11:57:58	718	851	Solar port heaters on
	12:00:06	720	882	Detector bias heater on at level 1
	12:02:14	722	892	SWICS on at level 3
	12:05:26	725	881	Detector bias heater off
	12:09:10	729	862	WFOV BB heater on at temp. 1
	12:09:42	730	872	MFOV BB heater on at temp. 1
	12:10:46	731	891	SWICS off

Table 8. Continued

(a) Continued

Date	Universal time		Hex command	Event description
	hr:min:sec	Minutes of day		
06/25/86	12:24:06	744	883	Detector bias heater on at level 2
	12:26:14	746	893	SWICS on at level 2
	12:29:26	749	881	Detector bias heater off
	12:33:10	753	863	WFOV BB heater on at temp. 2
	12:33:42	754	873	MFOV BB heater on at temp. 2
	12:34:46	755	891	SWICS off
	12:48:06	768	884	Detector bias heater on at level 3
	12:50:14	770	894	SWICS on at level 1
	12:52:22	772	881	Detector bias heater off
	12:55:02	775	852	Solar port heaters off
	12:56:06	776	861	WFOV BB heater off
	12:56:38	777	871	MFOV BB heater off
	12:57:10	777	851	Solar port heaters on
	12:57:42	778	891	SWICS off
End internal calibration sequence.				
Begin azimuth angle load commands for solar calibration				
06/25/86	13:00:22	780	419	Address azimuth position A
	13:00:54	781	2xx	Data command, high byte
	13:01:26	781	1xx	Data command, low byte
End azimuth angle load commands (A = 123.15°).				
Begin solar calibration sequence				
06/25/86	13:01:58	782	8A2	Begin solar calibration
	13:02:30	783	852	Solar port heaters off
	13:03:02	783	822	Elevate to solar ports (Sun)
	13:03:34	784	814	Azimuth to position A
	13:04:06	784	882	Detector bias heater on at level 1
	13:13:42	794	851	Solar port heaters on
	13:14:14	794	831	SMA shutter cycle on
	13:45:10	825	832	SMA shutter cycle off
	13:45:42	826	852	Solar port heaters off
	13:46:14	826	813	Azimuth to 180°
	13:46:46	827	881	Detector bias heater off
	13:56:22	836	823	Elevate to nadir (Earth)
	13:56:54	837	851	Solar port heaters on
	End solar calibration sequence.			
Begin azimuth angle load commands for 170°				
06/25/86	14:02:14	842	419	Address azimuth position A
	14:02:46	843	2xx	Data command, high byte
	14:03:18	843	1xx	Data command, low byte
End azimuth angle load commands (A = 170°)				
06/25/86	14:03:50	844	814	Azimuth to position A
Begin preinternal calibration sequence				
07/09/86	09:21:42	562	821	Elevate to internal source (stow)
	09:22:14	562	862	WFOV BB heater on at temp. 1

Table 8. Continued

(a) Continued

Date	Universal time		Hex command	Event description
	hr:min:sec	Minutes of day		
07/09/86	09:37:42	578	872	MFOV BB heater on at temp. 1
	11:04:38	665	823	Elevate to nadir (Earth)
End preinternal calibration sequence. Begin internal calibration sequence				
07/09/86	11:05:10	665	8A1	Begin internal calibration
	11:05:42	666	881	Detector bias heater off
	11:06:14	666	852	Solar port heaters off
	11:06:46	667	821	Elevate to internal source (stow)
	11:07:18	667	851	Solar port heaters on
	11:09:26	669	882	Detector bias heater on at level 1
	11:11:34	672	892	SWICS on at level 3
	11:14:46	675	881	Detector bias heater off
	11:18:30	679	862	WFOV BB heater on at temp. 1
	11:19:02	679	872	MFOV BB heater on at temp. 1
	11:20:06	680	891	SWICS off
	11:33:26	693	883	Detector bias heater on at level 2
	11:35:34	696	893	SWICS on at level 2
	11:38:46	699	881	Detector bias heater off
	11:42:30	703	863	WFOV BB heater on at temp. 2
	11:43:02	703	873	MFOV BB heater on at temp. 2
	11:44:06	704	891	SWICS off
	11:57:26	717	884	Detector bias heater on at level 3
	11:59:34	720	894	SWICS on at level 1
	12:01:42	722	881	Detector bias heater off
	12:04:22	724	852	Solar port heaters off
	12:05:26	725	861	WFOV BB heater off
	12:05:58	726	871	MFOV BB heater off
	12:06:30	727	851	Solar port heaters on
12:07:02	727	891	SWICS off	
End internal calibration sequence. Begin azimuth angle load commands for solar calibration				
07/09/86	12:09:42	730	419	Address azimuth position A
	12:10:14	730	2xx	Data command, high byte
	12:10:46	731	1xx	Data command, low byte
End azimuth angle load commands (A = 123.3°). Begin solar calibration sequence				
07/09/86	12:11:18	731	8A2	Begin solar calibration
	12:11:50	732	852	Solar port heaters off
	12:12:22	732	822	Elevate to solar ports (Sun)
	12:12:54	733	814	Azimuth to position A
	12:13:26	733	882	Detector bias heater on at level 1
	12:23:02	743	851	Solar port heaters on
	12:23:34	744	831	SMA shutter cycle on
	12:54:30	775	832	SMA shutter cycle off

Table 8. Continued

(a) Continued

Date	Universal time		Hex command	Event description
	hr:min:sec	Minutes of day		
07/09/86	12:55:02	775	852	Solar port heaters off
	12:55:34	776	813	Azimuth to 180°
	12:56:06	776	881	Detector bias heater off
	13:05:42	786	823	Elevate to nadir (Earth)
	13:06:14	786	851	Solar port heaters on
End solar calibration sequence.				
Begin azimuth angle load commands for 170°				
07/09/86	13:11:34	792	419	Address azimuth position A
	13:12:06	792	2xx	Data command, high byte
	13:12:38	793	1xx	Data command, low byte
End azimuth angle load commands (A = 170°)				
07/09/86	13:13:10	793	814	Azimuth to position A
Begin preinternal calibration sequence				
07/23/86	10:12:54	613	821	Elevate to internal source (stow)
	10:13:26	613	862	WFOV BB heater on at temp. 1
	10:28:54	629	872	MFOV BB heater on at temp. 1
	11:55:50	716	823	Elevate to nadir (Earth)
End preinternal calibration sequence.				
Begin internal calibration sequence				
07/23/86	11:56:22	716	8A1	Begin internal calibration
	11:56:54	717	881	Detector bias heater off
	11:57:26	717	852	Solar port heaters off
	11:57:58	718	821	Elevate to internal source (stow)
	11:58:30	719	851	Solar port heaters on
	12:00:38	721	882	Detector bias heater on at level 1
	12:02:46	723	892	SWICS on at level 3
	12:05:58	726	881	Detector bias heater off
	12:09:42	730	862	WFOV BB heater on at temp. 1
	12:10:14	730	872	MFOV BB heater on at temp. 1
	12:11:18	731	891	SWICS off
	12:24:38	745	883	Detector bias heater on at level 2
	12:26:46	747	893	SWICS on at level 2
	12:29:58	750	881	Detector bias heater off
	12:33:42	754	863	WFOV BB heater on at temp. 2
	12:34:14	754	873	MFOV BB heater on at temp. 2
	12:35:18	755	891	SWICS off
	12:48:38	769	884	Detector bias heater on at level 3
	12:50:46	771	894	SWICS on at level 1
	12:52:54	773	881	Detector bias heater off
	12:55:34	776	852	Solar port heaters off
	12:56:38	777	861	WFOV BB heater off
	12:57:10	777	871	MFOV BB heater off

Table 8. Continued

(a) Continued

Date	Universal time		Hex command	Event description
	hr:min:sec	Minutes of day		
07/23/86	12:57:42	778	851	Solar port heaters on
	12:58:14	778	891	SWICS off
End internal calibration sequence.				
Begin azimuth angle load commands for solar calibration				
07/23/86	13:00:54	781	419	Address azimuth position A
	13:01:26	781	2xx	Data command, high byte
	13:01:58	782	1xx	Data command, low byte
End azimuth angle load commands (A = 124.35°).				
Begin solar calibration sequence				
07/23/86	13:02:30	783	8A2	Begin solar calibration
	13:03:02	783	852	Solar port heaters off
	13:03:34	784	822	Elevate to solar ports (Sun)
	13:04:06	784	814	Azimuth to position A
	13:04:38	785	882	Detector bias heater on at level 1
	13:14:14	794	851	Solar port heaters on
	13:14:46	795	831	SMA shutter cycle on
	13:45:42	826	832	SMA shutter cycle off
	13:46:14	826	852	Solar port heaters off
	13:46:46	827	813	Azimuth to 180°
	13:47:18	827	881	Detector bias heater off
	13:56:54	837	823	Elevate to nadir (Earth)
	13:57:26	837	851	Solar port heaters on
End solar calibration sequence.				
Begin azimuth angle load commands for 170°				
07/23/86	14:02:46	843	419	Address azimuth position A
	14:03:18	843	2xx	Data command, high byte
	14:03:50	844	1xx	Data command, low byte
End azimuth angle load commands (A = 170°)				
07/23/86	14:04:22	844	814	Azimuth to position A
Begin preinternal calibration sequence				
08/06/86	09:22:14	562	821	Elevate to internal source (stow)
	09:22:46	563	862	WFOV BB heater on at temp. 1
	09:38:14	578	872	MFOV BB heater on at temp. 1
	11:05:10	665	823	Elevate to nadir (Earth)
End preinternal calibration sequence.				
Begin internal calibration sequence				
08/06/86	11:05:42	666	8A1	Begin internal calibration
	11:06:14	666	881	Detector bias heater off
	11:06:46	667	852	Solar port heaters off
	11:07:18	667	821	Elevate to internal source (stow)
	11:07:50	668	851	Solar port heaters on
	11:09:58	670	882	Detector bias heater on at level 1
	11:12:06	672	892	SWICS on at level 3
	11:15:18	675	881	Detector bias heater off

Table 8. Continued

(a) Continued

Date	Universal time		Hex command	Event description
	hr:min:sec	Minutes of day		
08/06/86	11:19:02	679	862	WFOV BB heater on at temp. 1
	11:19:34	680	872	MFOV BB heater on at temp. 1
	11:20:38	681	891	SWICS off
	11:33:58	694	883	Detector bias heater on at level 2
	11:36:06	696	893	SWICS on at level 2
	11:39:18	699	881	Detector bias heater off
	11:43:02	703	863	WFOV BB heater on at temp. 2
	11:43:34	704	873	MFOV BB heater on at temp. 2
	11:44:38	705	891	SWICS off
	11:57:58	718	884	Detector bias heater on at level 3
	12:00:06	720	894	SWICS on at level 1
	12:02:14	722	881	Detector bias heater off
	12:04:54	725	852	Solar port heaters off
	12:05:58	726	861	WFOV BB heater off
	12:06:30	727	871	MFOV BB heater off
	12:07:02	727	851	Solar port heaters on
12:07:34	728	891	SWICS off	
End internal calibration sequence.				
Begin azimuth angle load commands for solar calibration				
08/06/86	12:10:14	730	419	Address azimuth position A
	12:10:46	731	2xx	Data command, high byte
	12:11:18	731	1xx	Data command, low byte
End azimuth angle load commands ( $A = 126.15^\circ$ ).				
Begin solar calibration sequence				
08/06/86	12:11:50	732	8A2	Begin solar calibration
	12:12:22	732	852	Solar port heaters off
	12:12:54	733	822	Elevate to solar ports (Sun)
	12:13:26	733	814	Azimuth to position A
	12:13:58	734	882	Detector bias heater on at level 1
	12:23:34	744	851	Solar port heaters on
	12:24:06	744	831	SMA shutter cycle on
	12:55:02	775	832	SMA shutter cycle off
	12:55:34	776	852	Solar port heaters off
	12:56:06	776	813	Azimuth to $180^\circ$
	12:56:38	777	881	Detector bias heater off
	13:06:14	786	823	Elevate to nadir (Earth)
	13:06:46	787	851	Solar port heaters on
End solar calibration sequence.				
Begin azimuth angle load commands for $170^\circ$				
08/06/86	13:12:06	792	419	Address azimuth position A
	13:12:38	793	2xx	Data command, high byte
	13:13:10	793	1xx	Data command, low byte
End azimuth angle load commands ( $A = 170^\circ$ )				
08/06/86	13:13:42	794	814	Azimuth to position A

Table 8. Continued

(a) Continued

Date	Universal time		Hex command	Event description
	hr:min:sec	Minutes of day		
Begin preinternal calibration sequence				
08/20/86	10:12:55	613	821	Elevate to internal source (stow)
	10:13:27	613	862	WFOV BB heater on at temp. 1
	10:28:55	629	872	MFOV BB heater on at temp. 1
	11:55:51	716	823	Elevate to nadir (Earth)
End preinternal calibration sequence.				
Begin internal calibration sequence				
08/20/86	11:56:23	716	8A1	Begin internal calibration
	11:56:55	717	881	Detector bias heater off
	11:57:27	717	852	Solar port heaters off
	11:57:59	718	821	Elevate to internal source (stow)
	11:58:31	719	851	Solar port heaters on
	12:00:39	721	882	Detector bias heater on at level 1
	12:02:47	723	892	SWICS on at level 3
	12:05:59	726	881	Detector bias heater off
	12:09:43	730	862	WFOV BB heater on at temp. 1
	12:10:15	730	872	MFOV BB heater on at temp. 1
	12:11:19	731	891	SWICS off
	12:24:39	745	883	Detector bias heater on at level 2
	12:26:47	747	893	SWICS on at level 2
	12:29:59	750	881	Detector bias heater off
	12:33:43	754	863	WFOV BB heater on at temp. 2
	12:34:15	754	873	MFOV BB heater on at temp. 2
	12:35:19	755	891	SWICS off
	12:48:39	769	884	Detector bias heater on at level 3
	12:50:47	771	894	SWICS on at level 1
	12:52:55	773	881	Detector bias heater off
	12:55:35	776	852	Solar port heaters off
	12:56:39	777	861	WFOV BB heater off
	12:57:11	777	871	MFOV BB heater off
	12:57:43	778	851	Solar port heaters on
12:58:15	778	891	SWICS off	
End internal calibration sequence.				
Begin azimuth angle load commands for solar calibration				
08/20/86	13:00:55	781	419	Address azimuth position A
	13:01:27	781	2xx	Data command, high byte
	13:01:59	782	1xx	Data command, low byte
End azimuth angle load commands (A = 128.7°).				
Begin solar calibration sequence				
08/20/86	13:02:31	783	8A2	Begin solar calibration
	13:03:03	783	852	Solar port heaters off
	13:03:35	784	822	Elevate to solar ports (Sun)
	13:04:07	784	814	Azimuth to position A
	13:04:39	785	882	Detector bias heater on at level 1



Table 8. Continued

(a) Continued

Date	Universal time		Hex command	Event description
	hr:min:sec	Minutes of day		
08/20/86	13:14:15	794	851	Solar port heaters on
	13:14:47	795	831	SMA shutter cycle on
	13:45:43	826	832	SMA shutter cycle off
	13:46:15	826	852	Solar port heaters off
	13:46:47	827	813	Azimuth to 180°
	13:47:19	827	881	Detector bias heater off
	13:56:55	837	823	Elevate to nadir (Earth)
	13:57:27	837	851	Solar port heaters on
End solar calibration sequence.				
Begin azimuth angle load commands for 170°				
08/20/86	14:02:47	843	419	Address azimuth position A
	14:03:19	843	2xx	Data command, high byte
	14:03:51	844	1xx	Data command, low byte
End azimuth angle load commands (A = 170°)				
08/20/86	14:04:23	844	814	Azimuth to position A
Begin preinternal calibration sequence				
09/03/86	09:21:11	561	821	Elevate to internal source (stow)
	09:21:43	562	862	WFOV BB heater on at temp. 1
	09:37:11	577	872	MFOV BB heater on at temp. 1
	11:04:07	664	823	Elevate to nadir (Earth)
End preinternal calibration sequence.				
Begin internal calibration sequence				
09/03/86	11:04:39	665	8A1	Begin internal calibration
	11:05:11	665	881	Detector bias heater off
	11:05:43	666	852	Solar port heaters off
	11:06:15	666	821	Elevate to internal source (stow)
	11:06:47	667	851	Solar port heaters on
	11:08:55	669	882	Detector bias heater on at level 1
	11:11:03	671	892	SWICS on at level 3
	11:14:15	674	881	Detector bias heater off
	11:17:59	678	862	WFOV BB heater on at temp. 1
	11:18:31	679	872	MFOV BB heater on at temp. 1
	11:19:35	680	891	SWICS off
	11:32:55	693	883	Detector bias heater on at level 2
	11:35:03	695	893	SWICS on at level 2
	11:38:15	698	881	Detector bias heater off
	11:41:59	702	863	WFOV BB heater on at temp. 2
	11:42:31	703	873	MFOV BB heater on at temp. 2
	11:43:35	704	891	SWICS off
	11:56:55	717	884	Detector bias heater on at level 3
	11:59:03	719	894	SWICS on at level 1
	12:01:11	721	881	Detector bias heater off
	12:03:51	724	852	Solar port heaters off
	12:04:55	725	861	WFOV BB heater off

Table 8. Continued

(a) Continued

Date	Universal time		Hex command	Event description
	hr:min:sec	Minutes of day		
09/03/86	12:05:27	725	871	MFOV BB heater off
	12:05:59	726	851	Solar port heaters on
	12:06:31	727	891	SWICS off
End internal calibration sequence.				
Begin azimuth angle load commands for solar calibration				
09/03/86	12:09:11	729	419	Address azimuth position A
	12:09:43	730	2xx	Data command, high byte
	12:10:15	730	1xx	Data command, low byte
End azimuth angle load commands (A = 1131.63°).				
Begin solar calibration sequence				
09/03/86	12:10:47	731	8A2	Begin solar calibration
	12:11:19	731	852	Solar port heaters off
	12:11:51	732	822	Elevate to solar ports (Sun)
	12:12:23	732	814	Azimuth to position A
	12:12:55	733	882	Detector bias heater on at level 1
	12:22:31	743	851	Solar port heaters on
	12:23:03	743	831	SMA shutter cycle on
	12:53:59	774	832	SMA shutter cycle off
	12:54:31	775	852	Solar port heaters off
	12:55:03	775	813	Azimuth to 180°
	12:55:35	776	881	Detector bias heater off
	13:05:11	785	823	Elevate to nadir (Earth)
	13:05:43	786	851	Solar port heaters on
End solar calibration sequence.				
Begin azimuth angle load commands for 170°				
09/03/86	13:11:03	791	419	Address azimuth position A
	13:11:35	792	2xx	Data command, high byte
	13:12:07	792	1xx	Data command, low byte
End azimuth angle load commands (A = 170°)				
09/03/86	13:12:39	793	814	Azimuth to position A
Begin preinternal calibration sequence				
09/17/86	10:11:19	611	821	Elevate to internal source (stow)
	10:11:51	612	862	WFOV BB heater on at temp. 1
	10:27:19	627	872	MFOV BB heater on at temp. 1
	11:54:15	714	823	Elevate to nadir (Earth)
End preinternal calibration sequence.				
Begin internal calibration sequence				
09/17/86	11:54:47	715	8A1	Begin internal calibration
	11:55:19	715	881	Detector bias heater off
	11:55:51	716	852	Solar port heaters off
	11:56:23	716	821	Elevate to internal source (stow)
	11:56:55	717	851	Solar port heaters on
	11:59:03	719	882	Detector bias heater on at level 1
	12:01:11	721	892	SWICS on at level 3

Table 8. Continued

(a) Continued

Date	Universal time		Hex command	Event description
	hr:min:sec	Minutes of day		
09/17/86	12:04:23	724	881	Detector bias heater off
	12:08:07	728	862	WFOV BB heater on at temp. 1
	12:08:39	729	872	MFOV BB heater on at temp. 1
	12:09:43	730	891	SWICS off
	12:23:03	743	883	Detector bias heater on at level 2
	12:25:11	745	893	SWICS on at level 2
	12:28:23	748	881	Detector bias heater off
	12:32:07	752	863	WFOV BB heater on at temp. 2
	12:32:39	753	873	MFOV BB heater on at temp. 2
	12:33:43	754	891	SWICS off
	12:47:03	767	884	Detector bias heater on at level 3
	12:49:11	769	894	SWICS on at level 1
	12:51:19	771	881	Detector bias heater off
	12:53:59	774	852	Solar port heaters off
	12:55:03	775	861	WFOV BB heater off
	12:55:35	776	871	MFOV BB heater off
	12:56:07	776	851	Solar port heaters on
12:56:39	777	891	SWICS off	
End internal calibration sequence.				
Begin azimuth angle load commands for solar calibration				
09/17/86	12:59:19	779	419	Address azimuth position A
	12:59:51	780	2xx	Data command, high byte
	13:00:23	780	1xx	Data command, low byte
End azimuth angle load commands (A = 134.7°).				
Begin solar calibration sequence				
09/17/86	13:00:55	781	8A2	Begin solar calibration
	13:01:27	781	852	Solar port heaters off
	13:01:59	782	822	Elevate to solar ports (Sun)
	13:02:31	783	814	Azimuth to position A
	13:03:03	783	882	Detector bias heater on at level 1
	13:12:39	793	851	Solar port heaters on
	13:13:11	793	831	SMA shutter cycle on
	13:44:07	824	832	SMA shutter cycle off
	13:44:39	825	852	Solar port heaters off
	13:45:11	825	813	Azimuth to 180°
	13:45:43	826	881	Detector bias heater off
	13:55:19	835	823	Elevate to nadir (Earth)
	13:55:51	836	851	Solar port heaters on
	End solar calibration sequence.			
Begin azimuth angle load commands for 170°				
09/17/86	14:01:11	841	419	Address azimuth position A
	14:01:43	842	2xx	Data command, high byte
	14:02:15	842	1xx	Data command, low byte
End azimuth angle load commands (A = 170°)				

Table 8. Continued

(a) Continued

Date	Universal time		Hex command	Event description
	hr:min:sec	Minutes of day		
09/17/86	14:02:47	843	814	Azimuth to position A
Begin preinternal calibration sequence				
10/01/86	09:19:03	559	821	Elevate to internal source (stow)
	09:19:35	560	862	WFOV BB heater on at temp. 1
	09:35:03	575	872	MFOV BB heater on at temp. 1
	11:01:59	662	823	Elevate to nadir (Earth)
End preinternal calibration sequence.				
Begin internal calibration sequence				
10/01/86	11:02:31	663	8A1	Begin internal calibration
	11:03:03	663	881	Detector bias heater off
	11:03:35	664	852	Solar port heaters off
	11:04:07	664	821	Elevate to internal source (stow)
	11:04:39	665	851	Solar port heaters on
	11:06:47	667	882	Detector bias heater on at level 1
	11:08:55	669	892	SWICS on at level 3
	11:12:07	672	881	Detector bias heater off
	11:15:51	676	862	WFOV BB heater on at temp. 1
	11:16:23	676	872	MFOV BB heater on at temp. 1
	11:17:27	677	891	SWICS off
	11:30:47	691	883	Detector bias heater on at level 2
	11:32:55	693	893	SWICS on at level 2
	11:36:07	696	881	Detector bias heater off
	11:39:51	700	863	WFOV BB heater on at temp. 2
	11:40:23	700	873	MFOV BB heater on at temp. 2
	11:41:27	701	891	SWICS off
	11:54:47	715	884	Detector bias heater on at level 3
	11:56:55	717	894	SWICS on at level 1
	11:59:03	719	881	Detector bias heater off
12:01:43	722	852	Solar port heaters off	
12:02:47	723	861	WFOV BB heater off	
12:03:19	723	871	MFOV BB heater off	
12:03:51	724	851	Solar port heaters on	
12:04:23	724	891	SWICS off	
End internal calibration sequence.				
Begin azimuth angle load commands for solar calibration				
10/01/86	12:07:03	727	419	Address azimuth position A
	12:07:35	728	2xx	Data command, high byte
	12:08:07	728	1xx	Data command, low byte
End azimuth angle load commands ( $A = 137.33^\circ$ ).				
Begin solar calibration sequence				
10/01/86	12:08:39	729	8A2	Begin solar calibration
	12:09:11	729	852	Solar port heaters off
	12:09:43	730	822	Elevate to solar ports (Sun)
	12:10:15	730	814	Azimuth to position A

Table 8. Continued

(a) Continued

Date	Universal time		Hex command	Event description
	hr:min:sec	Minutes of day		
10/01/86	12:10:47	731	882	Detector bias heater on at level 1
	12:20:23	740	851	Solar port heaters on
	12:20:55	741	831	SMA shutter cycle on
	12:51:51	772	832	SMA shutter cycle off
	12:52:23	772	852	Solar port heaters off
	12:52:55	773	813	Azimuth to 180°
	12:53:27	773	881	Detector bias heater off
	13:03:03	783	823	Elevate to nadir (Earth)
	13:03:35	784	851	Solar port heaters on
End solar calibration sequence. Begin azimuth angle load commands for 170°				
10/01/86	13:08:55	789	419	Address azimuth position A
	13:09:27	789	2xx	Data command, high byte
	13:09:59	790	1xx	Data command, low byte
End azimuth angle load commands (A = 170°)				
10/01/86	13:10:31	791	814	Azimuth to position A
Begin preinternal calibration sequence				
10/15/86	10:09:11	609	821	Elevate to internal source (stow)
	10:09:43	610	862	WFOV BB heater on at temp. 1
	10:25:11	625	872	MFOV BB heater on at temp. 1
	11:52:07	712	823	Elevate to nadir (Earth)
End preinternal calibration sequence. Begin internal calibration sequence				
10/15/86	11:52:39	713	8A1	Begin internal calibration
	11:53:11	713	881	Detector bias heater off
	11:53:43	714	852	Solar port heaters off
	11:54:15	714	821	Elevate to internal source (stow)
	11:54:47	715	851	Solar port heaters on
	11:56:55	717	882	Detector bias heater on at level 1
	11:59:03	719	892	SWICS on at level 3
	12:02:15	722	881	Detector bias heater off
	12:05:59	726	862	WFOV BB heater on at temp. 1
	12:06:31	727	872	MFOV BB heater on at temp. 1
	12:07:35	728	891	SWICS off
	12:20:55	741	883	Detector bias heater on at level 2
	12:23:03	743	893	SWICS on at level 2
	12:26:15	746	881	Detector bias heater off
	12:29:59	750	863	WFOV BB heater on at temp. 2
	12:30:31	751	873	MFOV BB heater on at temp. 2
	12:31:35	752	891	SWICS off
	12:44:55	765	884	Detector bias heater on at level 3
	12:47:03	767	894	SWICS on at level 1
	12:49:11	769	881	Detector bias heater off
	12:51:51	772	852	Solar port heaters off

Table 8. Continued

(a) Continued

Date	Universal time		Hex command	Event description
	hr:min:sec	Minutes of day		
10/15/86	12:52:55	773	861	WFOV BB heater off
	12:53:27	773	871	MFOV BB heater off
	12:53:59	774	851	Solar port heaters on
	12:54:31	775	891	SWICS off
End internal calibration sequence. Begin azimuth angle load commands for solar calibration				
10/15/86	12:57:11	777	419	Address azimuth position A
	12:57:43	778	2xx	Data command, high byte
	12:58:15	778	1xx	Data command, low byte
End azimuth angle load commands (A = 139.28°). Begin solar calibration sequence				
10/15/86	12:58:47	779	8A2	Begin solar calibration
	12:59:19	779	852	Solar port heaters off
	12:59:51	780	822	Elevate to solar ports (Sun)
	13:00:23	780	814	Azimuth to position A
	13:00:55	781	882	Detector bias heater on at level 1
	13:10:31	791	851	Solar port heaters on
	13:11:03	791	831	SMA shutter cycle on
	13:41:59	822	832	SMA shutter cycle off
	13:42:31	823	852	Solar port heaters off
	13:43:03	823	813	Azimuth to 180°
	13:43:35	824	881	Detector bias heater off
	13:53:11	833	823	Elevate to nadir (Earth)
13:53:43	834	851	Solar port heaters on	
End solar calibration sequence. Begin azimuth angle load commands for 170°				
10/15/86	13:59:03	839	419	Address azimuth position A
	13:59:35	840	2xx	Data command, high byte
	14:00:07	840	1xx	Data command, low byte
End azimuth angle load commands (A = 170°)				
10/15/86	14:00:39	841	814	Azimuth to position A
Begin preinternal calibration sequence				
10/29/86	09:16:23	556	821	Elevate to internal source (stow)
	09:16:55	557	862	WFOV BB heater on at temp. 1
	09:32:23	572	872	MFOV BB heater on at temp. 1
	10:59:19	659	823	Elevate to nadir (Earth)
End preinternal calibration sequence. Begin internal calibration sequence				
10/29/86	10:59:51	660	8A1	Begin internal calibration
	11:00:23	660	881	Detector bias heater off
	11:00:55	661	852	Solar port heaters off
	11:01:27	661	821	Elevate to internal source (stow)
	11:01:59	662	851	Solar port heaters on
	11:04:07	664	882	Detector bias heater on at level 1

Table 8. Continued

(a) Continued

Date	Universal time		Hex command	Event description
	hr:min:sec	Minutes of day		
10/29/86	11:06:15	666	892	SWICS on at level 3
	11:09:27	669	881	Detector bias heater off
	11:13:11	673	862	WFOV BB heater on at temp. 1
	11:13:43	674	872	MFOV BB heater on at temp. 1
	11:14:47	675	891	SWICS off
	11:28:07	688	883	Detector bias heater on at level 2
	11:30:15	690	893	SWICS on at level 2
	11:33:27	693	881	Detector bias heater off
	11:37:11	697	863	WFOV BB heater on at temp. 2
	11:37:43	698	873	MFOV BB heater on at temp. 2
	11:38:47	699	891	SWICS off
	11:52:07	712	884	Detector bias heater on at level 3
	11:54:15	714	894	SWICS on at level 1
	11:56:23	716	881	Detector bias heater off
	11:59:03	719	852	Solar port heaters off
	12:00:07	720	861	WFOV BB heater off
	12:00:39	721	871	MFOV BB heater off
	12:01:11	721	851	Solar port heaters on
	12:01:43	722	891	SWICS off
End internal calibration sequence.				
Begin azimuth angle load commands for solar calibration				
10/29/86	12:04:23	724	419	Address azimuth position A
	12:04:55	725	2xx	Data command, high byte
	12:05:27	725	1xx	Data command, low byte
End azimuth angle load commands ( $A = 140.25^\circ$ ).				
Begin solar calibration sequence				
10/29/86	12:05:59	726	8A2	Begin solar calibration
	12:06:31	727	852	Solar port heaters off
	12:07:03	727	822	Elevate to solar ports (Sun)
	12:08:07	728	882	Detector bias heater on at level 1
	12:17:43	738	851	Solar port heaters on
	12:18:15	738	831	SMA shutter cycle on
	12:49:11	769	832	SMA shutter cycle off
	12:49:43	770	852	Solar port heaters off
	12:50:15	770	813	Azimuth to $180^\circ$
	12:50:47	771	881	Detector bias heater off
	13:00:23	780	823	Elevate to nadir (Earth)
	13:00:55	781	851	Solar port heaters on
End solar calibration sequence.				
Begin azimuth angle load commands for $170^\circ$				
10/29/86	13:06:15	786	419	Address azimuth position A
	13:06:47	787	2xx	Data command, high byte
	13:07:19	787	1xx	Data command, low byte
End azimuth angle load commands ( $A = 170^\circ$ )				

Table 8. Continued

(a) Continued

Date	Universal time		Hex command	Event description
	hr:min:sec	Minutes of day		
10/29/86	13:07:51	788	814	Azimuth to position A
Begin preinternal calibration sequence				
11/12/86	10:06:32	607	821	Elevate to internal source (stow)
	10:07:04	607	862	WFOV BB heater on at temp. 1
	10:22:32	623	872	MFOV BB heater on at temp. 1
	11:49:28	709	823	Elevate to nadir (Earth)
End preinternal calibration sequence.				
Begin internal calibration sequence				
11/12/86	11:50:00	710	8A1	Begin internal calibration
	11:50:32	711	881	Detector bias heater off
	11:51:04	711	852	Solar port heaters off
	11:51:36	712	821	Elevate to internal source (stow)
	11:52:08	712	851	Solar port heaters on
	11:54:16	714	882	Detector bias heater on at level 1
	11:56:24	716	892	SWICS on at level 3
	11:59:36	720	881	Detector bias heater off
	12:03:20	723	862	WFOV BB heater on at temp. 1
	12:03:52	724	872	MFOV BB heater on at temp. 1
	12:04:56	725	891	SWICS off
	12:18:16	738	883	Detector bias heater on at level 2
	12:20:24	740	893	SWICS on at level 2
	12:23:36	744	881	Detector bias heater off
	12:27:20	747	863	WFOV BB heater on at temp. 2
	12:27:52	748	873	MFOV BB heater on at temp. 2
	12:28:56	749	891	SWICS off
	12:42:16	762	884	Detector bias heater on at level 3
	12:44:24	764	894	SWICS on at level 1
	12:46:32	767	881	Detector bias heater off
12:49:12	769	852	Solar port heaters off	
12:50:16	770	861	WFOV BB heater off	
12:50:48	771	871	MFOV BB heater off	
12:51:20	771	851	Solar port heaters on	
12:51:52	772	891	SWICS off	
End internal calibration sequence.				
Begin azimuth angle load commands for solar calibration				
11/12/86	12:54:32	775	419	Address azimuth position A
	12:55:04	775	2xx	Data command, high byte
	12:55:36	776	1xx	Data command, low byte
End azimuth angle load commands (A = 140.1°).				
Begin solar calibration sequence				
11/12/86	12:56:08	776	8A2	Begin solar calibration
	12:56:40	777	852	Solar port heaters off
	12:57:12	777	822	Elevate to solar ports (Sun)
	12:57:44	778	814	Azimuth to position A



Table 8. Continued

(a) Continued

Date	Universal time		Hex command	Event description
	hr:min:sec	Minutes of day		
11/12/86	12:58:16	778	882	Detector bias heater on at level 1
	13:07:52	788	851	Solar port heaters on
	13:08:24	788	831	SMA shutter cycle on
	13:39:20	819	832	SMA shutter cycle off
	13:39:52	820	852	Solar port heaters off
	13:40:24	820	813	Azimuth to 180°
	13:40:56	821	881	Detector bias heater off
	13:50:32	831	823	Elevate to nadir (Earth)
	13:51:04	831	851	Solar port heaters on
End solar calibration sequence. Begin azimuth angle load commands for 170°				
11/12/86	13:56:24	836	419	Address azimuth position A
	13:56:56	837	2xx	Data command, high byte
	13:57:28	837	1xx	Data command, low byte
End azimuth angle load commands (A = 170°)				
11/12/86	13:58:00	838	814	Azimuth to position A
Begin preinternal calibration sequence				
11/26/86	09:14:32	555	821	Elevate to internal source (stow)
	09:14:48	555	862	WFOV BB heater on at temp. 1
	09:30:16	570	872	MFOV BB heater on at temp. 1
	10:57:12	657	823	Elevate to nadir (Earth)
End preinternal calibration sequence. Begin internal calibration sequence				
11/26/86	10:57:44	658	8A1	Begin internal calibration
	10:58:16	658	881	Detector bias heater off
	10:58:48	659	852	Solar port heaters off
	10:59:20	659	821	Elevate to internal source (stow)
	10:59:52	660	851	Solar port heaters on
	11:02:00	662	882	Detector bias heater on at level 1
	11:04:08	664	892	SWICS on at level 3
	11:07:20	667	881	Detector bias heater off
	11:11:04	671	862	WFOV BB heater on at temp. 1
	11:11:36	672	872	MFOV BB heater on at temp. 1
	11:12:40	673	891	SWICS off
	11:26:00	686	883	Detector bias heater on at level 2
	11:28:08	688	893	SWICS on at level 2
	11:31:20	691	881	Detector bias heater off
	11:35:04	695	863	WFOV BB heater on at temp. 2
	11:35:36	696	873	MFOV BB heater on at temp. 2
	11:36:40	697	891	SWICS off
	11:50:00	710	884	Detector bias heater on at level 3
	11:52:08	712	894	SWICS on at level 1
	11:54:16	714	881	Detector bias heater off
11:56:56	717	852	Solar port heaters off	

Table 8. Continued

(a) Continued

Date	Universal time		Hex command	Event description
	hr:min:sec	Minutes of day		
11/26/86	11:58:00	718	861	WFOV BB heater off
	11:58:32	719	871	MFOV BB heater off
	11:59:04	719	851	Solar port heaters on
	11:59:36	720	891	SWICS off
End internal calibration sequence. Begin azimuth angle load commands for solar calibration				
11/26/86	12:02:16	722	419	Address azimuth position A
	12:02:48	723	2xx	Data command, high byte
	12:03:20	723	1xx	Data command, low byte
End azimuth angle load commands ( $A = 139.13^\circ$ ). Begin solar calibration sequence				
11/26/86	12:03:52	724	8A2	Begin solar calibration
	12:04:24	724	852	Solar port heaters off
	12:04:56	725	822	Elevate to solar ports (Sun)
	12:05:28	725	814	Azimuth to position A
	12:06:00	726	882	Detector bias heater on at level 1
	12:15:36	736	851	Solar port heaters on
	12:16:08	736	831	SMA shutter cycle on
	12:47:04	767	832	SMA shutter cycle off
	12:47:36	768	852	Solar port heaters off
	12:48:08	768	813	Azimuth to $180^\circ$
	12:48:40	769	881	Detector bias heater off
	12:58:16	778	823	Elevate to nadir (Earth)
	12:58:48	779	851	Solar port heaters on
End solar calibration sequence. Begin azimuth angle load commands for $170^\circ$				
11/26/86	13:04:08	784	419	Address azimuth position A
	13:04:40	785	2xx	Data command, high byte
	13:05:12	785	1xx	Data command, low byte
End azimuth angle load commands ( $A = 170^\circ$ )				
11/26/86	13:05:44	786	814	Azimuth to position A
Begin preinternal calibration sequence				
12/10/86	10:04:56	605	821	Elevate to internal source (stow)
	10:05:28	605	862	WFOV BB heater on at temp. 1
	10:20:56	621	872	MFOV BB heater on at temp. 1
	11:47:52	708	823	Elevate to nadir (Earth)
End preinternal calibration sequence. Begin internal calibration sequence				
12/10/86	11:48:24	708	8A1	Begin internal calibration
	11:48:56	709	881	Detector bias heater off
	11:49:28	709	852	Solar port heaters off
	11:50:00	710	821	Elevate to internal source (stow)
	11:50:32	711	851	Solar port heaters on
	11:52:40	713	882	Detector bias heater on at level 1

Table 8. Continued

(a) Continued

Date	Universal time		Hex command	Event description	
	hr:min:sec	Minutes of day			
12/10/86	11:54:48	715	892	SWICS on at level 3	
	11:58:00	718	881	Detector bias heater off	
	12:01:44	722	862	WFOV BB heater on at temp. 1	
	12:02:16	722	872	MFOV BB heater on at temp. 1	
	12:03:20	723	891	SWICS off	
	12:16:40	737	883	Detector bias heater on at level 2	
	12:18:48	739	893	SWICS on at level 2	
	12:22:00	742	881	Detector bias heater off	
	12:25:44	746	863	WFOV BB heater on at temp. 2	
	12:26:16	746	873	MFOV BB heater on at temp. 2	
	12:27:20	747	891	SWICS off	
	12:40:40	761	884	Detector bias heater on at level 3	
	12:42:48	763	894	SWICS on at level 1	
	12:44:56	765	881	Detector bias heater off	
	12:47:36	768	852	Solar port heaters off	
	12:48:40	769	861	WFOV BB heater off	
	12:49:12	769	871	MFOV BB heater off	
	12:49:44	770	851	Solar port heaters on	
	12:50:16	770	891	SWICS off	
End internal calibration sequence.					
Begin azimuth angle load commands for solar calibration					
12/10/86	12:52:56	773	419	Address azimuth position A	
	12:53:28	773	2xx	Data command, high byte	
	12:54:00	774	1xx	Data command, low byte	
End azimuth angle load commands (A = 137.7°).					
Begin solar calibration sequence					
12/10/86	12:54:32	775	8A2	Begin solar calibration	
	12:55:04	775	852	Solar port heaters off	
	12:55:36	776	822	Elevate to solar ports (Sun)	
	12:56:08	776	814	Azimuth to position A	
	12:56:40	777	882	Detector bias heater on at level 1	
	13:06:16	786	851	Solar port heaters on	
	13:06:48	787	831	SMA shutter cycle on	
	13:37:44	818	832	SMA shutter cycle off	
	13:38:16	818	852	Solar port heaters off	
	13:38:48	819	813	Azimuth to 180°	
	13:39:20	819	881	Detector bias heater off	
	13:48:56	829	823	Elevate to nadir (Earth)	
	13:49:28	829	851	Solar port heaters on	
	End solar calibration sequence				

Table 8. Continued

(a) Continued

Date	Universal time		Hex command	Event description	
	hr:min:sec	Minutes of day			
Begin azimuth angle load commands for 170°					
12/10/86	13:54:48	835	419	Address azimuth position A	
	13:55:20	835	2xx	Data command, high byte	
	13:55:52	836	1xx	Data command, low byte	
End azimuth angle load commands (A = 170°)					
12/10/86	13:56:24	836	814	Azimuth to position A	
Begin preinternal calibration sequence					
12/24/86	09:14:16	554	821	Elevate to internal source (stow)	
	09:14:48	555	862	WFOV BB heater on at temp. 1	
	09:30:16	570	872	MFOV BB heater on at temp. 1	
	10:57:12	657	823	Elevate to nadir (Earth)	
End preinternal calibration sequence.					
Begin internal calibration sequence					
12/24/86	10:57:44	658	8A1	Begin internal calibration	
	10:58:16	658	881	Detector bias heater off	
	10:58:48	659	852	Solar port heaters off	
	10:59:20	659	821	Elevate to internal source (stow)	
	10:59:52	660	851	Solar port heaters on	
	11:02:00	662	882	Detector bias heater on at level 1	
	11:04:08	664	892	SWICS on at level 3	
	11:07:20	667	881	Detector bias heater off	
	11:11:04	671	862	WFOV BB heater on at temp. 1	
	11:11:36	672	872	MFOV BB heater on at temp. 1	
	11:12:40	673	891	SWICS off	
	11:26:00	686	883	Detector bias heater on at level 2	
	11:28:08	688	893	SWICS on at level 2	
	11:31:20	691	881	Detector bias heater off	
	11:35:04	695	863	WFOV BB heater on at temp. 2	
	11:35:36	696	873	MFOV BB heater on at temp. 2	
	11:36:40	697	891	SWICS off	
	11:50:00	710	884	Detector bias heater on at level 3	
	11:52:08	712	894	SWICS on at level 1	
	11:54:16	714	881	Detector bias heater off	
	11:56:56	717	852	Solar port heaters off	
	11:58:00	718	861	WFOV BB heater off	
	11:58:32	719	871	MFOV BB heater off	
	11:59:04	719	851	Solar port heaters on	
	11:59:36	720	891	SWICS off	
	End internal calibration sequence.				
	Begin azimuth angle load commands for solar calibration				
12/24/86	12:02:16	722	419	Address azimuth position A	
	12:02:48	723	2xx	Data command, high byte	
	12:03:20	723	1xx	Data command, low byte	
End azimuth angle load commands (A = 136.28°)					

Table 8. Continued

(a) Continued

Date	Universal time		Hex command	Event description
	hr:min:sec	Minutes of day		
Begin solar calibration sequence				
12/24/86	12:03:52	724	8A2	Begin solar calibration
	12:04:24	724	852	Solar port heaters off
	12:04:56	725	822	Elevate to solar ports (Sun)
	12:05:28	725	814	Azimuth to position A
	12:06:00	726	882	Detector bias heater on at level 1
	12:15:36	736	851	Solar port heaters on
	12:16:08	736	831	SMA shutter cycle on
	12:47:04	767	832	SMA shutter cycle off
	12:47:36	768	852	Solar port heaters off
	12:48:08	768	813	Azimuth to 180°
	12:48:40	769	881	Detector bias heater off
	12:58:16	778	823	Elevate to nadir (Earth)
	12:58:48	779	851	Solar port heaters on
End solar calibration sequence.				
Begin azimuth angle load commands for 170°				
12/24/86	13:04:08	784	419	Address azimuth position A
	13:04:40	785	2xx	Data command, high byte
	13:05:12	785	1xx	Data command, low byte
End azimuth angle load commands (A = 170°)				
12/24/86	13:05:44	786	814	Azimuth to position A
Begin preinternal calibration sequence				
01/21/87	09:16:24	556	821	Elevate to internal source (stow)
	09:16:56	557	862	WFOV BB heater on at temp. 1
	09:32:24	572	872	MFOV BB heater on at temp. 1
	10:59:20	659	823	Elevate to nadir (Earth)
End preinternal calibration sequence.				
Begin internal calibration sequence				
01/21/87	10:59:52	660	8A1	Begin internal calibration
	11:00:24	660	881	Detector bias heater off
	11:00:56	661	852	Solar port heaters off
	11:01:28	661	821	Elevate to internal source (stow)
	11:02:00	662	851	Solar port heaters on
	11:04:08	664	882	Detector bias heater on at level 1
	11:06:16	666	892	SWICS on at level 3
	11:09:28	669	881	Detector bias heater off
	11:13:12	673	862	WFOV BB heater on at temp. 1
	11:13:44	674	872	MFOV BB heater on at temp. 1
	11:14:48	675	891	SWICS off
	11:28:08	688	883	Detector bias heater on at level 2
	11:30:16	690	893	SWICS on at level 2
	11:33:28	693	881	Detector bias heater off
	11:37:12	697	863	WFOV BB heater on at temp. 2
	11:37:44	698	873	MFOV BB heater on at temp. 2

Table 8. Continued

(a) Concluded

Date	Universal time		Hex command	Event description
	hr:min:sec	Minutes of day		
01/21/87	11:38:48	699	891	SWICS off
	11:52:08	712	884	Detector bias heater on at level 3
	11:54:16	714	894	SWICS on at level 1
	11:56:24	716	881	Detector bias heater off
	11:59:04	719	852	Solar port heaters off
	12:00:08	720	861	WFOV BB heater off
	12:00:40	721	871	MFOV BB heater off
	12:01:12	721	851	Solar port heaters on
	12:01:44	722	891	SWICS off
End internal calibration sequence.				
Begin azimuth angle load commands for solar calibration				
01/21/87	12:04:24	724	419	Address azimuth position A
	12:04:56	725	2xx	Data command, high byte
	12:05:28	725	1xx	Data command, low byte
End azimuth angle load commands ( $A = 134.48^\circ$ ).				
Begin solar calibration sequence				
01/21/87	12:06:00	726	8A2	Begin solar calibration
	12:06:32	727	852	Solar port heaters off
	12:07:04	727	822	Elevate to solar ports (Sun)
	12:07:36	728	814	Azimuth to position A
	12:08:08	728	882	Detector bias heater on at level 1
	12:17:44	738	851	Solar port heaters on
	12:18:16	738	831	SMA shutter cycle on
	12:49:12	769	832	SMA shutter cycle off
	12:49:44	770	852	Solar port heaters off
	12:50:16	770	813	Azimuth to $180^\circ$
	12:50:48	771	881	Detector bias heater off
	13:00:24	780	823	Elevate to nadir (Earth)
	13:00:56	781	851	Solar port heaters on
	End solar calibration sequence.			
Begin azimuth angle load commands for $170^\circ$				
01/21/87	13:06:16	786	419	Address azimuth position A
	13:06:48	787	2xx	Data command, high byte
	13:07:20	787	1xx	Data command, low byte
End azimuth angle load commands ( $A = 170^\circ$ )				
01/21/87	13:07:52	788	814	Azimuth to position A

Table 8. Continued

## (b) Scanner commands

Date	Universal time		Hex command	Event description
	hr:min:sec	Minutes of day		
Begin internal calibration sequence				
02/05/86	10:04:53	605	8A1	Begin internal calibration
	10:05:25	605	897	SWICS on at level 1 modulated
	10:07:01	607	895	SWICS on at level 2 modulated
	10:08:37	609	893	SWICS on at level 3 modulated
	10:10:13	610	891	SWICS off
	10:13:25	613	897	SWICS on at level 1 modulated
	10:15:01	615	895	SWICS on at level 2 modulated
	10:16:37	617	893	SWICS on at level 3 modulated
	10:18:13	618	891	SWICS off
	10:37:25	637	897	SWICS on at level 1 modulated
	10:39:01	639	895	SWICS on at level 2 modulated
	10:40:37	641	893	SWICS on at level 3 modulated
	10:42:13	642	891	SWICS off
End internal calibration sequence.				
Begin azimuth angle load commands for solar calibration				
02/05/86	14:29:57	870	419	Address azimuth position A
	14:30:29	870	2xx	Data command, high byte
	14:31:01	871	1xx	Data command, low byte
	14:31:33	872	41B	Address azimuth position B
	14:32:05	872	2xx	Data command, high byte
	14:32:37	873	1xx	Data command, low byte
End azimuth angle load commands (A = 112.88°, B = 127.88°).				
Begin solar calibration sequence				
02/05/86	14:33:09	873	8A2	Begin solar calibration
	14:33:41	874	824	Short scan mode
	14:34:13	874	811	Azimuth to 0°
	14:34:45	875	814	Azimuth to position A
	14:39:33	880	825	MAM (solar) scan mode
	14:44:53	885	815	Azimuth to position B
	14:51:17	891	814	Azimuth to position A
	14:56:37	897	824	Short scan mode
	14:57:09	897	811	Azimuth to 0°
	15:01:57	902	822	Normal scan mode
End solar calibration sequence.				
Begin internal calibration sequence				
02/19/86	10:58:45	659	8A1	Begin internal calibration
	10:59:17	659	897	SWICS on at level 1 modulated
	11:00:53	661	895	SWICS on at level 2 modulated
	11:02:29	662	893	SWICS on at level 3 modulated
	11:04:05	664	891	SWICS off
	11:07:17	667	897	SWICS on at level 1 modulated
	11:08:53	669	895	SWICS on at level 2 modulated
	11:10:29	670	893	SWICS on at level 3 modulated

Table 8. Continued

(b) Continued

Date	Universal time		Hex command	Event description
	hr:min:sec	Minutes of day		
02/19/86	11:12:05	672	891	SWICS off
	11:31:17	691	897	SWICS on at level 1 modulated
	11:32:53	693	895	SWICS on at level 2 modulated
	11:34:29	694	893	SWICS on at level 3 modulated
	11:36:05	696	891	SWICS off
End internal calibration sequence. Begin azimuth angle load commands for solar calibration				
02/19/86	15:23:49	924	419	Address azimuth position A
	15:24:21	924	2xx	Data command, high byte
	15:24:53	925	1xx	Data command, low byte
	15:25:25	925	41B	Address azimuth position B
	15:25:57	926	2xx	Data command, high byte
	15:26:29	926	1xx	Data command, low byte
End azimuth angle load commands (A = 113.03°, B = 128.03°). Begin solar calibration sequence				
02/19/86	15:27:01	927	8A2	Begin solar calibration
	15:27:33	928	824	Short scan mode
	15:28:05	928	811	Azimuth to 0°
	15:28:37	929	814	Azimuth to position A
	15:33:25	933	825	MAM (solar) scan mode
	15:38:45	939	815	Azimuth to position B
	15:45:09	945	814	Azimuth to position A
	15:50:29	950	824	Short scan mode
	15:51:01	951	811	Azimuth to 0°
	15:55:49	956	822	Normal scan mode
End solar calibration sequence. Begin internal calibration sequence				
03/05/86	10:10:45	611	8A1	Begin internal calibration
	10:11:17	611	897	SWICS on at level 1 modulated
	10:12:53	613	895	SWICS on at level 2 modulated
	10:14:29	614	893	SWICS on at level 3 modulated
	10:16:05	616	891	SWICS off
	10:19:17	619	897	SWICS on at level 1 modulated
	10:20:53	621	895	SWICS on at level 2 modulated
	10:22:29	622	893	SWICS on at level 3 modulated
	10:24:05	624	891	SWICS off
	10:43:17	643	897	SWICS on at level 1 modulated
	10:44:53	645	895	SWICS on at level 2 modulated
	10:46:29	646	893	SWICS on at level 3 modulated
	10:48:05	648	891	SWICS off
End internal calibration sequence. Begin azimuth angle load commands for solar calibration				
03/05/86	14:35:49	876	419	Address azimuth position A
	14:36:21	876	2xx	Data command, high byte



Table 8. Continued

(b) Continued

Date	Universal time		Hex command	Event description
	hr:min:sec	Minutes of day		
03/05/86	14:36:53	877	1xx	Data command, low byte
	14:37:25	877	41B	Address azimuth position B
	14:37:57	878	2xx	Data command, high byte
	14:38:29	878	1xx	Data command, low byte
End azimuth angle load commands (A = 113.33°, B = 128.33°). Begin solar calibration sequence				
03/05/86	14:39:01	879	8A2	Begin solar calibration
	14:39:33	880	824	Short scan mode
	14:40:05	880	811	Azimuth to 0°
	14:40:37	881	814	Azimuth to position A
	14:45:25	885	825	MAM (solar) scan mode
Data dropout of 1 hr, 37 min, 20 sec				
03/05/86	16:24:37	985	822	Normal scan mode
End solar calibration sequence. Begin internal calibration sequence				
03/19/86	11:05:09	665	8A1	Begin internal calibration
	11:05:41	666	897	SWICS on at level 1 modulated
	11:07:17	667	895	SWICS on at level 2 modulated
	11:08:53	669	893	SWICS on at level 3 modulated
	11:10:29	670	891	SWICS off
	11:13:41	674	897	SWICS on at level 1 modulated
	11:15:17	675	895	SWICS on at level 2 modulated
	11:16:53	677	893	SWICS on at level 3 modulated
	11:18:29	678	891	SWICS off
	11:37:41	698	897	SWICS on at level 1 modulated
	11:39:17	699	895	SWICS on at level 2 modulated
	11:40:53	701	893	SWICS on at level 3 modulated
	11:42:29	702	891	SWICS off
End internal calibration sequence. Begin azimuth angle load commands for solar calibration				
03/19/86	15:30:13	930	419	Address azimuth position A
	15:30:45	931	2xx	Data command, high byte
	15:31:17	931	1xx	Data command, low byte
	15:31:49	932	41B	Address azimuth position B
	15:32:21	932	2xx	Data command, high byte
	15:32:53	933	1xx	Data command, low byte
End azimuth angle load commands (A = 113.63°, B = 128.63°). Begin solar calibration sequence				
03/19/86	15:33:25	933	8A2	Begin solar calibration
	15:33:57	934	824	Short scan mode
	15:34:29	934	811	Azimuth to 0°
	15:35:01	935	814	Azimuth to position A
	15:39:49	940	825	MAM (solar) scan mode
	15:45:09	945	815	Azimuth to position B

Table 8. Continued

(b) Continued

Date	Universal time		Hex command	Event description
	hr:min:sec	Minutes of day		
03/19/86	15:51:33	952	814	Azimuth to position A
	15:56:53	957	824	Short scan mode
	15:57:25	957	811	Azimuth to 0°
	16:02:13	962	822	Normal scan mode
End solar calibration sequence. Begin internal calibration sequence				
04/02/86	10:17:09	617	8A1	Begin internal calibration
	10:17:41	618	897	SWICS on at level 1 modulated
	10:19:17	619	895	SWICS on at level 2 modulated
	10:20:53	621	893	SWICS on at level 3 modulated
	10:22:29	622	891	SWICS off
	10:25:41	626	897	SWICS on at level 1 modulated
	10:27:17	627	895	SWICS on at level 2 modulated
	10:28:53	629	893	SWICS on at level 3 modulated
	10:30:29	630	891	SWICS off
	10:49:41	650	897	SWICS on at level 1 modulated
	10:51:17	651	895	SWICS on at level 2 modulated
	10:52:53	653	893	SWICS on at level 3 modulated
10:54:29	654	891	SWICS off	
End internal calibration sequence. Begin azimuth angle load commands for solar calibration				
04/02/86	14:42:13	882	419	Address azimuth position A
	14:42:45	883	2xx	Data command, high byte
	14:43:17	883	1xx	Data command, low byte
	14:43:49	884	41B	Address azimuth position B
	14:44:21	884	2xx	Data command, high byte
	14:44:53	885	1xx	Data command, low byte
End azimuth angle load commands (A = 113.63°, B = 128.63°). Begin solar calibration sequence				
04/02/86	14:45:25	885	8A2	Begin solar calibration
	14:45:57	886	824	Short scan mode
	14:46:29	886	811	Azimuth to 0°
	14:47:01	887	814	Azimuth to position A
	14:51:49	892	825	MAM (solar) scan mode
	14:57:09	897	815	Azimuth to position B
	15:03:33	904	814	Azimuth to position A
	15:08:53	909	824	Short scan mode
	15:09:25	909	811	Azimuth to 0°
	15:14:13	914	822	Normal scan mode
End solar calibration sequence. Begin internal calibration sequence				
04/16/86	09:29:09	569	8A1	Begin internal calibration
	09:29:41	570	897	SWICS on at level 1 modulated
	09:31:17	571	895	SWICS on at level 2 modulated

Table 8. Continued

(b) Continued

Date	Universal time		Hex command	Event description
	hr:min:sec	Minutes of day		
04/16/86	09:32:53	573	893	SWICS on at level 3 modulated
	09:34:29	574	891	SWICS off
	09:37:41	578	897	SWICS on at level 1 modulated
	09:39:17	579	895	SWICS on at level 2 modulated
	09:40:53	581	893	SWICS on at level 3 modulated
	09:42:29	582	891	SWICS off
	10:01:41	602	897	SWICS on at level 1 modulated
	10:03:17	603	895	SWICS on at level 2 modulated
	10:04:53	605	893	SWICS on at level 3 modulated
	10:06:29	606	891	SWICS off
End internal calibration sequence.				
Begin azimuth angle load commands for solar calibration				
04/16/86	15:36:05	936	419	Address azimuth position A
	15:36:37	937	2xx	Data command, high byte
	15:37:09	937	1xx	Data command, low byte
	15:37:41	938	41B	Address azimuth position B
	15:38:13	938	2xx	Data command, high byte
	15:38:45	939	1xx	Data command, low byte
End azimuth angle load commands (A = 113.18°, B = 128.18°).				
Begin solar calibration sequence				
04/16/86	15:39:17	939	8A2	Begin solar calibration
	15:39:49	940	824	Short scan mode
	15:40:21	940	811	Azimuth to 0°
	15:40:53	941	814	Azimuth to position A
	15:45:41	946	825	MAM (solar) scan mode
	15:51:01	951	815	Azimuth to position B
	15:57:25	957	814	Azimuth to position A
	16:02:45	963	824	Short scan mode
	16:03:17	963	811	Azimuth to 0°
	16:08:05	968	822	Normal scan mode
End solar calibration sequence.				
Begin internal calibration sequence				
04/30/86	10:22:29	622	8A1	Begin internal calibration
	10:23:01	623	897	SWICS on at level 1 modulated
	10:24:37	625	895	SWICS on at level 2 modulated
	10:26:13	626	893	SWICS on at level 3 modulated
	10:27:49	628	891	SWICS off
	10:31:01	631	897	SWICS on at level 1 modulated
	10:32:37	633	895	SWICS on at level 2 modulated
	10:34:13	634	893	SWICS on at level 3 modulated
	10:35:49	636	891	SWICS off
	10:55:01	655	897	SWICS on at level 1 modulated
	10:56:37	657	895	SWICS on at level 2 modulated

Table 8. Continued

(b) Continued

Date	Universal time		Hex command	Event description
	hr:min:sec	Minutes of day		
04/30/86	10:58:13	658	893	SWICS on at level 3 modulated
	10:59:49	660	891	SWICS off
End internal calibration sequence.				
Begin azimuth angle load commands for solar calibration				
04/30/86	14:48:05	888	419	Address azimuth position A
	14:48:37	889	2xx	Data command, high byte
	14:49:09	889	1xx	Data command, low byte
	14:49:41	890	41B	Address azimuth position B
	14:50:13	890	2xx	Data command, high byte
	14:50:45	891	1xx	Data command, low byte
End azimuth angle load commands (A = 112.28°, B = 127.28°).				
Begin solar calibration sequence				
04/30/86	14:51:17	891	8A2	Begin solar calibration
	14:51:49	892	824	Short scan mode
	14:52:21	892	811	Azimuth to 0°
	14:52:53	893	814	Azimuth to position A
	14:57:41	898	825	MAM (solar) scan mode
	15:03:01	903	815	Azimuth to position B
	15:09:25	909	814	Azimuth to position A
	15:14:45	915	824	Short scan mode
	15:15:17	915	811	Azimuth to 0°
	15:20:05	920	822	Normal scan mode
	End solar calibration sequence.			
Begin internal calibration sequence				
05/14/86	09:33:58	574	8A1	Begin internal calibration
	09:34:30	575	897	SWICS on at level 1 modulated
	09:36:06	576	895	SWICS on at level 2 modulated
	09:37:42	578	893	SWICS on at level 3 modulated
	09:39:18	579	891	SWICS off
	09:42:30	583	897	SWICS on at level 1 modulated
	09:44:06	584	895	SWICS on at level 2 modulated
	09:45:42	586	893	SWICS on at level 3 modulated
	09:47:18	587	891	SWICS off
	10:06:30	607	897	SWICS on at level 1 modulated
	10:08:06	608	895	SWICS on at level 2 modulated
	10:09:42	610	893	SWICS on at level 3 modulated
	10:11:18	611	891	SWICS off
End internal calibration sequence.				
Begin azimuth angle load commands for solar calibration				
05/14/86	13:59:02	839	419	Address azimuth position A
	13:59:34	840	2xx	Data command, high byte
	14:00:06	840	1xx	Data command, low byte
	14:00:38	841	41B	Address azimuth position B

Table 8. Continued

(b) Continued

Date	Universal time		Hex command	Event description
	hr:min:sec	Minutes of day		
05/14/86	14:01:10	841	2xx	Data command, high byte
	14:01:42	842	1xx	Data command, low byte
End azimuth angle load commands (A = 111.0°, B = 126.0°).				
Begin solar calibration sequence				
05/14/86	14:02:14	842	8A2	Begin solar calibration
	14:02:46	843	824	Short scan mode
	14:03:18	843	811	Azimuth to 0°
	14:03:50	844	814	Azimuth to position A
	14:08:38	849	825	MAM (solar) scan mode
	14:13:58	854	815	Azimuth to position B
	14:20:22	860	814	Azimuth to position A
	14:25:42	866	824	Short scan mode
	14:26:14	866	811	Azimuth to 0°
14:31:02	871	822	Normal scan mode	
End solar calibration sequence.				
Begin internal calibration sequence				
05/28/86	10:26:46	627	8A1	Begin internal calibration
	10:27:18	627	897	SWICS on at level 1 modulated
	10:28:54	629	895	SWICS on at level 2 modulated
	10:30:30	631	893	SWICS on at level 3 modulated
	10:32:06	632	891	SWICS off
	10:35:18	635	897	SWICS on at level 1 modulated
	10:36:54	637	895	SWICS on at level 2 modulated
	10:38:30	639	893	SWICS on at level 3 modulated
	10:40:06	640	891	SWICS off
	10:59:18	659	897	SWICS on at level 1 modulated
	11:00:54	661	895	SWICS on at level 2 modulated
	11:02:30	663	893	SWICS on at level 3 modulated
	11:04:06	664	891	SWICS off
End internal calibration sequence.				
Begin azimuth angle load commands for solar calibration				
05/28/86	14:51:50	892	419	Address azimuth position A
	14:52:22	892	2xx	Data command, high byte
	14:52:54	893	1xx	Data command, low byte
	14:53:26	893	41B	Address azimuth position B
	14:53:58	894	2xx	Data command, high byte
	14:54:30	895	1xx	Data command, low byte
End azimuth angle load commands (A = 109.65°, B = 124.65°).				
Begin solar calibration sequence				
05/28/86	14:55:02	895	8A2	Begin solar calibration
	14:55:34	896	824	Short scan mode
	14:56:06	896	811	Azimuth to 0°
	14:56:38	897	814	Azimuth to position A
	15:01:26	901	825	MAM (solar) scan mode

Table 8. Continued

(b) Continued

Date	Universal time		Hex command	Event description
	hr:min:sec	Minutes of day		
05/28/86	15:06:46	907	815	Azimuth to position B
	15:13:10	913	814	Azimuth to position A
	15:18:30	919	824	Short scan mode
	15:19:02	919	811	Azimuth to 0°
	15:23:50	924	822	Normal scan mode
End solar calibration sequence. Begin internal calibration sequence				
06/11/86	09:37:10	577	8A1	Begin internal calibration
	09:37:42	578	897	SWICS on at level 1 modulated
	09:39:18	579	895	SWICS on at level 2 modulated
	09:40:54	581	893	SWICS on at level 3 modulated
	09:42:30	583	891	SWICS off
	09:45:42	586	897	SWICS on at level 1 modulated
	09:47:18	587	895	SWICS on at level 2 modulated
	09:48:54	589	893	SWICS on at level 3 modulated
	09:50:30	591	891	SWICS off
	10:09:42	610	897	SWICS on at level 1 modulated
	10:11:18	611	895	SWICS on at level 2 modulated
	10:12:54	613	893	SWICS on at level 3 modulated
10:14:30	615	891	SWICS off	
End internal calibration sequence. Begin azimuth angle load commands for solar calibration				
06/11/86	14:02:14	842	419	Address azimuth position A
	14:02:46	843	2xx	Data command, high byte
	14:03:18	843	1xx	Data command, low byte
	14:03:50	844	41B	Address azimuth position B
	14:04:22	844	2xx	Data command, high byte
	14:04:54	845	1xx	Data command, low byte
End azimuth angle load commands (A = 108.6°, B = 123.6°). Begin solar calibration sequence				
06/11/86	14:05:26	845	8A2	Begin solar calibration
	14:05:58	846	824	Short scan mode
	14:06:30	847	811	Azimuth to 0°
	14:07:02	847	814	Azimuth to position A
	14:11:50	852	825	MAM (solar) scan mode
	14:17:10	857	815	Azimuth to position B
	14:23:34	864	814	Azimuth to position A
	14:28:54	869	824	Short scan mode
	14:29:26	869	811	Azimuth to 0°
	14:34:14	874	822	Normal scan mode
	End solar calibration sequence. Begin internal calibration sequence			
06/25/86	10:28:54	629	8A1	Begin internal calibration
	10:29:26	629	897	SWICS on at level 1 modulated

Table 8. Continued

(b) Continued

Date	Universal time		Hex command	Event description
	hr:min:sec	Minutes of day		
06/25/86	10:31:02	631	895	SWICS on at level 2 modulated
	10:32:38	633	893	SWICS on at level 3 modulated
	10:34:14	634	891	SWICS off
	10:37:26	637	897	SWICS on at level 1 modulated
	10:39:02	639	895	SWICS on at level 2 modulated
	10:40:38	641	893	SWICS on at level 3 modulated
	10:42:14	642	891	SWICS off
	11:01:26	661	897	SWICS on at level 1 modulated
	11:03:02	663	895	SWICS on at level 2 modulated
	11:04:38	665	893	SWICS on at level 3 modulated
	11:06:14	666	891	SWICS off
End internal calibration sequence.				
Begin azimuth angle load commands for solar calibration				
06/25/86	14:53:58	894	419	Address azimuth position A
	14:54:30	895	2xx	Data command, high byte
	14:55:02	895	1xx	Data command, low byte
	14:55:34	896	41B	Address azimuth position B
	14:56:06	896	2xx	Data command, high byte
	14:56:38	897	1xx	Data command, low byte
End azimuth angle load commands (A = 108.0°, B = 123.0°).				
Begin solar calibration sequence				
06/25/86	14:57:10	897	8A2	Begin solar calibration
	14:57:42	898	824	Short scan mode
	14:58:14	898	811	Azimuth to 0°
	14:58:46	899	814	Azimuth to position A
	15:03:34	904	825	MAM (solar) scan mode
	15:08:54	909	815	Azimuth to position B
	15:15:18	915	814	Azimuth to position A
	15:20:38	921	824	Short scan mode
	15:21:10	921	811	Azimuth to 0°
	15:25:58	926	822	Normal scan mode
End solar calibration sequence.				
Begin internal calibration sequence				
07/09/86	09:38:14	578	8A1	Begin internal calibration
	09:38:46	579	897	SWICS on at level 1 modulated
	09:40:22	580	895	SWICS on at level 2 modulated
	09:41:58	582	893	SWICS on at level 3 modulated
	09:43:34	584	891	SWICS off
	09:46:46	587	897	SWICS on at level 1 modulated
	09:48:22	588	895	SWICS on at level 2 modulated
	09:49:58	590	893	SWICS on at level 3 modulated
	09:51:34	592	891	SWICS off
	10:10:46	611	897	SWICS on at level 1 modulated
	10:12:22	612	895	SWICS on at level 2 modulated

Table 8. Continued

(b) Continued

Date	Universal time		Hex command	Event description
	hr:min:sec	Minutes of day		
07/09/86	10:13:58	614	893	SWICS on at level 3 modulated
	10:15:34	616	891	SWICS off
End internal calibration sequence.				
Begin azimuth angle load commands for solar calibration				
07/09/86	14:03:50	844	419	Address azimuth position A
	14:04:22	844	2xx	Data command, high byte
	14:04:54	845	1xx	Data command, low byte
	14:05:26	845	41B	Address azimuth position B
	14:05:58	846	2xx	Data command, high byte
	14:06:30	847	1xx	Data command, low byte
End azimuth angle load commands (A = 108.23°, B = 123.23°).				
Begin solar calibration sequence				
07/09/86	14:07:02	847	8A2	Begin solar calibration
	14:07:34	848	824	Short scan mode
	14:08:06	848	811	Azimuth to 0°
	14:08:38	849	814	Azimuth to position A
Data dropout of 1 hr, 32 min, 32 sec				
07/09/86	15:42:31	943	822	Normal scan mode
End solar calibration sequence.				
Begin internal calibration sequence				
07/23/86	10:29:26	629	8A1	Begin internal calibration
	10:29:58	630	897	SWICS on at level 1 modulated
	10:31:34	632	895	SWICS on at level 2 modulated
	10:33:10	633	893	SWICS on at level 3 modulated
	10:34:46	635	891	SWICS off
	10:37:58	638	897	SWICS on at level 1 modulated
	10:39:34	640	895	SWICS on at level 2 modulated
	10:41:10	641	893	SWICS on at level 3 modulated
	10:42:46	643	891	SWICS off
	11:01:58	662	897	SWICS on at level 1 modulated
	11:03:34	664	895	SWICS on at level 2 modulated
	11:05:10	665	893	SWICS on at level 3 modulated
11:06:46	667	891	SWICS off	
End internal calibration sequence.				
Begin azimuth angle load commands for solar calibration				
07/23/86	14:55:02	895	419	Address azimuth position A
	14:55:34	896	2xx	Data command, high byte
	14:56:06	896	1xx	Data command, low byte
	14:56:38	897	41B	Address azimuth position B
	14:57:10	897	2xx	Data command, high byte
	14:57:42	898	1xx	Data command, low byte
End azimuth angle load commands (A = 109.2°, B = 124.2°)				



Table 8. Continued

(b) Continued

Date	Universal time		Hex command	Event description
	hr:min:sec	Minutes of day		
Begin solar calibration sequence				
07/23/86	14:58:14	898	8A2	Begin solar calibration
	14:58:46	899	824	Short scan mode
	14:59:18	899	811	Azimuth to 0°
	14:59:50	900	814	Azimuth to position A
	15:04:38	905	825	MAM (solar) scan mode
	15:09:58	910	815	Azimuth to position B
	15:16:22	916	814	Azimuth to position A
	15:21:42	922	824	Short scan mode
	15:22:14	922	811	Azimuth to 0°
15:27:02	927	822	Normal scan mode	
End solar calibration sequence.				
Begin internal calibration sequence				
08/06/86	09:38:46	579	8A1	Begin internal calibration
	09:39:18	579	897	SWICS on at level 1 modulated
	09:40:54	581	895	SWICS on at level 2 modulated
	09:42:30	583	893	SWICS on at level 3 modulated
	09:44:06	584	891	SWICS off
	09:47:18	587	897	SWICS on at level 1 modulated
	09:48:54	589	895	SWICS on at level 2 modulated
	09:50:30	591	893	SWICS on at level 3 modulated
	09:52:06	592	891	SWICS off
	10:11:18	611	897	SWICS on at level 1 modulated
	10:12:54	613	895	SWICS on at level 2 modulated
	10:14:30	615	893	SWICS on at level 3 modulated
	10:16:06	616	891	SWICS off
End internal calibration sequence.				
Begin azimuth angle load commands for solar calibration				
08/06/86	14:03:50	844	419	Address azimuth position A
	14:04:22	844	2xx	Data command, high byte
	14:04:54	845	1xx	Data command, low byte
	14:05:26	845	41B	Address azimuth position B
	14:05:58	846	2xx	Data command, high byte
14:06:30	847	1xx	Data command, low byte	
End azimuth angle load commands (A = 111.0°, B = 126.0°).				
Begin solar calibration sequence				
08/06/86	14:07:02	847	8A2	Begin solar calibration
	14:07:34	848	824	Short scan mode
	14:08:06	848	811	Azimuth to 0°
	14:08:38	849	814	Azimuth to position A
	14:13:26	853	825	MAM (solar) scan mode
	14:18:46	859	815	Azimuth to position B
	14:25:10	865	814	Azimuth to position A
	14:30:30	871	824	Short scan mode

Table 8. Continued

(b) Continued

Date	Universal time		Hex command	Event description
	hr:min:sec	Minutes of day		
08/06/86	14:31:02	871	811	Azimuth to 0°
	14:35:50	876	822	Normal scan mode
End solar calibration sequence.				
Begin internal calibration sequence				
08/20/86	10:29:27	629	8A1	Begin internal calibration
	10:29:59	630	897	SWICS on at level 1 modulated
	10:31:35	632	895	SWICS on at level 2 modulated
	10:33:11	633	893	SWICS on at level 3 modulated
	10:34:47	635	891	SWICS off
	10:37:59	638	897	SWICS on at level 1 modulated
	10:39:35	640	895	SWICS on at level 2 modulated
	10:41:11	641	893	SWICS on at level 3 modulated
	10:42:47	643	891	SWICS off
	11:01:59	662	897	SWICS on at level 1 modulated
	11:03:35	664	895	SWICS on at level 2 modulated
11:05:11	665	893	SWICS on at level 3 modulated	
11:06:47	667	891	SWICS off	
End internal calibration sequence.				
Begin azimuth angle load commands for solar calibration				
08/20/86	14:54:31	895	419	Address azimuth position A
	14:55:03	895	2xx	Data command, high byte
	14:55:35	896	1xx	Data command, low byte
	14:56:07	896	41B	Address azimuth position B
	14:56:39	897	2xx	Data command, high byte
	14:57:11	897	1xx	Data command, low byte
End azimuth angle load commands (A = 113.55°, B = 128.55°).				
Begin solar calibration sequence				
08/20/86	14:57:43	898	8A2	Begin solar calibration
	14:58:15	898	824	Short scan mode
	14:58:47	899	811	Azimuth to 0°
	14:59:19	899	814	Azimuth to position A
	15:04:07	904	825	MAM (solar) scan mode
	15:09:27	909	815	Azimuth to position B
	15:15:51	916	814	Azimuth to position A
	15:21:11	921	824	Short scan mode
	15:21:43	922	811	Azimuth to 0°
	15:26:31	927	822	Normal scan mode
End solar calibration sequence.				
Begin internal calibration sequence				
09/03/86	09:37:43	578	8A1	Begin internal calibration
	09:38:15	578	897	SWICS on at level 1 modulated
	09:39:51	580	895	SWICS on at level 2 modulated
	09:41:27	581	893	SWICS on at level 3 modulated
	09:43:03	583	891	SWICS off

Table 8. Continued

(b) Continued

Date	Universal time		Hex command	Event description
	hr:min:sec	Minutes of day		
09/03/86	09:46:15	586	897	SWICS on at level 1 modulated
	09:47:51	588	895	SWICS on at level 2 modulated
	09:49:27	589	893	SWICS on at level 3 modulated
	09:51:03	591	891	SWICS off
	10:10:15	610	897	SWICS on at level 1 modulated
	10:11:51	612	895	SWICS on at level 2 modulated
	10:13:27	613	893	SWICS on at level 3 modulated
	10:15:03	615	891	SWICS off
End internal calibration sequence.				
Begin azimuth angle load commands for solar calibration				
09/03/86	14:02:47	843	419	Address azimuth position A
	14:03:19	843	2xx	Data command, high byte
	14:03:51	844	1xx	Data command, low byte
	14:04:23	844	41B	Address azimuth position B
	14:04:55	845	2xx	Data command, high byte
	14:05:27	845	1xx	Data command, low byte
End azimuth angle load commands (A = 116.48°, B = 131.48°).				
Begin solar calibration sequence				
09/03/86	14:05:59	846	8A2	Begin solar calibration
	14:06:31	847	824	Short scan mode
	14:07:03	847	811	Azimuth to 0°
	14:07:35	848	814	Azimuth to position A
	14:12:23	852	825	MAM (solar) scan mode
	14:17:43	858	815	Azimuth to position B
	14:24:07	864	814	Azimuth to position A
	14:29:27	869	824	Short scan mode
	14:29:59	870	811	Azimuth to 0°
	14:34:47	875	822	Normal scan mode
End solar calibration sequence.				
Begin internal calibration sequence				
09/17/86	10:27:51	628	8A1	Begin internal calibration
	10:28:23	628	897	SWICS on at level 1 modulated
	10:29:59	630	895	SWICS on at level 2 modulated
	10:31:35	632	893	SWICS on at level 3 modulated
	10:33:11	633	891	SWICS off
	10:36:23	636	897	SWICS on at level 1 modulated
	10:37:59	638	895	SWICS on at level 2 modulated
	10:39:35	640	893	SWICS on at level 3 modulated
	10:41:11	641	891	SWICS off
	11:00:23	660	897	SWICS on at level 1 modulated
	11:01:59	662	895	SWICS on at level 2 modulated
	11:03:35	664	893	SWICS on at level 3 modulated
	11:05:11	665	891	SWICS off
	End internal calibration sequence			

Table 8. Continued

(b) Continued

Date	Universal time		Hex command	Event description
	hr:min:sec	Minutes of day		
Begin azimuth angle load commands for solar calibration				
09/17/86	14:52:55	893	419	Address azimuth position A
	14:53:27	893	2xx	Data command, high byte
	14:53:59	894	1xx	Data command, low byte
	14:54:31	895	41B	Address azimuth position B
	14:55:03	895	2xx	Data command, high byte
	14:55:35	896	1xx	Data command, low byte
End azimuth angle load commands (A = 119.48°, B = 134.48°).				
Begin solar calibration sequence				
09/17/86	14:56:07	896	8A2	Begin solar calibration
	14:56:39	897	824	Short scan mode
	14:57:11	897	811	Azimuth to 0°
	14:57:43	898	814	Azimuth to position A
	15:02:31	903	825	MAM (solar) scan mode
	15:07:51	908	815	Azimuth to position B
	15:14:15	914	814	Azimuth to position A
	15:19:35	920	824	Short scan mode
	15:20:07	920	811	Azimuth to 0°
	15:24:55	925	822	Normal scan mode
End solar calibration sequence.				
Begin internal calibration sequence				
10/01/86	09:35:35	576	8A1	Begin internal calibration
	09:36:07	576	897	SWICS on at level 1 modulated
	09:37:43	578	895	SWICS on at level 2 modulated
	09:39:19	579	893	SWICS on at level 3 modulated
	09:40:55	581	891	SWICS off
	09:44:07	584	897	SWICS on at level 1 modulated
	09:45:43	586	895	SWICS on at level 2 modulated
	09:47:19	587	893	SWICS on at level 3 modulated
	09:48:55	589	891	SWICS off
	10:08:07	608	897	SWICS on at level 1 modulated
	10:09:43	610	895	SWICS on at level 2 modulated
	10:11:19	611	893	SWICS on at level 3 modulated
	10:12:55	613	891	SWICS off
End internal calibration sequence.				
Begin azimuth angle load commands for solar calibration				
10/01/86	14:01:11	841	419	Address azimuth position A
	14:01:43	842	2xx	Data command, high byte
	14:02:15	842	1xx	Data command, low byte
	14:02:47	843	41B	Address azimuth position B
	14:03:19	843	2xx	Data command, high byte
	14:03:51	844	1xx	Data command, low byte
End azimuth angle load commands (A = 122.18°, B = 137.18°)				

Table 8. Continued

(b) Continued

Date	Universal time		Hex command	Event description
	hr:min:sec	Minutes of day		
Begin solar calibration sequence				
10/01/86	14:04:23	844	8A2	Begin solar calibration
	14:04:55	845	824	Short scan mode
	14:05:27	845	811	Azimuth to 0°
	14:05:59	846	814	Azimuth to position A
	14:10:47	851	825	MAM (solar) scan mode
	14:16:07	856	815	Azimuth to position B
	14:22:31	863	814	Azimuth to position A
	14:27:51	868	824	Short scan mode
	14:28:23	868	811	Azimuth to 0°
	14:33:11	873	822	Normal scan mode
End solar calibration sequence.				
Begin internal calibration sequence				
10/15/86	10:25:43	626	8A1	Begin internal calibration
	10:26:15	626	897	SWICS on at level 1 modulated
	10:27:51	628	895	SWICS on at level 2 modulated
	10:29:27	629	893	SWICS on at level 3 modulated
	10:31:03	631	891	SWICS off
	10:34:15	634	897	SWICS on at level 1 modulated
	10:35:51	636	895	SWICS on at level 2 modulated
	10:37:27	637	893	SWICS on at level 3 modulated
	10:39:03	639	891	SWICS off
	10:58:15	658	897	SWICS on at level 1 modulated
	10:59:51	660	895	SWICS on at level 2 modulated
	11:01:27	661	893	SWICS on at level 3 modulated
	11:03:03	663	891	SWICS off
End internal calibration sequence.				
Begin azimuth angle load commands for solar calibration				
10/15/86	14:50:47	891	419	Address azimuth position A
	14:51:19	891	2xx	Data command, high byte
	14:51:51	892	1xx	Data command, low byte
	14:52:23	892	41B	Address azimuth position B
	14:52:55	893	2xx	Data command, high byte
	14:53:27	893	1xx	Data command, low byte
End azimuth angle load commands (A = 124.13°, B = 139.13°).				
Begin solar calibration sequence				
10/15/86	14:53:59	894	8A2	Begin solar calibration
	14:54:31	895	824	Short scan mode
	14:55:03	895	811	Azimuth to 0°
	14:55:35	896	814	Azimuth to position A
	15:00:23	900	825	MAM (solar) scan mode
	15:05:43	906	815	Azimuth to position B
	15:12:07	912	814	Azimuth to position A
	15:17:27	917	824	Short scan mode

Table 8. Continued

(b) Continued

Date	Universal time		Hex command	Event description
	hr:min:sec	Minutes of day		
10/15/86	15:17:59	918	811	Azimuth to 0°
	15:22:47	923	822	Normal scan mode
End solar calibration sequence. Begin internal calibration sequence				
10/29/86	09:32:55	573	8A1	Begin internal calibration
	09:33:27	573	897	SWICS on at level 1 modulated
	09:35:03	575	895	SWICS on at level 2 modulated
	09:36:39	577	893	SWICS on at level 3 modulated
	09:38:15	578	891	SWICS off
	09:41:27	581	897	SWICS on at level 1 modulated
	09:43:03	583	895	SWICS on at level 2 modulated
	09:44:39	585	893	SWICS on at level 3 modulated
	09:46:15	586	891	SWICS off
	10:05:27	605	897	SWICS on at level 1 modulated
	10:07:03	607	895	SWICS on at level 2 modulated
10:08:39	609	893	SWICS on at level 3 modulated	
10:10:15	610	891	SWICS off	
End internal calibration sequence. Begin azimuth angle load commands for solar calibration				
10/29/86	13:57:59	838	419	Address azimuth position A
	13:58:31	839	2xx	Data command, high byte
	13:59:03	839	1xx	Data command, low byte
	13:59:35	840	41B	Address azimuth position B
	14:00:07	840	2xx	Data command, high byte
	14:00:39	841	1xx	Data command, low byte
End azimuth angle load commands (A = 125.03°, B = 140.03°). Begin solar calibration sequence				
10/29/86	14:01:11	841	8A2	Begin solar calibration
	14:01:43	842	824	Short scan mode
	14:02:15	842	811	Azimuth to 0°
	14:02:47	843	814	Azimuth to position A
	14:07:35	848	825	MAM (solar) scan mode
	14:12:55	853	815	Azimuth to position B
	14:19:19	859	814	Azimuth to position A
	14:24:39	865	824	Short scan mode
	14:25:11	865	811	Azimuth to 0°
	14:29:59	870	822	Normal scan mode
End solar calibration sequence. Begin internal calibration sequence				
11/12/86	10:23:04	623	8A1	Begin internal calibration
	10:23:36	624	897	SWICS on at level 1 modulated
	10:25:12	625	895	SWICS on at level 2 modulated
	10:26:48	627	893	SWICS on at level 3 modulated
	10:28:24	628	891	SWICS off

Table 8. Continued

(b) Continued

Date	Universal time		Hex command	Event description
	hr:min:sec	Minutes of day		
11/12/86	10:31:36	632	897	SWICS on at level 1 modulated
	10:33:12	633	895	SWICS on at level 2 modulated
	10:34:48	635	893	SWICS on at level 3 modulated
	10:36:24	636	891	SWICS off
	10:55:36	656	897	SWICS on at level 1 modulated
	10:57:12	657	895	SWICS on at level 2 modulated
	10:58:48	659	893	SWICS on at level 3 modulated
	11:00:24	660	891	SWICS off
End internal calibration sequence.				
Begin azimuth angle load commands for solar calibration				
11/12/86	14:48:08	888	419	Address azimuth position A
	14:48:40	889	2xx	Data command, high byte
	14:49:12	889	1xx	Data command, low byte
	14:49:44	890	41B	Address azimuth position B
	14:50:16	890	2xx	Data command, high byte
	14:50:48	891	1xx	Data command, low byte
End azimuth angle load commands (A = 124.88°, B = 139.88°).				
Begin solar calibration sequence				
11/12/86	14:51:20	891	8A2	Begin solar calibration
	14:51:52	892	824	Short scan mode
	14:52:24	892	811	Azimuth to 0°
	14:52:56	893	814	Azimuth to position A
	14:57:44	898	825	MAM (solar) scan mode
	15:03:04	903	815	Azimuth to position B
	15:09:28	909	814	Azimuth to position A
	15:14:48	915	824	Short scan mode
	15:15:20	915	811	Azimuth to 0°
	15:20:08	920	822	Normal scan mode
End solar calibration sequence.				
Begin internal calibration sequence				
11/26/86	09:30:48	571	8A1	Begin internal calibration
	09:31:20	571	897	SWICS on at level 1 modulated
	09:32:56	573	895	SWICS on at level 2 modulated
	09:34:32	575	893	SWICS on at level 3 modulated
	09:36:08	576	891	SWICS off
	09:39:20	579	897	SWICS on at level 1 modulated
	09:40:56	581	895	SWICS on at level 2 modulated
	09:42:32	583	893	SWICS on at level 3 modulated
	09:44:08	584	891	SWICS off
	10:03:20	603	897	SWICS on at level 1 modulated
	10:04:56	605	895	SWICS on at level 2 modulated
	10:06:32	607	893	SWICS on at level 3 modulated
	10:08:08	608	891	SWICS off
	End internal calibration sequence			

Table 8. Continued

(b) Continued

Date	Universal time		Hex command	Event description
	hr:min:sec	Minutes of day		
Begin azimuth angle load commands for solar calibration				
11/26/86	15:38:16	938	419	Address azimuth position A
	15:38:48	939	2xx	Data command, high byte
	15:39:20	939	1xx	Data command, low byte
	15:39:52	940	41B	Address azimuth position B
	15:40:24	940	2xx	Data command, high byte
	15:40:56	941	1xx	Data command, low byte
End azimuth angle load commands (A = 123.83°, B = 138.83°).				
Begin solar calibration sequence				
11/26/86	15:41:28	941	8A2	Begin solar calibration
	15:42:00	942	824	Short scan mode
	15:42:32	943	811	Azimuth to 0°
	15:43:04	943	814	Azimuth to position A
	15:47:52	948	825	MAM (solar) scan mode
	15:53:12	953	815	Azimuth to position B
	15:59:36	960	814	Azimuth to position A
	16:04:56	965	824	Short scan mode
	16:05:28	965	811	Azimuth to 0°
	16:10:16	970	822	Normal scan mode
End solar calibration sequence.				
Begin internal calibration sequence				
12/10/86	10:21:28	621	8A1	Begin internal calibration
	10:22:00	622	897	SWICS on at level 1 modulated
	10:23:36	624	895	SWICS on at level 2 modulated
	10:25:12	625	893	SWICS on at level 3 modulated
	10:26:48	627	891	SWICS off
	10:30:00	630	897	SWICS on at level 1 modulated
	10:31:36	632	895	SWICS on at level 2 modulated
	10:33:12	633	893	SWICS on at level 3 modulated
	10:34:48	635	891	SWICS off
	10:54:00	654	897	SWICS on at level 1 modulated
	10:55:36	656	895	SWICS on at level 2 modulated
	10:57:12	657	893	SWICS on at level 3 modulated
	10:58:48	659	891	SWICS off
End internal calibration sequence.				
Begin azimuth angle load commands for solar calibration				
12/10/86	14:46:32	887	419	Address azimuth position A
	14:47:04	887	2xx	Data command, high byte
	14:47:36	888	1xx	Data command, low byte
	14:48:08	888	41B	Address azimuth position B
	14:48:40	889	2xx	Data command, high byte
	14:49:12	889	1xx	Data command, low byte
End azimuth angle load commands (A = 122.48°, B = 137.48°)				



Table 8. Continued

(b) Continued

Date	Universal time		Hex command	Event description
	hr:min:sec	Minutes of day		
Begin solar calibration sequence				
12/10/86	14:49:44	890	8A2	Begin solar calibration
	14:50:16	890	824	Short scan mode
	14:50:48	891	811	Azimuth to 0°
	14:51:20	891	814	Azimuth to position A
	14:56:08	896	825	MAM (solar) scan mode
	15:01:28	901	815	Azimuth to position B
	15:07:52	908	814	Azimuth to position A
	15:13:12	913	824	Short scan mode
	15:13:44	914	811	Azimuth to 0°
	15:18:32	919	822	Normal scan mode
End solar calibration sequence.				
Begin internal calibration sequence				
12/24/86	09:30:48	571	8A1	Begin internal calibration
	09:31:20	571	897	SWICS on at level 1 modulated
	09:32:56	573	895	SWICS on at level 2 modulated
	09:34:32	575	893	SWICS on at level 3 modulated
	09:36:08	576	891	SWICS off
	09:39:20	579	897	SWICS on at level 1 modulated
	09:40:56	581	895	SWICS on at level 2 modulated
	09:42:32	583	893	SWICS on at level 3 modulated
	09:44:08	584	891	SWICS off
	10:03:20	603	897	SWICS on at level 1 modulated
	10:04:56	605	895	SWICS on at level 2 modulated
	10:06:32	607	893	SWICS on at level 3 modulated
	10:08:08	608	891	SWICS off
	End internal calibration sequence.			
Begin azimuth angle load commands for solar calibration				
12/24/86	15:37:44	938	419	Address azimuth position A
	15:38:16	938	2xx	Data command, high byte
	15:38:48	939	1xx	Data command, low byte
	15:39:20	939	41B	Address azimuth position B
	15:39:52	940	2xx	Data command, high byte
	15:40:24	940	1xx	Data command, low byte
End azimuth angle load commands (A = 120.98°, B = 135.98°).				
Begin solar calibration sequence				
12/24/86	15:40:56	941	8A2	Begin solar calibration
	15:41:28	941	824	Short scan mode
	15:42:00	942	811	Azimuth to 0°
	15:42:32	943	814	Azimuth to position A
	15:47:20	947	825	MAM (solar) scan mode
	15:52:40	953	815	Azimuth to position B
	15:59:04	959	814	Azimuth to position A
	16:04:24	964	824	Short scan mode

Table 8. Concluded

(b) Concluded

Date	Universal time		Hex command	Event description
	hr:min:sec	Minutes of day		
12/24/86	16:04:56	965	811	Azimuth to 0°
	16:09:44	970	822	Normal scan mode
End solar calibration sequence				
01/20/87				Scanner failed

Table 9. List of Operational Commands Executed by Instruments on NOAA 10 Spacecraft

(a) Nonscanner commands

Date	Universal time		Hex command	Event description
	hr:min:sec	Minutes of day		
10/24/86	12:28:08	748	821	Elevate to internal source (stow)
	20:46:16	1246	823	Elevate to nadir (Earth)
Begin preinternal calibration sequence				
10/25/86	13:00:40	781	821	Elevate to internal source (stow)
	13:01:12	781	862	WFOV BB heater on at temp. 1
	13:16:40	797	872	MFOV BB heater on at temp. 1
	14:43:36	884	823	Elevate to nadir (Earth)
End preinternal calibration sequence.				
Begin internal calibration sequence				
10/25/86	14:44:08	884	8A1	Begin internal calibration
	14:44:40	885	881	Detector bias heater off
	14:45:12	885	852	Solar port heaters off
	14:45:44	886	821	Elevate to internal source (stow)
	14:46:16	886	851	Solar port heaters on
	14:48:24	888	882	Detector bias heater on at level 1
	14:50:32	891	892	SWICS on at level 3
	14:53:44	894	881	Detector bias heater off
	14:57:28	897	862	WFOV BB heater on at temp. 1
	14:58:00	898	872	MFOV BB heater on at temp. 1
	14:59:04	899	891	SWICS off
	15:12:24	912	883	Detector bias heater on at level 2
	15:14:32	915	893	SWICS on at level 2
	15:17:44	918	881	Detector bias heater off
	15:21:28	921	863	WFOV BB heater on at temp. 2
	15:22:00	922	873	MFOV BB heater on at temp. 2
	15:23:04	923	891	SWICS off
	15:36:24	936	884	Detector bias heater on at level 3
	15:38:32	939	894	SWICS on at level 1
	15:40:40	941	881	Detector bias heater off
	15:43:20	943	852	Solar port heaters off
	15:44:24	944	861	WFOV BB heater off
15:44:56	945	871	MFOV BB heater off	
15:45:28	945	851	Solar port heaters on	
15:46:00	946	891	SWICS off	
End internal calibration sequence.				
Begin azimuth angle load commands for solar calibration				
10/25/86	15:48:40	949	419	Address azimuth position A
	15:49:12	949	2xx	Data command, high byte
	15:49:44	950	1xx	Data command, low byte
End azimuth angle load commands (A = 156.3°).				
Begin solar calibration sequence				
10/25/86	15:50:16	950	8A2	Begin solar calibration
	15:50:48	951	852	Solar port heaters off
	15:51:20	951	822	Elevate to solar ports (Sun)

Table 9. Continued

(a) Continued

Date	Universal time		Hex command	Event description
	hr:min:sec	Minutes of day		
10/25/86	15:51:52	952	814	Azimuth to position A
	15:52:24	952	882	Detector bias heater on at level 1
	16:02:00	962	851	Solar port heaters on
	16:02:32	963	831	SMA shutter cycle on
	16:33:28	993	832	SMA shutter cycle off
	16:34:00	994	852	Solar port heaters off
	16:34:32	995	813	Azimuth to 180°
	16:35:04	995	881	Detector bias heater off
	16:44:40	1005	823	Elevate to nadir (Earth)
16:45:12	1005	851	Solar port heaters on	
End solar calibration sequence.				
Begin preinternal calibration sequence				
10/29/86	09:52:24	592	821	Elevate to internal source (stow)
	09:52:56	593	862	WFOV BB heater on at temp. 1
	10:08:24	608	872	MFOV BB heater on at temp. 1
	11:35:20	695	823	Elevate to nadir (Earth)
End preinternal calibration sequence.				
Begin internal calibration sequence				
10/29/86	11:35:52	696	8A1	Begin internal calibration
	11:36:24	696	881	Detector bias heater off
	11:36:56	697	852	Solar port heaters off
	11:37:28	697	821	Elevate to internal source (stow)
	11:38:00	698	851	Solar port heaters on
	11:40:08	700	882	Detector bias heater on at level 1
	11:42:16	702	892	SWICS on at level 3
	11:45:28	705	881	Detector bias heater off
	11:49:12	709	862	WFOV BB heater on at temp. 1
	11:49:44	710	872	MFOV BB heater on at temp. 1
	11:50:48	711	891	SWICS off
	12:04:08	724	883	Detector bias heater on at level 2
	12:06:16	726	893	SWICS on at level 2
	12:09:28	729	881	Detector bias heater off
	12:13:12	733	863	WFOV BB heater on at temp. 2
	12:13:44	734	873	MFOV BB heater on at temp. 2
	12:14:48	735	891	SWICS off
	12:28:08	748	884	Detector bias heater on at level 3
	12:30:16	750	894	SWICS on at level 1
	12:32:24	752	881	Detector bias heater off
	12:35:04	755	852	Solar port heaters off
	12:36:08	756	861	WFOV BB heater off
	12:36:40	757	871	MFOV BB heater off
	12:37:12	757	851	Solar port heaters on
12:37:44	758	891	SWICS off	
End internal calibration sequence				

Table 9. Continued

(a) Continued

Date	Universal time		Hex command	Event description
	hr:min:sec	Minutes of day		
Begin azimuth angle load commands for solar calibration				
10/29/86	12:40:24	760	419	Address azimuth position A
	12:40:56	761	2xx	Data command, high byte
	12:41:28	761	1xx	Data command, low byte
End azimuth angle load commands (A = 156.08°).				
Begin solar calibration sequence				
10/29/86	12:42:00	762	8A2	Begin solar calibration
	12:42:32	763	852	Solar port heaters off
	12:43:04	763	822	Elevate to solar ports (Sun)
	12:43:36	764	814	Azimuth to position A
	12:44:08	764	882	Detector bias heater on at level 1
	12:53:44	774	851	Solar port heaters on
	12:54:16	774	831	SMA shutter cycle on
	13:25:12	805	832	SMA shutter cycle off
	13:25:44	806	852	Solar port heaters off
	13:26:16	806	813	Azimuth to 180°
	13:26:48	807	881	Detector bias heater off
	13:36:24	816	823	Elevate to nadir (Earth)
	13:36:56	817	851	Solar port heaters on
	End solar calibration sequence.			
Begin preinternal calibration sequence				
11/01/86	10:28:08	628	821	Elevate to internal source (stow)
	10:28:40	629	862	WFOV BB heater on at temp. 1
	10:44:08	644	872	MFOV BB heater on at temp. 1
	12:11:04	731	823	Elevate to nadir (Earth)
End preinternal calibration sequence.				
Begin internal calibration sequence				
11/01/86	12:11:36	732	8A1	Begin internal calibration
	12:12:08	732	881	Detector bias heater off
	12:12:40	733	852	Solar port heaters off
	12:13:12	733	821	Elevate to internal source (stow)
	12:13:44	734	851	Solar port heaters on
	12:15:52	736	882	Detector bias heater on at level 1
	12:18:00	738	892	SWICS on at level 3
	12:21:12	741	881	Detector bias heater off
	12:24:56	745	862	WFOV BB heater on at temp. 1
	12:25:28	745	872	MFOV BB heater on at temp. 1
	12:26:32	747	891	SWICS off
	12:39:52	760	883	Detector bias heater on at level 2
	12:42:00	762	893	SWICS on at level 2
	12:45:12	765	881	Detector bias heater off
	12:48:56	769	863	WFOV BB heater on at temp. 2
	12:49:28	769	873	MFOV BB heater on at temp. 2
	12:50:32	771	891	SWICS off

Table 9. Continued

(a) Continued

Date	Universal time		Hex command	Event description
	hr:min:sec	Minutes of day		
Begin internal calibration sequence				
11/12/86	11:34:48	695	8A1	Begin internal calibration
	11:35:20	695	881	Detector bias heater off
	11:35:52	696	852	Solar port heaters off
	11:36:24	696	821	Elevate to internal source (stow)
	11:36:56	697	851	Solar port heaters on
	11:39:04	699	882	Detector bias heater on at level 1
	11:41:12	701	892	SWICS on at level 3
	11:44:24	704	881	Detector bias heater off
	11:48:08	708	862	WFOV BB heater on at temp. 1
	11:48:40	709	872	MFOV BB heater on at temp. 1
	11:49:44	710	891	SWICS off
	12:03:04	723	883	Detector bias heater on at level 2
	12:05:12	725	893	SWICS on at level 2
	12:08:24	728	881	Detector bias heater off
	12:12:08	732	863	WFOV BB heater on at temp. 2
	12:12:40	733	873	MFOV BB heater on at temp. 2
	12:13:44	734	891	SWICS off
	12:27:04	747	884	Detector bias heater on at level 3
	12:29:12	749	894	SWICS on at level 1
	12:31:20	751	881	Detector bias heater off
	12:34:00	754	852	Solar port heaters off
	12:35:04	755	861	WFOV BB heater off
	12:35:36	756	871	MFOV BB heater off
	12:36:08	756	851	Solar port heaters on
	12:36:40	757	891	SWICS off
End internal calibration sequence.				
Begin azimuth angle load commands for solar calibration				
11/12/86	12:39:20	759	419	Address azimuth position A
	12:39:52	760	2xx	Data command, high byte
	12:40:24	760	1xx	Data command, low byte
End azimuth angle load commands ( $A = 155.1^\circ$ ).				
Begin solar calibration sequence				
11/12/86	12:40:56	761	8A2	Begin solar calibration
	12:41:28	761	852	Solar port heaters off
	12:42:00	762	822	Elevate to solar ports (Sun)
	12:42:32	763	814	Azimuth to position A
	12:43:04	763	882	Detector bias heater on at level 1
	12:52:40	773	851	Solar port heaters on
	12:53:12	773	831	SMA shutter cycle on
	13:24:08	804	832	SMA shutter cycle off
	13:24:40	805	852	Solar port heaters off
	13:25:12	805	813	Azimuth to $180^\circ$
	13:25:44	806	881	Detector bias heater off

Table 9. Continued

(a) Continued

Date	Universal time		Hex command	Event description
	hr:min:sec	Minutes of day		
11/12/86	13:35:20	815	823	Elevate to nadir (Earth)
	13:35:52	816	851	Solar port heaters on
End solar calibration sequence.				
Begin preinternal calibration sequence				
11/26/86	09:49:31	590	821	Elevate to internal source (stow)
	09:50:03	590	862	WFOV BB heater on at temp. 1
	10:05:31	606	872	MFOV BB heater on at temp. 1
	11:32:27	692	823	Elevate to nadir (Earth)
End preinternal calibration sequence.				
Begin internal calibration sequence				
11/26/86	11:32:59	693	8A1	Begin internal calibration
	11:33:31	694	881	Detector bias heater off
	11:34:03	694	852	Solar port heaters off
	11:34:35	695	821	Elevate to internal source (stow)
	11:35:07	695	851	Solar port heaters on
	11:37:15	697	882	Detector bias heater on at level 1
	11:39:23	699	892	SWICS on at level 3
	11:42:35	703	881	Detector bias heater off
	11:46:19	706	862	WFOV BB heater on at temp. 1
	11:46:51	707	872	MFOV BB heater on at temp. 1
	11:47:55	708	891	SWICS off
	12:01:15	721	883	Detector bias heater on at level 2
	12:03:23	723	893	SWICS on at level 2
	12:06:35	727	881	Detector bias heater off
	12:10:19	730	863	WFOV BB heater on at temp. 2
	12:10:51	731	873	MFOV BB heater on at temp. 2
	12:11:55	732	891	SWICS off
	12:25:15	745	884	Detector bias heater on at level 3
	12:27:23	747	894	SWICS on at level 1
	12:29:31	750	881	Detector bias heater off
	12:32:11	752	852	Solar port heaters off
	12:33:15	753	861	WFOV BB heater off
	12:33:47	754	871	MFOV BB heater off
	12:34:19	754	851	Solar port heaters on
12:34:51	755	891	SWICS off	
End internal calibration sequence.				
Begin azimuth angle load commands for solar calibration				
11/26/86	12:37:31	758	419	Address azimuth position A
	12:38:03	758	2xx	Data command, high byte
	12:38:35	759	1xx	Data command, low byte
End azimuth angle load commands ( $A = 153.6^\circ$ ).				
Begin solar calibration sequence				
11/26/86	12:39:07	759	8A2	Begin solar calibration
	12:39:39	760	852	Solar port heaters off

Table 9. Continued

(a) Continued

Date	Universal time		Hex command	Event description
	hr:min:sec	Minutes of day		
11/26/86	12:40:11	760	822	Elevate to solar ports (Sun)
	12:40:43	761	814	Azimuth to position A
	12:41:15	761	882	Detector bias heater on at level 1
	12:50:51	771	851	Solar port heaters on
	12:51:23	771	831	SMA shutter cycle on
	13:22:19	802	832	SMA shutter cycle off
	13:22:51	803	852	Solar port heaters off
	13:23:23	803	813	Azimuth to 180°
	13:23:55	804	881	Detector bias heater off
	13:33:31	814	823	Elevate to nadir (Earth)
	13:34:03	814	851	Solar port heaters on
	End solar calibration sequence.			
Begin preinternal calibration sequence				
12/10/86	09:47:23	587	821	Elevate to internal source (stow)
	09:47:55	588	862	WFOV BB heater on at temp. 1
	10:03:23	603	872	MFOV BB heater on at temp. 1
	11:30:19	690	823	Elevate to nadir (Earth)
End preinternal calibration sequence.				
Begin internal calibration sequence				
12/10/86	11:30:51	691	8A1	Begin internal calibration
	11:31:23	691	881	Detector bias heater off
	11:31:55	692	852	Solar port heaters off
	11:32:27	692	821	Elevate to internal source (stow)
	11:32:59	693	851	Solar port heaters on
	11:35:07	695	882	Detector bias heater on at level 1
	11:37:15	697	892	SWICS on at level 3
	11:40:27	700	881	Detector bias heater off
	11:44:11	704	862	WFOV BB heater on at temp. 1
	11:44:43	705	872	MFOV BB heater on at temp. 1
	11:45:47	706	891	SWICS off
	11:59:07	719	883	Detector bias heater on at level 2
	12:01:15	721	893	SWICS on at level 2
	12:04:27	724	881	Detector bias heater off
	12:08:11	728	863	WFOV BB heater on at temp. 2
	12:08:43	729	873	MFOV BB heater on at temp. 2
	12:09:47	730	891	SWICS off
	12:23:07	743	884	Detector bias heater on at level 3
	12:25:15	745	894	SWICS on at level 1
	12:27:23	747	881	Detector bias heater off
	12:30:03	750	852	Solar port heaters off
	12:31:07	751	861	WFOV BB heater off
	12:31:39	752	871	MFOV BB heater off



Table 9. Continued

(a) Continued

Date	Universal time		Hex command	Event description
	hr:min:sec	Minutes of day		
12/10/86	12:32:11	752	851	Solar port heaters on SWICS off
	12:32:43	753	891	
End internal calibration sequence.				
Begin azimuth angle load commands for solar calibration				
12/10/86	12:35:23	755	419	Address azimuth position A
	12:35:55	756	2xx	Data command, high byte
	12:36:27	756	1xx	Data command, low byte
End azimuth angle load commands (A = 154.95°).				
Begin solar calibration sequence				
12/10/86	12:36:59	757	8A2	Begin solar calibration
	12:37:31	758	852	Solar port heaters off
	12:38:03	758	822	Elevate to solar ports (Sun)
	12:38:35	759	814	Azimuth to position A
	12:39:07	759	882	Detector bias heater on at level 1
	12:48:43	769	851	Solar port heaters on
	12:49:15	769	831	SMA shutter cycle on
	13:20:11	800	832	SMA shutter cycle off
	13:20:43	801	852	Solar port heaters off
	13:21:15	801	813	Azimuth to 180°
	13:21:47	802	881	Detector bias heater off
	13:31:23	811	823	Elevate to nadir (Earth)
	13:31:55	812	851	Solar port heaters on
End solar calibration sequence.				
Begin preinternal calibration sequence				
12/24/86	09:45:15	585	821	Elevate to internal source (stow)
	09:45:47	586	862	WFOV BB heater on at temp. 1
	10:01:15	601	872	MFOV BB heater on at temp. 1
	11:28:11	688	823	Elevate to nadir (Earth)
End preinternal calibration sequence.				
Begin internal calibration sequence				
12/24/86	11:28:43	689	8A1	Begin internal calibration
	11:29:15	689	881	Detector bias heater off
	11:29:47	690	852	Solar port heaters off
	11:30:19	690	821	Elevate to internal source (stow)
	11:30:51	691	851	Solar port heaters on
	11:32:59	693	882	Detector bias heater on at level 1
	11:35:07	695	892	SWICS on at level 3
	11:38:19	698	881	Detector bias heater off
	11:42:03	702	862	WFOV BB heater on at temp. 1
	11:42:35	703	872	MFOV BB heater on at temp. 1
	11:43:39	704	891	SWICS off
	11:56:59	717	883	Detector bias heater on at level 2
	11:59:07	719	893	SWICS on at level 2
	12:02:19	722	881	Detector bias heater off

Table 9. Continued

(a) Continued

Date	Universal time		Hex command	Event description
	hr:min:sec	Minutes of day		
12/24/86	12:06:03	726	863	WFOV BB heater on at temp. 2
	12:06:35	727	873	MFOV BB heater on at temp. 2
	12:07:39	728	891	SWICS off
	12:20:59	741	884	Detector bias heater on at level 3
	12:23:07	743	894	SWICS on at level 1
	12:25:15	745	881	Detector bias heater off
	12:27:55	748	852	Solar port heaters off
	12:28:59	749	861	WFOV BB heater off
	12:29:31	750	871	MFOV BB heater off
	12:30:03	750	851	Solar port heaters on
	12:30:35	751	891	SWICS off
End internal calibration sequence.				
Begin azimuth angle load commands for solar calibration				
12/24/86	12:33:15	753	419	Address azimuth position A
	12:33:47	754	2xx	Data command, high byte
	12:34:19	754	1xx	Data command, low byte
End azimuth angle load commands (A = 156.15°).				
Begin solar calibration sequence				
12/24/86	12:34:51	755	8A2	Begin solar calibration
	12:35:23	755	852	Solar port heaters off
	12:35:55	756	822	Elevate to solar ports (Sun)
	12:36:27	756	814	Azimuth to position A
	12:36:59	757	882	Detector bias heater on at level 1
	12:46:35	767	851	Solar port heaters on
	12:47:07	767	831	SMA shutter cycle on
	13:18:03	798	832	SMA shutter cycle off
	13:18:35	799	852	Solar port heaters off
	13:19:07	799	813	Azimuth to 180°
	13:19:39	800	881	Detector bias heater off
	13:29:15	809	823	Elevate to nadir (Earth)
	13:29:47	810	851	Solar port heaters on
End solar calibration sequence.				
Begin preinternal calibration sequence				
01/21/87	09:37:47	578	821	Elevate to internal source (stow)
	09:38:19	578	862	WFOV BB heater on at temp. 1
	09:53:47	594	872	MFOV BB heater on at temp. 1
	11:20:43	681	823	Elevate to nadir (Earth)
End preinternal calibration sequence.				
Begin internal calibration sequence				
01/21/87	11:21:15	681	8A1	Begin internal calibration
	11:21:47	682	881	Detector bias heater off
	11:22:19	682	852	Solar port heaters off
	11:22:51	683	821	Elevate to internal source (stow)
	11:23:23	683	851	Solar port heaters on

Table 9. Continued

(a) Concluded

Date	Universal time		Hex command	Event description
	hr:min:sec	Minutes of day		
01/21/87	11:25:31	686	882	Detector bias heater on at level 1
	11:27:39	688	892	SWICS on at level 3
	11:30:51	691	881	Detector bias heater off
	11:34:35	695	862	WFOV BB heater on at temp. 1
	11:35:07	695	872	MFOV BB heater on at temp. 1
	11:36:11	696	891	SWICS off
	11:49:31	710	883	Detector bias heater on at level 2
	11:51:39	712	893	SWICS on at level 2
	11:54:51	715	881	Detector bias heater off
	11:58:35	719	863	WFOV BB heater on at temp. 2
	11:59:07	719	873	MFOV BB heater on at temp. 2
	12:00:11	720	891	SWICS off
	12:13:31	734	884	Detector bias heater on at level 3
	12:15:39	736	894	SWICS on at level 1
	12:17:47	738	881	Detector bias heater off
	12:20:27	740	852	Solar port heaters off
	12:21:31	742	861	WFOV BB heater off
	12:22:03	742	871	MFOV BB heater off
	12:22:35	743	851	Solar port heaters on
	12:23:07	743	891	SWICS off
End internal calibration sequence.				
Begin azimuth angle load commands for solar calibration				
01/21/87	12:25:47	746	419	Address azimuth position A
	12:26:19	746	2xx	Data command, high byte
	12:26:51	747	1xx	Data command, low byte
End azimuth angle load commands (A = 160.65°).				
Begin solar calibration sequence				
01/21/87	12:27:23	747	8A2	Begin solar calibration
	12:27:55	748	852	Solar port heaters off
	12:28:27	748	822	Elevate to solar ports (Sun)
	12:28:59	749	814	Azimuth to position A
	12:29:31	750	882	Detector bias heater on at level 1
	12:39:07	759	851	Solar port heaters on
	12:39:39	760	831	SMA shutter cycle on
	13:10:35	791	832	SMA shutter cycle off
	13:11:07	791	852	Solar port heaters off
	13:11:39	792	813	Azimuth to 180°
	13:12:11	792	881	Detector bias heater off
	13:21:47	802	823	Elevate to nadir (Earth)
	13:22:19	802	851	Solar port heaters on
	End solar calibration sequence			

Table 9. Continued

## (b) Scanner commands

Date	Universal time		Hex command	Event description
	hr:min:sec	Minutes of day		
10/24/86	12:29:44	750	821	Scan to stow
	14:08:56	849	813	Azimuth to 180°
	15:46:00	946	814	Azimuth to position A
	17:25:12	1045	822	Normal scan mode
Begin internal calibration sequence				
10/24/86	20:48:56	1249	8A1	Begin internal calibration
	20:49:28	1249	897	SWICS on at level 1 modulated
	20:51:04	1251	895	SWICS on at level 2 modulated
	20:52:40	1253	893	SWICS on at level 3 modulated
	20:54:16	1254	891	SWICS off
	20:57:28	1257	897	SWICS on at level 1 modulated
	20:59:04	1259	895	SWICS on at level 2 modulated
	21:00:40	1261	893	SWICS on at level 3 modulated
	21:02:16	1262	891	SWICS off
	21:21:28	1281	897	SWICS on at level 1 modulated
	21:23:04	1283	895	SWICS on at level 2 modulated
	21:24:40	1285	893	SWICS on at level 3 modulated
21:26:16	1286	891	SWICS off	
End internal calibration sequence.				
Begin internal calibration sequence				
10/25/86	13:17:12	797	8A1	Begin internal calibration
	13:17:44	798	897	SWICS on at level 1 modulated
	13:19:20	799	895	SWICS on at level 2 modulated
	13:20:56	801	893	SWICS on at level 3 modulated
	13:22:32	803	891	SWICS off
	13:25:44	806	897	SWICS on at level 1 modulated
	13:27:20	807	895	SWICS on at level 2 modulated
	13:28:56	809	893	SWICS on at level 3 modulated
	13:30:32	811	891	SWICS off
	13:49:44	830	897	SWICS on at level 1 modulated
	13:51:20	831	895	SWICS on at level 2 modulated
	13:52:56	833	893	SWICS on at level 3 modulated
	13:54:32	835	891	SWICS off
End internal calibration sequence.				
Begin internal calibration sequence				
10/29/86	10:08:56	609	8A1	Begin internal calibration
	10:09:28	609	897	SWICS on at level 1 modulated
	10:11:04	611	895	SWICS on at level 2 modulated
	10:12:40	613	893	SWICS on at level 3 modulated
	10:14:16	614	891	SWICS off
	10:17:28	617	897	SWICS on at level 1 modulated
	10:19:04	619	895	SWICS on at level 2 modulated
	10:20:40	621	893	SWICS on at level 3 modulated
10:22:16	622	891	SWICS off	

Table 9. Continued

(b) Continued

Date	Universal time		Hex command	Event description
	hr:min:sec	Minutes of day		
10/29/86	10:41:28	641	897	SWICS on at level 1 modulated
	10:43:04	643	895	SWICS on at level 2 modulated
	10:44:40	645	893	SWICS on at level 3 modulated
	10:46:16	646	891	SWICS off
End internal calibration sequence. Begin internal calibration sequence				
11/01/86	10:44:40	645	8A1	Begin internal calibration
	10:45:12	645	897	SWICS on at level 1 modulated
	10:46:48	647	895	SWICS on at level 2 modulated
	10:48:24	648	893	SWICS on at level 3 modulated
	10:50:00	650	891	SWICS off
	10:53:12	653	897	SWICS on at level 1 modulated
	10:54:48	655	895	SWICS on at level 2 modulated
	10:56:24	656	893	SWICS on at level 3 modulated
	10:58:00	658	891	SWICS off
	11:17:12	677	897	SWICS on at level 1 modulated
	11:18:48	679	895	SWICS on at level 2 modulated
	11:20:24	680	893	SWICS on at level 3 modulated
11:22:00	682	891	SWICS off	
End internal calibration sequence. Begin internal calibration sequence				
11/05/86	10:59:04	659	8A1	Begin internal calibration
	10:59:36	660	897	SWICS on at level 1 modulated
	11:01:12	661	895	SWICS on at level 2 modulated
	11:02:48	663	893	SWICS on at level 3 modulated
	11:04:24	664	891	SWICS off
	11:07:36	668	897	SWICS on at level 1 modulated
	11:09:12	669	895	SWICS on at level 2 modulated
	11:10:48	671	893	SWICS on at level 3 modulated
	11:12:24	672	891	SWICS off
	11:31:36	692	897	SWICS on at level 1 modulated
	11:33:12	693	895	SWICS on at level 2 modulated
	11:34:48	695	893	SWICS on at level 3 modulated
11:36:24	696	891	SWICS off	
End internal calibration sequence. Begin internal calibration sequence				
11/12/86	10:07:52	608	8A1	Begin internal calibration
	10:08:24	608	897	SWICS on at level 1 modulated
	10:10:00	610	895	SWICS on at level 2 modulated
	10:11:36	612	893	SWICS on at level 3 modulated
	10:13:12	613	891	SWICS off
	10:16:24	616	897	SWICS on at level 1 modulated
	10:18:00	618	895	SWICS on at level 2 modulated
	10:19:36	620	893	SWICS on at level 3 modulated

Table 9. Continued

(b) Continued

Date	Universal time		Hex command	Event description
	hr:min:sec	Minutes of day		
11/12/86	10:21:12	621	891	SWICS off
	10:40:24	640	897	SWICS on at level 1 modulated
	10:42:00	642	895	SWICS on at level 2 modulated
	10:43:36	644	893	SWICS on at level 3 modulated
	10:45:12	645	891	SWICS off
End internal calibration sequence.				
Begin azimuth angle load commands for solar calibration				
11/12/86	14:09:28	849	419	Address azimuth position A
	14:10:00	850	2xx	Data command, high byte
	14:10:32	851	1xx	Data command, low byte
	14:11:04	851	41B	Address azimuth position B
	14:11:36	852	2xx	Data command, high byte
	14:12:08	852	1xx	Data command, low byte
End azimuth angle load commands (A = 34.95°, B = 154.65°)				
11/12/86	14:12:40	853	825	MAM (Solar) scan mode
	14:13:44	854	815	Azimuth to position B
	14:52:40	893	814	Azimuth to position A
	14:56:24	896	822	Normal scan mode
11/13/86	16:52:08	1012	821	Scan to stow
	18:33:47	1114	822	Normal scan mode
11/18/86	18:24:43	1105	821	Scan to stow
Begin azimuth angle load commands for 35° operation				
11/19/86	18:01:47	1082	419	Address azimuth position A
	18:02:51	1083	2xx	Data command, high byte
	18:04:59	1085	1xx	Data command, low byte
	18:07:07	1087	41B	Address azimuth position B
	18:08:11	1088	2xx	Data command, high byte
	19:45:15	1185	1xx	Data command, low byte
End azimuth angle load commands (A = 34.95°, B = 154.65°)				
11/20/86	14:24:11	864	815	Azimuth to position B
	16:01:47	962	814	Azimuth to position A
Begin internal calibration sequence				
11/26/86	10:06:03	606	8A1	Begin internal calibration
	10:06:35	607	897	SWICS on at level 1 modulated
	10:08:11	608	895	SWICS on at level 2 modulated
	10:09:47	610	893	SWICS on at level 3 modulated
	10:11:23	611	891	SWICS off
	10:14:35	615	897	SWICS on at level 1 modulated
	10:16:11	616	895	SWICS on at level 2 modulated
	10:17:47	618	893	SWICS on at level 3 modulated
	10:19:23	619	891	SWICS off

Table 9. Continued

(b) Continued

Date	Universal time		Hex command	Event description
	hr:min:sec	Minutes of day		
11/26/86	10:38:35	639	897	SWICS on at level 1 modulated
	10:40:11	640	895	SWICS on at level 2 modulated
	10:41:47	642	893	SWICS on at level 3 modulated
	10:43:23	643	891	SWICS off
End internal calibration sequence.				
Begin azimuth angle load commands for 35° operation				
12/03/86	18:02:19	1082	419	Address azimuth position A
	18:03:23	1083	2xx	Data command, high byte
	18:04:59	1085	1xx	Data command, low byte
End azimuth angle load commands (A = 34.95°)				
12/04/86	14:20:27	860	811	Azimuth to 0°
	19:21:47	1162	814	Azimuth to position A
12/05/86	15:36:11	936	822	Normal scan mode
Begin internal calibration sequence				
12/10/86	10:03:55	604	8A1	Begin internal calibration
	10:04:27	604	897	SWICS on at level 1 modulated
	10:06:03	606	895	SWICS on at level 2 modulated
	10:07:39	608	893	SWICS on at level 3 modulated
	10:09:15	609	891	SWICS off
	10:12:27	612	897	SWICS on at level 1 modulated
	10:14:03	614	895	SWICS on at level 2 modulated
	10:15:39	616	893	SWICS on at level 3 modulated
	10:17:15	617	891	SWICS off
	10:36:27	636	897	SWICS on at level 1 modulated
	10:38:03	638	895	SWICS on at level 2 modulated
	10:39:39	640	893	SWICS on at level 3 modulated
	10:41:15	641	891	SWICS off
	End internal calibration sequence.			
Begin internal calibration sequence				
12/24/86	10:01:47	602	8A1	Begin internal calibration
	10:02:19	602	897	SWICS on at level 1 modulated
	10:03:55	604	895	SWICS on at level 2 modulated
	10:05:31	606	893	SWICS on at level 3 modulated
	10:07:07	607	891	SWICS off
	10:10:19	610	897	SWICS on at level 1 modulated
	10:11:55	612	895	SWICS on at level 2 modulated
	10:13:31	614	893	SWICS on at level 3 modulated
	10:15:07	615	891	SWICS off
	10:34:19	634	897	SWICS on at level 1 modulated
	10:35:55	636	895	SWICS on at level 2 modulated
	10:37:31	638	893	SWICS on at level 3 modulated
	10:39:07	639	891	SWICS off
	End internal calibration sequence			

Table 9. Concluded

(b) Concluded

Date	Universal time		Hex command	Event description
	hr:min:sec	Minutes of day		
Begin internal calibration sequence				
01/21/87	09:54:19	594	8A1	Begin internal calibration
	09:54:51	595	897	SWICS on at level 1 modulated
	09:56:27	596	895	SWICS on at level 2 modulated
	09:58:03	598	893	SWICS on at level 3 modulated
	09:59:39	600	891	SWICS off
	10:02:51	603	897	SWICS on at level 1 modulated
	10:04:27	604	895	SWICS on at level 2 modulated
	10:06:03	606	893	SWICS on at level 3 modulated
	10:07:39	608	891	SWICS off
	10:26:51	627	897	SWICS on at level 1 modulated
	10:28:27	628	895	SWICS on at level 2 modulated
	10:30:03	630	893	SWICS on at level 3 modulated
	10:31:39	632	891	SWICS off
	End internal calibration sequence			



Table 10. Characteristics of ERBS and NOAA 9 Orbits on January 1, 1985, 1986, and 1987, and NOAA 10 Orbits on November 1, 1986, and January 1, 1987

(a) ERBS spacecraft

Parameter	Value at beginning of year—		
	1985	1986	1987
Semimajor axis, km . . . . .	6981	6981	6981
Eccentricity . . . . .	0.00189	0.00141	0.00099
Inclination, deg . . . . .	57.00	56.99	57.01
Period, min . . . . .	96.75	96.75	96.75
Mean altitude, km . . . . .	611.28	611.01	610.88
Minimum altitude, km . . . . .	599.65	600.37	602.17
Maximum altitude, km . . . . .	630.08	625.67	623.86
Mean anomaly rate, deg/min . . . . .	3.72	3.72	3.72
Argument of perigee rate of change, deg/day . . . . .	1.75	1.76	1.75
Rotation rate of right ascension of ascending node, deg/day . . . . .	-3.95	-3.97	-3.95
Local time of ascending node, hr:min of day . . . . .	23:17	23:25	23:40

(b) NOAA 9 spacecraft

Parameter	Value at beginning of year—		
	1985	1986	1987
Semimajor axis, km . . . . .	7230	7230	7230
Eccentricity . . . . .	0.00198	0.00117	0.00109
Inclination, deg . . . . .	98.93	98.98	99.03
Period, min . . . . .	102.00	101.97	101.96
Mean altitude, km . . . . .	866.63	866.38	866.22
Minimum altitude, km . . . . .	847.95	855.73	848.84
Maximum altitude, km . . . . .	879.01	878.71	876.47
Mean anomaly rate, deg/min . . . . .	3.53	3.53	3.53
Argument of perigee rate of change, deg/day . . . . .	-2.83	-2.82	-2.82
Rotation rate of right ascension of ascending node, deg/day . . . . .	1.000	1.003	1.010
Local time of ascending node, hr:min of day . . . . .	14:20	14:36	15:13

Table 10. Concluded

(c) NOAA 10 spacecraft

Parameter	Value at listed date—	
	Nov. 1, 1986	Jan. 1, 1987
Semimajor axis, km . . . . .	7192	7192
Eccentricity . . . . .	0.00212	0.00186
Inclination, deg . . . . .	98.74	98.74
Period, min . . . . .	101.16	101.17
Mean altitude, km . . . . .	829.16	828.61
Minimum altitude, km . . . . .	809.22	811.02
Maximum altitude, km . . . . .	852.47	842.10
Mean anomaly rate, deg/min . . . . .	3.56	3.55
Argument of perigee rate of change, deg/day . . . . .	-2.89	-2.87
Rotation rate of right ascension of ascending node, deg/day . . . . .	0.996	0.988
Local time of ascending node, hr:min of day . . . . .	07:31	07:32

Table 11. Edit Limits for Key Instrument Housekeeping Measurements

[For explanation of abbreviations, see "Nomenclature" on p. 1]

(a) Nonscanner instrument

Measurement	Telemetry subsystem edit limits					
	Low limit	Unit	High limit	Unit	Rate of change	Unit
ERBS spacecraft						
Heat sink temp. of all Earth-viewing detectors . . . . .	33.55	°C	33.75	°C	0.005	°C/sec
Heat sink temp. of solar monitor . . . . .	0	↓	30.0	↓	0.003125	↓
Aperture temp. of all Earth-viewing detectors . . . . .	33.0	↓	34.2	↓	0.003125	↓
Aperture temp. of solar monitor . . . . .	0	↓	30.0	↓	0.03125	↓
FOVL temp. of all Earth-viewing detectors . . . . .	0	↓	35.0	↓	0.025	↓
WFOV BB temp. . . . .	10.0	↓	30.0	↓	0.00625	↓
MFOV BB temp. . . . .	10.0	↓	30.0	↓	0.00625	↓
Slice 3 temp. . . . .	0	↓	40.0	↓	0.0625	↓
NOAA 9 spacecraft						
Heat sink temp. of all Earth-viewing detectors . . . . .	33.5	°C	33.7	°C	0.005	°C/sec
Heat sink temp. of solar monitor . . . . .	0	↓	30.0	↓	0.003125	↓
Aperture temp. of all Earth-viewing detectors . . . . .	33.0	↓	34.0	↓	0.003125	↓
Aperture temp. of solar monitor . . . . .	0	↓	30.0	↓	0.003125	↓
FOVL temp. of all Earth-viewing detectors . . . . .	0	↓	30.0	↓	0.025	↓
WFOV BB temp. . . . .	10.0	↓	30.0	↓	0.00625	↓
MFOV BB temp. . . . .	10.0	↓	30.0	↓	0.00625	↓
Slice 3 temp. . . . .	0	↓	40.0	↓	0.0625	↓
NOAA 10 spacecraft						
Heat sink temp. of all Earth-viewing detectors . . . . .	33.5	°C	33.7	°C	0.005	°C/sec
Heat sink temp. of solar monitor . . . . .	0	↓	30.0	↓	0.003125	↓
Aperture temp. of all Earth-viewing detectors . . . . .	32.2	↓	33.2	↓	0.003125	↓
Aperture temp. of solar monitor . . . . .	0	↓	30.0	↓	0.003125	↓
FOVL temp. of all Earth-viewing detectors . . . . .	0	↓	30.0	↓	0.025	↓
WFOV BB temp. . . . .	10.0	↓	30.0	↓	0.00625	↓
MFOV BB temp. . . . .	10.0	↓	30.0	↓	0.00625	↓
Slice 3 temp. . . . .	0	↓	40.0	↓	0.0625	↓

Table 11. Concluded

(b) Scanner instrument

Measurement	Telemetry subsystem edit limits					
	Low limit	Unit	High limit	Unit	Rate of change	Unit
ERBS spacecraft						
Det temp. all . . . . .	37.5	°C	38.5	°C	0.01	°C/sec
DAC voltages— all . . . . .	(a)		(a)		0.0125	V/sec
LW BB temp. . . . .	0	°C	50.0	°C	0.1	°C/sec
TOT BB temp. . . . .	0	↓	50.0	↓	0.1	↓
Slice 3 temp. . . . .	0		50.0		0.0625	
Box beam temp. . . . .	10.0	↓	35.0	↓	0.0625	↓
NOAA 9 spacecraft						
Det temp. all . . . . .	37.5	°C	38.5	°C	0.01	°C/sec
DAC voltages— all . . . . .	(a)		(a)		0.0125	V/sec
LW BB temp. . . . .	0	°C	50.0	°C	0.1	°C/sec
TOT BB temp. . . . .	0	↓	50.0	↓	0.1	↓
Slice 3 temp. . . . .	0		50.0		0.0625	
Box beam temp. . . . .	10.0	↓	35.0	↓	0.0625	↓
NOAA 10 spacecraft						
Det temp. all . . . . .	37.5	°C	38.5	°C	0.01	°C/sec
DAC voltages all . . . . .	(a)		(a)		0.0125	V/sec
LW BB temp. . . . .	0	°C	50.0	°C	0.1	°C/sec
TOT BB temp. . . . .	0	↓	50.0	↓	0.1	↓
Slice 3 temp. . . . .	0		50.0		0.0625	
Box beam temp. . . . .	10.0	↓	35.0	↓	0.0625	↓

<sup>a</sup>Not applicable.

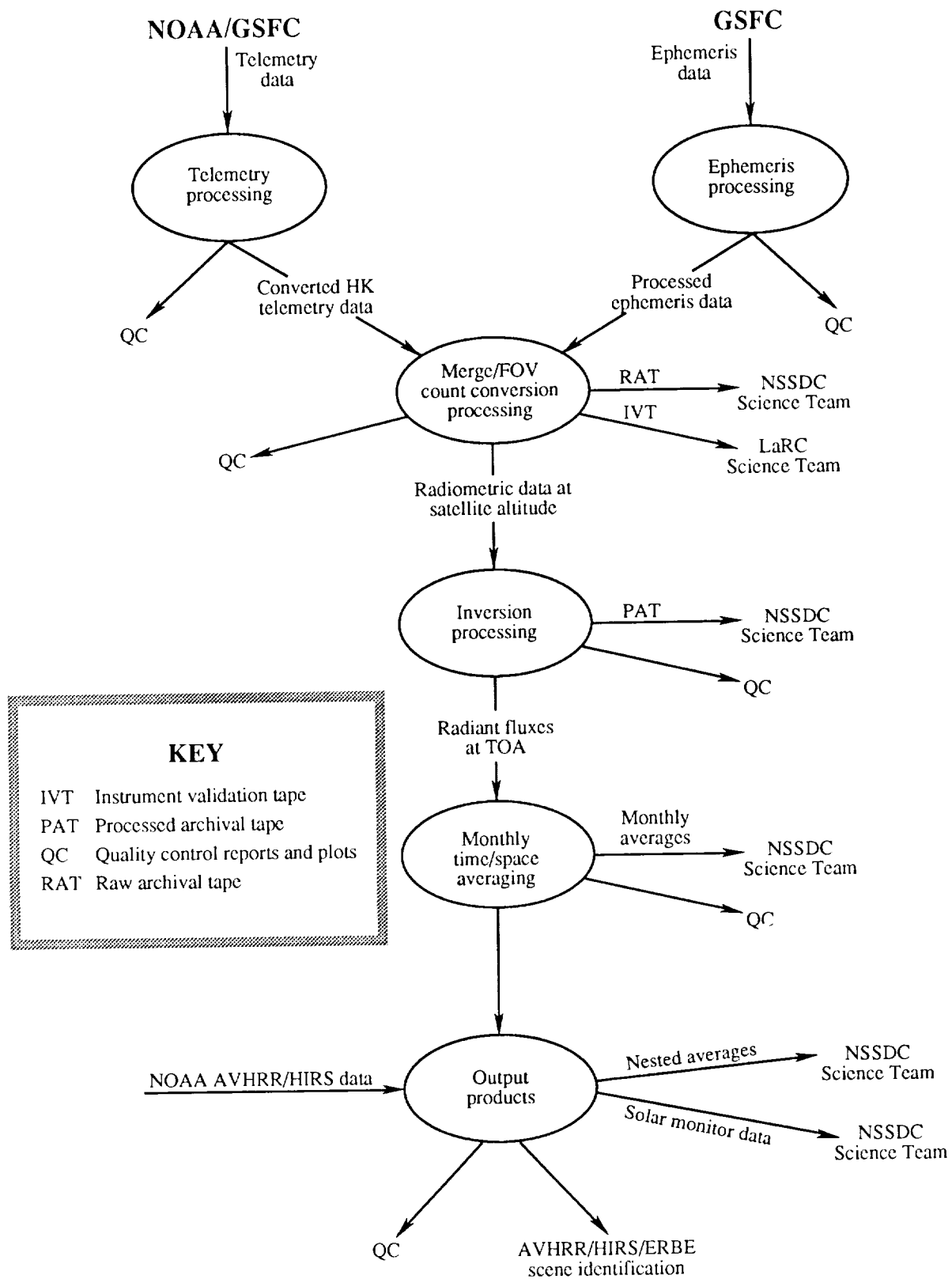
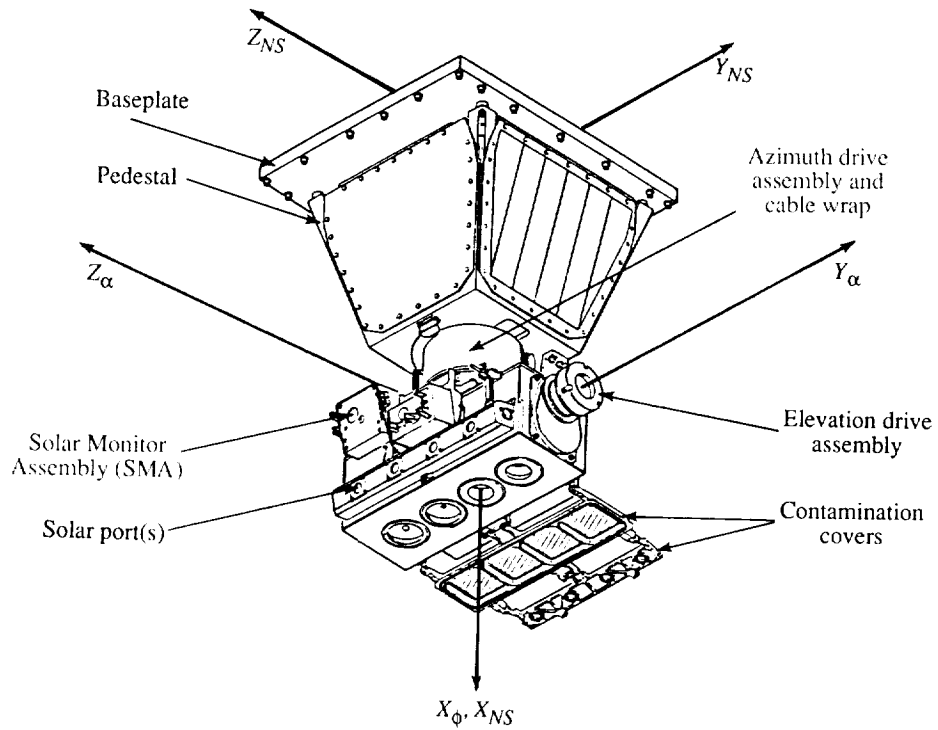
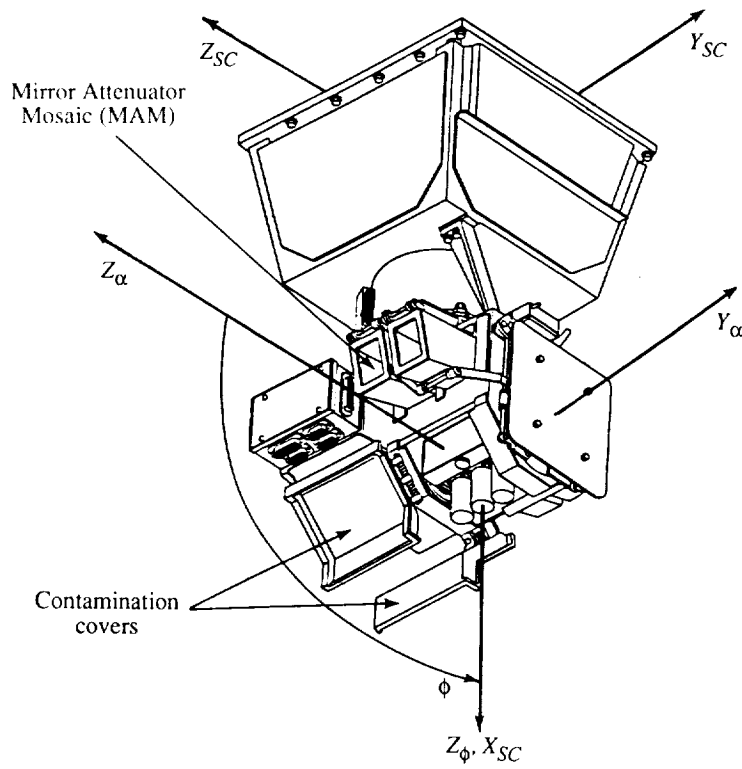

Figure 1. Overview of ERBE data processing.



(a) Nonscanner.



(b) Scanner.

Figure 2. Diagram of ERBE instruments illustrating coordinate axes.

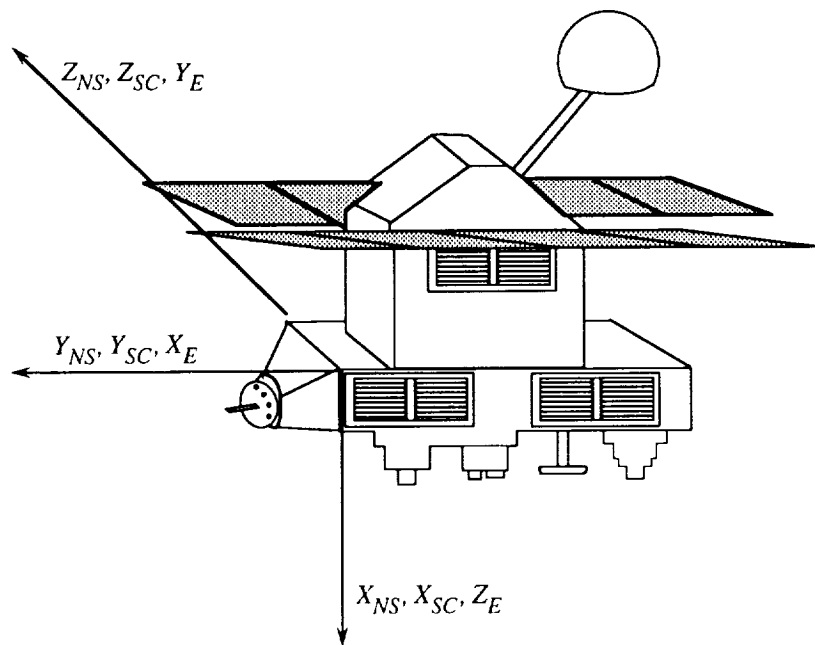

(a) ERBS spacecraft.

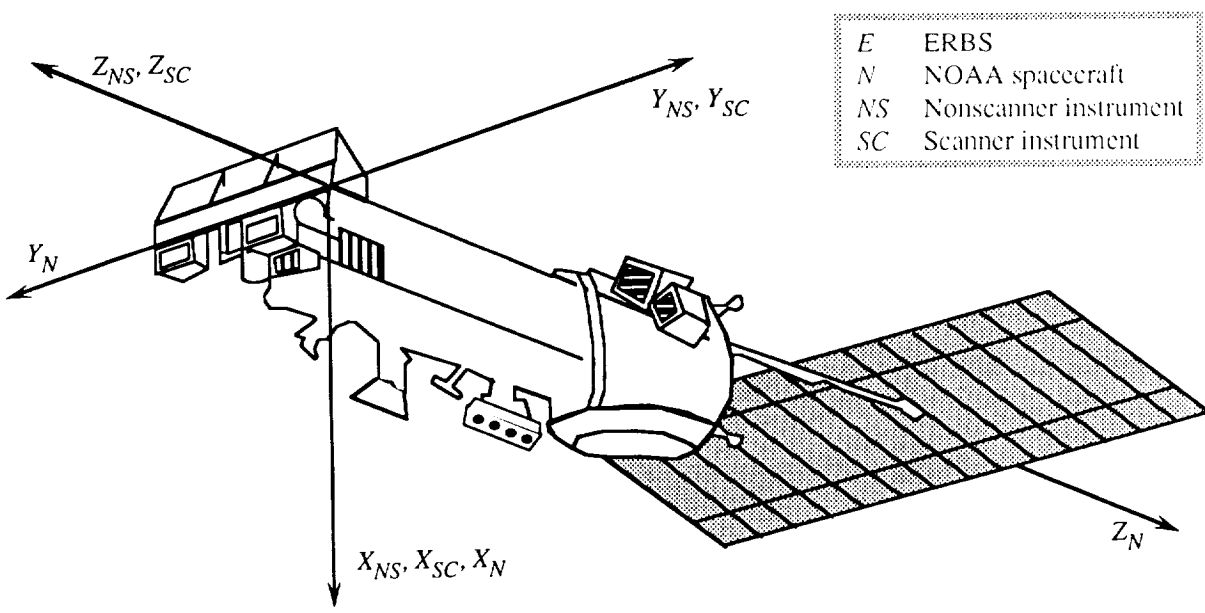

<i>E</i>	ERBS
<i>N</i>	NOAA spacecraft
<i>NS</i>	Nonscanner instrument
<i>SC</i>	Scanner instrument

(b) NOAA spacecraft.

Figure 3. Spacecraft coordinate systems and alignment of axes with instrument axes.

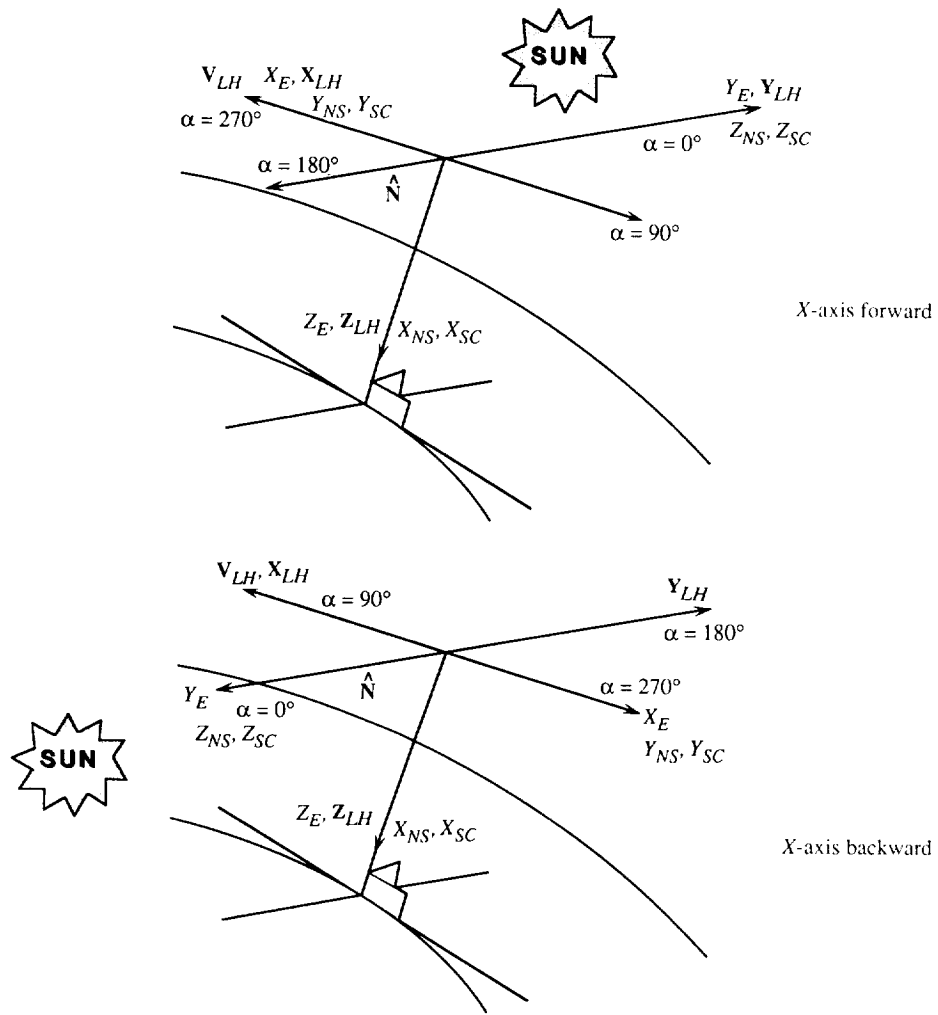

(a) ERBS spacecraft.

(b) NOAA spacecraft.

Figure 4. Alignment between spacecraft and their local horizon coordinates.



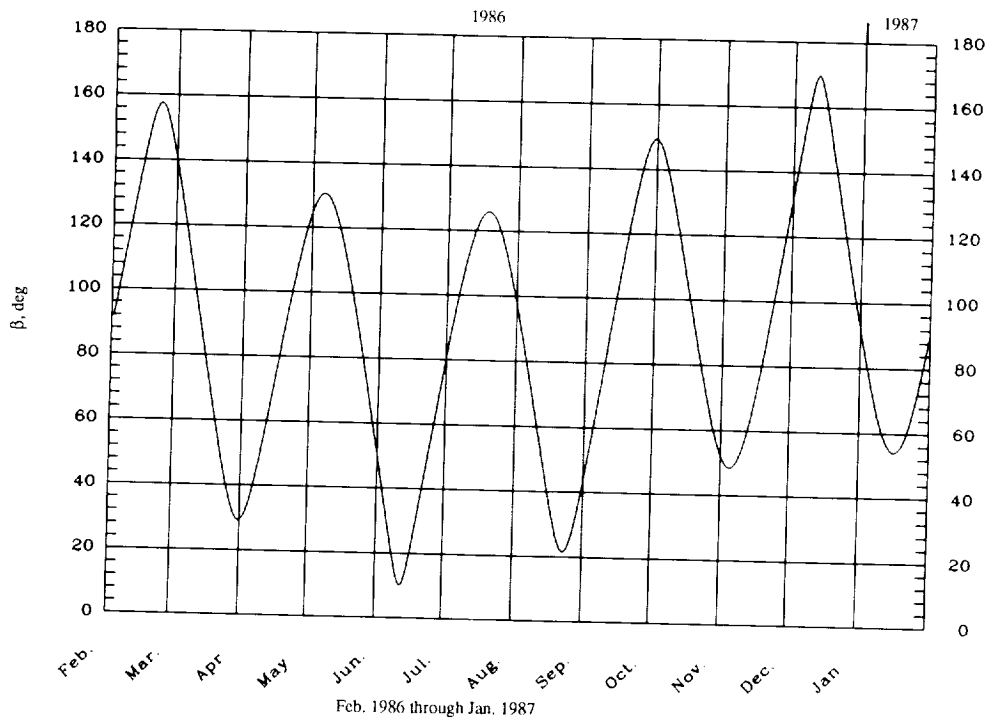

(a) ERBS spacecraft for February 1986 through January 1987.

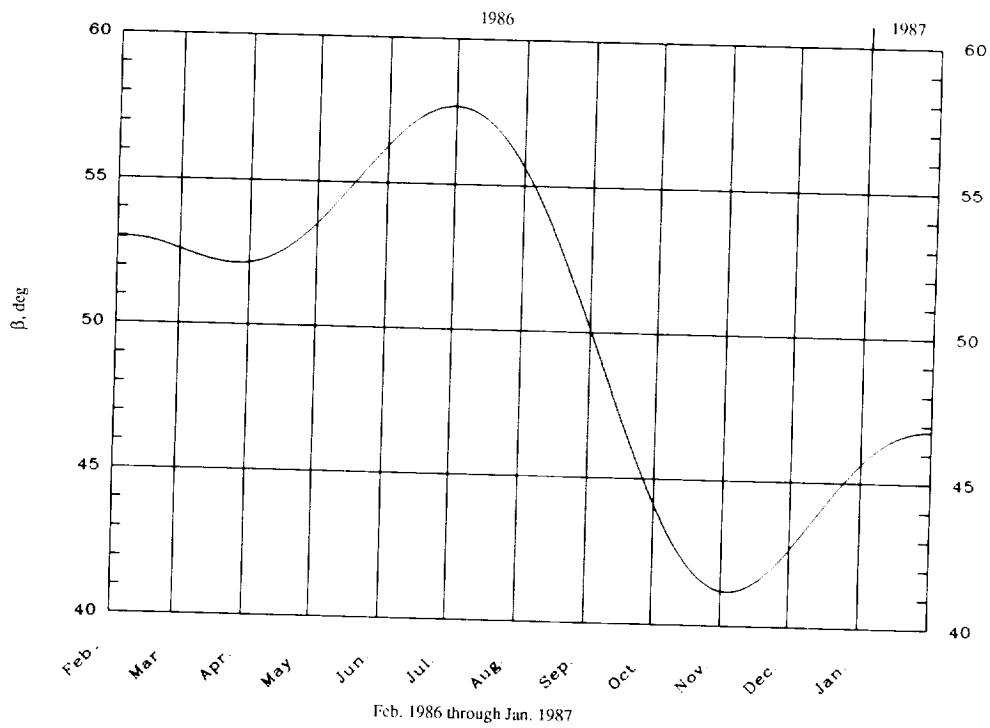

(b) NOAA 9 spacecraft for February 1986 through January 1987.

Figure 5. Beta angles ( $\beta$ ) for ERBS, NOAA 9, and NOAA 10 spacecraft orbits.

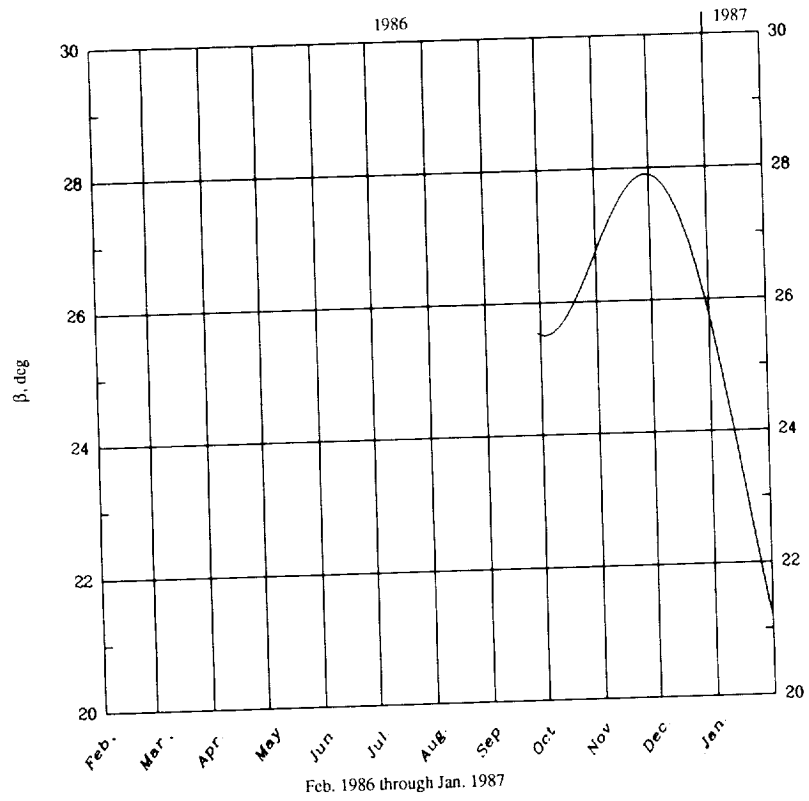

(c) NOAA 10 spacecraft for February 1986 through January 1987.

Figure 5. Concluded.

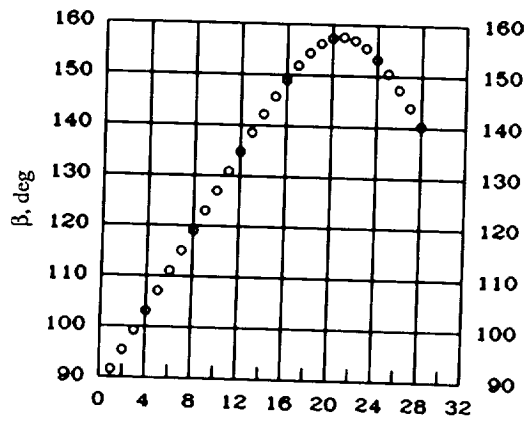

February 1986

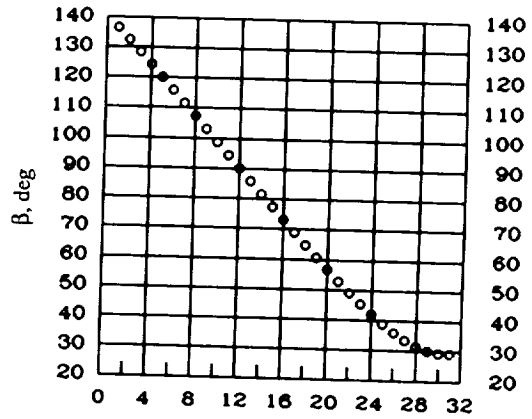

March 1986

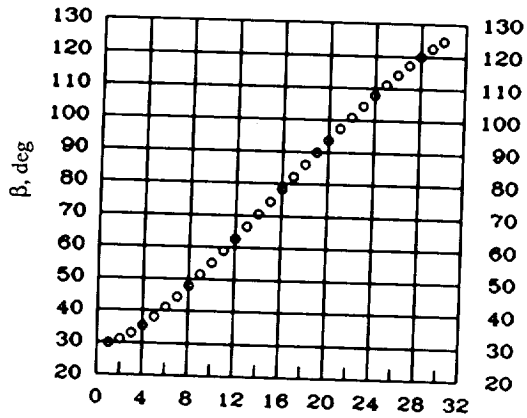

April 1986

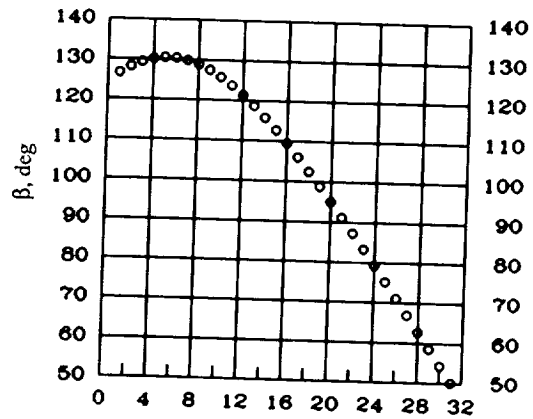

May 1986

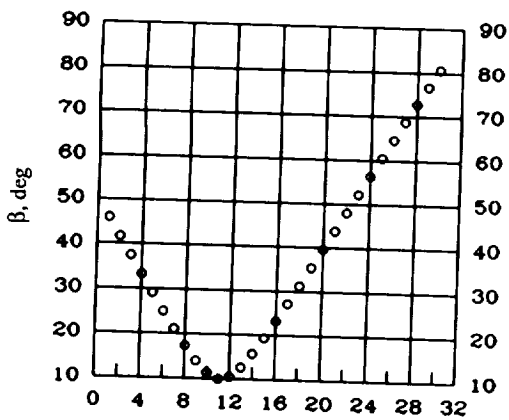

June 1986

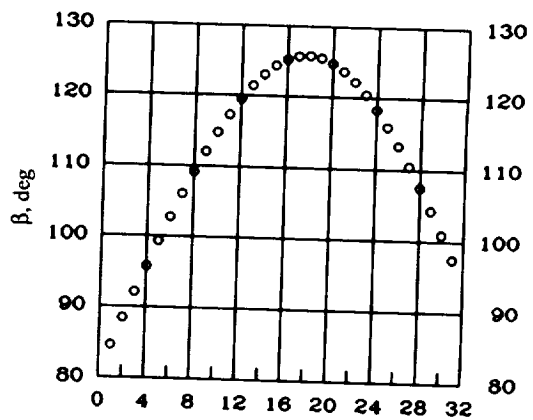

July 1986

(a) ERBS spacecraft.

Figure 6. Beta angles ( $\beta$ ) for ERBS, NOAA 9, and NOAA 10 spacecraft orbits for each month.

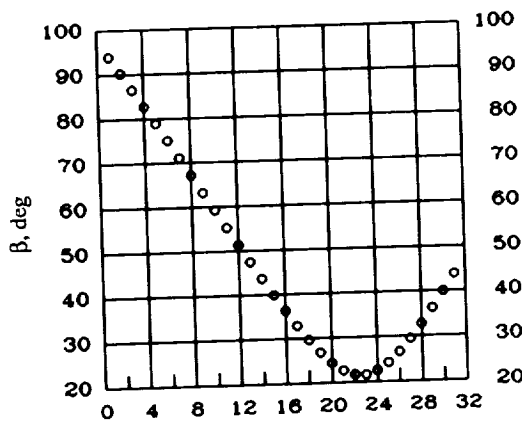

August 1986

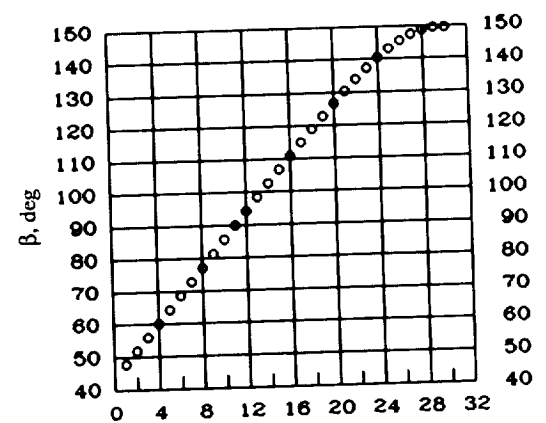

September 1986

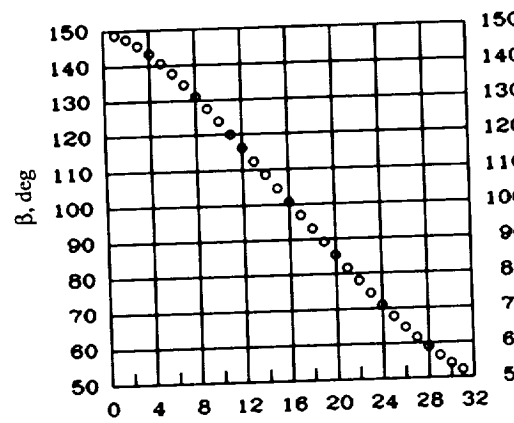

October 1986

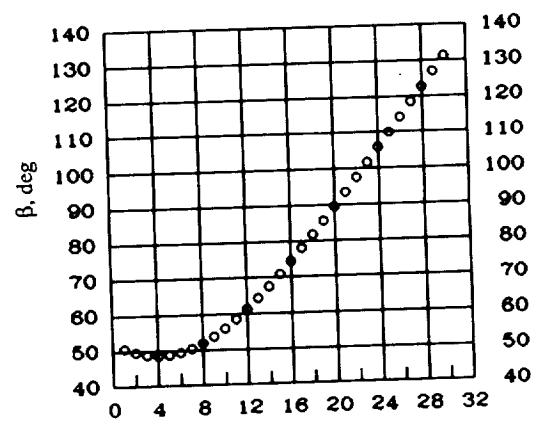

November 1986

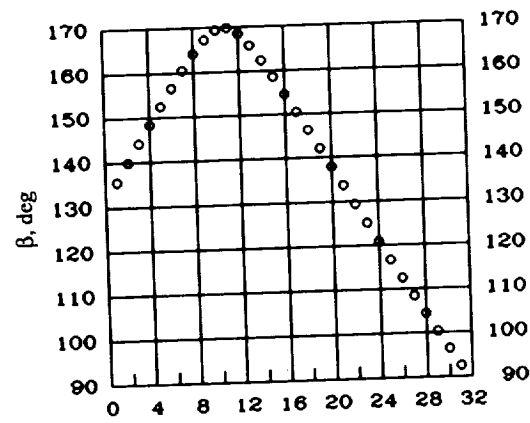

December 1986

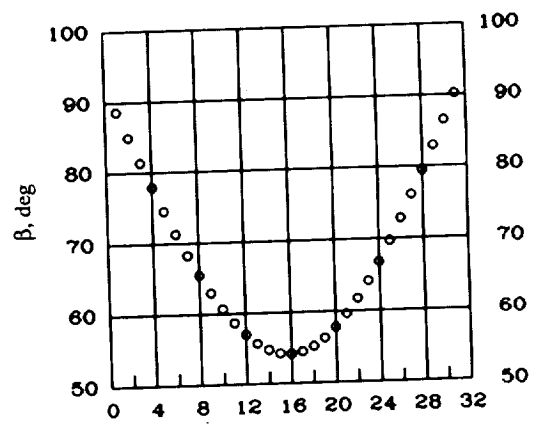

January 1987

(a) Concluded.

Figure 6. Continued.

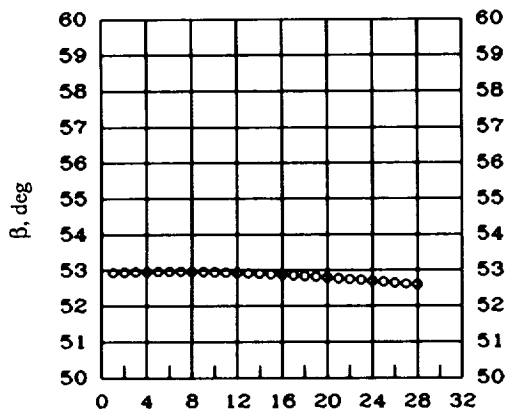

February 1986

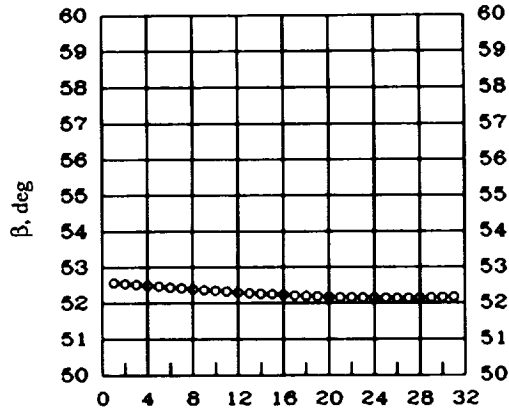

March 1986

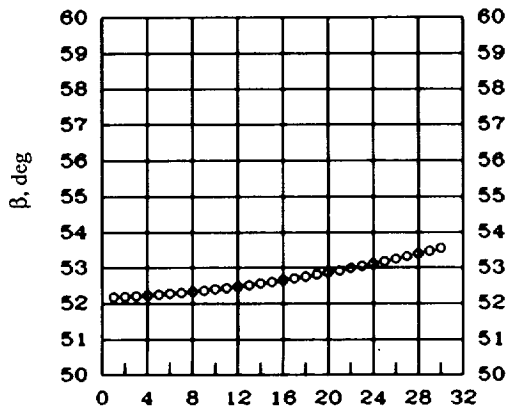

April 1986

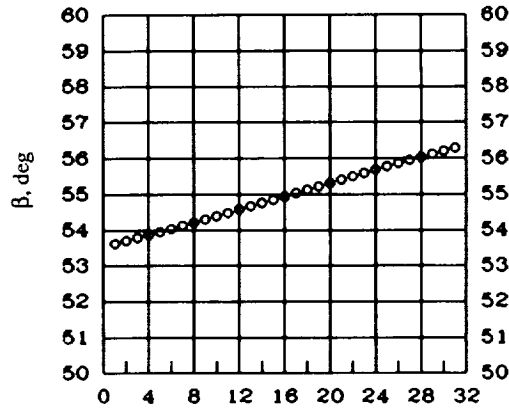

May 1986

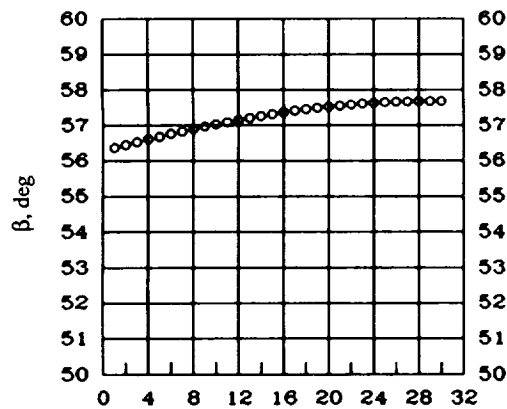

June 1986

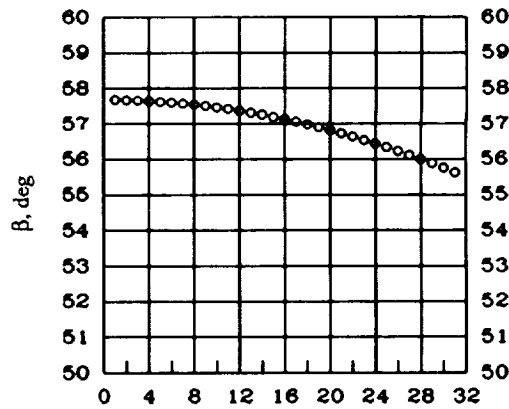

July 1986

(b) NOAA 9 spacecraft.

Figure 6. Continued.

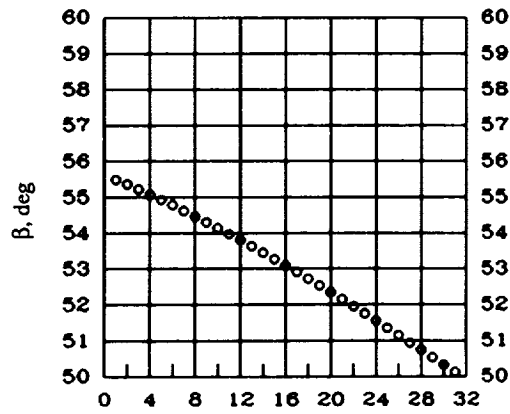

August 1986

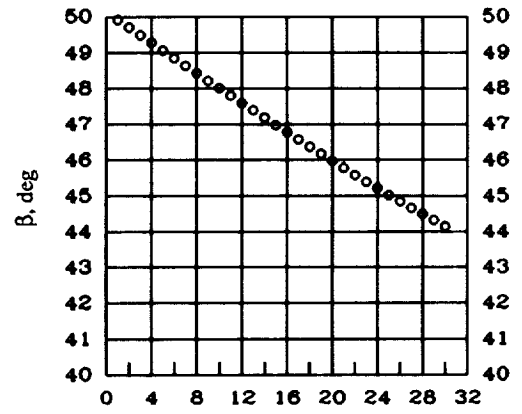

September 1986

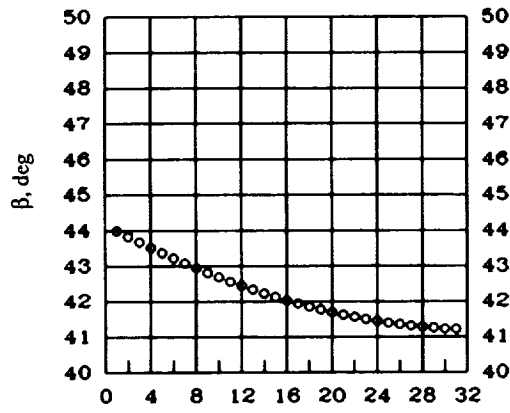

October 1986

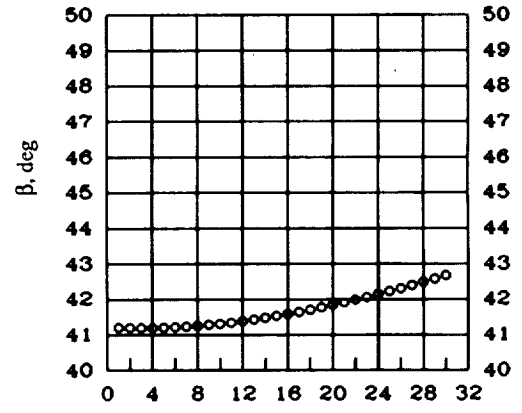

November 1986

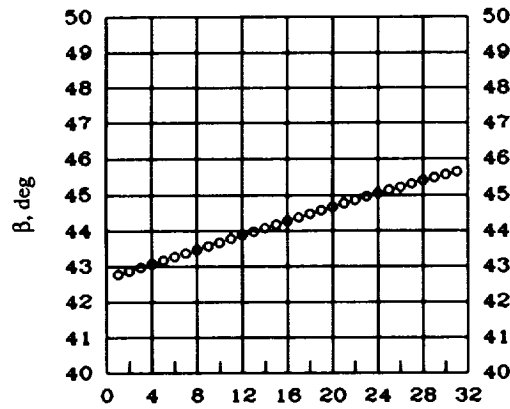

December 1986

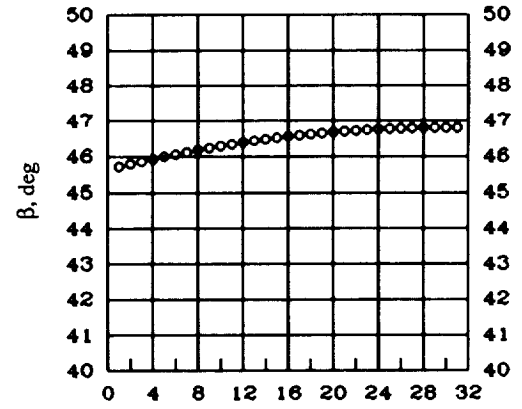

January 1987

(b) Concluded.

Figure 6. Continued.

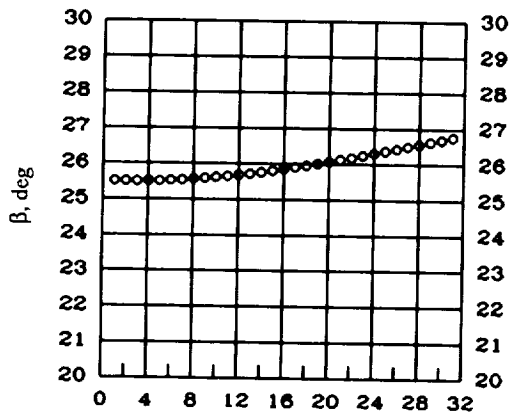

October 1986

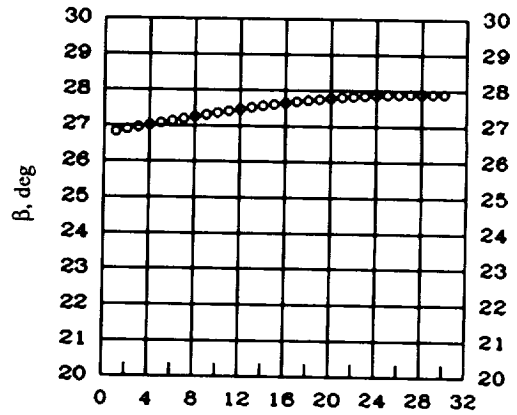

November 1986

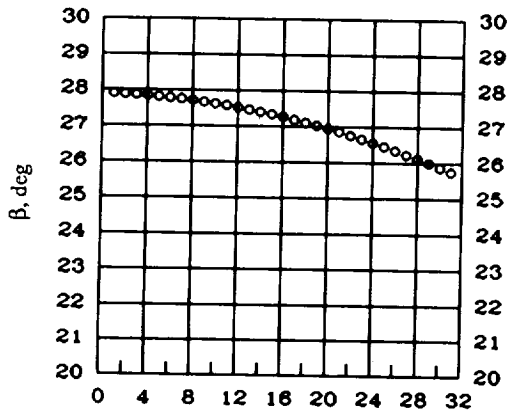

December 1986

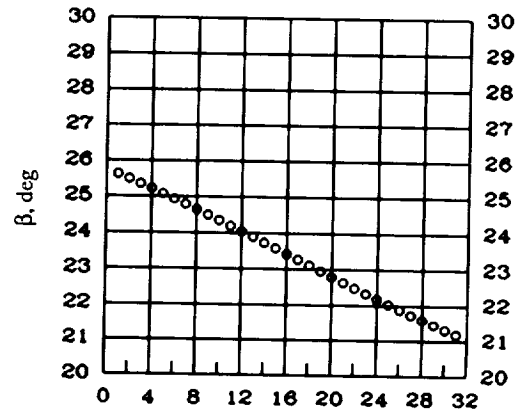

January 1987

(c) NOAA 10 spacecraft.

Figure 6. Concluded.

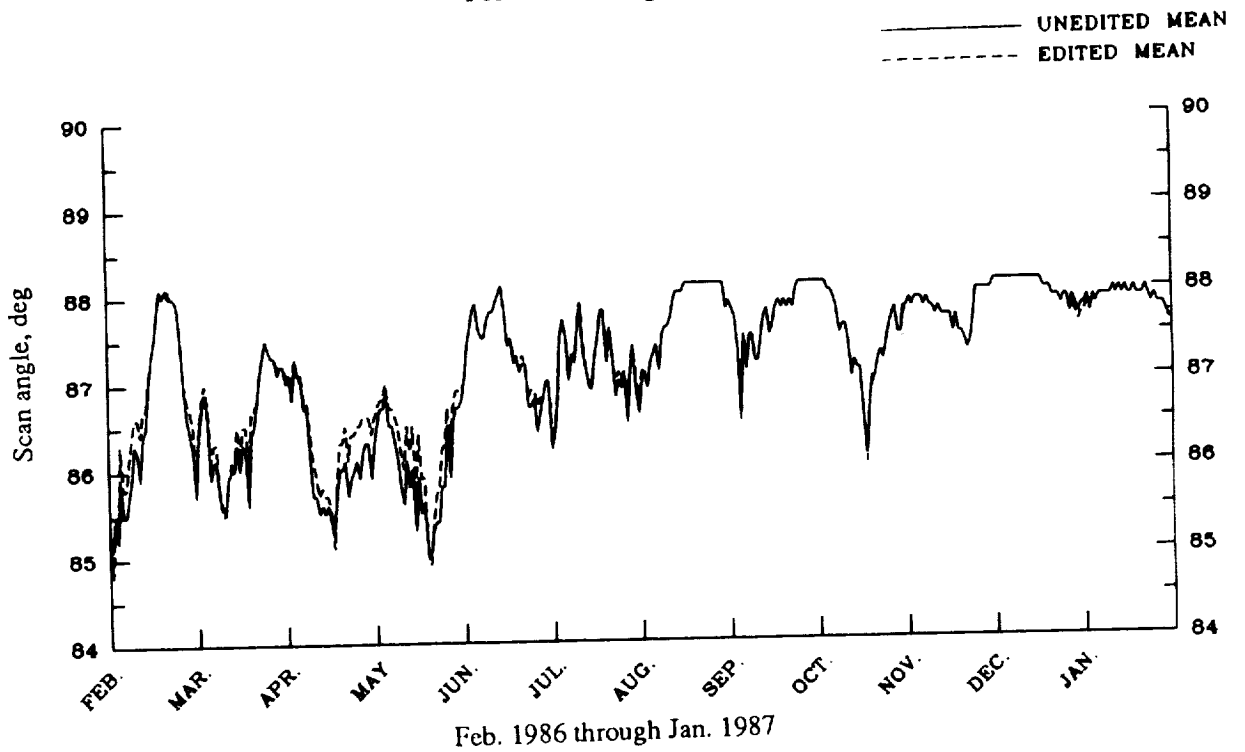
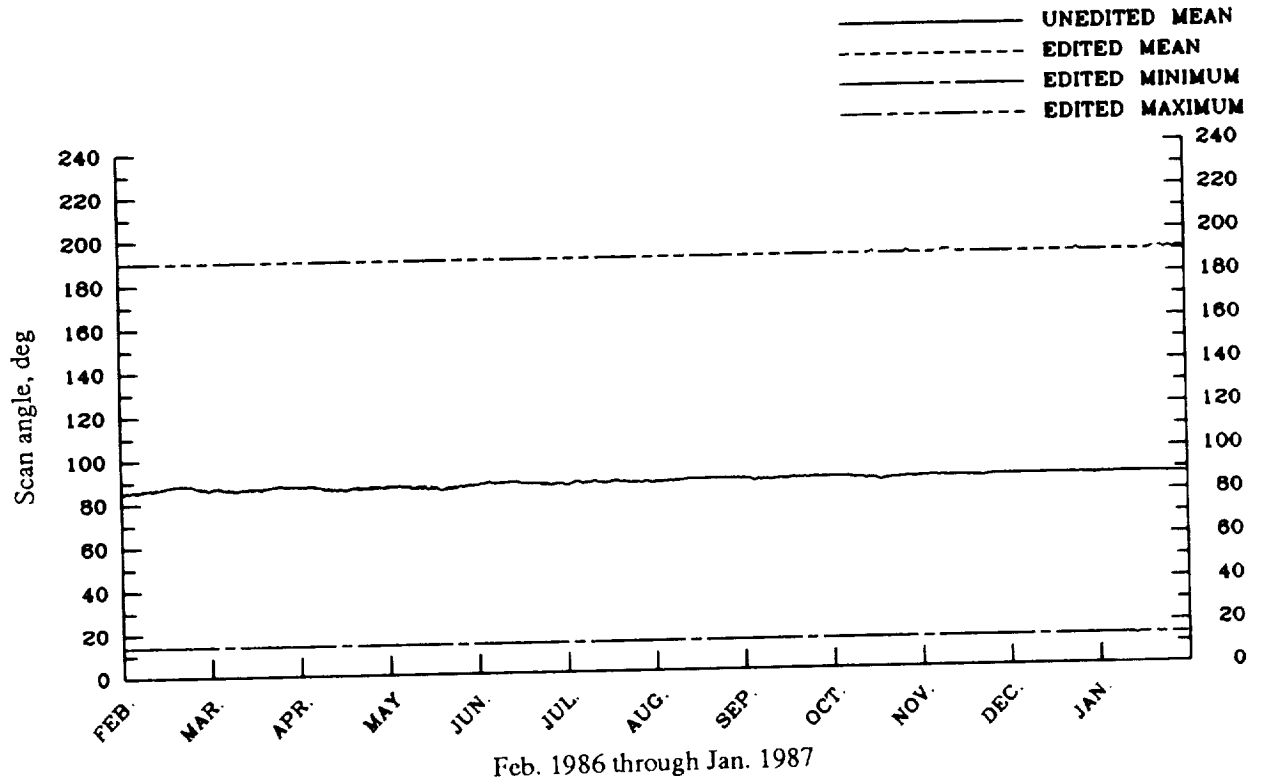

(a) ERBS spacecraft.

Figure 7. Daily values of minimum, mean, and maximum scan angles of elevation beam on scanner instrument.



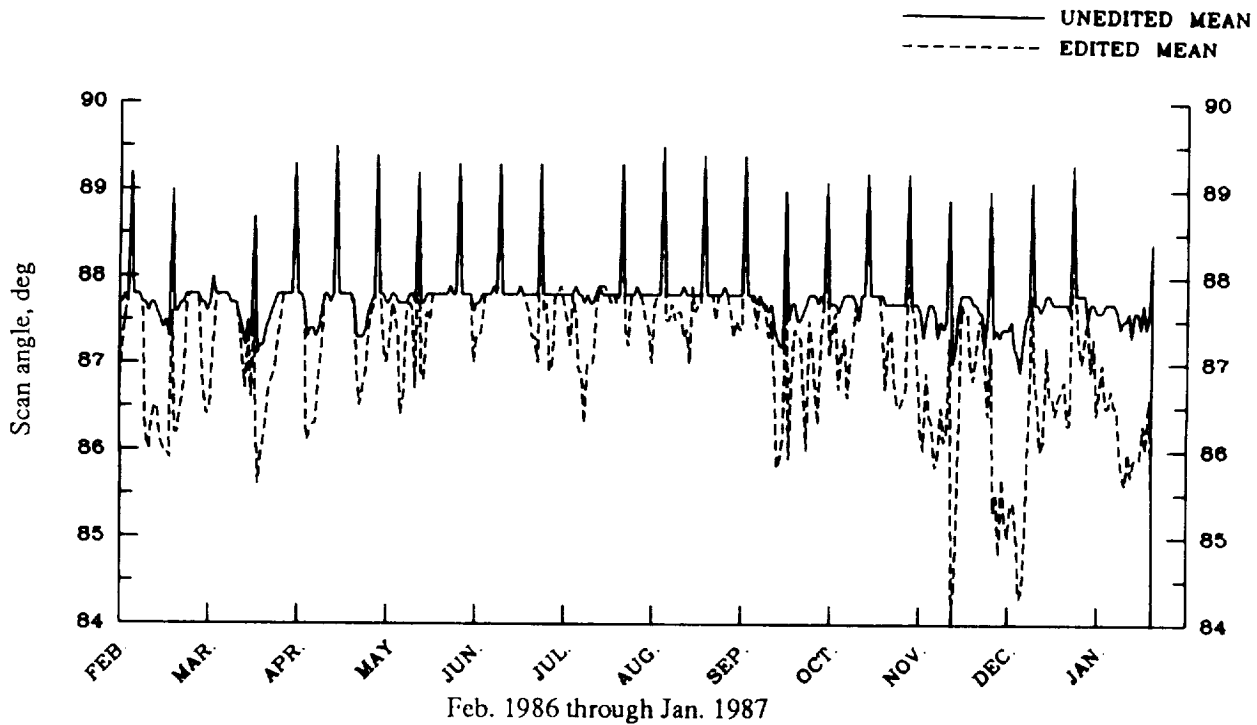
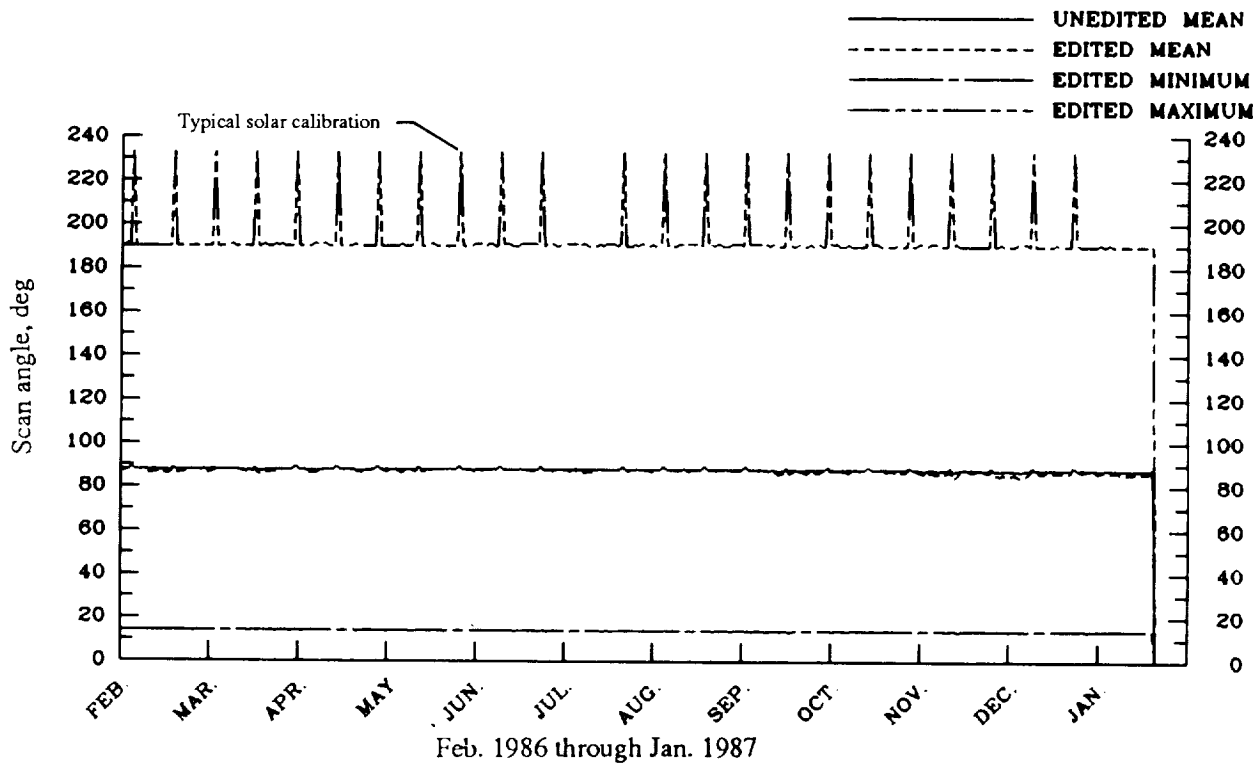

(b) NOAA 9 spacecraft.

Figure 7. Continued.

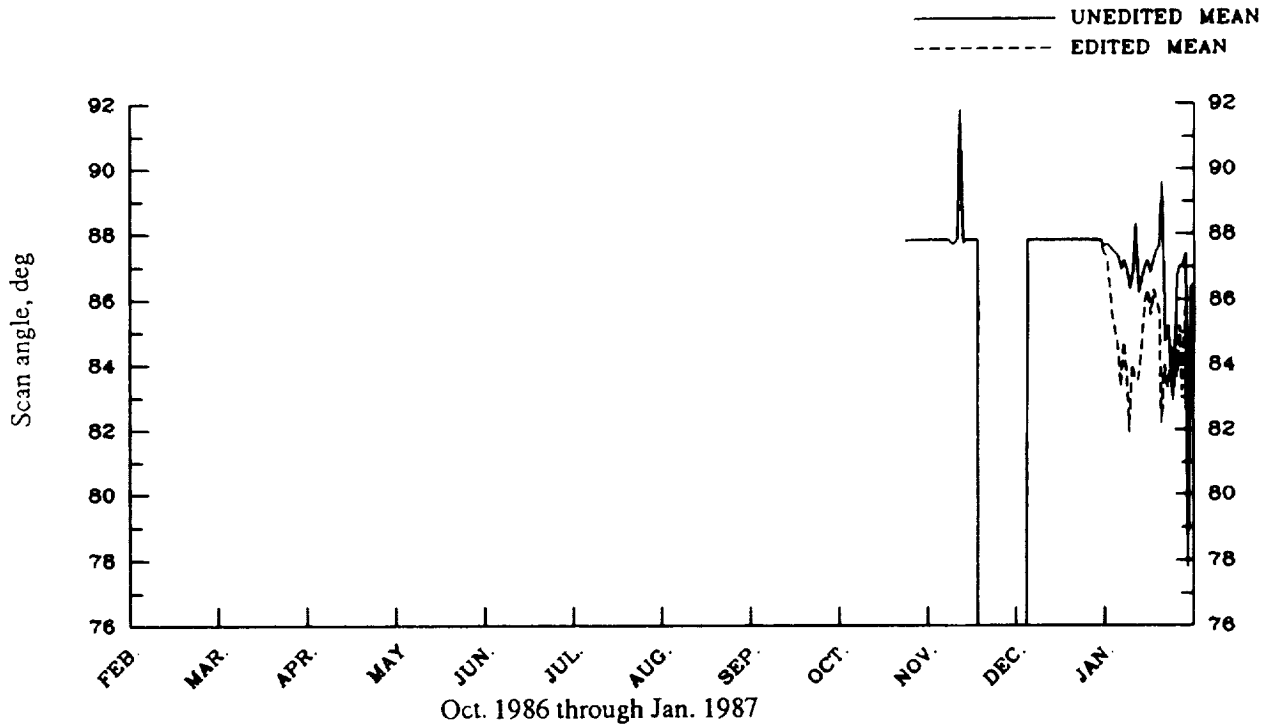
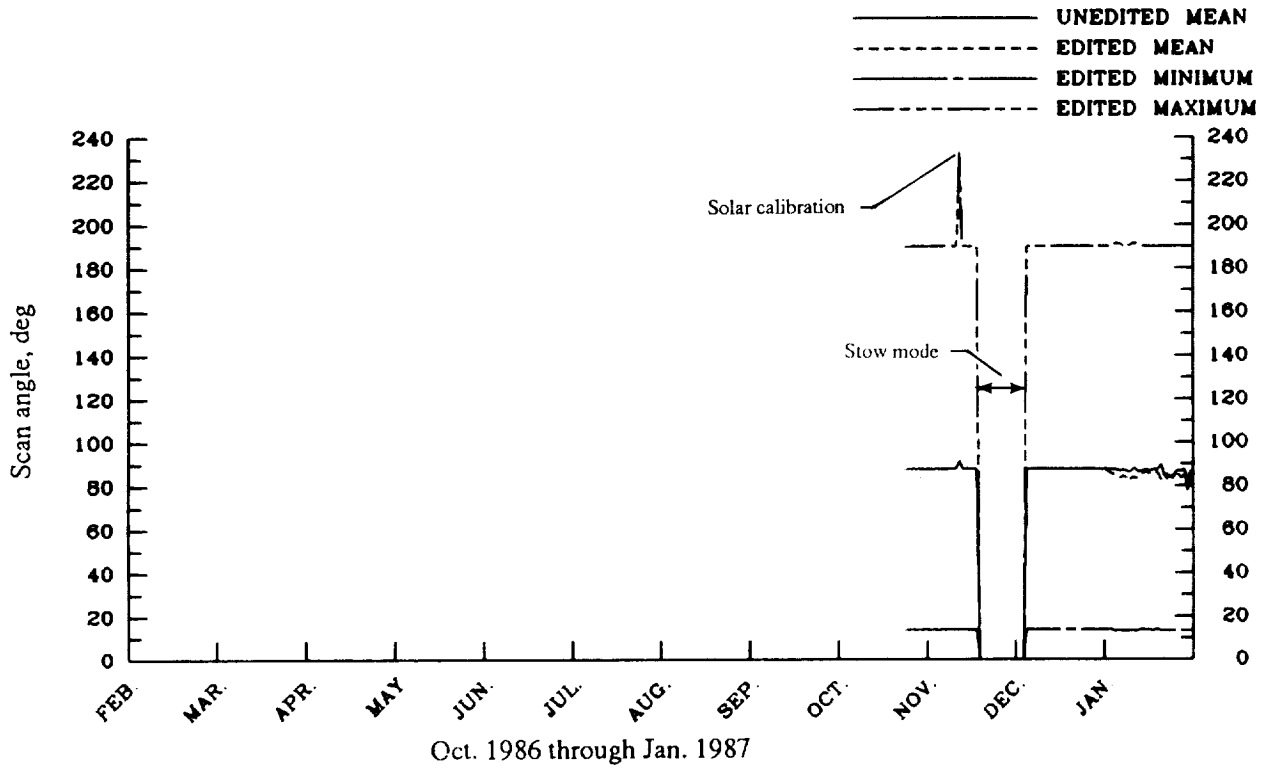

(c) NOAA 10 spacecraft.

Figure 7. Concluded.

— MEAN  
 - - - - MINIMUM  
 — MAXIMUM

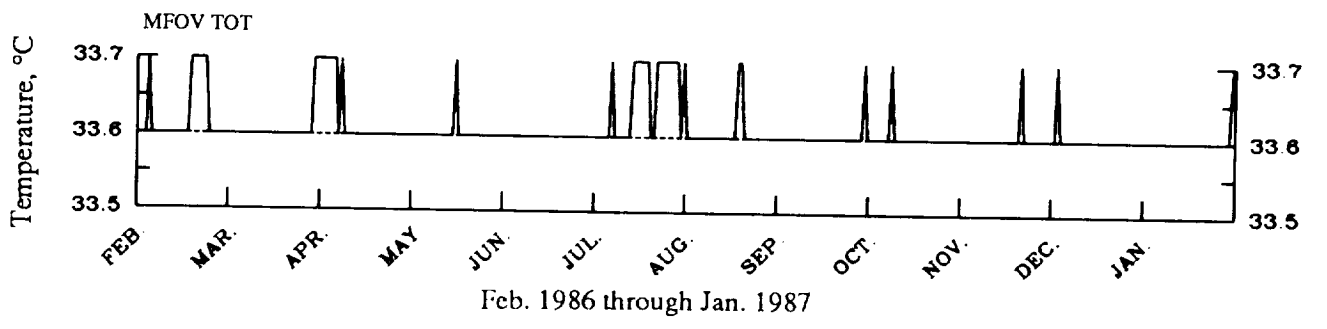
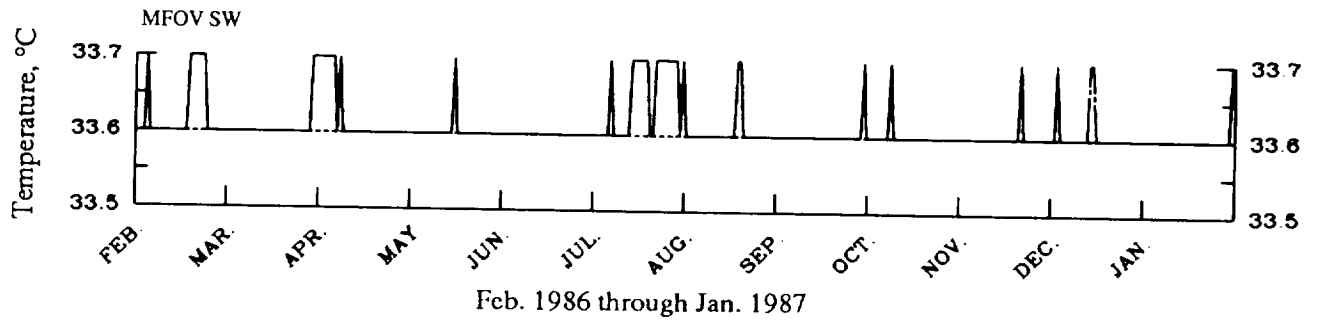
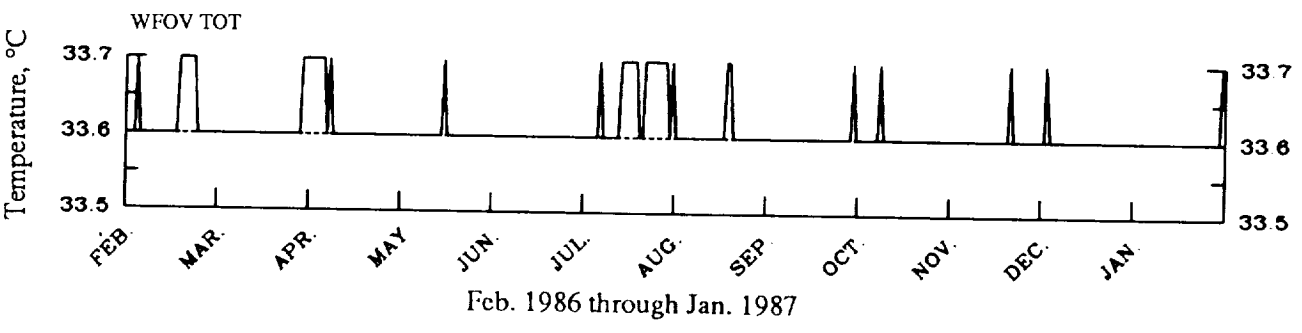
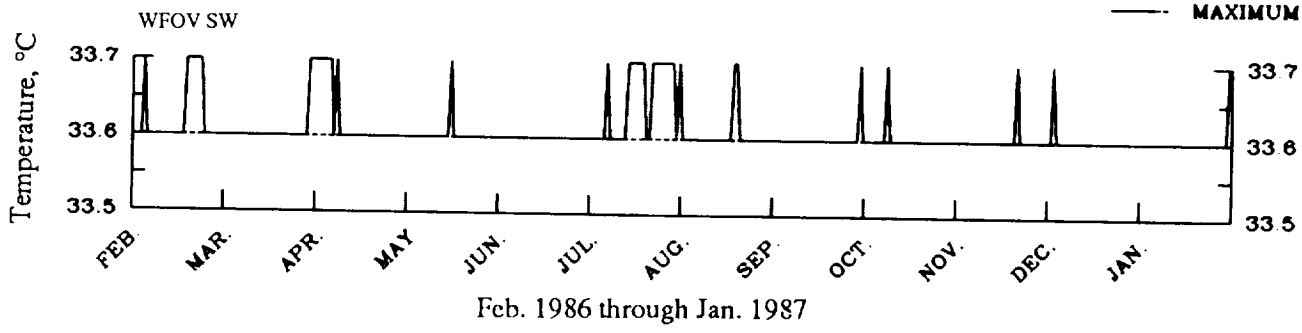

(a) Heat sink temperatures. Earth-viewing detectors.

Figure 8. Daily values of minimum, mean, and maximum housekeeping measurements from non-scanner instrument on ERBS spacecraft.

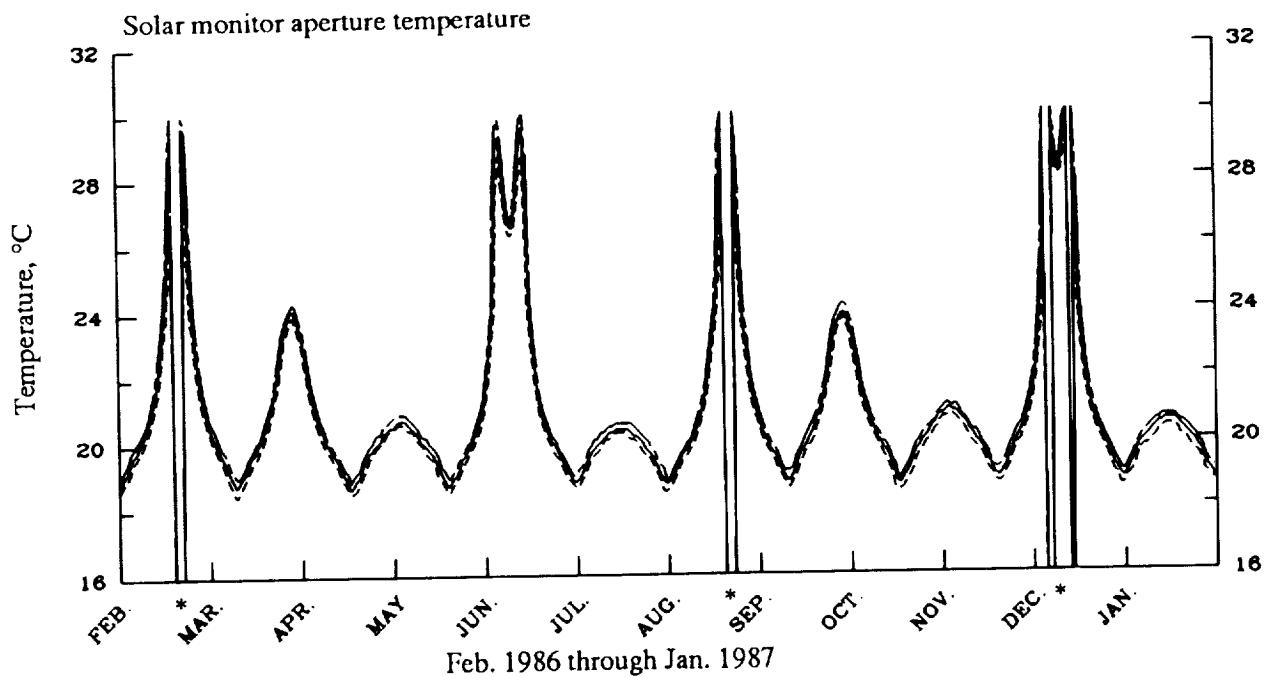
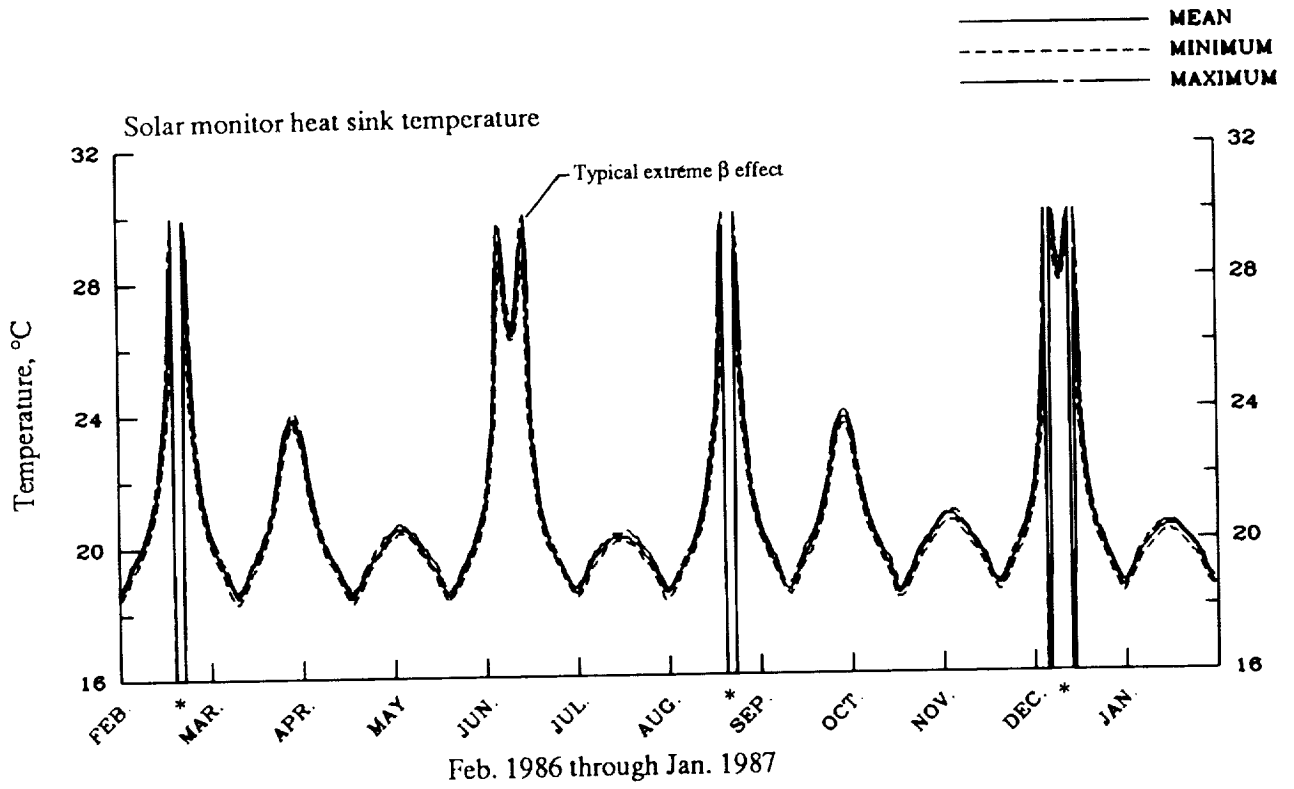

(d) Solar monitor heat sink and aperture temperatures. Asterisks (\*) denote that all data exceeded maximum telemetry edit limits.

Figure 8. Continued.

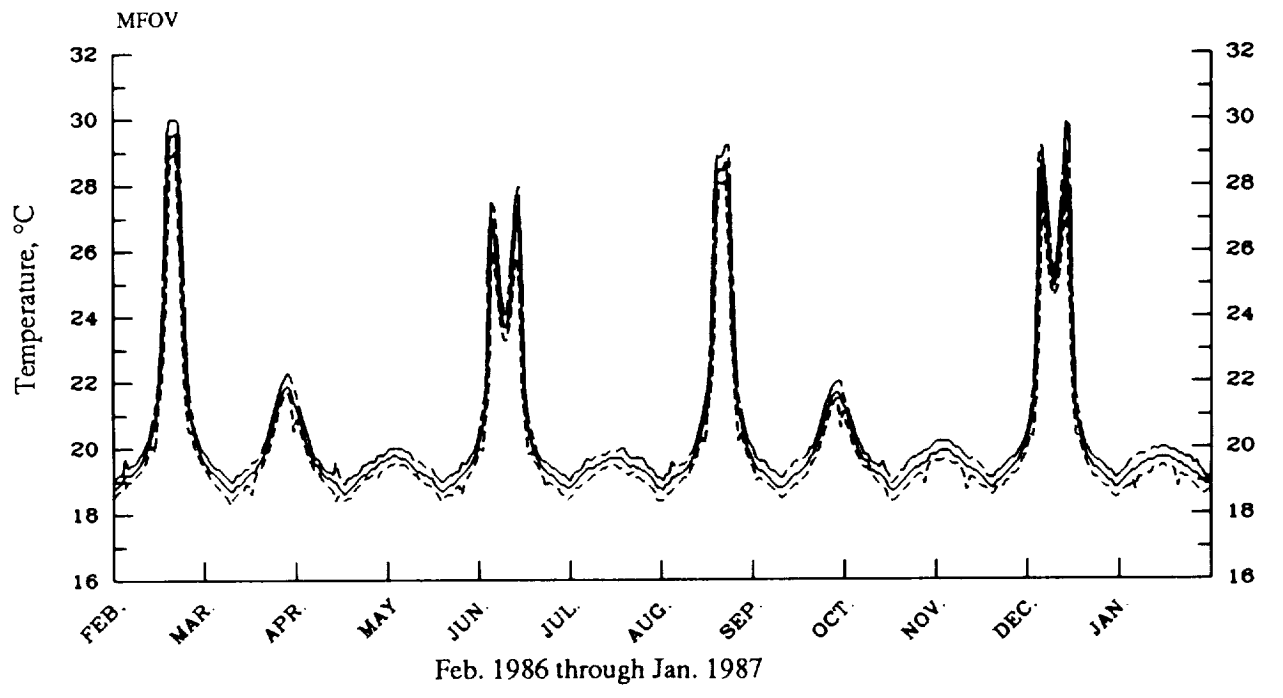
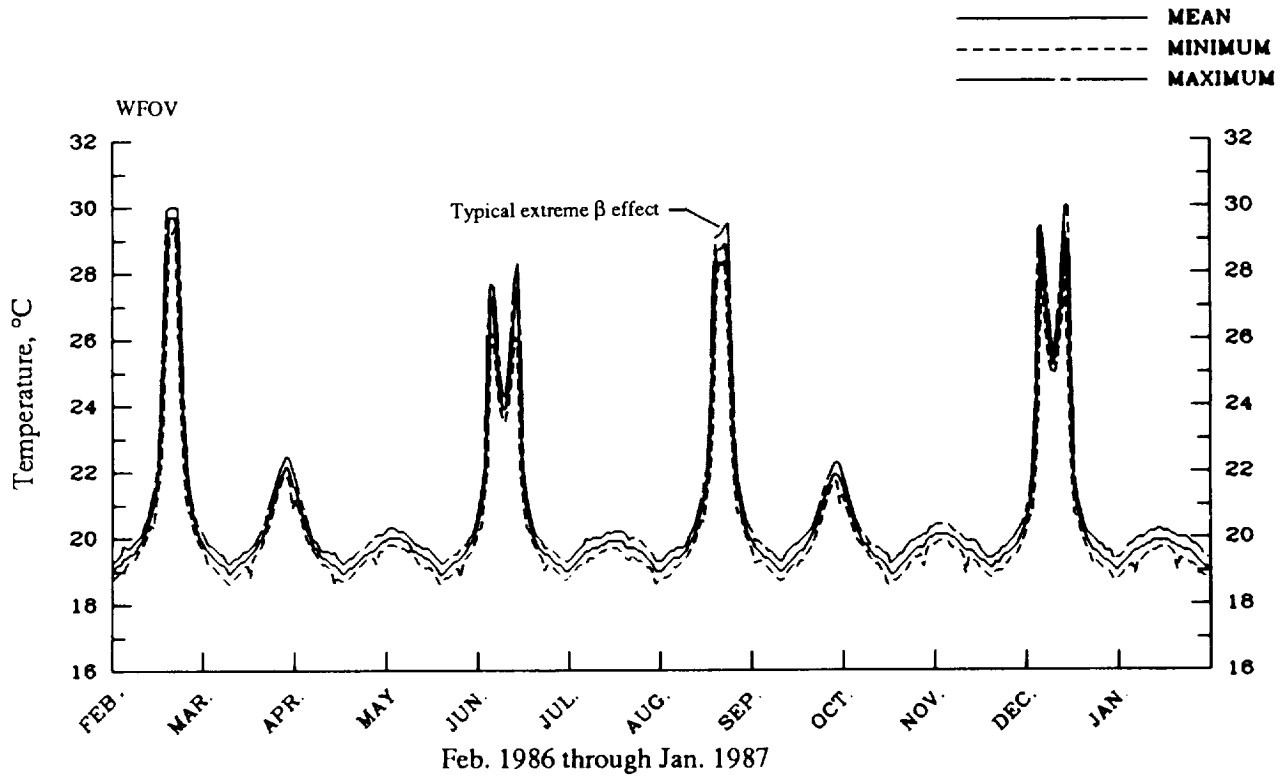

(e) Blackbody temperatures.

Figure 8. Continued.

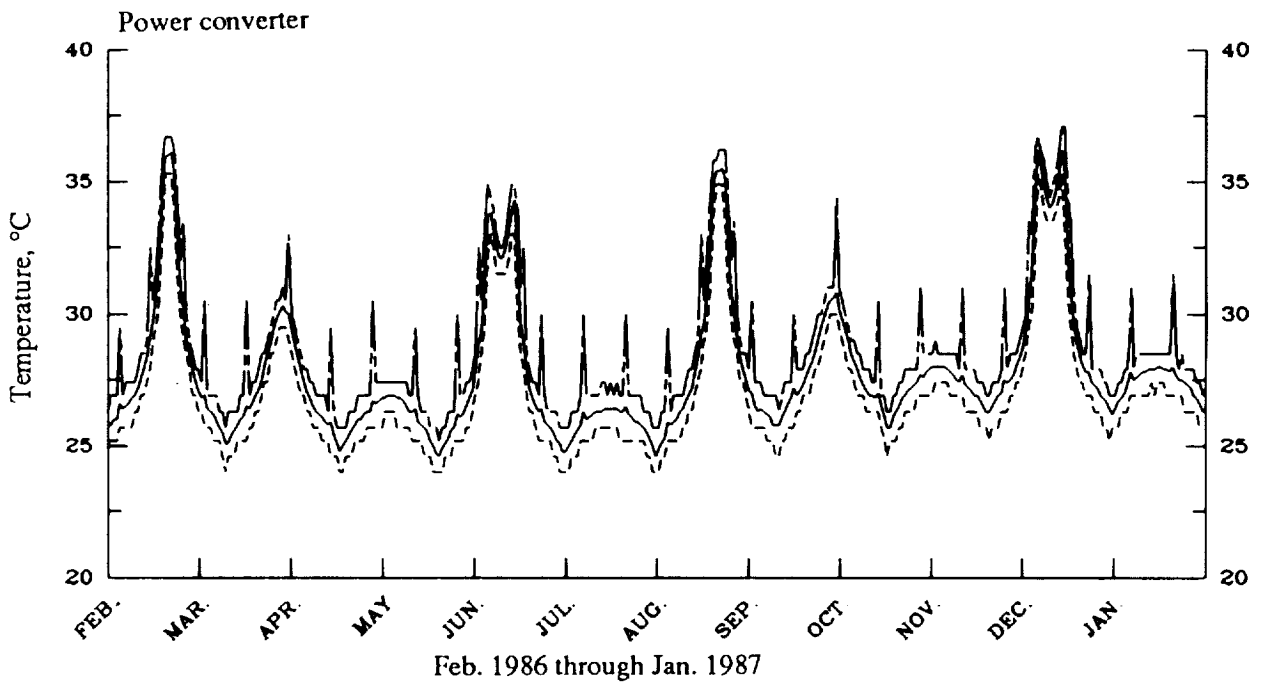
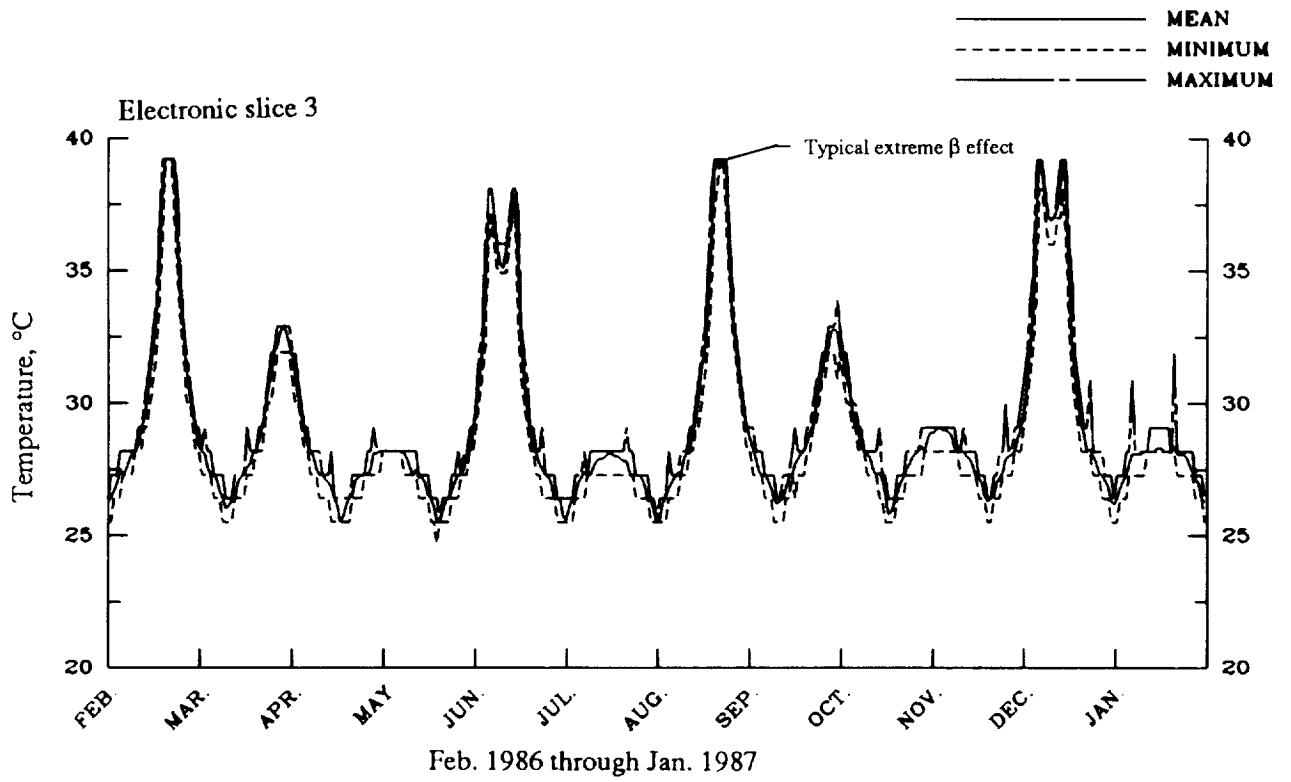

(f) Passive analog temperatures.

Figure 8. Concluded.

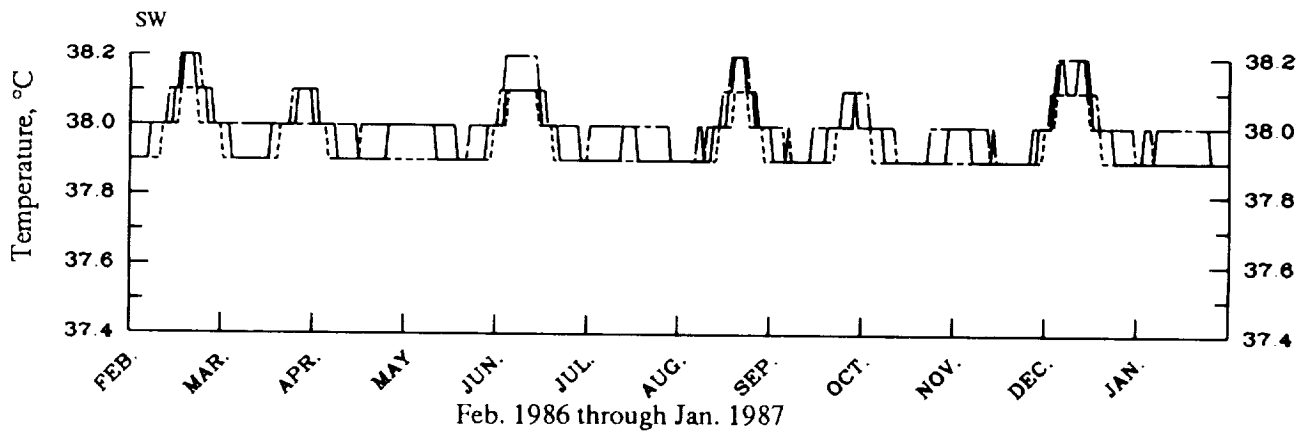
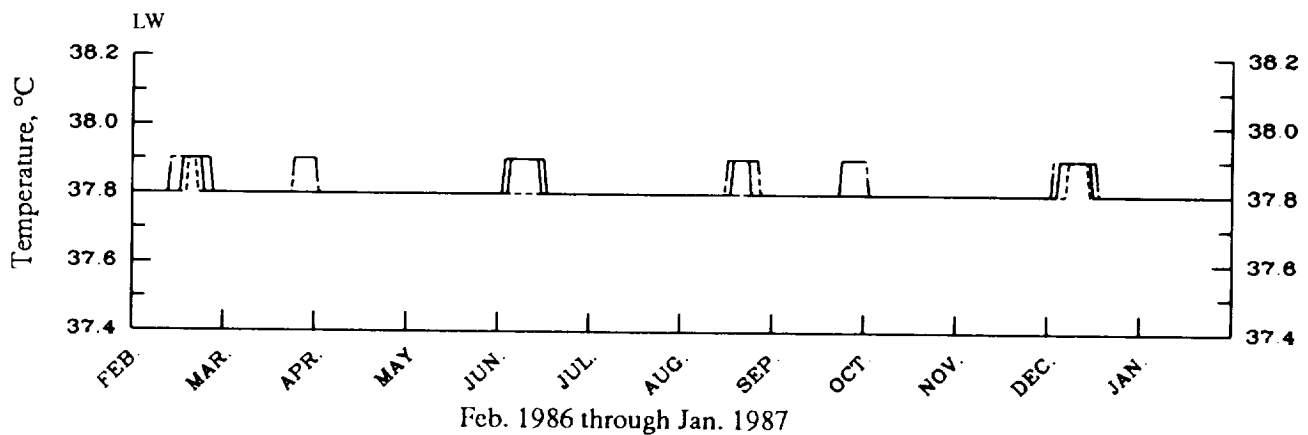
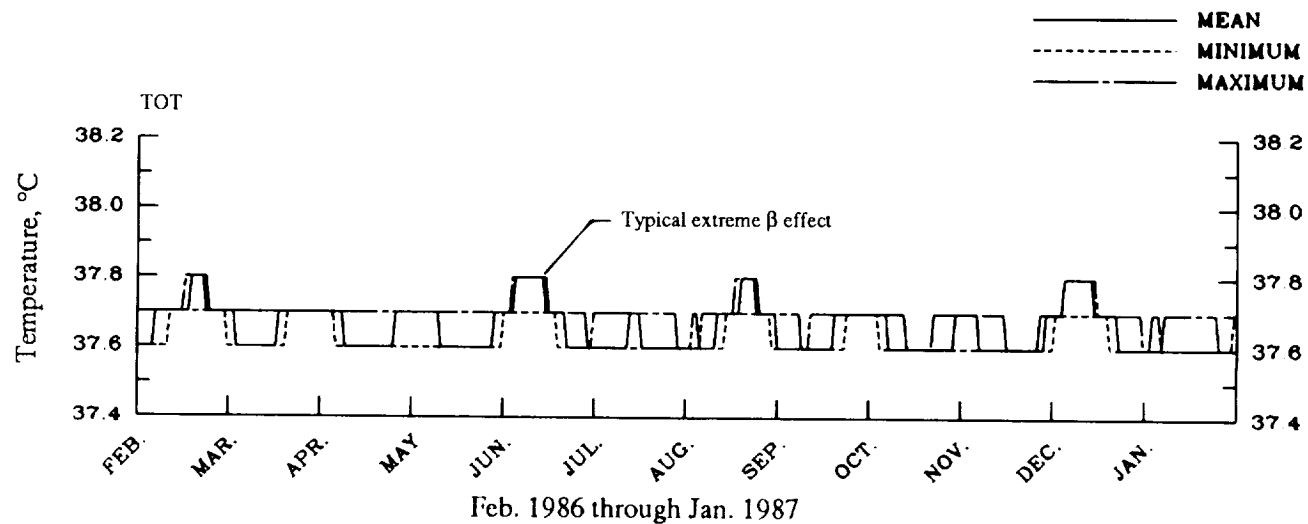

(a) Detector temperatures.

Figure 9. Daily values of minimum, mean, and maximum housekeeping measurements from scanner instrument on ERBS spacecraft.

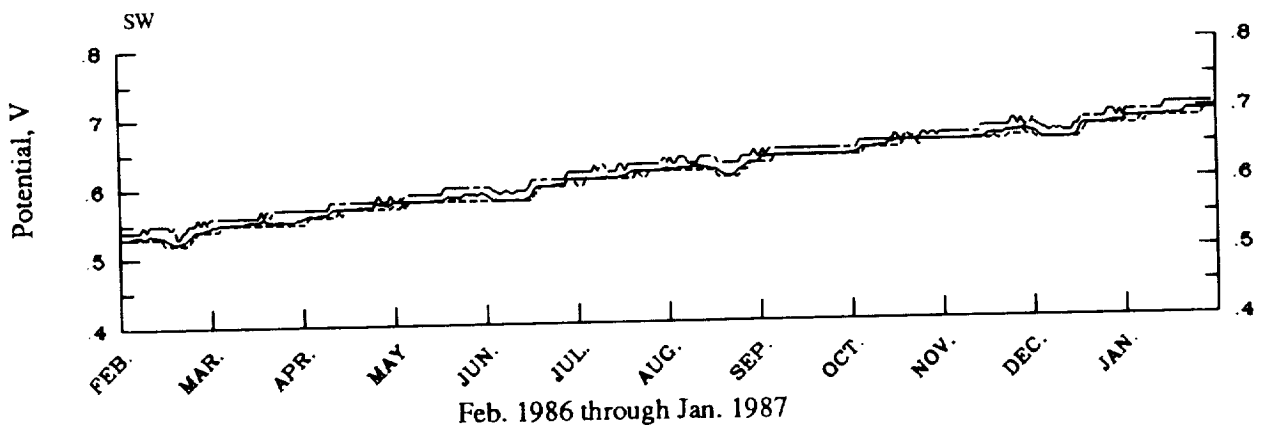
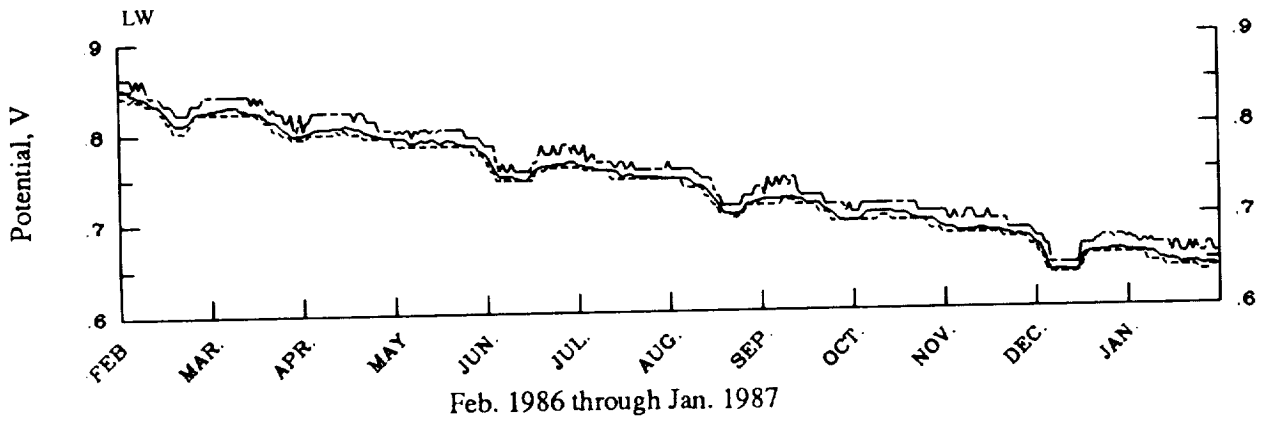
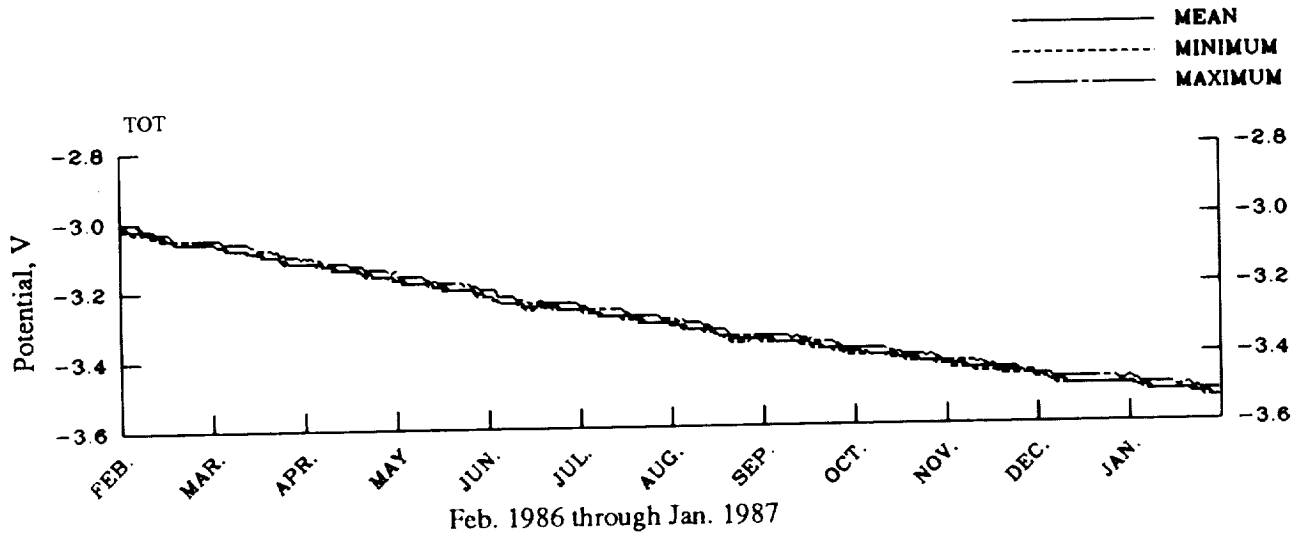

(b) Digital-to-analog (DAC) voltages.

Figure 9. Continued.



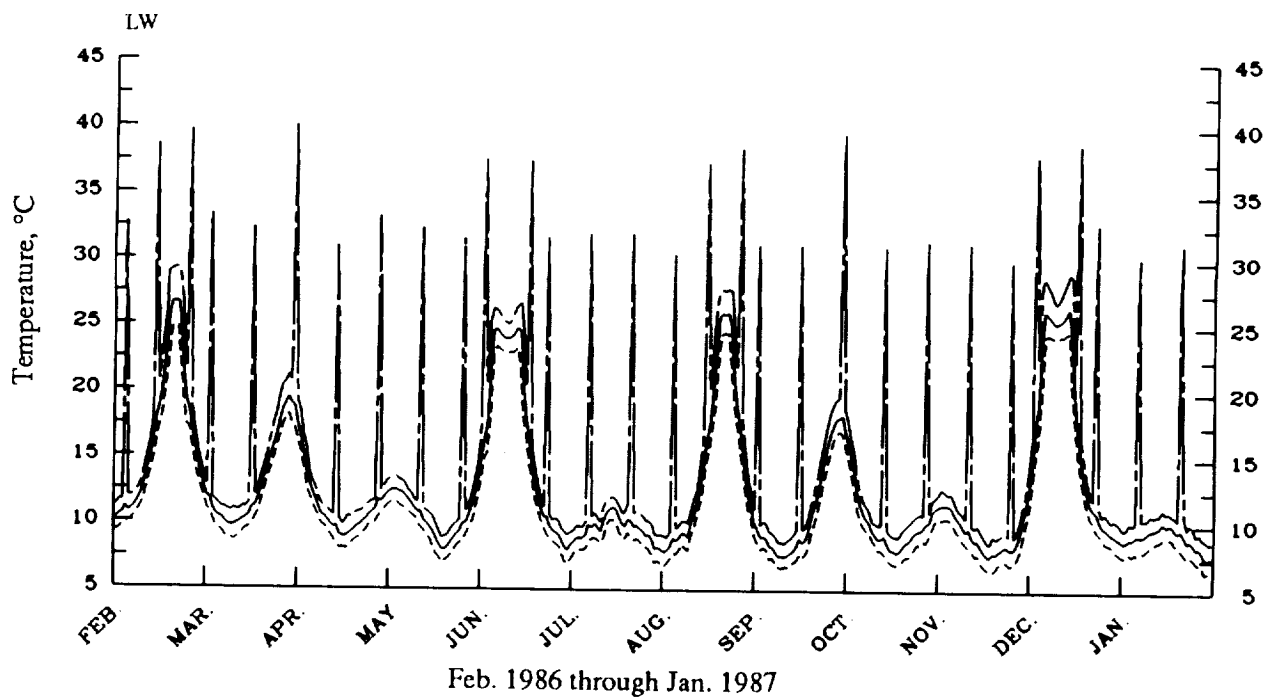
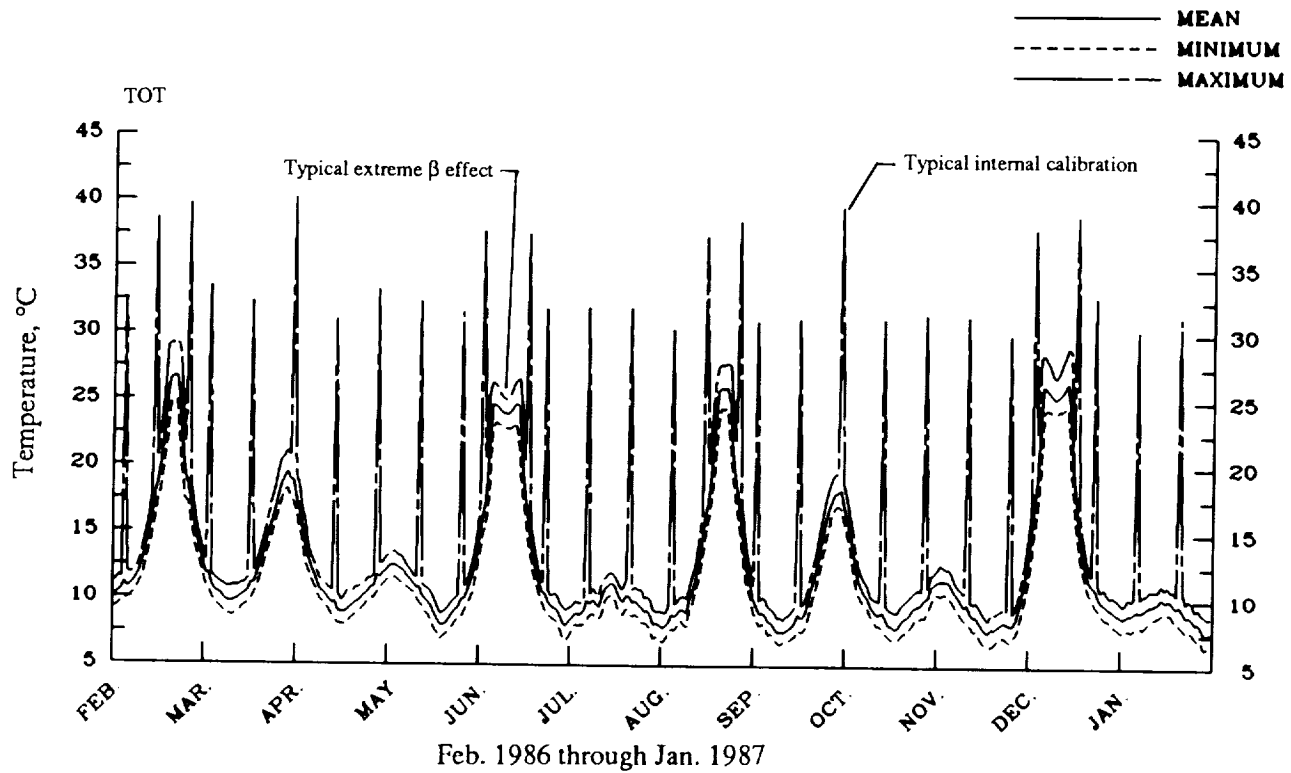

(e) Blackbody temperatures.

Figure 9. Continued.

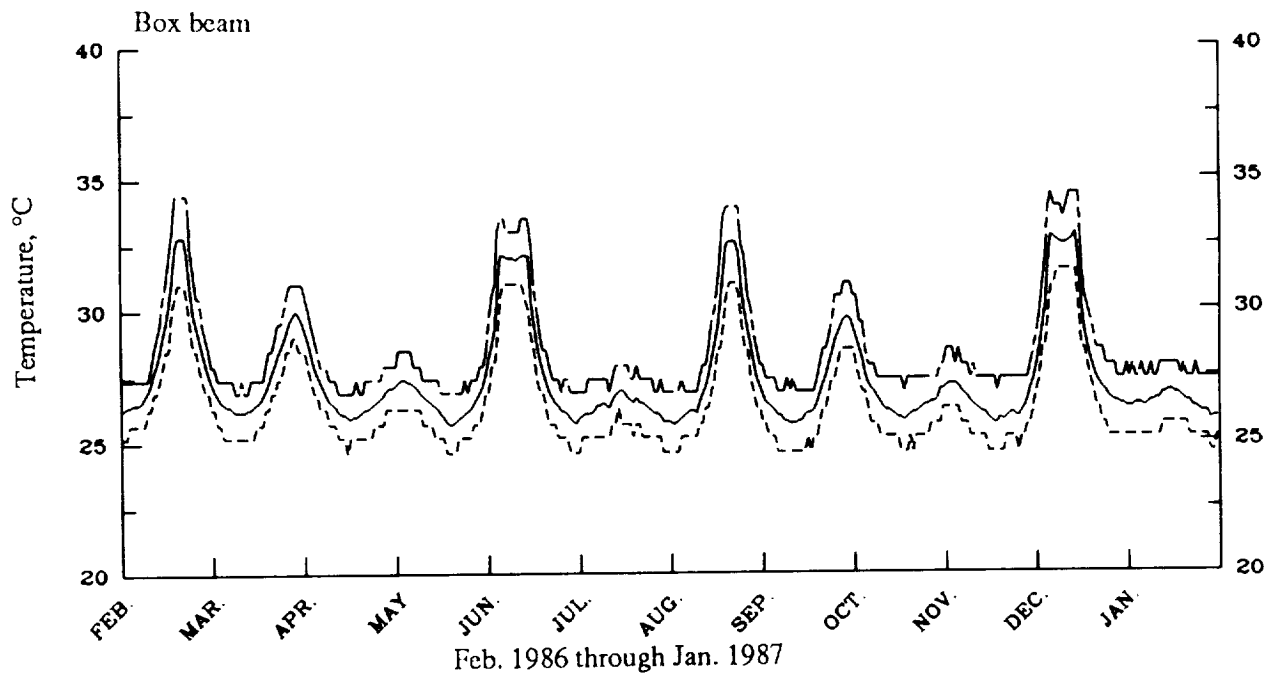
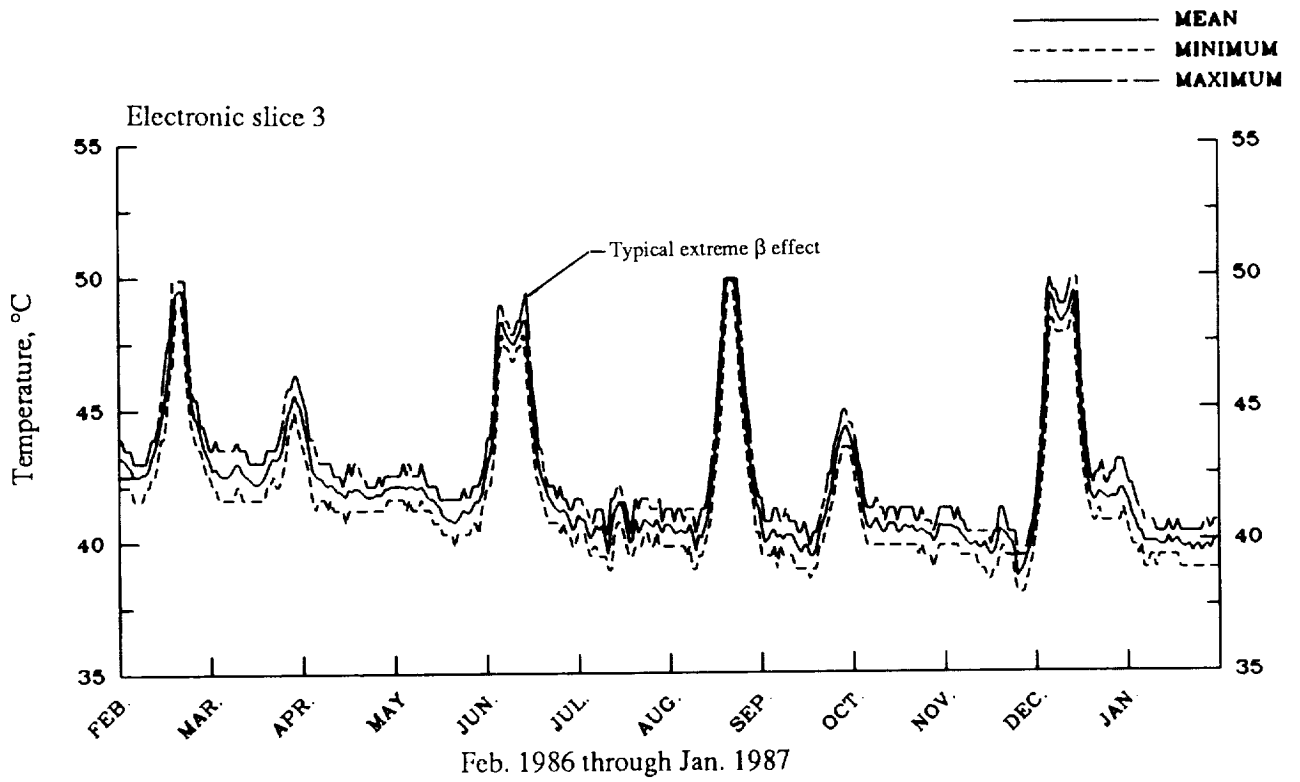

(d) Passive analog temperatures.

Figure 9. Concluded.

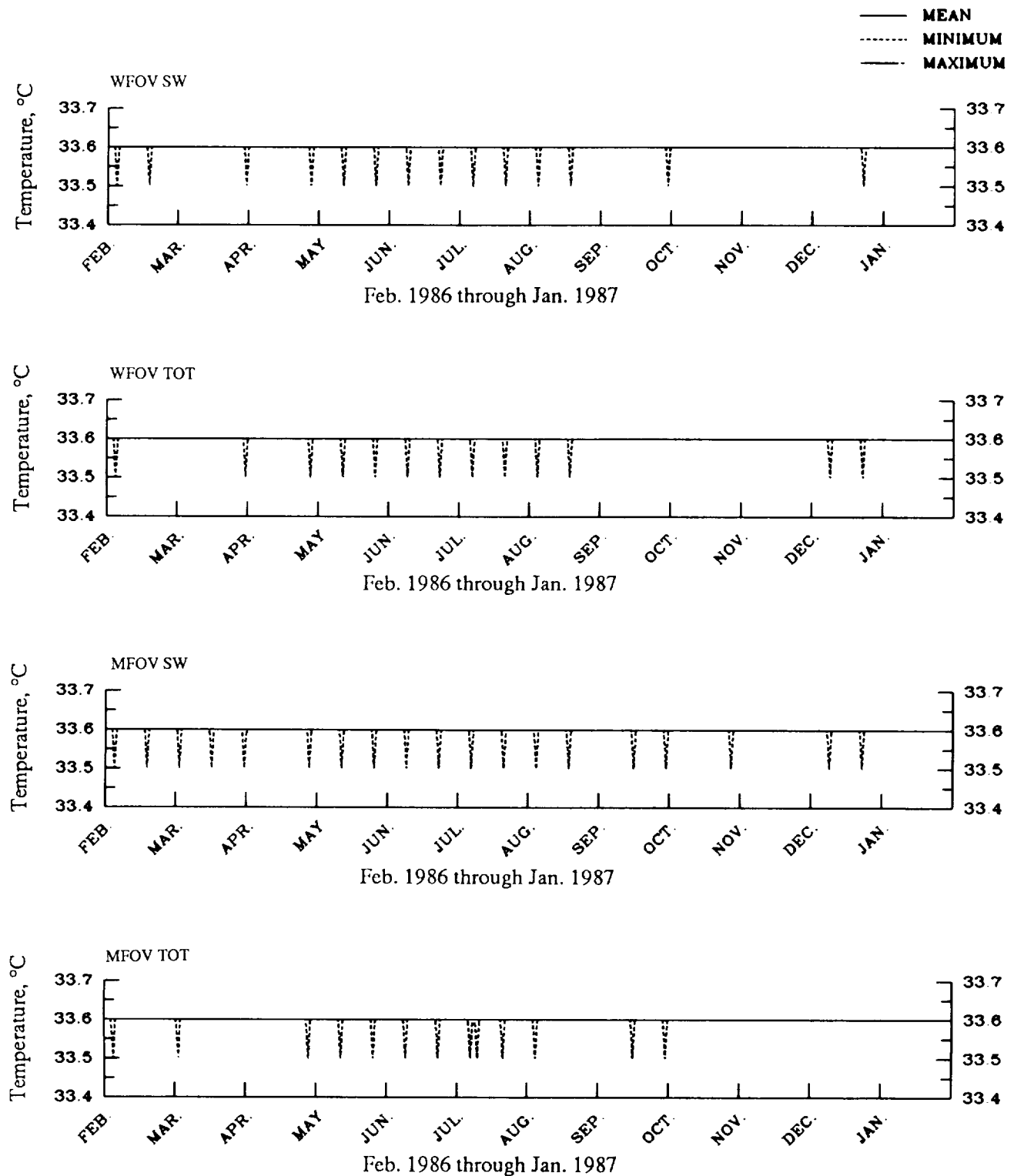

(a) Heat sink temperatures. Earth-viewing detectors.

Figure 10. Daily values of minimum, mean, and maximum housekeeping measurements from nonscanner instrument on NOAA 9 spacecraft.

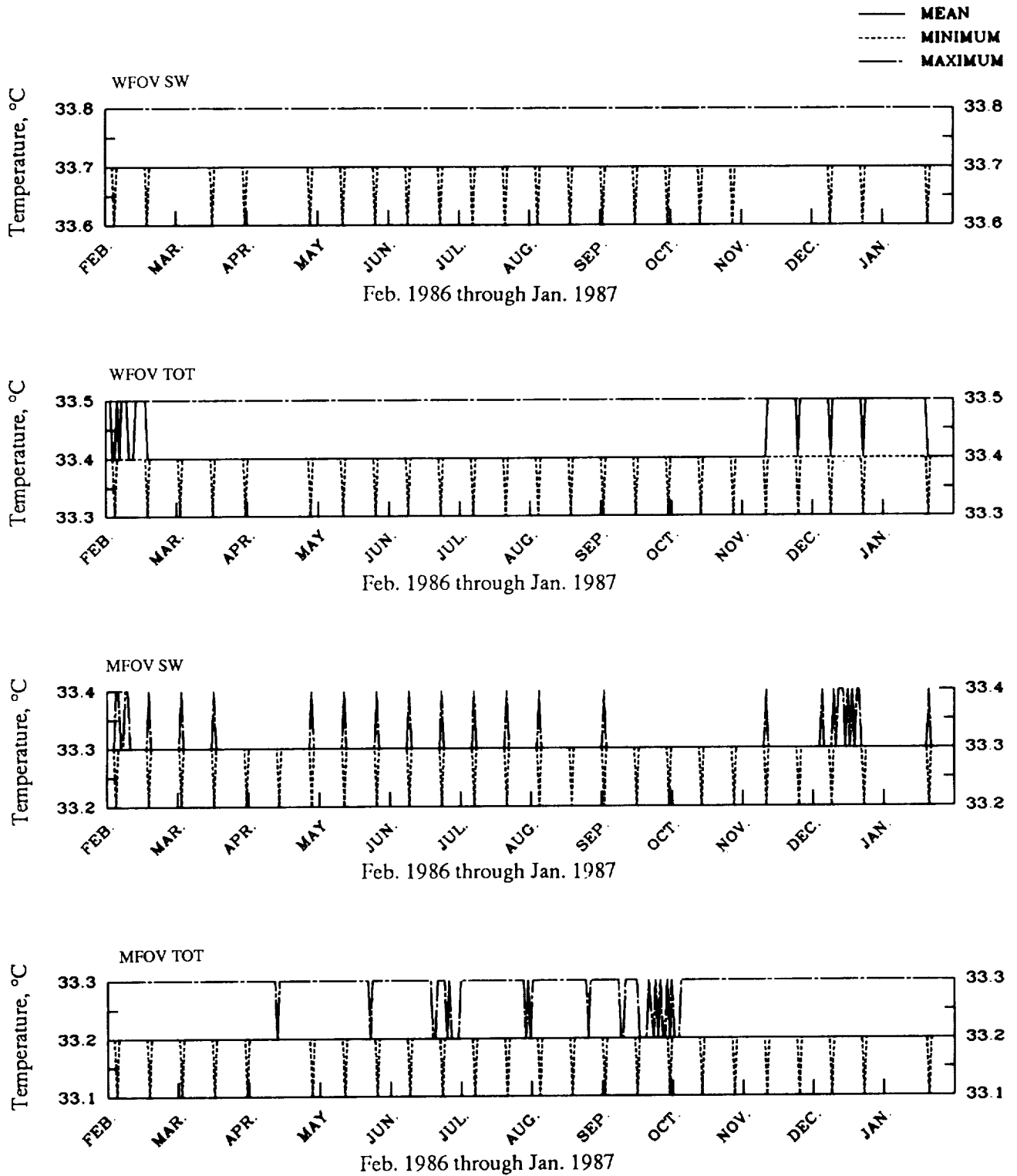

(b) Aperture temperatures. Earth-viewing detectors.

Figure 10. Continued.

— MEAN  
 - - - MINIMUM  
 — MAXIMUM

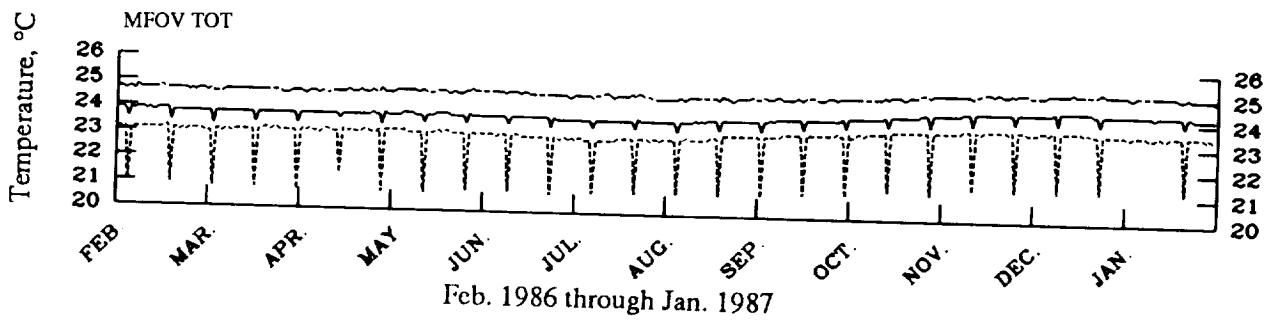
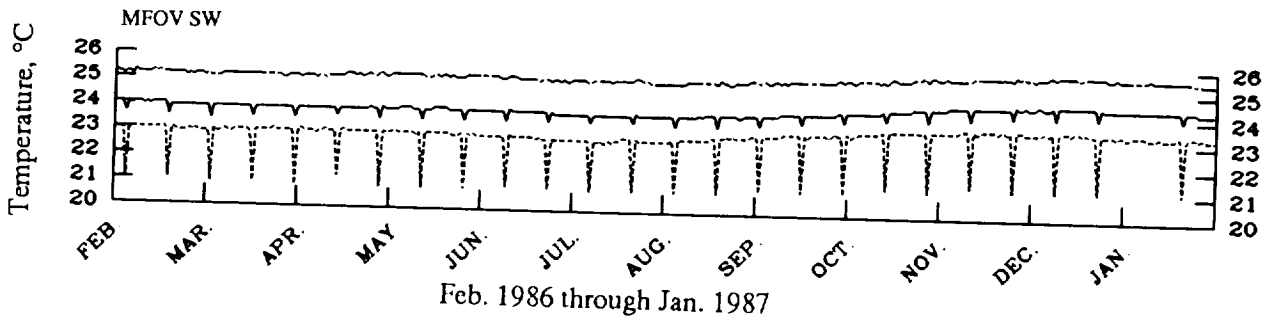
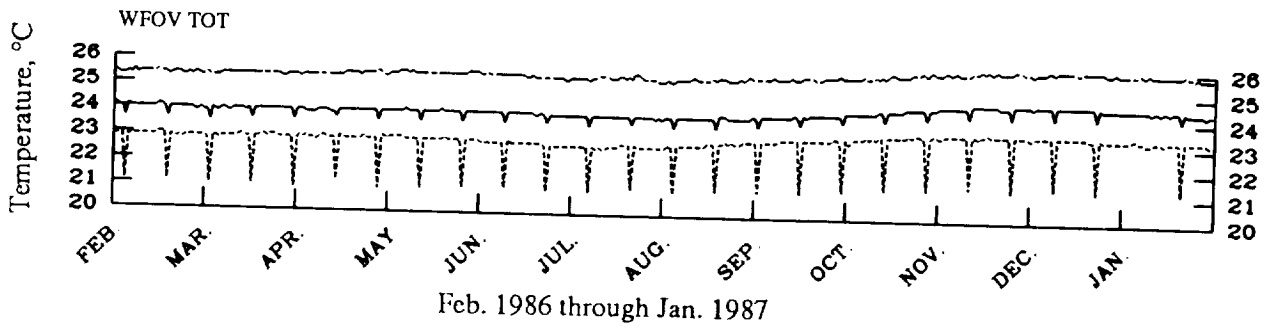
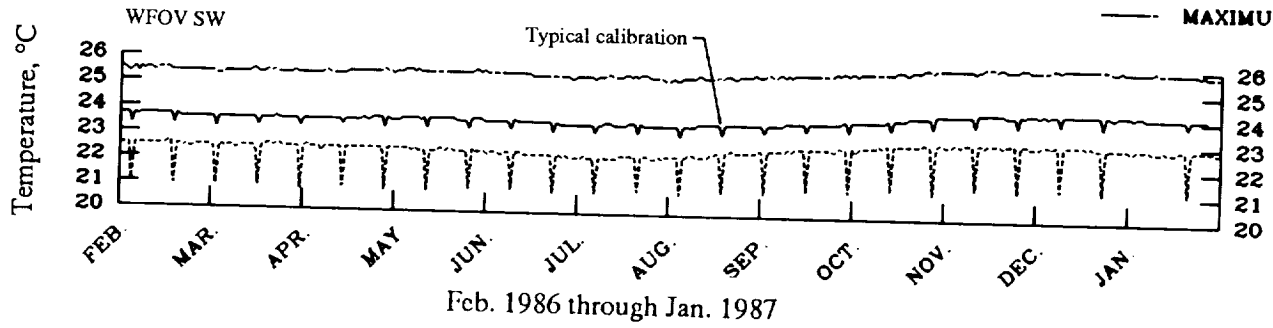

(c) Field-of-view limiter temperatures. Earth-viewing detectors.

Figure 10. Continued.

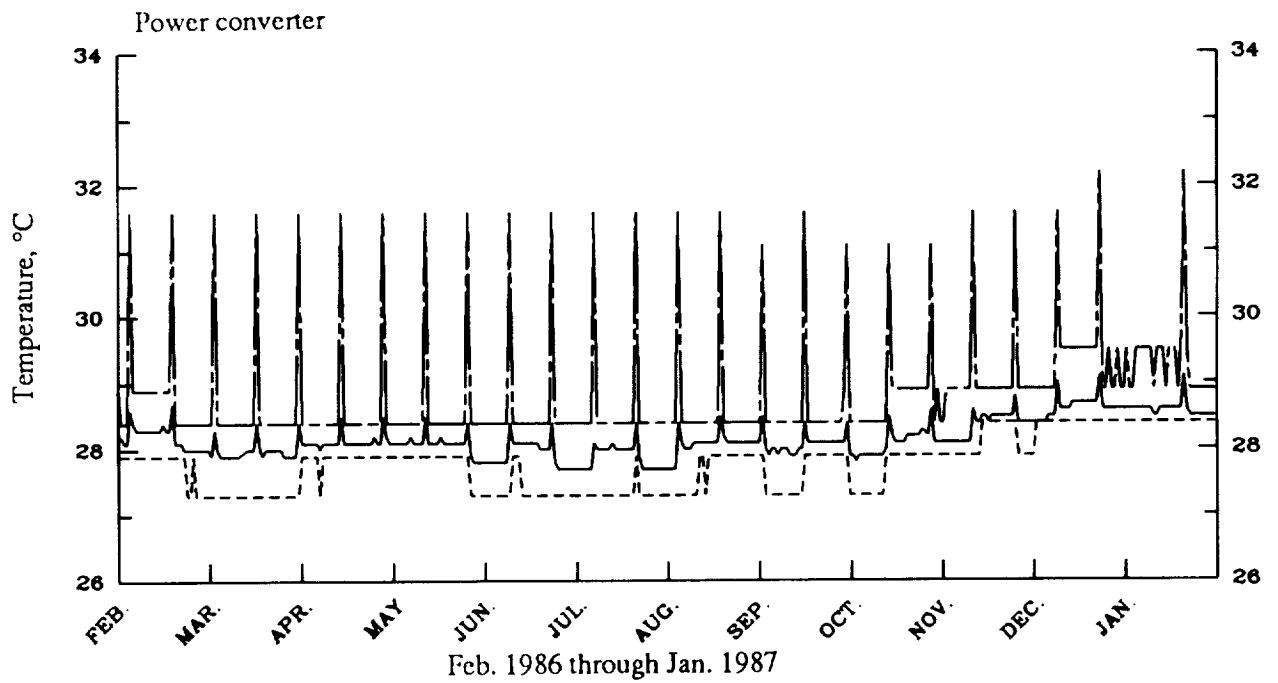
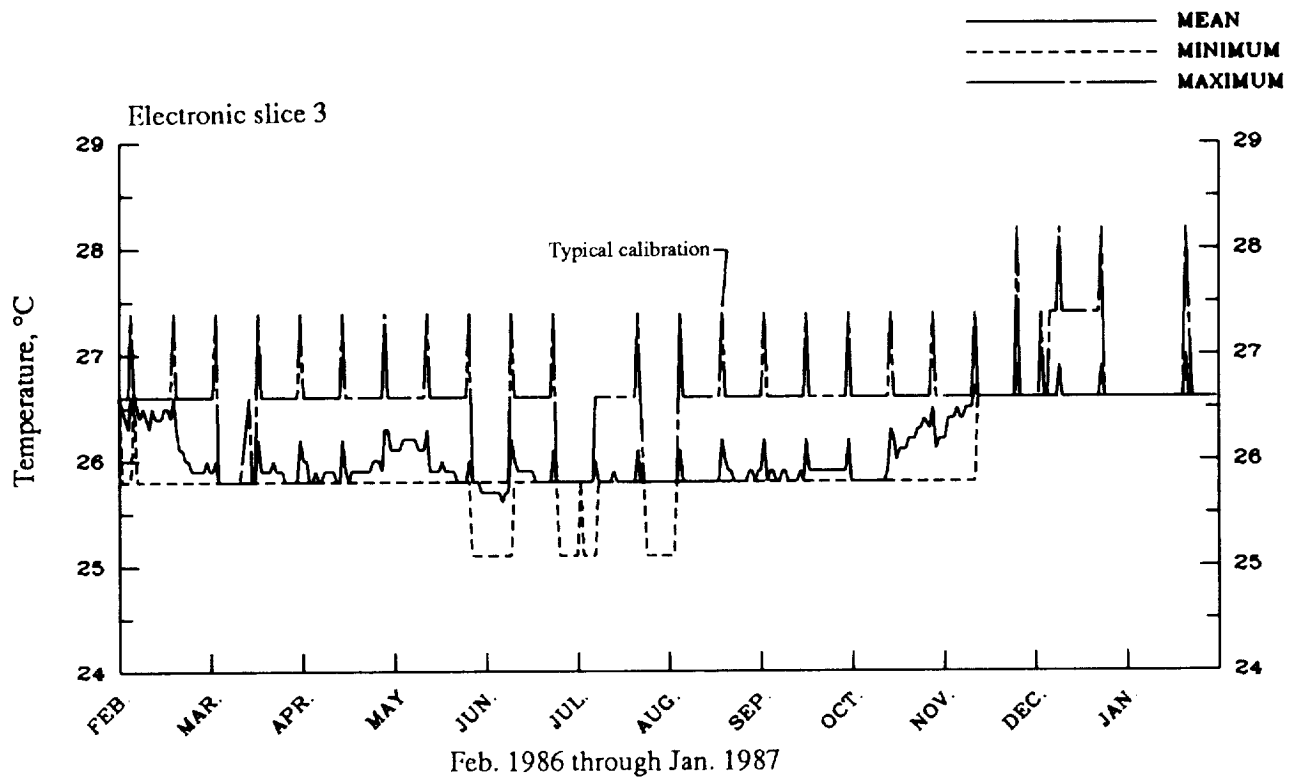

(f) Passive analog temperatures.

Figure 10. Concluded.

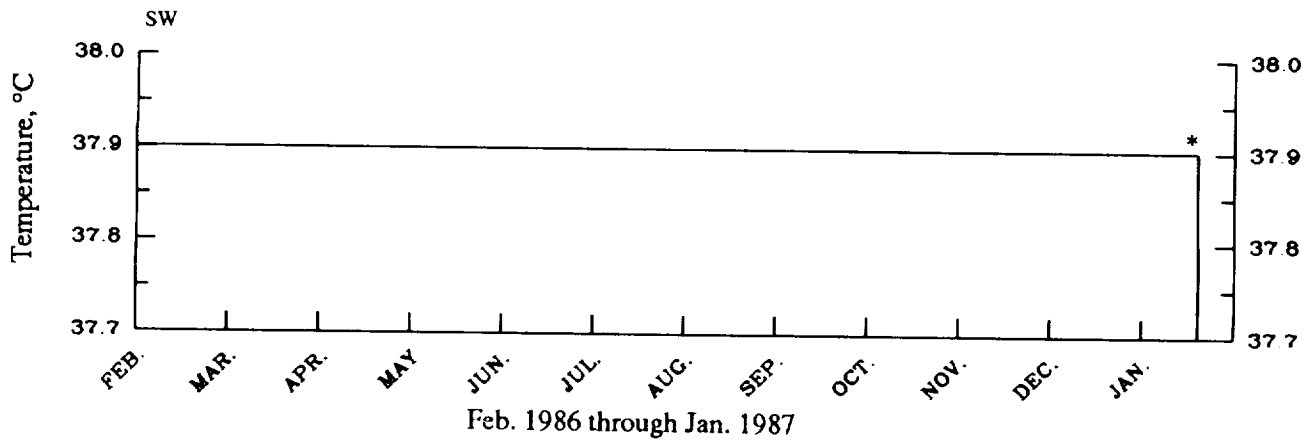
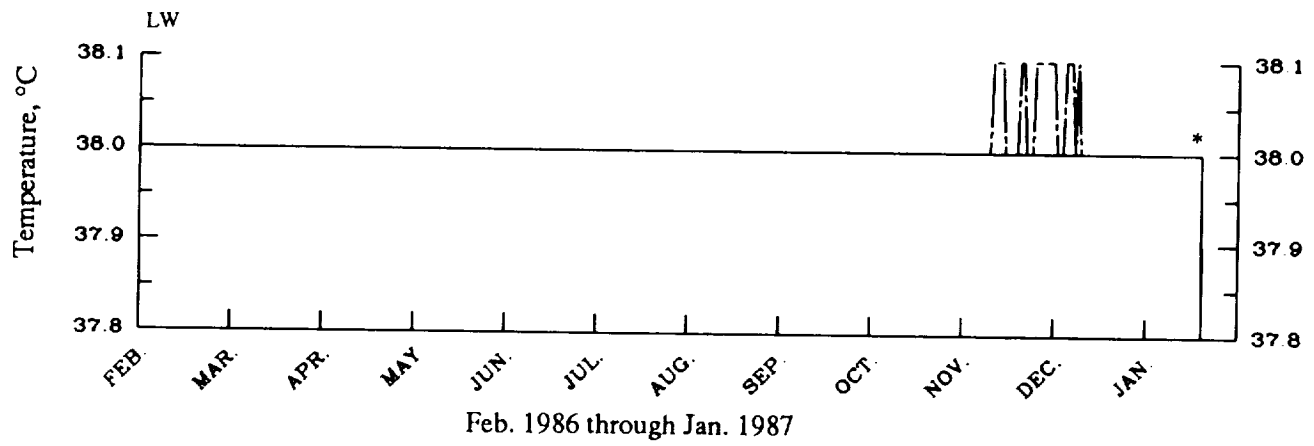
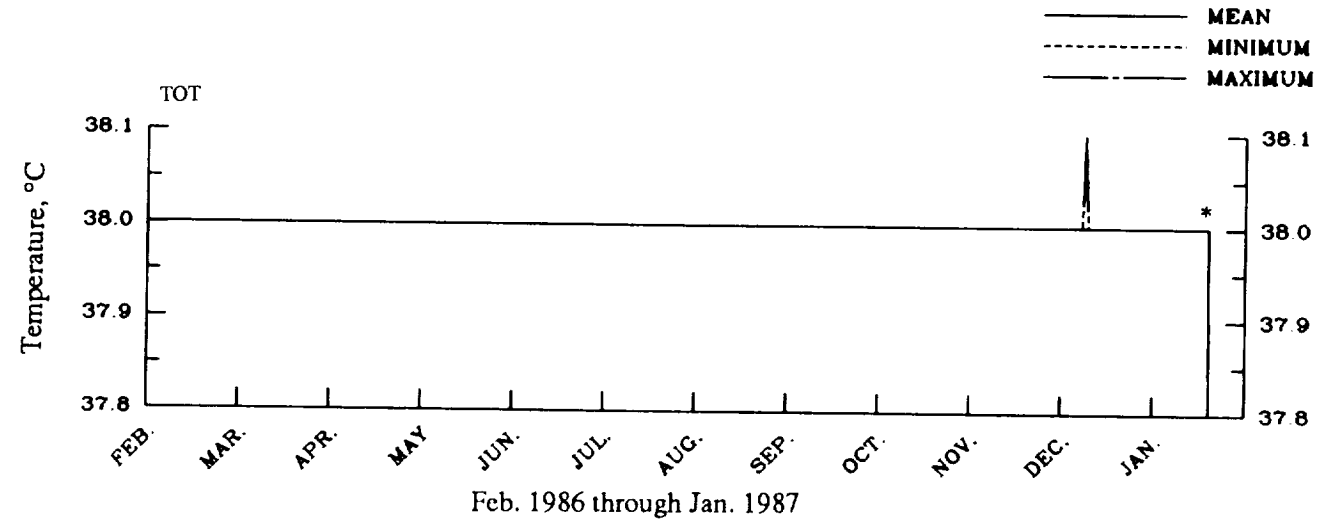

(a) Detector temperatures.

Figure 11. Daily values of minimum, mean, and maximum housekeeping measurements from scanner instrument on NOAA 9 spacecraft. Asterisks (\*) denote scanner failure on January 20, 1987. No valid data were available after this date.

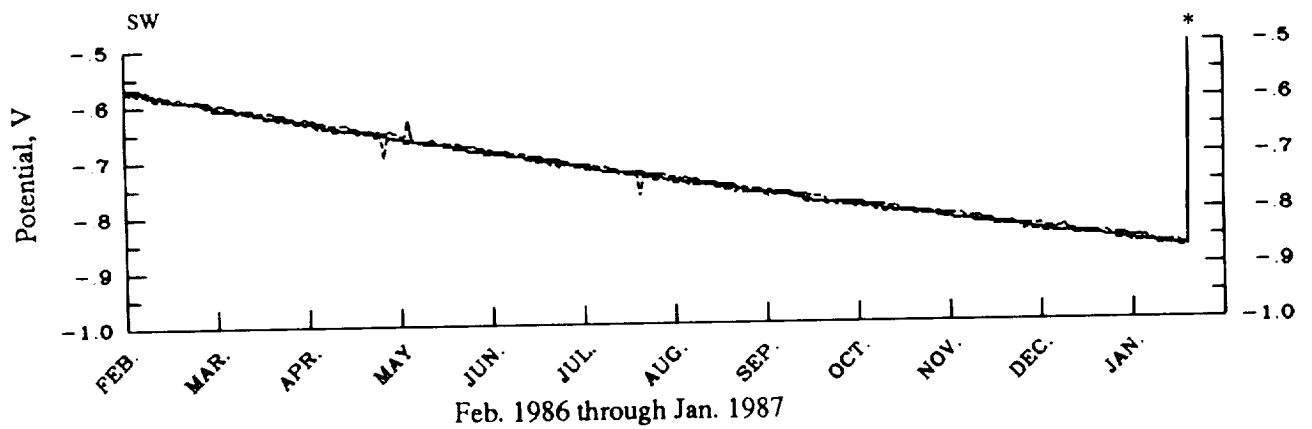
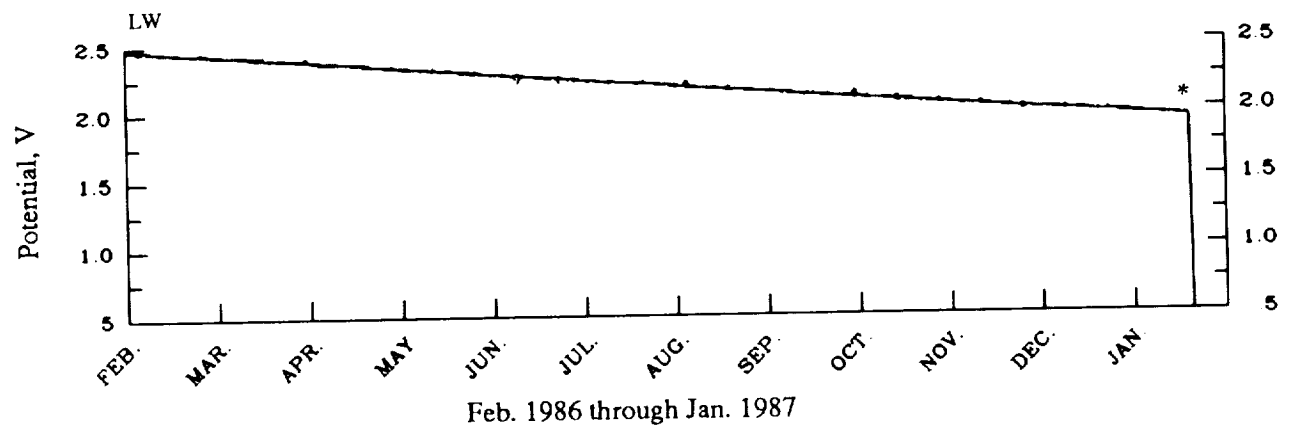
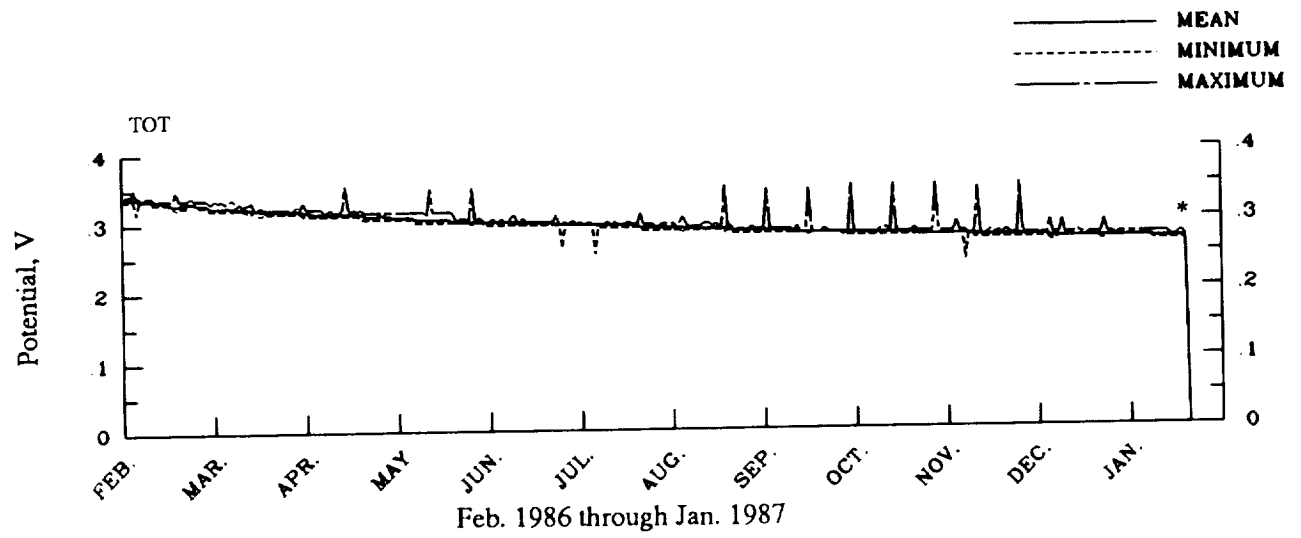

(b) Digital-to-analog (DAC) voltages.

Figure 11. Continued.



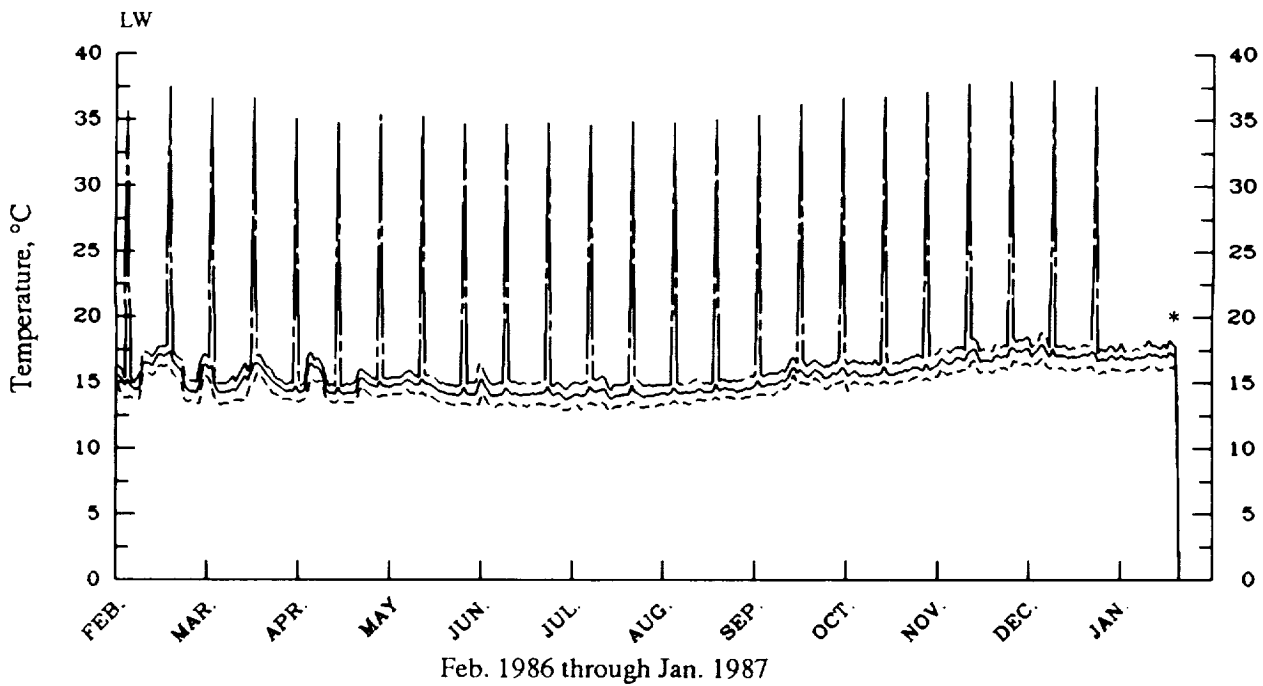
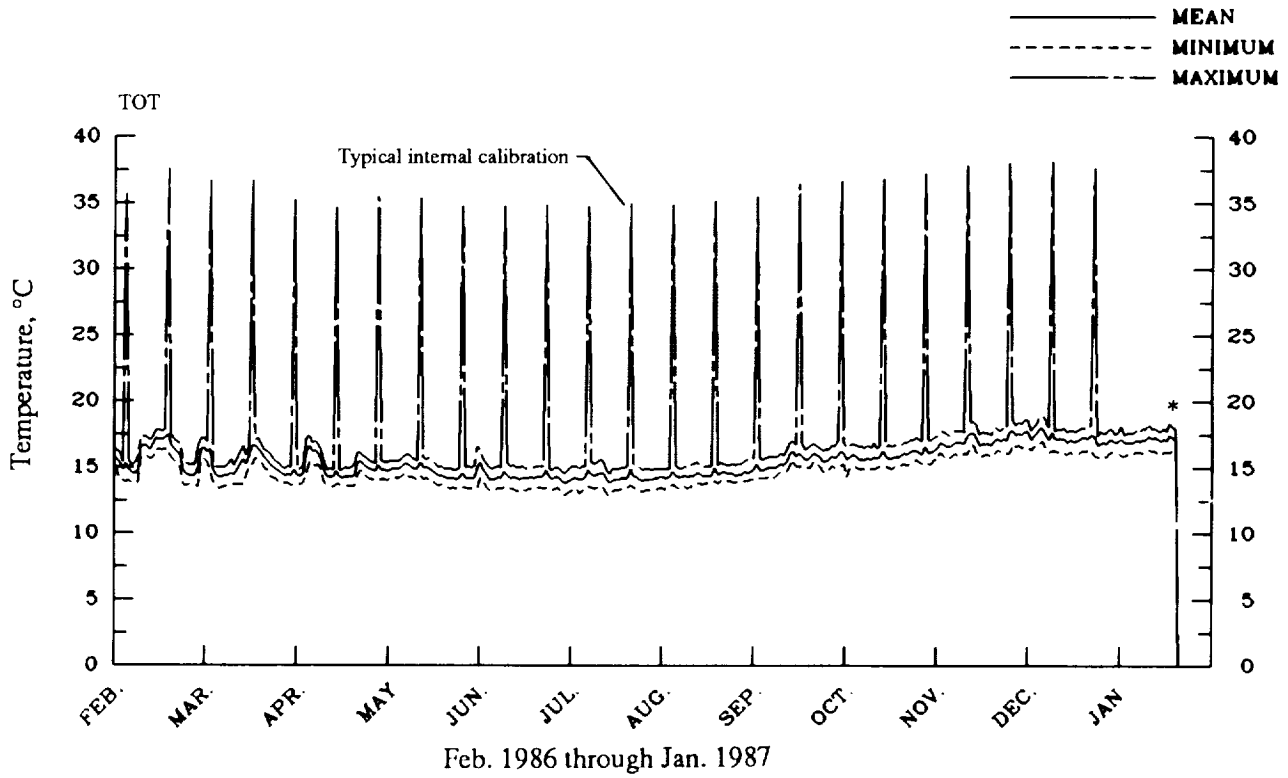

(c) Blackbody temperatures.

Figure 11. Continued.

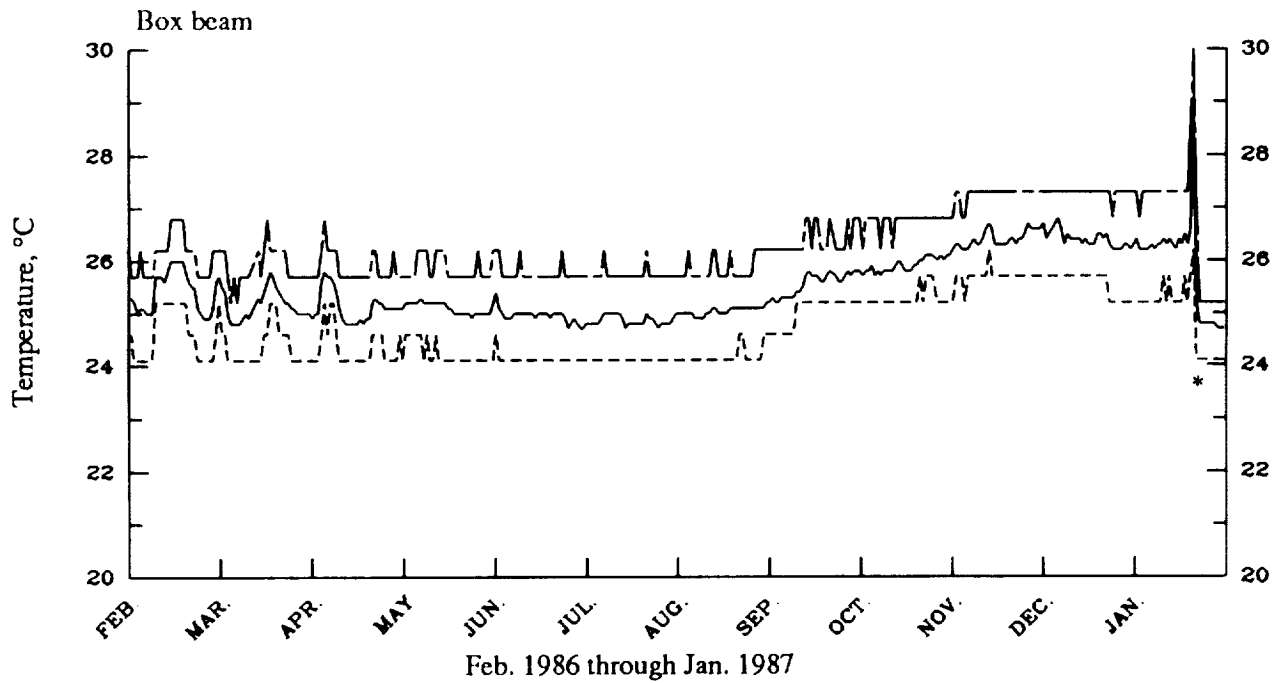
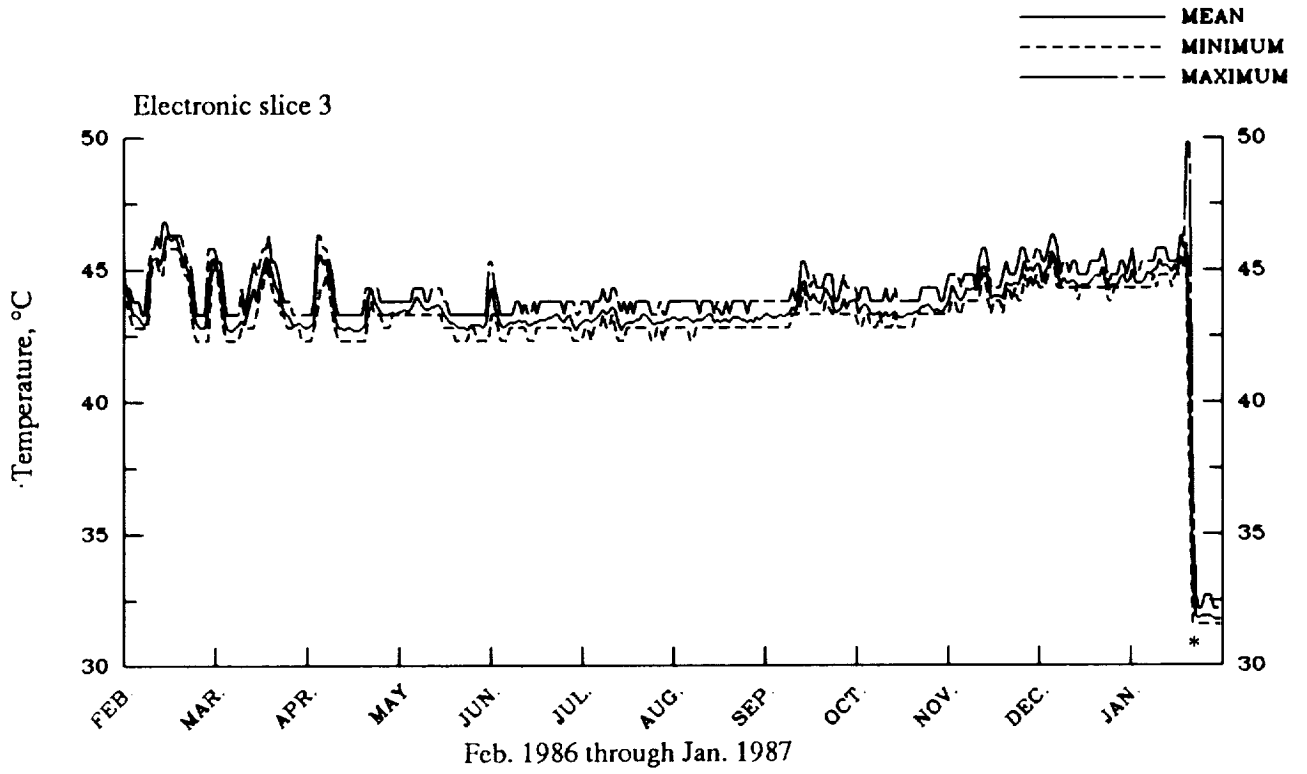

(d) Passive analog temperatures.

Figure 11. Concluded.

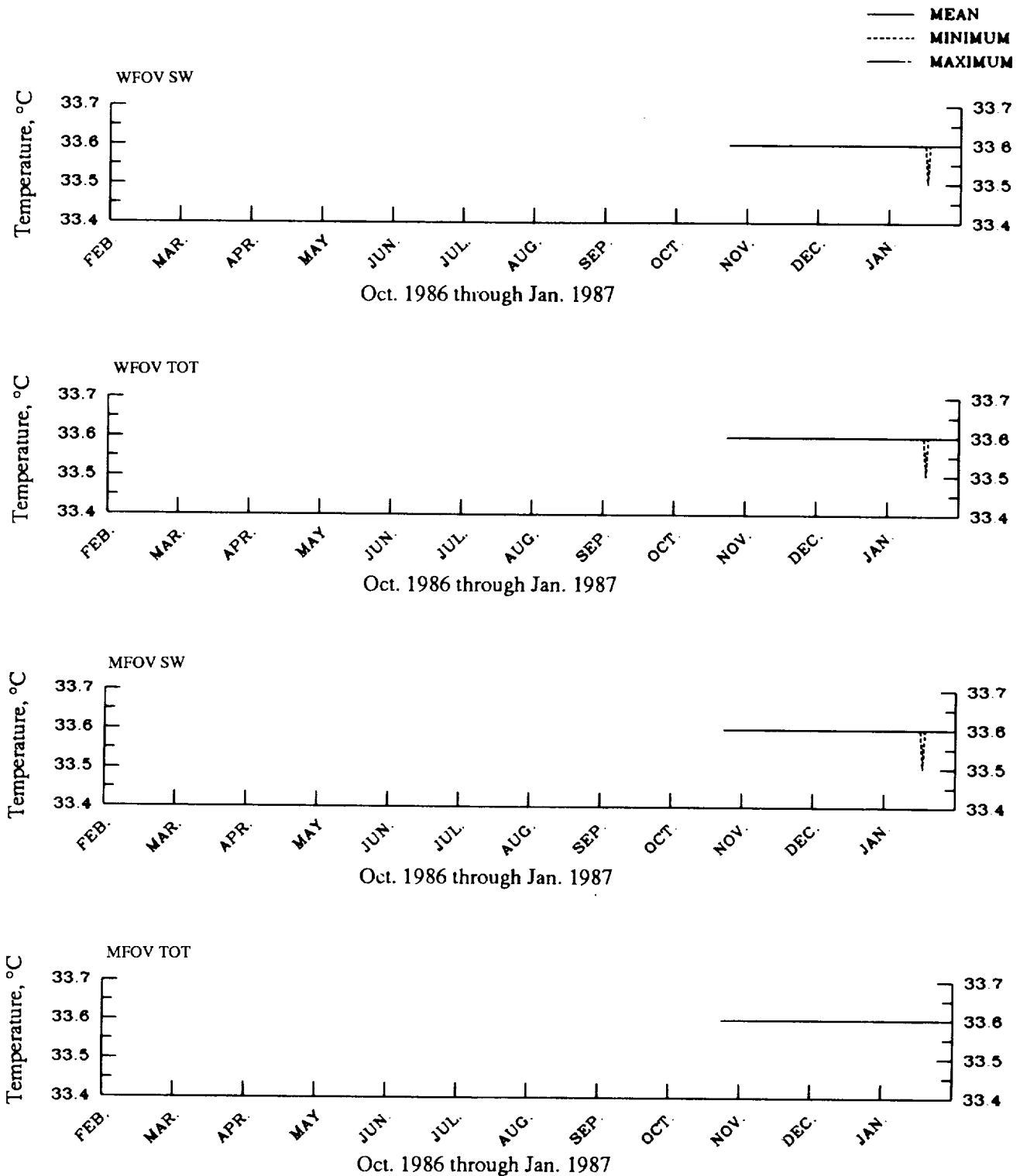

(a) Heat sink temperatures. Earth-viewing detectors.

Figure 12. Daily values of minimum, mean, and maximum housekeeping measurements from nonscanner instrument on NOAA 10 spacecraft.

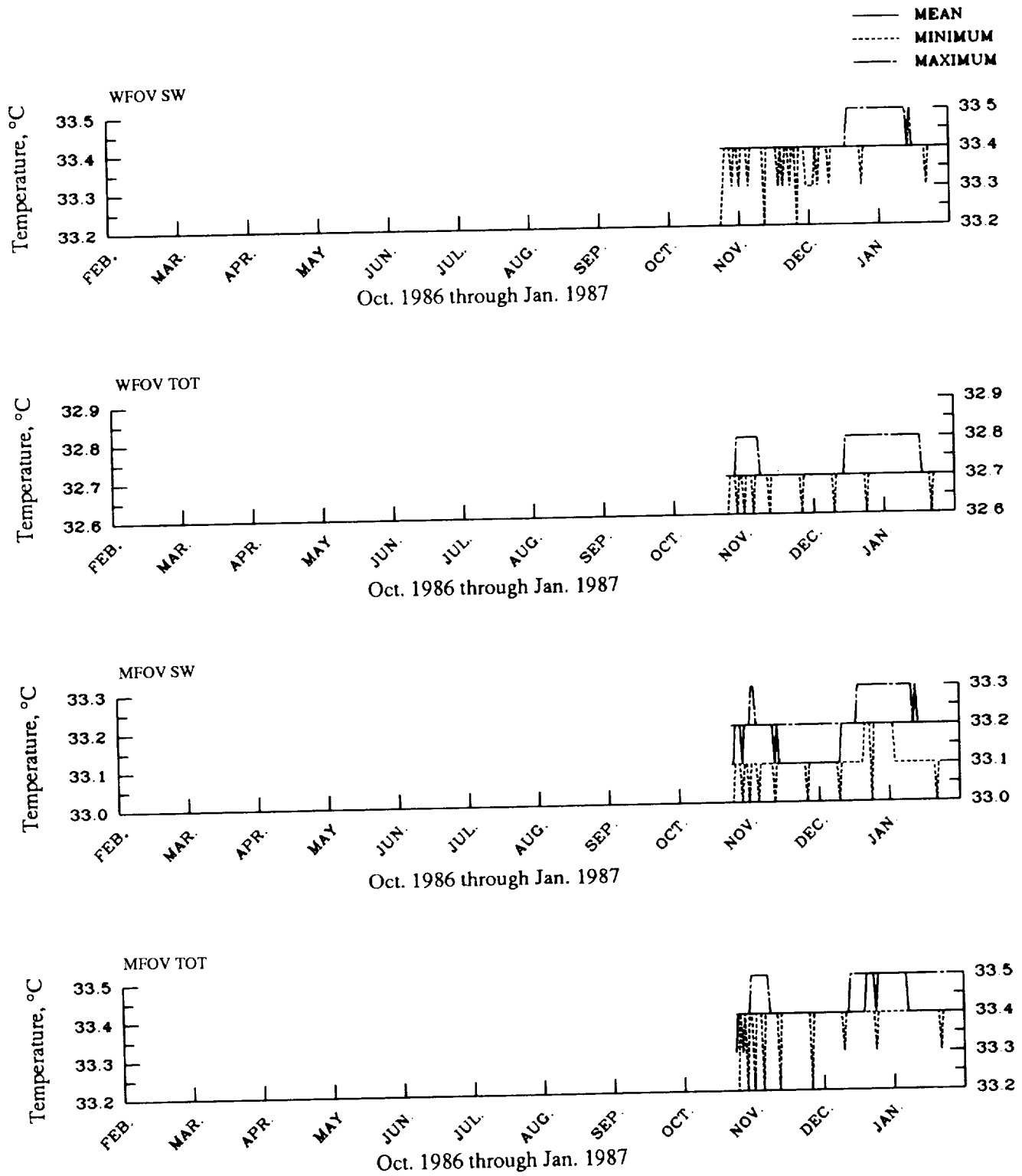

(b) Aperture temperatures. Earth-viewing detectors.

Figure 12. Continued.

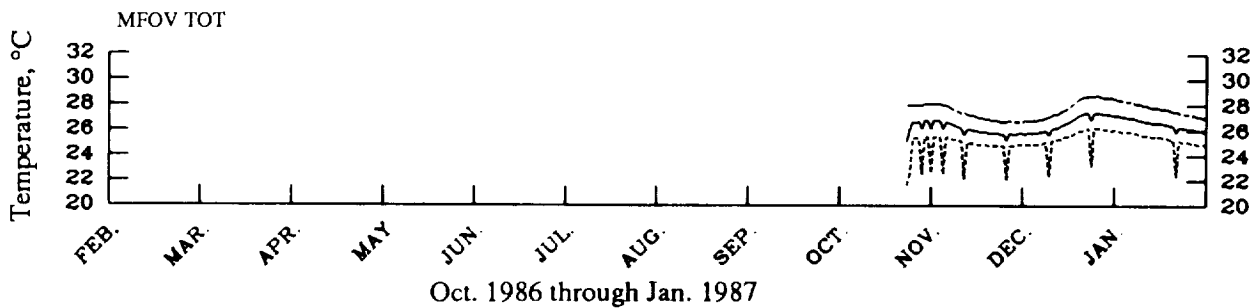
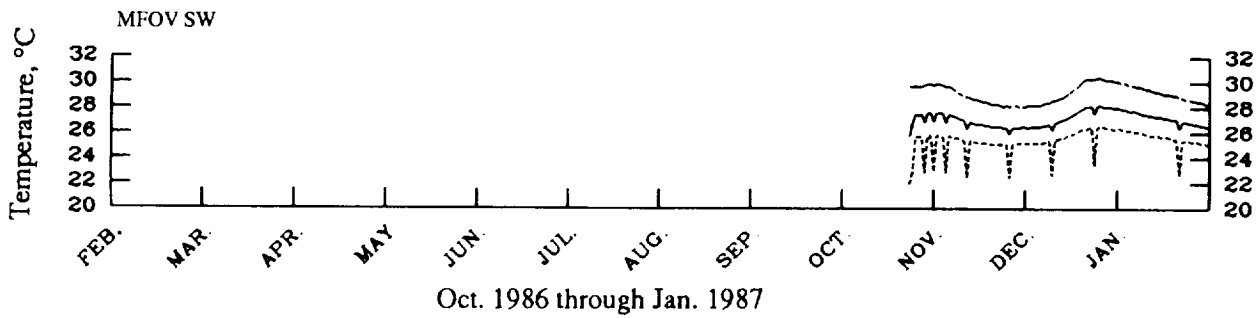
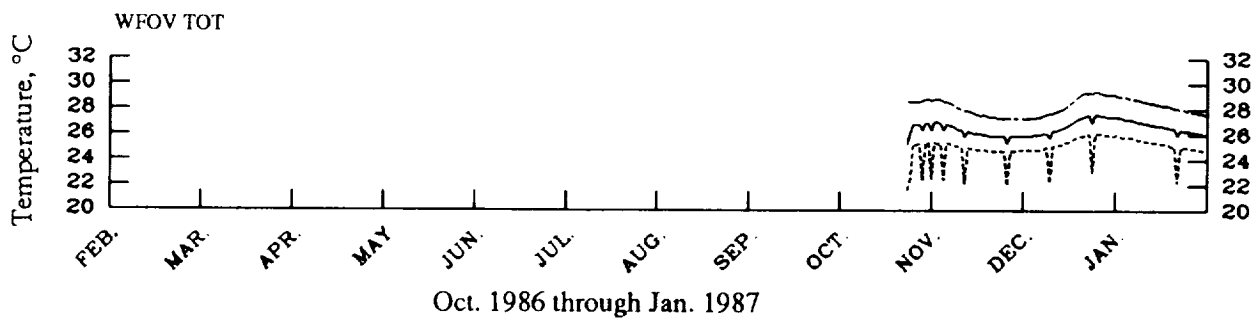
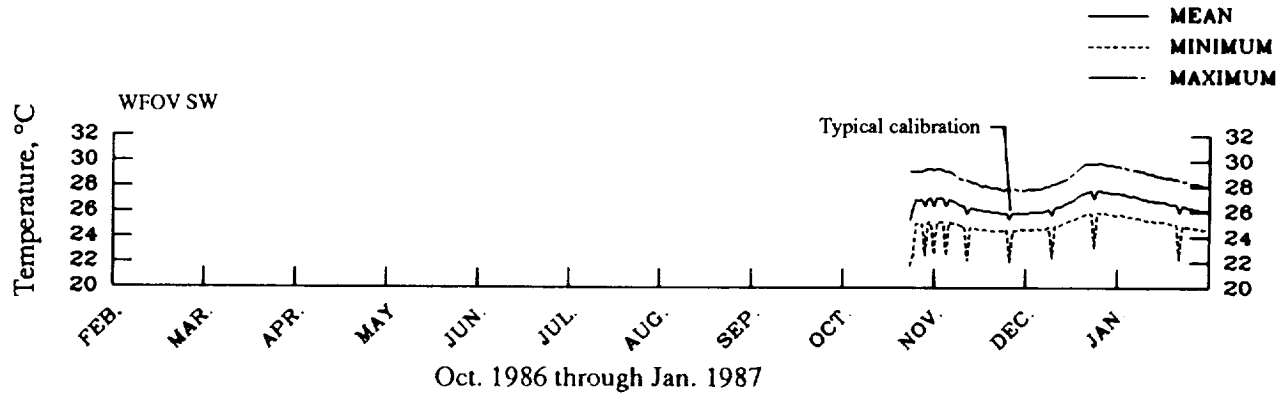

(c) Field-of-view limiter temperatures. Earth-viewing detectors.

Figure 12. Continued.

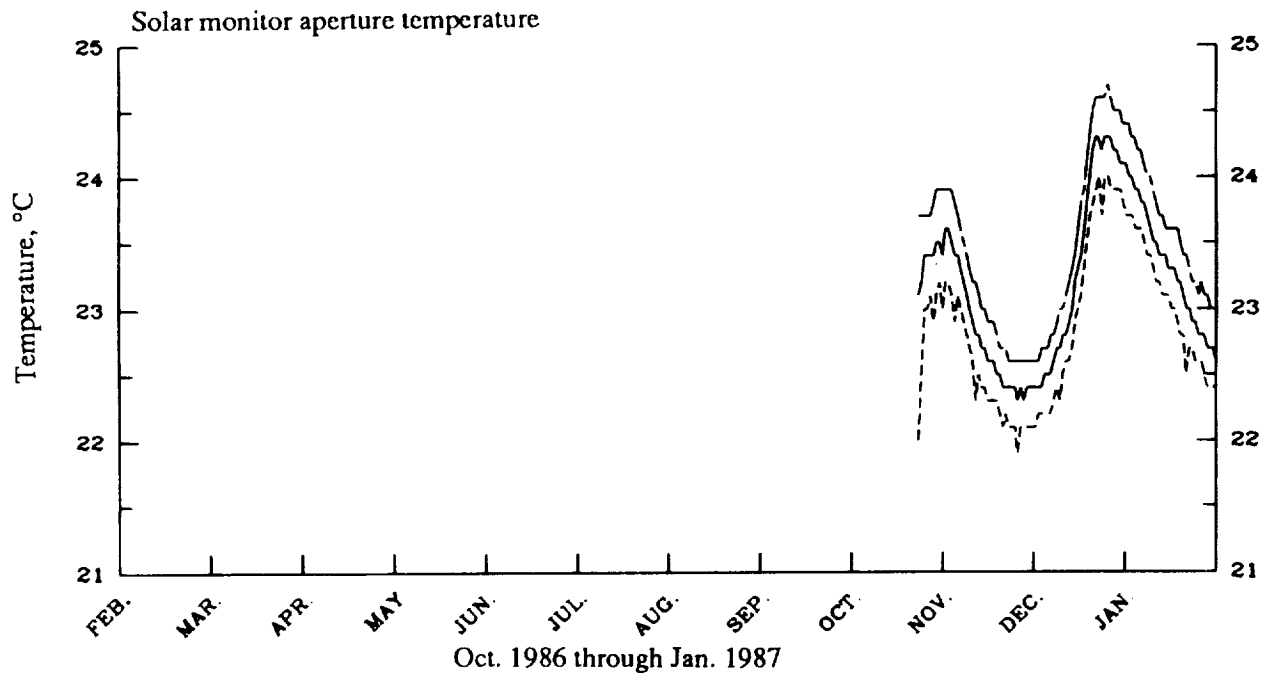
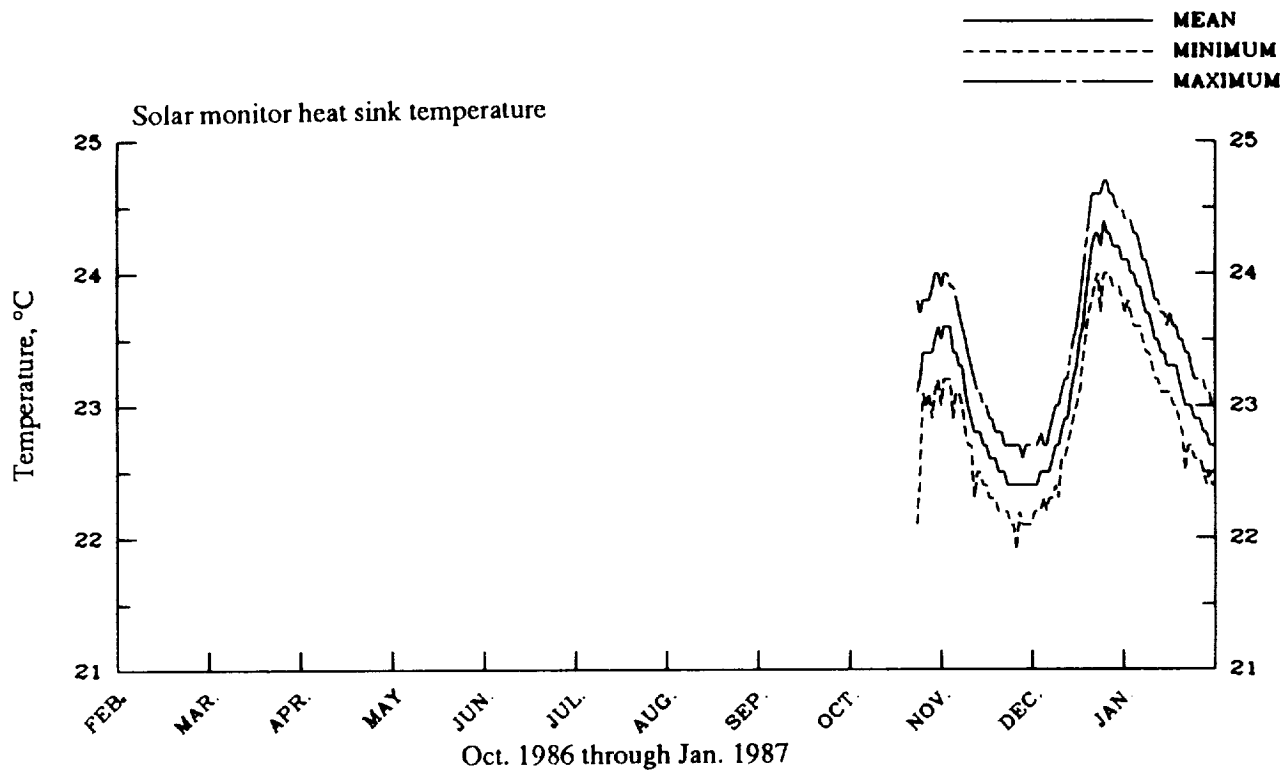

(d) Solar monitor heat sink and aperture temperatures.

Figure 12. Continued.

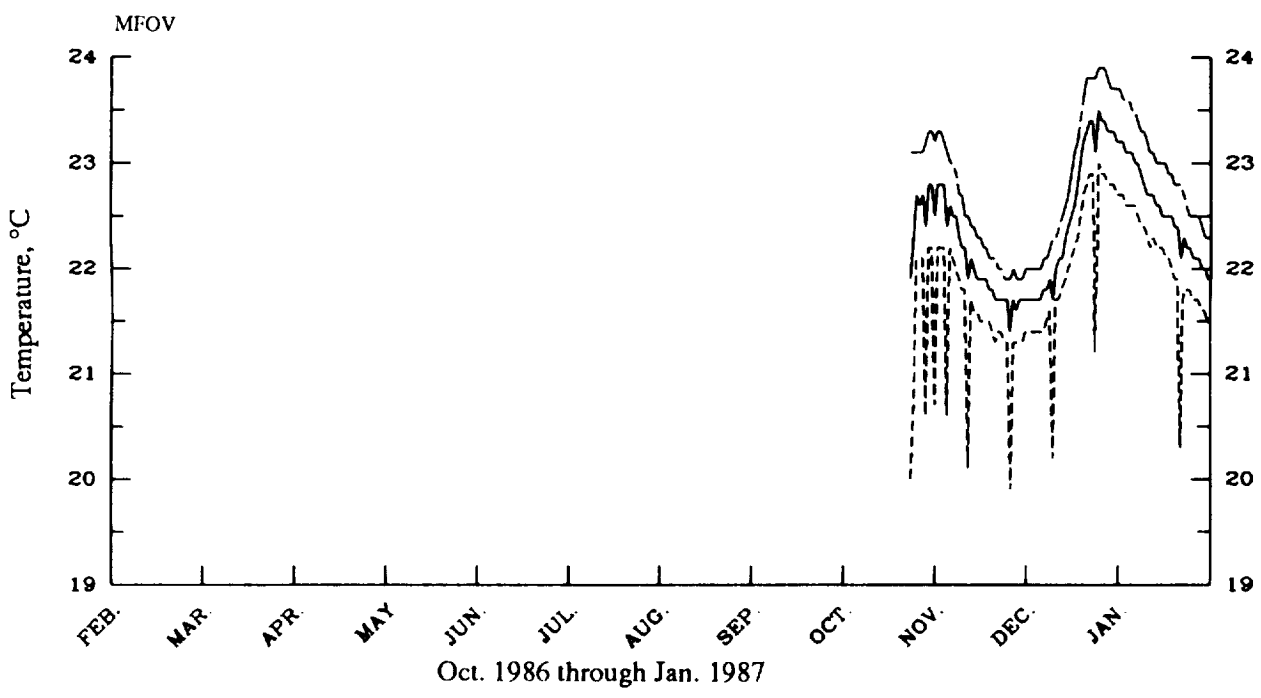
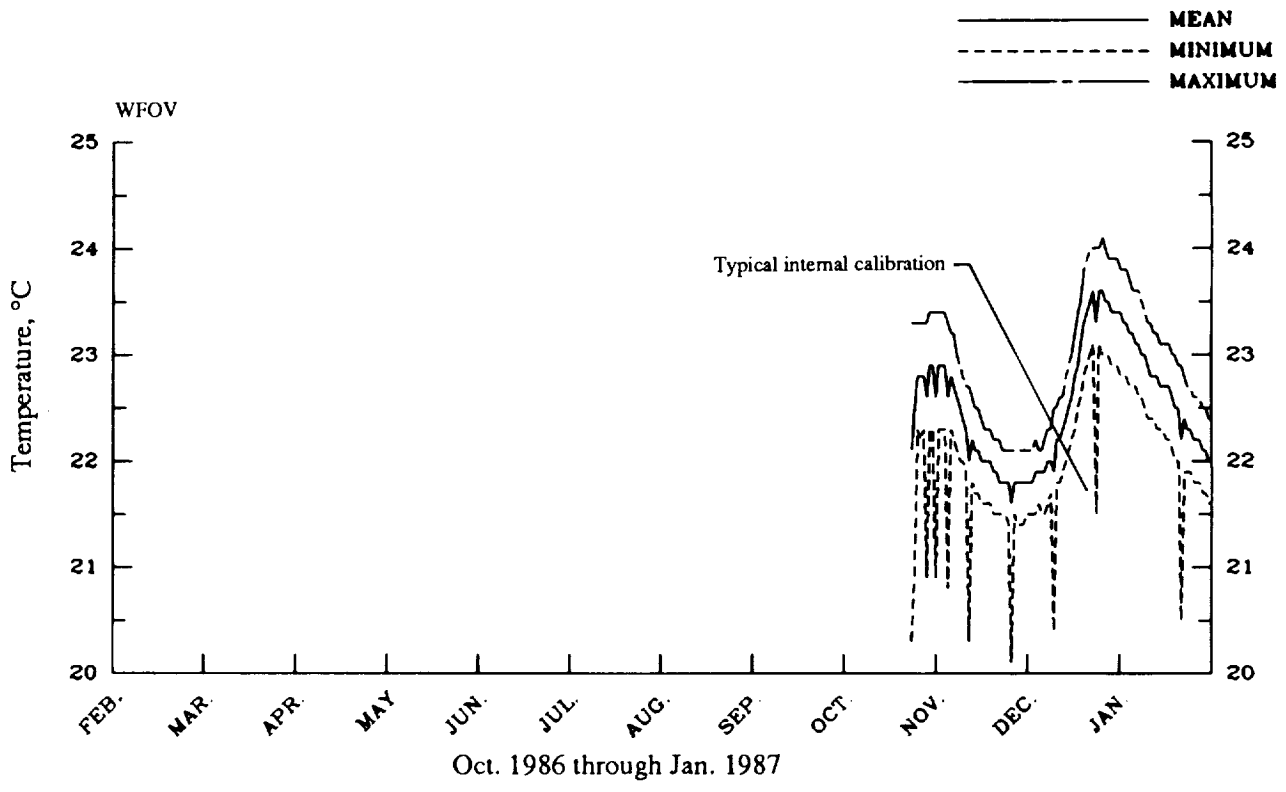

(e) Blackbody temperatures.

Figure 12. Continued.

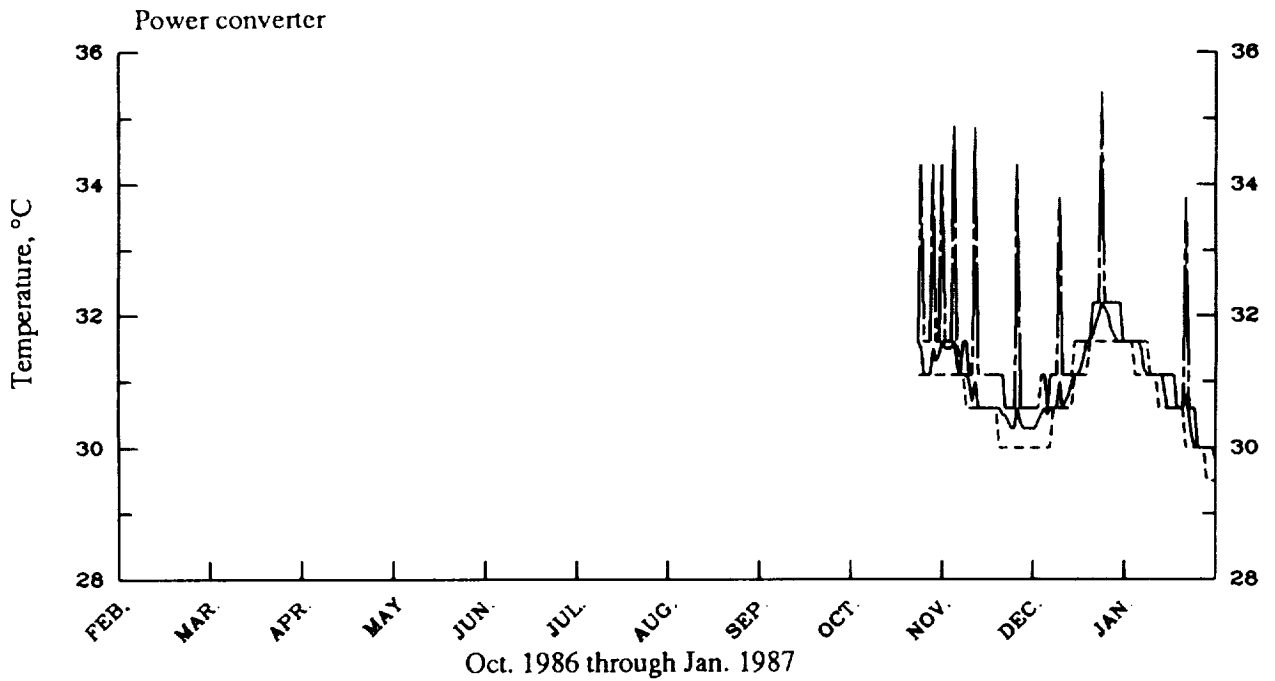
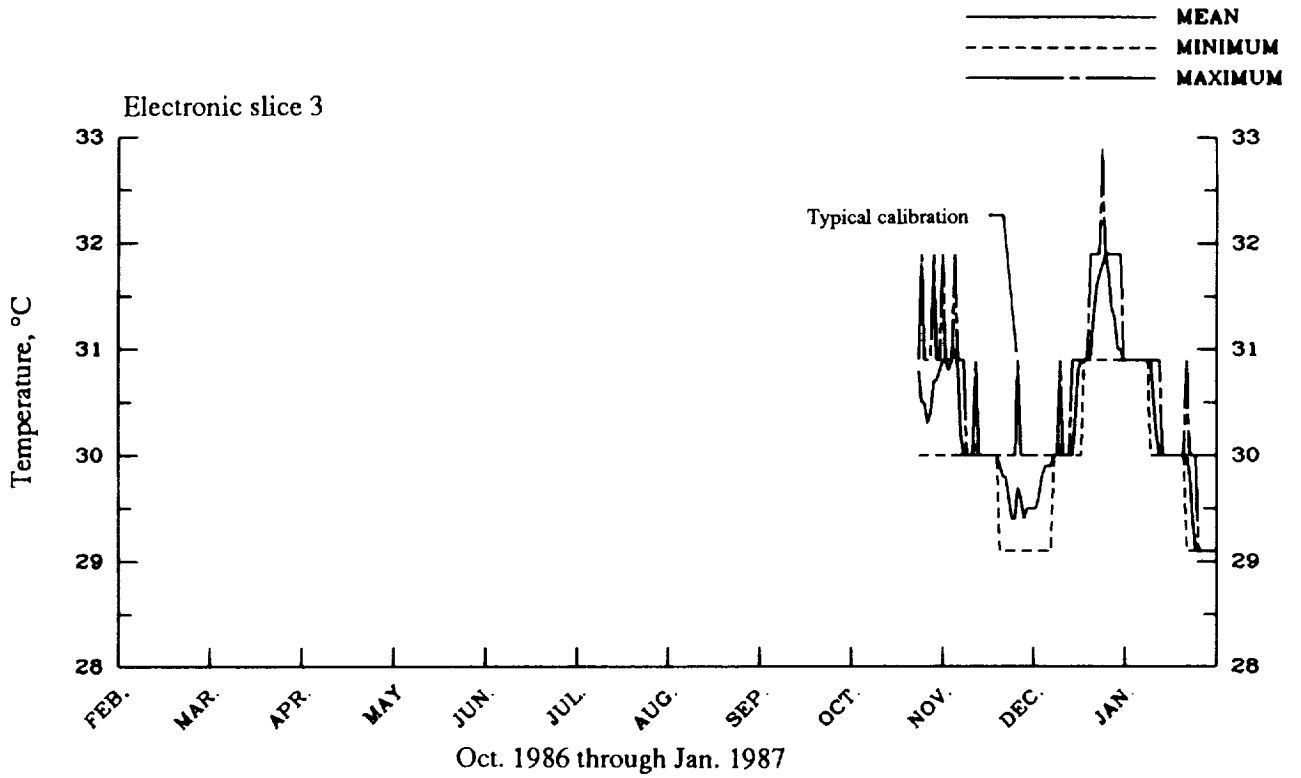

(f) Passive analog temperatures.

Figure 12. Concluded.



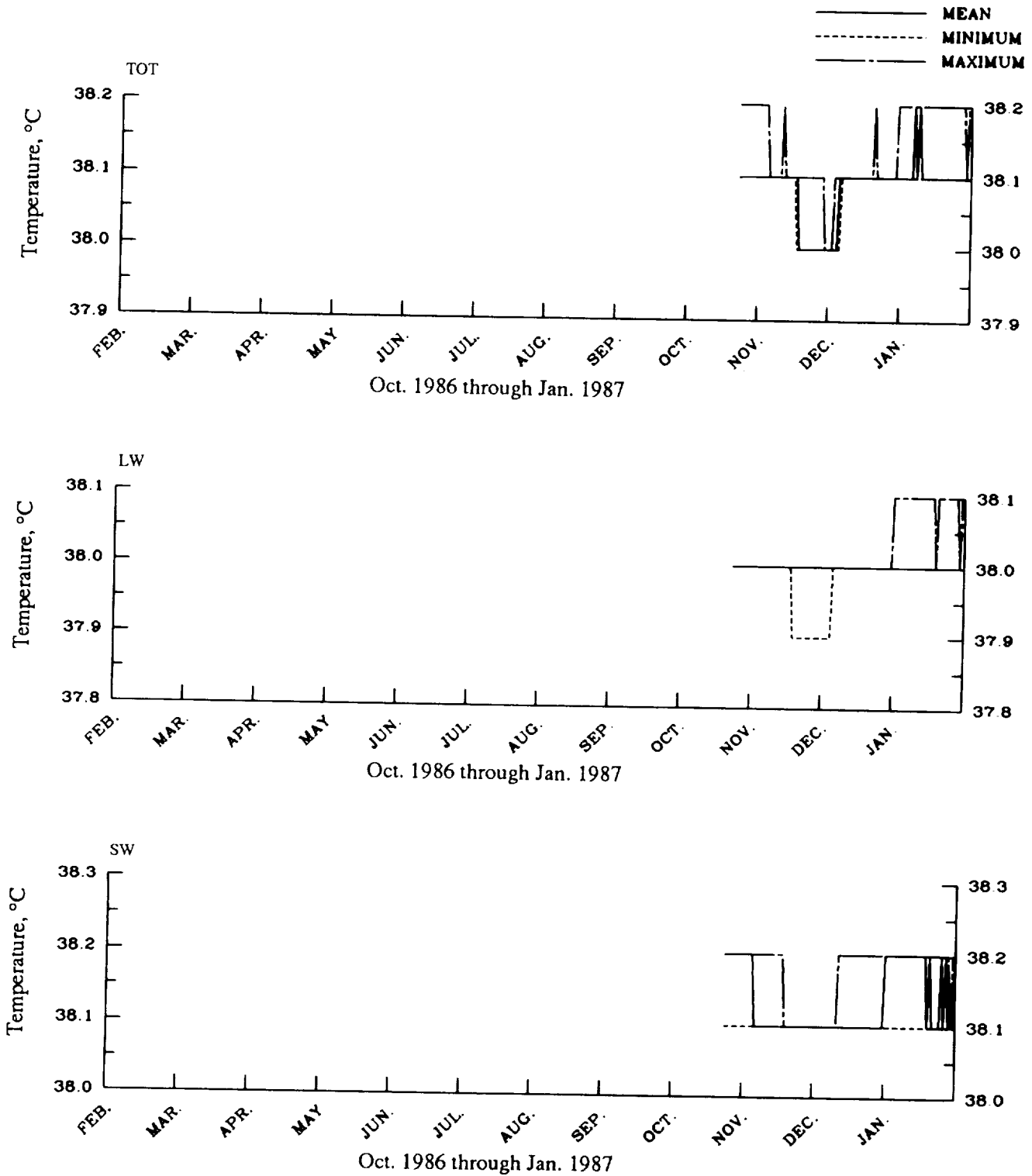

(a) Detector temperatures.

Figure 13. Daily values of minimum, mean, and maximum housekeeping measurements from scanner instrument on NOAA 10 spacecraft.

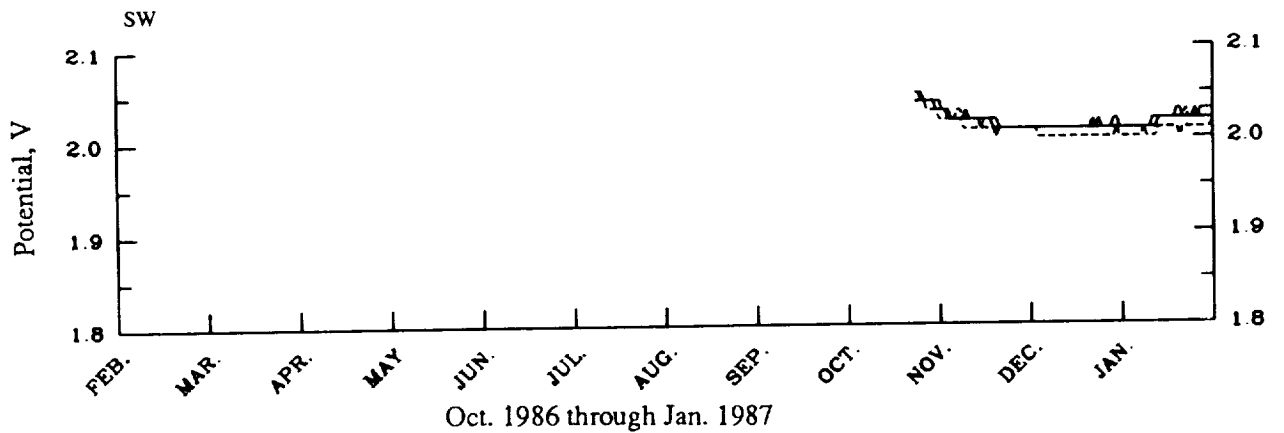
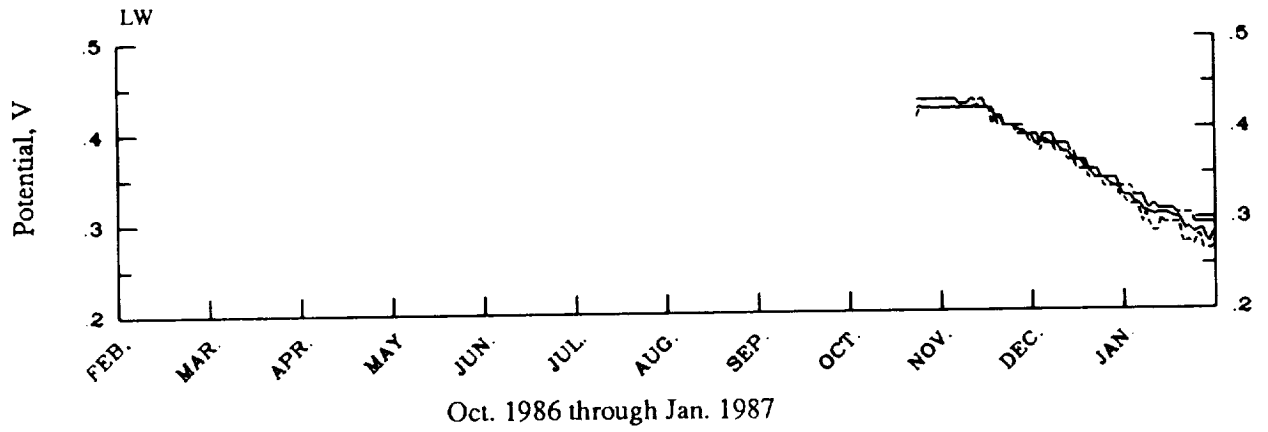
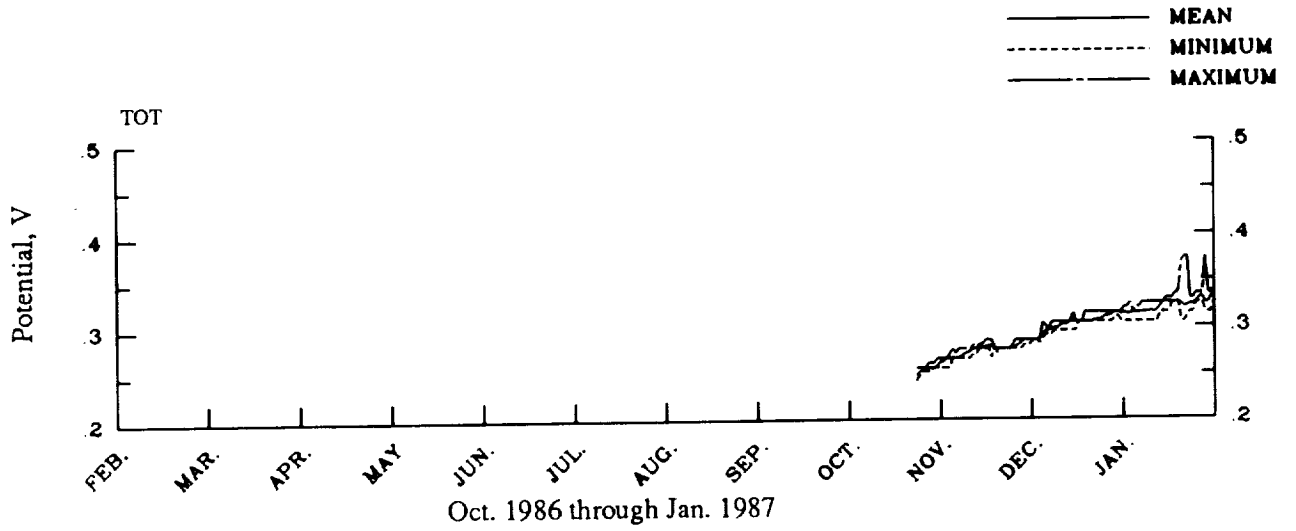

(b) Digital-to-analog (DAC) voltages.

Figure 13. Continued.

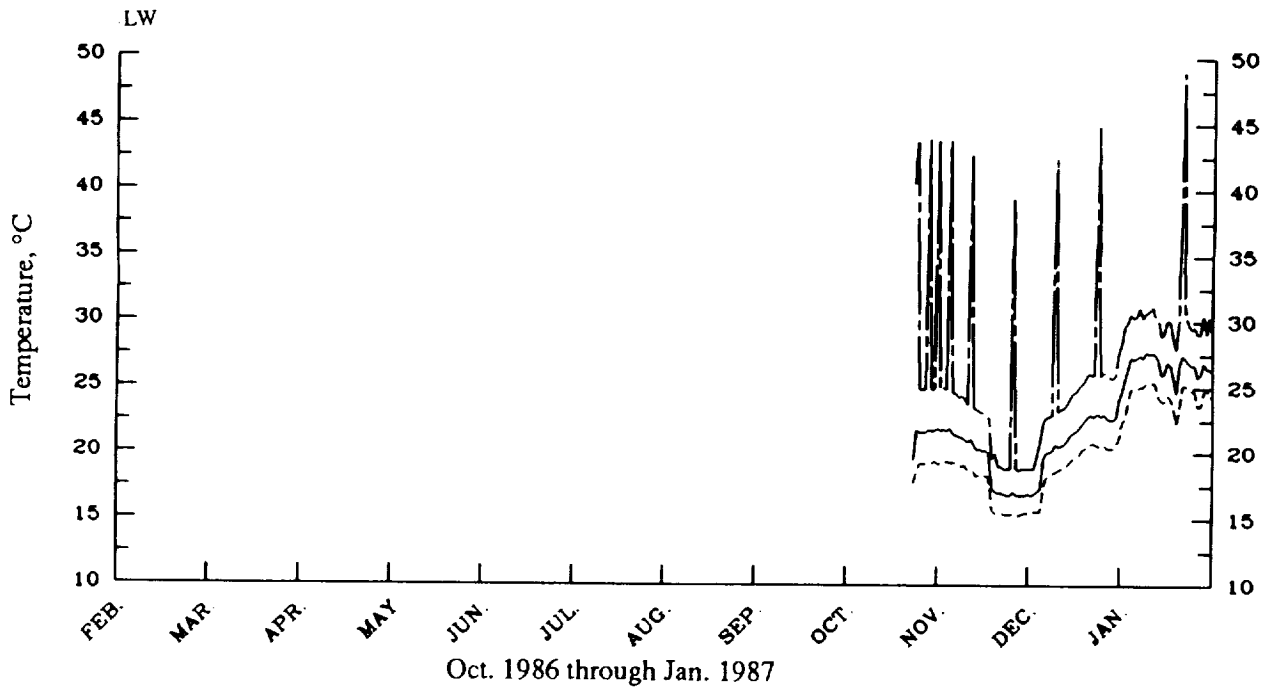
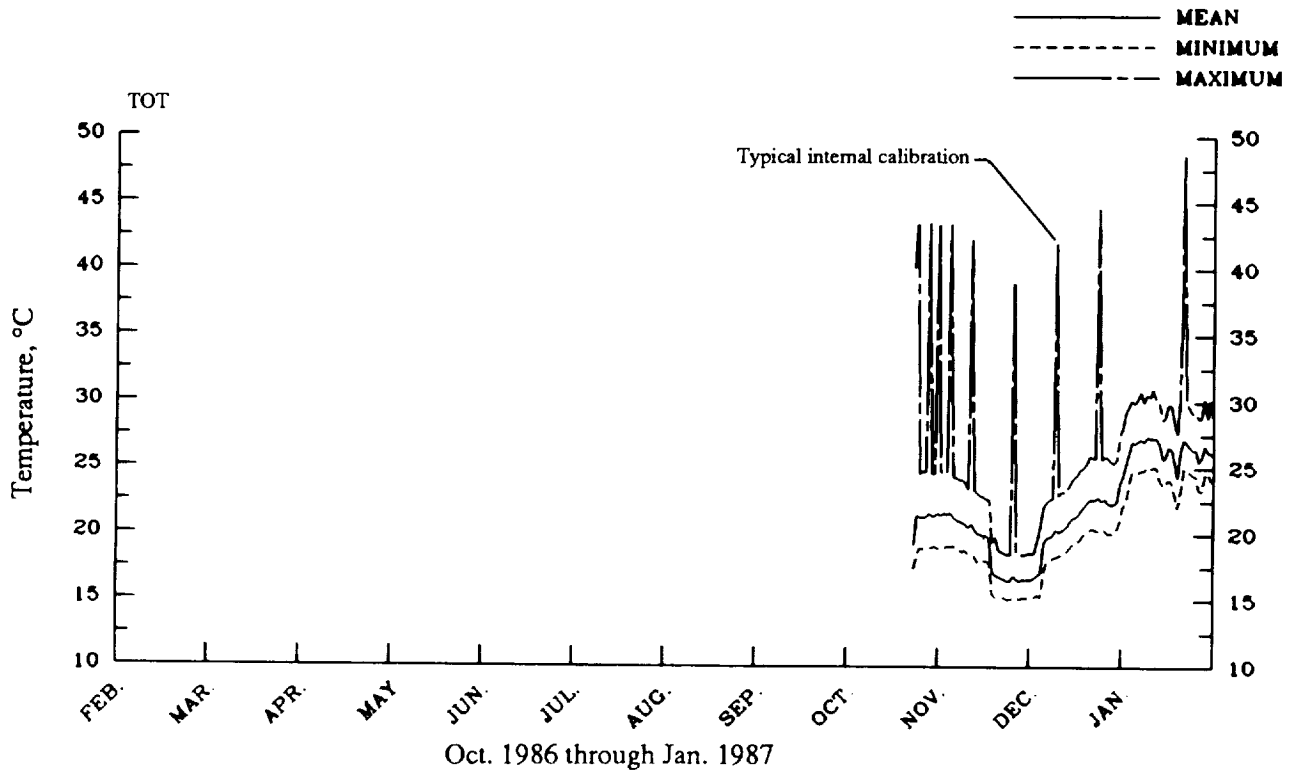

(c) Blackbody temperatures.

Figure 13. Continued.

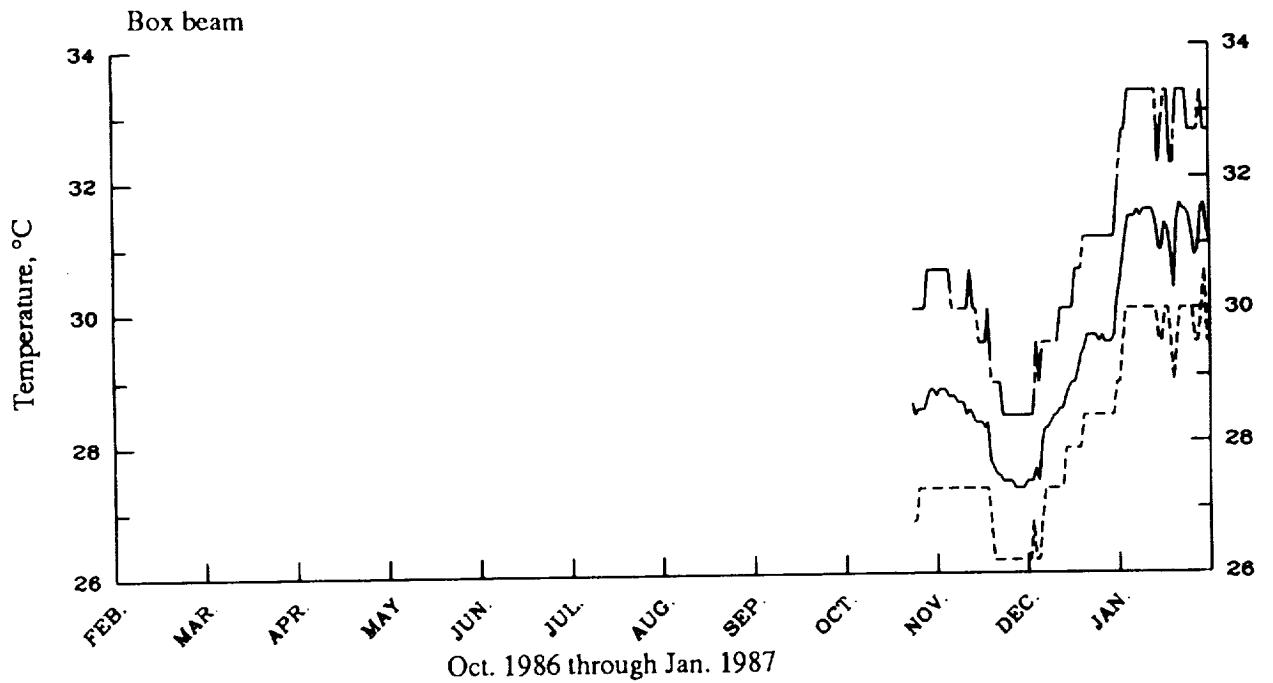
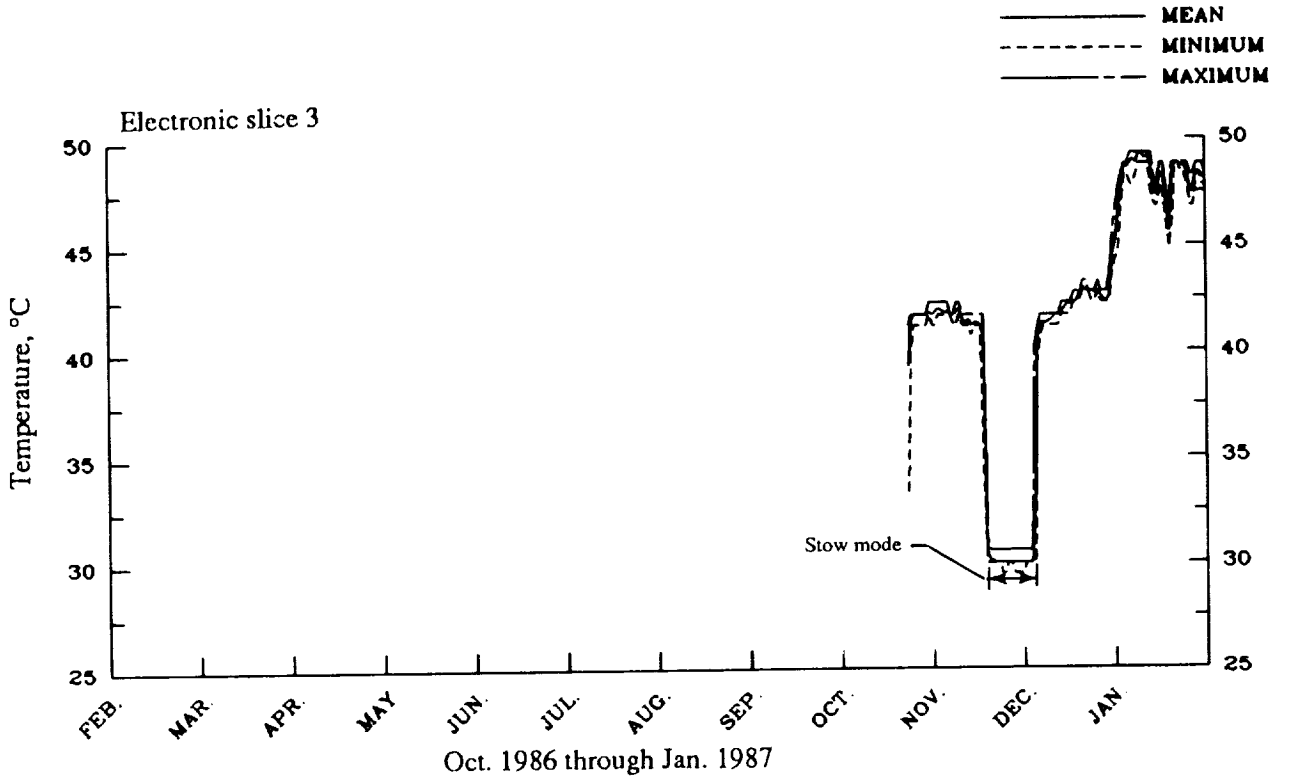

(d) Passive analog temperatures.

Figure 13. Concluded.







# REPORT DOCUMENTATION PAGE

Form Approved  
OMB No. 0704-0188

Public reporting burden for this collection of information is estimated to average 1 hour per response, including the time for reviewing instructions, searching existing data sources, gathering and maintaining the data needed, and completing and reviewing the collection of information. Send comments regarding this burden estimate or any other aspect of this collection of information, including suggestions for reducing this burden, to Washington Headquarters Services, Directorate for Information Operations and Reports, 1215 Jefferson Davis Highway, Suite 1204, Arlington, VA 22202-4302, and to the Office of Management and Budget, Paperwork Reduction Project (0704-0188), Washington, DC 20503.

<b>1. AGENCY USE ONLY (Leave blank)</b>	<b>2. REPORT DATE</b> August 1992	<b>3. REPORT TYPE AND DATES COVERED</b> Reference Publication	
<b>4. TITLE AND SUBTITLE</b> Mission Description and In-Flight Operations of ERBE Instruments on ERBS, NOAA 9, and NOAA 10 Spacecraft February 1986 Through January 1987		<b>5. FUNDING NUMBERS</b> WU 665-45-20	
<b>6. AUTHOR(S)</b> William L. Weaver, Kathryn A. Bush, Keith T. Degnan, Clayton E. Howerton, and Carol J. Tolson		<b>8. PERFORMING ORGANIZATION REPORT NUMBER</b> L-17069	
<b>7. PERFORMING ORGANIZATION NAME(S) AND ADDRESS(ES)</b> NASA Langley Research Center Hampton, VA 23681-0001		<b>10. SPONSORING/MONITORING AGENCY REPORT NUMBER</b> NASA RP-1279	
<b>9. SPONSORING/MONITORING AGENCY NAME(S) AND ADDRESS(ES)</b> National Aeronautics and Space Administration Washington, DC 20546-0001		<b>11. SUPPLEMENTARY NOTES</b> Weaver: Langley Research Center, Hampton, VA; Bush, Degnan, Howerton, and Tolson: ST Systems Corporation (STX), Hampton, VA.	
<b>12a. DISTRIBUTION/AVAILABILITY STATEMENT</b>  Unclassified Unlimited  Subject Category 43		<b>12b. DISTRIBUTION CODE</b>	
<b>13. ABSTRACT (Maximum 200 words)</b> Instruments of the Earth Radiation Budget Experiment (ERBE) are operating on three different Earth-orbiting spacecraft. The Earth Radiation Budget Satellite (ERBS) is operated by the National Aeronautics and Space Administration (NASA), and the NOAA 9 and NOAA 10 weather satellites are operated by the National Oceanic and Atmospheric Administration (NOAA). This paper is the second in a series that describes the ERBE mission, in-orbit environments, instrument design and operational features, and data processing and validation procedures. This paper describes the spacecraft and instrument operations for the second full year of in-orbit operations, which extends from February 1986 through January 1987. Validation and archival of radiation measurements made by ERBE instruments during this second year of operation were completed in July 1991. This period includes the only time, November 1986 through January 1987, during which all ERBE instruments aboard the ERBS, NOAA 9, and NOAA 10 spacecraft were simultaneously operational. The paper covers normal and special operations of the spacecraft and instruments, operational anomalies, and the responses of the instruments to in-orbit and seasonal variations in the solar environment.			
<b>14. SUBJECT TERMS</b> ERBE; ERBS; Instrument operations; Mission analysis; Orbital environment		<b>15. NUMBER OF PAGES</b> 215	
<b>17. SECURITY CLASSIFICATION OF REPORT</b> Unclassified		<b>16. PRICE CODE</b> A10	
<b>18. SECURITY CLASSIFICATION OF THIS PAGE</b> Unclassified	<b>19. SECURITY CLASSIFICATION OF ABSTRACT</b>	<b>20. LIMITATION OF ABSTRACT</b>	