

115135

P.26

NASA
Reference
Publication
1275

August 1992

SAGE I Data User's Guide

Leonard R. McMaster,
William P. Chu,
and Michael W. Rowland

(NASA-RP-1275) SAGE I DATA USER'S
GUIDE (NASA) 26 p

N92-33097

Unclas

H1/46 0115135





**NASA
Reference
Publication
1275**

1992

SAGE I Data User's Guide

Leonard R. McMaster
and William P. Chu
*Langley Research Center
Hampton, Virginia*

Michael W. Rowland
*ST Systems Corporation (STX)
Hampton, Virginia*

NASA

National Aeronautics and
Space Administration
Office of Management
Scientific and Technical
Information Program

Preface

The data products from the Stratospheric Aerosol and Gas Experiment I (SAGE I), flown on the Applications Explorer Mission 2 (AEM-2) satellite, have been archived on magnetic tapes at the National Space Sciences Data Center, NASA Goddard Space Flight Center, Greenbelt, Maryland 20771, and are now available to researchers. The AEM-2 satellite was launched on February 18, 1979, but because of the failure of the spacecraft power subsystem, the mission was terminated on November 11, 1981. Over the operational life of the spacecraft, the instrument collected 33 months of scientific data, including vertical profiles of stratospheric aerosol, ozone, and nitrogen dioxide. This document is intended to serve as a guide for using these data sets in scientific investigations of stratospheric chemistry related to aerosol, ozone, nitrogen dioxide, dynamics, and climate change. There are brief descriptions of the instrument operation; data collection, processing, and validation; and some descriptions of the scientific analyses that have been conducted. The SAGE I data products, containing the aerosol extinction data at 1000 and 450 nm, the ozone concentration data, and the nitrogen dioxide concentration data, are described in detail in appendixes A, B, and C.

Over the years, the SAGE I experiment's development and research have been guided by the SAGE I Science Team, made up of the following people:

M. P. McCormick, Principal Investigator, NASA Langley Research Center (LaRC); R. Craig, Florida State University; D. M. Cunnold and G. W. Grams, Georgia Institute of Technology; B. M. Herman, University of Arizona; M. Hirano, Kyoto University; D. E. Miller, British Meteorological Office; D. G. Murcray, University of Denver; T. J. Pepin, University of Wyoming; W. G. Planet, National Oceanic and Atmospheric Administration National Meteorological Center; and P. B. Russell, NASA Ames Research Center.

The efforts of the LaRC SAGE I Data Processing Team are also gratefully acknowledged.



Contents

Preface	iii
Summary	1
Introduction	1
AEM-2 SAGE I Mission	1
Instrument Description and Operation	2
Data Processing	3
Data Validation	6
Data Products	6
Scientific Studies	8
Concluding Remarks	9
Appendix A—SAGE I Aerosol Profile Record Format	10
Appendix B—SAGE I Ozone Profile Record Format	13
Appendix C—SAGE I Nitrogen Dioxide Profile Record Format	16
Appendix D—Meteorological Data Notes	19
References	20



Summary

The Stratospheric Aerosol and Gas Experiment I (SAGE I) instrument was launched on board the Applications Explorer Mission-2 (AEM-2) satellite, which was dedicated to the SAGE I mission. SAGE I provided global data collection of aerosol vertical extinction profiles, ozone vertical concentration profiles, and nitrogen dioxide vertical concentration profiles. The SAGE I instrument was a Sun photometer that measured the attenuation of solar radiation in four spectral regions through the Earth's atmosphere during spacecraft sunrise and sunset. The solar radiance data were combined with spacecraft ephemeris and National Oceanic and Atmospheric Administration (NOAA) meteorological data and then numerically inverted to yield altitude profiles of aerosol extinction at wavelengths of 1000 and 450 nm and altitude profiles of ozone and nitrogen dioxide concentration. The SAGE I aerosol data were validated by comparison with correlative lidar and dustsonde in situ measurements, the ozone data were validated by comparison with balloon electrochemical cell (ECC) ozonesonde and rocket measurements, and the nitrogen dioxide measurements were compared with climatology. These data are currently archived at the National Space Sciences Data Center (NSSDC). This publication describes the SAGE I experiment, instrument characteristics, and mode of operation; outlines the method of the data inversion; and explains to potential users the format of the data products archived at NSSDC. Results of the data validation and examples of data products are also presented to demonstrate the quality of the data and some of its applications in atmospheric studies.

Introduction

SAGE I was the second in a series of satellite experiments using the solar occultation technique to monitor and study stratospheric trace constituents. The Stratospheric Aerosol Measurement II (SAM II), the first automatic instrument to use this technique from space, was launched October 24, 1978, on the Nimbus 7 spacecraft (McCormick et al. 1979). The SAM II instrument uses a single spectral channel centered at a wavelength of 1000 nm for monitoring stratospheric aerosols. Because of the Nimbus 7's Sun-synchronous orbit, SAM II collects stratospheric aerosol data exclusively in the two polar regions at latitudes extending from 64° to 80° N and from 64° to 80° S. At the time this paper was prepared, SAM II was still operational and in its 13th year of data collection.

The Stratospheric Aerosol and Gas Experiment I (SAGE I) was launched February 18, 1979, aboard

the Applications Explorer Mission-2 (AEM-2) satellite (McCormick et al. 1979). The SAGE I instrument had four spectral channels centered at wavelengths of 1000, 600, 450, and 385 nm for measuring the atmospheric extinction on account of aerosols, ozone, and nitrogen dioxide. The AEM-2 satellite was placed in an orbit of approximately 600 km at an inclination of 56° to extend the latitudinal coverage for the solar occultation measurements from 79° S to 79° N. The SAGE I instrument collected data for almost 3 years until the AEM-2 satellite power subsystem failed. The processed SAGE I data have been archived at the National Space Sciences Data Center (NSSDC), NASA Goddard Space Flight Center, Greenbelt, Maryland 20771.

The most recent of these solar occultation experiments, the Stratospheric Aerosol and Gas Experiment II (SAGE II), uses seven spectral channels for measuring the atmospheric extinction of aerosols, ozone, nitrogen dioxide, and water vapor and is in an orbit similar to that of SAGE I, which allows data collection at latitudes from 80° S to 80° N. The SAGE II instrument was launched October 5, 1984, aboard the Earth Radiation Budget Satellite (ERBS) and was still collecting data after more than 7 years of operation at the time this paper was prepared (McMaster 1986). As the SAGE II data are processed and validated, they are also being archived at the NSSDC.

AEM-2 SAGE I Mission

The scientific objective of SAGE I was to develop a global stratospheric aerosol, ozone, and nitrogen dioxide data base that could be used for the investigation of the spatial and temporal variations of these species caused by seasonal and short-term meteorological variations, atmospheric chemistry and microphysics, and transient phenomena such as volcanic eruptions. The data base could also be used for the study of trends, atmospheric dynamics and transport, and potential climatic effects. The SAGE I sensor was designed to measure the attenuation of solar radiation resulting from atmospheric aerosol, ozone, and nitrogen dioxide at four spectral regions through the Earth's atmosphere during each spacecraft sunrise and sunset (fig. 1). The SAGE I sensor was a dedicated instrument on the AEM-2 satellite which, had its orbit tailored to maximize geographic coverage for solar occultation sampling. The AEM-2 satellite, with its orbital altitude of approximately 600 km and angle of inclination of 56°, provided 15 sunrise and 15 sunset measurements each day, with successive sunrise or sunset measurements occurring about 25° of longitude apart. The latitude of the sunrise or

sunset measurements varied slowly from day to day and provided near-global coverage every 3 to 4 weeks. As the seasons changed, the maximum latitude of the SAGE I measurements ranged from 79° S to 79° N. Figure 2 shows the latitudinal coverage of the SAGE I mission over the 33 months of instrument operation. Because of the spacecraft power subsystem problems that reduced the power capacity of its batteries, sunrise measurements from SAGE I were terminated after August 1979.

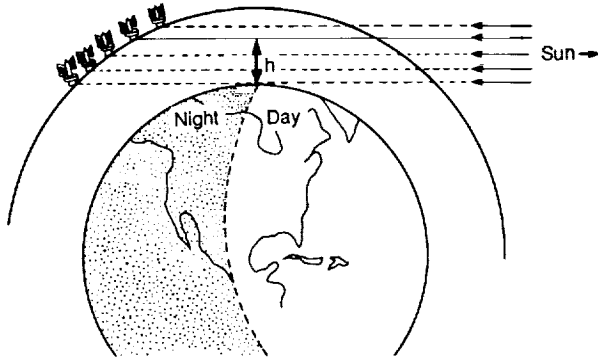
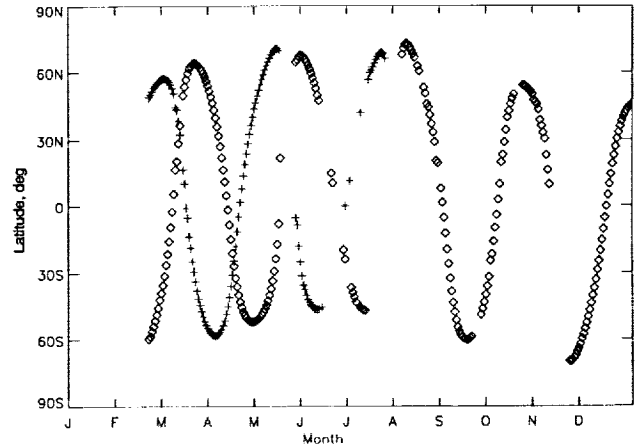

Figure 1. Solar occultation measurement geometry.

Instrument Description and Operation

The SAGE I instrument was a four-channel Sun photometer that used a Cassegrainian telescope, holographic grating, and four silicon photodiodes to define the four-spectral-channel bandpass. Figure 3 is a schematic of the SAGE I instrument. Solar radiation was reflected off a scan mirror into the telescope, with an image of the Sun being formed at the focal plane. The instrument's instantaneous field of view, defined by the aperture on the focal plane, was a 30-arcsec circle that produced a vertical resolution at the tangent point of about 0.5 km. Radiation passing through the aperture was transferred to the spectrometer section of the instrument which contained the holographic grating and four separate detector systems. The holographic grating dispersed the incoming radiation into the four spectral regions centered at wavelengths of 1000, 600, 450, and 385 nm. Slits on the Rowland circle of the grating defined the spectral bandpass of the four spectral channels. The bandpasses were 50, 30, 20, and 30 nm, respectively, for the above-mentioned wavelengths. The entire imaging and spectrometer system was inside the azimuth gimbal to allow the instrument to be pointed at the Sun without image rotation. The azimuth gimbal could be rotated over 360° so that measurements could be made at any azimuthal angle.



(a) 1979.

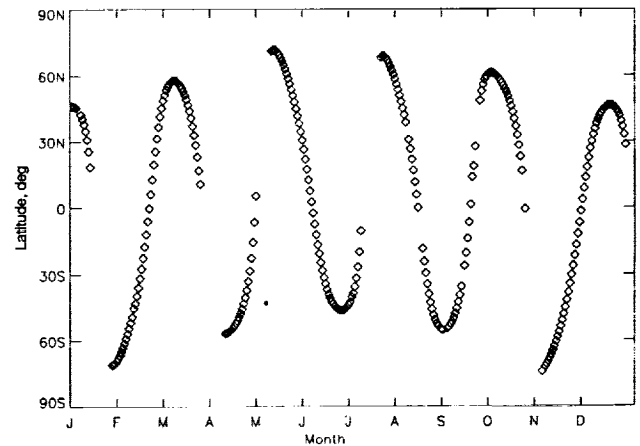

(b) 1980.

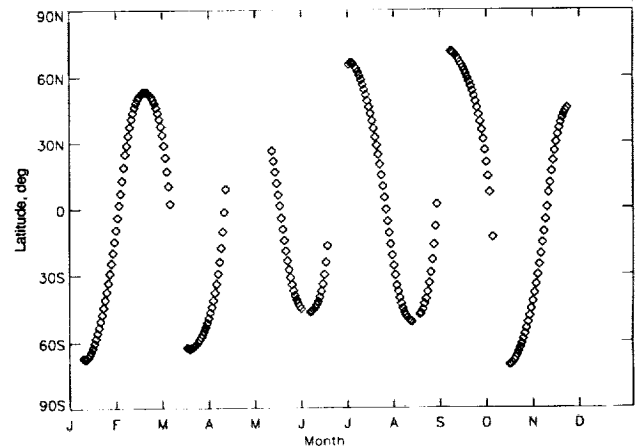

(c) 1981.

Figure 2. Latitudinal coverage for SAGE I measurements. Pluses indicate sunrise measurements and diamonds indicate sunset measurements.

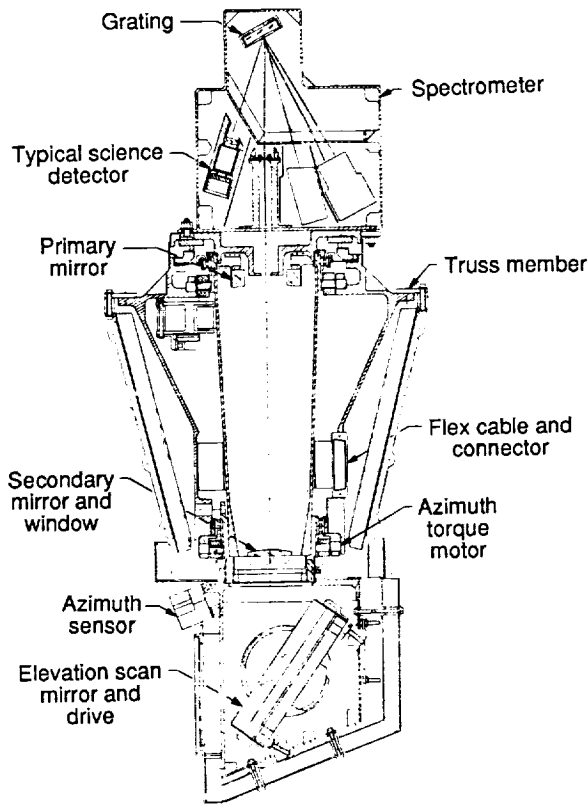

Figure 3. Schematic of SAGE I instrument. (From McCormick et al. 1979.)

The operation of the instrument, during each sunrise and sunset measurement, was totally automatic. Prior to each sunrise or sunset, the instrument was rotated in azimuth to its predicted solar acquisition position. When the Sun entered the instrument's field of view, the instrument adjusted its azimuth position to lock onto the radiometric center of the Sun to within ± 45 arcsec and then acquired the Sun by rotating its scan mirror to the proper elevation angle. As the Sun traversed between the horizon and the tangent height of 150 km, the elevation mirror scanned vertically across the solar disk. (See fig. 4.) The two solid lines in the figure represent the top and bottom edges of the solar disk during a sunset event. The gradual shrinking of the vertical shape of the solar image at the lower altitudes was caused by increasing atmospheric refraction. The dashed line represents the relative motion of the instrument elevation mirror as it scanned the Sun at a nominal rate of 15 arcmin/sec. The radiometric channel data were sampled at a rate of 64 samples per second per channel, digitized to 12-bit resolution, and recorded for later transmission back to Earth. Additional SAGE I instrument information can be found in McCormick et al. (1979).

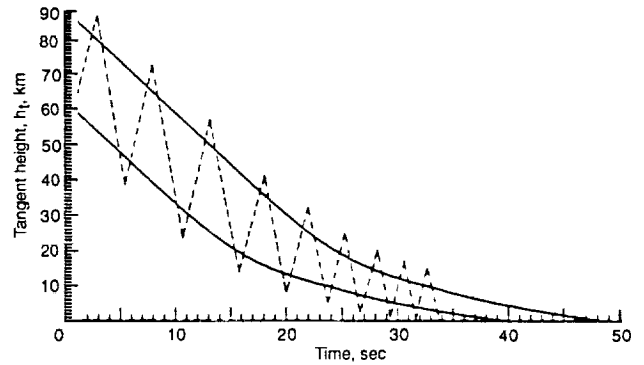

Figure 4. Typical SAGE I elevation scanning of solar disk for a sunset measurement event.

Data Processing

The SAGE I measurement data were processed with the algorithm developed by Chu and McCormick (1979) and its updated revision as discussed by Chu et al. (1989). In this section, a brief outline of the SAGE I algorithm is presented.

The measured radiance from the SAGE I instrument can be related to the atmospheric optical properties with the Lambert-Beer relation:

$$H_{\lambda}(t) = \int F(\theta, \phi) S(\theta, \phi, t) \exp[-\tau_{\lambda}(\theta)] d\Omega \quad (1)$$

where

$H_{\lambda}(t)$	measured radiance at time t for channel wavelength λ
$F(\theta, \phi)$	instrumental field-of-view function
$S(\theta, \phi, t)$	extraterrestrial solar radiance profile within the SAGE I spectral bandwidth at time t corrected for atmospheric refraction effects
$\tau_{\lambda}(\theta)$	optical thickness of atmosphere for elevation angle θ and wavelength λ
ϕ	azimuthal angle
Ω	total solid angle

Each elevation angle θ corresponds uniquely to an atmospheric tangent height h_t , the optical thickness $\tau_{\lambda}(\theta)$ can be related to atmospheric extinction properties through the following equation:

$$\tau_{\lambda}(h_t) = \int [\beta_a(h) + \beta_{O_3}(h) + \beta_{NO_2}(h) + \beta_{Ray}(h)] d\rho \quad (2)$$

where

$\beta_a(h)$	profile of aerosol extinction versus altitude
--------------	---

$\beta_{\text{O}_3}(h)$	profile of ozone extinction versus altitude
$\beta_{\text{NO}_2}(h)$	profile of nitrogen dioxide extinction versus altitude
$\beta_{\text{Ray}}(h)$	profile of Rayleigh extinction versus altitude
$d\rho$	differential path length through atmosphere

The integral is evaluated from the spacecraft position to the Sun.

The processing of the SAGE I data to generate the various species profiles was done in three steps. First, the measured radiance data were reduced with the spacecraft ephemeris, atmospheric refraction calculation, and the Sun-scan data and put into profiles of limb optical thickness $\tau_\lambda(h_t)$ as a function of tangent height h_t in the atmosphere for each channel centered at wavelength λ . The high-altitude solar-scan profiles for each channel were used as calibrated solar-limb profiles out of the atmosphere.

The second step was to subtract the estimated Rayleigh contribution along each limb path for each channel and to separate the four spectral optical thickness profiles into aerosol optical thickness profiles at 1000 and 450 nm, an ozone optical thickness profile at 600 nm, and a nitrogen dioxide optical thickness profile at 385 nm with the method described by Chu and McCormick (1979) and Chu et al. (1989). The Rayleigh contributions were computed from coincident temperature versus height profiles that were provided by the National Oceanic and Atmospheric Administration (NOAA).

The third step was to invert the species' optical thickness profiles into extinction profiles. Through division of the atmosphere into N homogeneous layers, the integral equation can be reduced to a system of linear equations as follows:

$$\tau_{\alpha i} = \sum_j^N \rho_{ij} \beta_{\alpha j} \quad (3)$$

where

$\tau_{\alpha i}$	measured limb optical thickness at i th layer for species α
ρ_{ij}	path length of the Sun's ray in j th layer with its tangent height at i th layer
$\beta_{\alpha j}$	averaged extinction coefficient for species α in j th layer

Equation (3) is then inverted with Twomey's modification of Chahine's nonlinear relaxation algorithm as described by Chu and McCormick (1979) and Chu et al. (1989). The SAGE I inversion algorithm generated vertical aerosol extinction profiles at 1000 and 450 nm and ozone and nitrogen dioxide vertical concentration profiles.

An example of the SAGE I aerosol data inversion is shown in figure 5. The aerosol extinction profiles of 1000 nm that are shown are from SAGE I radiance data collected April 24, 1979, at 0545 and 0722 LCT. They illustrate the background aerosol condition versus the presence of volcanic plume from the eruption of Soufrière volcano (McCormick et al. 1982). The error bars shown in the figures are estimates of the random errors associated with the calculations of the aerosol extinction that result from both the radiometric measurement and the mathematical inversion. These errors (also archived at NSSDC along with the constituent profiles) include contributions from random measurement and inversion noise, NOAA temperature uncertainties, and altitude uncertainties. Below an altitude of 25 km, where aerosol extinction exceeds molecular extinction by 50 percent, the total error in the retrieved aerosol extinction coefficient is typically less than 10 percent. Therefore, even under most background or nonvolcanic conditions, the extinction resulting from stratospheric aerosols can be measured to accuracies within 10 percent.

An example of the SAGE I ozone data inversion is shown in figure 6. The dashed-line profile of ozone partial pressure is from SAGE I radiance data collected on April 2, 1979. It illustrates a typical mid-latitude springtime ozone profile. The profile shown by the solid line in the figure is a coincident electrochemical cell (ECC) ozonesonde profile obtained at Garmisch-Partenkirchen, Germany (Reiter and McCormick 1982). The error bars associated with the SAGE I ozone profile are estimates of the random errors from the calculation of the ozone concentration profile. These errors are estimated similar to the errors in the aerosol extinction profiles. Generally, the uncertainties of the ozone concentration profiles retrieved from the SAGE I measurements are less than 10 percent from cloud-top height to a geometric altitude of about 45 km.

An example of the SAGE I nitrogen dioxide data inversion with the 385-nm channel is shown in figure 7. (See also WMO 1981.) Chu and McCormick (1986) suggested that measurement noise and difficulties associated with removing the Rayleigh, ozone, and aerosol contributions from this single wavelength retrieval led to an accuracy of approximately 20 percent, as shown by the error bars. The effect of the

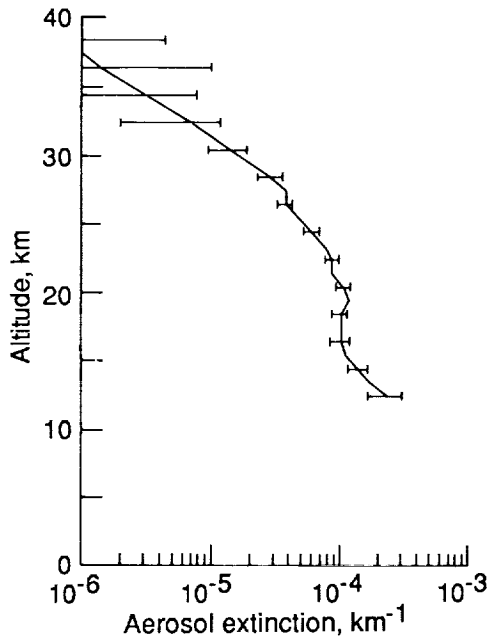

(a) Background conditions. 0722 LCT; long. 85.4° W; lat. 19.8° N.

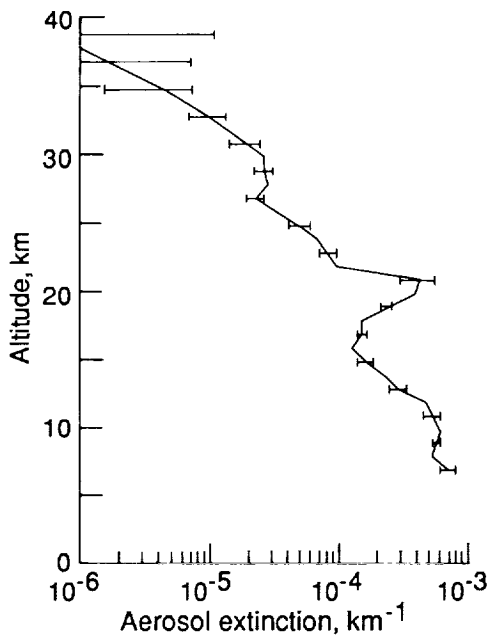

(b) Perturbed conditions resulting from La Soufrière volcano eruption. 0545 LCT; long. 61.0° W; lat. 19.5° N.

Figure 5. SAGE I aerosol extinction profile on April 24, 1979. Horizontal bars indicate 1σ error bar. (From McCormick et al. 1982.)

inhomogeneous distribution of nitrogen dioxide resulting from its diurnal variation along the slant tangent path has been neglected in the retrieval of nitrogen dioxide vertical profiles. This effect has been

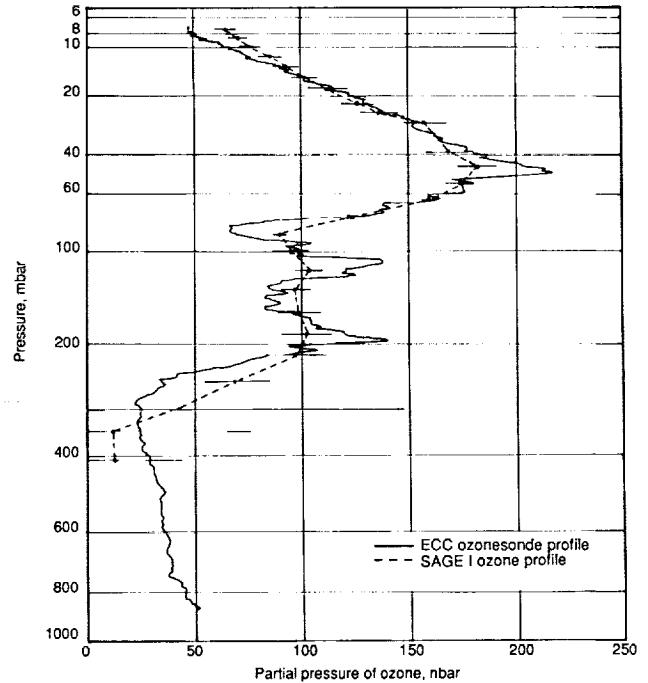

Figure 6. SAGE I measured ozone profile and coincident ECC ozonesonde profile obtained at Garmisch-Partenkirchen, Germany. Profiles obtained on April 2, 1979. ECC ozonesonde data starting at 1645 GMT; SAGE I measurements at 1743 GMT. (From Reiter and McCormick 1982.) Horizontal bars indicate 1σ error bar.

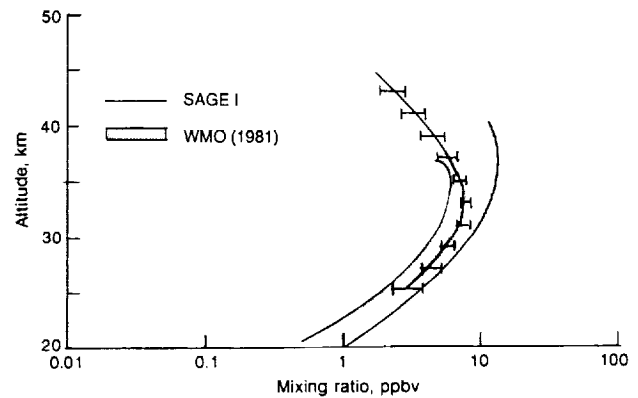

Figure 7. SAGE I sunset nitrogen dioxide data and previous measurements of nitrogen dioxide as shown in WMO (1981). Horizontal bars indicate 1σ error bar. (From Chu and McCormick 1986.)

analyzed by Kerr, Evans, and McConnell (1977) and the correction factors were found to be small. The SAGE II instrument uses two channels with relatively narrow bandwidths to make the nitrogen dioxide measurement, and this retrieval results in a significant improvement in the profile accuracy from that experiment (Cunnold et al. 1991).

SAGE I data were originally processed and archived at NSSDC in 1985, with corrections to NOAA temperature data at upper pressure levels as tabulated by Geller, Wu, and Gelman (1983). However, the tabulated correction factors were later determined to have sign errors (Gelman et al. 1986). The effects on the original SAGE I results were most pronounced in low-latitude-high-altitude regions. As part of the activities of the NASA-World Meteorological Organization (WMO) Ozone Trends Panel in 1987 (Watson et al. 1988), SAGE I data were reprocessed with the corrected temperature adjustment factors. This user's guide describes the revised SAGE I data set that has replaced the old SAGE I data set at NSSDC.

Data Validation

Before being archived, the SAGE I data were validated through an extensive correlative measurements program. Two major correlative measurement experiments were conducted—the first over Natal, Brazil, in April 1979, and the second over Poker Flat Research Range, Alaska, in July 1979. In each experiment, correlative aerosol and ozone measurements were made nearly coincident in space and time with the SAGE I measurements. The correlative aerosol data consisted of SAM II-measured aerosol extinction profiles, airborne lidar-measured aerosol backscatter data, balloon-borne optical particle counter (dustsonde) data, and other in situ particle counter measurements. These correlative aerosol measurements were collected and converted to aerosol extinctions for comparison with SAGE I aerosol data (Russell, McCormick, et al. 1981; Russell, Swisler et al. 1981; Russell et al. 1984). The correlative ozone data consisted of ECC ozonesondes measurements and rocket ozone data (McCormick et al. 1984). Figure 8 shows the aerosol data from the Poker Flat experiment, along with the SAGE I, the SAM II, the dustsonde (DS), filter, and the Ames Wire Impactor (AWI) data (Russell et al. 1984). Other comparisons of the SAGE I and SAM II aerosol extinction measurements have also been made (Yue, McCormick, and Chu 1984). Figure 9 shows the SAGE I ozone measurements and the ECC ozonesonde and rocket measurements at Poker Flat and Wallops Island, Virginia (McCormick et al. 1989). Comparisons of the SAGE I ozone data with other ECC data have also been made (Reiter and McCormick 1982). Because of the unavailability of any generally accepted nitrogen dioxide monitor, the SAGE I nitrogen dioxide measurements were compared with available climatology as well as noncoincident balloon

soundings and ground-based measurements (Chu and McCormick 1986).

These comparisons between SAGE I aerosol, ozone, and nitrogen dioxide measurements and correlative data demonstrate that the SAGE I measurements agree with the correlative data to within their measurement and conversion uncertainties. These results clearly support the validity of the SAGE I aerosol, ozone, and nitrogen dioxide data.

Data Products

The basic archived products from the SAGE I data processing are the aerosol profile tape, the ozone profile tape, and the nitrogen dioxide profile tape. These data products are archived and can be requested on magnetic tape from the National Space Sciences Data Center (NSSDC), NASA Goddard Space Flight Center, Code 933, Greenbelt, Maryland 20771. (Foreign requests should be sent to Code 930.2.) Each request should specify the experiment data desired (aerosol, ozone, or nitrogen dioxide), the NSSDC identification number (79-013A-01C), and the time period of interest. All 33 months of SAGE I data have been archived.

The aerosol profile tape contains the altitude profiles (plus the corresponding error estimates) of aerosol extinction coefficients at wavelengths of 1000 and 450 nm, Rayleigh extinction coefficients at wavelengths of 1000 and 450 nm, and the extinction ratio of aerosol extinction coefficient to Rayleigh extinction coefficient at a wavelength of 1000 nm. Auxiliary information that was used for processing the SAGE I data, such as NOAA's temperature-versus-altitude data, ephemeris-calculated latitude and longitude at the tangent location, beta angle of the spacecraft orbit (angle between the spacecraft orbit plane and the Earth-Sun direction), and event duration, is also included on the profile tape. There is one aerosol profile tape per year that covers 12 months of data from December of 1 year to November of the next year (winter to fall). The tapes are formatted as 6250-bpi, 9-track tapes and are archived at NSSDC. The aerosol profile tape record format is described in appendix A.

The ozone profile tapes contain the sunrise and sunset altitude profiles of ozone number density and mixing ratio, plus their corresponding error estimates. They contain the same auxiliary information as the aerosol profile tapes. There is one ozone profile tape per year that covers 12 months of data from December of 1 year to November of the next year. The tapes are formatted as 6250-bpi, 9-track tapes and are archived at NSSDC. The ozone profile tape format is described in appendix B.

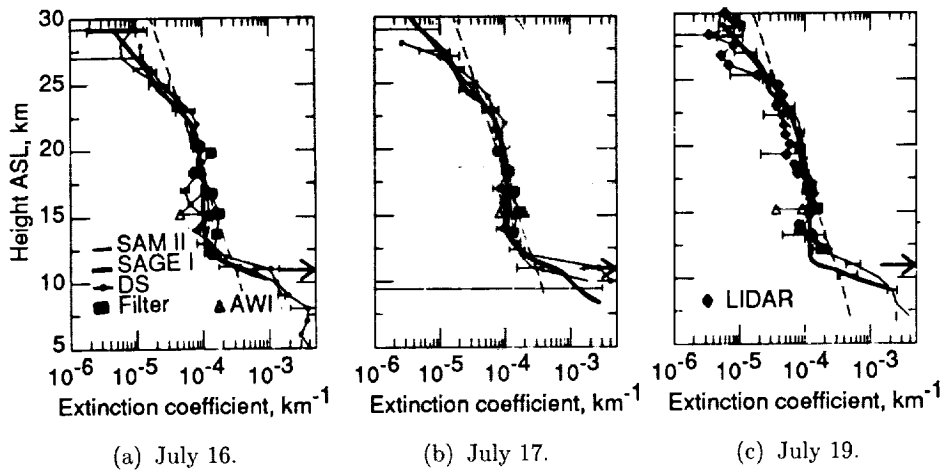

Figure 8. SAGE I aerosol extinction coefficient retrieval and correlative aerosol measurements collected during 1979 validation experiment over Poker Flat Research Range, Alaska. Arrows in figure indicate height of tropopause. $\lambda = 1.0 \mu\text{m}$. DS = Dustsonde; AWI = Ames Wire Impactor. (From Russell et al. 1984.)

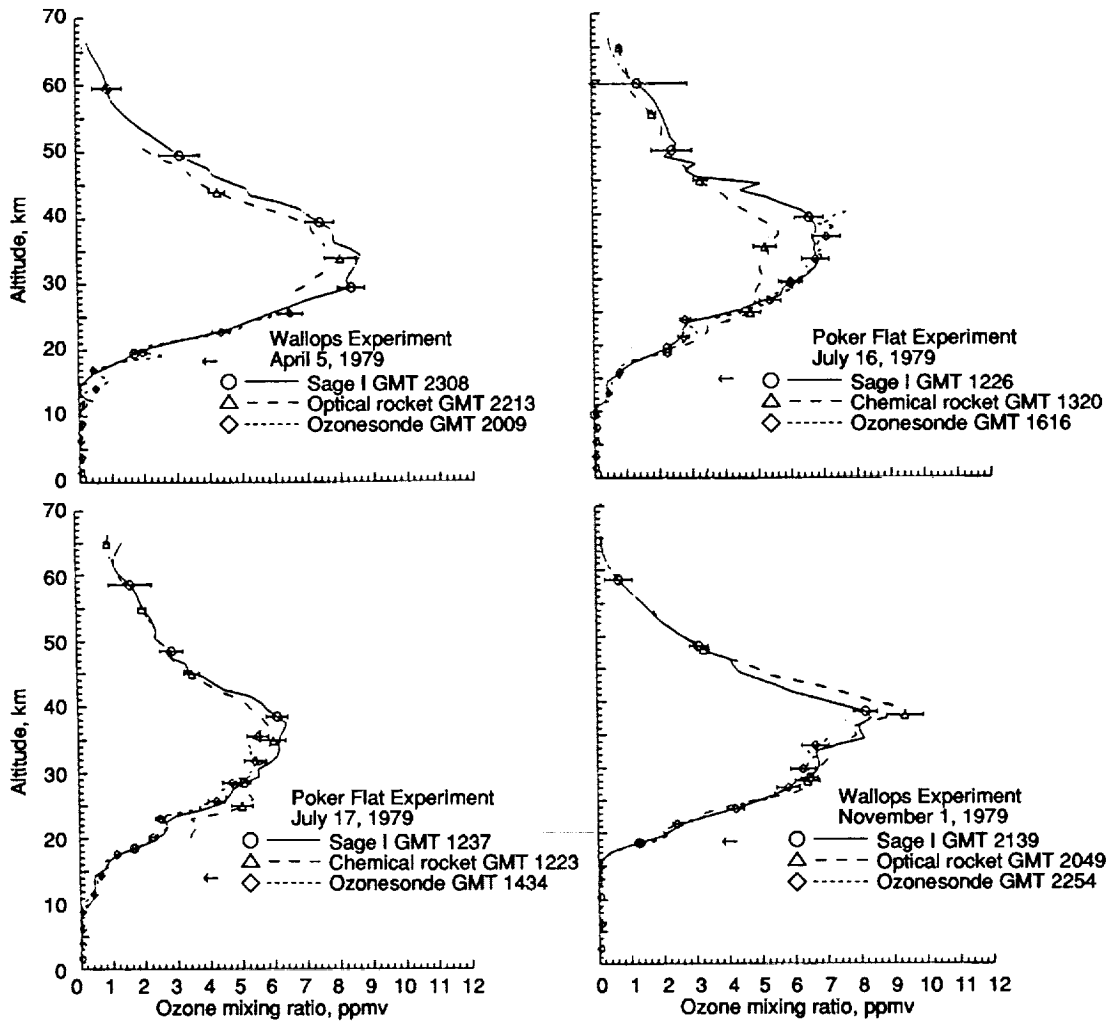

Figure 9. SAGE I ozone data with coincident ECC ozonesonde data and rocket ozonesonde data. Horizontal bars indicate 1σ error bar. (From McCormick et al. 1989.)

The nitrogen dioxide profile tapes contain SAGE I nitrogen dioxide data in the same format as the ozone profile tapes. Similarly, there is one nitrogen dioxide data tape per year that covers 12 months of data from December of 1 year to November of the next year. The nitrogen dioxide profile tape format is described in appendix C.

Appendixes A, B, and C refer to the meteorological data notes of appendix D to explain the meteorological fields supplied by the National Meteorological Center in the data records of the tapes. Appendix D also explains how the meteorological data were handled by the SAGE I processing team.

Scientific Studies

The SAGE I data have been used to perform a variety of atmospheric studies of atmospheric chemistry and dynamics, history of volcanic perturbation, and ozone and nitrogen dioxide long-term trends. The following discussion briefly describes some results of these investigations that used the SAGE I aerosol, ozone, and nitrogen dioxide data.

SAGE I aerosol data provided the first global description of volcanic perturbation of the stratospheric dust layer during the 33 months that SAGE I was in operation (Kent and McCormick 1984). Figure 10 shows the temporal variation of the optical depth of global stratospheric aerosols from 1979 to 1981, based on the combined SAGE I and SAM II aerosol measurements. It shows the effects of stratospheric aerosol loading resulting from the different volcanic

injections on both the Northern Hemisphere and the Southern Hemisphere. The two wavelengths of aerosol extinction coefficients obtained from the SAGE I measurements have been used to estimate the stratospheric aerosol size information, spatial distribution, and temporal evolution (Lenoble and Pruvost 1983; Yue and Deepak 1983; Yue and Deepak 1984).

The primary goal of the SAGE I mission was to monitor stratospheric trace species. However, the SAGE I instrument did make measurements in the troposphere at the cloud-free regions. Studies of the aerosols in the free troposphere, as measured by SAGE I, have been performed to research seasonal variability (Kent et al. 1988). Also, the SAGE I tropospheric data can be used to generate a high-altitude cloud climatology (Woodbury and McCormick 1986). Figure 11 illustrates a global map that was developed by the SAGE I data which shows the frequency of occurrence of the high-altitude clouds.

SAGE I aerosol, ozone, and nitrogen dioxide data have also been used for studies of atmospheric dynamics. For example, high-latitude aerosol, ozone, and nitrogen dioxide data have been used to study stratospheric sudden warming phenomena (Wang and McCormick 1985; Chu and McCormick 1986). SAGE I ozone data have been used to study the latitudinal transport in the atmosphere caused by wave activities (Wang, McCormick, and Chu 1983).

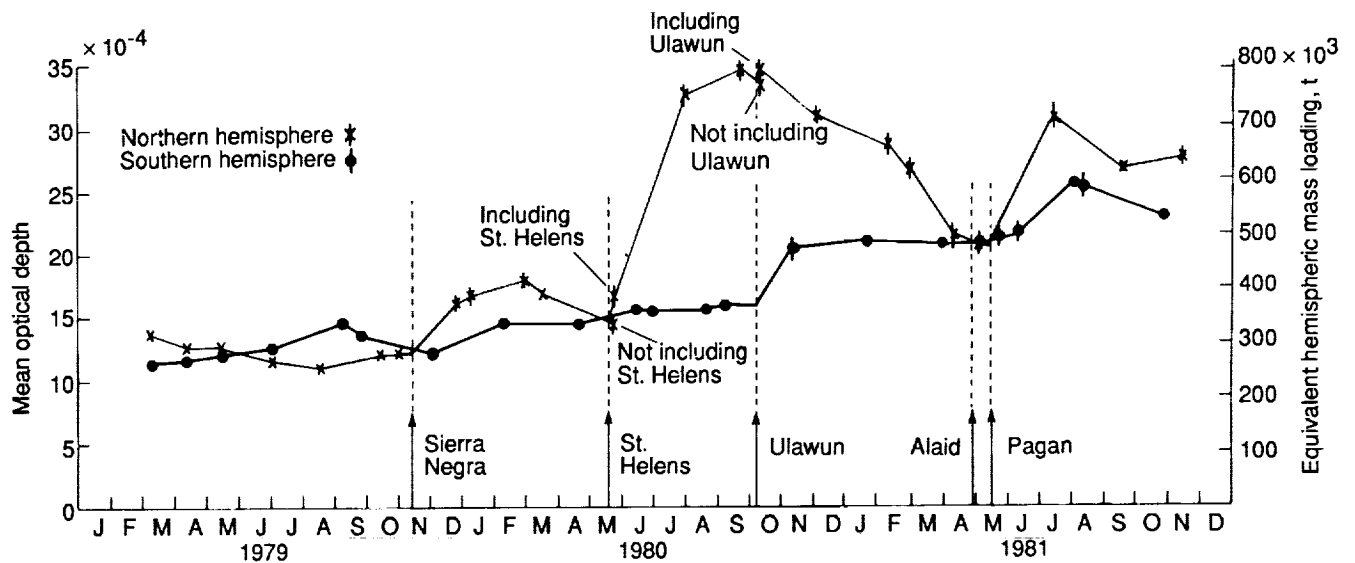

Figure 10. Temporal variation of optical depth of mean hemispheric stratospheric aerosols based on combined SAGE I and SAM II measurements from 1979 to 1981. Mass loading conversion factor = $1.10 \times 10^3 \text{ m}^2 \text{ kg}^{-1}$. (From Kent and McCormick 1984.)

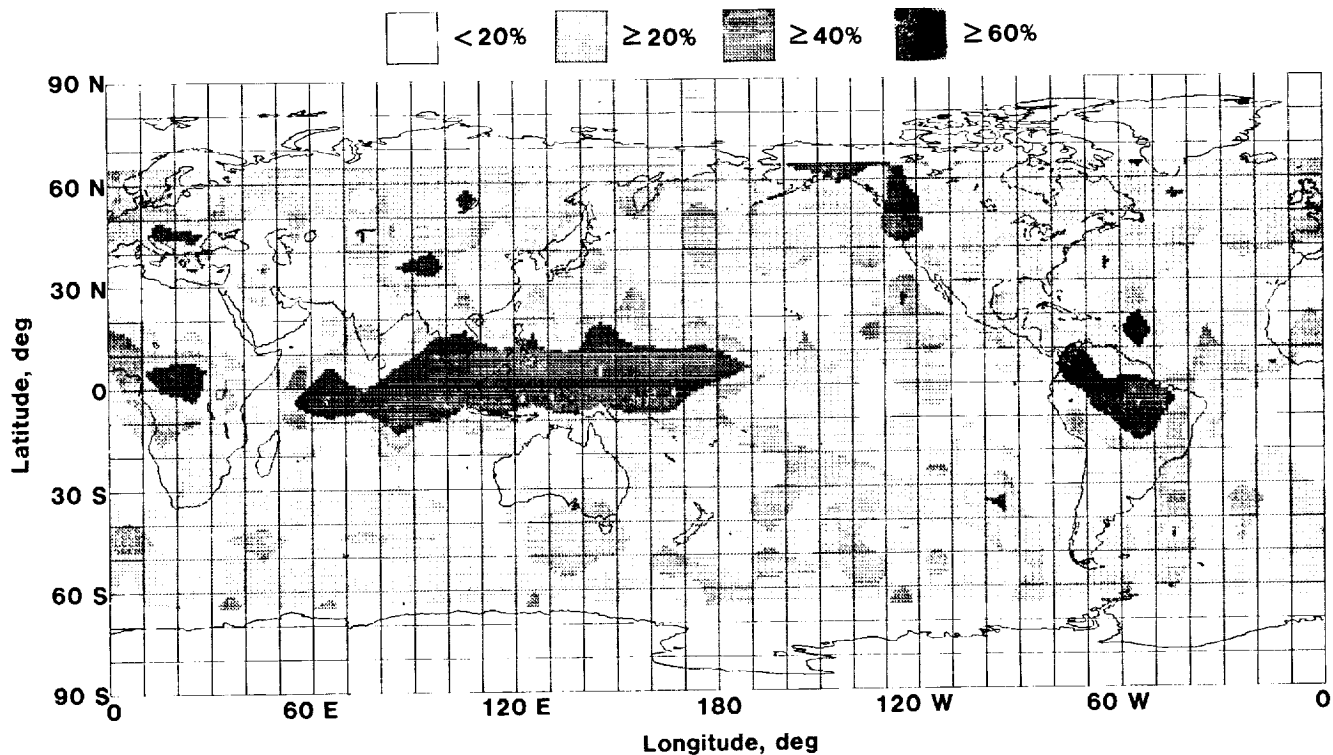

Figure 11. Average frequency of cirrus cloud occurrence during full 33 months of SAGE I operation. (From Woodbury and McCormick 1986.)

SAGE I ozone and nitrogen dioxide data have also been used to study atmospheric chemistry anomalies related to nitrogen dioxide photochemistry (Chu and McCormick 1986) and ozone chemistry (Wang, McCormick, and Chu 1983).

The SAGE I ozone data have been compared with SAGE II ozone data to determine the global ozone trends from 1979 to late 1980 (Watson et al. 1988; McCormick, Veiga, and Zawodny 1989). It was this comparison between SAGE I and SAGE II ozone data that demonstrated stratospheric ozone at 50 km did not decrease significantly over the period studied contrary to the trend results based on other satellite observations (Herman, Hudson, and Serafino 1990; Chandra et al. 1990). The SAGE I and SAGE II ozone data have been regarded as the most accurate ozone profile data measured from space (WMO 1990).

Concluding Remarks

This report has described the Stratospheric Aerosol and Gas Experiment I (SAGE I) instrument; its data collection, processing, and validation techniques; and the aerosol, ozone, and nitrogen dioxide archival products used in scientific investigations of various atmospheric sciences. These data products are archived and can be requested on magnetic tape from the National Space Sciences Data Center (NSSDC), NASA Goddard Space Flight Center, Code 933, Greenbelt, Maryland 20771. All 33 months of SAGE I data have been archived.

NASA Langley Research Center
Hampton, VA 23681-0001
May 28, 1992

Appendix A

SAGE I Aerosol Profile Record Format

Record Format

CYBER ^a words (60-bit)	Size	Field content description	Note (b)
40-km reference data			
0001	1	Event Date (yymmdd.0)	1
0002	↓	Event Time (hhmmss.0)	1
0003	↓	Subtangent Latitude ($0.0^\circ \pm 90.0^\circ$)	
0004	↓	Subtangent Longitude ($0.0^\circ \pm 180.0^\circ$)	
0005	↓	Spacecraft-Referenced Event Type (0.0 = Sunrise; 1.0 = Sunset)	2
0006	↓	Earth-Referenced Event Type (0.0 = Sunrise; 1.0 = Sunset)	2
0007	↓	Spacecraft Beta Angle ($0.0^\circ \pm 61.0^\circ$)	3
0008	↓	Coded Time of Year (ddd.fract)	4
NMC meteorological data (see appendix D)			
0009-0033	25	Temperature, K	
0034-0058	↓	Temperature Error, K	
0059-0083	↓	Geometric Altitude, m	
0084-0108	↓	Air Density, g/m^3	
0109-0133	↓	Air Density Error, percent	
0134	1	Temperature Correction Value for 5.0-mbar Level, K	
0135	↓	Temperature Correction Value for 2.0-mbar Level, K	
0136	↓	Temperature Correction Value for 1.0-mbar Level, K	
0137	↓	Temperature Correction Value for 0.4-mbar Level, K	
0138	↓	"Meteorological Data Not Complete" Flag (0 = Complete; 1 = Incomplete)	
0139	↓	"Start of Model Meteorological Data" Array Index Pointer (1 19)	
0140	↓	Model Meteorological Data Selection Code (ssll)	
0141	↓	Revision Date of LaRC Meteorological Model (yymmdd.0)	
NASA LaRC processing information			
0142	1	LaRC Driver Revision Level	
0143	↓	LaRC Transmission Revision Level	
0144	↓	LaRC Inversion Revision Level	
0145	↓	LaRC Event Tag (yymmddhhmm.sq)	5
0146	↓	LaRC Processing Date (yymmdd.0)	1
0147	↓	LaRC Processing Time (hhmmss.0)	1
0148	↓	Mean Subtangent Altitude for Event Limb Calibration, km	6
0149	↓	Value Designated as the Data Fill Number for this Event	7
Event ground-track slew data			
0150-0157	8	Subtangent Altitude, km	
0158-0165	8	Corresponding Latitude ($0.0^\circ \pm 90.0^\circ$)	
0166-0173	8	Corresponding Longitude ($0.0^\circ \pm 180.0^\circ$)	
0174	1	Time Span of Data from Levels 1 to 70, sec	
Altitude and meteorological data for profile arrays			
0175-0244	70	Geometric Altitude, km	
0245-0314	70	Corresponding Pressure, mbar	
0315-0384	70	Corresponding Temperature, K	
0385-0390	6	Spare	

^aTrademark of Control Data Corporation.

^bData field notes given after table.

CYBER ^a words (60-bit)	Size	Field content description	Note (b)
Quality estimations of channel optical depth profile			
0391	1 ↓	1000-nm-Wavelength Quality Factor	8
0392		Spare	
0393		Spare	
0394		Spare	
0395		450-nm-Wavelength Quality Factor	
0396		Spare	
0397		Spare	
0398-0400	3	Spare	
Rayleigh extinction profiles			
0401-0460	60 ↓	1000-nm Rayleigh Extinction, km ⁻¹	
0461-0520		1000-nm Rayleigh Extinction Error, km ⁻¹	
0521-0580		Spare	
0581-0640		Spare	
0641-0700		450-nm Rayleigh Extinction, km ⁻¹	
0701-0760		450-nm Rayleigh Extinction Error, km ⁻¹	
0761-0820		Spare	
0821-0880		Spare	
Aerosol profiles			
0881-0940	60 ↓	1000-nm Extinction, km ⁻¹	
0941-1000		1000-nm Extinction Error, km ⁻¹	
1001-1060		Spare	
1061-1120		Spare	
1121-1180		450-nm Extinction, km ⁻¹	
1181-1240		450-nm Extinction, km ⁻¹	
1241-1300		Spare	
1301-1360		Spare	
1361-1420		1000-nm Extinction Ratio	
1421-1480		1000-nm Extinction Ratio Error	
1481-1488	8	Spare	
End of event record			

^aTrademark of Control Data Corporation.

^bData field notes given after table.

Record Format Notes

General notes:

- Each field of the event record contains one 60-bit CYBER^a floating point number.
- All time and data references are to GMT, except fields 146 and 147, which are LaRC processing time.
- All latitudes and longitudes are given at the event subtangent point.
- If any field in the event record is considered invalid, or has missing data, a fill value will be placed in that field. For each event record, that fill value can be found in field 149. (See data field note 7 below.)
- Each profile level bin is centered at the 0.5-km point within a range of 1.0 km.

Data field notes:

1. The "yymmdd.0" and "hhmmss.0" fields are generated by the respective FORTRAN statements:

$$\text{DATE} = \text{FLOAT}(\text{IYY} * 10000 + \text{IMM} * 100 + \text{IDD})$$
$$\text{TIME} = \text{FLOAT}(\text{IHH} * 10000 + \text{IMM} * 100 + \text{ISS})$$

2. Spacecraft-Referenced Event Type and Earth-Referenced Event Type fields are normally the same type, but if the absolute value of the spacecraft beta angle is close to 61°, their values may be opposite. The Earth-Referenced Event Type field is based on a ground-observer's viewpoint.
3. The Spacecraft Beta Angle field is defined as the angle generated by the intersection of the Earth-Sun vector and the spacecraft orbit plane.
4. The Coded Time of Year field is the time at the beginning of the event (not the same time as for fields 1 and 2) and is generated by the FORTRAN statement:

$$\text{CODTIME} = \text{FLOAT}(\text{DOY}) + (\text{SOD}/86400.0)$$

where

$$\text{DOY} = \text{Day of year (1-366)}$$
$$\text{SOD} = \text{Seconds of the day (0.0-86399.99...)}$$

5. The LaRC Event Tag field is generated with statements similar to those in note 1. The ".sq" at the end of the value is the event number of the day divided by 100.
6. The Mean Subtangent Altitude for Event Limb Calibration field contains the altitude at which data for the exoatmospheric solar image were gathered for use in solar limb normalization for the event.
7. The Value Designated as the Data Fill Number for This Event field must be used to determine what data in the event record are valid. If any field other than this one contains this number, that field has no valid information and should not be used by the investigator.
8. The Quality Factor fields for each wavelength are equal to 1.0 minus the summation of the optical depth errors at each profile level from 20.5 to 59.5 km. In cases where a 40-km span cannot be realized, the quality factor is proportioned to a 40-km span to allow a better comparison across wavelengths and other events.
9. Extinction ratio = (Aerosol extinction + Rayleigh extinction)/Rayleigh extinction.

^aTrademark of Control Data Corporation.

Appendix B

SAGE I Ozone Profile Record Format

Record Format

CYBER ^a words (60-bit)	Size	Field content description	Note (b)
40-km reference data			
0001	1	Event Date (yymmdd.0)	1
0002	↓	Event Time (hhmmss.0)	1
0003	↓	Subtangent Latitude ($0.0^\circ \pm 90.0^\circ$)	
0004	↓	Subtangent Longitude ($0.0^\circ \pm 180.0^\circ$)	
0005	↓	Spacecraft-Referenced Event Type (0.0 = Sunrise; 1.0 = Sunset)	2
0006	↓	Earth-Referenced Event Type (0.0 = Sunrise; 1.0 = Sunset)	2
0007	↓	Spacecraft Beta Angle ($0.0^\circ \pm 61.0^\circ$)	3
0008	↓	Coded Time of Year (ddd.fract)	4
NMC meteorological data (see appendix D)			
0009-0033	25	Temperature, K	
0034-0058	↓	Temperature Error, K	
0059-0083	↓	Geometric Altitude, m	
0084-0108	↓	Air Density, g/m^3	
0109-0133	↓	Air Density Error, percent	
0134	1	Temperature Correction Value for 5.0-mbar Level, K	
0135	↓	Temperature Correction Value for 2.0-mbar Level, K	
0136	↓	Temperature Correction Value for 1.0-mbar Level, K	
0137	↓	Temperature Correction Value for 0.4-mbar Level, K	
0138	↓	"Meteorological Data Not Complete" Flag (0 = Complete; 1 = Incomplete)	
0139	↓	"Start of Model Meteorological Data" Array Index Pointer (1-19)	
0140	↓	Model Meteorological Data Selection Code (ssll)	
0141	↓	Revision Date of LaRC Meteorological Model (yymmdd.0)	
NASA LaRC processing information			
0142	1	LaRC Driver Revision Level	
0143	↓	LaRC Transmission Revision Level	
0144	↓	LaRC Inversion Revision Level	
0145	↓	LaRC Event Tag (yymmddhhmm.sq)	5
0146	↓	LaRC Processing Date (yymmdd.0)	1
0147	↓	LaRC Processing Time (hhmmss.0)	1
0148	↓	Mean Subtangent Altitude for Event Limb Calibration, km	6
0149	↓	Value Designated as the Data Fill Number for this Event	7
Event ground-track slew data			
0150-0157	8	Subtangent Altitude, km	
0158-0165	8	Corresponding Latitude ($0.0^\circ \pm 90.0^\circ$)	
0166-0173	8	Corresponding Longitude ($0.0^\circ \pm 180.0^\circ$)	
0174	1	Time Span of Data from Levels 1 to 70, sec	
Altitude and meteorological data for profile arrays			
0175-0244	70	Geometric Altitude, km	
0245-0314	70	Corresponding Pressure, mbar	
0315-0384	70	Corresponding Temperature, K	
0385-0390	6	Spare	

^aTrademark of Control Data Corporation.

^bData field notes given after table.

CYBER ^a words (60-bit)	Size	Field content description	Note (b)
Quality estimations of channel optical depth profile			
0391	1 ↓	Spare	8
0392		Spare	
0393		600-nm-Wavelength Quality Factor	
0394		Spare	
0395		Spare	
0396		Spare	
0397		Spare	
0398-0400	3	Spare	
Ozone profiles			
0401-0470	70 ↓	Number Density, molecules/cm ³	
0471-0540		Number Density Error, molecules/cm ³	
0541-0610		Volumetric Mixing Ratio, v/v	
0611-0680		Volumetric Mixing Ratio Error, v/v	
0681-0688	8	Spare	
End of event record			

^aTrademark of Control Data Corporation.

^bData field notes given after table.

Record Format Notes

General notes:

- Each field of the event record contains one 60-bit CYBER^a floating point number.
- All time and data references are to GMT, except fields 146 and 147, which are LaRC processing time.
- All latitudes and longitudes are given at the event subtangent point.
- If any field in the event record is considered invalid, or has missing data, a fill value will be placed in that field. For each event record, that fill value can be found in field 149. (See data field note 7 below.)
- Each profile level bin is centered at the 0.5-km point within a range of 1.0 km.

Data field notes:

1. The "yymmdd.0" and "hhmmss.0" fields are generated by the respective FORTRAN statements:

$$\text{DATE} = \text{FLOAT}(\text{IYY} * 10000 + \text{IMM} * 100 + \text{IDD})$$
$$\text{TIME} = \text{FLOAT}(\text{IHH} * 10000 + \text{IMM} * 100 + \text{ISS})$$

2. Spacecraft-Referenced Event Type and Earth-Referenced Event Type fields are normally the same type, but if the absolute value of the spacecraft beta angle is close to 61°, their values may be opposite. The Earth-Referenced Event Type field is based on a ground-observer's viewpoint.
3. The Spacecraft Beta Angle field is defined as the angle generated by the intersection of the Earth-Sun vector and the spacecraft orbit plane.
4. The Coded Time of Year field is the time at the beginning of the event (not the same time as for fields 1 and 2) and is generated by the FORTRAN statement:

$$\text{CODTIME} = \text{FLOAT}(\text{DOY}) + (\text{SOD}/86400.0)$$

where

$$\text{DOY} = \text{Day of year (1-366)}$$
$$\text{SOD} = \text{Seconds of the day (0.0-86399.99...)}$$

5. The LaRC Event Tag field is generated with statements similar to those in note 1. The ".sq" at the end of the value is the event number of the day divided by 100.
6. The Mean Subtangent Altitude for Event Limb Calibration field contains the altitude at which data for the exoatmospheric solar image were gathered for use in solar limb normalization for the event.
7. The Value Designated as the Data Fill Number for This Event field must be used to determine what data in the event record are valid. If any field other than this one contains this number, that field has no valid information and should not be used by the investigator.
8. The Quality Factor fields for each wavelength are equal to 1.0 minus the summation of the optical depth errors at each profile level from 20.5 to 59.5 km. In cases where a 40-km span cannot be realized, the quality factor is proportioned to a 40-km span to allow a better comparison across wavelengths and other events.

^aTrademark of Control Data Corporation.

Appendix C

SAGE I Nitrogen Dioxide Profile Record Format

Record Format

CYBER ^a words (60-bit)	Size	Field content description	Note (b)
40-km reference data			
0001	1	Event Date (yymmdd.0)	1
0002	↓	Event Time (hhmmss.0)	1
0003	↓	Subtangent Latitude ($0.0^\circ \pm 90.0^\circ$)	
0004	↓	Subtangent Longitude ($0.0^\circ \pm 180.0^\circ$)	
0005	↓	Spacecraft-Referenced Event Type (0.0 = Sunrise; 1.0 = Sunset)	2
0006	↓	Earth-Referenced Event Type (0.0 = Sunrise; 1.0 = Sunset)	2
0007	↓	Spacecraft Beta Angle ($0.0^\circ \pm 61.0^\circ$)	3
0008	↓	Coded Time of Year (ddd.fract)	4
NMC meteorological data (see appendix D)			
0009-0033	25	Temperature, K	
0034-0058	↓	Temperature Error, K	
0059-0083	↓	Geometric Altitude, m	
0084-0108	↓	Air Density, g/m^3	
0109-0133	↓	Air Density Error, percent	
0134	1	Temperature Correction Value for 5.0-mbar Level, K	
0135	↓	Temperature Correction Value for 2.0-mbar Level, K	
0136	↓	Temperature Correction Value for 1.0-mbar Level, K	
0137	↓	Temperature Correction Value for 0.4-mbar Level, K	
0138	↓	"Meteorological Data Not Complete" Flag (0 = Complete; 1 = Incomplete)	
0139	↓	"Start of Model Meteorological Data" Array Index Pointer (1-19)	
0140	↓	Model Meteorological Data Selection Code (ssll)	
0141	↓	Revision Date of LaRC Meteorological Model (yymmdd.0)	
NASA LaRC processing information			
0142	1	LaRC Driver Revision Level	
0143	↓	LaRC Transmission Revision Level	
0144	↓	LaRC Inversion Revision Level	
0145	↓	LaRC Event Tag (yymmddhhmm.sq)	5
0146	↓	LaRC Processing Date (yymmdd.0)	1
0147	↓	LaRC Processing Time (hhmmss.0)	1
0148	↓	Mean Subtangent Altitude for Event Limb Calibration, km	6
0149	↓	Value Designated as the Data Fill Number for this Event	7
Event ground-track slew data			
0150-0157	8	Subtangent Altitude, km	
0158-0165	8	Corresponding latitude ($0.0^\circ \pm 90.0^\circ$)	
0166-0173	8	Corresponding Longitude ($0.0^\circ \pm 180.0^\circ$)	
0174	1	Time Span of Data from Levels 1 to 70, sec	
Altitude and meteorological data for profile arrays			
0175-0244	70	Geometric Altitude, km	
0245-0314	70	Corresponding Pressure, mbar	
0315-0384	70	Corresponding Temperature, K	
0385-0390	6	Spare	

^aTrademark of Control Data Corporation.

^bData field notes given after table.

CYBER ^a words (60-bit)	Size	Field content description	Note (<i>b</i>)
Quality estimations of channel optical depth profile			
0391	1	Spare	
0392	↓	Spare	
0393		Spare	
0394		Spare	
0395		450-nm-Wavelength Quality Factor	8
0396		Spare	
0397	↓	385-nm-Wavelength Quality Factor	8
0398-0400	3	Spare	
Nitrogen dioxide profiles			
0401-0460	60	Number Density, molecules/cm ³	
0461-0520	↓	Number Density Error, molecules/cm ³	
0521-0580		Volumetric Mixing Ratio, v/v	
0581-0640	↓	Volumetric Mixing Ratio Error, v/v	
End of event record			

^aTrademark of Control Data Corporation.

^bData field notes given after table.

Record Format Notes

General notes:

- Each field of the event record contains one 60-bit CYBER^a floating point number.
- All time and data references are to GMT, except fields 146 and 147, which are LaRC processing time.
- All latitudes and longitudes are given at the event subtangent point.
- If any field in the event record is considered invalid, or has missing data, a fill value will be placed in that field. For each event record, that fill value can be found in field 149. (See data field note 7 below.)
- Each profile level bin is centered at the 0.5-km point within a range of 1.0 km.

Data field notes:

1. The "yymmdd.0" and "hhmmss.0" fields are generated by the respective FORTRAN statements:

$$\text{DATE} = \text{FLOAT} (\text{IYY} * 10000 + \text{IMM} * 100 + \text{IDD})$$
$$\text{TIME} = \text{FLOAT} (\text{IHH} * 10000 + \text{IMM} * 100 + \text{ISS})$$

2. Spacecraft-Referenced Event Type and Earth-Referenced Event Type fields are normally the same type, but if the absolute value of the spacecraft beta angle is close to 61°, their values may be opposite. The Earth-Referenced Event Type field is based on a ground-observer's viewpoint.
3. The Spacecraft Beta Angle field is defined as the angle generated by the intersection of the Earth-Sun vector and the spacecraft orbit plane.
4. The Coded Time of Year field is the time at the beginning of the event (not the same time as for fields 1 and 2) and is generated by the FORTRAN statement:

$$\text{CODTIME} = \text{FLOAT}(\text{DOY}) + (\text{SOD}/86400.0)$$

where

DOY = Day of year (1-366)

SOD = Seconds of the day (0.0-86399.99...)

5. The LaRC Event Tag field is generated with statements similar to those in note 1. The ".sq" at the end of the value is the event number of the day divided by 100.
6. The Mean Subtangent Altitude for Event Limb Calibration field contains the altitude at which data for the exoatmospheric solar image were gathered for use in solar limb normalization for the event.
7. The Value Designated as the Data Fill Number for This Event field must be used to determine what data in the event record are valid. If any field other than this one contains this number, that field has no valid information and should not be used by the investigator.
8. The Quality Factor fields for each wavelength are equal to 1.0 minus the summation of the optical depth errors at each profile level from 20.5 to 59.5 km. In cases where a 40-km span cannot be realized, the quality factor is proportioned to a 40-km span to allow a better comparison across wavelengths and other events.

^aTrademark of Control Data Corporation.

Appendix D

Meteorological Data Notes

Meteorological data are supplied to NASA Langley Research Center (LaRC) by NOAA National Weather Service, Climate Analysis Branch, Washington, D.C. Data for temperature, temperature error, geometric altitude, air density, and air density error are provided for 18 pressure levels (1000 to 0.4 mbar) and for the derived tropopause pressure. The pressure levels (in mbar) correspond to the 25-element meteorological data arrays (1 to 25) as follows: 1000, 850, 700, 500, 400, 300, 250, 200, 150, 100, 70, 50, 30, 10, 5, 2, 1, 0.4, 0.04, 0.01, spare, spare, spare, spare, and derived tropopause pressure. Elements 19 and 20 (0.04 and 0.01 mbar) contain LaRC model data for temperature and altitude only. Elements 21 to 24 (spares) contain fill values, and element 25 contains the NOAA-supplied tropopause information.

If NOAA cannot supply meteorological data as above, LaRC determines the highest pressure level for which data are supplied and then inserts model data from the next level up to the lowest pressure level of 0.01 mbar. Only temperature and altitude information are supplied from using these model data. Temperature error, density, and density error will be filled for the corresponding levels that contain the LaRC-supplied data.

Meteorological correction factors for temperatures at 5, 2, 1, and 0.4 mbar are already added to the value of the temperatures in elements 15 through 18 of the temperature array. These correction factors are only included in the NOAA-supplied data. If model data are in these locations, no correction factors are applied. The correction factors are listed in fields 134 to 137 of the record.

Meteorological data (fields 245 to 384 of the event record) are interpolated from the meteorological data in fields 9 to 133 of the record. Altitude data in fields 175 to 244 increment by 1 km with the center of each level at the 0.5-km point of the level bin.

Other meteorological data information is contained in the following record locations:

Field 0138: 0 if NOAA-supplied data are complete, 1 if incomplete.

Field 0139: the model pointer is the array index that points to the start of LaRC-supplied model data in the temperature and altitude arrays of the meteorological data.

Field 0140: model selection code (ssll) where ss is from 01 to 04 for spring to winter, and ll is from 0 to 80 in 10-deg increments for absolute latitude.

Field 0141: date of revision of the LaRC-supplied model.

References

- Chandra, S.; McPeters, R. D.; Hudson, R. D.; and Planet, W. 1990: Ozone Measurements From the NOAA-9 and the Nimbus-7 Satellites: Implications of Short and Long Term Variabilities. *Geophys. Res. Lett.*, vol. 17, no. 10, pp. 1573-1576.
- Chu, W. P.; and McCormick, M. P. 1979: Inversion of Stratospheric Aerosol and Gaseous Constituents From Spacecraft Solar Extinction Data in the 0.38-1.0- μm Wavelength Region. *Appl. Opt.*, vol. 18, no. 9, pp. 1404-1413.
- Chu, W. P.; and McCormick, M. P. 1986: SAGE Observations of Stratospheric Nitrogen Dioxide. *J. Geophys. Res.*, vol. 91, no. D5, pp. 5465-5476.
- Chu, W. P.; McCormick, M. P.; Lenoble, J.; Brogniez, C.; and Pruvost, P. 1989: SAGE II Inversion Algorithm. *J. Geophys. Res.*, vol. 94, no. D6, pp. 8339-8351.
- Cunnold, D. M.; Zawodny, J. M.; Chu, W. P.; Pommereau, J. P.; and Goutail, F. 1991: Validation of SAGE II NO_2 Measurements. *J. Geophys. Res.*, vol. 96, pp. 12,913-12,925.
- Geller, Marvin A.; Wu, Mao-Fou; and Gelman, Melvyn E. 1983: Tropospheric-Stratosphere (Surface-55 km) Monthly Winter General Circulation Statistics for the Northern Hemisphere - Four Year Averages. *J. Atmos. Sci.*, vol. 40, no. 5, pp. 1334-1352.
- Gelman, M. E.; Miller, A. J.; Johnson, K. W.; and Nagatani, R. M. 1986: Detection of Long-Term Trends in Global Stratospheric Temperatures From NMC Analyses Derived From NOAA Satellite Data. *Adv. Space Res.*, vol. 6, no. 10, pp. 17-26.
- Herman, J. R.; Hudson, R. D.; and Serafino, G. 1990: Analysis of the Eight-Year Trend in Ozone Depletion From Empirical Models of Solar Backscattered Ultraviolet Instrument Degradation. *J. Geophys. Res.*, vol. 95, no. D6, pp. 7403-7416.
- Kent, G. S.; and McCormick, M. P. 1984: SAGE and SAM II Measurements of Global Stratospheric Aerosol Optical Depth and Mass Loading. *J. Geophys. Res.*, vol. 89, no. D4, pp. 5303-5314.
- Kent, G. S.; Farrukh, U. O.; Wang, P. H.; and Deepak, A. 1988: SAGE I and SAM II Measurements of 1 μm Aerosol Extinction in the Free Troposphere. *J. Appl. Meteorol.*, vol. 27, pp. 269-279.
- Kerr, J. B.; Evans, W. F. J.; and McConnell, J. C. 1977: The Effects of NO_2 Changes at Twilight on Tangent Ray NO_2 Measurements. *Geophys. Res. Lett.*, vol. 4, no. 12, pp. 577-579.
- Lenoble, J.; and Pruvost, P. 1983: Inference of the Aerosol Angstrom Coefficient From SAGE Short-Wavelength Data. *J. Clim. & Appl. Meteorol.*, vol. 22, no. 10, pp. 1717-1725.
- McCormick, M. P.; Hamill, Patrick; Pepin, T. J.; Chu, W. P.; Swissler, T. J.; and McMaster, L. R. 1979: Satellite Studies of the Stratospheric Aerosol. *Bull. American Meteorol. Soc.*, vol. 60, no. 9, pp. 1038-1046.
- McCormick, M. P.; Kent, G. S.; Yue, G. K.; and Cunnold, D. M. 1982: Stratospheric Aerosol Effects From Soufrière Volcano as Measured by the SAGE Satellite System. *Science*, vol. 216, no. 4550, pp. 1115-1118.
- McCormick, M. P.; Swissler, T. J.; Hilsenrath, E.; Krueger, A. J.; and Osborn, M. T. 1984: Satellite and Correlative Measurements of Stratospheric Ozone: Comparison of Measurements Made by SAGE, ECC Balloons, Chemiluminescent, and Optical Rocketsondes. *J. Geophys. Res.*, vol. 89, no. D4, pp. 5315-5320.
- McCormick, M. P.; Zawodny, J. M.; Veiga, R. E.; Larsen, J. C.; and Wang, P. H. 1989: An overview of SAGE I and II Ozone Measurements. *Planet. & Space Sci.*, vol. 37, no. 12, pp. 1567-1586.
- McCormick, M. P.; Veiga, R. E.; and Zawodny, J. M. 1989: Comparison of SAGE I and SAGE II Stratospheric Ozone Measurements. *Ozone in the Atmosphere - Proceedings of the Quadrennial Ozone Symposium 1988 and Tropospheric Ozone Workshop*, Rumen D. Bojkov and Peter Fabian, eds., A. Deepak Publishing, pp. 202-205.
- McMaster, Leonard R. 1986: Stratospheric Aerosol and Gas Experiment (SAGE II). *Sixth Conference on Atmospheric Radiation*, American Meteorological Soc., pp. J46-J48.
- Reiter, R.; and McCormick, M. P. 1982: SAGE European Ozone Sonde Comparison. *Nature*, vol. 300, no. 5890, pp. 337-339.
- Russell, P. B.; McCormick, M. P.; Swissler, T. J.; Chu, W. P.; Livingston, J. M.; Fuller, W. H., Jr.; Rosen, J. M.; Hofmann, D. J.; McMaster, L. R.; Woods, D. C.; and Pepin, T. J. 1981: Satellite and Correlative Measurements of the Stratospheric Aerosol. II: Comparison of Measurements Made by SAM II, Dustsondes and an Airborne Lidar. *J. Atmos. Sci.*, vol. 38, no. 6, pp. 1295-1312.
- Russell, P. B.; Swissler, T. J.; McCormick, M. P.; Chu, W. P.; Livingston, J. M.; and Pepin, T. J. 1981: Satellite and Correlative Measurements of the Stratospheric Aerosol. I: An Optical Model for Data Conversions. *J. Atmos. Sci.*, vol. 38, no. 6, pp. 1279-1294.
- Russell, P. B.; McCormick, M. P.; Swissler, T. J.; Rosen, J. M.; Hofmann, D. J.; and McMaster, L. R. 1984: Satellite and Correlative Measurements of the Stratospheric Aerosol. III: Comparison of Measurements by SAM II, SAGE, Dustsondes, Filters, Impactors, and Lidar. *J. Atmos. Sci.*, vol. 41, no. 11, pp. 1791-1800.
- Wang, Pi-Huan; McCormick, M. P.; and Chu, W. P. 1983: A Study on the Planetary Wave Transport of Ozone During the Late February 1979 Stratospheric Warming Using the SAGE Ozone Observation and Meteorological Information. *J. Atmos. Sci.*, vol. 40, no. 10, pp. 2419-2431.
- Wang, Pi-Huan; and McCormick, M. P. 1985: Variations in Stratospheric Aerosol Optical Depth During Northern Warmings. *J. Geophys. Res.*, vol. 90, no. D6, pp. 10,597-10,606.

Watson, R. T. et al. 1988: *Present State of Knowledge of the Upper Atmosphere 1988: An Assessment Report*. NASA RP-1208.

WMO Global Ozone Research and Monitoring Project 1981: *The Stratosphere 1981—Theory and Measurements*. NASA TM-84125. (Available as WMO Rep. No. 11.)

WMO Global Ozone Research and Monitoring Proj. 1990: *Scientific Assessment of Stratospheric Ozone: 1989, Volume I*. Rep. No. 20, World Meteorological Organization.

Woodbury, Gerard E.; and McCormick, M. P. 1986: Zonal and Geographical Distributions of Cirrus Clouds Determined From SAGE Data. *J. Geophys. Res.*, vol. 91, no. D2, pp. 2775-2785.

Yue, Glenn K.; and Deepak, Adarsh 1983: Retrieval of Stratospheric Aerosol Size Distribution From Atmospheric Extinction of Solar Radiation at Two Wavelengths. *Appl. Opt.*, vol. 22, no. 11, pp. 1639-1645.

Yue, Glenn K.; and Deepak, Adarsh A. 1984: Latitudinal and Altitudinal Variation of Size Distribution of Stratospheric Aerosols Inferred From SAGE Aerosol Extinction Coefficient Measurements at Two Wavelengths. *Geophys. Res. Lett.*, vol. 11, no. 10, pp. 999-1002.

Yue, Glenn K.; McCormick, M. P.; and Chu, W. P. 1984: A Comparative Study of Aerosol Extinction Measurements Made by the SAM II and SAGE Satellite Experiments. *J. Geophys. Res.*, vol. 89, no. D4, pp. 5321-5327.

REPORT DOCUMENTATION PAGE			Form Approved OMB No. 0704-0188	
Public reporting burden for this collection of information is estimated to average 1 hour per response, including the time for reviewing instructions, searching existing data sources, gathering and maintaining the data needed, and completing and reviewing the collection of information. Send comments regarding this burden estimate or any other aspect of this collection of information, including suggestions for reducing this burden, to Washington Headquarters Services, Directorate for Information Operations and Reports, 1215 Jefferson Davis Highway, Suite 1204, Arlington, VA 22202-4302, and to the Office of Management and Budget, Paperwork Reduction Project (0704-0188), Washington, DC 20503				
1. AGENCY USE ONLY (Leave blank)	2. REPORT DATE August 1992	3. REPORT TYPE AND DATES COVERED Reference Publication		
4. TITLE AND SUBTITLE SAGE I Data User's Guide			5. FUNDING NUMBERS WU 665-45-30-21	
6. AUTHOR(S) L. R. McMaster, W. P. Chu, and M. W. Rowland				
7. PERFORMING ORGANIZATION NAME(S) AND ADDRESS(ES) NASA Langley Research Center Hampton, VA 23681-0001			8. PERFORMING ORGANIZATION REPORT NUMBER L-16879	
9. SPONSORING/MONITORING AGENCY NAME(S) AND ADDRESS(ES) National Aeronautics and Space Administration Washington, DC 20546-0001			10. SPONSORING/MONITORING AGENCY REPORT NUMBER NASA RP-1275	
11. SUPPLEMENTARY NOTES McMaster and Chu: Langley Research Center, Hampton, VA; Rowland: ST Systems Corporation (STX), Hampton, VA.				
12a. DISTRIBUTION/AVAILABILITY STATEMENT Unclassified-Unlimited Subject Category 46			12b. DISTRIBUTION CODE	
13. ABSTRACT (Maximum 200 words) This document is a guide for using the data products from the Stratospheric Aerosol and Gas Experiment I (SAGE I) for scientific investigations of stratospheric chemistry related to aerosol, ozone, nitrogen dioxide, dynamics, and climate change. Included is a detailed description of the aerosol profile tape, the ozone profile tape, and the nitrogen dioxide profile tape. These tapes are the SAGE I data products containing aerosol extinction data and ozone and nitrogen dioxide concentration data for use in the different scientific investigations. Also included are brief descriptions of the instrument operation; data collection, processing and validation; and some of the scientific analyses that have been conducted.				
14. SUBJECT TERMS SAGE; Aerosol; Ozone; Nitrogen dioxide			15. NUMBER OF PAGES 26	
			16. PRICE CODE A03	
17. SECURITY CLASSIFICATION OF REPORT Unclassified	18. SECURITY CLASSIFICATION OF THIS PAGE Unclassified	19. SECURITY CLASSIFICATION OF ABSTRACT	20. LIMITATION OF ABSTRACT	