

P. 265

**NASA  
Technical  
Paper  
3236**

**September 1992**

# **Effect of Afterbody Geometry on Aerodynamic Characteristics of Isolated Nonaxisymmetric Afterbodies at Transonic Mach Numbers**

**Linda S. Bangert  
and George T. Carson, Jr.**

(NASA-TP-3236) EFFECT OF AFTERBODY  
GEOMETRY ON AERODYNAMIC  
CHARACTERISTICS OF ISOLATED  
NONAXISYMMETRIC AFTERBODIES AT  
TRANSONIC MACH NUMBERS (NASA)  
265 p

N92-33706

Unclas

H1/02 0118019



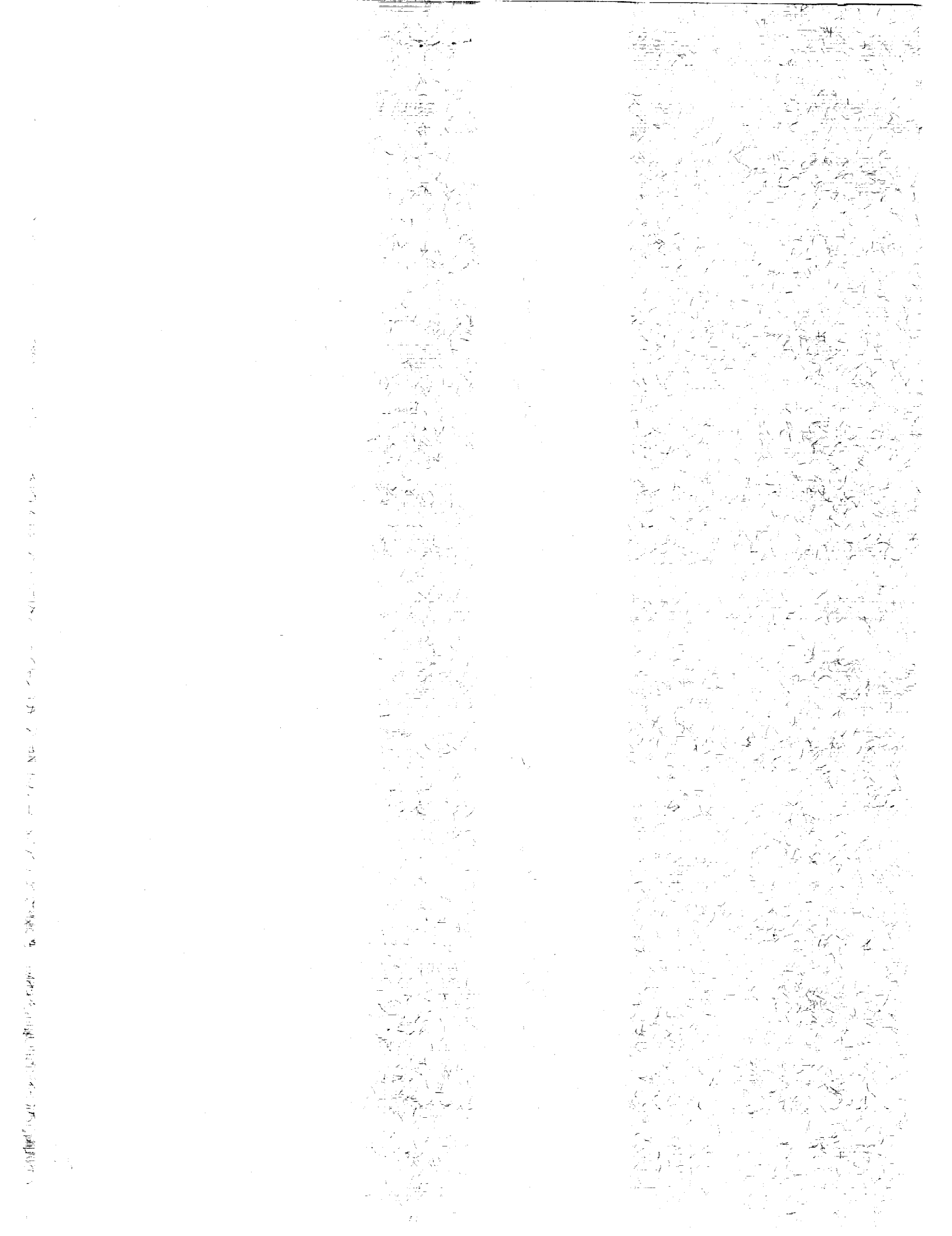

**NASA  
Technical  
Paper  
3236**

1992

**Effect of Afterbody  
Geometry on Aerodynamic  
Characteristics of  
Isolated Nonaxisymmetric  
Afterbodies at Transonic  
Mach Numbers**

Linda S. Bangert  
and George T. Carson, Jr.  
*Langley Research Center  
Hampton, Virginia*

**NASA**

National Aeronautics and  
Space Administration

Office of Management

Scientific and Technical  
Information Program



## Summary

A parametric study has been conducted in the Langley 16-Foot Transonic Tunnel on an isolated nonaxisymmetric fuselage model that simulates a twin-engine fighter. The effects of aft-end closure distribution (top/bottom nozzle-flap boattail angle versus nozzle-sidewall boattail angle) and afterbody and nozzle corner treatment (sharp or radius) were investigated. Four different closure distributions with three different corner radii were tested. Tests were conducted over a range of Mach numbers from 0.40 to 1.25 and over a range of angles of attack from  $-3^\circ$  to  $9^\circ$ . Solid plume simulators were used to simulate the jet exhaust.

An analysis of the results of this study indicates that for a given closure distribution in the range of Mach numbers tested, the sharp corner nozzles generally have the highest drag and the 2-in. corner-radius nozzles generally have the lowest drag. The effect of closure distribution on afterbody drag is highly dependent on configuration, plume simulation, and Mach number. Except at high subsonic Mach numbers, the nozzles with the top and bottom terminal boattail angle ( $\beta_{t,top/bot}$ ) of  $17.3^\circ$  and sidewall terminal boattail angle ( $\beta_{t,side}$ ) of  $9.7^\circ$  generally have the lowest drag for the plume-on configurations, whereas the nozzles with  $\beta_{t,top/bot} = \beta_{t,side} = 16.4^\circ$  generally have the lowest drag for the plume-off configurations. The nozzles with  $\beta_{t,top/bot} = 15.0^\circ/\beta_{t,side} = 22.4^\circ$  generally have the highest drag. However, the nozzles with  $\beta_{t,side} = 0^\circ$  have the lowest drag in the range of Mach numbers (approximately between 0.90 and 0.95) where the pressure recovery on the surfaces of the other nozzles is not sufficient to produce drag-reducing positive pressures. Further trade studies are necessary to determine which range of Mach numbers is most mission critical in order to choose the most beneficial closure distribution. All the nozzles had lower drag with the solid plume simulators installed (simulating a fully expanded jet exhaust) than with them removed (simulating a nonoperating jet).

## Introduction

The mission of the next generation of fighter aircraft will dictate a highly versatile and maneuverable vehicle that is capable of operating over a wide range of flight conditions. These aircraft require variable-geometry nozzles that change the aft-end shape, closure (the ratio of nozzle exit area to maximum fuselage cross-sectional area), and local boattail angle continuously throughout the operating range of Mach number, angle of attack, and engine pressure ratio. As demonstrated by test results, many studies have shown the importance of minimizing adverse

interference from propulsion exhaust-system integration. (See refs. 1 to 3.) In these studies the afterbodies of various aircraft, which accounted for only a small portion of the total aircraft, produced 38–50 percent of the total aircraft drag. These studies examined axisymmetric nozzles at cruise operating conditions with boattail angles of  $15^\circ$  to  $20^\circ$ . Current interest in nonaxisymmetric nozzles led to the study of twin-engine configurations with rectangular afterbodies and nozzles that achieved aft-end closure with large, variable boattail angles of the upper and lower nozzle flaps with the nozzle sidewalls having a small or  $0^\circ$  boattail angle (ref. 4). These results indicated that the best subsonic/transonic performance was obtained with nozzles having terminal boattail angles between  $7.8^\circ$  and  $20^\circ$ .

In order to obtain the required aft-end closure and maintain the recommended boattail angles, nozzles with nonzero sidewall boattail angles were investigated. The study reported in reference 5 examined three nonaxisymmetric nozzles with chord boattail angles ( $\beta_c$ ) of  $\beta_{c,top/bot}/\beta_{c,side} = 11.0^\circ/19.5^\circ, 13.5^\circ/13.5^\circ, 15.0^\circ/7.5^\circ$ , and it concluded that the nozzle with  $\beta_{c,top/bot} = \beta_{c,side}$  had the lowest nozzle drag and generally the least unfavorable tail interference. Since reference 5 considered only three nozzles, a more detailed investigation was warranted.

This paper presents the results of a parametric study in which aft-end closure distribution (top/bottom nozzle-flap boattail angle ( $\beta_{t,top/bot}$ ) versus nozzle-sidewall boattail angle ( $\beta_{t,side}$ )) and afterbody and nozzle corner treatment (sharp or radius) were varied. Four different closure distributions ( $\beta_{t,top/bot} = 17.9^\circ/\beta_{t,side} = 0^\circ, \beta_{t,top/bot} = 17.3^\circ/\beta_{t,side} = 9.7^\circ, \beta_{t,top/bot} = \beta_{t,side} = 16.4^\circ$ , and  $\beta_{t,top/bot} = 15.0^\circ/\beta_{t,side} = 22.4^\circ$ ) with three different corner radii (sharp, 1 in., and 2 in.) were tested. Tests were conducted on an isolated nonaxisymmetric fuselage model that simulated a twin-engine fighter. The model was tested in the Langley 16-Foot Transonic Tunnel over a range of Mach numbers from 0.40 to 1.25, Reynolds numbers per foot of  $2.25 \times 10^6$  to  $4.20 \times 10^6$ , and angles of attack from  $-3^\circ$  to  $9^\circ$ . Solid plume simulators of constant cross section were used to simulate fully expanded jet exhaust.

## Symbols and Abbreviations

$A_{base}$	base area of solid plume simulator or nozzle exit (when solid plume is removed), in <sup>2</sup>
$A_e$	nozzle exit area, in <sup>2</sup>

$A_{\max}$	model fuselage maximum cross-sectional area, in <sup>2</sup>	$p_{\infty}$	free-stream static pressure, psi
$A_{\text{seal}}$	cross-sectional area enclosed by seal strip at M.S. 33.10, in <sup>2</sup>	$q_{\infty}$	free-stream dynamic pressure, psi
$A_t$	nozzle throat area, in <sup>2</sup>	$R$	local corner radius, in.
AR	nozzle throat aspect ratio, Throat width/Throat height	$w_e$	nozzle exit width (see fig. 3), in.
$C_A$	corrected axial-force coefficient, $F_A/q_{\infty}A_{\max}$	$x$	distance from nozzle connect station (M.S. 41.27) along model longitudinal axis, in.
$C_{A,\text{bal}}$	axial-force coefficient measured by balance, $F_A/q_{\infty}A_{\max}$	$Y$	local half-width of nozzle, in.
$C_D$	drag coefficient measured by balance, $\text{Drag}/q_{\infty}A_{\max}$	$y$	lateral distance from model centerline, in.
$C_{D,f}$	skin-friction drag coefficient on nozzle	$y_R$	lateral distance of local corner-radius center from model centerline, in.
$C_{D,p}$	pressure drag coefficient on nozzle with solid plume simulator, computed by pressure integration	$Z$	local half-height of nozzle, in.
$(\Delta C_{D,i})_{\text{plume}}$	increment in drag due to plume interference	$z$	vertical distance from model centerline, in.
$C_p$	static pressure coefficient, $(p - p_{\infty})/q_{\infty}$	$z_R$	vertical distance of local corner-radius center from model centerline, in.
$C_{p,\text{crit}}$	critical static pressure coefficient (sonic flow)	$\alpha$	angle of attack, deg
$c$	chord of model support strut	$\beta_c$	chord boattail angle, deg
$D_f$	sum of skin-friction drag on centerbody section from M.S. 33.10 to M.S. 41.27 and on solid plume, when present, lbf	$\beta_t$	terminal boattail angle (see fig. 3), deg
$d_e$	equivalent diameter of nozzle exit, in.	Subscripts:	
$d_f$	equivalent diameter of model fuselage, in.	plume off	solid plume simulator removed (blanking plate installed)
$F_A$	corrected axial force, positive when measured in streamwise direction, lbf	plume on	solid plume simulator present
$F_{A,\text{bal}}$	axial force measured by balance, lbf	side	nozzle sidewall
$h_e$	nozzle exit height (see fig. 3), in.	top/bot	top and bottom nozzle flaps
$l$	nozzle length, 9.5 in.	Abbreviations:	
$M_{\infty}$	free-stream Mach number	B.L.	buttliness, measured laterally from model centerline, positive to right
$p$	local static pressure on nozzle, psi	M.S.	model station, measured aft from model nose, in.
$\bar{p}_{\text{base}}$	average static pressure on solid-plume-simulator base or nozzle-exit base, psi	W.L.	waterline, measured vertically from model centerline, positive up
$\bar{p}_{es}$	average static pressure at external seal at metric break (M.S. 33.10), psi		
$\bar{p}_i$	average internal static pressure, psi		

## Apparatus and Methods

### Facility

This investigation was conducted in the Langley 16-Foot Transonic Tunnel, which is a continuous-flow, single-return, atmospheric wind tunnel with a slotted octagonal test section and continuous air exchange. The wind tunnel has a continuously variable airspeed up to a Mach number of 1.30 with test-section plenum suction used for speeds above a Mach

number of 1.05. A complete description of the facility and operational characteristics can be found in reference 6.

### Model Design and Support System

The model tested, which was an isolated non-axisymmetric fuselage that simulated a twin-engine fighter, was mounted on a sting-strut support as shown in figure 1. This type of support system was chosen to minimize the effects of the support system on the afterbody flow. The model consisted of four parts: the forebody from M.S. 0.00 to M.S. 33.10, the centerbody from M.S. 33.10 to M.S. 41.27, the nozzle from M.S. 41.27 to M.S. 50.77, and the solid plume simulator from M.S. 50.77 to M.S. 62.15. Photographs of the model and support system installed in the Langley 16-Foot Transonic Tunnel are shown in figure 2.

The parameters selected for study were afterbody and nozzle corner radius and nozzle closure distribution (top/bottom nozzle-flap boattail angle versus nozzle-sidewall boattail angle). Model design began by specifying the maximum cross-sectional area (fuselage centerbody). Typical of twin-engine models previously tested (refs. 4 and 5), a 5.00-in-high by 10.00-in-wide rectangle was chosen with corner radius as the parameter to be varied. Three different forebody/centerbody combinations were designed with corner radii of 0.05 in. (sharp), 1 in., and 2 in. with a maximum cross-sectional area of the fuselage of 49.99 in<sup>2</sup>, 49.12 in<sup>2</sup>, and 46.57 in<sup>2</sup>, respectively. For each corner radius, the centerbody (M.S. 33.10 to M.S. 41.27) had a constant cross section. Three forebodies were then designed, one to join smoothly with each of the three centerbodies. The most aft section of each forebody had the same dimensions and corner radius as its corresponding centerbody and was faired forward by decreasing cross-sectional area and corner radius to a sharply pointed conical nose. To minimize strut interference on the metric portion of the model, forebody length was chosen so that the metric break was at least one equivalent fuselage diameter (that is,  $d_f = 2\sqrt{A_{\max}/\pi}$ ) downstream of the strut trailing edge.

To establish a criterion for the model afterbody and nozzle closure (the ratio of nozzle exit area to maximum fuselage cross-sectional area), typical current twin-engine fighters (e.g., the F-15 and F-18) were examined. These aircraft have a ratio of combined (dry power) nozzle throat area to maximum fuselage cross-sectional area ( $2A_t/A_{\max}$ ) of about 0.11. For the previously chosen maximum cross-sectional area of approximately 50.00 in<sup>2</sup>, this ratio

gives a nozzle throat area of 2.75 in<sup>2</sup> per engine. A nozzle expansion ratio ( $A_e/A_t$ ) of 1.15 was chosen as being typical of a nozzle at transonic flight, thus giving a combined nozzle exit area of 6.33 in<sup>2</sup>. All nozzles were designed with this exit area except for the nozzles with zero sidewall boattail angle, which had an exit area of 6.88 in<sup>2</sup> to allow for an internal longitudinal stiffener for structural considerations in a nozzle with internal flow.

Previous studies (e.g., ref. 4, which was also conducted in the 16-Foot Tunnel at Mach numbers similar to those of the present investigation) indicated that to maintain attached flow, the boattail angles should not exceed 20°. Nozzle length was chosen to be 9.50 in. (measured from the nozzle-to-centerbody connect station at M.S. 41.27) so that this maximum boattail angle criterion would be met for most of the closure distributions. To minimize support system interference in the region of interest, the length of the centerbody was chosen so that the beginning of the nozzle boattail would be greater than two equivalent fuselage diameters downstream of the strut trailing edge. This results in an overall model length of approximately 60 in., which is typical of 1/12-scale twin-engine fighter models tested in the 16-Foot Tunnel. A sketch of the nozzle geometry is shown in figure 3.

With the centerbody and nozzle exit areas determined, four fuselage closure distributions (top/bottom nozzle-flap boattail angle versus nozzle-sidewall boattail angle) shown in figure 4 were selected: zero sidewall boattail angle ( $\beta_{t,\text{side}} = 0^\circ$ ) from which  $\beta_{t,\text{top/bot}} = 17.9^\circ$  and AR = 14.49 are derived; equal top/bottom nozzle-flap boattail and nozzle-sidewall boattail angles ( $\beta_{t,\text{top/bot}} = \beta_{t,\text{side}} = 16.4^\circ$ ) which gives AR = 5.76; and two additional closure distributions where  $\beta_{t,\text{top/bot}} = 17.3^\circ$ ,  $\beta_{t,\text{side}} = 9.7^\circ$ , and AR = 9.23 and  $\beta_{t,\text{top/bot}} = 15.0^\circ$ ,  $\beta_{t,\text{side}} = 22.4^\circ$ , and AR = 3.28. A nozzle with each closure distribution was then mated to each of the three centerbodies (sharp, 1-in., and 2-in. corner radii) to complete a matrix of 12 nozzles. The most forward section of each nozzle had the same dimensions as its corresponding centerbody. In the case of the 1-in. and 2-in. corner-radius nozzles, the corner radius decreased along the nozzle length to a value of 0.05 in. (sharp) at the nozzle exit. The sharp-corner (0.05 in.) nozzles maintained this corner radius along the entire length of the nozzle, and therefore they are described completely in figure 3. Cross-sectional coordinates of the 1- and 2-in. corner-radius nozzles tested are given in table 1. The coordinates  $x$ ,  $y_R$ , and  $z_R$  in table 1 were measured from the wind tunnel model, and the corner radius  $R$  was computed from these

coordinates. The apparent discontinuity in corner radius is an artifact of this calculation and is not evident in the model.

To simulate fully expanded jet exhaust (except for the jet entrainment effects), a solid plume simulator having a constant cross section of the same dimensions as the nozzle exit was employed. (See fig. 2(b).) The solid plume simulator extended downstream four equivalent diameters of the nozzle exit (that is,  $d_e = 2\sqrt{A_e/\pi}$ ). Solid plumes have been verified as reasonable approximations of the fully expanded exhaust plume of axisymmetric nozzles at an angle of attack of  $0^\circ$  (ref. 7). To determine the effect of the solid plume simulator on flow over the non-axisymmetric nozzles of this investigation, a blanking plate was substituted for the solid plume simulator at the nozzle exit (plume off) as shown in figure 2(a). Because of structural considerations, the configurations with the solid plume simulator were tested only at an angle of attack of  $0^\circ$ .

Since the aft end is the region of interest, only the model aft of M.S. 33.10 was metric (mounted on the force balance). A clearance gap (metric break) was provided between the nonmetric and metric portions of the model at M.S. 33.10 to prevent fouling of the components upon each other. A flexible plastic strip inserted into circumferentially machined grooves in the components on either side of the metric break impeded flow into or out of the model cavity. The low coefficient of friction of the plastic strip minimized restraint between the metric and nonmetric portions of the model.

### Instrumentation

Forces and moments on the metric portion of the model (aft of M.S. 33.10) were measured by a six-component strain gauge balance that had an accuracy of  $\pm 1.25$  lb in axial force and  $\pm 4$  lb in normal force. Five static pressures were measured in the gap at the metric break (M.S. 33.10) external to the plastic seal strip. These pressure orifices were spaced about the right side of the model perimeter on the forebody. An additional two pressures were measured inside the model cavity at the metric break. These pressures were measured with individual pressure transducers, each with an accuracy of  $\pm 0.013$  psi. Ten static pressures were measured that were spaced on the right side of the solid-plume-simulator base. When the solid plume simulator was removed, the nozzle exit was sealed by a blanking plate, and five static pressure orifices were spaced across the width of the nozzle exit to measure the exit base pressure. These base pressures were measured with electronically scanned pressure modules

with an accuracy of  $\pm 0.075$  psi. These pressure measurements (external seal, internal cavity, and base) were then used to correct axial force measured by the balance for pressure-area tares as discussed in the "Data Reduction" section.

One hundred and ten static pressure orifices were located on the left side of the nozzle in 12 longitudinal rows as described in figure 5: four rows (42 orifices) on the upper (or "top") nozzle flap, three rows (28 orifices) on the lower (or "bottom") nozzle flap, and four rows (40 orifices) on the nozzle sidewall. Individual orifice locations for each nozzle are given in table 2. All model pressures were measured with electronically scanned pressure modules with an accuracy of  $\pm 0.075$  psi, and the modules were located in the (metric) model afterbody. Data obtained during each tunnel run were recorded on magnetic tape and were reduced with standard data reduction procedures. For each data point, 50 samples of data were recorded over a period of 5 sec and were averaged.

### Tests

This investigation was conducted in the Langley 16-Foot Transonic Tunnel at Mach numbers from 0.40 to 1.25, Reynolds numbers per foot of  $2.25 \times 10^6$  to  $4.20 \times 10^6$ , and angles of attack from  $-3^\circ$  to  $9^\circ$ . As recommended in references 8 and 9, all tests were conducted with a 0.125-in-wide boundary-layer transition strip consisting of No. 120 silicon carbide grit sparsely distributed in a thin film of lacquer. This strip was located 1.0 in. from the tip of the forebody nose.

### Data Reduction

**Corrections.** The strain gauge balance, which was mounted on the model centerline, measured the forces and moments due to the external flow field on the portion of the model (external and internal) aft of M.S. 33.10. In order to achieve the correct axial force, the axial force measured by the balance must be corrected for pressure-area tare forces acting on the model. The internal pressure at any given set of test conditions was uniform throughout the inside of the model; thus, no cavity flow was indicated. The external and internal pressure tare forces on the model were obtained by multiplying the difference between the average pressure (external seal, base, or internal pressures) and free-stream static pressure by the affected projected area normal to the model axis. Axial force was computed from the balance axial force with the following relationship:



$$F_A = F_{A,\text{bal}} + (\bar{p}_{es} - p_\infty)(A_{\text{max}} - A_{\text{seal}}) + (\bar{p}_i - p_\infty)A_{\text{seal}} - (\bar{p}_{\text{base}} - p_\infty)A_{\text{base}} - D_f \quad (1)$$

where the first term ( $F_{A,\text{bal}}$ ) includes all pressure and viscous forces on the model aft of M.S. 33.10. The second and third terms account for the forward seal rim and the interior pressure forces at the metric break, respectively. A negative differential pressure acting at the metric break, which is forward of the balance center (see fig. 1), causes a thrust tare. The fourth term accounts for the pressure forces on the base of either the solid plume simulator or the nozzle exit when the solid plume simulator is removed. A negative differential pressure acting at the plume or nozzle base, which is aft of the balance center, causes a drag tare. The last term ( $D_f$ ) is the sum of the skin-friction drag on the centerbody section from M.S. 33.10 to M.S. 41.27 and on the solid plume simulator when present. The skin-friction drag of all components was computed using the method of Frankl and Voishel (refs. 10 and 11) for compressible turbulent flow on a flat plate. The exact calculation method is described in detail in reference 11. An example (nozzle 10 with solid plume simulator) of the relative sizes of each of the terms in equation (1) is presented in coefficient form in chart A. Also presented in coefficient form is the balance accuracy ( $\pm 1.25$  lb).

The adjusted forces and moments were then transferred from the body axis of the metric portion of the model to the stability axis. The attitude of the metric afterbody relative to gravity was determined from a calibrated attitude indicator located in the (metric) model centerbody. Angle of attack  $\alpha$ , which is the angle between the afterbody centerline and the relative wind, was determined by applying a flow angularity term to the angle measured by the attitude indicator. The flow angularity adjustment was  $0.1^\circ$ , which is the average angle measured in the Langley 16-Foot Transonic Tunnel.

**Calculations.** The plume-interference drag increment was defined as

$$(\Delta C_{D,i})_{\text{plume}} = (C_D)_{\text{plume on}} - (C_D)_{\text{plume off}} \quad (2)$$

where  $(C_D)_{\text{plume on}}$  is the measured nozzle drag for a given nozzle with the solid plume simulator on, and  $(C_D)_{\text{plume off}}$  is the measured nozzle drag for the same nozzle with the solid plume simulator off (nozzle exit blanking plate installed). Hence, this interference increment represents the interference effects of the solid plume simulator on the nozzle.

Nozzle boattail static pressures were integrated to determine nozzle pressure drag  $C_{D,p}$  for the nozzles with the solid plume simulator installed. Since successful pressure integration is dependent on the density of the pressure taps, only the pressures on the upper quadrant of the nozzle, which contains 72 of the 110 orifices, were used for the pressure drag integration. This was a reasonable approach since the nozzle was symmetric about both the vertical and horizontal axes, and all data for these configurations (plume on) were obtained at a nominal angle of attack of  $0^\circ$ . If an individual pressure measurement was bad (from a plugged orifice, for instance), a pressure from the corresponding location on the bottom of the model was substituted where possible. An example of the grid used to divide the nozzle area is shown in figure 6. The axially and normally projected areas and the wetted area of each panel were computed, and the panels were then assigned to a pressure orifice with each panel area multiplied by 4.0 to account for the entire nozzle. From an examination of the pressure data, which will be presented in the "Discussion" section, it was determined that pressures changed rapidly along the length of the nozzle boattail, but they were fairly constant laterally across the nozzle flap or sidewall (except near the corners). An attempt was made to assign a panel to a given orifice based on this knowledge of the pressure distribution. (See fig. 6.)

Chart A

$M_\infty$	$C_A$	$C_{A,\text{bal}}$	First term	Second term	Third term	$C_{D,f}$	Accuracy
0.402	0.0179	0.0392	-0.0064	-0.0182	-0.0269	0.0236	$\pm 0.0180$
.900	.1650	.1871	-.0066	-.0158	-.0212	.0209	$\pm .0055$
1.202	.2417	.2847	-.0085	-.0198	-.0051	.0198	$\pm .0044$

## Presentation of Results

The results of this investigation, including repeated conditions, are presented in both tabular and plotted form. Table 3(a) presents an index of the configurations tested, and table 3(b) presents an index to the data presented in tables 4 to 21 and in figures 7 to 17. No data are presented for nozzles 1 and 4 (see table 3(a)), and for some nozzles, only the plume-on data or only the plume-off data are presented. Data for these configurations, as well as data at some Mach numbers for the other configurations, were compromised because of instrumentation problems encountered during testing. In cases where the data from an individual orifice in a key location were bad (for example, a plugged orifice), the pressure distribution was faired with a dashed line estimating the shape of the distribution.

## Discussion

### Basic Data

**Pressures.** Static pressure coefficients on the nozzle boattail and the effect of the solid plume simulator (when available) are shown in figure 7 at Mach numbers of 0.60, 0.90, and 1.20. Data for other Mach numbers may be found in tables 4 to 21. The external flow over all nozzle surfaces having a nonzero boattail angle (which excludes the sidewalls of nozzles 5 and 9) exhibited a strong expansion at the beginning of the nozzle boattail. This expansion was strong enough to produce a region of supersonic flow for  $M_\infty \geq 0.70$  or  $M_\infty \geq 0.80$ , depending on the boattail angle of the nozzle surface. At the lower subsonic Mach numbers, the initial expansion was followed by a strong pressure recovery as the flow continued downstream. This strong pressure recovery was sufficient to produce positive pressure coefficients which, when acting on the aft-facing nozzle boattail, decreased the drag on the nozzle.

If the initial expansion was strong enough to produce supersonic flow and the minimum pressure coefficient in the expansion was much less than  $C_{p,crit}$ , the region of supersonic flow terminated in a standing shock. Downstream of the shock, flow separation probably occurred as indicated by the suddenly reduced slope or flattening of the pressure recovery.

The external flow over the sidewalls of nozzles 5 and 9 ( $\beta_{t,side} = 0^\circ$ , see figs. 7(g) to 7(i) and 7(r) to 7(t), respectively) exhibits a weak expansion and pressure recovery at subsonic Mach numbers. The expansion is sufficient to produce local supersonic flow at  $M_\infty \geq 0.875$  (as shown in the data tables).

At  $M_\infty = 0.60$ , the downstream pressure recovery is generally sufficient to produce positive pressure coefficients. The pressure orifices located along the top/side corner are in a region where the boattail angle is transitioning from the top nozzle-flap boattail angle to  $\beta_{t,side} = 0^\circ$ , and therefore pressures measured at this orifice row follow the same trends as pressures along a nonzero boattail angle surface.

The shape of the pressure distributions is consistent between the top and bottom nozzle flaps. However, at  $M_\infty = 0.60$ , the initial expansion is generally slightly stronger on the top nozzle flap than on the bottom flap although the pressure recovery is generally similar. At  $M_\infty = 0.90$  the situation is reversed (a slightly stronger initial expansion on the bottom flap than on the top). Since the pressure gradients are steep at the beginning of the nozzle boattail, the pressure orifices may not be placed at the exact location of the maximum expansion. Therefore, the observed expansion-strength differences between the top and bottom flaps may actually be expansion-location differences. Since these differences are small, only the pressures from the top quadrant were used in the pressure integration, as was discussed in the "Data Reduction" section.

Keeping in mind the limitations of orifice location discussed previously, one would expect that the strength of the initial flow expansion over the nozzle boattail and the following pressure recovery would be strongly dependent on the boattail angle of the surface, but this is generally not the case. Examine, for example, the pressure distributions in figures 7(a) and 7(b) (nozzle 2 with  $\beta_{t,top/bot} = 17.3^\circ/\beta_{t,side} = 9.7^\circ$ ). At  $M_\infty = 0.60$  (fig. 7(a)), the expansion on the top and bottom nozzle flaps is much stronger than on the nozzle sidewalls, as would be expected since  $\beta_{t,top/bot} > \beta_{t,side}$ , but at  $M_\infty = 0.90$  (fig. 7(b)) the expansion on the nozzle sidewalls is stronger. Also, nozzles 3, 7, and 11 (figs. 7(d) to 7(f), 7(m) to 7(o), and 7(x) to 7(z), respectively), which have  $\beta_{t,top/bot} = \beta_{t,side} = 16.4^\circ$ , have different pressure distributions on the top and bottom nozzle flaps and nozzle sidewalls.

At all but a few locations, nozzle pressure coefficients are higher with the solid plume simulator installed than with it removed (nozzle exit blanking plate installed). The shape of the pressure distribution is generally unaffected. Notable exceptions are pressure distributions over the bottom flaps of nozzles 5, 11, and 12 at  $M_\infty = 1.20$  (figs. 7(i), 7(z), and 7(cc), respectively). In these cases, the separated flow downstream of the standing shock behaves differently for simulated plume-on and plume-off

conditions. The reasons for this difference are not known. As was noted in reference 7, solid plume simulators are reasonably effective at duplicating the effects of the exhaust plume of axisymmetric nozzles operating at design conditions. Therefore, the nozzle pressures with the solid plume simulators installed, compared with the nozzle pressures with the solid plume simulators off, should correspond to an operating and nonoperating jet, respectively. Nozzle boattail pressure coefficients were observed to be higher with an operating jet than with a nonoperating jet in the investigations of references 5, 12, and 13. The external flow over a nozzle with a nonoperating jet (solid plume simulator off) must expand over the nozzle boattail to fill in the large base region at the nozzle exit. This expansion acts to lower pressures on the nozzle boattail. When the jet is operating (solid plume simulator on), this expansion of the external flow is reduced, thus increasing boattail pressures.

**Nozzle drag characteristics.** The various component drag coefficients for each of the nozzles tested are presented in figure 8 as a function of free-stream Mach number. The left-hand plots show a comparison of several computed components of total drag: skin-friction drag on the nozzle ( $C_{D,f}$ ) (from M.S. 41.27 to M.S. 50.77); pressure drag on the nozzle with the solid plume simulator ( $C_{D,p}$ ) obtained from pressure integration; and the drag interference increment due to the solid plume simulator ( $(\Delta C_{D,i})_{\text{plume}}$ ) (when data are available for both plume-on and plume-off cases). The right-hand plots show a comparison of the drag measured by the force balance  $C_D$  with the sum of  $C_{D,f}$  and  $C_{D,p}$ . The plume-interference increment was not included in this summed drag coefficient because the effect of the plume is to change the nozzle boattail pressures, and therefore it is already included in the integrated pressure drag coefficient. Similarly, wave-drag coefficient (for  $M_\infty \geq 1.0$ ) was not determined separately since it is also included in  $C_{D,p}$ .

Figure 8 clearly shows that pressure drag is the largest contributor to nozzle drag at all Mach numbers by exhibiting the classic sharp rise in drag coefficient as subsonic Mach number increases above  $M_\infty = 0.70$ , and then the decrease in drag coefficient as Mach number continues to increase supersonically. As expected, the skin-friction drag coefficient was small and remained nearly constant across the range of Mach numbers tested. The plume-interference increments were negative and were fairly constant over the range of Mach numbers tested. Negative plume-interference increments would be expected from the previous discussion of the pressure distributions. Since the boattail pressures are lower

in the absence of the solid plume simulator, higher drag occurs for plume-off configurations.

An examination of the right-hand plots of figure 8 shows that the sum of pressure drag coefficient and skin-friction drag coefficient (both of which were computed as described in the "Data Reduction" section) is generally higher than the total afterbody drag  $C_D$  measured by the force balance. Differences between the measured and computed drag coefficients are much larger at the lower Mach numbers (as much as 125 percent of the measured drag coefficient). As with any attempt at pressure integration, the number of pressure orifices is finite, and care must be taken in assigning an area to each pressure in regions of rapid pressure changes. Since there is greater uncertainty in computing drag coefficient using pressure integration, the parameter  $C_D$  (the drag coefficient measured by the force balance) will be used to compare configurations in subsequent discussions.

### Effect of Corner Radius

Figures 9-12 present the effect of afterbody and nozzle corner radius for each boattail closure distribution with the solid plume simulator installed. Part (a) of these figures shows the measured (by the balance) drag coefficient as a function of Mach number, and parts (b) to (d) (parts (b) and (c) of fig. 12) show the boattail static pressure distributions. Note that the longitudinal rows of pressure orifices are at different spanwise locations for the different nozzle corner radii, as was shown in figure 5. Because of data availability, a complete comparison of the three corner radii can be made only for the nozzles with closure distribution of  $\beta_{t,\text{top/bot}} = \beta_{t,\text{side}}$  (fig. 11) at subsonic Mach numbers. The effect of corner radius on drag was generally less than 0.015 in  $C_D$  between any nozzles of a given closure distribution. However, an important point to recall is that  $C_D$  is an *afterbody* drag coefficient that is nondimensionalized by maximum fuselage cross-sectional area instead of an *aircraft* drag coefficient that is nondimensionalized by wing area. Therefore, afterbody drag coefficients are approximately an order of magnitude larger than aircraft drag coefficients.

In general, for the range of Mach numbers tested, the sharp-corner nozzles have the highest drag and the 2-in. corner-radius nozzles have the lowest drag. A notable exception is the nozzles with  $\beta_{t,\text{side}} = 0^\circ$  (fig. 9) at supersonic speeds where the 1-in. corner-radius nozzle (nozzle 5) had the lowest drag. (Sharp-corner-radius data are not available for this closure distribution.) The reason for this exception is not known. The observed effect of corner radius on

drag is expected since any differences between the top flap pressures and sidewall boattail pressures can be equalized more easily by flow traveling from high-pressure to low-pressure regions around a large corner radius.

The pressure distributions for the nonzero boattail angle nozzles generally support this expectation. For example, on the nozzles with  $\beta_{t,top/bot} = 17.3^\circ/\beta_{t,side} = 9.7^\circ$  at  $M_\infty = 0.60$  (fig. 10(b)), the pressures in the initial expansion region exhibit a smooth transition from the top flap to the sidewall on the 2-in. corner-radius nozzle, but they exhibit a sharp jump between the top flap and sidewall on the sharp-corner nozzle. Downstream in the pressure recovery region, the pressure levels are similar for all the orifice rows on each nozzle despite the apparent lack of pressure equalization around the corner of the nozzle in the initial expansion region. At  $M_\infty = 0.90$  and 1.20 (for example, figs. 10(c) and 10(d), respectively), the pressure distributions indicate a highly complex flow field with shocks and separation regions that form at different streamwise locations on the different nozzle surfaces.

In contrast, the pressure distributions at  $M_\infty = 0.60$  on the nozzles with  $\beta_{t,side} = 0^\circ$  (fig. 9(b)) behave differently. The far outboard row of orifices on the top flap (which are in the corner region of the nozzle for  $x/l < 0.3$ ) and the row of orifices along the top/side corner have pressures in the initial expansion region that transition between those on the top flap and the sidewall, as would be expected. However, this trend is not continued through the pressure recovery region farther downstream. Pressures for the top/side corner row do not recover to the level of either the top flap or the sidewall pressures, although those on the 2-in. corner-radius nozzle recover better than those on the 1-in. corner-radius nozzle. Since the change in boattail angle from  $17.9^\circ$  on the top/bottom nozzle flaps to  $0^\circ$  on the sidewalls is the most severe in this investigation, a vortex could form on the nozzle corner. The severity of this vortex would be mitigated by the larger corner radii, which is consistent with the observed pressure trends.

Figure 13 presents the effect of angle of attack on the measured (by the balance) afterbody drag coefficient for the various corner radii with the solid plume removed. Drag coefficients for plume-on configurations (tested only at  $\alpha = 0^\circ$ ) are presented for reference as solid symbols. Generally, the nozzle with the lowest drag at  $\alpha = 0^\circ$  had the lowest drag across the angle-of-attack range tested. As with the plume-on configurations, the 2-in. corner-radius nozzles generally had the lowest drag.

## Effect of Closure Distribution

Figures 14 to 16 present the effect of closure distribution for each nozzle corner radius with the solid plume simulator installed. Part (a) of these figures shows the measured drag coefficient as a function of Mach number, and parts (b) to (d) (parts (b) and (c) of fig. 14) show the static pressure distributions. As before, complete comparisons are not always possible. For certain corner radii at some Mach numbers, closure distribution has little or no effect on measured drag such as the sharp-corner nozzles at  $M_\infty \leq 0.70$  (fig. 14(a)) or the 1-in. corner-radius nozzles at  $M_\infty \geq 1.20$  (fig. 15(a)). The drag of the sharp-corner nozzles seems to be the least sensitive to closure distribution, but only data from the two nozzles with the least extreme closure distributions ( $\beta_{t,top/bot} = 17.3^\circ/\beta_{t,side} = 9.7^\circ$  and  $\beta_{t,top/bot} = \beta_{t,side} = 16.4^\circ$ ) are available. When closure distribution does have an appreciable effect on drag, the nozzles with  $\beta_{t,top/bot} = 17.3^\circ/\beta_{t,side} = 9.7^\circ$  generally have the lowest drag and the nozzles with  $\beta_{t,top/bot} = 15.0^\circ/\beta_{t,side} = 22.4^\circ$  generally have the highest drag.

A notable exception occurs for  $0.90 \leq M_\infty \leq 0.95$  with the 1- and 2-in. corner-radius nozzles (figs. 15(a) and 16(a), respectively) where the nozzle with  $\beta_{t,side} = 0^\circ$  has the lowest drag. Note, however, that data for the closure distribution of  $\beta_{t,top/bot} = 17.3^\circ/\beta_{t,side} = 9.7^\circ$  are not available for the 1-in. corner-radius nozzle. An examination of the pressure distributions for these nozzles at  $M_\infty = 0.90$  (figs. 15(c) and 16(c)) shows little effect of closure distribution for the pressures on the top or bottom nozzle flaps except in the strength of the initial expansion. However, this is not the case on the nozzle sidewalls. As was discussed previously, the flow over the nozzle sidewalls on the nozzles with  $\beta_{t,side} = 0^\circ$  exhibits neither the strong initial expansion nor the strong downstream pressure recovery seen for the nonzero boattail angle surfaces. At the lower subsonic Mach numbers, the strong downstream recovery on the nonzero boattail angle surfaces is sufficient to produce positive pressures that apparently offset the drag produced by the low pressures in the initial expansion region. At the higher subsonic Mach numbers, the pressure recovery on the nonzero boattail angle surfaces is not strong enough to produce positive pressures, and thus all the nonzero boattail angle surfaces contribute to drag. The sidewalls of the nozzles with  $\beta_{t,side} = 0^\circ$  have no aft-facing area for the pressures to act on, and thus they do not contribute to the pressure drag on the nozzle. Therefore, the nozzles with  $\beta_{t,side} = 0^\circ$  tend to have the lowest

drag in the range of Mach numbers where the pressure recovery on the surfaces of the other nozzles is not sufficient to produce positive pressures. Further trade studies are necessary to determine which range of Mach numbers is most mission critical in order to choose the most beneficial closure distribution.

A further examination of the pressure distributions does not disclose why the nozzles with a closure distribution of  $\beta_{t,top/bot} = 17.3^\circ/\beta_{t,side} = 9.7^\circ$  generally have the lowest drag. For example, the two sharp-corner nozzles (figs. 14(b) and 14(c)) have nearly identical pressure distributions on the top and bottom nozzle flaps. This result is expected since the boattail angle differs only by  $0.9^\circ$ . On the nozzle sidewall at  $M_\infty = 0.60$  (fig. 14(b)), the notably stronger pressure recovery for nozzle 3 indicates that the drag should be lower, especially since the larger sidewall boattail angle ( $\beta_{t,side} = 16.4^\circ$  versus  $\beta_{t,side} = 9.7^\circ$ ) yields more aft-facing area on which these positive pressures can act. However, no real difference occurs between the drag coefficients of these two nozzles at this Mach number. (See fig. 14(a).) On the other hand, at  $M_\infty = 0.90$  where there is a difference in drag, the differences in the sidewall boattail pressures between the two closure distributions are not as pronounced (fig. 14(c)) as they are at  $M_\infty = 0.60$ . The sidewall boattail pressures for nozzle 2 are somewhat higher than those of nozzle 3. This can result in lower drag for nozzle 2 if the aft-facing areas that these pressures act on are the same; but in fact nozzle 2 has less aft-facing area for these pressures to act on than nozzle 3, thus further reducing the significance of this pressure difference. Yet, examination of figure 14(a) clearly shows that  $C_D$  for nozzle 2 is lower at  $M_\infty = 0.90$ .

Figure 17 presents the effect of angle of attack on the measured afterbody drag for the various closure distributions with the solid plume simulator removed at Mach numbers of 0.60, 0.90, and 1.20. The plume-on drag coefficients at  $\alpha = 0^\circ$  are presented as solid symbols for reference purposes. For the 2-in. corner-radius nozzles (fig. 17(b)), the nozzle with the lowest drag at  $\alpha = 0^\circ$  generally has the lowest drag across the angle-of-attack range tested, as was observed previously. In the high-subsonic Mach number range ( $M_\infty = 0.90$ ), the nozzles with  $\beta_{t,side} = 0^\circ$  again have the lowest drag. However, in contrast to the plume-on configurations where the nozzles with  $\beta_{t,top/bot} = 17.3^\circ/\beta_{t,side} = 9.7^\circ$  generally have the lowest drag at  $M_\infty = 0.60$  and 1.20, the nozzles with  $\beta_{t,top/bot} = \beta_{t,side} = 16.4^\circ$  generally have the lowest drag for the plume-off

configurations. The cause is not clear, even with a further examination of the pressure distributions.

## Concluding Remarks

A parametric study has been conducted in the Langley 16-Foot Transonic Tunnel on an isolated nonaxisymmetric fuselage model that simulates a twin-engine fighter. The effects of aft-end closure distribution (top/bottom nozzle-flap boattail angle versus nozzle-sidewall boattail angle) and afterbody and nozzle corner treatment (sharp or radius) were investigated. Four different closure distributions with three different corner radii were tested. Tests were conducted over a range of Mach numbers from 0.40 to 1.25 and over a range of angles of attack from  $-3^\circ$  to  $9^\circ$ . Solid plume simulators were used to simulate the jet exhaust.

For a given closure distribution in the range of Mach numbers tested, the sharp-corner nozzles generally have the highest drag and the 2-in. corner-radius nozzles generally have the lowest drag.

The effect of closure distribution on afterbody drag is highly dependent on configuration, plume simulation, and Mach number. Except at high subsonic Mach numbers, the nozzles with the top and bottom terminal boattail angle ( $\beta_{t,top/bot}$ ) of  $17.3^\circ$  and sidewall terminal boattail angle ( $\beta_{t,side}$ ) of  $9.7^\circ$  generally have the lowest drag for the plume-on configurations, whereas the nozzles with  $\beta_{t,top/bot} = \beta_{t,side} = 16.4^\circ$  generally have the lowest drag for the plume-off configurations. The nozzles with  $\beta_{t,top/bot} = 15.0^\circ/\beta_{t,side} = 22.4^\circ$  generally have the highest drag. However, the nozzles with  $\beta_{t,side} = 0^\circ$  have the lowest drag in the range of Mach numbers (approximately between 0.90 and 0.95) where the pressure recovery on the surfaces of the other nozzles is not sufficient to produce drag-reducing positive pressures. Further trade studies are necessary to determine which range of Mach numbers is most mission critical in order to choose the most beneficial closure distribution.

All nozzles had lower drag with the solid plume simulators installed (approximating a fully expanded jet exhaust) than with them removed (approximating a nonoperating jet). This result has been noted previously for nozzles with a flowing jet.

NASA Langley Research Center  
Hampton, VA 23681-0001  
June 24, 1992

## References

1. Capone, Francis J.: The Nonaxisymmetric Nozzle --It Is for Real. AIAA Paper 79-1810, Aug. 1979.
2. Berrier, Bobby L.: Results From NASA Langley Experimental Studies of Multiaxis Thrust Vectoring Nozzles. *SAE 1988 Transactions Journal of Aerospace*, Section 1 Volume 97, c.1989, pp. 1.1289 1.1304. (Available as SAE Paper 881481.)
3. Berrier, Bobby L.; and Staff, Propulsion Integration Section: *A Review of Several Propulsion Integration Features Applicable to Supersonic-Cruise Fighter Aircraft*. NASA TM X-73991, 1976.
4. Pendergraft, Odis C., Jr.; Burley, James R., II; and Bare, E. Ann: *Parametric Study of Afterbody/Nozzle Drag on Twin Two-Dimensional Convergent-Divergent Nozzles at Mach Numbers From 0.60 to 1.20*. NASA TP-2640, 1986.
5. Bangert, Linda S.; Leavitt, Laurence D.; and Reubush, David E.: *Effects of Afterbody Boattail Design and Empennage Arrangement on Acropulsive Characteristics of a Twin-Engine Fighter Model at Transonic Speeds*. NASA TP-2704, 1987.
6. Staff of the Propulsion Aerodynamics Branch: *A User's Guide to the Langley 16-Foot Transonic Tunnel Complex Revision 1*. NASA TM-102750, 1990.
7. Reubush, David E.: *Experimental Study of the Effectiveness of Cylindrical Plume Simulators for Predicting Jet-On Boattail Drag at Mach Numbers up to 1.30*. NASA TN D-7795, 1974.
8. Braslow, Albert L.; and Knox, Eugene C.: *Simplified Method for Determination of Critical Height of Distributed Roughness Particles for Boundary-Layer Transition at Mach Numbers From 0 to 5*. NACA TN 4363, 1958.
9. Braslow, Albert L.; Hicks, Raymond M.; and Harris, Roy V., Jr.: *Use of Grit-Type Boundary-Layer-Transition Trips on Wind-Tunnel Models*. NASA TN D-3579, 1966.
10. Shapiro, Ascher H.: *The Dynamics and Thermodynamics of Compressible Fluid Flow, Volume II*. Ronald Press Co., c.1954.
11. Mercer, Charles E.; Berrier, Bobby L.; Capone, Francis J.; Grayston, Alan M.; and Sherman, C. D.: *Computations for the 16-Foot Transonic Tunnel NASA, Langley Research Center, Revision 1*. NASA TM-86319, 1987. (Supersedes NASA TM-86319, 1984.)
12. Leavitt, Laurence D.: *Effect of Empennage Location on Twin-Engine Afterbody/Nozzle Aerodynamic Characteristics at Mach Numbers From 0.6 to 1.2*. NASA TP-2116, 1983.
13. Berrier, Bobby L.: Empennage/Afterbody Integration for Single and Twin-Engine Fighter Aircraft. AIAA-83-1126, June 1983.

Table 1. Nozzle Cross-Section Coordinates for One Quadrant

[All dimensions are given in inches]

(a) Nozzle 5

$x$	$y_R$	$z_R$	$R$
0.9999	4.0120	1.4996	0.9934
1.0999	4.0034	1.4918	1.0049
1.1999	4.0202	1.5077	0.9827
1.2999	4.0227	1.5094	0.9798
1.3999	4.0182	1.5058	0.9857
1.4999	4.0173	1.5048	0.9869
1.5999	4.0166	1.5041	0.9879
1.6999	4.0075	1.4949	1.0006
1.7999	4.0078	1.4949	1.0004
1.8999	4.0168	1.5045	0.9876
1.9999	4.0126	1.4990	0.9941
2.0999	4.0146	1.5014	0.9910
2.1999	4.0104	1.4969	0.9970
2.2999	4.0200	1.5065	0.9834
2.3999	4.0213	1.5093	0.9797
2.4999	4.0348	1.5282	0.9553
2.5967	4.0241	1.5217	0.9640
2.6000	4.0095	1.5111	0.9810
2.7000	4.0057	1.5097	0.9758
2.8000	3.9732	1.4683	1.0147
2.9000	3.9619	1.4344	1.0313
3.0000	3.9775	1.4215	1.0136
3.1000	3.9865	1.3988	1.0068
3.2000	3.9950	1.3747	1.0014
3.3000	4.0160	1.3650	0.9774
3.4000	4.0326	1.3507	0.9592
3.5000	4.0381	1.3234	0.9581
3.6000	4.0698	1.3228	0.9196
3.7000	4.0851	1.3063	0.9041
3.8000	4.0890	1.2766	0.9055
3.9000	4.0887	1.2427	0.9129
4.0000	4.1360	1.2599	0.8513
4.1000	4.1397	1.2306	0.8524
4.2000	4.1844	1.2475	0.7925
4.3000	4.1946	1.2249	0.7849
4.4000	4.2144	1.2161	0.7604
4.5000	4.2324	1.2013	0.7418
4.5999	4.2038	1.1303	0.7950
4.6999	4.2298	1.1265	0.7635

$x$	$y_R$	$z_R$	$R$
4.7999	4.2401	1.1043	0.7551
4.8999	4.2638	1.0962	0.7282
4.9999	4.2750	1.0744	0.7189
5.0999	4.2859	1.0533	0.7096
5.1999	4.3125	1.0475	0.6787
5.2999	4.3272	1.0303	0.6642
5.3999	4.3361	1.0065	0.65 $\delta$
5.4999	4.3537	0.9917	0.6394
5.5999	4.3674	0.9721	0.6268
5.6999	4.3903	0.9620	0.6013
5.7999	4.4034	0.9426	0.5893
5.8999	4.4147	0.9216	0.5796
5.9999	4.4295	0.9037	0.5650
6.0999	4.4450	0.8865	0.5498
6.1999	4.4635	0.8724	0.5301
6.2999	4.4760	0.8528	0.5184
6.3999	4.4925	0.8363	0.5017
6.4999	4.5048	0.8166	0.4904
6.5999	4.5145	0.7927	0.4834
6.6999	4.5329	0.7799	0.4631
6.7070	4.5333	0.7747	0.4650
6.8000	4.5379	0.7506	0.4630
6.9000	4.5635	0.7451	0.4334
7.0000	4.5897	0.7394	0.4025
7.1000	4.6002	0.7169	0.3943
7.2000	4.6154	0.6995	0.3791
7.3000	4.6191	0.6706	0.3798
7.4000	4.6438	0.6628	0.3515
7.5000	4.6559	0.6431	0.3403
7.6000	4.6695	0.6228	0.3281
7.7000	4.6878	0.6097	0.3078
7.8000	4.7014	0.5903	0.2949
7.9000	4.7167	0.5734	0.2795
8.0000	4.7364	0.5604	0.2581
8.1000	4.7456	0.5373	0.2514
8.2000	4.7685	0.5283	0.2248
8.3000	4.7641	0.4920	0.2366
8.4000	4.7892	0.4842	0.2077
8.4898	4.8062	0.4698	0.1911

Table 1. Continued

(b) Nozzle 6

$x$	$y_R$	$z_R$	$R$
1.0001	4.0060	1.4894	0.9955
1.1001	4.0085	1.4909	0.9936
1.2001	4.0049	1.4863	0.9978
1.3001	4.0097	1.4903	0.9916
1.4001	4.0079	1.4888	0.9936
1.5001	4.0094	1.4897	0.9917
1.6001	4.0091	1.4875	0.9930
1.7001	4.0090	1.4871	0.9932
1.8001	4.0068	1.4846	0.9958
1.9001	4.0058	1.4830	0.9974
2.0001	4.0046	1.4810	0.9989
2.1001	4.0035	1.4792	1.0003
2.2001	4.0026	1.4776	1.0013
2.3001	3.9978	1.4722	1.0074
2.4001	3.9979	1.4713	1.0072
2.5001	3.9963	1.4697	1.0084
2.6001	4.0000	1.4721	1.0032
2.7001	4.0048	1.4758	0.9940
2.7764	4.0117	1.4848	0.9772
2.8000	4.0085	1.4819	0.9780
2.9000	4.0189	1.4941	0.9453
3.0000	4.0153	1.4839	0.9297
3.1000	4.0064	1.4655	0.9215
3.2000	4.0013	1.4473	0.9090
3.3000	3.9987	1.4308	0.8942
3.4000	3.9958	1.4132	0.8796
3.5000	3.9914	1.3947	0.8671
3.6000	3.9883	1.3772	0.8523
3.7000	3.9845	1.3589	0.8391
3.8000	3.9820	1.3420	0.8236
3.9000	3.9760	1.3215	0.8131
4.0000	3.9735	1.3038	0.7982
4.1000	3.9699	1.2860	0.7845
4.2000	3.9674	1.2690	0.7692
4.3000	3.9633	1.2504	0.7560
4.4000	3.9607	1.2334	0.7414
4.5000	3.9566	1.2151	0.7280
4.6000	3.9532	1.1965	0.7149
4.7000	3.9484	1.1773	0.7029
4.8000	3.9458	1.1600	0.6877
4.9000	3.9391	1.1364	0.6803
5.0000	3.9384	1.1234	0.6604
5.1000	3.9334	1.1030	0.6496
5.2000	3.9278	1.0826	0.6387

$x$	$y_R$	$z_R$	$R$
5.3003	3.9062	1.0486	0.6493
5.4003	3.9182	1.0408	0.6179
5.5003	3.9144	1.0216	0.6048
5.6003	3.9122	1.0053	0.5890
5.7003	3.9089	0.9873	0.5750
5.8003	3.9064	0.9696	0.5600
5.9003	3.9028	0.9511	0.5469
6.0003	3.8978	0.9313	0.5348
6.1003	3.8948	0.9138	0.5206
6.2003	3.8917	0.8958	0.5061
6.3003	3.8876	0.8774	0.4932
6.4003	3.8846	0.8594	0.4789
6.5003	3.8807	0.8410	0.4659
6.6003	3.8758	0.8208	0.4544
6.7003	3.8727	0.8038	0.4398
6.8003	3.8708	0.7860	0.4247
6.9003	3.8665	0.7674	0.4120
7.0003	3.8637	0.7497	0.3973
7.1003	3.8559	0.7310	0.3843
7.2003	3.8562	0.7118	0.3714
7.3003	3.8534	0.6942	0.3566
7.4003	3.8503	0.6764	0.3424
7.5003	3.8447	0.6561	0.3313
7.6003	3.8411	0.6379	0.3177
7.7003	3.8383	0.6197	0.3032
7.8003	3.8346	0.6017	0.2898
7.9003	3.8305	0.5829	0.2767
8.0003	3.8277	0.5646	0.2625
8.1003	3.8239	0.5461	0.2496
8.2003	3.8204	0.5280	0.2358
8.3003	3.8167	0.5096	0.2226
8.3679	3.8159	0.4996	0.2109
8.4001	3.8134	0.4919	0.2186
8.5001	3.8112	0.4734	0.1940
8.6001	3.8082	0.4562	0.1795
8.7001	3.8059	0.4409	0.1625
8.8001	3.8043	0.4259	0.1456
8.9001	3.8018	0.4097	0.1293
9.0001	3.7993	0.3932	0.1142
9.1001	3.7968	0.3760	0.0093
9.2001	3.7841	0.3594	0.0845
9.3001	3.7849	0.3368	0.0758
9.3955	3.7814	0.3194	0.0721



Table 1. Continued

(c) Nozzle 7

$x$	$y_R$	$z_R$	$R$
1.0004	4.0138	1.5030	0.9858
1.1004	4.0135	1.5034	0.9861
1.2004	4.0143	1.5036	0.9858
1.3004	4.0146	1.5045	0.9852
1.4004	4.0139	1.5021	0.9874
1.5004	4.0157	1.5039	0.9851
1.6004	4.0153	1.5029	0.9861
1.7004	4.0154	1.5031	0.9859
1.8004	4.0147	1.5033	0.9861
1.9004	4.0147	1.5028	0.9865
2.0004	4.0159	1.5042	0.9846
2.1004	4.0150	1.5031	0.9859
2.2004	4.0133	1.5020	0.9878
2.3004	4.0139	1.5033	0.9862
2.4004	4.0140	1.5024	0.9873
2.5004	4.0141	1.5026	0.9868
2.6004	4.0136	1.5034	0.9860
2.7004	4.0102	1.5028	0.9850
2.7500	4.0120	1.5061	0.9782
2.8001	4.0086	1.5038	0.9742
2.9001	4.0046	1.4998	0.9576
3.0001	3.9999	1.4938	0.9338
3.1001	3.9888	1.4827	0.9152
3.2001	3.9732	1.4688	0.9002
3.3001	3.9598	1.4541	0.8847
3.4001	3.9446	1.4403	0.8691
3.5001	3.9305	1.4266	0.8533
3.6001	3.9134	1.4098	0.8410
3.7001	3.8954	1.3921	0.8298
3.8001	3.8792	1.3765	0.8168
3.9001	3.8619	1.3588	0.8052
4.0001	3.8470	1.3441	0.7907
4.1001	3.8292	1.3259	0.7802
4.2001	3.8131	1.3104	0.7664
4.3001	3.7958	1.2931	0.7551
4.4001	3.7783	1.2753	0.7437
4.5001	3.7623	1.2605	0.7292
4.6001	3.7446	1.2424	0.7188
4.7001	3.7284	1.2263	0.7063
4.8001	3.7080	1.2064	0.6983
4.9001	3.6985	1.1959	0.6770

$x$	$y_R$	$z_R$	$R$
5.0001	3.6728	1.1716	0.6760
5.1001	3.6602	1.1581	0.6588
5.2001	3.6016	1.1005	0.7032
5.3001	3.6397	1.1397	0.6141
5.4001	3.6294	1.1290	0.5933
5.4501	3.6122	1.1084	0.6022
5.6501	3.5824	1.0791	0.5720
5.7501	3.5651	1.0622	0.5633
5.8501	3.5483	1.0453	0.5477
5.9501	3.5359	1.0331	0.5297
6.0501	3.5179	1.0155	0.5184
6.1501	3.5028	1.0009	0.5037
6.2501	3.4862	0.9842	0.4910
6.3501	3.4696	0.9682	0.4778
6.4501	3.4539	0.9530	0.4640
6.5501	3.4352	0.9352	0.4540
6.6501	3.4136	0.9139	0.4479
6.7501	3.3973	0.8971	0.4355
6.8501	3.3862	0.8868	0.4149
6.9501	3.3738	0.8742	0.3969
7.0501	3.3742	0.8749	0.3607
7.1501	3.3438	0.8434	0.3675
7.2501	3.3273	0.8265	0.3551
7.3501	3.3118	0.8115	0.3411
7.4501	3.2946	0.7930	0.3299
7.5501	3.2793	0.7785	0.3153
7.6501	3.2647	0.7641	0.2992
7.7501	3.2516	0.7526	0.2811
7.8501	3.2350	0.7363	0.2679
7.9501	3.2200	0.7209	0.2536
8.0501	3.2085	0.7089	0.2363
8.1996	3.1720	0.6713	0.2327
8.2996	3.1546	0.6542	0.2210
8.3996	3.1389	0.6389	0.2067
8.4996	3.1224	0.6220	0.1947
8.5996	3.1154	0.6160	0.1688
8.6996	3.0975	0.5978	0.1585
8.7996	3.0816	0.5816	0.1451
8.8996	3.0604	0.5648	0.1357
8.9996	3.0332	0.5392	0.1367
9.0193	3.0414	0.5405	0.1226

Table 1. Continued

(d) Nozzle 8

$x$	$y_R$	$z_R$	$R$
0.9991	4.0159	1.5147	0.9825
1.0991	4.0148	1.5131	0.9841
1.1991	4.0147	1.5129	0.9845
1.2991	4.0156	1.5134	0.9833
1.3991	4.0128	1.5112	0.9867
1.4991	4.0145	1.5133	0.9838
1.5991	4.0126	1.5114	0.9862
1.6991	4.0139	1.5142	0.9832
1.7991	4.0155	1.5168	0.9801
1.8991	4.0162	1.5181	0.9790
1.9991	4.0173	1.5202	0.9767
2.0991	4.0201	1.5240	0.9722
2.1991	4.0208	1.5257	0.9703
2.2991	4.0243	1.5307	0.9644
2.3991	4.0236	1.5312	0.9642
2.4991	4.0234	1.5321	0.9630
2.5991	4.0253	1.5341	0.9589
2.6991	4.0210	1.5289	0.9613
2.7503	4.0233	1.5266	0.9574
2.8007	4.0165	1.5153	0.9625
2.9007	4.0085	1.5008	0.9589
3.0007	3.9947	1.4835	0.9511
3.1007	3.9727	1.4678	0.9398
3.2007	3.9497	1.4556	0.9249
3.3007	3.9256	1.4453	0.9074
3.4007	3.9008	1.4339	0.8914
3.5007	3.8761	1.4237	0.8739
3.6007	3.8480	1.4092	0.8619
3.7007	3.8208	1.3966	0.8482
3.8007	3.7920	1.3823	0.8359
3.9007	3.7642	1.3695	0.8226
4.0007	3.7361	1.3564	0.8088
4.1007	3.7078	1.3431	0.7962
4.2007	3.6792	1.3292	0.7835
4.3007	3.6517	1.3168	0.7694
4.4007	3.6248	1.3046	0.7553
4.5007	3.5975	1.2926	0.7407
4.6007	3.5691	1.2780	0.7291
4.7007	3.5409	1.2649	0.7164
4.8007	3.5132	1.2516	0.7029
4.9007	3.4862	1.2390	0.6889
5.0007	3.4577	1.2250	0.6764
5.1007	3.4312	1.2128	0.6617
5.2007	3.4026	1.1984	0.6495
5.3007	3.3757	1.1861	0.6353
5.4007	3.3486	1.1734	0.6207
5.5007	3.3210	1.1601	0.6074
5.6007	3.2941	1.1476	0.5926
5.7007	3.2660	1.1345	0.5792
5.8007	3.2398	1.1225	0.5645
5.9007	3.2119	1.1096	0.5515
6.0007	3.1835	1.0957	0.5387
6.1007	3.1570	1.0844	0.5233
6.2007	3.1292	1.0706	0.5107
6.3007	3.1008	1.0569	0.4980
6.4007	3.0724	1.0434	0.4856
6.5007	3.0456	1.0306	0.4719
6.6007	3.0175	1.0172	0.4586
6.7007	2.9907	1.0047	0.4443
6.8007	2.9629	0.9918	0.4305
6.9007	2.9356	0.9783	0.4172
7.0007	2.9082	0.9652	0.4032
7.1007	2.8808	0.9528	0.3886
7.2007	2.8533	0.9396	0.3755
7.3007	2.8262	0.9278	0.3604
7.4007	2.7984	0.9139	0.3481
7.5007	2.7712	0.9009	0.3349
7.6007	2.7435	0.8882	0.3208
7.7007	2.7169	0.8766	0.3061
7.8007	2.6894	0.8636	0.2921
7.9007	2.6625	0.8515	0.2772
8.0007	2.6355	0.8388	0.2633
8.1007	2.6090	0.8268	0.2481
8.2007	2.5818	0.8143	0.2341
8.3007	2.5548	0.8012	0.2204
8.4007	2.5267	0.7877	0.2069
8.5007	2.5010	0.7753	0.1918
8.6007	2.4721	0.7611	0.1792
8.7007	2.4454	0.7486	0.1646
8.8007	2.4166	0.7341	0.1521
8.9007	2.3882	0.7201	0.1391
9.0007	2.3597	0.7053	0.1270
9.0164	2.3384	0.6834	0.1501

Table 1. Continued

(e) Nozzle 9

$x$	$y_R$	$z_R$	$R$
1.0000	3.0064	0.4965	1.9971
1.1000	3.0075	0.4985	1.9952
1.2000	3.0052	0.4960	1.9987
1.3000	3.0007	0.4922	2.0048
1.4000	3.0008	0.4929	2.0039
1.5000	3.0028	0.4945	2.0018
1.6000	3.0046	0.4971	1.9985
1.7000	3.0005	0.4927	2.0048
1.8000	3.0035	0.4961	2.0001
1.9000	3.0039	0.4961	1.9999
2.0000	3.0029	0.4952	2.0010
2.1000	3.0172	0.5094	1.9813
2.2000	3.0193	0.5115	1.9781
2.3000	3.0086	0.4994	1.9933
2.4000	3.0126	0.5037	1.9870
2.5000	3.0043	0.4956	1.9977
2.6000	3.0166	0.5078	1.9797
2.7000	3.0315	0.5268	1.9546
2.8000	3.0276	0.5251	1.9566
2.8645	3.0377	0.5346	1.9409
2.9000	2.9494	0.4537	2.0580
3.0000	3.0491	0.5281	1.9301
3.1000	3.0874	0.5367	1.8884
3.2000	3.1240	0.5406	1.8501
3.3000	3.1762	0.5587	1.7908
3.4000	3.2066	0.5560	1.7611
3.5000	3.2330	0.5475	1.7375
3.6000	3.2603	0.5425	1.7109
3.7000	3.2910	0.5403	1.6797
3.8000	3.3249	0.5406	1.6450
3.9000	3.3565	0.5399	1.6121
4.0000	3.3837	0.5338	1.5860
4.1000	3.4219	0.5388	1.5448
4.2000	3.4452	0.5306	1.5229
4.3000	3.4810	0.5339	1.4846
4.4000	3.5179	0.5381	1.4448
4.5000	3.5516	0.5382	1.4100
4.6000	3.5890	0.5431	1.3695
4.7000	3.6115	0.5324	1.3496

$x$	$y_R$	$z_R$	$R$
4.8000	3.6591	0.5471	1.2952
4.9000	3.6884	0.5444	1.2654
4.9489	3.6750	0.5121	1.2913
4.9996	3.6189	0.4554	1.3644
5.1003	3.7024	0.4857	1.2692
5.2003	3.7777	0.5331	1.1726
5.3003	3.8184	0.5403	1.1279
5.4003	3.8426	0.5315	1.1057
5.5003	3.8796	0.5366	1.0650
5.6003	3.9139	0.5378	1.0289
5.7003	3.9366	0.5259	1.0098
5.8003	3.9678	0.5249	0.9775
5.9003	3.9957	0.5191	0.9506
6.0003	4.0230	0.5134	0.9244
6.1003	4.0468	0.5040	0.9030
6.2003	4.0793	0.5039	0.8692
6.3003	4.1037	0.4950	0.8470
6.4003	4.1355	0.4928	0.8150
6.5003	4.1667	0.4906	0.7834
6.6003	4.1908	0.4817	0.7614
6.7003	4.2178	0.4745	0.7362
6.8003	4.2467	0.4689	0.7085
6.9003	4.2757	0.4641	0.6802
7.0003	4.3053	0.4596	0.6514
7.1003	4.3234	0.4436	0.6383
7.1681	4.2838	0.3892	0.6968
7.1996	4.2027	0.3346	0.7915
7.2996	4.3786	0.4332	0.5845
7.3996	4.4025	0.4222	0.5638
7.4996	4.4267	0.4127	0.5421
7.5996	4.4516	0.4028	0.5202
7.6996	4.4784	0.3948	0.4959
7.7996	4.5028	0.3851	0.4742
7.8996	4.5328	0.3817	0.4447
7.9996	4.5534	0.3680	0.4285
8.0996	4.5852	0.3665	0.3964
8.1996	4.6078	0.3552	0.3773
8.2996	4.6299	0.3441	0.3587
8.3618	4.6363	0.3293	0.3572

Table 1. Continued

(f) Nozzle 10

$x$	$y_R$	$z_R$	$R$
0.9992	3.0016	0.4936	2.0013
1.0992	3.0007	0.4935	2.0020
1.1992	3.0016	0.4937	2.0013
1.2992	3.0034	0.4953	1.9990
1.3992	3.0022	0.4938	2.0008
1.4992	3.0038	0.4950	1.9992
1.5992	3.0042	0.4957	1.9986
1.6992	3.0040	0.4952	1.9991
1.7992	3.0034	0.4946	2.0000
1.8992	3.0011	0.4922	2.0032
1.9992	3.0077	0.4995	1.9941
2.0992	3.0065	0.4967	1.9969
2.1992	3.0096	0.4998	1.9930
2.2992	3.0102	0.5007	1.9920
2.3992	3.0099	0.4996	1.9928
2.4992	3.0163	0.5063	1.9834
2.5992	3.0288	0.5189	1.9657
2.6001	3.0286	0.5186	1.9656
2.6497	3.0363	0.5263	1.9544
2.7497	3.0539	0.5492	1.9226
2.8497	3.0638	0.5667	1.8945
2.9497	3.0636	0.5688	1.8769
3.0497	3.0713	0.5682	1.8511
3.1497	3.0806	0.5646	1.8252
3.2497	3.0901	0.5606	1.7986
3.3497	3.1009	0.5577	1.7711
3.4497	3.1100	0.5526	1.7454
3.5497	3.1241	0.5520	1.7136
3.6497	3.1308	0.5455	1.6907
3.7497	3.1443	0.5437	1.6599
3.8497	3.1536	0.5399	1.6338
3.9497	3.1647	0.5360	1.6065
4.0497	3.1775	0.5340	1.5761
4.1497	3.1859	0.5287	1.5513
4.2497	3.1972	0.5254	1.5229
4.3497	3.2094	0.5233	1.4930
4.4497	3.2194	0.5197	1.4661
4.5497	3.2333	0.5191	1.4344
4.6497	3.2431	0.5141	1.4084
4.7497	3.2540	0.5115	1.3800
4.8497	3.2647	0.5071	1.3528
4.9497	3.2747	0.5021	1.3264

$x$	$y_R$	$z_R$	$R$
5.0497	3.2866	0.5002	1.2970
5.1497	3.2976	0.4971	1.2688
5.2497	3.3092	0.4945	1.2402
5.3497	3.3205	0.4912	1.2121
5.4497	3.3313	0.4875	1.1846
5.5497	3.3431	0.4855	1.1556
5.6497	3.3536	0.4812	1.1285
5.7497	3.3650	0.4783	1.0999
5.8497	3.3760	0.4747	1.0724
5.9497	3.3863	0.4717	1.0448
6.0497	3.3957	0.4661	1.0193
6.1497	3.4058	0.4611	0.9928
6.2497	3.4193	0.4606	0.9616
6.3497	3.4299	0.4569	0.9343
6.4497	3.4404	0.4530	0.9069
6.5497	3.4491	0.4475	0.8817
6.6497	3.4608	0.4447	0.8531
6.7497	3.4730	0.4422	0.8241
6.8497	3.4831	0.4382	0.7968
6.9497	3.4932	0.4339	0.7702
7.0497	3.5046	0.4306	0.7418
7.1497	3.5141	0.4261	0.7158
7.2497	3.5261	0.4237	0.6863
7.3497	3.5365	0.4195	0.6592
7.4497	3.5451	0.4140	0.6344
7.5497	3.5560	0.4110	0.6064
7.6497	3.5682	0.4088	0.5769
7.7497	3.5799	0.4058	0.5485
7.8497	3.5877	0.3992	0.5245
7.9497	3.5985	0.3961	0.4967
8.0497	3.6122	0.3950	0.4655
8.1497	3.6198	0.3883	0.4415
8.2497	3.6309	0.3852	0.4135
8.3497	3.6416	0.3817	0.3859
8.4497	3.6545	0.3801	0.3553
8.5497	3.6649	0.3757	0.3281
8.6497	3.6779	0.3738	0.2978
8.7497	3.6925	0.3758	0.2637
8.8497	3.7065	0.3760	0.2307
8.9497	3.7220	0.3782	0.1960
9.0497	3.7374	0.3788	0.1623
9.0732	3.7226	0.3580	0.1820

Table 1. Continued

(g) Nozzle 11

$x$	$y_R$	$z_R$	$R$
1.0002	3.0021	0.5133	1.9942
1.1002	3.0071	0.5177	1.9875
1.2002	3.0031	0.5140	1.9925
1.3002	3.0029	0.5130	1.9928
1.4002	3.0039	0.5136	1.9918
1.5002	3.0039	0.5133	1.9915
1.6002	3.0025	0.5117	1.9935
1.7002	3.0047	0.5143	1.9902
1.8002	3.0036	0.5138	1.9911
1.9002	3.0097	0.5193	1.9834
2.0002	3.0101	0.5197	1.9826
2.1002	3.0103	0.5193	1.9825
2.2002	3.0145	0.5236	1.9767
2.3002	3.0153	0.5246	1.9750
2.4002	3.0158	0.5253	1.9736
2.5002	3.0197	0.5283	1.9681
2.6002	3.0229	0.5317	1.9624
2.7002	3.0304	0.5382	1.9493
2.7498	3.0234	0.5259	1.9595
2.8000	3.0290	0.5326	1.9465
2.9000	3.0545	0.5651	1.8907
3.0000	3.0634	0.5769	1.8535
3.1000	3.0606	0.5759	1.8286
3.2000	3.0563	0.5725	1.8043
3.3000	3.0557	0.5728	1.7749
3.4000	3.0534	0.5719	1.7471
3.5000	3.0533	0.5721	1.7174
3.6000	3.0529	0.5718	1.6881
3.7000	3.0526	0.5721	1.6585
3.8000	3.0479	0.5674	1.6351
3.9000	3.0472	0.5664	1.6066
4.0000	3.0456	0.5653	1.5785
4.1000	3.0428	0.5632	1.5522
4.2000	3.0441	0.5642	1.5205
4.3000	3.0418	0.5620	1.4941
4.4000	3.0402	0.5601	1.4663
4.5000	3.0398	0.5592	1.4376
4.6000	3.0379	0.5577	1.4097
4.7000	3.0355	0.5548	1.3836
4.8000	3.0330	0.5520	1.3571
4.9000	3.0334	0.5523	1.3271
5.0000	3.0300	0.5488	1.3016
5.1000	3.0275	0.5465	1.2754

$x$	$y_R$	$z_R$	$R$
5.2000	3.0261	0.5447	1.2475
5.3000	3.0224	0.5417	1.2226
5.4000	3.0222	0.5411	1.1931
5.5000	3.0217	0.5407	1.1641
5.6000	3.0185	0.5376	1.1383
5.7000	3.0175	0.5369	1.1099
5.8000	3.0159	0.5353	1.0820
5.9000	3.0146	0.5339	1.0543
6.0000	3.0146	0.5341	1.0241
6.1000	3.0125	0.5317	0.9977
6.2000	3.0119	0.5305	0.9687
6.3000	3.0097	0.5287	0.9417
6.4000	3.0088	0.5280	0.9127
6.5000	3.0077	0.5269	0.8845
6.6000	3.0050	0.5238	0.8584
6.7000	3.0035	0.5229	0.8303
6.8000	3.0022	0.5215	0.8021
6.9000	3.0016	0.5213	0.7733
7.0000	3.0004	0.5207	0.7444
7.1000	2.9984	0.5189	0.7174
7.2000	2.9986	0.5183	0.6878
7.3000	2.9985	0.5186	0.6579
7.4000	2.9967	0.5166	0.6306
7.5000	2.9940	0.5137	0.6047
7.6000	2.9931	0.5127	0.5761
7.7000	2.9920	0.5115	0.5482
7.8000	2.9919	0.5111	0.5185
7.9000	2.9909	0.5102	0.4905
8.0000	2.9887	0.5080	0.4632
8.1000	2.9877	0.5073	0.4349
8.2000	2.9871	0.5065	0.4058
8.3000	2.9868	0.5057	0.3771
8.4000	2.9851	0.5031	0.3500
8.5000	2.9813	0.4991	0.3257
8.6000	2.9795	0.4969	0.2983
8.7000	2.9772	0.4938	0.2724
8.8000	2.9742	0.4911	0.2461
8.9000	2.9708	0.4869	0.2214
9.0000	2.9688	0.4847	0.1941
9.1000	2.9654	0.4815	0.1684
9.2000	2.9615	0.4772	0.1433
9.2410	2.9583	0.4734	0.1356

Table 1. Concluded

(h) Nozzle 12

$x$	$y_R$	$z_R$	$R$
1.0000	3.0007	0.4884	2.0069
1.1000	3.0025	0.4909	2.0041
1.2000	3.0031	0.4918	2.0035
1.3000	3.0037	0.4922	2.0028
1.4000	3.0034	0.4925	2.0033
1.5000	3.0032	0.4926	2.0036
1.6000	3.0035	0.4930	2.0031
1.7000	3.0048	0.4946	2.0014
1.8000	3.0054	0.4949	2.0008
1.9000	3.0043	0.4942	2.0020
2.0000	3.0024	0.4926	2.0041
2.1000	3.0043	0.4942	2.0016
2.2000	3.0073	0.4971	1.9974
2.3000	3.0064	0.4965	1.9980
2.4000	3.0065	0.4969	1.9976
2.5000	3.0093	0.4999	1.9935
2.6000	3.0144	0.5047	1.9865
2.7000	3.0234	0.5114	1.9744
2.7496	3.0326	0.5162	1.9618
2.8000	3.0362	0.5159	1.9555
2.9000	3.0477	0.5182	1.9277
3.0000	3.0413	0.5102	1.9090
3.1000	3.0268	0.5033	1.8889
3.2000	3.0119	0.4998	1.8656
3.3000	3.0072	0.5076	1.8274
3.4000	2.9935	0.5082	1.7998
3.5000	2.9793	0.5086	1.7728
3.6000	2.9681	0.5121	1.7425
3.7000	2.9550	0.5140	1.7139
3.8000	2.9420	0.5159	1.6859
3.9000	2.9421	0.5382	1.6346
4.0000	2.9167	0.5197	1.6292
4.1000	2.9039	0.5216	1.6013
4.2000	2.8917	0.5244	1.5717
4.3000	2.8801	0.5271	1.5424
4.4000	2.8691	0.5315	1.5108
4.5000	2.8558	0.5327	1.4836
4.6000	2.8414	0.5329	1.4574
4.7000	2.8308	0.5372	1.4263
4.8000	2.8161	0.5368	1.4004
4.9000	2.8059	0.5409	1.3692
5.0000	2.7916	0.5411	1.3426

$x$	$y_R$	$z_R$	$R$
5.1000	2.7799	0.5445	1.3120
5.2000	2.7655	0.5443	1.2864
5.3000	2.7546	0.5481	1.2556
5.4000	2.7418	0.5505	1.2267
5.5000	2.7304	0.5542	1.1957
5.6000	2.7172	0.5555	1.1684
5.7000	2.7047	0.5575	1.1402
5.8000	2.6927	0.5610	1.1099
5.9000	2.6815	0.5642	1.0800
6.0000	2.6666	0.5644	1.0541
6.1000	2.6537	0.5659	1.0260
6.2000	2.6416	0.5690	0.9966
6.3000	2.6288	0.5710	0.9681
6.4000	2.6168	0.5741	0.9386
6.5000	2.6049	0.5767	0.9089
6.6000	2.5915	0.5778	0.8818
6.7000	2.5801	0.5807	0.8521
6.8000	2.5664	0.5821	0.8242
6.9000	2.5523	0.5826	0.7973
7.0000	2.5393	0.5839	0.7697
7.1000	2.5275	0.5871	0.7393
7.2000	2.5143	0.5886	0.7117
7.3000	2.5013	0.5902	0.6839
7.4000	2.4888	0.5925	0.6549
7.5000	2.4761	0.5942	0.6268
7.6000	2.4630	0.5963	0.5983
7.7000	2.4498	0.5969	0.5709
7.8000	2.4369	0.5991	0.5427
7.9000	2.4252	0.6019	0.5132
8.0000	2.4122	0.6039	0.4848
8.1000	2.3999	0.6062	0.4555
8.2000	2.3869	0.6082	0.4275
8.3000	2.3739	0.6099	0.3997
8.4000	2.3625	0.6133	0.3691
8.5000	2.3479	0.6125	0.3437
8.6000	2.3359	0.6158	0.3135
8.7000	2.3224	0.6163	0.2867
8.8000	2.3092	0.6181	0.2581
8.9000	2.2983	0.6215	0.2278
9.0000	2.2848	0.6221	0.2001
9.1000	2.2737	0.6252	0.1701
9.1511	2.2648	0.6219	0.1599

Table 2. Pressure Orifice Locations for Each Nozzle

[All dimensions are given in inches]

(a) Nozzle 2

Top		Left side		Bottom	
x	y	x	z	x	y
1.446	-0.004	1.450	-2.191	1.449	-0.007
1.444	-2.606	1.452	0.000	2.143	-0.004
1.447	-3.905	1.451	1.463	2.844	-0.006
1.441	-4.562	1.452	2.194	3.195	-0.004
2.148	-4.454	2.148	2.033	3.895	-0.004
2.147	-3.813	2.148	1.354	5.295	-0.004
2.146	-2.546	2.148	0.002	6.696	-0.004
2.142	-0.002	2.148	-2.027	8.794	-0.007
2.846	-0.002	2.843	-1.861	1.446	-2.609
2.841	-2.486	2.846	0.003	1.444	-4.566
2.847	-3.725	2.844	1.244	2.142	-4.142
2.843	-4.350	2.844	1.865	2.143	-2.550
3.194	-4.300	3.198	1.789	2.843	-2.489
3.195	-3.683	3.195	1.195	2.843	-4.357
3.195	-2.454	3.197	0.003	3.191	-4.303
3.194	0.001	3.199	-1.781	3.191	-2.462
3.898	-0.001	3.896	-1.619	3.891	-2.398
3.894	-2.393	3.896	0.002	3.890	-4.199
3.896	-3.593	3.895	1.080	5.293	-3.988
3.893	-4.192	3.893	1.624	5.291	-2.283
4.595	-0.001	4.597	0.002	6.691	-2.161
5.296	-0.002	5.299	0.006	6.693	-3.777
5.295	-2.275	5.298	0.865	7.292	-3.672
5.296	-3.413	5.296	1.296	7.389	-2.100
5.293	-3.982	5.295	-1.291	8.094	-2.043
5.997	-0.002	5.996	-0.002	8.093	-3.574
6.694	-0.001	6.698	-0.964	8.794	-3.467
6.695	-2.155	6.696	0.002	8.792	-1.983
6.694	-3.234	6.698	0.647		
6.691	-3.771	6.695	0.964		
7.392	-3.672	7.395	0.535		
7.395	-3.141	7.395	0.802		
7.397	-2.097	7.398	0.002		
7.394	-0.002	8.099	0.003		
8.096	-0.002	8.098	0.430		
8.096	-2.034	8.099	0.636		
8.093	-3.051	8.799	0.479		
8.091	-3.566	8.795	0.318		
8.795	-3.458	8.795	0.003		
8.795	-2.966	8.798	-0.469		
8.792	-1.976				
8.795	-0.001				

Table 2. Continued

(b) Nozzle 3

Top		Left side		Bottom	
x	y	x	z	x	y
1.444	0.005	1.450	-2.171	1.444	-0.011
1.446	-2.694	1.449	0.001	1.446	-2.707
1.444	-4.044	1.450	1.448	1.444	-4.729
1.443	-4.717	1.447	2.169	2.145	-4.550
2.148	-4.532	2.148	2.018	2.148	-2.600
2.139	-3.888	2.146	1.350	2.148	-0.008
2.145	-2.591	2.148	0.004	2.847	-0.002
2.145	-0.003	2.150	-2.017	2.846	-2.501
2.849	0.000	2.850	-1.856	2.846	-4.367
2.844	-2.482	2.850	0.009	3.192	-4.293
2.844	-3.729	2.850	1.246	3.194	-2.443
2.841	-4.358	2.847	1.865	3.195	-0.005
3.195	-4.263	3.195	1.790	3.894	-0.003
3.198	-3.657	3.195	1.191	3.893	-2.343
3.198	-2.439	3.202	0.009	3.893	-4.098
3.197	0.000	3.198	-1.779	5.293	-3.734
3.894	0.010	3.899	-1.621	5.294	-2.139
3.895	-2.335	3.895	0.009	5.290	-0.006
3.898	-3.496	3.896	1.091	6.699	-0.010
3.895	-4.088	3.895	1.632	6.693	-1.932
4.595	0.005	4.599	0.002	6.694	-3.373
5.298	0.006	5.301	0.007	7.392	-3.195
5.298	-2.126	5.299	-1.317	7.394	-1.833
5.301	-3.194	5.295	0.886	8.098	-1.743
5.298	-3.729	5.295	1.321	8.094	-3.017
5.998	0.002	5.999	0.012	8.795	-2.836
6.695	-0.002	6.698	0.010	8.794	-1.624
6.696	-1.923	6.699	0.680	8.795	-0.006
6.698	-2.887	6.696	1.015		
6.699	-3.370	6.704	-1.002		
7.400	-3.184	7.397	0.013		
7.392	-2.724	7.395	0.579		
7.398	-1.814	7.392	0.854		
7.395	0.000	8.099	0.711		
8.098	0.000	8.101	0.481		
8.095	-1.713	8.102	0.009		
8.091	-2.580	8.800	0.010		
8.098	-3.006	8.799	0.373		
8.797	-2.819	8.800	0.558		
8.794	-2.414	8.798	-0.535		
8.798	-1.608				
8.785	0.000				



Table 2. Continued

(c) Nozzle 5

Top		Left side		Bottom	
x	y	x	z	x	y
1.443	0.003	1.450	-1.472	1.448	0.001
1.446	-2.499	1.447	-0.003	2.150	0.001
1.447	-3.745	1.447	1.469	2.843	-0.001
1.443	-4.376	1.447	2.167	3.195	0.001
2.145	-4.373	2.149	2.169	3.897	-0.002
2.147	-3.747	2.152	1.358	5.295	0.001
2.143	-2.499	2.152	-0.002	6.698	-0.001
2.150	0.002	2.152	-1.359	8.796	-0.001
2.841	0.000	2.847	-1.246	1.450	-2.500
2.843	-2.499	2.851	0.002	2.147	-2.499
2.843	-3.750	2.850	1.246	2.848	-2.502
2.843	-4.375	2.847	2.143	3.196	-2.500
3.192	-4.373	3.196	2.050	3.895	-2.499
3.194	-3.750	3.201	1.187	5.297	-2.500
3.192	-2.499	3.201	0.000	6.698	-2.500
3.191	-0.000	3.198	-1.189	7.396	-2.500
3.890	-0.000	3.899	-1.079	8.097	-2.501
3.894	-2.501	3.895	-0.002	8.795	-2.499
3.894	-3.748	3.897	1.072	1.447	-4.371
3.890	-4.378	3.899	1.863	2.144	-4.369
4.589	0.001	4.601	-0.003	2.845	-4.373
5.291	-0.000	5.300	0.000	3.198	-4.369
5.295	-2.499	5.302	-0.852	3.895	-4.373
5.294	-3.751	5.300	0.849	5.297	-4.374
5.293	-4.376	5.297	1.477	6.697	-4.374
5.991	0.000	6.002	-0.001	7.396	-4.376
6.691	-0.002	6.700	-0.001	8.095	-4.370
6.696	2.501	6.701	-0.627	8.796	-4.374
6.696	-3.750	6.700	0.624		
6.694	-4.377	6.699	1.098		
7.391	-4.376	7.395	0.906		
7.389	-3.750	7.399	0.507		
7.389	-2.501	7.399	-0.002		
7.391	0.002	8.100	-0.004		
8.093	0.002	8.100	0.394		
8.098	-2.502	8.097	0.715		
8.095	-3.746	8.799	0.524		
8.093	-4.378	8.799	0.285		
8.795	-4.379	8.801	-0.001		
8.794	-3.750	8.802	-0.284		
8.792	-2.498				
8.791	-0.002				

Table 2. Continued

(d) Nozzle 6

Top		Left side		Bottom	
x	y	x	z	x	y
1.446	-0.002	1.460	-1.456	1.444	-0.016
1.449	-2.605	1.449	0.004	1.444	-2.605
1.444	-3.910	1.439	1.467	1.444	-4.553
1.449	-4.561	1.436	2.206	2.138	-4.452
2.148	-4.459	2.137	2.209	2.143	-2.547
2.145	-3.822	2.142	1.362	2.148	-0.002
2.148	-2.548	2.148	0.010	2.847	0.002
2.148	-0.015	2.157	-1.344	2.846	-2.485
2.847	-0.007	2.855	-1.229	2.839	-4.348
2.844	-2.488	2.854	0.018	3.189	-4.294
2.849	-3.734	2.841	1.264	3.192	-2.454
2.844	-4.353	2.836	2.202	3.191	0.002
3.197	-4.299	3.184	2.114	3.891	0.003
3.194	-3.688	3.190	1.204	3.893	-2.397
3.195	-2.460	3.197	0.015	3.890	-4.187
3.195	-0.005	3.206	-1.174	5.288	-3.976
3.896	-0.003	3.907	-1.059	5.294	-2.277
3.899	-2.399	3.898	0.021	5.296	0.000
3.893	-3.594	3.896	1.099	6.699	0.002
3.894	-4.195	3.890	1.930	6.696	-2.166
4.600	-0.002	4.601	0.024	6.694	-3.776
5.296	0.000	5.296	0.029	7.392	-3.668
5.293	-2.279	5.293	0.889	7.398	-2.101
5.299	-3.419	5.292	1.565	8.094	-2.038
5.298	-3.980	5.304	-0.834	8.094	-3.557
5.994	0.000	6.003	0.031	8.795	-3.457
6.698	-3.772	6.699	-0.612	8.794	-1.976
6.698	-3.233	6.699	0.040	8.792	-0.002
6.696	-2.154	6.693	0.680		
6.698	-0.002	6.691	1.196		
7.397	-0.005	7.392	1.014		
7.397	-2.098	7.395	0.576		
7.397	-3.140	7.400	0.042		
7.397	-3.673	8.102	0.043		
8.090	-3.562	8.094	0.470		
8.096	-3.054	8.094	0.826		
8.098	-2.041	8.795	0.650		
8.099	0.000	8.795	0.363		
8.795	-0.005	8.798	0.051		
8.798	-1.975	8.800	-0.269		
8.794	-2.961				
8.794	-3.458				

Table 2. Continued

(e) Nozzle 7

Top		Left side		Bottom	
x	y	x	z	x	y
1.452	0.003	1.457	-1.445	1.450	0.003
1.451	-2.697	1.457	-0.001	1.453	-2.695
1.454	-4.047	1.457	1.448	1.450	-4.710
1.453	-4.715	1.452	2.204	2.150	-4.537
2.149	-4.536	2.156	2.205	2.148	-2.593
2.155	-3.891	2.157	1.341	2.152	0.006
2.154	-2.592	2.153	-0.001	2.847	-0.002
2.154	0.002	2.157	-1.345	2.845	-2.491
2.852	0.003	2.853	-1.240	2.846	-4.357
2.850	-2.487	2.854	-0.001	3.198	-4.268
2.849	-3.734	2.853	1.240	3.198	-2.435
2.848	-4.355	2.856	2.194	3.198	0.000
3.200	-4.263	3.208	2.114	3.902	-0.002
3.198	-3.655	3.203	1.187	3.899	-2.334
3.198	-2.436	3.206	0.001	3.899	-4.087
3.198	0.001	3.203	-1.194	5.300	-3.724
3.901	0.003	3.903	-1.089	5.302	-2.133
3.898	-2.336	3.903	-0.003	5.301	-0.003
3.900	-3.502	3.905	1.084	6.699	-0.001
3.901	-4.086	3.906	1.937	6.701	-1.921
4.603	0.002	4.604	-0.002	6.698	-3.362
5.301	0.001	5.302	-0.004	7.400	-3.184
5.304	-2.130	5.306	-0.885	7.402	-1.820
5.300	-3.194	5.305	0.878	8.102	-1.720
5.299	-3.728	5.306	1.582	8.102	-3.006
6.002	0.001	6.003	-0.001	8.801	-2.820
6.702	0.003	6.705	-0.002	8.802	-1.612
6.699	-1.922	6.703	-0.675	8.798	-0.001
6.699	-2.880	6.704	0.668		
6.697	-3.365	6.702	1.226		
7.403	-3.185	7.404	1.051		
7.399	-2.727	7.407	0.567		
7.400	-1.817	7.405	-0.003		
7.398	0.003	8.103	-0.002		
8.102	0.003	8.102	0.468		
8.099	-1.713	8.106	0.870		
8.103	-2.576	8.809	0.687		
8.099	-3.002	8.803	0.366		
8.797	-2.820	8.805	0.000		
8.800	-2.422	8.804	-0.371		
8.800	-1.615				
8.802	0.004				

Table 2. Continued

(f) Nozzle 8

Top		Left side		Bottom	
x	y	x	z	x	y
1.447	-0.002	1.452	-1.421	1.450	0.006
1.447	-2.796	1.453	0.004	1.450	-2.795
1.450	-4.193	1.452	1.431	1.450	-4.888
1.451	-4.895	1.448	2.206	2.150	-4.638
2.146	-4.637	2.146	2.206	2.148	-2.654
2.147	-3.980	2.152	1.335	2.146	0.006
2.144	-2.650	2.151	0.009	2.853	0.000
2.147	0.003	2.152	-1.330	2.851	-2.507
2.850	-0.001	2.850	-1.240	2.853	-4.391
2.850	-2.502	2.850	0.004	3.199	-4.265
2.850	-3.765	2.853	1.240	3.199	-2.438
2.850	-4.387	2.852	2.196	3.199	0.000
3.196	-4.259	3.201	2.132	3.902	0.005
3.198	-3.648	3.201	1.191	3.902	-2.291
3.196	-2.434	3.201	-0.001	3.895	-4.009
3.198	0.002	3.200	-1.191	5.299	-3.504
3.897	0.004	3.900	-1.100	5.302	-2.005
3.898	-2.286	3.904	0.001	5.295	0.005
3.898	-3.437	3.900	1.095	6.698	0.005
3.895	-4.007	3.905	1.969	6.702	-1.713
4.597	0.004	4.601	0.001	6.698	-3.009
5.295	0.001	5.297	-0.008	7.401	-2.758
5.297	-1.999	5.300	-0.917	7.398	-1.575
5.294	-3.004	5.297	0.904	8.099	-1.429
5.297	-3.502	5.302	1.642	8.100	-2.504
6.000	0.006	5.999	-0.005	8.802	-2.250
6.697	0.004	6.703	1.310	8.799	-1.284
6.698	-1.711	6.699	0.723	8.799	-0.003
6.697	-2.568	6.702	-0.008		
6.695	-3.004	6.700	-0.729		
7.396	-2.749	7.401	-0.006		
7.396	-2.355	7.404	0.625		
7.396	-1.565	7.406	1.150		
7.398	0.002	8.106	0.997		
8.098	-0.001	8.103	0.532		
8.100	-1.424	8.105	-0.003		
8.097	-2.144	8.801	-0.010		
8.097	-2.499	8.803	-0.444		
8.798	-2.242	8.798	0.439		
8.793	-1.923	8.799	0.838		
8.798	-1.281				
8.798	-0.001				

Table 2. Continued

(g) Nozzle 9

Top		Left side		Bottom	
x	y	x	z	x	y
1.447	-0.005	1.450	-1.472	1.442	0.003
1.445	-1.250	1.450	-0.002	1.442	-2.501
1.447	-2.499	1.448	1.469	1.446	-3.754
1.448	-3.750	1.451	1.921	2.144	-3.751
2.149	-3.750	2.144	1.921	2.143	-2.500
2.144	-2.505	2.148	1.356	2.144	-0.002
2.144	-1.250	2.147	-0.002	2.843	-0.003
2.144	-0.001	2.147	-1.357	2.843	-2.499
2.843	-0.004	2.850	-1.251	2.847	-3.759
2.843	-1.250	2.850	-0.001	3.199	-3.756
2.845	-2.502	2.851	1.242	3.194	-2.501
2.851	-3.762	2.851	1.867	3.191	-0.003
3.202	-3.752	3.196	1.801	3.892	-0.002
3.196	-2.510	3.201	1.190	3.892	-2.501
3.194	-1.251	3.196	-0.002	3.898	-3.753
3.196	-0.001	3.201	-1.194	5.294	-3.751
3.895	-0.004	3.903	-1.087	5.292	-2.501
3.895	-1.245	3.895	-0.005	5.292	-0.000
3.897	-2.497	3.898	1.078	6.692	0.003
3.905	-3.746	3.897	1.631	6.695	-2.496
4.593	0.001	4.599	-0.006	6.692	-3.751
5.297	-0.001	5.298	-0.004	7.391	-3.748
5.295	-1.253	5.298	-0.856	7.398	-2.499
5.297	-2.500	5.302	0.846	8.092	-2.498
5.294	3.749	5.297	1.303	8.091	-3.750
5.993	0.001	5.999	-0.005	8.793	-3.756
6.693	-0.001	6.698	-0.002	8.791	-2.496
6.695	-1.251	6.697	-0.628	8.791	0.003
6.697	-2.506	6.697	0.626		
6.695	-3.750	6.702	0.974		
7.401	-3.746	7.401	0.801		
7.398	-2.503	7.396	0.512		
7.396	-1.250	7.398	-0.001		
7.398	-0.001	8.100	0.003		
8.095	-0.001	8.102	0.399		
8.097	-1.250	8.102	0.637		
8.092	-2.497	8.795	0.483		
8.097	-3.750	8.799	0.286		
8.799	-3.749	8.798	0.002		
8.794	-2.505	8.801	-0.294		
8.796	-1.248				
8.793	0.001				

Table 2. Continued

(h) Nozzle 10

Top		Left side		Bottom	
x	y	x	z	x	y
1.443	-0.006	1.449	-1.454	1.443	0.000
1.443	-1.302	1.449	0.003	1.441	-2.605
1.442	-2.607	1.448	1.465	1.445	-3.904
1.446	-3.906	1.443	2.289	2.143	-3.815
2.147	-3.819	2.145	1.910	2.145	-2.546
2.146	-2.549	2.146	1.354	2.143	0.000
2.149	-1.276	2.146	0.001	2.843	0.002
2.143	-0.003	2.150	-1.346	2.843	-2.484
2.847	-0.004	2.850	-1.238	2.844	-3.724
2.847	-1.243	2.847	0.001	3.193	-3.679
2.848	-2.491	2.846	1.245	3.191	-2.456
2.845	-3.724	2.850	1.904	3.192	0.002
3.193	-3.681	3.192	1.827	3.893	0.002
3.195	-2.461	3.197	1.192	3.893	-2.396
3.198	-1.234	3.195	0.004	3.892	-3.589
3.195	-0.003	3.198	-1.188	5.289	-3.408
3.895	-0.007	3.895	-1.077	5.291	-2.273
3.896	-1.201	3.896	0.005	5.290	0.006
3.896	-2.395	3.897	1.083	6.695	0.004
3.897	-3.597	3.892	1.677	6.692	-2.153
4.595	-0.006	4.594	0.004	6.691	-3.231
5.295	-0.008	5.295	0.006	7.391	-3.141
5.298	-1.139	5.298	-0.861	7.391	-2.094
5.297	-2.279	5.298	0.867	8.089	-2.035
5.295	-3.413	5.291	1.355	8.086	-3.050
5.995	-0.006	5.996	0.008	8.790	-2.962
6.697	-0.004	6.697	0.003	8.791	-1.974
6.697	-1.077	6.695	-0.642	8.791	0.000
6.696	-2.156	6.695	0.648		
6.697	-3.235	6.695	1.039		
7.396	-3.143	7.395	0.878		
7.396	-2.098	7.391	0.539		
7.397	-1.050	7.393	0.004		
7.395	-0.002	8.096	0.009		
8.096	-0.002	8.095	0.428		
8.095	-1.021	8.095	0.720		
8.095	-2.037	8.795	0.562		
8.098	-3.054	8.793	0.322		
8.801	-2.965	8.793	0.010		
8.799	-1.978	8.795	-0.310		
8.801	-0.991				
8.795	-0.001				

Table 2. Continued

(i) Nozzle 11

Top		Left side		Bottom	
x	y	x	z	x	y
1.444	-0.006	1.446	-1.446	1.448	-0.005
1.443	-1.354	1.447	-0.008	1.447	-2.699
1.443	-2.702	1.447	1.437	1.445	-4.043
1.391	-4.048	1.451	1.904	2.143	-3.894
2.143	-3.890	2.149	1.904	2.143	-2.598
2.142	-2.596	2.147	1.340	2.145	-0.005
2.143	-1.298	2.147	-0.005	2.844	-0.002
2.143	-0.003	2.147	-1.344	2.841	-2.495
2.844	-0.004	2.847	-1.241	2.842	-3.737
2.842	-1.250	2.847	-0.008	3.194	-3.661
2.839	-2.495	2.846	1.237	3.192	-2.442
2.842	-3.737	2.846	1.893	3.194	-0.002
3.188	-3.665	3.197	1.812	3.894	-0.006
3.191	-2.445	3.194	1.182	3.895	-2.343
3.191	-1.224	3.194	-0.005	3.893	-3.509
3.193	-0.006	3.193	-1.191	5.294	-3.199
3.890	-0.005	3.898	-1.089	5.294	-2.135
3.892	-1.169	3.891	-0.007	5.291	-0.007
3.894	-2.339	3.895	1.078	6.692	-0.003
3.891	-3.509	3.898	1.654	6.695	-1.931
4.593	0.000	4.588	0.000	6.691	-2.891
5.287	-0.003	5.295	-0.004	7.394	-2.736
5.292	-1.069	5.295	-0.881	7.391	-1.823
5.293	-2.131	5.297	0.874	8.097	-1.721
5.295	-3.199	5.295	1.389	8.095	-2.562
5.990	-0.004	5.990	-0.006	8.796	-2.428
6.689	-0.001	6.687	-0.004	8.798	-1.620
6.690	-0.965	6.691	-0.674	8.797	-0.005
6.690	-1.928	6.691	0.672		
6.692	-2.888	6.695	1.098		
7.390	-2.734	7.395	0.949		
7.390	-1.821	7.391	0.567		
7.393	-0.911	7.390	-0.007		
7.391	0.002	8.086	-0.006		
8.091	-0.002	8.092	0.464		
8.091	-0.862	8.095	0.802		
8.089	-1.720	8.791	-0.368		
8.092	-2.581	8.786	-0.011		
8.791	-2.443	8.789	0.360		
8.791	-1.616	8.792	0.654		
8.791	-0.808				
8.790	0.000				

Table 2. Concluded

(j) Nozzle 12

Top		Left side		Bottom	
x	y	x	z	x	y
1.443	-0.003	1.445	-1.426	1.440	-0.003
1.444	-1.399	1.447	-0.001	1.440	-2.799
1.447	-2.799	1.443	1.423	1.440	-4.196
1.443	-4.197	1.444	1.916	2.139	-3.980
2.143	-3.977	2.143	1.917	2.135	-2.657
2.144	-2.652	2.142	1.330	2.139	-0.004
2.143	-1.328	2.147	-0.001	2.837	-0.003
2.143	-0.003	2.147	-1.329	2.838	-2.511
2.843	-0.006	2.846	-1.233	2.837	-3.761
2.839	-1.256	2.842	0.004	3.189	-3.656
2.839	-2.507	2.845	1.238	3.189	-2.442
2.843	-3.763	2.842	1.913	3.187	-0.002
3.191	-3.657	3.193	1.857	3.886	-0.003
3.193	-2.436	3.195	1.192	3.889	-2.296
3.192	-1.221	3.192	0.002	3.888	-3.441
3.190	-0.005	3.194	-1.181	5.288	-3.009
3.889	-0.005	3.895	-1.097	5.287	-2.010
3.890	-1.150	3.893	-0.002	5.290	-0.001
3.891	-2.292	3.891	1.096	6.691	-0.001
3.892	-3.442	3.891	1.724	6.688	-1.719
4.589	-0.007	4.588	0.002	6.688	-2.580
5.288	-0.004	5.293	-0.910	7.391	-2.363
5.289	-0.999	5.291	0.001	7.388	-1.573
5.291	-2.004	5.293	0.910	8.091	-1.432
5.293	-3.006	5.291	1.459	8.087	-2.144
5.991	-0.003	5.991	-0.001	8.791	-1.931
6.688	-0.003	6.694	-0.723	8.790	-1.287
6.691	-0.859	6.693	-0.002	8.790	-0.003
6.695	-1.717	6.691	0.720		
6.692	-2.578	6.688	1.200		
7.395	-2.356	7.390	1.067		
7.396	-1.574	7.398	0.633		
7.395	-0.787	7.394	0.001		
7.398	-0.002	8.092	0.936		
8.092	-0.002	8.101	0.535		
8.095	-0.713	8.091	-0.002		
8.095	-1.428	8.793	-0.446		
8.091	-2.140	8.790	0.000		
8.792	-1.927	8.795	0.442		
8.795	-1.284	8.789	0.807		
8.794	-0.643				
8.793	-0.004				



Table 3. Index of Configurations

(a) Nozzle configurations tested

Nozzle (a)	$\beta_{t,top/bot}/\beta_{t,side}$ deg				Corner radius		
	17.9/0	17.3/9.7	16.4/16.4	15.0/22.4	Sharp	1 in.	2 in.
(1)	X				X		
2		X			X		
3			X		X		
(4)				X	X		
5	X					X	
6		X				X	
7			X			X	
8				X		X	
9	X						X
10		X					X
11			X				X
12				X			X

<sup>a</sup> Nozzle number in parentheses indicates data not presented.

(b) Data tables and figures

Nozzle	Solid plume	Table	Figures
2	On	4	7(a)–7(c), 8(a), 10, 14
3	On	5	7(d)–7(f), 8(b), 11, 14
3	Off	6	7(d)–7(f), 13(b)
5	On	7	7(g)–7(i), 8(c), 9, 15
5	Off	8	7(g)–7(i), 13(a), 17(a)
6	Off	9	7(j)–7(l)
7	On	10	7(m)–7(o), 8(d), 11, 15
7	Off	11	7(m)–7(o), 13(b), 17(a)
8	On	12	7(p), 7(q), 8(e), 12, 15
8	Off	13	7(p), 7(q), 13(c), 17(a)
9	On	14	7(r)–7(t), 8(f), 9, 16
9	Off	15	7(r)–7(t), 13(a), 17(b)
10	On	16	7(u)–7(w), 8(g), 10, 16,
10	Off	17	7(u)–7(w), 17(b)
11	On	18	7(x)–7(z), 8(h), 11, 16
11	Off	19	7(x)–7(z), 13(b), 17(b)
12	On	20	7(aa)–7(cc), 8(i), 12, 16
12	Off	21	7(aa)–7(cc), 13(c), 17(b)

Table 4. Pressure and Force Data for Nozzle 2 With  $\beta_{r,top/bot} = 17.3^\circ$ ,  $\beta_{r,side} = 9.7^\circ$ , Plume On, and  $\alpha = 0^\circ$ 

(a) Static pressure coefficients on nozzle top flap

$M_\infty$	Static pressure coefficients on nozzle top flap at centerline with values of $x/l$ of—															
	.153	.226	.300	.337	.411	.484	.558	.632	.705	.779	.853	.926				
0.599	-0.304	-0.459	-1.096	-0.547	-0.225	—	-0.001	0.064	0.115	0.159	0.193	0.219				
0.700	-0.294	-0.447	-1.383	-0.579	-0.211	—	0.009	0.068	0.111	0.145	0.168	0.189				
0.801	-0.222	-0.329	-0.807	-0.324	-0.212	—	-0.110	-0.075	-0.048	-0.018	0.009	0.042				
1.250	-0.010	-0.017	-0.377	-0.521	-0.500	—	-0.184	-0.156	-0.143	-0.131	-0.117	-0.098				
1.201	-0.010	-0.024	-0.416	-0.569	-0.542	—	-0.193	-0.168	-0.158	-0.142	-0.126	-0.112				
1.149	-0.031	-0.048	-0.473	-0.629	-0.604	—	-0.211	-0.190	-0.173	-0.158	-0.144	-0.126				
0.950	-0.101	-0.166	-0.709	-0.409	-0.289	—	-0.219	-0.205	-0.190	-0.173	-0.156	-0.125				
0.926	-0.126	-0.197	-0.663	-0.332	-0.249	—	-0.202	-0.185	-0.171	-0.151	-0.125	-0.093				
0.899	-0.153	-0.228	-0.640	-0.293	-0.230	—	-0.188	-0.166	-0.147	-0.123	-0.096	-0.059				
0.873	-0.171	-0.256	-0.638	-0.283	-0.221	—	-0.168	-0.140	-0.116	-0.090	-0.062	-0.026				
0.852	-0.188	-0.277	-0.670	-0.292	-0.220	—	-0.153	-0.126	-0.098	-0.073	-0.042	-0.008				
0.801	-0.221	-0.329	-0.790	-0.319	-0.211	—	-0.109	-0.074	-0.047	-0.020	0.009	0.039				
0.701	-0.292	-0.444	-1.340	-0.564	-0.207	—	0.011	0.069	0.110	0.141	0.163	0.182				
0.603	-0.304	-0.457	-1.084	-0.540	-0.225	—	0.001	0.066	0.115	0.156	0.188	0.213				
0.400	-0.282	-0.413	-0.879	-0.490	-0.220	—	-0.010	0.056	0.102	0.148	0.180	0.210				

$M_\infty$	Static pressure coefficients on nozzle top flap at $y/Y = 0.50$ with values of $x/l$ of—															
	.153	.226	.300	.337	.411	.484	.558	.632	.705	.779	.853	.926				
0.599	-0.274	-0.426	-1.086	-0.520	-0.210	-0.006	0.106	0.153	0.187	0.217	0.217	0.217				
0.700	-0.265	-0.414	-1.380	-0.559	-0.204	0.005	0.107	0.143	0.168	0.188	0.188	0.188				
0.801	-0.208	-0.313	-0.843	-0.353	-0.223	-0.112	-0.047	-0.018	0.008	0.038	0.038	0.038				
1.250	-0.005	-0.011	-0.365	-0.523	-0.490	-0.195	-0.139	-0.124	-0.116	-0.116	-0.098	-0.098				
1.201	-0.005	-0.018	-0.407	-0.570	-0.532	-0.204	-0.153	-0.137	-0.130	-0.130	-0.114	-0.114				
1.149	-0.024	-0.043	-0.463	-0.635	-0.590	-0.223	-0.175	-0.160	-0.147	-0.147	-0.127	-0.127				
0.950	-0.092	-0.155	-0.724	-0.438	-0.306	-0.228	-0.201	-0.180	-0.162	-0.139	-0.139	-0.139				
0.926	-0.118	-0.185	-0.718	-0.381	-0.276	-0.212	-0.176	-0.154	-0.129	-0.099	-0.099	-0.099				
0.899	-0.141	-0.214	-0.701	-0.344	-0.257	-0.194	-0.149	-0.125	-0.096	-0.065	-0.065	-0.065				
0.873	-0.158	-0.240	-0.697	-0.326	-0.244	-0.173	-0.122	-0.094	-0.065	-0.031	-0.031	-0.031				
0.852	-0.176	-0.265	-0.719	-0.323	-0.236	-0.158	-0.100	-0.077	-0.045	-0.012	-0.012	-0.012				
0.801	-0.205	-0.312	-0.835	-0.353	-0.219	-0.107	-0.046	-0.020	0.007	0.038	0.038	0.038				
0.701	-0.265	-0.413	-1.345	-0.551	-0.201	0.007	0.106	0.140	0.165	0.185	0.185	0.185				
0.603	-0.271	-0.423	-1.075	-0.516	-0.206	-0.003	0.109	0.149	0.185	0.212	0.212	0.212				
0.400	-0.253	-0.381	-0.872	-0.467	-0.203	-0.009	0.095	0.141	0.179	0.210	0.210	0.210				

Table 4. Continued

(a) Concluded

$M_\infty$	Static pressure coefficients on nozzle top flap at $y/Y = 0.75$ with values of $x/l$ of—									
	.153	.226	.300	.337	.411	.558	.705	.779	.853	.926
0.599	-0.240	-0.376	-0.972	-0.465	-0.187	-	0.090	0.132	0.176	0.213
0.700	-0.243	-0.379	-1.274	-0.486	-0.188	-	0.097	0.134	0.165	0.193
0.801	-0.199	-0.299	-0.923	-0.412	-0.223	-	-0.034	-0.010	0.024	0.068
1.250	-0.006	-0.011	-0.369	-0.516	-0.454	-	-0.127	-0.116	-0.108	-0.083
1.201	-0.009	-0.019	-0.410	-0.564	-0.491	-	-0.145	-0.133	-0.120	-0.098
1.149	-0.028	-0.048	-0.461	-0.626	-0.546	-	-0.165	-0.151	-0.134	-0.111
0.950	-0.092	-0.150	-0.747	-0.484	-0.323	-	-0.199	-0.184	-0.163	-0.131
0.926	-0.115	-0.179	-0.748	-0.417	-0.292	-	-0.173	-0.151	-0.122	-0.085
0.899	-0.139	-0.210	-0.735	-0.377	-0.273	-	-0.146	-0.119	-0.082	-0.044
0.873	-0.156	-0.234	-0.736	-0.358	-0.258	-	-0.115	-0.087	-0.051	-0.007
0.852	-0.170	-0.258	-0.762	-0.359	-0.248	-	-0.094	-0.065	-0.031	0.014
0.801	-0.196	-0.302	-0.900	-0.411	-0.222	-	-0.036	-0.010	0.023	0.065
0.701	-0.241	-0.379	-1.236	-0.479	-0.185	-	0.094	0.131	0.160	0.187
0.603	-0.240	-0.375	-0.963	-0.460	-0.186	-	0.091	0.132	0.173	0.209
0.400	-0.224	-0.339	-0.790	-0.412	-0.174	-	0.079	0.119	0.162	0.203

$M_\infty$	Static pressure coefficients on nozzle top flap at $y/Y = 0.875$ with values of $x/l$ of—									
	.153	.226	.300	.337	.411	.558	.705	.779	.853	.926
0.599	-0.213	-0.253	-0.850	-0.412	-0.183	-0.024	0.072	0.113	0.154	0.197
0.700	-0.220	-0.345	-1.061	-0.440	-0.189	-0.017	0.079	0.116	0.152	0.187
0.801	-0.188	-0.289	-0.980	-0.433	-0.206	-0.084	-0.014	0.014	0.044	0.085
1.250	-0.003	-0.006	-0.355	-0.502	-0.342	-0.303	-0.146	-0.122	-0.102	-0.077
1.201	-0.004	-0.014	-0.393	-0.550	-0.375	-0.325	-0.156	-0.134	-0.114	-0.089
1.149	-0.028	-0.044	-0.451	-0.608	-0.426	-0.345	-0.171	-0.149	-0.128	-0.097
0.950	-0.086	-0.143	-0.728	-0.507	-0.326	-0.233	-0.193	-0.176	-0.149	-0.120
0.926	-0.110	-0.174	-0.758	-0.442	-0.294	-0.216	-0.167	-0.140	-0.107	-0.077
0.899	-0.133	-0.202	-0.771	-0.401	-0.278	-0.196	-0.135	-0.106	-0.072	-0.035
0.873	-0.148	-0.226	-0.778	-0.382	-0.264	-0.167	-0.103	-0.073	-0.036	0.002
0.852	-0.163	-0.250	-0.809	-0.389	-0.255	-0.144	-0.079	-0.048	-0.014	0.026
0.801	-0.186	-0.288	-0.960	-0.433	-0.208	-0.083	-0.015	0.013	0.045	0.084
0.701	-0.219	-0.343	-1.037	-0.433	-0.187	-0.015	0.080	0.116	0.151	0.184
0.603	-0.213	-0.331	-0.842	-0.410	-0.181	-0.022	0.072	0.113	0.152	0.195
0.400	-0.196	-0.297	-0.704	-0.362	-0.166	-0.025	0.064	0.101	0.142	0.184

Table 4. Continued

(b) Static pressure coefficients on nozzle sidewall

$M_\infty$	Static pressure coefficients on nozzle sidewall at $z/Z = 0.75$ with values of $x/l$ of—										
	.153	.226	.300	.337	.411	.558	.705	.779	.853	.926	
0.599	-0.197	-0.285	-0.501	-0.313	-0.180	-0.048	0.043	0.089	0.133	-	
0.700	-0.210	-0.313	-0.579	-0.350	-0.193	-0.045	0.048	0.093	0.137	-	
0.801	-0.191	-0.293	-0.918	-0.349	-0.181	-0.066	-0.005	0.025	0.057	-	
1.250	-0.003	-0.004	-0.322	-0.333	-0.302	-0.286	-0.223	-0.169	-0.115	-	
1.201	-0.006	-0.014	-0.361	-0.364	-0.338	-0.317	-0.233	-0.168	-0.112	-	
1.149	-0.032	-0.047	-0.415	-0.416	-0.386	-0.337	-0.238	-0.173	-0.120	-	
0.950	-0.087	-0.148	-0.677	-0.645	-0.414	-0.191	-0.142	-0.125	-0.105	-	
0.926	-0.112	-0.175	-0.722	-0.680	-0.351	-0.158	-0.110	-0.093	-0.070	-	
0.899	-0.134	-0.206	-0.778	-0.686	-0.285	-0.126	-0.085	-0.065	-0.040	-	
0.873	-0.150	-0.231	-0.828	-0.650	-0.217	-0.103	-0.060	-0.037	-0.010	-	
0.852	-0.167	-0.252	-0.877	-0.563	-0.189	-0.090	-0.042	-0.019	0.010	-	
0.801	-0.189	-0.289	-0.897	-0.351	-0.182	-0.065	-0.003	0.025	0.056	-	
0.701	-0.206	-0.307	-0.574	-0.346	-0.188	-0.043	0.051	0.094	0.135	-	
0.603	-0.195	-0.284	-0.498	-0.315	-0.180	-0.045	0.044	0.088	0.133	-	
0.400	-0.176	-0.252	-0.425	-0.271	-0.160	-0.041	0.037	0.077	0.118	-	

$M_\infty$	Static pressure coefficients on nozzle sidewall at $z/Z = 0.50$ with values of $x/l$ of—										
	.153	.226	.300	.337	.411	.558	.705	.779	.853	.926	
0.599	-0.200	-0.306	-	-0.313	-0.176	-	0.043	0.086	0.134	0.181	
0.700	-0.216	-0.334	-	-0.347	-0.187	-	0.050	0.091	0.137	0.182	
0.801	-0.199	-0.321	-	-0.366	-0.182	-	-0.002	0.028	0.064	0.108	
1.250	0.000	-0.009	-	-0.342	-0.326	-	-0.230	-0.187	-0.123	-0.049	
1.201	-0.008	-0.029	-	-0.382	-0.359	-	-0.244	-0.183	-0.113	-0.053	
1.149	-0.040	-0.063	-	-0.436	-0.414	-	-0.250	-0.183	-0.120	-0.061	
0.950	-0.097	-0.167	-	-0.693	-0.526	-	-0.128	-0.111	-0.091	-0.059	
0.926	-0.117	-0.197	-	-0.744	-0.435	-	-0.100	-0.081	-0.060	-0.024	
0.899	-0.141	-0.227	-	-0.795	-0.305	-	-0.076	-0.054	-0.029	0.012	
0.873	-0.157	-0.253	-	-0.821	-0.219	-	-0.053	-0.029	0.000	0.041	
0.852	-0.174	-0.274	-	-0.729	-0.190	-	-0.036	-0.011	0.020	0.061	
0.801	-0.198	-0.319	-	-0.364	-0.183	-	-0.002	0.031	0.065	0.109	
0.701	-0.213	-0.330	-	-0.343	-0.184	-	0.050	0.092	0.137	0.181	
0.603	-0.201	-0.304	-	-0.312	-0.178	-	0.044	0.087	0.133	0.180	
0.400	-0.180	-0.265	-	-0.273	-0.158	-	0.037	0.080	0.122	0.169	

Table 4. Continued

(b) Concluded

$M_\infty$	Static pressure coefficients on nozzle sidewall at centerline with values of $x/l$ of—												
	.153	.226	.300	.337	.411	.484	.558	.632	.705	.779	.853	.926	
0.599	-0.207	-0.310	-0.489	-0.310	-0.177	-0.099	-0.045	-0.002	0.043	0.085	0.131	0.181	
0.700	-0.222	-0.343	-0.560	-0.340	-0.185	-0.104	-0.045	0.002	0.049	0.091	0.135	0.183	
0.801	-0.207	-0.330	-0.954	-0.375	-0.187	-0.111	-0.064	-0.031	0.003	0.033	0.071	0.114	
1.250	0.006	-0.015	-0.328	-0.341	-0.333	-0.320	-0.282	-0.254	-0.236	-0.208	-0.135	-0.044	
1.201	-0.010	-0.032	-0.372	-0.378	-0.375	-0.354	-0.311	-0.281	-0.255	-0.197	-0.120	-0.052	
1.149	-0.041	-0.070	-0.427	-0.438	-0.429	-0.392	-0.322	-0.292	-0.256	-0.190	-0.120	-0.056	
0.950	-0.098	-0.174	-0.690	-0.695	-0.664	-0.278	-0.157	-0.130	-0.113	-0.101	-0.079	-0.053	
0.926	-0.123	-0.204	-0.739	-0.744	-0.557	-0.188	-0.117	-0.097	-0.086	-0.074	-0.050	-0.017	
0.899	-0.145	-0.233	-0.801	-0.796	-0.331	-0.140	-0.094	-0.081	-0.066	-0.048	-0.021	0.017	
0.873	-0.163	-0.262	-0.855	-0.844	-0.230	-0.113	-0.085	-0.066	-0.045	-0.024	0.010	0.047	
0.852	-0.179	-0.287	-0.904	-0.802	-0.192	-0.113	-0.080	-0.056	-0.032	-0.003	0.027	0.068	
0.801	-0.208	-0.332	-0.938	-0.376	-0.187	-0.113	-0.064	-0.030	0.003	0.033	0.071	0.114	
0.701	-0.218	-0.339	-0.557	-0.336	-0.182	-0.102	-0.043	0.005	0.048	0.091	0.137	0.179	
0.603	-0.209	-0.310	-0.488	-0.307	-0.173	-0.101	-0.045	-0.001	0.044	0.086	0.132	0.178	
0.400	-0.187	-0.270	-0.422	-0.268	-0.155	-0.092	-0.043	-0.001	0.038	0.076	0.119	0.165	

$M_\infty$	Static pressure coefficients on nozzle sidewall at $z/z = -0.75$ with values of $x/l$ of—												
	.153	.226	.300	.337	.411	.484	.558	.632	.705	.779	.853	.926	
0.599	-0.197	-0.288	-0.493	-	-	-	-	-0.049	0.047	-	-	-	
0.700	-0.209	-0.317	-0.572	-	-	-	-	-0.047	0.051	-	-	-	
0.801	-0.193	-0.301	-0.948	-	-	-	-	-0.069	0.005	-	-	-	
1.250	0.008	-0.004	-0.336	-	-	-	-	-0.289	-0.261	-	-	-	
1.201	-0.011	-0.029	-0.382	-	-	-	-	-0.324	-0.260	-	-	-	
1.149	-0.041	-0.059	-0.436	-	-	-	-	-0.344	-0.251	-	-	-	
0.950	-0.092	-0.158	-0.696	-	-	-	-	-0.183	-0.125	-	-	-	
0.926	-0.117	-0.184	-0.750	-	-	-	-	-0.154	-0.101	-	-	-	
0.899	-0.136	-0.214	-0.806	-	-	-	-	-0.119	-0.077	-	-	-	
0.873	-0.155	-0.239	-0.860	-	-	-	-	-0.100	-0.051	-	-	-	
0.852	-0.169	-0.262	-0.908	-	-	-	-	-0.091	-0.035	-	-	-	
0.801	-0.193	-0.303	-0.937	-	-	-	-	-0.068	0.007	-	-	-	
0.701	-0.206	-0.313	-0.567	-	-	-	-	-0.045	0.054	-	-	-	
0.603	-0.194	-0.287	-0.493	-	-	-	-	-0.047	0.047	-	-	-	
0.400	-0.168	-0.254	-0.421	-	-	-	-	-0.046	0.041	-	-	-	

Table 4. Continued

(c) Static pressure coefficients on nozzle bottom flap

$M_\infty$	Static pressure coefficients on nozzle bottom flap at $y/Y = 0.875$ with values of $x/l$ of—									
	.153	.226	.300	.337	.411	.558	.705	.779	.853	.926
0.599	-0.210	-	-0.766	-	-	-0.020	0.076	-	0.159	0.203
0.700	-0.221	-	-0.940	-	-	-0.016	0.086	-	0.164	0.202
0.801	-0.192	-	-1.050	-	-	-0.068	0.018	-	0.081	0.122
1.250	0.008	-	-0.357	-	-	-0.312	-0.218	-	-0.103	-0.062
1.201	-0.010	-	-0.398	-	-	-0.340	-0.184	-	-0.112	-0.079
1.149	-0.035	-	-0.456	-	-	-0.353	-0.184	-	-0.119	-0.085
0.950	-0.088	-	-0.732	-	-	-0.229	-0.170	-	-0.113	-0.079
0.926	-0.112	-	-0.774	-	-	-0.211	-0.154	-	-0.086	-0.048
0.899	-0.134	-	-0.807	-	-	-0.190	-0.122	-	-0.050	-0.010
0.873	-0.150	-	-0.842	-	-	-0.162	-0.083	-	-0.012	0.031
0.852	-0.166	-	-0.885	-	-	-0.137	-0.054	-	0.015	0.059
0.801	-0.193	-	-1.036	-	-	-0.064	0.021	-	0.082	0.123
0.701	-0.219	-	-0.922	-	-	-0.012	0.088	-	0.164	0.199
0.603	-0.210	-	-0.764	-	-	-0.018	0.076	-	0.159	0.201
0.400	-0.189	-	-0.647	-	-	-0.018	0.069	-	0.146	0.192

$M_\infty$	Static pressure coefficients on nozzle bottom flap at $y/Y = 0.50$ with values of $x/l$ of—									
	.153	.226	.300	.337	.411	.558	.705	.779	.853	.926
0.599	-0.279	-0.433	-0.962	-0.517	-0.208	-0.007	0.106	0.149	-	-
0.700	-0.279	-0.440	-1.323	-0.533	-0.199	0.002	0.112	0.150	-	-
0.801	-0.224	-0.342	-0.921	-0.411	-0.257	-0.104	-0.009	0.026	-	-
1.250	-0.002	-0.012	-0.371	-0.515	-0.498	-0.408	-0.150	-0.127	-	-
1.201	-0.020	-0.032	-0.415	-0.570	-0.545	-0.258	-0.174	-0.150	-	-
1.149	-0.043	-0.064	-0.473	-0.633	-0.604	-0.257	-0.194	-0.165	-	-
0.950	-0.107	-0.177	-0.749	-0.572	-0.351	-0.242	-0.175	-0.145	-	-
0.926	-0.132	-0.207	-0.753	-0.415	-0.294	-0.213	-0.155	-0.124	-	-
0.899	-0.154	-0.237	-0.729	-0.356	-0.266	-0.197	-0.130	-0.098	-	-
0.873	-0.173	-0.265	-0.745	-0.350	-0.264	-0.177	-0.098	-0.063	-	-
0.852	-0.191	-0.291	-0.771	-0.351	-0.261	-0.157	-0.077	-0.040	-	-
0.801	-0.222	-0.341	-0.920	-0.423	-0.260	-0.102	-0.004	0.032	-	-
0.701	-0.278	-0.439	-1.264	-0.520	-0.196	0.002	0.111	0.148	-	-
0.603	-0.276	-0.431	-0.947	-0.505	-0.202	-0.005	0.106	0.150	-	-
0.400	-0.255	-0.391	-0.786	-0.458	-0.197	-0.015	0.097	0.139	-	-

Table 4. Concluded

(c) Concluded

$M_\infty$	Static pressure coefficients on nozzle bottom flap at centerline with values of $y/l$ of—									
	.153	.226	.300	.337	.411	.558	.705	.926		
0.599	-0.294	-0.443	-0.958	-0.531	-0.235	-0.016	0.103	0.235		
0.700	-0.297	-0.454	-1.287	-0.556	-0.227	-0.005	0.110	0.223		
0.801	-0.232	-0.352	-1.000	-0.438	-0.235	-0.095	-0.005	0.094		
1.250	-0.001	-0.021	-0.371	-0.502	-0.491	-0.269	-0.172	-0.095		
1.201	-0.021	-0.043	-0.418	-0.538	-0.538	-0.251	-0.185	-0.107		
1.149	-0.047	-0.074	-0.472	-0.616	-0.598	-0.256	-0.207	-0.118		
0.950	-0.117	-0.194	-0.744	-0.490	-0.326	-0.245	-0.190	-0.098		
0.926	-0.139	-0.219	-0.735	-0.395	-0.281	-0.210	-0.158	-0.063		
0.899	-0.160	-0.246	-0.736	-0.358	-0.262	-0.193	-0.130	-0.030		
0.873	-0.180	-0.270	-0.754	-0.352	-0.252	-0.169	-0.101	0.006		
0.852	-0.196	-0.294	-0.796	-0.362	-0.254	-0.153	-0.077	0.031		
0.801	-0.230	-0.350	-0.959	-0.429	-0.242	-0.098	-0.008	0.091		
0.701	-0.294	-0.450	-1.287	-0.553	-0.224	-0.003	0.110	0.218		
0.603	-0.292	-0.442	-0.975	-0.531	-0.232	-0.015	0.103	0.228		
0.400	-0.272	-0.398	-0.815	-0.476	-0.221	-0.025	0.091	0.221		

(d) Force data

$M_\infty$	$C_D$	$C_{D,p}$	$C_{D,f}$
0.599	0.0383	0.0449	0.0128
0.700	0.0496	0.0564	0.0125
0.801	0.1052	0.1110	0.0122
1.250	0.2298	0.2204	0.0114
1.201	0.2473	0.2403	0.0115
1.149	0.2676	0.2666	0.0116
0.950	0.2232	0.2247	0.0120
0.926	0.1945	0.1965	0.0120
0.899	0.1717	0.1726	0.0121
0.873	0.1497	0.1516	0.0122
0.852	0.1350	0.1401	0.0122
0.801	0.0996	0.1100	0.0123
0.701	0.0488	0.0546	0.0126
0.603	0.0382	0.0444	0.0129
0.400	0.0321	0.0383	0.0137

Table 5. Pressure and Force Data for Nozzle 3 With  $\beta_{r,top/bot} = \beta_{r,side} = 16.4^\circ$ , Plume On, and  $\alpha = 0^\circ$ 

(a) Static pressure coefficients on nozzle top flap

$M_\infty$	Static pressure coefficients on nozzle top flap at centerline with values of $x/l$ of—												
	.153	.226	.300	.337	.411	.484	.558	.632	.705	.779	.853	.926	
0.602	-0.281	-0.424	-1.065	-0.507	-0.208	-0.076	0.010	0.075	0.123	0.166	0.201	0.227	
0.703	-0.273	-0.420	-1.342	-0.529	-0.196	-0.062	0.022	0.078	0.120	0.153	0.177	0.196	
0.797	-0.211	-0.316	-0.873	-0.361	-0.198	-0.120	-0.075	-0.037	-0.007	0.022	0.049	0.082	
0.952	-0.093	-0.154	-0.737	-0.447	-0.289	-0.240	-0.213	-0.198	-0.181	-0.155	-0.129	-0.089	
0.926	-0.116	-0.181	-0.698	-0.351	-0.251	-0.212	-0.192	-0.174	-0.153	-0.126	-0.093	-0.052	
0.904	-0.138	-0.210	-0.677	-0.329	-0.239	-0.206	-0.182	-0.156	-0.130	-0.098	-0.063	-0.024	
0.875	-0.160	-0.242	-0.680	-0.313	-0.230	-0.191	-0.160	-0.128	-0.100	-0.065	-0.032	0.005	
0.847	-0.180	-0.269	-0.717	-0.314	-0.220	-0.171	-0.133	-0.098	-0.069	-0.036	-0.003	0.034	
0.800	-0.213	-0.318	-0.850	-0.352	-0.204	-0.131	-0.083	-0.046	-0.016	0.013	0.042	0.075	
0.702	-0.276	-0.418	-1.317	-0.520	-0.197	-0.063	0.019	0.075	0.116	0.148	0.172	0.189	
0.600	-0.282	-0.426	-1.048	-0.505	-0.211	-0.078	0.009	0.073	0.123	0.164	0.195	0.220	
0.403	-0.258	-0.383	-0.864	-0.456	-0.204	-0.083	0.002	0.063	0.111	0.155	0.189	0.218	

$M_\infty$	Static pressure coefficients on nozzle top flap at $y/Y = 0.50$ with values of $x/l$ of—												
	.153	.226	.300	.337	.411	.484	.558	.632	.705	.779	.853	.926	
0.602	-0.258	-0.398	-1.050	-0.507	-0.208	-0.076	0.010	0.075	0.123	0.165	0.198	0.225	
0.703	-0.253	-0.393	-1.350	-0.529	-0.196	-0.062	0.021	0.078	0.118	0.154	0.178	0.198	
0.797	-0.199	-0.300	-0.892	-0.361	-0.198	-0.120	-0.075	-0.037	-0.009	0.020	0.048	0.080	
0.952	-0.088	-0.146	-0.748	-0.447	-0.289	-0.240	-0.213	-0.191	-0.165	-0.138	-0.095	-0.057	
0.926	-0.114	-0.173	-0.770	-0.447	-0.294	-0.258	-0.236	-0.211	-0.163	-0.133	-0.101	-0.057	
0.904	-0.134	-0.202	-0.762	-0.447	-0.275	-0.247	-0.219	-0.194	-0.137	-0.104	-0.071	-0.028	
0.875	-0.155	-0.229	-0.754	-0.447	-0.258	-0.228	-0.199	-0.169	-0.106	-0.071	-0.036	0.002	
0.847	-0.174	-0.257	-0.777	-0.447	-0.247	-0.214	-0.180	-0.140	-0.072	-0.038	-0.005	0.033	
0.800	-0.202	-0.303	-0.877	-0.447	-0.222	-0.187	-0.140	-0.087	-0.015	0.012	0.042	0.074	
0.702	-0.257	-0.396	-1.329	-0.520	-0.187	-0.116	-0.075	0.019	0.118	0.149	0.174	0.192	
0.600	-0.259	-0.398	-1.036	-0.505	-0.193	-0.104	-0.075	0.014	0.121	0.162	0.194	0.220	
0.403	-0.237	-0.356	-0.850	-0.456	-0.187	-0.113	-0.088	0.008	0.113	0.156	0.191	0.218	



Table 5. Continued

(a) Concluded

$M_\infty$	Static pressure coefficients on nozzle top flap at $y/Y = 0.75$ with values of $x/l$ of—									
	.153	.226	.300	.337	.411	.558	.705	.779	.853	.926
0.602	-0.229	-0.351	-0.969	-0.438	-0.167	0.020	0.120	0.155	0.192	0.223
0.703	-0.233	-0.360	-1.298	-0.460	-0.167	0.025	0.118	0.149	0.178	0.200
0.797	-0.191	-0.287	-0.977	-0.425	-0.219	-0.073	-0.003	0.024	0.058	0.093
0.952	-0.086	-0.138	-0.750	-0.682	-0.360	-0.237	-0.193	-0.168	-0.129	-0.084
0.926	-0.107	-0.169	-0.792	-0.491	-0.321	-0.222	-0.163	-0.131	-0.087	-0.040
0.904	-0.129	-0.194	-0.818	-0.432	-0.295	-0.200	-0.138	-0.100	-0.060	-0.016
0.875	-0.149	-0.220	-0.818	-0.393	-0.272	-0.171	-0.100	-0.064	-0.024	0.014
0.847	-0.167	-0.248	-0.842	-0.396	-0.258	-0.142	-0.068	-0.030	0.009	0.047
0.800	-0.194	-0.289	-0.948	-0.427	-0.227	-0.081	-0.011	0.018	0.052	0.089
0.702	-0.234	-0.363	-1.272	-0.459	-0.167	0.023	0.116	0.145	0.172	0.194
0.600	-0.229	-0.354	-0.962	-0.438	-0.168	0.019	0.116	0.153	0.188	0.217
0.403	-0.206	-0.316	-0.790	-0.391	-0.155	0.021	0.109	0.143	0.179	0.210

$M_\infty$	Static pressure coefficients on nozzle top flap at $y/Y = 0.875$ with values of $x/l$ of—									
	.153	.226	.300	.337	.411	.558	.705	.779	.853	.926
0.602	-0.209	-0.315	-0.884	-0.402	-0.152	0.019	0.116	0.153	0.187	0.217
0.703	-0.218	-0.333	-1.143	-0.426	-0.156	0.023	0.117	0.150	0.178	0.200
0.797	-0.186	-0.276	-1.047	-0.457	-0.215	-0.066	0.007	0.037	0.070	0.100
0.952	-0.082	-0.129	-0.736	-0.731	-0.367	-0.240	-0.188	-0.159	-0.119	-0.085
0.926	-0.107	-0.161	-0.789	-0.536	-0.331	-0.226	-0.157	-0.117	-0.078	-0.039
0.904	-0.126	-0.185	-0.836	-0.462	-0.303	-0.199	-0.126	-0.089	-0.049	-0.014
0.875	-0.145	-0.213	-0.862	-0.426	-0.281	-0.168	-0.091	-0.053	-0.013	0.020
0.847	-0.164	-0.239	-0.899	-0.427	-0.265	-0.136	-0.055	-0.019	0.019	0.052
0.800	-0.186	-0.276	-1.024	-0.456	-0.222	-0.072	0.001	0.032	0.065	0.094
0.702	-0.219	-0.335	-1.126	-0.428	-0.159	0.021	0.114	0.147	0.173	0.195
0.600	-0.210	-0.317	-0.878	-0.402	-0.153	0.019	0.112	0.151	0.184	0.212
0.403	-0.188	-0.281	-0.730	-0.356	-0.138	0.015	0.106	0.143	0.177	0.204

Table 5. Continued

(b) Static pressure coefficients on nozzle sidewall

$M_\infty$	Static pressure coefficients on nozzle sidewall at $z/Z = 0.75$ with values of $x/l$ of—										
	.153	.226	.300	.337	.411	.558	.705	.779	.853	.926	
0.602	-0.207	-0.321	-0.740	-0.383	-0.142	0.028	0.116	0.150	0.180	0.204	
0.703	-0.217	-0.342	-0.894	-0.405	-0.143	0.031	0.120	0.152	0.177	0.199	
0.797	-0.188	-0.289	-1.071	-0.501	-0.186	-0.028	0.049	0.078	0.102	0.127	
0.952	-0.084	-0.138	-0.734	-0.874	-0.513	-0.218	-0.140	-0.097	-0.058	-0.015	
0.926	-0.109	-0.166	-0.784	-0.900	-0.368	-0.193	-0.095	-0.059	-0.024	0.013	
0.904	-0.128	-0.193	-0.838	-0.751	-0.330	-0.170	-0.075	-0.040	-0.006	0.028	
0.875	-0.147	-0.220	-0.899	-0.578	-0.294	-0.138	-0.047	-0.012	0.019	0.054	
0.847	-0.165	-0.249	-0.964	-0.537	-0.260	-0.102	-0.012	0.021	0.051	0.082	
0.800	-0.189	-0.290	-1.062	-0.506	-0.192	-0.032	0.041	0.069	0.094	0.121	
0.702	-0.219	-0.342	-0.894	-0.407	-0.147	0.030	0.117	0.147	0.172	0.193	
0.600	-0.210	-0.321	-0.735	-0.381	-0.142	0.026	0.115	0.146	0.175	0.197	
0.403	-0.186	-0.284	-0.623	-0.336	-0.129	0.029	0.106	0.140	0.170	0.194	

$M_\infty$	Static pressure coefficients on nozzle sidewall at $z/Z = 0.50$ with values of $x/l$ of—										
	.153	.226	.300	.337	.411	.558	.705	.779	.853	.926	
0.602	-0.220	-0.351	-0.783	-0.408	-0.149	-	0.116	-	0.180	0.203	
0.703	-0.228	-0.369	-0.956	-0.427	-0.149	-	0.123	-	0.179	0.199	
0.797	-0.192	-0.307	-1.077	-0.523	-0.210	-	0.049	-	0.104	0.131	
0.952	-0.088	-0.150	-0.747	-0.924	-0.639	-	-0.106	-	-0.036	0.007	
0.926	-0.111	-0.179	-0.800	-0.941	-0.419	-	-0.079	-	-0.013	0.026	
0.904	-0.131	-0.204	-0.852	-0.697	-0.360	-	-0.072	-	-0.001	0.034	
0.875	-0.149	-0.233	-0.904	-0.546	-0.310	-	-0.050	-	0.024	0.058	
0.847	-0.170	-0.265	-0.956	-0.515	-0.282	-	-0.016	-	0.054	0.087	
0.800	-0.195	-0.308	-1.049	-0.521	-0.217	-	0.041	-	0.096	0.124	
0.702	-0.230	-0.373	-0.950	-0.427	-0.151	-	0.115	-	0.174	0.195	
0.600	-0.221	-0.351	-0.777	-0.406	-0.149	-	0.116	-	0.177	0.199	
0.403	-0.201	-0.315	-0.656	-0.363	-0.141	-	0.108	-	0.172	0.197	

Table 5. Continued

(b) Concluded

$M_\infty$	Static pressure coefficients on nozzle sidewall at centerline with values of $x/l$ of—												
	.153	.226	.300	.337	.411	.484	.558	.632	.705	.779	.853	.926	
0.602	-0.233	-0.371	-0.820	-0.418	-0.153	-0.043	0.030	0.079	0.120	0.152	0.178	0.206	
0.703	-0.241	-0.388	-1.020	-0.430	-0.153	-0.037	0.035	0.084	0.124	0.152	0.177	0.199	
0.797	-0.203	-0.316	-1.015	-0.481	-0.234	-0.116	-0.043	0.007	0.049	0.078	0.105	0.132	
0.952	-0.092	-0.156	-0.769	-0.925	-0.668	-0.320	-0.211	-0.140	-0.094	-0.061	-0.025	0.014	
0.926	-0.117	-0.185	-0.820	-0.903	-0.434	-0.296	-0.199	-0.128	-0.081	-0.045	-0.011	0.032	
0.904	-0.135	-0.213	-0.866	-0.592	-0.365	-0.274	-0.197	-0.131	-0.080	-0.039	-0.001	0.035	
0.875	-0.156	-0.239	-0.871	-0.478	-0.319	-0.233	-0.161	-0.102	-0.053	-0.015	0.022	0.057	
0.847	-0.176	-0.273	-0.883	-0.450	-0.294	-0.200	-0.124	-0.068	-0.018	0.018	0.055	0.087	
0.800	-0.204	-0.317	-0.990	-0.477	-0.240	-0.124	-0.052	0.002	0.040	0.072	0.101	0.129	
0.702	-0.242	-0.392	-1.007	-0.431	-0.152	-0.038	0.032	0.082	0.119	0.150	0.175	0.194	
0.600	-0.236	-0.372	-0.813	-0.417	-0.154	-0.043	0.028	0.078	0.117	0.149	0.178	0.197	
0.403	-0.214	-0.336	-0.686	-0.373	-0.145	-0.041	0.025	0.074	0.110	0.142	0.170	0.194	

$M_\infty$	Static pressure coefficients on nozzle sidewall at $z/Z = -0.75$ with values of $x/l$ of—												
	.153	.226	.300	.337	.411	.484	.558	.632	.705	.779	.853	.926	
0.602	-0.209	-0.315	-	-0.372	-	-0.372	0.024	0.024	0.116	0.204	0.204	0.204	
0.703	-0.217	-0.338	-	-0.398	-	-0.398	0.029	0.029	0.120	0.199	0.199	0.199	
0.797	-0.191	-0.289	-	-0.504	-	-0.504	-0.041	-0.041	0.050	0.136	0.136	0.136	
0.952	-0.086	-0.142	-	-0.909	-	-0.909	-0.203	-0.203	-0.106	0.006	0.006	0.006	
0.926	-0.110	-0.170	-	-0.914	-	-0.914	-0.189	-0.189	-0.098	0.020	0.020	0.020	
0.904	-0.127	-0.195	-	-0.702	-	-0.702	-0.176	-0.176	-0.077	0.031	0.031	0.031	
0.875	-0.146	-0.223	-	-0.538	-	-0.538	-0.146	-0.146	-0.051	0.055	0.055	0.055	
0.847	-0.167	-0.249	-	-0.496	-	-0.496	-0.117	-0.117	-0.016	0.087	0.087	0.087	
0.800	-0.195	-0.290	-	-0.497	-	-0.497	-0.047	-0.047	0.044	0.129	0.129	0.129	
0.702	-0.219	-0.339	-	-0.394	-	-0.394	0.027	0.027	0.116	0.192	0.192	0.192	
0.600	-0.205	-0.315	-	-0.373	-	-0.373	0.023	0.023	0.115	0.198	0.198	0.198	
0.403	-0.183	-0.279	-	-0.327	-	-0.327	0.024	0.024	0.107	0.194	0.194	0.194	

Table 5. Continued

(c) Static pressure coefficients on nozzle bottom flap

$M_\infty$	Static pressure coefficients on nozzle bottom flap at $y/Y = 0.875$ with values of $x/l$ of—									
	.153	.226	.300	.337	.411	.558	.705	.779	.853	.926
0.602	-0.214	-0.340	-0.733	-0.363	-0.144	0.020	0.116	0.152	0.188	0.219
0.703	-0.223	-0.365	-0.888	-0.390	-0.146	0.025	0.121	0.158	0.190	0.217
0.797	-0.194	-0.309	-1.085	-0.503	-0.203	-0.037	0.050	0.084	0.114	0.140
0.952	-0.087	-0.153	-0.774	-0.799	-0.405	-0.217	-0.147	-0.112	-0.072	-0.027
0.926	-0.111	-0.183	-0.812	-0.546	-0.303	-0.207	-0.146	-0.107	-0.067	-0.026
0.904	-0.132	-0.211	-0.838	-0.472	-0.282	-0.189	-0.117	-0.081	-0.042	-0.003
0.875	-0.150	-0.238	-0.857	-0.442	-0.263	-0.156	-0.082	-0.045	-0.008	0.029
0.847	-0.168	-0.266	-0.919	-0.465	-0.252	-0.119	-0.036	0.000	0.034	0.069
0.800	-0.196	-0.309	-1.059	-0.507	-0.211	-0.046	0.044	0.075	0.105	0.133
0.702	-0.227	-0.367	-0.880	-0.388	-0.149	0.023	0.117	0.155	0.186	0.212
0.600	-0.213	-0.340	-0.730	-0.362	-0.144	0.017	0.115	0.150	0.184	0.215
0.403	-0.190	-0.300	-0.619	-0.321	-0.129	0.016	0.107	0.146	0.175	0.209

$M_\infty$	Static pressure coefficients on nozzle bottom flap at $y/Y = 0.50$ with values of $x/l$ of—									
	.153	.226	.300	.337	.411	.558	.705	.779	.853	.926
0.602	-0.269	-0.432	-0.853	-0.437	-0.178	0.015	0.121	0.162	0.196	—
0.703	-0.275	-0.450	-1.121	-0.447	-0.171	0.022	0.127	0.164	0.196	—
0.797	-0.220	-0.355	-0.954	-0.466	-0.252	-0.069	0.039	0.075	0.107	—
0.952	-0.102	-0.181	-0.792	-0.729	-0.375	-0.230	-0.146	-0.110	-0.072	—
0.926	-0.125	-0.210	-0.740	-0.417	-0.282	-0.202	-0.139	-0.102	-0.067	—
0.904	-0.149	-0.238	-0.712	-0.373	-0.270	-0.187	-0.115	-0.080	-0.043	—
0.875	-0.168	-0.271	-0.694	-0.350	-0.256	-0.166	-0.084	-0.046	-0.011	—
0.847	-0.190	-0.303	-0.741	-0.369	-0.263	-0.140	-0.046	-0.007	0.029	—
0.800	-0.223	-0.355	-0.930	-0.459	-0.259	-0.075	0.029	0.067	0.096	—
0.702	-0.275	-0.453	-1.095	-0.447	-0.173	0.019	0.124	0.161	0.192	—
0.600	-0.271	-0.433	-0.849	-0.435	-0.180	0.011	0.118	0.159	0.194	—
0.403	-0.243	-0.385	-0.709	-0.391	-0.167	0.006	0.110	0.152	0.184	—

Table 5. Concluded

(c) Concluded

$M_\infty$	Static pressure coefficients on nozzle bottom flap at centerline with values of $x/l$ of—									
	.153	.226	.300	.337	.411	.558	.705	.926		
0.602	-0.284	-0.436	-0.872	-0.454	-	-0.002	0.112	0.242		
0.703	-0.294	-0.460	-1.109	-0.479	-	0.011	0.122	0.237		
0.797	-0.234	-0.366	-1.021	-0.492	-	-0.056	0.040	0.135		
0.952	-0.112	-0.196	-0.776	-0.534	-	-0.230	-0.176	-0.056		
0.926	-0.129	-0.222	-0.753	-0.423	-	-0.197	-0.132	-0.018		
0.904	-0.156	-0.246	-0.740	-0.395	-	-0.175	-0.105	0.004		
0.875	-0.177	-0.276	-0.765	-0.395	-	-0.155	-0.073	0.031		
0.847	-0.200	-0.312	-0.832	-0.417	-	-0.126	-0.036	0.065		
0.800	-0.237	-0.369	-0.990	-0.485	-	-0.066	0.031	0.124		
0.702	-0.293	-0.464	-1.094	-0.479	-	0.007	0.119	0.230		
0.600	-0.286	-0.438	-0.869	-0.455	-	-0.004	0.110	0.234		
0.403	-0.258	-0.388	-0.742	-0.403	-	-0.011	0.101	0.229		

(d) Force data

$M_\infty$	$C_D$	$C_{D,p}$	$C_{D,f}$
0.602	0.0378	0.0429	0.0122
0.703	0.0454	0.0576	0.0119
0.797	0.1068	0.1126	0.0117
0.952	0.2529	0.2512	0.0114
0.926	0.2185	0.2139	0.0115
0.904	0.1895	0.1911	0.0115
0.875	0.1655	0.1655	0.0116
0.847	0.1432	0.1457	0.0116
0.800	0.1111	0.1171	0.0117
0.702	0.0473	0.0589	0.0120
0.600	0.0368	0.0441	0.0123
0.403	0.0307	0.0352	0.0130

Table 6. Pressure and Force Data for Nozzle 3 With  $\beta_{r,top/bot} = \beta_{r,side} = 16.4^\circ$  and Plume Off

(a) Static pressure coefficients on nozzle top flap

$M_\infty$	$\alpha$ , deg	Static pressure coefficients on nozzle top flap at centerline with values of $\sqrt{t}$ of—														
		.153	.226	.300	.337	.411	.484	.558	.632	.705	.779	.853	.926			
1.249	-0.007	-0.028	-0.033	-0.393	-0.504	-0.499	-0.446	-0.318	-0.155	-0.135	-0.119	-0.112	-0.094			
1.201	0.017	-0.027	-0.036	-0.433	-0.551	-0.543	-0.494	-0.289	-0.173	-0.156	-0.139	-0.126	-0.114			
0.598	-0.026	-0.307	-0.458	-1.101	-0.550	-0.257	-0.126	-0.042	0.020	0.069	0.103	0.133	0.161			
0.599	-3.007	-0.320	-0.485	-1.220	-0.607	-0.299	-0.162	-0.071	-0.005	0.051	0.089	0.124	0.160			
0.600	0.030	-0.307	-0.460	-1.102	-0.551	-0.261	-0.129	-0.042	0.020	0.071	0.103	0.129	0.159			
0.601	2.997	-0.295	-0.442	-1.034	-0.522	-0.244	-0.117	-0.032	0.027	0.077	0.105	0.131	0.161			
0.601	5.992	-0.288	-0.436	-1.041	-0.527	-0.250	-0.123	-0.038	0.020	0.071	0.100	0.126	0.159			
0.601	9.003	-0.288	-0.442	-1.122	-0.561	-0.270	-0.139	-0.051	0.010	0.062	0.091	0.119	0.154			
0.948	0.036	-0.106	-0.166	-0.697	-0.378	-0.257	-0.214	-0.192	-0.180	-0.168	-0.152	-0.132	-0.108			
0.925	-0.011	-0.130	-0.196	-0.662	-0.325	-0.237	-0.203	-0.188	-0.176	-0.162	-0.142	-0.115	-0.085			
0.901	-0.012	-0.151	-0.223	-0.658	-0.314	-0.234	-0.203	-0.182	-0.165	-0.143	-0.119	-0.087	-0.054			
0.900	-3.024	-0.139	-0.208	-0.687	-0.334	-0.249	-0.215	-0.196	-0.178	-0.158	-0.139	-0.108	-0.070			
0.898	0.002	-0.152	-0.226	-0.649	-0.309	-0.228	-0.201	-0.181	-0.163	-0.143	-0.114	-0.085	-0.051			
0.898	3.002	-0.159	-0.235	-0.664	-0.323	-0.241	-0.214	-0.190	-0.166	-0.139	-0.104	-0.070	-0.031			
0.897	6.000	-0.165	-0.238	-0.715	-0.366	-0.275	-0.242	-0.210	-0.176	-0.140	-0.097	-0.058	-0.012			
0.899	9.018	-0.169	-0.233	-0.746	-0.390	-0.300	-0.263	-0.226	-0.187	-0.145	-0.098	-0.050	0.005			
0.875	0.025	-0.171	-0.249	-0.663	-0.309	-0.233	-0.195	-0.166	-0.142	-0.119	-0.089	-0.058	-0.022			
0.850	0.021	-0.188	-0.273	-0.698	-0.316	-0.227	-0.181	-0.147	-0.116	-0.090	-0.060	-0.029	0.003			
0.798	-0.018	-0.223	-0.327	-0.838	-0.342	-0.200	-0.131	-0.088	-0.052	-0.026	0.000	0.022	0.048			
0.700	0.002	-0.293	-0.440	-1.359	-0.582	-0.241	-0.106	-0.021	0.038	0.082	0.115	0.142	0.165			
0.401	-0.012	-0.297	-0.422	-0.913	-0.504	-0.252	-0.135	-0.057	0.002	0.044	0.082	0.112	0.141			
1.201	-3.030	-0.016	-0.022	-0.420	-0.536	-0.522	-0.490	-0.382	-0.184	-0.156	-0.141	-0.128	-0.112			
1.202	0.004	-0.015	-0.024	-0.423	-0.536	-0.530	-0.481	-0.249	-0.166	-0.145	-0.132	-0.118	-0.102			
1.199	2.942	-0.011	-0.026	-0.432	-0.542	-0.537	-0.492	-0.378	-0.204	-0.160	-0.140	-0.127	-0.109			
1.200	6.007	-0.017	-0.030	-0.429	-0.540	-0.538	-0.494	-0.409	-0.209	-0.167	-0.146	-0.134	-0.116			
1.198	9.002	-0.035	-0.046	-0.430	-0.550	-0.551	-0.518	-0.438	-0.212	-0.177	-0.158	-0.146	-0.130			
1.153	0.020	-0.023	-0.039	-0.475	-0.594	-0.595	-0.454	-0.210	-0.178	-0.157	-0.147	-0.133	-0.116			

Table 6. Continued

(a) Continued

$M_\infty$	$\alpha$ , deg	Static pressure coefficients on nozzle top flap at $y/Y = 0.50$ with values of $x/l$ of—											
		.153	.226	.300	.337	.411	.558	.705	.779	.853	.926		
1.249	-0.007	-0.023	-0.026	-0.379	-	-0.484	-0.390	-0.137	-0.123	-0.110	-0.095		
1.201	0.017	-0.024	-0.034	-0.419	-	-0.540	-0.383	-0.159	-0.142	-0.129	-0.113		
0.598	-0.026	-0.284	-0.429	-1.086	-	-0.232	-0.031	0.068	0.104	0.134	0.159		
0.599	-3.007	-0.298	-0.454	-1.199	-	-0.272	-0.058	0.051	0.092	0.130	0.161		
0.600	0.030	-0.287	-0.434	-1.093	-	-0.235	-0.030	0.067	0.101	0.134	0.158		
0.601	2.997	-0.276	-0.416	-1.047	-	-0.220	-0.022	0.072	0.105	0.138	0.162		
0.601	5.992	-0.273	-0.409	-1.067	-	-0.227	-0.023	0.070	0.102	0.137	0.162		
0.601	9.003	-0.283	-0.420	-1.144	-	-0.232	-0.023	0.070	0.101	0.134	0.160		
0.948	0.036	-0.100	-0.159	-0.738	-	-0.290	-0.213	-0.181	-0.163	-0.142	-0.109		
0.925	-0.011	-0.126	-0.187	-0.752	-	-0.285	-0.211	-0.175	-0.151	-0.122	-0.086		
0.901	-0.012	-0.146	-0.215	-0.753	-	-0.274	-0.204	-0.153	-0.124	-0.091	-0.053		
0.900	-3.024	-0.134	-0.202	-0.786	-	-0.291	-0.216	-0.173	-0.148	-0.117	-0.076		
0.898	0.002	-0.146	-0.215	-0.745	-	-0.270	-0.199	-0.148	-0.119	-0.088	-0.051		
0.898	3.002	-0.155	-0.225	-0.759	-	-0.281	-0.203	-0.142	-0.109	-0.072	-0.033		
0.897	6.000	-0.170	-0.235	-0.798	-	-0.315	-0.220	-0.146	-0.106	-0.062	-0.017		
0.899	9.018	-0.184	-0.240	-0.831	-	-0.337	-0.235	-0.151	-0.106	-0.053	-0.002		
0.875	0.025	-0.163	-0.240	-0.741	-	-0.260	-0.177	-0.124	-0.092	-0.062	-0.024		
0.850	0.021	-0.180	-0.264	-0.759	-	-0.254	-0.157	-0.093	-0.063	-0.032	0.002		
0.798	-0.018	-0.215	-0.314	-0.870	-	-0.218	-0.090	-0.026	-0.001	0.021	0.046		
0.700	0.002	-0.274	-0.415	-1.367	-	-0.228	-0.018	0.079	0.115	0.142	0.164		
0.401	-0.012	-0.270	-0.397	-0.893	-	-0.234	-0.048	0.048	0.085	0.115	0.141		
1.201	-3.030	-0.014	-0.020	-0.405	-	-0.514	-0.445	-0.162	-0.144	-0.128	-0.112		
1.202	0.004	-0.011	-0.021	-0.409	-	-0.526	-0.324	-0.150	-0.133	-0.118	-0.102		
1.199	2.942	-0.013	-0.023	-0.414	-	-0.535	-0.435	-0.164	-0.141	-0.126	-0.109		
1.200	6.007	-0.028	-0.034	-0.408	-	-0.556	-0.477	-0.168	-0.146	-0.131	-0.116		
1.198	9.002	-0.057	-0.058	-0.420	-	-0.567	-0.455	-0.176	-0.159	-0.145	-0.132		
1.153	0.020	-0.023	-0.039	-0.460	-	-0.596	-0.232	-0.164	-0.147	-0.134	-0.116		

Table 6. Continued  
(a) Continued

$M_\infty$	$\alpha$ , deg	Static pressure coefficients on nozzle top flap at $y/Y = 0.75$ with values of $v/U_\infty$ —														
		.153	.226	.300	.337	.411	.558	.705	.779	.853	.926					
1.249	-0.007	-0.020	-0.022	-0.372	-0.498	-0.470	-0.353	-0.136	-0.116	-0.100	-0.087					
1.201	0.017	-0.025	-0.035	-0.418	-0.549	-0.530	-0.382	-0.158	-0.137	-0.125	-0.106					
0.598	-0.026	-0.255	-0.385	-1.005	-0.476	-0.205	-0.022	0.064	0.099	0.127	0.153					
0.599	-3.007	-0.266	-0.409	-1.126	-0.533	-0.242	-0.044	0.050	0.091	0.123	0.155					
0.600	0.030	-0.258	-0.394	-1.012	-0.483	-0.209	-0.023	0.060	0.098	0.123	0.149					
0.601	2.997	-0.255	-0.374	-1.021	-0.467	-0.195	-0.014	0.067	0.105	0.129	0.155					
0.601	5.992	-0.267	-0.384	-1.023	-0.453	-0.181	-0.004	0.069	0.106	0.129	0.155					
0.601	9.003	-0.272	-0.393	-0.945	-0.424	-0.162	0.004	0.068	0.104	0.123	0.148					
0.948	0.036	-0.097	-0.150	-0.754	-0.524	-0.317	-0.226	-0.194	-0.175	-0.148	-0.110					
0.925	-0.011	-0.121	-0.180	-0.793	-0.465	-0.313	-0.226	-0.177	-0.153	-0.122	-0.081					
0.901	-0.012	-0.141	-0.209	-0.813	-0.427	-0.297	-0.207	-0.153	-0.122	-0.087	-0.047					
0.900	-3.024	-0.133	-0.196	-0.839	-0.480	-0.324	-0.225	-0.177	-0.149	-0.115	-0.070					
0.898	0.002	-0.141	-0.207	-0.810	-0.425	-0.295	-0.205	-0.146	-0.117	-0.083	-0.044					
0.898	3.002	-0.158	-0.222	-0.836	-0.448	-0.314	-0.207	-0.137	-0.102	-0.062	-0.021					
0.897	6.000	-0.180	-0.245	-0.851	-0.465	-0.345	-0.226	-0.139	-0.092	-0.043	0.002					
0.899	9.018	-0.187	-0.254	-0.826	-0.449	-0.347	-0.245	-0.142	-0.080	-0.020	0.028					
0.875	0.025	-0.161	-0.233	-0.812	-0.397	-0.278	-0.180	-0.120	-0.089	-0.055	-0.018					
0.850	0.021	-0.175	-0.254	-0.822	-0.392	-0.264	-0.155	-0.089	-0.061	-0.025	0.009					
0.798	-0.018	-0.203	-0.301	-0.941	-0.425	-0.226	-0.086	-0.024	0.000	0.025	0.050					
0.700	0.002	-0.253	-0.382	-1.319	-0.498	-0.203	-0.013	0.079	0.110	0.138	0.159					
0.401	-0.012	-0.240	-0.355	-0.836	-0.433	-0.199	-0.027	0.050	0.078	0.107	0.134					
1.201	-3.030	-0.016	-0.019	-0.397	-0.541	-0.503	-0.393	-0.157	-0.139	-0.122	-0.104					
1.202	0.004	-0.013	-0.020	-0.402	-0.537	-0.512	-0.358	-0.126	-0.126	-0.111	-0.095					
1.199	2.942	-0.023	-0.029	-0.409	-0.556	-0.534	-0.364	-0.171	-0.137	-0.115	-0.098					
1.200	6.007	-0.045	-0.051	-0.420	-0.566	-0.545	-0.375	-0.166	-0.139	-0.120	-0.105					
1.198	9.002	-0.057	-0.072	-0.430	-0.580	-0.573	-0.363	-0.166	-0.149	-0.133	-0.120					
1.153	0.020	-0.025	-0.040	-0.454	-0.596	-0.583	-0.288	-0.158	-0.144	-0.128	-0.111					



Table 6. Continued

(a) Concluded

$M_\infty$	$\alpha$ , deg	Static pressure coefficients on nozzle top flap at $y/Y = 0.875$ with values of $x/l$ of—												
		.153	.226	.300	.337	.411	.558	.705	.779	.853	.926			
1.249	-0.007	-0.016	-0.013	-0.361	-0.499	-0.372	-0.327	-0.160	-0.113	-0.092	-0.081			
1.201	0.017	-0.027	-0.028	-0.407	-0.546	-0.421	-0.362	-0.169	-0.130	-0.112	-0.098			
0.598	-0.026	-0.237	-0.344	-0.918	-0.436	-0.190	-0.023	0.066	0.099	0.128	0.150			
0.599	-3.007	-0.246	-0.362	-1.047	-0.488	-0.220	-0.040	0.055	0.093	0.126	0.152			
0.600	0.030	-0.240	-0.348	-0.927	-0.439	-0.194	-0.023	0.064	0.099	0.127	0.146			
0.601	2.997	-0.244	-0.339	-0.874	-0.395	-0.168	-0.009	0.074	0.107	0.134	0.153			
0.601	5.992	-0.250	-0.341	-0.816	-0.361	-0.145	0.002	0.078	0.109	0.133	0.150			
0.601	9.003	-0.254	-0.340	-0.741	-0.337	-0.132	0.010	0.077	0.105	0.126	0.141			
0.948	0.036	-0.097	-0.146	-0.752	-0.572	-0.331	-0.235	-0.198	-0.177	-0.149	-0.115			
0.925	-0.011	-0.119	-0.174	-0.800	-0.512	-0.326	-0.233	-0.176	-0.145	-0.112	-0.079			
0.901	-0.012	-0.140	-0.198	-0.843	-0.462	-0.308	-0.209	-0.147	-0.113	-0.078	-0.045			
0.900	-3.024	-0.137	-0.187	-0.848	-0.522	-0.336	-0.230	-0.173	-0.143	-0.107	-0.069			
0.898	0.002	-0.140	-0.199	-0.842	-0.461	-0.308	-0.206	-0.140	-0.109	-0.075	-0.042			
0.898	3.002	-0.156	-0.220	-0.841	-0.451	-0.326	-0.206	-0.124	-0.086	-0.049	-0.016			
0.897	6.000	-0.172	-0.238	-0.834	-0.450	-0.341	-0.222	-0.120	-0.071	-0.029	0.004			
0.899	9.018	-0.180	-0.247	-0.839	-0.451	-0.344	-0.247	-0.111	-0.061	-0.025	0.006			
0.875	0.025	-0.158	-0.221	-0.861	-0.434	-0.290	-0.178	-0.110	-0.080	-0.045	-0.014			
0.850	0.021	-0.169	-0.246	-0.883	-0.424	-0.274	-0.151	-0.081	-0.052	-0.019	0.014			
0.798	-0.018	-0.199	-0.289	-1.017	-0.455	-0.226	-0.081	-0.016	0.008	0.032	0.054			
0.700	0.002	-0.237	-0.353	-1.176	-0.459	-0.190	-0.014	0.078	0.110	0.138	0.156			
0.401	-0.012	-0.222	-0.318	-0.772	-0.397	-0.183	-0.030	0.046	0.082	0.107	0.130			
1.201	-3.030	-0.018	-0.017	-0.387	-0.538	-0.414	-0.361	-0.175	-0.133	-0.115	-0.098			
1.202	0.004	-0.011	-0.015	-0.393	-0.535	-0.403	-0.348	-0.149	-0.120	-0.102	-0.087			
1.199	2.942	-0.024	-0.027	-0.411	-0.568	-0.424	-0.342	-0.186	-0.131	-0.106	-0.090			
1.200	6.007	-0.038	-0.043	-0.429	-0.554	-0.395	-0.343	-0.178	-0.134	-0.111	-0.094			
1.198	9.002	-0.050	-0.059	-0.435	-0.538	-0.396	-0.337	-0.163	-0.137	-0.121	-0.109			
1.153	0.020	-0.024	-0.033	-0.447	-0.592	-0.458	-0.347	-0.151	-0.135	-0.118	-0.103			

Table 6. Continued

(b) Static pressure coefficients on nozzle sidewall

$M_\infty$	$\alpha$ , deg	Static pressure coefficients on nozzle sidewall at $z/Z = 0.75$ with values of $x/l$ of—														
		.153	.226	.300	.337	.411	.558	.705	.779	.853	.926					
1.249	-0.007	-0.012	-0.012	-0.370	-0.488	-0.375	-0.319	-0.205	-0.126	-0.087	-0.067					
1.201	0.017	-0.027	-0.029	-0.411	-0.536	-0.416	-0.355	-0.212	-0.133	-0.097	-0.081					
0.598	-0.026	-0.232	-0.350	-0.772	-0.416	-0.175	-0.010	0.072	0.098	0.123	0.150					
0.599	-3.007	-0.253	-0.374	-0.794	-0.437	-0.191	-0.024	0.064	0.090	0.119	0.153					
0.600	0.030	-0.235	-0.352	-0.775	-0.421	-0.175	-0.011	0.072	0.093	0.118	0.148					
0.601	2.997	-0.238	-0.350	-0.739	-0.399	-0.156	0.002	0.080	0.098	0.122	0.153					
0.601	5.992	-0.244	-0.354	-0.745	-0.385	-0.137	0.014	0.087	0.100	0.121	0.152					
0.601	9.003	-0.251	-0.356	-0.740	-0.371	-0.122	0.023	0.089	0.095	0.112	0.139					
0.948	0.036	-0.101	-0.154	-0.756	-0.877	-0.443	-0.238	-0.192	-0.160	-0.119	-0.083					
0.925	-0.011	-0.121	-0.180	-0.803	-0.902	-0.395	-0.214	-0.138	-0.101	-0.069	-0.038					
0.901	-0.012	-0.141	-0.209	-0.855	-0.815	-0.350	-0.188	-0.102	-0.070	-0.038	-0.013					
0.900	-3.024	-0.154	-0.224	-0.861	-0.851	-0.356	-0.212	-0.126	-0.092	-0.056	-0.025					
0.898	0.002	-0.141	-0.209	-0.856	-0.796	-0.350	-0.184	-0.098	-0.064	-0.035	-0.008					
0.898	3.002	-0.153	-0.226	-0.860	-0.770	-0.369	-0.188	-0.076	-0.038	-0.010	0.014					
0.897	6.000	-0.166	-0.233	-0.873	-0.893	-0.444	-0.197	-0.053	-0.018	0.006	0.027					
0.899	9.018	-0.174	-0.236	-0.871	-0.984	-0.552	-0.149	-0.028	-0.013	0.006	0.029					
0.875	0.025	-0.157	-0.234	-0.912	-0.644	-0.321	-0.154	-0.069	-0.037	-0.008	0.018					
0.850	0.021	-0.173	-0.255	-0.965	-0.585	-0.292	-0.126	-0.039	-0.009	0.019	0.043					
0.798	-0.018	-0.203	-0.303	-1.078	-0.543	-0.214	-0.053	0.015	0.039	0.060	0.077					
0.700	0.002	-0.237	-0.362	-0.926	-0.436	-0.175	-0.002	0.081	0.109	0.136	0.156					
0.401	-0.012	-0.222	-0.323	-0.661	-0.379	-0.168	-0.016	0.053	0.078	0.108	0.127					
1.201	-3.030	-0.029	-0.035	-0.425	-0.510	-0.384	-0.347	-0.229	-0.124	-0.099	-0.082					
1.202	0.004	-0.012	-0.017	-0.402	-0.522	-0.401	-0.344	-0.182	-0.114	-0.084	-0.068					
1.199	2.942	-0.026	-0.036	-0.410	-0.520	-0.404	-0.341	-0.199	-0.133	-0.092	-0.072					
1.200	6.007	-0.039	-0.045	-0.416	-0.542	-0.401	-0.353	-0.183	-0.139	-0.105	-0.081					
1.198	9.002	-0.054	-0.057	-0.418	-0.549	-0.423	-0.373	-0.171	-0.146	-0.134	-0.128					
1.153	0.020	-0.028	-0.038	-0.456	-0.576	-0.455	-0.389	-0.143	-0.107	-0.089	-0.078					

Table 6. Continued

(b) Continued

$M_\infty$	$\alpha$ , deg	Static pressure coefficients on nozzle sidewall at $z/Z = 0.50$ with values of $x/l$ of—												
		.153	.226	.300	.337	.411	.558	.705	.779	.853	.926			
1.249	-0.007	-0.009	-0.018	-0.374	-0.503	-0.470	-	-0.199	-	-0.089	-0.066			
1.201	0.017	-0.029	-0.035	-0.420	-0.547	-0.526	-	-0.201	-	-0.096	-0.079			
0.598	-0.026	-0.249	-0.381	-0.813	-0.444	-0.182	-	0.070	-	0.131	0.154			
0.599	-3.007	-0.255	-0.383	-0.913	-0.478	-0.196	-	0.067	-	0.132	0.159			
0.600	0.036	-0.257	-0.385	-0.812	-0.446	-0.184	-	0.069	-	0.131	0.155			
0.601	2.997	-0.261	-0.384	-0.801	-0.438	-0.174	-	0.075	-	0.135	0.160			
0.601	5.992	-0.266	-0.390	-0.831	-0.439	-0.165	-	0.079	-	0.134	0.157			
0.601	9.003	-0.270	-0.390	-0.874	-0.443	-0.158	-	0.075	-	0.120	0.141			
0.948	0.036	-0.102	-0.164	-0.765	-0.943	-0.593	-	-0.158	-	-0.094	-0.064			
0.925	-0.011	-0.123	-0.192	-0.816	-0.980	-0.465	-	-0.111	-	-0.053	-0.024			
0.901	-0.012	-0.144	-0.219	-0.873	-0.795	-0.388	-	-0.095	-	-0.028	-0.004			
0.900	-3.024	-0.144	-0.206	-0.899	-0.872	-0.444	-	-0.103	-	-0.032	-0.006			
0.898	0.002	-0.144	-0.221	-0.875	-0.774	-0.386	-	-0.092	-	-0.024	0.001			
0.898	3.002	-0.151	-0.229	-0.877	-0.819	-0.399	-	-0.082	-	-0.005	0.019			
0.897	6.000	-0.159	-0.229	-0.877	-0.972	-0.468	-	-0.065	-	0.008	0.030			
0.899	9.018	-0.166	-0.224	-0.875	-1.092	-0.566	-	-0.046	-	0.008	0.031			
0.875	0.025	-0.161	-0.244	-0.926	-0.619	-0.350	-	-0.068	-	-0.001	0.023			
0.850	0.021	-0.176	-0.269	-0.973	-0.571	-0.318	-	-0.042	-	0.025	0.048			
0.798	-0.018	-0.209	-0.321	-1.078	-0.565	-0.249	-	0.016	-	0.066	0.082			
0.700	0.002	-0.247	-0.392	-0.989	-0.457	-0.182	-	0.081	-	0.136	0.157			
0.401	-0.012	-0.236	-0.349	-0.694	-0.403	-0.180	-	0.058	-	0.111	0.134			
1.201	-3.030	-0.011	-0.014	-0.409	-0.565	-0.514	-	-0.214	-	-0.101	-0.080			
1.202	0.004	-0.010	-0.023	-0.406	-0.535	-0.508	-	-0.176	-	-0.081	-0.065			
1.199	2.942	-0.026	-0.040	-0.421	-0.549	-0.520	-	-0.195	-	-0.092	-0.073			
1.200	6.007	-0.040	-0.048	-0.424	-0.554	-0.510	-	-0.185	-	-0.109	-0.086			
1.198	9.002	-0.057	-0.058	-0.418	-0.566	-0.526	-	-0.181	-	-0.153	-0.142			
1.153	0.020	-0.032	-0.045	-0.461	-0.598	-0.570	-	-0.143	-	-0.086	-0.077			

Table 6. Continued

(b) Continued

$M_\infty$	$\alpha$ , deg	Static pressure coefficients on nozzle sidewall at centerline with values of $x/l$ of—														
		.153	.226	.300	.337	.411	.484	.558	.632	.705	.779	.853	.926			
1.249	-0.007	-0.008	-0.020	-0.387	-0.499	-0.485	-0.436	-0.350	-0.256	-0.196	-0.142	-0.093	-0.067			
1.201	0.017	-0.027	-0.042	-0.428	-0.548	-0.544	-0.484	-0.375	-0.276	-0.203	-0.139	-0.100	-0.074			
0.598	-0.026	-0.260	-0.393	-0.857	-0.449	-0.190	-0.079	-0.013	0.036	0.071	0.101	0.131	0.148			
0.599	-3.007	-0.263	-0.398	-0.911	-0.464	-0.193	-0.079	-0.013	0.040	0.072	0.106	0.138	0.150			
0.600	0.030	-0.263	-0.394	-0.862	-0.451	-0.192	-0.081	-0.019	0.036	0.066	0.101	0.134	0.141			
0.601	2.997	-0.267	-0.400	-0.918	-0.468	-0.196	-0.083	-0.021	0.037	0.066	0.102	0.137	0.143			
0.601	5.992	-0.270	-0.403	-1.011	-0.490	-0.204	-0.087	-0.025	0.035	0.061	0.098	0.132	0.135			
0.601	9.003	-0.261	-0.386	-1.086	-0.520	-0.221	-0.106	-0.047	0.008	0.028	0.065	0.105	0.115			
0.948	0.036	-0.106	-0.170	-0.782	-0.946	-0.814	-0.348	-0.231	-0.165	-0.122	-0.091	-0.064	-0.042			
0.925	-0.011	-0.128	-0.198	-0.834	-0.969	-0.484	-0.315	-0.217	-0.150	-0.103	-0.070	-0.042	-0.019			
0.901	-0.012	-0.150	-0.227	-0.887	-0.659	-0.403	-0.307	-0.220	-0.152	-0.102	-0.063	-0.029	-0.002			
0.900	-3.024	-0.148	-0.217	-0.880	-0.722	-0.440	-0.347	-0.254	-0.168	-0.102	-0.052	-0.015	0.007			
0.898	0.002	-0.150	-0.226	-0.886	-0.641	-0.395	-0.304	-0.221	-0.151	-0.099	-0.061	-0.025	-0.001			
0.898	3.002	-0.149	-0.218	-0.884	-0.693	-0.436	-0.343	-0.244	-0.149	-0.081	-0.040	-0.006	0.017			
0.897	6.000	-0.154	-0.209	-0.885	-0.885	-0.519	-0.404	-0.264	-0.155	-0.092	-0.047	-0.011	0.013			
0.899	9.018	-0.156	-0.201	-0.880	-1.096	-0.671	-0.393	-0.229	-0.128	-0.086	-0.040	-0.006	0.017			
0.875	0.025	-0.166	-0.249	-0.914	-0.544	-0.359	-0.268	-0.192	-0.127	-0.079	-0.037	-0.002	0.021			
0.850	0.021	-0.184	-0.276	-0.927	-0.505	-0.336	-0.240	-0.159	-0.097	-0.047	-0.008	0.024	0.046			
0.798	-0.018	-0.218	-0.329	-1.036	-0.533	-0.281	-0.154	-0.077	-0.025	0.013	0.041	0.066	0.080			
0.700	0.002	-0.261	-0.409	-1.061	-0.462	-0.187	-0.071	-0.003	0.045	0.080	0.109	0.136	0.154			
1.201	-0.012	-0.249	-0.371	-0.726	-0.416	-0.189	-0.087	-0.021	0.022	0.057	0.083	0.109	0.133			
1.201	-3.030	-0.008	-0.018	-0.405	-0.534	-0.505	-0.511	-0.378	-0.264	-0.200	-0.144	-0.105	-0.075			
1.202	0.004	-0.011	-0.027	-0.417	-0.537	-0.525	-0.477	-0.364	-0.259	-0.180	-0.118	-0.081	-0.062			
1.199	2.942	-0.026	-0.034	-0.423	-0.550	-0.528	-0.518	-0.386	-0.270	-0.199	-0.140	-0.094	-0.079			
1.200	6.007	-0.043	-0.043	-0.417	-0.560	-0.532	-0.557	-0.425	-0.280	-0.203	-0.158	-0.113	-0.097			
1.198	9.002	-0.052	-0.048	-0.418	-0.558	-0.546	-0.590	-0.448	-0.307	-0.243	-0.211	-0.190	-0.158			
1.153	0.020	-0.033	-0.054	-0.474	-0.598	-0.591	-0.540	-0.392	-0.235	-0.148	-0.104	-0.085	-0.076			

Table 6. Continued

(b) Concluded

$M_\infty$	$\alpha$ , deg	Static pressure coefficients on nozzle sidewall at $z/Z = -0.75$ with values of $x/l$ of—											
		.153	.226	.300	.337	.411	.558	.705	.926				
1.249	-0.007	-0.010	-0.018	—	-0.498	—	-0.322	-0.250	-0.071	—	-0.361	-0.255	-0.082
1.201	0.017	-0.023	-0.035	—	-0.548	—	-0.408	0.071	0.146	—	0.003	0.082	0.151
0.598	-0.026	-0.225	-0.345	—	-0.408	—	-0.385	0.072	0.140	—	-0.013	0.062	0.139
0.599	-3.007	-0.227	-0.345	—	-0.415	—	-0.445	0.042	0.132	—	-0.046	0.039	0.134
0.600	0.030	-0.224	-0.352	—	-0.415	—	-0.458	0.061	0.134	—	-0.061	0.039	0.134
0.601	2.997	-0.251	-0.383	—	-0.445	—	-0.489	0.026	-0.041	—	-0.212	-0.108	-0.029
0.601	5.992	-0.290	-0.427	—	-0.458	—	-0.754	-0.099	-0.011	—	-0.206	-0.099	-0.011
0.601	9.003	-0.336	-0.480	—	-0.489	—	-0.780	-0.093	0.006	—	-0.231	-0.093	0.006
0.948	0.036	-0.102	-0.157	—	-0.934	—	-0.731	-0.097	-0.006	—	-0.206	-0.097	-0.006
0.925	-0.011	-0.123	-0.181	—	-0.966	—	-0.790	-0.104	-0.003	—	-0.221	-0.104	-0.003
0.901	-0.012	-0.142	-0.209	—	-0.754	—	-0.943	-0.131	-0.007	—	-0.245	-0.131	-0.007
0.900	-3.024	-0.151	-0.222	—	-0.780	—	-1.036	-0.142	-0.015	—	-0.270	-0.142	-0.015
0.898	0.002	-0.140	-0.210	—	-0.731	—	-0.590	-0.075	0.019	—	-0.184	-0.075	0.019
0.898	3.002	-0.160	-0.228	—	-0.790	—	-0.547	-0.044	0.044	—	-0.154	-0.044	0.044
0.897	6.000	-0.198	-0.268	—	-0.943	—	-0.556	0.012	0.081	—	-0.080	0.012	0.081
0.899	9.018	-0.244	-0.321	—	-1.036	—	-0.425	0.079	0.153	—	-0.007	0.079	0.153
0.875	0.025	-0.157	-0.233	—	-0.590	—	-0.367	0.053	0.129	—	-0.027	0.053	0.129
0.850	0.021	-0.173	-0.256	—	-0.547	—	-0.532	-0.234	-0.076	—	-0.340	-0.234	-0.076
0.798	-0.018	-0.206	-0.306	—	-0.556	—	-0.535	-0.233	-0.067	—	-0.349	-0.233	-0.067
0.700	0.002	-0.235	-0.359	—	-0.425	—	-0.545	-0.290	-0.089	—	-0.373	-0.290	-0.089
0.401	-0.012	-0.218	-0.315	—	-0.367	—	-0.554	-0.353	-0.104	—	-0.380	-0.353	-0.104
1.201	-3.030	-0.007	-0.019	—	-0.532	—	-0.573	-0.391	-0.123	—	-0.398	-0.391	-0.123
1.202	0.004	-0.013	-0.020	—	-0.535	—	-0.595	-0.182	-0.083	—	-0.398	-0.182	-0.083
1.199	2.942	-0.052	-0.057	—	-0.545	—	—	—	—	—	—	—	—
1.200	6.007	-0.094	-0.103	—	-0.554	—	—	—	—	—	—	—	—
1.198	9.002	-0.148	-0.157	—	-0.573	—	—	—	—	—	—	—	—
1.153	0.020	-0.032	-0.044	—	-0.595	—	—	—	—	—	—	—	—

Table 6. Continued

(c) Static pressure coefficients on nozzle bottom flap

$M_\infty$	$\alpha$ , deg	Static pressure coefficients on nozzle bottom flap at $y/Y = 0.875$ with values of $x/l$ of—														
		.153	.226	.300	.337	.411	.558	.705	.779	.853	.926					
1.249	-0.007	-0.006	-0.021	-0.402	-0.475	-0.376	-0.331	-0.300	-0.167	-0.095	-0.069					
1.201	0.017	-0.029	-0.044	-0.447	-0.524	-0.420	-0.374	-0.278	-0.158	-0.110	-0.088					
0.598	-0.026	-0.236	-0.369	-0.769	-0.391	-0.178	-0.025	0.065	0.098	0.125	0.152					
0.599	-3.007	-0.241	-0.361	-0.714	-0.351	-0.154	-0.013	0.076	0.109	0.134	0.162					
0.600	0.030	-0.240	-0.377	-0.777	-0.392	-0.179	-0.031	0.064	0.098	0.123	0.151					
0.601	2.997	-0.251	-0.395	-0.869	-0.438	-0.210	-0.052	0.050	0.090	0.118	0.152					
0.601	5.992	-0.264	-0.409	-0.927	-0.467	-0.235	-0.077	0.038	0.082	0.115	0.153					
0.601	9.003	-0.277	-0.418	-0.970	-0.489	-0.254	-0.103	0.019	0.070	0.107	0.150					
0.948	0.036	-0.103	-0.167	-0.795	-0.879	-0.612	-0.261	-0.169	-0.130	-0.094	-0.068					
0.925	-0.011	-0.125	-0.196	-0.843	-0.764	-0.375	-0.249	-0.176	-0.132	-0.094	-0.060					
0.901	-0.012	-0.144	-0.223	-0.885	-0.585	-0.332	-0.226	-0.143	-0.106	-0.066	-0.033					
0.900	-3.024	-0.159	-0.243	-0.924	-0.630	-0.376	-0.243	-0.136	-0.088	-0.045	-0.012					
0.898	0.002	-0.143	-0.224	-0.885	-0.585	-0.333	-0.223	-0.139	-0.100	-0.062	-0.028					
0.898	3.002	-0.142	-0.215	-0.891	-0.614	-0.347	-0.239	-0.158	-0.117	-0.075	-0.035					
0.897	6.000	-0.149	-0.214	-0.902	-0.751	-0.391	-0.270	-0.171	-0.120	-0.076	-0.033					
0.899	9.018	-0.157	-0.211	-0.901	-0.930	-0.468	-0.291	-0.174	-0.113	-0.065	-0.019					
0.875	0.025	-0.162	-0.250	-0.922	-0.549	-0.320	-0.195	-0.109	-0.068	-0.030	0.002					
0.850	0.021	-0.178	-0.273	-0.983	-0.563	-0.314	-0.163	-0.069	-0.032	0.005	0.036					
0.798	-0.018	-0.211	-0.327	-1.130	-0.612	-0.273	-0.085	0.014	0.044	0.068	0.089					
0.700	0.002	-0.244	-0.388	-0.927	-0.420	-0.180	-0.014	0.073	0.105	0.131	0.157					
0.401	-0.012	-0.226	-0.339	-0.664	-0.363	-0.173	-0.032	0.049	0.079	0.106	0.133					
1.201	-3.030	-0.014	-0.033	-0.447	-0.530	-0.385	-0.348	-0.310	-0.187	-0.106	-0.069					
1.202	0.004	-0.013	-0.028	-0.433	-0.508	-0.404	-0.364	-0.236	-0.135	-0.098	-0.075					
1.199	2.942	-0.029	-0.034	-0.442	-0.537	-0.415	-0.386	-0.263	-0.156	-0.122	-0.101					
1.200	6.007	-0.041	-0.045	-0.443	-0.543	-0.433	-0.397	-0.370	-0.191	-0.133	-0.109					
1.198	9.002	-0.062	-0.052	-0.438	-0.541	-0.461	-0.405	-0.401	-0.352	-0.183	-0.102					
1.153	0.020	-0.029	-0.050	-0.486	-0.566	-0.459	-0.397	-0.200	-0.142	-0.112	-0.088					

Table 6. Continued

(c) Continued

$M_\infty$	$\alpha$ , deg	Static pressure coefficients on nozzle bottom flap at $y/Y = 0.50$ with values of $x/l$ of—												
		.153	.226	.300	.337	.411	.558	.705	.779	.853	.926			
1.249	-0.007	-0.007	-0.027	-0.412	-0.505	-0.495	-0.464	-0.200	-0.138	-0.107	-0.080			
1.201	0.017	-0.030	-0.049	-0.462	-0.558	-0.552	-0.500	-0.195	-0.155	-0.128	-0.105			
0.598	-0.026	-0.293	-0.464	-0.889	-0.473	-0.217	-0.038	0.064	0.100	0.131	0.151			
0.599	-3.007	-0.280	-0.446	-0.864	-0.453	-0.202	-0.031	0.070	0.106	0.136	0.155			
0.600	0.030	-0.295	-0.470	-0.897	-0.477	-0.220	-0.045	0.061	0.098	0.129	0.147			
0.601	2.997	-0.307	-0.496	-0.994	-0.531	-0.259	-0.076	0.041	0.085	0.122	0.146			
0.601	5.992	-0.310	-0.509	-1.080	-0.570	-0.289	-0.103	0.021	0.070	0.112	0.141			
0.601	9.003	-0.304	-0.512	-1.142	-0.598	-0.311	-0.127	-0.001	0.051	0.097	0.132			
0.948	0.036	-0.115	-0.195	-0.822	-0.887	-0.582	-0.288	-0.192	-0.151	-0.110	-0.072			
0.925	-0.011	-0.138	-0.224	-0.837	-0.568	-0.360	-0.253	-0.178	-0.139	-0.102	-0.060			
0.901	-0.012	-0.160	-0.252	-0.802	-0.457	-0.322	-0.229	-0.151	-0.110	-0.071	-0.035			
0.900	-3.024	-0.165	-0.257	-0.858	-0.529	-0.363	-0.259	-0.162	-0.113	-0.069	-0.031			
0.898	0.002	-0.161	-0.252	-0.794	-0.459	-0.320	-0.228	-0.146	-0.106	-0.069	-0.033			
0.898	3.002	-0.151	-0.239	-0.826	-0.491	-0.336	-0.239	-0.155	-0.114	-0.074	-0.028			
0.897	6.000	-0.139	-0.224	-0.884	-0.627	-0.387	-0.265	-0.166	-0.119	-0.074	-0.021			
0.899	9.018	-0.122	-0.203	-0.903	-0.875	-0.461	-0.287	-0.170	-0.118	-0.068	-0.007			
0.875	0.025	-0.179	-0.282	-0.793	-0.442	-0.317	-0.213	-0.122	-0.081	-0.042	-0.007			
0.850	0.021	-0.198	-0.310	-0.844	-0.461	-0.326	-0.191	-0.089	-0.045	-0.008	0.026			
0.798	-0.018	-0.242	-0.375	-1.034	-0.582	-0.343	-0.130	-0.015	0.026	0.056	0.077			
0.700	0.002	-0.294	-0.476	-1.165	-0.489	-0.212	-0.024	0.073	0.106	0.135	0.154			
0.401	-0.012	-0.283	-0.426	-0.762	-0.440	-0.217	-0.049	0.046	0.083	0.109	0.130			
1.201	-3.030	-0.012	-0.033	-0.445	-0.539	-0.533	-0.520	-0.244	-0.155	-0.119	-0.083			
1.202	0.004	-0.017	-0.036	-0.449	-0.543	-0.537	-0.477	-0.179	-0.144	-0.121	-0.093			
1.199	2.942	-0.022	-0.037	-0.447	-0.551	-0.533	-0.509	-0.190	-0.159	-0.136	-0.115			
1.200	6.007	-0.017	-0.031	-0.441	-0.550	-0.523	-0.521	-0.231	-0.171	-0.144	-0.123			
1.198	9.002	-0.013	-0.019	-0.430	-0.544	-0.512	-0.520	-0.454	-0.311	-0.157	-0.116			
1.153	0.020	-0.033	-0.061	-0.505	-0.603	-0.599	-0.438	-0.199	-0.168	-0.143	-0.114			

Table 6. Continued

(c) Concluded

$M_\infty$	$\alpha$ , deg	Static pressure coefficients on nozzle bottom flap at centerline with values of $x/l$ of—									
		.153	.226	.300	.337	.411	.558	.705	.926		
1.249	-0.007	-0.006	-0.032	-0.406	-0.486	—	-0.462	-0.182	-0.094		
1.201	0.017	-0.027	-0.054	-0.456	-0.538	—	-0.478	-0.192	-0.118		
0.598	-0.026	-0.311	-0.472	-0.920	-0.496	—	-0.051	0.056	0.152		
0.599	-3.007	-0.299	-0.456	-0.889	-0.473	—	-0.038	0.065	0.153		
0.600	0.030	-0.313	-0.478	-0.931	-0.501	—	-0.053	0.057	0.145		
0.601	2.997	-0.327	-0.504	-0.992	-0.545	—	-0.082	0.035	0.138		
0.601	5.992	-0.331	-0.518	-1.063	-0.579	—	-0.108	0.015	0.132		
0.601	9.003	-0.327	-0.521	-1.107	-0.602	—	-0.128	-0.004	0.121		
0.948	0.036	-0.125	-0.209	-0.818	-0.815	—	-0.287	-0.206	-0.079		
0.925	-0.011	-0.146	-0.234	-0.830	-0.556	—	-0.242	-0.174	-0.057		
0.901	-0.012	-0.170	-0.261	-0.822	-0.478	—	-0.220	-0.141	-0.032		
0.900	-3.024	-0.174	-0.266	-0.865	-0.540	—	-0.246	-0.150	-0.027		
0.898	0.002	-0.169	-0.261	-0.816	-0.475	—	-0.218	-0.138	-0.030		
0.898	3.002	-0.161	-0.254	-0.841	-0.507	—	-0.226	-0.148	-0.034		
0.897	6.000	-0.150	-0.243	-0.881	-0.598	—	-0.256	-0.172	-0.035		
0.899	9.018	-0.132	-0.226	-0.905	-0.771	—	-0.290	-0.190	-0.032		
0.875	0.025	-0.189	-0.290	-0.840	-0.476	—	-0.199	-0.110	-0.003		
0.850	0.021	-0.206	-0.319	-0.889	-0.496	—	-0.176	-0.082	0.028		
0.798	-0.018	-0.257	-0.387	-1.083	-0.611	—	-0.124	-0.016	0.082		
0.700	0.002	-0.313	-0.487	-1.165	-0.519	—	-0.039	0.066	0.159		
0.401	-0.012	-0.297	-0.429	-0.792	-0.450	—	-0.065	0.033	0.137		
1.201	-3.030	-0.013	-0.044	-0.447	-0.530	—	-0.498	-0.220	-0.102		
1.202	0.004	-0.017	-0.045	-0.447	-0.530	—	-0.452	-0.182	-0.107		
1.199	2.942	-0.021	-0.046	-0.449	-0.536	—	-0.460	-0.192	-0.125		
1.200	6.007	-0.016	-0.040	-0.443	-0.530	—	-0.510	-0.211	-0.133		
1.198	9.002	-0.004	-0.025	-0.435	-0.525	—	-0.504	-0.461	-0.129		
1.153	0.020	-0.034	-0.068	-0.500	-0.588	—	-0.442	-0.203	-0.118		



Table 6. Concluded

(d) Force data

$M_{\infty}$	$\alpha$ , deg	$C_D$
1.249	-0.007	0.2724
1.201	0.017	0.2926
0.598	-0.026	0.0676
0.599	-3.007	0.0672
0.600	0.030	0.0651
0.601	2.998	0.0675
0.601	5.992	0.0777
0.601	9.003	0.0937
0.948	0.036	0.2803
0.925	-0.011	0.2444
0.901	-0.012	0.2144
0.900	-3.024	0.2353
0.898	0.002	0.2137
0.898	3.002	0.2203
0.897	6.000	0.2446
0.899	9.018	0.2724
0.875	0.025	0.1939
0.850	0.021	0.1744
0.798	-0.018	0.1349
0.700	0.002	0.0805
0.401	-0.012	0.0651
1.201	-3.029	0.3048
1.202	0.004	0.2859
1.199	2.942	0.3004
1.200	6.007	0.3154
1.198	9.002	0.3395
1.153	0.020	0.3058

Table 7. Pressure and Force Data for Nozzle 5 With  $\beta_{t,top/bot} = 17.9^\circ/\beta_{t,side} = 0^\circ$ , Plume On, and  $\alpha = 0^\circ$

(a) Static pressure coefficients on nozzle top flap

$M_\infty$	Static pressure coefficients on nozzle top flap at centerline with values of $x/l$ of—													
	.153	.226	.300	.337	.411	.484	.558	.632	.705	.779	.853	.926		
0.696	-0.302	-0.462	-1.303	-0.578	-0.224	-0.087	-0.003	0.055	0.096	0.130	0.152	0.171		
0.799	-0.230	-0.342	-0.758	-0.351	-0.233	-0.175	-0.132	-0.097	-0.067	-0.041	-0.012	0.018		
1.252	-0.021	-0.025	-0.427	-0.523	-0.491	-0.431	-0.176	-0.158	-0.147	-0.139	-0.120	-0.105		
1.199	-0.018	-0.031	-0.473	-0.574	-0.541	-0.411	-0.191	-0.171	-0.162	-0.148	-0.135	-0.118		
1.150	-0.036	-0.055	-0.530	-0.637	-0.608	-0.326	-0.211	-0.193	-0.181	-0.167	-0.152	-0.135		
0.954	-0.105	-0.170	-0.669	-0.412	-0.304	-0.258	-0.235	-0.219	-0.205	-0.191	-0.173	-0.150		
0.926	-0.135	-0.206	-0.615	-0.359	-0.271	-0.236	-0.215	-0.199	-0.184	-0.167	-0.146	-0.121		
0.900	-0.156	-0.236	-0.596	-0.326	-0.256	-0.226	-0.201	-0.183	-0.162	-0.143	-0.121	-0.092		
0.876	-0.176	-0.264	-0.596	-0.314	-0.251	-0.218	-0.190	-0.165	-0.141	-0.124	-0.100	-0.068		
0.851	-0.195	-0.288	-0.629	-0.323	-0.248	-0.209	-0.179	-0.150	-0.125	-0.102	-0.075	-0.044		
0.801	-0.229	-0.341	-0.739	-0.352	-0.237	-0.177	-0.133	-0.098	-0.069	-0.043	-0.017	0.014		
0.702	-0.300	-0.459	-1.243	-0.589	-0.237	-0.097	-0.012	0.047	0.089	0.118	0.139	0.159		
0.602	-0.322	-0.490	-1.193	-0.533	-0.238	-0.103	-0.014	0.051	0.104	0.139	0.167	0.191		
0.400	-0.311	-0.460	-0.975	-0.498	-0.250	-0.124	-0.032	0.033	0.090	0.123	0.147	0.178		

$M_\infty$	Static pressure coefficients on nozzle top flap at $y/Y = 0.50$ with values of $x/l$ of—													
	.153	.226	.300	.337	.411	.484	.558	.632	.705	.779	.853	.926		
0.696	-0.272	-0.444	-	-0.547	-0.215	-0.018	-0.018	0.086	0.124	0.153	0.178	0.178		
0.799	-0.213	-0.339	-	-0.409	-0.248	-0.127	-0.061	-0.035	-0.035	-0.007	0.025	0.025		
1.252	-0.010	-0.022	-	-0.526	-0.479	-0.223	-0.139	-0.126	-0.126	-0.115	-0.099	-0.099		
1.199	-0.011	-0.030	-	-0.575	-0.525	-0.221	-0.154	-0.142	-0.142	-0.128	-0.112	-0.112		
1.150	-0.033	-0.058	-	-0.643	-0.590	-0.222	-0.175	-0.160	-0.160	-0.147	-0.128	-0.128		
0.954	-0.095	-0.168	-	-0.441	-0.325	-0.247	-0.216	-0.199	-0.199	-0.180	-0.154	-0.154		
0.926	-0.125	-0.205	-	-0.386	-0.289	-0.222	-0.191	-0.172	-0.172	-0.148	-0.124	-0.124		
0.900	-0.146	-0.236	-	-0.366	-0.275	-0.206	-0.168	-0.146	-0.146	-0.119	-0.090	-0.090		
0.876	-0.165	-0.264	-	-0.362	-0.270	-0.190	-0.144	-0.121	-0.121	-0.093	-0.064	-0.064		
0.851	-0.182	-0.286	-	-0.363	-0.263	-0.175	-0.124	-0.098	-0.098	-0.071	-0.039	-0.039		
0.801	-0.212	-0.337	-	-0.413	-0.252	-0.126	-0.065	-0.039	-0.039	-0.011	0.022	0.022		
0.702	-0.272	-0.442	-	-0.571	-0.227	-0.023	0.077	0.113	0.113	0.145	0.169	0.169		
0.602	-0.287	-0.466	-	-0.502	-0.221	-0.026	0.082	0.127	0.127	0.166	0.192	0.192		
0.400	-0.280	-0.439	-	-0.479	-0.223	-0.035	0.064	0.108	0.108	0.157	0.183	0.183		

Table 7. Continued

(a) Concluded

$M_\infty$	Static pressure coefficients on nozzle top flap at $y/Y = 0.75$ with values of $x/l$ of—									
	.153	.226	.300	.337	.411	.558	.705	.779	.853	.926
0.696	-0.248	-0.378	-1.098	-0.456	-0.226	-0.066	0.034	0.078	0.123	0.170
0.799	-0.207	-0.309	-0.911	-0.445	-0.224	-0.109	-0.051	-0.023	0.009	0.061
1.252	-0.013	-0.017	-0.418	-0.517	-0.338	-0.309	-0.215	-0.182	-0.161	-0.096
1.199	-0.018	-0.025	-0.462	-0.559	-0.366	-0.334	-0.219	-0.190	-0.166	-0.101
1.150	-0.042	-0.053	-0.523	-0.620	-0.421	-0.360	-0.222	-0.199	-0.178	-0.106
0.954	-0.100	-0.157	-0.741	-0.467	-0.328	-0.236	-0.204	-0.187	-0.160	-0.125
0.926	-0.130	-0.196	-0.678	-0.412	-0.291	-0.217	-0.181	-0.159	-0.130	-0.097
0.900	-0.151	-0.226	-0.676	-0.398	-0.278	-0.197	-0.155	-0.128	-0.102	-0.063
0.876	-0.168	-0.253	-0.695	-0.397	-0.271	-0.176	-0.131	-0.104	-0.075	-0.033
0.851	-0.183	-0.270	-0.738	-0.404	-0.260	-0.154	-0.105	-0.083	-0.050	-0.007
0.801	-0.207	-0.312	-0.890	-0.453	-0.230	-0.109	-0.054	-0.027	0.008	0.058
0.702	-0.251	-0.386	-1.112	-0.466	-0.233	-0.071	0.025	0.072	0.116	0.162
0.602	-0.256	-0.389	-0.930	-0.440	-0.228	-0.073	0.020	0.072	0.120	0.169
0.400	-0.248	-0.377	-0.786	-0.411	-0.223	-0.075	-0.006	0.053	0.096	0.147

$M_\infty$	Static pressure coefficients on nozzle top flap at $y/Y = 0.875$ with values of $x/l$ of—									
	.153	.226	.300	.337	.411	.558	.705	.779	.853	.926
0.696	-0.214	-0.325	-0.706	-0.476	-0.341	-0.166	-0.120	-0.110	-0.080	-0.002
0.799	-0.188	-0.288	-0.742	-0.419	-0.284	-0.167	-0.145	-0.133	-0.100	-0.030
1.252	-0.005	-0.014	-0.326	-0.314	-0.338	-0.398	-0.448	-0.471	-0.434	-0.316
1.199	-0.011	-0.026	-0.354	-0.342	-0.371	-0.428	-0.467	-0.475	-0.415	-0.287
1.150	-0.035	-0.055	-0.406	-0.393	-0.426	-0.469	-0.489	-0.503	-0.423	-0.288
0.954	-0.091	-0.156	-0.638	-0.450	-0.321	-0.246	-0.219	-0.191	-0.159	-0.121
0.926	-0.120	-0.192	-0.665	-0.384	-0.270	-0.212	-0.179	-0.155	-0.129	-0.097
0.900	-0.140	-0.220	-0.682	-0.364	-0.252	-0.196	-0.164	-0.136	-0.107	-0.069
0.876	-0.154	-0.242	-0.697	-0.357	-0.249	-0.187	-0.155	-0.129	-0.099	-0.052
0.851	-0.167	-0.257	-0.713	-0.370	-0.255	-0.176	-0.149	-0.128	-0.095	-0.043
0.801	-0.186	-0.287	-0.736	-0.418	-0.284	-0.168	-0.144	-0.128	-0.096	-0.028
0.702	-0.216	-0.329	-0.717	-0.480	-0.342	-0.170	-0.119	-0.106	-0.077	-0.001
0.602	-0.215	-0.321	-0.633	-0.442	-0.331	-0.176	-0.118	-0.104	-0.082	-0.009
0.400	-0.209	-0.306	-0.565	-0.397	-0.309	-0.186	-0.123	-0.104	-0.094	-0.028

Table 7. Continued

(b) Static pressure coefficients on nozzle sidewall

$M_\infty$	Static pressure coefficients on corner between nozzle top flap and sidewall with values of $x/l$ of—									
	.153	.226	.300	.337	.411	.558	.705	.779	.853	.926
0.696	-0.194	-0.287	-0.495	-0.413	-0.366	-0.313	-0.219	-0.148	-0.034	0.087
0.799	-0.178	-0.271	-0.514	-0.395	-0.329	-0.281	-0.216	-0.172	-0.093	0.016
1.252	-0.004	-0.017	-0.220	-0.214	-0.274	-0.433	-0.576	-0.513	-0.417	-0.270
1.199	-0.012	-0.028	-0.240	-0.237	-0.303	-0.468	-0.617	-0.528	-0.415	-0.258
1.150	-0.038	-0.059	-0.286	-0.283	-0.352	-0.509	-0.647	-0.537	-0.420	-0.249
0.954	-0.090	-0.153	-0.465	-0.435	-0.392	-0.291	-0.192	-0.169	-0.141	-0.115
0.926	-0.119	-0.189	-0.508	-0.424	-0.334	-0.211	-0.175	-0.164	-0.133	-0.094
0.900	-0.138	-0.215	-0.538	-0.411	-0.287	-0.222	-0.185	-0.163	-0.119	-0.069
0.876	-0.151	-0.233	-0.544	-0.389	-0.284	-0.242	-0.190	-0.165	-0.113	-0.048
0.851	-0.164	-0.251	-0.533	-0.375	-0.299	-0.255	-0.199	-0.167	-0.107	-0.029
0.801	-0.177	-0.270	-0.514	-0.394	-0.325	-0.275	-0.211	-0.172	-0.096	0.013
0.702	-0.196	-0.289	-0.501	-0.418	-0.365	-0.310	-0.216	-0.151	-0.040	0.081
0.602	-0.191	-0.276	-0.455	-0.387	-0.346	-0.311	-0.229	-0.169	-0.055	0.076
0.400	-0.185	-0.262	-0.417	-0.362	-0.322	-0.303	-0.242	-0.205	-0.096	0.047

$M_\infty$	Static pressure coefficients on nozzle sidewall at $z/Z = 0.50$ with values of $x/l$ of—									
	.153	.226	.300	.337	.411	.558	.705	.779	.853	.926
0.696	-	-	-0.230	-0.225	-0.208	-0.157	-0.091	-0.047	-	0.085
0.799	-	-	-0.255	-0.248	-0.224	-0.173	-0.119	-0.082	-	0.035
1.252	-	-	-0.047	-0.074	-0.110	-0.201	-0.288	-0.325	-	-0.328
1.199	-	-	-0.068	-0.094	-0.134	-0.233	-0.322	-0.364	-	-0.328
1.150	-	-	-0.104	-0.135	-0.177	-0.255	-0.339	-0.383	-	-0.314
0.954	-	-	-0.231	-0.272	-0.324	-0.331	-0.190	-0.151	-	-0.080
0.926	-	-	-0.270	-0.307	-0.334	-0.222	-0.143	-0.127	-	-0.071
0.900	-	-	-0.293	-0.319	-0.282	-0.183	-0.145	-0.117	-	-0.048
0.876	-	-	-0.291	-0.293	-0.244	-0.186	-0.140	-0.107	-	-0.027
0.851	-	-	-0.277	-0.267	-0.233	-0.181	-0.132	-0.101	-	-0.006
0.801	-	-	-0.257	-0.249	-0.224	-0.172	-0.119	-0.083	-	0.030
0.702	-	-	-0.236	-0.231	-0.214	-0.159	-0.096	-0.050	-	0.076
0.602	-	-	-0.213	-0.208	-0.198	-0.151	-0.101	-0.053	-	0.068
0.400	-	-	-0.195	-0.194	-0.195	-0.148	-0.122	-0.069	-	0.033

Table 7. Continued

(b) Concluded

$M_\infty$	Static pressure coefficients on nozzle sidewall at centerline with values of $x/l$ of—												
	.153	.226	.300	.337	.411	.484	.558	.632	.705	.779	.853	.926	
0.696	-	-0.162	-0.175	-0.176	-0.165	-0.146	-0.121	-0.094	-0.061	-0.021	0.029	0.092	
0.799	-	-0.177	-0.200	-0.203	-0.190	-0.169	-0.144	-0.121	-0.091	-0.056	-0.012	0.047	
1.252	-	-0.001	-0.016	-0.030	-0.069	-0.114	-0.165	-0.208	-0.246	-0.288	-0.326	-0.342	
1.199	-	-0.017	-0.032	-0.051	-0.095	-0.140	-0.192	-0.238	-0.286	-0.322	-0.368	-0.352	
1.150	-	-0.047	-0.066	-0.088	-0.135	-0.181	-0.214	-0.250	-0.297	-0.342	-0.388	-0.333	
0.954	-	-0.120	-0.180	-0.219	-0.290	-0.337	-0.330	-0.258	-0.184	-0.138	-0.101	-0.065	
0.926	-	-0.153	-0.215	-0.256	-0.314	-0.303	-0.211	-0.144	-0.125	-0.109	-0.089	-0.053	
0.900	-	-0.174	-0.234	-0.268	-0.267	-0.198	-0.162	-0.143	-0.123	-0.097	-0.071	-0.028	
0.876	-	-0.183	-0.228	-0.244	-0.220	-0.190	-0.162	-0.138	-0.115	-0.085	-0.055	-0.006	
0.851	-	-0.185	-0.218	-0.224	-0.206	-0.181	-0.160	-0.135	-0.107	-0.079	-0.041	0.011	
0.801	-	-0.181	-0.200	-0.204	-0.192	-0.170	-0.148	-0.120	-0.091	-0.057	-0.014	0.048	
0.702	-	-0.167	-0.176	-0.180	-0.170	-0.152	-0.127	-0.096	-0.062	-0.023	0.025	0.092	
0.602	-	-0.152	-0.155	-0.160	-0.152	-0.140	-0.120	-0.091	-0.063	-0.025	0.019	0.086	
0.400	-	-0.140	-0.135	-0.147	-0.141	-0.138	-0.116	-0.089	-0.069	-0.034	0.000	0.069	

$M_\infty$	Static pressure coefficients on nozzle sidewall at $z/Z = -0.50$ with values of $x/l$ of—												
	.153	.226	.300	.337	.411	.484	.558	.632	.705	.779	.853	.926	
0.696	-0.161	-	-0.221	-0.214	-0.197	-0.149	-0.149	-0.081	-0.081	0.090	0.090	0.090	
0.799	-0.161	-	-0.252	-0.245	-0.221	-0.171	-0.171	-0.109	-0.109	0.043	0.043	0.043	
1.252	0.001	-	-0.045	-0.062	-0.108	-0.201	-0.201	-0.282	-0.282	-0.341	-0.341	-0.341	
1.199	-0.010	-	-0.067	-0.088	-0.134	-0.230	-0.230	-0.321	-0.321	-0.325	-0.325	-0.325	
1.150	-0.038	-	-0.102	-0.125	-0.179	-0.254	-0.254	-0.336	-0.336	-0.311	-0.311	-0.311	
0.954	-0.083	-	-0.220	-0.263	-0.333	-0.333	-0.333	-0.182	-0.182	-0.075	-0.075	-0.075	
0.926	-0.112	-	-0.258	-0.300	-0.345	-0.216	-0.216	-0.135	-0.135	-0.066	-0.066	-0.066	
0.900	-0.129	-	-0.280	-0.316	-0.293	-0.178	-0.178	-0.134	-0.134	-0.043	-0.043	-0.043	
0.876	-0.139	-	-0.280	-0.294	-0.246	-0.179	-0.179	-0.127	-0.127	-0.024	-0.024	-0.024	
0.851	-0.151	-	-0.271	-0.267	-0.234	-0.178	-0.178	-0.121	-0.121	0.002	0.002	0.002	
0.801	-0.157	-	-0.251	-0.247	-0.225	-0.171	-0.171	-0.109	-0.109	0.039	0.039	0.039	
0.702	-0.159	-	-0.225	-0.222	-0.204	-0.151	-0.151	-0.081	-0.081	0.081	0.081	0.081	
0.602	-0.147	-	-0.199	-0.199	-0.185	-0.143	-0.143	-0.083	-0.083	0.070	0.070	0.070	
0.400	-0.133	-	-0.178	-0.184	-0.169	-0.139	-0.139	-0.085	-0.085	0.033	0.033	0.033	

Table 7. Continued

(c) Static pressure coefficients on nozzle bottom flap

$M_\infty$	Static pressure coefficients on nozzle bottom flap at $y/Y = 0.875$ with values of $x/l$ of—									
	.153	.226	.300	.337	.411	.558	.705	.779	.853	.926
0.696	-0.209	-0.327	-	-0.467	-0.327	-0.150	-0.091	-0.077	-	0.031
0.799	-0.187	-0.293	-	-0.446	-0.304	-0.160	-0.121	-0.106	-	-0.002
1.252	0.002	-0.014	-	-0.335	-0.343	-0.365	-0.422	-0.427	-	-0.252
1.199	-0.014	-0.033	-	-0.372	-0.383	-0.408	-0.436	-0.433	-	-0.245
1.150	-0.037	-0.062	-	-0.422	-0.436	-0.444	-0.447	-0.461	-	-0.249
0.954	-0.091	-0.157	-	-0.521	-0.360	-0.249	-0.200	-0.173	-	-0.100
0.926	-0.122	-0.193	-	-0.434	-0.293	-0.207	-0.157	-0.134	-	-0.077
0.900	-0.141	-0.220	-	-0.408	-0.271	-0.187	-0.140	-0.116	-	-0.052
0.876	-0.155	-0.241	-	-0.402	-0.267	-0.177	-0.131	-0.109	-	-0.036
0.851	-0.169	-0.260	-	-0.406	-0.272	-0.169	-0.128	-0.106	-	-0.022
0.801	-0.188	-0.292	-	-0.449	-0.307	-0.164	-0.124	-0.106	-	-0.004
0.702	-0.215	-0.329	-	-0.472	-0.330	-0.152	-0.095	-0.079	-	0.024
0.602	-0.212	-0.318	-	-0.434	-0.318	-0.155	-0.095	-0.078	-	0.017
0.400	-0.208	-0.303	-	-0.396	-0.303	-0.155	-0.094	-0.074	-	-0.001

$M_\infty$	Static pressure coefficients on nozzle bottom flap at $y/Y = 0.50$ with values of $x/l$ of—									
	.153	.226	.300	.337	.411	.558	.705	.779	.853	.926
0.696	-0.278	-0.442	-1.244	-0.501	-0.212	-0.018	0.096	0.138	0.168	0.192
0.799	-0.222	-0.341	-0.838	-0.467	-0.286	-0.112	-0.018	0.017	0.048	0.077
1.252	0.001	-0.012	-0.464	-0.528	-0.486	-0.352	-0.145	-0.122	-0.101	-0.078
1.199	-0.017	-0.030	-0.515	-0.581	-0.533	-0.270	-0.163	-0.140	-0.118	-0.096
1.150	-0.041	-0.061	-0.575	-0.645	-0.596	-0.254	-0.181	-0.154	-0.133	-0.108
0.954	-0.103	-0.172	-0.714	-0.480	-0.353	-0.263	-0.202	-0.174	-0.147	-0.117
0.926	-0.134	-0.209	-0.646	-0.412	-0.310	-0.235	-0.175	-0.147	-0.118	-0.089
0.900	-0.154	-0.238	-0.623	-0.384	-0.292	-0.217	-0.148	-0.116	-0.086	-0.054
0.876	-0.172	-0.264	-0.631	-0.380	-0.286	-0.198	-0.122	-0.090	-0.060	-0.030
0.851	-0.190	-0.288	-0.666	-0.395	-0.289	-0.175	-0.092	-0.061	-0.029	0.004
0.801	-0.222	-0.341	-0.820	-0.465	-0.285	-0.117	-0.020	0.016	0.046	0.075
0.702	-0.279	-0.441	-1.204	-0.514	-0.217	-0.029	0.088	0.129	0.160	0.181
0.602	-0.286	-0.451	-1.030	-0.464	-0.211	-0.039	0.085	0.133	0.170	0.192
0.400	-0.275	-0.425	-0.872	-0.434	-0.211	-0.062	0.066	0.116	0.159	0.177

Table 7. Concluded

(c) Concluded

$M_\infty$	Static pressure coefficients on nozzle bottom flap at centerline with values of $x/l$ of—									
	.153	.226	.300	.337	.411	.558	.705	.926		
0.696	-0.299	-0.462	-	-	-0.233	-0.016	0.100	0.213		
0.799	-0.234	-0.354	-	-	-0.276	-0.115	-0.018	0.080		
1.252	0.004	-0.020	-	-	-0.486	-0.222	-0.176	-0.097		
1.199	-0.020	-0.044	-	-	-0.536	-0.236	-0.183	-0.105		
1.150	-0.043	-0.069	-	-	-0.595	-0.255	-0.204	-0.113		
0.954	-0.110	-0.188	-	-	-0.349	-0.263	-0.207	-0.114		
0.926	-0.138	-0.219	-	-	-0.304	-0.231	-0.176	-0.088		
0.900	-0.158	-0.246	-	-	-0.289	-0.212	-0.147	-0.058		
0.876	-0.175	-0.271	-	-	-0.284	-0.194	-0.120	-0.033		
0.851	-0.197	-0.296	-	-	-0.284	-0.174	-0.093	0.008		
0.801	-0.231	-0.352	-	-	-0.276	-0.119	-0.021	0.076		
0.702	-0.296	-0.460	-	-	-0.239	-0.022	0.095	0.198		
0.602	-0.307	-0.473	-	-	-0.236	-0.031	0.093	0.210		
0.400	-0.294	-0.442	-	-	-0.239	-0.051	0.078	0.179		

(d) Force data

$M_\infty$	$C_D$	$C_{D,p}$	$C_{D,f}$
0.696	0.0600	0.0660	0.0131
0.799	0.1116	0.1250	0.0128
1.252	0.2367	0.2306	0.0119
1.199	0.2535	0.2439	0.0120
1.150	0.2656	0.2589	0.0122
0.954	0.2119	0.2171	0.0126
0.926	0.1814	0.1913	0.0127
0.900	0.1644	0.1740	0.0127
0.876	0.1501	0.1614	0.0128
0.851	0.1373	0.1511	0.0128
0.801	0.1103	0.1260	0.0130
0.702	0.0579	0.0722	0.0133
0.602	0.0445	0.0600	0.0136
0.400	0.0360	0.0624	0.0145

Table 8. Pressure and Force Data for Nozzle 5 With  $\beta_{r,top/bot} = 17.9^\circ$ ,  $\beta_{r,side} = 0^\circ$  and Plume Off

(a) Static pressure coefficients on nozzle top flap

$M_\infty$	$\alpha$ , deg	Static pressure coefficients on nozzle top flap at centerline with values of $v/l$ of—													
		.153	.226	.300	.337	.411	.484	.558	.632	.705	.779	.853	.926		
1.252	-0.005	-0.011	-0.017	-0.425	-0.522	-0.488	-0.382	-0.169	-0.152	-0.141	-0.129	-0.121	-0.107		
1.199	-0.009	-0.012	-0.026	-0.471	-0.577	-0.531	-0.363	-0.185	-0.164	-0.153	-0.143	-0.134	-0.120		
1.200	-2.999	-0.016	-0.024	-0.466	-0.577	-0.522	-0.445	-0.201	-0.178	-0.166	-0.158	-0.151	-0.138		
1.201	0.012	-0.012	-0.025	-0.467	-0.573	-0.531	-0.374	-0.184	-0.164	-0.151	-0.142	-0.135	-0.120		
1.199	2.950	-0.007	-0.028	-0.468	-0.572	-0.544	-0.484	-0.276	-0.197	-0.175	-0.165	-0.154	-0.132		
1.199	5.971	-0.010	-0.032	-0.466	-0.571	-0.548	-0.507	-0.383	-0.218	-0.188	-0.177	-0.166	-0.143		
1.152	0.004	-0.032	-0.050	-0.524	-0.627	-0.592	-0.314	-0.203	-0.184	-0.172	-0.162	-0.152	-0.141		
0.925	-0.239	-0.132	-0.200	-0.571	-0.297	-0.223	-0.195	-0.181	-0.169	-0.156	-0.144	-0.131	-0.117		
0.901	0.162	-0.153	-0.229	-0.549	-0.279	-0.216	-0.194	-0.176	-0.161	-0.149	-0.132	-0.116	-0.095		
0.877	0.006	-0.170	-0.253	-0.560	-0.282	-0.221	-0.187	-0.164	-0.146	-0.128	-0.110	-0.090	-0.064		
0.849	-0.036	-0.190	-0.280	-0.574	-0.278	-0.216	-0.181	-0.155	-0.132	-0.110	-0.085	-0.063	-0.038		
0.802	0.014	-0.219	-0.328	-0.663	-0.288	-0.195	-0.145	-0.113	-0.083	-0.059	-0.037	-0.015	0.013		
0.702	0.000	-0.298	-0.454	-1.271	-0.604	-0.247	-0.103	-0.018	0.042	0.085	0.118	0.143	0.162		
0.603	0.001	-0.325	-0.499	-1.244	-0.556	-0.254	-0.121	-0.038	0.026	0.075	0.119	0.156	0.188		
0.600	-3.002	-0.336	-0.521	-1.373	-0.608	-0.291	-0.154	-0.066	0.003	0.058	0.109	0.154	0.194		
0.602	0.001	-0.327	-0.501	-1.247	-0.559	-0.257	-0.125	-0.041	0.024	0.074	0.117	0.154	0.185		
0.602	2.996	-0.316	-0.483	-1.172	-0.531	-0.242	-0.115	-0.034	0.028	0.077	0.121	0.160	0.194		
0.602	6.008	-0.309	-0.477	-1.177	-0.538	-0.252	-0.128	-0.050	0.009	0.056	0.101	0.143	0.188		
0.602	8.986	-0.311	-0.485	-1.293	-0.584	-0.286	-0.160	-0.084	-0.026	0.019	0.064	0.112	0.167		
0.401	0.001	-0.309	-0.458	-1.011	-0.512	-0.252	-0.131	-0.050	0.011	0.059	0.103	0.142	0.177		



Table 8. Continued

(a) Continued

$M_\infty$	$\alpha$ , deg	Static pressure coefficients on nozzle top flap at $y/Y = 0.50$ with values of $\sqrt{v}$ of—											
		.153	.226	.300	.337	.411	.558	.705	.779	.853	.926		
1.252	-0.005	-0.005	-0.018	-	-0.522	-0.477	-0.200	-0.134	-0.119	-0.109	-0.103		
1.199	-0.009	-0.006	-0.028	-	-0.574	-0.520	-0.198	-0.145	-0.132	-0.122	-0.116		
1.200	-2.999	-0.011	-0.028	-	-0.573	-0.515	-0.228	-0.161	-0.149	-0.138	-0.129		
1.201	0.012	-0.006	-0.027	-	-0.573	-0.520	-0.204	-0.146	-0.134	-0.123	-0.116		
1.199	2.950	-0.005	-0.030	-	-0.574	-0.528	-0.305	-0.183	-0.162	-0.144	-0.127		
1.199	5.971	-0.013	-0.039	-	-0.580	-0.544	-0.346	-0.198	-0.175	-0.156	-0.140		
1.152	0.004	-0.030	-0.056	-	-0.635	-0.577	-0.210	-0.169	-0.154	-0.143	-0.134		
0.925	-0.239	-0.120	-0.200	-	-0.330	-0.240	-0.188	-0.161	-0.148	-0.134	-0.116		
0.901	0.162	-0.142	-0.231	-	-0.324	-0.246	-0.185	-0.154	-0.135	-0.117	-0.095		
0.877	0.006	-0.159	-0.252	-	-0.313	-0.233	-0.172	-0.130	-0.112	-0.091	-0.067		
0.849	-0.036	-0.176	-0.280	-	-0.325	-0.233	-0.153	-0.104	-0.085	-0.061	-0.038		
0.802	0.014	-0.203	-0.323	-	-0.352	-0.214	-0.108	-0.050	-0.029	-0.008	0.013		
0.702	0.000	-0.269	-0.437	-	-0.585	-0.232	-0.030	0.073	0.111	0.140	0.159		
0.603	0.001	-0.288	-0.469	-	-0.513	-0.236	-0.051	0.053	0.100	0.141	0.175		
0.600	-3.002	-0.297	-0.490	-	-0.562	-0.268	-0.072	0.038	0.087	0.136	0.178		
0.602	0.001	-0.290	-0.471	-	-0.515	-0.238	-0.053	0.052	0.097	0.140	0.175		
0.602	2.996	-0.280	-0.452	-	-0.499	-0.230	-0.052	0.047	0.091	0.134	0.173		
0.602	6.008	-0.276	-0.443	-	-0.515	-0.244	-0.071	0.021	0.062	0.107	0.152		
0.602	8.986	-0.291	-0.463	-	-0.554	-0.272	-0.100	-0.018	0.020	0.065	0.117		
0.401	0.001	-0.275	-0.432	-	-0.474	-0.231	-0.059	0.039	0.083	0.126	0.164		

Table 8. Continued  
(a) Continued

$M_\infty$	$\alpha$ , deg	Static pressure coefficients on nozzle top flap at $y/Y = 0.75$ with values of $x/l$ of—													
		.153	.226	.300	.337	.411	.558	.705	.779	.853	.926				
1.252	-0.005	-0.012	-0.013	-0.416	-0.510	-0.338	-0.302	-0.199	-0.170	-0.153	-0.147				
1.199	-0.009	-0.014	-0.020	-0.460	-0.554	-0.366	-0.323	-0.196	-0.174	-0.157	-0.152				
1.200	-2.999	-0.020	-0.021	-0.449	-0.563	-0.390	-0.325	-0.202	-0.180	-0.161	-0.154				
1.201	0.012	-0.013	-0.022	-0.458	-0.554	-0.364	-0.327	-0.202	-0.177	-0.160	-0.155				
1.199	2.950	-0.023	-0.035	-0.476	-0.560	-0.360	-0.348	-0.289	-0.261	-0.235	-0.181				
1.199	5.971	-0.040	-0.053	-0.483	-0.568	-0.375	-0.347	-0.325	-0.310	-0.295	-0.254				
1.152	0.004	-0.035	-0.049	-0.516	-0.614	-0.412	-0.334	-0.203	-0.186	-0.171	-0.168				
0.925	-0.239	-0.124	-0.187	-0.629	-0.354	-0.246	-0.183	-0.154	-0.144	-0.127	-0.112				
0.901	0.162	-0.146	-0.216	-0.635	-0.355	-0.251	-0.176	-0.139	-0.126	-0.105	-0.084				
0.877	0.006	-0.160	-0.239	-0.647	-0.349	-0.236	-0.155	-0.115	-0.100	-0.079	-0.058				
0.849	-0.036	-0.175	-0.261	-0.703	-0.369	-0.228	-0.136	-0.090	-0.073	-0.052	-0.030				
0.802	0.014	-0.200	-0.300	-0.852	-0.393	-0.194	-0.089	-0.041	-0.025	-0.005	0.014				
0.702	0.000	-0.245	-0.378	-1.134	-0.470	-0.235	-0.076	0.021	0.060	0.099	0.125				
0.603	0.001	-0.255	-0.382	-0.953	-0.444	-0.236	-0.090	0.001	0.041	0.087	0.123				
0.600	-3.002	-0.260	-0.396	-1.109	-0.479	-0.246	-0.093	-0.005	0.034	0.082	0.120				
0.602	0.001	-0.257	-0.385	-0.951	-0.446	-0.238	-0.092	-0.002	0.039	0.086	0.122				
0.602	2.996	-0.256	-0.370	-0.841	-0.415	-0.233	-0.096	-0.012	0.022	0.058	0.085				
0.602	6.008	-0.266	-0.376	-0.865	-0.404	-0.235	-0.111	-0.046	-0.027	-0.003	0.022				
0.602	8.986	-0.281	-0.394	-0.898	-0.405	-0.234	-0.126	-0.081	-0.073	-0.049	0.002				
0.401	0.001	-0.243	-0.355	-0.796	-0.405	-0.222	-0.088	-0.012	0.025	0.071	0.105				

Table 8. Continued

(a) Concluded

$M_\infty$	$\alpha$ , deg	Static pressure coefficients on nozzle top flap at $y/Y = 0.875$ with values of $x/l$ of—													
		.153	.226	.300	.337	.411	.558	.705	.779	.853	.926				
1.252	-0.005	-0.004	-0.014	-0.324	-0.316	-0.336	-0.395	-0.433	-0.453	-0.411	-0.357				
1.199	-0.009	-0.007	-0.021	-0.355	-0.342	-0.370	-0.427	-0.449	-0.451	-0.381	-0.337				
1.200	-2.999	-0.018	-0.020	-0.386	-0.383	-0.333	-0.383	-0.348	-0.317	-0.276	-0.236				
1.201	0.012	-0.006	-0.021	-0.352	-0.339	-0.368	-0.428	-0.452	-0.456	-0.391	-0.344				
1.199	2.950	-0.013	-0.040	-0.337	-0.324	-0.357	-0.453	-0.594	-0.667	-0.632	-0.476				
1.199	5.971	-0.026	-0.054	-0.341	-0.324	-0.348	-0.460	-0.660	-0.739	-0.689	-0.464				
1.152	0.004	-0.032	-0.049	-0.403	-0.386	-0.417	-0.457	-0.466	-0.472	-0.396	-0.355				
0.925	-0.239	-0.117	-0.180	-0.654	-0.327	-0.226	-0.177	-0.152	-0.140	-0.125	-0.109				
0.901	0.162	-0.136	-0.210	-0.654	-0.330	-0.229	-0.172	-0.144	-0.128	-0.111	-0.089				
0.877	0.006	-0.149	-0.229	-0.665	-0.320	-0.218	-0.156	-0.128	-0.114	-0.095	-0.073				
0.849	-0.036	-0.162	-0.249	-0.690	-0.337	-0.225	-0.145	-0.119	-0.104	-0.082	-0.057				
0.802	0.014	-0.180	-0.277	-0.701	-0.380	-0.242	-0.129	-0.107	-0.093	-0.074	-0.043				
0.702	0.000	-0.214	-0.326	-0.725	-0.485	-0.351	-0.177	-0.135	-0.130	-0.115	-0.062				
0.603	0.001	-0.215	-0.320	-0.643	-0.453	-0.347	-0.192	-0.147	-0.146	-0.137	-0.088				
0.600	-3.002	-0.215	-0.323	-0.699	-0.446	-0.323	-0.176	-0.082	-0.048	-0.016	0.030				
0.602	0.001	-0.217	-0.322	-0.644	-0.456	-0.350	-0.195	-0.149	-0.151	-0.142	-0.093				
0.602	2.996	-0.227	-0.329	-0.603	-0.444	-0.349	-0.225	-0.211	-0.209	-0.183	-0.090				
0.602	6.008	-0.235	-0.335	-0.569	-0.421	-0.327	-0.279	-0.260	-0.221	-0.135	0.006				
0.602	8.986	-0.246	-0.340	-0.565	-0.409	-0.321	-0.344	-0.307	-0.242	-0.135	0.023				
0.401	0.001	-0.203	-0.296	-0.566	-0.410	-0.320	-0.190	-0.144	-0.144	-0.140	-0.106				

Table 8. Continued

(b) Static pressure coefficients on nozzle sidewall

$M_\infty$	$\alpha$ , deg	Static pressure coefficients on corner between nozzle top flap and sidewall with values of $x/l$ of—												
		.153	.226	.300	.337	.411	.558	.705	.779	.853	.926			
1.252	-0.005	-0.005	-0.017	-0.215	-0.212	-0.273	-0.426	-0.567	-0.493	-0.401	-0.339			
1.199	-0.009	-0.005	-0.025	-0.236	-0.239	-0.303	-0.463	-0.596	-0.494	-0.391	-0.325			
1.200	-2.999	-0.018	-0.025	-0.255	-0.236	-0.259	-0.371	-0.508	-0.428	-0.350	-0.330			
1.201	0.012	-0.004	-0.023	-0.235	-0.239	-0.301	-0.464	-0.598	-0.503	-0.399	-0.331			
1.199	2.950	-0.015	-0.041	-0.248	-0.266	-0.350	-0.561	-0.635	-0.576	-0.485	-0.332			
1.199	5.971	-0.029	-0.057	-0.249	-0.280	-0.389	-0.649	-0.628	-0.578	-0.502	-0.350			
1.152	0.004	-0.033	-0.054	-0.279	-0.277	-0.344	-0.497	-0.613	-0.500	-0.401	-0.336			
0.925	-0.239	-0.116	-0.185	-0.501	-0.375	-0.269	-0.174	-0.139	-0.135	-0.120	-0.103			
0.901	0.162	-0.135	-0.212	-0.524	-0.377	-0.261	-0.183	-0.147	-0.131	-0.109	-0.081			
0.877	0.006	-0.148	-0.229	-0.524	-0.354	-0.254	-0.193	-0.138	-0.119	-0.088	-0.059			
0.849	-0.036	-0.160	-0.247	-0.514	-0.349	-0.267	-0.202	-0.137	-0.111	-0.075	-0.038			
0.802	0.014	-0.173	-0.263	-0.491	-0.364	-0.290	-0.218	-0.135	-0.097	-0.051	-0.005			
0.702	0.000	-0.195	-0.289	-0.504	-0.418	-0.370	-0.318	-0.232	-0.171	-0.077	0.029			
0.603	0.001	-0.191	-0.278	-0.458	-0.388	-0.357	-0.332	-0.272	-0.227	-0.134	0.001			
0.600	-3.002	-0.195	-0.281	-0.451	-0.350	-0.296	-0.248	-0.192	-0.158	-0.096	0.007			
0.602	0.001	-0.193	-0.280	-0.461	-0.392	-0.362	-0.336	-0.278	-0.233	-0.139	-0.003			
0.602	2.996	-0.213	-0.302	-0.490	-0.439	-0.433	-0.427	-0.339	-0.258	-0.119	0.022			
0.602	6.008	-0.239	-0.332	-0.521	-0.481	-0.491	-0.481	-0.322	-0.210	-0.073	0.045			
0.602	8.986	-0.247	-0.342	-0.503	-0.471	-0.486	-0.454	-0.269	-0.174	-0.058	0.060			
0.401	0.001	-0.178	-0.259	-0.408	-0.352	-0.331	-0.317	-0.283	-0.249	-0.166	-0.029			

Table 8. Continued

(b) Continued

$M_\infty$	$\alpha$ , deg	Static pressure coefficients on nozzle sidewall at $z/Z = 0.50$ with values of $y/l$ of—											
		.153	.226	.300	.337	.411	.558	.705	.779	.853	.926		
1.252	-0.005	-	-	-0.044	-0.068	-0.106	-0.196	-0.280	-0.319	-	-0.332		
1.199	-0.009	-	-	-0.064	-0.093	-0.132	-0.231	-0.320	-0.359	-	-0.346		
1.200	-2.999	-	-	-0.062	-0.086	-0.118	-0.204	-0.289	-0.327	-	-0.350		
1.201	0.012	-	-	-0.062	-0.090	-0.131	-0.230	-0.320	-0.358	-	-0.352		
1.199	2.950	-	-	-0.070	-0.103	-0.152	-0.253	-0.343	-0.376	-	-0.388		
1.199	5.971	-	-	-0.084	-0.119	-0.175	-0.271	-0.357	-0.388	-	-0.413		
1.152	0.004	-	-	-0.097	-0.128	-0.170	-0.251	-0.331	-0.375	-	-0.356		
0.925	-0.239	-	-	-0.260	-0.294	-0.299	-0.212	-0.129	-0.117	-	-0.083		
0.901	0.162	-	-	-0.282	-0.310	-0.277	-0.175	-0.135	-0.115	-	-0.066		
0.877	0.006	-	-	-0.283	-0.283	-0.235	-0.172	-0.128	-0.104	-	-0.044		
0.849	-0.036	-	-	-0.270	-0.263	-0.222	-0.170	-0.119	-0.091	-	-0.022		
0.802	0.014	-	-	-0.253	-0.245	-0.217	-0.164	-0.108	-0.077	-	0.004		
0.702	0.000	-	-	-0.237	-0.234	-0.213	-0.170	-0.108	-0.069	-	0.044		
0.603	0.001	-	-	-0.213	-0.209	-0.196	-0.164	-0.113	-0.080	-	0.036		
0.600	-3.002	-	-	-0.206	-0.196	-0.176	-0.137	-0.087	-0.054	-	0.050		
0.602	0.001	-	-	-0.217	-0.213	-0.199	-0.167	-0.118	-0.083	-	0.033		
0.602	2.996	-	-	-0.239	-0.240	-0.232	-0.205	-0.154	-0.112	-	0.031		
0.602	6.008	-	-	-0.270	-0.276	-0.273	-0.251	-0.193	-0.140	-	0.031		
0.602	8.986	-	-	-0.303	-0.311	-0.315	-0.296	-0.231	-0.169	-	0.031		
0.401	0.001	-	-	-0.188	-0.189	-0.179	-0.153	-0.114	-0.087	-	0.022		

Table 8. Continued

(b) Continued

$M_\infty$	$\alpha$ , deg	Static pressure coefficients on nozzle sidewall at centerline with values of $x/l$ of—														
		.153	.226	.300	.337	.411	.484	.558	.632	.705	.779	.853	.926			
1.252	-0.005	-	0.004	-0.010	-0.027	-0.068	-0.115	-0.157	-0.202	-0.242	-0.281	-0.321	-0.339			
1.199	-0.009	-	-0.012	-0.030	-0.049	-0.093	-0.142	-0.195	-0.237	-0.281	-0.323	-0.362	-0.353			
1.200	-2.999	-	-0.008	-0.024	-0.043	-0.086	-0.136	-0.190	-0.230	-0.271	-0.314	-0.356	-0.358			
1.201	0.012	-	-0.011	-0.027	-0.047	-0.091	-0.141	-0.194	-0.235	-0.279	-0.320	-0.361	-0.358			
1.199	2.950	-	-0.020	-0.032	-0.051	-0.093	-0.144	-0.196	-0.234	-0.277	-0.318	-0.360	-0.384			
1.199	5.971	-	-0.040	-0.050	-0.067	-0.102	-0.148	-0.193	-0.227	-0.270	-0.311	-0.355	-0.385			
1.152	0.004	-	-0.041	-0.061	-0.082	-0.131	-0.178	-0.209	-0.244	-0.289	-0.336	-0.378	-0.364			
0.925	-0.239	-	-0.150	-0.215	-0.253	-0.305	-0.306	-0.247	-0.172	-0.137	-0.124	-0.108	-0.081			
0.901	0.162	-	-0.172	-0.235	-0.268	-0.289	-0.235	-0.183	-0.159	-0.140	-0.121	-0.097	-0.063			
0.877	0.006	-	-0.182	-0.235	-0.253	-0.240	-0.200	-0.175	-0.152	-0.132	-0.110	-0.082	-0.045			
0.849	-0.036	-	-0.186	-0.224	-0.232	-0.218	-0.192	-0.169	-0.145	-0.123	-0.099	-0.067	-0.025			
0.802	0.014	-	-0.184	-0.207	-0.214	-0.203	-0.183	-0.160	-0.136	-0.111	-0.081	-0.050	-0.001			
0.702	0.000	-	-0.168	-0.182	-0.184	-0.178	-0.158	-0.140	-0.113	-0.085	-0.050	-0.008	0.050			
0.603	0.001	-	-0.150	-0.161	-0.164	-0.156	-0.145	-0.129	-0.108	-0.082	-0.052	-0.012	0.049			
0.600	-3.002	-	-0.155	-0.164	-0.167	-0.159	-0.147	-0.131	-0.110	-0.083	-0.052	-0.010	0.055			
0.602	0.001	-	-0.152	-0.163	-0.166	-0.159	-0.147	-0.131	-0.111	-0.084	-0.054	-0.014	0.047			
0.602	2.996	-	-0.156	-0.167	-0.169	-0.162	-0.151	-0.135	-0.114	-0.087	-0.057	-0.014	0.050			
0.602	6.008	-	-0.168	-0.178	-0.180	-0.174	-0.162	-0.148	-0.127	-0.099	-0.065	-0.019	0.047			
0.602	8.986	-	-0.188	-0.196	-0.198	-0.192	-0.181	-0.167	-0.145	-0.117	-0.080	-0.029	0.043			
0.401	0.001	-	-0.131	-0.141	-0.140	-0.137	-0.128	-0.118	-0.103	-0.080	-0.056	-0.019	0.033			

Table 8. Continued

(b) Concluded

$M_\infty$	$\alpha$ , deg	Static pressure coefficients on nozzle sidewall at $z/Z = -0.50$ with values of $x/l$ of—									
		.153	.226	.300	.337	.411	.558	.705	.926		
1.252	-0.005	0.010	-	-0.042	-0.061	-0.104	-0.196	-0.277	-0.370		
1.199	-0.009	-0.009	-	-0.066	-0.083	-0.134	-0.232	-0.319	-0.343		
1.200	-2.999	-0.007	-	-0.064	-0.086	-0.145	-0.249	-0.334	-0.358		
1.201	0.012	-0.006	-	-0.063	-0.082	-0.131	-0.229	-0.316	-0.356		
1.199	2.950	-0.021	-	-0.069	-0.086	-0.126	-0.209	-0.289	-0.406		
1.199	5.971	-0.055	-	-0.094	-0.107	-0.134	-0.188	-0.262	-0.395		
1.152	0.004	-0.036	-	-0.097	-0.120	-0.173	-0.254	-0.329	-0.374		
0.925	-0.239	-0.114	-	-0.261	-0.302	-0.366	-0.298	-0.180	-0.112		
0.901	0.162	-0.130	-	-0.283	-0.323	-0.353	-0.219	-0.181	-0.094		
0.877	0.006	-0.139	-	-0.290	-0.315	-0.293	-0.216	-0.177	-0.076		
0.849	-0.036	-0.153	-	-0.288	-0.294	-0.265	-0.215	-0.171	-0.060		
0.802	0.014	-0.162	-	-0.273	-0.273	-0.255	-0.209	-0.162	-0.039		
0.702	0.000	-0.163	-	-0.232	-0.228	-0.216	-0.174	-0.119	0.030		
0.603	0.001	-0.151	-	-0.205	-0.200	-0.190	-0.158	-0.110	0.030		
0.600	-3.002	-0.162	-	-0.227	-0.226	-0.223	-0.196	-0.144	0.028		
0.602	0.001	-0.154	-	-0.207	-0.202	-0.192	-0.161	-0.112	0.026		
0.602	2.996	-0.161	-	-0.199	-0.190	-0.174	-0.138	-0.089	0.036		
0.602	6.008	-0.187	-	-0.202	-0.188	-0.167	-0.128	-0.079	0.038		
0.602	8.986	-0.228	-	-0.216	-0.198	-0.173	-0.133	-0.085	0.032		
0.401	0.001	-0.139	-	-0.177	-0.170	-0.168	-0.149	-0.111	0.018		

Table 8. Continued

(c) Static pressure coefficients on nozzle bottom flap

$M_\infty$	$\alpha$ , deg	Static pressure coefficients on nozzle bottom flap at $y/Y = 0.875$ with values of $x/l$ of—										
		.153	.226	.300	.337	.411	.558	.705	.779	.853	.926	
1.252	-0.005	0.009	-0.007	-	-0.327	-0.339	-0.361	-0.424	-0.467	-	-0.362	
1.199	-0.009	-0.009	-0.030	-	-0.367	-0.380	-0.405	-0.471	-0.511	-	-0.331	
1.200	-2.999	-0.011	-0.046	-	-0.332	-0.352	-0.425	-0.565	-0.683	-	-0.400	
1.201	0.012	-0.008	-0.029	-	-0.366	-0.379	-0.402	-0.469	-0.509	-	-0.341	
1.199	2.950	-0.024	-0.031	-	-0.408	-0.352	-0.373	-0.395	-0.390	-	-0.258	
1.199	5.971	-0.052	-0.059	-	-0.449	-0.331	-0.338	-0.360	-0.367	-	-0.264	
1.152	0.004	-0.033	-0.058	-	-0.414	-0.429	-0.440	-0.499	-0.543	-	-0.369	
0.925	-0.239	-0.123	-0.200	-	-0.557	-0.421	-0.288	-0.239	-0.218	-	-0.160	
0.901	0.162	-0.142	-0.220	-	-0.526	-0.366	-0.253	-0.217	-0.203	-	-0.148	
0.877	0.006	-0.154	-0.244	-	-0.515	-0.351	-0.248	-0.218	-0.210	-	-0.162	
0.849	-0.036	-0.172	-0.266	-	-0.522	-0.358	-0.248	-0.219	-0.220	-	-0.179	
0.802	0.014	-0.192	-0.300	-	-0.549	-0.404	-0.256	-0.220	-0.235	-	-0.210	
0.702	0.000	-0.216	-0.337	-	-0.505	-0.369	-0.200	-0.153	-0.154	-	-0.088	
0.603	0.001	-0.211	-0.323	-	-0.450	-0.339	-0.185	-0.135	-0.133	-	-0.074	
0.600	-3.002	-0.223	-0.328	-	-0.433	-0.336	-0.218	-0.209	-0.212	-	-0.093	
0.602	0.001	-0.213	-0.324	-	-0.452	-0.341	-0.188	-0.138	-0.136	-	-0.078	
0.602	2.996	-0.215	-0.328	-	-0.444	-0.320	-0.172	-0.080	-0.048	-	0.031	
0.602	6.008	-0.232	-0.342	-	-0.425	-0.288	-0.154	-0.059	-0.018	-	0.068	
0.602	8.986	-0.262	-0.367	-	-0.417	-0.266	-0.141	-0.054	-0.014	-	0.071	
0.401	0.001	-0.199	-0.298	-	-0.402	-0.308	-0.177	-0.126	-0.120	-	-0.080	



Table 8. Continued

(c) Continued

$M_\infty$	$\alpha$ , deg	Static pressure on nozzle bottom flap at $y/Y = 0.50$ with values of $x/l$ of—												
		.153	.226	.300	.337	.411	.558	.705	.779	.853	.926			
1.252	-0.005	0.006	-0.006	-0.460	-0.526	-0.485	-0.396	-0.338	-0.326	-0.301	-0.174			
1.199	-0.009	-0.012	-0.027	-0.513	-0.579	-0.528	-0.431	-0.368	-0.349	-0.283	-0.148			
1.200	-2.999	-0.007	-0.025	-0.512	-0.580	-0.537	-0.420	-0.372	-0.361	-0.351	-0.251			
1.201	0.012	-0.010	-0.027	-0.511	-0.577	-0.527	-0.432	-0.370	-0.353	-0.288	-0.149			
1.199	2.950	-0.015	-0.027	-0.505	-0.573	-0.525	-0.420	-0.198	-0.164	-0.144	-0.125			
1.199	5.971	-0.015	-0.023	-0.500	-0.572	-0.524	-0.488	-0.234	-0.184	-0.159	-0.137			
1.152	0.004	-0.037	-0.056	-0.575	-0.642	-0.588	-0.467	-0.353	-0.298	-0.208	-0.141			
0.925	-0.239	-0.134	-0.208	-0.774	-0.541	-0.403	-0.295	-0.226	-0.190	-0.152	-0.115			
0.901	0.162	-0.155	-0.235	-0.745	-0.496	-0.378	-0.281	-0.201	-0.166	-0.128	-0.091			
0.877	0.006	-0.171	-0.259	-0.754	-0.491	-0.375	-0.258	-0.170	-0.130	-0.091	-0.056			
0.849	-0.036	-0.190	-0.290	-0.794	-0.511	-0.381	-0.238	-0.135	-0.091	-0.052	-0.017			
0.802	0.014	-0.225	-0.342	-0.939	-0.607	-0.406	-0.196	-0.072	-0.027	0.012	0.043			
0.702	0.000	-0.281	-0.443	-1.240	-0.594	-0.260	-0.069	0.033	0.077	0.115	0.149			
0.603	0.001	-0.291	-0.459	-1.073	-0.488	-0.231	-0.059	0.046	0.092	0.136	0.173			
0.600	-3.002	-0.281	-0.440	-1.028	-0.470	-0.223	-0.061	0.037	0.079	0.122	0.165			
0.602	0.001	-0.293	-0.460	-1.074	-0.489	-0.232	-0.061	0.045	0.091	0.135	0.172			
0.602	2.996	-0.299	-0.478	-1.195	-0.534	-0.261	-0.083	0.026	0.075	0.123	0.168			
0.602	6.008	-0.299	-0.485	-1.309	-0.567	-0.285	-0.104	0.006	0.055	0.104	0.154			
0.602	8.986	-0.291	-0.483	-1.397	-0.592	-0.304	-0.123	-0.015	0.033	0.083	0.134			
0.401	0.001	-0.278	-0.423	-0.898	-0.450	-0.225	-0.063	0.036	0.081	0.122	0.161			

Table 8. Continued

(c) Concluded

$M_\infty$	$\alpha$ , deg	Static pressure coefficients on nozzle bottom flap at centerline with values of $x/l$ of---										
		.153	.226	.300	.337	.411	.558	.705	.926			
1.252	-0.005	0.006	-0.016	-	-	-0.481	-0.474	-0.460	-0.097			
1.199	-0.009	-0.017	-0.039	-	-	-0.527	-0.517	-0.471	-0.105			
1.200	-2.999	-0.010	-0.035	-	-	-0.528	-0.514	-0.497	-0.142			
1.201	0.012	-0.016	-0.039	-	-	-0.527	-0.516	-0.474	-0.108			
1.199	2.950	-0.021	-0.042	-	-	-0.528	-0.374	-0.199	-0.140			
1.199	5.971	-0.018	-0.038	-	-	-0.526	-0.494	-0.214	-0.152			
1.152	0.004	-0.038	-0.066	-	-	-0.588	-0.545	-0.334	-0.133			
0.925	-0.239	-0.138	-0.218	-	-	-0.393	-0.296	-0.232	-0.121			
0.901	0.162	-0.159	-0.242	-	-	-0.369	-0.284	-0.207	-0.099			
0.877	0.006	-0.176	-0.267	-	-	-0.363	-0.258	-0.176	-0.059			
0.849	-0.036	-0.197	-0.298	-	-	-0.371	-0.237	-0.140	-0.021			
0.802	0.014	-0.234	-0.357	-	-	-0.399	-0.198	-0.080	0.035			
0.702	0.000	-0.301	-0.467	-	-	-0.284	-0.065	0.042	0.155			
0.603	0.001	-0.316	-0.481	-	-	-0.258	-0.057	0.053	0.176			
0.600	-3.002	-0.306	-0.466	-	-	-0.244	-0.051	0.055	0.181			
0.602	0.001	-0.318	-0.483	-	-	-0.260	-0.059	0.053	0.174			
0.602	2.996	-0.327	-0.503	-	-	-0.290	-0.084	0.034	0.176			
0.602	6.008	-0.330	-0.513	-	-	-0.315	-0.107	0.014	0.175			
0.602	8.986	-0.324	-0.515	-	-	-0.332	-0.126	-0.005	0.166			
0.401	0.001	-0.299	-0.440	-	-	-0.250	-0.064	0.041	0.167			

Table 8. Concluded

(d) Force data

$M_{\infty}$	$\alpha$ , deg	$C_D$
1.252	-0.005	0.2862
1.199	-0.009	0.3066
1.200	-2.999	0.3252
1.201	0.012	0.3065
1.199	2.950	0.2955
1.199	5.971	0.3155
1.152	0.004	0.3186
0.925	-0.239	0.2122
0.901	0.162	0.1949
0.877	0.006	0.1835
0.849	-0.036	0.1704
0.802	0.014	0.1473
0.702	0.000	0.0970
0.603	0.001	0.0853
0.600	-3.002	0.0935
0.602	0.001	0.0861
0.602	2.996	0.0927
0.602	6.008	0.1095
0.602	8.986	0.1335
0.401	0.001	0.0824

Table 9. Pressure and Force Data for Nozzle 6 With  $\beta_{t,top/bot} = 17.3^\circ/\beta_{t,side} = 9.7^\circ$  and Plume Off

(a) Static pressure coefficients on nozzle top flap

$M_\infty$	$\alpha$ , deg	Static pressure coefficients on nozzle top flap at centerline with values of $x/l$ of—														
		.153	.226	.300	.337	.411	.484	.558	.632	.705	.779	.853	.926			
1.252	-0.006	-0.014	-0.352	-0.508	-0.478	-0.440	-0.285	-0.158	-0.135	-0.123	-0.113	-0.097				
1.202	-0.070	-0.022	-0.395	-0.560	-0.532	-0.476	-0.259	-0.171	-0.154	-0.140	-0.128	-0.113				
0.902	-3.024	-0.200	-0.686	-0.308	-0.228	-0.199	-0.181	-0.167	-0.154	-0.140	-0.118	-0.090				
0.901	-0.029	-0.141	-0.216	-0.260	-0.199	-0.174	-0.157	-0.142	-0.127	-0.111	-0.092	-0.068				
0.900	3.018	-0.151	-0.229	-0.656	-0.299	-0.211	-0.190	-0.169	-0.141	-0.114	-0.086	-0.055				
0.899	6.012	-0.158	-0.234	-0.750	-0.393	-0.303	-0.236	-0.201	-0.161	-0.121	-0.080	-0.038				
0.850	-0.063	-0.178	-0.269	-0.657	-0.263	-0.199	-0.160	-0.107	-0.082	-0.063	-0.042	-0.010				
0.702	-0.062	-0.283	-0.436	-1.392	-0.633	-0.248	-0.103	0.046	0.095	0.125	0.149	0.173				
0.601	-0.004	-0.296	-1.117	-0.577	-0.255	-0.119	-0.028	0.033	0.087	0.119	0.146	0.179				
0.399	-0.006	-0.268	-0.412	-0.885	-0.512	-0.248	-0.028	0.030	0.087	0.110	0.131	0.167				

$M_\infty$	$\alpha$ , deg	Static pressure coefficients on nozzle top flap at $y/Y = 0.50$ with values of $x/l$ of—														
		.153	.226	.300	.337	.411	.558	.705	.779	.853	.926					
1.252	-0.028	0.001	-0.008	-0.340	-0.508	-0.469	-0.332	-0.138	-0.121	-0.112	-0.095					
1.202	-0.070	-0.008	-0.018	-0.384	-0.560	-0.520	-0.323	-0.155	-0.140	-0.128	-0.111					
0.902	-3.024	-0.124	-0.189	-0.744	-0.366	-0.258	-0.194	-0.157	-0.139	-0.118	-0.090					
0.901	-0.029	-0.134	-0.206	-0.686	-0.309	-0.226	-0.167	-0.132	-0.115	-0.092	-0.067					
0.900	3.018	-0.147	-0.219	-0.742	-0.371	-0.271	-0.199	-0.144	-0.116	-0.082	-0.048					
0.899	6.012	-0.161	-0.231	-0.819	-0.481	-0.344	-0.241	-0.159	-0.118	-0.071	-0.030					
0.850	-0.063	-0.171	-0.259	-0.730	-0.314	-0.218	-0.132	-0.084	-0.063	-0.036	-0.009					
0.702	-0.062	-0.263	-0.411	-1.372	-0.605	-0.225	-0.010	0.085	0.118	0.154	0.175					
0.601	-0.004	-0.269	-0.422	-1.083	-0.551	-0.226	-0.020	0.073	0.107	0.149	0.176					
0.399	-0.006	-0.244	-0.384	-0.865	-0.504	-0.210	-0.012	0.070	0.097	0.147	0.169					

Table 9. Continued

(a) Concluded

$M_\infty$	$\alpha$ , deg	Static pressure coefficients on nozzle top flap at $y/Y = 0.75$ with values of $x/l$ of—									
		.153	.226	.300	.337	.411	.558	.705	.779	.853	.926
1.252	-0.028	0.002	-0.004	-0.340	-0.512	-0.402	-0.316	-0.165	-0.122	-0.108	-0.091
1.202	-0.070	-0.008	-0.015	-0.387	-0.567	-0.438	-0.342	-0.170	-0.139	-0.121	-0.104
0.902	-3.024	-0.120	-0.176	-0.783	-0.417	-0.279	-0.201	-0.160	-0.142	-0.117	-0.088
0.901	-0.029	-0.130	-0.199	-0.729	-0.344	-0.239	-0.173	-0.133	-0.114	-0.091	-0.065
0.900	3.018	-0.150	-0.227	-0.763	-0.392	-0.285	-0.198	-0.131	-0.097	-0.063	-0.031
0.899	6.012	-0.168	-0.247	-0.813	-0.455	-0.352	-0.235	-0.125	-0.075	-0.035	-0.004
0.850	-0.063	-0.164	-0.254	-0.784	-0.350	-0.228	-0.131	-0.082	-0.055	-0.033	-0.005
0.702	-0.062	-0.237	-0.378	-1.189	-0.500	-0.203	-0.021	0.063	0.106	0.135	0.162
0.601	-0.004	-0.236	-0.372	-0.910	-0.471	-0.201	-0.029	0.048	0.094	0.123	0.156
0.399	-0.006	-0.213	-0.347	-0.739	-0.421	-0.181	-0.018	0.033	0.088	0.110	0.141

$M_\infty$	$\alpha$ , deg	Static pressure coefficients on nozzle top flap at $y/Y = 0.875$ with values of $x/l$ of—									
		.153	.226	.300	.337	.411	.558	.705	.779	.853	.926
1.252	-0.028	0.003	-0.005	-0.419	-0.410	-0.321	-0.304	-0.222	-0.173	-0.141	-0.114
1.202	-0.070	-0.009	-0.018	-0.463	-0.456	-0.355	-0.343	-0.223	-0.175	-0.140	-0.117
0.902	-3.024	-0.131	-0.186	-0.867	-0.447	-0.300	-0.215	-0.160	-0.138	-0.115	-0.084
0.901	-0.029	-0.130	-0.202	-0.767	-0.378	-0.254	-0.179	-0.128	-0.107	-0.084	-0.059
0.900	3.018	-0.149	-0.230	-0.818	-0.404	-0.282	-0.192	-0.115	-0.084	-0.057	-0.033
0.899	6.012	-0.166	-0.250	-0.862	-0.463	-0.342	-0.215	-0.102	-0.071	-0.048	-0.030
0.850	-0.063	-0.164	-0.252	-0.825	-0.394	-0.234	-0.123	-0.066	-0.043	-0.021	0.002
0.702	-0.062	-0.223	-0.347	-1.010	-0.433	-0.215	-0.045	0.047	0.082	0.111	0.139
0.601	-0.004	-0.216	-0.329	-0.863	-0.398	-0.208	-0.051	0.036	0.072	0.102	0.133
0.399	-0.006	-0.193	-0.295	-0.727	-0.346	-0.188	-0.042	0.035	0.074	0.097	0.120

Table 9. Continued

## (b) Static pressure coefficients on nozzle sidewall

$M_\infty$	$\alpha$ , deg	Static pressure coefficients on corner between nozzle top flap and sidewall with values of $x/l$ of—											
		.153	.226	.300	.337	.411	.558	.705	.779	.853	.926		
1.252	-0.028	0.004	-	-0.372	-0.371	-0.299	-0.289	-0.276	-0.231	-0.182	-0.141		
1.202	-0.070	-0.005	-	-0.417	-0.408	-0.334	-0.325	-0.284	-0.219	-0.174	-0.139		
0.902	-3.024	-0.132	-	-0.849	-0.494	-0.289	-0.212	-0.163	-0.141	-0.120	-0.098		
0.901	-0.029	-0.128	-	-0.826	-0.420	-0.251	-0.170	-0.122	-0.106	-0.086	-0.068		
0.900	3.018	-0.147	-	-0.876	-0.499	-0.282	-0.163	-0.110	-0.096	-0.078	-0.054		
0.899	6.012	-0.167	-	-0.901	-0.567	-0.333	-0.176	-0.115	-0.096	-0.074	-0.048		
0.850	-0.063	-0.161	-	-0.910	-0.426	-0.213	-0.101	-0.056	-0.045	-0.026	-0.006		
0.702	-0.062	-0.215	-	-0.882	-0.410	-0.209	-0.067	0.022	0.053	0.093	0.132		
0.601	-0.004	-0.206	-	-0.746	-0.377	-0.198	-0.073	0.008	0.035	0.079	0.126		
0.399	-0.006	-0.182	-	-0.634	-0.335	-0.168	-0.063	0.007	0.018	0.062	0.117		

Static pressure coefficients on nozzle sidewall at  $x/Z = 0.50$   
with values of  $x/l$  of—

$M_\infty$	$\alpha$ , deg	Static pressure coefficients on nozzle sidewall at $x/Z = 0.50$ with values of $x/l$ of—											
		.153	.226	.300	.337	.411	.558	.705	.779	.853	.926		
1.252	-0.028	0.007	-0.001	-0.319	-0.333	-0.322	-	-0.252	-0.243	-0.206	-0.152		
1.202	-0.070	-0.003	-0.018	-0.355	-0.374	-0.354	-	-0.276	-0.247	-0.197	-0.142		
0.902	-3.024	-0.131	-0.207	-0.761	-0.685	-0.305	-	-0.133	-0.110	-0.090	-0.064		
0.901	-0.029	-0.129	-0.207	-0.770	-0.717	-0.273	-	-0.096	-0.077	-0.059	-0.039		
0.900	3.018	-0.141	-0.217	-0.773	-0.786	-0.315	-	-0.090	-0.069	-0.050	-0.025		
0.899	6.012	-0.164	-0.235	-0.792	-0.823	-0.374	-	-0.109	-0.082	-0.056	-0.026		
0.850	-0.063	-0.165	-0.257	-0.879	-0.655	-0.191	-	-0.044	-0.022	-0.005	0.015		
0.702	-0.062	-0.217	-0.330	-0.599	-0.367	-0.206	-	0.015	0.057	0.093	0.134		
0.601	-0.004	-0.208	-0.303	-0.513	-0.331	-0.194	-	0.007	0.048	0.085	0.130		
0.399	-0.006	-0.194	-0.264	-0.428	-0.288	-0.170	-	0.007	0.049	0.080	0.127		

Table 9. Continued

(b) Concluded

$M_\infty$	$\alpha$ , deg	Static pressure coefficients on nozzle sidewall at centerline with values of $x/l$ of—													
		.153	.226	.300	.337	.411	.484	.558	.632	.705	.779	.853	.926		
1.252	-0.028	0.012	-0.006	-0.321	-0.335	-0.326	-0.306	-0.267	-0.243	-0.241	-0.247	-0.223	-		
1.202	-0.070	-0.002	-0.025	-0.364	-0.374	-0.368	-0.344	-0.306	-0.274	-0.266	-0.263	-0.219	-		
0.902	-3.024	-0.134	-0.220	-0.782	-0.792	-0.426	-0.190	-0.140	-0.124	-0.111	-0.098	-0.078	-		
0.901	-0.029	-0.134	-0.222	-0.782	-0.783	-0.354	-0.156	-0.112	-0.096	-0.089	-0.075	-0.055	-		
0.900	3.018	-0.135	-0.218	-0.785	-0.795	-0.388	-0.160	-0.114	-0.094	-0.085	-0.064	-0.041	-		
0.899	6.012	-0.150	-0.231	-0.792	-0.800	-0.451	-0.194	-0.145	-0.121	-0.106	-0.079	-0.050	-		
0.850	-0.063	-0.170	-0.274	-0.896	-0.817	-0.205	-0.120	-0.090	-0.061	-0.052	-0.026	-0.002	-		
0.702	-0.062	-0.220	-0.343	-0.582	-0.359	-0.203	-0.125	-0.073	-0.021	0.004	0.052	0.097	-		
0.601	-0.004	-0.208	-0.311	-0.505	-0.324	-0.190	-0.120	-0.075	-0.024	-0.004	0.046	0.093	-		
0.399	-0.006	-0.187	-0.268	-0.433	-0.279	-0.170	-0.108	-0.072	-0.016	-0.019	0.043	0.095	-		

$M_\infty$	$\alpha$ , deg	Static pressure coefficients on nozzle sidewall at $z/Z = -0.50$ with values of $x/l$ of—													
		.153	.226	.300	.337	.411	.558	.705	.779	.853	.926				
1.252	-0.028	0.009	-0.006	-0.315	-0.328	-	-	-0.276	-0.255	-0.255	-0.161	-	-		
1.202	-0.070	-0.005	-0.026	-0.358	-0.370	-	-	-0.317	-0.285	-0.285	-0.158	-	-		
0.902	-3.024	-0.146	-0.223	-0.773	-0.793	-	-	-0.149	-0.130	-0.130	-0.063	-	-		
0.901	-0.029	-0.133	-0.217	-0.771	-0.769	-	-	-0.125	-0.097	-0.097	-0.052	-	-		
0.900	3.018	-0.134	-0.213	-0.766	-0.748	-	-	-0.141	-0.089	-0.089	-0.034	-	-		
0.899	6.012	-0.160	-0.233	-0.784	-0.735	-	-	-0.190	-0.125	-0.125	-0.047	-	-		
0.850	-0.063	-0.166	-0.271	-0.883	-0.838	-	-	-0.102	-0.057	-0.057	-0.007	-	-		
0.702	-0.062	-0.211	-0.340	-0.607	-0.369	-	-	-0.072	0.015	0.015	0.112	-	-		
0.601	-0.004	-0.197	-0.313	-0.520	-0.332	-	-	-0.070	0.012	0.012	0.106	-	-		
0.399	-0.006	-0.168	-0.282	-0.437	-0.288	-	-	-0.059	0.018	0.018	0.078	-	-		

Table 9. Continued

(c) Static pressure coefficients on nozzle bottom flap

$M_\infty$	$\alpha$ , deg	Static pressure coefficients on nozzle bottom flap at $y/Y = 0.875$ with values of $x/l$ of—									
		.153	.226	.300	.337	.411	.558	.705	.779	.853	.926
1.252	-0.028	0.004	-0.011	-0.354	-0.429	-0.347	-0.311	-0.282	-0.219	-0.163	-0.122
1.202	-0.070	-0.016	-0.034	-0.402	-0.473	-0.391	-0.350	-0.293	-0.229	-0.176	-0.133
0.902	-3.024	-0.157	-0.241	-0.849	-0.801	-0.379	-0.212	-0.117	-0.095	-0.086	-0.079
0.901	-0.029	-0.139	-0.214	-0.840	-0.760	-0.351	-0.218	-0.133	-0.098	-0.070	-0.044
0.900	3.018	-0.139	-0.202	-0.829	-0.677	-0.330	-0.229	-0.153	-0.118	-0.086	-0.052
0.899	6.012	-0.169	-0.222	-0.829	-0.744	-0.371	-0.262	-0.176	-0.137	-0.105	-0.064
0.850	-0.063	-0.175	-0.266	-0.961	-0.679	-0.301	-0.160	-0.068	-0.032	-0.008	0.016
0.702	-0.062	-0.228	-0.352	-0.969	-0.456	-0.209	-0.056	0.038	0.076	0.102	0.137
0.601	-0.004	-0.215	-0.327	-0.805	-0.415	-0.195	-0.057	0.037	0.076	0.102	0.139
0.399	-0.006	-0.190	-0.293	-0.690	-0.360	-0.167	-0.059	0.036	0.078	0.096	0.134

$M_\infty$	$\alpha$ , deg	Static pressure coefficients on nozzle bottom flap at $y/Y = 0.50$ with values of $x/l$ of—									
		.153	.226	.300	.337	.411	.558	.705	.779	.853	.926
1.252	-0.028	0.002	-0.017	-0.366	-0.525	-0.490	-0.408	-0.169	-0.138	-0.113	-0.095
1.202	-0.070	-0.016	-0.045	-0.415	-0.578	-0.542	-0.420	-0.192	-0.159	-0.133	-0.109
0.902	-3.024	-0.159	-0.256	-0.853	-0.588	-0.398	-0.287	-0.184	-0.130	-0.080	-0.038
0.901	-0.029	-0.150	-0.250	-0.824	-0.489	-0.341	-0.257	-0.175	-0.132	-0.093	-0.055
0.900	3.018	-0.138	-0.233	-0.801	-0.442	-0.310	-0.237	-0.165	-0.129	-0.096	-0.062
0.899	6.012	-0.129	-0.220	-0.819	-0.536	-0.352	-0.262	-0.180	-0.142	-0.103	-0.068
0.850	-0.063	-0.189	-0.310	-0.878	-0.438	-0.331	-0.219	-0.108	-0.061	-0.022	0.010
0.702	-0.062	-0.277	-0.462	-1.193	-0.548	-0.215	-0.034	0.074	0.113	0.144	0.167
0.601	-0.004	-0.272	-0.446	-0.892	-0.527	-0.215	-0.039	0.073	0.115	0.149	0.172
0.399	-0.006	-0.245	-0.404	-0.749	-0.473	-0.203	-0.056	0.067	0.109	0.142	0.157



Table 9. Continued

(c) Concluded

$M_\infty$	$\alpha$ , deg	Static pressure coefficients on nozzle bottom flap at centerline with values of $x/l$ of—									
		.153	.226	.300	.337	.411	.558	.705	.926		
1.252	-0.028	0.002	-0.029	-0.370	-0.502	-0.488	-0.375	-0.172	-0.106		
1.202	-0.070	-0.021	-0.055	-0.417	-0.558	-0.543	-0.372	-0.198	-0.123		
0.902	-3.024	-0.169	-0.265	-0.842	-0.545	-0.378	-0.278	-0.184	-0.047		
0.901	-0.029	-0.162	-0.260	-0.813	-0.466	-0.331	-0.250	-0.172	-0.057		
0.900	3.018	-0.154	-0.253	-0.782	-0.417	-0.299	-0.231	-0.167	-0.064		
0.899	6.012	-0.144	-0.244	-0.821	-0.499	-0.332	-0.253	-0.184	-0.076		
0.850	-0.063	-0.203	-0.321	-0.912	-0.466	-0.319	-0.200	-0.100	0.006		
0.702	-0.062	-0.303	-0.485	-1.271	-0.594	-0.244	-0.032	0.081	0.161		
0.601	-0.004	-0.298	-0.467	-0.937	-0.561	-0.246	-0.039	0.079	0.164		
0.399	-0.006	-0.270	-0.421	-0.793	-0.499	-0.234	-0.049	0.077	0.139		

(d) Force data

$M_\infty$	$\alpha$ , deg	$C_D$
1.252	-0.028	0.2524
1.202	-0.070	0.2710
0.902	-3.024	0.2242
0.901	-0.029	0.1985
0.900	3.018	0.1978
0.899	6.012	0.2233
0.850	-0.063	0.1603
0.702	-0.062	0.0749
0.601	-0.004	0.0691
0.399	-0.006	0.0630

Table 10. Pressure and Force Data for Nozzle 7 With  $\beta_{r,top/bot} = \beta_{r,side} = 16.4^\circ$ , Plume On, and  $\alpha = 0^\circ$ 

(a) Static pressure coefficients on nozzle top flap

$M_\infty$	Static pressure coefficients on nozzle top flap at centerline with values of $x/l$ of—														
	.153	.226	.300	.337	.411	.484	.558	.632	.705	.779	.853	.926			
0.598	-0.289	-0.436	-1.014	-0.493	-0.203	-0.071	0.013	0.076	0.124	0.166	0.198	0.224			
0.699	-0.286	-0.439	-1.303	-0.514	-0.189	-0.057	0.025	0.083	0.125	0.161	0.185	0.204			
0.798	-0.222	-0.331	-0.827	-0.347	-0.200	-0.129	-0.082	-0.044	-0.012	0.020	0.048	0.082			
1.250	-0.004	-0.010	-0.383	-0.494	-0.471	-0.432	-0.232	-0.142	-0.127	-0.113	-0.096	-0.076			
1.200	-0.002	-0.017	-0.422	-0.544	-0.512	-0.471	-0.204	-0.158	-0.146	-0.128	-0.111	-0.088			
0.950	-0.096	-0.159	-0.712	-0.420	-0.275	-0.225	-0.200	-0.185	-0.168	-0.149	-0.122	-0.089			
0.926	-0.121	-0.190	-0.669	-0.349	-0.241	-0.204	-0.183	-0.164	-0.146	-0.121	-0.092	-0.061			
0.900	-0.146	-0.221	-0.644	-0.306	-0.224	-0.192	-0.169	-0.145	-0.121	-0.094	-0.065	-0.033			
0.874	-0.165	-0.247	-0.643	-0.296	-0.221	-0.185	-0.156	-0.126	-0.097	-0.064	-0.036	-0.003			
0.851	-0.183	-0.275	-0.681	-0.308	-0.218	-0.171	-0.136	-0.104	-0.072	-0.042	-0.009	0.026			
0.800	-0.218	-0.330	-0.807	-0.346	-0.200	-0.132	-0.084	-0.046	-0.013	0.017	0.048	0.081			
0.703	-0.285	-0.438	-1.277	-0.519	-0.193	-0.058	0.022	0.082	0.124	0.156	0.180	0.199			
0.603	-0.288	-0.440	-1.014	-0.488	-0.201	-0.070	0.013	0.077	0.124	0.164	0.195	0.222			
0.402	-0.263	-0.393	-0.834	-0.443	-0.196	-0.076	0.004	0.066	0.113	0.156	0.187	0.217			

$M_\infty$	Static pressure coefficients on nozzle top flap at $y/Y = 0.50$ with values of $x/l$ of—														
	.153	.226	.300	.337	.411	.484	.558	.632	.705	.779	.853	.926			
0.598	-0.262	-0.409	-1.008	-0.461	-0.181	0.017	0.017	0.123	0.164	0.195	0.224	0.224			
0.699	-0.265	-0.414	-1.285	-0.491	-0.180	0.025	0.025	0.125	0.160	0.186	0.206	0.206			
0.798	-0.210	-0.318	-0.876	-0.413	-0.226	-0.083	-0.083	-0.011	0.021	0.051	0.084	0.084			
1.250	-0.001	-0.007	-0.370	-0.500	-0.455	-0.267	-0.267	-0.124	-0.107	-0.091	-0.073	-0.073			
1.200	-0.002	-0.010	-0.411	-0.546	-0.494	-0.241	-0.241	-0.134	-0.117	-0.103	-0.082	-0.082			
0.950	-0.092	-0.150	-0.743	-0.498	-0.313	-0.222	-0.222	-0.184	-0.160	-0.129	-0.093	-0.093			
0.926	-0.115	-0.180	-0.749	-0.434	-0.292	-0.205	-0.205	-0.157	-0.127	-0.097	-0.061	-0.061			
0.900	-0.137	-0.209	-0.717	-0.386	-0.267	-0.182	-0.182	-0.124	-0.097	-0.064	-0.035	-0.035			
0.874	-0.157	-0.238	-0.721	-0.366	-0.254	-0.165	-0.165	-0.101	-0.068	-0.036	0.001	0.001			
0.851	-0.173	-0.263	-0.738	-0.367	-0.247	-0.145	-0.145	-0.077	-0.042	-0.008	0.028	0.028			
0.800	-0.208	-0.316	-0.856	-0.405	-0.227	-0.082	-0.082	-0.011	0.021	0.050	0.083	0.083			
0.703	-0.263	-0.412	-1.261	-0.503	-0.180	0.025	0.025	0.124	0.158	0.183	0.202	0.202			
0.603	-0.263	-0.411	-1.009	-0.461	-0.181	0.018	0.018	0.122	0.162	0.194	0.220	0.220			
0.402	-0.240	-0.367	-0.823	-0.417	-0.174	0.010	0.010	0.113	0.155	0.189	0.217	0.217			

Table 10. Continued

(a) Concluded

$M_\infty$	Static pressure coefficients on nozzle top flap at $y/Y = 0.75$ with values of $x/l$ of—										
	.153	.226	.300	.337	.411	.558	.705	.779	.853	.926	
0.598	-0.234	-0.362	-0.883	-0.408	-0.160	0.021	0.117	0.155	0.190	0.220	
0.699	-0.243	-0.377	-1.123	-0.436	-0.160	0.027	0.123	0.155	0.185	0.207	
0.798	-0.204	-0.308	-0.964	-0.470	-0.228	-0.070	0.001	0.031	0.066	0.101	
1.250	-0.006	-0.010	-0.378	-0.500	-0.421	-0.319	-0.113	-0.100	-0.082	-0.061	
1.200	-0.004	-0.013	-0.416	-0.544	-0.453	-0.294	-0.125	-0.110	-0.094	-0.073	
0.950	-0.093	-0.149	-0.764	-0.565	-0.338	-0.231	-0.188	-0.161	-0.126	-0.088	
0.926	-0.117	-0.177	-0.794	-0.479	-0.314	-0.214	-0.156	-0.123	-0.089	-0.053	
0.900	-0.138	-0.207	-0.777	-0.431	-0.286	-0.188	-0.122	-0.093	-0.057	-0.025	
0.874	-0.156	-0.234	-0.778	-0.411	-0.273	-0.163	-0.095	-0.060	-0.022	0.011	
0.851	-0.173	-0.257	-0.802	-0.415	-0.265	-0.142	-0.069	-0.034	0.003	0.038	
0.800	-0.202	-0.307	-0.935	-0.464	-0.228	-0.073	-0.001	0.031	0.063	0.099	
0.703	-0.245	-0.379	-1.119	-0.439	-0.161	0.026	0.120	0.153	0.182	0.204	
0.603	-0.235	-0.362	-0.884	-0.407	-0.160	0.021	0.116	0.154	0.187	0.217	
0.402	-0.211	-0.322	-0.732	-0.363	-0.147	0.022	0.108	0.143	0.180	0.211	

$M_\infty$	Static pressure coefficients on nozzle top flap at $y/Y = 0.875$ with values of $x/l$ of—										
	.153	.226	.300	.337	.411	.558	.705	.779	.853	.926	
0.598	-	-0.329	-0.818	-0.379	-0.149	-	0.113	0.151	0.185	0.213	
0.699	-	-0.349	-0.994	-0.411	-0.154	-	0.119	0.153	0.183	0.208	
0.798	-	-0.297	-1.052	-0.477	-0.205	-	0.018	0.045	0.077	0.107	
1.250	-	-0.006	-0.362	-0.454	-0.348	-	-0.117	-0.089	-0.071	-0.049	
1.200	-	-0.010	-0.401	-0.489	-0.382	-	-0.126	-0.102	-0.083	-0.061	
0.950	-	-0.145	-0.741	-0.660	-0.338	-	-0.188	-0.157	-0.120	-0.088	
0.926	-	-0.174	-0.794	-0.550	-0.324	-	-0.151	-0.119	-0.085	-0.052	
0.900	-	-0.202	-0.837	-0.466	-0.299	-	-0.118	-0.085	-0.053	-0.023	
0.874	-	-0.227	-0.864	-0.442	-0.282	-	-0.086	-0.053	-0.018	0.014	
0.851	-	-0.250	-0.899	-0.443	-0.269	-	-0.060	-0.024	0.010	0.043	
0.800	-	-0.293	-1.024	-0.472	-0.208	-	0.015	0.045	0.076	0.104	
0.703	-	-0.350	-1.005	-0.412	-0.155	-	0.117	0.152	0.180	0.204	
0.603	-	-0.328	-0.818	-0.380	-0.151	-	0.113	0.150	0.183	0.209	
0.402	-	-0.294	-0.684	-0.335	-0.136	-	0.104	0.142	0.175	0.202	

Table 10. Continued

(b) Static pressure coefficients on nozzle sidewall

$M_\infty$	Static pressure coefficients on corner between nozzle top flap and sidewall with values of $x/l$ of—									
	.153	.226	.300	.337	.411	.558	.705	.779	.853	.926
0.598	—	-0.326	-0.858	-0.355	-0.137	0.023	0.111	0.146	0.176	0.203
0.699	—	-0.346	-1.023	-0.382	-0.141	0.029	0.118	0.152	0.180	0.200
0.798	—	-0.296	-1.001	-0.536	-0.189	-0.029	0.040	0.065	0.083	0.101
1.250	—	-0.005	-0.401	-0.440	-0.325	-0.292	-0.145	-0.088	-0.058	-0.028
1.200	—	-0.009	-0.447	-0.481	-0.357	-0.324	-0.140	-0.093	-0.072	-0.048
0.950	—	-0.145	-0.809	-0.739	-0.341	-0.244	-0.187	-0.159	-0.135	-0.117
0.926	—	-0.172	-0.857	-0.651	-0.326	-0.225	-0.147	-0.115	-0.095	-0.074
0.900	—	-0.202	-0.874	-0.527	-0.303	-0.183	-0.107	-0.080	-0.054	-0.035
0.874	—	-0.227	-0.855	-0.498	-0.284	-0.145	-0.071	-0.041	-0.017	0.006
0.851	—	-0.249	-0.869	-0.503	-0.265	-0.115	-0.038	-0.010	0.013	0.034
0.800	—	-0.293	-0.965	-0.531	-0.191	-0.032	0.037	0.062	0.079	0.099
0.703	—	-0.347	-1.029	-0.384	-0.142	0.027	0.116	0.148	0.174	0.197
0.603	—	-0.325	-0.861	-0.358	-0.135	0.025	0.111	0.147	0.175	0.200
0.402	—	-0.288	-0.722	-0.314	-0.118	0.026	0.101	0.136	0.165	0.194

$M_\infty$	Static pressure coefficients on nozzle sidewall at $z/Z = 0.50$ with values of $x/l$ of—									
	.153	.226	.300	.337	.411	.558	.705	.779	.853	.926
0.598	-0.223	-0.357	-0.529	-0.397	-0.151	—	0.113	0.147	0.179	0.203
0.699	-0.230	-0.376	-0.660	-0.419	-0.152	—	0.118	0.152	0.181	0.203
0.798	-0.201	-0.317	-0.759	-0.526	-0.203	—	0.059	0.084	0.112	0.138
1.250	0.000	-0.007	-0.196	-0.474	-0.422	—	-0.152	-0.084	-0.036	0.008
1.200	-0.004	-0.018	-0.227	-0.519	-0.454	—	-0.139	-0.080	-0.046	-0.010
0.950	-0.094	-0.158	-0.483	-0.877	-0.441	—	-0.133	-0.100	-0.064	-0.024
0.926	-0.116	-0.186	-0.524	-0.853	-0.345	—	-0.105	-0.072	-0.035	-0.002
0.900	-0.138	-0.216	-0.568	-0.577	-0.301	—	-0.086	-0.050	-0.017	0.018
0.874	-0.156	-0.241	-0.606	-0.502	-0.281	—	-0.051	-0.014	0.019	0.052
0.851	-0.171	-0.266	-0.645	-0.492	-0.266	—	-0.018	0.017	0.049	0.079
0.800	-0.200	-0.315	-0.742	-0.520	-0.208	—	0.055	0.082	0.110	0.135
0.703	-0.232	-0.378	-0.662	-0.420	-0.151	—	0.117	0.151	0.179	0.201
0.603	-0.224	-0.353	-0.523	-0.398	-0.151	—	0.114	0.146	0.179	0.201
0.402	-0.202	-0.315	-0.408	-0.355	-0.140	—	0.106	0.141	0.171	0.197

Table 10. Continued

(b) Concluded

$M_\infty$	Static pressure coefficients on nozzle sidewall at centerline with values of $x/l$ of—														
	.153	.226	.300	.337	.411	.484	.558	.632	.705	.779	.853	.926			
0.598	-0.236	-0.383	-0.770	-0.414	-0.160	-0.047	0.023	0.073	0.115	0.147	0.178	0.204			
0.699	-0.244	-0.405	-0.925	-0.431	-0.154	-0.041	0.031	0.079	0.122	0.154	0.181	0.204			
0.798	-0.208	-0.335	-1.104	-0.526	-0.222	-0.095	-0.022	0.025	0.062	0.090	0.116	0.143			
1.250	0.007	-0.011	-0.386	-0.479	-0.471	-0.396	-0.297	-0.220	-0.155	-0.086	-0.031	0.018			
1.200	-0.003	-0.028	-0.430	-0.527	-0.511	-0.423	-0.318	-0.223	-0.138	-0.077	-0.041	-0.001			
0.950	-0.094	-0.167	-0.781	-0.904	-0.536	-0.249	-0.169	-0.136	-0.112	-0.087	-0.057	-0.014			
0.926	-0.120	-0.197	-0.835	-0.845	-0.376	-0.239	-0.175	-0.133	-0.098	-0.069	-0.033	0.003			
0.900	-0.140	-0.227	-0.882	-0.538	-0.314	-0.228	-0.170	-0.126	-0.087	-0.049	-0.015	0.021			
0.874	-0.159	-0.254	-0.901	-0.472	-0.293	-0.205	-0.140	-0.092	-0.050	-0.016	0.021	0.053			
0.851	-0.175	-0.280	-0.923	-0.463	-0.280	-0.180	-0.111	-0.059	-0.018	0.018	0.051	0.084			
0.800	-0.207	-0.332	-1.072	-0.519	-0.226	-0.099	-0.028	0.021	0.055	0.086	0.112	0.138			
0.703	-0.246	-0.404	-0.932	-0.429	-0.155	-0.042	0.028	0.079	0.119	0.151	0.178	0.200			
0.603	-0.238	-0.380	-0.768	-0.412	-0.156	-0.045	0.023	0.073	0.114	0.147	0.177	0.201			
0.402	-0.218	-0.343	-0.648	-0.370	-0.149	-0.045	0.021	0.068	0.108	0.138	0.168	0.194			

$M_\infty$	Static pressure coefficients on nozzle sidewall at $z/Z = -0.50$ with values of $x/l$ of—														
	.153	.226	.300	.337	.411	.484	.558	.632	.705	.779	.853	.926			
0.598	-0.221	-0.356	-0.758	-0.392	-0.151	-0.041	0.018	0.018	0.110	0.147	0.178	0.205			
0.699	-0.228	-0.374	-0.920	-0.414	-0.152	-0.041	0.027	0.027	0.116	0.154	0.181	0.207			
0.798	-0.198	-0.318	-1.126	-0.536	-0.215	-0.095	-0.021	-0.021	0.063	0.090	0.116	0.143			
1.250	0.012	-0.001	-0.387	-0.467	-0.426	-0.307	-0.307	-0.307	-0.186	-0.086	-0.031	0.018			
1.200	-0.002	-0.020	-0.432	-0.516	-0.458	-0.336	-0.336	-0.336	-0.156	-0.086	-0.031	0.018			
0.950	-0.090	-0.155	-0.782	-0.877	-0.537	-0.174	-0.174	-0.174	-0.099	-0.057	-0.021	0.018			
0.926	-0.111	-0.185	-0.834	-0.854	-0.366	-0.178	-0.178	-0.178	-0.099	-0.057	-0.021	0.018			
0.900	-0.135	-0.215	-0.890	-0.575	-0.309	-0.171	-0.171	-0.171	-0.084	-0.050	-0.021	0.018			
0.874	-0.152	-0.241	-0.925	-0.498	-0.287	-0.140	-0.140	-0.140	-0.051	-0.021	0.018	0.053			
0.851	-0.169	-0.265	-0.963	-0.491	-0.273	-0.109	-0.109	-0.109	-0.015	0.018	0.051	0.084			
0.800	-0.196	-0.313	-1.100	-0.533	-0.220	-0.025	-0.025	-0.025	0.059	0.086	0.112	0.138			
0.703	-0.228	-0.375	-0.927	-0.412	-0.151	0.026	0.026	0.026	0.118	0.147	0.177	0.201			
0.603	-0.219	-0.354	-0.757	-0.391	-0.149	0.021	0.021	0.021	0.111	0.147	0.177	0.201			
0.402	-0.197	-0.316	-0.639	-0.344	-0.136	0.018	0.018	0.018	0.104	0.138	0.168	0.194			

Table 10. Continued

(c) Static pressure coefficients on nozzle bottom flap

$M_\infty$	Static pressure coefficients on nozzle bottom flap at $y/Y = 0.875$ with values of $x/l$ of—										
	.153	.226	.300	.337	.411	.558	.705	.779	.853	.926	
0.598	-0.216	-0.328	-0.862	-0.377	-	0.015	0.113	0.149	0.185	0.217	
0.699	-0.227	-0.351	-1.025	-0.403	-	0.022	0.119	0.157	0.189	0.217	
0.798	-0.199	-0.303	-1.035	-0.566	-	-0.028	0.061	0.093	0.121	0.147	
1.250	0.008	-0.001	-0.412	-0.446	-	-0.315	-0.220	-0.093	-0.050	-0.012	
1.200	-0.007	-0.020	-0.454	-0.490	-	-0.342	-0.157	-0.102	-0.070	-0.038	
0.950	-0.090	-0.148	-0.816	-0.781	-	-0.212	-0.150	-0.121	-0.087	-0.050	
0.926	-0.114	-0.178	-0.867	-0.736	-	-0.208	-0.130	-0.095	-0.060	-0.024	
0.900	-0.135	-0.205	-0.893	-0.550	-	-0.180	-0.102	-0.066	-0.034	-0.001	
0.874	-0.152	-0.232	-0.877	-0.508	-	-0.148	-0.063	-0.031	0.003	0.036	
0.851	-0.168	-0.254	-0.893	-0.518	-	-0.113	-0.028	0.008	0.040	0.070	
0.800	-0.197	-0.299	-1.005	-0.567	-	-0.033	0.057	0.091	0.117	0.143	
0.703	-0.227	-0.352	-1.027	-0.400	-	0.020	0.117	0.156	0.187	0.214	
0.603	-0.214	-0.329	-0.857	-0.375	-	0.016	0.111	0.150	0.184	0.213	
0.402	-0.191	-0.291	-0.723	-0.330	-	0.014	0.102	0.141	0.175	0.205	

$M_\infty$	Static pressure coefficients on nozzle bottom flap at $y/Y = 0.50$ with values of $x/l$ of—										
	.153	.226	.300	.337	.411	.558	.705	.779	.853	.926	
0.598	-0.260	-0.411	-0.852	-0.463	-0.186	0.010	0.119	0.159	0.195	0.223	
0.699	-0.266	-0.433	-1.067	-0.482	-0.179	0.020	0.126	0.165	0.196	0.223	
0.798	-0.220	-0.345	-1.062	-0.513	-0.255	-0.053	0.051	0.085	0.113	0.137	
1.250	0.012	-0.004	-0.362	-0.498	-0.478	-0.432	-0.133	-0.102	-0.076	-0.046	
1.200	-0.004	-0.021	-0.410	-0.550	-0.512	-0.394	-0.142	-0.115	-0.090	-0.064	
0.950	-0.096	-0.170	-0.746	-0.669	-0.349	-0.215	-0.152	-0.118	-0.085	-0.049	
0.926	-0.119	-0.198	-0.787	-0.521	-0.313	-0.202	-0.131	-0.096	-0.061	-0.028	
0.900	-0.141	-0.229	-0.794	-0.418	-0.280	-0.185	-0.105	-0.070	-0.037	-0.002	
0.874	-0.162	-0.257	-0.811	-0.397	-0.271	-0.162	-0.073	-0.038	-0.001	0.031	
0.851	-0.180	-0.284	-0.848	-0.410	-0.278	-0.137	-0.041	-0.002	0.033	0.061	
0.800	-0.218	-0.341	-1.037	-0.508	-0.258	-0.059	0.045	0.078	0.109	0.135	
0.703	-0.266	-0.432	-1.077	-0.480	-0.179	0.019	0.124	0.162	0.193	0.217	
0.603	-0.259	-0.412	-0.851	-0.464	-0.184	0.007	0.118	0.159	0.192	0.219	
0.402	-0.237	-0.368	-0.715	-0.415	-0.175	0.002	0.110	0.150	0.185	0.214	

Table 10. Concluded

(c) Concluded

$M_\infty$	Static pressure coefficients on nozzle bottom flap at centerline with values of $x/l$ of—									
	.153	.226	.300	.337	.411	.558	.705	.926		
0.598	-0.278	-0.422	-0.867	-0.484	-0.213	-0.005	0.111	0.236		
0.699	-0.284	-0.444	-1.099	-0.510	-0.206	0.008	0.120	0.238		
0.798	-0.230	-0.354	-1.065	-0.508	-0.250	-0.057	0.044	0.139		
1.250	0.008	-0.014	-0.363	-0.480	-0.463	-0.386	-0.151	-0.066		
1.200	-0.009	-0.033	-0.408	-0.529	-0.509	-0.280	-0.164	-0.076		
0.950	-0.105	-0.187	-0.745	-0.584	-0.326	-0.228	-0.170	-0.061		
0.926	-0.128	-0.208	-0.769	-0.447	-0.286	-0.200	-0.136	-0.036		
0.900	-0.151	-0.237	-0.788	-0.417	-0.278	-0.181	-0.106	-0.004		
0.874	-0.168	-0.265	-0.818	-0.406	-0.269	-0.157	-0.073	0.029		
0.851	-0.187	-0.289	-0.859	-0.419	-0.265	-0.134	-0.043	0.063		
0.800	-0.229	-0.350	-1.043	-0.504	-0.254	-0.063	0.041	0.136		
0.703	-0.284	-0.444	-1.116	-0.510	-0.207	0.008	0.121	0.232		
0.603	-0.277	-0.420	-0.866	-0.483	-0.211	-0.005	0.112	0.234		
0.402	-0.250	-0.371	-0.723	-0.425	-0.199	-0.012	0.101	0.225		

(d) Force data

$M_\infty$	$C_D$	$C_{D,p}$	$C_{Df}$
0.598	0.0352	0.0381	0.0119
0.699	0.0408	0.0494	0.0117
0.798	0.1016	0.1075	0.0114
1.250	0.2365	0.2237	0.0106
1.200	0.2527	0.2409	0.0107
0.950	0.2394	0.2278	0.0112
0.926	0.2013	0.2034	0.0112
0.900	0.1766	0.1769	0.0113
0.874	0.1564	0.1571	0.0113
0.851	0.1388	0.1418	0.0114
0.800	0.1009	0.1075	0.0115
0.703	0.0406	0.0508	0.0117
0.603	0.0357	0.0386	0.0120
0.402	0.0307	0.0306	0.0128

Table 11. Pressure and Force Data for Nozzle 7 With  $\beta_{r,top/bot} = \beta_{r,side} = 16.4^\circ$  and Plume Off

(a) Static pressure coefficients on nozzle top flap

$M_\infty$	$\alpha$ , deg	Static pressure coefficients on nozzle top flap at centerline with values of $x/l$ of—														
		.153	.226	.300	.337	.411	.484	.558	.632	.705	.779	.853	.926			
1.199	6.017	-0.007	-0.025	-0.421	-0.540	-0.530	-0.468	-0.436	-0.200	-0.157	-0.139	-0.123	-0.104			
1.200	9.009	-0.021	-0.030	-0.419	-0.545	-0.521	-0.482	-0.333	-0.182	-0.159	-0.147	-0.138	-0.124			
1.151	-0.020	-0.026	-0.043	-0.476	-0.603	-0.575	-0.463	-0.202	-0.169	-0.153	-0.141	-0.128	-0.112			
0.950	0.078	-0.097	-0.161	-0.646	-0.351	-0.235	-0.190	-0.171	-0.158	-0.149	-0.138	-0.122	-0.099			
0.926	0.020	-0.123	-0.191	-0.616	-0.305	-0.217	-0.182	-0.169	-0.157	-0.145	-0.127	-0.107	-0.082			
0.899	-0.011	-0.147	-0.221	-0.616	-0.294	-0.214	-0.189	-0.168	-0.152	-0.130	-0.108	-0.082	-0.048			
0.900	-2.988	-0.134	-0.205	-0.660	-0.332	-0.237	-0.205	-0.185	-0.168	-0.148	-0.128	-0.104	-0.067			
0.903	-0.009	-0.144	-0.217	-0.623	-0.305	-0.219	-0.191	-0.171	-0.153	-0.130	-0.111	-0.086	-0.054			
0.902	3.016	-0.154	-0.230	-0.638	-0.322	-0.238	-0.207	-0.184	-0.161	-0.131	-0.104	-0.074	-0.039			
0.901	5.998	-0.158	-0.232	-0.710	-0.381	-0.280	-0.239	-0.210	-0.176	-0.142	-0.101	-0.062	-0.025			
0.900	9.035	-0.162	-0.229	-0.768	-0.436	-0.318	-0.270	-0.232	-0.190	-0.147	-0.099	-0.053	-0.009			
0.877	0.022	-0.165	-0.246	-0.635	-0.298	-0.222	-0.187	-0.161	-0.135	-0.109	-0.081	-0.051	-0.020			
0.848	0.003	-0.188	-0.276	-0.654	-0.293	-0.213	-0.169	-0.136	-0.110	-0.082	-0.054	-0.022	0.013			
0.802	0.000	-0.219	-0.327	-0.790	-0.335	-0.201	-0.134	-0.089	-0.055	-0.027	0.002	0.031	0.060			
0.701	-0.001	-0.292	-0.448	-1.317	-0.576	-0.225	-0.091	-0.011	0.050	0.092	0.127	0.155	0.180			
0.600	-0.012	-0.300	-0.455	-1.056	-0.518	-0.233	-0.102	-0.021	0.038	0.081	0.119	0.151	0.178			
0.601	-2.981	-0.320	-0.490	-1.202	-0.588	-0.286	-0.149	-0.065	0.000	0.048	0.092	0.133	0.169			
0.602	0.000	-0.302	-0.458	-1.065	-0.521	-0.235	-0.104	-0.023	0.037	0.080	0.118	0.151	0.177			
0.602	3.014	-0.282	-0.427	-0.966	-0.472	-0.202	-0.077	-0.002	0.054	0.093	0.126	0.155	0.180			
0.602	5.989	-0.269	-0.410	-0.944	-0.463	-0.198	-0.077	-0.005	0.048	0.084	0.117	0.145	0.170			
0.601	9.000	-0.263	-0.409	-1.011	-0.491	-0.217	-0.095	-0.023	0.029	0.065	0.096	0.126	0.154			
0.401	-0.005	-0.276	-0.409	-0.863	-0.467	-0.221	-0.103	-0.028	0.030	0.071	0.108	0.141	0.166			



Table 11. Continued

(a) Continued

$M_\infty$	$\alpha$ , deg	Static pressure coefficients on nozzle top flap at $y/Y = 0.50$ with values of $x/l$ of—													
		.153	.226	.300	.337	.411	.558	.705	.779	.853	.926				
1.199	6.017	-0.015	-0.025	-0.411	-0.548	-0.524	-0.404	-0.160	-0.142	-0.121	-0.100				
1.200	9.009	-0.048	-0.050	-0.416	-0.564	-0.559	-0.391	-0.159	-0.148	-0.135	-0.121				
1.151	-0.020	-0.023	-0.039	-0.466	-0.610	-0.562	-0.226	-0.156	-0.141	-0.128	-0.112				
0.950	0.078	-0.090	-0.150	-0.696	-0.408	-0.268	-0.191	-0.163	-0.149	-0.131	-0.103				
0.926	0.020	-0.116	-0.182	-0.701	-0.383	-0.262	-0.191	-0.157	-0.138	-0.113	-0.080				
0.899	-0.011	-0.139	-0.214	-0.705	-0.372	-0.259	-0.188	-0.140	-0.113	-0.084	-0.047				
0.900	-2.988	-0.127	-0.199	-0.748	-0.407	-0.279	-0.206	-0.163	-0.137	-0.109	-0.068				
0.903	-0.009	-0.136	-0.211	-0.706	-0.374	-0.262	-0.192	-0.145	-0.119	-0.090	-0.053				
0.902	3.016	-0.148	-0.224	-0.722	-0.395	-0.280	-0.201	-0.141	-0.109	-0.074	-0.035				
0.901	5.998	-0.161	-0.230	-0.801	-0.461	-0.322	-0.217	-0.138	-0.099	-0.057	-0.019				
0.900	9.035	-0.185	-0.247	-0.809	-0.477	-0.354	-0.239	-0.146	-0.100	-0.051	-0.008				
0.877	0.022	-0.156	-0.236	-0.718	-0.369	-0.261	-0.174	-0.115	-0.086	-0.054	-0.018				
0.848	0.003	-0.177	-0.267	-0.736	-0.363	-0.244	-0.146	-0.083	-0.051	-0.024	0.014				
0.802	0.000	-0.206	-0.314	-0.845	-0.401	-0.227	-0.089	-0.021	0.005	0.032	0.059				
0.701	-0.001	-0.269	-0.422	-1.293	-0.549	-0.210	-0.005	0.092	0.127	0.154	0.177				
0.600	-0.012	-0.272	-0.424	-1.045	-0.489	-0.206	-0.014	0.082	0.120	0.149	0.175				
0.601	-2.981	-0.289	-0.456	-1.186	-0.560	-0.259	-0.057	0.050	0.095	0.132	0.167				
0.602	0.000	-0.274	-0.427	-1.053	-0.493	-0.208	-0.016	0.081	0.118	0.148	0.174				
0.602	3.014	-0.254	-0.393	-0.980	-0.448	-0.176	0.004	0.092	0.126	0.153	0.177				
0.602	5.989	-0.243	-0.371	-0.989	-0.446	-0.176	0.000	0.084	0.116	0.142	0.168				
0.601	9.000	-0.255	-0.382	-1.026	-0.470	-0.192	-0.012	0.072	0.104	0.130	0.157				
0.401	-0.005	-0.248	-0.379	-0.849	-0.440	-0.197	-0.016	0.075	0.113	0.141	0.166				

Table 11. Continued

(a) Continued

$M_\infty$	$\alpha$ , deg	Static pressure coefficients on nozzle top flap at $y/Y = 0.75$ with values of $x/Y$ of—													
		.153	.226	.300	.337	.411	.538	.705	.779	.853	.926				
1.199	6.017	-0.029	-0.045	-0.444	-0.580	-0.500	-0.331	-0.158	-0.128	-0.109	-0.091				
1.200	9.009	-0.049	-0.067	-0.450	-0.580	-0.501	-0.326	-0.148	-0.132	-0.120	-0.109				
1.151	-0.020	-0.031	-0.041	-0.471	-0.606	-0.513	-0.301	-0.154	-0.140	-0.127	-0.109				
0.950	0.078	-0.093	-0.147	-0.738	-0.462	-0.298	-0.208	-0.178	-0.161	-0.137	-0.107				
0.926	0.020	-0.119	-0.178	-0.757	-0.433	-0.290	-0.206	-0.165	-0.138	-0.110	-0.075				
0.899	-0.011	-0.141	-0.207	-0.766	-0.420	-0.283	-0.191	-0.136	-0.109	-0.079	-0.044				
0.900	-2.988	-0.132	-0.187	-0.826	-0.479	-0.314	-0.217	-0.167	-0.140	-0.108	-0.071				
0.903	-0.009	-0.138	-0.205	-0.771	-0.427	-0.287	-0.198	-0.145	-0.116	-0.087	-0.052				
0.902	3.016	-0.156	-0.233	-0.750	-0.432	-0.305	-0.202	-0.133	-0.098	-0.063	-0.028				
0.901	5.998	-0.169	-0.245	-0.753	-0.445	-0.334	-0.215	-0.123	-0.082	-0.041	-0.005				
0.900	9.035	-0.186	-0.262	-0.767	-0.454	-0.347	-0.239	-0.134	-0.082	-0.031	0.012				
0.877	0.022	-0.155	-0.231	-0.778	-0.418	-0.280	-0.174	-0.111	-0.078	-0.046	-0.012				
0.848	0.003	-0.176	-0.262	-0.801	-0.417	-0.264	-0.143	-0.077	-0.046	-0.016	0.018				
0.802	0.000	-0.203	-0.306	-0.920	-0.457	-0.234	-0.081	-0.013	0.012	0.038	0.065				
0.701	-0.001	-0.250	-0.393	-1.167	-0.463	-0.185	0.001	0.089	0.121	0.150	0.174				
0.600	-0.012	-0.246	-0.378	-0.911	-0.431	-0.183	-0.007	0.082	0.113	0.145	0.170				
0.601	-2.981	-0.257	-0.403	-1.101	-0.505	-0.232	-0.042	0.056	0.094	0.132	0.164				
0.602	0.000	-0.247	-0.381	-0.920	-0.434	-0.185	-0.008	0.081	0.112	0.144	0.169				
0.602	3.014	-0.239	-0.351	-0.790	-0.366	-0.145	0.015	0.092	0.121	0.148	0.171				
0.602	5.989	-0.239	-0.344	-0.779	-0.336	-0.128	0.017	0.087	0.114	0.141	0.164				
0.601	9.000	-0.243	-0.349	-0.779	-0.324	-0.120	0.017	0.084	0.108	0.134	0.157				
0.401	-0.005	-0.221	-0.332	-0.756	-0.382	-0.164	-0.003	0.075	0.107	0.134	0.163				

Table 11. Continued

(a) Concluded

$M_\infty$	$\alpha$ , deg	Static pressure coefficients on nozzle top flap at $y/Y = 0.875$ with values of $x/l$ of—											
		.153	.226	.300	.337	.411	.558	.705	.779	.853	.926		
1.199	6.017	-	-0.047	-0.413	-0.474	-0.347	-	-0.168	-0.124	-0.101	-0.080		
1.200	9.009	-	-0.063	-0.432	-0.488	-0.347	-	-0.135	-0.115	-0.105	-0.093		
1.151	-0.020	-	-0.043	-0.454	-0.553	-0.442	-	-0.147	-0.131	-0.117	-0.101		
0.950	0.078	-	-0.143	-0.741	-0.552	-0.307	-	-0.188	-0.168	-0.140	-0.109		
0.926	0.020	-	-0.176	-0.788	-0.491	-0.304	-	-0.167	-0.140	-0.108	-0.076		
0.899	-0.011	-	-0.204	-0.825	-0.456	-0.298	-	-0.133	-0.102	-0.071	-0.042		
0.900	-2.988	-	-0.187	-0.845	-0.523	-0.338	-	-0.168	-0.136	-0.101	-0.070		
0.903	-0.009	-	-0.200	-0.826	-0.466	-0.305	-	-0.142	-0.110	-0.078	-0.050		
0.902	3.016	-	-0.228	-0.819	-0.439	-0.306	-	-0.122	-0.084	-0.049	-0.021		
0.901	5.998	-	-0.244	-0.802	-0.445	-0.326	-	-0.107	-0.065	-0.026	0.005		
0.900	9.035	-	-0.263	-0.835	-0.460	-0.343	-	-0.111	-0.057	-0.011	0.025		
0.877	0.022	-	-0.226	-0.856	-0.455	-0.298	-	-0.104	-0.071	-0.040	-0.010		
0.848	0.003	-	-0.253	-0.900	-0.451	-0.275	-	-0.069	-0.038	-0.008	0.022		
0.802	0.000	-	-0.296	-1.017	-0.483	-0.223	-	-0.002	0.022	0.046	0.069		
0.701	-0.001	-	-0.359	-1.029	-0.431	-0.176	-	0.088	0.122	0.150	0.171		
0.600	-0.012	-	-0.340	-0.844	-0.402	-0.171	-	0.080	0.114	0.143	0.168		
0.601	-2.981	-	-0.359	-1.021	-0.469	-0.211	-	0.058	0.097	0.131	0.162		
0.602	0.000	-	-0.342	-0.846	-0.405	-0.173	-	0.079	0.114	0.143	0.168		
0.602	3.014	-	-0.333	-0.688	-0.338	-0.139	-	0.091	0.121	0.147	0.168		
0.602	5.989	-	-0.328	-0.610	-0.304	-0.119	-	0.087	0.116	0.140	0.164		
0.601	9.000	-	-0.322	-0.607	-0.287	-0.108	-	0.086	0.110	0.132	0.153		
0.401	-0.005	-	-0.302	-0.708	-0.351	-0.151	-	0.075	0.109	0.135	0.158		

Table 11. Continued

(b) Static pressure coefficients on nozzle sidewall

$M_\infty$	$\alpha$ , deg	Static pressure coefficients on corner between nozzle top flap and sidewall with values of $x/l$ of—											
		.153	.226	.300	.337	.411	.558	.705	.779	.853	.926		
1.199	6.017	—	-0.048	-0.457	-0.458	-0.316	-0.300	-0.190	-0.136	-0.098	-0.069		
1.200	9.009	—	-0.064	-0.453	-0.455	-0.320	-0.278	-0.158	-0.129	-0.111	-0.092		
1.151	-0.020	—	-0.043	-0.502	-0.538	-0.416	-0.364	-0.148	-0.125	-0.110	-0.094		
0.950	0.078	—	-0.144	-0.797	-0.636	-0.311	-0.238	-0.208	-0.186	-0.160	-0.128		
0.926	0.020	—	-0.176	-0.840	-0.579	-0.313	-0.228	-0.169	-0.140	-0.115	-0.093		
0.899	-0.011	—	-0.205	-0.855	-0.526	-0.304	-0.197	-0.127	-0.097	-0.075	-0.051		
0.900	-2.988	—	-0.191	-0.853	-0.532	-0.339	-0.239	-0.173	-0.142	-0.113	-0.085		
0.903	-0.009	—	-0.201	-0.863	-0.540	-0.309	-0.206	-0.137	-0.108	-0.086	-0.062		
0.902	3.016	—	-0.228	-0.883	-0.561	-0.311	-0.190	-0.104	-0.072	-0.046	-0.020		
0.901	5.998	—	-0.247	-0.832	-0.525	-0.337	-0.190	-0.090	-0.050	-0.020	0.002		
0.900	9.035	—	-0.265	-0.835	-0.524	-0.348	-0.186	-0.081	-0.038	-0.006	0.014		
0.877	0.022	—	-0.226	-0.875	-0.518	-0.305	-0.170	-0.095	-0.064	-0.040	-0.020		
0.848	0.003	—	-0.254	-0.903	-0.520	-0.275	-0.125	-0.053	-0.026	-0.004	0.017		
0.802	0.000	—	-0.294	-0.994	-0.542	-0.210	-0.051	0.013	0.036	0.053	0.067		
0.701	-0.001	—	-0.357	-1.057	-0.404	-0.162	0.005	0.088	0.118	0.142	0.166		
0.600	-0.012	—	-0.336	-0.879	-0.378	-0.155	0.001	0.080	0.110	0.137	0.162		
0.601	-2.981	—	-0.357	-1.021	-0.424	-0.181	-0.022	0.063	0.096	0.126	0.154		
0.602	0.000	—	-0.338	-0.881	-0.379	-0.156	-0.001	0.080	0.110	0.137	0.162		
0.602	3.014	—	-0.334	-0.783	-0.328	-0.129	0.014	0.087	0.116	0.142	0.167		
0.602	5.989	—	-0.337	-0.700	-0.283	-0.109	0.016	0.091	0.118	0.143	0.165		
0.601	9.000	—	-0.328	-0.594	-0.256	-0.098	0.029	0.098	0.121	0.143	0.161		
0.401	-0.005	—	-0.297	-0.736	-0.328	-0.136	0.005	0.073	0.103	0.129	0.153		

Table 11. Continued

(b) Continued

$M_\infty$	$\alpha$ , deg	Static pressure coefficients on nozzle sidewall at $z/Z = 0.50$ with values of $x/l$ of—												
		.153	.226	.300	.337	.411	.558	.705	.779	.853	.926			
1.199	6.017	-0.046	-0.054	-0.199	-0.544	-0.488	-	-0.195	-0.147	-0.099	-0.072			
1.200	9.009	-0.071	-0.076	-0.210	-0.558	-0.493	-	-0.178	-0.146	-0.116	-0.087			
1.151	-0.020	-0.034	-0.053	-0.234	-0.583	-0.525	-	-0.152	-0.114	-0.093	-0.079			
0.950	0.078	-0.093	-0.157	-0.436	-0.826	-0.391	-	-0.192	-0.167	-0.132	-0.096			
0.926	0.020	-0.118	-0.188	-0.486	-0.794	-0.351	-	-0.146	-0.107	-0.073	-0.040			
0.899	-0.011	-0.142	-0.218	-0.534	-0.628	-0.318	-	-0.103	-0.068	-0.036	-0.008			
0.900	-2.988	-0.146	-0.217	-0.534	-0.588	-0.333	-	-0.155	-0.114	-0.074	-0.038			
0.903	-0.009	-0.141	-0.215	-0.540	-0.662	-0.325	-	-0.112	-0.076	-0.043	-0.016			
0.902	3.016	-0.152	-0.225	-0.549	-0.662	-0.334	-	-0.101	-0.063	-0.030	-0.002			
0.901	5.998	-0.170	-0.239	-0.564	-0.598	-0.352	-	-0.096	-0.056	-0.019	0.010			
0.900	9.035	-0.199	-0.269	-0.586	-0.662	-0.370	-	-0.098	-0.054	-0.016	0.014			
0.877	0.022	-0.154	-0.239	-0.600	-0.565	-0.309	-	-0.074	-0.037	-0.007	0.020			
0.848	0.003	-0.175	-0.268	-0.650	-0.531	-0.287	-	-0.032	0.002	0.028	0.051			
0.802	0.000	-0.201	-0.315	-0.739	-0.546	-0.233	-	0.030	0.055	0.075	0.092			
0.701	-0.001	-0.242	-0.389	-0.689	-0.442	-0.169	-	0.088	0.119	0.146	0.169			
0.600	-0.012	-0.233	-0.367	-0.537	-0.416	-0.170	-	0.081	0.114	0.142	0.166			
0.601	-2.981	-0.248	-0.386	-0.552	-0.429	-0.181	-	0.074	0.107	0.139	0.165			
0.602	0.000	-0.234	-0.368	-0.541	-0.417	-0.171	-	0.081	0.113	0.142	0.165			
0.602	3.014	-0.237	-0.366	-0.538	-0.413	-0.165	-	0.085	0.116	0.144	0.167			
0.602	5.989	-0.251	-0.374	-0.547	-0.411	-0.156	-	0.085	0.115	0.142	0.164			
0.601	9.000	-0.266	-0.378	-0.525	-0.390	-0.142	-	0.089	0.115	0.137	0.152			
0.401	-0.005	-0.210	-0.326	-0.420	-0.371	-0.155	-	0.078	0.107	0.135	0.159			

Table 11. Continued

(b) Continued

$M_\infty$	$\alpha$ , deg	Static pressure coefficients on nozzle sidewall at centerline with values of $x/l$ of—														
		.153	.226	.300	.337	.411	.484	.558	.632	.705	.779	.853	.926			
1.199	6.017	-0.039	-0.055	-0.442	-0.542	-0.498	-0.423	-0.362	-0.283	-0.230	-0.170	-0.114	-0.090			
1.200	9.009	-0.067	-0.081	-0.457	-0.554	-0.480	-0.427	-0.368	-0.286	-0.228	-0.189	-0.164	-0.143			
1.151	-0.020	-0.034	-0.063	-0.490	-0.595	-0.583	-0.480	-0.351	-0.231	-0.162	-0.118	-0.093	-0.077			
0.950	0.078	-0.097	-0.167	-0.785	-0.903	-0.541	-0.294	-0.226	-0.189	-0.163	-0.137	-0.107	-0.078			
0.926	0.020	-0.121	-0.199	-0.839	-0.898	-0.396	-0.259	-0.193	-0.153	-0.119	-0.091	-0.059	-0.032			
0.899	-0.011	-0.143	-0.228	-0.898	-0.641	-0.343	-0.245	-0.184	-0.134	-0.095	-0.060	-0.029	-0.005			
0.900	-2.988	-0.144	-0.225	-0.902	-0.806	-0.381	-0.270	-0.204	-0.151	-0.114	-0.078	-0.046	-0.021			
0.903	-0.009	-0.141	-0.225	-0.893	-0.685	-0.353	-0.250	-0.190	-0.139	-0.102	-0.066	-0.034	-0.013			
0.902	3.016	-0.143	-0.222	-0.894	-0.636	-0.369	-0.272	-0.205	-0.146	-0.105	-0.065	-0.031	-0.007			
0.901	5.998	-0.156	-0.234	-0.897	-0.651	-0.370	-0.280	-0.211	-0.155	-0.108	-0.067	-0.032	-0.004			
0.900	9.035	-0.180	-0.258	-0.919	-0.774	-0.391	-0.302	-0.244	-0.186	-0.128	-0.078	-0.033	0.003			
0.877	0.022	-0.159	-0.252	-0.936	-0.554	-0.326	-0.232	-0.162	-0.113	-0.071	-0.036	-0.004	0.020			
0.848	0.003	-0.177	-0.285	-0.979	-0.519	-0.303	-0.198	-0.124	-0.072	-0.031	0.004	0.031	0.052			
0.802	0.000	-0.210	-0.333	-1.098	-0.555	-0.260	-0.128	-0.052	-0.004	0.031	0.055	0.077	0.093			
0.701	-0.001	-0.253	-0.416	-0.976	-0.455	-0.175	-0.065	0.004	0.051	0.089	0.118	0.146	0.169			
0.600	-0.012	-0.247	-0.396	-0.792	-0.431	-0.174	-0.067	0.000	0.046	0.083	0.114	0.140	0.166			
0.601	-2.981	-0.251	-0.402	-0.823	-0.441	-0.177	-0.069	-0.001	0.045	0.083	0.114	0.140	0.167			
0.602	0.000	-0.249	-0.397	-0.796	-0.432	-0.174	-0.068	-0.001	0.046	0.084	0.114	0.140	0.166			
0.602	3.014	-0.253	-0.404	-0.825	-0.442	-0.178	-0.071	-0.003	0.044	0.081	0.112	0.138	0.166			
0.602	5.989	-0.265	-0.414	-0.827	-0.447	-0.183	-0.076	-0.009	0.038	0.075	0.105	0.131	0.159			
0.601	9.000	-0.280	-0.422	-0.811	-0.441	-0.183	-0.078	-0.012	0.034	0.069	0.097	0.115	0.133			
0.401	-0.005	-0.223	-0.356	-0.667	-0.386	-0.160	-0.063	0.002	0.046	0.081	0.107	0.133	0.159			

Table 11. Continued

(b) Concluded

$M_\infty$	$\alpha$ , deg	Static pressure coefficients on nozzle sidewall at $z/z = -0.50$ with values of $x/l$ of—									
		.153	.226	.300	.337	.411	.558	.705	.926		
1.199	6.017	-0.055	-0.062	-0.445	-0.527	-0.416	-0.372	-0.313	-0.118		
1.200	9.009	-0.107	-0.109	-0.464	-0.533	-0.427	-0.403	-0.374	-0.218		
1.151	-0.020	-0.034	-0.052	-0.492	-0.575	-0.530	-0.371	-0.194	-0.080		
0.950	0.078	-0.090	-0.158	-0.782	-0.892	-0.646	-0.219	-0.152	-0.065		
0.899	-0.011	-0.115	-0.187	-0.839	-0.913	-0.409	-0.184	-0.114	-0.031		
0.900	-2.988	-0.136	-0.216	-0.896	-0.698	-0.340	-0.181	-0.093	-0.005		
0.903	-0.009	-0.145	-0.224	-0.901	-0.787	-0.373	-0.194	-0.089	-0.004		
0.902	3.016	-0.134	-0.215	-0.889	-0.748	-0.347	-0.185	-0.098	-0.013		
0.901	5.998	-0.137	-0.212	-0.884	-0.756	-0.361	-0.204	-0.107	-0.014		
0.900	9.035	-0.165	-0.229	-0.893	-0.726	-0.379	-0.231	-0.132	-0.017		
0.877	0.022	-0.210	-0.265	-0.868	-0.575	-0.436	-0.318	-0.160	-0.003		
0.848	0.003	-0.152	-0.239	-0.946	-0.588	-0.328	-0.164	-0.070	0.020		
0.802	0.000	-0.172	-0.269	-1.000	-0.552	-0.307	-0.126	-0.029	0.052		
0.701	-0.001	-0.204	-0.316	-1.126	-0.581	-0.260	-0.051	0.032	0.095		
0.600	-0.012	-0.241	-0.387	-0.970	-0.438	-0.173	0.000	0.088	0.169		
0.601	-2.981	-0.228	-0.365	-0.781	-0.411	-0.169	-0.003	0.082	0.165		
0.602	0.000	-0.230	-0.362	-0.783	-0.408	-0.161	0.005	0.088	0.167		
0.602	3.014	-0.229	-0.366	-0.784	-0.412	-0.169	-0.004	0.083	0.164		
0.602	5.989	-0.244	-0.386	-0.813	-0.428	-0.180	-0.014	0.074	0.162		
0.601	9.000	-0.273	-0.413	-0.835	-0.438	-0.193	-0.028	0.058	0.147		
0.401	-0.005	-0.312	-0.445	-0.842	-0.446	-0.209	-0.050	0.020	0.119		
		-0.209	-0.325	-0.660	-0.360	-0.153	-0.001	0.076	0.157		

Table 11. Continued  
(c) Static pressure coefficients on nozzle bottom flap

$M_\infty$	$\alpha$ , deg	Static pressure coefficients on nozzle bottom flap at $y/Y = 0.875$ with values of $x/l$ of—												
		.153	.226	.300	.337	.411	.558	.705	.779	.853	.926			
1.199	6.017	-0.078	-0.070	-0.471	-0.536	-	-0.446	-0.415	-0.227	.853	.926			
1.200	9.009	-0.155	-0.132	-0.490	-0.556	-	-0.530	-0.466	-0.395	-0.219	-0.111			
1.151	-0.020	-0.035	-0.050	-0.516	-0.548	-	-0.390	-0.258	-0.155	-0.104	-0.081			
0.950	0.078	-0.092	-0.152	-0.818	-0.849	-	-0.244	-0.160	-0.124	-0.092	-0.066			
0.926	0.020	-0.116	-0.182	-0.873	-0.853	-	-0.223	-0.150	-0.111	-0.079	-0.047			
0.899	-0.011	-0.140	-0.208	-0.928	-0.702	-	-0.199	-0.117	-0.083	-0.050	-0.022			
0.900	-2.988	-0.157	-0.239	-0.928	-0.699	-	-0.201	-0.097	-0.055	-0.021	0.003			
0.903	-0.009	-0.137	-0.206	-0.925	-0.734	-	-0.206	-0.124	-0.090	-0.057	-0.028			
0.902	3.016	-0.140	-0.194	-0.928	-0.788	-	-0.232	-0.145	-0.106	-0.069	-0.036			
0.901	5.998	-0.175	-0.217	-0.934	-0.841	-	-0.251	-0.157	-0.113	-0.071	-0.031			
0.900	9.035	-0.241	-0.264	-0.933	-0.735	-	-0.334	-0.168	-0.109	-0.055	-0.010			
0.877	0.022	-0.152	-0.230	-0.950	-0.602	-	-0.171	-0.089	-0.050	-0.019	0.010			
0.848	0.003	-0.174	-0.261	-0.975	-0.578	-	-0.138	-0.043	-0.009	0.023	0.046			
0.802	0.000	-0.201	-0.304	-1.067	-0.612	-	-0.069	0.021	0.053	0.076	0.094			
0.701	-0.001	-0.235	-0.365	-1.079	-0.426	-	-0.008	0.082	0.118	0.145	0.169			
0.600	-0.012	-0.224	-0.339	-0.885	-0.394	-	-0.008	0.079	0.111	0.141	0.166			
0.601	-2.981	-0.229	-0.330	-0.700	-0.331	-	0.010	0.090	0.120	0.146	0.169			
0.602	0.000	-0.225	-0.341	-0.887	-0.395	-	-0.010	0.078	0.111	0.140	0.166			
0.602	3.014	-0.241	-0.361	-1.062	-0.460	-	-0.042	0.054	0.092	0.127	0.159			
0.602	5.989	-0.279	-0.393	-1.179	-0.524	-	-0.085	0.025	0.068	0.110	0.147			
0.601	9.000	-0.335	-0.436	-1.281	-0.590	-	-0.140	-0.014	0.036	0.085	0.130			
0.401	-0.005	-0.201	-0.299	-0.744	-0.346	-	-0.007	0.074	0.106	0.133	0.158			



Table 11. Continued

(c) Continued

$M_\infty$	$\alpha$ , deg	Static pressure coefficients on nozzle bottom flap at $y/Y = 0.50$ with values of $x/l$ of—													
		.153	.226	.300	.337	.411	.558	.705	.779	.853	.926				
1.199	6.017	-0.012	-0.021	-0.398	-0.547	-0.500	-0.503	-0.357	-0.182	-0.144	-0.121				
1.200	9.009	-0.009	-0.016	-0.391	-0.542	-0.495	-0.506	-0.455	-0.451	-0.203	-0.126				
1.151	-0.020	-0.030	-0.053	-0.464	-0.611	-0.582	-0.506	-0.205	-0.158	-0.129	-0.098				
0.950	0.078	-0.096	-0.171	-0.755	-0.924	-0.752	-0.312	-0.195	-0.145	-0.099	-0.063				
0.926	0.020	-0.122	-0.203	-0.804	-0.695	-0.385	-0.248	-0.165	-0.127	-0.091	-0.058				
0.899	-0.011	-0.148	-0.233	-0.843	-0.528	-0.334	-0.218	-0.132	-0.096	-0.059	-0.030				
0.900	-2.988	-0.156	-0.241	-0.869	-0.645	-0.398	-0.257	-0.144	-0.099	-0.055	-0.022				
0.903	-0.009	-0.144	-0.230	-0.837	-0.535	-0.337	-0.227	-0.139	-0.101	-0.066	-0.037				
0.902	3.016	-0.131	-0.212	-0.834	-0.581	-0.350	-0.233	-0.148	-0.111	-0.073	-0.040				
0.901	5.998	-0.118	-0.194	-0.837	-0.762	-0.401	-0.251	-0.158	-0.116	-0.074	-0.032				
0.900	9.035	-0.107	-0.180	-0.837	-1.005	-0.575	-0.284	-0.172	-0.117	-0.065	-0.016				
0.877	0.022	-0.164	-0.258	-0.867	-0.486	-0.323	-0.198	-0.106	-0.064	-0.030	0.002				
0.848	0.003	-0.187	-0.292	-0.931	-0.502	-0.329	-0.172	-0.066	-0.025	0.012	0.038				
0.802	0.000	-0.222	-0.348	-1.089	-0.605	-0.325	-0.105	0.005	0.040	0.069	0.090				
0.701	-0.001	-0.276	-0.445	-1.166	-0.512	-0.207	-0.014	0.084	0.118	0.147	0.172				
0.600	-0.012	-0.272	-0.424	-0.880	-0.487	-0.207	-0.021	0.080	0.115	0.145	0.170				
0.601	-2.981	-0.254	-0.394	-0.813	-0.442	-0.175	0.000	0.093	0.125	0.151	0.174				
0.602	0.000	-0.273	-0.427	-0.884	-0.488	-0.208	-0.023	0.079	0.115	0.144	0.169				
0.602	3.014	-0.287	-0.457	-1.013	-0.563	-0.259	-0.064	0.047	0.089	0.126	0.160				
0.602	5.989	-0.293	-0.474	-1.127	-0.619	-0.301	-0.101	0.015	0.060	0.102	0.143				
0.601	9.000	-0.289	-0.478	-1.207	-0.661	-0.332	-0.132	-0.014	0.033	0.077	0.124				
0.401	-0.005	-0.248	-0.382	-0.736	-0.433	-0.195	-0.022	0.072	0.107	0.135	0.162				

Table 11. Continued

(c) Concluded

$M_\infty$	$\alpha$ , deg	Static pressure coefficients on nozzle bottom flap at centerline with values of $x/l$ of—											
		.153	.226	.300	.337	.411	.558	.705	.926				
1.199	6.017	-0.011	-0.033	-0.407	-0.534	-0.510	-0.494	-0.293					
1.200	9.009	-0.001	-0.022	-0.398	-0.526	-0.506	-0.490	-0.451					
1.151	-0.020	-0.032	-0.061	-0.459	-0.588	-0.570	-0.507	-0.204					
0.950	0.078	-0.107	-0.188	-0.754	-0.898	-0.759	-0.292	-0.186					
0.926	0.020	-0.130	-0.213	-0.797	-0.623	-0.364	-0.249	-0.172					
0.899	-0.011	-0.155	-0.239	-0.827	-0.486	-0.325	-0.218	-0.139					
0.900	-2.988	-0.161	-0.245	-0.868	-0.611	-0.387	-0.249	-0.148					
0.903	-0.009	-0.152	-0.236	-0.828	-0.504	-0.329	-0.220	-0.140					
0.902	3.016	-0.144	-0.229	-0.836	-0.538	-0.338	-0.227	-0.151					
0.901	5.998	-0.129	-0.218	-0.844	-0.679	-0.385	-0.257	-0.170					
0.900	9.035	-0.116	-0.206	-0.852	-0.897	-0.519	-0.291	-0.185					
0.877	0.022	-0.169	-0.264	-0.862	-0.479	-0.316	-0.195	-0.107					
0.848	0.003	-0.194	-0.298	-0.934	-0.506	-0.321	-0.170	-0.067					
0.802	0.000	-0.233	-0.357	-1.094	-0.610	-0.324	-0.112	-0.002					
0.701	-0.001	-0.292	-0.460	-1.199	-0.541	-0.236	-0.028	0.079					
0.600	-0.012	-0.288	-0.437	-0.899	-0.507	-0.238	-0.035	0.070					
0.601	-2.981	-0.270	-0.409	-0.834	-0.465	-0.206	-0.011	0.084					
0.602	0.000	-0.290	-0.439	-0.904	-0.509	-0.239	-0.036	0.068					
0.602	3.014	-0.308	-0.470	-0.977	-0.566	-0.286	-0.076	0.035					
0.602	5.989	-0.317	-0.490	-1.048	-0.611	-0.323	-0.111	0.004					
0.601	9.000	-0.315	-0.496	-1.091	-0.640	-0.347	-0.136	-0.021					
0.401	-0.005	-0.263	-0.389	-0.747	-0.445	-0.222	-0.039	0.059					

Table 11. Concluded

(d) Force data

$M_\infty$	$\alpha$ , deg	$C_D$
1.199	6.017	0.3050
1.200	9.009	0.3139
1.151	-0.020	0.2989
0.950	0.078	0.2762
0.926	0.020	0.2313
0.899	-0.011	0.2027
0.900	-2.988	0.2276
0.903	-0.009	0.2044
0.902	3.016	0.2101
0.901	5.998	0.2315
0.900	9.035	0.2488
0.877	0.022	0.1864
0.848	0.003	0.1672
0.802	0.000	0.1335
0.701	-0.001	0.0748
0.600	-0.012	0.0709
0.601	-2.981	0.0682
0.602	0.000	0.0691
0.602	3.014	0.0715
0.602	5.989	0.0748
0.601	9.000	0.0846
0.401	-0.005	0.0687

0.2

Table 12. Pressure and Force Data for Nozzle 8 With  $\beta_{r,top/bot} = 15.0^\circ$ ,  $\beta_{r,side} = 22.4^\circ$ , Plume On, and  $\alpha = 0^\circ$

(a) Static pressure coefficients on nozzle top flap

$M_\infty$	Static pressure coefficients on nozzle top flap at centerline with values of $x/l$ of—													
	.153	.226	.300	.337	.411	.484	.558	.632	.705	.779	.853	.926		
0.600	-0.281	-0.423	-0.965	-0.470	-0.213	-0.093	-0.010	0.052	0.103	0.148	0.189	0.223		
0.598	-0.281	-0.423	-0.961	-0.469	-0.214	-0.093	-0.011	0.051	0.102	0.147	0.189	0.222		
0.702	-0.278	-0.427	-1.266	-0.502	-0.217	-0.094	-0.015	0.045	0.094	0.137	0.175	0.204		
0.797	-0.224	-0.333	-1.020	-0.513	-0.270	-0.153	-0.076	-0.023	0.019	0.051	0.082	0.107		
0.948	-0.102	-0.163	-0.789	-0.618	-0.317	-0.240	-0.201	-0.173	-0.154	-0.133	-0.110	-0.085		
0.925	-0.124	-0.191	-0.790	-0.449	-0.279	-0.223	-0.190	-0.163	-0.140	-0.119	-0.095	-0.068		
0.901	-0.144	-0.217	-0.774	-0.407	-0.263	-0.210	-0.172	-0.143	-0.113	-0.088	-0.063	-0.034		
0.876	-0.164	-0.245	-0.765	-0.389	-0.252	-0.197	-0.153	-0.119	-0.086	-0.060	-0.032	-0.002		
0.853	-0.182	-0.270	-0.797	-0.397	-0.254	-0.184	-0.134	-0.093	-0.060	-0.029	-0.001	0.029		
0.802	-0.220	-0.328	-0.961	-0.493	-0.266	-0.155	-0.081	-0.029	0.010	0.040	0.069	0.095		
0.700	-0.277	-0.425	-1.220	-0.495	-0.218	-0.093	-0.014	0.047	0.096	0.137	0.171	0.202		
0.599	-0.277	-0.417	-0.947	-0.466	-0.216	-0.091	-0.010	0.054	0.106	0.148	0.184	0.220		
0.399	-0.250	-0.368	-0.778	-0.408	-0.194	-0.084	-0.009	0.052	0.096	0.137	0.174	0.209		

$M_\infty$	Static pressure coefficients on nozzle top flap at $y/Y = 0.50$ with values of $x/l$ of—													
	.153	.226	.300	.337	.411	.484	.558	.632	.705	.779	.853	.926		
0.600	-0.253	-0.392	-0.937	-0.444	-0.196	-0.007	-0.007	0.102	0.149	0.189	0.223	0.223		
0.598	-0.254	-0.391	-0.933	-0.442	-0.195	-0.007	-0.007	0.101	0.148	0.188	0.222	0.222		
0.702	-0.251	-0.395	-1.213	-0.462	-0.198	-0.017	-0.017	0.089	0.134	0.172	0.205	0.205		
0.797	-0.208	-0.315	-1.049	-0.523	-0.266	-0.073	-0.073	0.020	0.055	0.084	0.110	0.110		
0.948	-0.094	-0.156	-0.793	-0.717	-0.329	-0.197	-0.197	-0.153	-0.131	-0.113	-0.086	-0.067		
0.925	-0.116	-0.185	-0.822	-0.496	-0.289	-0.189	-0.189	-0.143	-0.118	-0.095	-0.067	-0.034		
0.901	-0.137	-0.206	-0.805	-0.422	-0.269	-0.176	-0.176	-0.119	-0.091	-0.064	-0.034	-0.001		
0.876	-0.155	-0.233	-0.802	-0.413	-0.264	-0.154	-0.154	-0.092	-0.061	-0.032	-0.001	0.030		
0.853	-0.174	-0.257	-0.836	-0.426	-0.265	-0.134	-0.134	-0.061	-0.029	0.000	0.030	0.030		
0.802	-0.207	-0.311	-0.992	-0.511	-0.267	-0.078	-0.078	0.012	0.044	0.073	0.099	0.099		
0.700	-0.251	-0.394	-1.175	-0.460	-0.194	-0.016	-0.016	0.088	0.130	0.170	0.202	0.202		
0.599	-0.252	-0.390	-0.923	-0.444	-0.192	-0.005	-0.005	0.103	0.145	0.186	0.220	0.220		
0.399	-0.229	-0.347	-0.760	-0.391	-0.173	-0.003	-0.003	0.100	0.139	0.177	0.208	0.208		

Table 12. Continued

(a) Concluded

$M_\infty$	Static pressure coefficients on nozzle top flap at $y/Y = 0.75$ with values of $x/l$ of—									
	.153	.226	.300	.337	.411	.558	.705	.779	.853	.926
0.600	-0.242	-	-	-0.400	-0.169	-0.003	0.100	0.141	0.183	0.220
0.598	-0.241	-	-	-0.399	-0.169	-0.003	0.099	0.140	0.182	0.219
0.702	-0.241	-	-	-0.395	-0.166	-0.032	0.075	0.122	0.167	0.202
0.797	-0.215	-	-	-0.494	-0.233	-0.074	0.023	0.054	0.086	0.114
0.948	-0.111	-	-	-0.686	-0.329	-0.204	-0.156	-0.136	-0.113	-0.087
0.925	-0.134	-	-	-0.496	-0.292	-0.192	-0.147	-0.122	-0.100	-0.068
0.901	-0.151	-	-	-0.437	-0.272	-0.178	-0.120	-0.095	-0.063	-0.035
0.876	-0.169	-	-	-0.432	-0.266	-0.157	-0.093	-0.063	-0.030	-0.001
0.853	-0.186	-	-	-0.444	-0.259	-0.134	-0.060	-0.029	0.003	0.032
0.802	-0.215	-	-	-0.492	-0.235	-0.077	0.011	0.045	0.073	0.102
0.700	-0.240	-	-	-0.393	-0.162	-0.029	0.073	0.120	0.162	0.196
0.599	-0.240	-	-	-0.399	-0.168	-0.002	0.096	0.140	0.180	0.214
0.399	-0.220	-	-	-0.353	-0.148	0.023	0.100	0.131	0.167	0.198

$M_\infty$	Static pressure coefficients on nozzle top flap at $y/Y = 0.875$ with values of $x/l$ of—									
	.153	.226	.300	.337	.411	.558	.705	.779	.853	.926
0.600	-0.227	-0.344	-0.836	-0.395	-0.153	-0.009	0.091	0.137	0.179	0.214
0.598	-0.227	-0.344	-0.834	-0.395	-0.153	-0.009	0.091	0.136	0.177	0.212
0.702	-0.225	-0.346	-0.900	-0.356	-0.150	-0.053	0.058	0.113	0.160	0.196
0.797	-0.207	-0.318	-0.971	-0.371	-0.210	-0.098	0.015	0.055	0.088	0.115
0.948	-0.107	-0.171	-0.736	-0.495	-0.325	-0.244	-0.171	-0.143	-0.113	-0.088
0.925	-0.130	-0.199	-0.761	-0.411	-0.293	-0.212	-0.153	-0.125	-0.097	-0.072
0.901	-0.146	-0.225	-0.764	-0.377	-0.278	-0.186	-0.124	-0.096	-0.063	-0.036
0.876	-0.163	-0.250	-0.787	-0.374	-0.271	-0.164	-0.095	-0.063	-0.029	-0.002
0.853	-0.178	-0.272	-0.827	-0.386	-0.258	-0.137	-0.061	-0.028	0.004	0.031
0.802	-0.203	-0.312	-0.940	-0.380	-0.211	-0.099	0.008	0.046	0.077	0.103
0.700	-0.222	-0.342	-0.887	-0.354	-0.144	-0.050	0.059	0.112	0.157	0.193
0.599	-0.224	-0.341	-0.821	-0.390	-0.150	-0.010	0.092	0.137	0.177	0.212
0.399	-0.209	-0.315	-0.709	-0.360	-0.135	0.023	0.098	0.127	0.159	0.191

Table 12. Continued

(b) Static pressure coefficients on nozzle sidewall

$M_\infty$	Static pressure coefficients on corner between nozzle top flap and sidewall with values of $x/l$ of—									
	.153	.226	.300	.337	.411	.558	.705	.779	.853	.926
0.600	-0.227	-	-0.869	-0.386	-0.128	-0.007	0.085	0.129	0.170	0.208
0.598	-0.227	-	-0.867	-0.383	-0.127	-0.008	0.084	0.128	0.169	0.205
0.702	-0.223	-	-0.903	-0.315	-0.141	-0.068	0.040	0.096	0.149	0.188
0.797	-0.207	-	-0.949	-0.352	-0.206	-0.114	-0.005	0.046	0.085	0.111
0.948	-0.106	-	-0.719	-0.445	-0.325	-0.262	-0.192	-0.156	-0.129	-0.101
0.925	-0.128	-	-0.737	-0.384	-0.293	-0.228	-0.162	-0.132	-0.107	-0.081
0.901	-0.146	-	-0.742	-0.358	-0.281	-0.197	-0.129	-0.099	-0.073	-0.046
0.876	-0.163	-	-0.766	-0.359	-0.273	-0.172	-0.097	-0.066	-0.037	-0.010
0.853	-0.179	-	-0.811	-0.368	-0.264	-0.143	-0.062	-0.029	0.000	0.023
0.802	-0.204	-	-0.923	-0.361	-0.207	-0.114	-0.010	0.035	0.073	0.097
0.700	-0.220	-	-0.888	-0.314	-0.134	-0.065	0.038	0.093	0.144	0.182
0.599	-0.224	-	-0.852	-0.381	-0.125	-0.008	0.085	0.125	0.167	0.204
0.399	-0.215	-	-0.751	-0.363	-0.107	0.039	0.089	0.115	0.147	0.181

$M_\infty$	Static pressure coefficients on nozzle sidewall at $z/Z = 0.50$ with values of $x/l$ of—									
	.153	.226	.300	.337	.411	.558	.705	.779	.853	.926
0.600	-0.218	-0.348	-0.745	-0.369	-0.144	-0.046	0.070	0.129	0.180	0.213
0.598	-0.217	-0.347	-0.739	-0.362	-0.144	-0.046	0.068	0.128	0.179	0.213
0.702	-0.210	-0.332	-0.660	-0.222	-0.161	-0.115	0.015	0.092	0.152	0.190
0.797	-0.195	-0.312	-0.746	-0.235	-0.199	-0.167	-0.029	0.045	0.097	0.131
0.948	-0.099	-0.167	-0.700	-0.365	-0.295	-0.275	-0.199	-0.157	-0.113	-0.068
0.925	-0.123	-0.195	-0.698	-0.310	-0.263	-0.246	-0.172	-0.130	-0.086	-0.044
0.901	-0.137	-0.220	-0.707	-0.295	-0.252	-0.218	-0.139	-0.095	-0.051	-0.009
0.876	-0.156	-0.246	-0.731	-0.297	-0.252	-0.207	-0.106	-0.056	-0.014	0.026
0.853	-0.170	-0.268	-0.770	-0.302	-0.248	-0.187	-0.074	-0.020	0.025	0.060
0.802	-0.195	-0.309	-0.742	-0.238	-0.198	-0.169	-0.037	0.040	0.089	0.125
0.700	-0.209	-0.329	-0.657	-0.223	-0.157	-0.112	0.013	0.088	0.148	0.186
0.599	-0.218	-0.345	-0.731	-0.361	-0.141	-0.049	0.068	0.130	0.179	0.213
0.399	-0.209	-0.335	-0.719	-0.467	-0.088	0.041	0.090	0.112	0.146	0.185

Table 12. Continued

(b) Concluded

$M_\infty$	Static pressure coefficients on nozzle sidewall at centerline with values of $x/l$ of—											
	.153	.226	.300	.337	.411	.484	.558	.632	.705	.779	.853	.926
0.600	-0.232	-0.366	-0.687	-0.267	-0.149	-0.106	-0.053	0.006	0.067	0.126	0.179	—
0.598	-0.231	-0.365	-0.687	-0.267	-0.150	-0.108	-0.052	0.004	0.066	0.128	0.179	—
0.702	-0.218	-0.342	-0.558	-0.172	-0.152	-0.149	-0.119	-0.061	0.012	0.089	0.149	—
0.797	-0.202	-0.323	-0.507	-0.174	-0.176	-0.190	-0.166	-0.111	-0.035	0.039	0.095	—
0.948	-0.100	-0.174	-0.641	-0.277	-0.253	-0.264	-0.263	-0.240	-0.206	-0.162	-0.114	—
0.925	-0.123	-0.201	-0.597	-0.226	-0.219	-0.234	-0.237	-0.214	-0.180	-0.136	-0.088	—
0.901	-0.140	-0.225	-0.575	-0.213	-0.209	-0.223	-0.218	-0.190	-0.147	-0.100	-0.053	—
0.876	-0.158	-0.251	-0.566	-0.210	-0.212	-0.224	-0.210	-0.168	-0.117	-0.064	-0.014	—
0.853	-0.176	-0.276	-0.571	-0.208	-0.214	-0.220	-0.195	-0.147	-0.083	-0.026	0.026	—
0.802	-0.203	-0.319	-0.502	-0.165	-0.174	-0.191	-0.172	-0.117	-0.041	0.033	0.093	—
0.700	-0.218	-0.336	-0.552	-0.167	-0.148	-0.146	-0.113	-0.059	0.010	0.083	0.145	—
0.599	-0.232	-0.358	-0.670	-0.252	-0.145	-0.110	-0.057	-0.001	0.062	0.128	0.181	—
0.399	-0.230	-0.365	-0.739	-0.471	-0.077	0.001	0.042	0.066	0.085	0.110	0.140	—

$M_\infty$	Static pressure coefficients on nozzle sidewall at $z/Z = -0.50$ with values of $x/l$ of—											
	.153	.226	.300	.337	.411	.484	.558	.632	.705	.779	.853	.926
0.600	-0.221	-0.346	-0.765	-0.386	—	-0.042	0.074	0.209	0.209	0.209	0.209	—
0.598	-0.221	-0.345	-0.770	-0.399	—	-0.039	0.074	0.209	0.209	0.209	0.209	—
0.702	-0.213	-0.330	-0.697	-0.238	—	-0.110	0.018	0.187	0.187	0.187	0.187	—
0.797	-0.197	-0.305	-0.694	-0.210	—	-0.173	-0.036	0.135	0.135	0.135	0.135	—
0.948	-0.095	-0.161	-0.668	-0.292	—	-0.264	-0.217	-0.079	-0.079	-0.079	-0.079	—
0.925	-0.116	-0.190	-0.632	-0.236	—	-0.243	-0.192	-0.059	-0.059	-0.059	-0.059	—
0.901	-0.134	-0.213	-0.611	-0.210	—	-0.230	-0.163	-0.020	-0.020	-0.020	-0.020	—
0.876	-0.152	-0.240	-0.615	-0.210	—	-0.222	-0.128	0.018	0.018	0.018	0.018	—
0.853	-0.166	-0.262	-0.618	-0.207	—	-0.205	-0.095	0.058	0.058	0.058	0.058	—
0.802	-0.190	-0.304	-0.679	-0.205	—	-0.173	-0.043	0.125	0.125	0.125	0.125	—
0.700	-0.208	-0.324	-0.678	-0.232	—	-0.110	0.016	0.180	0.180	0.180	0.180	—
0.599	-0.216	-0.340	-0.747	-0.376	—	-0.048	0.073	0.203	0.203	0.203	0.203	—
0.399	-0.210	-0.336	-0.729	-0.468	—	0.042	0.092	0.181	0.181	0.181	0.181	—

Table 12. Continued

(c) Static pressure coefficients on nozzle bottom flap

$M_\infty$	Static pressure coefficients on nozzle bottom flap at $y/Y = 0.875$ with values of $x/l$ of—									
	.153	.226	.300	.337	.411	.558	.705	.779	.853	.926
0.600	-0.222	-0.332	-0.853	-0.404	-0.158	-0.010	0.088	0.132	0.174	0.212
0.598	-0.222	-0.331	-0.846	-0.403	-0.158	-0.009	0.087	0.131	0.173	0.210
0.702	-0.218	-0.334	-0.939	-0.374	-0.150	-0.045	0.057	0.109	0.158	0.197
0.797	-0.201	-0.301	-0.915	-0.383	-0.219	-0.109	0.013	0.063	0.106	0.140
0.948	-0.100	-0.160	-0.706	-0.400	-0.305	-0.300	-0.237	-0.169	-0.103	-0.049
0.925	-0.123	-0.188	-0.643	-0.321	-0.267	-0.288	-0.199	-0.133	-0.082	-0.038
0.901	-0.139	-0.211	-0.628	-0.301	-0.263	-0.257	-0.146	-0.088	-0.045	-0.011
0.876	-0.157	-0.236	-0.656	-0.310	-0.269	-0.219	-0.101	-0.050	-0.010	0.025
0.853	-0.171	-0.256	-0.697	-0.327	-0.267	-0.183	-0.063	-0.012	0.026	0.060
0.802	-0.197	-0.298	-0.873	-0.376	-0.220	-0.115	0.007	0.059	0.096	0.132
0.700	-0.214	-0.328	-0.915	-0.363	-0.147	-0.046	0.054	0.109	0.155	0.194
0.599	-0.219	-0.327	-0.836	-0.393	-0.155	-0.010	0.085	0.133	0.172	0.208
0.399	-0.208	-0.303	-0.731	-0.371	-0.147	0.016	0.091	0.128	0.158	0.192

$M_\infty$	Static pressure coefficients on nozzle bottom flap at $y/Y = 0.50$ with values of $x/l$ of—									
	.153	.226	.300	.337	.411	.558	.705	.779	.853	.926
0.600	-	-0.387	-0.909	-0.443	-0.200	-0.016	0.093	0.139	0.181	0.223
0.598	-	-0.386	-0.904	-0.441	-0.199	-0.015	0.093	0.138	0.180	0.222
0.702	-	-0.397	-1.164	-0.465	-0.205	-0.026	0.081	0.127	0.171	0.213
0.797	-	-0.321	-1.144	-0.586	-0.289	-0.072	0.036	0.078	0.116	0.149
0.948	-	-0.162	-0.806	-0.882	-0.459	-0.243	-0.137	-0.095	-0.057	-0.027
0.925	-	-0.190	-0.856	-0.747	-0.371	-0.221	-0.128	-0.091	-0.056	-0.027
0.901	-	-0.214	-0.896	-0.576	-0.330	-0.190	-0.104	-0.072	-0.037	-0.008
0.876	-	-0.240	-0.931	-0.525	-0.317	-0.170	-0.078	-0.043	-0.003	0.026
0.853	-	-0.264	-0.965	-0.522	-0.308	-0.145	-0.043	-0.004	0.033	0.065
0.802	-	-0.317	-1.090	-0.569	-0.291	-0.086	0.029	0.070	0.108	0.140
0.700	-	-0.394	-1.119	-0.458	-0.200	-0.028	0.079	0.125	0.169	0.211
0.599	-	-0.383	-0.893	-0.437	-0.196	-0.018	0.092	0.138	0.180	0.218
0.399	-	-0.342	-0.747	-0.390	-0.179	-0.011	0.090	0.132	0.168	0.204



Table 12. Concluded

(c) Concluded

$M_\infty$	Static pressure coefficients on nozzle bottom flap at centerline with values of $x/l$ of—									
	.153	.226	.300	.337	.411	.558	.705	.926		
0.600	-0.267	-0.397	-0.908	-0.454	-0.218	-0.026	0.086	0.229		
0.598	-0.267	-0.396	-0.907	-0.454	-0.218	-0.027	0.086	0.229		
0.702	-0.271	-0.414	-1.179	-0.492	-0.227	-0.030	0.081	0.224		
0.797	-0.223	-0.335	-1.185	-0.643	-0.303	-0.068	0.042	0.158		
0.948	-0.107	-0.177	-0.815	-0.889	-0.697	-0.205	-0.110	-0.014		
0.925	-0.126	-0.198	-0.869	-0.868	-0.402	-0.199	-0.111	-0.020		
0.901	-0.148	-0.222	-0.907	-0.592	-0.351	-0.190	-0.102	-0.004		
0.876	-0.166	-0.247	-0.935	-0.540	-0.337	-0.168	-0.074	0.029		
0.853	-0.180	-0.273	-0.975	-0.549	-0.329	-0.144	-0.038	0.070		
0.802	-0.217	-0.330	-1.130	-0.620	-0.310	-0.080	0.035	0.144		
0.700	-0.270	-0.411	-1.137	-0.486	-0.227	-0.032	0.080	0.221		
0.599	-0.263	-0.392	-0.893	-0.448	-0.216	-0.028	0.086	0.225		
0.399	-0.239	-0.348	-0.741	-0.390	-0.197	-0.027	0.078	0.211		

(d) Force data

$M_\infty$	$C_D$	$C_{D,p}$	$C_{D,f}$
0.598	0.0482	0.0684	0.0115
0.702	0.0677	0.0902	0.0112
0.797	0.1146	0.1307	0.0110
0.948	0.2365	0.2333	0.0108
0.925	0.2054	0.2092	0.0108
0.901	0.1822	0.1888	0.0109
0.876	0.1648	0.1730	0.0109
0.853	0.1475	0.1595	0.0110
0.802	0.1147	0.1317	0.0111
0.700	0.0677	0.0881	0.0113
0.599	0.0473	0.0674	0.0116
0.399	0.0325	0.0520	0.0123

Table 13. Pressure and Force Data for Nozzle 8 With  $\beta_{r,top/bot} = 15.0^\circ/\beta_{r,side} = 22.4^\circ$  and Plume Off

(a) Static pressure coefficients on nozzle top flap

$M_\infty$	$\alpha$ , deg	Static pressure coefficients on nozzle top flap at centerline with values of $x/l$ of—														
		.153	.226	.300	.337	.411	.484	.558	.632	.705	.779	.853	.926			
0.952	0.001	-0.098	-0.158	-0.787	-0.771	-0.390	-0.232	-0.188	-0.165	-0.148	-0.127	-0.109	-0.085			
0.923	-0.007	-0.125	-0.192	-0.801	-0.535	-0.294	-0.224	-0.187	-0.162	-0.141	-0.115	-0.092	-0.063			
0.901	0.010	-0.144	-0.217	-0.774	-0.416	-0.265	-0.211	-0.179	-0.152	-0.128	-0.101	-0.073	-0.040			
0.898	-2.990	-0.135	-0.204	-0.835	-0.524	-0.306	-0.238	-0.204	-0.175	-0.149	-0.119	-0.089	-0.052			
0.900	0.013	-0.146	-0.218	-0.779	-0.416	-0.269	-0.216	-0.184	-0.154	-0.129	-0.104	-0.077	-0.043			
0.898	3.014	-0.155	-0.231	-0.776	-0.416	-0.274	-0.221	-0.186	-0.154	-0.124	-0.090	-0.059	-0.021			
0.898	5.999	-0.159	-0.233	-0.866	-0.550	-0.337	-0.266	-0.218	-0.171	-0.127	-0.084	-0.043	0.005			
0.901	9.018	-0.161	-0.226	-0.909	-1.002	-0.484	-0.302	-0.232	-0.166	-0.104	-0.048	0.001	0.050			
0.877	-0.016	-0.162	-0.242	-0.777	-0.394	-0.256	-0.202	-0.163	-0.129	-0.101	-0.070	-0.044	-0.012			
0.849	-0.003	-0.186	-0.275	-0.814	-0.405	-0.262	-0.190	-0.141	-0.101	-0.069	-0.039	-0.009	0.022			
0.801	-0.010	-0.219	-0.325	-0.980	-0.502	-0.281	-0.170	-0.098	-0.043	-0.002	0.032	0.063	0.089			
0.703	0.004	-0.282	-0.430	-1.294	-0.539	-0.238	-0.111	-0.035	0.025	0.070	0.109	0.143	0.172			
0.603	-0.006	-0.285	-0.431	-0.988	-0.491	-0.233	-0.111	-0.034	0.026	0.072	0.110	0.143	0.174			
0.603	-2.990	-0.303	-0.463	-1.111	-0.552	-0.281	-0.153	-0.072	-0.010	0.041	0.084	0.123	0.161			
0.603	0.018	-0.286	-0.432	-0.987	-0.491	-0.234	-0.112	-0.034	0.025	0.071	0.109	0.141	0.172			
0.602	3.028	-0.267	-0.403	-0.896	-0.446	-0.203	-0.087	-0.013	0.042	0.085	0.117	0.145	0.173			
0.601	5.994	-0.253	-0.385	-0.869	-0.431	-0.195	-0.081	-0.009	0.042	0.083	0.110	0.134	0.159			
0.602	8.988	-0.247	-0.384	-0.924	-0.453	-0.210	-0.094	-0.022	0.028	0.068	0.093	0.115	0.140			
0.400	0.018	-0.259	-0.382	-0.799	-0.429	-0.211	-0.103	-0.030	0.025	0.067	0.102	0.134	0.163			

Table 13. Continued

(a) Continued

$M_\infty$	$\alpha$ , deg	Static pressure coefficients on nozzle top flap at $y/Y = 0.50$ with values of $x/l$ of—											
		.153	.226	.300	.337	.411	.558	.705	.779	.853	.926		
0.952	0.001	-0.091	-0.149	-0.793	-0.832	-0.426	-0.189	-0.150	-0.134	-0.115	-0.089		
0.923	-0.007	-0.118	-0.183	-0.840	-0.637	-0.306	-0.187	-0.147	-0.122	-0.095	-0.063		
0.901	0.010	-0.137	-0.208	-0.838	-0.478	-0.290	-0.186	-0.131	-0.102	-0.074	-0.039		
0.898	-2.990	-0.129	-0.198	-0.892	-0.676	-0.336	-0.211	-0.156	-0.123	-0.091	-0.051		
0.900	0.013	-0.138	-0.210	-0.837	-0.467	-0.287	-0.185	-0.131	-0.101	-0.074	-0.040		
0.898	3.014	-0.150	-0.223	-0.838	-0.472	-0.297	-0.188	-0.126	-0.094	-0.059	-0.019		
0.898	5.999	-0.163	-0.232	-0.913	-0.675	-0.354	-0.209	-0.124	-0.081	-0.038	0.009		
0.901	9.018	-0.186	-0.247	-0.925	-1.020	-0.429	-0.224	-0.104	-0.049	0.000	0.049		
0.877	-0.016	-0.154	-0.232	-0.831	-0.432	-0.279	-0.173	-0.108	-0.076	-0.045	-0.012		
0.849	-0.003	-0.176	-0.265	-0.869	-0.447	-0.280	-0.147	-0.074	-0.039	-0.007	0.026		
0.801	-0.010	-0.207	-0.314	-1.023	-0.529	-0.289	-0.094	-0.001	0.035	0.066	0.090		
0.703	0.004	-0.258	-0.404	-1.256	-0.501	-0.218	-0.033	0.070	0.110	0.144	0.171		
0.603	-0.006	-0.260	-0.404	-0.964	-0.465	-0.212	-0.025	0.074	0.113	0.144	0.174		
0.603	-2.990	-0.276	-0.435	-1.085	-0.530	-0.261	-0.064	0.045	0.090	0.127	0.162		
0.603	0.018	-0.261	-0.406	-0.965	-0.467	-0.212	-0.025	0.074	0.112	0.144	0.173		
0.602	3.028	-0.243	-0.374	-0.899	-0.426	-0.183	-0.006	0.085	0.119	0.147	0.172		
0.601	5.994	-0.233	-0.354	-0.904	-0.420	-0.178	-0.004	0.081	0.112	0.137	0.159		
0.602	8.988	-0.247	-0.366	-0.937	-0.443	-0.193	-0.014	0.070	0.099	0.123	0.143		
0.400	0.018	-0.235	-0.359	-0.786	-0.410	-0.192	-0.017	0.075	0.110	0.137	0.161		

Table 13. Continued

(a) Continued

$M_\infty$	$\alpha$ , deg	Static pressure coefficients on nozzle top flap at $y/Y = 0.75$ with values of $v/l$ of—												
		.153	.226	.300	.337	.411	.558	.705	.779	.853	.926			
0.952	0.001	-0.105	-0.150	-	-0.791	-0.379	-0.213	-0.161	-0.143	-0.123	-0.096	-0.096	-0.096	
0.923	-0.007	-0.131	-0.183	-	-0.619	-0.313	-0.199	-0.149	-0.126	-0.098	-0.066	-0.066	-0.066	
0.901	0.010	-0.151	-0.208	-	-0.502	-0.293	-0.188	-0.133	-0.104	-0.073	-0.042	-0.042	-0.042	
0.898	-2.990	-0.152	-0.193	-	-0.696	-0.346	-0.220	-0.155	-0.123	-0.087	-0.052	-0.052	-0.052	
0.900	0.013	-0.153	-0.211	-	-0.489	-0.290	-0.191	-0.134	-0.104	-0.073	-0.043	-0.043	-0.043	
0.898	3.014	-0.168	-0.237	-	-0.493	-0.305	-0.190	-0.127	-0.096	-0.060	-0.022	-0.022	-0.022	
0.898	5.999	-0.182	-0.252	-	-0.608	-0.362	-0.211	-0.124	-0.082	-0.038	0.008	0.008	0.008	
0.901	9.018	-0.196	-0.265	-	-0.831	-0.432	-0.223	-0.102	-0.052	-0.006	0.041	0.041	0.041	
0.877	-0.016	-0.166	-0.231	-	-0.464	-0.286	-0.175	-0.109	-0.076	-0.043	-0.013	-0.013	-0.013	
0.849	-0.003	-0.186	-0.263	-	-0.474	-0.282	-0.146	-0.071	-0.038	-0.005	0.028	0.028	0.028	
0.801	-0.010	-0.213	-0.303	-	-0.536	-0.267	-0.088	0.001	0.035	0.066	0.092	0.092	0.092	
0.703	0.004	-0.246	-0.368	-	-0.438	-0.193	-0.036	0.066	0.106	0.142	0.172	0.172	0.172	
0.603	-0.006	-0.248	-0.360	-	-0.422	-0.188	-0.016	0.078	0.113	0.144	0.171	0.171	0.171	
0.603	-2.990	-0.263	-0.385	-	-0.499	-0.243	-0.053	0.054	0.096	0.133	0.163	0.163	0.163	
0.603	0.018	-0.249	-0.363	-	-0.425	-0.190	-0.016	0.077	0.113	0.143	0.170	0.170	0.170	
0.602	3.028	-0.241	-0.339	-	-0.363	-0.157	-0.001	0.086	0.119	0.146	0.168	0.168	0.168	
0.601	5.994	-0.241	-0.332	-	-0.339	-0.145	0.005	0.085	0.116	0.138	0.156	0.156	0.156	
0.602	8.988	-0.247	-0.338	-	-0.332	-0.135	0.010	0.085	0.113	0.130	0.143	0.143	0.143	
0.400	0.018	-0.223	-0.321	-	-0.374	-0.167	0.002	0.083	0.108	0.134	0.157	0.157	0.157	

Table 13. Continued

(a) Concluded

$M_\infty$	$\alpha$ , deg	Static pressure coefficients on nozzle top flap at $y/Y = 0.875$ with values of $x/l$ of—												
		.153	.226	.300	.337	.411	.558	.705	.779	.853	.926			
0.952	0.001	-0.104	-0.167	-0.732	-0.607	-0.362	-0.269	-0.192	-0.160	-0.129	-0.100			
0.923	-0.007	-0.130	-0.200	-0.786	-0.491	-0.322	-0.233	-0.164	-0.135	-0.099	-0.069			
0.901	0.010	-0.149	-0.225	-0.813	-0.447	-0.302	-0.208	-0.139	-0.110	-0.074	-0.042			
0.898	-2.990	-0.156	-0.220	-0.845	-0.543	-0.382	-0.255	-0.162	-0.125	-0.086	-0.054			
0.900	0.013	-0.150	-0.226	-0.813	-0.435	-0.297	-0.206	-0.139	-0.108	-0.075	-0.044			
0.898	3.014	-0.168	-0.251	-0.782	-0.404	-0.294	-0.207	-0.132	-0.098	-0.057	-0.019			
0.898	5.999	-0.185	-0.267	-0.788	-0.422	-0.343	-0.230	-0.130	-0.084	-0.037	0.007			
0.901	9.018	-0.194	-0.279	-0.869	-0.514	-0.396	-0.227	-0.100	-0.056	-0.010	0.035			
0.877	-0.016	-0.164	-0.247	-0.843	-0.429	-0.290	-0.185	-0.110	-0.078	-0.043	-0.012			
0.849	-0.003	-0.183	-0.279	-0.896	-0.439	-0.279	-0.151	-0.074	-0.038	-0.004	0.026			
0.801	-0.010	-0.208	-0.316	-1.014	-0.458	-0.244	-0.100	-0.001	0.034	0.068	0.094			
0.703	0.004	-0.235	-0.360	-0.990	-0.409	-0.173	-0.051	0.055	0.102	0.142	0.170			
0.603	-0.006	-0.235	-0.354	-0.864	-0.417	-0.172	-0.018	0.078	0.114	0.146	0.171			
0.603	-2.990	-0.253	-0.380	-1.055	-0.504	-0.227	-0.050	0.060	0.102	0.139	0.166			
0.603	0.018	-0.236	-0.355	-0.869	-0.420	-0.174	-0.018	0.077	0.113	0.145	0.169			
0.602	3.028	-0.241	-0.347	-0.709	-0.351	-0.144	-0.006	0.085	0.121	0.151	0.171			
0.601	5.994	-0.247	-0.344	-0.629	-0.323	-0.132	0.005	0.090	0.122	0.147	0.160			
0.602	8.988	-0.248	-0.338	-0.637	-0.311	-0.119	0.018	0.096	0.122	0.140	0.145			
0.400	0.018	-0.219	-0.325	-0.738	-0.378	-0.158	0.003	0.084	0.113	0.135	0.154			



Table 13. Continued

(b) Continued

$M_\infty$	$\alpha$ , deg	Static pressure coefficients on nozzle sidewall at $z/Z = 0.50$ with values of $x/l$ of—											
		.153	.226	.300	.337	.411	.558	.705	.779	.853	.926		
0.952	0.001	-0.094	-0.163	-0.711	-0.435	-0.334	-	-0.224	-0.184	-0.147	-0.103		
0.923	-0.007	-0.120	-0.196	-0.745	-0.373	-0.304	-	-0.182	-0.144	-0.103	-0.056		
0.901	0.010	-0.139	-0.222	-0.768	-0.352	-0.288	-	-0.151	-0.112	-0.068	-0.029		
0.898	-2.990	-0.147	-0.227	-0.795	-0.412	-0.331	-	-0.175	-0.131	-0.081	-0.030		
0.900	0.013	-0.141	-0.224	-0.764	-0.342	-0.284	-	-0.152	-0.108	-0.065	-0.025		
0.898	3.014	-0.154	-0.236	-0.784	-0.372	-0.317	-	-0.152	-0.099	-0.049	-0.007		
0.898	5.999	-0.178	-0.254	-0.818	-0.415	-0.360	-	-0.146	-0.090	-0.034	0.012		
0.901	9.018	-0.205	-0.279	-0.861	-0.477	-0.398	-	-0.188	-0.117	-0.040	0.021		
0.877	-0.016	-0.155	-0.244	-0.791	-0.345	-0.287	-	-0.123	-0.073	-0.031	0.003		
0.849	-0.003	-0.174	-0.274	-0.848	-0.362	-0.288	-	-0.079	-0.027	0.013	0.047		
0.801	-0.010	-0.199	-0.315	-0.890	-0.326	-0.248	-	-0.023	0.039	0.080	0.106		
0.703	0.004	-0.223	-0.355	-0.767	-0.288	-0.192	-	0.027	0.098	0.147	0.176		
0.603	-0.006	-0.229	-0.366	-0.811	-0.452	-0.156	-	0.077	0.120	0.158	0.183		
0.603	-2.990	-0.245	-0.388	-0.849	-0.491	-0.161	-	0.081	0.119	0.150	0.172		
0.603	0.018	-0.232	-0.368	-0.815	-0.452	-0.159	-	0.077	0.119	0.157	0.183		
0.602	3.028	-0.237	-0.366	-0.797	-0.432	-0.163	-	0.075	0.119	0.156	0.181		
0.601	5.994	-0.253	-0.377	-0.819	-0.444	-0.167	-	0.083	0.121	0.148	0.162		
0.602	8.988	-0.274	-0.391	-0.822	-0.471	-0.162	-	0.087	0.114	0.126	0.129		
0.400	0.018	-0.219	-0.350	-0.759	-0.514	-0.127	-	0.098	0.118	0.137	0.156		

Table 13. Continued

(b) Continued

$M_\infty$	$\alpha$ , deg	Static pressure coefficients on nozzle sidewall at centerline with values of $x/l$ of—														
		.153	.226	.300	.337	.411	.484	.558	.632	.705	.779	.853	.926			
0.952	0.001	-0.097	-0.166	-0.695	-0.337	-0.292	-0.301	-0.294	-0.268	-0.230	-0.191	-0.146	-			
0.923	-0.007	-0.124	-0.201	-0.669	-0.279	-0.258	-0.270	-0.260	-0.234	-0.195	-0.148	-0.097	-			
0.901	0.010	-0.142	-0.227	-0.657	-0.261	-0.251	-0.253	-0.240	-0.205	-0.160	-0.113	-0.066	-			
0.898	-2.990	-0.148	-0.229	-0.721	-0.308	-0.292	-0.291	-0.280	-0.242	-0.189	-0.129	-0.066	-			
0.900	0.013	-0.144	-0.228	-0.650	-0.251	-0.245	-0.248	-0.238	-0.204	-0.161	-0.114	-0.063	-			
0.898	3.014	-0.147	-0.227	-0.694	-0.294	-0.284	-0.278	-0.256	-0.209	-0.156	-0.102	-0.047	-			
0.898	5.999	-0.160	-0.239	-0.811	-0.424	-0.357	-0.318	-0.286	-0.230	-0.164	-0.096	-0.033	-			
0.901	9.018	-0.180	-0.257	-0.859	-0.484	-0.378	-0.356	-0.350	-0.311	-0.244	-0.148	-0.048	-			
0.877	-0.016	-0.160	-0.252	-0.660	-0.258	-0.249	-0.251	-0.225	-0.184	-0.130	-0.079	-0.029	-			
0.849	-0.003	-0.178	-0.284	-0.683	-0.266	-0.256	-0.249	-0.213	-0.155	-0.090	-0.031	0.018	-			
0.801	-0.010	-0.205	-0.323	-0.635	-0.224	-0.225	-0.227	-0.189	-0.121	-0.037	0.034	0.086	-			
0.703	0.004	-0.232	-0.365	-0.642	-0.213	-0.187	-0.172	-0.125	-0.055	0.023	0.098	0.153	-			
0.603	-0.006	-0.245	-0.388	-0.768	-0.336	-0.171	-0.113	-0.051	0.010	0.067	0.118	0.159	-			
0.603	-2.990	-0.251	-0.397	-0.821	-0.369	-0.166	-0.107	-0.044	0.017	0.074	0.121	0.156	-			
0.603	0.018	-0.247	-0.389	-0.776	-0.341	-0.172	-0.112	-0.049	0.012	0.066	0.119	0.160	-			
0.602	3.028	-0.253	-0.396	-0.804	-0.345	-0.175	-0.121	-0.059	0.009	0.068	0.122	0.160	-			
0.601	5.994	-0.266	-0.409	-0.824	-0.372	-0.184	-0.123	-0.054	0.018	0.078	0.122	0.142	-			
0.602	8.988	-0.285	-0.424	-0.838	-0.411	-0.204	-0.141	-0.069	0.006	0.051	0.067	0.067	-			
0.400	0.018	-0.239	-0.384	-0.793	-0.534	-0.124	-0.014	0.041	0.073	0.096	0.114	0.133	-			



Table 13. Continued

(b) Concluded

$M_\infty$	$\alpha$ , deg	Static pressure coefficients on nozzle sidewall at $z/Z = -0.50$ with values of $x/l$ of—									
		.153	.226	.300	.337	.411	.558	.705	.926		
0.952	0.001	-0.089	-0.160	-0.708	-0.379	-	-0.284	-0.234	-0.107		
0.923	-0.007	-0.116	-0.194	-0.699	-0.290	-	-0.257	-0.202	-0.059		
0.901	0.010	-0.135	-0.217	-0.680	-0.261	-	-0.242	-0.171	-0.025		
0.898	-2.990	-0.149	-0.230	-0.717	-0.291	-	-0.269	-0.196	-0.021		
0.900	0.013	-0.136	-0.219	-0.674	-0.250	-	-0.241	-0.171	-0.027		
0.898	3.014	-0.140	-0.218	-0.701	-0.292	-	-0.258	-0.164	-0.005		
0.898	5.999	-0.163	-0.235	-0.698	-0.330	-	-0.319	-0.188	0.016		
0.901	9.018	-0.202	-0.266	-0.580	-0.310	-	-0.362	-0.262	0.021		
0.877	-0.016	-0.153	-0.240	-0.681	-0.248	-	-0.235	-0.137	0.008		
0.849	-0.003	-0.172	-0.268	-0.703	-0.251	-	-0.219	-0.095	0.052		
0.801	-0.010	-0.195	-0.309	-0.761	-0.241	-	-0.195	-0.039	0.112		
0.703	0.004	-0.217	-0.349	-0.779	-0.292	-	-0.117	0.029	0.171		
0.603	-0.006	-0.227	-0.365	-0.825	-0.455	-	-0.035	0.077	0.178		
0.603	-2.990	-0.229	-0.364	-0.818	-0.438	-	-0.035	0.078	0.172		
0.603	0.018	-0.227	-0.369	-0.833	-0.468	-	-0.032	0.078	0.175		
0.602	3.028	-0.243	-0.389	-0.867	-0.484	-	-0.039	0.077	0.160		
0.601	5.994	-0.270	-0.418	-0.902	-0.497	-	-0.041	0.054	0.130		
0.602	8.988	-0.309	-0.451	-0.897	-0.458	-	-0.078	-0.013	0.115		
0.400	0.018	-0.217	-0.352	-0.765	-0.510	-	0.035	0.097	0.154		

Table 13. Continued

(c) Static pressure coefficients on nozzle bottom flap

$M_\infty$	$\alpha$ , deg	Static pressure coefficients on nozzle bottom flap at $y/Y = 0.875$ with values of $x/l$ of---													
		.153	.226	.300	.337	.411	.558	.705	.779	.853	.926				
0.952	0.001	-0.096	-0.156	-0.742	-0.522	-0.353	-0.300	-0.246	-0.195	-0.138	-0.083				
0.923	-0.007	-0.122	-0.190	-0.717	-0.381	-0.306	-0.294	-0.207	-0.142	-0.087	-0.040				
0.901	0.010	-0.142	-0.215	-0.684	-0.341	-0.288	-0.272	-0.171	-0.109	-0.061	-0.019				
0.898	-2.990	-0.164	-0.245	-0.651	-0.329	-0.287	-0.286	-0.175	-0.101	-0.042	0.004				
0.900	0.013	-0.144	-0.217	-0.680	-0.334	-0.286	-0.272	-0.167	-0.106	-0.059	-0.018				
0.898	3.014	-0.152	-0.210	-0.734	-0.380	-0.323	-0.297	-0.179	-0.108	-0.050	0.000				
0.898	5.999	-0.194	-0.238	-0.745	-0.410	-0.367	-0.355	-0.198	-0.109	-0.042	0.016				
0.901	9.018	-0.268	-0.290	-0.696	-0.382	-0.362	-0.420	-0.267	-0.145	-0.051	0.027				
0.877	-0.016	-0.155	-0.233	-0.698	-0.342	-0.293	-0.239	-0.119	-0.068	-0.027	0.010				
0.849	-0.003	-0.177	-0.262	-0.755	-0.372	-0.302	-0.199	-0.075	-0.024	0.016	0.050				
0.801	-0.010	-0.200	-0.301	-0.924	-0.432	-0.264	-0.127	-0.004	0.044	0.080	0.108				
0.703	0.004	-0.226	-0.346	-1.007	-0.408	-0.174	-0.050	0.052	0.099	0.137	0.168				
0.603	-0.006	-0.228	-0.343	-0.885	-0.426	-0.178	-0.021	0.070	0.108	0.139	0.168				
0.603	-2.990	-0.234	-0.334	-0.696	-0.350	-0.145	-0.004	0.084	0.120	0.147	0.171				
0.603	0.018	-0.230	-0.345	-0.887	-0.427	-0.178	-0.022	0.071	0.109	0.139	0.167				
0.602	3.028	-0.250	-0.370	-1.054	-0.510	-0.238	-0.065	0.043	0.091	0.127	0.163				
0.601	5.994	-0.294	-0.409	-1.170	-0.595	-0.315	-0.122	0.013	0.076	0.120	0.159				
0.602	8.988	-0.362	-0.462	-1.265	-0.676	-0.393	-0.181	-0.027	0.050	0.103	0.153				
0.400	0.018	-0.213	-0.314	-0.755	-0.388	-0.165	-0.002	0.079	0.108	0.133	0.154				

Table 13. Continued

(c) Continued

$M_\infty$	$\alpha$ , deg	Static pressure coefficients on nozzle bottom flap at $y/Y = 0.50$ with values of $x/l$ of—												
		.153	.226	.300	.337	.411	.558	.705	.779	.853	.926			
0.952	0.001	—	-0.156	—	-0.890	-0.618	-0.272	-0.172	-0.127	-0.086	-0.048			
0.923	-0.007	—	-0.190	—	-0.874	-0.422	-0.237	-0.140	-0.099	-0.060	-0.025			
0.901	0.010	—	-0.215	—	-0.725	-0.369	-0.213	-0.121	-0.083	-0.046	-0.012			
0.898	-2.990	—	-0.228	—	-0.981	-0.443	-0.208	-0.094	-0.053	-0.018	0.010			
0.900	0.013	—	-0.217	—	-0.715	-0.364	-0.212	-0.122	-0.084	-0.048	-0.012			
0.898	3.014	—	-0.199	—	-0.850	-0.410	-0.236	-0.127	-0.080	-0.034	0.006			
0.898	5.999	—	-0.182	—	-0.959	-0.499	-0.270	-0.138	-0.079	-0.024	0.024			
0.901	9.018	—	-0.164	—	-0.982	-0.560	-0.316	-0.168	-0.096	-0.026	0.036			
0.877	-0.016	—	-0.237	—	-0.608	-0.346	-0.190	-0.097	-0.059	-0.025	0.009			
0.849	-0.003	—	-0.268	—	-0.576	-0.344	-0.166	-0.061	-0.020	0.016	0.047			
0.801	-0.010	—	-0.317	—	-0.613	-0.327	-0.105	0.006	0.047	0.079	0.107			
0.703	0.004	—	-0.401	—	-0.486	-0.220	-0.041	0.061	0.101	0.134	0.164			
0.603	-0.006	—	-0.395	—	-0.459	-0.211	-0.036	0.066	0.104	0.138	0.165			
0.603	-2.990	—	-0.366	—	-0.415	-0.178	-0.013	0.082	0.115	0.144	0.166			
0.603	0.018	—	-0.396	—	-0.460	-0.212	-0.038	0.065	0.104	0.137	0.164			
0.602	3.028	—	-0.425	—	-0.525	-0.260	-0.079	0.035	0.078	0.118	0.151			
0.601	5.994	—	-0.438	—	-0.573	-0.297	-0.112	0.009	0.056	0.100	0.134			
0.602	8.988	—	-0.440	—	-0.606	-0.324	-0.139	-0.015	0.034	0.080	0.116			
0.400	0.018	—	-0.351	—	-0.407	-0.195	-0.030	0.067	0.100	0.128	0.153			

Table 13. Continued

(c) Concluded

$M_\infty$	$\alpha$ , deg	Static pressure coefficients on nozzle bottom flap at centerline with values of $y/l$ of—									
		.153	.226	.300	.337	.411	.558	.705	.926		
0.952	0.001	-0.104	-0.176	-0.805	-0.875	-0.785	-0.254	-0.145	-0.042		
0.923	-0.007	-0.130	-0.203	-0.874	-0.948	-0.510	-0.205	-0.115	-0.016		
0.901	0.010	-0.147	-0.226	-0.924	-0.895	-0.391	-0.191	-0.104	-0.001		
0.898	-2.990	-0.156	-0.235	-0.935	-1.025	-0.472	-0.192	-0.076	0.017		
0.900	0.013	-0.149	-0.229	-0.926	-0.860	-0.387	-0.193	-0.106	-0.005		
0.898	3.014	-0.139	-0.220	-0.926	-0.984	-0.460	-0.201	-0.102	0.013		
0.898	5.999	-0.127	-0.208	-0.921	-1.011	-0.686	-0.238	-0.111	0.033		
0.901	9.018	-0.110	-0.192	-0.907	-1.000	-0.879	-0.274	-0.128	0.044		
0.877	-0.016	-0.164	-0.248	-0.966	-0.641	-0.366	-0.187	-0.091	0.016		
0.849	-0.003	-0.192	-0.282	-1.030	-0.602	-0.362	-0.164	-0.057	0.052		
0.801	-0.010	-0.225	-0.336	-1.165	-0.658	-0.345	-0.106	0.007	0.106		
0.703	0.004	-0.273	-0.422	-1.220	-0.511	-0.242	-0.049	0.055	0.164		
0.603	-0.006	-0.274	-0.409	-0.932	-0.470	-0.234	-0.049	0.056	0.163		
0.603	-2.990	-0.255	-0.383	-0.867	-0.430	-0.202	-0.023	0.073	0.165		
0.603	0.018	-0.274	-0.411	-0.935	-0.472	-0.234	-0.049	0.056	0.160		
0.602	3.028	-0.291	-0.440	-1.002	-0.521	-0.277	-0.086	0.025	0.146		
0.601	5.994	-0.298	-0.456	-1.064	-0.557	-0.308	-0.115	0.000	0.127		
0.602	8.988	-0.294	-0.461	-1.114	-0.582	-0.329	-0.137	-0.021	0.108		
0.400	0.018	-0.246	-0.362	-0.768	-0.410	-0.214	-0.045	0.052	0.152		

Table 13. Concluded

(d) Force data

$M_\infty$	$\alpha$ , deg	$C_D$
0.952	0.001	0.2739
0.923	-0.007	0.2360
0.901	0.010	0.2123
0.898	-2.990	0.2328
0.900	0.013	0.2105
0.898	3.014	0.2216
0.898	5.999	0.2446
0.901	9.018	0.2797
0.877	-0.016	0.1938
0.849	-0.003	0.1722
0.801	-0.010	0.1435
0.703	0.004	0.0923
0.603	-0.006	0.0745
0.603	-2.990	0.0730
0.603	0.018	0.0741
0.602	3.028	0.0771
0.601	5.994	0.0827
0.602	8.988	0.0919
0.400	0.018	0.0531

Table 14. Pressure and Force Data for Nozzle 9 With  $\beta_{t,top/bot} = 17.9^\circ/\beta_{t,side} = 0^\circ$ , Plume On, and  $\alpha = 0^\circ$

(a) Static pressure coefficients on nozzle top flap

$M_\infty$	Static pressure coefficients on nozzle top flap at centerline with values of $x/l$ of—												
	.226	.300	.337	.411	.484	.558	.632	.705	.779	.853	.926		
0.600	-.482	-1.061	-0.527	-0.223	-0.092	-0.008	0.057	0.108	0.154	0.191	0.219		
0.697	-.476	-1.414	-0.557	-0.211	-0.080	0.003	0.064	0.112	0.151	0.183	0.205		
0.799	-.355	-0.795	-0.350	-0.240	-0.174	-0.125	-0.080	-0.047	-0.012	0.020	0.050		
1.251	-0.016	-0.385	-0.522	-0.493	-0.408	-0.167	-0.149	-0.136	-0.123	-0.106	-0.085		
1.198	-0.032	-0.431	-0.575	-0.537	-0.352	-0.182	-0.164	-0.151	-0.136	-0.121	-0.097		
1.149	-0.060	-0.488	-0.648	-0.605	-0.322	-0.211	-0.190	-0.174	-0.161	-0.142	-0.122		
0.954	-0.183	-0.730	-0.432	-0.303	-0.256	-0.234	-0.212	-0.198	-0.181	-0.160	-0.135		
0.927	-0.219	-0.672	-0.346	-0.263	-0.232	-0.211	-0.192	-0.174	-0.155	-0.133	-0.107		
0.897	-0.255	-0.640	-0.311	-0.249	-0.225	-0.203	-0.181	-0.158	-0.131	-0.108	-0.076		
0.877	-0.279	-0.654	-0.313	-0.255	-0.222	-0.195	-0.168	-0.142	-0.113	-0.087	-0.051		
0.848	-0.309	-0.678	-0.323	-0.252	-0.211	-0.177	-0.143	-0.113	-0.082	-0.051	-0.015		
0.802	-0.363	-0.788	-0.357	-0.253	-0.186	-0.136	-0.093	-0.062	-0.031	0.003	0.033		
0.700	-0.473	-1.376	-0.563	-0.217	-0.082	0.002	0.063	0.109	0.147	0.176	0.199		
0.601	-0.481	-1.054	-0.526	-0.222	-0.092	-0.008	0.057	0.107	0.153	0.187	0.215		
0.401	-0.435	-0.868	-0.474	-0.214	-0.093	-0.012	0.052	0.098	0.145	0.182	0.211		

$M_\infty$	Static pressure coefficients on nozzle top flap at $y/Y = 0.25$ with values of $x/l$ of—												
	.153	.226	.300	.337	.411	.558	.705	.779	.853	.926			
0.600	-0.290	-0.462	-1.041	-0.522	-0.221	-0.011	0.105	0.153	0.191	0.221			
0.697	-0.286	-0.458	-1.394	-0.550	-0.213	-0.004	0.108	0.149	0.181	0.207			
0.799	-0.221	-0.344	-0.838	-0.370	-0.245	-0.123	-0.044	-0.011	0.020	0.048			
1.251	0.002	-0.012	-0.377	-0.522	-0.490	-0.176	-0.135	-0.121	-0.105	-0.086			
1.198	-0.004	-0.025	-0.424	-0.578	-0.537	-0.187	-0.152	-0.134	-0.122	-0.100			
1.149	-0.029	-0.055	-0.481	-0.643	-0.602	-0.214	-0.174	-0.161	-0.145	-0.125			
0.954	-0.105	-0.176	-0.733	-0.446	-0.309	-0.232	-0.199	-0.180	-0.160	-0.136			
0.927	-0.132	-0.209	-0.682	-0.354	-0.265	-0.211	-0.175	-0.155	-0.135	-0.109			
0.897	-0.159	-0.246	-0.658	-0.319	-0.255	-0.205	-0.163	-0.135	-0.111	-0.080			
0.877	-0.176	-0.269	-0.672	-0.321	-0.256	-0.195	-0.144	-0.116	-0.087	-0.055			
0.848	-0.192	-0.298	-0.705	-0.336	-0.255	-0.176	-0.115	-0.081	-0.051	-0.014			
0.802	-0.227	-0.350	-0.842	-0.387	-0.254	-0.134	-0.058	-0.025	0.003	0.033			
0.700	-0.284	-0.458	-1.359	-0.559	-0.213	-0.005	0.104	0.145	0.177	0.200			
0.601	-0.292	-0.461	-1.037	-0.521	-0.221	-0.011	0.103	0.150	0.186	0.216			
0.401	-0.271	-0.414	-0.856	-0.470	-0.208	-0.012	0.097	0.145	0.183	0.213			

Table 14. Continued

(a) Concluded

$M_\infty$	Static pressure coefficients on nozzle top flap at $y/Y = 0.50$ with values of $x/l$ of—										
	.153	.226	.300	.337	.411	.558	.705	.779	.853	.926	
0.600	-0.263	-0.412	-0.976	-0.494	-0.217	-0.030	0.085	0.132	0.180	0.216	
0.697	-0.262	-0.420	-1.290	-0.518	-0.218	-0.023	0.090	0.134	0.173	0.206	
0.799	-0.209	-0.325	-0.963	-0.436	-0.239	-0.105	-0.030	-0.003	0.031	0.070	
1.251	-0.003	-0.012	-0.383	-0.527	-0.442	-0.268	-0.125	-0.114	-0.099	-0.071	
1.198	-0.005	-0.023	-0.431	-0.578	-0.480	-0.237	-0.142	-0.128	-0.114	-0.087	
1.149	-0.032	-0.054	-0.489	-0.644	-0.540	-0.236	-0.166	-0.151	-0.137	-0.108	
0.954	-0.104	-0.168	-0.760	-0.487	-0.322	-0.233	-0.197	-0.180	-0.158	-0.131	
0.927	-0.129	-0.202	-0.726	-0.384	-0.274	-0.211	-0.175	-0.154	-0.132	-0.103	
0.897	-0.156	-0.239	-0.717	-0.357	-0.267	-0.201	-0.158	-0.131	-0.103	-0.069	
0.877	-0.171	-0.257	-0.735	-0.359	-0.266	-0.191	-0.137	-0.109	-0.078	-0.040	
0.848	-0.188	-0.284	-0.781	-0.377	-0.266	-0.165	-0.103	-0.073	-0.035	0.004	
0.802	-0.220	-0.334	-0.947	-0.450	-0.255	-0.119	-0.046	-0.016	0.016	0.054	
0.700	-0.261	-0.421	-1.270	-0.519	-0.218	-0.022	0.087	0.130	0.166	0.198	
0.601	-0.262	-0.416	-0.972	-0.495	-0.219	-0.030	0.082	0.131	0.176	0.210	
0.401	-0.243	-0.377	-0.803	-0.442	-0.200	-0.023	0.074	0.121	0.170	0.207	

$M_\infty$	Static pressure coefficients on nozzle top flap at $y/Y = 0.75$ with values of $x/l$ of—										
	.153	.226	.300	.337	.411	.558	.705	.779	.853	.926	
0.600	-0.204	-0.307	-0.763	-0.462	-0.300	-	-0.010	-	0.079	0.140	
0.697	-0.211	-0.323	-0.899	-0.509	-0.314	-	-0.005	-	0.070	0.128	
0.799	-0.184	-0.281	-0.923	-0.459	-0.261	-	-0.056	-	0.006	0.048	
1.251	-0.002	-0.008	-0.277	-0.357	-0.354	-	-0.270	-	-0.151	-0.070	
1.198	-0.005	-0.018	-0.315	-0.395	-0.391	-	-0.264	-	-0.147	-0.077	
1.149	-0.033	-0.052	-0.369	-0.451	-0.446	-	-0.279	-	-0.163	-0.087	
0.954	-0.095	-0.154	-0.616	-0.658	-0.307	-	-0.187	-	-0.143	-0.118	
0.927	-0.121	-0.188	-0.668	-0.567	-0.255	-	-0.164	-	-0.114	-0.087	
0.897	-0.145	-0.222	-0.728	-0.499	-0.244	-	-0.141	-	-0.084	-0.056	
0.877	-0.158	-0.236	-0.770	-0.481	-0.239	-	-0.122	-	-0.062	-0.036	
0.848	-0.171	-0.257	-0.822	-0.473	-0.239	-	-0.095	-	-0.031	-0.005	
0.802	-0.193	-0.291	-0.918	-0.471	-0.270	-	-0.067	-	-0.007	0.032	
0.700	-0.213	-0.322	-0.890	-0.506	-0.313	-	-0.010	-	0.063	0.120	
0.601	-0.205	-0.307	-0.758	-0.461	-0.300	-	-0.010	-	0.074	0.134	
0.401	-0.189	-0.277	-0.642	-0.403	-0.270	-	-0.007	-	0.076	0.134	

Table 14. Continued

(b) Static pressure coefficients on nozzle sidewall

$M_\infty$	Static pressure coefficients on corner between nozzle top flap and sidewall with values of $x/l$ of—										
	.153	.226	.300	.337	.411	.558	.705	.779	.853	.926	
0.600	-0.170	-	-0.358	-0.382	-0.275	-0.206	-0.170	-0.114	-0.059	0.040	
0.697	-0.177	-	-0.399	-0.426	-0.297	-0.211	-0.160	-0.098	-0.040	0.054	
0.799	-0.167	-	-0.433	-0.467	-0.287	-0.204	-0.164	-0.110	-0.070	-0.009	
1.251	0.000	-	-0.089	-0.190	-0.217	-0.296	-0.422	-0.464	-0.478	-0.267	
1.198	-0.004	-	-0.110	-0.220	-0.247	-0.330	-0.469	-0.510	-0.449	-0.230	
1.149	-0.037	-	-0.156	-0.268	-0.296	-0.360	-0.507	-0.551	-0.469	-0.242	
0.954	-0.093	-	-0.313	-0.468	-0.446	-0.286	-0.166	-0.131	-0.126	-0.121	
0.927	-0.118	-	-0.351	-0.513	-0.382	-0.198	-0.155	-0.142	-0.143	-0.120	
0.897	-0.141	-	-0.390	-0.549	-0.319	-0.187	-0.173	-0.142	-0.127	-0.091	
0.877	-0.151	-	-0.411	-0.557	-0.280	-0.200	-0.173	-0.134	-0.109	-0.072	
0.848	-0.161	-	-0.424	-0.524	-0.275	-0.202	-0.166	-0.119	-0.088	-0.043	
0.802	-0.177	-	-0.436	-0.472	-0.295	-0.211	-0.170	-0.120	-0.079	-0.018	
0.700	-0.177	-	-0.395	-0.421	-0.293	-0.211	-0.158	-0.097	-0.041	0.054	
0.601	-0.167	-	-0.352	-0.376	-0.272	-0.204	-0.170	-0.114	-0.062	0.038	
0.401	-0.152	-	-0.307	-0.326	-0.240	-0.186	-0.167	-0.123	-0.079	0.021	

$M_\infty$	Static pressure coefficients on nozzle sidewall at $z/Z = 0.50$ with values of $x/l$ of—										
	.153	.226	.300	.337	.411	.558	.705	.779	.853	.926	
0.600	-0.147	-0.178	-0.212	-0.211	-0.197	-0.153	-0.095	-0.060	-0.008	-	
0.697	-0.157	-0.196	-0.237	-0.235	-0.216	-0.159	-0.092	-0.050	0.004	-	
0.799	-0.156	-0.201	-0.265	-0.269	-0.232	-0.170	-0.108	-0.072	-0.026	-	
1.251	0.002	-0.002	-0.031	-0.053	-0.116	-0.205	-0.286	-0.322	-0.356	-	
1.198	-0.006	-0.011	-0.048	-0.074	-0.142	-0.236	-0.325	-0.364	-0.400	-	
1.149	-0.039	-0.049	-0.093	-0.117	-0.189	-0.258	-0.354	-0.394	-0.431	-	
0.954	-0.092	-0.129	-0.214	-0.261	-0.365	-0.347	-0.184	-0.129	-0.103	-	
0.927	-0.117	-0.160	-0.246	-0.298	-0.384	-0.225	-0.134	-0.122	-0.108	-	
0.897	-0.141	-0.185	-0.279	-0.329	-0.340	-0.177	-0.146	-0.122	-0.093	-	
0.877	-0.149	-0.199	-0.291	-0.330	-0.280	-0.186	-0.141	-0.110	-0.076	-	
0.848	-0.155	-0.205	-0.284	-0.299	-0.247	-0.180	-0.128	-0.092	-0.054	-	
0.802	-0.167	-0.213	-0.279	-0.277	-0.243	-0.179	-0.120	-0.082	-0.038	-	
0.700	-0.158	-0.195	-0.238	-0.235	-0.216	-0.158	-0.095	-0.052	0.002	-	
0.601	-0.147	-0.176	-0.211	-0.207	-0.194	-0.151	-0.098	-0.060	-0.007	-	
0.401	-0.130	-0.153	-0.177	-0.175	-0.168	-0.134	-0.095	-0.065	-0.017	-	



Table 14. Continued

(b) Concluded

$M_\infty$	Static pressure coefficients on nozzle sidewall at centerline with values of $x/l$ of—											
	.153	.226	.300	.337	.411	.484	.558	.632	.705	.779	.853	.926
0.600	-0.120	-0.140	-	-0.147	-0.139	-0.122	-0.106	-0.078	-0.050	-0.017	0.029	0.080
0.697	-0.135	-0.156	-	-0.170	-0.154	-0.133	-0.113	-0.081	-0.048	-0.010	0.037	0.090
0.799	-0.140	-0.173	-	-0.203	-0.185	-0.157	-0.130	-0.103	-0.070	-0.035	0.006	0.052
1.251	0.007	0.003	-	-0.022	-0.056	-0.100	-0.146	-0.185	-0.222	-0.255	-0.292	-0.328
1.198	-0.007	-0.012	-	-0.042	-0.080	-0.129	-0.179	-0.223	-0.258	-0.295	-0.337	-0.348
1.149	-0.044	-0.049	-	-0.083	-0.121	-0.157	-0.194	-0.240	-0.280	-0.321	-0.363	-0.364
0.954	-0.088	-0.121	-	-0.209	-0.286	-0.357	-0.374	-0.292	-0.179	-0.117	-0.082	-0.059
0.927	-0.112	-0.149	-	-0.243	-0.317	-0.346	-0.230	-0.130	-0.107	-0.097	-0.079	-0.053
0.897	-0.134	-0.175	-	-0.269	-0.303	-0.218	-0.156	-0.135	-0.115	-0.091	-0.063	-0.028
0.877	-0.142	-0.184	-	-0.263	-0.252	-0.189	-0.158	-0.135	-0.109	-0.081	-0.046	-0.011
0.848	-0.147	-0.184	-	-0.234	-0.211	-0.178	-0.151	-0.122	-0.092	-0.061	-0.026	0.014
0.802	-0.153	-0.186	-	-0.216	-0.199	-0.172	-0.142	-0.113	-0.081	-0.047	-0.006	0.041
0.700	-0.137	-0.156	-	-0.171	-0.157	-0.135	-0.112	-0.080	-0.048	-0.012	0.036	0.088
0.601	-0.122	-0.139	-	-0.148	-0.136	-0.119	-0.102	-0.079	-0.048	-0.016	0.029	0.081
0.401	-0.101	-0.116	-	-0.124	-0.111	-0.100	-0.086	-0.065	-0.042	-0.014	0.023	0.070

$M_\infty$	Static pressure coefficients on nozzle sidewall at $z/Z = -0.50$ with values of $x/l$ of—											
	.153	.226	.300	.337	.411	.484	.558	.632	.705	.779	.853	.926
0.600	-	-0.174	-0.224	-0.203	-	-	-0.144	-0.087	-	-	-	-
0.697	-	-0.192	-0.251	-0.230	-	-	-0.153	-0.081	-	-	-	-
0.799	-	-0.203	-0.291	-0.273	-	-	-0.171	-0.100	-	-	-	-
1.251	-	0.004	-0.057	-0.063	-	-	-0.200	-0.274	-	-	-	-
1.198	-	-0.017	-0.076	-0.086	-	-	-0.234	-0.316	-	-	-	-
1.149	-	-0.053	-0.117	-0.128	-	-	-0.259	-0.344	-	-	-	-
0.954	-	-0.130	-0.239	-0.265	-	-	-0.398	-0.478	-	-	-	-
0.927	-	-0.161	-0.275	-0.303	-	-	-0.235	-0.124	-	-	-	-
0.897	-	-0.189	-0.306	-0.333	-	-	-0.179	-0.138	-	-	-	-
0.877	-	-0.196	-0.319	-0.334	-	-	-0.186	-0.130	-	-	-	-
0.848	-	-0.206	-0.311	-0.310	-	-	-0.184	-0.119	-	-	-	-
0.802	-	-0.217	-0.303	-0.285	-	-	-0.181	-0.113	-	-	-	-
0.700	-	-0.195	-0.252	-0.231	-	-	-0.153	-0.083	-	-	-	-
0.601	-	-0.175	-0.222	-0.201	-	-	-0.144	-0.083	-	-	-	-
0.401	-	-0.150	-0.187	-0.167	-	-	-0.126	-0.081	-	-	-	-

Table 14. Continued

(c) Static pressure coefficients on nozzle bottom flap

$M_\infty$	Static pressure coefficients on nozzle bottom flap at $y/Y = 0.75$ with values of $x/l$ of—									
	.153	.226	.300	.337	.411	.558	.705	.779	.853	.926
0.600	-0.199	-0.293	-0.689	-	-0.308	-0.117	-0.005	0.033	0.082	-
0.697	-0.206	-0.307	-0.794	-	-0.324	-0.113	-0.006	0.030	0.074	-
0.799	-0.185	-0.277	-0.762	-	-0.304	-0.122	-0.039	-0.013	0.023	-
1.251	0.009	-0.006	-0.193	-	-0.374	-0.351	-0.325	-0.227	-0.155	-
1.198	-0.012	-0.024	-0.231	-	-0.418	-0.390	-0.310	-0.219	-0.149	-
1.149	-0.042	-0.063	-0.282	-	-0.477	-0.430	-0.309	-0.234	-0.158	-
0.954	-0.098	-0.156	-0.492	-	-0.425	-0.241	-0.179	-0.150	-0.115	-
0.927	-0.124	-0.186	-0.542	-	-0.302	-0.202	-0.142	-0.115	-0.087	-
0.897	-0.148	-0.218	-0.595	-	-0.294	-0.188	-0.119	-0.088	-0.057	-
0.877	-0.160	-0.234	-0.629	-	-0.284	-0.175	-0.102	-0.071	-0.041	-
0.848	-0.173	-0.251	-0.677	-	-0.275	-0.153	-0.075	-0.044	-0.016	-
0.802	-0.196	-0.286	-0.757	-	-0.314	-0.134	-0.050	-0.025	0.008	-
0.700	-0.205	-0.309	-0.787	-	-0.323	-0.112	-0.007	0.028	0.070	-
0.601	-0.199	-0.293	-0.682	-	-0.307	-0.116	-0.005	0.034	0.081	-
0.401	-0.180	-0.265	-0.588	-	-0.279	-0.110	-0.001	0.041	0.084	-

$M_\infty$	Static pressure coefficients on nozzle bottom flap at $y/Y = 0.50$ with values of $x/l$ of—									
	.153	.226	.300	.337	.411	.558	.705	.779	.853	.926
0.600	-0.254	-0.407	-0.931	-0.474	-0.217	-0.033	0.085	0.138	0.182	0.215
0.697	-0.258	-0.418	-1.163	-0.498	-0.216	-0.028	0.090	0.139	0.179	0.212
0.799	-0.213	-0.333	-1.035	-0.542	-0.282	-0.083	0.016	0.054	0.084	0.119
1.251	0.005	-0.010	-0.385	-0.515	-0.445	-0.374	-0.141	-0.106	-0.079	-0.053
1.198	-0.013	-0.031	-0.434	-0.569	-0.486	-0.366	-0.149	-0.119	-0.090	-0.065
1.149	-0.045	-0.068	-0.492	-0.631	-0.550	-0.338	-0.170	-0.138	-0.110	-0.081
0.954	-0.108	-0.180	-0.761	-0.612	-0.383	-0.257	-0.183	-0.150	-0.117	-0.084
0.927	-0.134	-0.209	-0.750	-0.446	-0.316	-0.227	-0.158	-0.129	-0.094	-0.065
0.897	-0.160	-0.246	-0.771	-0.440	-0.322	-0.215	-0.130	-0.094	-0.056	-0.022
0.877	-0.173	-0.264	-0.795	-0.442	-0.318	-0.198	-0.111	-0.070	-0.032	0.006
0.848	-0.190	-0.293	-0.839	-0.454	-0.312	-0.165	-0.067	-0.029	0.008	0.045
0.802	-0.219	-0.342	-1.010	-0.548	-0.297	-0.103	0.000	0.036	0.069	0.103
0.700	-0.258	-0.416	-1.161	-0.499	-0.219	-0.030	0.089	0.136	0.175	0.206
0.601	-0.257	-0.406	-0.927	-0.472	-0.215	-0.034	0.083	0.134	0.178	0.211
0.401	-0.237	-0.371	-0.781	-0.425	-0.197	-0.033	0.078	0.130	0.175	0.209

Table 14. Concluded

(c) Concluded

$M_\infty$	Static pressure coefficients on nozzle bottom flap at centerline with values of $\alpha/l$ of—									
	.153	.226	.300	.337	.411	.558	.705	.926		
0.600	-0.289	-0.445	-1.003	-0.516	-0.231	-0.022	0.098	-	-	-
0.697	-0.288	-0.453	-1.305	-0.544	-0.230	-0.013	0.102	-	-	-
0.799	-0.228	-0.351	-0.999	-0.505	-0.285	-0.102	0.003	-	-	-
1.251	0.004	-0.017	-0.385	-0.509	-0.486	-0.206	-0.158	-	-	-
1.198	-0.015	-0.038	-0.434	-0.566	-0.534	-0.220	-0.172	-	-	-
1.149	-0.045	-0.071	-0.494	-0.631	-0.601	-0.253	-0.202	-	-	-
0.954	-0.115	-0.195	-0.755	-0.520	-0.358	-0.263	-0.201	-	-	-
0.927	-0.139	-0.223	-0.716	-0.402	-0.302	-0.230	-0.172	-	-	-
0.897	-0.166	-0.253	-0.714	-0.383	-0.297	-0.223	-0.149	-	-	-
0.877	-0.180	-0.276	-0.741	-0.396	-0.301	-0.212	-0.127	-	-	-
0.848	-0.200	-0.304	-0.806	-0.417	-0.301	-0.178	-0.083	-	-	-
0.802	-0.236	-0.359	-0.968	-0.499	-0.296	-0.121	-0.014	-	-	-
0.700	-0.290	-0.454	-1.290	-0.548	-0.231	-0.016	0.102	-	-	-
0.601	-0.289	-0.444	-0.995	-0.515	-0.231	-0.024	0.098	-	-	-
0.401	-0.267	-0.400	-0.830	-0.457	-0.217	-0.026	0.091	-	-	-

(d) Force data

$M_\infty$	$C_D$	$C_{D,p}$	$C_{D,f}$
0.600	0.0460	0.0422	0.0136
0.697	0.0543	0.0538	0.0133
0.799	0.1061	0.1086	0.0130
1.251	0.2412	0.2036	0.0121
1.198	0.2564	0.2154	0.0122
1.149	0.2708	0.2383	0.0123
0.954	0.2065	0.2091	0.0127
0.927	0.1771	0.1808	0.0128
0.897	0.1584	0.1651	0.0129
0.877	0.1456	0.1551	0.0129
0.848	0.1301	0.1386	0.0130
0.802	0.1026	0.1192	0.0131
0.700	0.0554	0.0555	0.0134
0.601	0.0504	0.0432	0.0137
0.401	0.0414	0.0343	0.0146

Table 15. Pressure and Force Data for Nozzle 9 With  $\beta_{r,top/bot} = 17.9^\circ$ ,  $\beta_{r,side} = 0^\circ$  and Plume Off

(a) Static pressure coefficients on nozzle top flap

$M_\infty$	$\alpha$ , deg	Static pressure coefficients on nozzle top flap at centerline with values of $\sqrt{v}$ of—															
		.153	.226	.300	.337	.411	.484	.558	.632	.705	.779	.853	.926				
1.251	0.002	-	-0.018	-0.387	-0.520	-0.494	-0.447	-0.196	-0.154	-0.140	-0.128	-0.119	-0.100				
0.600	0.005	-	-0.497	-1.087	-0.549	-0.253	-0.122	-0.042	0.020	0.069	0.113	0.153	0.189				
0.601	-2.990	-	-0.526	-1.212	-0.610	-0.296	-0.161	-0.076	-0.011	0.044	0.091	0.138	0.184				
0.603	0.035	-	-0.499	-1.094	-0.554	-0.252	-0.124	-0.041	0.019	0.068	0.113	0.154	0.187				
0.600	3.003	-	-0.477	-1.025	-0.523	-0.234	-0.111	-0.034	0.023	0.069	0.112	0.153	0.190				
0.601	6.007	-	-0.465	-1.014	-0.520	-0.234	-0.116	-0.040	0.014	0.060	0.103	0.145	0.190				
0.601	9.020	-	-0.471	-1.090	-0.558	-0.262	-0.143	-0.068	-0.015	0.030	0.072	0.116	0.169				
0.402	0.020	-	-0.450	-0.902	-0.501	-0.240	-0.122	-0.044	0.014	0.057	0.103	0.142	0.180				
0.874	-0.018	-	-0.268	-0.603	-0.274	-0.223	-0.194	-0.168	-0.144	-0.124	-0.101	-0.075	-0.048				
0.851	0.000	-	-0.293	-0.608	-0.275	-0.221	-0.187	-0.158	-0.129	-0.103	-0.078	-0.049	-0.018				
0.800	-0.020	-	-0.351	-0.726	-0.317	-0.222	-0.165	-0.119	-0.081	-0.048	-0.017	0.009	0.039				
0.702	-0.035	-	-0.480	-1.405	-0.636	-0.249	-0.114	-0.030	0.031	0.080	0.122	0.156	0.184				
1.200	-2.991	-	-0.030	-0.426	-0.575	-0.540	-0.518	-0.405	-0.209	-0.189	-0.171	-0.160	-0.143				
1.200	2.974	-	-0.036	-0.433	-0.572	-0.557	-0.513	-0.504	-0.503	-0.392	-0.214	-0.133	-0.086				
0.952	0.012	-	-0.179	-0.655	-0.345	-0.246	-0.206	-0.185	-0.169	-0.160	-0.151	-0.141	-0.121				
0.927	-0.086	-	-0.209	-0.608	-0.291	-0.222	-0.194	-0.175	-0.160	-0.148	-0.137	-0.125	-0.103				
0.901	-0.131	-	-0.242	-0.578	-0.268	-0.219	-0.195	-0.175	-0.158	-0.139	-0.124	-0.106	-0.078				
0.903	-3.040	-	-0.221	-0.616	-0.289	-0.222	-0.195	-0.178	-0.161	-0.146	-0.133	-0.115	-0.090				
0.902	0.085	-	-0.238	-0.580	-0.266	-0.211	-0.189	-0.171	-0.155	-0.138	-0.122	-0.102	-0.080				
0.898	2.836	-	-0.254	-0.627	-0.316	-0.254	-0.228	-0.206	-0.181	-0.154	-0.128	-0.097	-0.066				
0.899	6.572	-	-0.259	-0.721	-0.405	-0.313	-0.277	-0.245	-0.212	-0.177	-0.143	-0.104	-0.064				
0.897	9.226	-	-0.256	-0.771	-0.449	-0.343	-0.297	-0.257	-0.218	-0.178	-0.141	-0.099	-0.056				

Table 15. Continued

(a) Continued

$M_\infty$	$\alpha$ , deg	Static pressure coefficients on nozzle top flap at $y/Y = 0.25$ with values of $x/l$ of—										
		.153	.226	.300	.337	.411	.558	.705	.779	.853	.926	
1.251	0.002	-0.002	-0.012	-0.377	-0.520	-0.491	-0.223	-0.139	-0.127	-0.115	-0.100	
0.600	0.005	-0.303	-0.477	-1.074	-0.550	-0.247	-0.047	0.063	0.108	0.148	0.184	
0.601	-2.990	-0.317	-0.505	-1.193	-0.612	-0.287	-0.078	0.037	0.085	0.134	0.179	
0.603	0.035	-0.304	-0.480	-1.078	-0.554	-0.246	-0.046	0.063	0.108	0.149	0.186	
0.600	3.003	-0.291	-0.459	-1.022	-0.524	-0.228	-0.039	0.063	0.106	0.146	0.187	
0.601	6.007	-0.281	-0.445	-1.016	-0.522	-0.233	-0.047	0.051	0.096	0.137	0.183	
0.601	9.020	-0.281	-0.450	-1.079	-0.562	-0.263	-0.076	0.016	0.061	0.104	0.157	
0.402	0.020	-0.285	-0.437	-0.890	-0.502	-0.237	-0.049	0.052	0.097	0.138	0.177	
0.874	-0.018	-0.166	-0.261	-0.625	-0.290	-0.228	-0.171	-0.122	-0.099	-0.075	-0.046	
0.851	0.000	-0.182	-0.285	-0.649	-0.297	-0.227	-0.159	-0.101	-0.076	-0.049	-0.018	
0.800	-0.020	-0.221	-0.342	-0.788	-0.346	-0.225	-0.117	-0.046	-0.014	0.013	0.040	
0.702	-0.035	-0.293	-0.465	-1.394	-0.628	-0.248	-0.036	0.072	0.118	0.154	0.183	
1.200	-2.991	-0.014	-0.026	-0.419	-0.573	-0.539	-0.434	-0.190	-0.171	-0.157	-0.138	
1.200	2.974	-0.008	-0.030	-0.425	-0.574	-0.558	-0.466	-0.391	-0.278	-0.154	-0.095	
0.952	0.012	-0.099	-0.170	-0.660	-0.358	-0.250	-0.185	-0.161	-0.151	-0.139	-0.122	
0.927	-0.086	-0.123	-0.200	-0.610	-0.296	-0.221	-0.174	-0.149	-0.138	-0.121	-0.103	
0.901	-0.131	-0.148	-0.234	-0.598	-0.283	-0.221	-0.173	-0.142	-0.125	-0.103	-0.080	
0.903	-3.040	-0.134	-0.212	-0.624	-0.293	-0.222	-0.178	-0.145	-0.132	-0.116	-0.093	
0.902	0.085	-0.147	-0.230	-0.610	-0.288	-0.221	-0.176	-0.138	-0.122	-0.102	-0.079	
0.898	2.836	-0.158	-0.244	-0.663	-0.341	-0.261	-0.208	-0.156	-0.128	-0.095	-0.064	
0.899	6.572	-0.166	-0.250	-0.741	-0.427	-0.320	-0.247	-0.179	-0.144	-0.104	-0.063	
0.897	9.226	-0.170	-0.251	-0.777	-0.459	-0.347	-0.260	-0.182	-0.143	-0.097	-0.054	

Table 15. Continued

(a) Continued

$M_\infty$	$\alpha$ , deg	Static pressure coefficients on nozzle top flap at $y/Y = 0.50$ with values of $y/l$ of—												
		.153	.226	.300	.337	.411	.558	.705	.779	.853	.926			
1.251	0.002	-0.002	-0.010	-0.383	-0.524	-0.445	-0.319	-0.141	-0.121	-0.111	-0.099			
0.600	0.005	-0.274	-0.430	-1.001	-0.521	-0.246	-0.063	0.037	0.082	0.128	0.170			
0.601	-2.990	-0.283	-0.453	-1.120	-0.577	-0.280	-0.088	0.013	0.062	0.110	0.157			
0.603	0.035	-0.272	-0.434	-1.008	-0.522	-0.246	-0.063	0.039	0.082	0.130	0.171			
0.600	3.003	-0.262	-0.408	-0.952	-0.483	-0.228	-0.064	0.032	0.074	0.119	0.159			
0.601	6.007	-0.258	-0.392	-1.004	-0.490	-0.229	-0.076	0.012	0.054	0.098	0.142			
0.601	9.020	-0.275	-0.413	-1.068	-0.521	-0.248	-0.096	-0.019	0.018	0.060	0.108			
0.402	0.020	-0.257	-0.395	-0.833	-0.467	-0.226	-0.059	0.032	0.072	0.117	0.159			
0.874	-0.018	-0.161	-0.248	-0.692	-0.327	-0.236	-0.167	-0.118	-0.097	-0.072	-0.042			
0.851	0.000	-0.175	-0.270	-0.731	-0.341	-0.236	-0.152	-0.092	-0.069	-0.041	-0.014			
0.800	-0.020	-0.207	-0.321	-0.904	-0.413	-0.222	-0.099	-0.034	-0.011	0.015	0.038			
0.702	-0.035	-0.268	-0.425	-1.343	-0.559	-0.247	-0.054	0.051	0.094	0.136	0.170			
1.200	-2.991	-0.016	-0.024	-0.423	-0.572	-0.496	-0.405	-0.212	-0.167	-0.148	-0.134			
1.200	2.974	-0.013	-0.028	-0.434	-0.595	-0.508	-0.392	-0.349	-0.306	-0.259	-0.199			
0.952	0.012	-0.096	-0.161	-0.691	-0.380	-0.256	-0.186	-0.159	-0.151	-0.137	-0.122			
0.927	-0.086	-0.120	-0.191	-0.646	-0.317	-0.230	-0.176	-0.149	-0.137	-0.121	-0.104			
0.901	-0.131	-0.145	-0.225	-0.651	-0.312	-0.230	-0.174	-0.140	-0.121	-0.102	-0.078			
0.903	-3.040	-0.130	-0.206	-0.681	-0.323	-0.234	-0.178	-0.142	-0.129	-0.113	-0.096			
0.902	0.085	-0.143	-0.224	-0.660	-0.315	-0.232	-0.176	-0.139	-0.123	-0.101	-0.078			
0.898	2.836	-0.156	-0.239	-0.714	-0.375	-0.280	-0.207	-0.149	-0.119	-0.086	-0.053			
0.899	6.572	-0.169	-0.247	-0.800	-0.455	-0.344	-0.245	-0.174	-0.134	-0.092	-0.050			
0.897	9.226	-0.188	-0.265	-0.815	-0.474	-0.359	-0.257	-0.177	-0.135	-0.091	-0.047			

Table 15. Continued

(a) Concluded

$M_\infty$	$\alpha$ , deg	Static pressure coefficients on nozzle top flap at $y/Y = 0.75$ with values of $x/l$ of—													
		.153	.226	.300	.337	.411	.558	.705	.779	.853	.926				
1.251	0.002	0.000	-0.009	-0.277	-0.361	-0.358	-	-0.306	-	-0.188	-0.157				
0.600	0.005	-0.215	-0.319	-0.780	-0.481	-0.323	-	-0.050	-	0.027	0.077				
0.601	-2.990	-0.220	-0.328	-0.858	-0.499	-0.326	-	-0.048	-	0.043	0.089				
0.603	0.035	-0.217	-0.318	-0.782	-0.484	-0.326	-	-0.051	-	0.028	0.076				
0.600	3.003	-0.222	-0.317	-0.688	-0.452	-0.311	-	-0.102	-	-0.045	0.009				
0.601	6.007	-0.226	-0.316	-0.623	-0.426	-0.294	-	-0.158	-	-0.117	-0.075				
0.601	9.020	-0.238	-0.323	-0.650	-0.421	-0.294	-	-0.144	-	-0.118	-0.068				
0.402	0.020	-0.201	-0.292	-0.672	-0.429	-0.296	-	-0.048	-	0.026	0.070				
0.874	-0.018	-0.152	-0.225	-0.758	-0.437	-0.212	-	-0.109	-	-0.067	-0.047				
0.851	0.000	-0.163	-0.242	-0.802	-0.436	-0.211	-	-0.089	-	-0.045	-0.025				
0.800	-0.020	-0.186	-0.279	-0.902	-0.443	-0.241	-	-0.056	-	-0.016	0.005				
0.702	-0.035	-0.222	-0.332	-0.935	-0.535	-0.339	-	-0.046	-	0.026	0.074				
1.200	-2.991	-0.021	-0.021	-0.304	-0.412	-0.398	-	-0.368	-	-0.245	-0.192				
1.200	2.974	-0.023	-0.050	-0.342	-0.349	-0.369	-	-0.354	-	-0.329	-0.318				
0.952	0.012	-0.089	-0.148	-0.612	-0.561	-0.238	-	-0.153	-	-0.133	-0.117				
0.927	-0.086	-0.112	-0.176	-0.658	-0.458	-0.215	-	-0.137	-	-0.112	-0.095				
0.901	-0.131	-0.135	-0.207	-0.709	-0.426	-0.212	-	-0.124	-	-0.091	-0.069				
0.903	-3.040	-0.129	-0.189	-0.695	-0.442	-0.219	-	-0.128	-	-0.096	-0.084				
0.902	0.085	-0.135	-0.203	-0.705	-0.435	-0.214	-	-0.127	-	-0.089	-0.070				
0.898	2.836	-0.153	-0.235	-0.726	-0.448	-0.252	-	-0.134	-	-0.089	-0.066				
0.899	6.572	-0.171	-0.253	-0.729	-0.483	-0.313	-	-0.177	-	-0.114	-0.079				
0.897	9.226	-0.185	-0.265	-0.748	-0.468	-0.321	-	-0.176	-	-0.109	-0.072				

Table 15. Continued

## (b) Static pressure coefficients on nozzle sidewall

$M_\infty$	$\alpha$ , deg	Static pressure coefficients on corner between nozzle top flap and sidewall with values of $x/l$ of—													
		.153	.226	.300	.337	.411	.558	.705	.779	.853	.926				
1.251	0.002	0.003	—	-0.089	-0.191	-0.219	-0.297	-0.424	-0.471	.853	.926				
0.600	0.005	-0.178	—	-0.370	-0.393	-0.291	-0.231	-0.217	-0.177	-0.502	-0.387				
0.601	-2.990	-0.183	—	-0.376	-0.386	-0.260	-0.188	-0.165	-0.132	-0.152	-0.065				
0.603	0.035	-0.179	—	-0.370	-0.396	-0.293	-0.235	-0.218	-0.180	-0.123	-0.076				
0.600	3.003	-0.192	—	-0.385	-0.424	-0.337	-0.296	-0.284	-0.230	-0.153	-0.066				
0.601	6.007	-0.209	—	-0.411	-0.454	-0.385	-0.361	-0.349	-0.270	-0.166	-0.046				
0.601	9.020	-0.222	—	-0.413	-0.449	-0.395	-0.383	-0.361	-0.277	-0.168	-0.045				
0.402	0.020	-0.163	—	-0.325	-0.349	-0.264	-0.216	-0.216	-0.188	-0.157	-0.042				
0.874	-0.018	-0.143	—	-0.402	-0.523	-0.254	-0.165	-0.129	-0.099	-0.173	-0.092				
0.851	0.000	-0.152	—	-0.414	-0.502	-0.254	-0.175	-0.129	-0.091	-0.083	-0.059				
0.800	-0.020	-0.168	—	-0.427	-0.454	-0.275	-0.187	-0.137	-0.091	-0.068	-0.039				
0.702	-0.035	-0.187	—	-0.416	-0.442	-0.314	-0.238	-0.205	-0.158	-0.062	-0.017				
1.200	-2.991	-0.021	—	-0.112	-0.220	-0.234	-0.278	-0.383	-0.422	-0.121	-0.034				
1.200	2.974	-0.024	—	-0.144	-0.251	-0.286	-0.398	-0.548	-0.479	-0.485	-0.506				
0.952	0.012	-0.085	—	-0.306	-0.458	-0.366	-0.207	-0.143	-0.127	-0.351	-0.313				
0.927	-0.086	-0.108	—	-0.342	-0.494	-0.306	-0.168	-0.114	-0.103	-0.122	-0.117				
0.901	-0.131	-0.129	—	-0.378	-0.523	-0.276	-0.153	-0.121	-0.102	-0.101	-0.093				
0.903	-3.040	-0.130	—	-0.376	-0.534	-0.235	-0.142	-0.105	-0.088	-0.093	-0.073				
0.902	0.085	-0.128	—	-0.374	-0.523	-0.284	-0.155	-0.122	-0.104	-0.085	-0.081				
0.898	2.836	-0.145	—	-0.398	-0.547	-0.373	-0.205	-0.173	-0.143	-0.094	-0.079				
0.899	6.572	-0.168	—	-0.425	-0.581	-0.476	-0.256	-0.240	-0.207	-0.122	-0.090				
0.897	9.226	-0.184	—	-0.443	-0.570	-0.453	-0.271	-0.237	-0.203	-0.166	-0.101				
										-0.150	-0.077				



Table 15. Continued

(b) Continued

$M_\infty$	$\alpha$ , deg	Static pressure coefficients on nozzle sidewall at $z/Z = 0.50$ with values of $x/l$ of—													
		.153	.226	.300	.337	.411	.558	.705	.779	.853	.926				
1.251	0.002	0.002	-0.004	-0.035	-0.054	-0.119	-0.207	-0.288	-0.323	-0.357	-				
0.600	0.005	-0.159	-0.188	-0.224	-0.223	-0.211	-0.174	-0.132	-0.103	-0.057	-				
0.601	-2.990	-0.167	-0.193	-0.224	-0.216	-0.191	-0.142	-0.100	-0.069	-0.029	-				
0.603	0.035	-0.159	-0.191	-0.223	-0.225	-0.213	-0.176	-0.132	-0.103	-0.061	-				
0.600	3.003	-0.173	-0.208	-0.246	-0.255	-0.258	-0.232	-0.190	-0.161	-0.110	-				
0.601	6.007	-0.201	-0.236	-0.287	-0.300	-0.320	-0.308	-0.273	-0.245	-0.188	-				
0.601	9.020	-0.231	-0.275	-0.333	-0.350	-0.386	-0.390	-0.365	-0.344	-0.290	-				
0.402	0.020	-0.140	-0.166	-0.196	-0.194	-0.187	-0.159	-0.129	-0.105	-0.069	-				
0.874	-0.018	-0.138	-0.191	-0.283	-0.317	-0.263	-0.168	-0.121	-0.092	-0.068	-				
0.851	0.000	-0.145	-0.198	-0.282	-0.300	-0.241	-0.170	-0.117	-0.084	-0.056	-				
0.800	-0.020	-0.161	-0.206	-0.272	-0.271	-0.233	-0.170	-0.110	-0.077	-0.040	-				
0.702	-0.035	-0.171	-0.207	-0.255	-0.252	-0.233	-0.184	-0.127	-0.093	-0.046	-				
1.200	-2.991	-0.022	-0.024	-0.057	-0.076	-0.135	-0.206	-0.282	-0.314	-0.348	-				
1.200	2.974	-0.029	-0.040	-0.074	-0.097	-0.178	-0.288	-0.374	-0.414	-0.444	-				
0.952	0.012	-0.085	-0.123	-0.210	-0.254	-0.342	-0.280	-0.187	-0.148	-0.130	-				
0.927	-0.086	-0.108	-0.150	-0.243	-0.287	-0.338	-0.229	-0.119	-0.102	-0.094	-				
0.901	-0.131	-0.128	-0.173	-0.271	-0.315	-0.320	-0.172	-0.123	-0.100	-0.078	-				
0.903	-3.040	-0.134	-0.180	-0.275	-0.324	-0.279	-0.181	-0.118	-0.102	-0.099	-				
0.902	0.085	-0.126	-0.173	-0.264	-0.315	-0.323	-0.173	-0.122	-0.099	-0.080	-				
0.898	2.836	-0.143	-0.191	-0.281	-0.335	-0.403	-0.207	-0.171	-0.143	-0.115	-				
0.899	6.572	-0.172	-0.223	-0.312	-0.368	-0.495	-0.277	-0.257	-0.237	-0.205	-				
0.897	9.226	-0.197	-0.255	-0.351	-0.409	-0.539	-0.322	-0.311	-0.293	-0.258	-				

Table 15. Continued

(b) Continued

$M_\infty$	$\alpha$ , deg	Static pressure coefficients on nozzle sidewall at centerline with values of $v//$ of—														
		.153	.226	.300	.337	.411	.484	.558	.632	.705	.779	.853	.926			
1.251	0.002	0.003	0.002	—	-0.024	-0.055	-0.101	-0.146	-0.189	-0.221	-0.257	-0.294	-0.326			
0.600	0.005	-0.132	-0.148	—	-0.162	-0.154	-0.140	-0.124	-0.101	-0.078	-0.050	-0.015	0.036			
0.601	-2.990	-0.142	-0.155	—	-0.168	-0.160	-0.147	-0.131	-0.107	-0.083	-0.054	-0.017	0.037			
0.603	0.035	-0.135	-0.149	—	-0.162	-0.153	-0.140	-0.124	-0.101	-0.077	-0.051	-0.013	0.035			
0.600	3.003	-0.143	-0.157	—	-0.168	-0.161	-0.149	-0.133	-0.110	-0.087	-0.060	-0.021	0.029			
0.601	6.007	-0.163	-0.177	—	-0.189	-0.178	-0.170	-0.154	-0.137	-0.112	-0.085	-0.044	0.011			
0.601	9.020	-0.196	-0.209	—	-0.219	-0.211	-0.204	-0.190	-0.176	-0.153	-0.126	-0.081	-0.015			
0.402	0.020	-0.112	-0.124	—	-0.136	-0.129	-0.119	-0.109	-0.092	-0.071	-0.050	-0.019	0.027			
0.874	-0.018	-0.135	-0.176	—	-0.261	-0.269	-0.206	-0.168	-0.143	-0.122	-0.099	-0.068	-0.039			
0.851	0.000	-0.139	-0.180	—	-0.244	-0.232	-0.188	-0.163	-0.137	-0.112	-0.087	-0.054	-0.022			
0.800	-0.020	-0.150	-0.183	—	-0.219	-0.204	-0.176	-0.154	-0.126	-0.099	-0.071	-0.038	0.003			
0.702	-0.035	-0.145	-0.168	—	-0.187	-0.174	-0.154	-0.135	-0.107	-0.079	-0.047	-0.008	0.045			
1.200	-2.991	-0.016	-0.018	—	-0.048	-0.085	-0.134	-0.180	-0.222	-0.256	-0.291	-0.330	-0.356			
1.200	2.974	-0.030	-0.031	—	-0.061	-0.092	-0.139	-0.185	-0.229	-0.263	-0.298	-0.335	-0.363			
0.952	0.012	-0.083	-0.116	—	-0.204	-0.277	-0.340	-0.355	-0.321	-0.263	-0.193	-0.137	-0.107			
0.927	-0.086	-0.108	-0.143	—	-0.236	-0.306	-0.341	-0.309	-0.214	-0.138	-0.109	-0.101	-0.081			
0.901	-0.131	-0.128	-0.166	—	-0.261	-0.313	-0.281	-0.194	-0.143	-0.127	-0.106	-0.086	-0.058			
0.903	-3.040	-0.133	-0.172	—	-0.267	-0.315	-0.289	-0.248	-0.185	-0.152	-0.139	-0.118	-0.086			
0.902	0.085	-0.124	-0.162	—	-0.257	-0.316	-0.277	-0.188	-0.140	-0.121	-0.105	-0.084	-0.058			
0.898	2.836	-0.132	-0.172	—	-0.267	-0.332	-0.277	-0.168	-0.137	-0.120	-0.102	-0.079	-0.049			
0.899	6.572	-0.157	-0.196	—	-0.293	-0.355	-0.330	-0.209	-0.160	-0.146	-0.128	-0.099	-0.060			
0.897	9.226	-0.190	-0.230	—	-0.330	-0.381	-0.345	-0.237	-0.189	-0.174	-0.153	-0.118	-0.067			

Table 15. Continued

(b) Concluded

$M_\infty$	$\alpha$ , deg	Static pressure coefficients on nozzle sidewall at $z/Z = -0.50$ with values of $x/l$ of—									
		.153	.226	.300	.337	.411	.558	.705	.926		
1.251	0.002	—	0.000	-0.055	-0.063	—	-0.202	-0.276	—	—	
0.600	0.005	—	-0.188	-0.238	-0.216	—	-0.168	-0.123	—	—	
0.601	-2.990	—	-0.205	-0.260	-0.246	—	-0.216	-0.168	—	—	
0.603	0.035	—	-0.186	-0.239	-0.216	—	-0.169	-0.121	—	—	
0.600	3.003	—	-0.193	-0.238	-0.206	—	-0.139	-0.092	—	—	
0.601	6.007	—	-0.216	-0.250	-0.211	—	-0.129	-0.085	—	—	
0.601	9.020	—	-0.261	-0.283	-0.234	—	-0.143	-0.105	—	—	
0.402	0.020	—	-0.162	-0.203	-0.183	—	-0.154	-0.115	—	—	
0.874	-0.018	—	-0.194	-0.317	-0.343	—	-0.227	-0.189	—	—	
0.851	0.000	—	-0.202	-0.321	-0.336	—	-0.224	-0.179	—	—	
0.800	-0.020	—	-0.217	-0.318	-0.309	—	-0.220	-0.169	—	—	
0.702	-0.035	—	-0.207	-0.271	-0.249	—	-0.182	-0.125	—	—	
1.200	-2.991	—	-0.028	-0.091	-0.106	—	-0.276	-0.359	—	—	
1.200	2.974	—	-0.039	-0.093	-0.098	—	-0.211	-0.286	—	—	
0.952	0.012	—	-0.127	-0.237	-0.263	—	-0.471	-0.375	—	—	
0.927	-0.086	—	-0.156	-0.270	-0.300	—	-0.413	-0.210	—	—	
0.901	-0.131	—	-0.181	-0.298	-0.330	—	-0.246	-0.198	—	—	
0.903	-3.040	—	-0.195	-0.313	-0.349	—	-0.389	-0.291	—	—	
0.902	0.085	—	-0.177	-0.293	-0.324	—	-0.246	-0.188	—	—	
0.898	2.836	—	-0.181	-0.304	-0.330	—	-0.178	-0.137	—	—	
0.899	6.572	—	-0.210	-0.342	-0.361	—	-0.190	-0.127	—	—	
0.897	9.226	—	-0.257	-0.397	-0.413	—	-0.206	-0.144	—	—	

Table 15. Continued  
(c) Static pressure coefficients on nozzle bottom flap

$M_\infty$	$\alpha$ , deg	Static pressure coefficients on nozzle bottom flap at $y/Y = 0.75$ with values of $x/l$ of—										
		.153	.226	.300	.337	.411	.558	.705	.779	.853	.926	
1.251	0.002	0.005	-0.007	-0.195	—	-0.374	-0.351	-0.372	-0.316	-0.310	—	—
0.600	0.005	-0.211	-0.306	-0.713	—	-0.338	-0.157	-0.050	-0.014	0.027	—	—
0.601	-2.990	-0.215	-0.305	-0.636	—	-0.321	-0.151	-0.097	-0.075	-0.026	—	—
0.603	0.035	-0.211	-0.308	-0.716	—	-0.339	-0.156	-0.052	-0.014	0.028	—	—
0.600	3.003	-0.216	-0.314	-0.760	—	-0.339	-0.162	-0.048	0.000	0.043	—	—
0.601	6.007	-0.221	-0.319	-0.782	—	-0.326	-0.161	-0.049	-0.005	0.038	—	—
0.601	9.020	-0.233	-0.330	-0.800	—	-0.312	-0.158	-0.054	-0.013	0.030	—	—
0.402	0.020	-0.194	-0.281	-0.617	—	-0.310	-0.148	-0.047	-0.009	0.029	—	—
0.874	-0.018	-0.157	-0.233	-0.633	—	-0.381	-0.237	-0.159	-0.125	-0.091	—	—
0.851	0.000	-0.170	-0.251	-0.672	—	-0.352	-0.222	-0.140	-0.111	-0.076	—	—
0.800	-0.020	-0.194	-0.288	-0.764	—	-0.383	-0.207	-0.111	-0.081	-0.040	—	—
0.702	-0.035	-0.217	-0.324	-0.835	—	-0.358	-0.158	-0.056	-0.022	0.020	—	—
1.200	-2.991	-0.017	-0.048	-0.272	—	-0.392	-0.409	-0.342	-0.341	-0.327	—	—
1.200	2.974	-0.029	-0.035	-0.217	—	-0.421	-0.386	-0.399	-0.382	-0.281	—	—
0.952	0.012	-0.096	-0.156	-0.495	—	-0.696	-0.443	-0.305	-0.249	-0.202	—	—
0.927	-0.086	-0.122	-0.187	-0.543	—	-0.548	-0.319	-0.223	-0.183	-0.147	—	—
0.901	-0.131	-0.144	-0.214	-0.589	—	-0.434	-0.259	-0.182	-0.146	-0.113	—	—
0.903	-3.040	-0.156	-0.236	-0.624	—	-0.527	-0.310	-0.248	-0.219	-0.184	—	—
0.902	0.085	-0.137	-0.208	-0.585	—	-0.429	-0.253	-0.177	-0.143	-0.111	—	—
0.898	2.836	-0.133	-0.198	-0.571	—	-0.360	-0.226	-0.156	-0.127	-0.095	—	—
0.899	6.572	-0.138	-0.198	-0.562	—	-0.382	-0.238	-0.157	-0.124	-0.090	—	—
0.897	9.226	-0.149	-0.206	-0.567	—	-0.442	-0.256	-0.162	-0.122	-0.083	—	—

Table 15. Continued

(c) Continued

$M_\infty$	$\alpha$ , deg	Static pressure coefficients on nozzle bottom flap at $y/Y = 0.50$ with values of $x/Y$ of—														
		.153	.226	.300	.337	.411	.558	.705	.779	.853	.926					
1.251	0.002	0.004	-0.010	-0.384	-0.515	-0.452	-0.382	-0.345	-0.320	-0.277	-0.207					
0.600	0.005	-0.271	-0.426	-0.968	-0.505	-0.246	-0.075	0.032	0.081	0.126	0.167					
0.601	-2.990	-0.261	-0.404	-0.876	-0.462	-0.227	-0.071	0.032	0.079	0.120	0.159					
0.603	0.035	-0.271	-0.427	-0.975	-0.506	-0.246	-0.074	0.034	0.080	0.125	0.168					
0.600	3.003	-0.277	-0.443	-1.088	-0.551	-0.272	-0.095	0.015	0.061	0.109	0.157					
0.601	6.007	-0.274	-0.446	-1.173	-0.580	-0.287	-0.110	-0.001	0.046	0.097	0.146					
0.601	9.020	-0.268	-0.443	-1.240	-0.602	-0.301	-0.125	-0.019	0.027	0.077	0.126					
0.402	0.020	-0.254	-0.392	-0.817	-0.456	-0.230	-0.070	0.028	0.071	0.115	0.157					
0.874	-0.018	-0.170	-0.263	-0.906	-0.594	-0.410	-0.255	-0.146	-0.099	-0.057	-0.020					
0.851	0.000	-0.186	-0.288	-0.943	-0.590	-0.405	-0.226	-0.110	-0.065	-0.025	0.012					
0.800	-0.020	-0.221	-0.344	-1.103	-0.687	-0.390	-0.156	-0.041	0.002	0.037	0.067					
0.702	-0.035	-0.267	-0.431	-1.258	-0.541	-0.253	-0.073	0.034	0.081	0.125	0.165					
1.200	-2.991	-0.019	-0.041	-0.440	-0.582	-0.483	-0.409	-0.333	-0.302	-0.271	-0.229					
1.200	2.974	-0.026	-0.034	-0.427	-0.577	-0.506	-0.441	-0.295	-0.191	-0.143	-0.123					
0.952	0.012	-0.103	-0.179	-0.766	-0.925	-0.766	-0.344	-0.241	-0.196	-0.153	-0.110					
0.927	-0.086	-0.129	-0.210	-0.815	-0.748	-0.487	-0.320	-0.223	-0.174	-0.129	-0.087					
0.901	-0.131	-0.151	-0.240	-0.857	-0.626	-0.425	-0.298	-0.190	-0.139	-0.094	-0.056					
0.903	-3.040	-0.161	-0.245	-0.894	-0.732	-0.494	-0.335	-0.203	-0.141	-0.091	-0.049					
0.902	0.085	-0.149	-0.234	-0.854	-0.620	-0.421	-0.289	-0.187	-0.139	-0.096	-0.056					
0.898	2.836	-0.140	-0.219	-0.840	-0.550	-0.382	-0.262	-0.175	-0.134	-0.098	-0.061					
0.899	6.572	-0.131	-0.203	-0.852	-0.609	-0.414	-0.284	-0.188	-0.143	-0.102	-0.063					
0.897	9.226	-0.121	-0.192	-0.869	-0.717	-0.460	-0.311	-0.198	-0.146	-0.101	-0.055					

Table 15. Continued

(c) Concluded

$M_\infty$	$\alpha$ , deg	Static pressure coefficients on nozzle bottom flap at centerline with values of $x/l$ of—										
		.153	.226	.300	.337	.411	.558	.705	.926			
1.251	0.002	0.005	-0.016	-0.385	-0.508	-0.489	-0.480	-0.398	—	—	—	—
0.600	0.005	-0.303	-0.464	-1.045	-0.548	-0.262	-0.063	0.048	—	—	—	—
0.601	-2.990	-0.290	-0.446	-0.991	-0.516	-0.240	-0.050	0.055	—	—	—	—
0.603	0.035	-0.303	-0.466	-1.052	-0.550	-0.265	-0.061	0.048	—	—	—	—
0.600	3.003	-0.312	-0.484	-1.131	-0.592	-0.297	-0.087	0.027	—	—	—	—
0.601	6.007	-0.313	-0.491	-1.201	-0.621	-0.316	-0.109	0.012	—	—	—	—
0.601	9.020	-0.307	-0.491	-1.241	-0.640	-0.332	-0.127	-0.008	—	—	—	—
0.402	0.020	-0.284	-0.420	-0.870	-0.486	-0.248	-0.062	0.043	—	—	—	—
0.874	-0.018	-0.179	-0.271	-0.860	-0.524	-0.388	-0.268	-0.171	—	—	—	—
0.851	0.000	-0.197	-0.297	-0.909	-0.545	-0.391	-0.243	-0.133	—	—	—	—
0.800	-0.020	-0.236	-0.360	-1.074	-0.648	-0.405	-0.182	-0.055	—	—	—	—
0.702	-0.035	-0.297	-0.464	-1.378	-0.612	-0.269	-0.058	0.049	—	—	—	—
1.200	-2.991	-0.012	-0.036	-0.432	-0.562	-0.546	-0.535	-0.384	—	—	—	—
1.200	2.974	-0.021	-0.041	-0.431	-0.560	-0.544	-0.510	-0.207	—	—	—	—
0.952	0.012	-0.108	-0.192	-0.782	-0.911	-0.742	-0.389	-0.255	—	—	—	—
0.927	-0.086	-0.133	-0.218	-0.817	-0.672	-0.453	-0.336	-0.246	—	—	—	—
0.901	-0.131	-0.156	-0.247	-0.830	-0.551	-0.407	-0.306	-0.211	—	—	—	—
0.903	-3.040	-0.162	-0.247	-0.882	-0.661	-0.474	-0.351	-0.236	—	—	—	—
0.902	0.085	-0.157	-0.244	-0.822	-0.540	-0.400	-0.295	-0.207	—	—	—	—
0.898	2.836	-0.150	-0.238	-0.782	-0.475	-0.355	-0.266	-0.190	—	—	—	—
0.899	6.572	-0.140	-0.227	-0.822	-0.542	-0.390	-0.283	-0.202	—	—	—	—
0.897	9.226	-0.127	-0.215	-0.866	-0.629	-0.435	-0.315	-0.218	—	—	—	—

Table 15. Concluded

(d) Force data

$M_\infty$	$\alpha$ , deg	$C_D$
1.251	0.002	0.2980
0.600	0.005	0.0808
0.601	-2.990	0.0823
0.603	0.035	0.0791
0.600	3.003	0.0863
0.601	6.007	0.0999
0.601	9.020	0.1209
0.402	0.020	0.0640
0.874	-0.018	0.1761
0.851	0.000	0.1656
0.800	-0.020	0.1360
0.702	-0.035	0.0917
1.200	-2.991	0.3261
1.200	2.974	0.3360
0.952	0.012	0.2539
0.927	-0.086	0.2159
0.901	-0.131	0.1925
0.903	-3.040	0.2226
0.902	0.085	0.1910
0.898	2.836	0.1877
0.899	6.572	0.2113
0.897	9.226	0.2252

Table 16. Pressure and Force Data for Nozzle 10 With  $\beta_{r,top/bot} = 17.3^\circ/\beta_{r,side} = 9.7^\circ$ , Plume On, and  $\alpha = 0^\circ$

(a) Static pressure coefficients on nozzle top flap

$M_\infty$	Static pressure coefficients on nozzle top flap at centerline with values of $x/l$ of—													
	.153	.226	.300	.337	.411	.484	.558	.632	.705	.779	.853	.926		
0.598	-0.285	-0.441	-1.012	-0.514	-0.213	-0.083	0.001	0.065	0.115	0.158	0.196	0.222		
0.700	-0.280	-0.436	-1.349	-0.533	-0.199	-0.068	0.014	0.073	0.116	0.153	0.182	0.202		
0.797	-0.217	-0.328	-0.831	-0.336	-0.206	-0.142	-0.096	-0.056	-0.025	0.008	0.041	0.071		
1.249	0.005	-0.006	-0.387	-0.512	-0.488	-0.444	-0.174	-0.138	-0.126	-0.113	-0.096	-0.076		
1.202	0.000	-0.019	-0.426	-0.560	-0.526	-0.450	-0.180	-0.153	-0.142	-0.127	-0.113	-0.089		
1.149	-0.024	-0.043	-0.487	-0.617	-0.585	-0.402	-0.204	-0.182	-0.166	-0.153	-0.135	-0.112		
0.951	-0.095	-0.161	-0.722	-0.417	-0.283	-0.237	-0.210	-0.191	-0.173	-0.161	-0.141	-0.114		
0.930	-0.118	-0.189	-0.674	-0.344	-0.249	-0.216	-0.195	-0.179	-0.162	-0.145	-0.123	-0.092		
0.900	-0.145	-0.222	-0.645	-0.301	-0.231	-0.203	-0.179	-0.158	-0.134	-0.113	-0.089	-0.053		
0.876	-0.163	-0.248	-0.639	-0.289	-0.226	-0.193	-0.166	-0.140	-0.111	-0.088	-0.061	-0.023		
0.850	-0.181	-0.276	-0.670	-0.299	-0.225	-0.183	-0.144	-0.115	-0.081	-0.055	-0.027	0.011		
0.803	-0.214	-0.326	-0.785	-0.319	-0.212	-0.151	-0.106	-0.067	-0.034	-0.005	0.027	0.061		
0.700	-0.279	-0.438	-1.308	-0.526	-0.201	-0.069	0.012	0.071	0.115	0.148	0.175	0.196		
0.600	-0.284	-0.442	-1.004	-0.512	-0.213	-0.083	0.001	0.065	0.114	0.157	0.189	0.218		
0.402	-0.264	-0.400	-0.826	-0.461	-0.204	-0.083	-0.005	0.056	0.103	0.147	0.182	0.212		

$M_\infty$	Static pressure coefficients on nozzle top flap at $y/Y = 0.25$ with values of $x/l$ of—													
	.153	.226	.300	.337	.411	.484	.558	.632	.705	.779	.853	.926		
0.598	-0.276	-0.434	-1.006	-0.502	-0.209	-0.002	0.002	0.112	0.156	0.194	0.224	0.224		
0.700	-0.270	-0.429	-1.341	-0.522	-0.198	0.009	0.009	0.115	0.152	0.180	0.204	0.204		
0.797	-0.211	-0.325	-0.844	-0.347	-0.217	-0.102	-0.024	-0.024	0.006	0.037	0.072	0.072		
1.249	0.006	-0.004	-0.384	-0.507	-0.483	-0.198	-0.127	-0.127	-0.111	-0.096	-0.076	-0.076		
1.202	0.005	-0.014	-0.423	-0.558	-0.521	-0.187	-0.144	-0.144	-0.125	-0.109	-0.088	-0.088		
1.149	-0.019	-0.042	-0.480	-0.621	-0.584	-0.211	-0.167	-0.167	-0.151	-0.135	-0.113	-0.113		
0.951	-0.090	-0.159	-0.720	-0.417	-0.286	-0.212	-0.178	-0.178	-0.162	-0.143	-0.114	-0.114		
0.930	-0.113	-0.187	-0.673	-0.342	-0.250	-0.196	-0.165	-0.165	-0.146	-0.124	-0.093	-0.093		
0.900	-0.141	-0.220	-0.655	-0.307	-0.235	-0.181	-0.140	-0.140	-0.114	-0.089	-0.056	-0.056		
0.876	-0.159	-0.246	-0.664	-0.302	-0.233	-0.167	-0.114	-0.114	-0.088	-0.061	-0.027	-0.027		
0.850	-0.177	-0.274	-0.687	-0.309	-0.230	-0.148	-0.089	-0.089	-0.056	-0.024	0.011	0.011		
0.803	-0.207	-0.321	-0.818	-0.345	-0.214	-0.101	-0.033	-0.033	-0.001	0.029	0.060	0.060		
0.700	-0.269	-0.431	-1.303	-0.520	-0.195	0.012	0.114	0.114	0.150	0.177	0.200	0.200		
0.600	-0.274	-0.434	-0.996	-0.501	-0.206	0.002	0.111	0.111	0.155	0.190	0.218	0.218		
0.402	-0.252	-0.389	-0.825	-0.450	-0.198	-0.003	0.103	0.103	0.147	0.185	0.214	0.214		



Table 16. Continued

(a) Concluded

$M_\infty$	Static pressure coefficients on nozzle top flap at $y/Y = 0.50$ with values of $x/l$ of—										
	.153	.226	.300	.337	.411	.558	.705	.779	.853	.926	
0.598	-0.251	-0.394	-0.955	-0.473	-0.196	-0.004	0.103	0.144	0.186	0.221	
0.700	-0.252	-0.396	-1.270	-0.491	-0.190	0.006	0.109	0.144	0.178	0.206	
0.797	-0.204	-0.309	-0.896	-0.404	-0.226	-0.091	-0.016	0.012	0.046	0.083	
1.249	0.005	-0.003	-0.385	-0.513	-0.445	-0.297	-0.119	-0.107	-0.091	-0.068	
1.202	0.003	-0.012	-0.427	-0.562	-0.485	-0.241	-0.136	-0.122	-0.108	-0.085	
1.149	-0.025	-0.042	-0.487	-0.628	-0.540	-0.233	-0.162	-0.147	-0.130	-0.105	
0.951	-0.091	-0.153	-0.739	-0.450	-0.300	-0.213	-0.180	-0.164	-0.147	-0.119	
0.930	-0.114	-0.181	-0.701	-0.376	-0.265	-0.198	-0.168	-0.147	-0.127	-0.096	
0.900	-0.139	-0.215	-0.675	-0.334	-0.247	-0.183	-0.139	-0.114	-0.089	-0.055	
0.876	-0.155	-0.240	-0.688	-0.333	-0.248	-0.169	-0.117	-0.088	-0.060	-0.024	
0.850	-0.173	-0.268	-0.721	-0.344	-0.245	-0.148	-0.089	-0.053	-0.024	0.015	
0.803	-0.202	-0.309	-0.859	-0.389	-0.225	-0.096	-0.026	0.002	0.035	0.070	
0.700	-0.251	-0.401	-1.240	-0.487	-0.189	0.007	0.107	0.144	0.173	0.200	
0.600	-0.252	-0.397	-0.952	-0.471	-0.195	-0.003	0.103	0.144	0.183	0.215	
0.402	-0.232	-0.359	-0.787	-0.421	-0.181	-0.003	0.095	0.134	0.176	0.210	

$M_\infty$	Static pressure coefficients on nozzle top flap at $y/Y = 0.75$ with values of $x/l$ of—										
	.153	.226	.300	.337	.411	.558	.705	.779	.853	.926	
0.598	-0.212	-0.321	-0.749	-0.444	-0.211	-0.039	0.074	0.119	0.159	0.198	
0.700	-0.219	-0.340	-0.906	-0.480	-0.214	-0.029	0.082	0.123	0.160	0.194	
0.797	-0.192	-0.295	-0.918	-0.468	-0.192	-0.069	0.002	0.032	0.068	0.109	
1.249	0.005	-0.003	-0.265	-0.435	-0.387	-0.329	-0.160	-0.118	-0.085	-0.047	
1.202	0.003	-0.012	-0.300	-0.475	-0.424	-0.355	-0.154	-0.123	-0.096	-0.063	
1.149	-0.027	-0.045	-0.353	-0.539	-0.481	-0.376	-0.166	-0.142	-0.110	-0.074	
0.951	-0.088	-0.147	-0.602	-0.684	-0.299	-0.211	-0.173	-0.157	-0.135	-0.107	
0.930	-0.111	-0.174	-0.646	-0.554	-0.273	-0.201	-0.162	-0.139	-0.111	-0.078	
0.900	-0.136	-0.206	-0.704	-0.459	-0.262	-0.181	-0.127	-0.102	-0.069	-0.033	
0.876	-0.151	-0.229	-0.751	-0.443	-0.259	-0.160	-0.100	-0.072	-0.037	0.003	
0.850	-0.168	-0.253	-0.806	-0.447	-0.239	-0.130	-0.065	-0.034	0.002	0.040	
0.803	-0.192	-0.293	-0.907	-0.463	-0.194	-0.076	-0.006	0.023	0.057	0.097	
0.700	-0.221	-0.339	-0.898	-0.478	-0.215	-0.029	0.080	0.122	0.157	0.188	
0.600	-0.211	-0.321	-0.748	-0.442	-0.210	-0.039	0.074	0.117	0.157	0.191	
0.402	-0.191	-0.287	-0.631	-0.391	-0.191	-0.037	0.064	0.109	0.148	0.185	

Table 16. Continued

## (b) Static pressure coefficients on nozzle sidewall

$M_\infty$	Static pressure coefficients on corner between nozzle top flap and sidewall with values of $x/l$ of—									
	.153	.226	.300	.337	.411	.558	.705	.779	.853	.926
0.598	-0.201	-	-0.659	-0.374	-0.196	-0.062	0.024	0.071	0.124	0.179
0.700	-0.212	-	-0.777	-0.409	-0.206	-0.058	0.035	0.084	0.136	0.183
0.797	-0.193	-	-0.954	-0.430	-0.183	-0.065	-0.002	0.028	0.060	0.096
1.249	0.005	-	-0.287	-0.371	-0.324	-0.273	-0.280	-0.221	-0.133	-0.042
1.202	0.001	-	-0.318	-0.409	-0.356	-0.304	-0.272	-0.194	-0.108	-0.044
1.149	-0.031	-	-0.378	-0.468	-0.409	-0.330	-0.260	-0.193	-0.113	-0.058
0.951	-0.090	-	-0.629	-0.735	-0.355	-0.185	-0.140	-0.124	-0.110	-0.095
0.930	-0.112	-	-0.672	-0.747	-0.287	-0.167	-0.119	-0.104	-0.090	-0.073
0.900	-0.136	-	-0.736	-0.728	-0.252	-0.132	-0.088	-0.070	-0.052	-0.031
0.876	-0.151	-	-0.786	-0.709	-0.224	-0.109	-0.066	-0.048	-0.027	-0.001
0.850	-0.166	-	-0.843	-0.651	-0.189	-0.088	-0.041	-0.021	0.003	0.033
0.803	-0.193	-	-0.941	-0.443	-0.181	-0.067	-0.005	0.021	0.052	0.087
0.700	-0.212	-	-0.770	-0.409	-0.205	-0.057	0.036	0.080	0.131	0.178
0.600	-0.202	-	-0.653	-0.373	-0.196	-0.061	0.023	0.068	0.120	0.176
0.402	-0.183	-	-0.556	-0.326	-0.175	-0.054	0.016	0.057	0.107	0.164

$M_\infty$	Static pressure coefficients on nozzle sidewall at $z/Z = 0.50$ with values of $x/l$ of—									
	.153	.226	.300	.337	.411	.558	.705	.779	.853	.926
0.598	-0.192	-0.282	-0.529	-0.317	-0.178	-	0.025	0.067	0.118	0.170
0.700	-0.202	-0.307	-0.614	-0.351	-0.190	-	0.033	0.075	0.126	0.175
0.797	-0.188	-0.295	-0.935	-0.371	-0.182	-	0.003	0.032	0.072	0.116
1.249	0.007	-0.003	-0.299	-0.317	-0.299	-	-0.247	-0.238	-0.174	-0.045
1.202	-0.003	-0.017	-0.335	-0.351	-0.329	-	-0.272	-0.234	-0.132	-0.042
1.149	-0.036	-0.056	-0.392	-0.409	-0.382	-	-0.273	-0.226	-0.133	-0.054
0.951	-0.094	-0.153	-0.645	-0.654	-0.499	-	-0.113	-0.098	-0.073	-0.043
0.930	-0.116	-0.179	-0.688	-0.697	-0.390	-	-0.091	-0.077	-0.053	-0.020
0.900	-0.138	-0.209	-0.749	-0.747	-0.274	-	-0.068	-0.049	-0.021	0.018
0.876	-0.154	-0.232	-0.799	-0.773	-0.211	-	-0.050	-0.028	0.002	0.045
0.850	-0.171	-0.255	-0.854	-0.711	-0.173	-	-0.029	-0.003	0.030	0.074
0.803	-0.191	-0.295	-0.924	-0.379	-0.182	-	0.000	0.032	0.067	0.112
0.700	-0.207	-0.308	-0.609	-0.349	-0.189	-	0.033	0.077	0.126	0.174
0.600	-0.195	-0.284	-0.525	-0.317	-0.178	-	0.025	0.066	0.117	0.167
0.402	-0.174	-0.250	-0.449	-0.275	-0.158	-	0.023	0.059	0.106	0.158

Table 16. Continued

(b) Concluded

$M_\infty$	Static pressure coefficients on nozzle sidewall at centerline with values of $x/l$ of—												
	.153	.226	.300	.337	.411	.484	.558	.632	.705	.779	.853	.926	
0.598	-0.186	-0.284	-0.459	-0.285	-0.164	-0.099	-0.044	-0.009	0.031	0.070	0.116	-	
0.700	-0.198	-0.310	-0.528	-0.315	-0.177	-0.103	-0.042	-0.005	0.038	0.078	0.124	-	
0.797	-0.189	-0.303	-0.931	-0.340	-0.177	-0.107	-0.052	-0.023	0.012	0.042	0.078	-	
1.249	0.013	0.002	-0.351	-0.323	-0.279	-0.265	-0.245	-0.239	-0.230	-0.235	-0.184	-	
1.202	0.002	-0.014	-0.394	-0.356	-0.308	-0.291	-0.275	-0.265	-0.259	-0.248	-0.138	-	
1.149	-0.036	-0.054	-0.455	-0.412	-0.361	-0.333	-0.291	-0.277	-0.268	-0.241	-0.135	-	
0.951	-0.090	-0.151	-0.729	-0.645	-0.551	-0.297	-0.149	-0.105	-0.089	-0.072	-0.053	-	
0.930	-0.112	-0.177	-0.775	-0.687	-0.487	-0.182	-0.104	-0.078	-0.072	-0.058	-0.038	-	
0.900	-0.135	-0.209	-0.844	-0.744	-0.308	-0.119	-0.077	-0.064	-0.052	-0.033	-0.008	-	
0.876	-0.151	-0.232	-0.899	-0.773	-0.217	-0.101	-0.070	-0.054	-0.037	-0.014	0.016	-	
0.850	-0.167	-0.256	-0.960	-0.662	-0.171	-0.099	-0.065	-0.040	-0.018	0.009	0.043	-	
0.803	-0.192	-0.298	-0.933	-0.347	-0.178	-0.108	-0.057	-0.024	0.008	0.037	0.075	-	
0.700	-0.200	-0.307	-0.528	-0.315	-0.179	-0.102	-0.045	-0.004	0.037	0.079	0.125	-	
0.600	-0.190	-0.281	-0.461	-0.284	-0.166	-0.100	-0.048	-0.007	0.031	0.070	0.118	-	
0.402	-0.168	-0.249	-0.400	-0.252	-0.143	-0.089	-0.041	-0.008	0.027	0.065	0.107	-	

$M_\infty$	Static pressure coefficients on nozzle sidewall at $z/Z = -0.50$ with values of $x/l$ of—												
	.153	.226	.300	.337	.411	.558	.705	.926					
x	-0.194	-0.281	-0.515	-0.301	-	-0.055	0.027	0.172					
0.700	-0.208	-0.307	-0.599	-0.335	-	-0.054	0.034	0.180					
0.797	-0.196	-0.295	-0.961	-0.369	-	-0.063	0.010	0.133					
1.249	0.013	-0.002	-0.318	-0.315	-	-0.256	-0.251	-0.042					
1.202	-0.004	-0.021	-0.355	-0.351	-	-0.286	-0.278	-0.039					
1.149	-0.038	-0.055	-0.414	-0.407	-	-0.304	-0.288	-0.049					
0.951	-0.090	-0.152	-0.668	-0.644	-	-0.156	-0.090	-0.027					
0.930	-0.110	-0.178	-0.712	-0.687	-	-0.120	-0.074	-0.010					
0.900	-0.133	-0.210	-0.773	-0.743	-	-0.094	-0.055	0.033					
0.876	-0.148	-0.234	-0.823	-0.776	-	-0.081	-0.038	0.058					
0.850	-0.163	-0.259	-0.880	-0.731	-	-0.071	-0.016	0.086					
0.803	-0.190	-0.297	-0.953	-0.379	-	-0.063	0.009	0.125					
0.700	-0.201	-0.308	-0.595	-0.335	-	-0.053	0.038	0.176					
0.600	-0.189	-0.284	-0.514	-0.303	-	-0.055	0.029	0.170					
0.402	-0.168	-0.251	-0.444	-0.260	-	-0.052	0.022	0.159					

Table 16. Continued

(c) Static pressure coefficients on nozzle bottom flap

$M_\infty$	Static pressure coefficients on nozzle bottom flap at $y/Y = 0.75$ with values of $x/l$ of—										
	.226	.300	.337	.411	.558	.705	.779	.853	.926		
0.598	-0.210	-	-0.431	-0.201	-0.034	0.074	0.119	0.162	0.197		
0.700	-0.220	-	-0.468	-0.207	-0.027	0.083	0.126	0.166	0.196		
0.797	-0.196	-	-0.555	-0.209	-0.054	0.037	0.071	0.105	0.136		
1.249	0.011	-	-0.439	-0.392	-0.334	-0.197	-0.118	-0.077	-0.044		
1.202	-0.007	-	-0.483	-0.429	-0.368	-0.175	-0.120	-0.086	-0.054		
1.149	-0.038	-	-0.545	-0.484	-0.406	-0.176	-0.131	-0.095	-0.059		
0.951	-0.093	-	-0.778	-0.360	-0.215	-0.147	-0.116	-0.088	-0.056		
0.930	-0.115	-	-0.659	-0.298	-0.204	-0.141	-0.109	-0.078	-0.045		
0.900	-0.140	-	-0.561	-0.283	-0.178	-0.104	-0.071	-0.036	0.000		
0.876	-0.154	-	-0.536	-0.273	-0.153	-0.071	-0.037	-0.001	0.036		
0.850	-0.170	-	-0.531	-0.250	-0.118	-0.033	0.003	0.036	0.072		
0.803	-0.195	-	-0.551	-0.215	-0.064	0.029	0.067	0.097	0.128		
0.700	-0.219	-	-0.464	-0.206	-0.028	0.083	0.127	0.163	0.194		
0.600	-0.209	-	-0.430	-0.201	-0.036	0.074	0.120	0.158	0.195		
0.402	-0.192	-	-0.382	-0.184	-0.038	0.069	0.112	0.150	0.189		

$M_\infty$	Static pressure coefficients on nozzle bottom flap at $y/Y = 0.50$ with values of $x/l$ of—										
	.226	.300	.337	.411	.558	.705	.779	.853	.926		
0.598	-0.247	-0.918	-0.460	-0.195	-0.010	0.099	0.144	0.184	0.216		
0.700	-0.251	-1.177	-0.483	-0.194	-0.002	0.105	0.148	0.182	0.212		
0.797	-0.210	-0.981	-0.483	-0.269	-0.072	0.030	0.065	0.095	0.125		
1.249	0.010	-0.381	-0.510	-0.456	-0.387	-0.130	-0.100	-0.077	-0.052		
1.202	-0.005	-0.421	-0.560	-0.497	-0.369	-0.139	-0.115	-0.087	-0.066		
1.149	-0.035	-0.482	-0.621	-0.553	-0.321	-0.162	-0.131	-0.105	-0.075		
0.951	-0.098	-0.746	-0.567	-0.357	-0.240	-0.159	-0.128	-0.093	-0.064		
0.930	-0.120	-0.724	-0.415	-0.295	-0.214	-0.150	-0.121	-0.089	-0.060		
0.900	-0.144	-0.716	-0.375	-0.280	-0.195	-0.117	-0.084	-0.048	-0.017		
0.876	-0.161	-0.733	-0.375	-0.278	-0.175	-0.087	-0.053	-0.015	0.019		
0.850	-0.178	-0.772	-0.385	-0.277	-0.149	-0.050	-0.013	0.022	0.053		
0.803	-0.207	-0.932	-0.470	-0.270	-0.082	0.020	0.057	0.088	0.115		
0.700	-0.252	-1.142	-0.477	-0.190	-0.002	0.104	0.145	0.180	0.207		
0.600	-0.248	-0.910	-0.457	-0.191	-0.012	0.097	0.143	0.181	0.211		
0.402	-0.225	-0.764	-0.411	-0.180	-0.014	0.091	0.135	0.173	0.205		

Table 16. Concluded

(c) Concluded

$M_\infty$	Static pressure coefficients on nozzle bottom flap at centerline with values of $x/l$ of—									
	.153	.226	.300	.337	.411	.558	.705	.926		
0.598	-0.272	-0.416	-	-	-0.218	-	0.102	0.235		
0.700	-0.272	-0.423	-	-	-0.214	-	0.109	0.231		
0.797	-0.218	-0.332	-	-	-0.258	-	0.022	0.128		
1.249	0.008	-0.009	-	-	-0.477	-	-0.147	-0.073		
1.202	-0.009	-0.028	-	-	-0.520	-	-0.162	-0.084		
1.149	-0.038	-0.064	-	-	-0.582	-	-0.191	-0.100		
0.951	-0.106	-0.179	-	-	-0.322	-	-0.184	-0.083		
0.930	-0.126	-0.201	-	-	-0.287	-	-0.158	-0.061		
0.900	-0.150	-0.230	-	-	-0.261	-	-0.129	-0.023		
0.876	-0.166	-0.254	-	-	-0.261	-	-0.096	0.012		
0.850	-0.184	-0.281	-	-	-0.259	-	-0.060	0.047		
0.803	-0.215	-0.330	-	-	-0.260	-	0.011	0.111		
0.700	-0.272	-0.425	-	-	-0.213	-	0.109	0.221		
0.600	-0.271	-0.416	-	-	-0.218	-	0.102	0.226		
0.402	-0.249	-0.375	-	-	-0.207	-	0.090	0.222		

(d) Force data

$M_\infty$	$C_D$	$C_{D,p}$	$C_{D,f}$
1.249	0.2313	0.2102	0.0121
1.202	0.2417	0.2247	0.0122
1.149	0.2661	0.2451	0.0123
0.951	0.2210	0.2061	0.0127
0.930	0.1966	0.1824	0.0128
0.900	0.1650	0.1572	0.0128
0.876	0.1438	0.1416	0.0129
0.850	0.1235	0.1234	0.0130
0.803	0.0903	0.0927	0.0131
0.700	0.0414	0.0380	0.0134
0.600	0.0322	0.0316	0.0137
0.402	0.0179	0.0256	0.0146

Table 17. Pressure and Force Data for Nozzle 10 With  $\beta_{t,top/bot} = 17.3^\circ/\beta_{t,side} = 9.7^\circ$  and Plume Off

(a) Static pressure coefficients on nozzle top flap

$M_\infty$	$\alpha$ , deg	Static pressure coefficients on nozzle top flap at centerline with values of $x/l$ of—															
		.153	.226	.300	.337	.411	.484	.558	.632	.705	.779	.853	.926				
0.952	-0.161	-0.091	-0.157	-0.658	-0.342	-0.239	-0.197	-0.175	-0.158	-0.150	-0.139	-0.127	-0.107				
0.927	-0.125	-0.118	-0.188	-0.610	-0.283	-0.212	-0.182	-0.165	-0.150	-0.138	-0.126	-0.112	-0.090				
0.899	-0.117	-0.141	-0.220	-0.599	-0.268	-0.208	-0.182	-0.160	-0.140	-0.122	-0.105	-0.087	-0.059				
0.900	-3.120	-0.127	-0.203	-0.660	-0.317	-0.243	-0.209	-0.185	-0.166	-0.148	-0.134	-0.115	-0.085				
0.899	-0.100	-0.142	-0.221	-0.601	-0.273	-0.214	-0.184	-0.162	-0.145	-0.124	-0.108	-0.090	-0.063				
0.900	2.877	-0.151	-0.231	-0.620	-0.287	-0.223	-0.200	-0.178	-0.156	-0.132	-0.104	-0.075	-0.045				
0.900	5.817	-0.158	-0.238	-0.708	-0.366	-0.288	-0.257	-0.226	-0.189	-0.149	-0.108	-0.065	-0.024				
0.899	8.873	-0.160	-0.234	-0.780	-0.438	-0.337	-0.292	-0.250	-0.203	-0.153	-0.103	-0.055	-0.009				
0.877	-0.145	-0.160	-0.245	-0.604	-0.264	-0.208	-0.179	-0.154	-0.132	-0.109	-0.088	-0.065	-0.036				
0.847	-0.145	-0.182	-0.276	-0.630	-0.272	-0.207	-0.173	-0.143	-0.115	-0.089	-0.061	-0.034	-0.003				
0.800	-0.144	-0.214	-0.327	-0.771	-0.309	-0.199	-0.143	-0.100	-0.064	-0.034	-0.006	0.019	0.047				
0.698	-0.132	-0.288	-0.450	-1.372	-0.591	-0.241	-0.108	-0.024	0.034	0.080	0.117	0.149	0.176				
0.602	-0.139	-0.294	-0.461	-1.049	-0.540	-0.242	-0.115	-0.035	0.025	0.071	0.113	0.147	0.179				
0.600	-3.125	-0.311	-0.492	-1.190	-0.611	-0.293	-0.162	-0.078	-0.017	0.032	0.078	0.120	0.161				
0.602	-0.141	-0.298	-0.463	-1.059	-0.546	-0.244	-0.118	-0.038	0.023	0.067	0.110	0.146	0.178				
0.602	2.842	-0.277	-0.430	-0.961	-0.489	-0.207	-0.086	-0.014	0.041	0.081	0.117	0.147	0.178				
0.601	5.868	-0.263	-0.410	-0.928	-0.474	-0.199	-0.083	-0.013	0.038	0.074	0.109	0.139	0.171				
0.602	8.847	-0.257	-0.408	-0.980	-0.500	-0.217	-0.100	-0.033	0.017	0.052	0.087	0.119	0.155				
0.401	-0.151	-0.278	-0.418	-0.871	-0.492	-0.233	-0.115	-0.039	0.018	0.056	0.101	0.138	0.169				

Table 17. Continued

(a) Continued

$M_\infty$	$\alpha$ , deg	Static pressure coefficients on nozzle top flap at $y/Y = 0.25$ with values of $x/l$ of—													
		.153	.226	.300	.337	.411	.558	.705	.779	.853	.926				
0.952	-0.161	-0.088	-0.154	-0.659	-0.347	-0.239	-0.178	-0.150	-0.140	-0.127	-0.107				
0.927	-0.125	-0.114	-0.186	-0.613	-0.288	-0.212	-0.168	-0.142	-0.128	-0.109	-0.088				
0.899	-0.117	-0.137	-0.218	-0.605	-0.275	-0.208	-0.162	-0.127	-0.106	-0.081	-0.055				
0.900	-3.120	-0.124	-0.201	-0.675	-0.331	-0.245	-0.188	-0.152	-0.135	-0.110	-0.081				
0.899	-0.100	-0.139	-0.220	-0.614	-0.283	-0.212	-0.163	-0.129	-0.111	-0.086	-0.062				
0.900	2.877	-0.147	-0.228	-0.638	-0.303	-0.235	-0.185	-0.136	-0.108	-0.077	-0.043				
0.900	5.817	-0.156	-0.236	-0.730	-0.392	-0.302	-0.231	-0.153	-0.111	-0.067	-0.024				
0.899	8.873	-0.162	-0.236	-0.786	-0.448	-0.347	-0.257	-0.159	-0.109	-0.057	-0.010				
0.877	-0.145	-0.157	-0.244	-0.625	-0.282	-0.215	-0.159	-0.112	-0.089	-0.062	-0.033				
0.847	-0.145	-0.179	-0.275	-0.657	-0.288	-0.216	-0.146	-0.090	-0.063	-0.033	-0.001				
0.800	-0.144	-0.209	-0.324	-0.790	-0.329	-0.206	-0.100	-0.035	-0.006	0.022	0.049				
0.698	-0.132	-0.280	-0.443	-1.365	-0.584	-0.237	-0.026	0.076	0.114	0.148	0.176				
0.602	-0.139	-0.284	-0.448	-1.045	-0.531	-0.234	-0.034	0.069	0.111	0.145	0.178				
0.600	-3.125	-0.300	-0.478	-1.180	-0.599	-0.286	-0.079	0.031	0.077	0.117	0.159				
0.602	-0.141	-0.287	-0.450	-1.051	-0.533	-0.237	-0.039	0.067	0.109	0.142	0.176				
0.602	2.842	-0.266	-0.419	-0.962	-0.481	-0.200	-0.011	0.079	0.116	0.145	0.174				
0.601	5.868	-0.251	-0.398	-0.931	-0.466	-0.193	-0.014	0.073	0.108	0.135	0.167				
0.602	8.847	-0.245	-0.394	-0.971	-0.491	-0.214	-0.034	0.049	0.085	0.113	0.149				
0.401	-0.151	-0.267	-0.408	-0.863	-0.482	-0.227	-0.040	0.060	0.100	0.133	0.168				

Table 17. Continued

(a) Continued

$M_\infty$	$\alpha$ , deg	Static pressure coefficients on nozzle top flap at $y/Y = 0.50$ with values of $x/Y$ of—														
		.153	.226	.300	.337	.411	.558	.705	.779	.853	.926					
0.952	-0.161	-0.086	-0.148	-0.679	-0.367	-0.249	-0.179	-0.152	-0.143	-0.130	-0.110					
0.927	-0.125	-0.113	-0.182	-0.635	-0.310	-0.221	-0.171	-0.146	-0.131	-0.113	-0.091					
0.899	-0.117	-0.134	-0.214	-0.636	-0.300	-0.221	-0.166	-0.129	-0.109	-0.087	-0.059					
0.900	-3.120	-0.122	-0.198	-0.720	-0.370	-0.261	-0.195	-0.158	-0.136	-0.114	-0.084					
0.899	-0.100	-0.137	-0.218	-0.643	-0.308	-0.226	-0.168	-0.136	-0.113	-0.093	-0.066					
0.900	2.877	-0.149	-0.224	-0.663	-0.341	-0.255	-0.189	-0.136	-0.106	-0.072	-0.038					
0.900	5.817	-0.163	-0.235	-0.774	-0.439	-0.332	-0.232	-0.146	-0.099	-0.053	-0.011					
0.899	8.873	-0.185	-0.253	-0.831	-0.488	-0.366	-0.255	-0.150	-0.095	-0.042	0.003					
0.877	-0.145	-0.155	-0.238	-0.661	-0.315	-0.230	-0.161	-0.114	-0.090	-0.062	-0.034					
0.847	-0.145	-0.175	-0.268	-0.699	-0.327	-0.231	-0.146	-0.090	-0.061	-0.032	0.000					
0.800	-0.144	-0.203	-0.314	-0.847	-0.380	-0.218	-0.096	-0.032	-0.003	0.025	0.052					
0.698	-0.132	-0.261	-0.415	-1.309	-0.536	-0.224	-0.031	0.066	0.106	0.141	0.170					
0.602	-0.139	-0.259	-0.406	-0.991	-0.496	-0.220	-0.034	0.062	0.099	0.137	0.171					
0.600	-3.125	-0.272	-0.431	-1.128	-0.563	-0.266	-0.072	0.027	0.067	0.110	0.150					
0.602	-0.141	-0.262	-0.407	-0.995	-0.498	-0.222	-0.036	0.061	0.097	0.136	0.169					
0.602	2.842	-0.245	-0.374	-0.905	-0.438	-0.182	-0.016	0.071	0.099	0.131	0.159					
0.601	5.868	-0.234	-0.348	-0.934	-0.431	-0.172	-0.014	0.065	0.088	0.120	0.151					
0.602	8.847	-0.245	-0.358	-0.982	-0.454	-0.187	-0.030	0.046	0.068	0.102	0.136					
0.401	-0.151	-0.244	-0.375	-0.827	-0.447	-0.206	-0.034	0.054	0.086	0.124	0.158					



Table 17. Continued

(a) Concluded

$M_\infty$	$\alpha$ , deg	Static pressure coefficients on nozzle top flap at $y/Y = 0.75$ with values of $x/l$ of—													
		.153	.226	.300	.337	.411	.558	.705	.779	.853	.926				
0.952	-0.161	-0.083	-0.142	-0.592	-0.561	-0.259	-0.183	-0.152	-0.143	-0.131	-0.113				
0.927	-0.125	-0.110	-0.173	-0.641	-0.435	-0.236	-0.176	-0.145	-0.129	-0.109	-0.092				
0.899	-0.117	-0.131	-0.202	-0.690	-0.403	-0.237	-0.167	-0.121	-0.100	-0.078	-0.057				
0.900	-3.120	-0.124	-0.186	-0.681	-0.514	-0.282	-0.202	-0.152	-0.130	-0.108	-0.082				
0.899	-0.100	-0.133	-0.205	-0.692	-0.407	-0.239	-0.173	-0.127	-0.105	-0.083	-0.060				
0.900	2.877	-0.151	-0.235	-0.699	-0.411	-0.251	-0.180	-0.117	-0.087	-0.054	-0.027				
0.900	5.817	-0.169	-0.256	-0.723	-0.481	-0.312	-0.210	-0.106	-0.065	-0.028	-0.001				
0.899	8.873	-0.186	-0.271	-0.750	-0.513	-0.343	-0.219	-0.096	-0.047	-0.008	0.018				
0.877	-0.145	-0.148	-0.227	-0.737	-0.412	-0.244	-0.156	-0.103	-0.080	-0.053	-0.029				
0.847	-0.145	-0.167	-0.255	-0.797	-0.435	-0.235	-0.129	-0.069	-0.043	-0.016	0.008				
0.800	-0.144	-0.192	-0.295	-0.908	-0.462	-0.194	-0.074	-0.012	0.013	0.038	0.058				
0.698	-0.132	-0.228	-0.354	-0.950	-0.511	-0.246	-0.063	0.043	0.083	0.119	0.148				
0.602	-0.139	-0.219	-0.332	-0.776	-0.465	-0.233	-0.068	0.035	0.075	0.112	0.146				
0.600	-3.125	-0.227	-0.348	-0.883	-0.515	-0.259	-0.095	0.009	0.050	0.091	0.130				
0.600	-0.141	-0.221	-0.334	-0.777	-0.467	-0.235	-0.071	0.034	0.073	0.111	0.145				
0.602	2.842	-0.219	-0.320	-0.649	-0.404	-0.201	-0.042	0.048	0.081	0.108	0.132				
0.601	5.868	-0.219	-0.307	-0.556	-0.357	-0.175	-0.038	0.034	0.062	0.093	0.123				
0.602	8.847	-0.224	-0.304	-0.569	-0.351	-0.171	-0.049	0.021	0.050	0.082	0.115				
0.401	-0.151	-0.199	-0.297	-0.656	-0.413	-0.212	-0.066	0.030	0.065	0.102	0.135				

Table 17. Continued

## (b) Static pressure coefficients on nozzle sidewall

$M_\infty$	$\alpha$ , deg	Static pressure coefficients on corner between nozzle top flap and sidewall with values of $x/l$ of—												
		.153	.226	.300	.337	.411	.558	.705	.779	.853	.926			
0.952	-0.161	-0.087	-	-0.623	-0.704	-0.283	-0.179	-0.159	-0.154	-0.147	-0.135			
0.927	-0.125	-0.112	-	-0.675	-0.667	-0.248	-0.167	-0.132	-0.119	-0.104	-0.090			
0.899	-0.117	-0.132	-	-0.732	-0.637	-0.239	-0.137	-0.096	-0.084	-0.065	-0.051			
0.900	-3.120	-0.133	-	-0.722	-0.737	-0.286	-0.181	-0.133	-0.120	-0.099	-0.082			
0.899	-0.100	-0.135	-	-0.734	-0.644	-0.241	-0.142	-0.100	-0.090	-0.071	-0.057			
0.900	2.877	-0.152	-	-0.754	-0.695	-0.248	-0.132	-0.091	-0.077	-0.064	-0.052			
0.900	5.817	-0.174	-	-0.776	-0.779	-0.297	-0.152	-0.105	-0.090	-0.073	-0.050			
0.899	8.873	-0.192	-	-0.787	-0.724	-0.299	-0.153	-0.089	-0.069	-0.049	-0.030			
0.877	-0.145	-0.151	-	-0.783	-0.644	-0.226	-0.116	-0.070	-0.056	-0.040	-0.024			
0.847	-0.145	-0.170	-	-0.847	-0.626	-0.193	-0.092	-0.044	-0.028	-0.008	0.011			
0.800	-0.144	-0.193	-	-0.949	-0.457	-0.181	-0.067	-0.007	0.013	0.037	0.060			
0.698	-0.132	-0.221	-	-0.807	-0.435	-0.225	-0.086	-0.004	0.029	0.071	0.124			
0.602	-0.139	-0.210	-	-0.677	-0.391	-0.213	-0.084	-0.013	0.022	0.060	0.113			
0.600	-3.125	-0.220	-	-0.756	-0.416	-0.222	-0.088	-0.016	0.017	0.049	0.087			
0.602	-0.141	-0.212	-	-0.680	-0.392	-0.215	-0.086	-0.015	0.021	0.060	0.112			
0.602	2.842	-0.214	-	-0.625	-0.368	-0.209	-0.083	-0.002	0.048	0.096	0.129			
0.601	5.868	-0.224	-	-0.583	-0.343	-0.195	-0.071	0.014	0.051	0.081	0.114			
0.602	8.847	-0.231	-	-0.512	-0.308	-0.175	-0.062	0.000	0.032	0.065	0.105			
0.401	-0.151	-0.189	-	-0.578	-0.341	-0.191	-0.077	-0.021	0.014	0.049	0.095			

Table 17. Continued

(b) Continued

$M_\infty$	$\alpha$ , deg	Static pressure coefficients on nozzle sidewall at $z/Z = 0.50$ with values of $x/l$ of—													
		.153	.226	.300	.337	.411	.558	.705	.779	.853	.926				
0.952	-0.161	-0.089	-0.149	-0.640	-0.651	-0.410	—	-0.164	-0.157	-0.139	-0.117				
0.927	-0.125	-0.116	-0.180	-0.691	-0.695	-0.323	—	-0.116	-0.103	-0.086	-0.068				
0.899	-0.117	-0.137	-0.209	-0.748	-0.726	-0.274	—	-0.081	-0.068	-0.050	-0.033				
0.900	-3.120	-0.143	-0.205	-0.756	-0.765	-0.330	—	-0.120	-0.107	-0.087	-0.065				
0.899	-0.100	-0.141	-0.210	-0.747	-0.730	-0.277	—	-0.083	-0.069	-0.053	-0.034				
0.900	2.877	-0.151	-0.226	-0.754	-0.762	-0.293	—	-0.079	-0.068	-0.043	-0.020				
0.900	5.817	-0.180	-0.256	-0.774	-0.803	-0.357	—	-0.116	-0.109	-0.067	-0.030				
0.899	8.873	-0.208	-0.293	-0.806	-0.839	-0.328	—	-0.111	-0.096	-0.057	-0.025				
0.877	-0.145	-0.153	-0.231	-0.796	-0.750	-0.225	—	-0.060	-0.046	-0.025	-0.006				
0.847	-0.145	-0.171	-0.258	-0.859	-0.703	-0.182	—	-0.040	-0.021	0.003	0.025				
0.800	-0.144	-0.195	-0.297	-0.937	-0.393	-0.184	—	-0.010	0.013	0.041	0.067				
0.698	-0.132	-0.216	-0.319	-0.630	-0.367	-0.207	—	-0.001	0.035	0.079	0.126				
0.602	-0.139	-0.201	-0.292	-0.545	-0.330	-0.193	—	-0.004	0.029	0.072	0.119				
0.600	-3.125	-0.210	-0.307	-0.591	-0.345	-0.198	—	-0.004	0.028	0.067	0.108				
0.602	-0.141	-0.199	-0.293	-0.548	-0.331	-0.195	—	-0.006	0.026	0.070	0.117				
0.602	2.842	-0.206	-0.295	-0.534	-0.329	-0.198	—	-0.010	0.027	0.076	0.119				
0.601	5.868	-0.223	-0.312	-0.536	-0.338	-0.212	—	-0.026	0.007	0.057	0.105				
0.602	8.847	-0.243	-0.332	-0.532	-0.340	-0.220	—	-0.044	-0.018	0.039	0.093				
0.401	-0.151	-0.178	-0.257	-0.466	-0.290	-0.174	—	-0.008	0.021	0.062	0.104				

Table 17. Continued

(b) Continued

$M_\infty$	$\alpha$ , deg	Static pressure coefficients on nozzle sidewall at centerline with values of $x/l$ of—														
		.153	.226	.300	.337	.411	.484	.558	.632	.705	.779	.853	.926			
0.952	-0.161	-0.085	-0.149	-0.725	-0.641	-0.535	-0.334	-0.214	-0.168	-0.144	-0.135	-0.120	-			
0.927	-0.125	-0.112	-0.179	-0.780	-0.693	-0.486	-0.217	-0.129	-0.105	-0.093	-0.088	-0.074	-			
0.899	-0.117	-0.134	-0.208	-0.842	-0.745	-0.359	-0.146	-0.093	-0.078	-0.069	-0.061	-0.043	-			
0.900	-3.120	-0.142	-0.212	-0.842	-0.755	-0.419	-0.177	-0.122	-0.107	-0.102	-0.092	-0.073	-			
0.899	-0.100	-0.136	-0.208	-0.844	-0.747	-0.364	-0.147	-0.096	-0.080	-0.075	-0.062	-0.042	-			
0.900	2.877	-0.139	-0.210	-0.836	-0.755	-0.401	-0.145	-0.090	-0.075	-0.066	-0.050	-0.032	-			
0.900	5.817	-0.159	-0.226	-0.844	-0.782	-0.514	-0.191	-0.124	-0.104	-0.092	-0.072	-0.050	-			
0.899	8.873	-0.193	-0.256	-0.859	-0.806	-0.532	-0.227	-0.162	-0.132	-0.114	-0.088	-0.060	-			
0.877	-0.145	-0.152	-0.233	-0.894	-0.781	-0.256	-0.118	-0.083	-0.068	-0.057	-0.039	-0.021	-			
0.847	-0.145	-0.171	-0.262	-0.964	-0.716	-0.193	-0.115	-0.081	-0.058	-0.041	-0.018	0.006	-			
0.800	-0.144	-0.196	-0.304	-0.974	-0.368	-0.190	-0.123	-0.076	-0.043	-0.019	0.011	0.040	-			
0.698	-0.132	-0.210	-0.318	-0.548	-0.330	-0.193	-0.124	-0.072	-0.031	-0.001	0.041	0.083	-			
0.602	-0.139	-0.195	-0.291	-0.476	-0.297	-0.178	-0.115	-0.064	-0.031	0.004	0.035	0.074	-			
0.600	-3.125	-0.201	-0.299	-0.486	-0.304	-0.182	-0.119	-0.065	-0.033	0.005	0.036	0.074	-			
0.602	-0.141	-0.197	-0.293	-0.477	-0.300	-0.180	-0.117	-0.064	-0.032	0.004	0.033	0.071	-			
0.602	2.842	-0.202	-0.299	-0.489	-0.306	-0.184	-0.120	-0.069	-0.036	0.001	0.032	0.070	-			
0.601	5.868	-0.221	-0.318	-0.510	-0.320	-0.197	-0.133	-0.082	-0.051	-0.011	0.019	0.055	-			
0.602	8.847	-0.249	-0.344	-0.529	-0.340	-0.216	-0.153	-0.101	-0.073	-0.032	-0.005	0.034	-			
0.401	-0.151	-0.175	-0.258	-0.411	-0.263	-0.157	-0.102	-0.054	-0.030	0.000	0.029	0.063	-			

Table 17. Continued

(b) Concluded

$M_\infty$	$\alpha$ , deg	Static pressure coefficients on nozzle sidewall at $z/Z = -0.50$ with values of $y/l$ of—									
		.153	.226	.300	.337	.411	.558	.705	.926		
0.952	-0.161	-0.089	-0.150	-0.663	-0.637	-	-0.322	-0.193	-0.097		
0.927	-0.125	-0.114	-0.183	-0.714	-0.689	-	-0.152	-0.115	-0.069		
0.899	-0.117	-0.135	-0.213	-0.772	-0.744	-	-0.113	-0.090	-0.041		
0.900	-3.120	-0.153	-0.234	-0.785	-0.769	-	-0.144	-0.136	-0.072		
0.899	-0.100	-0.136	-0.216	-0.773	-0.747	-	-0.114	-0.090	-0.046		
0.900	2.877	-0.134	-0.202	-0.775	-0.758	-	-0.116	-0.076	-0.016		
0.900	5.817	-0.161	-0.222	-0.796	-0.793	-	-0.171	-0.112	-0.036		
0.899	8.873	-0.209	-0.265	-0.831	-0.843	-	-0.221	-0.147	-0.047		
0.877	-0.145	-0.152	-0.236	-0.823	-0.788	-	-0.103	-0.074	-0.017		
0.847	-0.145	-0.171	-0.265	-0.888	-0.809	-	-0.101	-0.056	0.013		
0.800	-0.144	-0.196	-0.307	-0.977	-0.429	-	-0.093	-0.032	0.051		
0.698	-0.132	-0.210	-0.322	-0.613	-0.354	-	-0.077	0.002	0.123		
0.602	-0.139	-0.201	-0.290	-0.530	-0.314	-	-0.075	-0.003	0.124		
0.600	-3.125	-0.208	-0.290	-0.520	-0.312	-	-0.080	-0.002	0.127		
0.602	-0.141	-0.204	-0.290	-0.534	-0.316	-	-0.078	-0.006	0.125		
0.602	2.842	-0.209	-0.305	-0.572	-0.327	-	-0.077	-0.007	0.110		
0.601	5.868	-0.239	-0.336	-0.620	-0.351	-	-0.094	-0.026	0.098		
0.602	8.847	-0.284	-0.379	-0.673	-0.385	-	-0.130	-0.068	0.075		
0.401	-0.151	-0.180	-0.257	-0.454	-0.270	-	-0.070	-0.008	0.112		

Table 17. Continued

(c) Static pressure coefficients on nozzle bottom flap

$M_\infty$	$\alpha$ , deg	Static pressure coefficients on nozzle bottom flap at $y/Y = 0.75$ with values of $x/l$ of—											
		.153	.226	.300	.337	.411	.558	.705	.779	.853	.926		
0.952	-0.161	-0.092	-0.152	-	-0.841	-0.732	-0.322	-0.166	-0.114	-0.080	-0.063		
0.927	-0.125	-0.118	-0.184	-	-0.858	-0.432	-0.259	-0.173	-0.129	-0.091	-0.057		
0.899	-0.117	-0.139	-0.213	-	-0.822	-0.371	-0.228	-0.136	-0.091	-0.055	-0.023		
0.900	-3.120	-0.160	-0.248	-	-0.798	-0.374	-0.229	-0.116	-0.071	-0.040	-0.017		
0.899	-0.100	-0.141	-0.216	-	-0.825	-0.371	-0.234	-0.140	-0.095	-0.059	-0.025		
0.900	2.877	-0.131	-0.194	-	-0.764	-0.354	-0.232	-0.147	-0.111	-0.075	-0.040		
0.900	5.817	-0.135	-0.189	-	-0.821	-0.394	-0.263	-0.170	-0.132	-0.090	-0.051		
0.899	8.873	-0.150	-0.197	-	-0.899	-0.481	-0.294	-0.189	-0.143	-0.095	-0.050		
0.877	-0.145	-0.158	-0.239	-	-0.797	-0.348	-0.200	-0.104	-0.065	-0.028	0.004		
0.847	-0.145	-0.178	-0.267	-	-0.745	-0.316	-0.162	-0.065	-0.025	0.008	0.036		
0.800	-0.144	-0.204	-0.310	-	-0.688	-0.269	-0.113	-0.012	0.025	0.054	0.080		
0.698	-0.132	-0.229	-0.350	-	-0.485	-0.228	-0.063	0.041	0.081	0.116	0.150		
0.602	-0.139	-0.217	-0.324	-	-0.445	-0.221	-0.061	0.036	0.077	0.114	0.147		
0.600	-3.125	-0.215	-0.309	-	-0.382	-0.188	-0.034	0.051	0.083	0.108	0.131		
0.602	-0.141	-0.219	-0.326	-	-0.450	-0.223	-0.063	0.033	0.074	0.113	0.146		
0.602	2.842	-0.227	-0.342	-	-0.496	-0.250	-0.089	0.009	0.053	0.091	0.131		
0.601	5.868	-0.240	-0.356	-	-0.531	-0.270	-0.109	-0.014	0.030	0.071	0.117		
0.602	8.847	-0.256	-0.370	-	-0.558	-0.287	-0.125	-0.034	0.008	0.052	0.102		
0.401	-0.151	-0.199	-0.289	-	-0.400	-0.205	-0.059	0.033	0.069	0.104	0.137		

Table 17. Continued

(c) Continued

$M_\infty$	$\alpha$ , deg	Static pressure coefficients on nozzle bottom flap at $y/Y = 0.50$ with values of $x/l$ of—													
		.153	.226	.300	.337	.411	.558	.705	.779	.853	.926				
0.952	-0.161	-0.096	-	-0.768	-0.932	-0.802	-0.327	-0.203	-0.149	-0.103	-0.065				
0.927	-0.125	-0.121	-	-0.812	-0.646	-0.425	-0.300	-0.208	-0.161	-0.119	-0.077				
0.899	-0.117	-0.144	-	-0.828	-0.530	-0.382	-0.266	-0.168	-0.121	-0.079	-0.042				
0.900	-3.120	-0.157	-	-0.859	-0.560	-0.419	-0.285	-0.159	-0.102	-0.056	-0.022				
0.899	-0.100	-0.145	-	-0.836	-0.533	-0.381	-0.270	-0.171	-0.124	-0.083	-0.046				
0.900	2.877	-0.130	-	-0.817	-0.503	-0.357	-0.246	-0.165	-0.126	-0.087	-0.051				
0.900	5.817	-0.120	-	-0.842	-0.585	-0.397	-0.273	-0.181	-0.136	-0.096	-0.055				
0.899	8.873	-0.108	-	-0.858	-0.747	-0.454	-0.304	-0.199	-0.150	-0.102	-0.056				
0.877	-0.145	-0.164	-	-0.857	-0.512	-0.372	-0.243	-0.139	-0.090	-0.048	-0.012				
0.847	-0.145	-0.186	-	-0.887	-0.508	-0.370	-0.209	-0.092	-0.046	-0.006	0.025				
0.800	-0.144	-0.218	-	-1.046	-0.599	-0.362	-0.135	-0.018	0.022	0.055	0.077				
0.698	-0.132	-0.260	-	-1.193	-0.507	-0.219	-0.039	0.060	0.100	0.134	0.162				
0.602	-0.139	-0.255	-	-0.935	-0.476	-0.214	-0.037	0.059	0.098	0.133	0.165				
0.600	-3.125	-0.241	-	-0.826	-0.418	-0.178	-0.015	0.068	0.099	0.126	0.153				
0.602	-0.141	-0.259	-	-0.942	-0.479	-0.216	-0.038	0.057	0.096	0.131	0.163				
0.602	2.842	-0.267	-	-1.084	-0.544	-0.256	-0.073	0.027	0.070	0.108	0.148				
0.601	5.868	-0.271	-	-1.202	-0.591	-0.289	-0.101	0.000	0.045	0.086	0.134				
0.602	8.847	-0.267	-	-1.282	-0.620	-0.311	-0.122	-0.021	0.024	0.068	0.121				
0.401	-0.151	-0.239	-	-0.791	-0.432	-0.201	-0.038	0.052	0.091	0.123	0.155				

Table 17. Continued

(c) Concluded

$M_\infty$	$\alpha$ , deg	Static pressure coefficients on nozzle bottom flap at centerline with values of $x/l$ of—									
		.153	.226	.300	.337	.411	.558	.705	.926		
0.952	-0.161	-0.104	-0.177	-	-	-0.753	-	-0.233	-0.089		
0.927	-0.125	-0.127	-0.204	-	-	-0.404	-	-0.216	-0.085		
0.899	-0.117	-0.150	-0.233	-	-	-0.360	-	-0.177	-0.052		
0.900	-3.120	-0.155	-0.240	-	-	-0.394	-	-0.169	-0.041		
0.899	-0.100	-0.150	-0.235	-	-	-0.362	-	-0.176	-0.057		
0.900	2.877	-0.139	-0.217	-	-	-0.328	-	-0.176	-0.057		
0.900	5.817	-0.128	-0.207	-	-	-0.366	-	-0.190	-0.063		
0.899	8.873	-0.114	-0.194	-	-	-0.426	-	-0.212	-0.059		
0.877	-0.145	-0.168	-0.255	-	-	-0.352	-	-0.149	-0.021		
0.847	-0.145	-0.191	-0.289	-	-	-0.351	-	-0.103	0.018		
0.800	-0.144	-0.227	-0.343	-	-	-0.362	-	-0.032	0.074		
0.698	-0.132	-0.282	-0.438	-	-	-0.242	-	0.065	0.169		
0.602	-0.139	-0.280	-0.428	-	-	-0.238	-	0.062	0.175		
0.600	-3.125	-0.261	-0.399	-	-	-0.204	-	0.073	0.174		
0.602	-0.141	-0.283	-0.431	-	-	-0.240	-	0.059	0.177		
0.602	2.842	-0.299	-0.460	-	-	-0.284	-	0.028	0.162		
0.601	5.868	-0.305	-0.473	-	-	-0.316	-	0.001	0.152		
0.602	8.847	-0.301	-0.476	-	-	-0.338	-	-0.021	0.139		
0.401	-0.151	-0.262	-0.388	-	-	-0.227	-	0.050	0.171		



Table 17. Concluded

(d) Force data

$M_\infty$	$\alpha$ , deg	$C_D$
0.952	-0.161	0.2641
0.927	-0.125	0.2208
0.899	-0.117	0.1946
0.900	-3.120	0.2155
0.899	-0.100	0.1960
0.900	2.877	0.1919
0.900	5.817	0.2160
0.899	8.873	0.2385
0.877	-0.145	0.1770
0.847	-0.145	0.1564
0.800	-0.144	0.1241
0.698	-0.132	0.0769
0.602	-0.139	0.0718
0.600	-3.125	0.0752
0.602	-0.141	0.0718
0.602	2.842	0.0777
0.601	5.868	0.0885
0.602	8.847	0.0997
0.401	-0.151	0.0857

Table 18. Pressure and Force Data for Nozzle 11 With  $\beta_{l,top/bot} = \beta_{l,side} = 16.4^\circ$ , Plume On, and  $\alpha = 0^\circ$

(a) Static pressure coefficients on nozzle top flap

$M_\infty$	Static pressure coefficients on nozzle top flap at centerline with values of $x/l$ of—												
	.153	.226	.300	.337	.411	.484	.558	.632	.705	.779	.853	.926	
0.600	-0.276	-0.427	-	-0.487	-0.204	-0.076	0.006	0.070	0.117	-	-	0.196	0.224
0.700	-0.278	-0.433	-	-0.502	-0.194	-0.064	0.017	0.076	0.122	-	-	0.191	0.212
0.798	-0.219	-0.330	-	-0.382	-0.208	-0.124	-0.068	-0.027	0.007	-	-	0.070	0.099
1.250	0.001	-0.006	-	-0.497	-0.475	-0.430	-0.255	-0.131	-0.115	-	-	-0.082	-0.057
1.202	-0.002	-0.018	-	-0.543	-0.516	-0.469	-0.191	-0.143	-0.127	-	-	-0.093	-0.070
0.951	-0.095	-0.162	-	-0.452	-0.289	-0.233	-0.206	-0.183	-0.165	-	-	-0.116	-0.083
0.926	-0.121	-0.192	-	-0.358	-0.244	-0.209	-0.183	-0.162	-0.139	-	-	-0.082	-0.047
0.903	-0.141	-0.219	-	-0.326	-0.236	-0.199	-0.174	-0.148	-0.121	-	-	-0.057	-0.019
0.876	-0.163	-0.250	-	-0.318	-0.233	-0.188	-0.157	-0.125	-0.094	-	-	-0.026	0.013
0.852	-0.181	-0.277	-	-0.317	-0.221	-0.168	-0.130	-0.096	-0.063	-	-	0.003	0.040
0.799	-0.218	-0.332	-	-0.377	-0.204	-0.124	-0.072	-0.030	0.002	-	-	0.062	0.092
0.702	-0.277	-0.432	-	-0.498	-0.193	-0.064	0.017	0.077	0.122	-	-	0.186	0.207
0.602	-0.278	-0.426	-	-0.484	-0.204	-0.076	0.006	0.068	0.118	-	-	0.193	0.220
0.399	-0.253	-0.381	-	-0.434	-0.194	-0.077	0.001	0.061	0.105	-	-	0.186	0.216

$M_\infty$	Static pressure coefficients on nozzle top flap at $y/Y = 0.25$ with values of $x/l$ of—												
	.153	.226	.300	.337	.411	.484	.558	.632	.705	.779	.853	.926	
0.600	-0.268	-0.419	-0.962	-0.476	-0.197	0.007	0.007	0.117	0.161	0.161	0.196	0.226	
0.700	-0.270	-0.427	-1.300	-0.494	-0.188	0.016	0.016	0.122	0.161	0.161	0.190	0.214	
0.798	-0.214	-0.326	-0.898	-0.389	-0.214	-0.070	0.006	0.006	0.039	0.069	0.069	0.096	
1.250	0.002	-0.008	-0.379	-0.497	-0.471	-0.324	-0.119	-0.119	-0.100	-0.083	-0.059	-0.059	
1.202	-0.001	-0.015	-0.417	-0.539	-0.511	-0.221	-0.131	-0.131	-0.114	-0.094	-0.071	-0.071	
0.951	-0.094	-0.160	-0.748	-0.494	-0.305	-0.210	-0.171	-0.171	-0.144	-0.117	-0.083	-0.083	
0.926	-0.119	-0.191	-0.725	-0.377	-0.260	-0.189	-0.141	-0.141	-0.114	-0.086	-0.050	-0.050	
0.903	-0.140	-0.217	-0.704	-0.342	-0.242	-0.178	-0.125	-0.125	-0.091	-0.057	-0.022	-0.022	
0.876	-0.160	-0.249	-0.694	-0.322	-0.233	-0.160	-0.096	-0.096	-0.064	-0.026	0.010	0.010	
0.852	-0.178	-0.273	-0.724	-0.328	-0.226	-0.133	-0.065	-0.065	-0.031	0.003	0.039	0.039	
0.799	-0.214	-0.330	-0.876	-0.379	-0.208	-0.071	0.003	0.003	0.034	0.063	0.092	0.092	
0.702	-0.270	-0.425	-1.272	-0.493	-0.187	0.018	0.120	0.120	0.158	0.187	0.210	0.210	
0.602	-0.269	-0.419	-0.959	-0.478	-0.195	0.008	0.115	0.115	0.158	0.193	0.222	0.222	
0.399	-0.245	-0.372	-0.788	-0.428	-0.186	0.001	0.108	0.108	0.151	0.187	0.217	0.217	

Table 18. Continued

(a) Concluded

$M_\infty$	Static pressure coefficients on nozzle top flap at $y/Y = 0.50$ with values of $x/l$ of—									
	.153	.226	.300	.337	.411	.558	.705	.779	.853	.926
0.600	-0.250	-0.388	-0.924	-0.449	-0.182	0.010	0.116	0.155	0.194	0.224
0.700	-0.257	-0.403	-1.216	-0.472	-0.181	0.017	0.121	0.156	0.189	0.215
0.798	-0.209	-0.318	-0.935	-0.432	-0.221	-0.065	0.013	0.042	0.072	0.103
1.250	-0.001	-0.009	-0.377	-0.498	-0.439	-0.366	-0.111	-0.094	-0.077	-0.052
1.202	-0.002	-0.016	-0.418	-0.547	-0.476	-0.314	-0.125	-0.110	-0.092	-0.068
0.951	-0.097	-0.157	-0.766	-0.582	-0.327	-0.215	-0.174	-0.150	-0.120	-0.082
0.926	-0.119	-0.187	-0.767	-0.426	-0.282	-0.198	-0.147	-0.119	-0.086	-0.049
0.903	-0.138	-0.214	-0.752	-0.381	-0.262	-0.182	-0.125	-0.094	-0.060	-0.022
0.876	-0.160	-0.243	-0.749	-0.365	-0.251	-0.162	-0.099	-0.065	-0.029	0.011
0.852	-0.176	-0.267	-0.773	-0.365	-0.243	-0.135	-0.065	-0.030	0.005	0.041
0.799	-0.212	-0.320	-0.915	-0.424	-0.217	-0.067	0.007	0.036	0.065	0.095
0.702	-0.257	-0.402	-1.201	-0.470	-0.178	0.019	0.120	0.155	0.186	0.210
0.602	-0.253	-0.392	-0.923	-0.451	-0.182	0.010	0.114	0.153	0.189	0.218
0.399	-0.227	-0.350	-0.757	-0.400	-0.168	0.011	0.105	0.141	0.180	0.210

$M_\infty$	Static pressure coefficients on nozzle top flap at $y/Y = 0.75$ with values of $x/l$ of—									
	.153	.226	.300	.337	.411	.558	.705	.779	.853	.926
0.600	-0.215	-0.339	-	-0.429	-0.175	0.001	0.105	0.145	0.184	0.217
0.700	-0.227	-0.363	-	-0.464	-0.178	0.008	0.112	0.152	0.186	0.215
0.798	-0.195	-0.307	-	-0.511	-0.192	-0.044	0.030	0.059	0.090	0.122
1.250	0.000	-0.008	-	-0.448	-0.402	-0.321	-0.133	-0.087	-0.062	-0.031
1.202	-0.005	-0.018	-	-0.492	-0.438	-0.353	-0.125	-0.100	-0.078	-0.051
0.951	-0.093	-0.155	-	-0.777	-0.346	-0.227	-0.170	-0.145	-0.109	-0.074
0.926	-0.114	-0.185	-	-0.634	-0.301	-0.209	-0.142	-0.111	-0.074	-0.040
0.903	-0.134	-0.212	-	-0.514	-0.279	-0.188	-0.118	-0.086	-0.049	-0.013
0.876	-0.152	-0.238	-	-0.473	-0.270	-0.163	-0.088	-0.053	-0.014	0.021
0.852	-0.167	-0.260	-	-0.467	-0.251	-0.128	-0.051	-0.015	0.021	0.057
0.799	-0.194	-0.310	-	-0.502	-0.193	-0.048	0.024	0.053	0.083	0.115
0.702	-0.226	-0.362	-	-0.463	-0.177	0.009	0.112	0.151	0.184	0.211
0.602	-0.216	-0.341	-	-0.429	-0.174	0.001	0.104	0.145	0.183	0.213
0.399	-0.194	-0.300	-	-0.376	-0.160	0.001	0.096	0.136	0.172	0.203

Table 18. Continued

## (b) Static pressure coefficients on nozzle sidewall

$M_\infty$	Static pressure coefficients on corner between nozzle top flap and sidewall with values of $x/l$ of—									
	.153	.226	.300	.337	.411	.558	.705	.779	.853	.926
0.600	-0.218	-	-0.744	-0.411	-0.161	0.006	0.097	0.135	0.171	0.205
0.700	-0.229	-	-0.903	-0.445	-0.166	0.011	0.104	0.142	0.177	0.207
0.798	-0.200	-	-1.013	-0.554	-0.176	-0.017	0.057	0.083	0.108	0.127
1.250	0.001	-	-0.319	-0.446	-0.381	-0.281	-0.202	-0.114	-0.049	-0.003
1.202	-0.005	-	-0.360	-0.489	-0.413	-0.313	-0.176	-0.101	-0.058	-0.023
0.951	-0.094	-	-0.677	-0.844	-0.431	-0.206	-0.152	-0.127	-0.104	-0.088
0.926	-0.119	-	-0.732	-0.815	-0.319	-0.188	-0.119	-0.091	-0.066	-0.044
0.903	-0.139	-	-0.782	-0.704	-0.281	-0.164	-0.088	-0.058	-0.030	-0.010
0.876	-0.158	-	-0.836	-0.615	-0.264	-0.129	-0.050	-0.020	0.006	0.028
0.852	-0.171	-	-0.892	-0.578	-0.239	-0.089	-0.011	0.015	0.042	0.062
0.799	-0.200	-	-1.013	-0.550	-0.177	-0.019	0.053	0.079	0.102	0.120
0.702	-0.228	-	-0.899	-0.444	-0.163	0.013	0.105	0.140	0.175	0.204
0.602	-0.219	-	-0.741	-0.411	-0.158	0.005	0.095	0.131	0.168	0.202
0.399	-0.197	-	-0.622	-0.361	-0.143	0.009	0.088	0.123	0.158	0.192

$M_\infty$	Static pressure coefficients on nozzle sidewall at $z/Z = 0.50$ with values of $x/l$ of—									
	.153	.226	.300	.337	.411	.558	.705	.779	.853	.926
0.600	-0.216	-0.332	-0.720	-0.411	-0.158	-	0.098	0.134	0.173	0.205
0.700	-0.226	-0.358	-0.869	-0.446	-0.164	-	0.105	0.141	0.178	0.208
0.798	-0.200	-0.311	-1.004	-0.555	-0.195	-	0.063	0.095	0.126	0.156
1.250	-0.004	-0.010	-0.320	-0.447	-0.409	-	-0.205	-0.130	-0.049	0.009
1.202	-0.009	-0.024	-0.355	-0.486	-0.442	-	-0.194	-0.107	-0.049	-0.004
0.951	-0.100	-0.163	-0.668	-0.853	-0.549	-	-0.119	-0.090	-0.053	-0.010
0.926	-0.122	-0.192	-0.722	-0.875	-0.346	-	-0.088	-0.055	-0.017	0.022
0.903	-0.141	-0.217	-0.770	-0.770	-0.309	-	-0.066	-0.029	0.009	0.046
0.876	-0.162	-0.244	-0.830	-0.664	-0.288	-	-0.030	0.004	0.040	0.075
0.852	-0.173	-0.266	-0.880	-0.608	-0.265	-	0.007	0.037	0.072	0.105
0.799	-0.204	-0.314	-1.004	-0.553	-0.199	-	0.062	0.091	0.121	0.152
0.702	-0.227	-0.356	-0.865	-0.442	-0.160	-	0.103	0.141	0.177	0.206
0.602	-0.217	-0.334	-0.715	-0.408	-0.158	-	0.095	0.135	0.171	0.203
0.399	-0.195	-0.295	-0.603	-0.363	-0.144	-	0.092	0.125	0.161	0.194

Table 18. Continued

(b) Concluded

$M_\infty$	Static pressure coefficients on nozzle sidewall at centerline with values of $x/l$ of—													
	.153	.226	.300	.337	.411	.484	.558	.632	.705	.779	.853	.926		
0.600	-0.218	-0.344	-0.846	-0.385	-0.153	-0.052	0.013	0.058	0.101	0.135	0.170	—		
0.700	-0.230	-0.366	-1.015	-0.409	-0.156	-0.051	0.015	0.064	0.108	0.142	0.177	—		
0.798	-0.202	-0.313	-1.041	-0.569	-0.251	-0.089	-0.010	0.037	0.074	0.103	0.131	—		
1.250	0.005	-0.008	-0.384	-0.492	-0.405	-0.330	-0.265	-0.225	-0.198	-0.134	-0.049	—		
1.202	-0.006	-0.024	-0.427	-0.540	-0.437	-0.352	-0.289	-0.248	-0.195	-0.109	-0.044	—		
0.951	-0.099	-0.159	-0.784	-0.920	-0.619	-0.238	-0.158	-0.117	-0.090	-0.066	-0.032	—		
0.926	-0.122	-0.188	-0.838	-0.854	-0.381	-0.216	-0.144	-0.103	-0.073	-0.039	-0.004	—		
0.903	-0.141	-0.214	-0.864	-0.578	-0.372	-0.242	-0.149	-0.093	-0.052	-0.019	0.016	—		
0.876	-0.159	-0.242	-0.882	-0.540	-0.356	-0.212	-0.118	-0.063	-0.020	0.015	0.047	—		
0.852	-0.173	-0.264	-0.906	-0.534	-0.336	-0.174	-0.080	-0.023	0.015	0.048	0.079	—		
0.799	-0.204	-0.316	-1.016	-0.566	-0.248	-0.093	-0.013	0.034	0.069	0.099	0.129	—		
0.702	-0.229	-0.364	-1.005	-0.407	-0.155	-0.052	0.015	0.065	0.106	0.142	0.176	—		
0.602	-0.220	-0.345	-0.837	-0.384	-0.153	-0.053	0.010	0.057	0.097	0.134	0.169	—		
0.399	-0.198	-0.312	-0.703	-0.339	-0.139	-0.049	0.010	0.055	0.091	0.125	0.161	—		

$M_\infty$	Static pressure coefficients on nozzle sidewall at $z/Z = -0.50$ with values of $x/l$ of—													
	.153	.226	.300	.337	.411	.484	.558	.632	.705	.779	.853	.926		
0.600	-0.216	-0.331	-0.780	-0.389	-0.153	-0.052	0.013	0.058	0.101	0.135	0.170	—		
0.700	-0.229	-0.354	-0.948	-0.418	-0.156	-0.051	0.015	0.064	0.108	0.142	0.177	—		
0.798	-0.202	-0.311	-1.075	-0.589	-0.251	-0.089	-0.010	0.037	0.074	0.103	0.131	—		
1.250	0.006	-0.011	-0.348	-0.463	-0.405	-0.330	-0.265	-0.225	-0.198	-0.134	-0.049	—		
1.202	-0.009	-0.028	-0.390	-0.505	-0.437	-0.352	-0.289	-0.248	-0.195	-0.109	-0.044	—		
0.951	-0.097	-0.164	-0.721	-0.871	-0.619	-0.238	-0.158	-0.117	-0.090	-0.066	-0.032	—		
0.926	-0.121	-0.193	-0.775	-0.883	-0.381	-0.216	-0.144	-0.103	-0.073	-0.039	-0.004	—		
0.903	-0.139	-0.216	-0.825	-0.782	-0.372	-0.242	-0.149	-0.093	-0.052	-0.019	0.016	—		
0.876	-0.160	-0.243	-0.884	-0.654	-0.356	-0.212	-0.118	-0.063	-0.020	0.015	0.047	—		
0.852	-0.170	-0.265	-0.939	-0.605	-0.336	-0.174	-0.080	-0.023	0.015	0.048	0.079	—		
0.799	-0.202	-0.314	-1.076	-0.584	-0.248	-0.093	-0.013	0.034	0.069	0.099	0.129	—		
0.702	-0.225	-0.355	-0.942	-0.417	-0.155	-0.052	0.015	0.065	0.106	0.142	0.176	—		
0.602	-0.213	-0.332	-0.780	-0.387	-0.153	-0.053	0.010	0.057	0.097	0.134	0.169	—		
0.399	-0.190	-0.297	-0.653	-0.339	-0.139	-0.049	0.010	0.055	0.091	0.125	0.161	—		

Table 18. Continued

(c) Static pressure coefficients on nozzle bottom flap

$M_\infty$	Static pressure coefficients on nozzle bottom flap at $y/Y = 0.75$ with values of $x/l$ of—										
	.153	.226	.300	.337	.411	.558	.705	.779	.853	.926	
0.600	-0.222	-0.337	-0.765	-0.422	-0.169	0.002	0.104	0.146	0.184	0.218	
0.700	-0.234	-0.363	-0.929	-0.454	-0.174	0.007	0.112	0.153	0.190	0.221	
0.798	-0.207	-0.315	-1.020	-0.604	-0.209	-0.018	0.074	0.108	0.138	0.164	
1.250	0.005	-0.011	-0.321	-0.453	-0.405	-0.340	-0.159	-0.082	-0.052	-0.021	
1.202	-0.013	-0.030	-0.362	-0.496	-0.443	-0.370	-0.134	-0.093	-0.063	-0.036	
0.951	-0.099	-0.166	-0.678	-0.830	-0.461	-0.197	-0.126	-0.086	-0.062	-0.026	
0.926	-0.123	-0.196	-0.729	-0.749	-0.312	-0.196	-0.122	-0.086	-0.049	-0.013	
0.903	-0.142	-0.220	-0.777	-0.664	-0.298	-0.177	-0.092	-0.052	-0.017	0.019	
0.876	-0.163	-0.247	-0.837	-0.591	-0.283	-0.145	-0.051	-0.013	0.021	0.056	
0.852	-0.176	-0.269	-0.888	-0.573	-0.265	-0.105	-0.012	0.026	0.060	0.092	
0.799	-0.208	-0.317	-1.018	-0.597	-0.213	-0.022	0.072	0.104	0.133	0.158	
0.702	-0.232	-0.362	-0.928	-0.450	-0.173	0.007	0.112	0.152	0.188	0.216	
0.602	-0.223	-0.338	-0.765	-0.421	-0.172	0.000	0.101	0.144	0.180	0.214	
0.399	-0.198	-0.300	-0.644	-0.374	-0.157	-0.002	0.092	0.136	0.172	0.204	

$M_\infty$	Static pressure coefficients on nozzle bottom flap at $y/Y = 0.50$ with values of $x/l$ of—										
	.153	.226	.300	.337	.411	.558	.705	.779	.853	.926	
0.600	-0.248	-0.384	-0.815	-0.447	-0.184	0.003	0.112	0.153	0.190	0.222	
0.700	-0.256	-0.408	-0.999	-0.475	-0.184	0.009	0.117	0.158	0.194	0.224	
0.798	-0.218	-0.337	-1.092	-0.534	-0.253	-0.037	0.069	0.105	0.134	0.158	
1.250	0.009	-0.008	-0.378	-0.490	-0.458	-0.397	-0.117	-0.087	-0.060	-0.036	
1.202	-0.010	-0.025	-0.418	-0.534	-0.497	-0.414	-0.127	-0.096	-0.069	-0.045	
0.951	-0.102	-0.174	-0.759	-0.750	-0.374	-0.211	-0.135	-0.102	-0.069	-0.036	
0.926	-0.126	-0.203	-0.790	-0.492	-0.300	-0.197	-0.119	-0.086	-0.052	-0.017	
0.903	-0.147	-0.230	-0.806	-0.440	-0.288	-0.180	-0.096	-0.058	-0.021	0.013	
0.876	-0.168	-0.258	-0.839	-0.420	-0.284	-0.154	-0.058	-0.020	0.016	0.047	
0.852	-0.183	-0.282	-0.868	-0.424	-0.280	-0.128	-0.022	0.017	0.052	0.084	
0.799	-0.219	-0.338	-1.074	-0.528	-0.256	-0.041	0.064	0.100	0.129	0.154	
0.702	-0.254	-0.408	-0.990	-0.470	-0.183	0.009	0.116	0.156	0.191	0.219	
0.602	-0.246	-0.385	-0.812	-0.450	-0.185	-0.001	0.107	0.149	0.186	0.215	
0.399	-0.223	-0.345	-0.685	-0.400	-0.176	-0.005	0.099	0.142	0.177	0.209	

Table 18. Concluded

(c) Concluded

$M_\infty$	Static pressure coefficients on nozzle bottom flap at centerline with values of $x/l$ of—									
	.153	.226	.300	.337	.411	.558	.705	.926		
0.600	-0.271	-0.411	-0.849	-0.471	-0.210	-0.008	0.104	0.234		
0.700	-0.280	-0.437	-1.055	-0.498	-0.209	0.002	0.116	0.235		
0.798	-0.231	-0.358	-1.097	-0.531	-0.249	-0.044	0.063	0.158		
1.250	0.006	-0.017	-0.383	-0.478	-0.464	-0.398	-0.124	-0.043		
1.202	-0.009	-0.037	-0.425	-0.525	-0.508	-0.265	-0.138	-0.057		
0.951	-0.113	-0.192	-0.768	-0.572	-0.323	-0.222	-0.161	-0.054		
0.926	-0.135	-0.218	-0.778	-0.433	-0.280	-0.189	-0.127	-0.022		
0.903	-0.153	-0.241	-0.773	-0.395	-0.269	-0.180	-0.103	0.008		
0.876	-0.176	-0.270	-0.808	-0.397	-0.269	-0.158	-0.069	0.043		
0.852	-0.193	-0.296	-0.865	-0.422	-0.263	-0.125	-0.029	0.080		
0.799	-0.233	-0.358	-1.076	-0.530	-0.252	-0.046	0.058	0.152		
0.702	-0.276	-0.435	-1.052	-0.496	-0.206	0.001	0.114	0.229		
0.602	-0.270	-0.411	-0.852	-0.472	-0.210	-0.011	0.104	0.227		
0.399	-0.247	-0.366	-0.715	-0.417	-0.197	-0.017	0.094	0.220		

(d) Force data

$M_\infty$	$C_D$	$C_{D,p}$	$C_{D,f}$
0.600	0.0348	0.0396	0.0120
0.700	0.0381	0.0498	0.0117
0.798	0.0919	0.0986	0.0114
1.250	0.2338	0.2192	0.0106
1.202	0.2462	0.2332	0.0107
0.951	0.2336	0.2322	0.0112
0.926	0.1998	0.1966	0.0112
0.903	0.1762	0.1759	0.0113
0.876	0.1534	0.1553	0.0113
0.852	0.1341	0.1347	0.0114
0.799	0.0917	0.1000	0.0115
0.702	0.0438	0.0496	0.0118
0.602	0.0379	0.0405	0.0120
0.399	0.0315	0.0318	0.0128

Table 19. Pressure and Force Data for Nozzle 11 With  $\beta_{r,top/bot} = \beta_{r,side} = 16.4^\circ$  and Plume Off

(a) Static pressure coefficients on nozzle top flap

$M_\infty$	$\alpha$ , deg	Static pressure coefficients on nozzle top flap at centerline with values of $x/l$ of—														
		.153	.226	.300	.337	.411	.484	.558	.632	.705	.779	.853	.926			
1.251	-0.020	0.002	-0.006	—	-0.493	-0.478	-0.428	-0.275	-0.132	-0.112	—	-0.084	-0.066			
1.198	-0.021	-0.003	-0.019	—	-0.551	-0.527	-0.466	-0.200	-0.145	-0.129	—	-0.101	-0.083			
1.200	-0.022	0.000	-0.015	—	-0.545	-0.525	-0.464	-0.203	-0.144	-0.127	—	-0.102	-0.083			
1.200	2.984	0.003	-0.018	—	-0.545	-0.533	-0.455	-0.230	-0.151	-0.133	—	-0.101	-0.078			
1.200	6.037	0.002	-0.020	—	-0.543	-0.537	-0.471	-0.425	-0.215	-0.160	—	-0.116	-0.086			
1.150	-0.010	-0.020	-0.040	—	-0.601	-0.578	-0.455	-0.196	-0.164	-0.148	—	-0.118	-0.102			
0.952	-0.027	-0.096	-0.160	—	-0.389	-0.250	-0.203	-0.178	-0.163	-0.147	—	-0.121	-0.096			
0.924	-0.033	-0.124	-0.196	—	-0.322	-0.226	-0.193	-0.172	-0.155	-0.138	—	-0.096	-0.067			
0.900	-0.015	-0.144	-0.223	—	-0.307	-0.221	-0.187	-0.168	-0.145	-0.122	—	-0.069	-0.036			
0.900	-3.015	-0.132	-0.207	—	-0.359	-0.254	-0.213	-0.191	-0.170	-0.149	—	-0.098	-0.063			
0.900	0.022	-0.145	-0.224	—	-0.310	-0.221	-0.187	-0.166	-0.144	-0.125	—	-0.071	-0.038			
0.901	2.967	-0.153	-0.235	—	-0.337	-0.247	-0.208	-0.182	-0.151	-0.119	—	-0.049	-0.011			
0.901	5.968	-0.161	-0.240	—	-0.406	-0.298	-0.251	-0.213	-0.171	-0.128	—	-0.043	0.000			
0.900	8.984	-0.163	-0.236	—	-0.445	-0.323	-0.268	-0.223	-0.175	-0.129	—	-0.036	0.012			
0.877	-0.016	-0.164	-0.249	—	-0.304	-0.217	-0.185	-0.155	-0.130	-0.105	—	-0.048	-0.010			
0.850	-0.023	-0.185	-0.280	—	-0.315	-0.223	-0.174	-0.137	-0.101	-0.072	—	-0.010	0.024			
0.800	-0.031	-0.218	-0.334	—	-0.368	-0.208	-0.131	-0.082	-0.039	-0.010	—	0.048	0.075			
0.701	-0.012	-0.287	-0.442	—	-0.543	-0.225	-0.094	-0.016	0.042	0.086	—	0.153	0.178			
0.601	-0.012	-0.440	-0.440	—	-0.510	-0.229	-0.104	-0.027	0.031	0.076	—	0.144	0.173			
0.602	-3.020	-0.304	-0.474	—	-0.582	-0.282	-0.152	-0.073	-0.012	0.035	—	0.115	0.152			
0.600	0.002	-0.288	-0.441	—	-0.511	-0.230	-0.105	-0.028	0.030	0.073	—	0.143	0.172			
0.601	3.010	-0.265	-0.405	—	-0.456	-0.190	-0.071	0.000	0.033	0.090	—	0.146	0.168			
0.602	5.979	-0.249	-0.385	—	-0.440	-0.180	-0.066	0.000	0.049	0.084	—	0.136	0.159			
0.601	8.990	-0.241	-0.382	—	-0.464	-0.199	-0.084	-0.018	0.030	0.063	—	0.116	0.139			
0.402	-0.026	-0.263	-0.395	—	-0.458	-0.214	-0.102	-0.029	0.026	0.066	—	0.135	0.162			



Table 19. Continued

(a) Continued

$M_\infty$	$\alpha$ , deg	Static pressure coefficients on nozzle top flap at $y/Y = 0.25$ with values of $x/l$ of—													
		.153	.226	.300	.337	.411	.558	.705	.779	.853	.926				
1.251	-0.020	0.005	-0.006	-0.377	-0.493	-0.472	-0.317	-0.117	-0.098	-0.086	-0.067				
1.198	-0.021	-0.001	-0.019	-0.423	-0.546	-0.519	-0.230	-0.135	-0.116	-0.103	-0.084				
1.200	-0.022	0.003	-0.015	-0.418	-0.542	-0.517	-0.235	-0.133	-0.115	-0.102	-0.084				
1.200	2.984	0.006	-0.016	-0.422	-0.544	-0.523	-0.249	-0.135	-0.114	-0.098	-0.077				
1.200	6.037	0.002	-0.019	-0.422	-0.545	-0.527	-0.451	-0.163	-0.134	-0.111	-0.082				
1.150	-0.010	-0.020	-0.038	-0.468	-0.594	-0.574	-0.211	-0.150	-0.135	-0.120	-0.101				
0.952	-0.027	-0.092	-0.159	-0.709	-0.406	-0.259	-0.182	-0.151	-0.138	-0.121	-0.098				
0.924	-0.033	-0.122	-0.193	-0.685	-0.348	-0.239	-0.176	-0.143	-0.120	-0.094	-0.066				
0.900	-0.015	-0.140	-0.221	-0.679	-0.328	-0.236	-0.173	-0.127	-0.097	-0.069	-0.036				
0.900	-3.015	-0.129	-0.206	-0.731	-0.373	-0.261	-0.195	-0.154	-0.126	-0.099	-0.064				
0.900	0.022	-0.141	-0.222	-0.675	-0.322	-0.230	-0.166	-0.127	-0.098	-0.071	-0.038				
0.901	2.967	-0.149	-0.232	-0.704	-0.351	-0.254	-0.183	-0.124	-0.085	-0.050	-0.014				
0.901	5.968	-0.158	-0.239	-0.778	-0.422	-0.308	-0.213	-0.133	-0.085	-0.042	-0.002				
0.900	8.984	-0.165	-0.240	-0.808	-0.450	-0.328	-0.223	-0.133	-0.084	-0.034	0.011				
0.877	-0.016	-0.159	-0.247	-0.683	-0.323	-0.229	-0.159	-0.108	-0.075	-0.045	-0.008				
0.850	-0.023	-0.183	-0.279	-0.728	-0.335	-0.229	-0.138	-0.075	-0.044	-0.011	0.023				
0.800	-0.031	-0.214	-0.328	-0.877	-0.387	-0.217	-0.079	-0.008	0.023	0.050	0.076				
0.701	-0.012	-0.278	-0.436	-1.328	-0.533	-0.218	-0.015	0.084	0.122	0.152	0.178				
0.601	-0.012	-0.279	-0.432	-0.992	-0.503	-0.222	-0.025	0.074	0.112	0.145	0.172				
0.602	-3.020	-0.297	-0.465	-1.129	-0.574	-0.276	-0.071	0.034	0.078	0.116	0.152				
0.600	0.002	-0.281	-0.433	-0.997	-0.505	-0.224	-0.027	0.072	0.111	0.143	0.171				
0.601	3.010	-0.258	-0.397	-0.906	-0.450	-0.183	0.001	0.090	0.122	0.147	0.167				
0.602	5.979	-0.242	-0.376	-0.879	-0.435	-0.175	0.001	0.083	0.112	0.136	0.158				
0.601	8.990	-0.236	-0.373	-0.916	-0.460	-0.195	-0.018	0.062	0.092	0.116	0.139				
0.402	-0.026	-0.256	-0.385	-0.817	-0.449	-0.210	-0.026	0.067	0.106	0.135	0.164				

Table 19. Continued  
(a) Continued

$M_\infty$	$\alpha$ , deg	Static pressure coefficients on nozzle top flap at $y/Y = 0.50$ with values of $v/l$ of—													
		.153	.226	.300	.337	.411	.558	.705	.779	.853	.926				
1.251	-0.020	-0.002	-0.005	-0.375	-0.496	-0.438	-0.357	-0.113	-0.097	-0.083	-0.062				
1.198	-0.021	-0.004	-0.017	-0.422	-0.548	-0.484	-0.315	-0.128	-0.114	-0.099	-0.080				
1.200	-0.022	0.000	-0.014	-0.417	-0.544	-0.481	-0.320	-0.127	-0.112	-0.099	-0.080				
1.200	2.984	-0.002	-0.017	-0.421	-0.564	-0.509	-0.295	-0.126	-0.107	-0.091	-0.073				
1.200	6.037	-0.012	-0.023	-0.420	-0.565	-0.530	-0.385	-0.160	-0.124	-0.100	-0.074				
1.150	-0.010	-0.023	-0.040	-0.469	-0.603	-0.536	-0.253	-0.148	-0.133	-0.119	-0.096				
0.952	-0.027	-0.097	-0.157	-0.737	-0.452	-0.278	-0.190	-0.160	-0.145	-0.127	-0.098				
0.924	-0.033	-0.121	-0.190	-0.725	-0.381	-0.257	-0.187	-0.149	-0.124	-0.098	-0.064				
0.900	-0.015	-0.141	-0.216	-0.730	-0.369	-0.256	-0.178	-0.130	-0.103	-0.072	-0.037				
0.900	-3.015	-0.130	-0.200	-0.798	-0.435	-0.288	-0.205	-0.161	-0.133	-0.102	-0.065				
0.900	0.022	-0.142	-0.218	-0.719	-0.356	-0.248	-0.174	-0.131	-0.103	-0.074	-0.039				
0.901	2.967	-0.155	-0.231	-0.746	-0.390	-0.278	-0.187	-0.126	-0.088	-0.052	-0.013				
0.901	5.968	-0.172	-0.243	-0.832	-0.467	-0.334	-0.212	-0.127	-0.079	-0.037	0.004				
0.900	8.984	-0.194	-0.263	-0.837	-0.471	-0.339	-0.221	-0.130	-0.079	-0.033	0.014				
0.877	-0.016	-0.160	-0.242	-0.734	-0.359	-0.248	-0.164	-0.108	-0.079	-0.045	-0.009				
0.850	-0.023	-0.180	-0.272	-0.776	-0.372	-0.245	-0.140	-0.074	-0.042	-0.011	0.024				
0.800	-0.031	-0.211	-0.321	-0.916	-0.432	-0.229	-0.075	-0.003	0.024	0.051	0.075				
0.701	-0.012	-0.264	-0.412	-1.259	-0.501	-0.203	-0.012	0.084	0.117	0.149	0.176				
0.601	-0.012	-0.262	-0.403	-0.945	-0.472	-0.204	-0.019	0.074	0.109	0.142	0.169				
0.602	-3.020	-0.276	-0.433	-1.086	-0.544	-0.256	-0.063	0.037	0.077	0.115	0.150				
0.600	0.002	-0.263	-0.405	-0.948	-0.474	-0.206	-0.021	0.072	0.108	0.140	0.169				
0.601	3.010	-0.243	-0.363	-0.872	-0.413	-0.161	0.010	0.090	0.119	0.145	0.164				
0.602	5.979	-0.235	-0.340	-0.887	-0.403	-0.151	0.010	0.084	0.110	0.134	0.155				
0.601	8.990	-0.247	-0.353	-0.924	-0.425	-0.167	-0.007	0.067	0.093	0.118	0.139				
0.402	-0.026	-0.236	-0.358	-0.781	-0.419	-0.189	-0.015	0.068	0.100	0.132	0.160				

Table 19. Continued

(a) Concluded

$M_\infty$	$\alpha$ , deg	Static pressure coefficients on nozzle top flap at $y/Y = 0.75$ with values of $x/l$ of—													
		.153	.226	.300	.337	.411	.558	.705	.779	.853	.926				
1.251	-0.020	-0.001	-0.006	-	-0.450	-0.401	-0.323	-0.128	-0.091	-0.072	-0.055				
1.198	-0.021	-0.004	-0.016	-	-0.494	-0.446	-0.356	-0.127	-0.107	-0.089	-0.074				
1.200	-0.022	-0.002	-0.013	-	-0.491	-0.443	-0.354	-0.126	-0.106	-0.088	-0.073				
1.200	2.984	-0.012	-0.041	-	-0.456	-0.408	-0.326	-0.132	-0.103	-0.080	-0.065				
1.200	6.037	-0.026	-0.052	-	-0.480	-0.389	-0.330	-0.198	-0.137	-0.096	-0.068				
1.150	-0.010	-0.029	-0.046	-	-0.551	-0.497	-0.370	-0.140	-0.124	-0.109	-0.090				
0.952	-0.027	-0.091	-0.153	-	-0.654	-0.292	-0.208	-0.168	-0.152	-0.129	-0.102				
0.924	-0.033	-0.116	-0.187	-	-0.544	-0.275	-0.202	-0.150	-0.125	-0.095	-0.061				
0.900	-0.015	-0.135	-0.212	-	-0.494	-0.275	-0.193	-0.128	-0.100	-0.067	-0.032				
0.900	-3.015	-0.130	-0.193	-	-0.622	-0.322	-0.227	-0.160	-0.132	-0.097	-0.061				
0.900	0.022	-0.137	-0.213	-	-0.481	-0.269	-0.192	-0.129	-0.102	-0.069	-0.035				
0.901	2.967	-0.156	-0.247	-	-0.456	-0.274	-0.192	-0.109	-0.071	-0.033	0.001				
0.901	5.968	-0.174	-0.266	-	-0.487	-0.311	-0.205	-0.095	-0.049	-0.006	0.027				
0.900	8.984	-0.193	-0.282	-	-0.460	-0.315	-0.207	-0.104	-0.056	-0.007	0.033				
0.877	-0.016	-0.154	-0.238	-	-0.465	-0.267	-0.171	-0.103	-0.072	-0.038	-0.006				
0.850	-0.023	-0.170	-0.265	-	-0.478	-0.260	-0.135	-0.062	-0.031	-0.001	0.031				
0.800	-0.031	-0.197	-0.311	-	-0.519	-0.207	-0.061	0.010	0.036	0.060	0.082				
0.701	-0.012	-0.234	-0.374	-	-0.485	-0.200	-0.019	0.079	0.114	0.145	0.170				
0.601	-0.012	-0.223	-0.351	-	-0.445	-0.194	-0.024	0.069	0.106	0.136	0.165				
0.602	-3.020	-0.232	-0.371	-	-0.512	-0.233	-0.057	0.040	0.080	0.114	0.150				
0.600	0.002	-0.224	-0.353	-	-0.448	-0.196	-0.026	0.068	0.104	0.134	0.164				
0.601	3.010	-0.221	-0.330	-	-0.366	-0.155	0.003	0.086	0.116	0.140	0.160				
0.602	5.979	-0.221	-0.315	-	-0.322	-0.129	0.008	0.077	0.104	0.125	0.147				
0.601	8.990	-0.225	-0.307	-	-0.313	-0.125	-0.003	0.067	0.095	0.116	0.137				
0.402	-0.026	-0.202	-0.312	-	-0.396	-0.176	-0.025	0.062	0.098	0.128	0.153				

Table 19. Continued

(b) Static pressure coefficients on nozzle sidewall

$M_\infty$	$\alpha$ , deg	Static pressure coefficients on corner between nozzle top flap and sidewall with values of $x/l$ of—									
		.153	.226	.300	.337	.411	.558	.705	.779	.853	.926
1.251	-0.020	0.000	-	-0.320	-0.444	-0.380	-0.280	-0.199	-0.120	-0.080	-0.058
1.198	-0.021	-0.006	-	-0.360	-0.492	-0.420	-0.317	-0.181	-0.116	-0.092	-0.076
1.200	-0.022	-0.004	-	-0.357	-0.489	-0.417	-0.314	-0.181	-0.116	-0.091	-0.075
1.200	2.984	-0.015	-	-0.376	-0.492	-0.393	-0.300	-0.175	-0.122	-0.088	-0.063
1.200	6.037	-0.030	-	-0.383	-0.479	-0.363	-0.288	-0.227	-0.183	-0.130	-0.080
1.150	-0.010	-0.033	-	-0.411	-0.547	-0.472	-0.349	-0.160	-0.121	-0.106	-0.091
0.952	-0.027	-0.096	-	-0.677	-0.788	-0.347	-0.213	-0.181	-0.169	-0.145	-0.118
0.924	-0.033	-0.121	-	-0.734	-0.738	-0.309	-0.201	-0.146	-0.118	-0.092	-0.070
0.900	-0.015	-0.140	-	-0.786	-0.684	-0.294	-0.180	-0.110	-0.082	-0.054	-0.032
0.900	3.015	-0.139	-	-0.783	-0.778	-0.340	-0.221	-0.153	-0.122	-0.091	-0.064
0.900	0.022	-0.141	-	-0.786	-0.669	-0.290	-0.181	-0.114	-0.086	-0.059	-0.036
0.901	2.967	-0.159	-	-0.804	-0.681	-0.284	-0.166	-0.076	-0.044	-0.013	0.007
0.901	5.968	-0.180	-	-0.819	-0.601	-0.315	-0.187	-0.070	-0.029	0.005	0.027
0.900	8.984	-0.199	-	-0.808	-0.484	-0.308	-0.201	-0.088	-0.044	-0.008	0.014
0.877	-0.016	-0.158	-	-0.834	-0.621	-0.277	-0.150	-0.077	-0.048	-0.022	-0.001
0.850	-0.023	-0.177	-	-0.896	-0.612	-0.255	-0.105	-0.030	-0.003	0.017	0.037
0.800	-0.031	-0.203	-	-1.014	-0.577	-0.195	-0.034	0.032	0.055	0.074	0.089
0.701	-0.012	-0.238	-	-0.932	-0.465	-0.184	-0.012	0.072	0.105	0.134	0.159
0.601	-0.012	-0.227	-	-0.760	-0.426	-0.175	-0.017	0.065	0.096	0.125	0.153
0.602	3.020	-0.237	-	-0.863	-0.478	-0.205	-0.039	0.048	0.081	0.114	0.143
0.600	0.002	-0.228	-	-0.766	-0.430	-0.178	-0.018	0.063	0.094	0.124	0.151
0.601	3.010	-0.227	-	-0.675	-0.374	-0.146	0.003	0.079	0.109	0.135	0.158
0.602	5.979	-0.234	-	-0.606	-0.322	-0.118	0.010	0.073	0.096	0.118	0.139
0.601	8.990	-0.237	-	-0.502	-0.267	-0.102	-0.003	0.062	0.088	0.112	0.132
0.402	-0.026	-0.204	-	-0.643	-0.376	-0.158	-0.010	0.058	0.088	0.116	0.142

Table 19. Continued

(b) Continued

$M_\infty$	$\alpha$ , deg	Static pressure coefficients on nozzle sidewall at $z/Z = 0.50$ with values of $x/l$ of—													
		.153	.226	.300	.337	.411	.558	.705	.779	.853	.926				
1.251	-0.020	-0.002	-0.013	-0.316	-0.447	-0.407	-	-0.202	-0.148	-0.098	-0.058				
1.198	-0.021	-0.010	-0.025	-0.358	-0.492	-0.446	-	-0.201	-0.144	-0.099	-0.070				
1.200	-0.022	-0.007	-0.023	-0.354	-0.488	-0.443	-	-0.200	-0.143	-0.098	-0.068				
1.200	2.984	-0.022	-0.040	-0.368	-0.506	-0.442	-	-0.196	-0.145	-0.092	-0.057				
1.200	6.037	-0.046	-0.065	-0.385	-0.525	-0.428	-	-0.233	-0.198	-0.131	-0.079				
1.150	-0.010	-0.037	-0.055	-0.409	-0.546	-0.504	-	-0.185	-0.137	-0.107	-0.084				
0.952	-0.027	-0.098	-0.161	-0.671	-0.837	-0.445	-	-0.175	-0.158	-0.128	-0.094				
0.924	-0.033	-0.123	-0.194	-0.729	-0.846	-0.348	-	-0.127	-0.096	-0.061	-0.032				
0.900	-0.015	-0.143	-0.221	-0.778	-0.798	-0.320	-	-0.089	-0.057	-0.023	0.004				
0.900	-3.015	-0.149	-0.218	-0.781	-0.855	-0.349	-	-0.133	-0.101	-0.065	-0.034				
0.900	0.022	-0.145	-0.221	-0.777	-0.786	-0.315	-	-0.092	-0.061	-0.026	0.001				
0.901	2.967	-0.162	-0.239	-0.790	-0.748	-0.353	-	-0.070	-0.034	-0.002	0.023				
0.901	5.968	-0.191	-0.268	-0.814	-0.621	-0.400	-	-0.080	-0.033	0.004	0.026				
0.900	8.984	-0.220	-0.304	-0.845	-0.510	-0.372	-	-0.132	-0.083	-0.027	0.013				
0.877	-0.016	-0.160	-0.244	-0.827	-0.715	-0.304	-	-0.057	-0.025	0.006	0.030				
0.850	-0.023	-0.177	-0.270	-0.889	-0.670	-0.287	-	-0.016	0.013	0.040	0.061				
0.800	-0.031	-0.205	-0.317	-1.002	-0.597	-0.221	-	0.041	0.063	0.084	0.102				
0.701	-0.012	-0.236	-0.369	-0.900	-0.464	-0.181	-	0.072	0.106	0.135	0.163				
0.601	-0.012	-0.223	-0.341	-0.734	-0.426	-0.176	-	0.065	0.099	0.129	0.157				
0.602	-3.020	-0.236	-0.360	-0.801	-0.462	-0.195	-	0.056	0.092	0.123	0.151				
0.600	0.002	-0.225	-0.343	-0.739	-0.430	-0.178	-	0.064	0.097	0.127	0.155				
0.601	3.010	-0.228	-0.340	-0.710	-0.405	-0.160	-	0.071	0.104	0.133	0.157				
0.602	5.979	-0.245	-0.353	-0.696	-0.388	-0.146	-	0.069	0.096	0.119	0.140				
0.601	8.990	-0.261	-0.362	-0.646	-0.338	-0.120	-	0.056	0.082	0.104	0.123				
0.402	-0.026	-0.202	-0.303	-0.621	-0.377	-0.158	-	0.059	0.092	0.121	0.148				

Table 19. Continued

(b) Continued

$M_\infty$	$\alpha$ , deg	Static pressure coefficients on nozzle sidewall at centerline with values of $x/l$ of—														
		.153	.226	.300	.337	.411	.484	.558	.632	.705	.779	.853	.926			
1.251	-0.020	0.005	-0.005	-0.384	-0.489	-0.406	-0.325	-0.264	-0.226	-0.198	-0.170	-0.123	-			
1.198	-0.021	-0.010	-0.023	-0.433	-0.541	-0.442	-0.356	-0.293	-0.249	-0.215	-0.169	-0.120	-			
1.200	-0.022	-0.008	-0.021	-0.429	-0.537	-0.440	-0.353	-0.291	-0.247	-0.213	-0.168	-0.119	-			
1.200	2.984	-0.021	-0.031	-0.430	-0.540	-0.438	-0.372	-0.314	-0.265	-0.230	-0.176	-0.105	-			
1.200	6.037	-0.048	-0.054	-0.436	-0.548	-0.437	-0.396	-0.346	-0.297	-0.273	-0.238	-0.151	-			
1.150	-0.010	-0.038	-0.057	-0.477	-0.603	-0.498	-0.402	-0.315	-0.257	-0.205	-0.158	-0.123	-			
0.952	-0.027	-0.098	-0.159	-0.776	-0.915	-0.587	-0.271	-0.199	-0.166	-0.147	-0.126	-0.104	-			
0.924	-0.033	-0.124	-0.191	-0.841	-0.907	-0.412	-0.233	-0.164	-0.127	-0.098	-0.070	-0.042	-			
0.900	-0.015	-0.144	-0.218	-0.889	-0.672	-0.393	-0.258	-0.167	-0.112	-0.073	-0.042	-0.013	-			
0.900	-3.015	-0.152	-0.223	-0.898	-0.739	-0.402	-0.266	-0.186	-0.136	-0.100	-0.069	-0.041	-			
0.900	0.022	-0.145	-0.219	-0.889	-0.671	-0.389	-0.254	-0.167	-0.113	-0.076	-0.043	-0.013	-			
0.901	2.967	-0.151	-0.220	-0.882	-0.636	-0.406	-0.279	-0.182	-0.116	-0.073	-0.035	-0.005	-			
0.901	5.968	-0.173	-0.237	-0.887	-0.632	-0.431	-0.322	-0.220	-0.144	-0.091	-0.048	-0.014	-			
0.900	8.984	-0.209	-0.269	-0.895	-0.562	-0.400	-0.352	-0.293	-0.217	-0.147	-0.081	-0.026	-			
0.877	-0.016	-0.160	-0.243	-0.912	-0.580	-0.378	-0.237	-0.140	-0.084	-0.040	-0.009	0.015	-			
0.850	-0.023	-0.178	-0.270	-0.943	-0.572	-0.369	-0.205	-0.101	-0.042	-0.005	0.024	0.047	-			
0.800	-0.031	-0.209	-0.316	-1.032	-0.594	-0.288	-0.118	-0.035	0.011	0.044	0.066	0.087	-			
0.701	-0.012	-0.237	-0.373	-1.049	-0.425	-0.175	-0.072	-0.008	0.036	0.075	0.104	0.134	-			
0.601	-0.012	-0.226	-0.353	-0.859	-0.399	-0.169	-0.071	-0.010	0.033	0.066	0.097	0.127	-			
0.602	-3.020	-0.232	-0.359	-0.875	-0.405	-0.170	-0.072	-0.011	0.033	0.067	0.097	0.128	-			
0.600	0.002	-0.228	-0.355	-0.863	-0.401	-0.170	-0.073	-0.012	0.031	0.065	0.095	0.126	-			
0.601	3.010	-0.234	-0.361	-0.882	-0.409	-0.174	-0.075	-0.014	0.030	0.064	0.095	0.124	-			
0.602	5.979	-0.253	-0.381	-0.912	-0.422	-0.183	-0.084	-0.023	0.019	0.051	0.079	0.106	-			
0.601	8.990	-0.281	-0.403	-0.913	-0.427	-0.189	-0.094	-0.037	0.001	0.031	0.059	0.088	-			
0.402	-0.026	-0.204	-0.318	-0.725	-0.357	-0.155	-0.064	-0.009	0.030	0.064	0.091	0.118	-			

Table 19. Continued

(b) Concluded

$M_\infty$	$\alpha$ , deg	Static pressure coefficients on nozzle sidewall at $z/Z = -0.50$ with values of $x/l$ of—									
		.153	.226	.300	.337	.411	.558	.705	.926		
1.251	-0.020	0.010	-0.011	-0.346	-0.456	-	-0.285	-0.224	-0.090		
1.198	-0.021	-0.011	-0.032	-0.392	-0.509	-	-0.319	-0.248	-0.093		
1.200	-0.022	-0.008	-0.030	-0.388	-0.506	-	-0.316	-0.246	-0.093		
1.200	2.984	-0.024	-0.041	-0.386	-0.519	-	-0.355	-0.286	-0.067		
1.200	6.037	-0.063	-0.076	-0.401	-0.538	-	-0.407	-0.353	-0.097		
1.150	-0.010	-0.039	-0.060	-0.442	-0.564	-	-0.344	-0.245	-0.104		
0.952	-0.027	-0.097	-0.161	-0.716	-0.871	-	-0.214	-0.150	-0.060		
0.924	-0.033	-0.123	-0.194	-0.777	-0.923	-	-0.162	-0.096	-0.013		
0.900	-0.015	-0.142	-0.220	-0.830	-0.903	-	-0.160	-0.072	0.011		
0.900	-3.015	-0.161	-0.241	-0.846	-0.858	-	-0.175	-0.084	-0.002		
0.900	0.022	-0.142	-0.221	-0.829	-0.901	-	-0.159	-0.071	0.009		
0.901	2.967	-0.144	-0.218	-0.824	-0.942	-	-0.176	-0.082	0.008		
0.901	5.968	-0.172	-0.242	-0.835	-1.001	-	-0.213	-0.107	-0.001		
0.900	8.984	-0.224	-0.291	-0.859	-0.668	-	-0.298	-0.148	0.016		
0.877	-0.016	-0.160	-0.244	-0.882	-0.822	-	-0.135	-0.042	0.037		
0.850	-0.023	-0.178	-0.273	-0.952	-0.741	-	-0.101	-0.006	0.068		
0.800	-0.031	-0.208	-0.317	-1.073	-0.645	-	-0.038	0.040	0.103		
0.701	-0.012	-0.233	-0.365	-0.989	-0.437	-	-0.013	0.071	0.162		
0.601	-0.012	-0.222	-0.341	-0.802	-0.404	-	-0.017	0.066	0.156		
0.602	-3.020	-0.224	-0.337	-0.762	-0.378	-	-0.005	0.075	0.158		
0.600	0.002	-0.224	-0.343	-0.802	-0.405	-	-0.019	0.063	0.153		
0.601	3.010	-0.238	-0.362	-0.883	-0.439	-	-0.035	0.051	0.145		
0.602	5.979	-0.268	-0.395	-0.959	-0.483	-	-0.067	0.026	0.133		
0.601	8.990	-0.314	-0.440	-1.024	-0.528	-	-0.107	-0.001	0.125		
0.402	-0.026	-0.201	-0.306	-0.672	-0.357	-	-0.017	0.060	0.146		

Table 19. Continued

(c) Static pressure coefficients on nozzle bottom flap

$M_\infty$	$\alpha$ , deg	Static pressure coefficients on nozzle bottom flap at $y/Y = 0.75$ with values of $x/l$ of—														
		.153	.226	.300	.337	.411	.558	.705	.779	.853	.926					
1.251	-0.020	0.008	-0.010	-0.318	-0.451	-0.403	-0.336	-0.305	-0.269	-0.182	-0.068					
1.198	-0.021	-0.014	-0.033	-0.364	-0.500	-0.448	-0.372	-0.332	-0.286	-0.169	-0.071					
1.200	-0.022	-0.012	-0.031	-0.361	-0.496	-0.446	-0.371	-0.330	-0.282	-0.166	-0.069					
1.200	2.984	-0.023	-0.031	-0.352	-0.502	-0.438	-0.407	-0.364	-0.203	-0.097	-0.068					
1.200	6.037	-0.042	-0.047	-0.353	-0.509	-0.432	-0.433	-0.411	-0.340	-0.127	-0.088					
1.150	-0.010	-0.038	-0.061	-0.413	-0.556	-0.498	-0.415	-0.351	-0.276	-0.154	-0.076					
0.952	-0.027	-0.099	-0.163	-0.677	-0.862	-0.756	-0.245	-0.149	-0.113	-0.080	-0.053					
0.924	-0.033	-0.127	-0.199	-0.736	-0.883	-0.411	-0.224	-0.142	-0.101	-0.066	-0.033					
0.900	-0.015	-0.145	-0.223	-0.784	-0.856	-0.351	-0.205	-0.110	-0.071	-0.036	-0.003					
0.900	-3.015	-0.166	-0.258	-0.800	-0.812	-0.334	-0.190	-0.089	-0.050	-0.018	0.006					
0.900	0.022	-0.146	-0.225	-0.784	-0.854	-0.350	-0.205	-0.112	-0.073	-0.039	-0.006					
0.901	2.967	-0.140	-0.209	-0.772	-0.885	-0.379	-0.224	-0.125	-0.085	-0.049	-0.011					
0.901	5.968	-0.151	-0.209	-0.769	-0.972	-0.520	-0.242	-0.136	-0.090	-0.049	-0.010					
0.900	8.984	-0.173	-0.222	-0.775	-1.000	-0.653	-0.280	-0.151	-0.090	-0.037	0.014					
0.877	-0.016	-0.164	-0.248	-0.835	-0.803	-0.330	-0.174	-0.079	-0.038	-0.004	0.025					
0.850	-0.023	-0.182	-0.276	-0.900	-0.766	-0.316	-0.135	-0.035	0.003	0.033	0.058					
0.800	-0.031	-0.211	-0.322	-1.019	-0.707	-0.263	-0.063	0.030	0.063	0.088	0.107					
0.701	-0.012	-0.242	-0.376	-0.981	-0.477	-0.198	-0.020	0.073	0.109	0.140	0.168					
0.601	-0.012	-0.231	-0.349	-0.791	-0.442	-0.190	-0.025	0.066	0.102	0.133	0.162					
0.602	-3.020	-0.225	-0.325	-0.634	-0.363	-0.150	0.004	0.086	0.117	0.142	0.163					
0.600	0.002	-0.232	-0.350	-0.790	-0.442	-0.191	-0.026	0.065	0.100	0.133	0.161					
0.601	3.010	-0.243	-0.370	-0.904	-0.506	-0.232	-0.061	0.034	0.073	0.108	0.142					
0.602	5.979	-0.260	-0.390	-0.990	-0.559	-0.272	-0.097	0.000	0.041	0.081	0.121					
0.601	8.990	-0.282	-0.409	-1.056	-0.604	-0.310	-0.133	-0.031	0.012	0.057	0.102					
0.402	-0.026	-0.206	-0.310	-0.664	-0.392	-0.174	-0.024	0.059	0.095	0.126	0.154					



Table 19. Continued

(c) Continued

$M_\infty$	$\alpha$ , deg	Static pressure coefficients on nozzle bottom flap at $y/Y = 0.50$ with values of $x/l$ of—													
		.153	.226	.300	.337	.411	.558	.705	.779	.853	.926				
1.251	-0.020	0.009	-0.008	-0.373	-0.491	-0.455	-0.397	-0.336	-0.291	-0.137	-0.056				
1.198	-0.021	-0.013	-0.029	-0.422	-0.540	-0.503	-0.439	-0.365	-0.290	-0.136	-0.067				
1.200	-0.022	-0.011	-0.027	-0.419	-0.536	-0.501	-0.437	-0.363	-0.283	-0.132	-0.066				
1.200	2.984	-0.012	-0.021	-0.413	-0.541	-0.495	-0.458	-0.319	-0.148	-0.101	-0.075				
1.200	6.037	-0.012	-0.018	-0.405	-0.541	-0.495	-0.473	-0.426	-0.227	-0.125	-0.094				
1.150	-0.010	-0.033	-0.056	-0.472	-0.593	-0.558	-0.477	-0.388	-0.249	-0.128	-0.079				
0.952	-0.027	-0.103	-0.173	-0.762	-0.912	-0.772	-0.279	-0.167	-0.124	-0.086	-0.059				
0.924	-0.033	-0.130	-0.205	-0.821	-0.710	-0.385	-0.242	-0.153	-0.112	-0.074	-0.041				
0.900	-0.015	-0.148	-0.211	-0.860	-0.574	-0.350	-0.224	-0.125	-0.083	-0.045	-0.011				
0.900	-3.015	-0.165	-0.248	-0.887	-0.600	-0.387	-0.233	-0.117	-0.073	-0.035	-0.007				
0.900	0.022	-0.150	-0.236	-0.859	-0.579	-0.353	-0.227	-0.126	-0.085	-0.047	-0.014				
0.901	2.967	-0.135	-0.219	-0.862	-0.659	-0.365	-0.230	-0.134	-0.093	-0.054	-0.015				
0.901	5.968	-0.127	-0.210	-0.862	-0.926	-0.449	-0.255	-0.150	-0.105	-0.060	-0.018				
0.900	8.984	-0.115	-0.205	-0.858	-1.031	-0.651	-0.291	-0.159	-0.099	-0.042	0.008				
0.877	-0.016	-0.169	-0.105	-0.900	-0.531	-0.348	-0.202	-0.095	-0.053	-0.012	0.017				
0.850	-0.023	-0.190	-0.091	-0.961	-0.537	-0.352	-0.170	-0.054	-0.012	0.025	0.053				
0.800	-0.031	-0.223	-0.086	-1.112	-0.628	-0.326	-0.089	0.021	0.056	0.083	0.103				
0.701	-0.012	-0.265	-0.076	-1.055	-0.500	-0.208	-0.023	0.076	0.112	0.143	0.170				
0.601	-0.012	-0.256	-0.071	-0.841	-0.472	-0.209	-0.030	0.068	0.104	0.137	0.165				
0.602	-3.020	-0.238	-0.076	-0.727	-0.402	-0.162	0.003	0.089	0.119	0.144	0.165				
0.600	0.002	-0.258	-0.084	-0.841	-0.473	-0.210	-0.031	0.066	0.103	0.135	0.164				
0.601	3.010	-0.269	-0.084	-0.975	-0.544	-0.257	-0.071	0.030	0.071	0.108	0.142				
0.602	5.979	-0.274	-0.083	-1.079	-0.597	-0.296	-0.108	-0.004	0.040	0.081	0.124				
0.601	8.990	-0.272	-0.087	-1.151	-0.635	-0.326	-0.136	-0.031	0.015	0.058	0.104				
0.402	-0.026	-0.234	-0.084	-0.705	-0.420	-0.191	-0.030	0.063	0.097	0.130	0.153				

Table 19. Continued

(c) Concluded

$M_\infty$	$\alpha$ , deg	Static pressure coefficients on nozzle bottom flap at centerline with values of $x/l$ of—											
		.153	.226	.300	.337	.411	.558	.705	.926				
1.251	-0.020	0.008	-0.016	-0.379	-0.478	-0.462	-0.453	-0.404	-0.047				
1.198	-0.021	-0.013	-0.038	-0.429	-0.531	-0.513	-0.492	-0.427	-0.063				
1.200	-0.022	-0.011	-0.036	-0.428	-0.529	-0.510	-0.490	-0.422	-0.063				
1.200	2.984	-0.013	-0.036	-0.425	-0.527	-0.507	-0.491	-0.242	-0.083				
1.200	6.037	-0.010	-0.033	-0.421	-0.522	-0.504	-0.489	-0.408	-0.100				
1.150	-0.010	-0.036	-0.064	-0.481	-0.586	-0.566	-0.536	-0.429	-0.080				
0.952	-0.027	-0.112	-0.191	-0.779	-0.901	-0.752	-0.277	-0.169	-0.060				
0.924	-0.033	-0.137	-0.219	-0.826	-0.626	-0.365	-0.240	-0.160	-0.042				
0.900	-0.015	-0.159	-0.245	-0.850	-0.515	-0.336	-0.224	-0.132	-0.014				
0.900	-3.015	-0.167	-0.252	-0.878	-0.555	-0.368	-0.234	-0.125	-0.011				
0.900	0.022	-0.160	-0.246	-0.853	-0.522	-0.339	-0.224	-0.133	-0.017				
0.901	2.967	-0.149	-0.235	-0.846	-0.535	-0.336	-0.229	-0.146	-0.025				
0.901	5.968	-0.139	-0.224	-0.866	-0.661	-0.386	-0.262	-0.175	-0.039				
0.900	8.984	-0.124	-0.210	-0.884	-0.951	-0.568	-0.293	-0.175	-0.006				
0.877	-0.016	-0.177	-0.272	-0.890	-0.501	-0.333	-0.201	-0.102	0.016				
0.850	-0.023	-0.200	-0.305	-0.956	-0.521	-0.335	-0.173	-0.064	0.051				
0.800	-0.031	-0.239	-0.363	-1.129	-0.627	-0.328	-0.100	0.012	0.104				
0.701	-0.012	-0.287	-0.451	-1.128	-0.527	-0.234	-0.032	0.071	0.172				
0.601	-0.012	-0.281	-0.427	-0.879	-0.494	-0.235	-0.041	0.061	0.167				
0.602	-3.020	-0.257	-0.391	-0.799	-0.440	-0.192	-0.009	0.084	0.169				
0.600	0.002	-0.282	-0.427	-0.881	-0.497	-0.236	-0.043	0.059	0.167				
0.601	3.010	-0.299	-0.457	-0.971	-0.554	-0.282	-0.084	0.022	0.146				
0.602	5.979	-0.305	-0.474	-1.054	-0.600	-0.318	-0.118	-0.009	0.128				
0.601	8.990	-0.303	-0.480	-1.103	-0.628	-0.342	-0.143	-0.034	0.108				
0.402	-0.026	-0.258	-0.379	-0.737	-0.436	-0.217	-0.041	0.054	0.158				

Table 19. Concluded

(d) Force data

$M_\infty$	$\alpha$ , deg	$C_D$
1.251	-0.020	0.2654
1.198	-0.021	0.2885
1.200	-0.022	0.2868
1.200	2.984	0.2805
1.200	6.037	0.3035
1.150	-0.010	0.3115
0.952	-0.027	0.2746
0.924	-0.033	0.2293
0.900	-0.015	0.2040
0.900	-3.015	0.2210
0.900	0.022	0.2036
0.901	2.967	0.2076
0.901	5.968	0.2241
0.900	8.984	0.2399
0.877	-0.016	0.1841
0.850	-0.023	0.1616
0.800	-0.031	0.1256
0.701	-0.012	0.0752
0.601	-0.012	0.0693
0.602	-3.020	0.0667
0.600	0.002	0.0712
0.601	3.010	0.0708
0.602	5.979	0.0724
0.601	8.990	0.0817
0.402	-0.026	0.0664

Table 20. Pressure and Force Data for Nozzle 12 With  $\beta_{r,top/bot} = 15.0^\circ/\beta_{r,side} = 22.4^\circ$ , Plume On, and  $\alpha = 0^\circ$

(a) Static pressure coefficients on nozzle top flap

$M_\infty$	Static pressure coefficients on nozzle top flap at centerline with values of $x/l$ of—													
	.153	.226	.300	.337	.411	.484	.558	.632	.705	.779	.853	.926		
0.597	-0.270	-	-0.859	-0.456	-0.201	-0.079	0.000	0.061	0.107	0.153	0.189	0.221		
0.698	-0.280	-	-1.117	-0.485	-0.205	-0.079	0.002	0.063	0.111	0.155	0.191	0.223		
0.799	-0.222	-	-1.126	-0.564	-0.264	-0.132	-0.048	0.009	0.050	0.087	0.114	0.137		
1.252	0.002	-	-0.377	-0.466	-0.459	-0.405	-0.402	-0.177	-0.095	-0.073	-0.052	-0.022		
1.198	-0.007	-	-0.426	-0.517	-0.500	-0.446	-0.426	-0.145	-0.107	-0.088	-0.066	-0.041		
1.151	-0.026	-	-0.474	-0.572	-0.559	-0.501	-0.335	-0.163	-0.136	-0.117	-0.095	-0.066		
0.953	-0.096	-	-0.772	-0.863	-0.456	-0.255	-0.186	-0.151	-0.126	-0.102	-0.086	-0.058		
0.923	-0.128	-	-0.823	-0.573	-0.300	-0.224	-0.182	-0.150	-0.123	-0.096	-0.072	-0.045		
0.899	-0.147	-	-0.843	-0.462	-0.277	-0.208	-0.164	-0.129	-0.098	-0.068	-0.041	-0.013		
0.874	-0.166	-	-0.854	-0.427	-0.264	-0.193	-0.142	-0.100	-0.066	-0.036	-0.006	0.022		
0.853	-0.183	-	-0.886	-0.431	-0.261	-0.178	-0.122	-0.078	-0.041	-0.007	0.024	0.050		
0.802	-0.223	-	-1.079	-0.537	-0.265	-0.136	-0.058	0.001	0.043	0.075	0.104	0.128		
0.703	-0.278	-	-1.122	-0.481	-0.202	-0.077	0.003	0.063	0.111	0.153	0.186	0.217		
0.599	-0.270	-	-0.849	-0.454	-0.201	-0.078	0.000	0.060	0.108	0.150	0.185	0.218		
0.402	-0.245	-	-0.707	-0.403	-0.187	-0.078	-0.001	0.056	0.098	0.142	0.177	0.211		

$M_\infty$	Static pressure coefficients on nozzle top flap at $y/Y = 0.25$ with values of $x/l$ of—													
	.153	.226	.300	.337	.411	.484	.558	.632	.705	.779	.853	.926		
0.597	-0.263	-0.406	-0.865	-0.447	-0.195	0.000	0.000	0.109	0.152	0.188	0.222	0.222		
0.698	-0.271	-0.429	-1.127	-0.475	-0.196	0.002	0.002	0.113	0.157	0.193	0.222	0.222		
0.799	-0.216	-0.337	-1.126	-0.561	-0.262	-0.050	-0.050	0.050	0.087	0.116	0.138	0.138		
1.252	0.006	-0.008	-0.371	-0.467	-0.457	-0.404	-0.404	-0.100	-0.076	-0.055	-0.029	-0.029		
1.198	-0.002	-0.023	-0.418	-0.516	-0.500	-0.434	-0.434	-0.111	-0.090	-0.069	-0.044	-0.044		
1.151	-0.023	-0.048	-0.470	-0.572	-0.557	-0.429	-0.429	-0.143	-0.119	-0.095	-0.070	-0.070		
0.953	-0.093	-0.163	-0.764	-0.871	-0.492	-0.183	-0.183	-0.127	-0.101	-0.081	-0.057	-0.057		
0.923	-0.124	-0.200	-0.822	-0.604	-0.304	-0.181	-0.181	-0.121	-0.094	-0.071	-0.043	-0.043		
0.899	-0.145	-0.226	-0.850	-0.476	-0.279	-0.164	-0.164	-0.096	-0.067	-0.040	-0.013	-0.013		
0.874	-0.165	-0.254	-0.868	-0.437	-0.266	-0.142	-0.142	-0.068	-0.035	-0.007	0.020	0.020		
0.853	-0.181	-0.278	-0.906	-0.441	-0.261	-0.121	-0.121	-0.042	-0.006	0.024	0.051	0.051		
0.802	-0.216	-0.334	-1.086	-0.541	-0.262	-0.057	-0.057	0.043	0.077	0.106	0.129	0.129		
0.703	-0.270	-0.427	-1.126	-0.474	-0.195	0.004	0.004	0.112	0.153	0.188	0.218	0.218		
0.599	-0.261	-0.405	-0.858	-0.446	-0.194	0.001	0.001	0.107	0.151	0.186	0.218	0.218		
0.402	-0.238	-0.359	-0.712	-0.398	-0.182	-0.001	-0.001	0.101	0.146	0.181	0.212	0.212		

Table 20. Continued

(a) Concluded

$M_\infty$	Static pressure coefficients on nozzle top flap at $y/Y = 0.50$ with values of $x/l$ of—										
	.153	.226	.300	.337	.411	.558	.705	.779	.853	.926	
0.597	-0.248	-0.384	-0.843	-0.429	-0.179	0.010	0.113	0.149	0.187	0.220	
0.698	-0.253	-0.405	-1.078	-0.453	-0.182	0.008	0.113	0.153	0.189	0.221	
0.799	-0.210	-0.326	-1.129	-0.557	-0.248	-0.044	0.051	0.087	0.115	0.141	
1.252	0.003	-0.009	-0.372	-0.472	-0.438	-0.380	-0.108	-0.077	-0.056	-0.027	
1.198	-0.002	-0.022	-0.417	-0.522	-0.481	-0.417	-0.116	-0.092	-0.069	-0.043	
1.151	-0.027	-0.048	-0.469	-0.578	-0.536	-0.463	-0.143	-0.118	-0.095	-0.066	
0.953	-0.091	-0.157	-0.764	-0.878	-0.446	-0.190	-0.127	-0.105	-0.085	-0.058	
0.923	-0.123	-0.195	-0.826	-0.643	-0.305	-0.179	-0.125	-0.099	-0.072	-0.042	
0.899	-0.143	-0.225	-0.869	-0.500	-0.282	-0.166	-0.100	-0.069	-0.041	-0.013	
0.874	-0.162	-0.251	-0.900	-0.463	-0.270	-0.141	-0.067	-0.036	-0.006	0.022	
0.853	-0.177	-0.275	-0.937	-0.464	-0.264	-0.119	-0.040	-0.006	0.024	0.052	
0.802	-0.208	-0.324	-1.092	-0.541	-0.249	-0.051	0.045	0.078	0.106	0.129	
0.703	-0.254	-0.406	-1.079	-0.451	-0.181	0.008	0.112	0.151	0.185	0.216	
0.599	-0.246	-0.385	-0.839	-0.424	-0.176	0.011	0.111	0.149	0.183	0.215	
0.402	-0.225	-0.342	-0.701	-0.377	-0.162	0.013	0.108	0.143	0.177	0.207	

$M_\infty$	Static pressure coefficients on nozzle top flap at $y/Y = 0.75$ with values of $x/l$ of—										
	.153	.226	.300	.337	.411	.558	.705	.779	.853	.926	
0.597	-0.225	-0.352	-0.867	-0.406	-0.158	0.016	0.115	0.150	0.182	0.208	
0.698	-0.230	-0.364	-1.050	-0.422	-0.163	0.006	0.110	0.151	0.186	0.215	
0.799	-0.198	-0.303	-1.013	-0.479	-0.230	-0.058	0.050	0.087	0.118	0.143	
1.252	0.002	-0.005	-0.353	-0.480	-0.404	-0.347	-0.144	-0.066	-0.040	-0.017	
1.198	-0.002	-0.018	-0.398	-0.533	-0.444	-0.388	-0.120	-0.083	-0.059	-0.034	
1.151	-0.034	-0.051	-0.453	-0.591	-0.500	-0.441	-0.138	-0.107	-0.083	-0.051	
0.953	-0.091	-0.151	-0.731	-0.638	-0.380	-0.256	-0.156	-0.117	-0.084	-0.058	
0.923	-0.121	-0.187	-0.785	-0.498	-0.324	-0.200	-0.127	-0.098	-0.068	-0.042	
0.899	-0.141	-0.214	-0.811	-0.456	-0.299	-0.175	-0.100	-0.068	-0.037	-0.011	
0.874	-0.159	-0.238	-0.830	-0.437	-0.280	-0.147	-0.067	-0.035	-0.022	0.024	
0.853	-0.170	-0.259	-0.863	-0.445	-0.273	-0.121	-0.038	-0.005	0.028	0.054	
0.802	-0.195	-0.303	-0.973	-0.470	-0.232	-0.067	0.041	0.079	0.108	0.132	
0.703	-0.230	-0.363	-1.040	-0.418	-0.163	0.005	0.108	0.149	0.182	0.211	
0.599	-0.225	-0.348	-0.855	-0.401	-0.155	0.017	0.112	0.148	0.178	0.203	
0.402	-0.205	-0.315	-0.719	-0.360	-0.147	0.015	0.109	0.144	0.174	0.197	

Table 20. Continued

(b) Static pressure coefficients on nozzle sidewall

$M_\infty$	Static pressure coefficients on corner between nozzle top flap and sidewall with values of $x/l$ of—									
	.153	.226	.300	.337	.411	.558	.705	.779	.853	.926
0.597	-0.223	-	-0.906	-0.422	-0.139	0.036	0.117	0.150	0.174	0.195
0.698	-0.228	-	-1.060	-0.413	-0.147	0.006	0.108	0.146	0.178	0.203
0.799	-0.196	-	-0.935	-0.409	-0.237	-0.085	0.033	0.078	0.114	0.142
1.252	0.004	-	-0.335	-0.512	-0.406	-0.332	-0.163	-0.055	-0.025	-0.003
1.198	-0.003	-	-0.377	-0.568	-0.447	-0.374	-0.126	-0.067	-0.048	-0.030
1.151	-0.034	-	-0.434	-0.630	-0.500	-0.427	-0.128	-0.091	-0.067	-0.060
0.953	-0.091	-	-0.693	-0.500	-0.359	-0.276	-0.190	-0.145	-0.103	-0.067
0.923	-0.121	-	-0.732	-0.423	-0.322	-0.227	-0.143	-0.106	-0.075	-0.043
0.899	-0.142	-	-0.745	-0.392	-0.306	-0.197	-0.108	-0.071	-0.040	-0.013
0.874	-0.156	-	-0.758	-0.376	-0.290	-0.169	-0.070	-0.032	-0.001	0.026
0.853	-0.170	-	-0.796	-0.387	-0.287	-0.142	-0.040	-0.001	0.032	0.056
0.802	-0.196	-	-0.899	-0.400	-0.235	-0.092	0.025	0.069	0.106	0.133
0.703	-0.227	-	-1.051	-0.410	-0.144	0.003	0.104	0.141	0.173	0.199
0.599	-0.225	-	-0.888	-0.415	-0.134	0.037	0.116	0.143	0.169	0.192
0.402	-0.208	-	-0.752	-0.379	-0.127	0.040	0.114	0.143	0.167	0.187

$M_\infty$	Static pressure coefficients on nozzle sidewall at $z/Z = 0.50$ with values of $x/l$ of—									
	.153	.226	.300	.337	.411	.558	.705	.779	.853	.926
0.597	-	-0.349	-0.970	-0.442	-0.125	-	0.119	0.148	0.174	0.198
0.698	-	-0.346	-1.038	-0.369	-0.171	-	0.104	0.146	0.180	0.205
0.799	-	-0.294	-0.865	-0.360	-0.233	-	0.018	0.071	0.115	0.148
1.252	-	-0.001	-0.359	-0.549	-0.460	-	-0.138	-0.059	-0.014	0.033
1.198	-	-0.017	-0.407	-0.604	-0.502	-	-0.120	-0.063	-0.035	0.013
1.151	-	-0.053	-0.463	-0.670	-0.558	-	-0.128	-0.083	-0.049	0.013
0.953	-	-0.149	-0.711	-0.455	-0.345	-	-0.193	-0.147	-0.099	-0.055
0.923	-	-0.183	-0.705	-0.387	-0.302	-	-0.153	-0.111	-0.066	-0.023
0.899	-	-0.209	-0.698	-0.363	-0.289	-	-0.117	-0.072	-0.027	0.013
0.874	-	-0.233	-0.715	-0.355	-0.280	-	-0.080	-0.031	0.012	0.048
0.853	-	-0.252	-0.752	-0.372	-0.280	-	-0.049	0.001	0.042	0.077
0.802	-	-0.291	-0.828	-0.349	-0.237	-	0.007	0.065	0.109	0.141
0.703	-	-0.344	-1.018	-0.360	-0.168	-	0.096	0.140	0.175	0.202
0.599	-	-0.347	-0.949	-0.436	-0.120	-	0.115	0.144	0.172	0.195
0.402	-	-0.316	-0.814	-0.413	-0.122	-	0.122	0.150	0.170	0.193

Table 20. Continued

(b) Concluded

$M_\infty$	Static pressure coefficients on nozzle sidewall at centerline with values of $x/l$ of—												
	.153	.226	.300	.337	.411	.484	.558	.632	.705	.779	.853	.926	
0.597	-0.232	-0.380	-0.886	-0.483	-0.111	-0.017	0.044	0.083	0.119	0.147	0.173	-	
0.698	-0.225	-0.366	-0.776	-0.256	-0.199	-0.130	-0.037	0.042	0.104	0.149	0.181	-	
0.799	-0.192	-0.307	-0.690	-0.229	-0.223	-0.194	-0.131	-0.057	0.017	0.073	0.115	-	
1.252	0.012	-0.003	-0.356	-0.565	-0.518	-0.409	-0.275	-0.185	-0.115	-0.050	-0.002	-	
1.198	-0.006	-0.024	-0.404	-0.623	-0.568	-0.446	-0.295	-0.186	-0.106	-0.053	-0.018	-	
1.151	-0.038	-0.061	-0.460	-0.689	-0.630	-0.502	-0.308	-0.186	-0.116	-0.067	-0.026	-	
0.953	-0.092	-0.156	-0.691	-0.372	-0.300	-0.284	-0.269	-0.237	-0.196	-0.148	-0.100	-	
0.923	-0.120	-0.192	-0.678	-0.296	-0.261	-0.255	-0.236	-0.199	-0.161	-0.116	-0.066	-	
0.899	-0.139	-0.219	-0.684	-0.284	-0.257	-0.246	-0.218	-0.172	-0.126	-0.076	-0.029	-	
0.874	-0.155	-0.245	-0.688	-0.271	-0.252	-0.236	-0.199	-0.145	-0.088	-0.036	0.012	-	
0.853	-0.168	-0.263	-0.694	-0.267	-0.250	-0.228	-0.182	-0.118	-0.057	-0.003	0.045	-	
0.802	-0.192	-0.305	-0.682	-0.225	-0.215	-0.196	-0.137	-0.065	0.006	0.065	0.108	-	
0.703	-0.225	-0.360	-0.752	-0.245	-0.197	-0.133	-0.042	0.038	0.097	0.141	0.177	-	
0.599	-0.231	-0.374	-0.870	-0.468	-0.107	-0.019	0.036	0.079	0.115	0.142	0.171	-	
0.402	-0.216	-0.352	-0.767	-0.479	-0.113	-0.006	0.058	0.096	0.124	0.148	0.170	-	

$M_\infty$	Static pressure coefficients on nozzle sidewall at $z/Z = -0.50$ with values of $x/l$ of—												
	.153	.226	.300	.337	.411	.484	.558	.632	.705	.779	.853	.926	
0.597	-0.220	-0.343	-1.026	-0.437	-	-	0.040	0.116	0.197	0.204	0.204	-	
0.698	-0.217	-0.339	-1.145	-0.381	-	-	-0.012	0.105	0.204	0.204	0.149	-	
0.799	-0.188	-0.285	-0.802	-0.332	-	-	-0.122	0.014	0.149	0.149	0.023	-	
1.252	0.016	0.002	-0.336	-0.562	-	-	-0.346	-0.145	0.023	0.002	0.002	-	
1.198	-0.003	-0.019	-0.386	-0.619	-	-	-0.376	-0.112	0.002	0.001	0.001	-	
1.151	-0.037	-0.052	-0.438	-0.685	-	-	-0.405	-0.123	0.001	0.001	0.001	-	
0.953	-0.082	-0.145	-0.628	-0.356	-	-	-0.268	-0.208	0.001	0.001	0.001	-	
0.923	-0.113	-0.180	-0.578	-0.271	-	-	-0.240	-0.177	0.001	0.001	0.001	-	
0.899	-0.131	-0.203	-0.575	-0.256	-	-	-0.229	-0.143	0.001	0.001	0.001	-	
0.874	-0.151	-0.227	-0.588	-0.252	-	-	-0.208	-0.103	0.001	0.001	0.001	-	
0.853	-0.163	-0.246	-0.620	-0.267	-	-	-0.188	-0.069	0.001	0.001	0.001	-	
0.802	-0.187	-0.284	-0.772	-0.323	-	-	-0.128	0.007	0.001	0.001	0.001	-	
0.703	-0.214	-0.338	-1.121	-0.376	-	-	-0.017	0.101	0.199	0.199	0.192	-	
0.599	-0.216	-0.342	-1.011	-0.430	-	-	0.038	0.114	0.142	0.171	0.171	-	
0.402	-0.202	-0.317	-0.863	-0.406	-	-	0.043	0.122	0.148	0.170	0.170	-	

Table 20. Continued

(c) Static pressure coefficients on nozzle bottom flap

$M_\infty$	Static pressure coefficients on nozzle bottom flap at $y/Y = 0.75$ with values of $x/l$ of—											
	.153	.226	.300	.337	.411	.558	.705	.779	.853	.926		
0.597	-0.218	-0.340	-0.900	-0.397	-0.159	0.013	0.109	0.146	0.179	0.207		
0.698	-0.223	-0.351	-1.090	-0.413	-0.166	0.002	0.106	0.147	0.183	0.214		
0.799	-0.189	-0.292	-0.929	-0.455	-0.243	-0.073	0.045	0.090	0.129	0.160		
1.252	0.015	-0.001	-0.394	-0.472	-0.407	-0.368	-0.199	-0.061	-0.027	-0.001		
1.198	-0.006	-0.020	-0.445	-0.523	-0.449	-0.410	-0.119	-0.067	-0.040	-0.015		
1.151	-0.035	-0.053	-0.503	-0.583	-0.501	-0.457	-0.129	-0.090	-0.063	-0.032		
0.953	-0.085	-0.148	-0.748	-0.471	-0.337	-0.280	-0.215	-0.155	-0.092	-0.029		
0.923	-0.115	-0.184	-0.688	-0.373	-0.293	-0.261	-0.175	-0.113	-0.052	0.002		
0.899	-0.134	-0.209	-0.687	-0.366	-0.294	-0.235	-0.123	-0.062	-0.011	0.032		
0.874	-0.149	-0.231	-0.710	-0.370	-0.293	-0.196	-0.076	-0.018	0.027	0.067		
0.853	-0.162	-0.250	-0.754	-0.391	-0.288	-0.162	-0.039	0.014	0.056	0.093		
0.802	-0.188	-0.291	-0.897	-0.445	-0.249	-0.083	0.034	0.082	0.120	0.155		
0.703	-0.221	-0.352	-1.086	-0.410	-0.166	-0.001	0.102	0.145	0.179	0.210		
0.599	-0.217	-0.341	-0.894	-0.394	-0.159	0.011	0.106	0.145	0.174	0.203		
0.402	-0.198	-0.310	-0.755	-0.357	-0.150	0.007	0.101	0.141	0.169	0.197		

$M_\infty$	Static pressure coefficients on nozzle bottom flap at $y/Y = 0.50$ with values of $x/l$ of—											
	.153	.226	.300	.337	.411	.558	.705	.779	.853	.926		
0.597	-0.022	-0.373	-0.786	-0.416	-0.181	-0.001	0.105	0.145	0.179	0.213		
0.698	-0.021	-0.396	-0.957	-0.445	-0.189	-0.002	0.105	0.148	0.185	0.221		
0.799	-0.020	-0.326	-1.136	-0.562	-0.242	-0.051	0.057	0.099	0.136	0.168		
1.252	0.034	-0.003	-0.384	-0.459	-0.449	-0.394	-0.146	-0.067	-0.032	-0.006		
1.198	0.021	-0.024	-0.431	-0.510	-0.494	-0.431	-0.112	-0.071	-0.043	-0.017		
1.151	-0.004	-0.058	-0.486	-0.567	-0.550	-0.478	-0.132	-0.096	-0.065	-0.038		
0.953	-0.010	-0.163	-0.777	-0.823	-0.408	-0.250	-0.157	-0.103	-0.049	-0.004		
0.923	-0.017	-0.197	-0.843	-0.670	-0.342	-0.224	-0.119	-0.069	-0.021	0.015		
0.899	-0.020	-0.228	-0.895	-0.592	-0.319	-0.187	-0.082	-0.038	0.000	0.032		
0.874	-0.020	-0.253	-0.942	-0.549	-0.305	-0.156	-0.046	-0.003	0.033	0.066		
0.853	-0.020	-0.275	-0.986	-0.542	-0.292	-0.127	-0.017	0.024	0.061	0.094		
0.802	-0.020	-0.322	-1.109	-0.553	-0.246	-0.058	0.048	0.091	0.128	0.162		
0.703	-0.023	-0.398	-0.958	-0.444	-0.189	-0.005	0.102	0.145	0.182	0.217		
0.599	-0.021	-0.373	-0.782	-0.415	-0.182	-0.003	0.103	0.144	0.178	0.210		
0.402	-0.019	-0.333	-0.667	-0.371	-0.172	-0.006	0.097	0.137	0.172	0.203		



Table 20. Concluded

(c) Concluded

$M_\infty$	Static pressure coefficients on nozzle bottom flap at centerline with values of $x/l$ of—										
	.153	.226	.300	.337	.411	.558	.705	.926			
0.597	-0.265	-0.389	-0.811	-0.432	-0.203	-0.015	0.094	0.225			
0.698	-0.276	-0.417	-1.003	-0.467	-0.213	-0.012	0.097	0.229			
0.799	-0.230	-0.348	-1.182	-0.647	-0.277	-0.046	0.062	0.178			
1.252	0.006	-0.012	-0.388	-0.447	-0.433	-0.424	-0.126	-0.010			
1.198	-0.012	-0.035	-0.440	-0.500	-0.480	-0.459	-0.125	-0.022			
1.151	-0.040	-0.066	-0.494	-0.558	-0.537	-0.463	-0.143	-0.046			
0.953	-0.109	-0.182	-0.795	-0.877	-0.723	-0.196	-0.101	0.006			
0.923	-0.135	-0.213	-0.866	-0.909	-0.400	-0.171	-0.087	0.013			
0.899	-0.158	-0.239	-0.920	-0.694	-0.356	-0.173	-0.076	0.028			
0.874	-0.176	-0.263	-0.962	-0.592	-0.343	-0.154	-0.045	0.067			
0.853	-0.190	-0.288	-1.007	-0.587	-0.336	-0.127	-0.015	0.096			
0.802	-0.228	-0.343	-1.156	-0.631	-0.291	-0.055	0.056	0.167			
0.703	-0.271	-0.417	-1.029	-0.465	-0.211	-0.013	0.099	0.225			
0.599	-0.263	-0.390	-0.818	-0.431	-0.204	-0.015	0.094	0.219			
0.402	-0.240	-0.346	-0.694	-0.381	-0.192	-0.020	0.084	0.213			

(d) Force data

$M_\infty$	$C_D$	$C_{D,p}$	$C_{D,f}$
0.597	0.0439	0.0567	0.0115
0.698	0.0543	0.0732	0.0112
0.799	0.1081	0.1222	0.0110
1.252	0.2511	0.2295	0.0102
1.198	0.2683	0.2510	0.0103
1.151	0.2894	0.2808	0.0104
0.953	0.2495	0.2444	0.0107
0.923	0.2056	0.2099	0.0108
0.899	0.1813	0.1891	0.0108
0.874	0.1607	0.1696	0.0109
0.853	0.1441	0.1570	0.0109
0.802	0.1081	0.1235	0.0110
0.703	0.0517	0.0736	0.0113
0.599	0.0391	0.0560	0.0115
0.402	0.0311	0.0444	0.0123

Table 21. Pressure and Force Data for Nozzle 12 With  $\beta_{r,top/bot} = 15.0^\circ/\beta_{r,side} = 22.4^\circ$  and Plume Off

(a) Static pressure coefficients on nozzle top flap

$M_\infty$	$\alpha$ , deg	Static pressure coefficients on nozzle top flap at centerline with values of $x/l$ of—														
		.153	.226	.300	.337	.411	.484	.558	.632	.705	.779	.853	.926			
1.251	0.008	0.000	-	-0.375	-0.461	-0.453	-0.400	-0.399	-0.325	-0.109	-0.074	-0.055	-0.036			
1.198	0.015	-0.002	-	-0.420	-0.514	-0.505	-0.441	-0.445	-0.210	-0.116	-0.088	-0.069	-0.053			
1.150	0.012	-0.020	-	-0.470	-0.565	-0.550	-0.491	-0.443	-0.168	-0.127	-0.103	-0.087	-0.070			
0.952	-0.015	-0.096	-	-0.772	-0.765	-0.394	-0.246	-0.194	-0.163	-0.143	-0.122	-0.102	-0.071			
0.922	0.029	-0.128	-	-0.814	-0.544	-0.294	-0.222	-0.186	-0.159	-0.135	-0.111	-0.084	-0.052			
0.899	-0.014	-0.148	-	-0.835	-0.471	-0.280	-0.215	-0.178	-0.142	-0.114	-0.085	-0.057	-0.023			
0.899	-2.979	-0.134	-	-0.875	-0.781	-0.377	-0.260	-0.203	-0.157	-0.122	-0.088	-0.057	-0.020			
0.900	-0.006	-0.148	-	-0.835	-0.482	-0.287	-0.222	-0.182	-0.148	-0.117	-0.087	-0.061	-0.025			
0.899	2.987	-0.157	-	-0.830	-0.460	-0.284	-0.221	-0.182	-0.142	-0.110	-0.078	-0.045	-0.006			
0.899	5.992	-0.162	-	-0.897	-0.675	-0.363	-0.270	-0.209	-0.149	-0.100	-0.054	-0.014	0.031			
0.899	9.005	-0.165	-	-0.903	-1.033	-0.498	-0.303	-0.205	-0.125	-0.064	-0.015	0.025	0.065			
0.875	0.016	-0.167	-	-0.849	-0.441	-0.270	-0.205	-0.158	-0.119	-0.085	-0.053	-0.023	0.012			
0.849	0.016	-0.189	-	-0.904	-0.455	-0.275	-0.192	-0.134	-0.087	-0.048	-0.015	0.017	0.046			
0.802	0.005	-0.227	-	-1.115	-0.587	-0.306	-0.170	-0.086	-0.023	0.022	0.058	0.090	0.115			
0.701	-0.010	-0.287	-	-1.194	-0.506	-0.224	-0.100	-0.024	0.033	0.077	0.113	0.144	0.171			
0.601	-0.012	-0.282	-	-0.885	-0.478	-0.221	-0.103	-0.029	0.028	0.071	0.107	0.137	0.165			
0.602	-2.995	-0.300	-	-1.007	-0.548	-0.274	-0.151	-0.074	-0.013	0.033	0.074	0.110	0.145			
0.602	-0.012	-0.283	-	-0.891	-0.480	-0.222	-0.104	-0.030	0.028	0.070	0.107	0.136	0.164			
0.603	2.995	-0.262	-	-0.804	-0.429	-0.185	-0.073	-0.003	0.049	0.085	0.116	0.140	0.162			
0.600	5.993	-0.242	-	-0.766	-0.407	-0.172	-0.064	0.000	0.048	0.081	0.109	0.130	0.149			
0.600	8.995	-0.234	-	-0.805	-0.427	-0.187	-0.079	-0.014	0.034	0.066	0.093	0.113	0.132			
0.400	0.030	-0.254	-	-0.733	-0.424	-0.207	-0.100	-0.029	0.024	0.061	0.098	0.128	0.155			

Table 21. Continued

(a) Continued

$M_\infty$	$\alpha$ , deg	Static pressure coefficients on nozzle top flap at $y/Y = 0.25$ with values of $x/l$ of—														
		.153	.226	.300	.337	.411	.558	.705	.779	.853	.926					
1.251	0.008	0.003	-0.006	-0.370	-0.463	-0.451	-0.405	-0.117	-0.075	-0.054	-0.037					
1.198	0.015	0.003	-0.019	-0.414	-0.513	-0.499	-0.445	-0.121	-0.088	-0.071	-0.051					
1.150	0.012	-0.016	-0.040	-0.464	-0.565	-0.553	-0.467	-0.129	-0.104	-0.087	-0.068					
0.952	-0.015	-0.093	-0.161	-0.762	-0.793	-0.413	-0.193	-0.145	-0.123	-0.101	-0.071					
0.922	0.029	-0.124	-0.199	-0.815	-0.582	-0.304	-0.189	-0.136	-0.110	-0.082	-0.051					
0.899	-0.014	-0.141	-0.226	-0.840	-0.491	-0.284	-0.179	-0.112	-0.085	-0.055	-0.022					
0.899	-2.979	-0.131	-0.210	-0.867	-0.806	-0.374	-0.202	-0.123	-0.091	-0.056	-0.020					
0.900	-0.006	-0.144	-0.227	-0.843	-0.509	-0.291	-0.183	-0.117	-0.089	-0.057	-0.024					
0.899	2.987	-0.153	-0.239	-0.834	-0.469	-0.285	-0.182	-0.111	-0.080	-0.043	-0.003					
0.899	5.992	-0.160	-0.245	-0.889	-0.699	-0.361	-0.204	-0.099	-0.054	-0.010	0.032					
0.899	9.005	-0.167	-0.244	-0.895	-1.041	-0.481	-0.198	-0.065	-0.019	0.025	0.065					
0.875	0.016	-0.161	-0.250	-0.862	-0.455	-0.278	-0.158	-0.087	-0.050	-0.020	0.014					
0.849	0.016	-0.184	-0.285	-0.918	-0.462	-0.276	-0.134	-0.050	-0.015	0.016	0.047					
0.802	0.005	-0.220	-0.337	-1.115	-0.587	-0.302	-0.084	0.023	0.060	0.092	0.117					
0.701	-0.010	-0.277	-0.436	-1.194	-0.500	-0.217	-0.022	0.079	0.116	0.147	0.171					
0.601	-0.012	-0.271	-0.418	-0.890	-0.472	-0.217	-0.024	0.072	0.112	0.139	0.165					
0.602	-2.995	-0.290	-0.452	-1.010	-0.541	-0.270	-0.070	0.034	0.079	0.113	0.145					
0.602	-0.012	-0.273	-0.420	-0.895	-0.473	-0.218	-0.025	0.072	0.112	0.139	0.164					
0.603	2.995	-0.252	-0.386	-0.816	-0.422	-0.179	0.001	0.087	0.121	0.142	0.163					
0.600	5.993	-0.232	-0.360	-0.777	-0.400	-0.166	0.004	0.082	0.114	0.132	0.150					
0.600	8.995	-0.225	-0.355	-0.807	-0.422	-0.184	-0.012	0.067	0.098	0.116	0.134					
0.400	0.030	-0.247	-0.368	-0.733	-0.418	-0.202	-0.030	0.065	0.104	0.132	0.158					

Table 21. Continued

(a) Continued

$M_\infty$	$\alpha$ , deg	Static pressure coefficients on nozzle top flap at $y/Y = 0.50$ with values of $x/l$ of—													
		.153	.226	.300	.337	.411	.558	.705	.779	.853	.926				
1.251	0.008	0.005	-0.009	-0.370	-0.468	-0.432	-0.378	-0.137	-0.076	-0.053	-0.029				
1.198	0.015	-0.002	-0.019	-0.413	-0.518	-0.476	-0.417	-0.128	-0.092	-0.068	-0.049				
1.150	0.012	-0.021	-0.044	-0.463	-0.572	-0.529	-0.456	-0.130	-0.105	-0.088	-0.066				
0.952	-0.015	-0.091	-0.159	-0.764	-0.833	-0.423	-0.192	-0.145	-0.124	-0.103	-0.073				
0.922	0.029	-0.123	-0.196	-0.820	-0.650	-0.311	-0.191	-0.139	-0.112	-0.082	-0.051				
0.899	-0.014	-0.144	-0.223	-0.867	-0.534	-0.298	-0.177	-0.116	-0.087	-0.054	-0.021				
0.899	-2.979	-0.131	-0.206	-0.875	-0.795	-0.369	-0.207	-0.131	-0.093	-0.057	-0.018				
0.900	-0.006	-0.144	-0.225	-0.869	-0.554	-0.301	-0.180	-0.120	-0.088	-0.056	-0.023				
0.899	2.987	-0.159	-0.241	-0.869	-0.492	-0.305	-0.182	-0.119	-0.083	-0.045	-0.005				
0.899	5.992	-0.176	-0.253	-0.910	-0.699	-0.372	-0.194	-0.099	-0.053	-0.011	0.031				
0.899	9.005	-0.198	-0.272	-0.917	-1.030	-0.448	-0.191	-0.077	-0.030	0.011	0.055				
0.875	0.016	-0.160	-0.246	-0.897	-0.490	-0.285	-0.160	-0.085	-0.054	-0.022	0.014				
0.849	0.016	-0.181	-0.277	-0.954	-0.491	-0.281	-0.131	-0.048	-0.015	0.017	0.048				
0.802	0.005	-0.215	-0.329	-1.120	-0.590	-0.289	-0.078	0.023	0.059	0.091	0.117				
0.701	-0.010	-0.261	-0.416	-1.146	-0.473	-0.201	-0.014	0.080	0.116	0.145	0.169				
0.601	-0.012	-0.256	-0.397	-0.875	-0.448	-0.199	-0.014	0.077	0.111	0.141	0.164				
0.899	-2.979	-0.131	-0.206	-0.875	-0.795	-0.369	-0.207	-0.131	-0.093	-0.057	-0.018				
0.900	-0.006	-0.144	-0.225	-0.869	-0.554	-0.301	-0.180	-0.120	-0.088	-0.056	-0.023				
0.899	2.987	-0.159	-0.241	-0.869	-0.492	-0.305	-0.182	-0.119	-0.083	-0.045	-0.005				
0.899	5.992	-0.176	-0.253	-0.910	-0.699	-0.372	-0.194	-0.099	-0.053	-0.011	0.031				
0.899	9.005	-0.198	-0.272	-0.917	-1.030	-0.448	-0.191	-0.077	-0.030	0.011	0.055				
0.400	0.030	-0.232	-0.352	-0.716	-0.394	-0.181	-0.011	0.071	0.101	0.132	0.155				

Table 21. Continued

(a) Concluded

$M_\infty$	$\alpha$ , deg	Static pressure coefficients on nozzle top flap at $y/Y = 0.75$ with values of $x/l$ of—														
		.153	.226	.300	.337	.411	.558	.705	.779	.853	.926					
1.251	0.008	0.003	-0.007	-0.355	-0.483	-0.396	-0.347	-0.220	-0.074	-0.047	-0.027					
1.198	0.015	-0.003	-0.018	-0.398	-0.534	-0.437	-0.389	-0.163	-0.087	-0.063	-0.044					
1.150	0.012	-0.028	-0.046	-0.448	-0.585	-0.493	-0.432	-0.135	-0.104	-0.082	-0.062					
0.952	-0.015	-0.092	-0.152	-0.733	-0.757	-0.400	-0.232	-0.160	-0.133	-0.105	-0.075					
0.922	0.029	-0.120	-0.189	-0.792	-0.560	-0.339	-0.211	-0.144	-0.114	-0.083	-0.050					
0.899	-0.014	-0.139	-0.214	-0.828	-0.504	-0.316	-0.194	-0.120	-0.088	-0.055	-0.023					
0.899	-2.979	-0.135	-0.196	-0.820	-0.515	-0.373	-0.256	-0.146	-0.100	-0.059	-0.022					
0.900	-0.006	-0.140	-0.214	-0.831	-0.509	-0.319	-0.197	-0.123	-0.091	-0.056	-0.026					
0.899	2.987	-0.160	-0.249	-0.809	-0.470	-0.297	-0.192	-0.117	-0.080	-0.041	-0.006					
0.899	5.992	-0.179	-0.269	-0.809	-0.457	-0.321	-0.202	-0.092	-0.049	-0.008	0.029					
0.899	9.005	-0.198	-0.285	-0.881	-0.585	-0.360	-0.211	-0.089	-0.042	0.000	0.039					
0.875	0.016	-0.156	-0.236	-0.860	-0.480	-0.303	-0.166	-0.088	-0.053	-0.018	0.014					
0.849	0.016	-0.174	-0.265	-0.909	-0.494	-0.295	-0.136	-0.048	-0.013	0.019	0.047					
0.802	0.005	-0.202	-0.311	-1.019	-0.536	-0.274	-0.085	0.023	0.061	0.093	0.118					
0.701	-0.010	-0.238	-0.377	-1.106	-0.446	-0.182	-0.013	0.084	0.119	0.146	0.169					
0.601	-0.012	-0.235	-0.364	-0.893	-0.426	-0.178	-0.009	0.082	0.114	0.143	0.161					
0.602	-2.995	-0.246	-0.386	-1.067	-0.503	-0.231	-0.052	0.055	0.093	0.127	0.149					
0.602	-0.012	-0.236	-0.365	-0.896	-0.427	-0.178	-0.009	0.083	0.114	0.143	0.162					
0.603	2.995	-0.234	-0.343	-0.699	-0.348	-0.139	0.015	0.092	0.117	0.142	0.157					
0.600	5.993	-0.229	-0.320	-0.583	-0.296	-0.109	0.013	0.087	0.115	0.138	0.149					
0.600	8.995	-0.228	-0.299	-0.563	-0.270	-0.131	-0.003	0.085	0.112	0.132	0.138					
0.400	0.030	-0.213	-0.325	-0.738	-0.374	-0.163	-0.008	0.076	0.110	0.134	0.152					

Table 21. Continued

## (b) Static pressure coefficients on nozzle sidewall

$M_\infty$	$\alpha$ , deg	Static pressure coefficients on corner between nozzle top flap and sidewall with values of $x/l$ of—												
		.153	.226	.300	.337	.411	.558	.705	.779	.853	.926			
1.251	0.008	0.003	-	-0.337	-0.515	-0.406	-0.333	-0.212	-0.088	-0.040	-0.023	-	-	
1.198	0.015	-0.004	-	-0.381	-0.565	-0.443	-0.374	-0.187	-0.083	-0.058	-0.039	-	-	
1.150	0.012	-0.029	-	-0.427	-0.625	-0.493	-0.418	-0.139	-0.093	-0.074	-0.059	-	-	
0.952	-0.015	-0.092	-	-0.701	-0.622	-0.409	-0.274	-0.185	-0.153	-0.122	-0.088	-	-	
0.922	0.029	-0.122	-	-0.755	-0.484	-0.353	-0.238	-0.158	-0.124	-0.093	-0.060	-	-	
0.899	-0.014	-0.142	-	-0.776	-0.445	-0.335	-0.213	-0.128	-0.091	-0.059	-0.027	-	-	
0.899	-2.979	-0.140	-	-0.751	-0.406	-0.343	-0.279	-0.170	-0.119	-0.071	-0.033	-	-	
0.900	-0.006	-0.142	-	-0.781	-0.451	-0.337	-0.215	-0.131	-0.095	-0.062	-0.031	-	-	
0.899	2.987	-0.161	-	-0.779	-0.455	-0.345	-0.215	-0.124	-0.085	-0.046	-0.010	-	-	
0.899	5.992	-0.182	-	-0.699	-0.386	-0.333	-0.251	-0.148	-0.110	-0.071	-0.028	-	-	
0.899	9.005	-0.199	-	-0.655	-0.373	-0.339	-0.290	-0.200	-0.168	-0.141	-0.058	-	-	
0.875	0.016	-0.156	-	-0.801	-0.429	-0.320	-0.188	-0.090	-0.051	-0.019	0.010	-	-	
0.849	0.016	-0.174	-	-0.844	-0.443	-0.319	-0.156	-0.049	-0.012	0.021	0.046	-	-	
0.802	0.005	-0.205	-	-0.954	-0.472	-0.282	-0.106	0.012	0.057	0.090	0.113	-	-	
0.701	-0.010	-0.239	-	-1.143	-0.449	-0.163	-0.002	0.088	0.119	0.143	0.164	-	-	
0.601	-0.012	-0.235	-	-0.932	-0.443	-0.160	0.013	0.090	0.117	0.139	0.159	-	-	
0.602	-2.995	-0.247	-	-1.077	-0.512	-0.206	-0.018	0.074	0.105	0.125	0.145	-	-	
0.602	-0.012	-0.236	-	-0.939	-0.445	-0.160	0.013	0.091	0.118	0.139	0.160	-	-	
0.603	2.995	-0.235	-	-0.814	-0.375	-0.125	0.027	0.094	0.119	0.139	0.158	-	-	
0.600	5.993	-0.236	-	-0.690	-0.292	-0.093	0.017	0.087	0.116	0.137	0.152	-	-	
0.600	8.995	-0.232	-	-0.462	-0.188	-0.159	0.003	0.092	0.117	0.132	0.134	-	-	
0.400	0.030	-0.215	-	-0.769	-0.396	-0.144	0.018	0.084	0.113	0.133	0.151	-	-	

Table 21. Continued

(b) Continued

$M_\infty$	$\alpha$ , deg	Static pressure coefficients on nozzle sidewall at $z/Z = 0.50$ with values of $x/l$ of —												
		.153	.226	.300	.337	.411	.558	.705	.779	.853	.926			
1.251	0.008	—	-0.005	-0.362	-0.549	-0.456	—	-0.169	-0.099	-0.042	-0.019			
1.198	0.015	—	-0.019	-0.407	-0.606	-0.496	—	-0.170	-0.092	-0.051	-0.034			
1.150	0.012	—	-0.049	-0.459	-0.666	-0.551	—	-0.142	-0.090	-0.068	-0.055			
0.952	-0.015	—	-0.150	-0.734	-0.561	-0.405	—	-0.194	-0.154	-0.115	-0.077			
0.922	0.029	—	-0.186	-0.747	-0.445	-0.347	—	-0.167	-0.127	-0.085	-0.044			
0.899	-0.014	—	-0.210	-0.739	-0.408	-0.321	—	-0.136	-0.091	-0.049	-0.010			
0.899	-2.979	—	-0.205	-0.665	-0.337	-0.306	—	-0.173	-0.119	-0.067	-0.017			
0.900	-0.006	—	-0.211	-0.746	-0.414	-0.323	—	-0.139	-0.095	-0.053	-0.013			
0.899	2.987	—	-0.230	-0.783	-0.453	-0.347	—	-0.150	-0.094	-0.043	0.005			
0.899	5.992	—	-0.261	-0.742	-0.419	-0.350	—	-0.230	-0.157	-0.075	-0.002			
0.899	9.005	—	-0.297	-0.712	-0.410	-0.355	—	-0.286	-0.215	-0.113	-0.007			
0.875	0.016	—	-0.231	-0.753	-0.398	-0.315	—	-0.097	-0.052	-0.011	0.025			
0.849	0.016	—	-0.258	-0.799	-0.423	-0.314	—	-0.060	-0.011	0.029	0.061			
0.802	0.005	—	-0.299	-0.895	-0.438	-0.284	—	-0.004	0.052	0.091	0.119			
0.701	-0.010	—	-0.362	-1.172	-0.435	-0.171	—	0.088	0.122	0.148	0.170			
0.601	-0.012	—	-0.362	-1.001	-0.475	-0.151	—	0.097	0.121	0.142	0.163			
0.602	-2.995	—	-0.381	-1.108	-0.521	-0.179	—	0.082	0.105	0.125	0.145			
0.602	-0.012	—	-0.363	-1.008	-0.478	-0.153	—	0.097	0.122	0.142	0.164			
0.603	2.995	—	-0.360	-0.962	-0.440	-0.130	—	0.096	0.119	0.139	0.159			
0.600	5.993	—	-0.363	-0.899	-0.376	-0.103	—	0.078	0.103	0.122	0.138			
0.600	8.995	—	-0.356	-0.733	-0.254	-0.151	—	0.062	0.083	0.090	0.095			
0.400	0.030	—	-0.324	-0.837	-0.431	-0.143	—	0.099	0.122	0.141	0.156			

Table 21. Continued

(b) Continued

$M_\infty$	$\alpha$ , deg	Static pressure coefficients on nozzle sidewall at centerline with values of $x/l$ of—														
		.153	.226	.300	.337	.411	.484	.558	.632	.705	.779	.853	.926			
1.251	0.008	0.008	-0.007	-0.357	-0.566	-0.516	-0.405	-0.272	-0.190	-0.149	-0.103	-0.059	-			
1.198	0.015	-0.006	-0.026	-0.406	-0.623	-0.565	-0.440	-0.298	-0.216	-0.161	-0.105	-0.064	-			
1.150	0.012	-0.031	-0.056	-0.453	-0.686	-0.626	-0.490	-0.313	-0.211	-0.147	-0.099	-0.067	-			
0.952	-0.015	-0.093	-0.160	-0.717	-0.492	-0.370	-0.323	-0.286	-0.243	-0.198	-0.158	-0.116	-			
0.922	0.029	-0.121	-0.194	-0.741	-0.382	-0.311	-0.289	-0.254	-0.214	-0.172	-0.130	-0.085	-			
0.899	-0.014	-0.138	-0.219	-0.737	-0.340	-0.291	-0.269	-0.235	-0.189	-0.142	-0.094	-0.050	-			
0.899	-2.979	-0.146	-0.224	-0.704	-0.308	-0.277	-0.275	-0.256	-0.216	-0.169	-0.118	-0.067	-			
0.900	-0.006	-0.139	-0.219	-0.743	-0.343	-0.294	-0.272	-0.239	-0.191	-0.147	-0.098	-0.053	-			
0.899	2.987	-0.146	-0.221	-0.771	-0.372	-0.330	-0.317	-0.280	-0.221	-0.163	-0.101	-0.045	-			
0.899	5.992	-0.167	-0.237	-0.721	-0.315	-0.299	-0.309	-0.306	-0.274	-0.227	-0.150	-0.068	-			
0.899	9.005	-0.200	-0.266	-0.675	-0.308	-0.304	-0.319	-0.327	-0.311	-0.274	-0.196	-0.095	-			
0.875	0.016	-0.154	-0.241	-0.748	-0.326	-0.286	-0.261	-0.215	-0.161	-0.105	-0.053	-0.009	-			
0.849	0.016	-0.173	-0.272	-0.784	-0.331	-0.289	-0.249	-0.191	-0.125	-0.063	-0.011	0.030	-			
0.802	0.005	-0.199	-0.313	-0.803	-0.298	-0.262	-0.221	-0.149	-0.072	-0.003	0.051	0.094	-			
0.701	-0.010	-0.237	-0.387	-0.940	-0.339	-0.198	-0.116	-0.026	0.041	0.089	0.124	0.149	-			
0.601	-0.012	-0.242	-0.392	-0.928	-0.528	-0.140	-0.033	0.027	0.068	0.101	0.123	0.144	-			
0.602	-2.995	-0.248	-0.399	-0.946	-0.535	-0.143	-0.036	0.024	0.063	0.095	0.115	0.135	-			
0.602	-0.012	-0.244	-0.394	-0.936	-0.532	-0.143	-0.034	0.028	0.068	0.101	0.122	0.144	-			
0.603	2.995	-0.250	-0.402	-0.957	-0.539	-0.144	-0.037	0.023	0.061	0.093	0.114	0.133	-			
0.600	5.993	-0.264	-0.412	-0.954	-0.518	-0.139	-0.045	0.008	0.041	0.071	0.087	0.101	-			
0.600	8.995	-0.288	-0.429	-0.935	-0.497	-0.156	-0.074	-0.021	0.015	0.031	0.036	0.047	-			
0.400	0.030	-0.223	-0.363	-0.789	-0.502	-0.132	-0.024	0.036	0.074	0.099	0.121	0.141	-			



Table 21. Continued

(b) Concluded

$M_\infty$	$\alpha$ , deg	Static pressure coefficients on nozzle sidewall at $z/Z = -0.50$ with values of $x/l$ of —									
		.153	.226	.300	.377	.411	.558	.705	.926		
1.251	0.008	0.013	0.003	-0.334	-0.559	—	-0.344	-0.193	-0.038		
1.198	0.015	-0.005	-0.022	-0.383	-0.618	—	-0.369	-0.205	-0.045		
1.150	0.012	-0.032	-0.046	-0.434	-0.682	—	-0.402	-0.195	-0.054		
0.952	-0.015	-0.087	-0.147	-0.675	-0.447	—	-0.289	-0.213	-0.078		
0.922	0.029	-0.116	-0.180	-0.646	-0.345	—	-0.262	-0.190	-0.047		
0.899	-0.014	-0.136	-0.203	-0.623	-0.306	—	-0.246	-0.156	-0.011		
0.899	-2.979	-0.153	-0.223	-0.629	-0.321	—	-0.257	-0.171	-0.026		
0.900	-0.006	-0.135	-0.204	-0.622	-0.307	—	-0.248	-0.161	-0.016		
0.899	2.987	-0.140	-0.203	-0.652	-0.328	—	-0.280	-0.178	-0.002		
0.899	5.992	-0.167	-0.226	-0.629	-0.300	—	-0.310	-0.235	-0.001		
0.899	9.005	-0.217	-0.273	-0.617	-0.309	—	-0.339	-0.293	-0.005		
0.875	0.016	-0.148	-0.224	-0.637	-0.302	—	-0.231	-0.119	0.028		
0.849	0.016	-0.168	-0.251	-0.671	-0.314	—	-0.206	-0.074	0.065		
0.802	0.005	-0.192	-0.291	-0.814	-0.378	—	-0.145	-0.006	0.120		
0.701	-0.010	-0.228	-0.355	-1.253	-0.449	—	-0.011	0.089	0.167		
0.601	-0.012	-0.227	-0.355	-1.060	-0.465	—	0.020	0.094	0.160		
0.602	-2.995	-0.230	-0.350	-1.009	-0.426	—	0.027	0.095	0.157		
0.602	-0.012	-0.229	-0.357	-1.069	-0.469	—	0.019	0.093	0.160		
0.603	2.995	-0.243	-0.377	-1.180	-0.514	—	0.001	0.077	0.143		
0.600	5.993	-0.270	-0.406	-1.253	-0.550	—	-0.022	0.055	0.122		
0.600	8.995	-0.316	-0.451	-1.330	-0.599	—	-0.058	0.025	0.118		
0.400	0.030	-0.209	-0.323	-0.879	-0.424	—	0.018	0.094	0.153		

Table 21. Continued

(c) Static pressure coefficients on nozzle bottom flap

$M_\infty$	$\alpha$ , deg	Static pressure coefficients on nozzle bottom flap at $y/Y = 0.75$ with values of $x/l$ of—													
		.153	.226	.300	.337	.411	.558	.705	.779	.853	.926				
1.251	0.008	0.013	0.000	-0.392	-0.468	-0.403	-0.369	-0.325	-0.238	-0.105	-0.039				
1.198	0.015	-0.005	-0.024	-0.443	-0.526	-0.446	-0.411	-0.347	-0.221	-0.101	-0.047				
1.150	0.012	-0.028	-0.047	-0.497	-0.578	-0.493	-0.450	-0.342	-0.189	-0.104	-0.056				
0.952	-0.015	-0.086	-0.148	-0.781	-0.586	-0.383	-0.291	-0.215	-0.161	-0.108	-0.057				
0.922	0.029	-0.116	-0.184	-0.759	-0.432	-0.334	-0.274	-0.183	-0.126	-0.072	-0.026				
0.899	-0.014	-0.133	-0.206	-0.730	-0.406	-0.319	-0.249	-0.147	-0.086	-0.036	0.007				
0.899	-2.979	-0.153	-0.240	-0.710	-0.387	-0.309	-0.246	-0.134	-0.071	-0.024	0.018				
0.900	-0.006	-0.134	-0.207	-0.729	-0.402	-0.320	-0.254	-0.151	-0.089	-0.040	0.004				
0.899	2.987	-0.131	-0.194	-0.792	-0.446	-0.356	-0.290	-0.169	-0.094	-0.038	0.012				
0.899	5.992	-0.144	-0.195	-0.804	-0.448	-0.373	-0.348	-0.220	-0.126	-0.046	0.024				
0.899	9.005	-0.170	-0.209	-0.817	-0.453	-0.387	-0.399	-0.275	-0.159	-0.059	0.026				
0.875	0.016	-0.147	-0.227	-0.749	-0.412	-0.323	-0.216	-0.097	-0.042	0.004	0.040				
0.849	0.016	-0.168	-0.256	-0.805	-0.440	-0.326	-0.178	-0.049	0.000	0.038	0.069				
0.802	0.005	-0.196	-0.298	-0.941	-0.501	-0.293	-0.104	0.015	0.060	0.094	0.121				
0.701	-0.010	-0.231	-0.363	-1.148	-0.437	-0.185	-0.014	0.077	0.115	0.144	0.167				
0.601	-0.012	-0.225	-0.354	-0.930	-0.418	-0.181	-0.011	0.076	0.110	0.137	0.161				
0.602	-2.995	-0.222	-0.333	-0.729	-0.342	-0.137	0.016	0.089	0.117	0.138	0.157				
0.602	-0.012	-0.226	-0.355	-0.936	-0.420	-0.182	-0.013	0.075	0.110	0.137	0.161				
0.603	2.995	-0.238	-0.376	-1.089	-0.489	-0.235	-0.057	0.045	0.088	0.120	0.147				
0.600	5.993	-0.255	-0.394	-1.197	-0.548	-0.286	-0.103	0.009	0.057	0.092	0.127				
0.600	8.995	-0.283	-0.417	-1.303	-0.607	-0.345	-0.162	-0.041	0.016	0.061	0.106				
0.400	0.030	-0.206	-0.318	-0.780	-0.377	-0.170	-0.014	0.068	0.104	0.132	0.152				

Table 21. Concluded

(c) Continued

$M_\infty$	$\alpha$ , deg	Static pressure coefficients on nozzle bottom flap at $y/Y = 0.50$ with values of $x/l$ of—													
		.153	.226	.300	.337	.411	.558	.705	.779	.853	.926				
1.251	0.008	0.036	-0.005	-0.384	-0.461	-0.448	-0.390	-0.360	-0.300	-0.103	-0.035				
1.198	0.015	0.022	-0.023	-0.430	-0.510	-0.491	-0.433	-0.391	-0.257	-0.097	-0.045				
1.150	0.012	0.004	-0.052	-0.480	-0.559	-0.545	-0.473	-0.423	-0.194	-0.096	-0.058				
0.952	-0.015	-0.009	-0.163	-0.776	-0.865	-0.502	-0.257	-0.165	-0.122	-0.077	-0.043				
0.922	0.029	-0.015	-0.200	-0.846	-0.805	-0.380	-0.238	-0.140	-0.092	-0.050	-0.016				
0.899	-0.014	-0.016	-0.224	-0.894	-0.686	-0.355	-0.211	-0.106	-0.059	-0.022	0.010				
0.899	-2.979	-0.014	-0.244	-0.916	-0.768	-0.367	-0.200	-0.092	-0.046	-0.009	0.023				
0.900	-0.006	-0.016	-0.225	-0.893	-0.687	-0.355	-0.216	-0.109	-0.062	-0.024	0.010				
0.899	2.987	-0.019	-0.205	-0.892	-0.824	-0.411	-0.245	-0.122	-0.068	-0.022	0.021				
0.899	5.992	-0.019	-0.189	-0.883	-0.870	-0.457	-0.305	-0.159	-0.086	-0.022	0.032				
0.899	9.005	-0.021	-0.175	-0.876	-0.922	-0.486	-0.351	-0.195	-0.111	-0.033	0.036				
0.875	0.016	-0.014	-0.248	-0.944	-0.628	-0.337	-0.179	-0.071	-0.027	0.011	0.036				
0.849	0.016	-0.018	-0.280	-1.014	-0.615	-0.327	-0.145	-0.036	0.005	0.041	0.065				
0.802	0.005	-0.019	-0.330	-1.137	-0.616	-0.289	-0.084	0.023	0.063	0.094	0.119				
0.701	-0.010	-0.021	-0.407	-1.008	-0.463	-0.206	-0.025	0.075	0.111	0.141	0.163				
0.601	-0.012	-0.022	-0.389	-0.815	-0.437	-0.199	-0.028	0.071	0.104	0.133	0.158				
0.602	-2.995	-0.021	-0.351	-0.708	-0.374	-0.155	0.004	0.089	0.116	0.139	0.158				
0.602	-0.012	-0.023	-0.391	-0.819	-0.440	-0.201	-0.029	0.070	0.104	0.132	0.158				
0.603	2.995	-0.025	-0.418	-0.952	-0.505	-0.249	-0.071	0.036	0.074	0.109	0.141				
0.600	5.993	-0.026	-0.431	-1.050	-0.556	-0.289	-0.108	0.001	0.042	0.080	0.117				
0.600	8.995	-0.027	-0.436	-1.136	-0.598	-0.324	-0.145	-0.033	0.011	0.054	0.097				
0.400	0.030	-0.016	-0.346	-0.689	-0.391	-0.192	-0.030	0.062	0.096	0.125	0.145				

Table 21. Concluded

(c) Concluded

$M_\infty$	$\alpha$ , deg	Static pressure coefficients on nozzle bottom flap at centerline with values of $x/l$ of—										
		.153	.226	.300	.337	.411	.558	.705	.926			
1.251	0.008	0.007	-0.013	-0.388	-0.447	-0.432	-0.423	-0.389	-0.038			
1.198	0.015	-0.014	-0.037	-0.439	-0.501	-0.481	-0.464	-0.419	-0.048			
1.150	0.012	-0.035	-0.059	-0.487	-0.554	-0.535	-0.500	-0.458	-0.058			
0.952	-0.015	-0.108	-0.183	-0.800	-0.880	-0.790	-0.225	-0.131	-0.031			
0.922	0.029	-0.134	-0.213	-0.868	-0.948	-0.481	-0.192	-0.110	-0.010			
0.899	-0.014	-0.155	-0.237	-0.921	-0.848	-0.396	-0.189	-0.093	0.010			
0.899	-2.979	-0.162	-0.244	-0.928	-0.904	-0.412	-0.182	-0.080	0.023			
0.900	-0.006	-0.156	-0.238	-0.922	-0.863	-0.396	-0.189	-0.094	0.007			
0.899	2.987	-0.146	-0.229	-0.919	-0.990	-0.484	-0.196	-0.094	0.022			
0.899	5.992	-0.135	-0.218	-0.913	-1.013	-0.740	-0.225	-0.110	0.039			
0.899	9.005	-0.120	-0.203	-0.907	-1.010	-0.902	-0.253	-0.133	0.041			
0.875	0.016	-0.174	-0.260	-0.975	-0.714	-0.378	-0.174	-0.068	0.042			
0.849	0.016	-0.197	-0.293	-1.040	-0.661	-0.370	-0.149	-0.036	0.072			
0.802	0.005	-0.233	-0.350	-1.174	-0.683	-0.330	-0.084	0.023	0.122			
0.701	-0.010	-0.284	-0.430	-1.073	-0.488	-0.232	-0.037	0.065	0.165			
0.601	-0.012	-0.274	-0.405	-0.848	-0.455	-0.225	-0.043	0.058	0.158			
0.602	-2.995	-0.251	-0.372	-0.761	-0.403	-0.186	-0.012	0.078	0.160			
0.602	-0.012	-0.275	-0.408	-0.855	-0.458	-0.227	-0.044	0.056	0.158			
0.603	2.995	-0.293	-0.437	-0.938	-0.510	-0.271	-0.084	0.022	0.139			
0.600	5.993	-0.299	-0.452	-1.002	-0.549	-0.304	-0.117	-0.011	0.115			
0.600	8.995	-0.299	-0.461	-1.043	-0.576	-0.331	-0.146	-0.038	0.095			
0.400	0.030	-0.250	-0.360	-0.717	-0.400	-0.213	-0.045	0.046	0.148			

Table 21. Concluded

(d) Force data

$M_\infty$	$\alpha$ , deg	$C_D$
1.251	0.008	0.2786
1.198	0.015	0.2999
1.200	-2.995	0.3114
1.200	-0.014	0.2992
1.198	2.995	0.3020
1.199	6.000	0.3237
1.199	8.988	0.3384
1.150	0.012	0.3222
0.952	-0.015	0.2718
0.922	0.029	0.2336
0.899	-0.014	0.2097
0.899	-2.979	0.2220
0.900	-0.006	0.2100
0.899	2.987	0.2199
0.899	5.992	0.2414
0.899	9.005	0.2709
0.875	0.016	0.1912
0.849	0.016	0.1709
0.802	0.005	0.1368
0.701	-0.010	0.0801
0.601	-0.012	0.0718
0.602	-2.995	0.0697
0.602	-0.012	0.0701
0.603	2.995	0.0715
0.600	5.993	0.0777
0.600	8.995	0.0869
0.400	0.030	0.0646

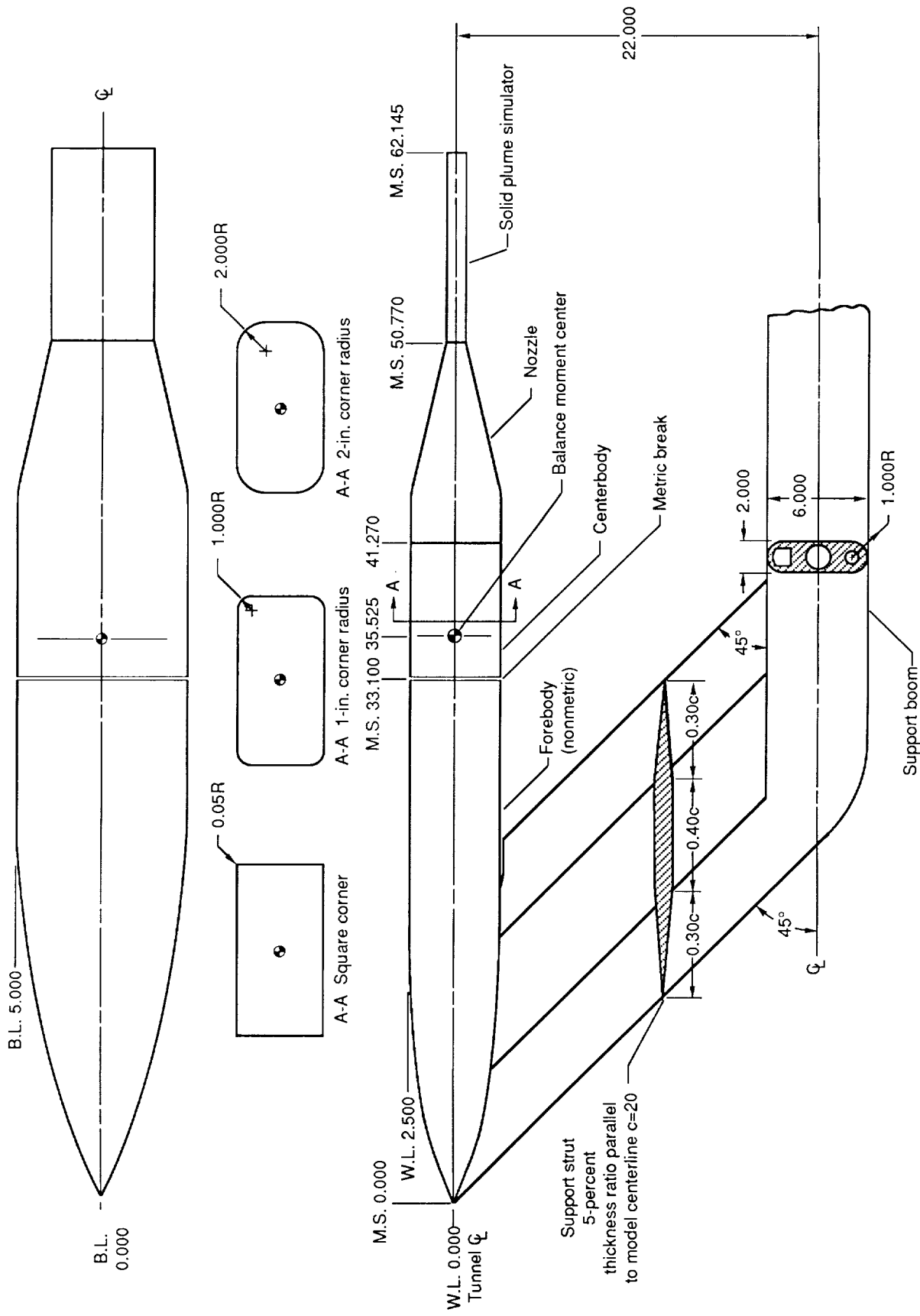
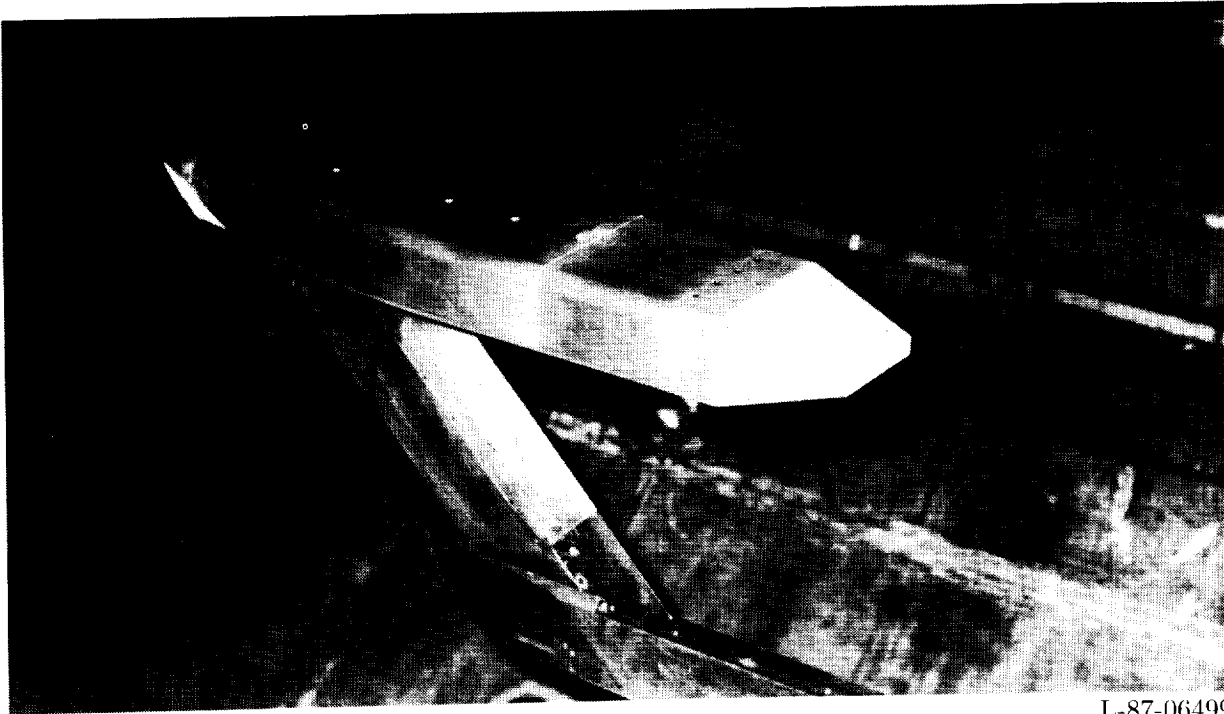

Figure 1. General arrangement of model and support system showing three fuselage cross sections with different corner radii. All linear dimensions are given in inches.

ORIGINAL PAGE  
BLACK AND WHITE PHOTOGRAPH



L-87-06499

(a) Nozzle 7 without solid plume simulator.



L-87-06327

(b) Nozzle 7 with solid plume simulator.

Figure 2. Model installed in the Langley 16-Foot Transonic Tunnel.

ORIGINAL PAGE  
BLACK AND WHITE PHOTOGRAPH

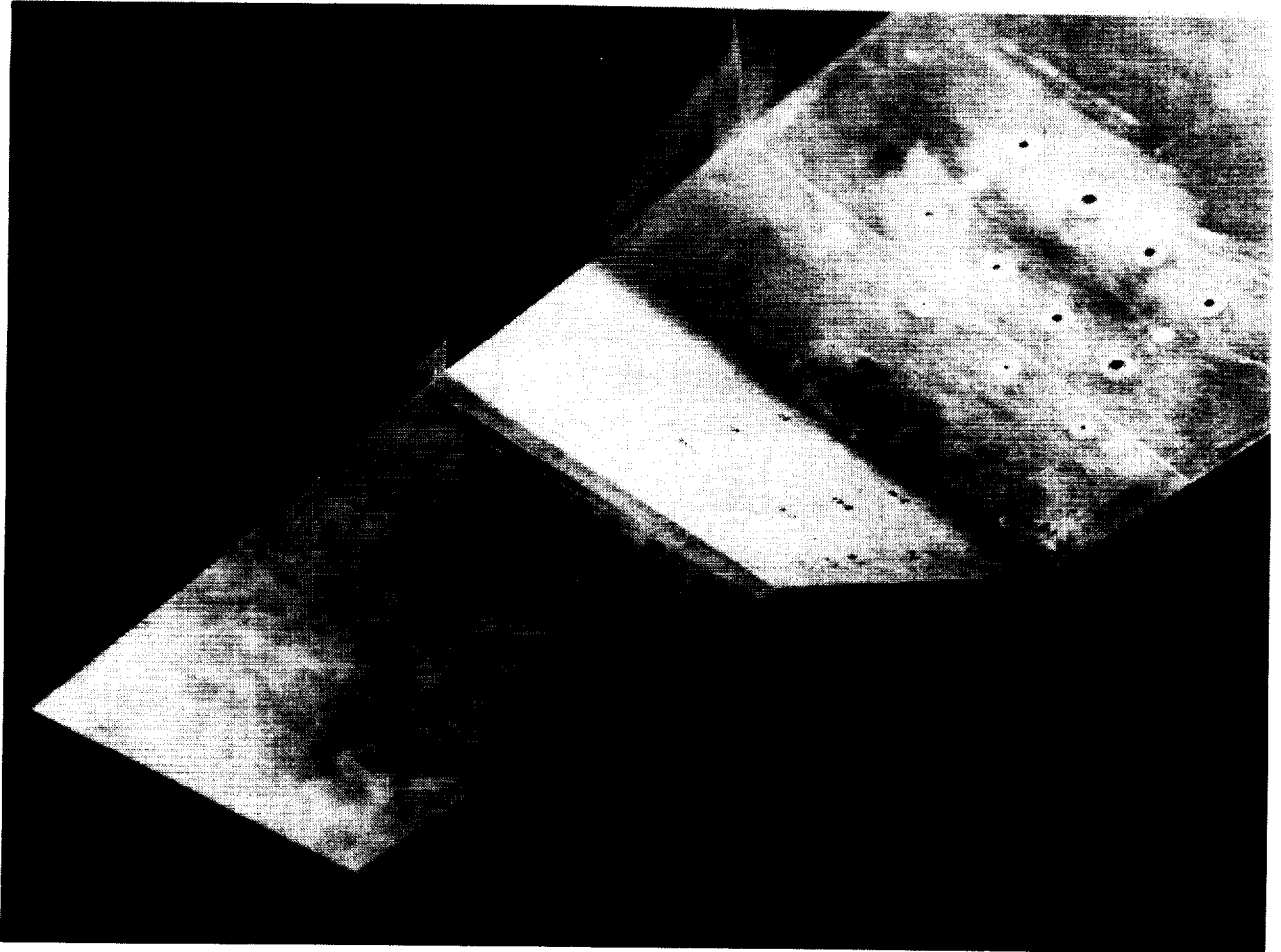

L-87-06210

(c) Nozzle 2 with solid plume simulator.

Figure 2. Concluded.



Nozzle	AR	$h_e$ , in.	$w_e$ , in.	$\beta_{t,top/bot}$ , deg	$\beta_{t,side}$ , deg	R, in.
1	14.49	0.69	10.00	17.9	0	0
2	9.23	.83	7.66	17.3	9.7	0
3	5.76	1.05	6.05	16.4	16.4	0
4	3.28	1.39	4.56	15.0	22.4	0
5	14.49	.69	10.00	17.9	0	1
6	9.23	.83	7.66	17.3	9.7	1
7	5.76	1.05	6.05	16.4	16.4	1
8	3.28	1.39	4.56	15.0	22.4	1
9	14.49	.69	10.00	17.9	0	2
10	9.23	.83	7.66	17.3	9.7	2
11	5.76	1.05	6.05	16.4	16.4	2
12	3.28	1.39	4.56	15.0	22.4	2

M.S. 41.27

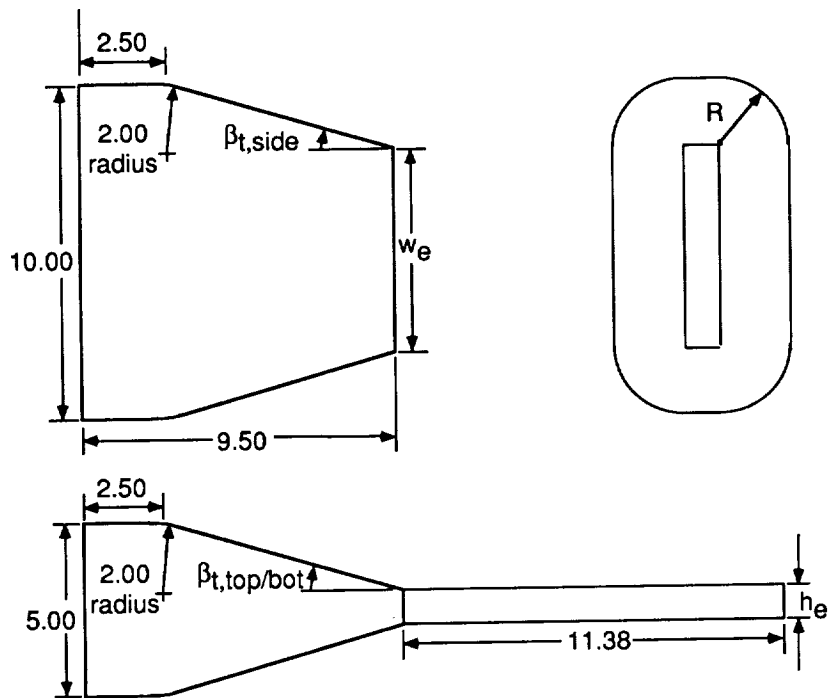

Figure 3. Geometry of nozzle with solid plume simulator. Linear dimensions are given in inches.

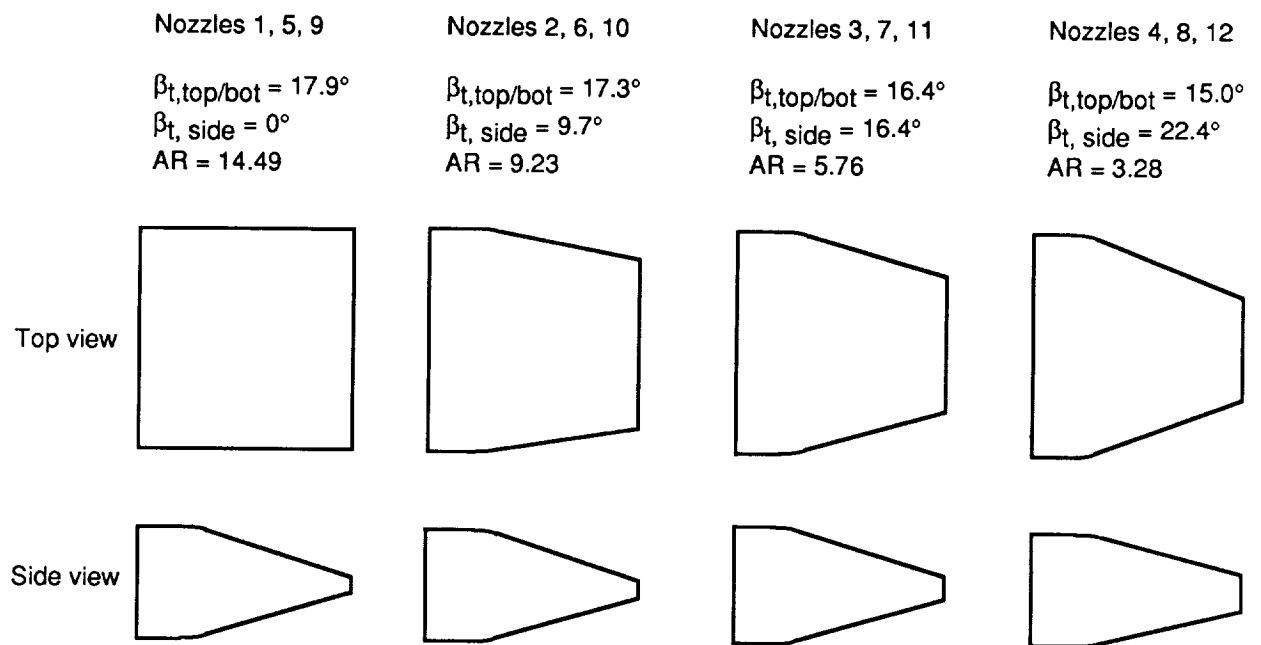
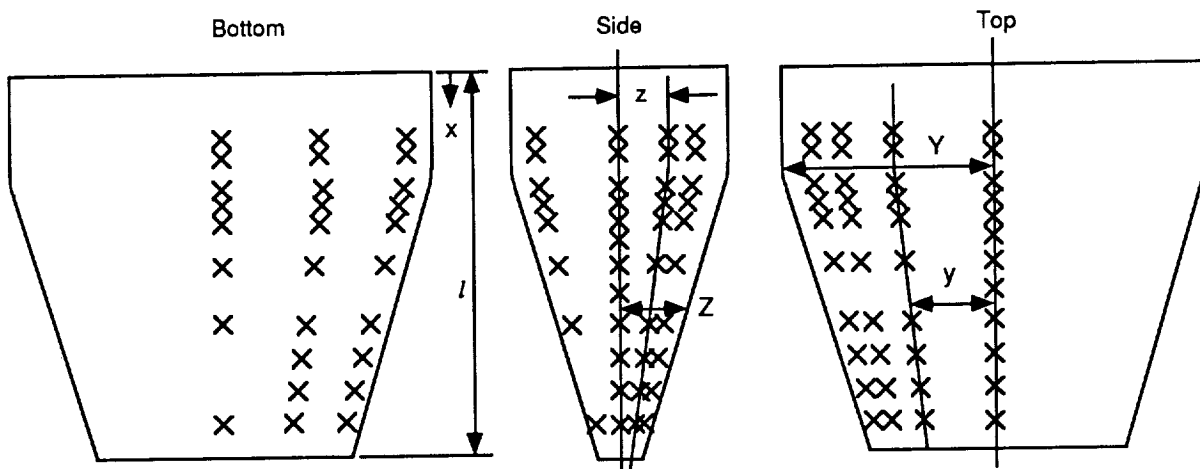
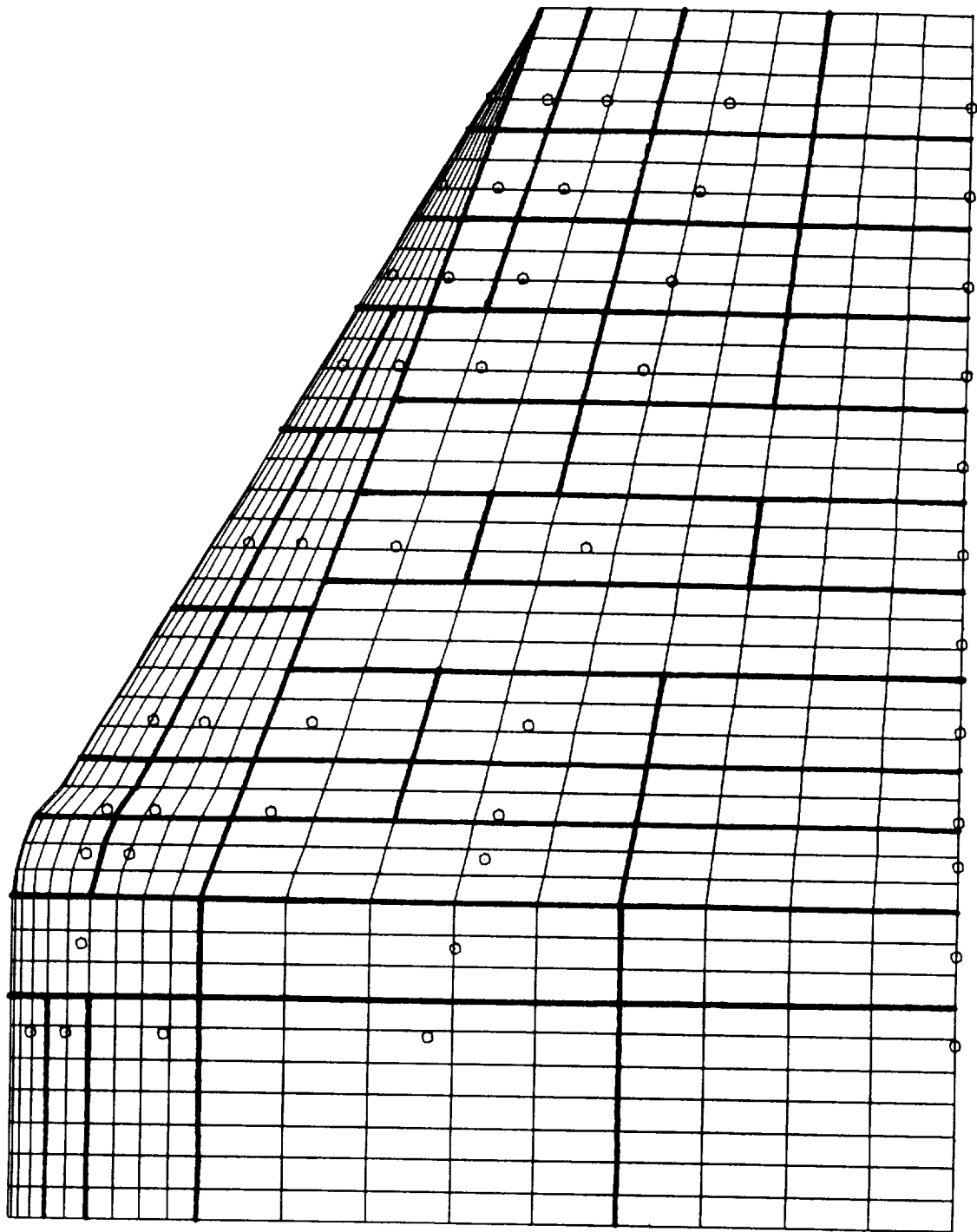

Figure 4. Closure distributions of nozzles.



Nozzle corner radius	Top y/Y	Side z/Z	Bottom y/Y
Sharp (nozzles 2, 3)	0	0.75	0.875
	.50	.50	.50
	.75	0	0
	.875	-.75	
1-in. (nozzles 5-8)	0	Top/Side corner	0.875
	.50	0.50	.50
	.75	0	0
	.875	-.50	
2-in. (nozzles 9-12)	0	Top/Side corner	0.75
	.25	0.50	.50
	.50	0	0
	.75	-.50	

Figure 5. Locations of nozzle pressure orifices.



(a) Nozzle upper flap.

Figure 6. Grid used for determining areas for pressure integration.

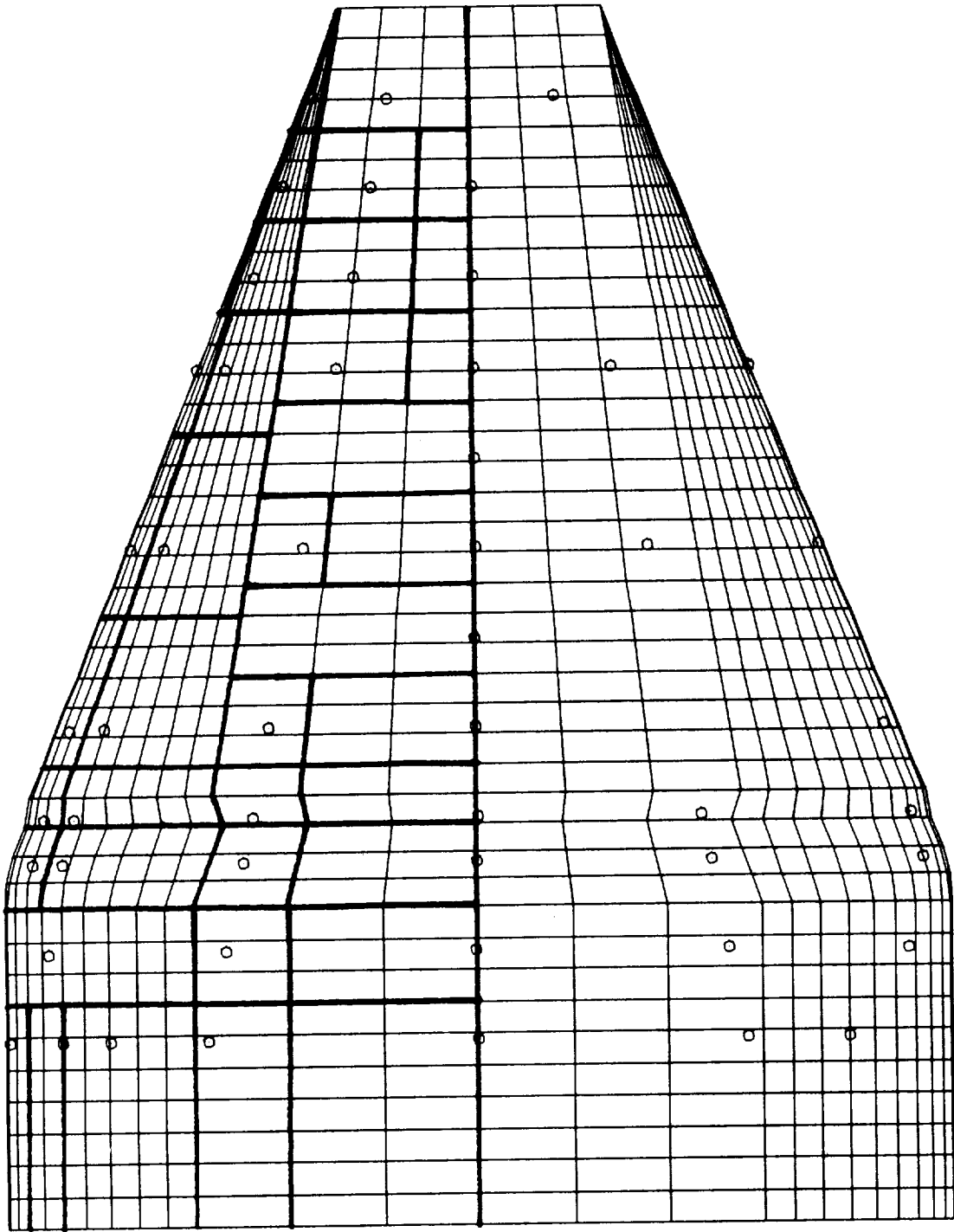

(b) Nozzle sidewall.

Figure 6. Concluded.

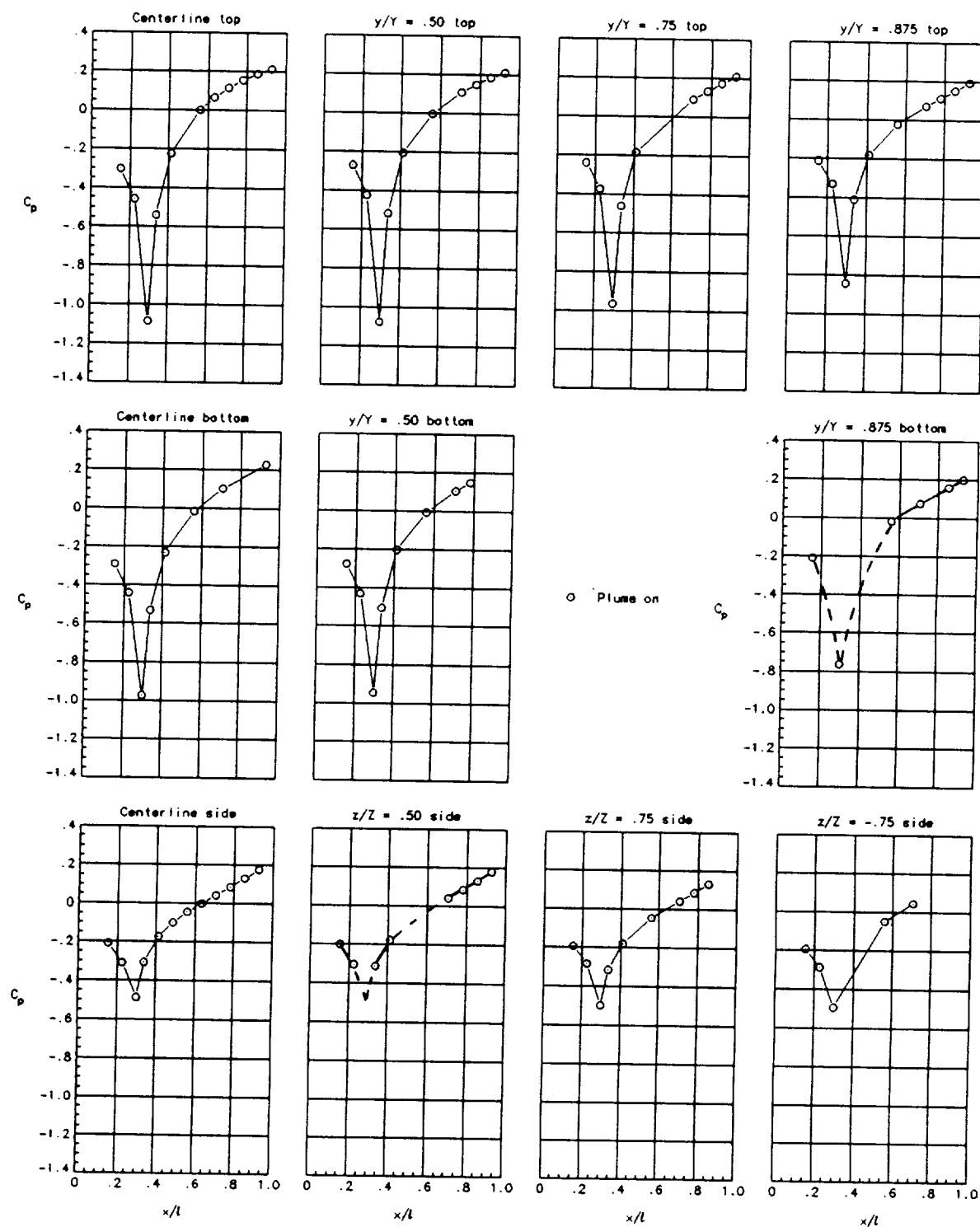

(a) Nozzle 2 with  $\beta_{t,top/bot} = 17.3^\circ / \beta_{t,side} = 9.7^\circ$  and sharp corner at  $M_\infty = 0.6$ .  $C_{p,crit} = -1.290$ .

Figure 7. Static pressure coefficient distributions on nozzles at  $\alpha = 0^\circ$ .

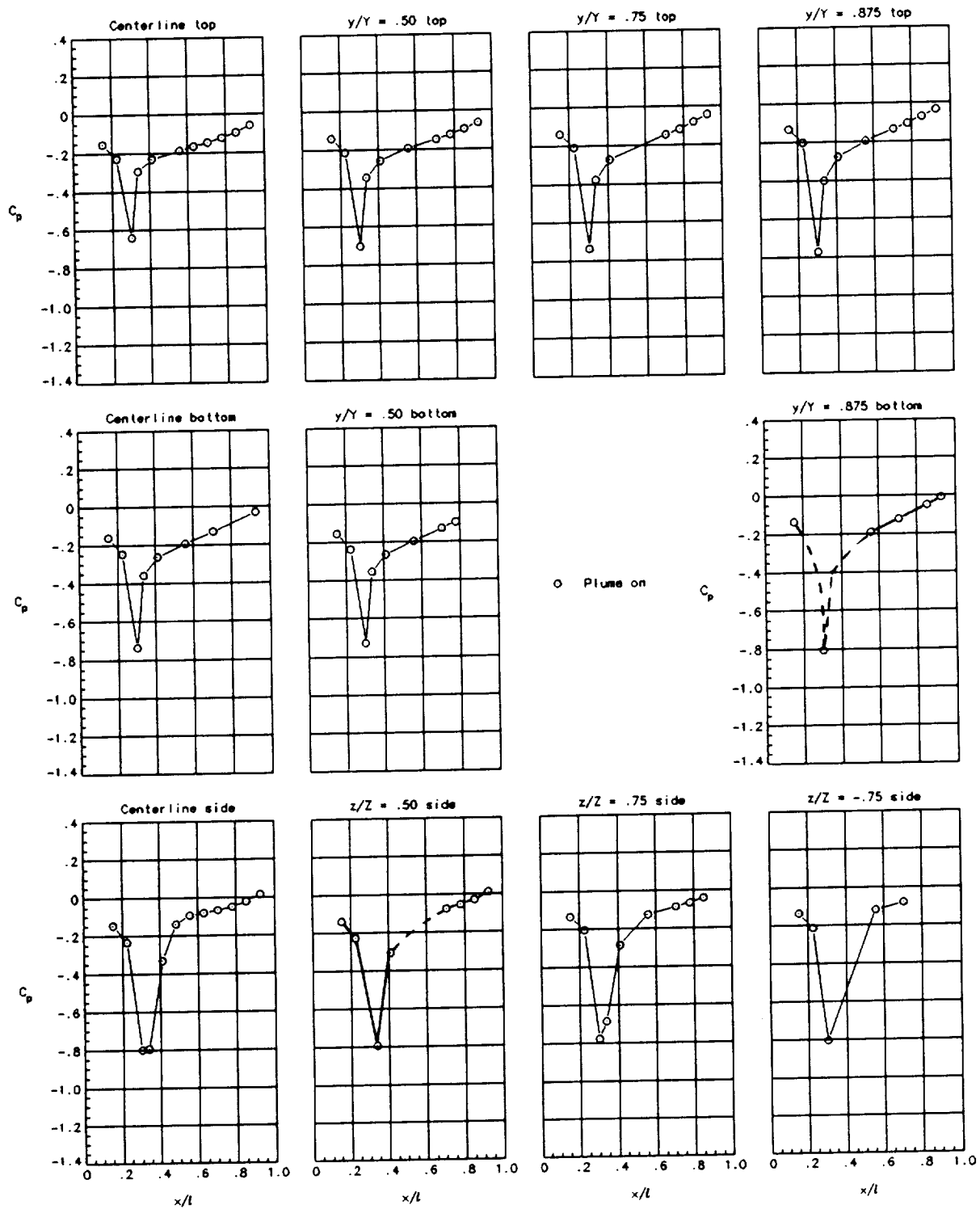

(b) Nozzle 2 with  $\beta_{t,top/bot} = 17.3^\circ / \beta_{t,side} = 9.7^\circ$  and sharp corner at  $M_\infty = 0.9$ .  $C_{p,crit} = -0.188$ .

Figure 7. Continued.

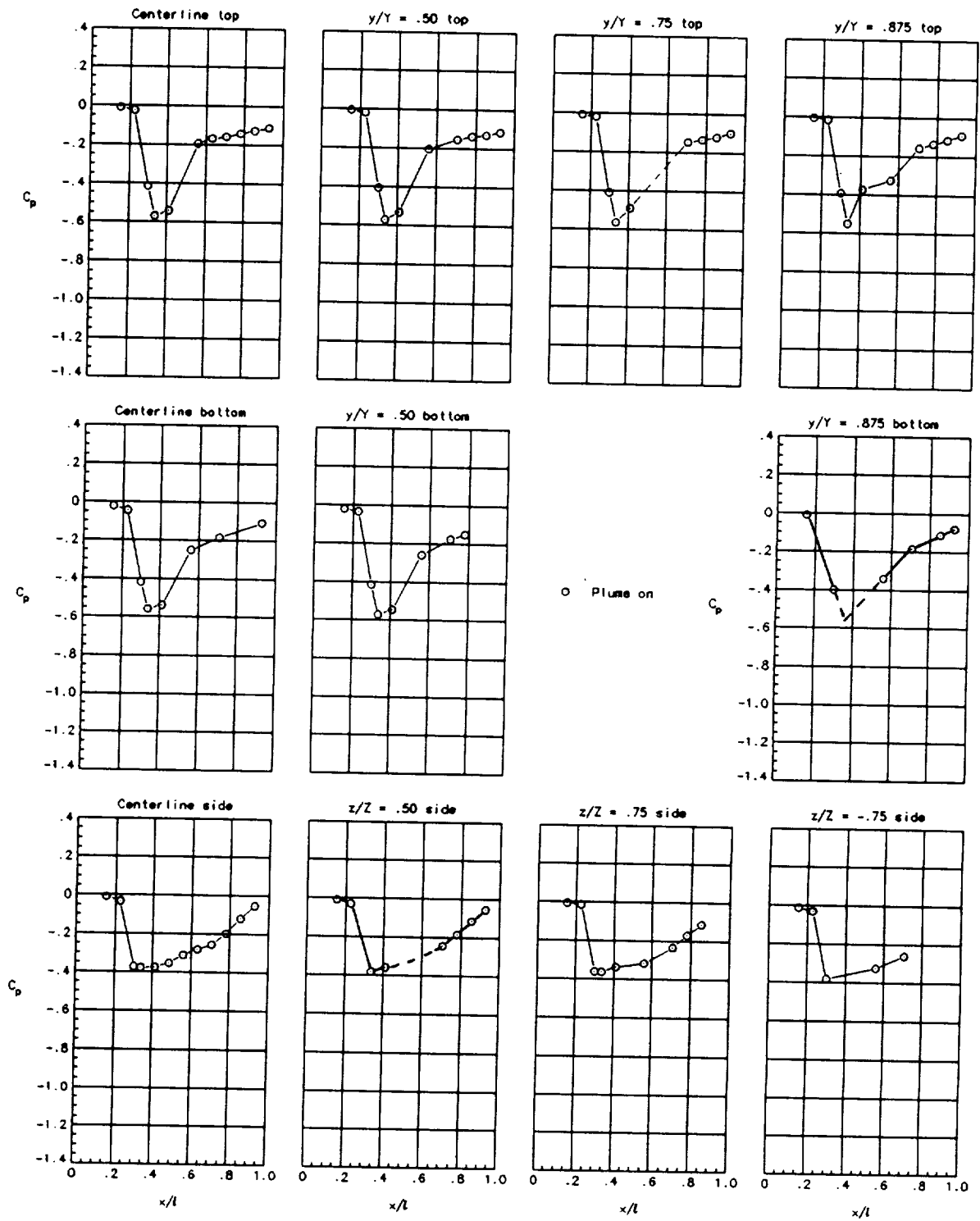

(c) Nozzle 2 with  $\beta_{t,top/bot} = 17.3^\circ / \beta_{t,side} = 9.7^\circ$  and sharp corner at  $M_\infty = 1.2$ .  $C_{p,crit} = 0.279$ .

Figure 7. Continued.



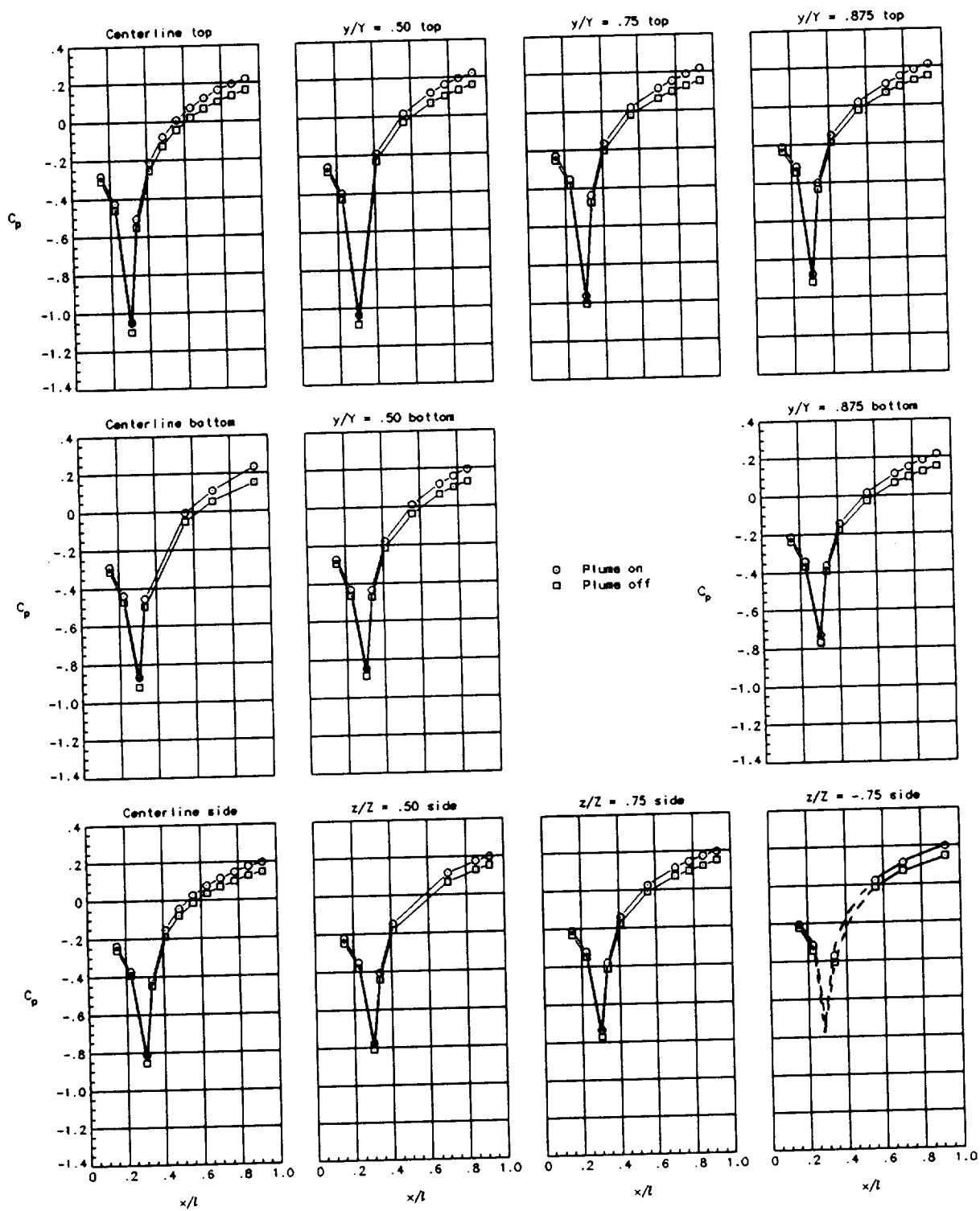

(d) Nozzle 3 with  $\beta_{t,top/bot} = 16.4^\circ / \beta_{t,side} = 16.4^\circ$  and sharp corner at  $M_\infty = 0.6$ .  $C_{p,crit} = -1.290$ .

Figure 7. Continued.

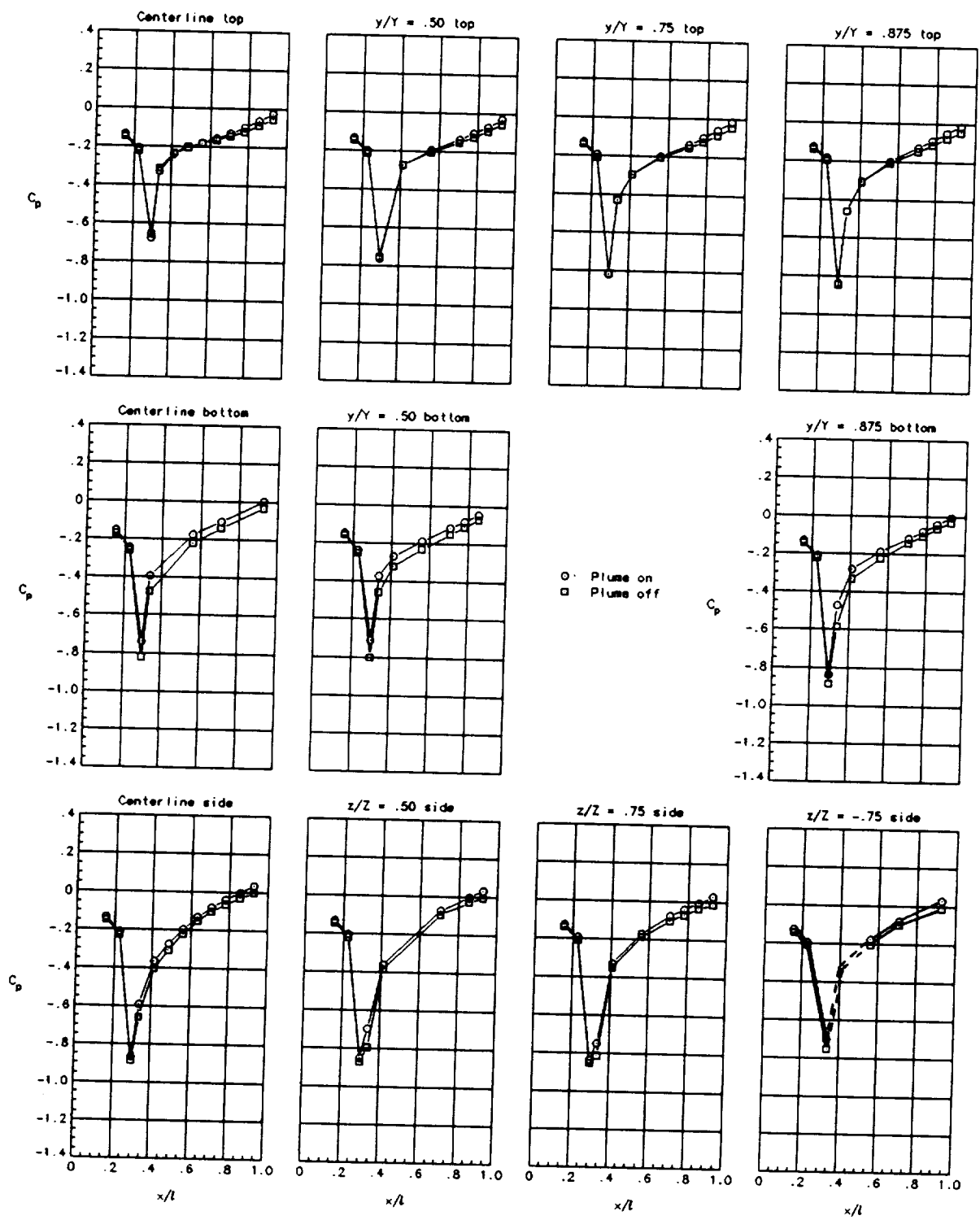

(e) Nozzle 3 with  $\beta_{t,top/bot} = 16.4^\circ / \beta_{t,side} = 16.4^\circ$  and sharp corner at  $M_\infty = 0.9$ .  $C_{p,crit} = -0.188$ .

Figure 7. Continued.

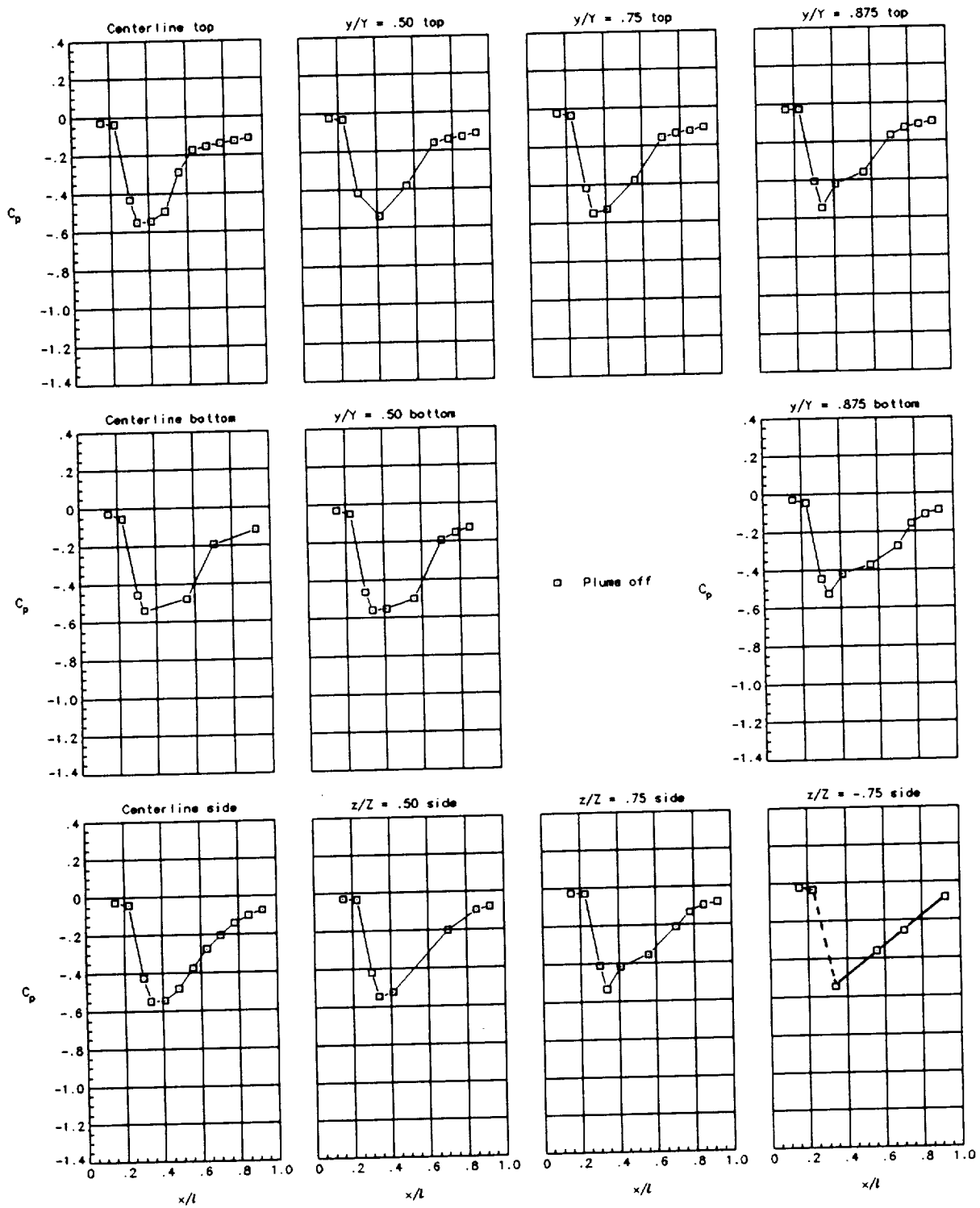

(f) Nozzle 3 with  $\beta_{t,top/bot} = 16.4^\circ / \beta_{t,side} = 16.4^\circ$  and sharp corner at  $M_\infty = 1.2$ .  $C_{p,crit} = 0.279$ .

Figure 7. Continued.

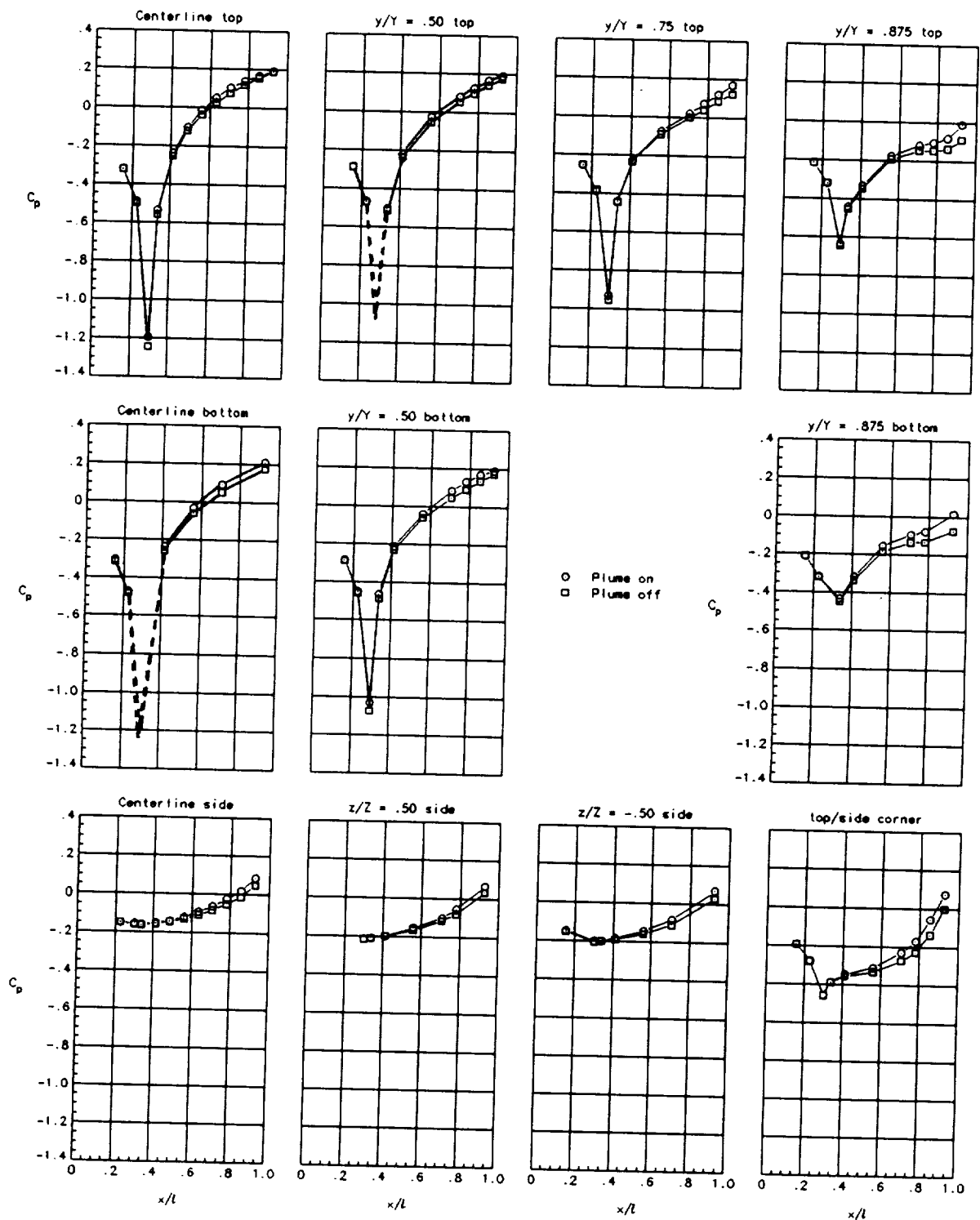

(g) Nozzle 5 with  $\beta_{t,top/bot} = 17.9^\circ / \beta_{t,side} = 0^\circ$  and 1-in. corner radius at  $M_\infty = 0.6$ .  $C_{p,crit} = -1.290$ .

Figure 7. Continued.

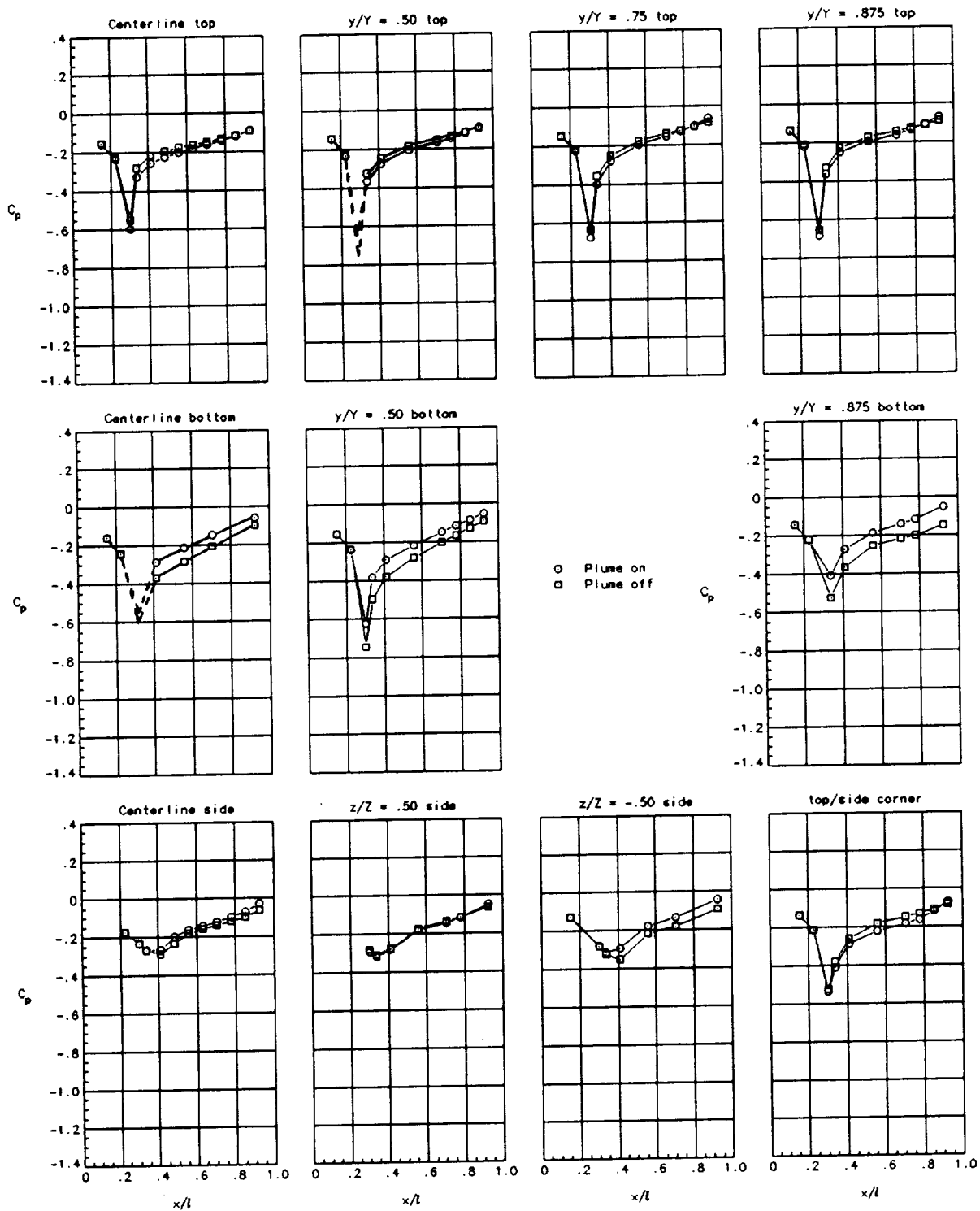

(h) Nozzle 5 with  $\beta_{t,top/bot} = 17.9^\circ / \beta_{t,side} = 0^\circ$  and 1-in. corner radius at  $M_\infty = 0.9$ .  $C_{p,crit} = -0.188$ .

Figure 7. Continued.

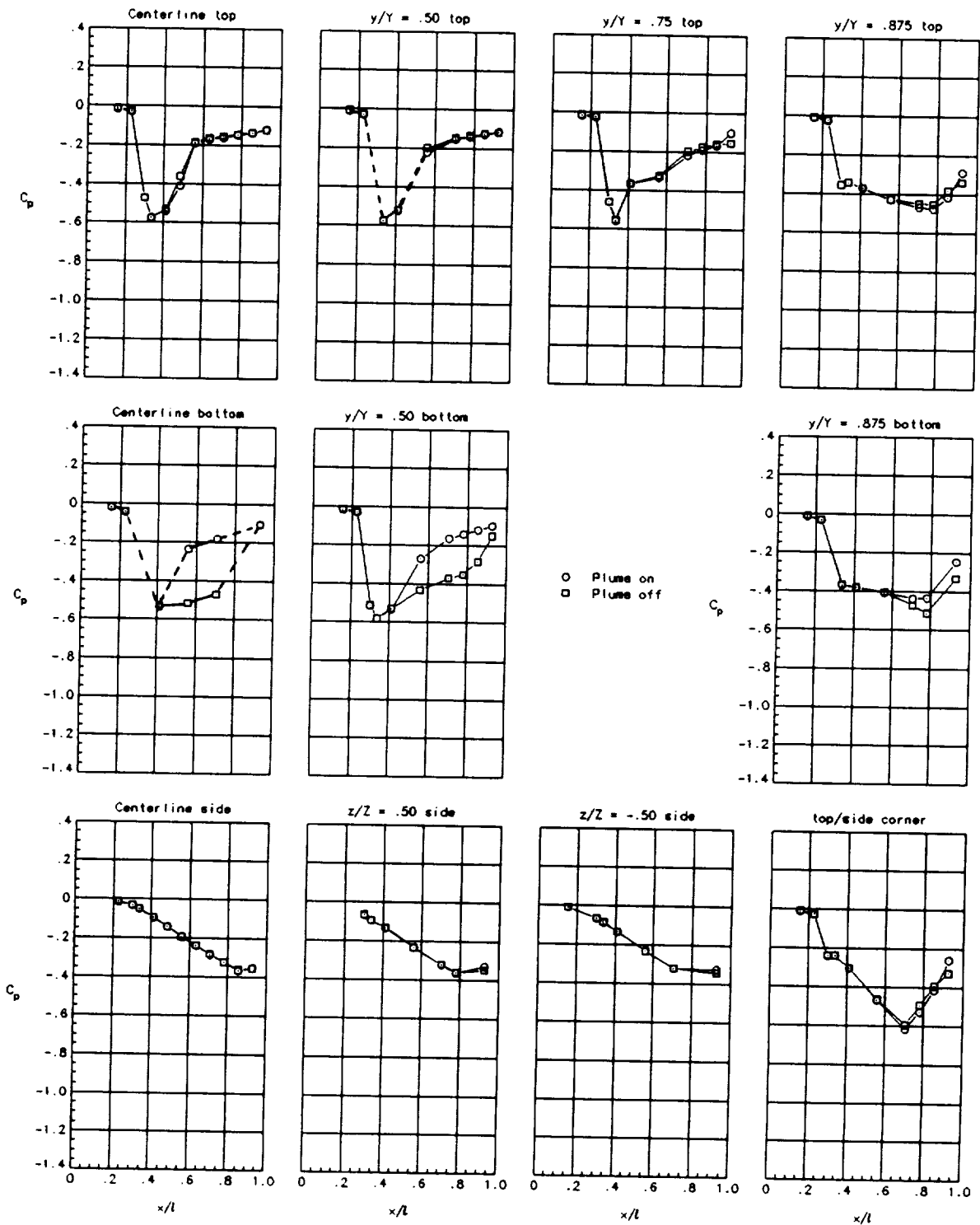

(i) Nozzle 5 with  $\beta_{t,top/bot} = 17.9^\circ / \beta_{t,side} = 0^\circ$  and 1-in. corner radius at  $M_\infty = 1.2$ .  $C_{p,crit} = 0.279$ .

Figure 7. Continued.

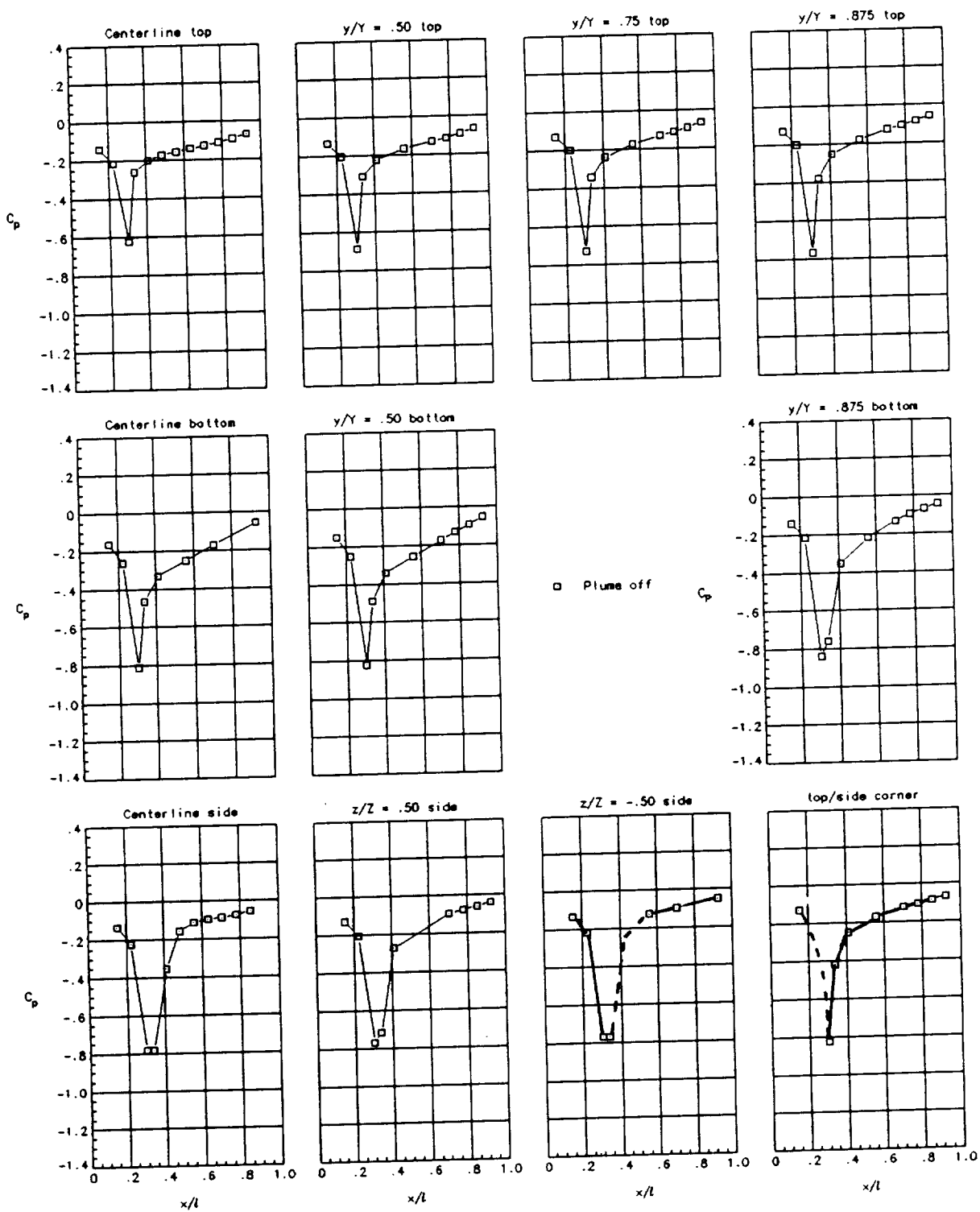

(j) Nozzle 6 with  $\beta_{t,top/bot} = 17.3^\circ / \beta_{t,side} = 9.7^\circ$  and 1-in. corner radius at  $M_\infty = 0.6$ .  $C_{p,crit} = -1.290$ .

Figure 7. Continued.

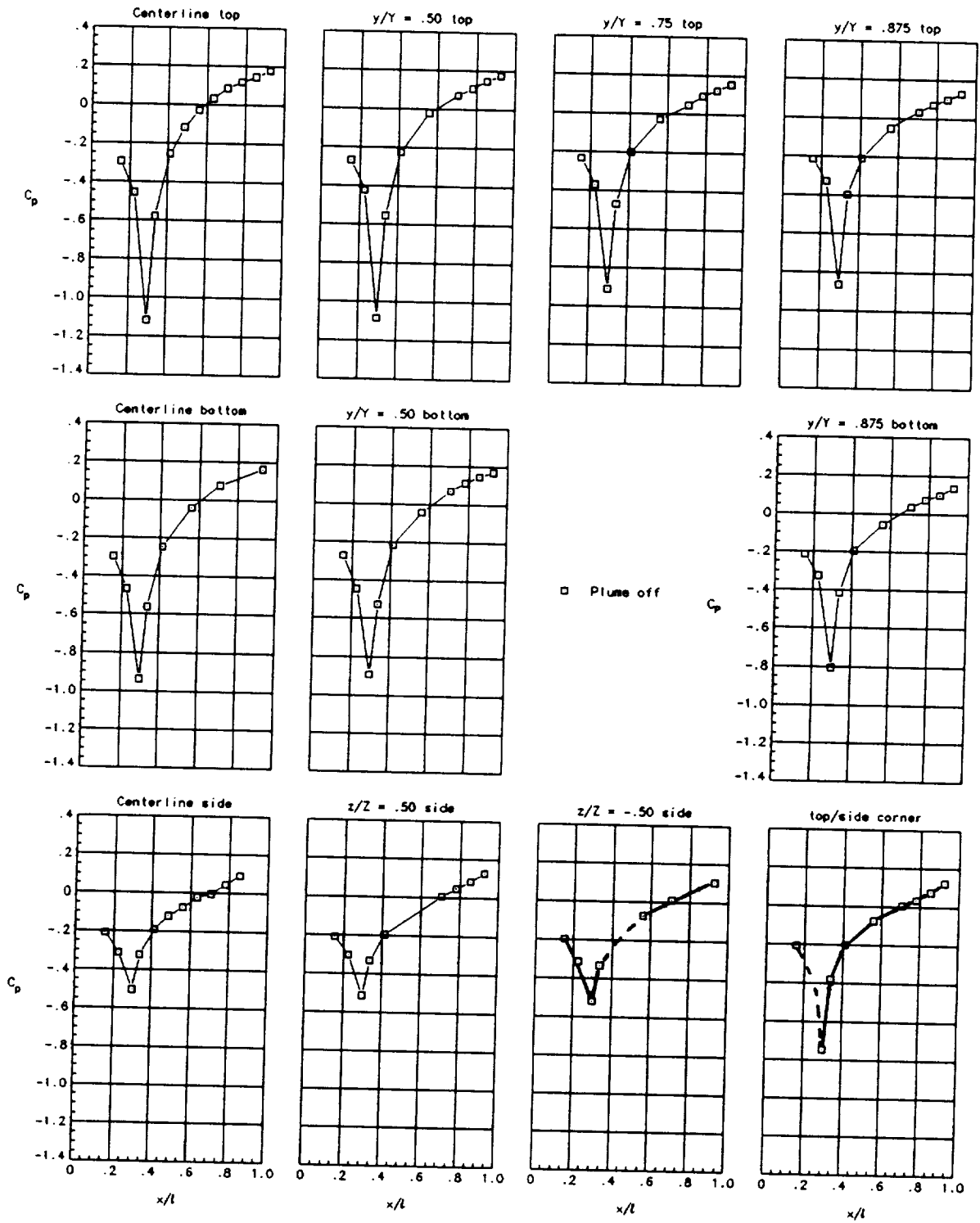

(k) Nozzle 6 with  $\beta_{t,top/bot} = 17.3^\circ / \beta_{t,side} = 9.7^\circ$  and 1-in. corner radius at  $M_\infty = 0.9$ .  $C_{p,crit} = -0.188$ .

Figure 7. Continued.



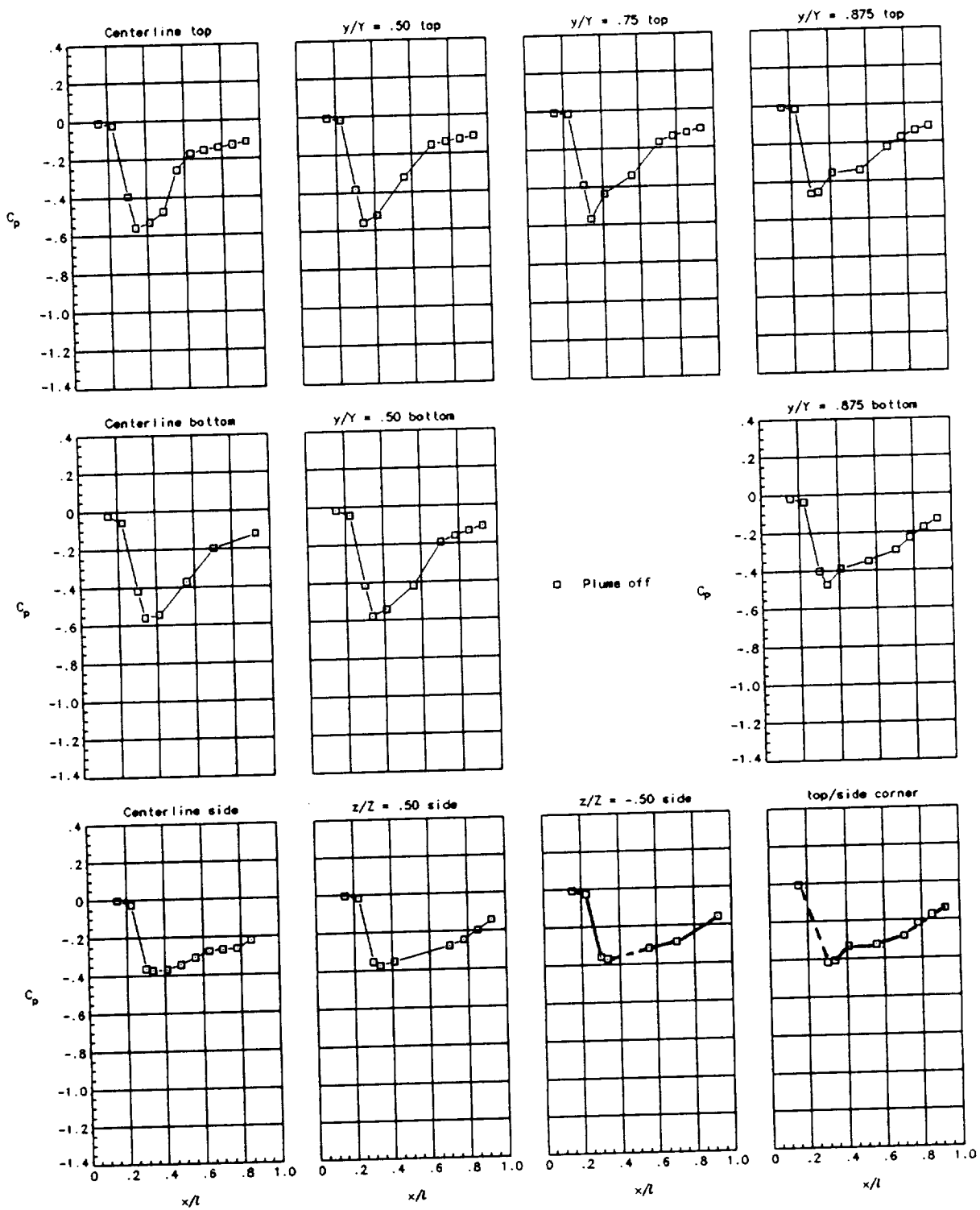

(1) Nozzle 6 with  $\beta_{t,top/bot} = 17.3^\circ / \beta_{t,side} = 9.7^\circ$  and 1-in. corner radius at  $M_\infty = 1.2$ .  $C_{p,crit} = 0.279$ .

Figure 7. Continued.

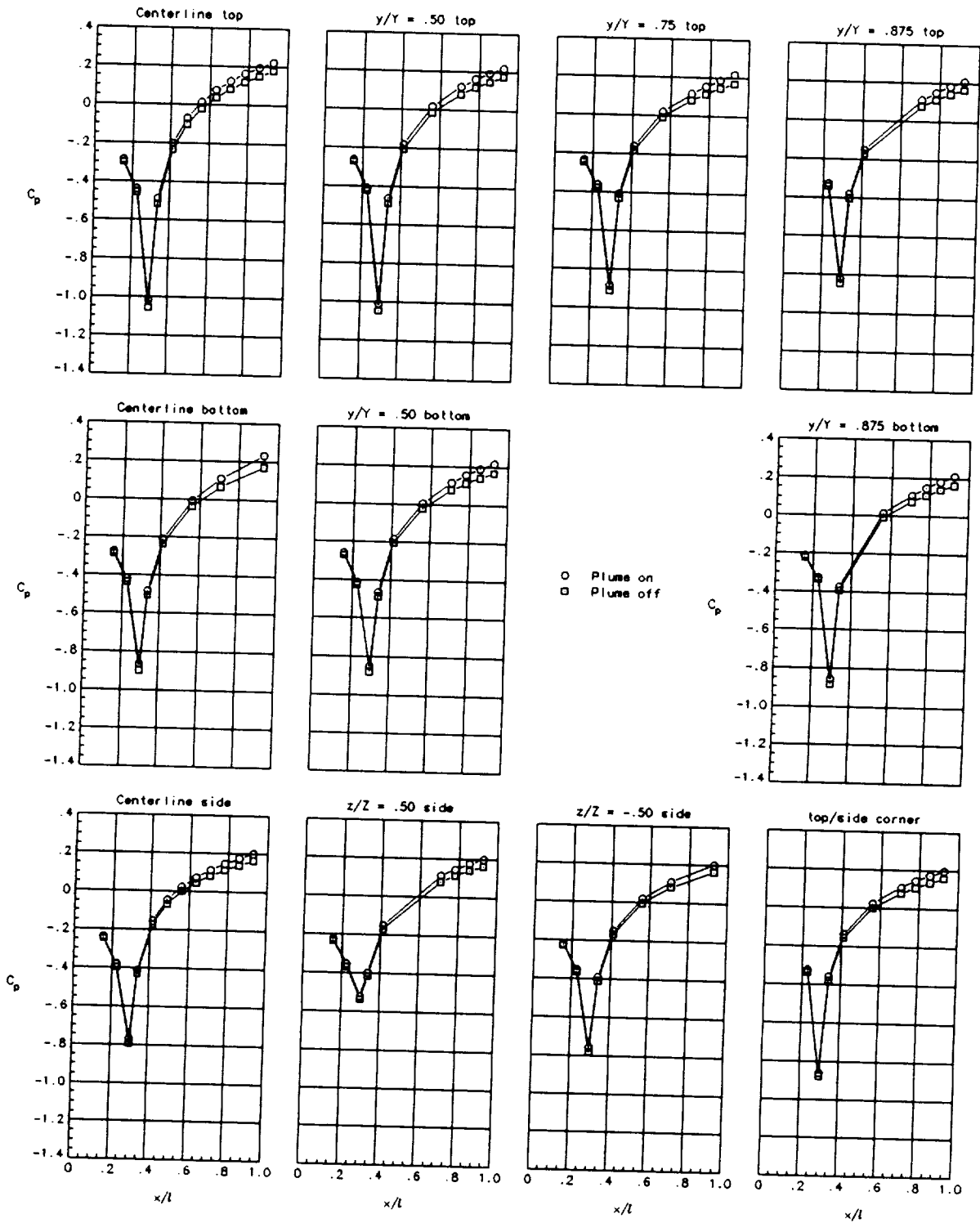

(m) Nozzle 7 with  $\beta_{t,top/bot} = 16.4^\circ / \beta_{t,side} = 16.4^\circ$  and 1-in. corner radius at  $M_\infty = 0.6$ .  $C_{p,crit} = -1.290$ .

Figure 7. Continued.

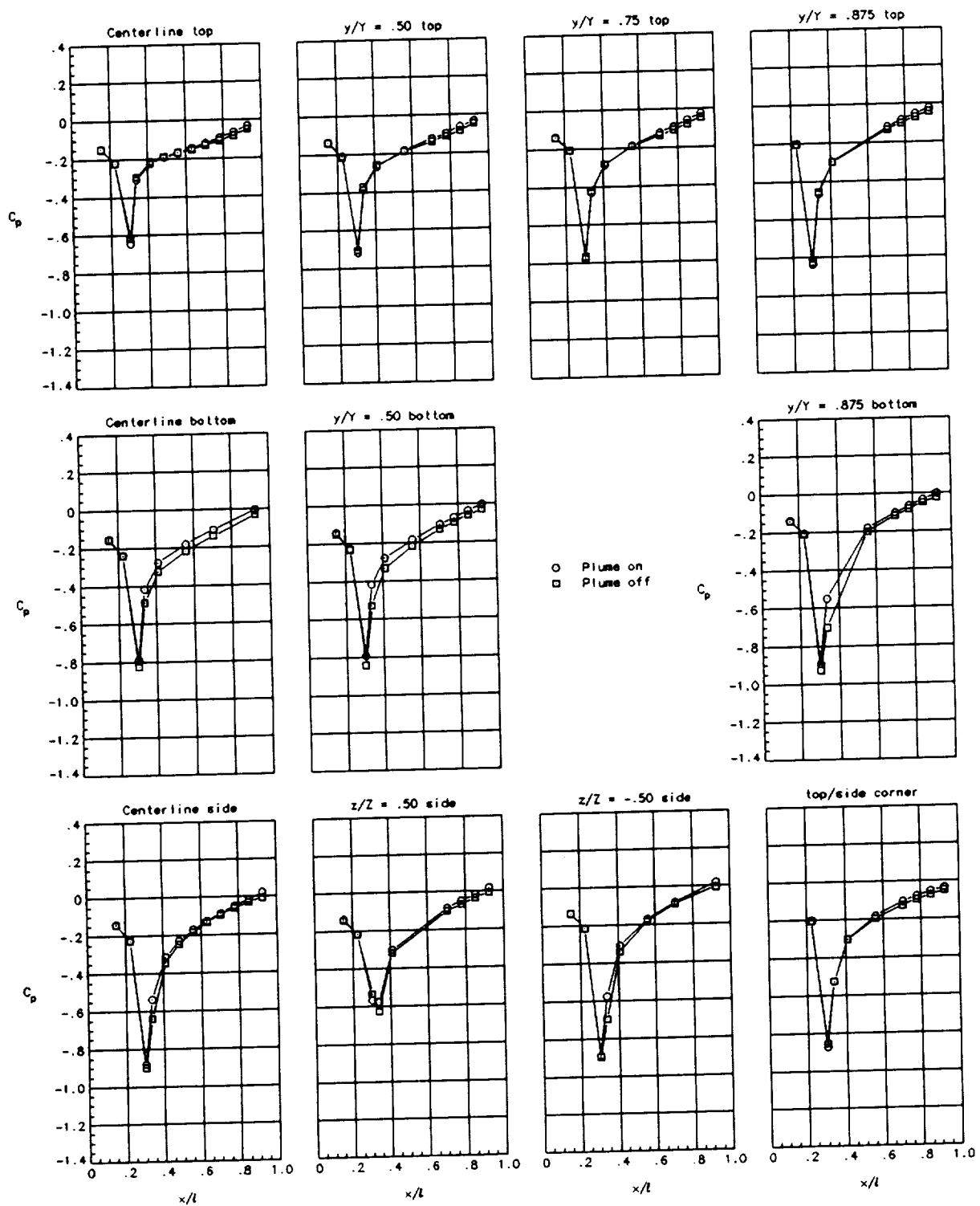

(n) Nozzle 7 with  $\beta_{t,top/bot} = 16.4^\circ / \beta_{t,side} = 16.4^\circ$  and 1-in. corner radius at  $M_\infty = 0.9$ .  $C_{p,crit} = -0.188$ .

Figure 7. Continued.

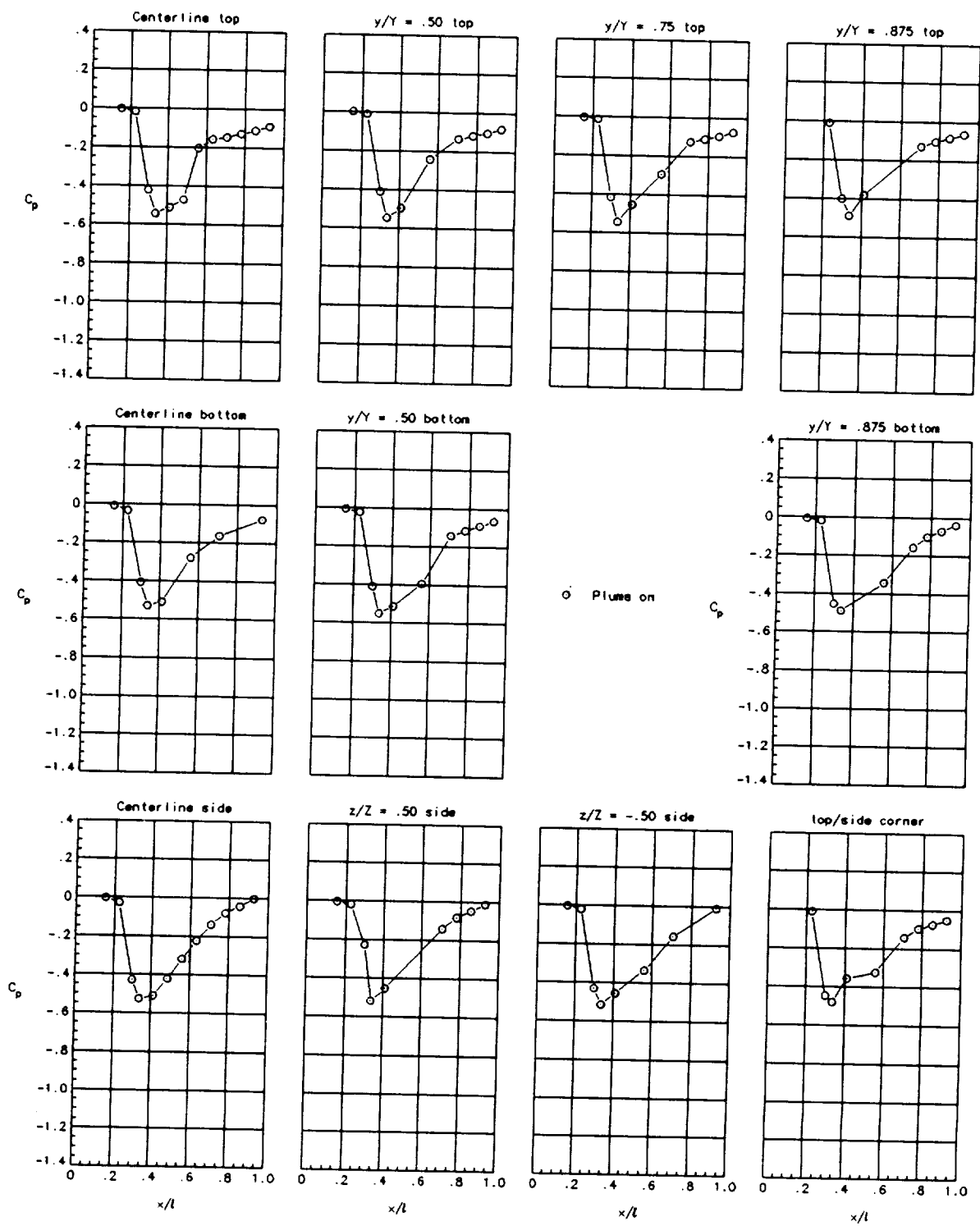

(o) Nozzle 7 with  $\beta_{t,top/bot} = 16.4^\circ / \beta_{t,side} = 16.4^\circ$  and 1-in. corner radius at  $M_\infty = 1.2$ .  $C_{p,crit} = 0.279$ .

Figure 7. Continued.

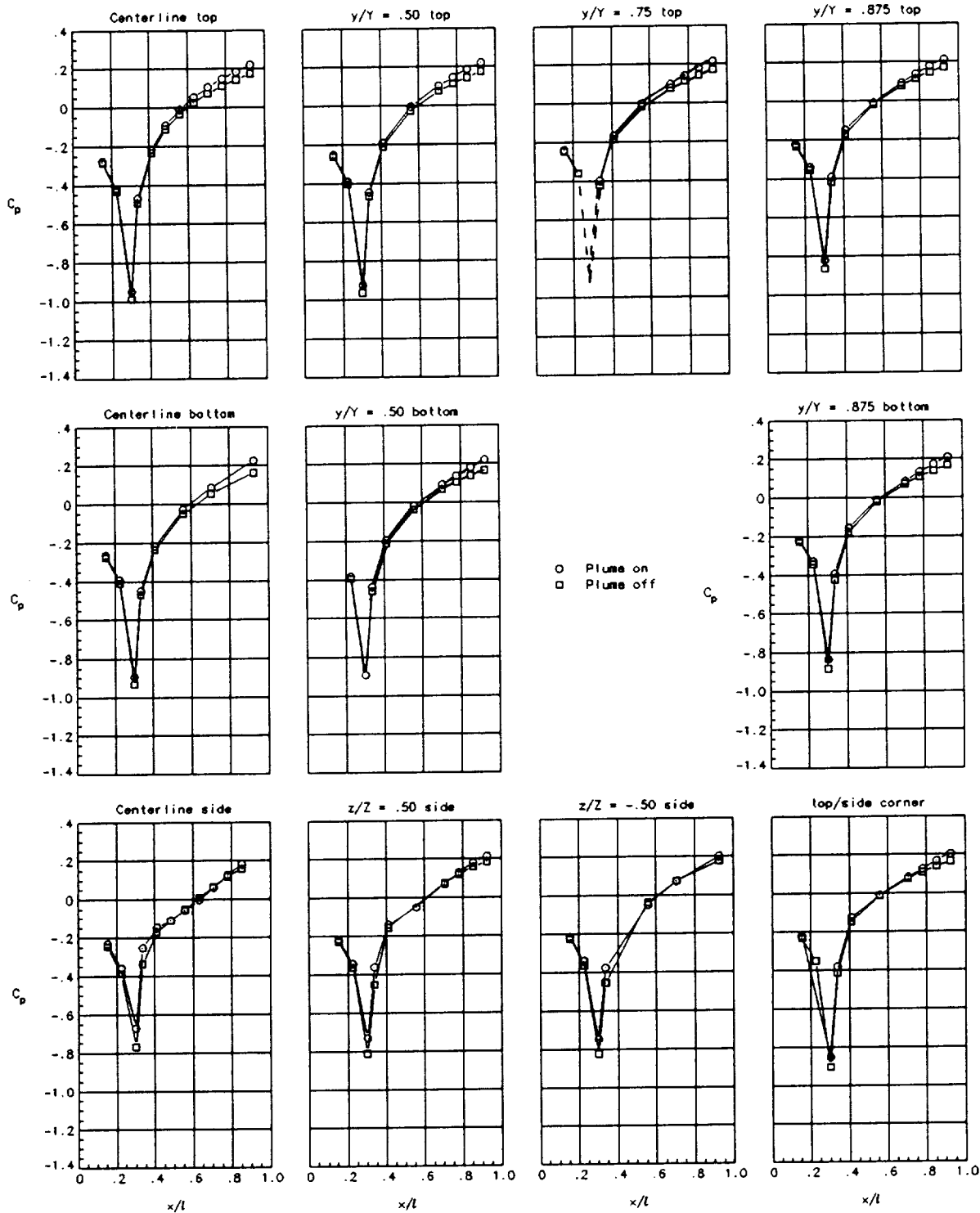

(p) Nozzle 8 with  $\beta_{t,top/bot} = 15.0^\circ / \beta_{t,side} = 22.4^\circ$  and 1-in. corner radius at  $M_\infty = 0.6$ .  $C_{p,crit} = -1.290$ .

Figure 7. Continued.

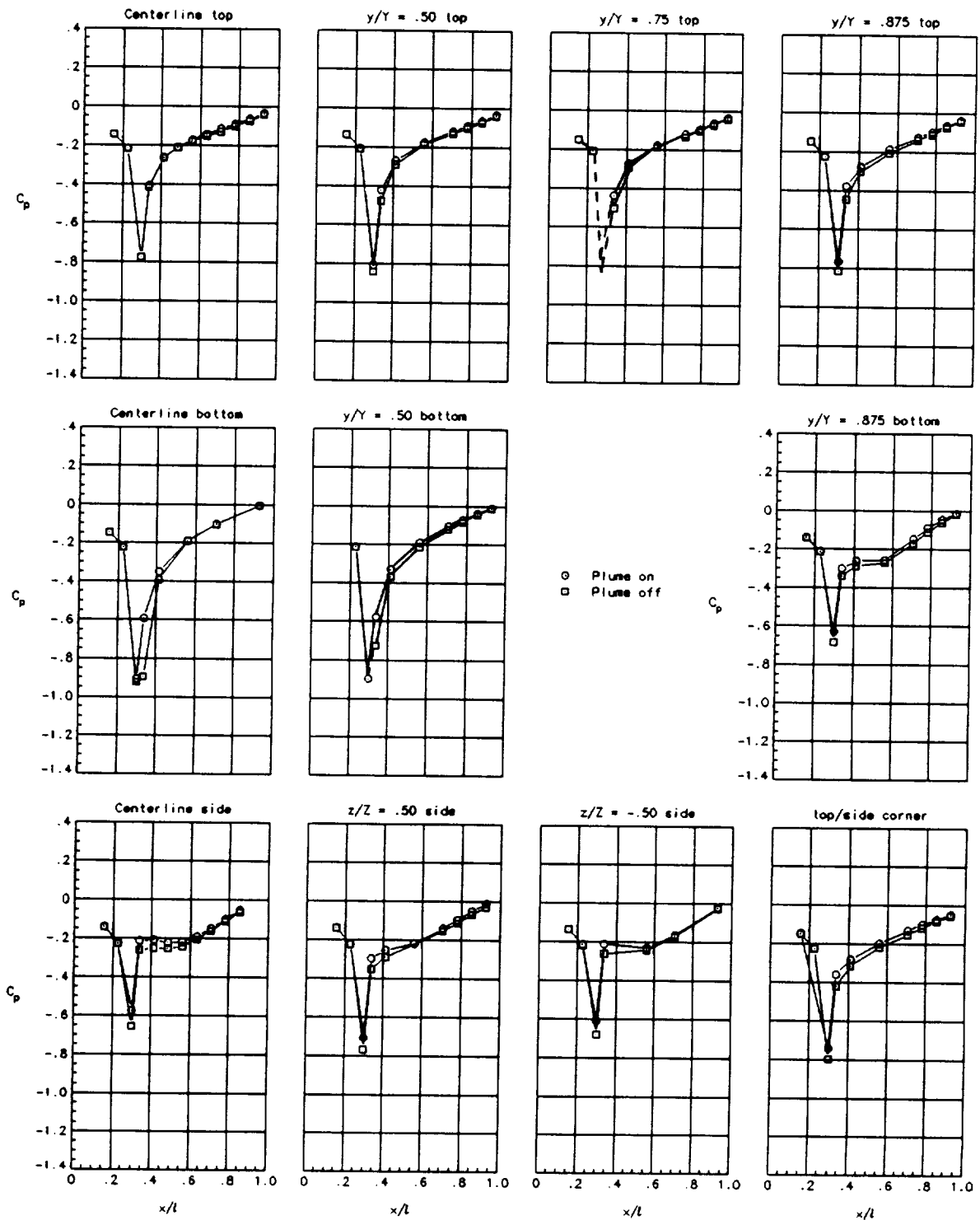

(q) Nozzle 8 with  $\beta_{t,top/bot} = 15.0^\circ / \beta_{t,side} = 22.4^\circ$  and 1-in. corner radius at  $M_\infty = 0.9$ .  $C_{p,crit} = -0.188$ .

Figure 7. Continued.

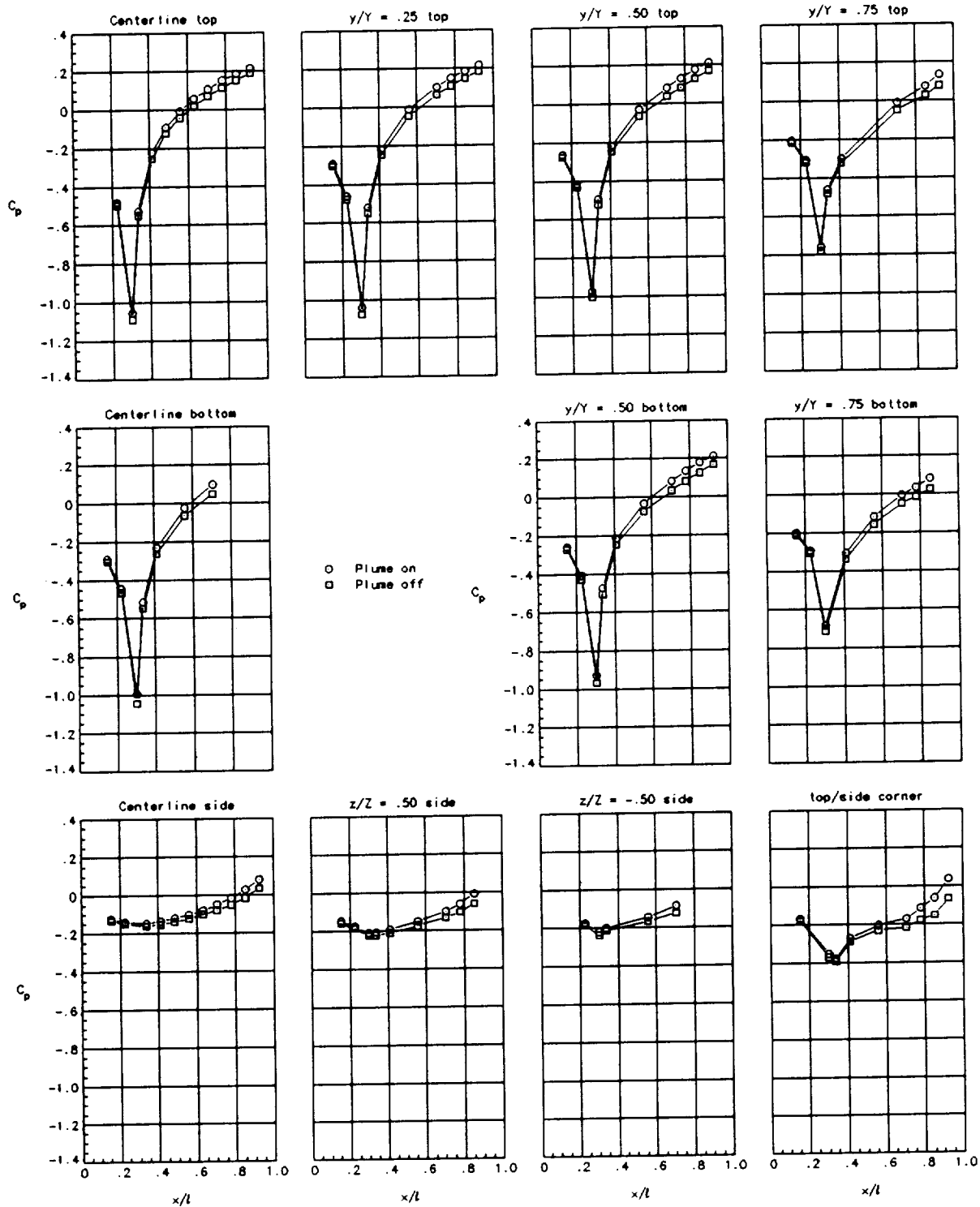

(r) Nozzle 9 with  $\beta_{t,top/bot} = 17.9^\circ / \beta_{t,side} = 0^\circ$  and 2-in. corner radius at  $M_\infty = 0.6$ .  $C_{p,crit} = -1.290$ .

Figure 7. Continued.

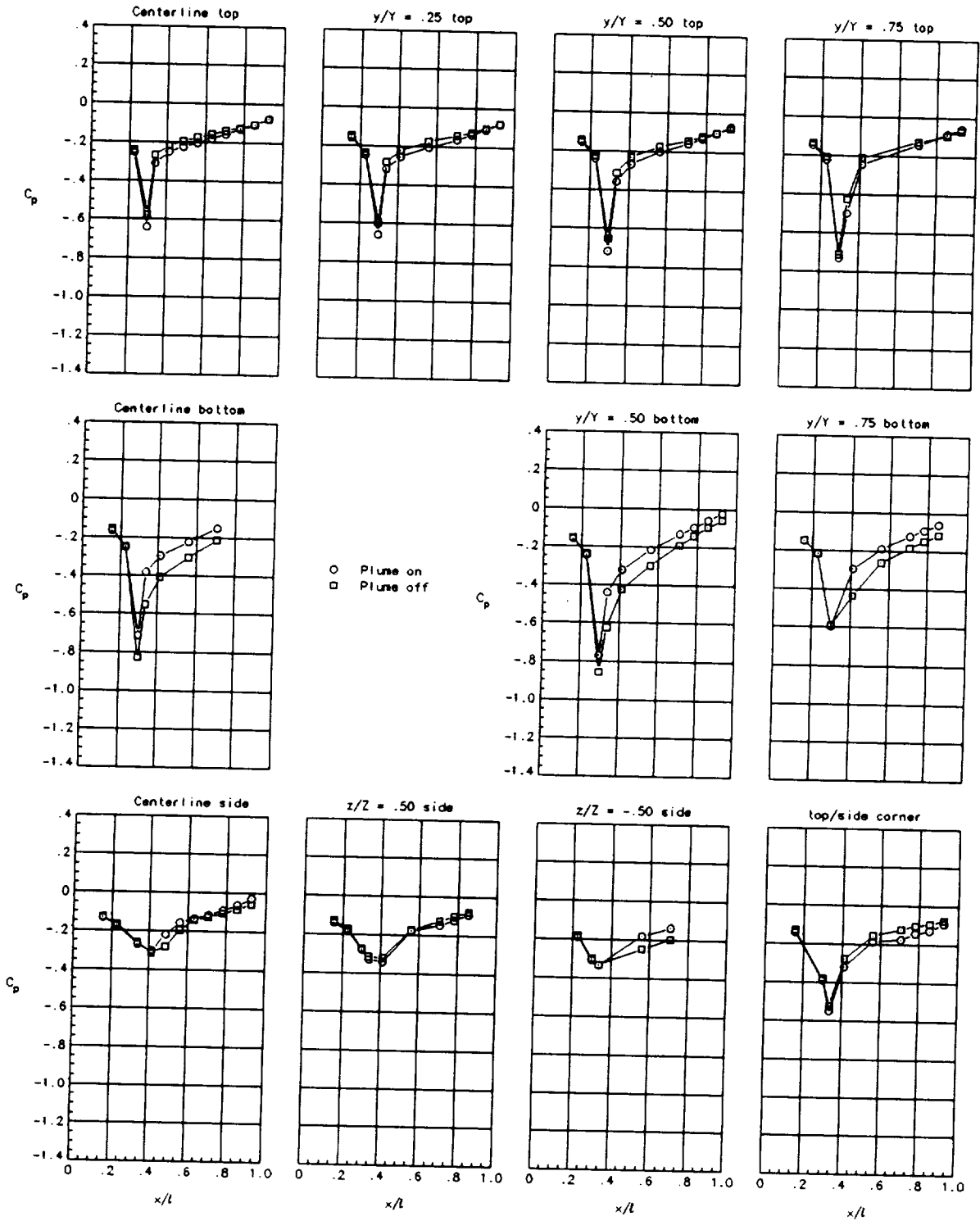

(s) Nozzle 9 with  $\beta_{t,top/bot} = 17.9^\circ / \beta_{t,side} = 0^\circ$  and 2-in. corner radius at  $M_\infty = 0.9$ .  $C_{p,crit} = -0.188$ .

Figure 7. Continued.



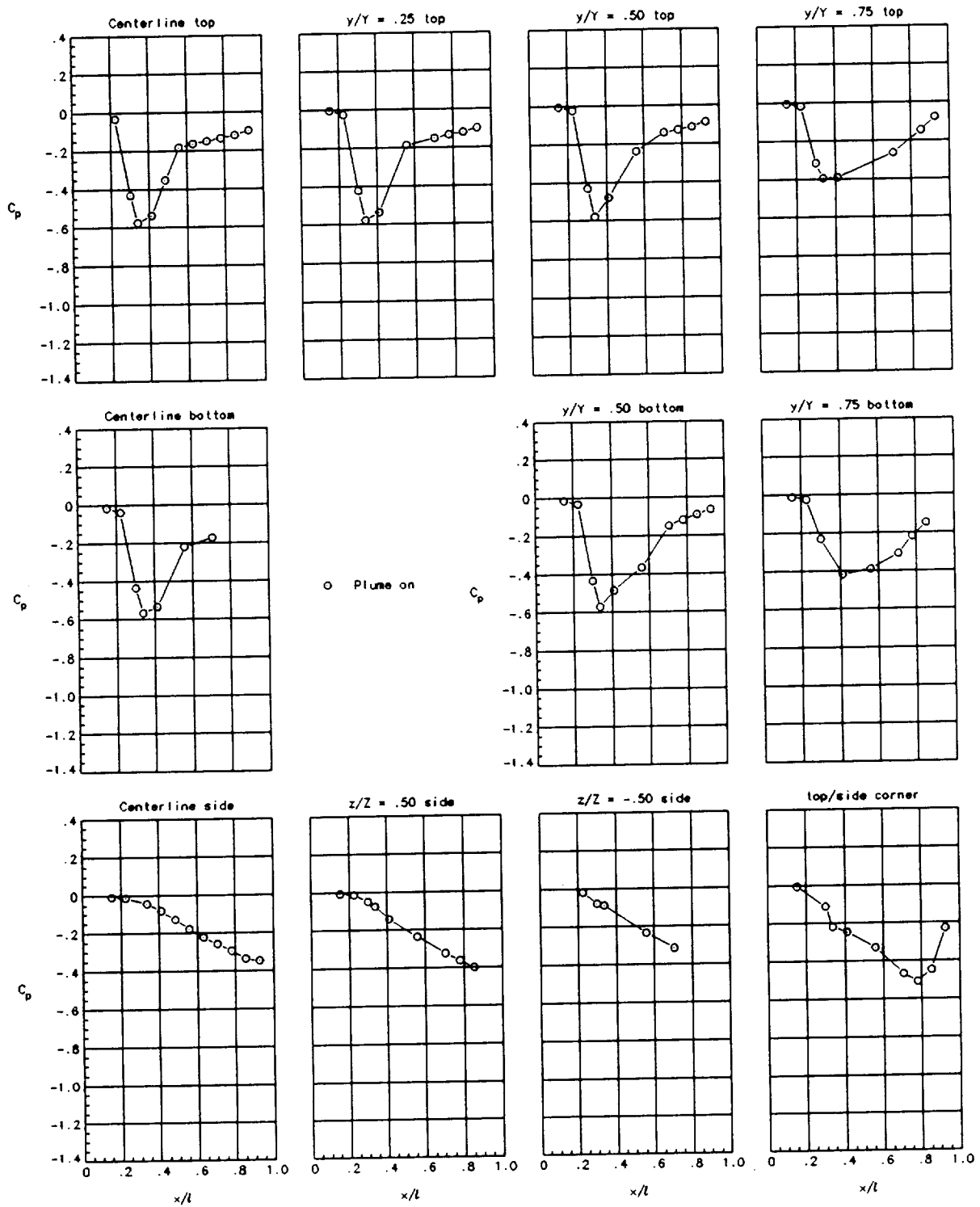

(t) Nozzle 9 with  $\beta_{t,top/bot} = 17.9^\circ / \beta_{t,side} = 0^\circ$  and 2-in. corner radius at  $M_\infty = 1.2$ .  $C_{p,crit} = 0.279$ .

Figure 7. Continued.

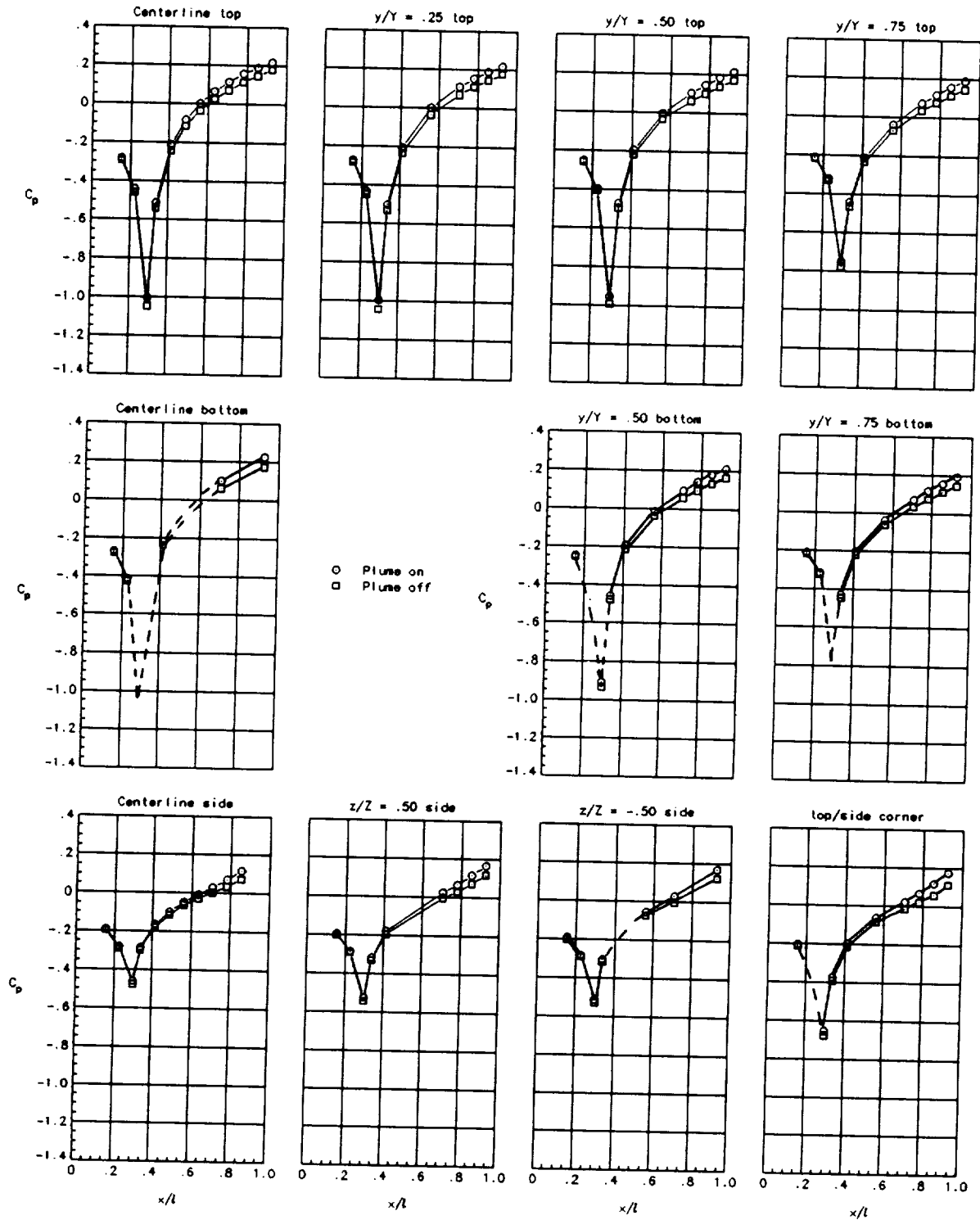

(u) Nozzle 10 with  $\beta_{t,top/bot} = 17.3^\circ / \beta_{t,side} = 9.7^\circ$  and 2-in. corner radius at  $M_\infty = 0.6$ .  $C_{p,crit} = -1.290$ .

Figure 7. Continued.

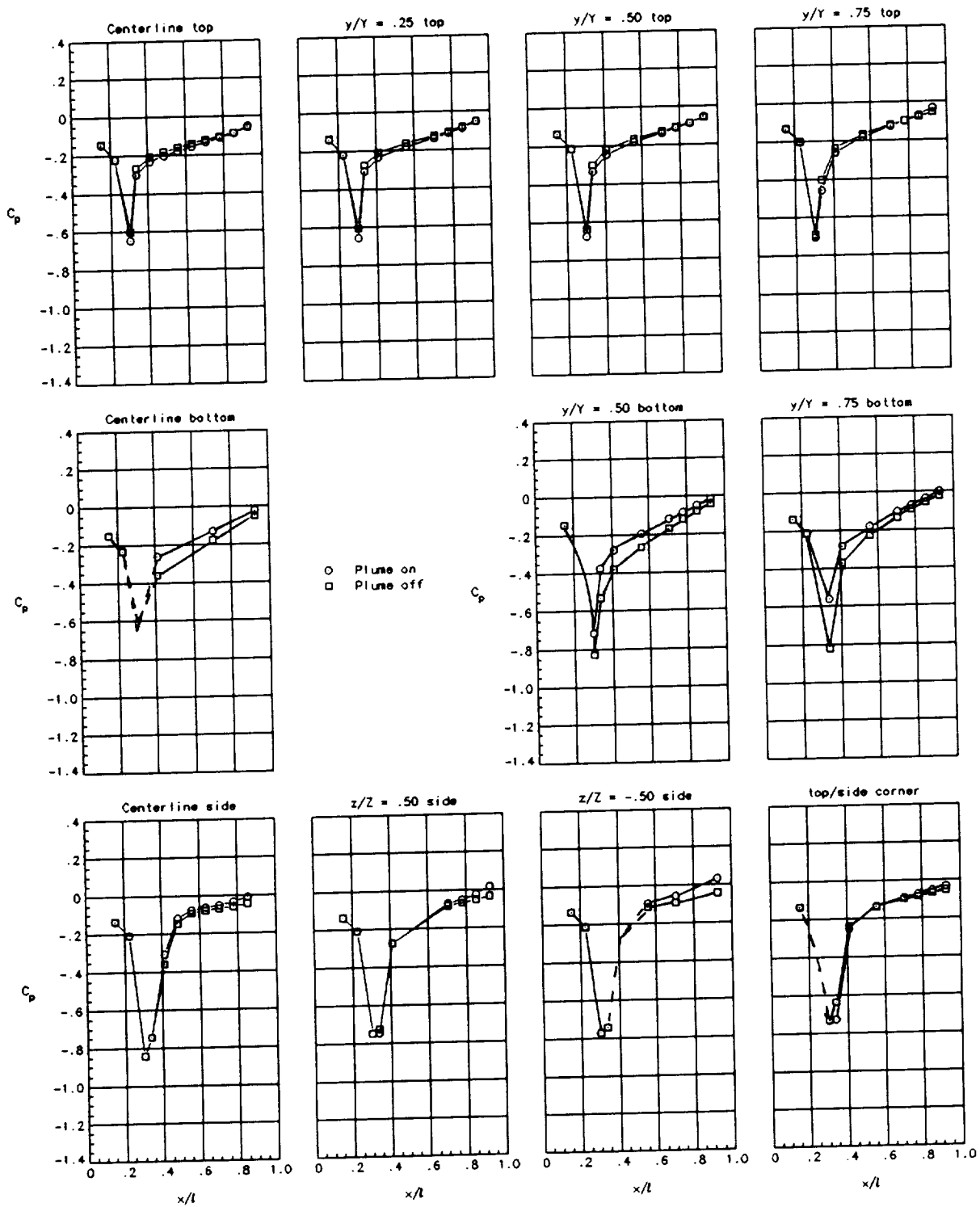

(v) Nozzle 10 with  $\beta_{t,top/bot} = 17.3^\circ / \beta_{t,side} = 9.7^\circ$  and 2-in. corner radius at  $M_\infty = 0.9$ .  $C_{p,crit} = -0.188$ .

Figure 7. Continued.

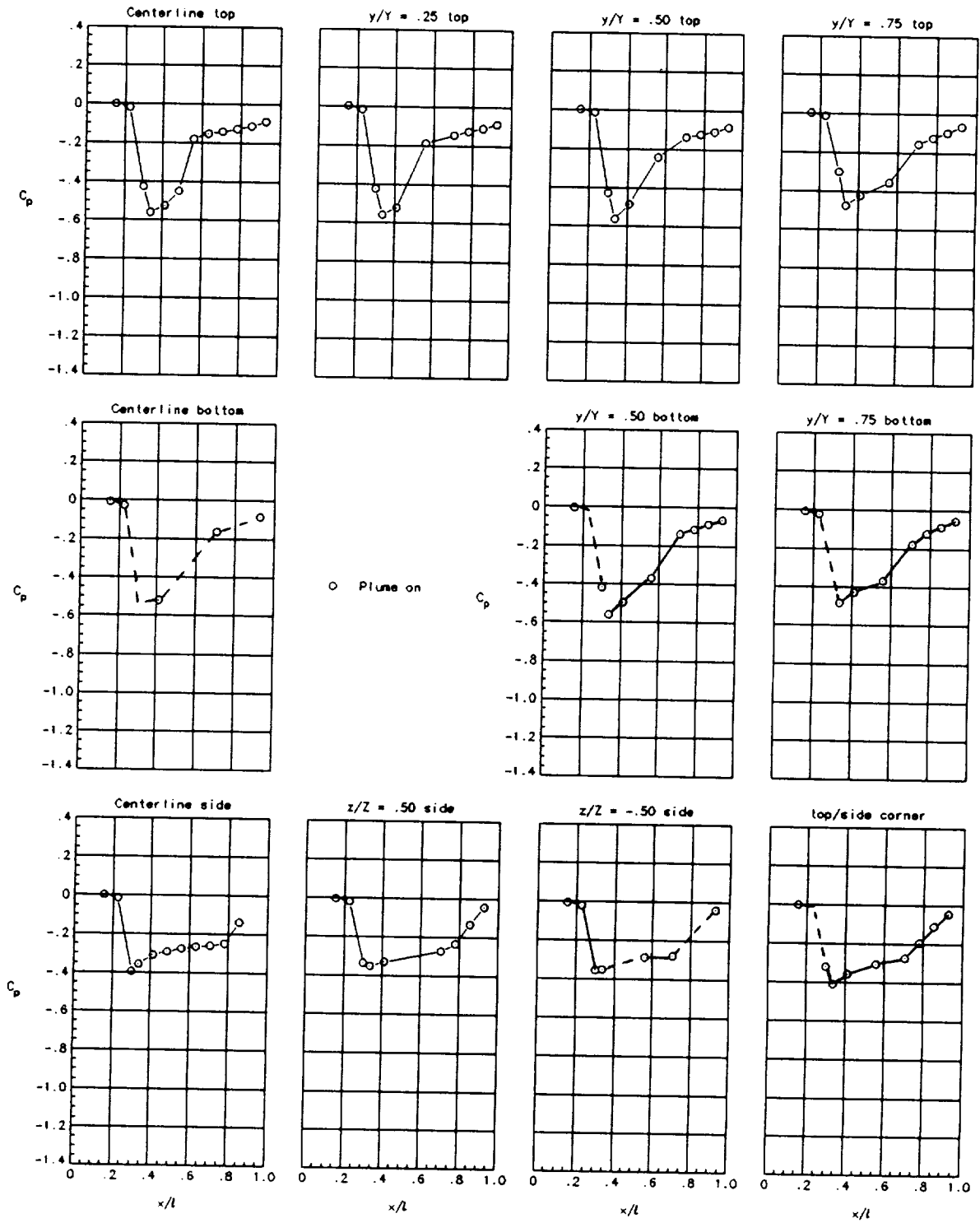

(w) Nozzle 10 with  $\beta_{t,top/bot} = 17.3^\circ / \beta_{t,side} = 9.7^\circ$  and 2-in. corner radius at  $M_\infty = 1.2$ .  $C_{p,crit} = 0.279$ .

Figure 7. Continued.

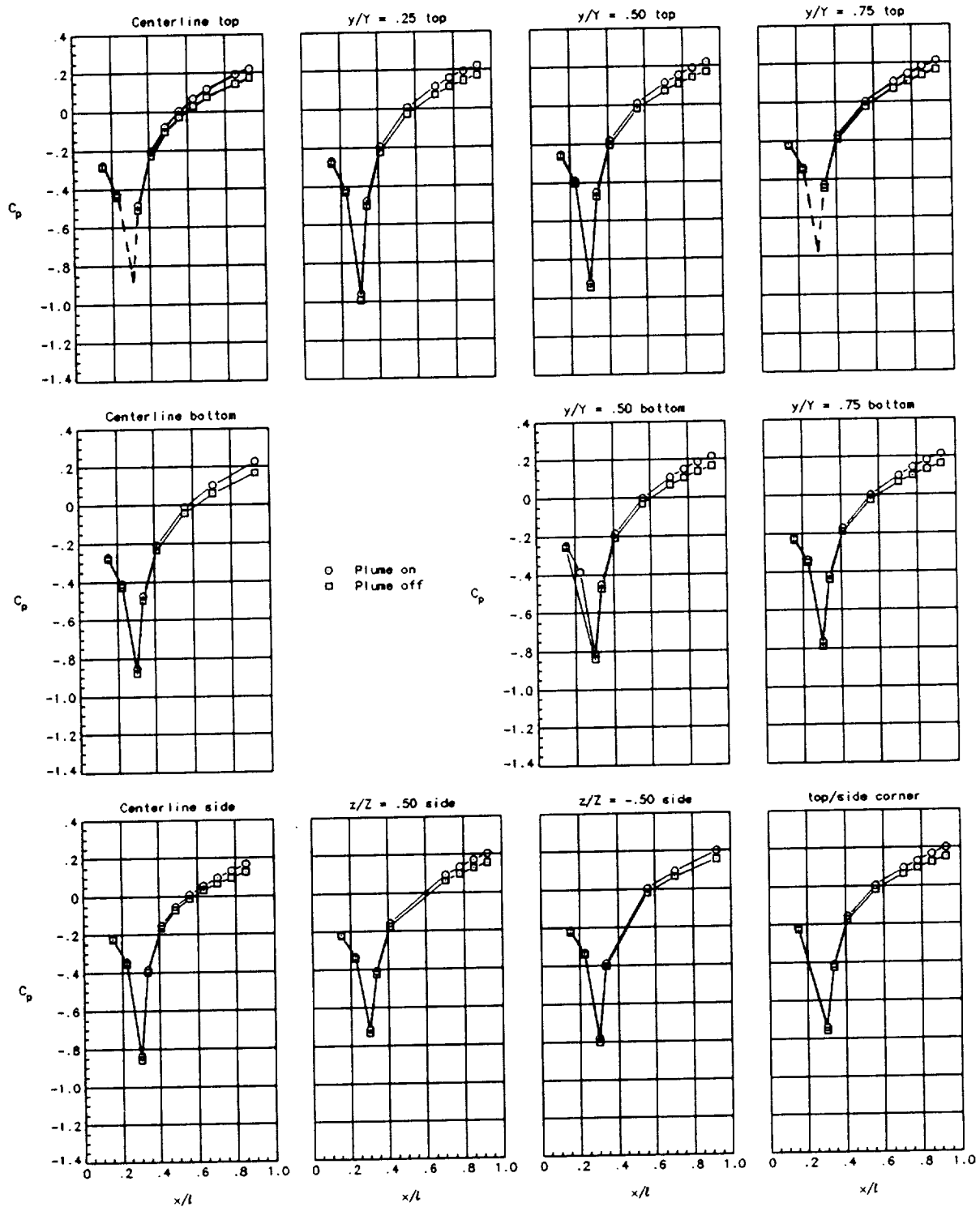

(x) Nozzle 11 with  $\beta_{t,top/bot} = 16.4^\circ / \beta_{t,side} = 16.4^\circ$  and 2-in. corner radius at  $M_\infty = 0.6$ .  $C_{p,crit} = -1.290$ .

Figure 7. Continued.

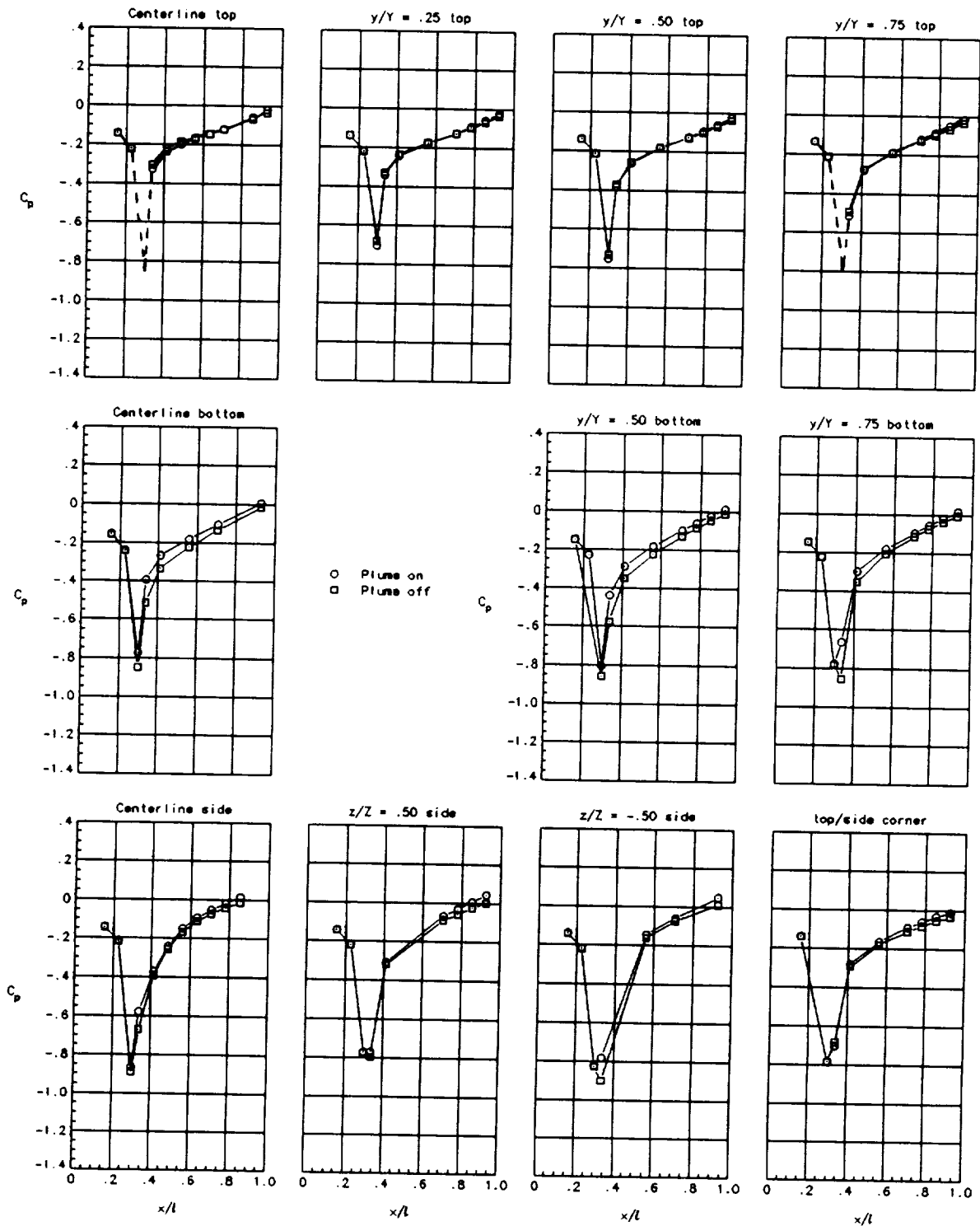

(y) Nozzle 11 with  $\beta_{t,top/bot} = 16.4^\circ / \beta_{t,side} = 16.4^\circ$  and 2-in. corner radius at  $M_\infty = 0.9$ .  $C_{p,crit} = -0.188$ .

Figure 7. Continued.

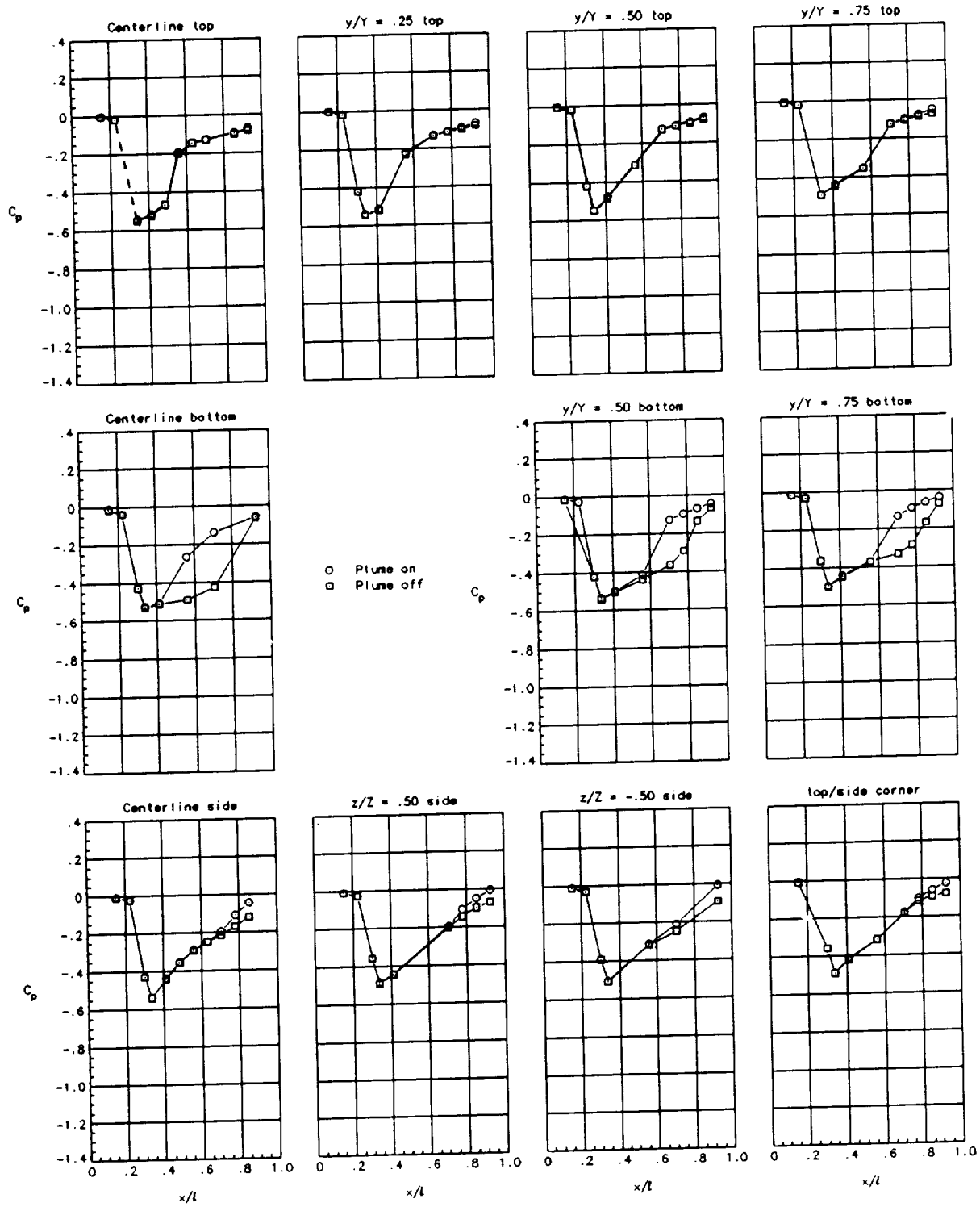

(z) Nozzle 11 with  $\beta_{t,top/bot} = 16.4^\circ / \beta_{t,side} = 16.4^\circ$  and 2-in. corner radius at  $M_\infty = 1.2$ .  $C_{p,crit} = 0.279$ .

Figure 7. Continued.

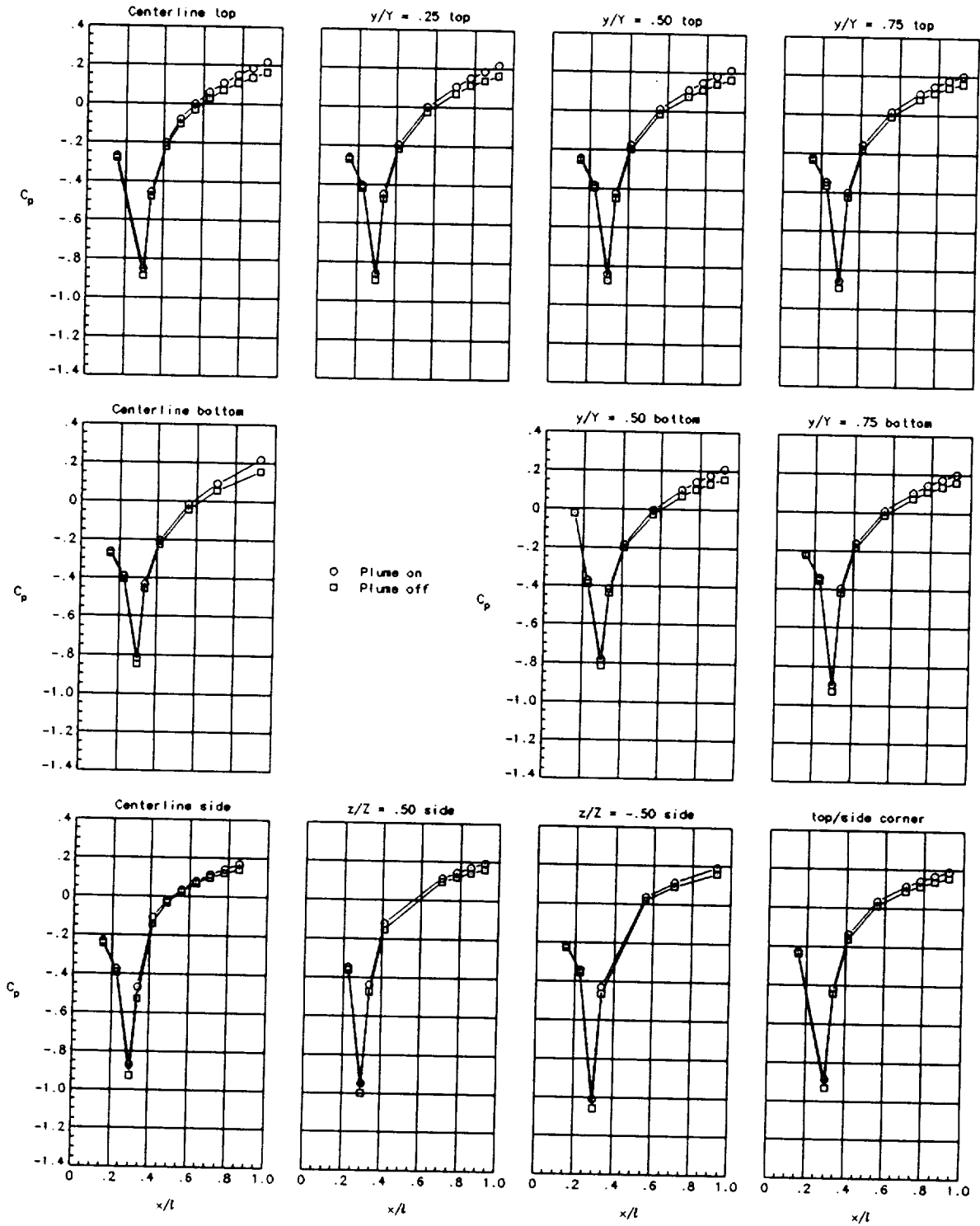

(aa) Nozzle 12 with  $\beta_{t,top/bot} = 15.0^\circ / \beta_{t,side} = 22.4^\circ$  and 2-in. corner radius at  $M_\infty = 0.6$ .  $C_{p,crit} = -1.290$ .

Figure 7. Continued.



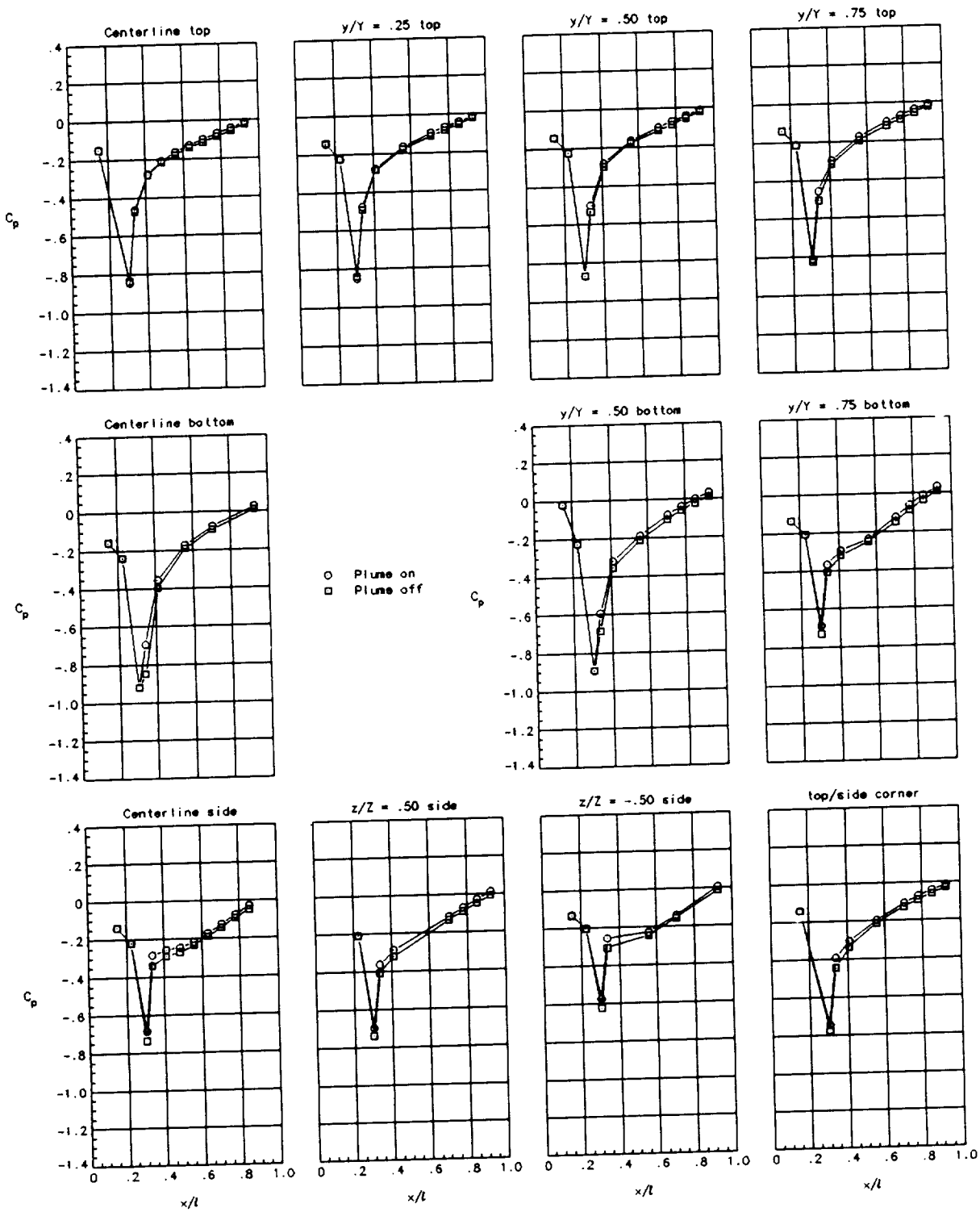

(bb) Nozzle 12 with  $\beta_{t,top/bot} = 15.0^\circ / \beta_{t,side} = 22.4^\circ$  and 2-in. corner radius at  $M_\infty = 0.9$ .  $C_{p,crit} = -0.188$ .

Figure 7. Continued.

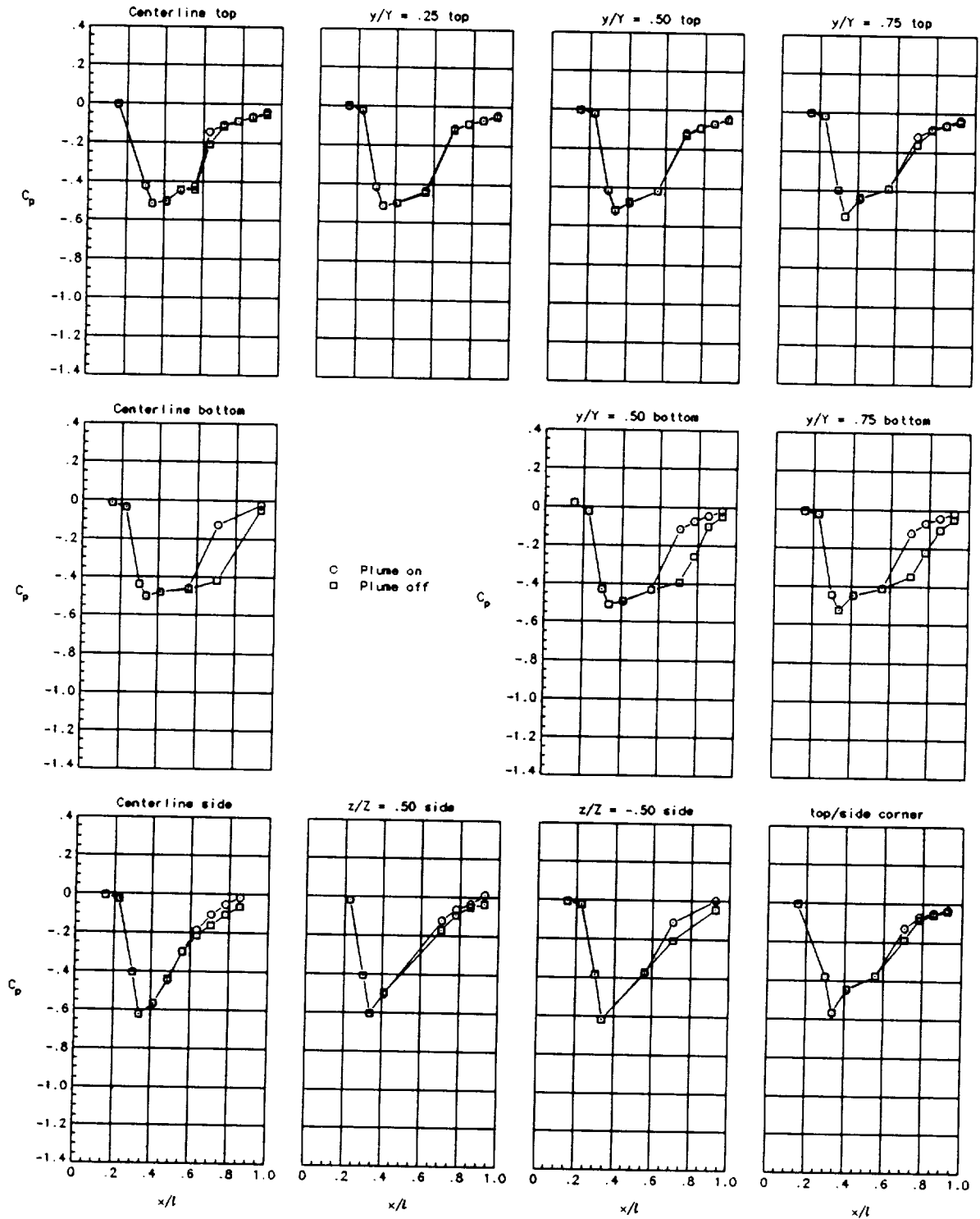

(cc) Nozzle 12 with  $\beta_{t,top/bot} = 15.0^\circ / \beta_{t,side} = 22.4^\circ$  and 2-in. corner radius at  $M_\infty = 1.2$ .  $C_{p,crit} = 0.279$ .

Figure 7. Concluded.

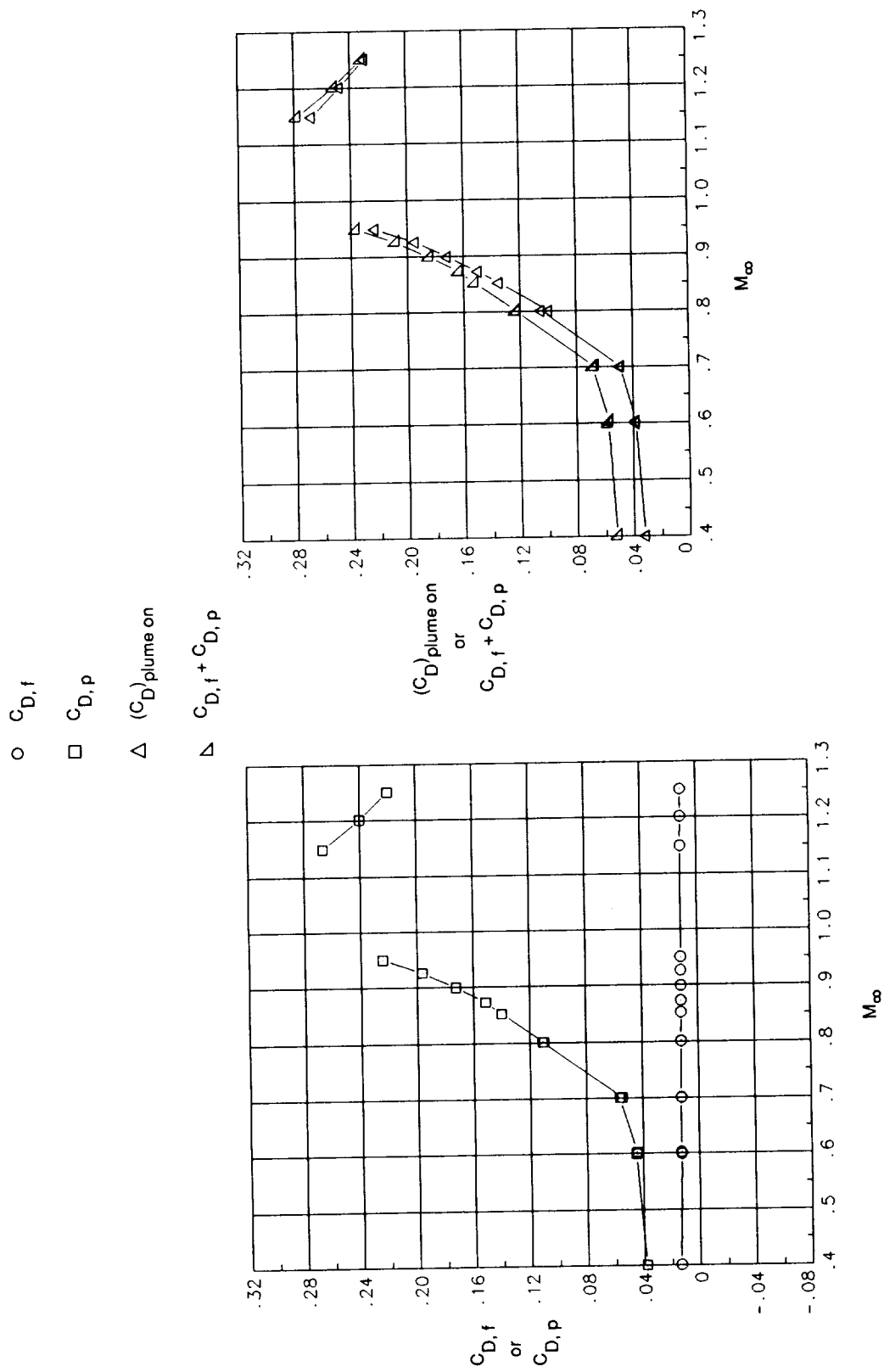

(a) Nozzle 2 with  $\beta_{t,\text{top/bot}} = 17.3^\circ / \beta_{t,\text{side}} = 9.7^\circ$  and sharp-corner radius.

Figure 8. Various component drag coefficients as a function of Mach number at  $\alpha = 0^\circ$ .

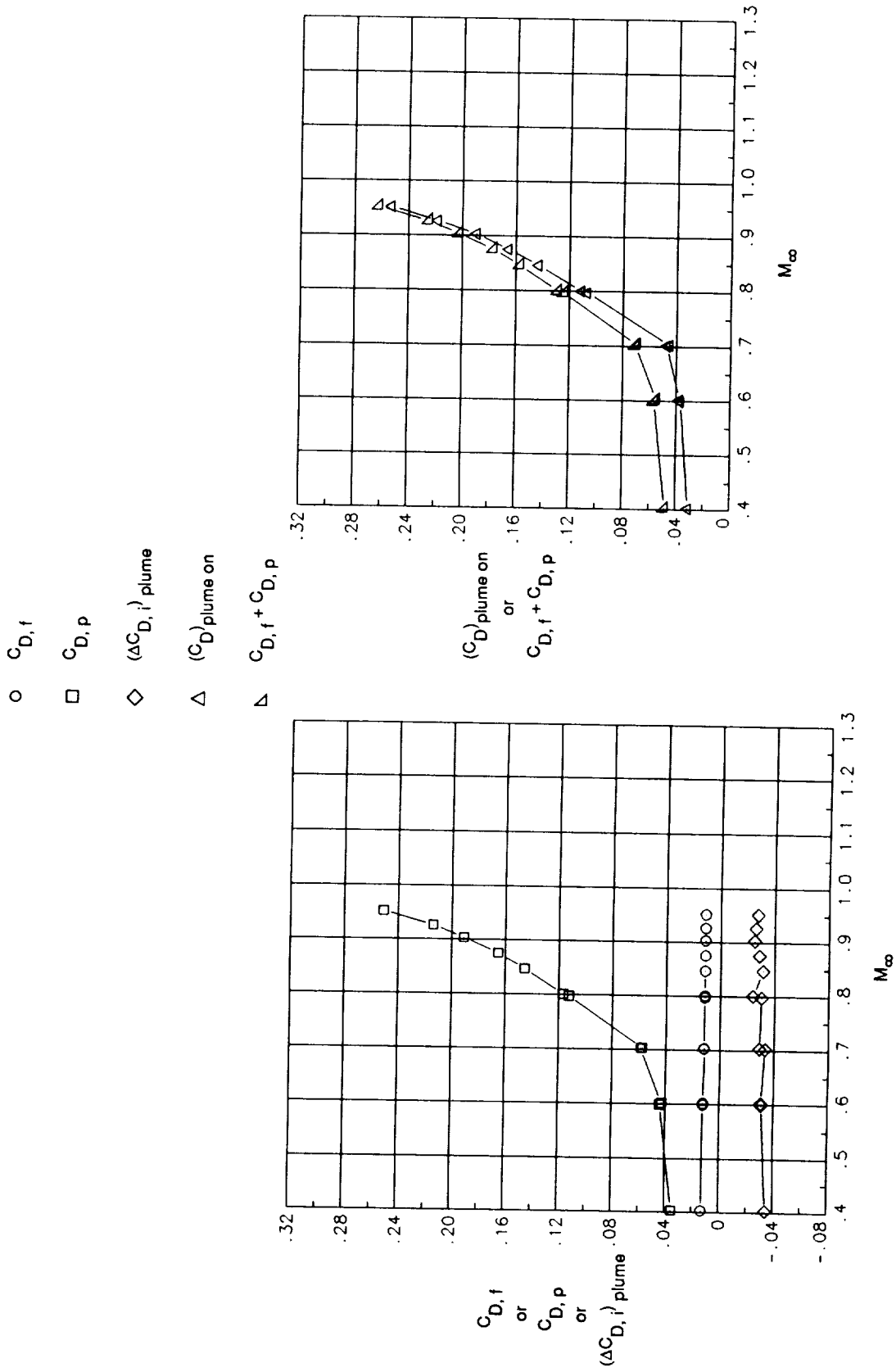

(b) Nozzle 3 with  $\beta_{t,top}/bot = 16.4^\circ / \beta_{t,side} = 16.4^\circ$  and sharp-corner radius.

Figure 8. Continued.

- $C_{D,f}$
- $C_{D,p}$
- ◇  $(\Delta C_{D,i})$  plume
- △  $(C_D)$  plume on
- ▴  $C_{D,f} + C_{D,p}$

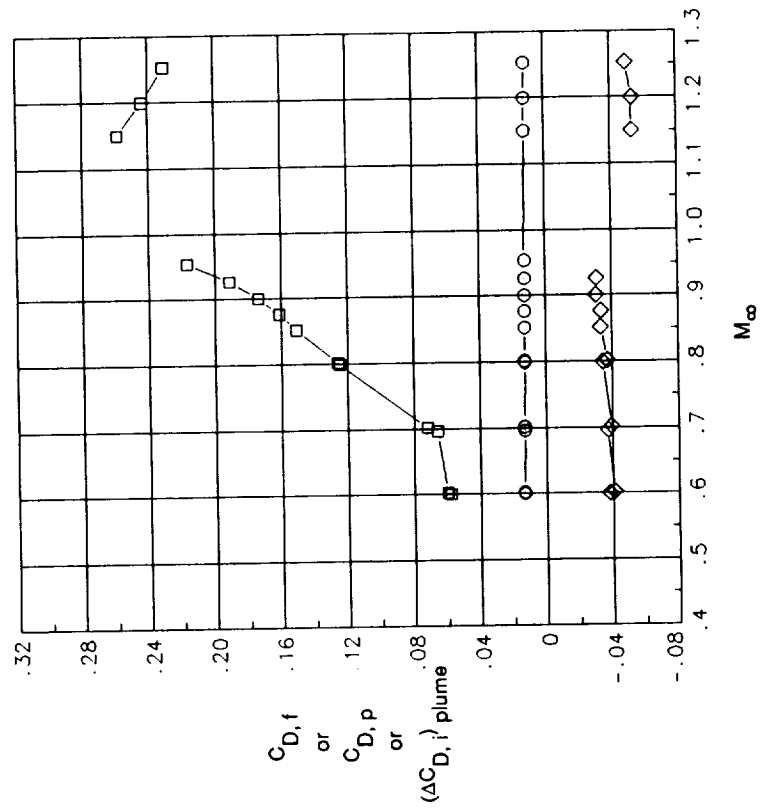
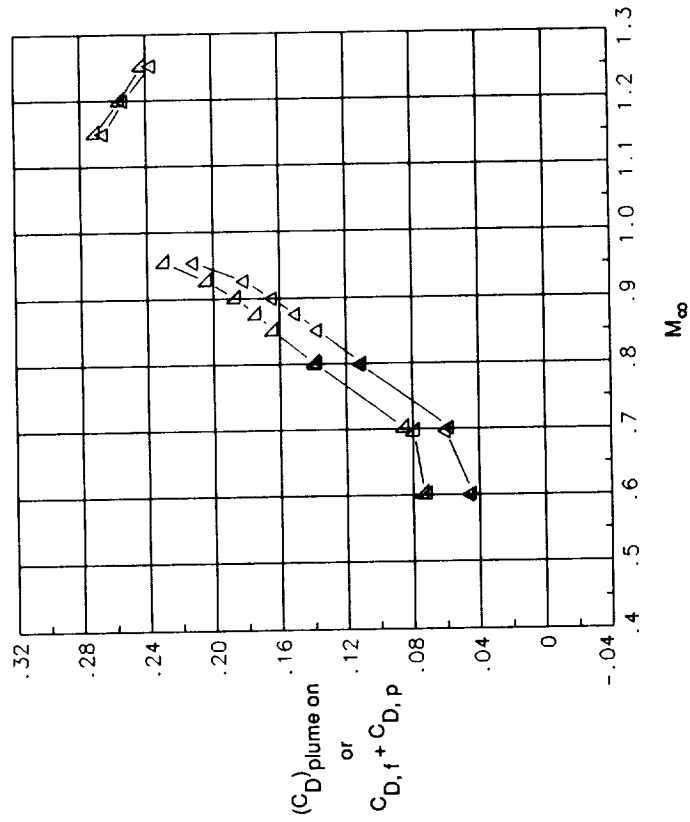

(c) Nozzle 5 with  $\beta_{t,top/bot} = 17.9^\circ / \beta_{t,side} = 0^\circ$  and 1-in. corner radius.

Figure 8. Continued.

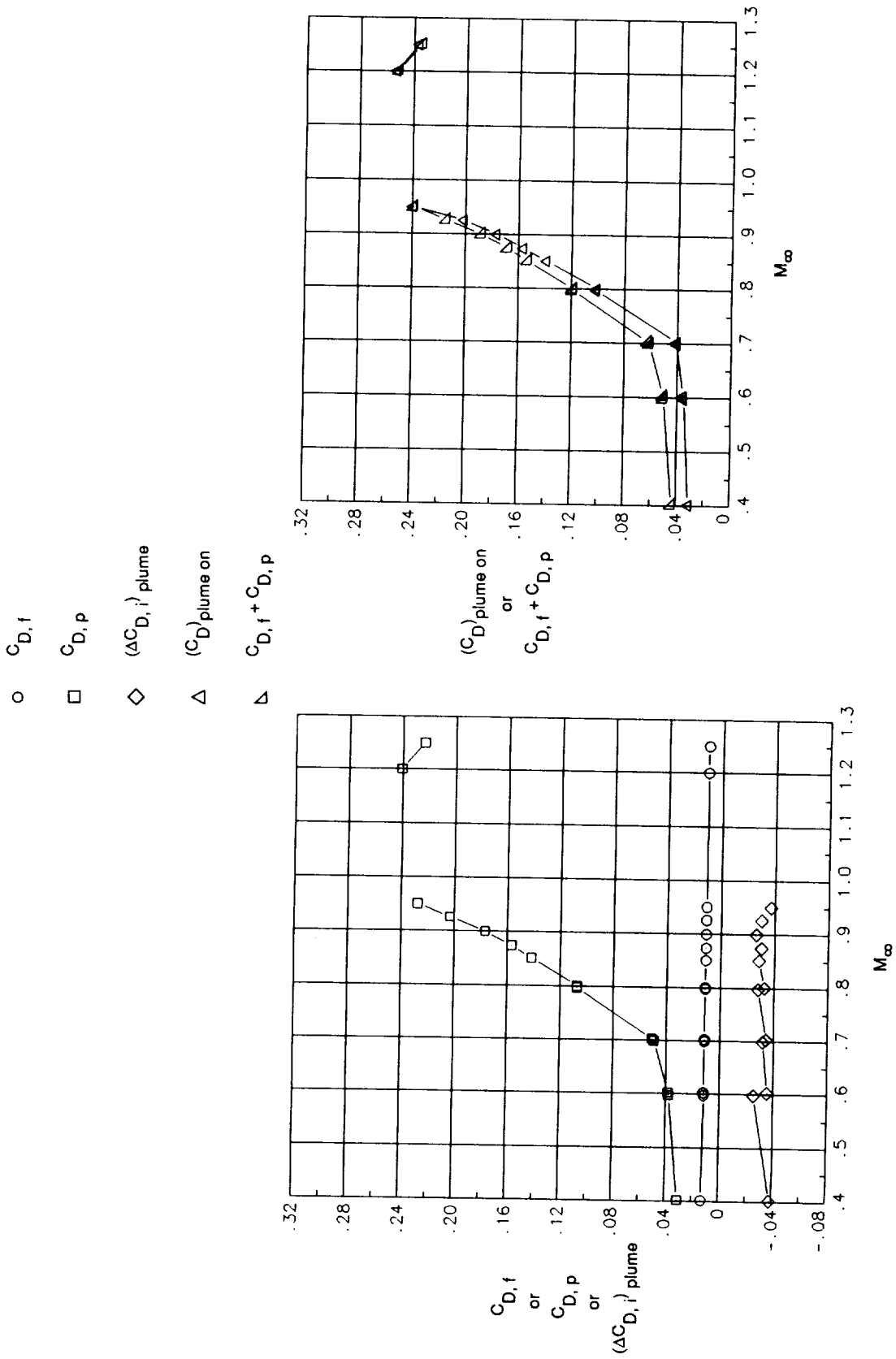

(d) Nozzle 7 with  $\beta_{t,top/bot} = 16.4^\circ / \beta_{t,side} = 16.4^\circ$  and 1-in. corner radius.

Figure 8. Continued.

- $C_{D,f}$
- $C_{D,p}$
- ◇  $(\Delta C_{D,i})$  plume
- △  $(C_D)$  plume on
- ▴  $C_{D,f} + C_{D,p}$

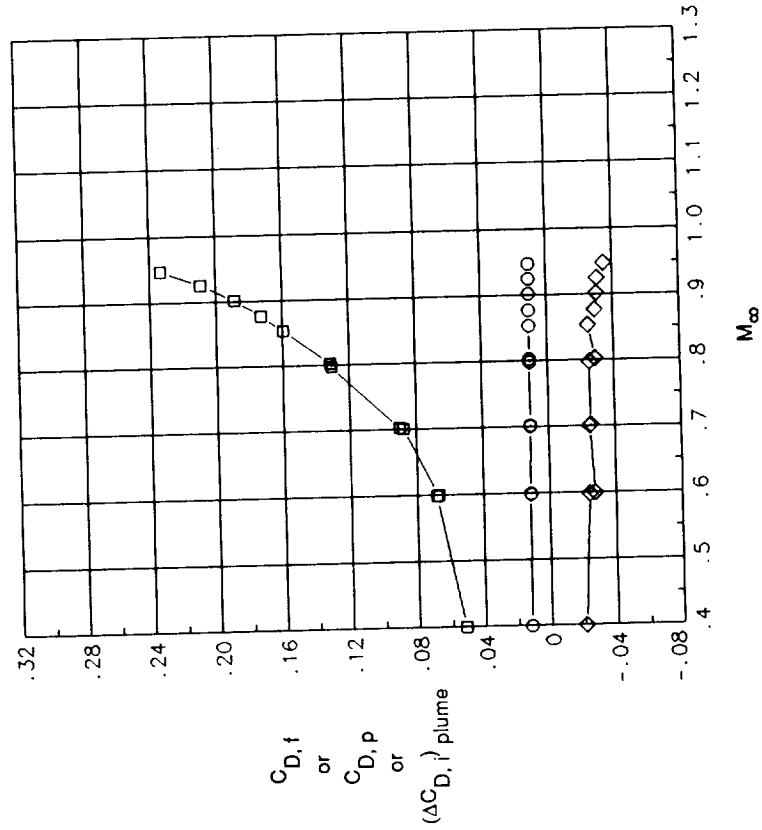
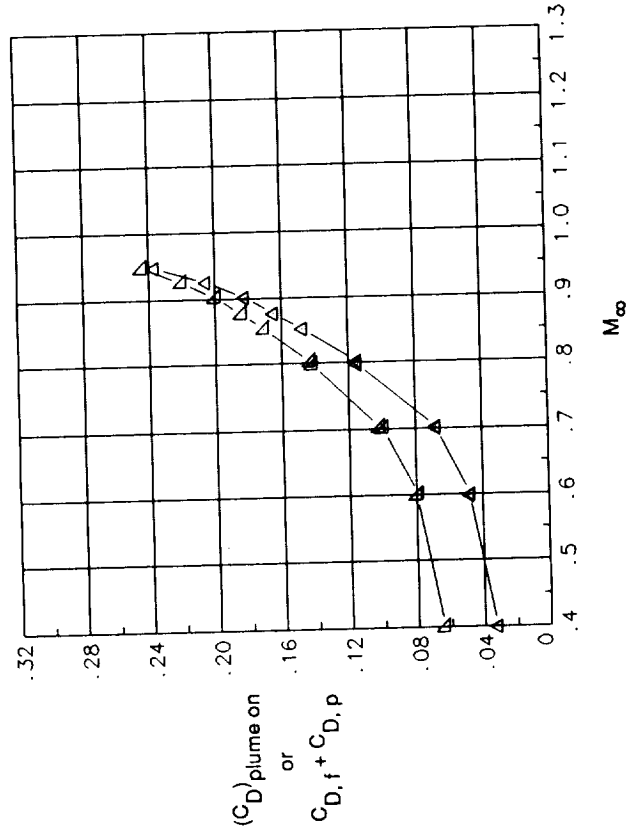

(e) Nozzle 8 with  $\beta_{t,top/bot} = 15.0^\circ / \beta_{t,side} = 22.4^\circ$  and 1-in. corner radius.

Figure 8. Continued.

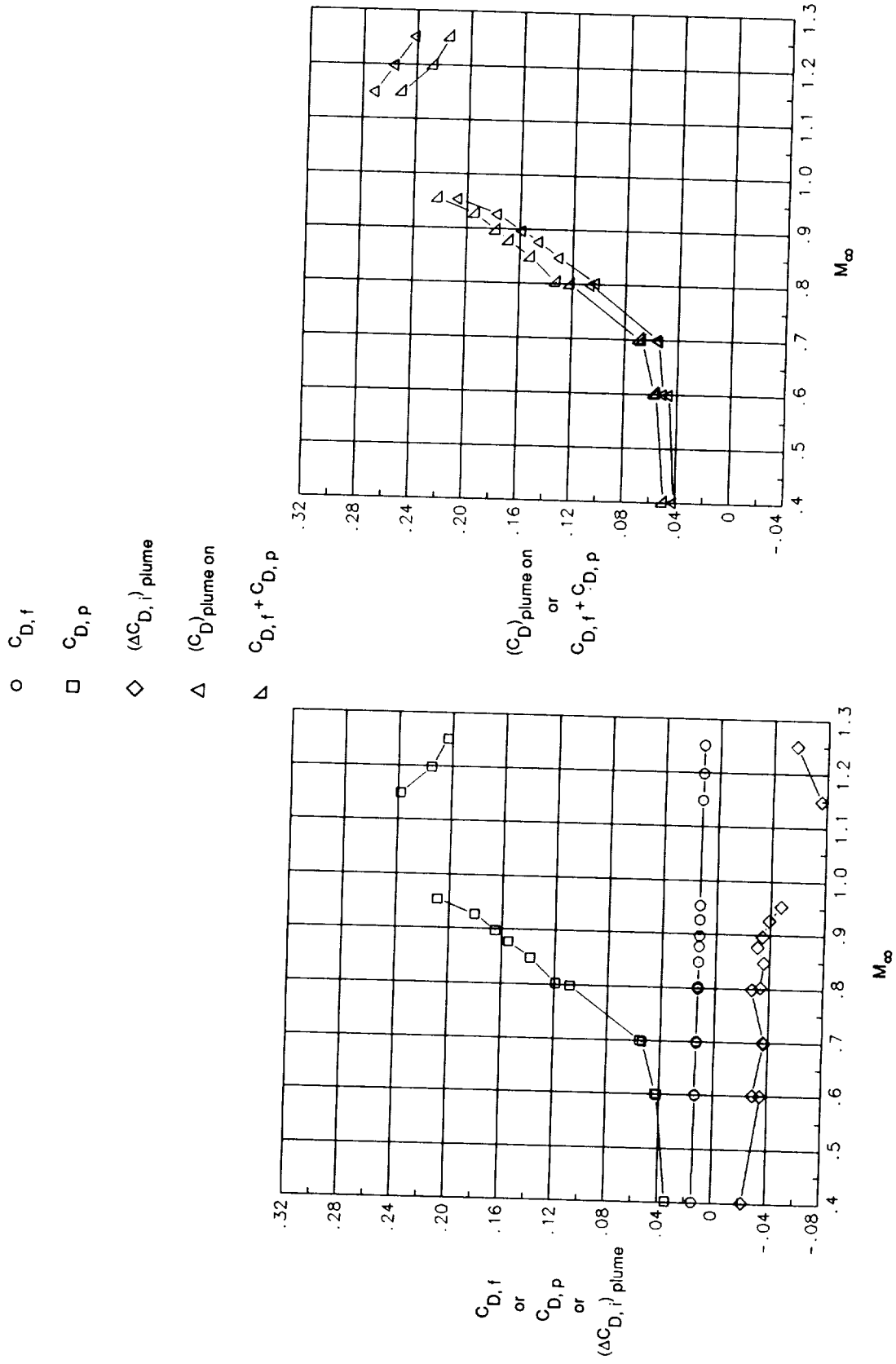

(f) Nozzle 9 with  $\beta_{t,\text{top/bot}} = 17.9^\circ / \beta_{t,\text{side}} = 0^\circ$  and 2-in. corner radius.

Figure 8. Continued.



- $C_{D,f}$
- $C_{D,p}$
- ◇  $(\Delta C_{D,i})$  plume
- △  $(C_D)$  plume on
- △  $C_{D,f} + C_{D,p}$

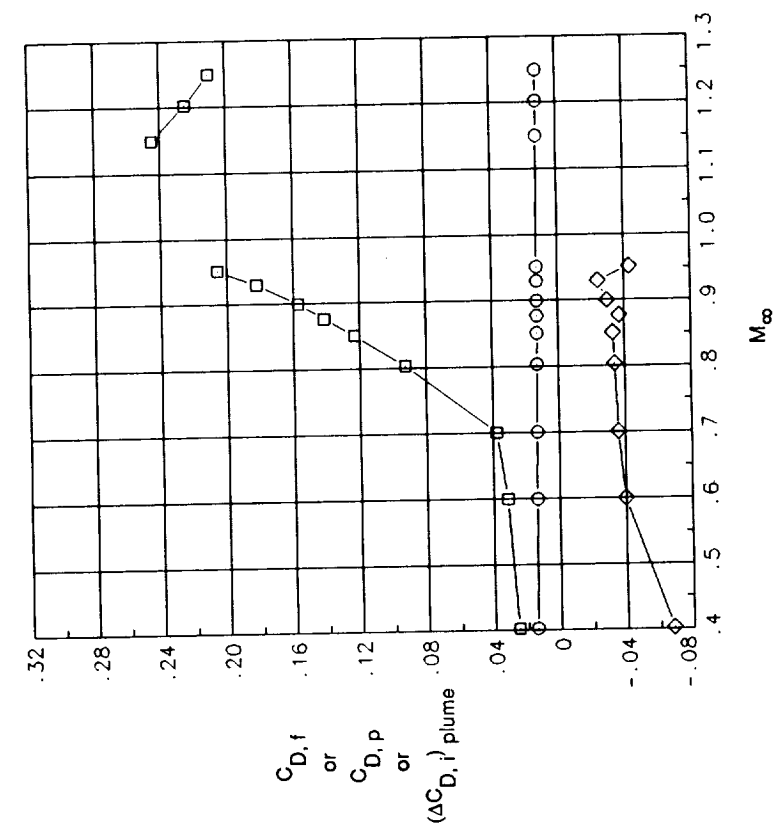
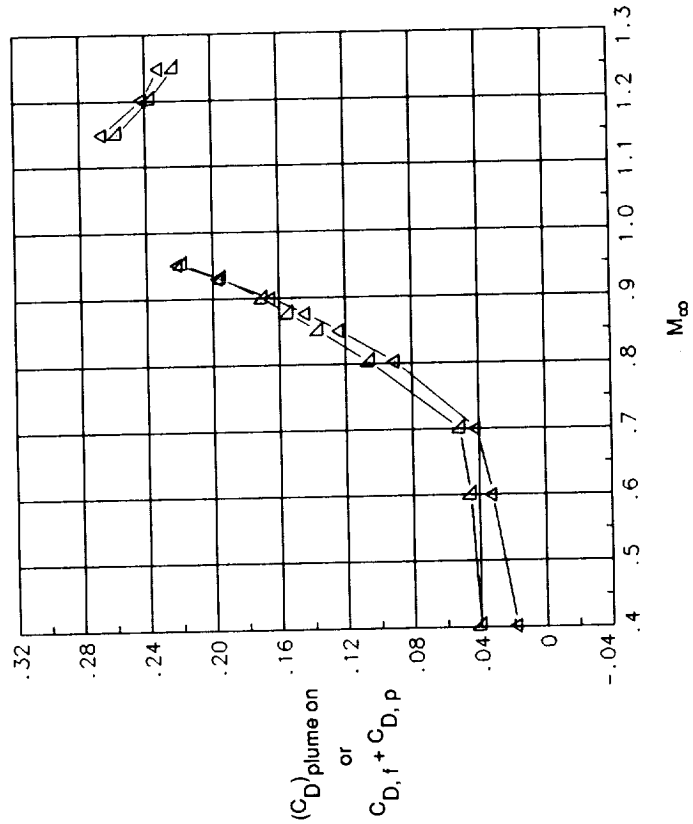

(g) Nozzle 10 with  $\beta_{t,top/bot} = 17.3^\circ$  /  $\beta_{t,side} = 9.7^\circ$  and 2-in. corner radius.

Figure 8. Continued.

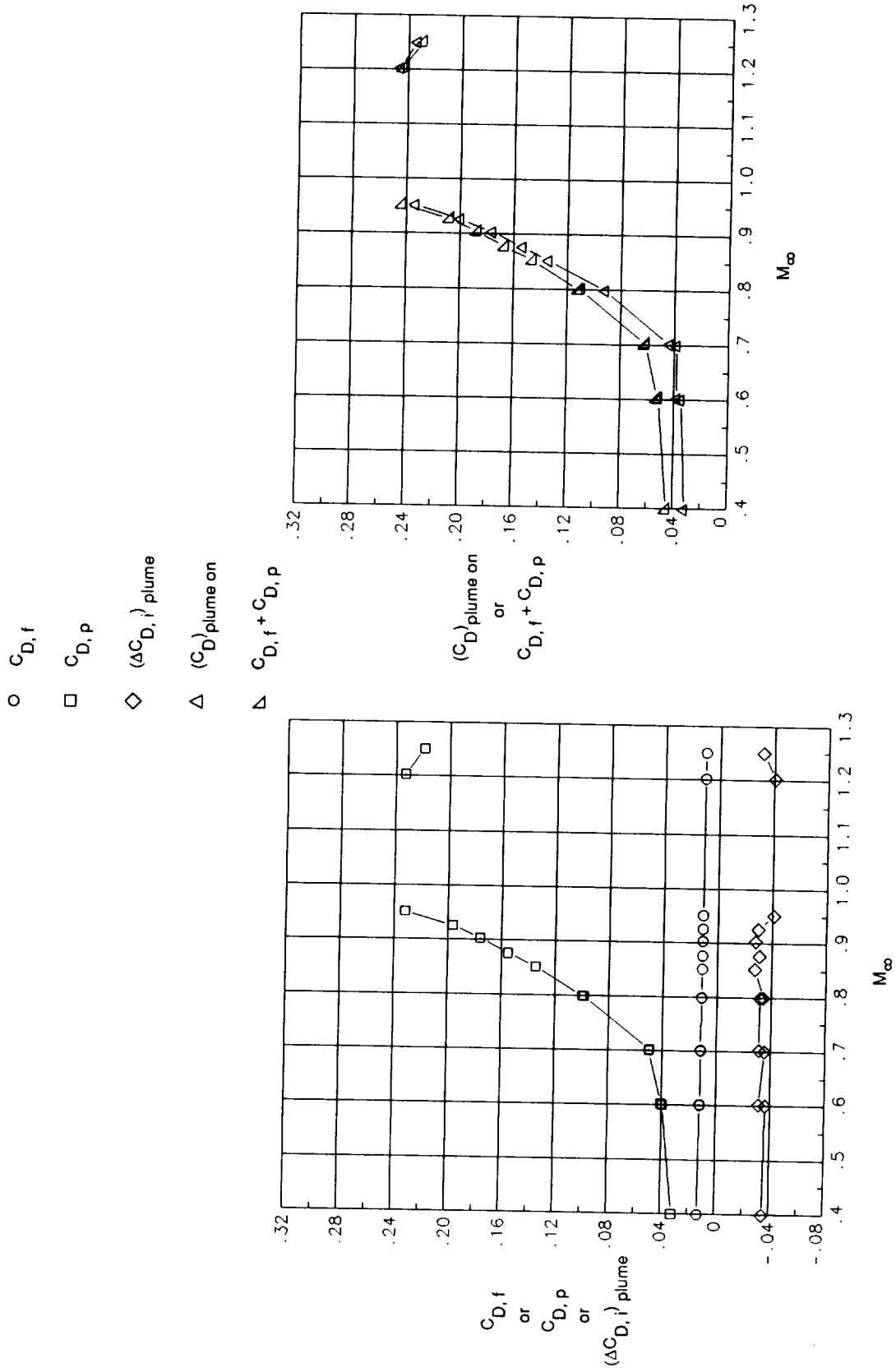

(h) Nozzle 11 with  $\beta_{t,top/bot} = 16.4^\circ / \beta_{t,side} = 16.4^\circ$  and 2-in. corner radius.

Figure 8. Continued.

- $C_{D,f}$
- $C_{D,p}$
- ◇  $(\Delta C_{D,i})$  plume
- △  $(C_D)$  plume on
- ▴  $C_{D,f} + C_{D,p}$

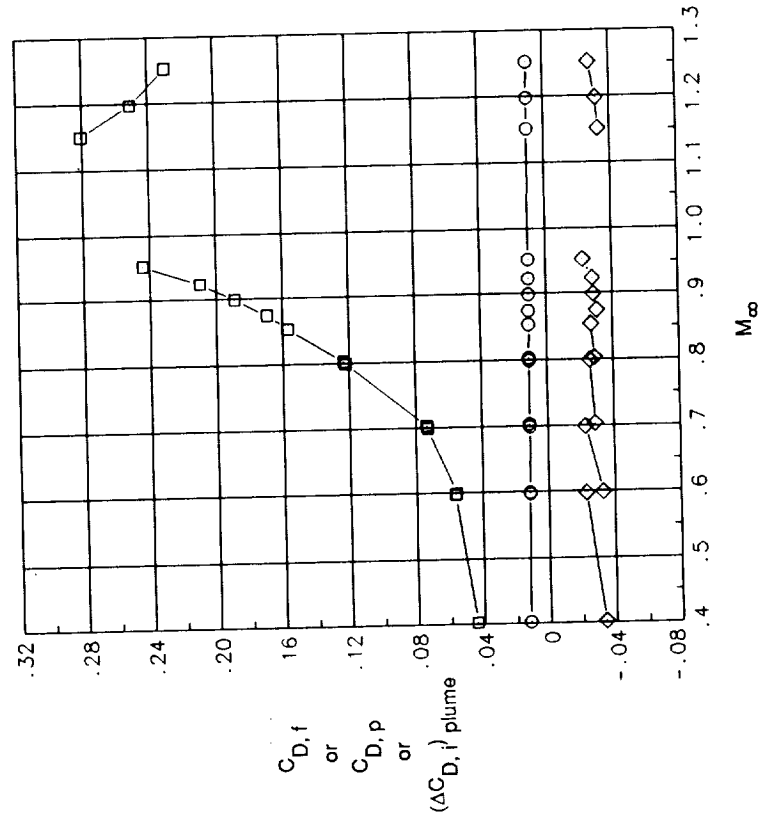
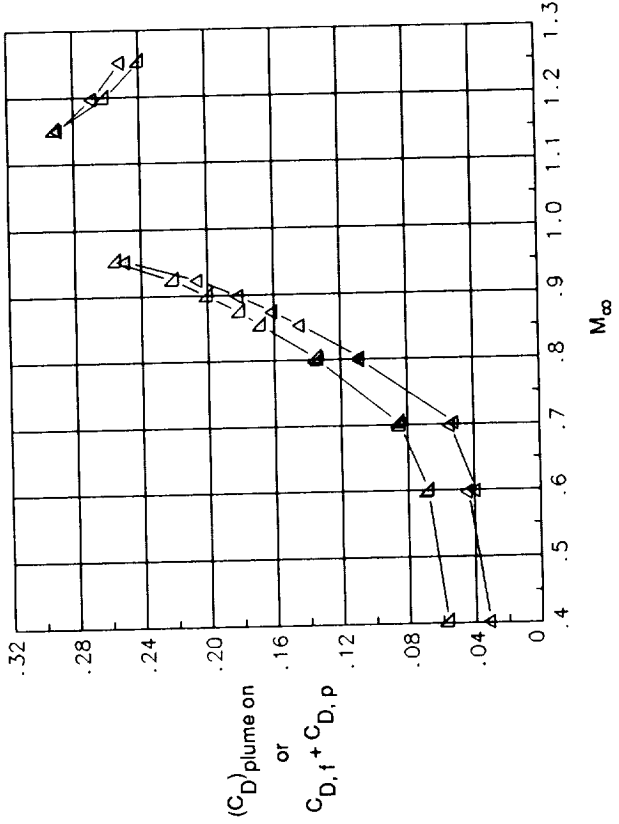

(i) Nozzle 12 with  $\beta_{t,top/bot} = 15.0^\circ / \beta_{t,side} = 22.4^\circ$  and 2-in. corner radius.

Figure 8. Concluded.

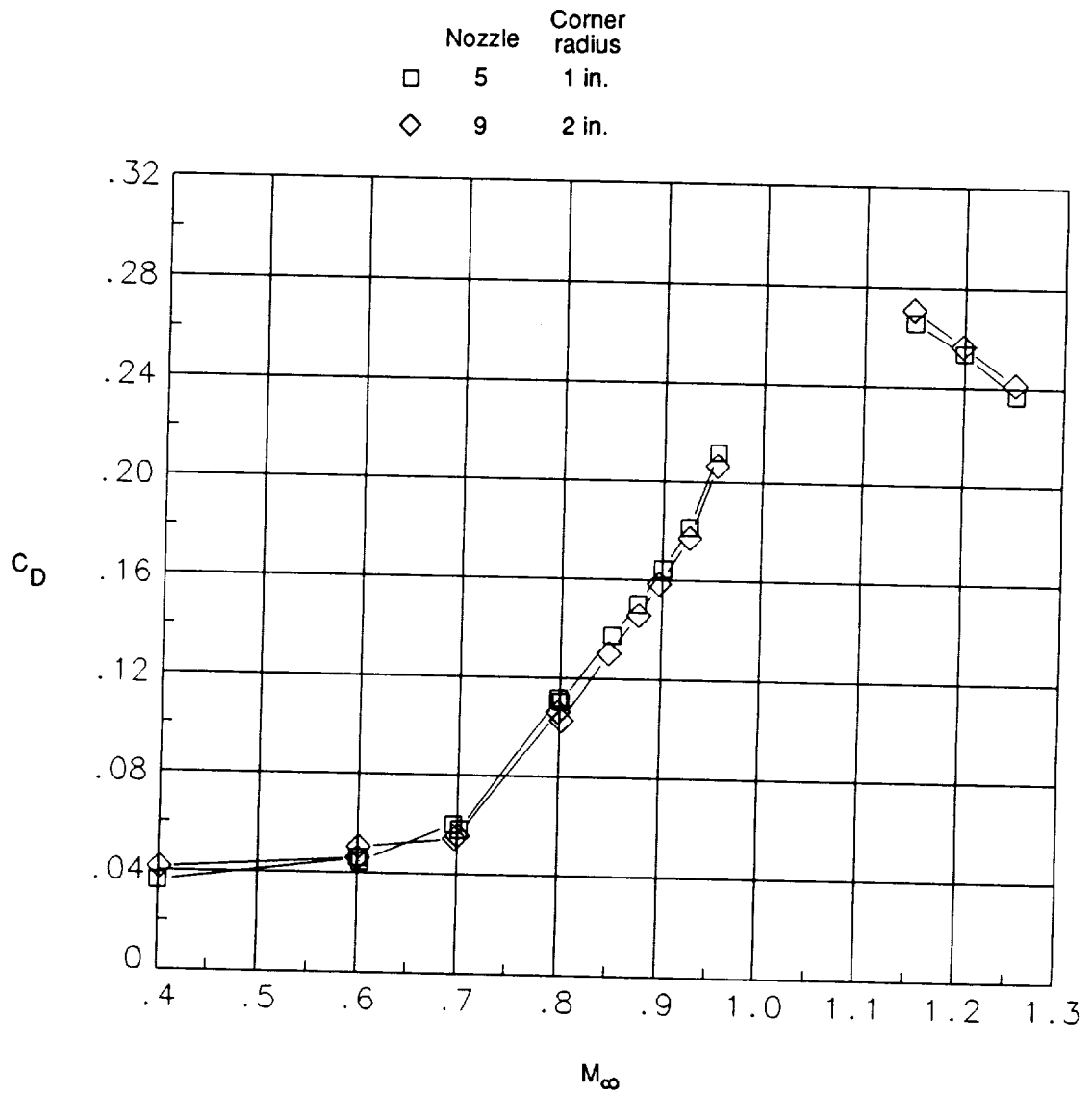

(a) Afterbody drag with plume on.

Figure 9. Effect of corner radius on nozzles with  $\beta_{t,top/bot} = 17.9^\circ / \beta_{t,side} = 0^\circ$  at  $\alpha = 0^\circ$ .

- Centerline top
- $y/Y = 0.50$  top
- ◇  $y/Y = 0.75$  top
- △  $y/Y = 0.875$  top
- ▵ Top/Side corner
- ▷  $z/Z = 0.50$  side
- ◻ Centerline side

- Centerline top
- $y/Y = 0.25$  top
- ◇  $y/Y = 0.50$  top
- △  $y/Y = 0.75$  top
- ▵ Top/Side corner
- ▷  $z/Z = 0.50$  side
- ◻ Centerline side

Nozzle 5: 1-in. corner radius

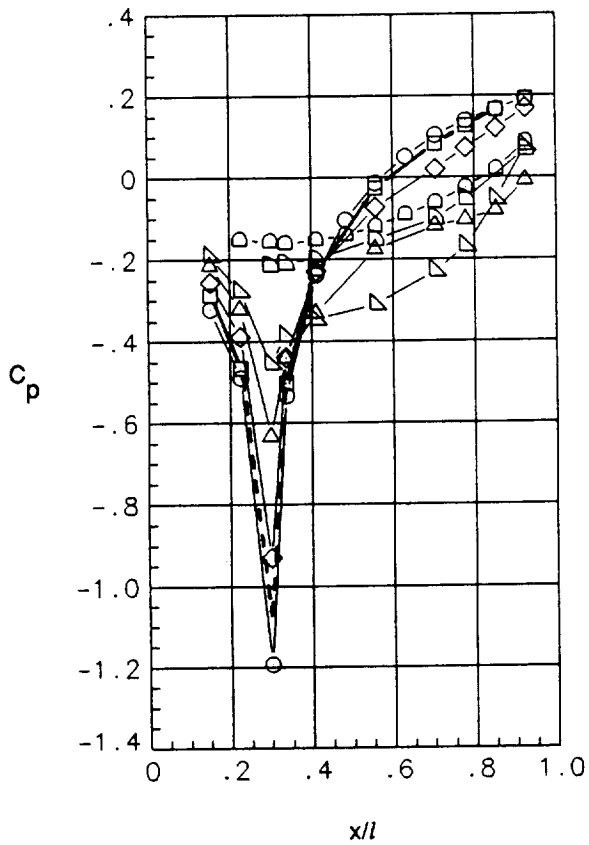

Nozzle 9: 2-in. corner radius

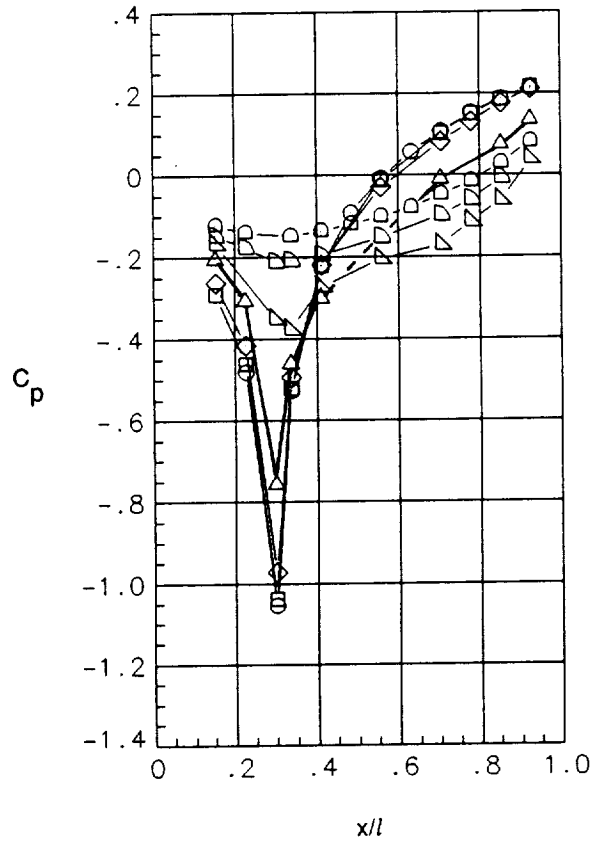

(b) Pressure distributions at  $M_\infty = 0.6$ .

Figure 9. Continued.

- Centerline top
- $y/Y = 0.50$  top
- ◇  $y/Y = 0.75$  top
- △  $y/Y = 0.875$  top
- ▴ Top/Side corner
- ▷  $z/Z = 0.50$  side
- ◻ Centerline side

- Centerline top
- $y/Y = 0.25$  top
- ◇  $y/Y = 0.50$  top
- △  $y/Y = 0.75$  top
- ▴ Top/Side corner
- ▷  $z/Z = 0.50$  side
- ◻ Centerline side

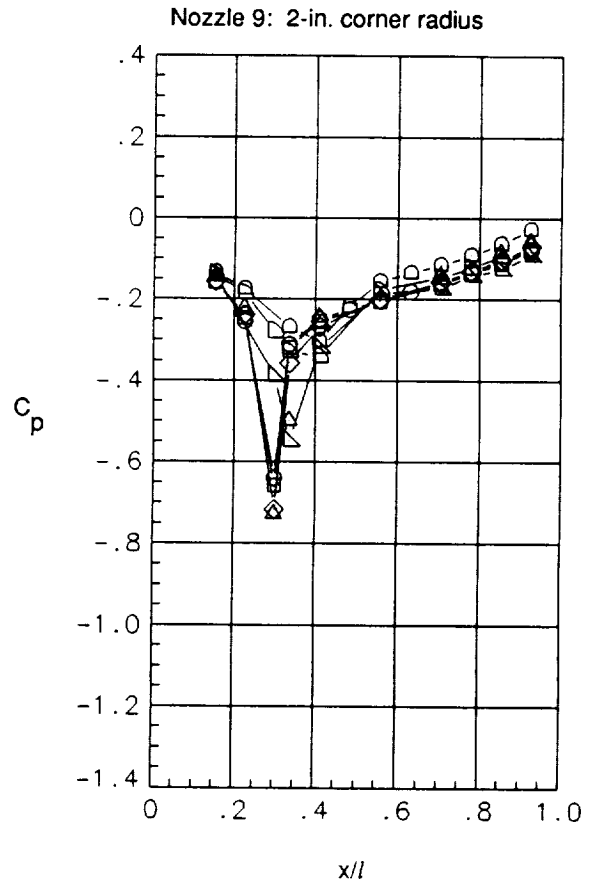
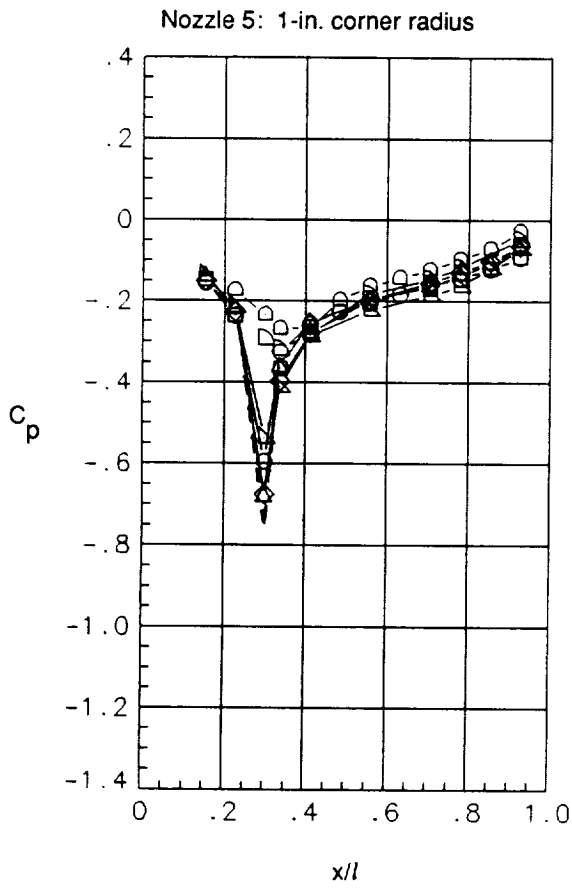

(c) Pressure distributions at  $M_\infty = 0.9$ .

Figure 9. Continued.

- Centerline top
- $y/Y = 0.50$  top
- ◇  $y/Y = 0.75$  top
- △  $y/Y = 0.875$  top
- ▴ Top/Side corner
- ▷  $z/Z = 0.50$  side
- ◻ Centerline side

- Centerline top
- $y/Y = 0.25$  top
- ◇  $y/Y = 0.50$  top
- △  $y/Y = 0.75$  top
- ▴ Top/Side corner
- ▷  $z/Z = 0.50$  side
- ◻ Centerline side

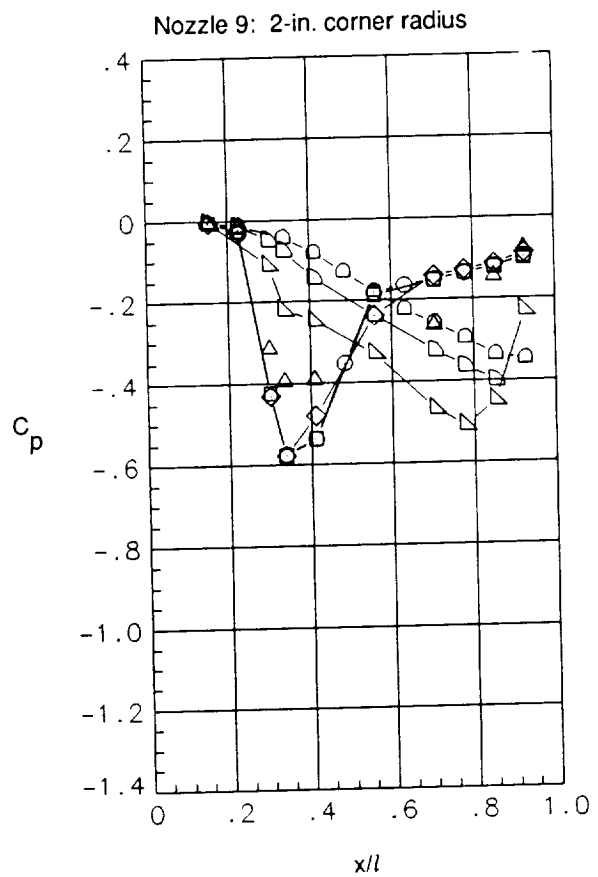
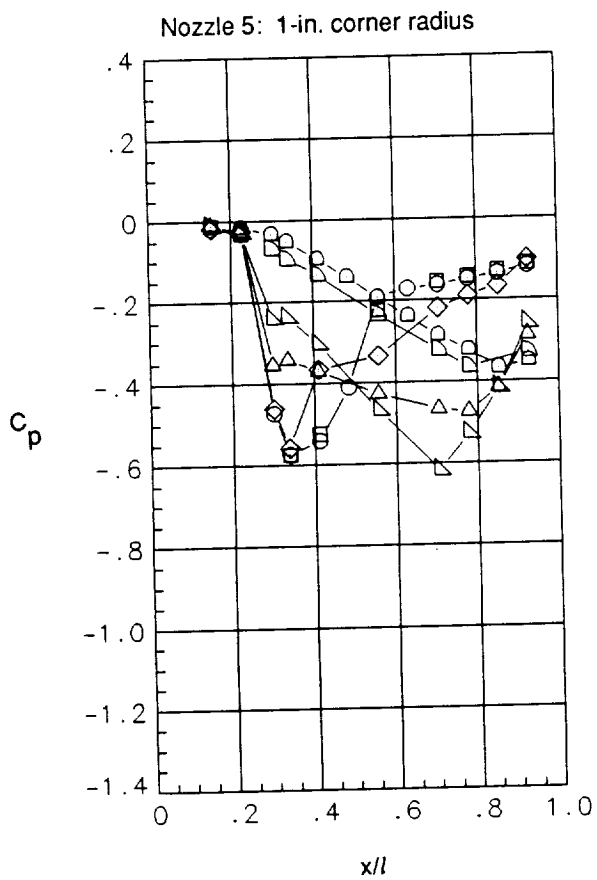

(d) Pressure distributions at  $M_\infty = 1.2$ .

Figure 9. Concluded.

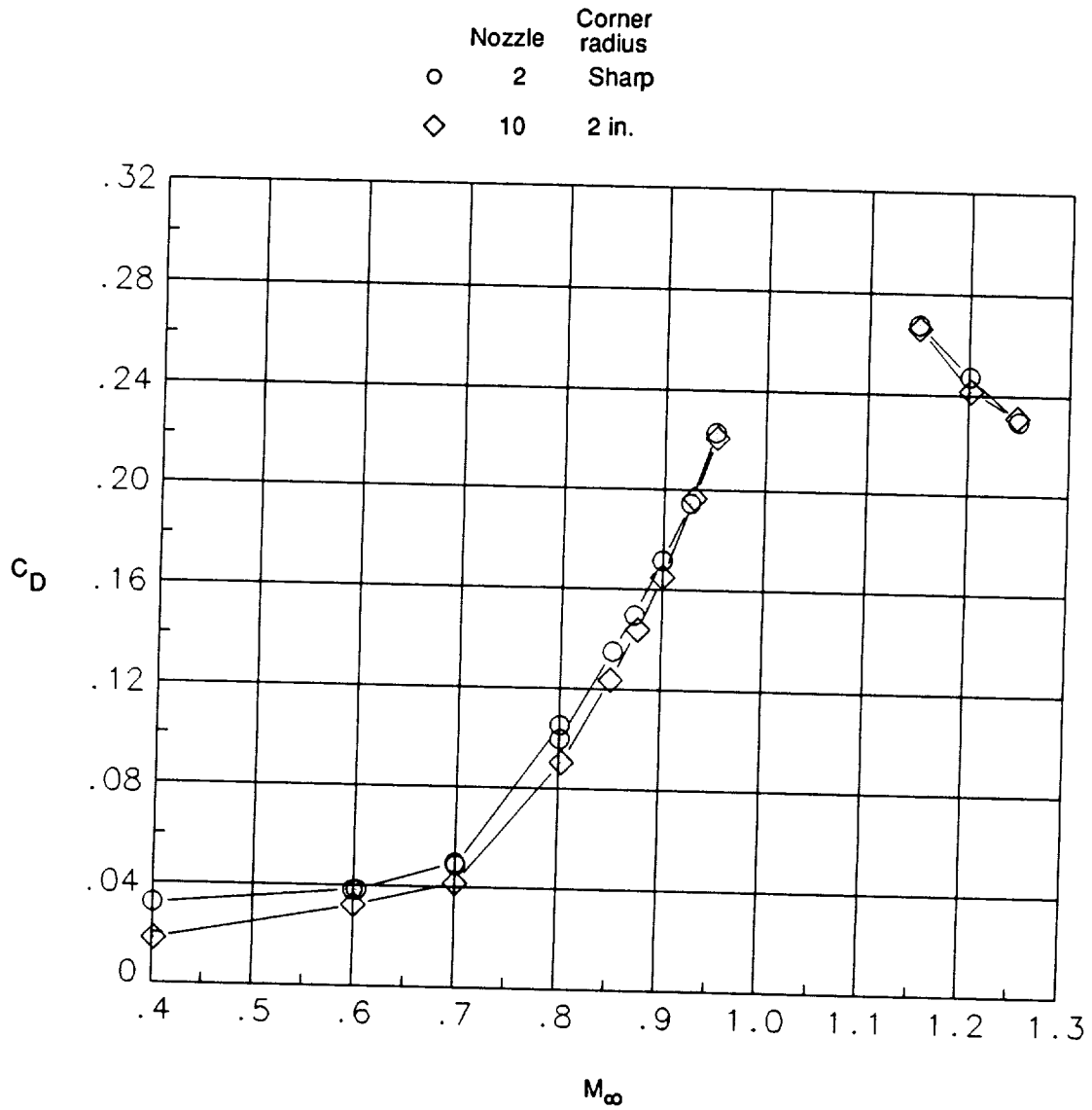

(a) Afterbody drag with plume on.

Figure 10. Effect of corner radius on nozzles with  $\beta_{t,top/bot} = 17.3^\circ / \beta_{t,side} = 9.7^\circ$  at  $\alpha = 0^\circ$ .



- Centerline top
- $y/Y = 0.50$  top
- ◇  $y/Y = 0.75$  top
- △  $y/Y = 0.875$  top
- ▵  $z/Z = 0.75$  side
- ▷  $z/Z = 0.50$  side
- Centerline side

- Centerline top
- $y/Y = 0.25$  top
- ◇  $y/Y = 0.50$  top
- △  $y/Y = 0.75$  top
- ▵ Top/Side corner
- ▷  $z/Z = 0.50$  side
- Centerline side

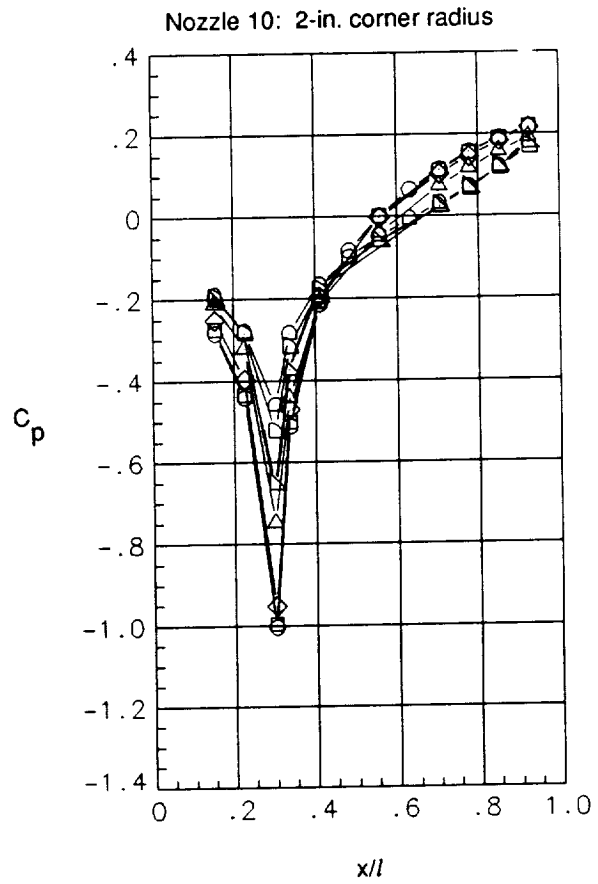
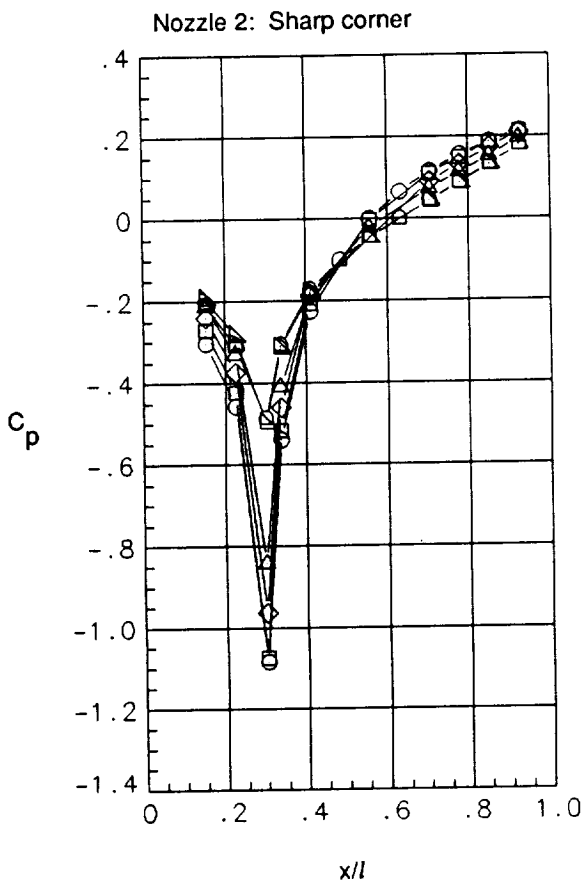

(b) Pressure distributions at  $M_\infty = 0.6$ .

Figure 10. Continued.

- Centerline top
- $y/Y = 0.50$  top
- ◇  $y/Y = 0.75$  top
- △  $y/Y = 0.875$  top
- ▴  $z/Z = 0.75$  side
- ▷  $z/Z = 0.50$  side
- ◻ Centerline side

- Centerline top
- $y/Y = 0.25$  top
- ◇  $y/Y = 0.50$  top
- △  $y/Y = 0.75$  top
- ▴ Top/Side corner
- ▷  $z/Z = 0.50$  side
- ◻ Centerline side

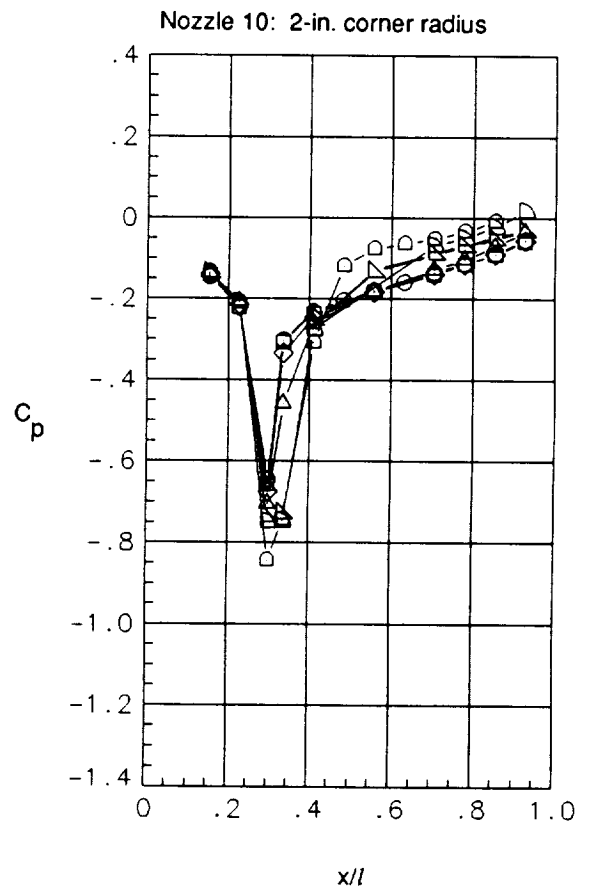
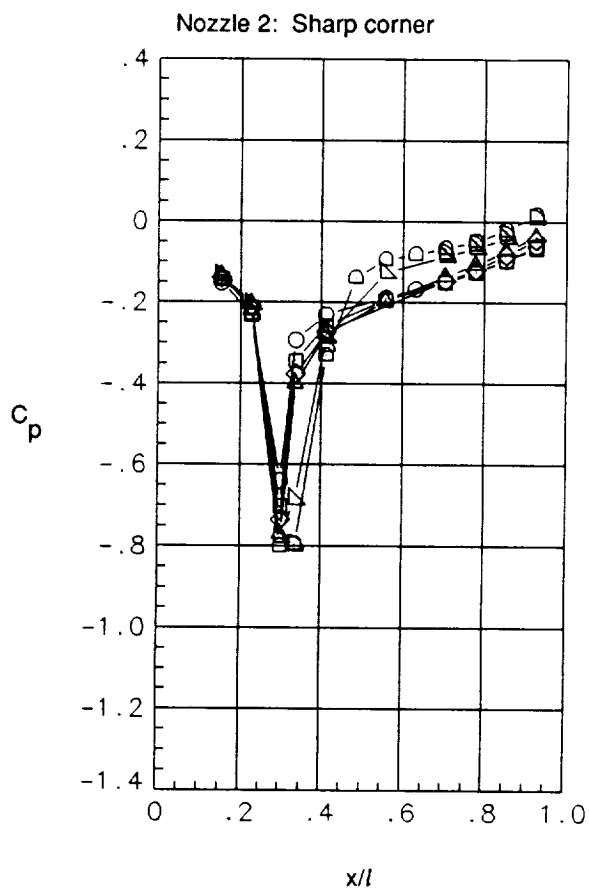

(c) Pressure distributions at  $M_\infty = 0.9$ .

Figure 10. Continued.

- Centerline top
- $y/Y = 0.50$  top
- ◇  $y/Y = 0.75$  top
- △  $y/Y = 0.875$  top
- ▵  $z/Z = 0.75$  side
- ▷  $z/Z = 0.50$  side
- ◻ Centerline side

- Centerline top
- $y/Y = 0.25$  top
- ◇  $y/Y = 0.50$  top
- △  $y/Y = 0.75$  top
- ▵ Top/Side corner
- ▷  $z/Z = 0.50$  side
- ◻ Centerline side

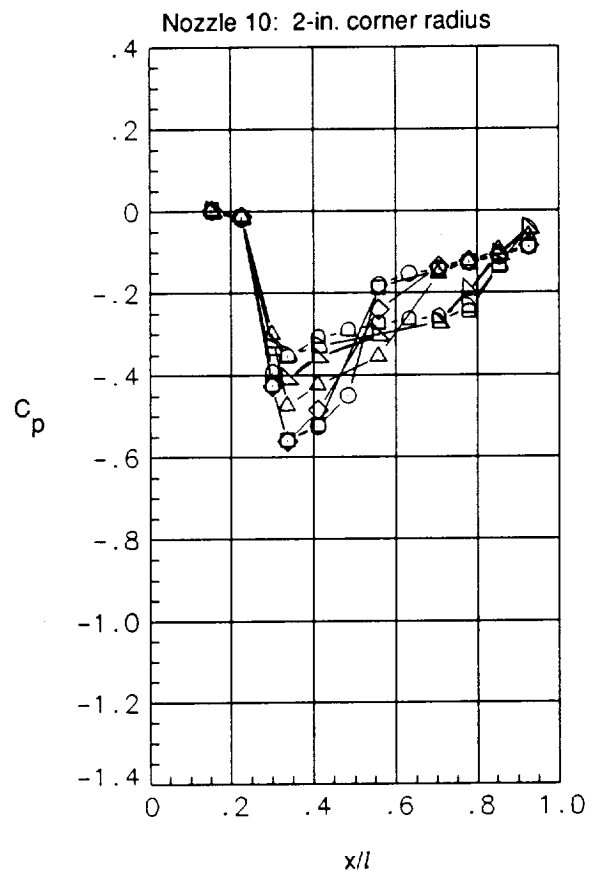
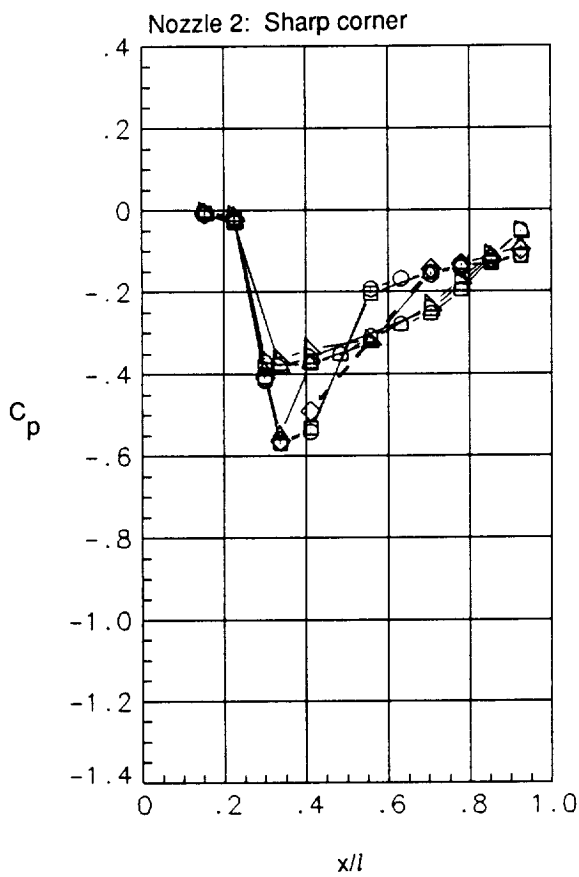

(d) Pressure distributions at  $M_\infty = 1.2$ .

Figure 10. Concluded.

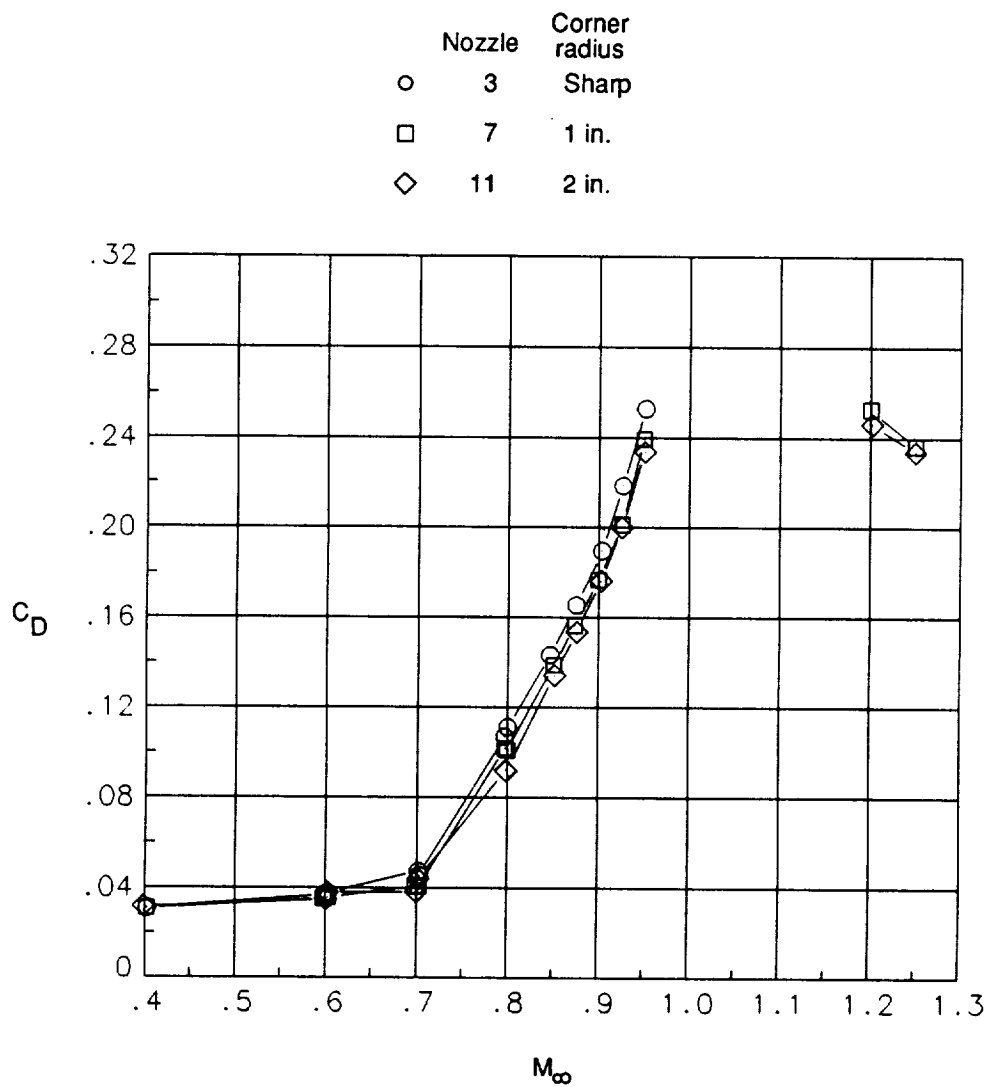

(a) Afterbody drag with plume on.

Figure 11. Effect of corner radius on nozzles with  $\beta_{t,top/bot} = \beta_{t,side} = 16.4^\circ$  at  $\alpha = 0^\circ$ .

- Centerline top
- $y/Y = 0.50$  top
- ◇  $y/Y = 0.75$  top
- △  $y/Y = 0.875$  top
- ▽  $z/Z = 0.75$  side
- ◻  $z/Z = 0.50$  side
- ◑ Centerline side

Nozzle 3: Sharp corner

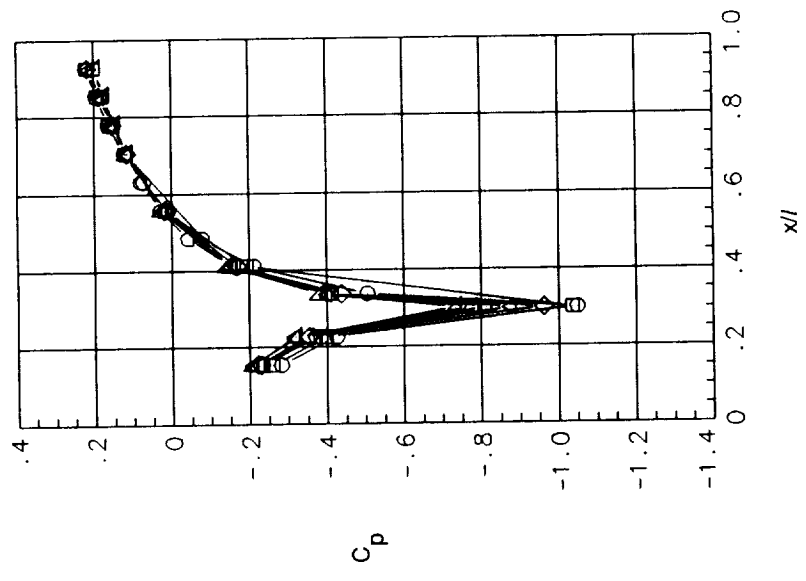

- Centerline top
- $y/Y = 0.50$  top
- ◇  $y/Y = 0.75$  top
- △  $y/Y = 0.875$  top
- ▽ Top/Side corner
- ◻  $z/Z = 0.50$  side
- ◑ Centerline side

Nozzle 7: 1-in. corner radius

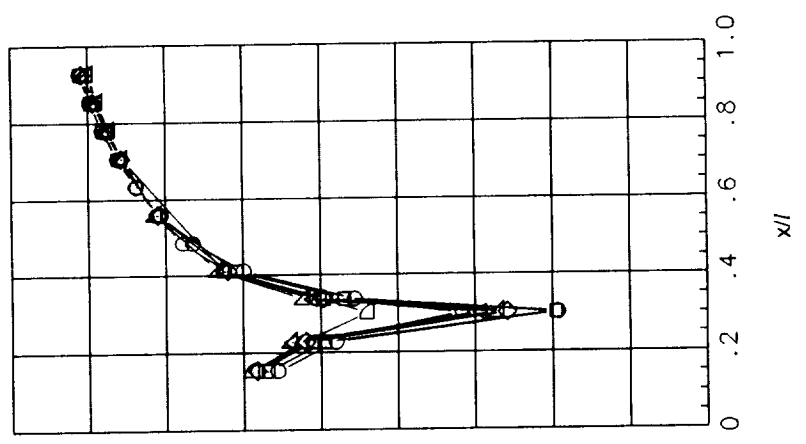

- Centerline top
- $y/Y = 0.25$  top
- ◇  $y/Y = 0.50$  top
- △  $y/Y = 0.75$  top
- ▽ Top/Side corner
- ◻  $z/Z = 0.50$  side
- ◑ Centerline side

Nozzle 11: 2-in. corner radius

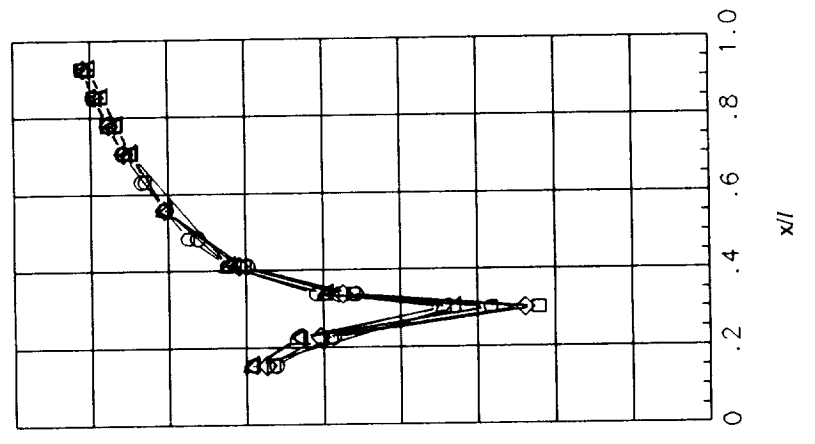

(b) Pressure distributions at  $M_\infty = 0.6$ .

Figure 11. Continued.

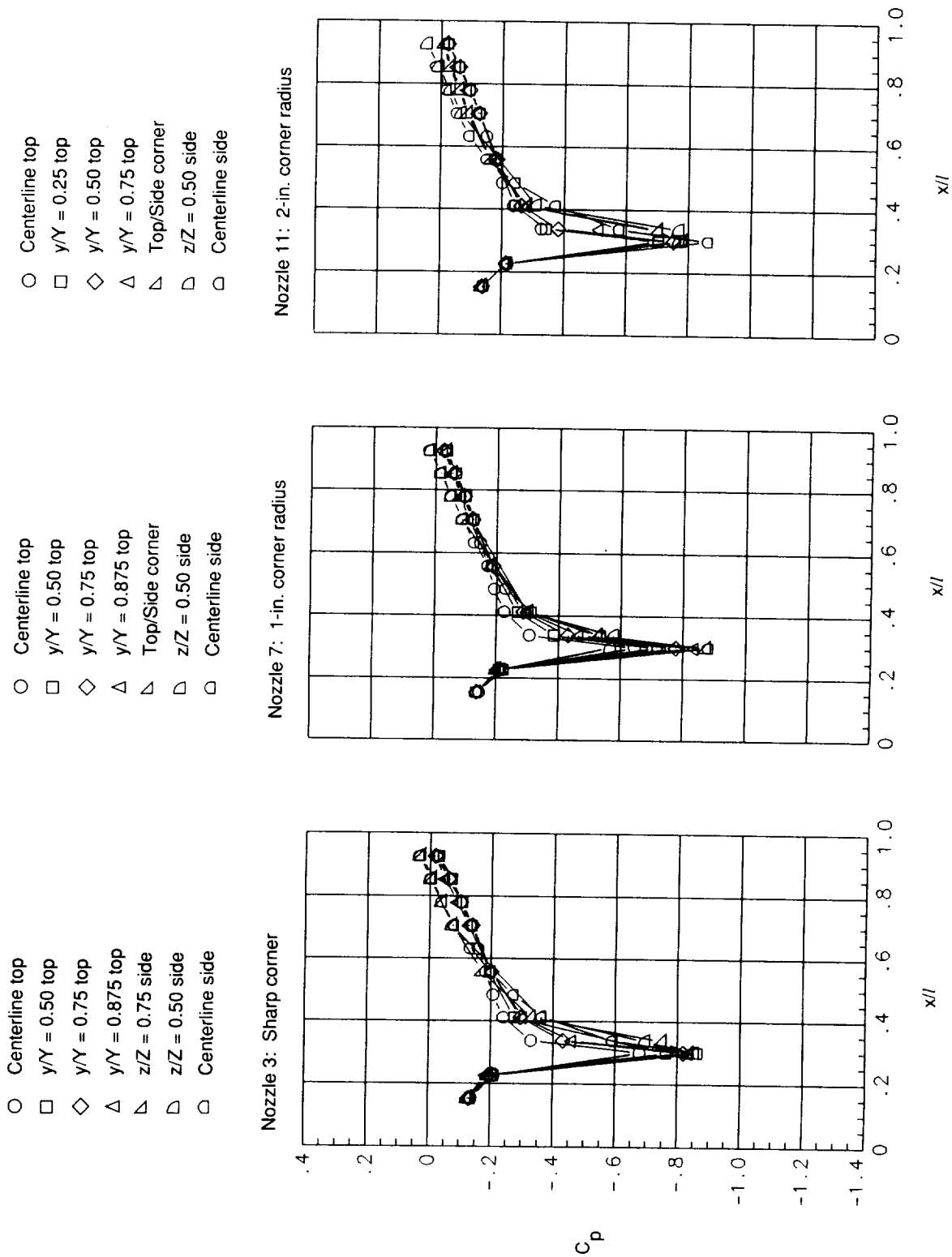

(c) Pressure distributions at  $M_\infty = 0.9$ .

Figure 11. Continued.

- Centerline top
- $y/Y = 0.50$  top
- ◇  $y/Y = 0.75$  top
- △  $y/Y = 0.875$  top
- ▵ Top/Side corner
- ▷  $z/Z = 0.50$  side
- ◻ Centerline side

- Centerline top
- $y/Y = 0.25$  top
- ◇  $y/Y = 0.50$  top
- △  $y/Y = 0.75$  top
- ▵ Top/Side corner
- ▷  $z/Z = 0.50$  side
- ◻ Centerline side

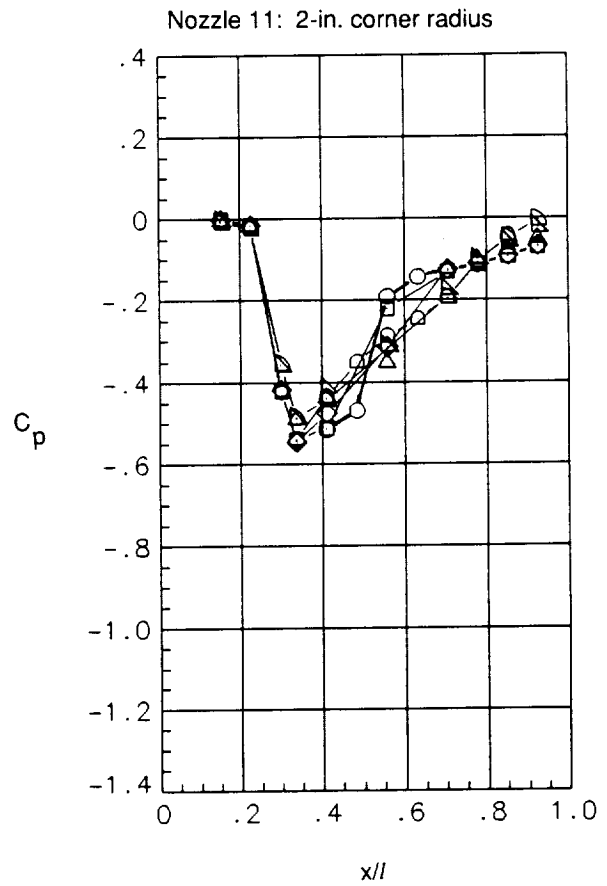
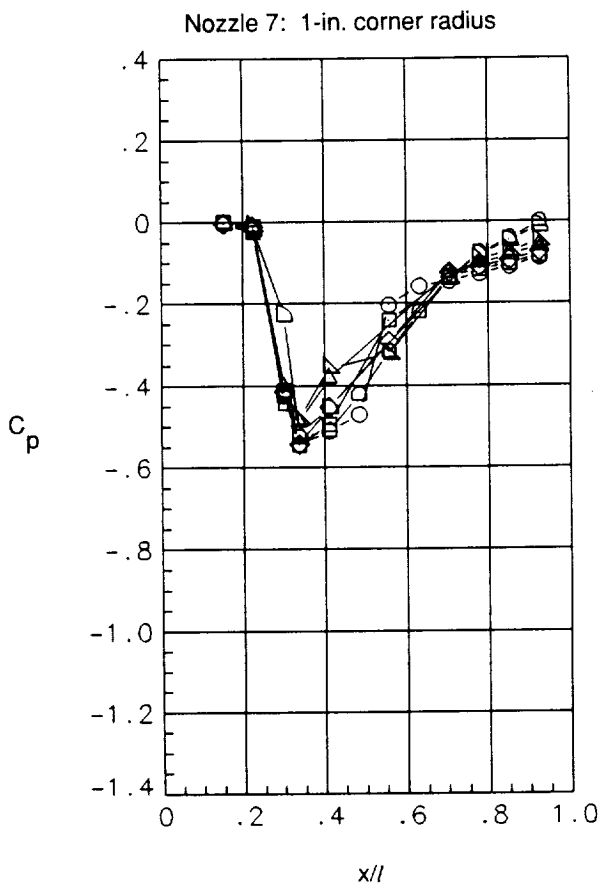

(d) Pressure distributions at  $M_\infty = 1.2$ .

Figure 11. Concluded.

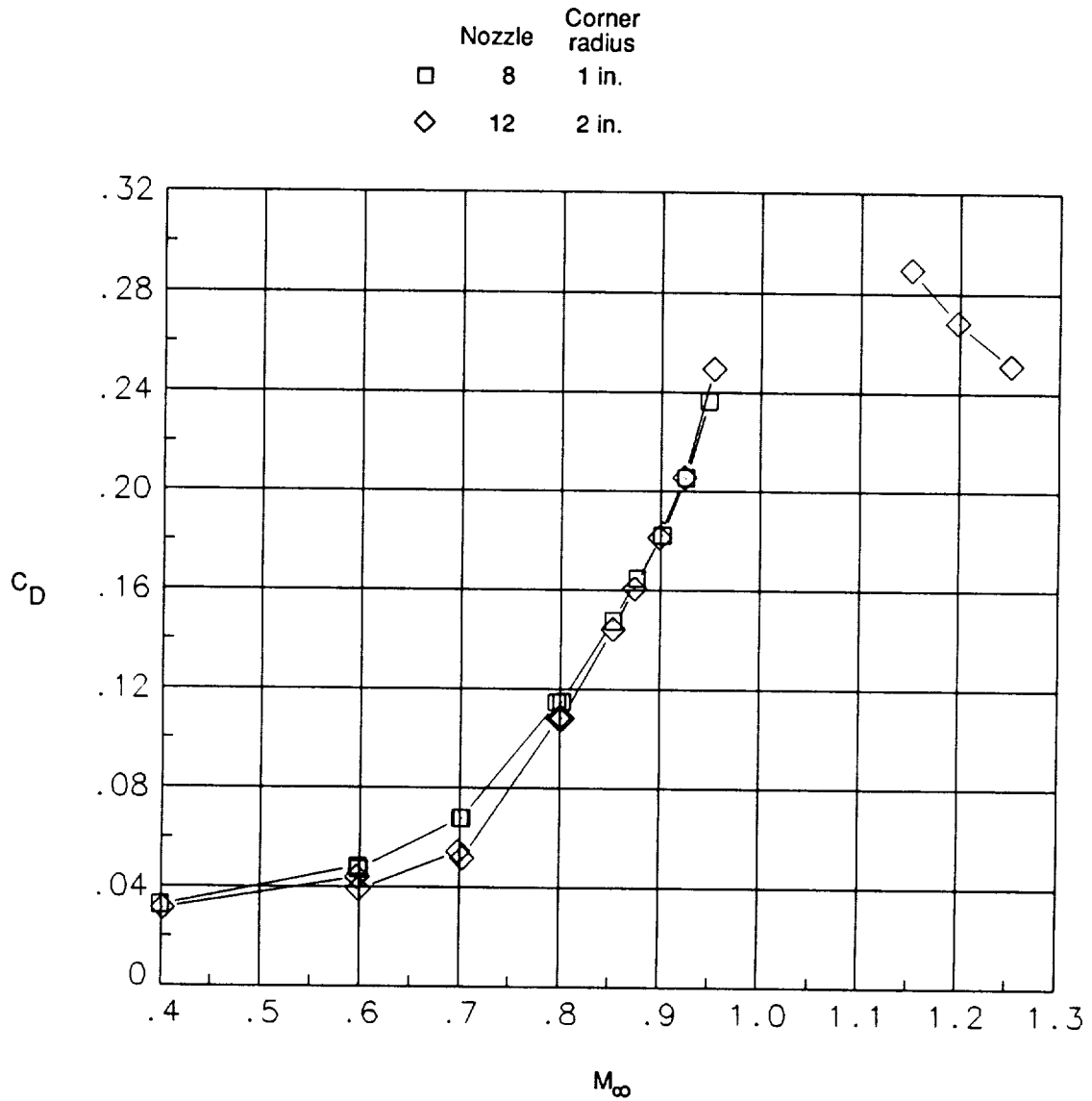

(a) Afterbody drag with plume on.

Figure 12. Effect of corner radius on nozzles with  $\beta_{t,top/bot} = 15^\circ / \beta_{t,side} = 22.4^\circ$  at  $\alpha = 0^\circ$ .



- Centerline top
- $y/Y = 0.50$  top
- ◇  $y/Y = 0.75$  top
- △  $y/Y = 0.875$  top
- ▵ Top/Side corner
- ▷  $z/Z = 0.50$  side
- ◻ Centerline side

- Centerline top
- $y/Y = 0.25$  top
- ◇  $y/Y = 0.50$  top
- △  $y/Y = 0.75$  top
- ▵ Top/Side corner
- ▷  $z/Z = 0.50$  side
- ◻ Centerline side

Nozzle 8: 1-in. corner radius

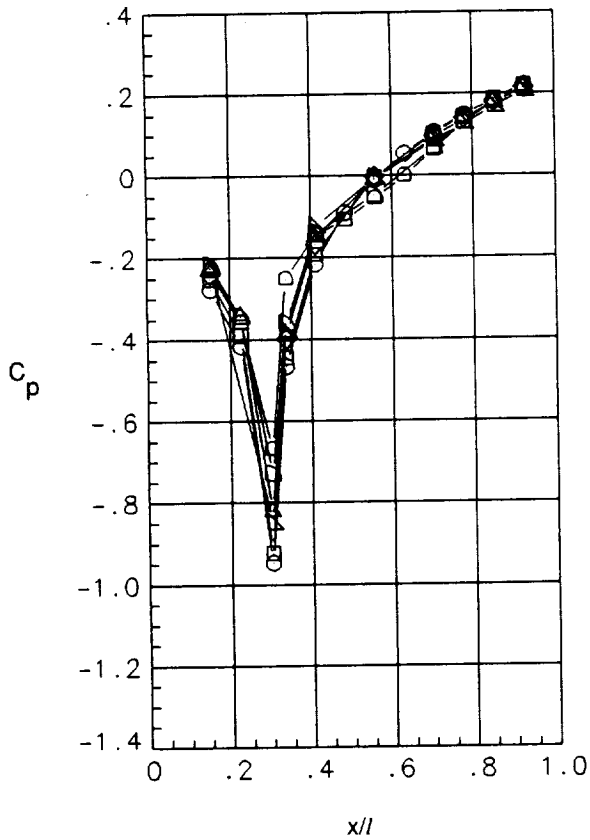

Nozzle 12: 2-in. corner radius

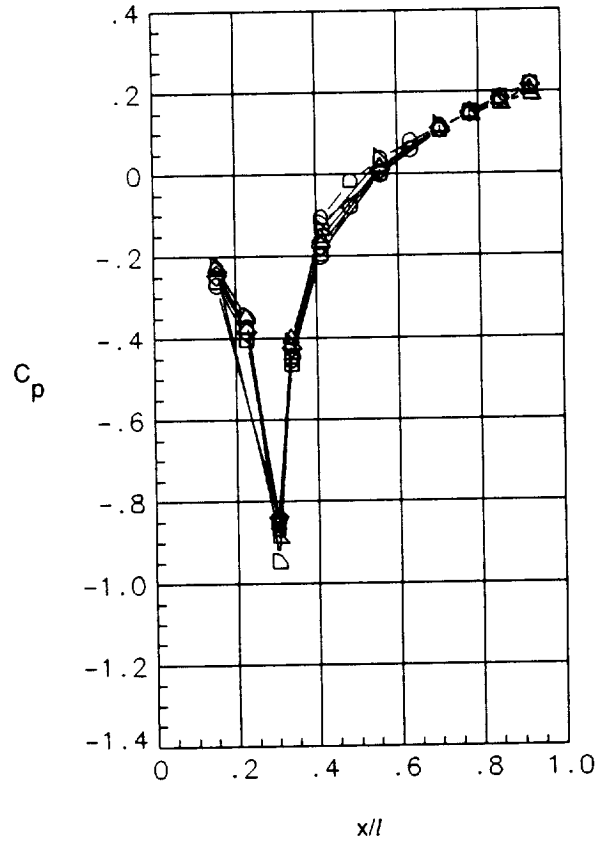

(b) Pressure distributions at  $M_\infty = 0.6$ .

Figure 12. Continued.

- Centerline top
- $y/Y = 0.50$  top
- ◇  $y/Y = 0.75$  top
- △  $y/Y = 0.875$  top
- ▵ Top/Side corner
- ▷  $z/Z = 0.50$  side
- ◻ Centerline side

- Centerline top
- $y/Y = 0.25$  top
- ◇  $y/Y = 0.50$  top
- △  $y/Y = 0.75$  top
- ▵ Top/Side corner
- ▷  $z/Z = 0.50$  side
- ◻ Centerline side

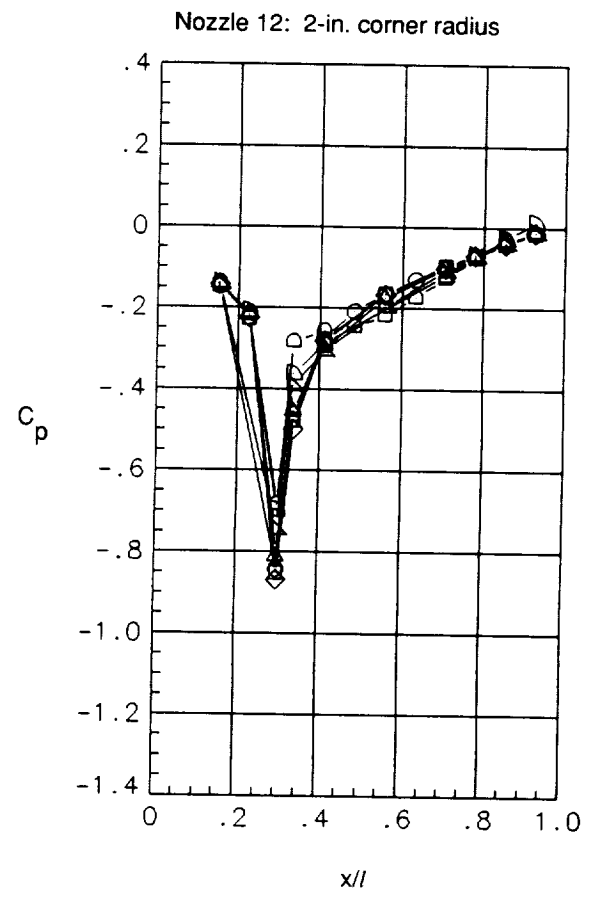
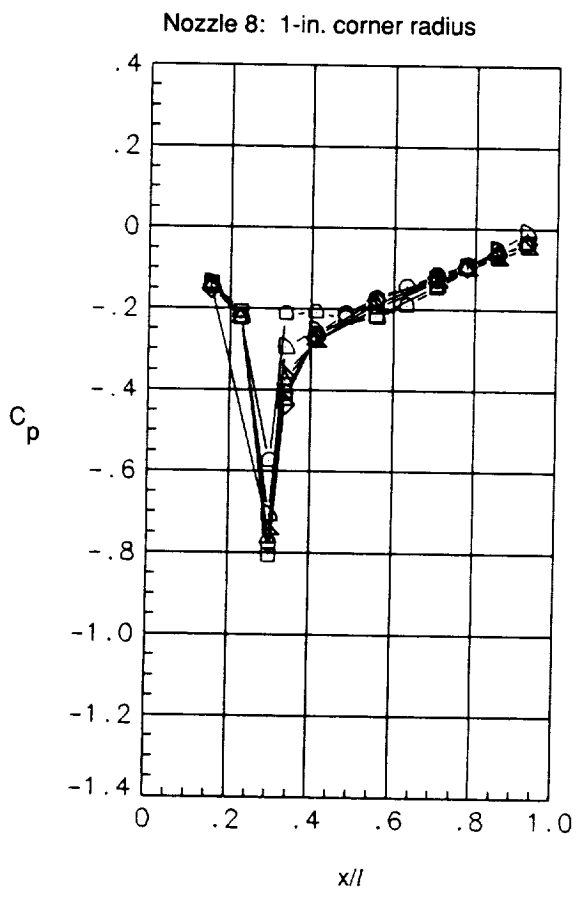

(c) Pressure distributions at  $M_\infty = 0.9$ .

Figure 12. Concluded.

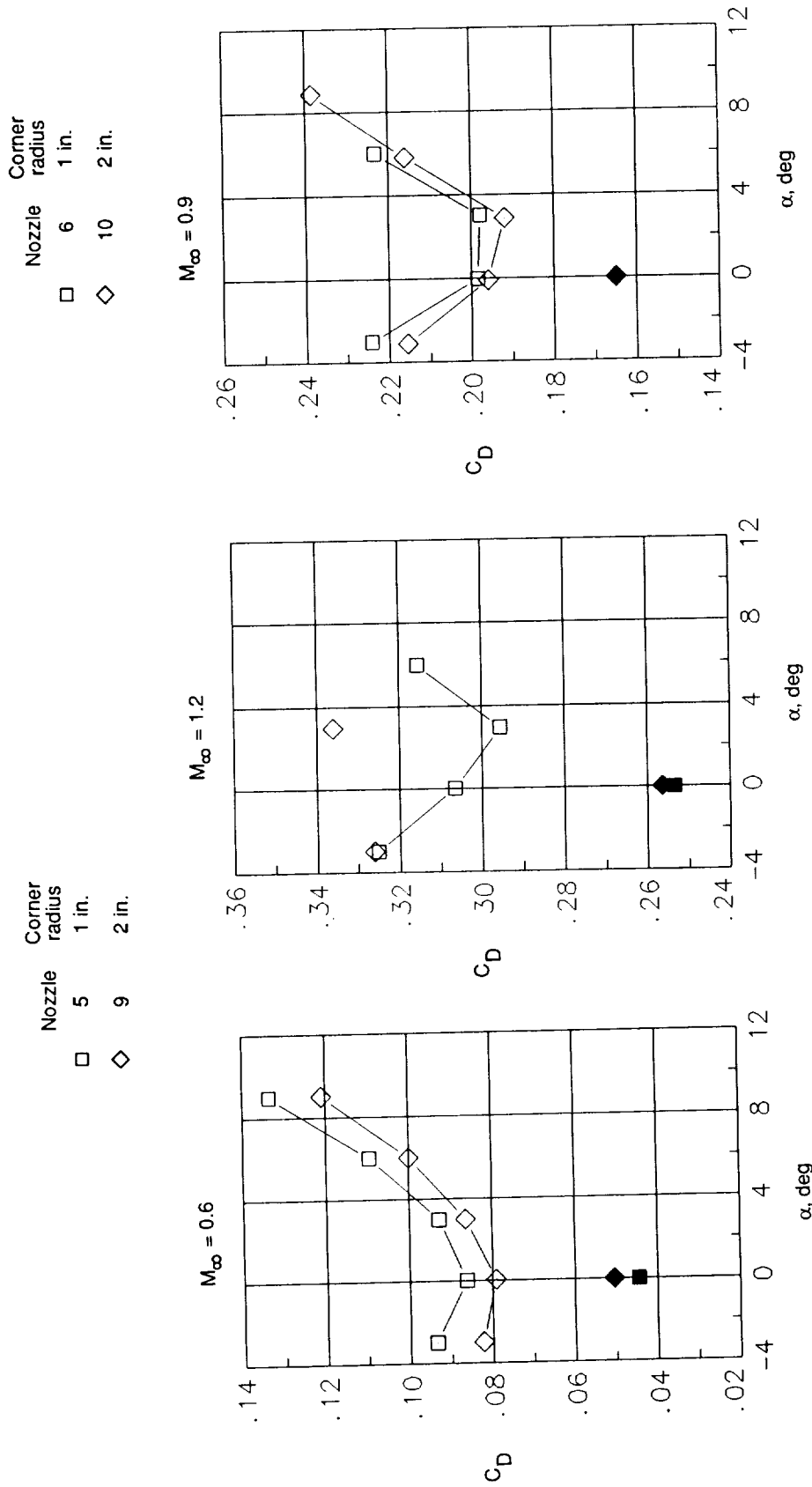

(a) Nozzle with  $\beta_{t,top}/\beta_{t,bot} = 17.9^\circ$ ,  $\beta_{t,side} = 0^\circ$ .  
 (b) Nozzles with  $\beta_{t,top}/\beta_{t,bot} = 17.3^\circ$ ,  $\beta_{t,side} = 9.7^\circ$ .

Figure 13. Effect of corner radius on afterbody drag. Open symbols denote plume off; solid symbols denote plume on.

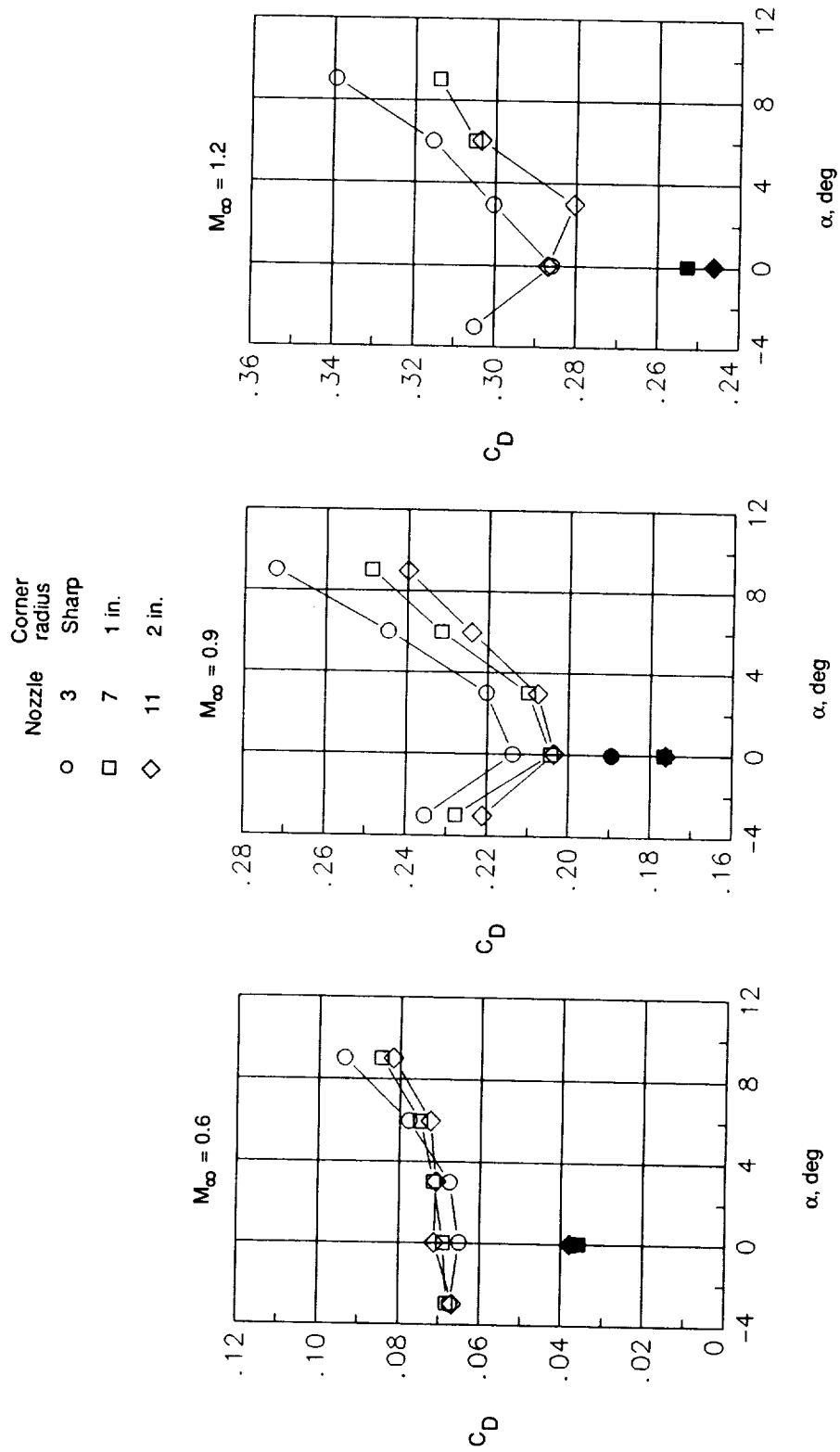

(c) Nozzles with  $\beta_{t,top}/bot = \beta_{t,side} = 16.4^\circ$ .

Figure 13. Continued.

Nozzle  
 radius  
 8 1 in.  
 12 2 in.

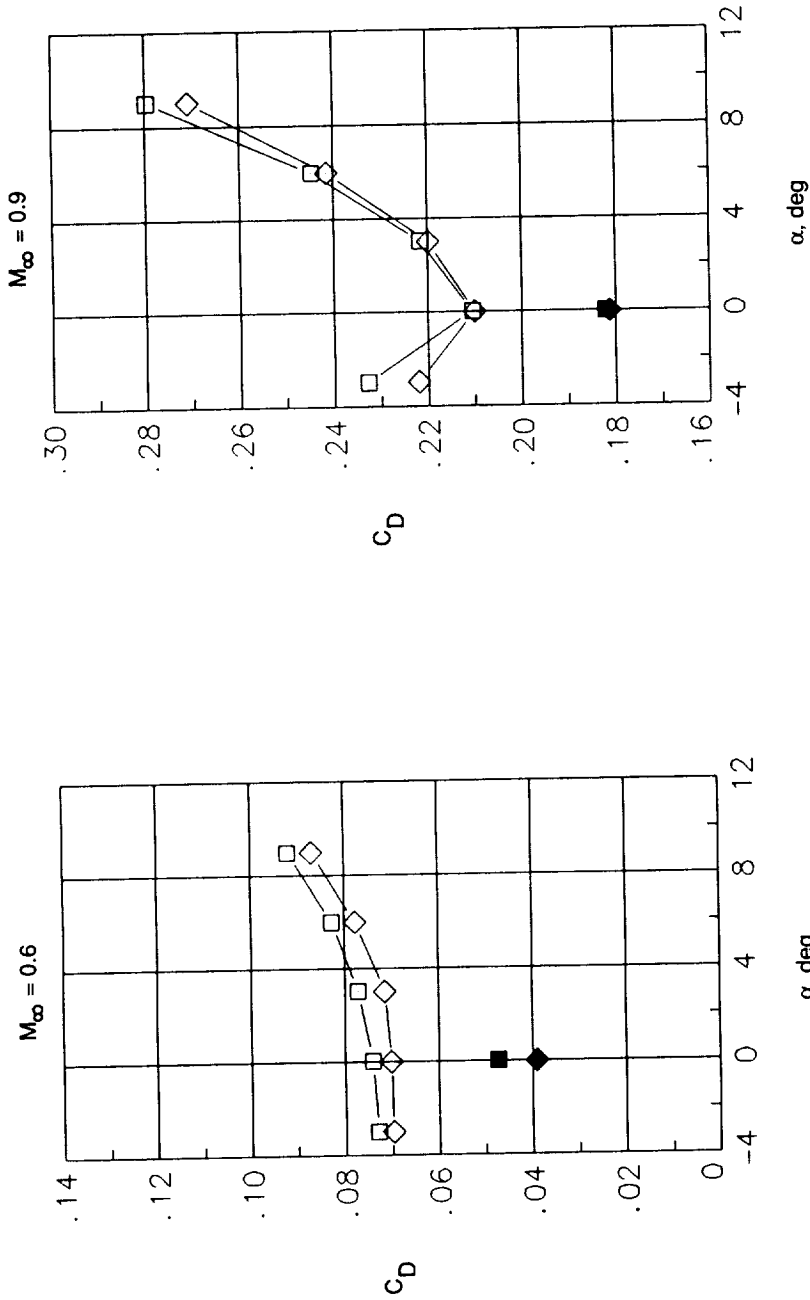

(d) Nozzles with  $\beta_{t,top/bot} = 15.0^\circ$  and  $\beta_{t,side} = 22.4^\circ$ .

Figure 13. Concluded.

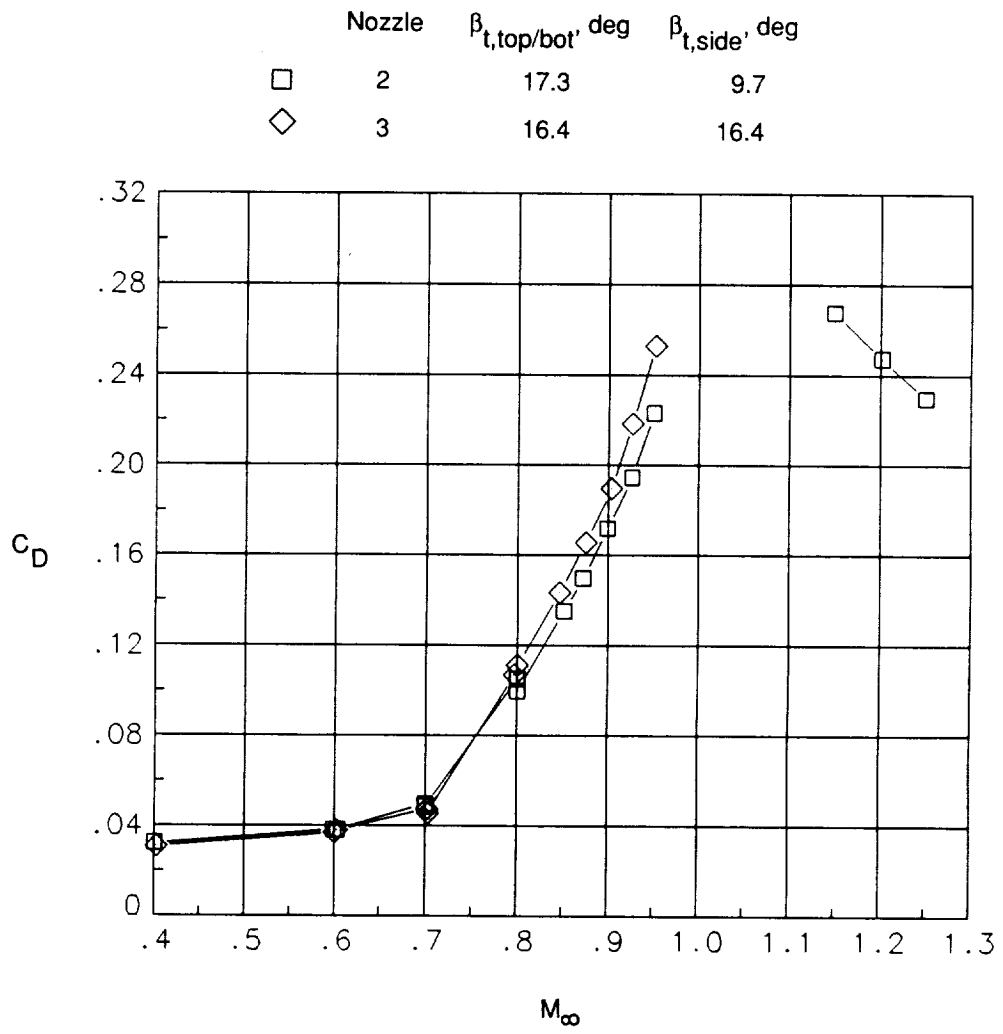

(a) Afterbody drag plume on.

Figure 14. Effect of closure distribution on nozzles with sharp corner at  $\alpha = 0^\circ$ .

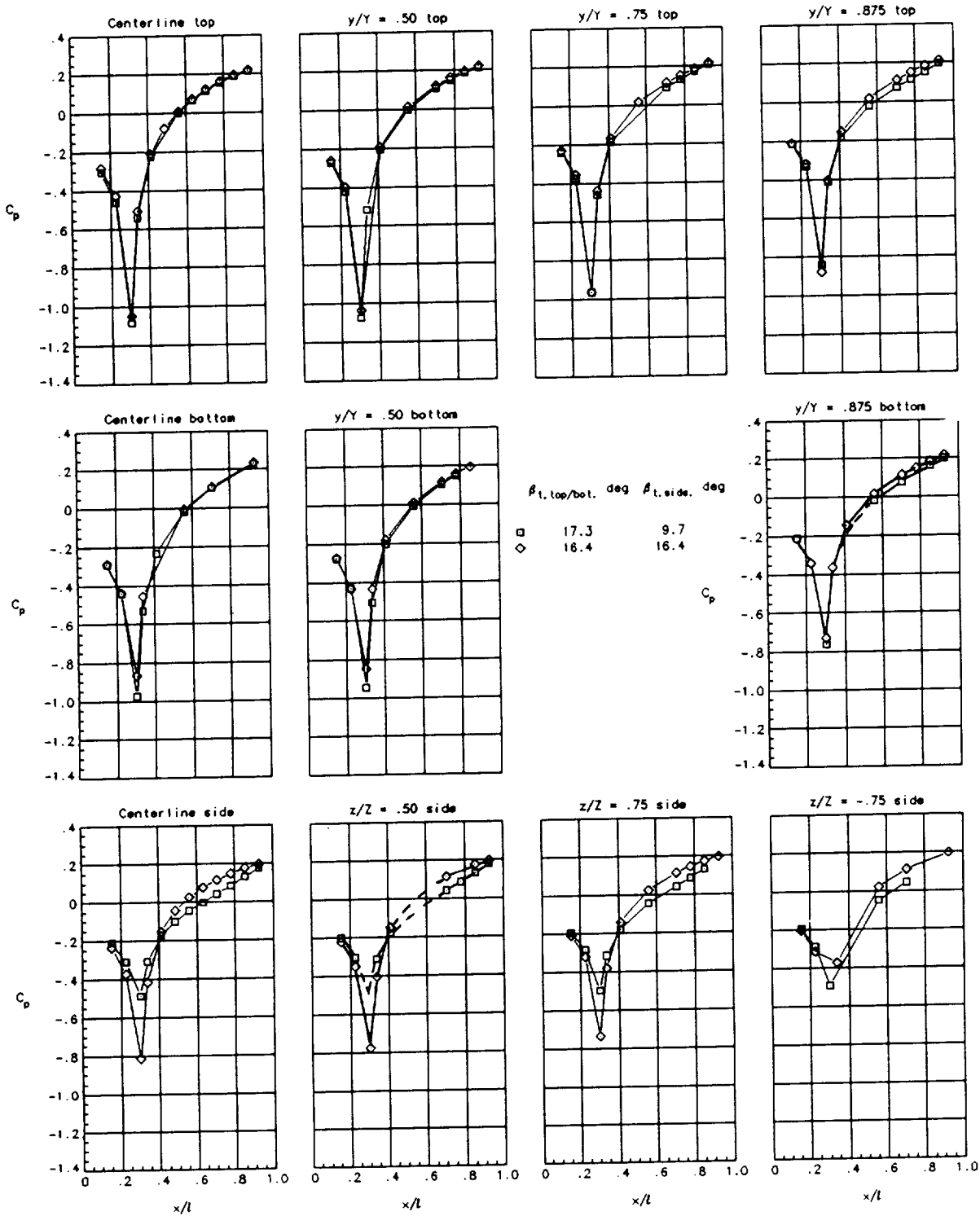

(b) Pressure distributions at  $M_\infty = 0.6$ .

Figure 14. Continued.

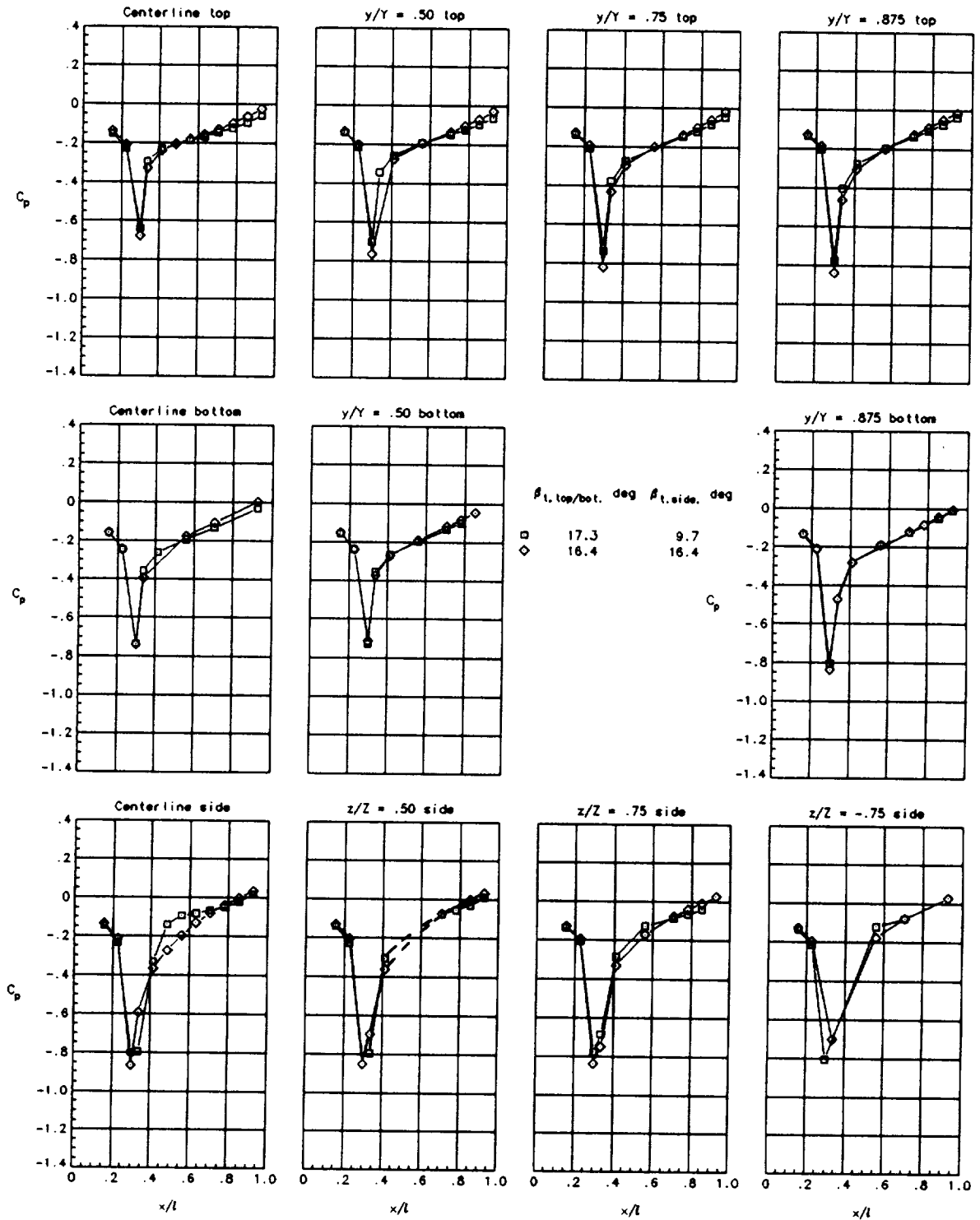

(c) Pressure distributions at  $M_\infty = 0.9$ .

Figure 14. Concluded.



	Nozzle	$\beta_{t,top/bot}$ , deg	$\beta_{t,side}$ , deg
○	5	17.9	0
□	7	16.4	16.4
◇	8	15.0	22.4

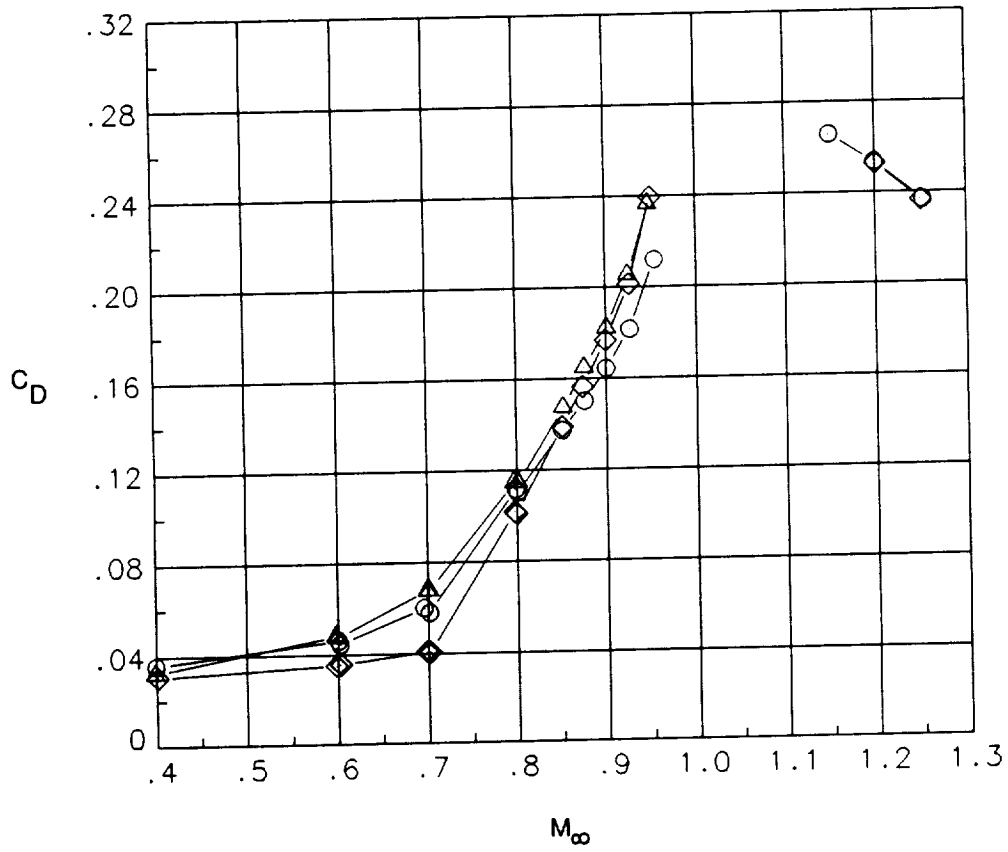

(a) Afterbody drag with plume on.

Figure 15. Effect of closure distribution on nozzles with 1-in. corner radius at  $\alpha = 0^\circ$ .

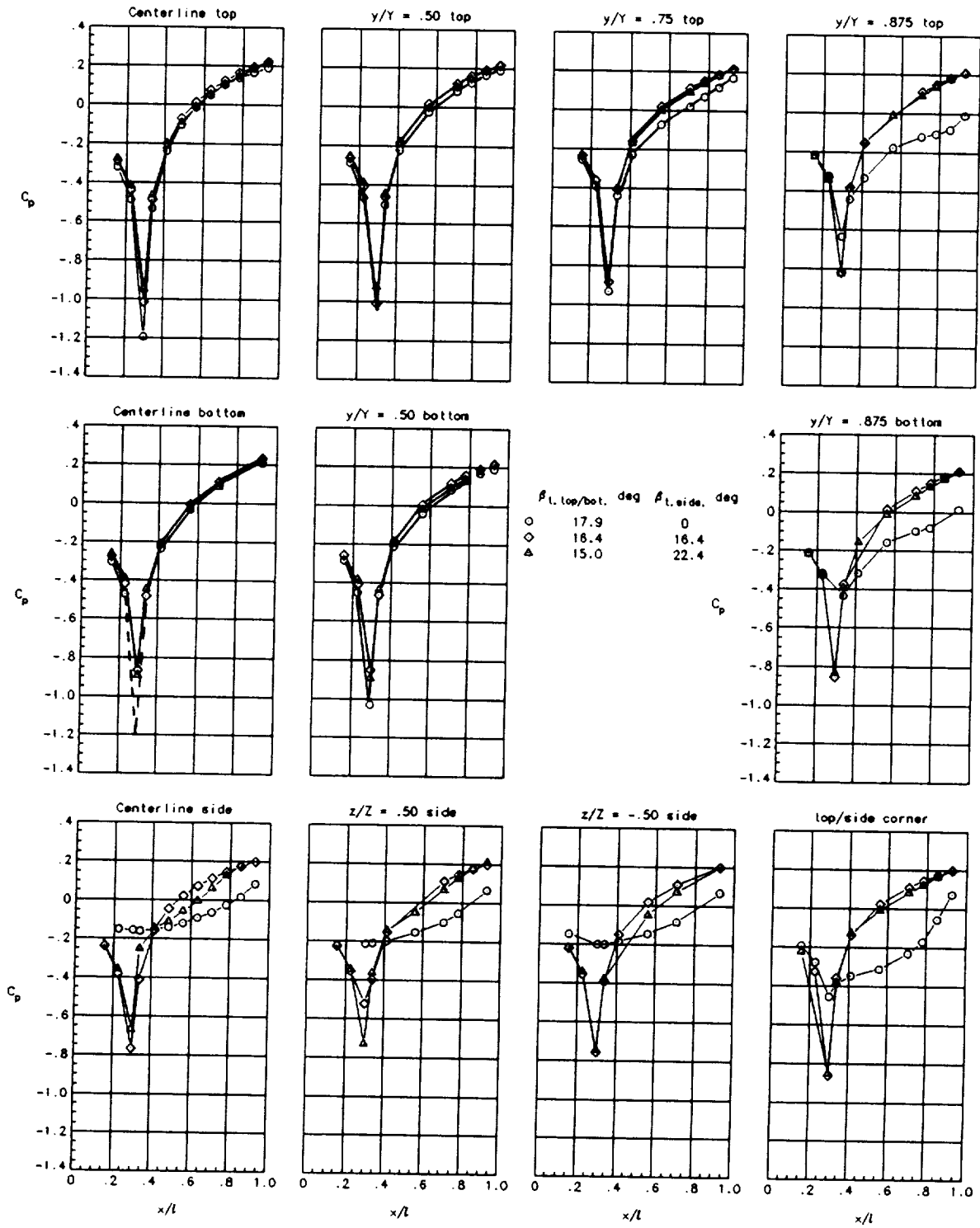

(b) Pressure distributions at  $M_\infty = 0.6$ .

Figure 15. Continued.

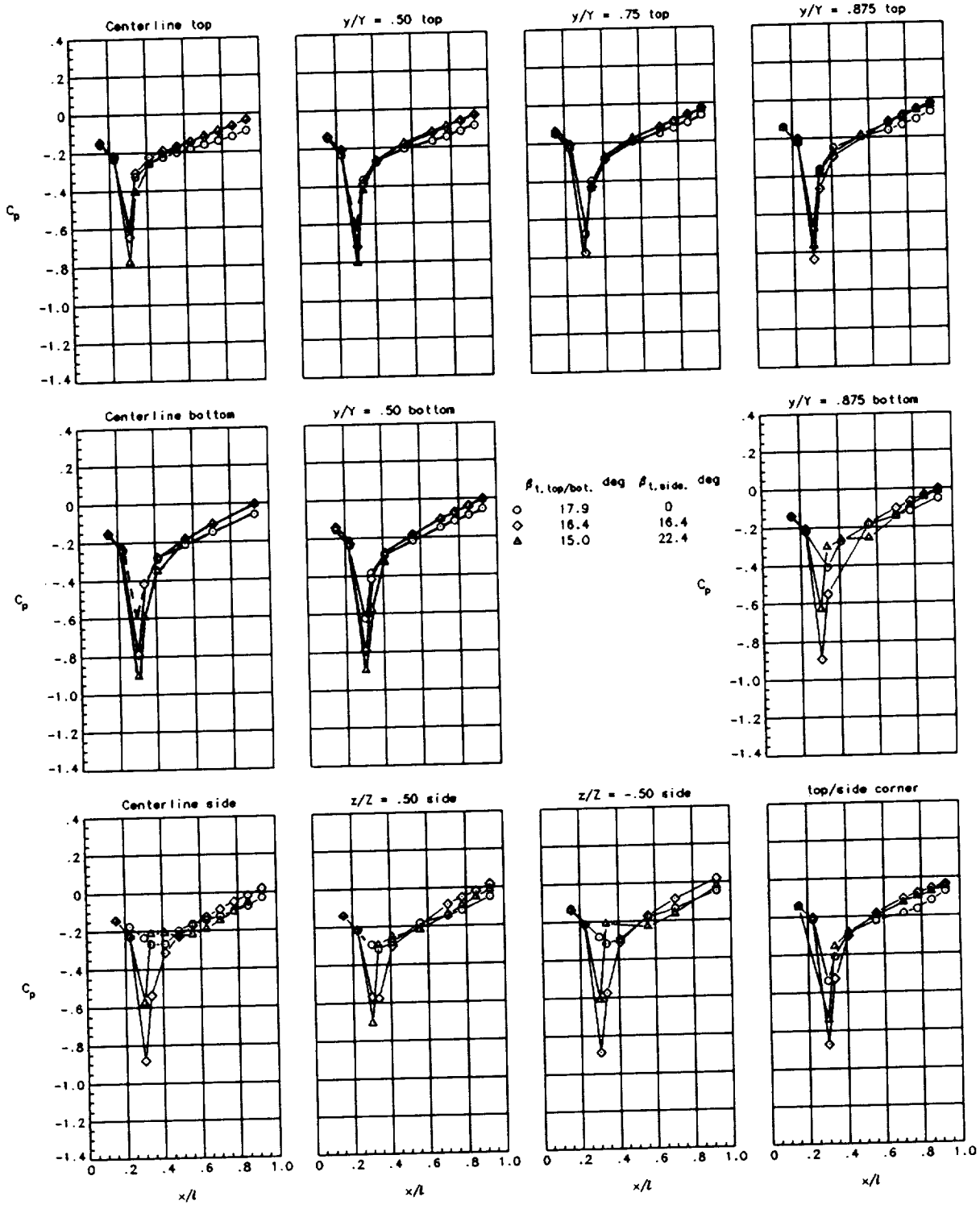

(c) Pressure distributions at  $M_\infty = 0.9$ .

Figure 15. Continued.

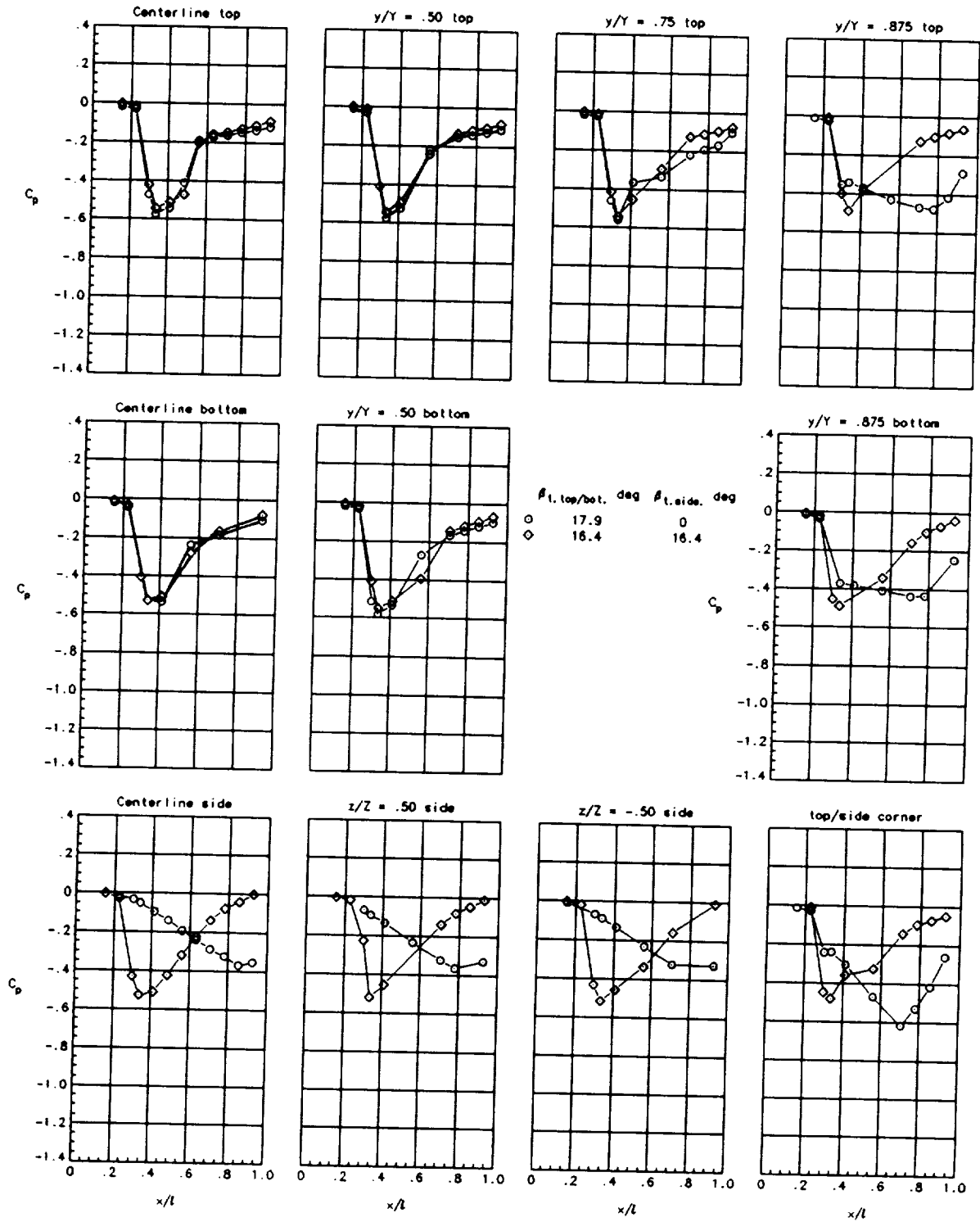

(d) Pressure distributions at  $M_\infty = 1.2$ .

Figure 15. Concluded.

	Nozzle	$\beta_{t,top/bot}$ , deg	$\beta_{t,side}$ , deg
○	9	17.9	0
□	10	17.3	9.7
◇	11	16.4	16.4
△	12	15.0	22.4

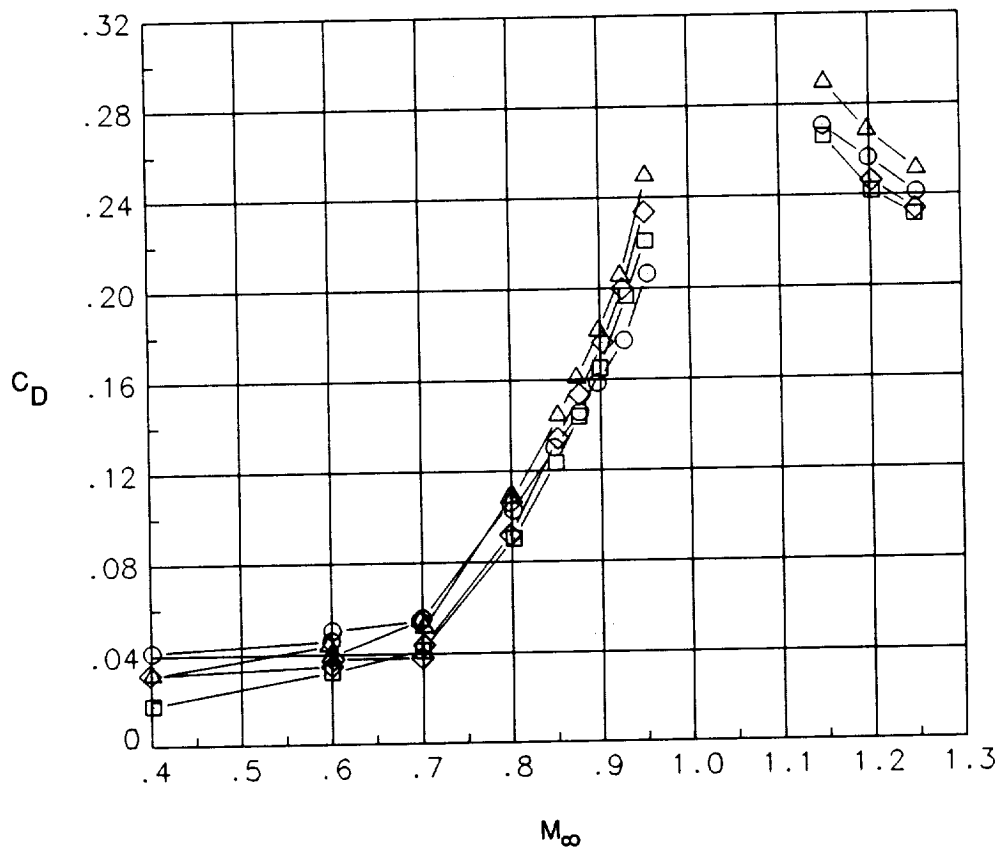

(a) Afterbody drag with plume on.

Figure 16. Effect of closure distribution on nozzles with 2-in. corner radius at  $\alpha = 0^\circ$ .

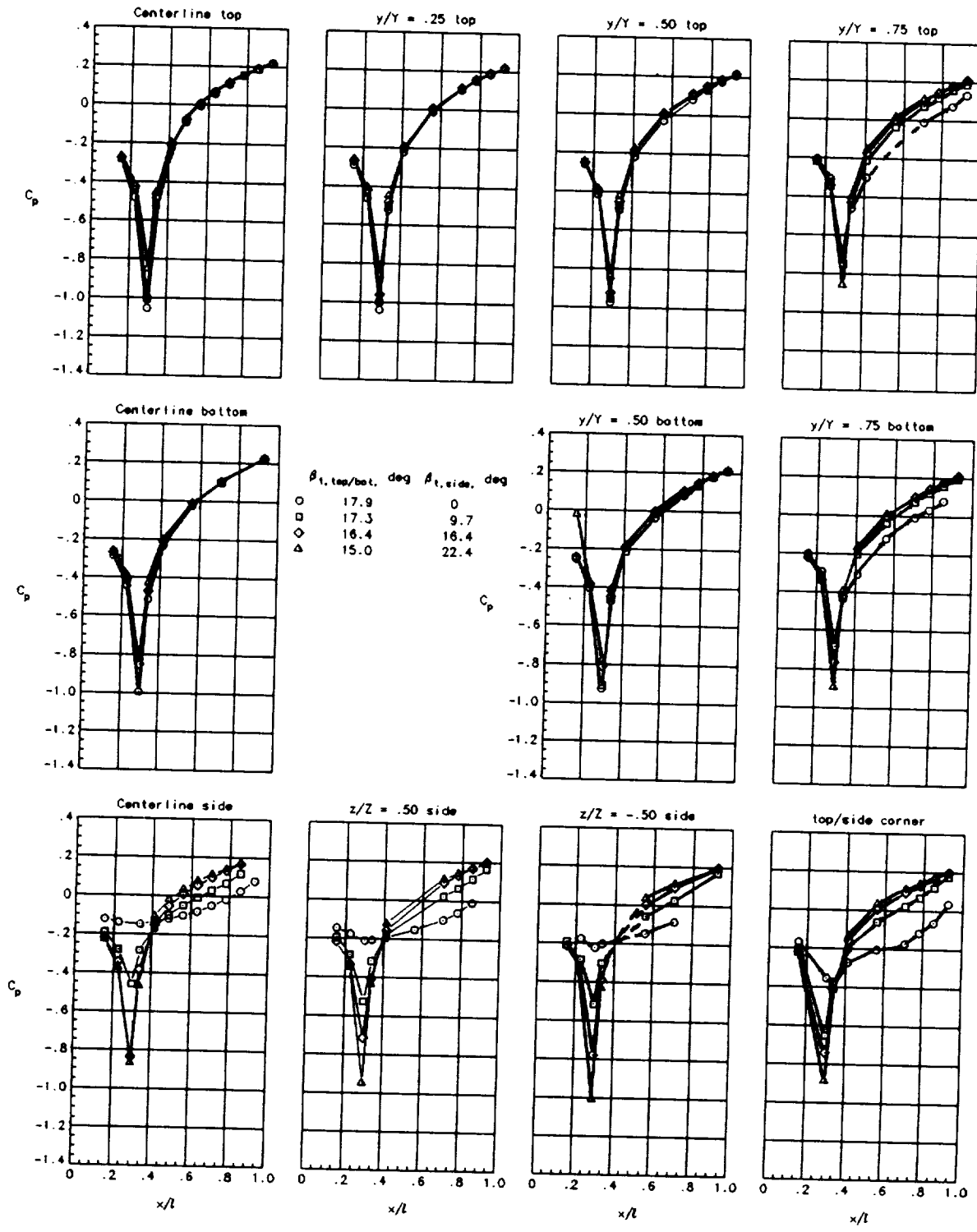

(b) Pressure distributions at  $M_\infty = 0.6$ .

Figure 16. Continued.

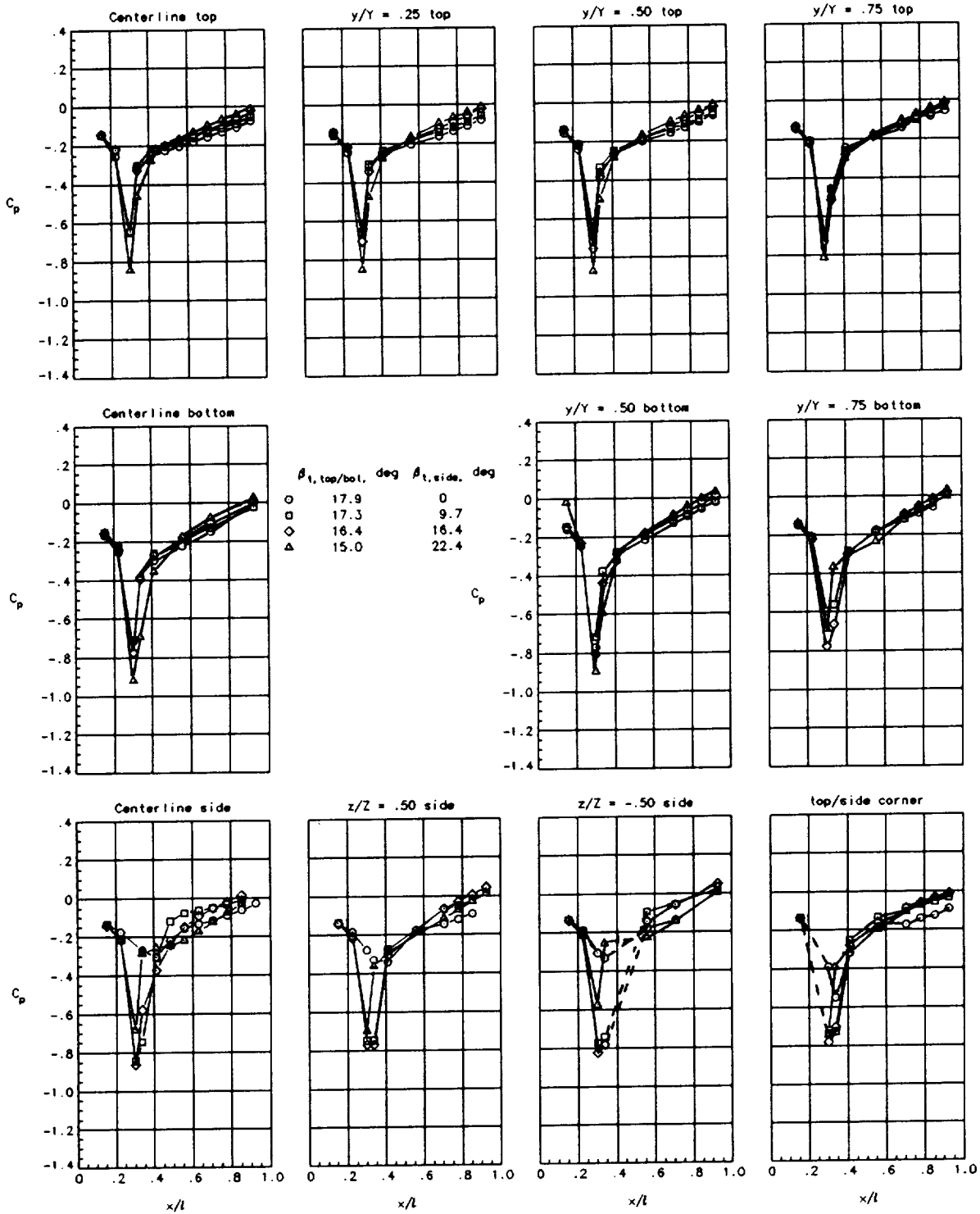

(c) Pressure distributions at  $M_\infty = 0.9$ .

Figure 16. Continued.

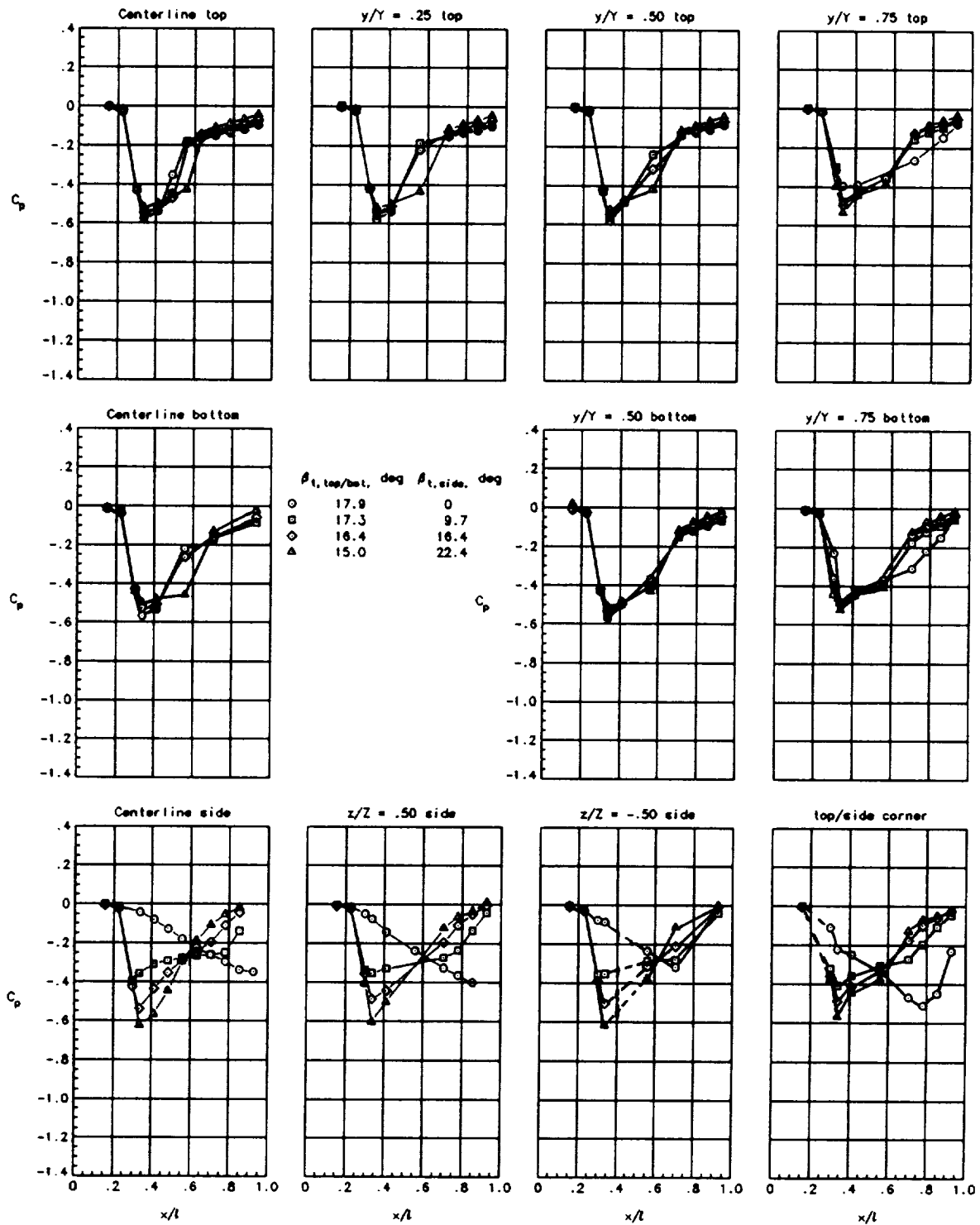

(d) Pressure distributions at  $M_\infty = 1.2$ .

Figure 16. Concluded.



Nozzle	$\beta_{t,top/bot}$ ' deg	$\beta_{t,side}$ ' deg
○	5	17.9
□	6	17.3
◇	7	16.4
△	8	15.0
		0
		9.7
		16.4
		22.4

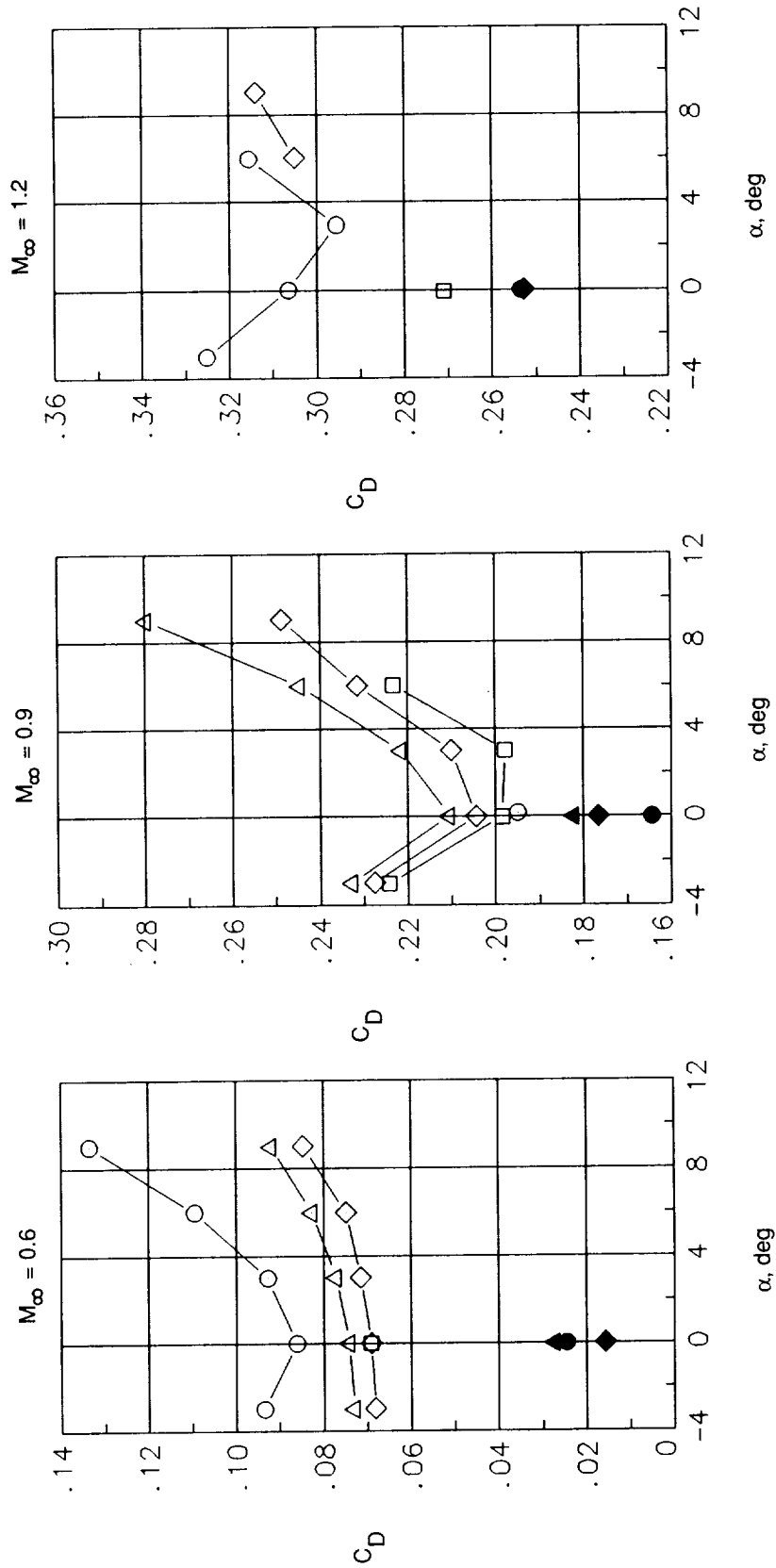

(a) Nozzles with 1-in. corner radius.

Figure 17. Effect of closure distribution on afterbody drag. Open symbols denote plume off; solid symbols denote plume on.

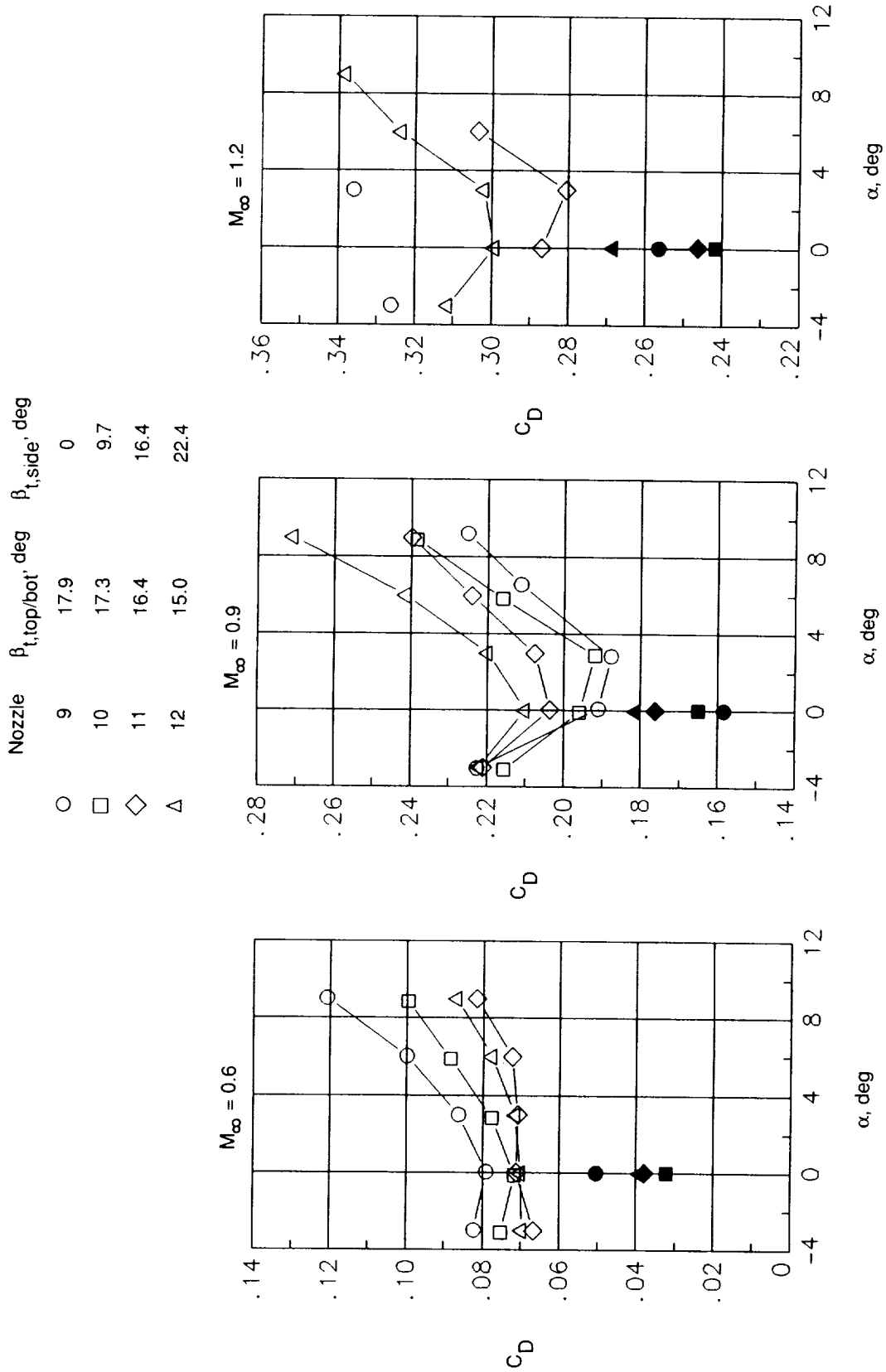

(b) Nozzles with 2-in. corner radius.

Figure 17. Concluded.







REPORT DOCUMENTATION PAGE			Form Approved OMB No. 0704-0188	
Public reporting burden for this collection of information is estimated to average 1 hour per response, including the time for reviewing instructions, searching existing data sources, gathering and maintaining the data needed, and completing and reviewing the collection of information. Send comments regarding this burden estimate or any other aspect of this collection of information, including suggestions for reducing this burden, to Washington Headquarters Services, Directorate for Information Operations and Reports, 1215 Jefferson Davis Highway, Suite 1204, Arlington, VA 22202-4302, and to the Office of Management and Budget, Paperwork Reduction Project (0704-0188), Washington, DC 20503.				
1. AGENCY USE ONLY (Leave blank)	2. REPORT DATE September 1992	3. REPORT TYPE AND DATES COVERED Technical Paper		
4. TITLE AND SUBTITLE Effect of Afterbody Geometry on Aerodynamic Characteristics of Isolated Nonaxisymmetric Afterbodies at Transonic Mach Numbers			5. FUNDING NUMBERS WU 505-62-30-01	
6. AUTHOR(S) Linda S. Bangert and George T. Carson, Jr.				
7. PERFORMING ORGANIZATION NAME(S) AND ADDRESS(ES) NASA Langley Research Center Hampton, VA 23681-0001			8. PERFORMING ORGANIZATION REPORT NUMBER L-17034	
9. SPONSORING/MONITORING AGENCY NAME(S) AND ADDRESS(ES) National Aeronautics and Space Administration Washington, DC 20546-0001			10. SPONSORING/MONITORING AGENCY REPORT NUMBER NASA TP-3236	
11. SUPPLEMENTARY NOTES				
12a. DISTRIBUTION/AVAILABILITY STATEMENT Unclassified Unlimited Subject Category 02			12b. DISTRIBUTION CODE	
13. ABSTRACT (Maximum 200 words) A parametric study has been conducted in the Langley 16-Foot Transonic Tunnel on an isolated nonaxisymmetric fuselage model that simulates a twin-engine fighter. The effects of aft-end closure distribution (top/bottom nozzle-flap boattail angle versus nozzle-sidewall boattail angle) and afterbody and nozzle corner treatment (sharp or radius) were investigated. Four different closure distributions with three different corner radii were tested. Tests were conducted over a range of Mach numbers from 0.40 to 1.25 and over a range of angles of attack from $-3^\circ$ to $9^\circ$ . Solid plume simulators were used to simulate the jet exhaust. For a given closure distribution in the range of Mach numbers tested, the sharp-corner nozzles generally had the highest drag and the 2-in. corner-radius nozzles generally had the lowest drag. The effect of closure distribution on afterbody drag was highly dependent on configuration and flight condition.				
14. SUBJECT TERMS Nonaxisymmetric afterbodies; Afterbody drag; Boattail drag			15. NUMBER OF PAGES 263	
			16. PRICE CODE A12	
17. SECURITY CLASSIFICATION OF REPORT Unclassified	18. SECURITY CLASSIFICATION OF THIS PAGE Unclassified	19. SECURITY CLASSIFICATION OF ABSTRACT	20. LIMITATION OF ABSTRACT	

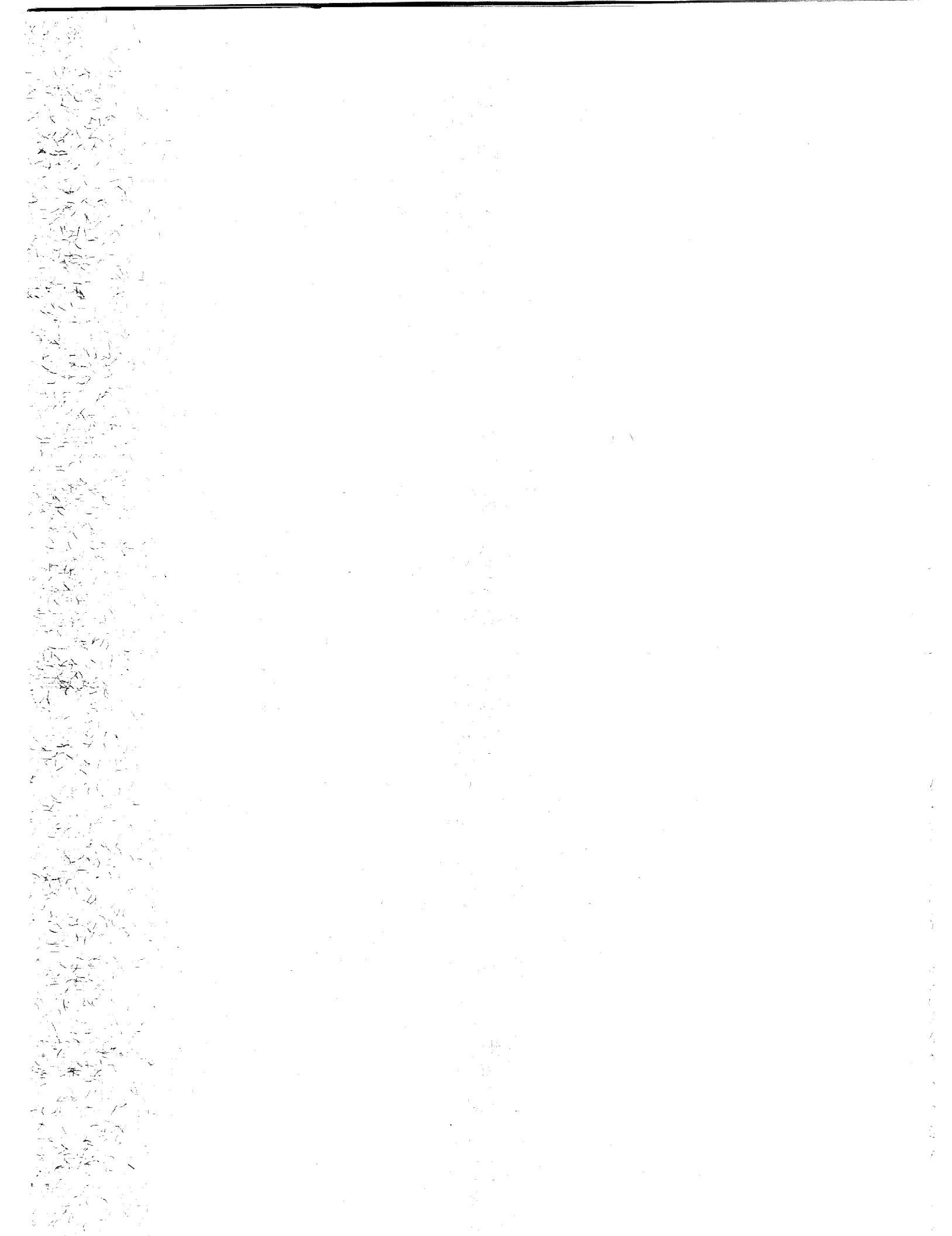

National Aeronautics and  
Space Administration  
Code JTT  
Washington, D.C.  
20546-0001  
Official Business  
Penalty for Private Use, \$300



National Aeronautics and  
Space Administration

Washington, D.C. **SPECIAL FOURTH CLASS MAIL**  
20546 **BOOK**

Postage and Fees Paid  
National Aeronautics and  
Space Administration  
NASA-451

Official Business  
Penalty for Private Use \$300



LI 001 TP-3236 9209283090569A  
NASA  
CENTER FOR AEROSPACE INFORMATION  
ACCESSIONING  
P O BOX 8757 BWI AIRPRT  
BALTIMORE MD 21240



POSTMASTER: If Undeliverable, please see  
Postal Manual for Mail Return