

N93-11956

CONTACT DETECTION AND CONTACT MOTION FOR ERROR RECOVERY IN THE PRESENCE OF UNCERTAINTIES

Jing Xiao

Computer Science Department
University of North Carolina at Charlotte
Charlotte, NC 28223
E-mail: xiao@unccvax.uncc.edu

Abstract

Due to various kinds of uncertainties, a robot motion may fail and result in some unintended contact between the object held by the robot and the environment, which greatly hampers robotics applications on tasks with high-precision requirement, such as assembly tasks. Aiming at automatically recovering a robotic task from such a failure, this paper discusses, in the presence of uncertainties, contact detection based on contact motion for recovery. It presents a framework for on-line recognizing contacts using multiple sensor modalities in the presence of sensing uncertainties and means for ensuring successful compliant motions in the presence of sensing and control uncertainties.

1 Introduction

The issue of detecting and recovering errors of robot actions due to uncertainties (e.g., mechanical, control, modeling, manufacturing, and sensing uncertainties) is crucial for robotics applications on tasks with high-precision requirement, such as assembly tasks. Since errors of a robot action almost always lead to some unintended collisions between the object moved by the robot and some other objects, on-line recognition of those collisions or contacts is extremely important to recovery strategies. On the other hand, recovery motions are usually preferred to be contact motions, i.e., compliant motions, in order to reduce the effect of uncertainties via the physical constraints among objects.

The contact detection problem not only requires sensing and sensor-based reasoning but also demands them in greater precision with sensing uncertainties being taken into account. Fig. 1 shows an example to illustrate this. A robot is used to perform the peg-in-hole task as depicted in Fig. 1a. Due to uncertainties, the peg may hit somewhere other than the desired goal, as in the two cases shown in Fig. 1b and c, respectively. If the peg in Fig. 1c only leans very slightly towards the wall, then the contact may not be distinguishable from the one in Fig. 1b due to sensing uncertainties (e.g., position/orientation sensing uncertainties). Nevertheless, the recovery strategies for the two cases

should be different. The recovery motion for the case in Fig. 1b can simply be a compliant translation, while for the case in Fig. 1c, the recovery motion should also involve rotation. Thus, the two cases have to be distinguished. On the other hand, not all the details about a contact are important to recovery motions. For example, the cases shown in Fig. 1b, Fig. 1d, and Fig. 1e are different in terms of the relative locations of the objects in contact and the precise topological relationships among the surface elements of those objects. Nevertheless, the recovery motions of those contacts may follow the same strategy — a compliant translation along the surface of contact towards the hole.

The research directly targeted to contact detection in the presence of uncertainties can be found in the work by Desai et al.[3, 4] and by Spreng[6]. Both approaches are of hypotheses-and-tests kind, i.e., testing the validity of certain contact hypotheses to obtain the correct contact information. Desai's method, in particular, first assumed a set of possible contact formations (between two objects), and then used force/moment equilibrium conditions with the force/moment sensory data to eliminate certain contact formations. However, the key problem of how to obtain the contact hypotheses (i.e., initial contact formations) remains intact. Spreng's method used position/orientation sensing data to hypothesize about a contact in terms of motion freedoms and test motions for verification. The method, however, seems to be limited to 2D cases. Moreover, the use of test motions may cause new failures and further complicate the situation.

Although recovery motions are apt to be compliant to be less sensitive to uncertainties, the effect of uncertainties must still be taken into account in order to ensure successful implementations of the desired compliant motions. For example, in order to push the object in Fig. 2a along the surface successfully, the applied force must be in proper direction (w.r.t. the normal \mathbf{N} of the surface) and magnitude to overcome the friction as well as to keep the object always in contact with the surface. This, however, has to be achieved in the presence of the orientation sensing uncertainty in \mathbf{N} , the force/moment sensing uncertainty, and the modeling/control uncertainty in the force controller. So far the problem has not been addressed in the literature.

2 Contacts and Assumptions

Since the contact detection problem mainly deals with unexpected *interactions* between the object held by a robot and the environment which, in most cases, is known approximately, we can assume that the environment is *fixed* in the sense that all parts or fixtures in the environment are pre-known; only the collisions between the held part and other parts can be unexpected. Thus, the problem can take advantage of a relatively stable and known environment in contrast to a robot navigation problem. We can also assume that the objects involved in an unexpected collision (i.e., the held object and some fixed objects in the environment) are in a static state, provided that there are force/moment guards to stop a robot motion once a collision occurs.

Now the concern is what kind of contact information will be needed in providing enough aid to the planning of recovery motions. From the example shown in Fig. 1, one can see that the detection of contact surfaces is surely important since they constitute the constraining surfaces for the compliant recovery motion. In addition, the basic topological formation of contact also matters since different formations may require different courses of recovery motion even if the contact surfaces are the same (as shown by the two contact cases in Fig. 1b and Fig. 1c). However, not all the details in the formation of a contact are important to recovery motions (e.g., the cases shown in Fig. 1b, Fig. 1d, and Fig. 1e share the same kind of recovery motion). Thus, we will introduce the concepts of contact which both facilitate detection and meet the need of recovery planning.

We will use the following topological exterior-elements of objects: faces, edges, and vertices in our descriptions. We define a *face* as a closed surface, i.e., a surface and its boundaries, and an *edge* as a closed edge line, i.e., an edge line and its boundary points¹. Clearly, the exterior of a finite solid consists of finite faces with shared boundaries (among two or more faces). The boundaries of a face consist of edges, and the boundaries of an edge consist of (two) vertices. We say *two topological elements touch* iff the *interior* region of the two elements touch. Thus, we don't think that an edge touches a face if only a boundary point of the edge (i.e., a vertex) touches the face, and instead, we say that a vertex touches a face.

We now define a *principal contact* (PC) between two faces as one of the following: face-face (f-f), face-edge or edge-face (f-e or e-f), face-vertex or vertex-face (f-v or v-f), edge-cross (e-cross), edge-touch (e-touch), edge-vertex or vertex-edge (e-v or v-e), vertex-vertex (v-v) (Fig. 3), such that if there are more than one pair of topological elements (from the two faces respectively) that touch each other, the PC is determined by the pair in which the two topological elements are not the boundaries of the topological elements (of their respective faces) in the other pairs in touch. Now a *contact formation* (CF) can be introduced to define a contact between two objects, as a set of PC's involved (e.g., $\{ \langle f_1^1, f_3^2 \rangle, \langle e_4^1, f_1^2 \rangle, \dots \}$)².

¹Formal definitions of *surfaces*, *edge lines*, and *vertex points* can be found in [10].

²This definition is quite different from that in [4, 3].

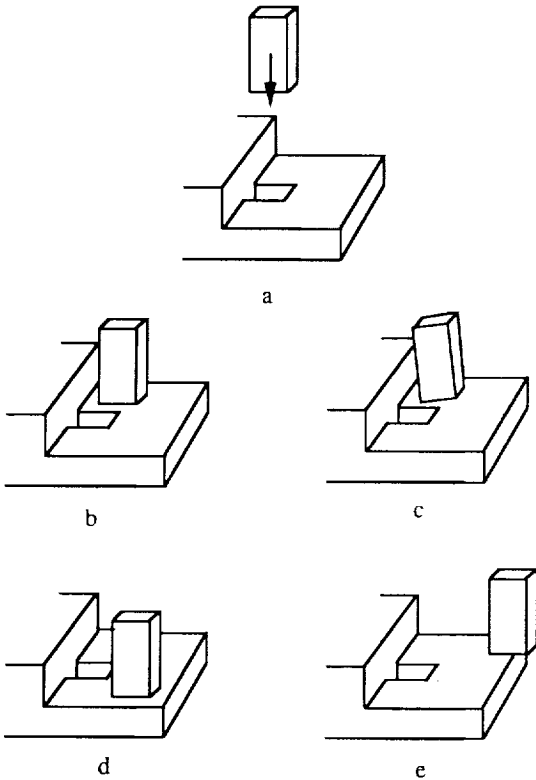

Figure 1: A Peg-in-Hole Example

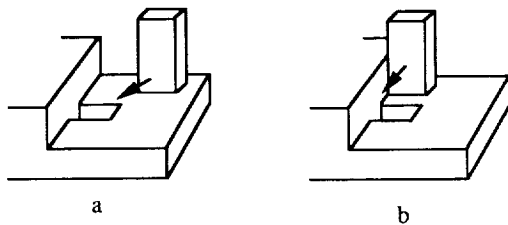

Figure 2: Compliant Translations

This paper will first discuss what kind of contact information is *enough* for planning recovery motions, an issue that has not been addressed in previous research, and define *recovery-oriented* concepts of contact. Then it will present a framework of using different sensors, especially position/orientation and vision sensors, to compensate each other in order to obtain the contact information of desired precision in spite of sensing uncertainties. It will also explain how to ensure the success of compliant motions by imposing proper force/moment constraints on the commanded force/moment applied to the held object (by the robot) and certain design constraints on the nominal and uncertainty parameters of the system.

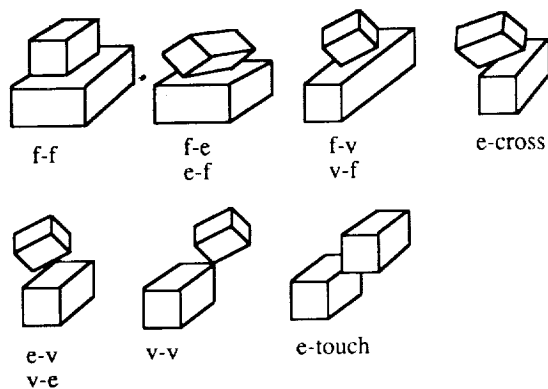

Figure 3: Principal Contacts between Two Faces

It is not difficult to observe that, for polyhedral objects, a PC of type f-f, f-e (or e-f), f-v (or v-f), or e-cross, involves only one *contact plane* (CP) — the tangent plane through the contact points determined by the principal contact. For non-polyhedral objects, a PC of type f-f, f-e (or e-f), f-v (or v-f), or e-cross, involves either a *contact surface* determined by the principal contact points or a *contact plane* tangent to the principal contact point(s).

It is, on the other hand, not generally proper to talk about a contact plane or surface for a PC of e-touch, e-v (or v-e), or v-v type, since there exists an infinite number of such contact planes or surfaces. However, PC's of types e-touch, e-v (or v-e), and v-v are rather purely mathematical concepts and rarely occur in reality due to their extremely unstable nature. Thus, we will not consider those types in this paper, assuming that they have zero probability of occurring. For simplicity, we will also restrict our discussion to polyhedral objects; thus *surfaces* are reduced to *planes* only, edge lines are reduced to *straight-lines*, and there is a *contact plane* associated with each PC.

3 Contact Detection

Let's consider an unexpected collision result in a contact between the object held by the robot obj_h and one fixed object. In principle, if the location of the held object can be sensed, then the contact formation can be deduced or derived from that sensed location, the boundary representations of both objects in the CAD model-base, and the pre-known location of the fixed object. However, in practice, the sensed location is often different from the actual location due to sensing uncertainty; thus, the contact formation derived can be wrong, or the derivation yields no contact at all. To solve the problem, our proposed strategy

is to first obtain all *possible* contact formations based on the current locations sensed about the two objects, taking into account position/orientation sensing uncertainties, and then to use vision sensing to reduce the set of contact formations and to obtain satisfactory information about the contact. Force/moment or other sensing methods can also be included in the system.

3.1 Position/Orientation Sensing

First, the fixed object can be identified fairly accurately based on the sensed location of obj_h , since the contact was due to the motion deviation of obj_h from a *preplanned* path³, and the deviation is generally small. Suppose the fixed object identified is obj_f . Then, the location of obj_f can be obtained from the pre-stored database. Let f_f , e_f , and v_f denote the face, edge, and vertex items of obj_f respectively, which are described with respect to the coordinate system of obj_f . Given the location of obj_f in the reference coordinate system of the workspace, i.e., the world coordinate system, those descriptions can then be easily transformed to be with respect to the world coordinate system. Similarly, let f_h , e_h , and v_h indicate the face, edge, and vertex items of obj_h , described in the coordinate system of obj_h . Based on the sensed location of obj_h in the world coordinate system, those descriptions can be transformed to be with respect to the world coordinate system.

Now we need to examine how the information of the given location of obj_f and the *sensed* location of obj_h can contribute to the detection of the contact formation between obj_f and obj_h . Let ϵ_p denote the *position sensing uncertainty*, such that for any point P , $\|P^a - P^s\| \leq \epsilon_p$, where P^a and P^s are the actual and the sensed positions of P . Let the angle ϵ_o denote the *orientation sensing uncertainty*, such that for any vector N , $\angle(N^a, N^s) \leq \epsilon_o$, where N^a and N^s are the actual and the sensed vectors. Obviously, the uncertainties ϵ_p and ϵ_o in the location of obj_h affect the descriptions of f_h , e_h , and v_h items in the world coordinate system and thus the determination of the spatial relationships between those surface elements of obj_h and the surface elements of obj_f . Fig. 4 gives an example showing the ambiguity in determining a PC due to ϵ_p and ϵ_o . It is not difficult to observe that while there are many possible PC's, the possible contact planes involved are fewer. In other words, contact planes are relatively robust and insensitive to position/orientation sensing uncertainties. Therefore, we use position/orientation sensing to reason about contact planes first. The objective is to determine all *possible* contact planes, and for each contact plane, all possible PC's that may contribute to it, based on the given location of obj_f , the sensed location of obj_h , and the position/orientation sensing uncertainties ϵ_p and ϵ_o .

The detection of possible contact planes can be done by checking the relationship between a face of obj_h and a face of obj_f for all possible pairs of such faces between the two objects. Consider a face f_h^i of obj_h and a face f_f^j of obj_f ,

³Therefore, the sequence of the objects adjacent to the path is known.

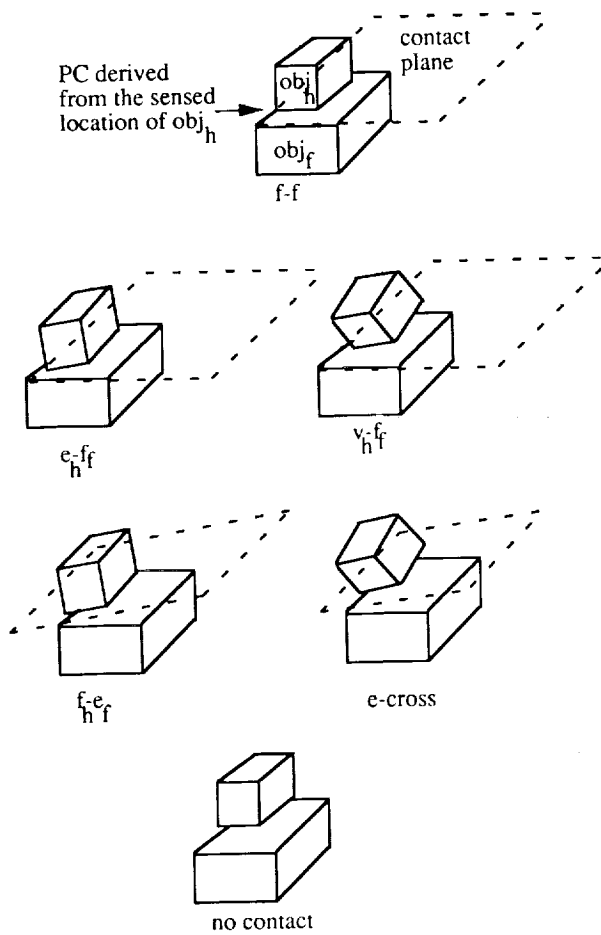

Figure 4: The Uncertainties in PC due to ϵ_p and ϵ_o

which lie on planes p_h^i and p_f^j respectively. If the projection of f_h^i on p_f^j possibly intersects f_f^j , taking into account ϵ_p and ϵ_o , then we can check if the minimum distance d_{min} between the sensed f_h^i and f_f^j is greater than ϵ_p or not. Fig. 5 shows examples of different spatial relationships between f_h^i and f_f^j and the corresponding d_{min} for each case. If $d_{min} > \epsilon_p$, we can conclude that there is no contact between f_h^i and f_f^j . Otherwise, there exists the possibility of a contact between f_h^i and f_f^j . The next step is to determine all the possible contact planes and PC's between the two faces. Our strategy is to construct models of all possible PC's by virtually (not physically) conducting the following operations on f_h^i and f_f^j :

- TOUCH — translate f_h^i (or f_f^j) along d_{min} a distance d_{min} to make f_h^i (or f_f^j) touch f_f^j (or f_h^i),
- TILT — tilt f_h^i (or f_f^j) about some axis on p_f^j coinciding an edge or vertex of f_h^i (or f_f^j).

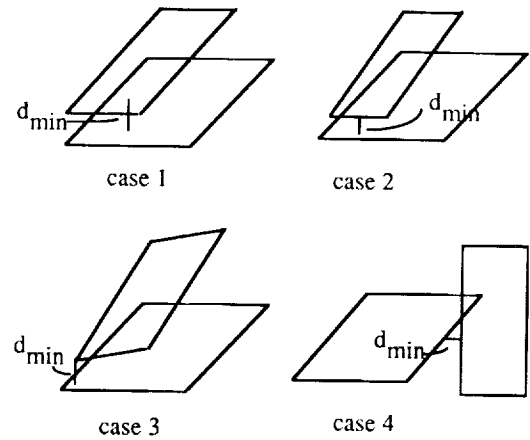

Figure 5: d_{min} between f_h^i and f_f^j

Specifically, if $d_{min} \leq \epsilon_p$, TOUCH will be conducted to make f_h^i contact f_f^j , and a PC can be determined by the orientations of f_h^i and f_f^j . The relationships between f_h^i and f_f^j can be distinguished in the following ways (Fig. 5):

1. $f_h^i \parallel f_f^j$;
2. case 1 does not hold, and some edge e of one face is on the plane of another face;
3. both 1 and 2 do not hold, and all vertices of one face are on the same side of the plane of the other face;
4. none of 1, 2 and 3 hold.

Based on which case holds, the PC can be of types f-f, e-f or f-e, f-v or v-f, and e-cross respectively.

Based on the result of TOUCH, which gives a contact plane and a PC, TILT can be applied to vary the orientations of f_h^i and f_f^j within the orientation sensing uncertainty bound ϵ_o so that other possible PC's and contact planes can be obtained. Fig. 6 shows some examples. Note that the fundamental issue about TILT is *how to tilt* in order to get all possible PC's. There are generally an infinite number of ways of tilting f_h^i or f_f^j with the variations of orientation maintained within the range of ϵ_o . However, since the variations can only result in a finite number of PC's, just such number of tiltings will be sufficient. The definition of TILT above reflects this observation. For example, if the initial PC is $\langle f_h^i, f_f^j \rangle$, we can tilt f_h^i or f_f^j along all its edges and each line through one of its vertices on the contact plane which is not collinear to the two edges forming the vertex; then we will obtain all possible e-f (or f-e) and v-f (or f-v) types of PCs. Based on each e-f (or f-e) PC, if the edge intersects an edge of the other face, then by tilting about the latter edge, a possible e-cross PC can be obtained.

By considering all possible face pairs between obj_h and obj_f in the way described, while trying to avoid or eliminate redundancy, the possible contact formations between obj_h and obj_f can be obtained. The final result would contain a set of possible contact planes (CP), and for each CP, a set of possible PC's that may result in the CP.

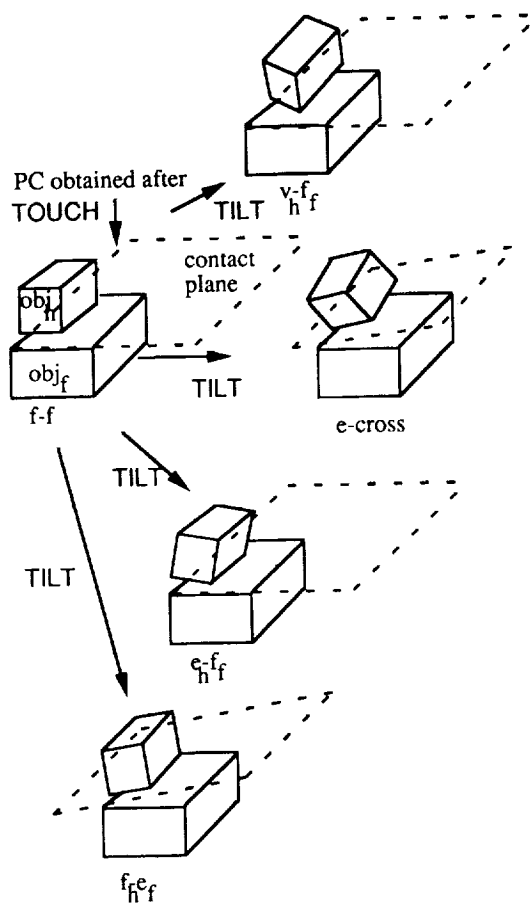

Figure 6: Possible PC's obtained by TILT

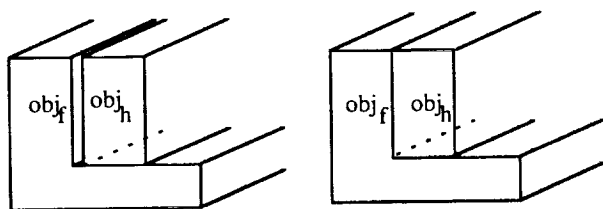

Figure 7: The Ambiguity in Contact Formation

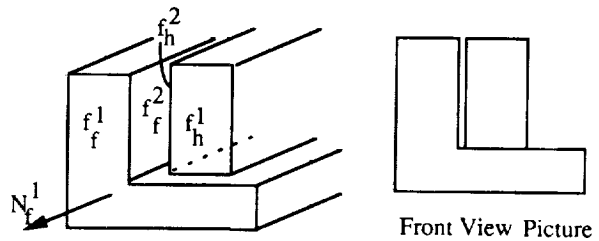

Figure 8: A Picture to Show if f_f^2 and f_h^2 Are in Contact

3.2 Vision Sensing

Using vision sensing to identify contacts is attractive in that the image information of a contact can convey most directly the *topological meaning* of the contact, i.e., the contact formation. As introduced previously, due to the position/orientation sensing uncertainties, it is difficult to determine whether a basic contact formation between obj_f and obj_h really exists given the location of obj_f and the sensed location of obj_h . For example, in Fig. 7, it is impossible to know which contact formation the contact is really in from position/orientation sensing only, if the horizontal distance between obj_f and obj_h is smaller than ϵ_p . By vision sensing, however, the problem could be solved *if certain picture(s) could be taken properly and reasoned effectively*. For example, if a picture can be taken from the direction opposite to the normal of f_f^1 , then whether f_f^2 and f_h^2 are in contact can be determined by checking whether f_f^2 touches f_h^2 in the image (Fig. 8). Obviously, the following issues are important in using vision:

- how to view the contact, i.e., how to place the camera and take a picture;
- how to separate the features of interest from the rest of the things in an image;
- how many different views should be taken in order to obtain sufficient information about a contact.

The information obtained from position/orientation sensing is essential for dealing with the above issues. Recall that from position/orientation sensing, all possible contact planes can be obtained and for each contact plane, all possible PC's that may contribute to the contact plane can also be obtained. This information not only defines the goal of vision sensing: to eliminate non-existing contact planes and the non-existing PC's, but also provides clues on how to do it.

To view a contact, pictures can be taken based on each contact plane and the associated PC's which are the result of processing position/orientation sensing data. We can assume that a camera is held by another robot hand so that it can be placed in different locations easily. Then the topological surface elements that appear in a picture and contribute to a PC (and the contact plane) can be extracted

from the picture by combining image segmentation/labeling techniques with the 3D modeling information and the sensed position/orientation of those elements. Since the processed image will only contain simple surface elements in the forms of 2D edges and vertices, it will be easy to reason about their relationship. With several images taken from different views, one can expect to obtain sufficient information about a PC. In the following paragraphs, we will describe a strategy to detect a PC using vision. By this strategy, what we want to know from an image will be a simple fact such as whether the concerned surface elements of two objects are in a line contact, in a point contact, or in no contact, and that information can be quite reliable in spite of noise (or uncertainties) in the image. We assume that proper thresholds can be easily found based on the size of the objects and the (bounded) noise to determine whether a contact is a *line* or a *point*.

To check if a given contact plane really exists, one can place the camera in a way such that the image plane is perpendicular to the contact plane (see Fig. 8, where the contact plane is determined by f_j^2 and f_h^2). By processing the image so that it contains only the edges of f_j^2 and f_h^2 , whether the contact plane really exists can be determined easily.

To eliminate the wrong types of PC's from a given set of possible PC's of a contact plane, one can take pictures for each possible PC and check if the result is as predicted. If not, the PC can be eliminated. Specifically, to confirm a f-f PC $\langle f_h^i, f_j^j \rangle$, four pictures can be sufficient (Fig. 9):

- *pic1* — taken along the contact plane in a direction orthogonal to an edge of f_h^i ;
- *pic2* — taken along the contact plane in the direction orthogonal to the direction of picture 1;
- *pic3* — taken along the contact plane in a direction orthogonal to an edge of f_j^j ;
- *pic4* — taken along the contact plane in the direction orthogonal to the direction of picture 3.

If all the pictures (which should be segmented and labeled as described previously) show that the contact region between the face elements of f_h^i and f_j^j forms a *line*, then $\langle f_h^i, f_j^j \rangle$ is confirmed. In some cases two pictures can be sufficient. For example, if there is no f-e (or e-f) type of PC's for the given contact plane, then we only need *pic1* and *pic2* to confirm the PC $\langle f_h^i, f_j^j \rangle$. To confirm a f-e (or e-f) PC $\langle f_h^i, e \rangle$ (or $\langle e, f_j^j \rangle$), the following two pictures can be sufficient (Fig. 10):

- *pic1* — taken along the edge e on the contact plane;
- *pic2* — taken along the direction perpendicular to e along the contact plane.

If *pic2* shows a *line* contact region between the relevant face elements of the two objects, while *pic1* shows an approximate *point* contact (or a *much shorter* line contact as the

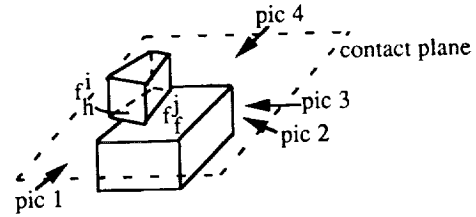

Figure 9: Four Pictures to Confirm a f-f Type PC

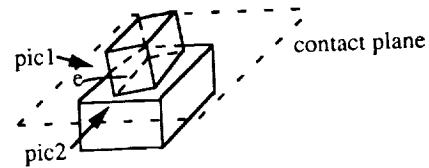

Figure 10: Two Pictures to Confirm a f-e or e-f Type PC

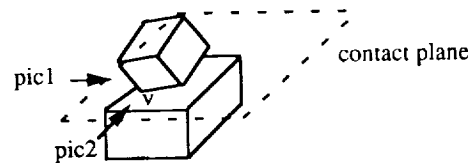

Figure 11: Two Pictures to Confirm a f-v or v-f Type PC

effect of orientation sensing uncertainty in e), then $\langle f_h^i, e \rangle$ (or $\langle e, f_j^j \rangle$) is confirmed. Similarly, two pictures are sufficient to confirm a f-v (or v-f) PC $\langle f_h^i, v \rangle$ (or $\langle v, f_j^j \rangle$). If two pictures are taken along the contact plane in orthogonal directions towards the vertex v (Fig. 11), and the contact regions shown on both pictures are points, then the PC $\langle f_h^i, v \rangle$ (or $\langle v, f_j^j \rangle$) is confirmed. As for an e-cross PC, since it will not share a contact plane with other type of PC's, if the contact plane exists, the PC is confirmed.

4 Integration of Other Sensors

We have shown that by using vision to eliminate the non-existing contact planes and the non-existing PC's, the exact contact formation can be determined from the set of possible contact formations initially obtained from position/orientation sensing. However, the major limitation of vision sensing lies in the possible occlusion of certain PC's, especially when the objects are non-convex. Thus, other sensing means, such as force/moment and tactile sensing[3, 4][1, 2] may also be needed, which can be readily added in this stage.

5 Compliant Motions for Error Recovery

A compliant recovery motion of the held object from an unexpected contact can be automatically planned[11] with the detection of the contact formation and the contact planes involved, as well as other information, such as the desired path of the held object and its current (sensed) location.

For polyhedral objects (as assumed in Section 2), there are the following basic types of compliant motions:

- translations constrained by one plane or two planes (Fig. 2),
- frictional rotations (Fig. 12a),
- non-frictional point-constrained and line-constrained rotations (Fig. 12b),
- combined frictional/non-frictional rotation (Fig. 13a), and
- combined translation/frictional-rotations (Fig. 13b and c).

It is necessary to determine then, in the presence of uncertainties (as introduced in Section 1), proper forces and moments to be applied to the held object by the robot, so that, based on the contact information (contact formation and contact planes), each type of the above motions can be implemented successfully in spite of uncertainties.

For *pure* compliant translations and rotations (as listed above), detailed analysis can be found in[9, 8] in which the proper forces and moments are determined in terms of force and moment constraints involving uncertainty bounds and under certain design constraints of system parameters. Note that the orientation sensing uncertainty is modeled as ϵ_o in Section 3.1. of this paper. The imperfections associated with force/moment sensing, modeling, and control are modeled simply as *force/moment control uncertainties*, ϵ_{ff} and ϵ_{mm} , which are defined as the maximum possible difference in magnitude between a desired or commanded force and the actual force applied and the maximum possible difference in magnitude between a desired or commanded moment and the actual moment applied respectively.

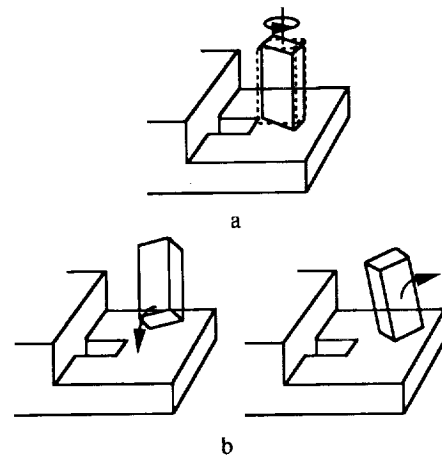

Figure 12: Compliant Rotations

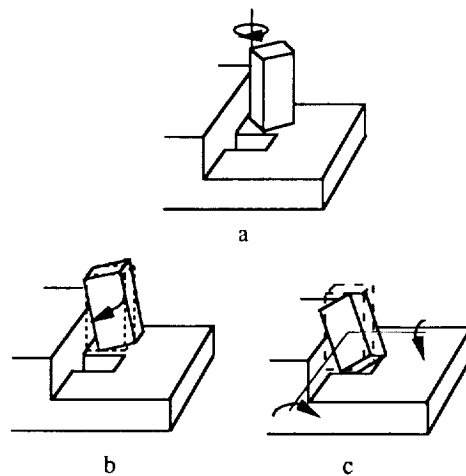

Figure 13: Combined Compliant Motions

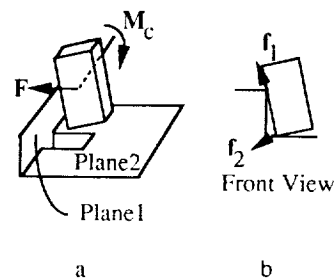

Figure 14: Force/Moment for a Combined Motion of Translation/Frictional-Rotation

In the same fashion, constraints can be derived for combined compliant motions, for example, a combined motion of translation and frictional rotation (as depicted in Fig. 13b). Such a motion can be implemented by applying a force \mathbf{F} and a moment \mathbf{M}_c on the center of the object as shown in Fig. 14a. The combination of \mathbf{F} and \mathbf{M}_c will result in compliant translations of the contact points of the held object against frictions⁴, where \mathbf{f}_1 and \mathbf{f}_2 are the equivalent forces generating the compliant translations. However, due to ϵ_o in the sensed normal \mathbf{n}_1^s of plane 1 and ϵ_{ff} , the actual applied force \mathbf{F}^a may not be parallel to the actual normal \mathbf{n}_1^a . Similarly, due to ϵ_o and ϵ_{mm} , the actual applied moment \mathbf{M}_c^a may not be exactly parallel to the actual intersection line of plane 1 and plane 2. It is thus necessary to distinguish the force/moment components that will generate the desired translation/frictional-rotation from the components that may cause undesirable motions of the held object. Upon the force/moment components for generating the translation/frictional-rotation, constraints can be derived involving ϵ_o , ϵ_{ff} , ϵ_{mm} , and the friction coefficient μ , which when satisfied, guarantee that no sticking will occur and that the motion will always be compliant (i.e., contacts will always be maintained). On the other hand, upon the force/moment components that may cause undesired motions, constraints (also involving ϵ_o , ϵ_{ff} , ϵ_{mm} , and μ) can be derived so that when they are satisfied, the effect of friction will prevent the undesirable motions from occurring. By synthesizing the two sets of constraints obtained, proper constraints on the magnitudes of the commanded \mathbf{F} and \mathbf{M} can be obtained, as well as possible design constraints on ϵ_o , ϵ_{ff} , ϵ_{mm} , μ , and other object-related parameters (such as those characterizing the shape and size of the held object). Upon the satisfaction of the design constraints, and by choosing proper \mathbf{F} and \mathbf{M} based on the force/moment constraints, the desired translation/frictional-rotation can be achieved in spite of uncertainties. As for the force/moment control to implement a desired force/moment (which is determined by our force/moment constraints), many approaches can be found in the literature, as have been surveyed and compared by Hollerbach[5] and Whitney[7].

6 Conclusions

This paper studied the effect of uncertainties in recognizing failures of robot motion in the forms of contacts and in implementing contact-based recovery motions. It proposed recovery-oriented contact detection using multiple sensing modalities and outlined means to ensure successful contact motions in spite of uncertainties. The research, however, is in its early stage. Further development and testing of the idea are necessary in the future. Subjects of special importance includes studying how accurate vision information will be and uncertainties in vision, investigating further integrations of different sensors in the system, and testing the existing and new results.

⁴Let μ be the friction coefficient of the materials, and assume the Coulomb friction cone model.

References

- [1] P. K. Allen. *Robotic Object Recognition Using Vision and Touch*. Kluwer Academic Publishers, 1987.
- [2] Paolo Dario. Contact sensing for robot active touch. In M. Brady, editor, *Robotics Science*, pages 138–163. MIT Press, 1989.
- [3] R. Desai. *On Fine Motion in Mechanical Assembly in Presence of Uncertainty*. PhD thesis, Department of Mechanical Engineering, the University of Michigan, 1989.
- [4] R. Desai, J. Xiao, and R. Volz. Contact formations and design constraints: A new basis for the automatic generation of robot programs. In B. Ravani, editor, *NATO ARW: CAD Based Programming for Sensor Based Robots*. Springer-Verlag, July 1988.
- [5] J. M. Hollerbach. Kinematics and dynamics for control. In M. Brady, editor, *Robotics Science*, pages 378–431. MIT Press, 1989.
- [6] M. Spreng. Dealing with unexpected situations during the execution of robot motions. In *Proc. IEEE International Conference on Robotics and Automation*, 1991.
- [7] D. E. Whitney. Historical perspective and state of the art in robot force control. In *IEEE Int. Conf. Robotics and Automation*, 1985.
- [8] J. Xiao. *On Uncertainty Handling in Robot Part-Mating Planning*. PhD thesis, Department of EECS, the University of Michigan, 1990.
- [9] J. Xiao. Force/moment constraints for robot compliant motions in the presence of uncertainties. In *IEEE Int. Symposium on Intelligent Control*, August 1991.
- [10] J. Xiao. On recognition of contacts between objects in the presence of uncertainties. In *SPIE's International Symposium on Optical Engineering and Photonics in Aerospace Sensing*, April 1991.
- [11] J. Xiao and R. Volz. On replanning for assembly tasks using robots in the presence of uncertainties. In *IEEE Int. Conf. Robotics and Automation*, 1989.