

**Final Report**

**submitted to**

**NATIONAL AERONAUTICS AND SPACE ADMINISTRATION  
GEORGE C. MARSHALL SPACE FLIGHT CENTER, ALABAMA 35812**

**September 30, 1992**

**for Contract NAS8 - 38609**

**Delivery Order ~~136~~**

**entitled**

**Fingerprinting of Materials**

**by**

**Gary L. Workman Ph.D.  
Principal Investigator**

**Materials Processing Laboratory  
Center for Automation & Robotics  
University of Alabama in Huntsville  
Huntsville, Alabama 35899**

N93-15916  
--THRU--  
N93-15917  
Unclas

G3  
~~136~~/45 0137121

(NASA-CR-184482) FINGERPRINTING OF  
MATERIALS Final Report (NASA)  
201 p

485312



**Final Report**

**submitted to**

**NATIONAL AERONAUTICS AND SPACE ADMINISTRATION  
GEORGE C. MARSHALL SPACE FLIGHT CENTER, ALABAMA 35812**

**September 30, 1992**

**for Contract NAS8 - 38609**

**Delivery Order 13**

**entitled**

**Fingerprinting of Materials**

**by**

**Gary L. Workman Ph.D.  
Principal Investigator**

**Materials Processing Laboratory  
Center for Automation & Robotics  
University of Alabama in Huntsville  
Huntsville, Alabama 35899**





# CHEMICAL FINGERPRINTING HANDBOOK

## Table of Contents

<b>1.0</b>	<b>Introduction</b>	<b>1</b>
1.1	Objectives	
1.2	Definitions	
1.3	Benefits	
1.4	Background	
1.5	Supplier Interfaces	
<b>2.0</b>	<b>Technical Approach</b>	<b>10</b>
2.1	Implementation	
2.2	Applications and Utilization areas	
<b>3.0</b>	<b>Methods Development</b>	<b>25</b>
3.1	Sampling	
3.2	Data Quality Control	
3.3	Database Compilation	
<b>4.0</b>	<b>References</b>	<b>50</b>
<b>5.0</b>	<b>Tables of Instrumental Methods</b>	<b>58</b>
<b>6.0</b>	<b>Appendix: Benefits Analysis</b>	<b>62</b>

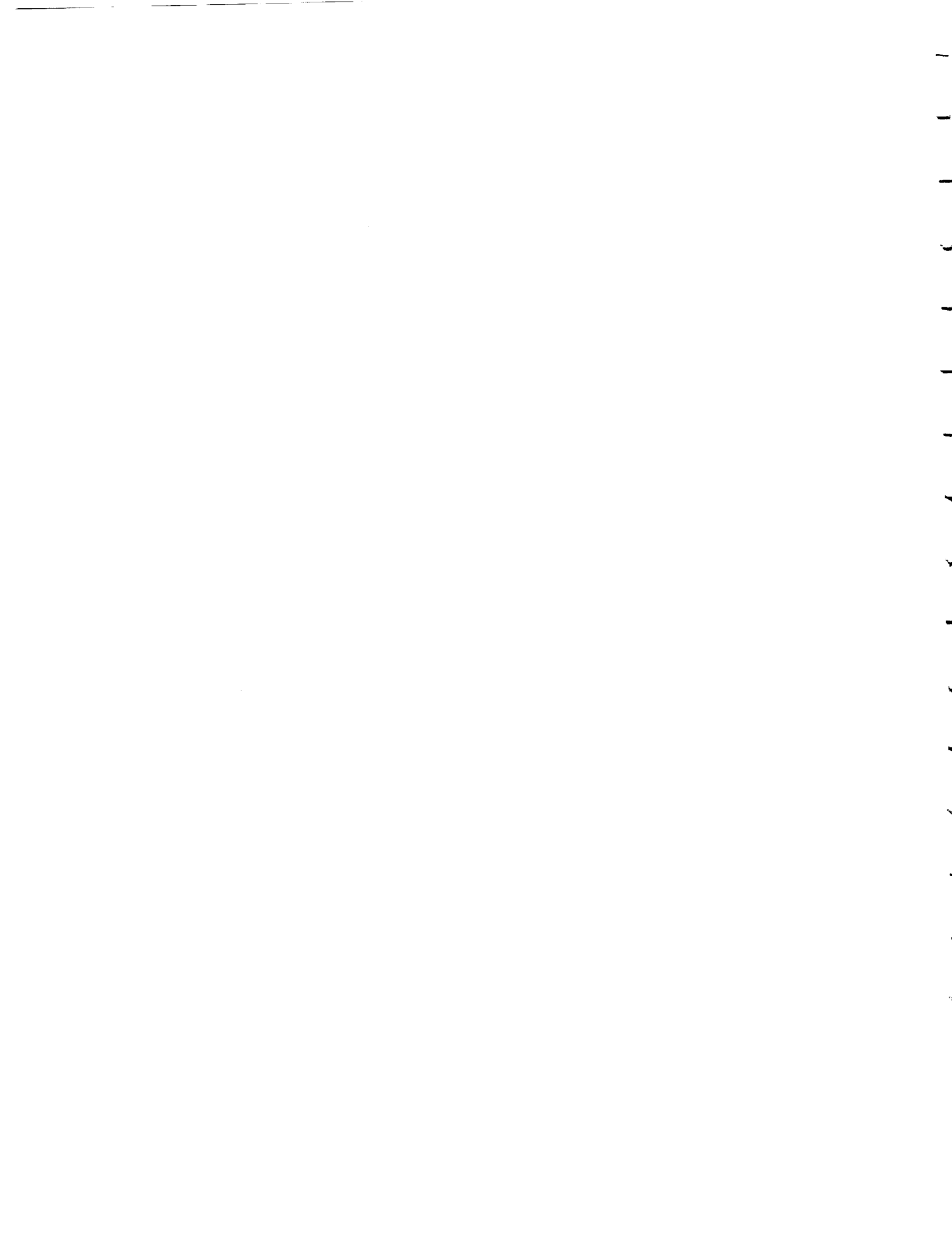

## 1.0 INTRODUCTION

### 1.1 Objectives

Recent issues emerging in our fiscal and ecological environments have promulgated that federal agencies shall promote activities which respond to the improvement of both. In response to these developments, the National Aeronautics and Space Administration (NASA) has undertaken an innovative approach to improve the control of materials used in all NASA manufacturing activities. In concert with this goal, NASA is requiring that its contractors and their sub-contractors perform a more intensive consolidation of technologies that can provide an accounting of materials, which includes in-coming materials, materials in process, end-products and waste materials.

This concept is especially desirable for all contractor organizations participating in space hardware construction and refurbishment. Many NASA contractors are already participating in organizational improvement programs, such as Total Quality Management (TQM). TQM techniques are currently seen as the most effective management techniques to improve productivity and reliability. In parallel with the concepts for improving management efficiency, TQM also promotes the development of efficient strategies for managing materials control. Within the basic philosophy of TQM, NASA and its contracting organizations will provide a materials control infra-structure to maintain knowledge of any critical material's lack of conformance to specifications at all times. In addition the same data will permit the identification of waste materials for ecological control. The practice of chemical fingerprinting principles will provide this capability.

Chemical fingerprinting is an emerging technology which enables the manufacturing organization to maintain control over the materials used in its operations. In this respect chemical fingerprinting provides a Total Quality Management tool that can develop confidence in the integrity of incoming materials and knowledge of the composition of wastes. Using the appropriate blend of chemical analysis, data management, and chemometrics, chemical fingerprinting programs provide management with information needed for making critical decisions at the appropriate time. The utility of fingerprint analysis spreads across all manufacturing programs and can provide many benefits, including quality, safety and cost-effectiveness. These benefits are achieved primarily through cost-avoidance occurrences and open communication between manufacturing and management.

The purpose of this handbook is to provide guidelines to NASA and its contractor personnel for the planning and implementation of chemical fingerprinting programs and to illustrate the chemical and statistical fundamentals required for successful use of chemical fingerprinting in a NASA contractor's facility. Generic examples of both equipment and procedures are included in these guidelines to illustrate how the various methodologies (chemical analysis, database management, and chemometrics) can work together in a cohesive chemical fingerprinting program. These guidelines are necessarily

limited in scope, since there will undoubtedly be other approaches to chemical fingerprinting which are feasible and, in some cases, even necessary due to a particular set of circumstances. Innovation is a very significant part of chemical fingerprinting and it is important to encourage everyone to work towards a uniform capability across the aerospace industry.

A number of analytical methods using instrumentation currently available in chemical laboratories are listed here, as well as some very specialized instruments which are normally more expensive and more limited in their scope of activities. However, each of the instruments listed is able to provide a characteristic fingerprint or property of the material being tested and can be used for subsequent signature analysis. Two themes which are important to establishing chemical fingerprinting programs are:

1. The instrumentation needed by each contractor will depend on their particular set of requirements for both implementing and maintaining a chemical fingerprinting program.
2. In most cases, each contractor has appropriate analytical equipment, personnel, and procedures to either be currently performing such analyses, or be able to begin to collect data, that will contribute to the baseline information needed for chemical fingerprinting.

The accessibility and sharing of this information by all NASA contractors will become an objective in the future.

The critical philosophy underlying chemical fingerprints is to be able to determine the crucial relationships among the many fingerprints that can be obtained with analytical instrumentation. Only then can proper decisions be made regarding the materials conformance to specification or fitness for use. Often, unambiguous results can only be obtained with the assistance of statistical (or chemometric) techniques. It is the complementary collaboration between chemical and statistical analysis which is the key to a successful fingerprint application. The chosen methods must produce results which can be utilized effectively for both engineering and management purposes.

## 1.2. Definitions

### 1.2.1 *Chemical Fingerprinting*

Chemical fingerprinting utilizes various materials characterization techniques to acquire specific types of information (See Appendix I for a brief description of applicable techniques), such as the following:

- a.) the elemental or molecular composition of a material,
- b.) the measurement of the individual constituents of a material, or
- c.) the measurement of a relevant property of the material.

Dependent upon the need, this information may be qualitative or quantitative in nature. The utility of chemical fingerprinting to provide a means for determining a material uniquely is realized through the use of individual measurements (chemical fingerprints) and the compilation of such measurements (signatures). For example, the concept of chemical fingerprints, can be defined by considering recorded measurements on a material using various analytical instruments as shown in Figure 1 below.

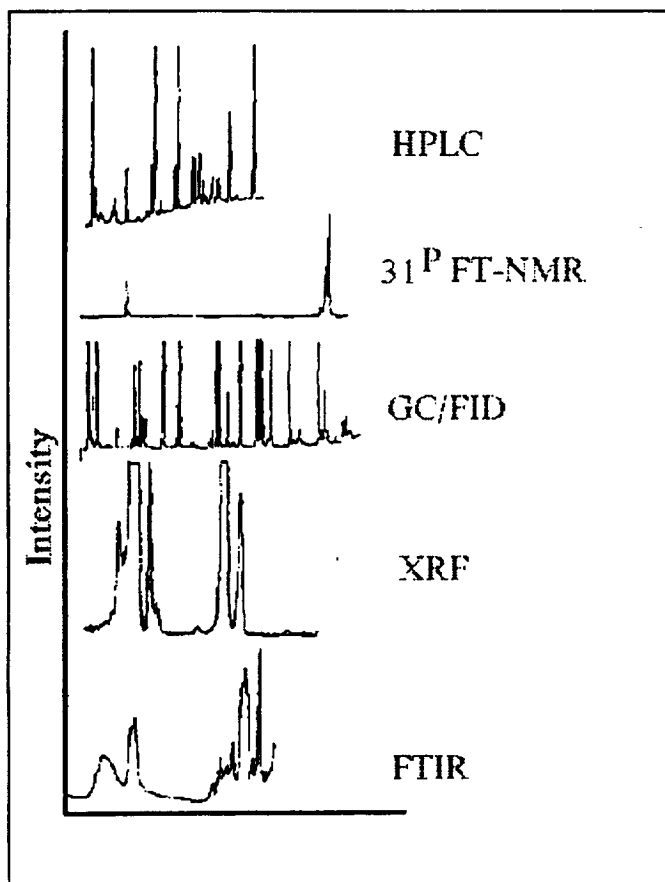

Figure 1. Pictorial representation of several fingerprints to make a signature.

Each of these individual fingerprints were acquired from measurements on the same material and thus provides individual features that are pertinent to that material. If analysis of a new batch of the same material indicates different features, then obviously the materials are not equivalent. It is the ability to completely characterize materials of interest with an appropriate "signature" that enables chemical fingerprinting methodology to promote confidence in the materials used in manufacturing.

### 1.2.2 Signature

A "signature" is the composite data from several analytical instruments for the same material. The signature allows one to characterize a material of interest using chemical

and physical measurements. Each of the fingerprints shown in Figure 1 contains information about the materials; however, that one piece of information may not contribute to determining whether a material is "fit for service" or conforms to a specific specification. A fingerprint yields important, but limited, information and usually cannot adequately characterize a complex multi-component material. It is the ability to completely characterize materials of interest with an appropriate "signature" that enables chemical fingerprinting methodology to promote confidence in the materials used in manufacturing.

The signature of the material represented in Figure 1 may be complete using the data as shown. However, different materials will require a different set of analyses from those shown in Figure 1. For less complex materials, one would expect that fewer individual measurements or fingerprints would be required to formulate the desired signature.

### 1.2.3 *Data Management Systems*

Implicit in the concept of signature or fingerprint analysis is the computerized database or databases which contain the baseline information and historical archiving of fingerprints over extended periods of time. Such databases are normally maintained in individual datafiles supplied with analytical instrumentation and supporting software. Robust data management systems (also known commercially as Laboratory Information Management Systems or LIMS) for handling the full fingerprint and signature information are not always readily available. Consequently, the data management systems used in chemical fingerprinting programs will continuously have to be upgraded to meet the demands of the organization. Hence, there is no single definition or solution for the data management requirements which fits all organizations. NASA may elect to establish a fingerprint database in the future and will at that time provide a consistent definition for the development of a database architecture and protocol.

### 1.2.4. *Chemometrics*

Chemometrics is a discipline within analytical chemistry concerned with the selection and optimization of instrumental methods as well as the interpretation of data from these chemical analyses. Chemometrics makes extensive use of mathematical and statistical methods with the intent of producing a maximum of concise chemical information. The use of chemometrics becomes more obvious as the data analysis becomes more complex. Chemometric techniques can assist the measurement process by determining sampling requirements, the number of experiments required to characterize an analytical procedure, or to extract the useful characteristics from otherwise ambiguous data sets. Many software packages are available commercially to provide support in statistical analysis.

### 1.2.5. *Fitness-for-Use and "Lot-to-Lot Consistency"*

The terms "fitness for use" and "lot-to-lot consistency" relate to the knowledge of the exact physical and chemical nature of the material, together with the material's intended

use. The exact definitions are dependent upon both the material in question and its intended process or product application. A clear and concise statement of these ideas as they relate to a given material is a necessary prerequisite to any fingerprinting effort.

The term "lot-to-lot consistency" is important in any production facility that requires multiple suppliers or materials from the same supplier over an extended period of time. It refers to the consistency of the material used in production of a specific part.

Specifications for in-coming materials, for instance, can become a starting point for determining what signatures need to be determined early on in the program. Each contractor organization can determine what constitutes the minimum essential information for which "fingerprints" should be established. A successfully tested material is then one whose "fitness for use" can be easily and quickly demonstrated by the results of one or more instrumental test procedures. Over a period of time the lot-to-lot consistency of the vendor can then be determined.

Both chemical and physical measurements obtained from instruments found in the analytical laboratory can provide the data required for a correct evaluation of the materials characteristics. Note that it can be a challenge, for a given material, to discover and elucidate the most efficient combination of practical procedures which will successfully accomplish the goals of the chemical fingerprinting program.

### 1.3 Benefits

The fact that chemical fingerprinting utilizes instrumental methods, as compared to classical wet chemical analysis, provides many advantages. It is the use of the instrumental technique that provides the diagnostic capability of fingerprinting, which is one of the most important benefits. The other major advantages which are obtained through the use of the analytical instruments described here are the ease with which a manufacturer can provide instrument interfaces to computers for data acquisition, statistical analysis of the experimental results, and compilation of fingerprint data. Many instruments are also equipped with automated sampling systems to allow complete sample analysis without the need for a hand's on operator, resulting in considerable cost-savings.

With these advantages, instrumental analysis provides a major capability for the characterization and identification of materials in a reliable and timely manner. It is also anticipated that the analytical instruments which are used for chemical fingerprinting are primarily already physically in place in most laboratories, being used primarily for in-process verification of particular products or processes. Combining these capabilities with computer based systems for laboratory automation, data manipulation and statistical analysis, these same instruments can provide the basic foundation for implementing a chemical fingerprinting program.

The use of fingerprinting as a quality assurance technique can be profitably applied to

problems in all industries ranging from aerospace to pharmaceuticals. The major benefit to NASA is the ability to build space hardware at reduced costs over the life cycle of the system. All manufacturing organizations can benefit from the chemical fingerprinting approach in a number of different ways. The three major benefit areas, which are described below, are cost avoidance, increased materials reliability and expeditious resolution of materials problems when they occur. For example, cost benefits are enhanced through the manufacturing operation by eliminating the processing of materials which would not allow the final product to conform to the specifications. It is more cost effective to reject defective materials than defective parts.

In addition, the following statements list some benefits derived from utilization of chemical fingerprinting in a manufacturing operation:

1. When fully developed, the fingerprints and signatures developed provide a baseline chemical profile of those materials currently in use and considered to be in conformance with the specifications. This information can be utilized strictly in-house, as part of the contractor's operations, or more importantly, shared with other contractor's as part of a database for materials used in NASA's manufacturing programs.
2. Lot-to-lot consistency from multiple suppliers or materials from the same supplier over an extended period of time can be monitored. This would eliminate the customer not knowing of the occurrence of formulation changes which would affect the manufacturing processes, its inspectability, or cause environmental damage.
3. Mislabeled products, process contaminations, and material degradations can all be identified. An organization which utilizes chemical fingerprinting techniques for materials control will be less likely to be effected by such incidents. As mentioned earlier, a tremendous cost-avoidance can occur when defective materials are not introduced into the manufacturing process. Other undesirable and costly problems, such as contaminating good materials already in production or forming toxic fumes or flammable by-products when the wrong chemicals are mixed, can easily be avoided when the materials are correctly identified before use.
4. Material changes, when they do occur, can readily be traced to their source by comparison of the questionable lot with the historical information. Formulation variations and substitutions can be identified whether made at the vendor's facility or at one of his suppliers.
5. The chemical fingerprinting may be the basis upon which a change, by vendor or production site, may not require an expensive requalification effort.
6. The acceptance testing of material from a small supplier, who is really a "blender" and cannot afford an analytical laboratory, may be one of the more practical uses of fingerprinting. Often a blender may receive ingredients from multiple suppliers who likewise could not afford the instrumentation or personnel for its own fingerprinting



program.

7. In addition to inspecting in-coming materials for conformance to specifications, the chemical fingerprinting approach can also be used to monitor intermediate products or processes in production. Used in this fashion, the approach can then provide confidence towards the reliable performance of the manufacturing processes and the end products.

8. The database can also supply vital information for failure analyses. Without prior knowledge of the constituents contained in a material, failure analysis can be a long and difficult process. The process can be shortened with a more thorough knowledge of the material.

9. New materials can be developed in a faster time frame and with superior properties. For example, chemical fingerprinting can identify how a specific ingredient interacts with other ingredients to provide the optimal formulation to obtain the desired properties of the material.

10. When existing materials or ingredients are removed from the marketplace, as in the case of legislation due to environmental concerns, replacement materials must be found quickly. These replacements may be developmental in nature and not completely understood. Knowledge of contaminants, by-products, and degradation products are important to insure employee safety, material performance, and compatibility with existing production facilities.

11. Waste management has become a significant portion of any manufacturing organization, particularly in the case of the complex processes involved in manufacturing today's space systems. Thorough knowledge of the ingredients which leave the manufacturing site, as a gas, liquid, or solid is mandatory in some localities. Organizations which are performing appropriate accounting of materials are going to benefit accordingly as environmental laws and regulations are promulgated by both the federal and the state governments.

#### 1.4 Background

The major advantages which are obtained through the use of analytical instruments such as described here are the diagnostic capabilities and the ease with which a manufacturer can provide instrument interfaces to computers for data acquisition, statistical analysis of the experimental results, and compilation of fingerprint data. There are many useful examples of chemical fingerprinting programs which successfully guide manufacturing to produce good products. Most of these programs have been established in industries with high liability when defective products are sent to the marketplace. For example, pharmaceuticals and food processing facilities cannot afford to have products containing toxic materials shipped from the production facilities to the marketplace. Consequently, their in-coming materials are always fingerprinted to insure against inadvertent accidents to the customers who use their products. Liability lawsuits, which can drain a

corporations fiscal health, are the major results of such accidents. In addition, a number of chemical industries which use materials by the carload prefer to maintain programs which make sure of the identity of the reactants before mixing them. In this case the costs incurred is heavily in favor of performing chemical analysis prior to mixing, rather than taking a chance that the supplier sent the right material and proceed on with no due caution.

A number of aerospace examples also have been documented. For instance, the acceptance testing difficulties encountered during the extensive use of critical but proprietary insulating foam materials for a NASA propulsion program gave rise to the critical need for chemical fingerprinting. These formulations are chemically complex and involve a number of chemical sub-systems, including catalysts, flame retardants, blowing agents, and surfactants. Some of the critical ingredients are proprietary even at the sub-tier supplier level. A major risk in the use of proprietary materials is that only the supplier has purview over the formulation and can, therefore, make any changes he deems desirable or necessary. While there was no desire for the NASA contractor to "crack" the formulations, it was imperative to assure the lot-to-lot consistency of these critical materials for reliable performance of the product. The chemical fingerprinting approach was the contractor's solution to this dilemma. The NASA contractor subsequently developed a signature for the formulation and now has confidence in his ability to evaluate the deliverables required for the end product.

### 1.5 Supplier Interfaces

Supplier cooperation is vital to any fingerprinting effort for a manufacturing operation. In order to attain maximum cooperation from suppliers they must be given assurances that all intellectual property, i.e., proprietary information, will be held in the strictest confidence. There are benefits for the suppliers who participate in the prime contractor's chemical fingerprinting program, such as a more in-depth knowledge of their products. This level of knowledge can only be obtained through use of sophisticated, state-of-the-art analytical equipment. Many suppliers are equipped with minimally staffed and instrumented quality control laboratories. Data which provide more comprehensive insight to their raw materials, processes and products can become a useful product of the supplier interface. In the case where the vendor is skeptical and reluctant to provide information, often this problem will resolve itself with fruitful exchanges of information. The vendor needs to be assured that the intent is not to derive the formulation, but simply for diagnostic purposes when a material problem is suspected. Often better relationships are obtained when vendors see how much faster and more conclusive failure investigations are when material fingerprinting has been previously performed. One example in which a better relationship was obtained with a reluctant vendor occurred when fingerprinting diagnosed the cause of a material problem to be not with the primary vendor but a supplier to that vendor. After notifying the primary vendor that his supplier was delivering inferior materials, the primary vendor then became very positive in his commitment to the program.

Depending upon the complexity of the material, knowledge of the supplier's constituents is essential to the analytical chemist to develop baseline information. Without knowledge of the constituents, fingerprinting can be done, but the method development phase takes much longer and the resultant database is not as informative.

Prerequisites for the supplier interface should include a comprehensive knowledge and understanding of the instrumentation used in the fingerprinting process. Ideally, the interface personnel should possess a background in the chemistry of the products to be fingerprinted. The interface personnel may also be the designated custodian of any test materials received from the supplier and must comply with the spirit and intent of the proprietary agreements when disseminating these materials.



## 2.0 Technical Approach

### 2.1 Implementation

The implementation of chemical fingerprinting in any organization will have to be an evolutionary process, since chemical signatures will have to be obtained over a significant period of time for true confidence in the process to evolve. However, most organizations already have acquired some analytical data which they have used for comparison purposes on critical materials, thus providing a starting point for the chemical fingerprinting program. In addition, the NASA contractors, or NASA itself, can make available a fingerprinting database containing many significant materials of interest. For proper implementation, one should take into consideration many factors, including the products or services, the customer's needs, the manufacturing processes and the raw materials, and the knowledge, skills, and experience of the personnel. Like any other TQM methodology, it is important that everyone involved in the process become committed early on.

The major emphasis in establishing a chemical fingerprinting program within manufacturing is to begin with a well defined approach to both the implementation and the ensuing activities. The primary activities which need to be performed routinely within the fingerprint program are:

1. Select materials to include in the fingerprint program.
2. Select instrument and techniques for these materials.
3. Obtain baseline fingerprints for the materials using these instruments.
4. Compile material signatures from acquired fingerprints.
5. Develop a signature database on the appropriate system.
6. Perform materials analyses on materials as required.

Intertwined within these activities are several types of secondary activities which may not have to be performed on a routine basis. More complex materials or more difficult analyses will often require considerably more effort to develop the appropriate methodology for chemical fingerprinting these materials. These secondary activities include such functions as:

1. Obtain background information on material or analyses.
2. Develop analytical methods for material which are not currently available or documented and develop criteria for method evaluation.
3. Obtain listing of ingredients from vendor and perform analysis on those materials to establish baseline fingerprints.
4. Establish a statistical framework for complex or difficult analyses.

The following flowchart identifies the relationships of the primary and secondary activities which will be included in most approaches to chemical fingerprinting.

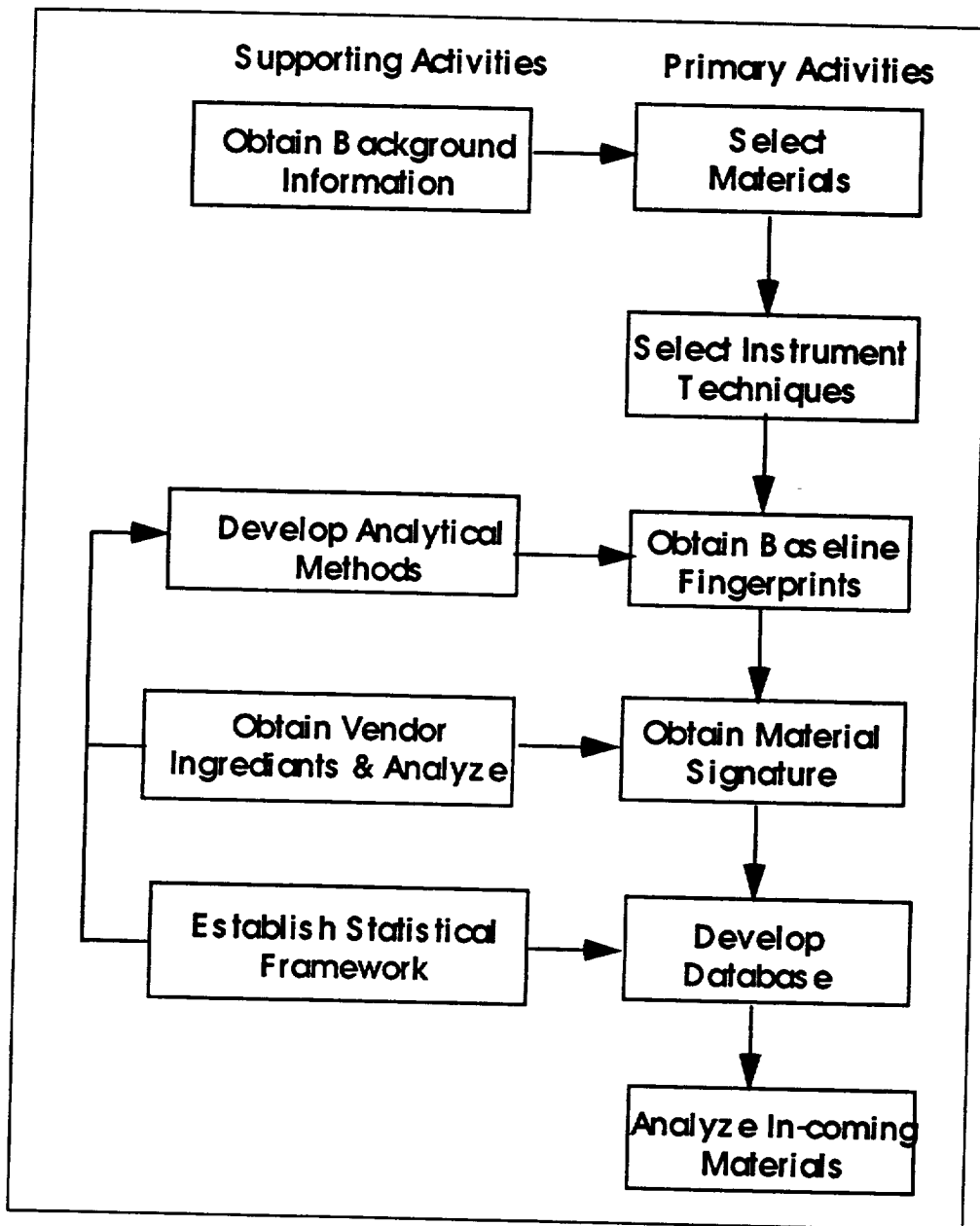

Figure 2. Flowchart showing the major activities involved in chemical fingerprint implementations.

The first consideration when developing a fingerprint project will be the material selection process. Generally the need for chemical fingerprinting will be determined by the criticality of the application in which the material is to be used. For instance, a bondline material used in a primary structure or a material used in the crew compartment are examples of critical materials which will probably need to be included in the fingerprint program. Note that background information at this time will include what is currently known about the material and its application.

Once it has been determined that chemical fingerprinting of a particular material should

be performed, the next step should be to identify which instruments and which techniques are to be used to obtain fingerprints. A number of questions need to be answered in order to formulate the appropriate strategy for fingerprinting the material. These questions can be categorized for selection of the instrumental method and the sampling methodology required. These questions include:

1. What is the physical state of the material (solid, liquid, gas, etc.)?
2. Are bulk, surface, or micro properties to be analyzed?
3. Are the analyses needed for inorganics, organics, or a mixture of both?
4. What type of information is needed: qualitative, quantitative, or a mixture?
5. What analytical accuracy and precision are required?
6. Are the components of interest present at major, minor, or trace levels of concentration?
7. What type of analyses is needed: elemental, component, or a functional group?
8. Are there analytical interference or masking problems?
9. What are the important properties of the sample matrix?
10. Are there one or more chemically/physically distinct phases?
11. Does the sample contain a single component or is it a complex mixture?
12. Is a component separation procedure required?
13. What sampling procedure will be employed?
14. Is there a limitation on the size of the sample?
15. Can the sample be consumed by the analysis or is a nondestructive test needed?
16. What are the required number of samples to be analyzed?

Once the required instrumentation and sampling procedures are defined, there are other important considerations which can be used to finalize the overall approach for chemical fingerprinting of a particular material. These considerations are:

- a.) the availability of the required resources,
- b.) the variability of the equipment,
- c.) the required sample turn around time,
- d.) the skill of the personnel,
- e.) availability of off-site analyses,
- f.) and the costs associated with the analyses.

The ultimate fingerprint strategy will be dictated by the material's complexity. A simple material might require a single analytical method, while a complicated formulation might require a number of instrumental techniques or tandem techniques.

*Example 1. Single analysis for simple material.*

This point can be illustrated using a gas chromatographic analysis with a flame ionization detector for a simple material. Figure 3 is a chromatogram of a simple material, the solvent reducer of an epoxy paint. This sample is a two component mixture containing chemically similar components (solvents) both present at high concentrations (>10%) as pictured below.

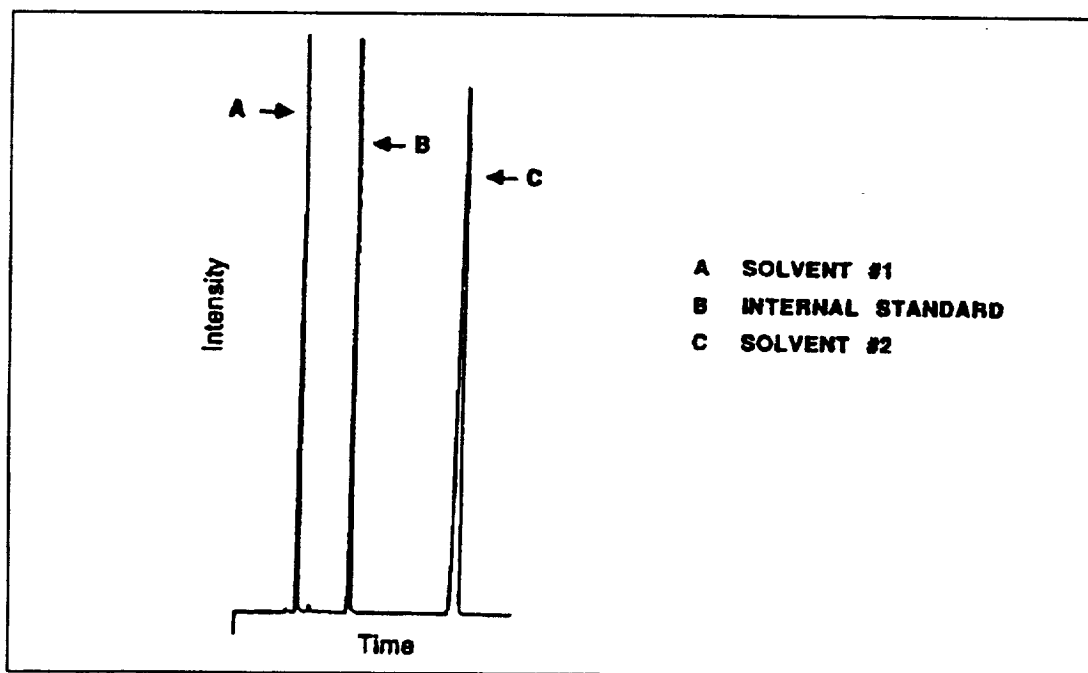

Figure 3. Gas chromatogram of a simple material.

For most purposes, this fingerprint completely characterizes the material both qualitatively via retention times, and quantitatively via integrated peak areas. Contaminated material will show other peaks. Once it can be shown statistically that the above fingerprint satisfies the requirement for determining the consistency of the material, it then becomes usable as the signature for the material.

*Example 2 . Multiple analyses to characterize complex materials*

On the other hand, an example of a complex material can be given with a urethane modified isocyanurate rigid foam formulation. This material is produced from a two-component system in which the A component is a diisocyanate mixture and the B component is a mixture of polyols, catalysts, and other additives. These two components are combined together in a specific ratio to produce a rigid foam product. The complexity of the foam ingredients can be represented by the ingredients shown in Figure 4 on the following page.



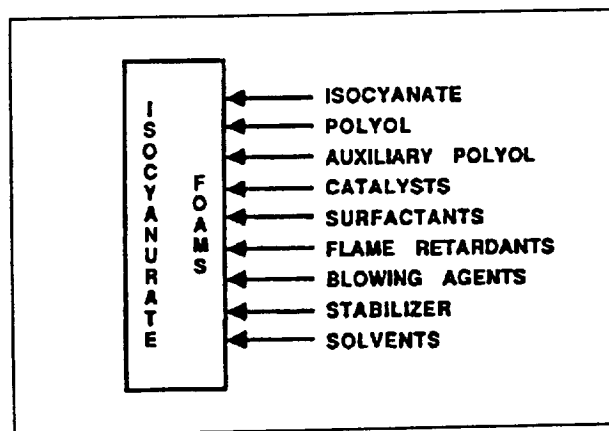

Figure 4. Schematic of a complex formulation for foam preparation.

This type of process requires a considerable amount of chemical fingerprinting to insure the integrity of the materials used for producing the final product. Consequently, it provides an example of the worst case in terms of complexity and difficulty in implementation of chemical fingerprinting. On the other hand, the rewards for successful implementation are high also. The many many benefits described in chapter one are particularly rewarding when used for this type of process or materials.

The complexity of this type of material can be further demonstrated when one looks at the types of fingerprints which might be used to analyze the material. Since it is a multi-component organic material, chromatographic techniques are frequently considered to be an essential fingerprint technique. The complexity of the material also presents a problem trying to utilize only one technique for the fingerprint. This example also illustrates the limitations of a single fingerprint when the number of features which are characteristic of the material are numerous and difficult to interpret. Once again a gas chromatography analysis using a flame ionization detector can be used to obtain a chemical fingerprint of the in-coming material.

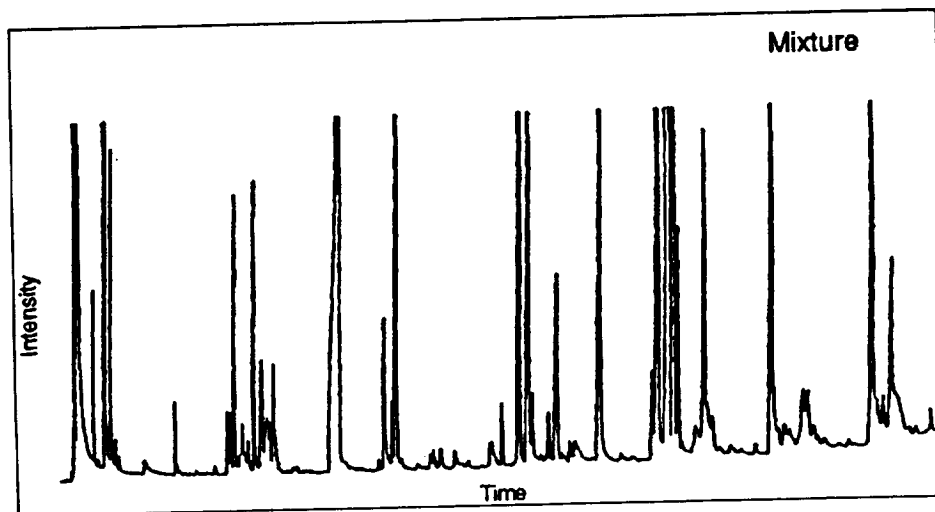

Figure 5. GC/FID fingerprint of a complex material.

Although the chromatogram for the B component in Figure 5 contains more than 30 peaks (individual substances), this technique only detects the volatile ingredients. Since less volatile components (polymers, inorganic compounds, etc.) are present, additional analytical procedures are required to obtain other fingerprints.

Not only is the complexity of the sample important, but also the complexity of the required information. The amount of information known before the analysis begins is also important. The analysis of a completely unknown sample requires orders of magnitude more effort compared to a sample where some background information is available. The situation of an unknown sample is often encountered when dealing with materials having proprietary formulations.

Instrumental analyses are beneficial in these situations owing to their ability to provide objective, quantitative, and diagnostic data on complex multicomponent materials. Formulation inconsistencies and variations in materials can have a significant impact on material performance, production processes, and schedule. In addition to the quality of the major ingredients, the consistency, degradation, and contamination of the additives, catalysts, and solvents used in the formulation must be known. A complex mixture or a blend used in foam production can contain as many as twenty-five components in concentrations ranging from less than 1% up to 60% of the total. The components may encompass a wide variety of chemistries such as volatile organics, semi-volatile organics, polymers, or inorganics.

## 2.2 Utilization Areas

Many technical activities can benefit from the application of the fingerprinting methodology. A few examples will be given.

### 2.2.1 Receiving Inspection

Fingerprinting methods are well suited to receiving inspection tests due, in part, to their inherent diagnostic nature. An example is the reactivity of a cured foam in which the traditional receiving tests required the mixing of two liquid components together in order to measure how long it takes for the foam to cream, to rise, and to become tack free. These tests will determine if there is a problem with the material, but will not uncover the actual cause. Whereas a fingerprint test, a gas chromatograph (GC) of the catalyst, will diagnose the problem and provide information to solve the problem. The GC could tell whether the wrong concentration of catalyst was added, whether the catalyst had degraded, or whether the wrong type of catalyst was used. Figure 6 depicts a sample that failed with too slow a reactivity. The chromatogram shows that the stabilizer, peak B, was decreasing in concentration and the degradation product, peak A, was increasing in concentration. In this case, the catalyst was degrading and appropriate remedial actions were then performed.

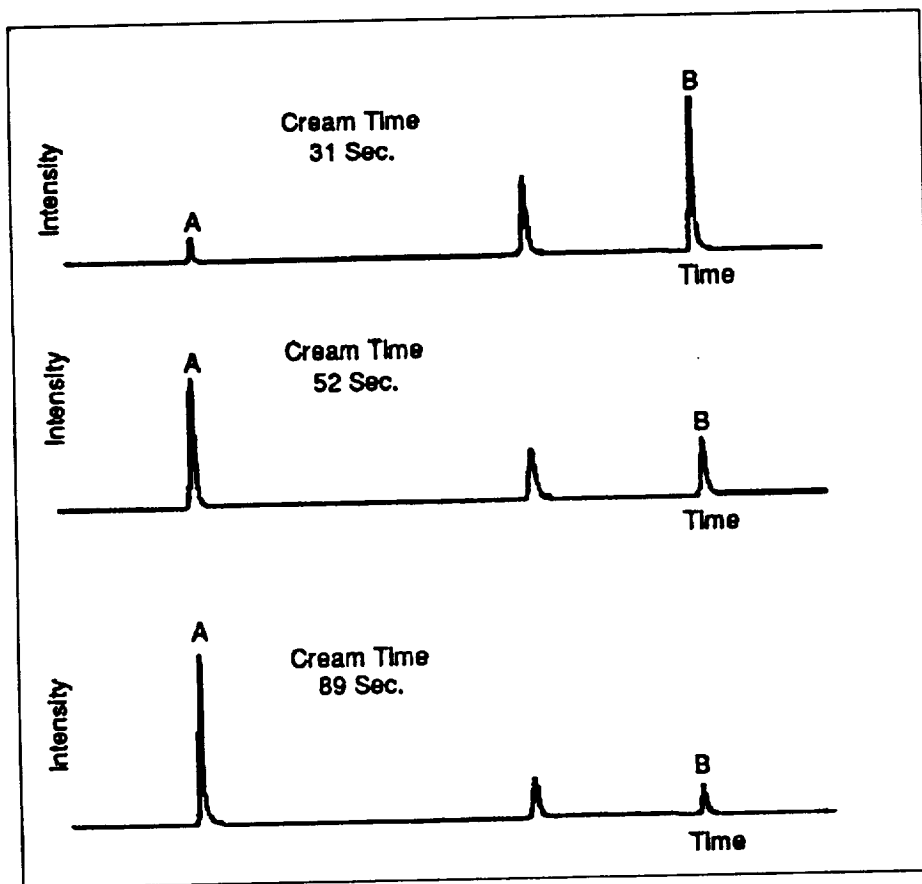

Figure 6. GC/SIM Detects Degradation of the Stabilizer

Another example is a vendor formulation change. Figure 7 illustrates how consistent this material was from 1982 to 1984, then the FTIR spectrum changes in 1985. As part of the fingerprint studies, the individual ingredients used to formulate the product had been analyzed, and a reference library established, so that the origin of each peak in the FTIR spectrum was known. From this information it could be determined which ingredient had changed.

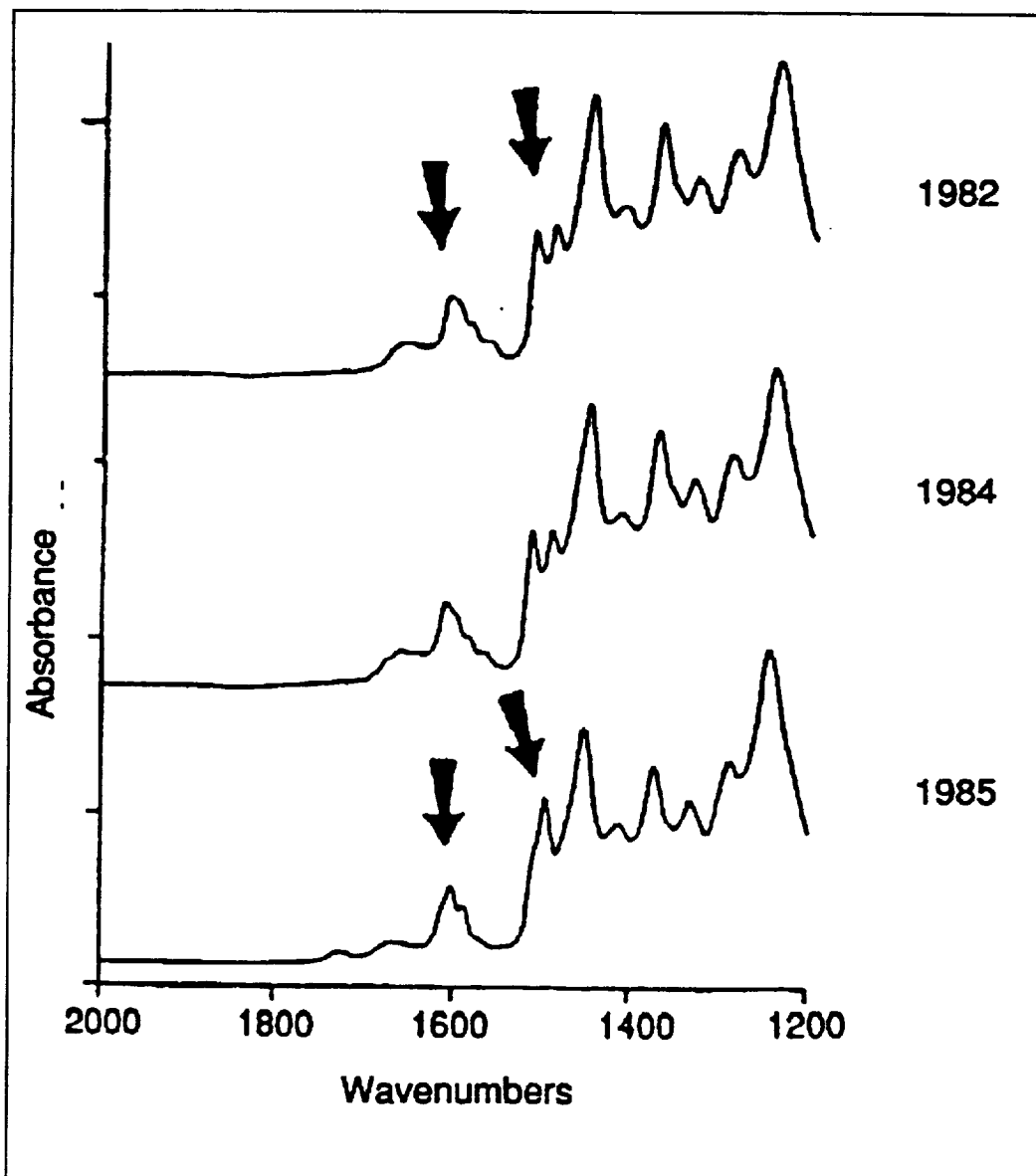

Figure 7. FTIR Detects Vendor Formulation Change

Fingerprinting can also detect mislabeled products. One example results from the activities currently underway to replace certain Freons in industrial processes since some chlorofluorocarbons have been found to deplete the ozone layer and are being gradually phased out. A replacement is needed for the Freon which is used as a blowing agent in

the foam formulation. New hydrochlorofluorocarbons, HCFC, are being evaluated as the Freon replacements. A gas chromatographic method was developed to monitor the new HCFCs and the conventional Freon, as pictured in Figure 8. The GC method detected a batch which was presumed to have had a new HCFC to be used for evaluation studies and, in fact, contained the conventional Freon.

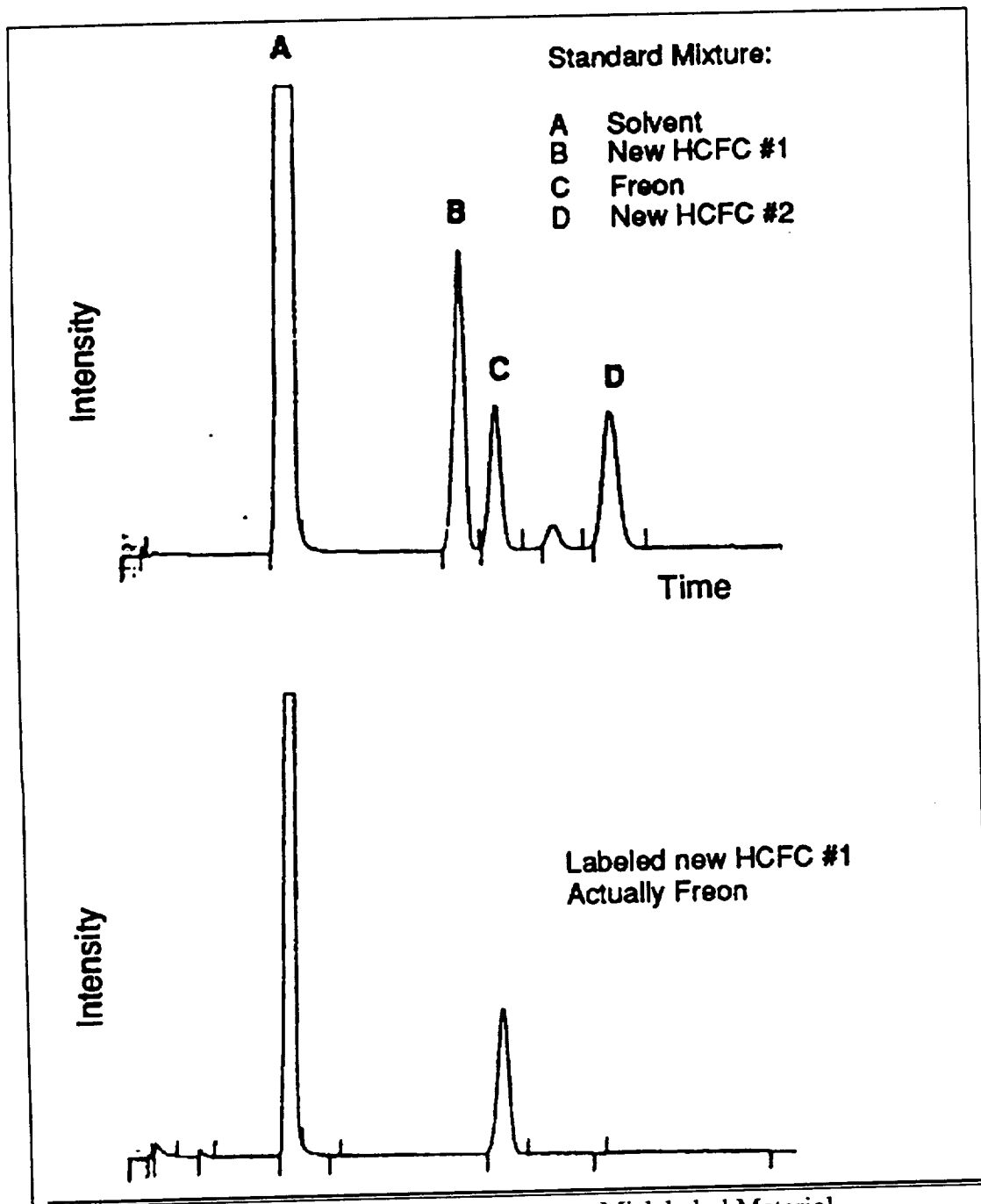

Figure 8. GC/TCD Detects Mislabeled Material

### 2.2.2 Production

The diagnostic nature of fingerprinting is also beneficial to production. The foam used for the thermal protection system on the External Tank is sprayed on using two parts component A to one part component B. Questions arise on whether the correct ratio was sprayed for subsequent reliable performance. A quantitative method using FTIR was developed that can calculate the sprayed ratio from a sample of cured foam. A peak height ratio used to monitor this condition is demonstrated in Figure 9.

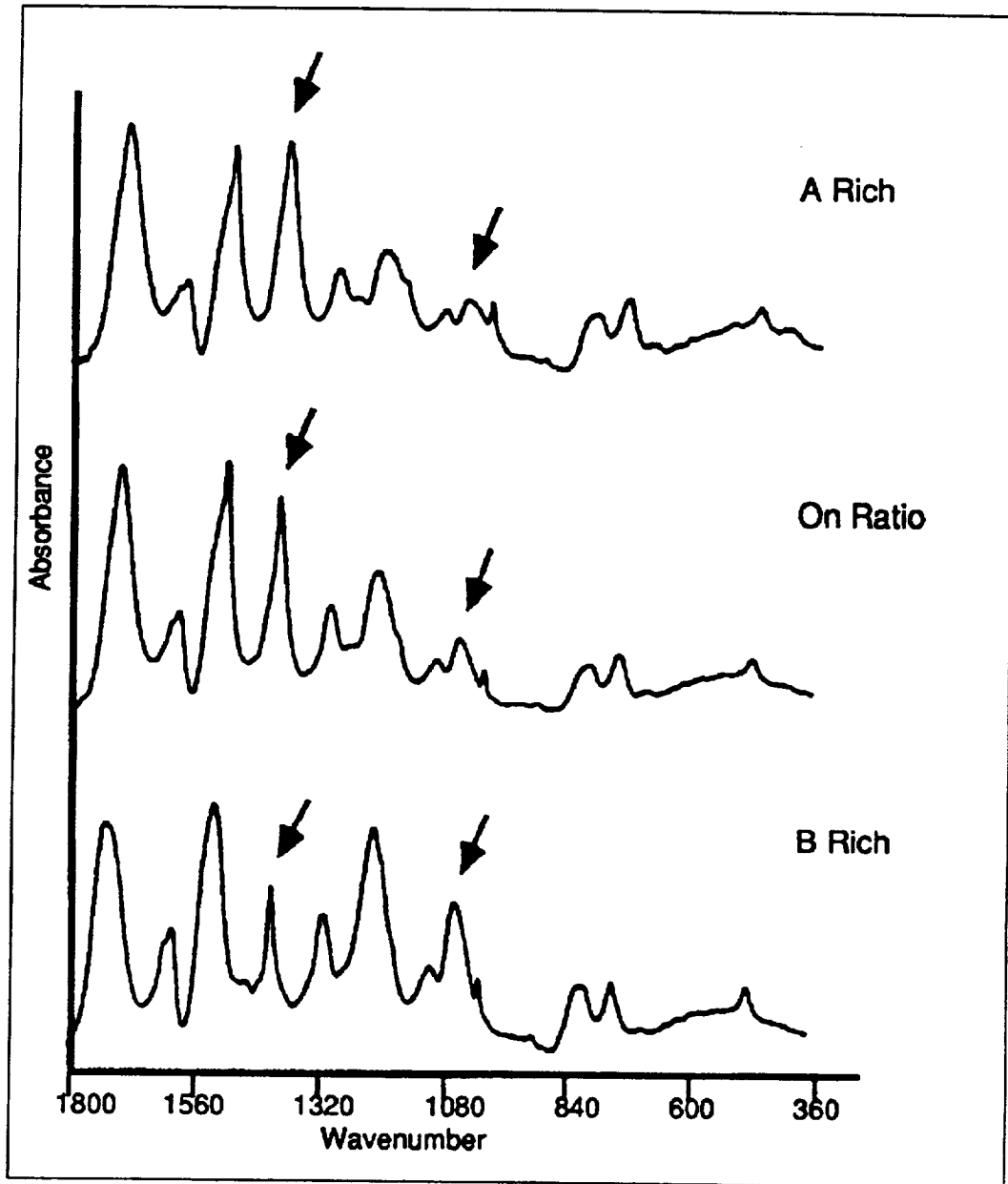

Figure 9. FTIR Detects Off-Ratio Application

### 2.2.3 Failure Investigations

Failure investigations benefit from fingerprint analyses, not necessarily with cost savings, but cost avoidance. When a material is characterized and a reference library is established, the question as to whether the problem is the material or the process and what the solution should be is answered quickly. An example is the electrical harness connector assembly which exhibited an oily residue on the connector face. Fingerprint analyses were able to identify the composition of the oily residue and trace it to its source. A number of potential sources were investigated, such as hydrocarbon oils, but FTIR analysis identified the source to be a silicone fluid (Figure 10) which was used by the vendor to lubricate the metallic braiding sleeve on the exterior of the conductor.

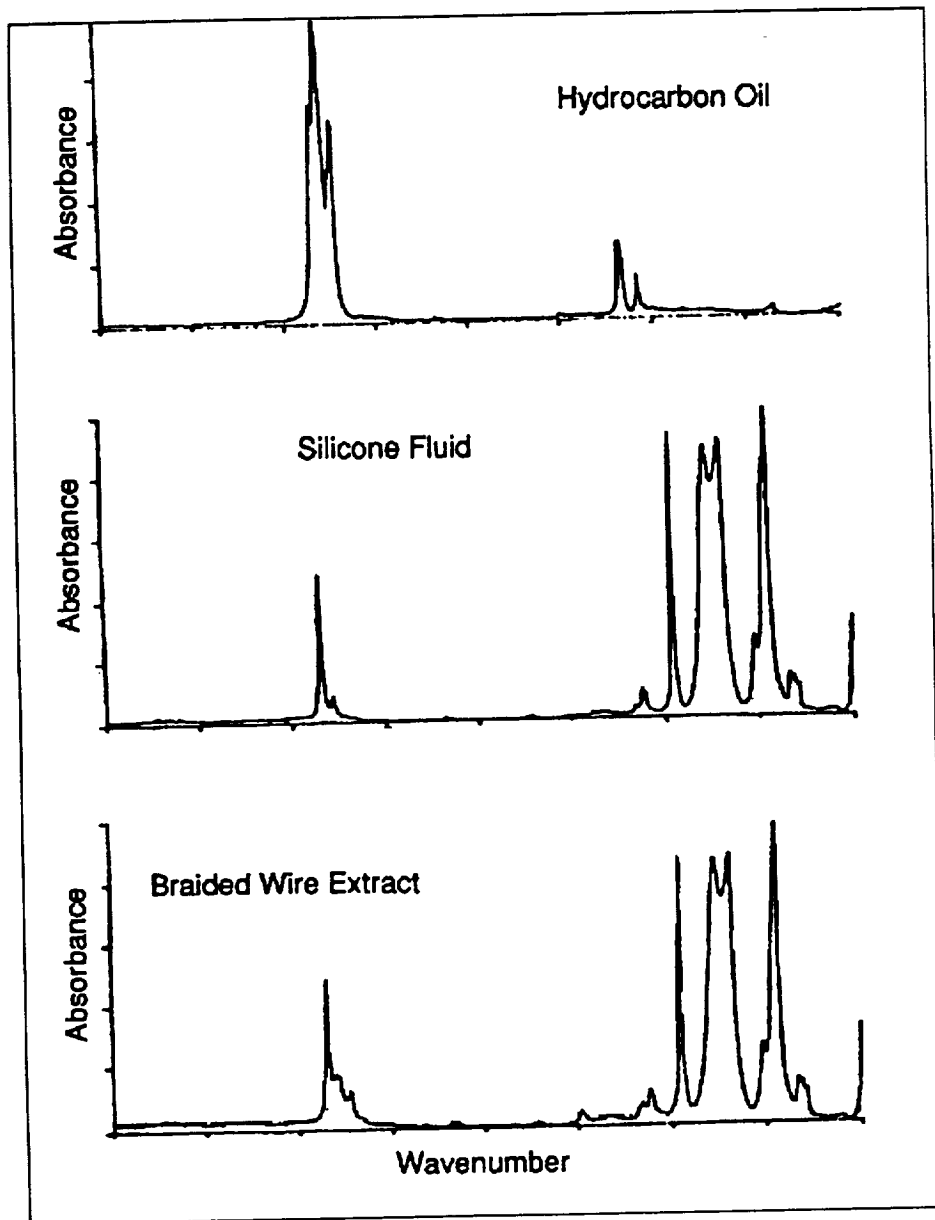

Figure 10. FTIR Identified Unknown Contaminant.

#### 2.2.4 New Material Development

There are many functions fingerprinting can provide in the development of new materials. One is the stability of the formulation. Fingerprinting can determine if a specific ingredient is unstable, that is 1) the ingredient is lost due to volatility, 2) the ingredient degrades, or 3) the ingredient interacts with another ingredient. The formulator then knows whether to replace an ingredient or to put it into a separate component to be added when needed. This information can also be used to measure and increase the shelf life of the material. Correlations between fingerprint tests and performance properties can be obtained to aid in formulation development.

##### *Example 3. Polyurethane foam insulation determination of the 'a' to 'b' ratio*

An important requirement in the preparation of a cured thermal protection polyurethane foam material is the control of the 'A':'B' component ratio. An investigation to determine the true relative amounts of the 'A' Component (isocyanate) and the 'B' Component (polyol) has been conducted. In addition, a study of instrumental analytical methods (FTIR, ICP, and TGA) to determine the true ratio of these components has been completed. The application of these analytical methods together with the use of multivariate linear regression techniques permit the determination of the true 'A':'B' ratio with an error of less than ten percent (10%).

Fingerprinting work performed on these foam material has demonstrated that FTIR, ICP, and TGA are the instrumental methods best suited to the ratio determination. A single lot of foam material for which the results from the full complement of acceptance tests were available was used to prepare accurately weighed "cup" samples (in triplicate) of 0.60:1.00, 0.80:2.00, 1.00:1.00, 1.20:1.00 and 1.40:1.00 'A':'B' ratios. A complement of "production sprayed" samples were also prepared for correlation analysis. The ability to produce these samples (cured foam material) from such extreme ratios is a testimonial to the robust nature of this formulation. The individual samples were then each subjected to FTIR, ICP, and TGA analyses. Both a forward and backward stepwise multiple linear regression analysis was performed on the results from each method and on a composite of all of the results. The resulting predicting equations are of the form:

$$Z = a + b_1x_1 + b_2x_2 \dots + b_ix_i$$

where: Z = 'A':'B' ratio  
a = intercept (forced to zero)  
b = regression coefficient  
x = predictor variable

From the analysis of fourteen wavelengths in the infra-red spectrum, 1510  $\text{cm}^{-1}$  and 1067  $\text{cm}^{-1}$  were identified as the critical predictor variables. These two intensities remained the critical predictors in the composite regression analysis. Partial "f" tests and "t" tests confirmed the significance of these two predictors at the 95% confidence level. The final prediction equation defines a three dimensional planar surface :



$$Z = 0.02349x_1 - 0.02494x_2$$

where:  $x_1$  = intensity at  $1510 \text{ cm}^{-1}$   
 $x_2$  = intensity at  $1067 \text{ cm}^{-1}$

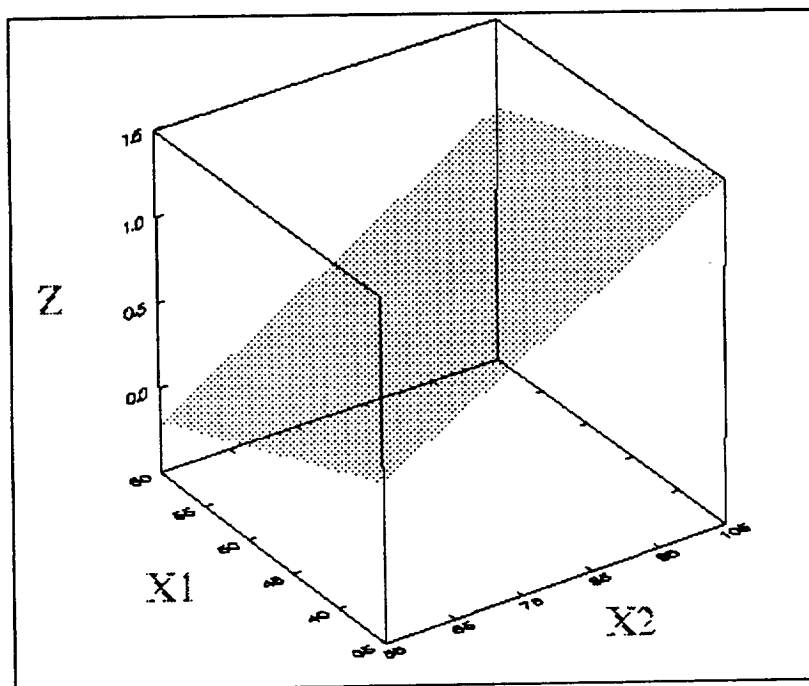

Figure 11. Surface defined by analysis of the IR spectrum at  $1510 \text{ cm}^{-1}$  and  $1067 \text{ cm}^{-1}$ .

This equation produces an adjusted coefficient of determination  $r^2 = 0.999$  and an interval error estimate of  $\pm 0.071$  meaning that 99.9% of the 'A':'B' ratio is explained over the entire ratio interval with a probable error no greater than 7%. The ICP and TGA regressions each had a coefficient of determination of approximately 0.95 and interval error estimates of 0.10 (10%).

Conclusions and recommendations from this study consists of an on-going study to determine if foam aging has a significant effect on the analytical results. Consideration has also been given to the expansion of this effort to include the correlation of the foam's physical and mechanical properties to both the 'A':'B' ratio and its analytical predictors. Alternatively, the knowledge gained in this study could be applied to the adjustment of some or all of the major material or process factors to produce the desired 'A':'B' ratio. It is now possible to accurately determine whether, in the foam application process, the desired 'A':'B' ratio has, in fact, been achieved. FTIR analysis, in particular, revealed that the ratio of infra-red light absorption be a pulverized sample of foam at  $1410 \text{ cm}^{-1}$  and  $1067 \text{ cm}^{-1}$  is a direct measure of the relative amounts of the 'A' and 'B' components reacted to form the cured foam.

### 2.2.5 New Supplier Certification

There are situations when a vendor cannot or no longer wants to supply a product or has changed ownership or the product is produced at a new site. On such occasions, the product delivered by a new supplier needs to be certified. Fingerprinting can increase confidence and decrease certification cost by comparing the new material to a fingerprint data base established for the past product. An example of this occurred when a material changed both ownership and processing location. A data base using quantitative fingerprint parameters was established for ten lots of material supplied by the original vendor. Where possible, reference libraries were compiled on materials supplied by both the primary vendor and sub-tier vendors. When the first lot was received from the new vendor, the color of the material was different, thereby raising questions about the new supplier. Using fingerprint data, it was determined that the problem was caused not by the new owner and location, but by an established sub-tier vendor.

### 2.2.6 Waste Management

Every manufacturing facility which falls under the jurisdiction of the Environmental Protection Agency must comply with CFR 40 in controlling wastes that may endanger the environment or health of mankind. In particular, CFR 40, Part 262 provides specific instructions on "Standards Applicable to Generators of Hazardous Wastes". Each manufacturer that disposes of materials used in the manufacturing operations must understand and comply with these instructions or face potentially heavy penalties for failure to comply.

The major component of CFR 40, Part 262 is that the generator of wastes must know whether or not he is dumping hazardous materials into the environment. Once that assessment is determined and acknowledged, then proper procedures are established to allow for removing the waste materials from the facilities. Note that a complete knowledge of the waste materials leaving the facility is necessary in order to ensure against any subsequent environmental events at disposal sites creating a perception that the facility was not knowledgeable about the composition of its waste materials or that the facility was not in control of the materials leaving the facility. It is also important to remember that once a hazardous material is identified in the waste materials from a facility, then compliance with Department of Transportation regulations are also required. In addition to the federal regulations described in CFR 40, there are also a number of state and local regulatory bodies who may require stringent control of waste materials, with similar potentials for heavy penalties when compliance is not attained.

The organizations who have chemical fingerprinting programs in place have a built in buffer to deal with these types of issues. For one thing, the facilities' materials are part of the chemical fingerprint database and the organization will always have data to substantiate their waste materials lists. The legal ramifications of inadequate waste management can cost heavily in running a manufacturing facility. It is important for all

NASA contractors and sub-contractors to develop adequate chemical fingerprinting capabilities to avoid unnecessary environmental issues



### 3.0 METHODS DEVELOPMENT

When developing an analytical method, a number of steps need to be considered:

1. Define the analytical problem
2. Determine representative sampling techniques
3. Develop techniques to prepare samples and separate interferences
4. Develop instrumental method
5. Control environmental factors
6. Select methods of standardization
7. Utilize statistical methods to evaluate data

The objective of the analysis is to extract the desired information from the sample and compile it in a usable format. Note from the list above that instrumentation is only one step of the total method. Potential sources of error need to be identified for the entire process. Inadequate attention to any one of the steps listed could render the results meaningless. Also note that the preparatory steps are as important and may be more difficult and time-consuming than the instrumental analysis step.

#### 3.1 Defining the Problem

The analytical problem must first be defined. Determinations need to be made about the nature of the problem, how the analytical results will be used, what species are to be analyzed, and what information is required. The needed data may be qualitative or quantitative. The identification of one or more components in a sample is qualitative data, whereas the determination of the amounts is quantitative data. For quantitative data, parameters such as required accuracy, precision, and detection limits are needed along with an estimate of the analyte's concentration. Other considerations are outlined in section 2.1.

#### 3.2 Sampling

The composition of the sample must represent the bulk of the material from which it was taken in order to yield meaningful information. It can take a lot of effort and time to obtain a representative sample when the bulk is large and inhomogeneous. Analytical data quality is critically dependent on the validity of the sample and the sampling program. Care must be taken to minimize uncertainties in the sampling processes or in the storage, preservation, or pretreatment of samples prior to analysis. Poor analytical results may be caused by a number of factors. Examples are contaminated reagents, biased methods, analyst errors in procedure or data handling. Blanks, standards, and reference samples can be used to control most of these error sources. However, neither a control nor blank will solve the problem of an invalid sample.<sup>1</sup>

The composition of the sample must be considered. Depending on the problem either

homogeneous or heterogeneous samples may be sought. With a homogeneous sample every conceivable sample has essentially the same composition, whereas with a heterogeneous sample the composition varies. Additionally, there are different types of heterogeneous samples. The heterogeneity may be of a general nature, or the samples may be different somewhat, but also have within-strata variability such as physically discrete layers. Thirdly, an otherwise homogeneous sample may consist of localized areas, pockets or individual items scattered throughout the matrix.<sup>2</sup> A decision must be made on what constitutes the sample population and what doesn't. The analyst must be cognizant of phase separations, demulsification of emulsions, the plating out of suspended matter and similar problems. At times homogenization may be needed to eliminate subsampling variability problems between laboratories, individuals, or occasions. Techniques can range from simple mixing to grinding or blending.

Sample stability may also need to be considered. Once the sample is removed from its environment, its composition may change due to kinetic effects, container interactions, radiation, air, and more.<sup>2</sup> For example, adsorbed moisture in some solid samples may need to be removed. Otherwise the percent composition of the material may depend on the humidity of the environment at the time of analysis. Proper procedures must be used to store and preserve both samples and standards. Possible dilution or contamination must be avoided. Samples may also need to be analyzed within a safe holding period. Consideration must be given to interactions between other constituents, walls of the container or transfer lines. The samples must be properly handled, labeled, and documented to avoid substitutions, mislabeling or accidental confusion. Throughout the sampling and subsampling procedures, the integrity of the results must be maintained. Take the example of insulating foam on a metal substrate. The foam is applied by multiple passes, thereby causing discrete layers called knit lines. The foam on the outside is exposed to environmental factors such as temperature, humidity, or UV radiation. The outer layer is, therefore, different from the inner layers. The question then becomes: what is a representative sample and will different labs define a representative sampling differently?

An acceptable sampling program will include:

1. A statistical design which accounts for the goals of the studies and its certainties and uncertainties.
2. Instructions for sample collection, labeling, preservation, and transport to the laboratory.
3. Personnel training in the specified sampling techniques and procedures.

Holding time (See Figure 12 below) can be defined as the maximum period of time that can elapse from sampling to measurement before significant deterioration can be expected to occur<sup>2</sup>. The following statistical procedure is suggested to evaluate holding time. A sufficiently large quantity of typical sample is held under a condition of storage

and/or preservation for a period of time. Increments are withdrawn at the beginning and at intervals and measured in duplicate. The differences of the duplicate measurements allow estimation of the standard deviation of measurement. The smallest difference in two measured values that is significant at the 95% level of confidence is  $2(2)^{1/2} s$ , which is approximately equal to  $3s$ .

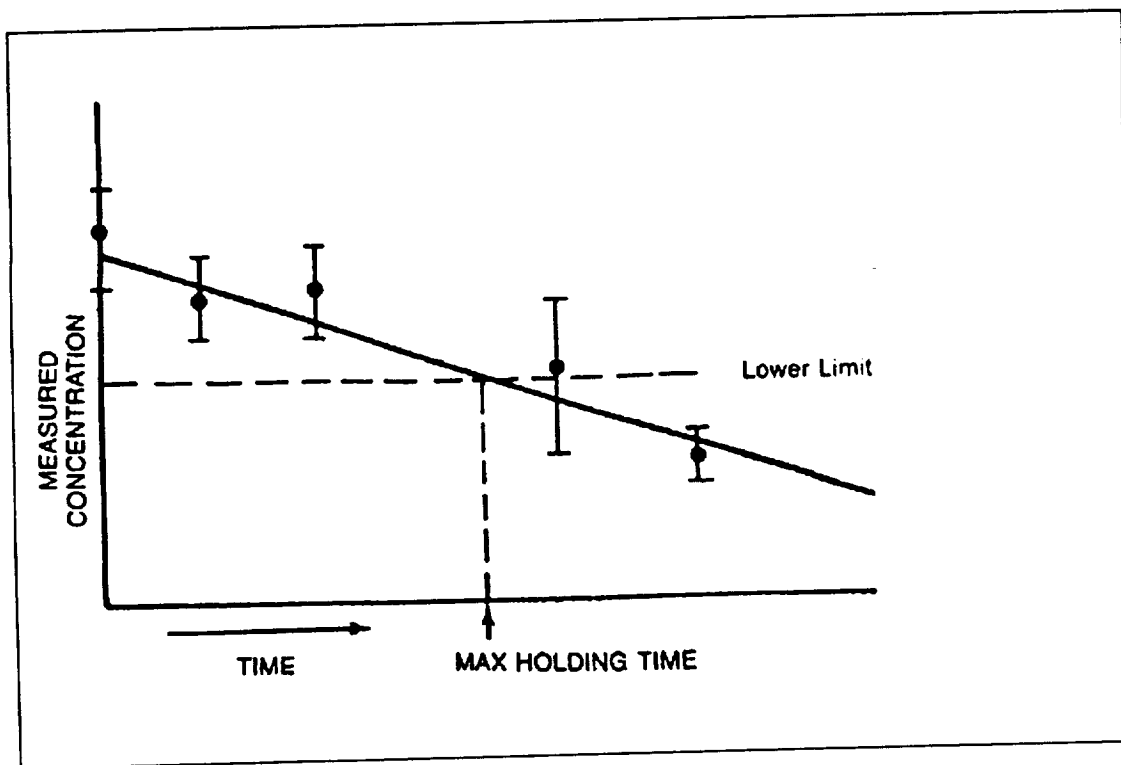

Figure 12 Estimation of holding time (as defined in reference 2).

### 3.3 Procedures

Procedures can be discussed in terms of

- a. pretreatment
- b. controls and calibration checks.

Before actually analyzing the sample, it is sometimes necessary to perform some form of separation or sample pretreatment. The sample may need to be homogenized prior to subsampling or analysis. The pretreatment may involve physical operations such as sieving, blending, crushing, or drying. For example, the KBr used to make pellets for the analysis of solid materials by FTIR needs to be dried before using. The analytical technique may require that the analyses be performed on solutions of the sample. This preparation step may be a difficult and time consuming task when solvents don't exist for some materials such as high molecular weight polymers. Interferences may need to be removed, or analytes may need to be concentrated to reach the desired range for

analysis. Chemical operations may involve dissolution, fusion, separation, dilution, concentration, chemical derivatization, or addition of preservatives, standards, or other materials. Care must be taken to not change the analytes concentration or to introduce contaminants or interferences. The contaminants can be introduced by a number of sources, such as the container, reagents, equipment, atmosphere, environment, or added internal standards. For example, the chemical environment may affect the stability of the analyte through evaporation of the analyte itself or evaporation of a solvent, thereby causing concentration of the analyte. The temperature or pH may need to be controlled. To reduce sources of error, the number of procedural steps and manual operations should be kept to a minimum.

Once an instrumental method has been developed, and before generating data for use, preliminary tests must be performed to demonstrate competence. These will include controls and calibration steps to identify and prevent sources of error, evaluation of acceptable precision and accuracy, a minimization of contamination and interferences, and detailed procedural documentation to enable multiple analysts to achieve replication of results. Proper standardization of the instrument is mandatory for accurate analysis. The standardization method needs to be suitable for a particular procedure and may include calibration curves, standard addition, external standards, or internal standards.

A calibration curve is a plot of the instrument's response to standards of known composition versus the concentrations of these standards. A good rule of thumb for the initial curve is triplicate analysis of five (minimums of three) different concentrations which bracket the expected concentration of the analyte. Calibration must be performed using the same conditions to be used for the sample analysis. The matrix composition for the standard solutions must be as close as possible to the actual samples. Periodic checks or repetition of the calibration curve must be performed to detect any changes in instrument response. These checks should entail one reagent blank and one standard at a level expected in the samples. If the results of the verification are not within  $\pm 10\%$  of the original curve, a new standard should be prepared and analyzed. If the second verification is not within  $\pm 10\%$  of the original curve, then a reference standard should be analyzed to determine if the problem is with the standard or the instrument. The purity of the standard must be known and a purity of 99.5% or better is recommended. If the purity is less than 98%, the appropriate correction factor must be included in all calculations of standard concentration. New standards should be prepared on a quarterly basis at a minimum and more frequently for analytes with shorter shelf lives. Proper preparation, storage, and handling of standards is very important.

The method of standard additions compensates for physical and chemical interferences of the sample matrix. It is necessary that the calibration be linear over the range of interest and have a zero intercept. The analyte signal must be corrected for any background signal. In standard additions a known concentration of the analyte is added to the previously analyzed sample (spike) and the analysis is repeated using identical reagents, instrument parameters, and procedures. Analysis of a minimum of two spiked



samples along with the unspiked sample is recommended in which additions of the analyte equal twice and half the amount of analyte in the original sample. Spiked and unspiked samples should be diluted to the same final volume so that any interferent in the sample matrix would effect each solution identically. Sufficient time should also be allocated to reach solution equilibrium between the spiked standard and matrix interferences. The instrument response of each solution is plotted versus the concentrations of analyte added to the sample solutions, graphically represented in Figure 13.

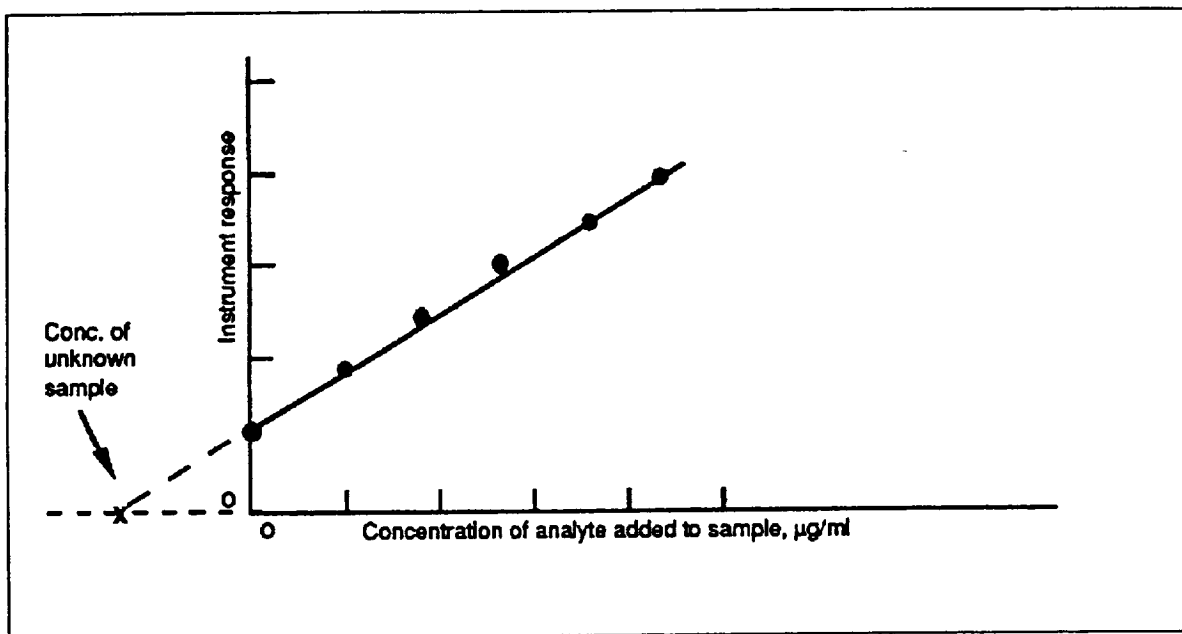

Figure 13 Method of Standard Additions

The concentration of the unknown sample is derived graphically by extrapolation to zero response on the negative X axis. This method is extensively used in atomic absorption and flame emission spectroscopy and electro-analytical chemistry.

The internal standard method compensates for differences in the physical properties of a group of samples with the same analyte. An example of these variables would be the injection volume from sample to sample in chromatographic analyses. When selecting an internal standard for a particular method, there are several properties that the internal standard should have. The concentration of the internal standard in samples and standards must always be the same. Its chemical and physical properties should be as similar as possible. The compound should be stable, be of a known purity, and have as low a toxicity as possible. The measurement of the internal standard should not be affected by method or matrix interference. The internal standard should be of the same order of magnitude as that of the analyte. The response should not interfere with the response of the analyte, therefore, it should not be indigenous to the sample. With these

limitations, no internal standard can be chosen that is applicable to all samples. For a multi-component sample, often more than one internal standard will be needed. This method is often used in gas chromatographic analysis with the additional recommendation that the retention time of the internal standard be close to the retention time of the analyte. In the method a fixed known amount of a pure compound, the internal standard, is added both to the samples and the standards. The response ratio is the response of the analyte divided by the response of the internal standard. A calibration curve is established by plotting the response ratio as a function of the analyte concentration.

### 3.4 Quality Control

When using fingerprinting as a quality assurance tool, fingerprint measurements themselves need their own quality assurance program to ensure reliable data.<sup>4</sup> Each laboratory should have a formal quality control program, which covers the entire analytical measurement system, including sampling measurement, calibration and quality assurance. When developing the program, other factors such as time, resources, and sample availability need to be considered and may necessitate compromises. To bring this all together it is important to have interaction between and within the various departments which have the individual expertise in chemical analysis, statistics and production.

There should be an initial demonstration of the laboratory's capability for the fingerprint method and an ongoing analysis of quality control samples to evaluate and document data quality. The characteristics of the method must match the measurement requirements. The laboratory should determine that the method has adequate:

- sensitivity
- selectivity
- accuracy
- precision

These characteristics will be covered in detail in the chemometrics section. There are other desirable characteristics that the method should have, including:

- large dynamic measurement range
- ease of operation
- multiconstituent applicability
- low cost
- ruggedness
- portability

Once a method is developed and subsequently adopted it must be used in a reliable and consistent manner to ensure that reproducible data are provided. The best way to

implement the method is to document it in detailed written procedures.

The objective of a quality assurance program for analytical measurements is to reduce measurement errors to tolerable limits and to provide a means of ensuring that the measurements generated have a high probability of being of acceptable quality. Quality control is the mechanism established to control errors, while quality assessment is the mechanism to verify that the system is operating within acceptable limits. Reference 4 provides a thorough discussion of these concepts.

The quality needed for the fingerprint measurement is relative. What may constitute high quality in one situation may be unacceptable in another. For example, if the purpose of the method is to calculate the concentration of catalyst in a formulation and a change of 5% will affect the processing properties unacceptably then the variance in the measurement itself must be less than 5%. The error that is tolerable for each property to be measured must be first established based on the judgement of the end user. These tolerance limits must be the best estimate within which the "measured property must be known to be useful for its intended purpose." The permissible tolerances in measurement error can then be established after the tolerance limits for the measured property has been determined. The measurement system must be in a state of statistical control to provide the basis for establishing confidence limits that are reliable for the data input.

A list of elements to assure the quality of the fingerprint data are:<sup>3</sup>

1. Maintenance of skilled personnel, written and validated methods, and properly constructed, equipped, and maintained laboratory facilities.
2. Provision of representative samples and controls
3. Use of high-quality glassware, solvents, and other testing materials
4. Calibration, adjustment, and maintenance of equipment
5. Use of control samples and standard samples, with proper records
6. Directly observing the performance of certain critical tests
7. Review and critique of results
8. Tests of internal and external proficiency testing
9. Use of replicate samples
10. Comparison of replicate results with other laboratories
11. Response to user complaints
12. The monitoring of results
13. Correction of departures from standards of quality.

The following quality control samples and procedures will be discussed and are recommended for use:

- Standard Reference Materials (SRM)
- interlaboratory comparisons

- multiple instruments
- blanks
- replicate samples
- spiked samples
- control charts

An evaluation sample can be defined as any test sample that is used to evaluate any aspect of a measurement process. There are three requirements for the evaluation samples. First, the matrix of the evaluation sample must match the sample of interest so that the composition of the sample and the kind and level of minor constituents and impurities that could be present are equivalent. Second, samples must be reasonably homogeneous so that subsamples have an insignificant variance of composition. The third requirement is that the samples should not show any significant deterioration or change in analyte level during the time interval expected for use.<sup>2</sup>

A good rule of thumb, when determining the amount of analyses for fingerprinting quality control (laboratory QC) expressed as a percentage of the overall analysis, is 10%. An additional 5% should be added for field QC when appropriate.

#### 3.4.1 Standard Reference Materials

Standard Reference Materials are materials for which the properties and composition are certified that they can be used to monitor data accuracy. For such the source, composition, and standard purity must be established. The standard purity must be documented and possible interferences or time dependence of the composition must be known. The stability of the reference material is just as important as the certified value. Resources of these materials and information are:

- National Institute of Standards and Technology (formerly U. S. National Bureau of Standards)
- U. S. Environmental Protection Agency
- U. S. Food and Drug Administration
- U. S. Department of Agriculture
- Commercial sources

Reference 5 focuses on "Standard Reference Materials and the Goal of Accuracy." Standard Reference Materials (SRMs) can be obtained for a diversity of materials from alloys to foodstuff to polystyrene spheres (manufactured on the space shuttle). To obtain these materials is just the first step; they must subsequently be used properly and their limitations understood. When using SRMs it is important to distinguish between precision and accuracy.

The *accuracy* of the data can be confirmed by SRMs. Accuracy is the degree of agreement of a measured value with the true or expected value of the quantity of

concern. Precision is the degree of mutual agreement characteristic of independent measurements as the result of repeated application of the process under specified conditions. Precision then gives no indication of how closely a set of measurements approaches the true value. One can have a set of measurements that are extremely precise, but also extremely wrong.<sup>3</sup> Therefore, SRMs are needed for accuracy determination despite the precision of instrumental methods today. In fact the precision of a specific experiment can be better than the certainty estimates that accompany each SRM. This is due to material nonhomogeneity and for the material being studied, the extent and type of nonhomogeneity must be understood before using an SRM. The nonhomogeneity of the SRM should also be considered. The SRM should be used after the analytical method is shown to be in a state of statistical control. Precision should be established as a prelude to accuracy. Note, since SRMs can be expensive and available in limited amounts, their use is discouraged when demonstrating the statistics of the measurement process, so other materials should be used.

When choosing an SRM, the composition of the standard must simulate the composition of the samples to imply that an accurate measurement of the standards equates to an accurate measurement of the sample. The reference material should simulate the actual sample with respect to both the matrix and the level of analyte. The protocol used on both the standard and the sample must be the same and no special care must be taken in analyzing the standard other than that usually used. In some cases, a single reference material may not completely diagnose a measurement system. There may be a need for several reference materials that differ in the analyte level to assure the absence of significant bias throughout the concentration range of interest or to identify its nature if found.

#### 3.4.2 Interlaboratory Comparisons

A laboratory can demonstrate close agreement with acceptable levels of accuracy by participation in interlaboratory comparisons. Another needed comparison is multiple operator variability. Interchange of operators and apparatus/equipment can be used as a quality assessment technique.

#### 3.4.3. Multiple Instruments

Comparison tests may be performed on different analytical techniques to assure the analyst that neither positive nor negative interference effects are operative, thereby distorting the accuracy of the reported values. An important utilization is the quantification of elemental content when a new or unusual sample matrix is encountered. For example, comparison tests may be performed between Inductively Coupled Plasma/Atomic Emission Spectrometry (ICP/AES) and Atomic Absorption Spectroscopy. ICP/AES results can be affected by physical or chemical interferences that are highly dependent on matrix type and the specific analyte element. Another example is gas chromatographic analysis using a flame ionization detector (GC/FID) in

which multiple compounds are indistinguishable because they elute at the same time, or a higher concentration analyte masks a lower concentration analyte and the result for either case is a single peak. This problem can be circumvented by confirming the lack of coelution or the identity of the coelutant by GC analyses using a mass spectrometric detector.

#### 3.4.4. Blanks

A good discussion on analytical blanks can be found in Reference 6. The analytical blank can be defined as contamination from all sources external to the sample. How well the blank can be controlled will greatly affect the accuracy of low-level trace determinations. In high-accuracy analysis, the blank will also affect the accuracy that can ultimately be obtained. The sources of the blank are variable. This variability determines the uncertainty of the blank correction and often the lower limit of the trace concentration that can be determined with reliability. Therefore, the variability of the analytical blank must be controlled in order to improve the accuracy and lower limit of trace determinations. To reduce the size of the blank, the sources of the blank must be controlled.

The analytical blank is a result of contamination from four main sources:

- the analysis environment
- the reagents used in the analysis
- the apparatus used
- the analyst performing the analysis.

Whenever a blank contribution is significant, the quality control program must give special emphasis to blank control. When performing analyses on an analytical batch, each batch should be accompanied by a reagent blank. The analytical batch can be defined as a set of samples which are analyzed together by the same method sequence using the same lot of reagents handled with the same manipulations and analyzed within the same time period or in continuous sequential time periods. For measurement purposes, the sample that is measured as the blank is an artificial sample designed to monitor artifacts that are introduced into the process.

A reagent blank is prepared from an aliquot of analyte-free water, solvent, or matrix that contains all constituents except the sample. The reagent blank is carried through the entire analytical procedure. If the procedure calls for the addition of internal or surrogate standards to the sample, they are likewise added to the blank. If acids or chemical preservatives are used, the same quantity of preservative should be added to the blank as normally would be added to the sample. (Note: Some texts will differentiate between a reagent blank and a method blank.) As such, the reagent blank consists of each reagent or solvent used in a given method of analysis. The method blank determines whether the cumulative blank interferes with the analysis and is

determined by following the procedure step-by-step from sampling to detection, including all reagents and solvents in the quantity required by the method). To calculate the "true" concentration of the sample, the value obtained for the method blank is subtracted from the value measured for the sample. In some cases field or equipment blanks are necessary and are included as one of the cumulative contributions to the method blank. Field blanks are aliquots of analyte-free water or solvents brought to the field in sealed containers and transported back to the laboratory with the sample containers. Equipment blanks may be needed to check the cleanliness of the sampling device and as such they are opened in the field and the contents are poured, as appropriate, over or through the sample collection device, collected in a sample container, and returned to the laboratory as a sample.

To help the analyst to control or reduce the blanks, causes or recommendations will now be discussed.

Environment Ways to control the environment can range from good housekeeping practices to conducting all operations in a clean room. There are a variety of clean benches and enclosures that can be purchased to provide clean areas to carry out specific operations.

Reagents All the chemicals that may contact a sample can add to the reagent blank. In cases where the sample needs to be dissolved or extracted, then large quantities of chemicals are involved and can make large contributions to the reagent blank. Even if the chemicals are relatively pure, care must be taken especially when trace analyses are conducted. Water or non-aqueous liquids that are used to dissolve, dilute, or wash can add to the blank. To obtain reproducible blanks, both the quality and quantity of reagents need to be known and controlled. The chemicals used should be recorded and a set of measurements should be made for each manufacturing lot.

Apparatus The apparatus that is used can add to the blank especially if chemical operations are involved. There may be a number of apparatuses used if there are multiple steps such as recrystallization, precipitation, distillation, extraction, or washing with an appropriate solvent. Both positive and negative blanks can result from such things as glassware, bottles, filters, mortars, sieves, stoppers, syringes, shakers, septa, and transfer lines. Positive blanks would involve additions such as contaminants from storage bottles. Negative blanks would be removal or losses such as irreversible absorption of trace metals on glassware, or organics on chromatographic columns.

To control apparatus blanks, care must be taken in choosing the materials, i.e., a specific grade of solvents, and controlling the areas where the work is being performed. In some cases a piece of equipment or a specific facility must be dedicated exclusively to a particular sample or a narrow concentration range of the analyte. For example, in quantitative trace levels of elements, glassware used for high concentration standards should not also be used for low level standards. Another example is separate facilities

for volatile and semivolatile organic analyses in which extractions with methylene chloride for semivolatile analysis should not be done in the same vicinity as volatile analysis since in volatile analysis methylene chloride is one of the analytes measured.

It is important to write and consistently follow procedures for cleaning and/or conditioning the instrument, glassware, storage bottles, sample containers, and transfer lines. Storage after cleaning needs also to be controlled. Special care must be taken if a central location is used for cleaning. The use, cleaning, and storage of specific items must be pre-identified and followed otherwise all items cleaned in the central facility must be cleaned according to the method with the most stringent requirements.

Analyst Contamination or sample losses can result from the physical contact of the analyst, or the garments that are worn. An example frequently encountered are gloves. Organics such as phthalates can be extracted from the gloves and subsequently contaminate the sample during cleaning or sample manipulation.

When measurements are getting close to the limit of detection, blank corrections become increasingly important. A small variability of the blank can have a major effect on the sample value. A question often asked is what constitutes an acceptable limit for a blank. The accurate evaluation appears more important than the absolute value of the blank, however, for good measurement practices the value should be kept to a minimum and within reasonable limits. A good rule of thumb in the case of trace analysis is to limit the blank correction to no more than ten times the acceptable limit of error for the measurement and, also, that it should never exceed the concentration level expected in the sample.<sup>6</sup>

Whenever an analysis is made, a method blank should be determined. How many blanks to run is determined by the method of analyses and the number of samples being analyzed at a given time. For example, in a gas chromatographic analyses of semivolatile organics, a blank is run with each series of samples analyzed. If all procedural steps are the same for the series of samples then analyzing one blank for every nine samples is a good rule of thumb. However, if a calibration is changed or reagents are changed or some other procedure step is changed, then another blank will need to be analyzed representative of the change resulting in a greater frequency of blanks analyzed.

#### 3.4.5 Replicate Samples

A replicate sample is prepared by dividing a sample into two or more separate aliquots and analyzing each aliquot. Duplicate samples are considered to be two replicates. Some texts will differentiate between split samples and replicates, when duplicate samples are collected (replicates) versus when a representative subsample from the collected sample is removed (split samples). Replicate sample analyses will assess the precision of the method. A good rule of thumb is to analyze a duplicate with each analytical batch or once per twenty samples, whichever is the greater frequency.



### 3.4.6 Spiked Samples

Either a sample or a blank can be spiked with a predetermined quantity of a stock solution of analyte. A *matrix spike* occurs when the actual sample matrix is spiked. A *check sample* is a blank which is spiked with the analyte to monitor the execution of the analytical method. Spiked samples are effective for the analysis of samples by gas chromatography, liquid chromatography, ion chromatography, gas chromatography/mass spectrometry and inorganic analytes. Another type of a spiked sample is the *surrogate spike*. The difference between spikes and surrogates is that spiking refers to the addition of the analyte to be measured to a sample, while a surrogate is a different substance which has the same measurement properties as the analyte of interest. Surrogates should be chosen with care with the best ones being labeled analytes, isotopes, and isomers. Surrogate spikes are used in the environmental chromatographic analysis of organics. Here surrogates are organic compounds which are similar to the analytes of interest in chemical composition, extraction behavior, and chromatography, but which are not normally found in environmental samples. Often deuterated compounds are used. All blanks, standards samples and spiked samples are spiked with the surrogate compounds prior to analysis. The percent recovery is calculated for each surrogate. The advantage of surrogate spikes is that it checks the accuracy of every sample analyzed. This is important in multistep methods where problems could occur from multiple sources such as sample loss during extraction or concentration, septa or column leaks, error in injection volume, and cold spots in the chromatographic transfer lines, just to name a few. This is especially true when needing reliable measurements at very low levels.

The recovery of the method is derived from measuring spiked samples. The recovery is determined by the equation:

$$\% \text{ recovery} = \frac{C(\text{found})}{C(\text{added})} \times 100$$

where C(added) is the known added concentration of the analyte and C(found) is based on the net analyte signal for the spiked sample.

The objective of spiking is to determine the extent of matrix bias or interference on analyte recovery. Spiked samples provide a proficiency check for accuracy of analytical procedures. Like replicates, the same rule of thumb for analysis frequency holds: one spike with each analytical batch or once per twenty samples.

### 3.4.7 Evaluation Samples

Considerable care must be taken when preparing evaluation samples. The method of choice is gravimetric addition because volume additive effects can be significant

when using volumetric procedures. (Note: In environmental organic analysis, surrogates are often added by volume using a syringe; however, the volume of surrogate relative to sample volume is negligible.) To prepare evaluation samples by blending, either measured amounts of the components or a dilute mixture of the analyte is added to a measured amount of matrix. Specifically, how liquids, solids, and gases are handled follows.<sup>2</sup>

#### 3.4.7.1 Liquid Samples

Even though miscible liquids blend perfectly, the analyst must be careful that the method of addition doesn't cause stratification of the constituents. For example, if two liquids differ a lot in density, then layers could result from bulk additions of one liquid into another. Multilayers may not be detected in opaque containers or if one additive is especially small in volume (i.e., 10  $\mu$ L of surrogate spiked into 10 mL of sample). These problems can be taken care of by always ensuring that there is careful and adequate mixing.

#### 3.4.7.2 Solid Samples

A solid sample can be spiked by addition of either a solid or a liquid. One problem that may be encountered is after the solvent evaporates the analyte may deposit in a localized area of the matrix. Uniform mixing in this case may be difficult. Likewise uniform mixing of a small amount of one solid with a larger amount of a second solid is difficult. In both cases, consumption of the entire mixture may be advisable.

#### 3.4.7.3 Gas Samples

To blend gases statically, quantities can be mixed together that are measured gravimetrically, volumetrically, or manometrically. To completely mix gases will take a considerable amount of time, especially if there are disproportionate quantities. Consequently this method is rarely used when working with trace amounts of analyte.

A better way to produce gas mixtures is to dynamically blend two gas streams together with careful control and measurement of the flow rates. In the design of the blending system, there should be turbulence at the point of mixing.

#### 3.4.8 Control Charts

Measurements of replicates, spiked samples, and surrogates can best be interpreted using control charts. The result of a quantitative chemical analysis (*fingerprint*) is a measurement (stated as a number) of a property of the sample(s). Since variation is ever present, the measurement must include an estimate of the errors inherent in the determination. The quantification and minimization of these errors is at the heart of the quality assurance effort and are a never ending activity. A very effective approach is to

consider the analysis to be a *process* and employ the methods of Statistical Process Control (SPC).

Statistical process control has created a profound and fundamental shift in emphasis from defect detection (Quality Control) to defect prevention (Quality Assurance). The basic tools of SPC are control charts which are originated, used, and maintained by the process operator (analyst). They provide visual quantitative information on the current state of the process as well as a performance record over time (trends). Utilizing the chart, potential problems can be detected and corrected before the process performance is impaired.

The control chart is a pair of graphs which present consecutive determinations of means (averages) of sample measurements (*fingerprints*) and an associated estimate of the variation (usually the *range* or *standard deviation*). On both graphs there is a central horizontal line which is the grand average of the data used to establish the chart (Figure 13). It is necessary to collect as large a number of observations (not less than 50) as possible in order to obtain an adequate estimate of these means. This initial activity has the additional advantage of providing (frequently for the first time) an accurate picture of the measurement capability of the analytical process. This initial evaluation is known as a "*Process Capability Study*" and is a critical step in establishing control of the process. If the process capability study demonstrates that the process is not within the required limits, action must be taken to improve the process and then be followed by a new round of data collection. In any case, the data collection should consist of a number of "*runs*" of fixed size (3 - 6) which is dictated by the nature of limit lines (Figure 13). These lines are based on multiples of the "*standard error of the mean*" added to (upper lines) and subtracted from (lower lines) the grand average. Once established, the chart is maintained by plotting the mean and range or standard deviation computed from the same fixed size "*runs*" used to set the control line values.

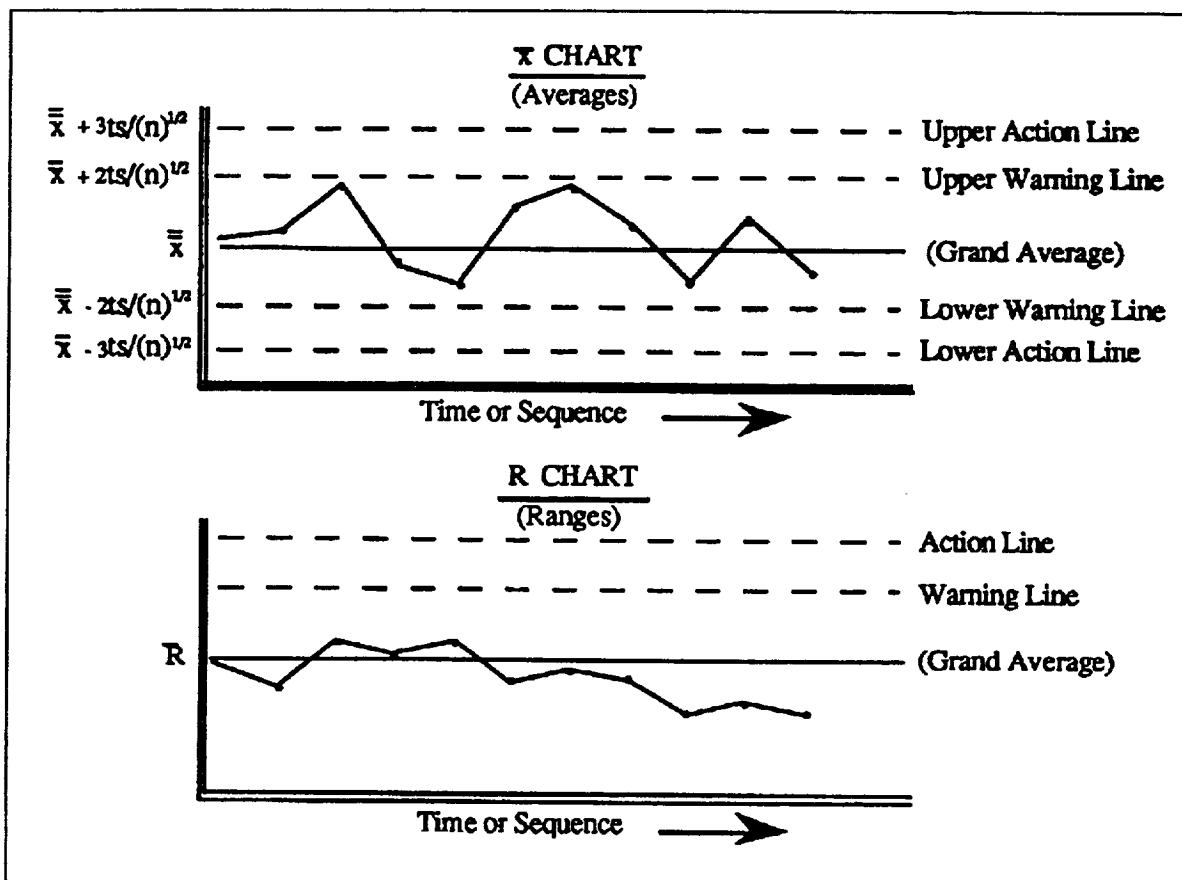

Figure 13 Example of a Control Chart

For complex instrumental analyses it may be desirable to use several control charts. For example, in gas chromatography, using a selected standard sample, retention time, peak area, and column resolution may each be the subject of a control chart. The proper application of SPC control charts promotes statistical awareness, facilitates control and maintenance, provides a graphic history of process variation, and most importantly, becomes a tool for constant improvement.

### 3.5 DATABASE COMPILATION

The fingerprinting of a complex material is necessarily dependent on the analysis of a large amount of chemical data. These data must be conveniently accessible to the analyst in a form suitable for study and exploration with the aid of a computer. Since the analyst is often involved in the treatment of only some of the available data, extraction of the desired information using selection rules is a valuable capability.

Careful planning of the database format should precede the entry of any

information. First a decision must be made as to the general kind of information the database is to contain. For example, if the database is to be used to collect information from analyses performed on a single analytical instrument, it will probably take the form of a "Log Book." That is, it would have an individual record for each sample analyzed with categories provided for specific data such as: date, start and finish times, method used, calibration data, standards used, chromatography column, scan parameters, detector gain, and analytical results (or a reference to the file containing them). The detailed planning for a "fingerprinting" database should include considerations of at least the following:

1. An identification format (name) is needed for the records. This is generally the sample identification or laboratory account number.
2. Date information (sample received and/or sample completed) should be identified.
3. The analytical instrument and/or analyst should be identified.
4. For the analytical results, one category should be provided for each type of analysis and specify both the numerical result and the units.
5. If the reported analytical result is the mean of several observations, the number of observations and the standard deviation, coefficient of variation, or variance should be included.
6. If the analysis was part of an acceptance test, the result (pass/fail) should be an included category.
7. If the analysis resulted in a rejection of the sample, a category for the identification of the rejection form should be provided.
8. A category for the notation of any special conditions or circumstances (remarks) should be provided
9. If the original order of database entry is important, a sequence number category (which can be used to restore this order) must be provided.

The real benefits of a good database manager program stem from its ability to display the same data in a variety of creatively different ways. Given a well planned, maintained, and accurate database, many ad hoc queries can be made which result in reports including those based on time intervals, numerical ranges of results, records containing missing data, reports arranged in chronological order, reports arranged in ascending or descending order by analytical result and many ordered combinations of these criteria. The reports, generated by these queries can *themselves* be made into a

separate database. Most modern database manager programs make provisions for the creation of calculated categories which may be used for some data pretreatment in advance of more complex analysis. The reports generated may also be exported to other computer programs such as spreadsheets (for additional calculations) and word processors (for preparation of printed reports) and even to other computers via networks, modems, or magnetic media (disks or tapes).

### Statistical Software

In recent years a number of excellent and exceptionally extensive statistical software packages have appeared. These programs can be installed on computer platforms ranging from rather modest personal computers (PCs) to large mainframe machines. They offer as many as twenty separate groups of statistical analysis procedures complete with embedded graphics routines (many in color) and often include a database management facility with spreadsheet options. The statistical procedures provided are applicable to a spectrum of analytical and exploratory activities from business and social sciences to physical sciences and engineering (including applications in quality and reliability analyses). Many of these programs recognize that, no matter how complete their procedures are, some users will need to make modifications or otherwise customize certain applications and, therefore, provide a high level programming language for this purpose.

Although these statistical programs are very reasonably priced (especially given their many features), if project resources or the limited statistical scope precludes their purchase, most of the required programming procedures are well documented in the available literature and may be entered directly into the PC by the analyst/statistician. In particular, Volume 4 of "Data Handling in Science and Technology" (see Appendix) contains most of the required statistical procedures in the form of modules in the BASIC programming language.

## 3.6 BASIC RESOURCES

### 3.6.1 Instruments

Fingerprinting is performed on analytical instruments and as such it is important to select and purchase reliable instruments. The relative cost of the purchase will dictate the amount of time and energy to be invested. When choosing components or complete instrument systems, the following parameters should be considered:<sup>6</sup>

- Validity of methodology
- Versatility
- Ruggedness and simplicity of design
- Skill requirements
- Compatibility with existing equipment

- Availability of service and parts
- Reputation and experience of manufacturer
- Capability for updating or adding accessories in the event of changes of technology or in the program of the laboratory

### 3.6.1.1 In-House versus Subcontract

Analytical instrumentation is complex and costly and preferably requires a skilled operator, especially during the method development and preventive maintenance stages. One may, therefore, question whether to set up and perform the task in-house or to subcontract the work to a specialist laboratory or university. To answer this question a realistic cost trade analysis is needed.

In addition to a cost estimate, there are many other questions to ask:

- Will higher quality data be obtained in-house?
- Is the service difficult to obtain externally?
- Is there a need to protect the proprietary nature of the method or data so that it must be done in-house?
- What is the required response time and will the response be quicker in-house?
- Do in-house programs have a gap that this capability will fill?
- Will this service attract other services that are needed?
- Does it provide employment where resulting losses are compensated by other gains?
- How long will the product be needed?
- Are there rapid changes in the technology?

Determining quality in third party laboratories is an important issue in aerospace. Consequently third-party auditing and accrediting of both independent and in-house materials testing laboratories is available through organizations such as the National Aerospace and Defense Contractors Accreditation Program at the Performance Review Institute (sponsored through the Society of Automotive Engineers).

Even with an unfavorable cost estimate, yes answers to certain of the questions above may be more important and make it necessary to establish an in-house capability. Another option is a rental or lease agreement.

If services are contracted to an outside laboratory it is very important to ensure that the laboratory provides the quality of data that is needed.

### 3.6.2. Personnel Requirements

For a laboratory to generate reliable fingerprint data it is very important that the

personnel have adequate education and training. The instrumentation used for fingerprinting is complex, especially during the method development stage such that an undergraduate education no longer sufficiently trains an analytical chemist. Many analytical chemists specialize today where one may be trained in chromatography, another in surface science, and another in elemental analysis. Some further specialize in one technique, such as a mass spectrometrist. Even analytical chemists with advanced degrees and/or experience periodically need additional training since the field is dynamic with technological advances and the introduction of new instrumental techniques. On the job training must be considered a continuing activity that starts with new employees and provides reviews for continuing staff.

Recommendations can be made for a skill base with the understanding that fingerprint programs will differ in size and available resources. The person implementing the fingerprint program should be a chemist by degree or by experience with instrumental analysis of organic and inorganic compounds. Preferentially lead chemists are needed in one or more of the following areas:

- Gas chromatography with various detectors (mass spectrometer especially beneficial)
- Liquid chromatography
- Infrared spectroscopy
- Elemental analysis (ICP/AES especially beneficial)
- Surface science
- Thermal/Mechanical analysis

These lead chemists need more than just to be able to run the instrument. Their experience must cover four categories:

- Instrument troubleshooting
- Method development
- Instrument and accessories operation
- Data interpretation

It is mandatory that laboratory personnel understand when an instrument is and is not generating reliable data. With lead chemists as technical supervisors, then much of the sample analysis can be performed by degreed chemists with little experience. The methods, including analysis and calculations, can be automated, but data must be reviewed by lead chemists.

Another category to be stressed is a thorough understanding of sampling. The analytical chemist should train the sampling personnel to ensure the sample is worthy of analyses. A questionable sample could vitiate an otherwise valid measurement program.

Training courses are provided by the instrument manufacturers, universities and



private companies. Courses are available for each type of instrument that specialize in areas such as theory, instrument operation and repair, method development or data interpretation. Attendance provides opportunities to associate with colleagues, to exchange ideas, and to receive specific information. Personnel should also be encouraged to read technical publications. Most agree that research personnel should continually update their knowledge, but a more narrow view is usually taken of analytical personnel in a support function. This should not be the case. The resource allotment is small to encourage educational and training activities, but can yield improved measurements and contribute to the continuous outputting of quality data. Training courses can be included in the purchase contracts for new equipment.

### 3.6.3. Laboratory Information Management Systems (LIMS)

Analytical effort is always accompanied by volumes of data. Laboratories are routinely required to control, store, manipulate, and report large quantities of these data. In the past these data management tasks were accomplished using intensive labor, reams of paper, manual delivery, and filing cabinets. Manual techniques for lab data management require a large percentage of laboratory manpower and create a drain on technical expertise. This need has resulted in a movement to automate data management for the laboratory environment.

A relatively new tool available commercially for performing these data management tasks is the Laboratory Information Management System (LIMS). LIMS is a classification of technical database that is specifically designed to support the collection and reporting of laboratory data. LIMS technology is a rapidly expanding and diverse field. A variety of choices awaits the potential LIMS user, but in general, LIMS provides the capability to collect lab specific data, store the data in a secure central database, and allow electronic access to the data. Typically data entry is via keyboard, data storage is accomplished using various computer media, and reporting is handled via video display or printer.

LIMS technology offers laboratories the opportunity to increase information flow while enhancing the productivity of data management. Since LIMS provides a rapidly accessible centralized data storage facility, data can be accessed, manipulated, and reported in fractions of the amount of time required for manual techniques. Additionally, computer based data can be accessed and reported automatically using easily implemented programming techniques thus removing even more touch labor from the data handling process. Typical lab data management functions that benefit from productivity enhancement as a result of LIMS implementation include:

- Formatted reporting of laboratory data
- Generation of periodic reports
- Data validation and process control
- Data storage and retrieval

- Sample tracking and progress reporting
- Management decision making

Advanced LIMS applications frequently further enhance lab productivity by providing automated capture of test data, interactive data analysis capability, and automated distribution of lab data.

#### 3.6.3.1. Production Process Database Requirements

Laboratory database requirements vary with laboratory applications. All labs require collection and storage of sample background and test result data. Some labs, however, require more extensive support of these and other data. For example environmental and clinical labs require more exhaustive audit trail support than do typical QC labs. Many other requirements for LIMS functionality must be considered. Requirements typical of an aerospace LIMS applications are delineated below.

#### 3.6.3.2. Data Support

LIMS must be capable of tracking the various types of laboratory data:

##### Sample Data:

- Sample description
- Sampling information
- Lot numbers
- Special instructions
- Warnings & handling information
- Special codes and designators

##### Accounting Information:

- Charge numbers
- Analyst and personnel information

##### Audit Trail Data:

- Time stamps
- Responsible personnel
- Sample location (chain of custody)
- Sample alterations and deletion

##### Requirement Information:

- Document name and revision
- Analysis requirement range and units
- Result specifications (sensitivity, etc...)

##### Analysis Data:

- Analysis results
- Analytical remarks and comments
- Analytical units
- Labor expenditure

### 3.6.3.3. Flexibility and Tailorability

LIMS must provide the flexibility to tailor applications to the requirements of the laboratory. This requirement includes the ability to interface "add on" and "third party" applications. LIMS administrators must have the ability to alter the database by changing existing programs or adding new ones to optimize laboratory utilization. Tailorability is most often necessary for adapting LIMS input and output routines to best suit laboratory requirements. The ability to tailor applications to specific lab requirements translates into enhanced database productivity and more efficient laboratory operation. Typical tailored applications include:

New analytical techniques

All data collection routine

Customized reports and graphics:

- Formatted analysis results
- Management decision support reports
- Technical graphics and SPC applications

Automated capture of test data, that is, interfaced:

- Instrumentation
- Voice Systems
- Data loggers

Automated database maintenance, that is, interfaced database:

- Clean-up programs
- Control programs

### 3.6.3.4. Security

LIMS must provide for secure entry, storage, and access of laboratory data. Data handling applications must be controlled so that only specifically identified individuals within the laboratory structure have access to and control over them. This is imperative when the laboratory is part of the product or quality assurance function of the company. A complete audit trail of this access is also necessary. Additionally, access to test results,

especially intermediate results, by non-laboratory personnel must be strictly controlled. At a minimum the entry to a LIMS should be password protected and security structuring for internal applications should be provided. Many tailored applications may generate sensitive information and should also be protected by security measures. Extreme care should be taken when the hardware running a LIMS system is LAN or modem connected. LIMS should never run the risk of exposure to espionage or viruses. Any loss or corruption of lab data can be catastrophic.

#### 3.6.3.5. The Fingerprinting Subset

LIMS can be employed to support Fingerprinting and other R&D efforts. In general all database requirements for production LIMS also apply to R&D efforts.

Several special requirements should be considered when developing the fingerprint subset. These include correlation of receiving inspection tests to production process analyses for the materials fingerprinted, technical applications in support of fingerprint decision making, and eventual incorporation of fingerprint applications into the production process database.

Additionally, a routine analysis result disposition field is also tracked in the fingerprint subset to show the acceptability of the material with respect to existing analytical techniques. Specially tailored applications may be required to assist R&D personnel with identifying and quantifying fingerprint results. Typically these may include listing and trending results, statistical analyses, and specialized reporting capabilities. Successful fingerprinting studies will result in new analytical techniques and these techniques must be included in the production database. Fingerprint applications should be designed to migrate efficiently into the production database upon acceptance. This is desirable because it allows for testing of the "new" LIMS applications while they are part of the R&D subset and provides for rapid assimilation of the accepted fingerprint application into the production system.

### 3.7. Intelligent Analysis Support Systems

Knowledge Based Systems commonly known as Artificial Intelligence (AI) programs or Expert Systems can be used to support many aspects of fingerprinting. AI programs are used to "capture knowledge" from expert individuals. Captured knowledge can subsequently be interactively accessed and used by less experienced employees to get advice from the expert system. Additionally, this access provides the ability for the "novice" to query the AI program about the line of reasoning used to provide the advice. AI programs are most frequently used to capture expertise in demanding or complex operations or where that expertise is critical due to limited access (only one expert available) or potential for loss (retirement, transfer, attrition, etc.). Since instrumental analysis exhibits both complex operations and critical expertise requirements, AI programs make excellent computer based support tools for

fingerprinting studies. Applied AI programs can enhance the productivity of instrumental analyses by reducing analytical learning curves, extending "expert" support of analysis to multishift operations, providing guidelines to expert operators, guarding against catastrophic loss of expertise, and establishing an analytical baseline for consistent instrumental investigation.



## 4.0 REFERENCES

### References

1. Taylor, J., and Kratochvil, B., *Anal. Chem.*, **53** (8), 924A (1981)
2. Taylor, J. K., *Quality Assurance of Chemical Measurements*, Lewis Publishers, Inc., Michigan, 1987
3. MacDougall, D., et. al., *Anal. Chem.*, **52** (14), 2242 (1980)
4. Taylor, J. K., *Anal. Chem.*, **53** (14), 1588A (1981)
5. *Anal. Chem.*, **60**(7), 471A (1988)

### Other Reference Materials

This section contains recommended books that we have found beneficial. They are listed according to topic.

#### Chemometrics

Brereton, Richard G., *Chemometrics*, Ellis Horwood, New York, 1990

Burgard, D. R. and J. T. Kuznicki, *Chemometrics: Chemical and Sensory Data*, CRC Press, Cleveland, OH, 1990

Kowalski, B. R., *Chemometrics: Theory and Application*, American Chemical Society, Washington D. C., 1977.

Massart, D. L., Vandeginste, B. G. M., Deming, S. N., Michotte, Y., and Kaufman, L., *Data Handling in Science and Technology*, Vol 2, "Chemometrics: A Textbook," Elsevier, New York, 1988.

#### Computers

Smardzewski, R. R., *Data Handling in Science and Technology*, Vol 1, "Microprocessor Programming and Applications for Scientists and Engineers," Elsevier, New York, 1984.

Valkó, P., and Vajda, S., *Data Handling in Science and Technology*, Vol 4, "Advanced Scientific Computing in BASIC with Applications in Chemistry, Biology, and Pharmacology," Elsevier, New York, 1989.

### Design of Experiments

Box, G. P., Hunter, W. G., and Hunter, J. S., *Statistics for Experimenters - An Introduction to Design, Data Analysis, and Model Building*, John Wiley & Sons, New York, 1978.

Breyfogle III, F.W., *Statistical Methods for Testing, Development and Manufacturing*, Wiley and sons, New York, 1991

Deming, S. N., and Morgan, S. L., *Data Handling in Science and Technology*, Vol 3, "Experimental Design: A Chemometric Approach," Elsevier, New York, 1987.

Montgomery, D. C., *Design and Analysis of Experiments*, Second Ed., John Wiley & Sons, New York, 1984.

### Graphical Methods

Cleveland, W. S., *The Elements of Graphing Data*, Wadsworth Advanced Books and Software, California, 1985.

Tufte, E. R., *Envisioning Information*, Graphics Press, Connecticut, 1990.

Tufte, E. R., *The Visual Display of Quantitative Information*, Graphics Press, Connecticut, 1983.

### Instrumental Analysis

Gardiner, D. J., and Graves, P. R., *Practical Raman Spectroscopy*, Springer-Verlag, New York, NY, 1989.

Griffiths, P. R., *Chemical Infrared Fourier Transform Spectroscopy*, John Wiley & Sons, New York, 1975.

Miller, J. M., *Chromatography: Concepts and Contrasts*, John Wiley & Sons, New York, NY, 1988.

Robinson, J. W., *Atomic Spectroscopy*, Marcel Dekker, New York, NY, 1990.

Skoog, D. A., *Principles of Instrumental Analysis*, Third Ed., Saunders College Publishing, Fort Worth, TX, 1984.

Skoog, D. A., West, D. M., and Holler, F. J., *Fundamentals of Analytical Chemistry*, Fifth Ed., Saunders College Publishing, Fort Worth, TX, 1988.

Smith, A. L., *Applied Infrared Spectroscopy. Fundamentals, Techniques, and Analytical Problem-Solving*, John Wiley & Sons, New York, 1978.



Strobel, H. A. and Heineman, W. R., *Chemical Instrumentation: A Systematic Approach*, Third Ed., John Wiley & Sons, New York, NY, 1989.

Willard, H. H., Merritt Jr., L. L., Dean, J. A., and Settle Jr., F. A., *Instrumental Methods of Analysis*, Seventh Ed., Wadsworth Publishing, Belmont, CA, 1988.

#### Microspectroscopy

Krishnan, K., and Hill, S. L., *FTIR Microsampling Techniques*, Notes No. 73, BioRad Digilab Division, Cambridge, Massachusetts, April 1990.

Messerschmidt, R. G., Harthcock, M. A., *Infrared Microspectroscopy*, Marcel Dekker, Inc. New York, 1988.

Roush, P. B., *The Design, Sample Handling and Applications of Infrared Microscopes*, ASTM Special Technical Publication 949, ASTM, Philadelphia, PA, 1987.

#### Multivariate Analysis

Hawkins, D. M., *Topics in Applied Multivariate Analysis*, Cambridge University Press, New York, 1982.

Chatfield, C. and Collins, A. J., *Introduction to Multivariate Analysis*, Chapman and Hall, New York, 1980.

Everitt, B. S., *Graphical Techniques for Multivariate Data*, North-Holland, New York, 1978.

Flury, B. and Riedwyl, W., *Multivariate Statistics, A Practical Approach*, Chapman and Hall, New York, 1988.

Gnanadesikan, R., *Methods for Statistical Data Analysis of Multivariate Observations*, John Wiley & Sons, New York, 1977.

Hair Jr., J. F., Anderson, R. E., and Tatham, R. L., *Multivariate Data Analysis with Readings*, Second Ed., Macmillan Publishing Company, New York, 1987.

Jackson, J. E., *A User's Guide to Principal Components*, John Wiley & Sons, New York, 1991.

Kaufman, L. and Rousseeuw, P. J., *Finding Groups in Data. An Introduction to Cluster Analysis*, John Wiley & Sons, New York, 1990.

Malinowski, E.R., *Factor Analysis in Chemistry*, Wiley-Interscience, New York, 1991

Manly, B. F. J., *Multivariate Statistical Methods - A Primer*, Chapman and Hall, New York, 1986.

Martens, H. and Naes T., *Multivariate Calibration*, Wiley and Sons, New York, 1989

Marriott, F. H. C., *The Interpretation of Multiple Observations*, Academic Press, New York, 1974.

Schiffman, S. S., Reynolds, M. L., Young, F. W., *Introduction to Multidimensional Scaling-Theory, Methods and Applications*, Academic Press, New York, 1981.

#### Spectral Interpretation

Silverstein, R. M., Bassler, G. C., and Morrill, T. C., *Spectrometric Identification of Organic Compounds*, John Wiley & Son, New York, 1974.

Sternhell, S. and Kalman, J. R., *Organic Structures from Spectra*, John Wiley & Sons, New York, 1986.

#### Spectral Interpretation - ESCA/Auger

Davis, L. E., MacDonald, N. C. Palmberg, P. W., Riach, G. E., and Weber, R. E., *Handbook of Auger Electron Spectroscopy*, Second Ed., Physical Electronics Division, Perkin-Elmer Corp., 1976.

Wagner, C. D., Riggs, W. M., Davis, L. E., Moulder, J. F., and Muilenberg, G. E., *Handbook of X-ray Photoelectron Spectroscopy*, Physical Electronics Division, Perkin-Elmer Corp., 1979.

#### Spectral Interpretation -Infrared and Raman

Colthup, N. B., Daly, L. H., and Wiberly, S. E., *Introduction to Infrared and Raman Spectroscopy*, Academic Press, New York, 1975.

Nakamoto, K., *Infrared and Raman Spectra of Inorganic and Coordination Compounds*, Fourth Ed., John Wiley & Sons, New York, 1986.

Pouchert, C. J., *The Aldrich Library of FTIR Spectra*, First Ed., Vols 1 and 2, Aldrich Chemical Co., Inc., Wisconsin, 1985.

#### Spectral Interpretation - Mass Spectra

Heller, S. R., Milne, G. W. A., *EPA/NIH Mass Spectral Data Base*, Parts 1-9, NSRDS-NBS 63, National Bureau of Standards, Washington, D. C., 1978.

McLafferty, F. W., *Interpretation of Mass Spectra*, Third Ed., University Science Books, California, 1980.

McLafferty, F. W., Venkataraghavan, R., *Mass Spectral Correlations*, Second Ed., American Chemical Society, Washington, D. C., 1982.

Mass Spectrometry Data Center, *Eight Peak Index of Mass Spectra*, Second Ed., Vol 1, 2, 3, 4, Pendragon House, Inc., Palo Alto, California, 1974.

#### Spectral Interpretation - NMR

Levy, G. C., Lichter, R. L., and Nelson, G. L., *Carbon-13 Nuclear Magnetic Resonance Spectroscopy*, John Wiley & Sons, New York, 1980.

#### Statistics

American Society for Quality Control, Statistics Division, *Glossary and Tables for Statistical Quality Control*, American Society for Quality Control, Wisconsin, 1983.

Beyer, W. H., *CRC Standard Probability and Statistics Tables and Formulae*, CRC Press, Boston, 1991.

Marriott, F. H. C., *A Dictionary of Statistical Terms*, Fifth Ed., John Wiley & Sons, New York, 1990.

Miller, J. C., and Miller, J. N. *Statistics for Analytical Chemistry*, Second Ed., John Wiley & Sons, New York, 1988.

Wadsworth Jr., H. M., *Handbook of Statistical Methods for Engineers and Scientists*, McGraw-Hill Publishing Co., New York, 1990.

#### Surface Science

Briggs, D., and Seah, M. P., *Practical Surface Analysis by Auger and X-ray Photoelectron Spectroscopy*, John Wiley & Sons, New York, 1983.

Casper, L. A., and Powell, C. J., *Industrial Applications of Surface Analysis*, American Chemical Society, Washington D. C., 1982.

#### Quality Assurance - Quality Control

Taylor, J. K., *Quality Assurance of Chemical Measurements*, Lewis Publishers, Inc., Michigan, 1987.



## List of Acronyms

<b>AAS</b>	Atomic absorption spectroscopy
<b>AES</b>	(1) Atomic emission spectroscopy, (2) Auger electron spectroscopy
<b>AFS</b>	Atomic fluorescence spectroscopy
<b>AA</b>	Atomic absorption
<b>AI</b>	Artificial Intelligence
<b>AMU</b>	Atomic mass unit
<b>ANOVA</b>	Analysis of variance
<b>ASCII</b>	American Standard Code for Information Interchange
<b>ATR</b>	Attenuated total reflectance
<b>AUFS</b>	Absorbance units full scale
<b>CC</b>	Capillary column
<b>CFC</b>	Chlorofluorocarbons
<b>CI</b>	Chemical ionization
<b>CILO</b>	Computer Integrated Laboratory Operations
<b>COV</b>	Coefficient of variation
<b>CPU</b>	Central processing unit
<b>CRT</b>	Cathode ray tube
<b>DF</b>	Degrees of freedom
<b>DOE</b>	Design of experiments
<b>DSC</b>	Differential scanning calorimetry
<b>DTGS</b>	Deuterated triglycine sulfate
<b>ECD</b>	Electron capture detectors
<b>EDS</b>	Energy Dispersive X-ray Spectroscopy
<b>EI</b>	Electron impact
<b>ES</b>	Expert Systems
<b>ESCA</b>	Electron spectroscopy for chemical analysis
<b>ET</b>	External Tank
<b>FAAS</b>	Flame atomic absorption spectroscopy
<b>FAB</b>	Fast atom bombardment
<b>FES</b>	Flame emission spectroscopy
<b>FID</b>	Flame ionization detector
<b>FTIR</b>	Fourier transform infrared spectroscopy
<b>GC</b>	Gas chromatograph
<b>GC/FID</b>	Gas chromatographic with a flame ionization detector
<b>GC/MS</b>	Gas chromatography/mass spectrometry
<b>GLC</b>	Gas-liquid chromatography
<b>GSC</b>	Gas-solid chromatography
<b>HCFC</b>	Hydrochlorofluorocarbons
<b>HPLC</b>	High performance liquid chromatography
<b>IC</b>	Ion chromatography
<b>ICP</b>	Inductively coupled plasma

<b>ICP/AES</b>	Inductively coupled plasma/atomic emission spectroscopy
<b>IEC</b>	Ion-exchange chromatography
<b>IR</b>	Infrared spectroscopy
<b>IRE</b>	Internal reflection element
<b>ISS</b>	Ion scattering spectroscopy
<b>LAN</b>	Local area network
<b>LC</b>	Liquid chromatography
<b>LLC</b>	Liquid-liquid chromatography
<b>LIMS</b>	Laboratory Information Management System
<b>LHDS</b>	Laboratory Host Data System
<b>LNTB</b>	Laboratory Network Test Bed
<b>LSC</b>	Liquid-solid chromatography
<b>MAD</b>	Mean absolute deviation
<b>MAPTIS</b>	Materials and Processes Technical Information System
<b>MCT</b>	Mercury cadmium telluride
<b>MR</b>	Midrange
<b>MS</b>	Mass spectrometer
<b>NMR</b>	Nuclear magnetic resonance
<b>NPD</b>	Nitrogen-phosphorus detector
<b>NP</b>	Normal phase (LC term)
<b>NS</b>	Nonpolar stationary phase (GC term)
<b>P</b>	Polar stationary phase (GC term)
<b>PC</b>	(1) Personal computers; (2) Packed column (GC term)
<b>PMT</b>	Photo multiplier tube
<b>QC</b>	Quality control
<b>QEL</b>	Quality Evaluation Laboratories
<b>QLI</b>	Quality Laboratory Instructions
<b>QMA</b>	Quadrupole mass analyzer
<b>RDS</b>	Rheometrics dynamic spectrometry
<b>RI</b>	Refractive index
<b>RP</b>	Reverse phase (LC term)
<b>SA</b>	Solid adsorbent (GC term)
<b>SAM</b>	Scanning Auger microscopy
<b>SEC</b>	Size exclusion chromatography
<b>SEM</b>	Scanning electron microscopy
<b>SFC</b>	Supercritical fluid chromatography
<b>SIMS</b>	Secondary ion mass spectroscopy
<b>SIM</b>	Selective ion monitoring
<b>SOP</b>	Standard operating procedures
<b>SPC</b>	Statistical process control
<b>SRM</b>	Standard Reference Materials
<b>TCD</b>	Thermal conductivity detector
<b>TED</b>	Thermionic emission detector
<b>TGA</b>	Thermo-gravimetric analysis
<b>TMA</b>	Thermal Mechanical analysis

**UV** Ultra-violet  
**XPS** X-ray photoelectron spectroscopy  
**XRF** X-ray fluorescence spectroscopy





TABLE I. COMMON INSTRUMENTAL ANALYSIS TECHNIQUES

Method	Applications	Advantages	Method Limitations	Sample Limitations	Sample Size
Atomic Absorption Spectrometry (AAS)	Quantitative and/or trace analysis of a single element for each measurement	Fast, reliable, high sensitivity for some 70 elements, relatively inexpensive	Not applicable to most non-metallic materials or simultaneous multi-element analysis, Small linear response range	Requires time-consuming dissolution of sample or graphite furnace for atomizing solids.	mg to g
Inductively Coupled Plasma- Atomic Emission Spectrometry (ICP-AES)	Quantitative multi-elemental analysis Determination of trace, minor and major elements	Simultaneous determination of up to 60 elements. Good for refractory materials. Large dynamic range	Limited sensitivity for nonmetals. Expensive	Requires time-consuming dissolution of sample or graphite buffer for atomizing solids.	mg to g
X-ray Fluorescence Spectrometry (XRF)	Quantitative analysis of all elements of atomic no. > 14. Qualitative determination of all elements with atomic no. > 11.	Minimal sample preparation. Inexpensive	Detection limits not as good as AA or ICP/AES	Solid or nonvolatile liquid	mg
Infrared Spectrometry (IR or FTIR)	Identification and structural determination of materials, including surface adsorbants	Applicable to most materials. Extensive libraries of reference spectra available.	Composition limited to molecular species identified. Medium sensitivity. Trace and minor components can be masked by major components.	Material must contain bonds which undergo dipole moment change during vibration	µg
Raman Spectroscopy	Identification and structural determination of materials, including surface adsorbants	Identification of non-polar functional groups. Minimal sample preparation.	Low sensitivity. Fluorescence can interfere with Raman signals. Limited libraries of reference spectra. Expensive.	Material must contain bonds which undergo polarizability change during vibration	1 to 100 mg
Nuclear Magnetic Resonance Spectroscopy (NMR)	Structural determination and identification of both organic and inorganic materials	Determination of molecular configuration and conformation	Applicable only to samples containing magnetic moment. Low sensitivity. Expensive	Sample must be liquid or soluble solid	1 - 100 mg
Energy Dispersive X-ray Spectroscopy (EDS)	Elemental inorganic identification of elements	Low level detection	Elements $\geq$ Na	Sample must be liquid or soluble solid	~ 3 cm diameter

TABLE I. COMMON INSTRUMENTAL ANALYSIS TECHNIQUES (continued)

Method	Applications	Advantages	Method Limitations	Sample Limitations	Sample Size
Mass Spectrometry	Structural determination and identification of organic and some inorganic materials.	Widely applicable to most materials. Extensive on-line reference libraries available.	Slow Expensive	Sample must be volatilized.	0.01 g
Gas Chromatography (GC)	Separation of multicomponent mixtures of volatile materials.	Selectivity ranges from general to specific	Not applicable to nonvolatile and thermally unstable materials	Material must be volatile and thermally stable	µg to mg
Liquid Chromatography (LC or HPLC)	Separation of multicomponent mixtures of liquids and soluble solids	Widely applicable to nonvolatile organics. Applicable to thermally unstable materials. Separated materials can be identified by other methods.	No sensitive universal detector. Subsequent analysis by IR or MS necessary to identify components. Moderately expensive.	Must be soluble in one of many suitable solvents.	µg to mg
Ion Chromatography (IC)	Separation of complex mixtures of ionic species for quantitative analysis. Elemental analysis of organics after decomposition.	Applicable to a wide range of organic and inorganic anions and to many cations.	Analysis of trace species in presence of high concentration species is difficult. Method development is time consuming. Moderately expensive.	Must ionize in solution. Nonaqueous applications limited. Decomposition of organics time consuming.	1 to 5 mg
Size Exclusion Chromatography (SEC) Gel Permeation Chromatography (GPC)	Separation of complex mixtures based on molecular size. Determination of polymer molecular weight distribution.	Applicable to polymers. Determines molecular weight distribution.	Calibration time consuming. Moderately expensive.	Must be soluble in limited number of suitable solvents. GPC performed in water.	µg to mg.
Combined Gas or Liquid Chromatography with Mass Spectrometry (GC/MS or LC/MS)	Separation, identification and quantitative analysis of complex mixtures.	Combines separation capability of GC or LC with identification and sensitivity of MS	Slow Method development is time consuming Expensive	Same as GC, LC and MS	20 - 200 ng.

TABLE II. OTHER USEFUL INSTRUMENTAL ANALYSIS TECHNIQUES

Method	Applications	Advantages	Method Limitations	Sample Limitations	Sample Size
Differential Thermal Analysis (DTA)	Quantitative characterization of materials & contaminants Dilatometry, autoignition	Separates materials by differences in thermal properties in inert or oxidizing atmosphere	Very few; can handle a large variety of solids and liquids, such as foams, films, powders, or fibers.	Small sections that fit in sample crucibles Sample containment can be expensive	mg
Thermal Gravimetric Analysis (TGA)	Quantitative characterization of materials, wire coatings	Measures resistance to thermal degradation. Inert or oxidizing atmosphere.	Very few; can handle a large variety of solids and liquids, such as foams, films, powders, or fibers.	Small sections; determined by size of sample pan and autobalance range.	mg
Differential Scanning Calorimetry (DSC)	Quantitative characterization of polymers & inorganics by heat absorption, $T_g$	Differences in thermal properties easily measured. Inert or oxidizing atmosphere.	Very few; can handle a large variety of solids and liquids, such as foams, films, powders, or fibers.	Small sections determined by sample pan size.	mg
Thermal Mechanical Analysis (TMA)	Semi-quantitative characterization of polymers & organics	Distinguishes materials by differences in thermo-mechanical properties.	Very few; can handle a large variety of solids and liquids, such as foams, films, powders, or fibers.	Small sections determined by sample pan size.	mg
Rheometric Dynamic Spectrometer (RDS)	Quantitative characterization of viscous and elastic properties	Measures properties with many geometries	Can handle both solid and liquid samples.	Small sections that fit into test cells.	mg
Dynamic Mechanical Analysis (DMA)	Quantitative characterization of viscous and elastic properties $T_g$ and $T_m$ .	Separates materials by differences in mechanical properties	solid samples	small sections that fit into test cell.	mg
Optical Microscopy	Qualitative analysis of Particulates	Fast Relatively inexpensive	Knowledge and experience of personnel very important	Small samples	ng
X-ray Diffraction (XDS)	compound identification of crystalline materials	Identify crystalline compounds	Slow process	Small sections of single crystal or powder	1 x mm <sup>3</sup>
Transmission Electron Microscope (TEM)	Microstructural analysis of metals, ceramics and polymers.	Very high magnification	Slow & expensive	small sections of solids Sample preparation can be difficult	$\mu$
Scanning Electron Microscope (SEM)	Surface Morphology and high spatial resolution of small samples.	Greater depth of field and resolution than optical microscopy.	Samples must withstand High vacuum	small sections of solids Sample preparation can be time consuming	$\mu$

TABLE III. COMMON SURFACE ANALYSIS TECHNIQUES

Method	Applications	Advantages	Method Limitations	Sample Limitations	Sample Size
Auger Electron Spectroscopy (AES)	Compositional analysis of conducting surfaces	High Spatial resolution. Surface sensitive in upper 10 nm.	Insensitive to He and H Semi-quantitative	Solids, must be conductive, vacuum compatible	microns down to nm.
X-ray Photoelectron Spectroscopy (XPS) and Electron Spectroscopy for Chemical Analysis (ESCA)	Elemental analysis of surfaces and coatings Chemical state identification	Nondestructive Quantitative and rapid	Interrogates only top 10 nm.	Solids, vacuum compatible	cm
Ion Scattering Spectroscopy (ISS)	Identification of elements on surfaces Depth profiling of ultrathin films	Depth profiling can analyze for elements through several thousand Angstroms.	Can be time consuming to depth profile several thousand Angstroms	Solid, vacuum compatible	down to 0.05 cm
Secondary Ion Mass Spectroscopy (SIMS)	Surface compositional analysis Trace element analysis of surfaces and thin films	Good resolution from 1 to 5 nm in depth	Analysis is destructive and can be time consuming	Solid, vacuum compatible Flat surfaces desired	cm
Low Energy Electron Diffraction (LEED)	Surface analysis of conducting materials	High resolution	Surface preparation can be expensive and difficult	small sections of solids	

1  
2  
3  
4  
5  
6  
7  
8  
9  
10  
11  
12  
13  
14  
15  
16  
17  
18  
19  
20  
21  
22  
23  
24  
25



omit

## **Chemical Fingerprinting - An Important TQM Tool for Control of Materials**

### ***Introduction***

Changing global economics has resulted in the need for many U.S. companies to re-evaluate how they must do business in order to remain competitive in manufacturing products that are either to sold in global markets or have to maintain market share in the U.S. against products manufactured overseas. Successful organizations have developed a new way of thinking during the 1980's and revitalized some old lessons from the past. The key concept in this new rendering of age-old values is quality. Quality goods at competitive costs provides a manufacturer a firm foundation upon which to exist in today's marketplace. This foundation has not evolved easily for U.S. firms who enjoyed the relatively non-competitive markets of the past. However, the lessons learned in achieving new and hard-earned market shares certainly make for a firmer foundation for the future. It is no surprise that aerospace manufacturers belong to this group.

The new proliferating quality issues take many different forms; however, most variations are described in concepts centered around Total Quality Management or (TQM). Broadly speaking, TQM encompasses a number of mangement issues which can assist in reaching the goal to manufacture quality products at reduced costs for a larger marketplace. Significant ideas relating to improved quality at reduced costs dictates that management (and the workers) must have available a number of tools for optimizing upon this common goal. Good design methodology and a generous allotment of statistical process control (SPC) are standard techniques which, when practiced throughout the manufacturing facility, does provide noticeable improvements in product quality and at reduced costs. However, another useful area for evaluation, which can also assist manufacturing operations in achieving reduced costs with improved quality, is in the accountability of materials used in the manufacturing processes. Consolidation of technologies that can provide an accounting of materials, which includes in-coming materials, materials in process, end-products and waste materials will result in substancial cost savings. Also most government agencies are aware of recent issues emerging in our fiscal and ecological environments that have been promulgated such that federal agencies shall promote activities which respond to the improvement of both.

This concept is especially desirable for all contractor organizations participating in space hardware construction and refurbishment. Many NASA contractors are already participating in organizational improvement programs, such as Total Quality Management (TQM)<sup>1</sup>. TQM techniques are currently seen as the most effective management techniques to improve

productivity and reliability. In parallel with the concepts for improving management efficiency, TQM also promotes the development of efficient strategies for managing materials control. Within the basic philosophy of TQM, NASA and its contracting organizations will provide a materials control infra-structure to maintain knowledge of any critical material's lack of conformance to specifications at all times. In addition the same data will permit the identification of waste materials for ecological control. The practice of chemical fingerprinting principles will provide this capability. Currently at least one major aerospace manufacturer maintains a chemical fingerprinting programs<sup>2</sup>.

Chemical fingerprinting is currently an emerging technology which enables a manufacturing organization to maintain control over the materials used in its operations. In this respect chemical fingerprinting is a total quality management tool that allows management and the employees to develop confidence in the integrity incoming materials and knowledge of the composition of wastes. Using the appropriate blend of chemical analysis, data management, and chemometrics, chemical fingerprinting programs provide management with information needed for making critical decisions at the appropriate time. The utility of fingerprint analysis spreads across all manufacturing programs and can provide many benefits, including quality, safety and cost-effectiveness. These benefits are realized primarily through cost-avoidance occurrences and open communication between manufacturing, suppliers, and management.

The critical philosophy underlying chemical fingerprints is to be able to determine the crucial relationships among the many fingerprints that can be obtained with analytical instrumentation. Only then can proper decisions be made regarding the materials conformance to specification or fitness for use. Often, unambiguous results can only be obtained with the assistance of statistical (or chemometric) techniques. It is the complementary collaboration between chemical and statistical analysis which is the key to a successful fingerprint application. The chosen methods must produce results which can be utilized effectively for both engineering and management purposes.

1. The instrumentation needed by each contractor will depend on their particular set of requirements for both implementing and maintaining a chemical fingerprinting program.

2. In most cases, each contractor has appropriate analytical equipment, personnel, and procedures to either be currently performing such analyses, or be able to begin to collect data, that will contribute to the baseline information needed for chemical fingerprinting.



## **Background**

Fingerprinting encompasses the field of analytical chemistry utilizing instrumental methods as compared to classical wet chemical analysis. The major advantages which are obtained through the use of analytical instruments such as described here are the ease with which a manufacturer can provide instrument interfaces to computers for data acquisition, statistical analysis of the experimental results, and compilation of fingerprint data.

Chemical fingerprinting is a materials characterization technique which is concerned with either

- a.) the qualitative determination of the elemental or molecular composition of a material,
- b.) the quantitative measurement of the individual constituents of a material, or
- c.) the quantitative measurement of a relevant property of the material.

There are many useful examples of chemical fingerprinting programs which successfully guide manufacturing to produce good products. Most of these programs have been established in industries with high liability when defective products are sent to the marketplace. For example, pharmaceuticals and food processing facilities cannot afford to have products containing toxic materials shipped from the production facilities to the marketplace. Consequently their in-coming materials are always fingerprinted to insure against inadvertent accidents to the customers who use their products. Liability lawsuits, which can drain a corporations fiscal health, are the major results of such accidents. In addition, a number of chemical industries which use materials by the carload prefer to maintain programs which make sure of the identity of the reactants before mixing them. In this case the costs incurred is heavily in favor of performing chemical analysis prior to mixing, rather than taking a chance that the supplier sent the right material and proceed on with no due caution.

The composite data taken with several analytical instruments for the same material represents a signature of that material. The signature allows one to characterize a material of interest using chemical and physical measurements. Each fingerprint contains information about the materials; however, that one piece of information may not contribute to determining whether a material is "fit for service" or conforms to a specific specification. A fingerprint yields important, but limited, information and usually cannot adequately characterize a complex multi-component material. It is the ability

to completely characterize materials of interest with an appropriate "signature" that enables chemical fingerprinting methodology to promote confidence in the materials used in manufacturing.

Implicit in the concept of signature or fingerprint analysis is the computerized database or databases which contain the baseline information and historical archiving of fingerprints over extended periods of time. Such databases are normally maintained in individual datafiles supplied with analytical instrumentation and supporting software. Robust data management systems (also known commercially as Laboratory Information Management Systems or LIMS) for handling the full fingerprint and signature information are not always readily available. Consequently the data management systems used in chemical fingerprinting programs will continuously have to be up-graded to meet the demands of the organization. Hence, there is no single definition or solution for the data management requirements which fits all organizations.

Chemometrics is a discipline within analytical chemistry concerned with the selection and optimization of instrumental methods as well as the interpretation of data from these chemical analyses. Chemometrics makes extensive use of mathematical and statistical methods with the intent of producing a maximum of concise chemical information. The use of chemometrics becomes more obvious as the data analysis becomes more complex. Chemometric techniques can assist the measurement process by determining sampling requirements, the number of experiments required to characterize an analytical procedure, or to extract the useful characteristics from otherwise ambiguous data sets. Many software packages are available commercially to provide support in statistical analysis.

A major goal in the lot-to-lot consistency of its products is important in any production facility that requires multiple suppliers or materials from the same supplier over an extended period of time. The consistency of the materials used in production of a specific part or in TQM terms, the reduction of variation in the material, is extremely important in formulating not only the performance level of the part in service; but also being able to predict how much that part truly costs to manufacture.

Specifications and engineering parameters for in-coming materials, for instance, can become a starting point for determining what signatures need to be determined early on in the program. Each contractor organization can determine what constitutes the minimum essential information for which "fingerprints" should be established. A successfully tested material is then one whose "fitness for use" can be easily and quickly demonstrated by the results of one or more instrumental test procedures. Over a period of time the lot-to-lot consistency of the vendor can then be determined.

Both chemical and physical measurements obtained from instruments found in the analytical laboratory can provide the data required for a correct evaluation of the materials characteristics. Note that there can be a challenge, for a given material, to discover and elucidate the most efficient combination of practical procedures which will successfully accomplish the goals of the chemical fingerprinting program.

### ***Benefits***

Fingerprinting encompasses the field of analytical chemistry utilizing instrumental methods as compared to classical wet chemical analysis. The major advantages which are obtained through the use of the analytical instruments described here are the ease with which a manufacturer can provide instrument interfaces to computers for data acquisition, statistical analysis of the experimental results, and compilation of fingerprint data.

With these advantages, instrumental analysis provides a major capability for the characterization and identification of materials in a reliable and timely manner. It is also anticipated that the analytical instruments which are used for chemical fingerprinting are primarily already physically in place in most laboratories, being used primarily for in-process verification of particular products or processes. Combining these capabilities with computer based systems for data manipulation and statistical analysis, these same instruments can provide the basic foundation for implementing a chemical printing program.

The use of fingerprinting as a quality assurance technique can be profitably applied to problems in all industries ranging from aerospace to pharmaceuticals. The major benefit to NASA is the ability to build space hardware at reduced costs over the life cycle of the system. All manufacturing organizations can benefit from the chemical fingerprinting approach in a number of different ways. The two major benefit areas, which are described below, are cost avoidance and increased materials reliability. For example, cost benefits are enhanced through the manufacturing operation by eliminating the processing of materials which would not allow the final product to conform to the specifications required. It is more cost effective to reject defective materials, rather than defective parts.

In addition, the following statements list some benefits derived from utilization of chemical fingerprinting in a manufacturing operation:

1. When fully developed, the fingerprints and signatures developed provide a baseline chemical profile of those materials currently in use and considered

to be in conformance with the specifications. This information can be utilized strictly in-house, as part of the contractor's operations or more importantly, shared with other contractor's as part of a database for materials used in NASA's manufacturing programs.

2. Lot-to-lot consistency from multiple suppliers or materials from the same supplier over an extended period of time can be monitored. If any formulation changes occur that could affect the manufacturing processes, its inspectability, or cause environmental damage unbeknown to the customer, then obviously major problems will occur.

3. Mislabeled products, process contaminations, and material degradations can all be identified. An organization which utilizes chemical fingerprinting techniques for materials control, will be less likely to be effected by such incidents. As mentioned earlier, a tremendous cost-savings can occur when defective materials are not introduced into the manufacturing process. Other undesirable and costly problems, such as contaminating good materials already in production or forming toxic fumes when the wrong chemicals are mixed, can easily be avoided when the materials are correctly identified before use.

4. Material changes, when they do occur, can readily be traced to their source by comparison of the questionable lot with the historical information. Formulation variations and substitutions can be identified whether made at the vendor's facility or at one of his suppliers.

5. The chemical fingerprinting may be the basis upon which a change, by vendor or production site, may not require an expensive requalification effort.

6. The acceptance testing of material from a small supplier who is really a "blender" and cannot afford an analytical laboratory, may be one the more practical uses of fingerprinting.

7. In addition to inspecting in-coming materials for conformance to specifications, the chemical fingerprinting approach can also be used to monitor intermediate products or processes in production. Used in this fashion, the approach can then provide confidence towards the reliable performance of the manufacturing processes and the end products.

8. The data base can also supply vital information for failure analyses. Without prior knowledge of the constituents contained in a material, failure analysis can be a long and difficult process. The process can be shortened with a more thorough knowledge of the material.

9. Waste management has become a significant portion of any manufacturing organization, particularly in the case of the complex processes involved in manufacturing today's space systems. Thorough knowledge of the ingredients which leave the manufacturing site, as a gas, liquid, or solid is mandatory in some localities. Organizations which are performing appropriate accounting of materials are going to benefit accordingly as environmental laws and regulations are promulgated by both the federal and the state governments.

A number of aerospace examples also have been documented. For instance, the acceptance testing difficulties encountered during the extensive use of critical but proprietary insulating foam materials for a NASA propulsion program gave rise to the critical need for chemical fingerprinting. These formulations are chemically complex and involve a number of chemical sub-systems, including catalysts, flame retardants, blowing agents, and surfactants. Some of the critical ingredients are even proprietary at the sub-tier supplier level. A major risk in the use of proprietary materials is that only the supplier has purview over the formulation and can, therefore, make any changes he deems desirable or necessary. While there was no desire for the NASA contractor to "crack" the formulations, it was imperative to assure the lot-to-lot consistency of these critical materials for reliable performance of the product. The chemical fingerprinting approach was the contractor's solution to this dilemma. Subsequently a battery of chemical and physical tests on both the reactants and the cured product was instituted. These measures consisted of approximately twenty single value tests which, although adequate, were both time and labor intensive. The end result was that the NASA contractor developed a signature for the formulation and now has confidence in his ability to evaluate the deliverables required for the end product.

### ***Cost Benefits Analysis***

In determining a realistic cost benefits model for chemical fingerprinting, it is difficult to obtain background data from current manufacturers due to proprietary constraints. Consequently the following model is developed from life cycle costing<sup>4</sup> and quality engineering<sup>5</sup> considerations.

Cost models for labor and materials, in their simplest form, can be written as<sup>4</sup>:

Direct Labor Cost

$$(1) \quad DLC = \sum_{j=1}^N R_j \left( STD_j + \frac{SSO_j}{LS_j} \right),$$

where:       $j$  = number of operations  
 $R_j$  = hourly rate  
 $LS_j$  = Lot size  
 $SSO_j$  = Set up time  
 $STD_j$  = Lot size

These direct labor cost estimates must include all operations. In addition to estimating the labor costs for all processes for forming product, it must also include activities such as analysis of incoming materials, failure analysis of defective products and repair of defective products, and labor for handling removal of scrap and waste materials. Only then can the cost benefits for chemical fingerprinting be truly understood.

#### Direct Materials Cost

$$(2) \quad DMC = (Q)(CQ) \left( 1 + \sum_{i=1}^4 \gamma_i \right) - \text{scrap}$$

where       $Q$  = Quantity of materials used in product  
 $CQ$  = Cost per unit quantity of material  
 $\gamma_1$  = non-deliverable materials used in production  
 $\gamma_2$  = scrap material  
 $\gamma_3$  = waste material  
 $\gamma_4$  = unsuspected non-conforming material

Obviously the goal of production engineering is to maximize on delivered product from the incoming materials with as little scrap and waste material as possible. It is assumed that maximum utilization of materials has been implemented into the production scheme and only unintended deviations from that schedule will affect the cost benefits analysis.

#### Quality Engineering Considerations

When Motorola won the Malcolm Baldrige Award in 1990, a major thrust of their submission was developed around setting goals for quality within the manufacturing operations. In developing these goals, the plan to improve quality consisted of progressive improvement from the defect rate of  $3\sigma$  at that time to  $6\sigma$  by 1995. The following table defines the defect rate

production for this progression<sup>5</sup>:

Defect Occurance Rate	Parts per Million	Per Cent Defects
3σ	66810	6.68 %
4σ	6210	0.62 %
5σ	233	0.002 %
6σ	3.4	0.0003 %

The final goal of 3.4 ppm defect production was philosophically designed to give each worker a goal in which he or she could logically relate to in terms of minimizing mistakes. The alternative was to state that every worker should make no mistakes, and that philosophy was deemed to be unrealistic by all.

For our purposes, the rate of defect occurrence in the manufacturing processes can be developed in terms of current quality in the manufacturing environment. For example if the current quality at a particular manufacturing facility is still at the 3σ level then there is a 6.68 % error factor generated as the product is formed. Likewise if the suppliers to an aerospace manufacturer operate at the 3σ level, there is a high probability that some fraction of that 6.68 % is going to show up in received materials. Our goal is to determine how chemical fingerprinting can then avoid the potential costs incurred by aerospace manufacturer by utilization of chemical fingerprinting of incoming materials.

The impact of operating at the 3σ level without chemical fingerprinting can be considered in the following way. Since it is very unlikely that 6.68 % of the suppliers products are non-conforming, we suggest a fraction of the 6.68 %, say 1 % will be passed on the customer. In the equation for direct material costs, then  $\gamma_4$  would be equal to 2 % (1 % for defective materials and 1 % for the replacement material needed to manufacture the parts). Thus, according to equation (2), the minimum impact on materials costs would be:

$$(3) \quad DMC = (Q)(CQ)(1 + \sum_{i=1}^3 \gamma_i + 0.02) - scrap$$

Determining the Direct Labor Costs for an organization not using chemical fingerprinting follows a similar pattern. Unfortunately, it is more difficult to estimate the excessive manhours required for failure analysis and repair, or remake of the part. Total labor costs is very dependent on which phase in the product manufacturing cycle the defective component is found and acted upon. It is easy to see that a small number of operations in performing

chemical fingerprinting can prevent a much larger number of unneeded operations from being performed on repaired or scrap parts.

Using the  $3\sigma$  criteria, 6.68 % will be the normal amount of defects manufactured into various parts in the production cycle; hence this number can also represent a minimum impact on the costs associated with producing defects.

Hence if Total Direct Costs = DLC + DMC

or (4)  $TDC \geq 1.0668(DLC) + 1.02(DMC)$

The more progressive aerospace firms will have instituted more recent innovations in total quality management and will purchase materials from suppliers who also follow such practices. Hence the next level of progress would be for firms who satisfy the  $4\sigma$  quality rate. Using similar arguments one can show that the following relationship is obtained:

(5)  $TDC \geq 1.01(DLC) + 1.006(DMC)$

Likewise, firms operating in a true TQM environment, operating in a  $5\sigma$  level of quality would be realistically showing costs of:

(6)  $TDC = 1.002(DLC) + 1.001(DMC)$

Note that the internal defect rate has been reduced so that the  $\geq$  is not required in (5).

For the purposes of the cost benefits analysis, let's assume that direct labor costs are 3 times direct materials cost per year for the production of a particular aerospace system, which amounts to \$ 100 Million per year in order to develop some concept of scale. Thus for these simplified calculations, DLC = \$ 75 M and DMC = \$ 25 M. The following minimum excess costs (or minimum cost avoidance estimates) are obtained.

	Defect Occurrence Rate	Minimum Excess Labor Costs	Minimum Excess Material Costs	Minimum Cost Avoidance
Case 1	$3\sigma$	5.01	0.5	5.51 M
Case 2	$4\sigma$	0.75	0.15	0.90 M
Case 3	$5\sigma$	0.15	0.03	0.18 M



Some comments are in order to establish how chemical fingerprinting relates to these estimates. Firms operating in Case 1 obviously have to move to chemical fingerprinting of in-coming materials in order to survive in a competitive environment. Firms operating in Cases 2 are probably moving toward a greater utilization of TQM in their manufacturing programs and without implementing chemical fingerprinting will not achieve  $5\sigma$  (or in Motorola's case,  $6\sigma$ ). It is also important to remember that in most cases the aerospace manufacturer and the supplier may not be operating in the same environment. Particularly in the most probable case in which the supplier may operate at  $3\sigma$  or less, the only methodology for cost avoidance is to perform chemical fingerprinting on in-coming materials. A significant result of Table 2.0 is that operating at  $5\sigma$  or better results in significant cost savings for the customer. All program managers of both small and large aerospace will appreciate the impact of this result in their respective programs.

The analysis for determining return on investment for implementation of a chemical fingerprinting program depends upon the cost savings gained by not receiving out-of-specification materials<sup>6</sup>. The normal approaches to making important decisions use cash flow (or cost avoidance in our scheme) for determining return on investment. For example an initial investment into implementing a chemical fingerprinting program may require \$ 2M in equipment and \$ 0.5 M in personnel in an attempt to overcome the \$ 5.5 M excess costs for a firm operating at the  $3\sigma$  defect rate. The company can depreciate the full cost of the equipment over 5 years and assuming a straightline improvement in savings of \$ 1M due to fingerprinting, the following table results:

Year	1	2	3	4	5
Depreciated Value	\$ 400 K	\$ 400 K	\$ 400 K	\$ 400 K	\$ 400 K
Cost Avoidance	\$ 1.0 M	\$ 2.0 M	\$ 3.0 M	\$ 4.0 M	\$ 5.0 M
Cash Flow or Net Savings (w/o personnel costs)	\$ 1.4 M	\$ 2.4 M	\$ 3.4 M	\$ 4.4 M	\$ 5.4 M
Cash Flow or Net Savings (with personnel costs)	\$ 0.9 M	\$ 1.9 M	\$ 2.9 M	\$ 3.9 M	\$ 4.9 M

These estimated cash flows imply a payoff for the equipment investment in less than 3 years. Likewise the calculation for the return on investment is also quite favorable:

Average Investment = (Cost +  $\Sigma$  undepreciated balance) / (years to depreciate)

$$= (2 \text{ M} + 1.6 \text{ M} + 1.2 \text{ M} + 0.8 \text{ M} + 0.4 \text{ M}) / 5$$

$$= 1.2 \text{ M.}$$

The average cash flow from the above table over the five years is \$ 3.4 M, hence the average return on investment is:

$$\text{Return on Investment} = 1.2 \text{ M} / 3.4 = 0.353 \text{ or } 35.3 \%$$

It is important to remember that these calculations are very simplistic, real data from firms maintaining a chemical fingerprinting program has not been made available for this analysis. The results of this analysis provides a provocative concept for programs managers in both government and the contractor environments. Chemical fingerprinting can more than pay its way by analyzing in-coming materials alone. The other benefits derived from chemical fingerprinting in waste disposal, health and safety considerations, and product development only add to this simplified estimate.

### **Supplier Interfaces**

Supplier cooperation is vital to any fingerprinting effort for a manufacturing operation. As shown in the above analysis, the supplier probably is not operating at a 3 $\sigma$  environment. In a number of cases the supplier to the aerospace is merely a distributor who is able to submit the lowest bid. For this reason, it is important that the aerospace prime contractors lead the way into establishing chemical fingerprinting programs and thus to bring the rest of the industry into a higher quality environment. There are benefits for the suppliers who participate in the prime contractor's chemical fingerprinting program, such as a more in-depth knowledge of their products. This level of knowledge can only be obtained through use of sophisticated, state of the art analytical equipment.

There are special relationships which need to be developed in terms of the vendor (supplier) and the prime contractors. Since many suppliers are equipped with minimally staffed and instrumented quality control laboratories, then chemical fingerprinting data will be able to provide a more comprehensive insight to their raw materials, processes and products. This exchange of information can become a useful product of the supplier interface and elevate the productivity and quality of the products manufactured by the prime contractor. One example in which a better relationship was obtained with a reluctant vendor occurred when fingerprinting diagnosed the cause of a material problem to be not with the primary vendor but a supplier to that

vendor. After notifying the primary vendor that his supplier was delivering inferior materials, the primary vendor then became very positive in his commitment to the program.

#### References

1. Total Quality Management - Market supplement to Aviation Week, May 21, 1990
2. Martin- Marietta Final Report, NAS 8 -
3. "Activity-Based Costing Facilitates Concurrent Engineering", D. Webster, Current Engineering, Issues, Technology and Practice, vol. 1, No. 6, December, 1991, Auerbach Publishers, pp. 10 - 18.
4. Life Cycle Costing, B. S. Dhillon, Gordon and Breach, New York, 9189
5. Motorola Quality Engineering Satellite Presentation, IEEE Satellite Down-Link on Malcolm Balderidge Awards, November, 1990.
6. Successful Management of the Analytical Laboratory, O. I. Milner, Lewis Publishers, Chelsea, MI, 1992







3/1/92  
13/1/92  
N93-15917 P-125

**Final Report**

**submitted to**

**NATIONAL AERONAUTICS AND SPACE ADMINISTRATION  
GEORGE C. MARSHALL SPACE FLIGHT CENTER, ALABAMA 35812**

**September 30, 1992**

**for Contract NAS8 - 38609**

**Delivery Order 13**

**entitled**

**Fingerprinting of Materials  
Technical Supplement**

**by**

**Gary L. Workman Ph.D.  
Principal Investigator**

**Materials Processing Laboratory  
Center for Automation & Robotics  
University of Alabama in Huntsville  
Huntsville, Alabama 35899**





## Foreword

This supplement to the Guidelines for Maintaining and a Chemical Fingerprinting Program has been developed to assist NASA personnel, contractors, and sub-contractors in defining the technical aspects and basic concepts which can be used in chemical fingerprinting programs. This material is not meant to be totally inclusive to all chemical fingerprinting programs; but merely to present current concepts. Each program will be tailored to meet the needs of the individual organizations using chemical fingerprinting to improve their quality and reliability in the production of aerospace systems.



# CHEMICAL FINGERPRINTING HANDBOOK

## Technical Supplement

### Table of Contents

<b>1.0</b>	<b>Instrumentation</b>	<b>1</b>
1.1	Chromatography	
1.2	Spectroscopy and Spectrometry	
1.3	Microanalytical	
1.4	Surface Science	
1.5	Thermal Mechanical Techniques	
1.6	Strategy for Instrument Heirarchy	
<b>2.0</b>	<b>Chemometrics</b>	<b>79</b>
2.1	Basic Statistics	
2.2	Design of Experiments	
2.3	Multivariate Analysis	
<b>3.0</b>	<b>References</b>	<b>115</b>



## 1.0 INSTRUMENTATION

Modern instrumental analysis laboratories utilize a variety of chemical analysis instrumentation. This chapter describes the most commonly used analytical instruments, the principles behind the corresponding analytical techniques, and the applications and requirements of these techniques.

### 1.1. Chromatography

Chromatography is used to separate the components of a mixture. A chromatographic system consists of two mutually immiscible phases: a mobile phase which can be a gas or a liquid, and a stationary phase which is either a solid or a liquid supported on a solid within a column. The mixture is introduced into the mobile phase which flows through the stationary phase. Chemical species within the sample interact with both the mobile and stationary phases. The extent of interaction depends upon the chemical and physical properties of each component. Each component of the mixture partitions, or distributes itself between the two phases based on properties such as polarity, charge, or molecular size. With proper selection of mobile and stationary phases, the component species are gradually separated into distinct volumes or bands within the mobile phase. Separated components are eluted from the column in order of increasing interaction with the stationary phase. A detector placed at the end of the column responds to the eluted species, and its signal is plotted as a function of time. The resulting plot, called a chromatogram, consists of a series of peaks. The location of a peak along the time axis can be used to identify the component, and the area under each peak provides a quantitative measure of the component.

Chromatographic techniques can be broadly classified according to the physical state of the mobile phase (Figure 1.1). Gas chromatography (GC) refers to a technique in which the mobile phase is a gas, whereas in liquid chromatography (LC) the mobile phase is a liquid.

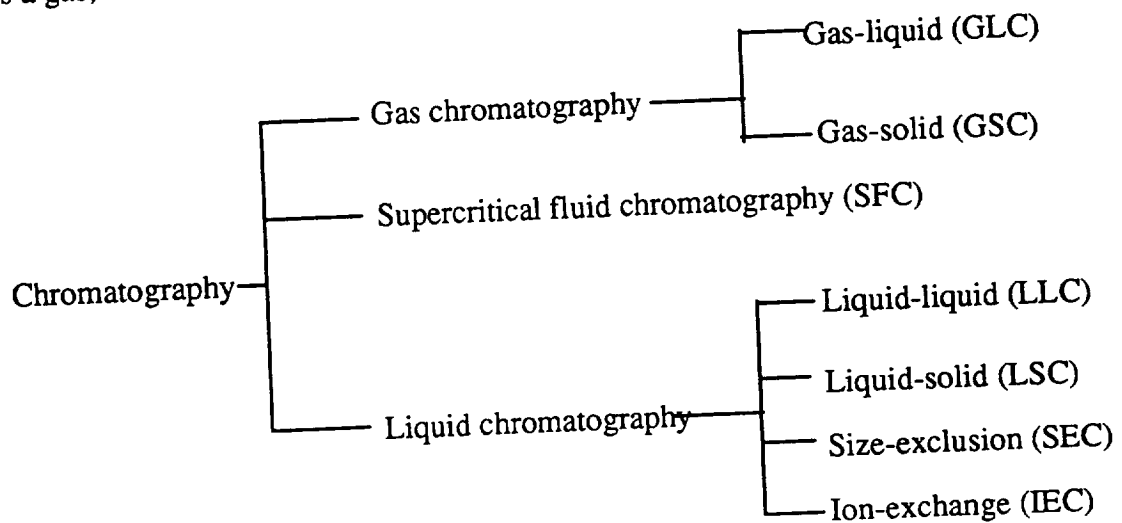

Figure 1.1. Classification of Chromatographic Techniques

Chromatographic methods can be further categorized according to the stationary phase's physical state or its mode of interaction with the sample. When the separation involves partitioning between a gaseous mobile phase and a liquid stationary phase, the method is called gas-liquid chromatography (GLC). In gas-solid chromatography (GSC), separation is based on size exclusion or adsorption of sample components onto the surface of a solid stationary phase. Liquid-liquid chromatography (LLC) and liquid-solid chromatography (LSC) refer to the analogous methods using liquid mobile phases. Two additional liquid chromatographic methods are commonly used. In size exclusion chromatography (SEC), species are separated based on molecular size due to differential permeation of a porous stationary phase. In ion-exchange chromatography (IEC) ionic species are separated by selective exchange of counter ions with an ion-exchange resin.

Recently, supercritical fluids have been used as chromatographic mobile phases with both liquid and solid stationary phases. Supercritical fluids exhibit properties intermediate between gases and liquids, and supercritical fluid chromatography (SFC) can be described as a hybrid of GC and LC. Although SFC has advantages over both GC and LC in certain applications, it cannot replace either method. SFC is infrequently used in industrial laboratories and will not be discussed further in this handbook.

Discussions of the kinetic processes and physical forces that comprise the theoretical basis of chromatography are beyond the scope of this handbook. However, several definitions and concepts are essential for a practical understanding of chromatographic techniques. Chromatographic separations arise from selective retention of components on the stationary phase. Retention results from interactions between the component and the stationary phase. Four modes of interaction occur in chromatography: partition, adsorption, size exclusion, and ion-exchange. In the partition mode, sample components distribute themselves between the stationary and mobile phases on the basis of the relative phase solubility of the components. Components having differing phase solubilities will spend different amounts of time in the stationary phase, and will be eluted from the column separately. Most GC and LC separations are based on partitioning. In the adsorption mode, components selectively adsorb onto the surface of the stationary phase. At one time, adsorption was the most widely used separation mode in both GC and LC. Although adsorption chromatography sometimes suffers from irreversible adsorption or peak distortion due to slow desorption, it remains the preferred approach in certain applications. In the size exclusion or sieving mode, separation is based on a component's ability to penetrate the pores of the stationary phase. Large molecules that are excluded from the pore structure are rapidly eluted from the column, whereas small molecules permeate the pore structure and remain in the column longer. Size exclusion is used in both LC and GC. Ion-exchange is based on exchange equilibria between ions in the sample solution and ions on the surface of an ion-exchange resin. This mode of separation is applicable only to LC.

Parameters used to describe chromatographic separations can be understood by examining the hypothetical chromatogram in Figure 1.2.

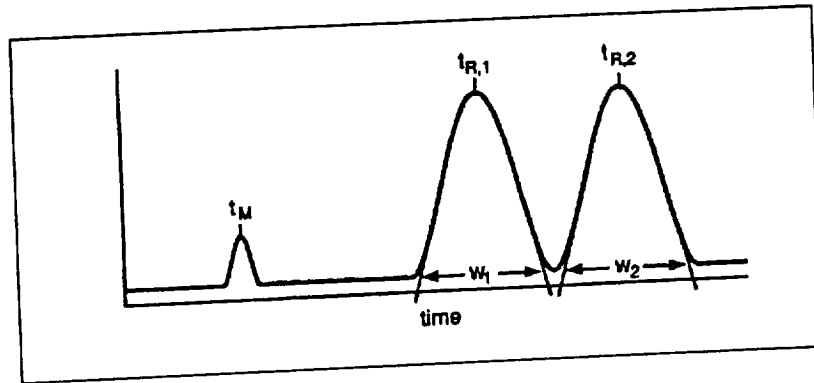

Figure 1.2 Hypothetical Chromatogram

In this example, a sample composed of Species 1 and 2 entered the system at time zero on the chromatogram. Solvents and sample components that do not interact with the stationary phase move through the column at the velocity of the mobile phase, and are eluted from the column at time  $t_M$ . In this example, species 1 and 2 interact with the stationary phase, with species 2 interacting more than species 1. The retention time,  $t_R$ , of each component is defined as the time required for the component to elute from the column and be detected. The peak width,  $W$ , is obtained by drawing tangents to the sides of the peak and measuring the distance between the tangents as they intersect the baseline.

The sample is initially applied to the column as a narrow band on plug. However, as the species present in the sample move through the column and are separated, the bands broaden. Chromatographic peak shapes are similar to the normal, or Gaussian, curve.

Band broadening adversely affects the efficiency or separation capability of a chromatographic system. Band broadening in chromatography can be attributed to mass-transfer processes. One such process is eddy diffusion, which is due to the multitude of pathways a molecule or ion can follow through a packed column. Because these pathways differ in length, molecules or ions of the same species reach the end of the column at different times. A second process that can lead to band broadening is longitudinal diffusion, the migration of a molecule or ion away from the center of a band, where its concentration is highest, to regions of low concentration on the outskirts of the band. Longitudinal diffusion is more significant in gas chromatography due to the relatively high diffusion rates of species through gaseous media. Another process responsible for band broadening is stationary phase mass-transfer. For a liquid stationary phase, this involves the diffusion of a solute through the liquid stationary phase to the stationary phase/mobile phase interface where transfer to the mobile phase occurs. When the stationary phase is a solid, the stationary phase mass-transfer is controlled by the rate at which the solute is adsorbed onto or desorbed from the surface of the stationary phase.

Band broadening can often be minimized by judicious selection of experimental parameters. Improved separation efficiency can be achieved by decreasing the stationary phase particle size, by decreasing the thickness of the immobilized liquid in the case of liquid mobile phases, and by decreasing the viscosity of the mobile phase. In gas chromatography, longitudinal diffusion can be minimized by lowering the temperature of the column and mobile phase.

Three factors control the resolution or quality of a separation: efficiency, capacity, and selectivity. All can be calculated directly from the chromatogram. The efficiency of a chromatographic column is expressed in terms of  $N$ , the number of theoretical plates, or  $H$ , the height equivalent of a theoretical plate. These parameters are related to each other and to the column length,  $L$ .

$$L = NH$$

Column efficiency is increased as the number of theoretical plates becomes larger or as the column length increases. The number of theoretical plates can be readily calculated from two experimentally measured parameters,  $t_R$  and  $W$ :

$$N = 16 \left( \frac{t_R}{W} \right)^2$$

Both  $N$  and  $H$  are used by column manufacturers and by analysts as a measure of a chromatographic column's performance. To compare the efficiencies of two columns, it is essential that  $N$  or  $H$  be determined with the same compound and under the same experimental conditions (mobile phase composition and flow rate, temperature, etc.). To compare columns of different length,  $H$  must be used.

The selectivity factor,  $\alpha$ , is a measure of the relative retention of two components in a mixture. Selectivity can be calculated as:

$$\alpha = \frac{t_{(R,2)} - t_M}{t_{(R,1)} - t_M}$$

where  $t_{R,2}$  is measured for the more strongly retained component. Selectivity depends on the nature of the mobile and stationary phases and temperature.

The capacity factor,  $k'$ , is a measure of the time a component spends in the stationary phase compared to the time it spends in the mobile phase. This parameter is important because it is an indication of the column's ability to retain a solvent. The capacity factor can be calculated from the chromatogram:

$$k' = \frac{t_R - t_M}{t_M}$$

Values of  $k'$  between 1.5 and 4 are desired for adequate retention and reasonable analysis times.

Efficiency, selectivity, and capacity factors together control the resolution,  $R$ , between two peaks:

$$R = \left( \frac{N^{1/2}}{4} \right) \left( \frac{\alpha - 1}{\alpha} \right) \left( \frac{k'}{1 + k'} \right),$$



Resolution can also be calculated directly from the chromatogram:

$$R = \frac{t_{(R,2)} - t_{(R,1)}}{0.5 (W_2 + W_1)}$$

A resolution of 1.5 corresponds to 0.2% overlap of peak areas and is adequate for most separations. Figure 1.3 demonstrates the effect of selectivity, capacity factor, and efficiency on the resolution of the separation.

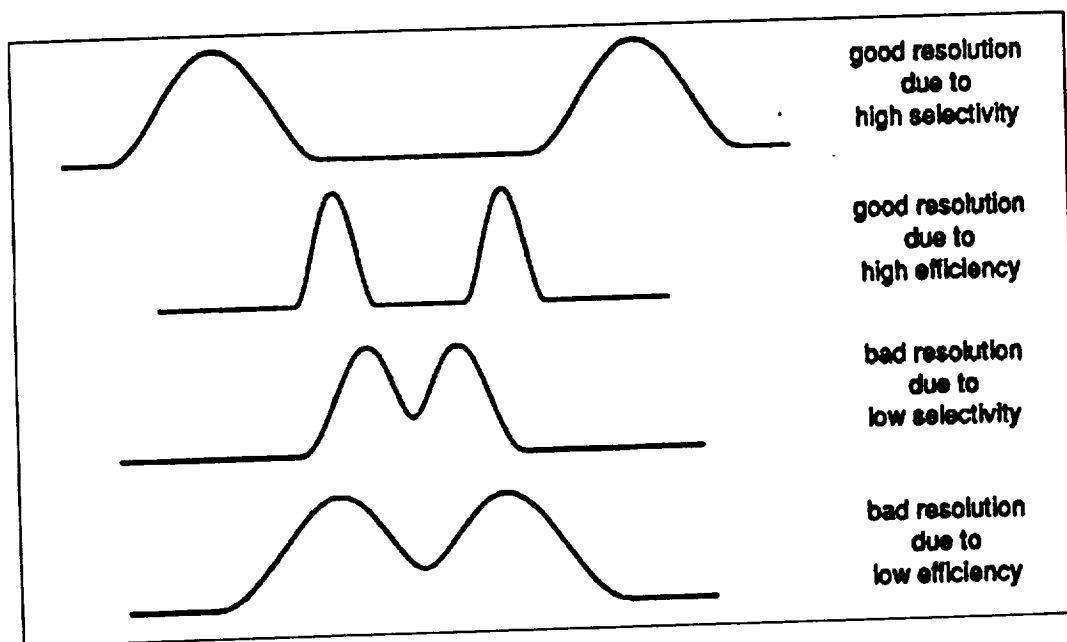

Figure 1.3 Chromatographic Resolution

Many similarities exist between GC and LC. The definitions and basic concepts discussed above apply to both techniques. In addition, all instruments used for either GC or LC include the following basic components: a mobile phase reservoir and delivery device, a sample introduction device, the chromatographic column, a detector, and a readout device. However, the types of samples analyzed by each technique, and the exact nature of the individual instrumental components required by each technique are different. Because of these differences, these techniques will now be discussed separately.

### 1.1.1 Gas Chromatography

Gas chromatography (GC) is used to separate thermally stable volatile substances. In GC, a vaporized sample is carried through a column by an inert carrier (mobile phase) gas. Components of the sample are separated due to differences in vapor pressure and affinity for the stationary phase. As each component is eluted from the column, its presence is sensed by a detector and a response is displayed on a recording device. The major components of a GC system are shown in Figure 1.4.

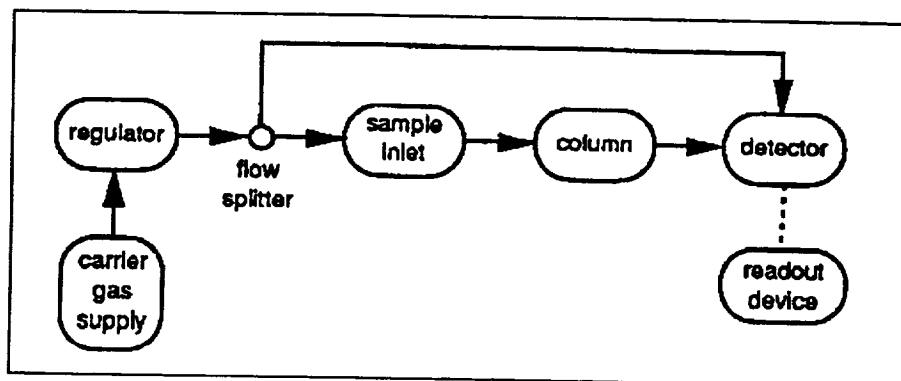

Figure 1.4 Schematic of a Gas Chromatograph

The samples are usually introduced into the system by direct injection. The sample is injected by a microsyringe through a septum into a heated sample port where it is vaporized and carried into the column. Use of automatic samplers increase precision and frees the analyst for other duties. The carrier gas must be chemically inert and pure. Helium, nitrogen, and hydrogen are the most commonly used mobile phases in GC. Because contaminants such as water or oxygen can cause deterioration of column or detector performance, purity is essential.

Two types of columns are commonly used: the packed column and the open tubular or capillary column. Packed columns can accommodate much larger sample volumes and are usually easier to use. Open tubular columns give much better resolution and are preferred for separations of complex mixtures. Packed columns are constructed from glass or metal tubing. Column inner diameters range from 1 to 10 millimeters, and lengths range from 2 to 3 meters. For gas-liquid chromatography, the columns are packed with a solid support material (125 to 250  $\mu$ m diameter) that has been coated with an organic liquid layer immobilized by adsorption or chemical bonding. For gas-solid chromatography, the packing may be a porous organic polymer or molecular sieves. Open tubular columns are usually constructed from fused silica. These columns have an internal diameter of 0.1 to 0.5 millimeter, and a length of 10 to 100 meters. Wide-bore capillary columns made of glass have an inner diameter of 0.75 mm. The inner surface of the column is coated with a liquid stationary phase, 1 to 5 micrometers thick.

The selection of the stationary phase is a crucial step in method development. Hundreds of materials have been proposed as stationary phases for gas-liquid chromatography. The ideal stationary phase will be thermally stable, chemically inert, and non-volatile. Selection of a suitable stationary phase for a specific application is based on the selectivity and polarity of the stationary phase. Non-polar stationary phases are used to separate components having significantly different boiling points. A stationary phase that will selectively interact with one or several of the components should be selected when the mixture contains components having similar boiling points.

The most frequently used liquid stationary phases are the silicone polymers. Poly(dimethylsiloxane) is a nonpolar stationary phase used for separations of nonpolar compounds based on boiling point. By replacing some of the methyl groups with phenyl groups, slightly polar phases capable of separating olefins, aromatics, and other unsaturated

species are obtained. Replacement of the silicone's methyl groups with even more polar functionalities (such as cyanopropyl or trifluoropropyl) gives a more polar or more selective stationary phase. Most chromatographic supply catalogues offer excellent advice on the selection of stationary phases. Some common stationary phases, and their applications, are listed in Table 1.5.

Solid materials used as GC stationary phases include the molecular sieves and porous polymers. Molecular sieves are porous alkali metal aluminosilicates. Pore size is uniform and depends on the cation present. Porous polymer packings are made from styrene divinyl benzene copolymers. Molecules smaller than the pore dimension penetrate the particles and are adsorbed. Therefore, separation is based on molecular size and shape. Gases and low boiling point liquids can be separated on these solid stationary phases.

Because column temperature must be controlled to within  $\pm 1^\circ \text{C}$  for precise work, GC columns are coiled and housed in a thermostated oven. Column temperature is selected based on the boiling range of the sample. If the sample components boil over a narrow range, it may be possible to achieve the separation in a single isothermal run at a temperature near the average boiling point of the sample components. If the sample boils over a broad range, it may be necessary to use temperature programming, i.e., to continuously or incrementally increase the column temperature during the separation. The column temperature is initially set below the boiling point of the lowest boiling component. The final temperature is near the boiling point of the highest boiling component (but within the thermal limit of the stationary phase). Thermal programming shortens the retention time of the later eluting components, decreasing both the band broadening of the later peaks and the total analysis time.

The detector senses the presence of the separated components as they elute from the column. Dozens of detectors have been used for GC. The five types described below are the most frequently used. Figure 1.5 illustrates the range over which the most popular detectors are used, while a guide for detector selection is given in Figure 1.31 on page 66.

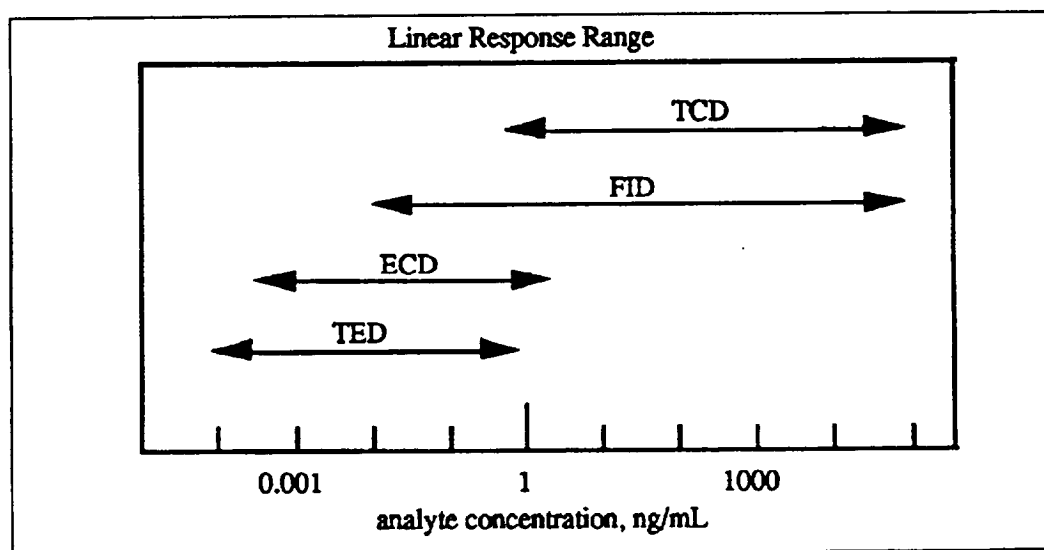

Figure 1.5. Useful ranges for Gas Chromatographic Detectors

Thermal conductivity detectors (TCD) display universal response and are rugged, relatively inexpensive, and nondestructive of sample. The TCD is based on changes in the thermal conductivity of the gas stream emerging from the GC column. The sensing element of the TCD consists of a metal block container and a filament that is electrically heated. When gas flows over the filament, heat is transported from the filament to the metal block. Heat loss from the filament results in decreased temperature and electrical resistance. Because the thermal conductivities of helium and hydrogen are six to ten times greater than those of most organic compounds, even small levels of organics in the column effluent cause large decrease changes in thermal conductivity and a marked increase in filament temperature and resistance. A change in filament resistance signals the emergence of a sample component from the column.

Flame ionization detectors (FID) display nearly universal response, high sensitivity, wide linear response range, and excellent reliability. Compared to the TCD, the FID is approximately 1000 times more sensitive, but also more complicated, more expensive, and destructive. In the FID, combustible sample components are burned in a hydrogen/air flame, generating free ions and electrons. The flame in the FID is located between two electrodes. Ions and free electrons present in the pure flame give rise to a small current when a potential is applied across the electrodes. As a carrier gas containing combustible sample components passes through the flame, additional ions and free electrons are generated and the current markedly increases. Response is proportional to the number of reduced carbons in the sample component. Oxidized carbons (present in functional groups such as carbonyl, alcohol, carboxylic acid, ether and their sulfur analogs) produce little or no response. Because the FID does not respond at all to water or to the permanent gases ( $N_2$ ,  $O_2$ ,  $CO$ ,  $CO_2$ , etc.), it is ideal for trace analysis in aqueous solutions and air samples.

Thermionic emission detectors (TED) respond only to compounds that contain nitrogen or phosphorus. The TED is similar to the FID except that the flame temperature and electrode polarity are optimized to enhance ionization of nitrogen and phosphorus containing compounds, and to suppress ionization of other compounds. The TED is 500 times more sensitive for nitrogen, and 50 times more sensitive for phosphorus than the FID. The TED is frequently referred to as the nitrogen-phosphorus detector (NPD).

Electron capture detectors (ECD) respond selectively to molecules containing electronegative functional groups such as halogens, nitrate, nitrite, and peroxide. The ECD also responds to unsaturated compounds such as polynuclear aromatics. In the ECD, the chromatographic effluent passes between two polarized electrodes, one of which is coated with a radioisotope that emits beta particles. The beta particles bombard the carrier gas, producing a burst of electrons and current flow between the electrodes. The presence of electron-capturing species is detected as a decrease in current.

Mass spectrometers are used as highly specific and highly sensitive GC detectors. Combined gas chromatography/mass spectrometry (GC/MS) can be used to quantitate and identify the components of a mixture. Mass spectrometers operate under high vacuum. The gas flow rates from capillary columns is usually low enough to permit direct connection between the column and the mass spectrometer. With packed columns, an interface system must be used to remove

most of the carrier gas. Two frequently used interfaces are the jet separator and the membrane separator. The jet separator takes advantage of the faster diffusion rate of the carrier gas compared to analyte. When column effluent is forced through a fine nozzle into a vacuum chamber it rapidly expands. The carrier gas expands more rapidly than the analyte. An orifice aligned with the nozzle collects the core of the effluent stream which is now enriched in analyte. The membrane separator is based on differences between the abilities of the carrier gas and analyte molecules to permeate a silicone membrane separating the column effluent from the mass spectrometer. Organic analyte molecules pass more readily through the membrane and into the mass spectrometer.

Detectors on mass spectrometers can acquire and display data in several ways. All of the ion currents can be summed and plotted as a function of time to give a total ion current chromatogram. If the analyst is interested in a particular peak the mass spectrum acquired at the time the peak passes through the detector can be plotted. The spectrum can then be used to identify the separated component.

In selective ion monitoring (SIM), the instrumental parameters are adjusted to detect only those ions associated with a particular compound or class of compounds. For example, if *a*-Methylstyrene were the only analyte of interest, only the 118 and 117 *m/z* ions would be monitored. SIM gives enhanced sensitivity because the background signal due to other ions is filtered out and because more time can be spent collecting data for the selected ions.

### 1.1.2 Liquid Chromatography

Liquid chromatography is used to separate mixtures of high molecular weight polyfunctional materials, polymers, thermally unstable compounds, and ionic species. Unlike GC, LC is not limited to thermally stable, volatile materials. LC and GC are complementary techniques.

Liquid chromatography was originally performed in large glass columns up to 5 m long and 5 cm diameter. To minimize mobile phase flow rates, the stationary phase particle diameters as large as 200  $\mu\text{m}$  were used. Even under these conditions, separations required several hours. Attempts to shorten the analysis time by increasing the mobile phase flow rate resulted in decreased separation efficiency. In the 1960s it became possible to produce highly efficient stationary phase packings with particle diameters near 10  $\mu\text{m}$ . These small diameter packings lead to the development of new instrumentation capable of operating at higher pressures. This new technology was called HPLC, high performance liquid chromatography. Except for preparative applications, HPLC has replaced classical glass-column LC.

Figure 1.6 shows the major components of a typical HPLC instrument. The components perform the following functions: delivery of the mobile phase, sample introduction, separation of the mixtures components, and detection of each component.

A liquid chromatographic separation can be performed by isocratic elution, in which a single mobile phase is used, or by gradient elution, in which two or more solvents are used in varying ratios throughout the run. For isocratic elution, the minimal mobile phase delivery system consists of a mobile phase reservoir and a pump. Gradient elution requires a reservoir and

(usually) a pump for each solvent, and a gradient mixing device.

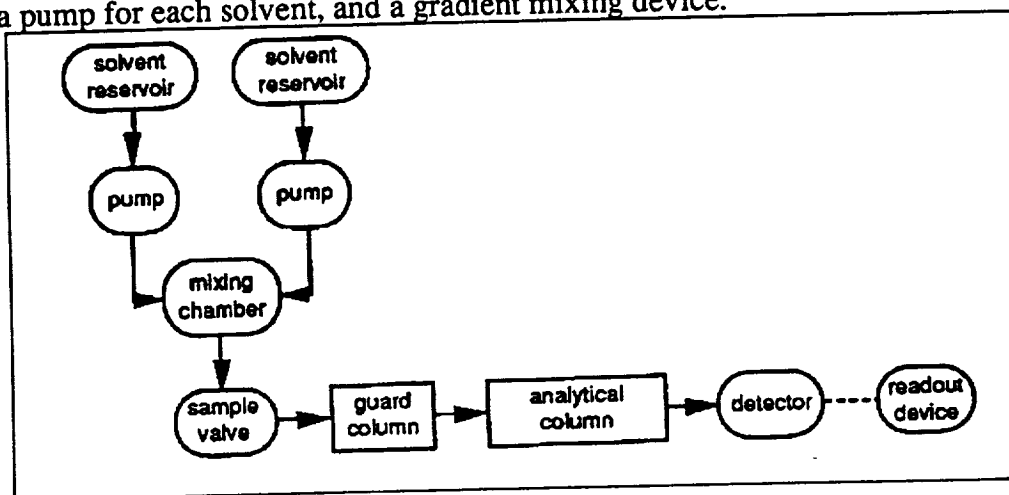

Figure 1.6 Functional Schematic of a Liquid Chromatograph

Solvent reservoirs are constructed of glass or stainless steel. The original solvent bottle is often adequate. The mobile phase itself must be free of particulates which may cause blockages and dissolved gases which may be released as bubbles in the detector or in the pump check valves. Particulates are removed by in-line filters placed between the reservoir and the pump. Gases may be removed by sparging, sonicating, vacuum pumping, or by heating and stirring.

Pumps used for HPLC must be able to operate at pressures up to 6000 psi and to produce reproducible and constant flow rates of 0.1 to 10 mL/min. Two types of pumps are used: reciprocating piston and positive displacement. Reciprocating piston pumps are the most popular. In a piston pump, a small (30 or 400 mL) cylindrical chamber is alternately filled and emptied by the back-and-forth motion of a motor-driven piston. Flow direction is controlled by means of check valves. On the backward stroke, the piston pulls solvent from the external mobile phase reservoir. On the forward stroke, mobile phase is pumped to the column. Because no solvent is pumped to the column on the backward stroke, the flow is pulsed, and a pulse damping system should be used. Dual-head (or triple head) pumps consist of two (or three) pistons mechanically coupled so that pumping and filling occur simultaneously. Flow pulsations are greatly reduced, but not eliminated, in the dual head and triple-head pumps. Advantages of reciprocating pumps include unrestricted operating time due to the use of an external reservoir and rapid solvent change over due to the pump's small internal volume. Positive displacement, or syringe, pumps consist of a large (250 to 500 mL) solvent reservoir equipped with a plunger. A stepping motor actuates the plunger through a screw-driven mechanism. Displacement pumps produce a pulse-free flow. However, it suffers from limited solvent capacity, requiring periodic shut-down of the system for refilling.

Two types of gradient mixing devices are used: low-pressure and high-pressure. In a low-pressure system, the gradient is formed ahead of the high pressure pump. A system of proportioning valves accurately measure and deliver up to four solvents to a low volume mixing chamber. In a high pressure system, mixing of the solvents occurs after the pumps. High pressure systems are more costly because they require a separate pump for each solvent used in the gradient. However, they provide more precise control over the gradient composition. In

both types of gradient systems, changes in the mobile phase composition are controlled by a gradient programmer. Both continuous and step gradients are used. Because the mixing process can generate heat which can result in gas evolution thorough degassing of each mobile phase is essential.

The most widely used sample introduction devices are sampling valves. These devices permit sample introduction at high pressure with minimal interruption of mobile phase flow. Typical valves can deliver 10 to 500  $\mu$ L with a few tenths percent precision. Automatic samplers available for HPLC allow unattended operation of the equipment.

HPLC columns are constructed of smooth-bore stainless steel tubing or glass-lined metal tubing. Several types of analytical columns are used: standard, short, and narrow bore. Standard columns are 20 to 30 cm in length with an inner diameter of 4 to 5 mm and stationary phase particle size of 3 to 10  $\mu$ m. Short columns that are 3 to 6 cm long and packed with 3  $\mu$ m particles give good separations with increased sample throughput and minimal solvent consumption. These columns are useful for relatively easy separations ( $N \leq 4000$ ) when speed is essential as in quality control applications. Narrow-bore (or microbore) columns have small internal diameters, usually 1 to 2 mm. Narrow-bore columns offer several advantages including decreased solvent consumption and increased detector response. Disadvantages include a requirement of special low volume injection valves, detector cells, and pumps.

Guard columns are sometimes placed between the injection valve and the analytical column. Guard columns are short and packed with a stationary phase similar to that used in the analytical column, but of larger particle size. Guard columns protect the analytical column by trapping particulates and sample components that would be permanently retained on the analytical column.

As mentioned before, there are four modes of liquid chromatography: liquid-liquid (partition), liquid-solid (adsorption), ion exchange, and size exclusion. Each mode is applicable to different types of samples and each mode makes use of different types of stationary phases. Liquid chromatographic techniques are also categorized on the basis of the relative polarities of the stationary and mobile phases. In normal-phase chromatography, a polar stationary phase is used with a nonpolar mobile phase. In reverse-phase chromatography, the stationary phase is less polar than the mobile phase.

Column packings used for partition chromatography are of two types. In the liquid-coated type, the liquid stationary phase is held on the solid support particles by adsorption. In bonded-phase packings, the stationary phase is covalently bonded to the support particles. Bonded-phase packings have almost completely replaced the liquid-coating packings due to their greater stability. Bonded phase packings are based on rigid silica particles. The organic stationary phase is bonded to the silica surface through a siloxane linkage:

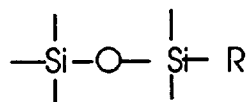

where R is an organic group. The polarity and selectivity of the stationary phase can be

controlled by varying the organic group. In the most popular bonded phase packings, the alkyl group is an  $\eta$ -octyl ( $C_8$ ), or an  $\eta$ -octadecyl ( $C_{18}$ ) group. Both are nonpolar, however, the size of the alkyl group affects retention. The  $C_8$  packing will accomplish the separation faster, but the  $C_{18}$  phase can be used with larger sample sizes. Bonded phases containing phenyl groups are also nonpolar, but more selectively interact with aromatic and unsaturated hydrocarbons. Phases that contain cyano groups are moderately polar and are used to separate ethers, esters, ketones, aldehydes, and nitro compounds. Amino alkyl bonded phases are highly polar, and are useful in separations involving alcohols, phenols, carbohydrates, and amines.

Column packings used for liquid-solid chromatography are composed of silica, alumina, or carbon. Silica packings are the most frequently used. LSC is primarily used to separate nonpolar, water-soluble molecules. LSC can also be used to separate isomeric mixtures.

Size exclusion packings are composed of cross-linked polymers or porous glass or silica. Styrene-divinylbenzene copolymers are frequently used.

In packings used for ion chromatography, a monolayer of small (0.1 to 0.3  $\mu$ m) polymeric beads are aminated or sulfonated and electrostatically bonded to a relatively large (10 to 30  $\mu$ m) polymeric or glass bead. The aminated resins are used to separate anions, while the sulfonated material are used for cations.

Liquid chromatography has no detector as sensitive and as universally applicable as the FID and TCD detectors used in gas chromatography. The most commonly used HPLC detectors and their properties are listed in Table 1.1.

Detector	Type	Sensitivity(g/mL)	Linearity
UV-Visible absorption	selective	10 <sup>-10</sup>	10 <sup>5</sup>
Refractive index	universal	10 <sup>-7</sup>	10 <sup>4</sup>
Fluorometric	selective	10 <sup>-11</sup>	10 <sup>5</sup>
Amperometric	selective	10 <sup>-12</sup>	10 <sup>5</sup>
Conductometric	selective	10 <sup>-8</sup>	10 <sup>3</sup>

Table 1.1 HPLC Detectors

UV-visible absorption detectors are based on the absorption of ultraviolet or visible radiation by components as they pass out of the column. Three types of UV-visible detectors are available: fixed-wavelength, variable-wavelength, and photodiode-array. Fixed-wavelength detectors use discrete light sources which emit light at several wavelengths. Each wavelength can be selected by use of narrow bandpass filters. A fixed-wavelength detector with a mercury lamp as the source has useful emission lines at 254, 280, 313, 334, and 365 nm. These detectors are simple, stable, sensitive, and inexpensive. However, only the solutes that absorb at the given wavelengths will be detected. Variable wavelength detectors use continuous light sources in combination with a monochromator. These detectors offer unlimited selection of UV and visible wavelengths. Photodiode array detectors consist of a continuous light source, a monochromator, and silicon diode array detector. These detectors simultaneously monitor all



wavelengths. An entire spectrum can be collected and stored as each separated species passes out of the column. Photodiode array detectors are especially useful during the development of a new LC method because they help the analyst identify the optimal detector wavelength. UV visible detectors are selective in that they respond only to species that absorb ultraviolet or visible radiation. Detectable species include the unsaturated hydrocarbons, including aromatics, and compounds that contain atoms such as nitrogen, oxygen, sulfur, and halogen.

Refractive index (RI) detectors are based on difference in refractive index between the mobile phase (reference) and the column eluent. Because most substances differ in refractive index, the refractive index detector is universal in response. However, this detector is not very sensitive and is seldom useful for trace-level components. Its universal response usually precludes its use in gradient elution procedures where the changing mobile phase composition results in drifting baselines. Refractive index detectors are extremely sensitive to temperature changes and flow rate fluctuations.

Fluorometric detectors respond to the fluorescent emission of molecules that have been electronically excited by a suitable source. Fluorometric detectors are more selective and more sensitive than UV-visible absorption detectors. The detector's selectivity is due to the fact that not all molecule fluoresce. Compounds that can be detected include pollutants such as the polynuclear aromatics and biologically significant species such as vitamins, alkaloids, and catecholamines. The extreme sensitivity of fluorometric detectors results from a low background level of fluorescence. This detector can be used with gradient elution.

Amperometric detectors are based on the measurement of current flow as analytes in the eluent undergo oxidation or reduction at an electrode. Typical amperometric detector cells have a three-electrode arrangement consisting of a working electrode (which detects the analyte), an inert reference electrode, and an auxiliary electrode. A potential is applied between the working and reference electrodes, while current flows between the working and auxiliary electrodes. The working electrode composition is important because it determines the range of potentials that can be applied and, therefore, the species that can be detected. Dual electrode detector cells have two working electrodes which can be placed in series or in parallel with the flowing eluent. In the series configuration, the upstream electrode produces an electrochemically active product that can be detected at the downstream electrode. This approach enhances the selectivity of the detector, and also enhances sensitivity by reducing background noise due to mobile phase electrolysis. In the parallel configuration, the two working electrodes are held at different potentials. The ratio of currents measured at the two electrodes provides an indication of the peaks purity and identity. Amperometric detectors are more sensitive and more selective than UV-visible and RI detectors. Amperometric detection is widely applicable. However, amperometric detectors are not widely used due to several disadvantages. Amperometric detectors adversely respond to fluctuations in eluent flow rate. Many compounds adsorb onto the electrodes, requiring frequent and time-consuming cleaning and recalibration. Operation in the reductive mode may require exclusion of oxygen from the system and the use of mercury electrodes.

Conductivity detectors measure the ability of the eluent to carry an electric current under the influence of a potential gradient. These detectors respond to species that form ions in solution

(electrolytes). Conductivity detectors are used with ion chromatography.

The mobile phases used in ion chromatography are ionic solutions which produce a high background conductivity. To detect analytes, the eluent conductivity must be suppressed. Membrane suppressors are used for anion (and cation) exchange separations. The eluent is passed over one side of a cation (or anion) exchange membrane. The membrane is continuously regenerated by flowing an acidic (or basic) solution over the other side of the membrane.

Mass spectrometer detectors provide both structural and quantitative information. Interfacing liquid chromatography with mass spectrometry has been difficult because of the mismatch between the large mass flow rates used in liquid chromatography and the vacuum requirements of mass spectrometry. Several interfaces have been developed. In the moving-belt interface, the column effluent is deposited on a continuous moving belt. The belt moves through a heated chamber, where the solvent is evaporated, and into the ion source of the spectrometer. In the thermospray interface, the column effluent is passed through a heated capillary tube to produce an aerosol of solvent vapor and analyte molecules. When polar mobile phases containing a salt (such as ammonium acetate) are used, the analyte can be ionized through charge exchange with the salt. When nonpolar or weakly ionizable mobile phases are used, an electron beam is used to achieve ionization.

## 1.2. Spectroscopy and Spectrometry

This section introduces the fundamental principles of spectroscopy, and describes specific instrumental methods based on these principles. Absorption, emission, or scattering of electromagnetic radiation alters the energy state of the interacting atom or molecule. Because each chemical species has characteristic energy states, a species interacts only with a particular region or energy range of the electromagnetic spectrum. The energy at which interaction occurs can be used to identify the interacting species, and the intensity of the interaction can be used to quantify its concentration.

Spectroscopic methods are based on absorption, emission, or scattering of electromagnetic radiation by matter. Electromagnetic radiation is a form of energy that is transmitted through space at the speed of light ( $3 \times 10^8$  m/s). Electromagnetic radiation can be described in terms of a wave model. An electromagnetic wave consists of electrical and magnetic field components which oscillate in planes perpendicular to each other and to the direction of wave propagation. The electrical field component of electromagnetic radiation is responsible for most of its interactions with matter. Figure 1.7 depicts the electrical field component and illustrates several parameters used to characterize electromagnetic radiation.

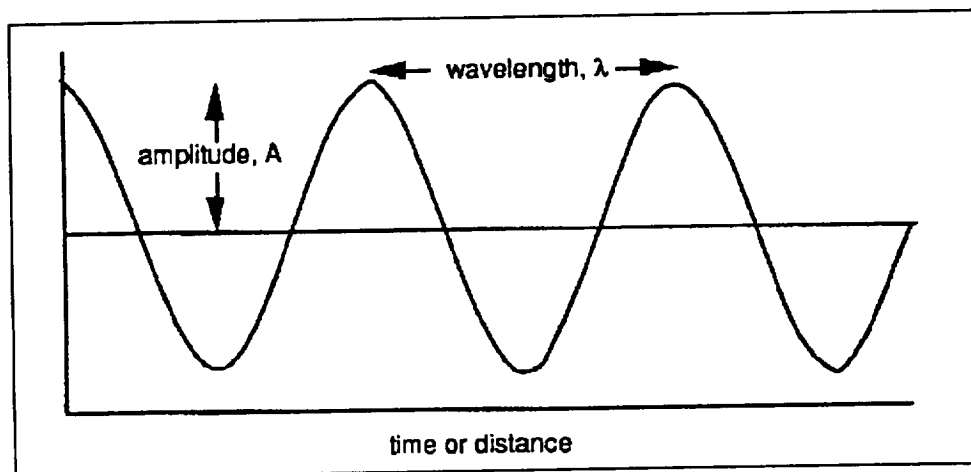

Figure 1.7. Electromagnetic Wave

The wavelength,  $\lambda$ , is the distance between successive maxima or minima of either the electrical or magnetic component. The frequency,  $\nu$ , is the number of waves that pass a fixed point in a unit of time, usually a second. Frequency is determined by the source of the radiation and remains unchanged by propagation of the wave through matter. The velocity of propagation,  $v$ , is the rate at which the wave passes through a medium. The velocity of electromagnetic radiation in a vacuum,  $c$ , is  $3 \times 10^8$  m/s. Due to interactions between the electric field component and matter, electromagnetic radiation is propagated or transmitted through matter at velocities less than  $c$ . The ratio of the speed of light in a vacuum to the speed of light in a medium is the refractive index  $n$  of the medium. Because the frequency is invariant, the wavelength must also decrease as radiation

passes from a vacuum to another medium. The wavenumber,  $\bar{\nu}$ , in units of  $\text{cm}^{-1}$  is the number of wave crests that occur per centimeter. Wavenumbers are often used instead of frequency, and can be calculated as:

$$\bar{\nu} = 1/\lambda \text{ or } \bar{\nu} = \frac{\nu}{c}$$

The radiant power,  $P$ , is the amount of energy transmitted per second and is proportional to the square of the wave amplitude,  $A$ .

Refraction, diffraction, and interference are phenomena that can readily be explained by the wave model. However, absorption and emission of electromagnetic radiation by matter can be described only by treating radiation as a stream of discrete particles or quanta of energy known as photons. The energy of a photon depends upon the frequency of the radiation, and is given by:

$$E = h\nu$$

where  $E$  is in joules, and  $h$  is Planck's constant ( $6.62 \times 10^{-34}$  J sec).

The quantum model is needed to describe photoionization, the emission of electrons from the surface of a solid when a sufficiently energetic radiation impinges on the surface. The energy of the emitted electrons is related to the frequency of incident radiation:

$$E = h\nu - w$$

where the work function,  $w$ , of the solid is the work required to remove an electron. The number of emitted electrons is dependent on the number of impinging quanta of radiation having a certain minimum energy.

Figure 1.8 on the next page depicts the electromagnetic spectrum, the broad range of radiations that extend from gamma rays to radio waves. The various types of electromagnetic radiation differ in frequency, wavelength, and nature of interaction with chemical species.

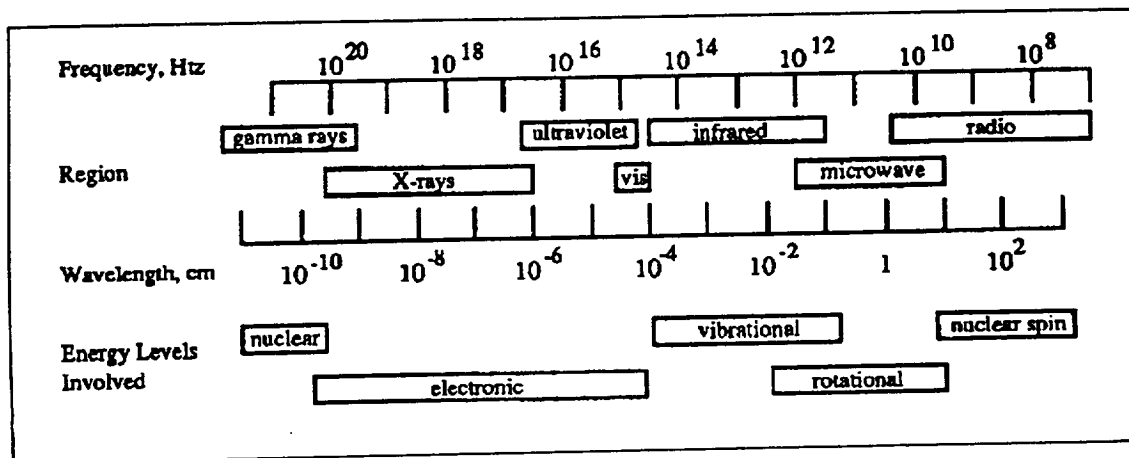

Figure 1.8. Electromagnetic Spectrum

Low-energy radio waves cause reorientation of nuclear spin states in materials placed in a magnetic field. Photons in the microwave region cause changes in rotational energy states of molecules. Absorption of infrared radiation results in changes in both vibrational and rotational energy states of molecules and complex ions. Absorption of visible or ultraviolet radiation changes the energy states of outer shell (valence) electrons. X-ray absorption results in ejection of inner shell (core) electrons (the photoelectron effect). These interactions of electromagnetic radiation with chemical species will be described in more detail in the following pages.

When electromagnetic radiation passes through a sample of matter, select frequencies may be transferred to the sample's atoms and molecules by the process of absorption. As a result, the absorbing species are promoted from a low energy state to a higher energy state, or excited state. Most chemical species at room temperature are in the lowest energy state, a ground state. Absorption, then, usually involves a transition from the ground state to an excited state. An atom or molecule in an excited state may return to the ground state by emission, the release of energy as radiation.

According to quantum theory, atoms and molecules exist only in a limited number of discrete potential energy levels. The energy of the impinging photon must match the energy difference between the ground state and an excited state of the absorbing particle for absorption to occur. Similarly, energy lost by emission of radiation must match the energy difference between an excited state and the ground state, or between two excited states. Because these energy differences are unique for each atom or molecule, the energies (frequencies) at which a species absorbs or emits radiation can be used to identify the species.

Absorption or emission of radiation is accompanied by transition of electrons between fixed energy levels. Ultraviolet and visible radiation are sufficiently energetic to cause transitions of outer shell or valence electrons. Absorption or emission of x-rays leads to transition of inner shell, or core, electrons.

Molecular spectra are more complex than atomic spectra due to an increased

number of energy states available. The potential energy of a molecule is the sum of the electronic, vibrational, and rotational energies. Normally, several rotational energy states exist for each vibrational energy state, and several vibrational states exist for each electronic state. The schematic energy level diagram in Figure 1.9 shows some of the electronic and vibrational states of a molecule. Lines labelled  $E_n$  represent electronic energy states.  $E_0$  refers to the electronic ground state,  $E_1$  and  $E_2$  refer to first and second electronic excited states. Several vibrational energy levels (labelled  $v_0$  to  $v_3$ ) are pictured for each electronic state. The energy differences between adjacent electronic states is 10 to 100 times greater than the energy differences between adjacent vibrational states. The figure also illustrates two analytically useful processes, absorption and fluorescence.

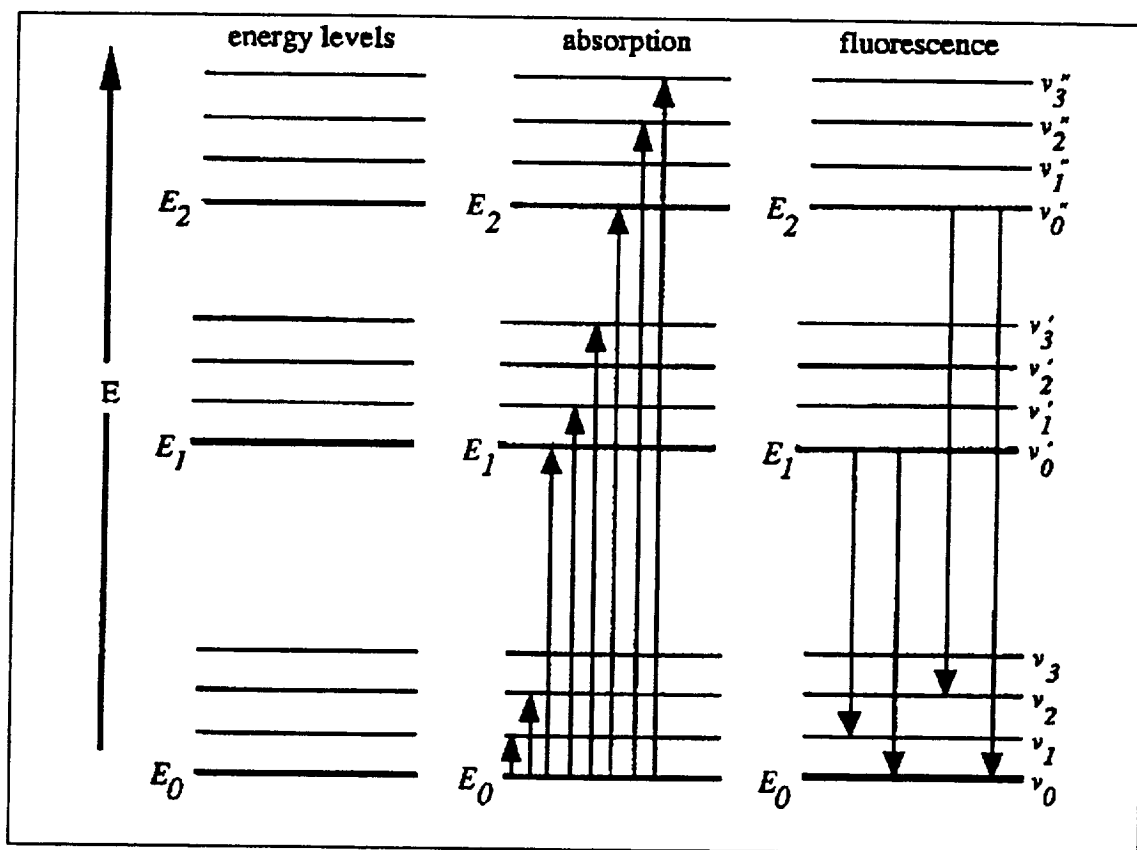

Figure 1.9. Molecular Energy Levels

### 1.2.1 Atomic Spectroscopy

Atomic spectroscopy is used to determine the concentration of a particular element in a sample, regardless of the chemical environment and oxidation state of the element. Atomic spectroscopic methods are listed in Table 1.2. In each method, the molecular components of the sample are converted to free atoms by the process of atomization. In atomic emission spectroscopy (AES), absorption of additional thermal energy from the atomization device transforms the free atoms to excited electronic states. As the excited atoms return to the ground state, they emit ultraviolet or visible

radiation at wavelengths characteristic of the atoms present in the sample. The intensity of the emitted radiation is measured, and is the basis of the analytical determination. In atomic absorption spectroscopy (AAS), the atoms are transformed to excited states by absorption of radiant energy from an external ultraviolet/visible light source. The analytical determination is based on the amount of radiant energy absorbed. In atomic fluorescence spectroscopy (AFS), the atoms are excited by a radiation source placed at  $90^\circ$  to the optical axis of the spectrometer. Quantitation is based on the intensity of radiation emitted as fluorescence. The basic components of instruments used for AES, AAS, and AFS are compared in Figure 1.10. All instruments used for atomic spectroscopy include an atomization device, a monochromator to resolve the emitted or transmitted light into its component wavelengths, and a detector for ultraviolet/visible radiation. Atomic spectroscopic instruments differ primarily in atomizer type, the absence or presence of an external light source, and orientation of the components.

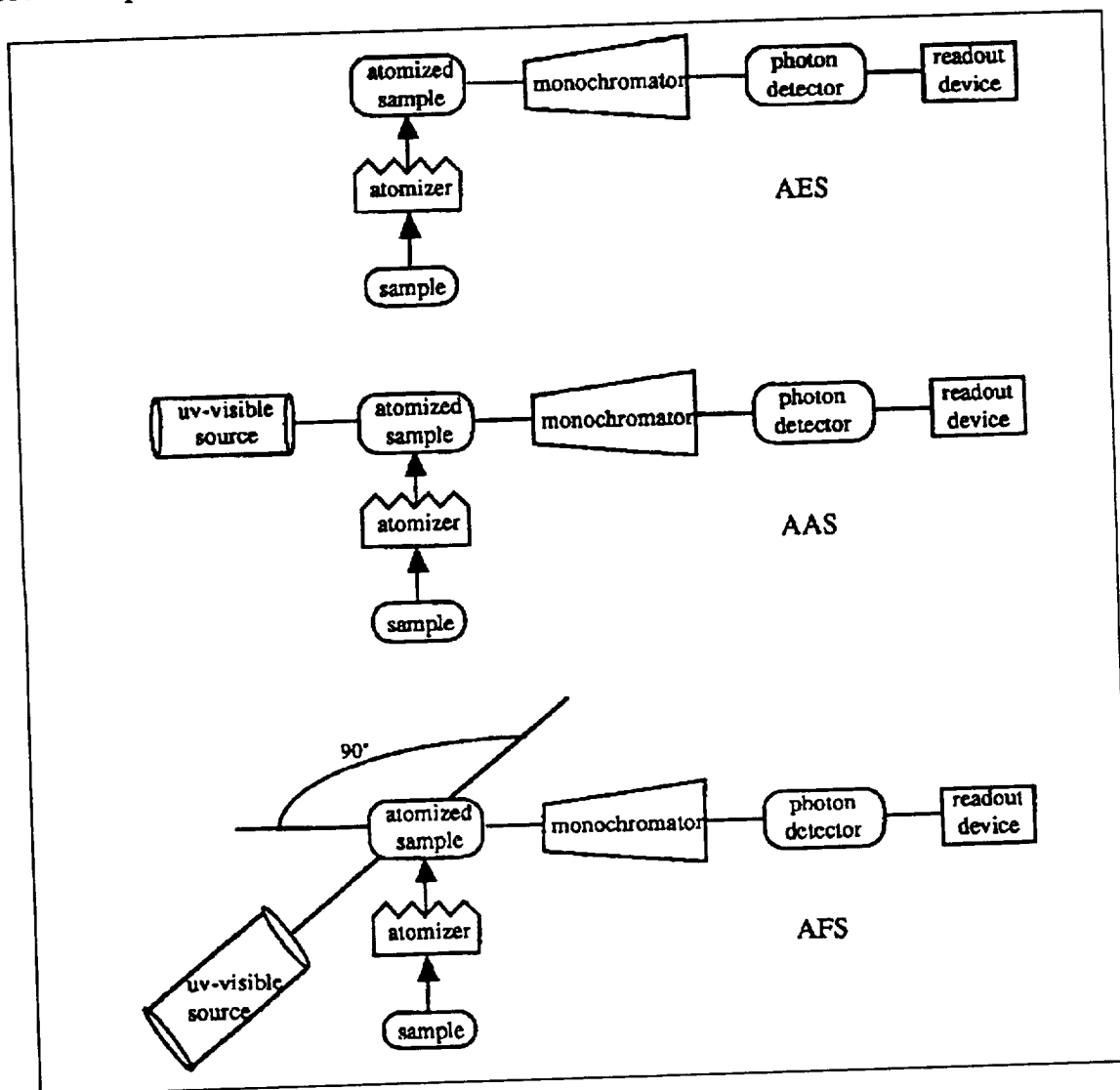

Figure 1.10. Instruments for Atomic Spectroscopy

Atomic spectroscopic methods are frequently classified according to atomizer type. The most commonly used atomizers are the combustion flame, the electrothermal analyzer, and the plasma. Flame atomizers are used for AES, AAS, and AFS. Electrothermal atomizers are primarily used for AAS and AFS, whereas plasma sources are used for AES and AFS.

<u>Technique (Abbreviation)</u>	<u>Atomization Source (Temperature)</u>
Flame atomic absorption spectroscopy (FAAS)	Flame (1700-3200° C)
Electrothermal atomic absorption spectroscopy	Furnace (1200-3000° C)
Flame emission spectroscopy (FES)	Flame (1700-3200° C)
Inductively coupled plasma atomic emission spectroscopy (ICP/AES)	Argon plasma (6000-8000° C)
Direct current argon plasma spectroscopy (DCP)	Argon plasma (6000-10000° C)
Arc-source emission spectroscopy	Arc plasma (4000-6000° C)
Spark-source emission spectroscopy	Spark plasma
Atomic fluorescence spectroscopy (AFS)	Flame (1700-3200° C)
Electrothermal atomic fluorescence spectroscopy	Furnace (1200-3000° C)
Inductively coupled plasma atomic fluorescence spectroscopy (ICP/AFS)	Plasma (6000-8000° C)

Table 1.2 Atomic Spectroscopy Methods

In the following section, the atomic spectroscopic techniques most commonly used will be discussed. These techniques are: flame atomic absorption spectroscopy, electrothermal atomic absorption spectroscopy, and inductively coupled plasma/atomic emission spectroscopy.

### 1.2.2 Flame and Electrothermal Atomic Absorption Spectroscopy

Atomic absorption spectroscopy is a sensitive technique for the quantitative determination of approximately seventy metallic or metalloid elements in solution matrices. The basic instrumental components were shown above in Figure 1.10.



Electrothermal and flame atomizers are used in atomic absorption instruments. Flame atomizers consist of a nebulizer and a burner. The nebulizer transforms the liquid sample into an aerosol which is introduced into the burner. Figure 1.11 illustrates the two main types of burners: the total consumption (turbulent flow) and laminar flow burners.

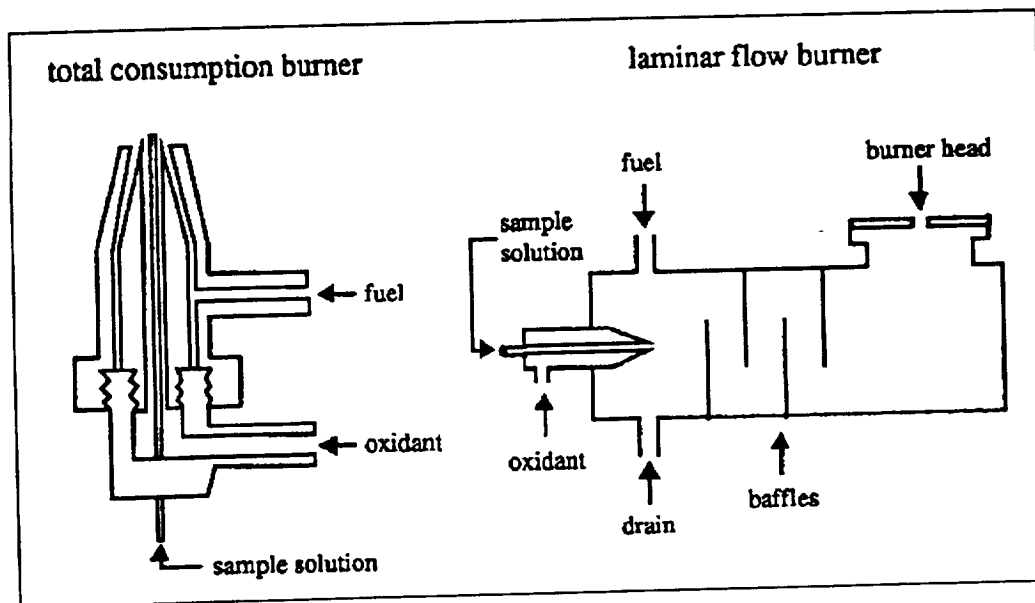

Figure 1.11. Atomizers for Atomic Absorption Spectroscopy

In the total consumption burner, the nebulizer and burner are combined into a single unit. The oxidant flow around the sample capillary tip draws the sample up the capillary and into the burner. Fuel gas mixes with the oxidant and the sample, and helps to break up the sample. The flame forms at the top of the burner. Total consumption burners offer several advantages over laminar flow burners: (1) the entire sample is aspirated into the flame, eliminating error due to loss of nonvolatile components, (2) no possibility of flashback or explosion exists (see discussion of laminar flow burner, below), and (3) the burner is inexpensive and easy to maintain. Disadvantages include: (1) vaporization and atomization efficiency are low, (2) operators must take special precautions to prevent clogging of the tip, (3) short flame path length results in decreased signal in AAS, and (4) total consumption burners are very noisy, both electronically and aurally due to turbulence.

In the laminar flow burner, the sample is drawn into a mixing chamber and nebulized by the flow of oxidant across the capillary tip. A series of baffles in the mixing chamber remove larger droplets from the sample stream. The remaining aerosol mixes with additional oxidant and fuel, and passes into the burner head and the flame. Laminar flow burners offer several advantages: (1) sensitivity is greater due to relatively long path length (5-10 cm), (2) burner is quiet, and (3) because larger drops are eliminated in the premix chamber, laminar flow burners seldom clog. Disadvantages are: (1) in samples containing more than one solvent, the more volatile components

may be preferentially vaporized in the mixing chamber, while less volatile components may drain off and not reach the flame (2) the mixing chamber contains an explosive mixture which can be ignited by a flashback, and (3) most of the sample goes down the drain.

Conversion of the sample to free atoms in the flame involves a sequence of events. The sample enters the flame as a solution aerosol. The solvent evaporates or, in the case of an organic solvent, burns, leaving behind a solid aerosol. The solid particles undergo volatilization, and then dissociation to form free atoms. These atoms are then excited by radiant energy from a uv-visible light source. Atomization efficiency is the efficiency with which the flame produces atoms by this sequence of events. Several processes can decrease atomization efficiency and, therefore, the analytical response. If the sample drops are too large, they may pass through the flame without completely evaporating. Droplet size can change significantly with a change in solvent due to viscosity differences. The rate at which the sample is introduced into the flame also affects atomization efficiency because solvent evaporation requires energy and lowers flame temperature.

Flame atomization surpasses other atomization methods in terms of reproducibility. However, sampling efficiency of the flame is low because much of the sample is discarded (in case of the laminar flow burner) or incompletely atomized (in the case of the total consumption burner), and the residence time of the analyte atoms in the optical path of the flame is short. The sampling efficiency and, therefore, sensitivity of other atomization methods is better.

Electrothermal atomizers provide high sensitivity because the entire sample is atomized quickly and the residence time in the optical path is on the order of seconds. Compared to flame atomization, electrothermal atomization enhances sensitivity by factor of 100 to 4000. Electrothermal atomizers can accommodate very small sample volumes (0.5 - 100  $\mu$ L) and solid samples. Electrothermal atomizers are electronically less noisy than flames. However, the precision of electrothermal methods, typically 5 to 10%, compares unfavorably with the 1 to 2% precision obtained with the flame methods.

An excitation source that emits light having an energy equal to the difference in energies between the ground state and excited state of the element being analyzed is used. Hollow cathode lamps are the most common excitation sources for AAS. Hollow cathode lamps consist of a cylindrical cathode constructed of the element being analyzed, and a tungsten anode, both sealed in a glass tube filled with an inert gas. When a sufficiently large potential is applied across the electrodes, the inert gas ionizes, forming highly energetic cations. As these cations strike the cathode's surface, atoms on the surface are dislodged. Some of the metal atoms are in excited electronic states and emit lines of radiation characteristic of the cathode element as they return to the ground state. Usually, a different lamp must be used for each element, although some multielement lamps are available. The source emission is directed through the atomized sample in the flame or furnace. The light not absorbed by the sample passes through to

the monochromator and the detector. The absorbance is calculated from the intensities of light detected with ( $I$ ) and without ( $I_0$ ) the analyte in the flame:

$$A = \log (I_0/I)$$

To absorb the source radiation, an atom in the flame must be of the same element used in the source lamp. Therefore, the absorbance is element-specific. The absorbance is also directly proportional to the analyte's concentration.

### 1.2.3 Inductively Coupled Plasma/Atomic Emission Spectroscopy

Inductively coupled plasma/atomic emission spectroscopy is used for the qualitative and quantitative analysis for over seventy elements in solution. ICP/AES is capable of multi-element analysis, performed in either a simultaneous or rapid sequential mode. This technique is used for determination of major, minor and trace level elements.

In ICP/AES the sample is atomized by an argon plasma sustained by inductive coupling to an rF (radio frequency) field. An ICP torch consists of three concentric quartz tubes as shown in Figure 1.12. An induction coil, powered by an rf generator, circles the top of the tube assembly. Argon flowing between the two inner tubes is initially ionized by a spark from a Tesla coil. An annular plasma forms when the resulting ions and electrons interact with the oscillating magnetic field generated by the induction coils. The analyte is introduced as an aerosol through the central tube. A gas (usually argon) flows tangentially between the two outer tubes to contain the plasma and to cool the quartz cylinder walls.

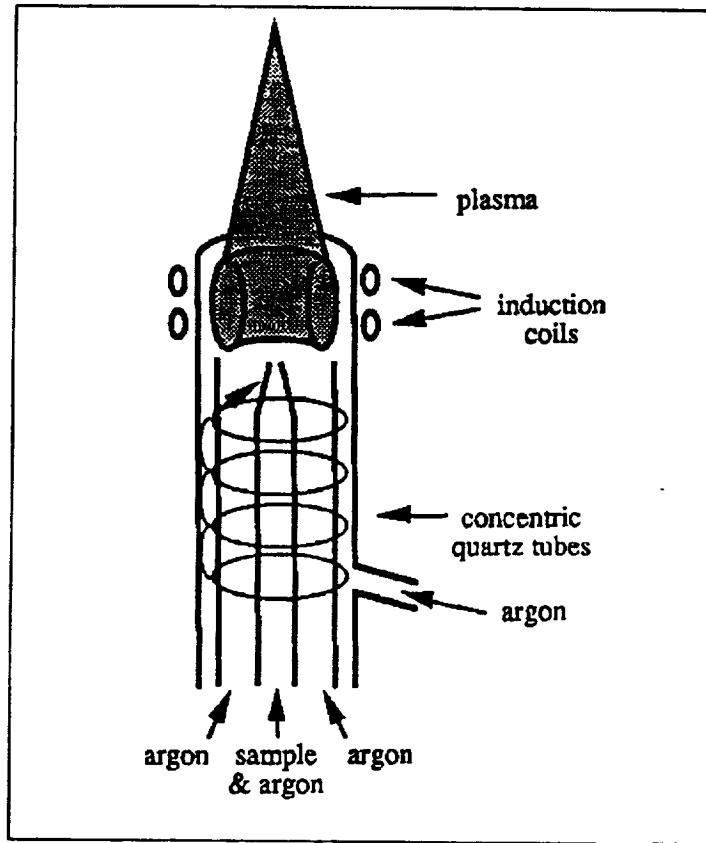

Figure 1.12. Inductively Coupled Plasma Atomizer

Samples are usually introduced into the plasma as a solution aerosol generated by a pneumatic nebulizer. The most commonly used pneumatic nebulizers are the concentric (or Meinhard) nebulizer and the crossflow nebulizer. In both types, the sample is drawn through a capillary into a low pressure region generated by the flow of a gas past the capillary tip. The aerosol produced in the nebulizer passes through a spray chamber, which removes or breaks up the larger droplets, and into the ICP torch.

When the sample is introduced into the plasma it is atomized and elevated to an excited state as a result of collisions with the argon ions. The excited analyte atoms relax to their ground state by emitting photons. The emitted radiation is dispersed by either a polychromator, for simultaneous multi-element analysis, or by a scanning monochromator, for sequential multi-element analysis.

In the polychromator, the emitted light is focused onto a concave grating where it is dispersed into its component wavelengths. Selected spectral lines are isolated by a series of exit slits. Each line is focused onto a detection device, a photomultiplier tube. The polychromator permits the simultaneous detection of up to 60 spectral lines (corresponding to 60 elements). Simultaneous multi-element analysis is especially useful in applications involving routine analyses of large numbers of samples having similar elemental composition. In the scanning monochromator, a lens focuses the emitted light onto a concave mirror, which collimates the light onto a planar grating

mounted on a computer-controlled stepper motor. The grating disperses the light, and a final mirror focuses the light onto an exit slit before the detector. The wavelength is selected by rotating the grating. Only one wavelength can be detected at a given time. For multi-element analysis, the grating must be driven in a sequential manner to a position corresponding to the appropriate analytical wavelength for each element to be measured. The scanning monochromator is more flexible than the polychromator because it offers a greater choice of analytical wavelengths. This is an advantage in the development of new methods, or in laboratories where samples vary widely in elemental composition.

#### 1.2.4 X-ray Fluorescence Spectroscopy

X-ray fluorescence (XRF) spectroscopy is used for qualitative and quantitative multi-element analysis. XRF can qualitatively identify all elements of atomic number greater than eleven, and quantitatively measure all elements of atomic number greater than fourteen present within a sample at the parts-per-million (ppm) or greater level. This technique is extremely useful because it is readily applicable to most solid and liquid samples with minimal sample preparation.

XRF is based on the emission of characteristic x-ray lines by atoms following excitation by high energy photons from an x-ray source. The most commonly used x-ray source is the x-ray tube which consists of a tungsten filament cathode and a target anode, both sealed within a highly evacuated tube. Electrons are thermally emitted from the cathode when the filament is heated. These electrons are then accelerated across a high potential gradient to the target anode. Target materials include copper, molybdenum, iron, chromium, nickel, silver, and tungsten. X-rays are produced by bombardment of the target material. X-rays emitted by the source are then directed onto the sample. Upon absorption of the x-radiation, atoms within the sample become electronically excited. The excited atoms relax to their ground states by fluorescent emission of x-rays of characteristic energy. Sample fluorescence is collimated, and then dispersed by a crystal mounted on a goniometer. The goniometer permits control of the angle  $q$  between the incident collimated radiation and the crystal face. The collimated x-rays are diffracted from lattice planes within the crystal. The value at which a given wavelength  $\lambda$  is diffracted is given by Bragg's law,  $n\lambda = 2d \sin \theta$ , where  $d$  is the lattice spacing of the crystal. X-rays diffracted by the analyzing crystal are detected by gas-filled detectors or by scintillation counters.

Compared to ICP/AES and AA, XRF is more rapid and more readily applicable to various samples. However, ICP/AES and AA are more sensitive than XRF.

#### 1.2.5 Infrared Spectroscopy

Infrared spectroscopy (IR) is used to identify organic and inorganic materials, to elucidate molecular structures, and to quantitatively determine nontrace components of mixtures. This technique can be applied to solid, liquid, or gaseous samples.

The infrared region of the electromagnetic spectrum includes radiation with wavenumbers between 12,800 and 10  $\text{cm}^{-1}$  (wavelengths between 0.78 and 1000  $\mu\text{m}$ ). Most analytical applications make use of the mid-infrared region which encompasses wavenumbers from 4400 to 200  $\text{cm}^{-1}$ .

Absorption of infrared radiation by a molecule results in vibration of the molecule's component atoms relative to each other. Two types of vibrations occur: stretching and bending. Stretching involves a change in the distance between two atoms, with movement along the bond axis. Bending can occur in any molecule having three or more atoms and involves a change in the angle(s) between bonds.

A molecule will absorb infrared radiation only when the molecule undergoes a net change in dipole moment as a result of its vibrational motion. For example, the hydrogen chloride molecule possesses a significant dipole moment due to non-symmetric charge distribution between the hydrogen and chlorine atoms. Stretching of the hydrogen-chlorine bond causes a change in dipole moment, and absorption of infrared radiation can occur provided the frequency of the radiation matches the vibrational frequency. It is not necessary for a molecule to possess a permanent dipole moment to absorb infrared radiation. For example, due to its symmetry, the carbon dioxide molecule has no permanent dipole moment. However, two of its three vibrations produce a change in dipole moment. These vibrations absorb infrared radiation. Vibration of homonuclear diatomic molecules, such as  $\text{N}_2$  and  $\text{O}_2$ , does not cause a net change in dipole moment. Vibrations of such molecules are not accompanied by absorption of infrared radiation.

Infrared spectra of diatomic and triatomic molecules are simple. Polyatomic molecules containing a number of different types of atoms exhibit complex spectra. The number of possible vibrations within a molecule containing  $N$  atoms is  $3N-6$  (or  $3N-5$  for a linear molecule). Each of these vibrations is called a normal mode of vibration, and its frequency is referred to as a fundamental frequency. The number of peaks observed in the infrared spectrum does not necessarily equal the number of normal modes. Some normal modes do not give rise to an infrared absorption peak because no net dipole moment occurs, or the vibrational frequency is beyond the range of the instrument. If two or more vibrations occur at the same or nearly the same frequency, only one peak may appear. Additional peaks may be observed in the spectrum due to interaction or coupling of two normal modes. Overtone lines appear at approximately two and three times the fundamental frequency. The occurrence of multiple vibrations in a molecule gives rise to a complex spectrum that is uniquely characteristic of the molecule.

The frequency at which an organic functional group (such as C-H, C=O, C=C) vibrates is determined by the masses of the atoms involved and the force constant of the bond between them. This frequency, called a group frequency, is often unchanged, or only slightly changed, by other atoms attached to the functional group. Over the years, group frequencies have been determined empirically for a large number of functional groups and are commonly summarized in correlation charts, as shown in Figure 1.28 and 1.29. Group frequencies are used to establish the presence or absence of a

functional group in a molecule. Fingerprint frequencies are due to vibrations of the molecule as a whole and are characteristic of the specific molecule.

Several types of infrared instruments are commercially available. Most widely used are the dispersive instruments, which use a grating for wavelength selection, and the popular nondispersive Fourier Transform Infrared (FTIR) spectrometer, which uses an interferometer. Whether dispersive or nondispersive, each infrared instrument contains three essential elements: a radiation source, an optical system for wavelength selection, and a detector. The components of an FTIR instrument are shown in Figure 1.13.

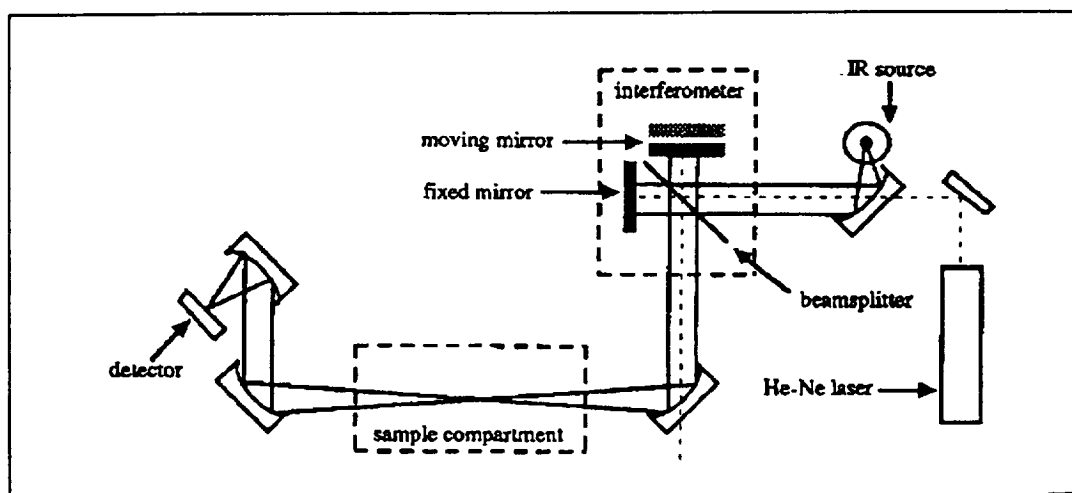

Figure 1.13. Schematic of an Infrared Spectrometer

Mid-infrared sources include the incandescent wire, the Nernst glower, and the Globar. The incandescent wire source consists of a tightly wound coil of nichrome wire electrically heated to about 1100° C. The Globar is a silicon carbide rod electrically heated to about 1300°C. The Nernst glower is composed of zirconium, yttrium, and erbium oxides electrically heated to about 1500° C. Globar and Nernst glower sources are hotter and, therefore, more intense than the incandescent wire source. However, the incandescent wire is more rugged and requires less maintenance.

Two types of detectors are used in the mid-infrared region: thermal and photon. In a thermal detector the infrared radiation is absorbed by a detector element. The resultant rise in temperature produces a measurable change in a physical property of the detector. A thermal detector may consist of several thermocouples, each fabricated from two dissimilar metals. When a thermocouple absorbs infrared energy, a measurable potential difference develops at the junction of the two metals. Another type of thermal detector is the pyroelectric detector. In this device, the sensing element is a thin crystal of a pyroelectric material, such as deuterated triglycine sulfate (DTGS), between two electrodes. Heating of the crystal by absorption of infrared radiation alters the polarization of charge within the crystal, and a measurable change in capacitance is produced. In a photon detector, infrared photons striking a semiconductor surface excite

electrons on the surface from a nonconducting energy state, or valence band, into a conducting state. The photovoltaic detector is a type of photon detector in which a small voltage is produced in response to infrared radiation exposure. Two examples of the photovoltaic detector are the lead tin telluride detector and the mercury cadmium telluride detector. Photon detectors respond more rapidly than the thermal detectors, but the two types have similar sensitivities.

Infrared spectra can be obtained for gaseous, liquid, and solid samples. Most widely used as cell windows are the alkali halides, especially sodium chloride and potassium bromide. Unfortunately, these materials are fogged by exposure to moisture. Silver chloride can be used for aqueous solutions or most samples. However, silver chloride darkens with continued exposure to light.

Solid and liquid samples can be analyzed in solution. No single solvent is transparent over the entire infrared region. To obtain the entire spectrum of a sample, two or more solvents must be used. Carbon tetrachloride and carbon disulfide are useful for many organic compounds. Carbon tetrachloride is transparent at wavenumbers above  $1333\text{cm}^{-1}$ , whereas carbon disulfide is transparent below  $1333\text{cm}^{-1}$ . Acetone, acetonitrile, chloroform, and methylene chloride are used for polar materials that are insoluble in carbon tetrachloride and carbon disulfide. Because alkali halide cell windows are attacked by moisture, solvents must be dried before use. Water absorbs strongly in the infrared and is seldom used as a solvent for infrared analysis. Infrared cells for solution samples are commonly constructed with sodium chloride windows separated by Teflon spacers or gaskets. Because solvents absorb infrared radiation, path lengths are short (0.005 to 5 mm). Both variable path length and fixed path length cells are available.

When a suitable solvent is not available, spectra of liquids can be obtained from capillary films. A drop of liquid is placed between two windows, which are squeezed together to give a thin (0.001 to 0.05 mm) film. This technique does not give a reproducible path length and is limited to qualitative investigations.

Spectra of solids not soluble in a suitable solvent are often obtained from a dispersion of the solid sample in a solid or liquid matrix called a mull. To prevent signal loss due to scattering or refraction of the infrared radiation, the sample must be thoroughly ground to a particle size smaller than the analytical wavelength (less than  $2\cdot\mu\text{m}$ ) and dispersed in a mulling agent whose refractive index is close to that of the sample. For best results, a very small amount (less than 10-20 mg) of sample is ground in an agate mortar until the powder forms a glossy cake on the sides of the mortar. The resulting powder is then mixed with the mulling agent.

Mineral oil (Nujol) is frequently used as a liquid mulling agent. If hydrocarbon bands interfere, a chlorofluorocarbon grease (Fluorolube) or hexachlorobutadiene may be used. To obtain a complete spectrum free of interfering bands, the halogenated agents are used for the 4000 to  $1340\text{cm}^{-1}$  region, and mineral oil is used below  $1340\text{cm}^{-1}$ . One or two drops of mulling oil are added to the powder in the mortar, and the grinding action continued until the solid is uniformly dispersed in the oil. The resulting



paste is then analyzed as a thin film.

Potassium bromide and other alkali halides are used as solid mulling agents. In the KBr mull or pellet technique, the finely ground sample (up to 1 mg) is intimately mixed with approximately 100 mg powdered KBr. The mixture is then pressed in a die, under a pressure of 10,000-15,000 psi, to form a transparent or translucent disc. Better results are often achieved when the die is evacuated to eliminate occluded air. Adequate KBr pellets can be obtained without evacuation in a stainless steel Mini-Press. This device consists of two highly polished bolts within a cylindrical nut. The KBr mixture is placed between the bolts, and the bolts are tightened against each other to produce a pellet.

The KBr pellet method has several advantages: (1) KBr has no interfering bands, (2) quantitative analysis is readily possible with an internal standard, and (3) the formed pellets can often be stored. However, the method also has disadvantages: (1) Some materials decompose or change form under the pressure and heat encountered during pellet formation, (2) inorganic salts may exchange ions with the KBr, and (3) KBr may absorb water which absorbs near 3450 and 1640  $\text{cm}^{-1}$ .

Polyurethane and polyisocyanurate foams, cork, and epoxy resins are examples of materials that cannot be reduced to a powder by grinding in a mortar. A mechanical grinder or ball mill can be used for such materials. Grinding efficiency may be enhanced by first freezing the sample with liquid nitrogen.

Polymers can be analyzed as unsupported films. A polymer solution is poured onto a glass or metal casting plate. The solvent is evaporated in a vacuum oven or under an infrared lamp, and the sample film is stripped from the plate. Samples run as unsupported films frequently exhibit interference fringes which interfere with the spectrum. In these cases, the attenuated total reflectance (ATR) technique, described below, is extremely useful.

Attenuated total reflectance ATR (also called internal reflectance) greatly enhances the sampling capability of infrared spectroscopy. With this technique, infrared spectra can be obtained from solid materials that cannot be readily dissolved, dispersed in mulls, or cast as films. ATR is widely used to sample polymers, rubbers, cured resins, fibers, textiles, and papers. Figure 1.14 shows an internal reflection element (IRE), composed of a transparent material of high refractive index, surrounded by a sample. When radiation passes from a more dense medium into a less dense medium, part of the radiation is transmitted through the interface and part is reflected. The fraction of the radiation that is reflected increases as the angle of incidence at the interface between the two media becomes larger. Beyond a certain critical angle, all of the radiation is reflected. During the reflection process, the radiation penetrates a very small distance into the sample, and a portion of the radiation is absorbed by the sample. The loss in intensity due to sample absorption is sensed by the detector.

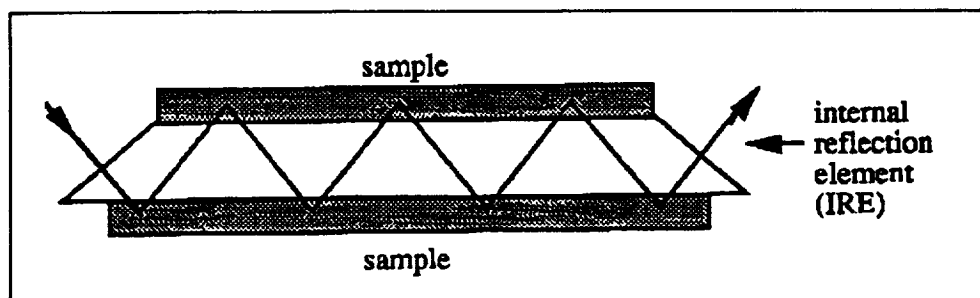

Figure 1.14. Attenuated Total Reflectance Apparatus

### 1.2.6 Raman Spectroscopy

Raman spectroscopy is used primarily for the identification of functional groups and the determination of molecular structure in organic and inorganic compounds. Similar to infrared spectroscopy, Raman spectroscopy is based on vibrational changes within molecules. However, vibrations that are observed in the Raman spectrum may not be seen in the infrared spectrum, and vice versa. Therefore, complimentary information can be obtained from using both techniques.

Raman spectroscopy is based on a light scattering phenomenon. When light passes through a transparent material, a very small fraction of the light is scattered due to collisions with molecules present within the material. Two types of collisions occur: elastic and inelastic. In an elastic collision, the scattered light is of the same energy as the incident light. However, in an inelastic collision, energy is exchanged between the molecule and the incident radiation so that the energy of the scattered light is different from that of the incident light. This is known as the Raman effect. When this type of collision occurs, the energy of the scattered light is  $h(n_0 \pm n_n)$  where  $h$  is Plank's constant,  $n_0$  is the frequency of the incident radiation, and  $n_n$  is a frequency in the infrared region of the electromagnetic spectrum. The Raman effect is inherently very weak. The intensity of the Raman scattered light is, at most, only 0.001% the intensity of the source radiation.

Inelastic collisions give rise to two types of scattered radiation: Stokes radiation and anti-Stokes radiation. Stokes radiation, observed at a lower energy than the incident radiation, occurs when a molecule initially in the ground vibrational level is raised to an excited vibrational level as a result of interaction with the incident light. The energy of the Stokes radiation is  $h(n_0 - n_n)$  where  $h n_n$  is the difference in energy between the ground vibrational level and the excited vibrational level. Anti-Stokes radiation occurs when molecules already in an excited vibrational level decay to the ground vibrational level during the interaction with the incident light. Anti-Stokes radiation is observed at a higher energy than the incident radiation. The energy of the anti-Stokes scattered radiation is  $h(n_0 + n_n)$ . Because most molecules are initially in the ground vibrational level, anti-Stokes radiation is much less intense than Stokes radiation. Except for very specialized applications, the Stokes lines are predominantly used in analytical Raman spectroscopy.

In the previous section, it was stated that for a vibration to be observed in the infrared spectrum, the vibration must cause a change in the molecule's dipole moment. The dipole moment is the product of the distance between two centers of charge in a molecule and the magnitude of the charge difference. Polar function groups such as hydroxyl (O-H) and carbonyl (C=O) give strong peaks in the infrared. For a vibration to be observed in the Raman spectrum, the polarizability of the molecule must change as a result of the vibration. Polarizability is the measure of the ease with which the electron distribution within the molecule is distorted in an electromagnetic field. Nonpolar functional groups with symmetrical charge distribution, such as C=C, N=N, S-S, and C≡C, give strong Raman peaks. Some vibrational modes can be observed in both the Raman and infrared spectra. Other vibrations can be observed only by infrared spectroscopy, or only by Raman spectroscopy. Therefore, although each technique provides considerable information about the functional groups present in a molecule, more information is obtained by using both techniques to characterize a material.

Raman spectroscopy is especially useful for detecting the C=C group in olefins. The C=C stretching mode is usually very weak in the infrared spectrum. When the C=C group is symmetrically substituted, as in ethylene ( $\text{H}_2\text{C}=\text{CH}_2$ ), no band appears in the infrared spectrum because there is no change in dipole moment during the vibration. On the other hand, this group gives an intense peak in the Raman. Similarly, Raman surpasses infrared in detecting disubstituted acetylenes (R-C≡C-R) and disulfides (R-S-S-R). Even in cases where the two R groups are not identical, but only similar in size, the intensity of the Raman peak will be stronger than that of the infrared peak. Raman spectroscopy can also be used to detect and analyze homonuclear diatomic molecules, such as  $\text{H}_2$  or  $\text{N}_2$ , which are not infrared active. Another area in which Raman spectroscopy is useful is the study of materials in aqueous solution. Water is a weak Raman scatterer and therefore does not cause interference. In contrast, it is difficult to obtain infrared spectra from aqueous solutions because water absorbs strongly in the infrared.

A typical Raman spectrometer is shown schematically in Figure 1.15. Because of the inherent weakness of the Raman effect, lasers are used almost exclusively as sources in Raman spectroscopy. The most commonly used lasers are continuous-wave gas lasers. The helium/neon laser produces an intense line at 632.8 nm. The argon laser produces useful lines at 488.0 and 514.5 nm. The laser beam is focused on the sample by a series of lenses and mirrors. Because both the incident and scattered radiations are in the visible region of the electromagnetic spectrum, glass can be used for cell windows, lenses, and other optical components. The scattered light is collected at 90° relative to the laser beam and is focused on the entrance slit of a double monochromator. The scattered light is dispersed into its component frequencies by gratings within the monochromator, and the dispersed light passes through the monochromator exit slit into the detector. The most commonly used detector for Raman spectroscopy is the photomultiplier tube (PMT). PMT's give low background signals and high sensitivity in the visible region of the spectrum. Because PMT response is a function of wavelength, the type of PMT used depends on which laser line is used for excitation.

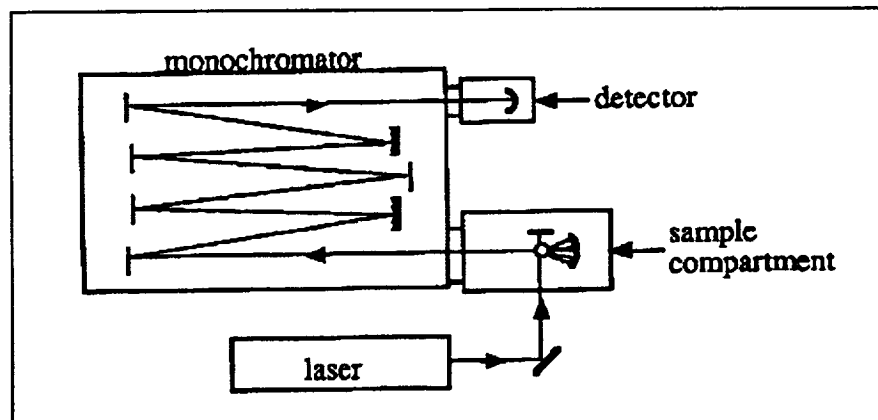

Figure 1.15. Schematic of a Raman Spectrometer

Raman spectroscopy can be performed on solids, liquids, and gases. Liquids are usually contained in a glass capillary tube. Solids are sampled in several ways: as pure powders in a glass capillary tube, as pressed pellets (either pure or mixed with an inert solid), and as single crystals. A visible light microscope can be coupled to the optical system and can be used to obtain spectra from microscopic particles. A major limitation to Raman spectroscopy is interference by fluorescence originating either in the analyte itself, or in other species present in the sample. Because fluorescence is inherently more intense than Raman scattering, it is difficult if not impossible to detect Raman scattering in the presence of fluorescence. If the fluorescence is due to other species present, it may be possible to remove the fluorescent component by extraction, distillation, or another purification procedure. If the fluorescence is due to the analyte itself, selection of a different laser line for excitation may be helpful. Another problem is the decomposition of the sample in the laser beam. This occurs frequently when the sample is highly absorbing (colored). This problem can sometimes be overcome by rotating the sample or by reducing the power of the laser source.

### 1.2.7 Nuclear Magnetic Resonance Spectroscopy

Nuclear magnetic resonance (NMR) spectroscopy is used primarily to elucidate the structure of organic and inorganic compounds containing atoms which possess a magnetic moment, such as  $^1\text{H}$ ,  $^{13}\text{C}$ ,  $^{19}\text{F}$ ,  $^{29}\text{Si}$ , and  $^{31}\text{P}$ .

When the nuclei of certain atoms spin, a magnetic moment is generated. If these nuclei are placed in a strong magnetic field, the magnetic moments will assume different orientations with respect to the external field. Each orientation corresponds to a discrete energy state. Absorption of radio-frequency radiation causes a nucleus to undergo a transition from one orientation to another. The required energy of the radio-frequency radiation depends, in part, on the the identity of the nucleus and chemical environment of the nucleus. Therefore, this technique is extremely useful in the determination of molecular structure.

The components of a Fourier transform NMR spectrometer are shown in Figure

1.16. In this instrument, all of the nuclei are excited simultaneously by a pulsed, high intensity radio-frequency source. This generates a time-domain spectrum that is converted to frequency-domain by Fourier transformation. A computer controls the pulses and performs the Fourier transformation.

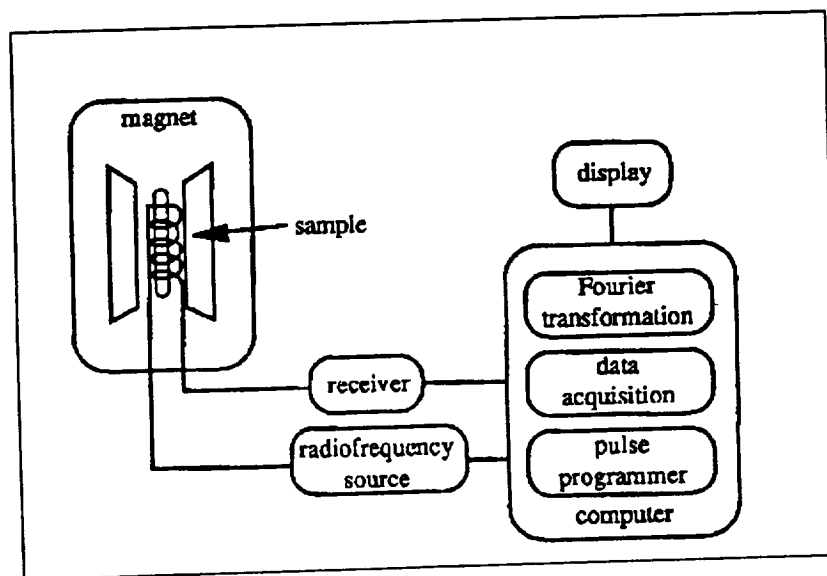

Figure 1.16 Schematic of a Nuclear Magnetic Resonance Spectrometer

Two effects are important in structural analysis: chemical shift and spin-spin splitting. Not all nuclei of the same type (e.g.,  $^1\text{H}$  or  $^{13}\text{C}$ ) absorb at the same frequency. The frequency at which absorption occurs is strongly affected by the chemical environment of the nucleus. This effect, called the chemical shift, is due to the circulation of electrons around the atom being probed. Electron circulation generates a small magnetic field which is usually in opposition to the external field. The field actually sensed by the nucleus depends on the electron density and, therefore, the chemical environment around the nucleus. NMR peaks are usually reported relative to the peak obtained for a reference compound that is measured at the same time. Neighboring nuclei which have nonzero magnetic moments generate magnetic fields. This effect causes splitting of the NMR peaks and is called spin-spin splitting. Structural analysis is based on an analysis of the chemical shifts and spin-spin splitting observed in the NMR spectrum.

### 1.2.8 Mass Spectrometry

Mass spectrometry provides qualitative and quantitative information about the atomic and molecular composition of organic and inorganic materials. This technique is used to elucidate the molecular structure of unknown compounds, and to confirm the presence of known compounds. Combined with a separation technique, such as gas or liquid chromatography, mass spectrometry can also be used to identify and quantitatively measure the components of a complex mixture.

In mass spectrometry, molecules within a sample are converted into highly ener-

getic, gaseous ions. During the ionization process, the molecule may be fragmented to produce smaller ions. These ions are then separated on the basis of their mass-to-charge ( $m/z$ ) ratios. A mass spectrum is a plot of the relative abundance of ions measured at each value of  $m/z$ . Every compound has a unique fragmentation pattern, and therefore a unique mass spectrum.

The major components of a mass spectrometer are pictured in Figure 1.17. The sample introduction system must permit introduction of the sample into the ion source, which is maintained at  $10^{-5}$  to  $10^{-6}$  Torr. Sample introduction systems include batch inlets, direct insertion probes, and gas and liquid chromatographic inlets. Gases and volatile liquids can be introduced through a batch inlet system in which the sample is first volatilized (by applying vacuum and, sometimes, heat) and then allowed to leak into the ionization chamber through a pinhole in a glass or metal diaphragm. Solids and nonvolatile liquids can be introduced with a direct insertion probe. The sample is placed on the probe which is then introduced directly into the ionization chamber. The chromatographic inlets are described in Section 1.1.

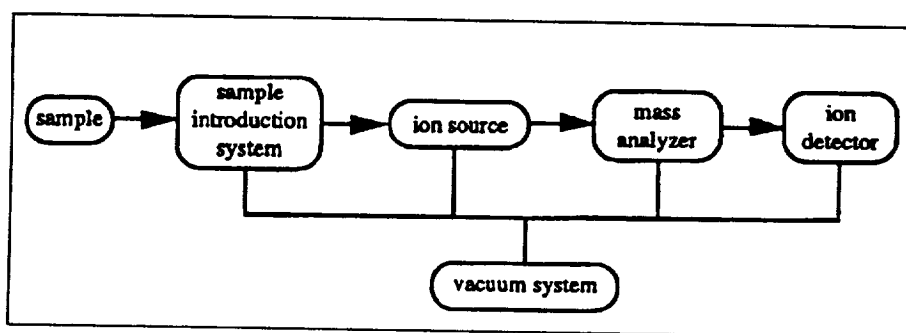

Figure 1.17. Schematic of a Mass Spectrometer

The ion source ionizes and fragments the molecules within the sample. Commonly used ionization sources include the electron impact (EI), chemical ionization (CI), and fast atom bombardment (FAB) sources. The electron impact source is the most commonly used. Electrons emitted from a heated filament are accelerated by applying a potential between the filament and an anode. When these high energy electrons collide with the sample molecules, positive ions are produced. Some of these ions have the same mass as the original analyte molecule, and are referred to as the molecular or parent ions. Because of the high energy of the electron impact source, many of the molecules are extensively fragmented. The fragmentation pattern is characteristic of the molecule and is useful for identification. However, in some cases fragmentation is so extensive that the molecular ion is not observed. In these cases, it is more difficult to determine the molecular weight and, therefore, the structure of the compound. In chemical ionization, the gaseous sample is ionized by collisions with ions generated by electron bombardment of a reagent gas, usually methane. Chemical ionization produces less fragmentation than electron impact ionization. In fast atom bombardment, the sample is ionized by collisions with high energy argon or xenon atoms. Fast atom bombardment produces relatively large amounts of the parent ion, and is especially useful for the characterization of high-molecular-weight materials.

After leaving the ion source, the ions are accelerated and focused onto the entrance of the mass analyzer. The mass analyzer separates the ions according to their mass-to-charge ratios. The magnetic sector and the quadrupole mass analyzers are the most commonly used. Magnetic sector mass analyzers utilize an electromagnet to bend the paths of the ions. Ions of different mass are alternately focused on the exit slit by varying the strength of the magnetic fields. In quadrupole mass analyzers, four electrically conducting rods are positioned parallel to and symmetrically around the ion path. Opposite pairs of rods are electrically connected, and one pair is held at a positive dc potential, while the other pair is at a negative dc potential. In addition, radio-frequency ac potentials, 180° out of phase with each other, are applied to the two pairs. The combined electromagnetic fields cause the ions to oscillate as they pass along the axis of the quadrupole. When the oscillations are sufficiently large, the ions collide with the rods and are neutralized. By varying the dc potential and/or the frequency of the ac field, ions of different mass-to-charge ratio are allowed to pass through the analyzer.

Most mass spectrometers use electron multipliers for ion detection. Ions leaving the mass analyzer are accelerated and focused onto a metal plate, or dynode. The dynode emits several electrons as a result of each ion bombardment. These electrons are accelerated toward a second dynode, where more electrons are emitted. As the electrons strike successive dynodes, the amplification process continues. Current amplification of  $10^5$  to  $10^7$  is attained.

### 1.3 Microanalytical Techniques

The advent of high technology has brought about the need to interrogate smaller and smaller samples of materials to solve complex materials problems. From the concerns of particulate contamination in high performance aerospace engines to the performance of magnetic storage media there is a great demand for the capability to analyze very small quantities of materials. And with this demand for analysis comes the necessity to successfully collect and test the material of interest. When the sample comes from an almost endless source such as in the production of commodity materials, the problem is not too little sample, but in contamination or failure investigations the samples are usually limited and hard to recover. This section will describe sampling and detection methods for microscopic analysis. Sampling techniques will be discussed in detail since this topic is seldom covered in instrumental analysis text books.

#### 1.3.1. Microsampling Techniques

Microsampling techniques are usually applied to materials with limited quantity and can either be solids or liquids. The solid samples can include particles, fibers, films, laminates, inclusions, suspensions or residues. Each of these materials requires a different approach to their collection. Another confounding aspect to the sampling is the accessibility of the material. If the material of interest is under a film as an inclusion or in a solid mixture as a discrete particle the analyst must be creative, and sure-handed to retrieve the materials.

Some of the tools that can be used for microsampling include tweezers with sharpened tips, Exacto knives and single-edged razor blades, tungsten probes that have been formed into fine points, glass slides, capillary brushes, Roller Knife and maybe the most important is a prep microscope. The prep microscope is used to see samples when they are being transferred or prepared for analysis. The prep microscope can have magnification from 10x to 50x and should have the capability for transmission and reflectance imaging. It should have a substantial fixed stage that will support some force in forming samples. Any variation from the Bausch and Lomb StereoZoom series or equivalent would be a good choice. Pamphlets <sup>1, 2</sup> supplied with the microscope give some instruction as to the use of the microscope but experience from others or with time will better develop knowledge needed in specific applications. Publications such as "The Microscope"<sup>3</sup> is also a good source of information for microscopic sample collection.

Collecting samples in the field requires many specialized tools to effectively isolate and collect the sample. Along with the techniques and tools to be described later there are several items that are useful and should be included in a Microscopists tool kit. The most important of these items is a magnifier. This is almost a necessity since to sample it is necessary to see the object. The magnifier can be used with a flashlight or can be equipped with an appropriate illuminator as an integral part of the magnifier. Sample transfer from the point of sampling is also important since the effort expended in sampling can be negated if the sample is lost or contaminated with unrelated foreign matter. Foresight in selecting sample containers that have been previously inspected for microcontamination will benefit the analyst in the long run. Plastic petrie dishes and self-sealing bags are convenient but require prior inspection to assure that particles are not present as a result of static attraction or contamination during production.

#### 1.3.1.1. Particulate Sampling

Particulate sampling is probably one of the easier sampling problems but by no means simple. Particulates that are loosely adhered to a surface can be easily removed using tweezers with very sharp, straight points. This fact needs to be emphasized; don't share the sampling tools that you accumulate with anyone that is not familiar with their use. It might seem trivial that anyone can use tweezers but to care for a finely sharpened pair and then have them used as a pry to remove a stuck septa or ferrule can be very disconcerting. Particles that are brittle, very flat or adhere strongly to the substrate may require the use of a sharp blade such as a single-edge razor, or an Exacto knife. Cleanliness is paramount when using any sampling device and should be of special concern with blades. A small foreign particle on the blade prior to collection of the sample can become a point of contention when the sample is analyzed because this foreign particle can be misconstrued as part or a major portion of the suspect. The use of lens paper or lint-free laboratory wipes to clean the sampling tools prior to use followed by subsequent inspection using a microscope to observe cleanliness is a minimum.



In dry atmospheres charges tend to accumulate on sampling tools and particles. With loose samples this can manifest itself in the "Calivaris County Frog Syndrome" where the precious sample that is setting so pristinely on the substrate leaps uncontrollably out of sight. This charge concentration phenomena can be eliminated by using a static discharge gun such as a Zerostat gun (Ernest F. Fullam, Latham, N.Y). Two conditions should be observed when using this static discharge gun. First, never use the gun in an explosive environment and second, the gun discharges both positive and negative charges with each stroke ; a positive discharge with the squeeze of the trigger and negative discharge with the release of the trigger. It is important to discharge both the sample and the sampling tools prior to sampling. This is a trial and error effort to select the proper discharge combination that hopefully doesn't end in errors too frequently. Of course since opposites attract, static charges can also be a benefit since they can aid sample collection by causing particles to cling to the sampling tool, a very fortuitous event.

In addition to the tweezers and blade, a tungsten probe is very useful to push or hold a particle while using another tool to retrieve it, or if static charges are helpful, to pick up the sample. A capillary brush (whose construction will be detailed later) is also a useful tool to collect large numbers of particles. The application of the capillary brush is limited in particulate collection since separation of the particles from the brush fibers might be problematic. An alternative to the capillary brush is the vacuum tip, a device constructed to provide a vacuum to pick up small particles and a filter medium to capture the particle for analysis. This apparatus can be constructed of a capillary and filter holder attached to an appropriate vacuum source. The use of adhesive tapes are quite useful in collecting and transporting particulates, but removing the sample from the adhesive can be cumbersome. An alternative is to dissolve the adhesive from the backing using filtered toluene and evaporating it onto the KBr window prior to analysis. The particle is surrounded in a matrix that can hold it securely and can be removed digitally from the collected spectrum by spectral subtraction.

Particles are found not only on the surface, but can also be imbedded in objects as inclusions. Included particles are complex sampling problems. If the material in which they are contained is soft and pliable it is possible to excise them from the material using blades, probes, dental picks and tweezers. The best approach is to observe the particle under a prep microscope. A large diameter tungsten probe would be beneficial since it could be used to penetrate the substrate and pry the sample to the surface where it can be picked up with tweezers or a blade. The adherence of the surrounding material is of some concern, but it is of benefit and can be used in the analysis of the particle as a reference in spectral subtraction (the application of spectral subtraction will be covered elsewhere). This sampling technique is of course destructive in nature but can probably be limited to small areas. Substrates of an intractable nature are more problematic since the substrate can prevent penetration because of their hardness and strength. If probes and blades are not successful it might be necessary to cut the substrate and the particle using a diamond or jeweler's saw. The cut will have to be made first to remove a larger piece from the substrate to include the particle and then through the particle to expose it to the surface. A microtome can also be useful here to

take a small, thin slice of the sample. The microtome is an expensive item, so unless this type of sampling is a routine occurrence the effort expended in sawing is more cost-effective.

Particles suspended in liquids can be handled very easily by using filtration media of the proper construction and observe cleanliness in sample handling. A typical apparatus that would be used to separate suspended particles would include a gas tight syringe of 5 ml or less supplied with a Luer-Lok connector. A syringe filter holder and filter medium constructed of materials compatible with the suspension solvent should be used. Filter media such as Nuclepore filters and equipment (Costar Corp. Cambridge, MA.) is a good selection since the filter media has uniform pore size and is constructed of nonfibrous, solvent resistant materials. It is important to use a filter medium free of fibers to avoid confusion of sample with medium. To aid in locating transparent samples more easily, the filter media can be sputter-coated with gold/palladium from a sputter coating apparatus used in Scanning Electron Microscopy if available. An aliquot of the suspension is passed through the filter and then flushed with an aliquot of the same solvent as the suspension to rinse the filter of any dissolved material that might crystallize after the solvent has evaporated. The flushing solvent should have been passed through a filter medium of at least the same pore size as that used for the sampling to avoid contamination of the sample with foreign particles. Once rinsed the filter media containing the particles of interest can be examined under a prep microscope and the particles can be removed from the filter by any appropriate method previously mentioned.

#### 1.3.1.2. Fibers

The problems that arise in fiber collection are far fewer than those experienced in particulate sampling. Fibers are an easier material to handle since they are flexible and usually have one large dimension. They can exhibit charging as do particles, that can be neutralized with static discharge guns. Tweezers are the most appropriate tool to use in fiber collection, but things as diverse as adhesive tape or vacuum filters can also be used. An easy vacuum method utilizes the filter support and media used to filter solutions and a vacuum source. These techniques are appropriate for isolated fibers or those that are loose and non-woven. For woven fabric or bundled fibers the sampling methods become more complex. In fabric the sampling of individual fibers can be performed by using a tungsten probe to lift the fiber from the weave, tweezers to pull out an appropriate length and a pair of sharp, small scissors to cut the selected fiber. With this method any number of individual fibers can be removed from the fabric for analysis. Fiber bundles can be treated in the same manner as fabric except for a need to immobilize the bundle. Immobilizing the bundles can be done with adhesive tape as a support or by holding the bundle between two glass slides so that their ends extend past the edge of the slide. It should be noted that some glass slides are lubricated with formate salts and should be removed by scraping one slide edge over the surface of another. This will eliminate the possibility of sample contamination. The individual fibers can then be selected using tweezers. If the fiber is coated or multilayered and a cross-section is desired so that each layer can be observed, the fiber can be mounted into

epoxy contained in the end of a Pasteur pipet. The mounted sample can then be sliced or microtomed before analysis.

Fibers are usually extruded and for that reason have a uniform cylindrical shape. This shape acts as a lens when exposed to the spectrometer and distorts the beam causing aberrations in the baseline and changes in relative absorptivities of some peaks. To avoid this problem it is best to flatten the fiber in the area of interest. This can be performed using either a rigid spatula or a Roller Blade (Spectra Tech, Stamford CT). The Roller Blade can be used with the smallest fibers to roll a portion of the sample flat. This flattened area is then ideal for analysis.

#### 1.3.1.3. Films and Laminates

The sampling of films and laminates can be divided into two classes that are dependent on the choice of analytical method. For thin films, transmission measurements would be the most appropriate if the film is transparent and thin enough to allow light to pass through. In this case the film should be treated as particulate material. If the film is too thick for transmission or opaque or a laminate, a thin cut can be taken from the edge of the sample using the following procedure. The film is placed between two glass slides (which have been cleaned as mentioned earlier) in such a way as to leave a portion of the film overlapping the edge. The exposed film edge is then cut flush with the glass slides. The sample is then repositioned so that a thin section overlaps the edge of the slide and a very thin cut is made from the edge of the sample. The use of a prep microscope is of benefit here. The thin section that was formed in the second cut should be almost translucent and can be handled as a particle. If the sample is a laminate each of the layers can be analyzed individually. The laminates can also be sampled by cutting obliquely through the sample thickness to expose wide surfaces of each laminate. As an alternative to sectioning, thick films of an adequate size can be sampled using organic-free abrasive paper such as is supplied with the Si-Carb Sampling Kit (Spectra Tech, Stamford, CT). The abrasive paper is used to remove a portion of the surface of the film and then analyzed by reflectance techniques directly on the pad. This sampling is limited to surfaces and would be ineffective in laminated structures.

#### 1.3.1.4. Micro-pyrolysis

Solid samples are at times intractable even to crushing. This requires harsh treatment of the sample in order to transform it into a more easily manipulated configuration. This can be done using micro-pyrolysis. Micro-pyrolysis is a technique that is used to convert insoluble, hard samples to a soluble liquid or solid. The method involves placing the sample particle or film into a capillary about 3 mm from the end. The sample end of the capillary is heat-sealed and the particle is then heated with a microburner until pyrolysate droplets are formed. The sealed end of the tube containing the ash, if any, is broken off and solvent is allowed to flush the sample onto an appropriate surface for analysis. As was previously noted cleanliness of the solvent is

critical to the analysis to avoid contamination.

#### 1.3.1.5. Liquid Micro-Sampling

Liquids are probably the easiest samples to collect since they are not usually subject to static charges and infrequently do they adhere to the substrate. However, the small quantities that usually occur when collected for micro-analysis are easily lost in the collecting tools normally used for liquid collection, such as pipets or syringes. Certainly microsyringes are appropriate for this task since they hold very small volumes. When samples are not confined to small volumes, but spread out over a large area or in small droplets, it is difficult to collect samples. A solution to this is the use of the capillary brush. The capillary brush is a glass capillary fitted with glass fibers welded to the end. The process of making these brushes is tedious but worthwhile. Small groups of silica fibers such as those used in gas chromatography are placed in the end of the capillary. A microtorch is then used to melt the capillary slightly, enough to hold the fibers but not so much as to close the capillary. The fibers are allowed to extend out of the capillary and are trimmed to form an even tip. This brush can be used to collect samples from enclosed areas or broad surfaces by immersing the fibers into the liquid and allowing it to "capillary" into the fibers and capillary tube. Once the sample is isolated in the capillary it can be transported to the analytical station and removed from the capillary by flushing the capillary with a solvent by "capillary action" onto an appropriate surface for analysis.

#### 1.3.2. Micro-Spectroscopy Using Fourier Transform Infrared and Raman Spectroscopies

Molecular vibrational spectroscopy is an important means of identifying the structure of chemical compounds. Each bond in a molecule has a specific response to incident light energy and will affect the energy contained in the incident light in a specific way. All wavelengths of the incident energy are not absorbed, but rather only those energies that interact with bonds in the sample will be affected. This absorption occurs at specific frequencies and is related to the bonds in the structure with which it has interacted. The interactions are not random but abide by specific rules described by quantum mechanics and are, therefore, reproducible and predictable. When these absorptions are detected and plotted as a function of incident energy frequency it represents an absorption spectrum. Each peak of this absorption plot can be assigned a specific structure with which the incident light has interacted. These interactions cause the atoms and bonds to distort by stretching or bending.

##### 1.3.2.1. Infrared Micro-spectroscopy

The application of microscopic sampling to infrared spectroscopy has had a long history dating back to the 1940s when Burch<sup>2</sup> applied a microscopic accessory equipped with Cassagranian lenses to collect microspectra using a dispersive infrared instrument. The first application<sup>2</sup> of microspectroscopy to Fourier transform instruments was in

1983 when BioRad Instruments introduced the FT-IR microscope.

Figure 1.18 is a schematic of the beam path of a typical infrared microscope. It is similar to a sophisticated light microscope in that it contains both a substage condenser and an objective lens. These lenses are, however, reflective rather than transmissive lenses to accommodate the infrared beam. Standard glass lenses would be opaque through most of the mid-infrared region and therefore are not used. Another difference between the light microscope and the infrared microscope is that the latter includes a movable beamsplitter that allows viewing the sample during positioning and focusing, and variable apertures, in some cases, both before and after the sample. The apertures are used to mask both the incident beam and the transmitted beam. This "redundant aperturing" is used to assure that an undistorted baseline is collected by removing stray light (light which has passed around the sample). The aperture after the sample in the transmitted beam can be used to spectrally isolate the unwanted portions of complex sample from contributing to the collected spectrum. The spectral isolation permits analysis of small inclusions in larger matrices that would contribute to the sample's spectrum. The aperture before the sample limits the light scattered by the substage condenser from reaching the detector. The microscope accessory can be used to collect spectra in both the transmission (through the sample) and reflection (from the surface) mode. Reflectance is more troublesome in the interpretation of the resulting spectrum since they are usually distorted by refractive index effects. These refractive index effects are manifested in the reflectance spectra by "derivative-shaped" peaks. The position of the peak is also shifted by several wavenumbers from typical positions found in transmission spectra.

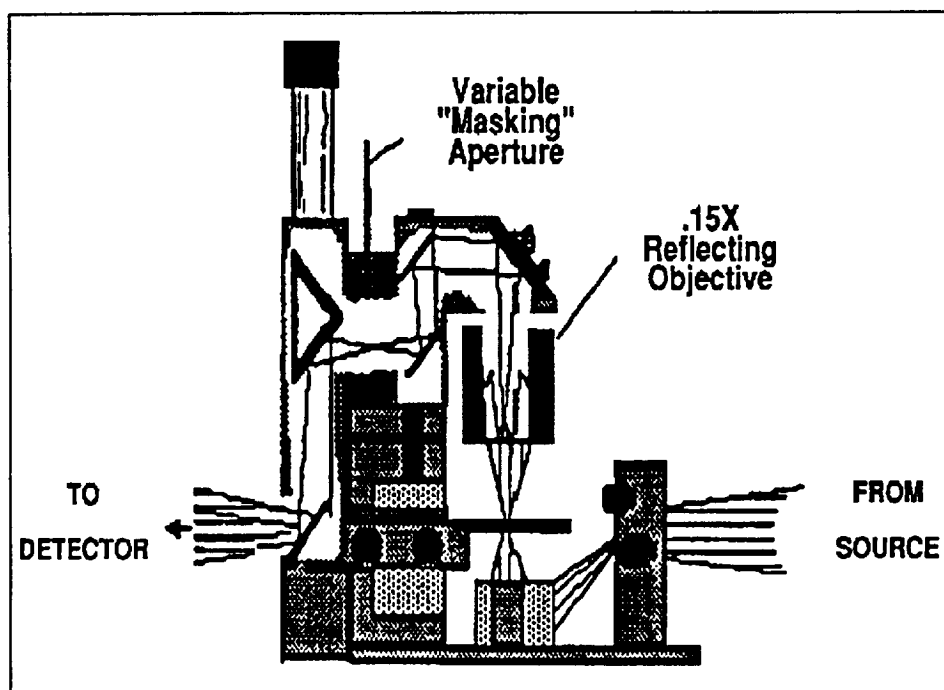

Figure 1.18. Schematic of the Beampath of an Infrared Microscope

The operation of the infrared microscope is straight-forward and is very similar to a light microscope. Unlike light microscopy, however, the infrared radiation wavelength imparts problems to the collection of spectra from samples whose particle size is less than about 50  $\mu$ m. Particles in this range will be of the same size or smaller than the infrared wavelength. Shape and thickness of the sample are critical since irregularly shaped samples are capable of greater diffraction of the incident beam. The diffracted beam then forms nodes that divide the incident energy and reduce the total throughput of the sample. The use of apertures again play a significant role here but this time to the detriment of total signal since they effectively eliminate some of the diffracted nodes. Some improvement in the spectrum is gained because the apertures eliminate the diffracted nodes from other areas of the sample, which is the spectral isolation function mentioned earlier.

Most samples to be analyzed by infrared microspectroscopy are introduced into the accessory by placing the sample on an infrared-transparent material such as a KBr or NaCl window. The first step of the collection process is focusing the microscope on the sample. Focusing is important since it minimizes spectral distortions caused by irregular samples. It is good practice to focus deep into the sample if the sample has a rough surface. That is to say, rather than use the top surface of the sample use a focal plane that appears to be inside the sample. Flat samples are easily analyzed since they have a uniform surface and focusing on the top surface is adequate for data collection.

The second step in the collection process is to select the area of interest in the sample by using the apertures to outline this area. This aperturing performs two practical functions. The first is to define the portion of the sample to be analyzed and the second is to block radiation not passing through the sample or the area of interest. The radiation not passing through the sample will cause a shift or distortion of the baseline leading to spectral irregularities such as incorrect peak ratios within the sample and sloping baseline. The sloping baseline manifests itself in the display of the spectrum and in spectral subtraction (to be covered later).

Once the sample is in place the third step is data collection. The FT-IR instrument is a single-beam spectrometer and it is necessary to collect a background spectrum to which the sample spectrum is ratioed. The sample in the microscope has been masked by an aperture and it is necessary to collect the background using the same aperture size as the sample. Since it is impossible to know the sample aperture size before-hand it is common to collect the background spectrum after the sample spectrum but before ratioing the sample to a background. The background spectrum is collected by moving the image field from the sample to an area of the supporting window that has no sample present.

The collection of a good spectrum using microspectroscopy is best served by analyzing flat samples, but, in practice few samples are flat. Particles that are too thick to produce a spectrum of less than 2 AUFS (absorbance units full scale) should be crushed to reduce the thickness. Spectral absorbance above 2 AUFS will distort the relative ratios of the absorbing peaks, especially the peaks of greatest intensity.

Crushing can be done by placing the particle between two clean glass microscope slides and squeezing it until the sample is translucent. The crushed sample can then be transferred to a KBr window for analysis. Two KBr windows can also be used to crush softer samples. When crushing between KBr windows, additional KBr powder should be placed between the windows to provide a location for collecting a background. If no KBr were present an interference fringe would be formed by the gap between the two windows when the background was collected. The interference in the background would unnecessarily distort the sample spectrum during ratioing. In the case of elastomeric materials the difficulty in collecting a spectrum is not in flattening a thick sample, but maintaining the thickness after crushing. Because of their resilience the elastomers tend to return to their original shape. The solution to this problem is to compress the sample between two KBr windows and while holding them securely place fast-curing glue (Crazy Glue, for example) on the edge of the windows to hold them in place. Allow the glue to cure and then collect the spectrum. Samples that are difficult to secure on the slide can be immobilized on the KBr window by embedding them in rubber cement diluted 1:1 with cyclohexane. The spectrum can then be collected and the embedding media contribution to the spectrum can be removed by spectral subtraction.

Single fibers are a difficult sample for classical transmission spectroscopy because of their dimensions. In conventional spectroscopy the single fiber was difficult to mount reproducibly into the infrared beam and to observe without spectral distortion. Microspectroscopy has opened the field to capabilities that were non-existent in the past. The infrared microspectroscopic accessory enables the analyst to collect high quality spectrum from single fibers as small as 5  $\mu$ m in diameter. The fiber sample can be synthetic or natural of any dimension. The only restriction on the sample is that it should be capable of compression to form a flat area for analysis. This flat area can be formed using a hard probe to roll the fiber or a diamond anvil cell to crush the area of interest. In either case the fiber is flattened so that it does not act as a cylindrical lens in the infrared beam. It should be noted here that modifying the fiber in such a manner will possibly alter any orientation information that can be obtained from the spectrum.

Samples that are in the form of fine powders can pose a problem in conventional spectroscopy since the formation of a pellet will so dilute the sample that a complete spectrum is impossible to collect. The preparation of the sample as a salt dispersion or micropellet can be of benefit only when the sample can be observed. A salt dispersion can be made on a glass slide by mixing the sample with salt and then crushing the particles to reduce their size. The micropellet provides an easier means of handling the sample and can be made using a microgrinder (such as a Wiggle-Bug) and dies that produce 3 mm pellets when compressed. The microscope provides the method of condensing and focusing the beam to collect the spectrum.

The infrared microscope is not only useful for solid materials, but is also useful for limited amounts of liquids. The deposition of the liquid sample onto a window by an appropriate technique such as a microbrush or microsyringe can form a spot that is dependent on sample size but can be focused on by the accessory. With careful concen-

tration on the window a small spot can be formed whose spectrum can then be collected as with any other transparent sample. Microspectroscopy is applicable as a tandem technique for gas chromatography since the spectrum of the liquid can be collected and then have the sample transferred to the GC for further investigation. It can also be applied to HPLC eluents where evaporation of the mobile phase and resultant analysis can yield spectral information about the solute.

#### 1.3.2.2. Raman Microspectroscopy

The first application of microspectroscopy was reported in 1979.<sup>4</sup> The advent of laser applied to Raman spectroscopy has enabled standard metallurgical microscopes to be coupled with the Raman spectrometer for the collection of spectra from small samples. Optical glass does not have a Raman interaction and is therefore readily adapted to Raman spectroscopy with little modification to the microscope optics. The Raman microscope has the same limitations as does Raman spectroscopy in that only samples with little color and low fluorescence can be analyzed. The spatial resolution of the microscope is excellent with sample sizes only limited by the focal size of the incident laser onto the sample. In practical terms this resolution is 5-10  $\mu$ m.

The operation of the Raman microscope is relatively straightforward for sample analysis. The sample is placed onto the sample stage with the microscope in the reflectance mode, the area of interest is located, and focus is obtained for the sample and the laser spot on the sample. For samples that are thermally stable the spectrum can be collected using high laser energy input. The greater the incident energy the greater the emitted signal. Thermally labile samples are significantly more complex in the analytical approach used. Because the high incident created in the microscope field by the laser generates significant amounts of heat, thermally sensitive samples must be handled with more conservative methods.

The thermal deterioration is significant since repeated occurrences lead to the deterioration of the microscope objective through deposition of the evolved materials onto the objective. The first and most obvious means of reducing thermal destruction is to reduce the incident energy. This approach will reduce the thermal load on the sample but with proportional reductions in Raman effect emitted light. The compromise here is to increase the data collection time with either increased sampling rate or increased number of coadded scans. Both of these options increase data collection times but provide less aggressive environments. An alternative to incident energy reduction is to provide a means for heat to dissipate from the sample during analysis. The easiest and most straight forward methods are to embed the sample in water glass, a concentrated solution of sodium silicate that is transparent to the Raman effect and forms a hard, transparent mount for the sample. The water glass also protects the sample and objectives from thermal decomposition by providing a mode for the excess heat energy to be dissipated. Samples can also be diluted in a pellet made of materials that have no Raman effect such as alkali halides to minimize heating. Defocusing the incident beam is also an effective technique for mediation of localized heating but signal reduction may result in poor quality spectra.



Liquid samples of limited volumes can also be analyzed by Raman microspectroscopy. The application does not require complex sampling method but merely placing the sample in a glass capillary. Care should be taken in focusing the laser beam on the sample. It is necessary to first focus the visual image of the capillary surface and then while observing the laser image raise the stage to move the beam into the capillary. A distinct change in the laser image will occur when the beam has passed into the capillary contents. Data collection is identical to any other sample.

Fiber samples can also be evaluated as with infrared microspectroscopy except that the fiber need not be crushed to reduce thickness but can be collected without modification. Samples can be immobilized on a glass slide using adhesive tape. In addition, surface particles on the fibers can be evaluated using appropriate pinhole masks to spatially separate the area from the matrix. Characteristics of the area of interest can also be accentuated in the final spectrum by spectral subtraction.

### 1.3.3. Scanning Electron Microscopy

Scanning electron microscopy (SEM) is used to produce high resolution and depth of field images of sample and to provide chemical analysis of micron sized areas on or near the surface. Products obtained from interactions between bombarding electrons and the atomic species in the specimen are ejected from an excitation volume in the sample and monitored during a typical SEM scan. Any partially conducting material or non-conducting materials coated with a thin layer of gold or gold alloy, which has a low vapor pressure can be analyzed with the SEM.

In SEM analysis, the specimen is bombarded with high energy electrons (5 to 30 kilovolts) which produces several different types of signals to provide information about the specimen. Both elastic and inelastic collisions result from the interactions of the electrons with the atoms in the sample. The elastic collisions between the bombarding electrons and the atomic nuclei of the specimen produce backscattered electrons (BSE), as shown in Figure 1.19, which provides both topographical and compositional information about the sample. Imaging with the BSE signals provides a means of distinguishing zones of different atomic number within a specimen due to the greater probability of elastic collisions with higher atomic number. The penetration depth of the bombarding electrons depends upon the accelerating voltage and the atomic number of the sample. Typically the BSE images provide useful information down to about 0.5 microns.

Inelastic collisions between the bombarding electrons and the atomic electrons of the specimen produce secondary electron imaging signals, x-rays and Auger electrons from interactions with inner shell electrons and light in the form of cathodoluminescence from lower energy processes. The secondary electrons are collected to produce the micrograph images which are normally associated with SEM. The depth of penetration for these signals are usually 2 to 10 nm for metals and 5 to 50 nm for poor conductors. The x-ray information typically arises from a volume around 1 micron in

depth, while cathodo-luminescence is observed almost totally from the surface. Auger electrons arise from interactions in the first 0.5 to 2 nanometer layer of the specimen.

The great depth of field of the SEM ( up to 500 times that of an optical microscope) allows it to produce completely in-focus images of rough surfaces at high magnification. However, SEM is generally inferior to the optical microscope for routine examination of samples prepared using standard metallographic techniques at low magnification (300 X - 400X). Some of the current SEM instruments allow for samples as large as 15 to 20 cm to be analyzed. An excellent reference for using SEM in a variety of analytical applications is given in the monograph by Gabriel.

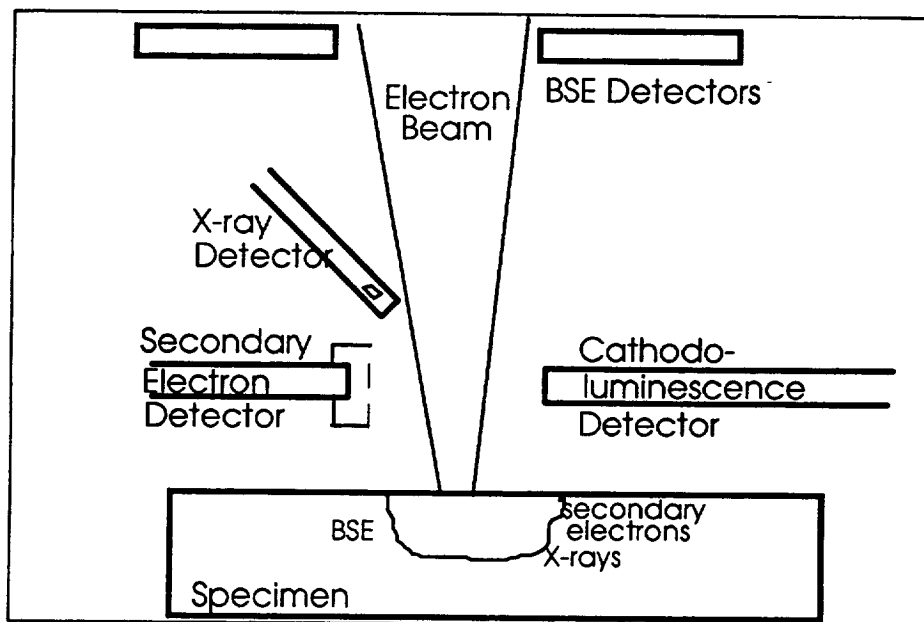

Figure 1.19 Schematic showing the principal mechanisms occurring in SEM.

#### 1.3.4. Optical Microscopy

Conventional optical microscopy is a relative inexpensive analytical tool for the examination of particulates and microstructures. Typically resolutions of 500 nanometers are possible, which allows for observation of surface faceting and dislocations. Catalogs of particulates, fibers, and morphological species of many materials are available for use to identify a particular material. Many applications using polarized light and the new confocal microscopes enables optical microscopy to continue to provide analytical information which is not available from the other methods.

A major disadvantage of current uses of optical microscopy is that experienced microscopists can identify many species; however, computerized databases with efficient pattern recognition capabilities are not readily available for the industrial laboratory. Such data can be included in chemical fingerprinting databases and will make the technique even more useful.

### 1.3.5. Transmission Electron Microscopy

Transmission electron microscopy is extremely useful for characterizing materials with high resolution imaging from small (submicron) regions of the sample. The information obtained from TEM analysis includes microstructural analysis of metallic, ceramic and polymeric materials as well as chemical and crystallographic information. Certain crystallographic details such as crystal orientation and matrix-precipitate orientation relationships are also possible. The advent of scanning transmission electron microscopes (STEM) has expanded the role of this analytical tool from primarily new chemical structures and failure analysis to activities such as fingerprinting.

TEM and STEM normally use an electron beam (varying from 60 to 300 kilovolts for TEM and 2- 50 kilovolts for STEM) to pass through a thin specimen and the resulting intensity distribution is imaged by a photographic imaging system or electron energy loss spectrometer. The interactions between the electron beam and the sample provides several types of information. Chemical and density effects result in intensity variations much like an optical microscope, except that the resolution of the electron microscope is much is near the wavelength of the electron beam. In addition diffraction effects from the crystal lattices present in the specimen can also be used to identify or characterize the material.

The capability to attach an energy dispersive x-ray spectrometer on the side of the instrument column allows collection of x-rays generated by interactions between the focused electron beam and the specimen; enabling characterization or identification of the chemical or elemental composition of submicron volumes possible. The limitations of current energy dispersive spectrometer systems is for the atomic number must be 6 or higher.

### 1.3.6. X-ray Diffraction

X-ray diffraction is extremely useful for identifying and characterizing a large variety of materials. In general, x-ray analysis is restricted to crystalline materials, although some information may be obtained from amorphous and powdered samples. Most x-ray diffraction techniques are rapid and nondestructive and are capable of identifying the phases, grain size, texture, and crystal imperfection. Samples are acceptable in many different forms, depending upon the availability of the material and the type of analysis to be performed.

The X-ray diffraction technique is based upon diffraction effects of x-rays traveling through a sample. This phenomenon is characterized by the Bragg equation:

$$\sin \theta = \frac{n\lambda}{d}$$

where  $\lambda$  is the wavelength of the x-rays and  $d$  is the characteristic interatomic distance of the material. A number of spots or fringes are observed at various angles represented by the  $\sin \theta$ . These spots or fringes result from constructive interference of the diffracted beams and are specific for the crystal lattices of each material. Hence the ability to identify or characterize a material is quite good.

Current x-ray diffraction instrumentation can be portable. Also, there is a substantial amount of software available today supporting the interpretation of x-ray diffraction data as well as databases associated with compilations from different laboratories.

### 1.3.7. Low Energy Electron Diffraction

Low energy electron diffraction is a technique for characterizing surfaces and overlayers adsorbed on surfaces. It can be considered the surface analog of x-ray diffraction. Low energy electrons (30 - 200 electron volts) have limited penetration into materials and consequently provides high sensitivity for periodic atomic structure at the surface. The periodic atomic structures at the surface diffracts a monoenergetic electron beam like a diffraction grating. The diffraction pattern and its intensity distribution can provide information about the atomic positions and the crystallographic features of the surface.

The diffraction pattern obtained during a LEED analysis consists of a small number of spots displayed as a CRT image as whose symmetry of arrangement is that of the surface grid of atoms. Any surface contamination on the surface of the material will significantly affect the diffraction pattern observed and provides a useful capability for discriminating against undesired surface features. Catalogued LEED patterns are available for many single-crystalline materials.

The diffraction pattern obtained during a LEED analysis consists of a small number of spots displayed as a CRT image as whose symmetry of arrangement is that of the surface grid of atoms. Any surface contamination on the surface of the material will significantly affect the diffraction pattern observed and provides a useful capability for discriminating against undesired surface features. Catalogued LEED patterns are available for many single-crystalline materials.

#### 1.4. Surface Science

Surface Science has evolved over the past 25 years to become widely accepted for the evaluation and characterization of solid vacuum compatible materials used in the aerospace industry. Although there are many techniques available, the most practical are:

- ESCA or XPS - Electron Spectroscopy for Chemical Analysis  
or X-ray Photoelectron Spectroscopy
- AES - Auger Electron Spectroscopy
- SAM - Scanning Auger Microscopy
- SIMS - Secondary Ion Mass Spectroscopy
- ISS - Ion Scattering Spectroscopy

Each of these techniques exhibits certain advantages when used alone, but when two or more techniques are combined they exhibit a synergism that constitutes a better understanding of the process or material being studied.

Except for OM or CM, the primary excitation sources used by these techniques include photons, electrons or ions. The primary particles interact with the surface and emit secondary particles (i.e., photoelectrons, Auger electrons, secondary ions or scattered ions). The emitted secondary particles are analyzed using either an energy or mass analyzer.

The information gained from surface analysis includes the elemental and chemical composition of typically the top 2.0 - 5.0 nanometers (top few atom layers) of the sample surface. The surface sensitivity of surface analysis is due to the inelastic mean free path of low energy electrons in solids. The energy of the emitted electrons is typically between 30 and 2000 eV. Such low energy particles allow only those originating from the very near surface of the material to escape and be detected. Particles originating deeper within the solid will interact with neighboring atoms lose their energy and be absorbed by the solid or contribute to the background signal. Generally, the elemental sensitivity of surface analysis is of the order of 0.5 % of an atom layer which further makes surface science very sensitive to surface contamination.

Surface science can be used on a wide variety of failure and special materials investigations or characterizations. Some of the materials investigations where surface science has proven most valuable include:

- Chemical Staining of Processed 2219 T87 Aluminum
- Epoxy Primer Pinhole Investigations

- Waste Minimization
- Aluminum/Lithium Weld Development
- Weld Defect Investigation
- Epoxy Primer to Metal Adhesive Debonds

The following is a brief discussion of each of the surface science techniques mentioned above, their advantages, disadvantages, types of samples analyzed, method for technique selection and examples.

#### 1.4.1 Electron Spectroscopy for Chemical Analysis and X-ray Photoelectron Spectroscopy

ESCA is a technique which uses an X-ray source of known energy for the primary source of sample excitation (Figure 1.20).

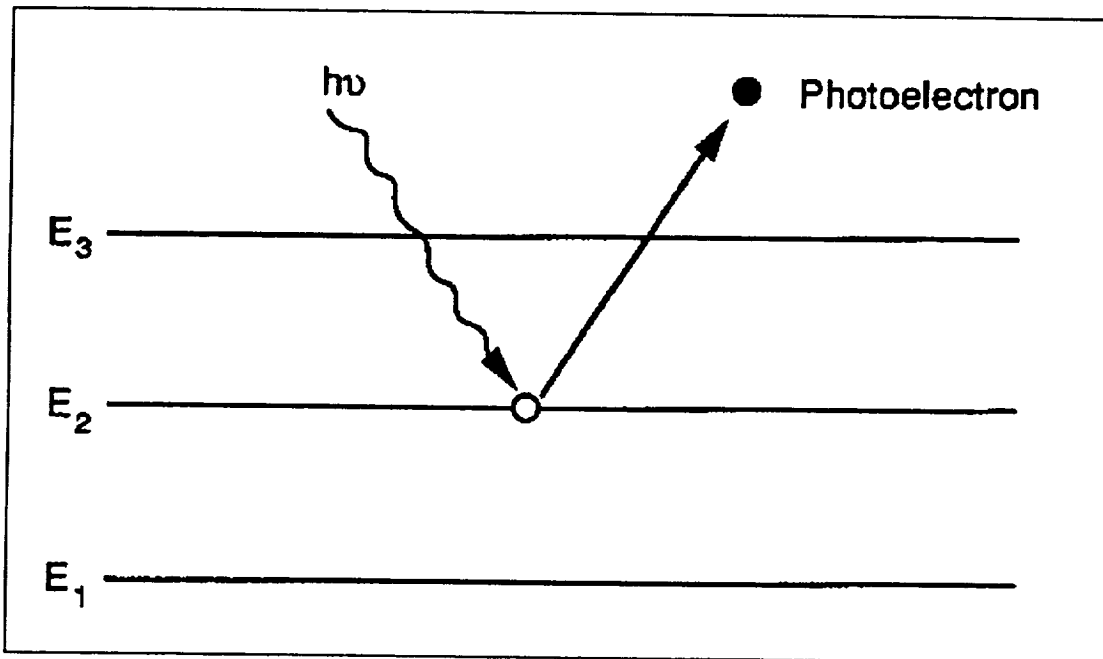

Figure 1.20. Diagram of the ESCA Process.

Typically, a dual magnesium (1253.6 eV) and aluminum (1486.6 eV) source is used. However, it has been found that the use of a high energy zirconium (2042.4 eV) anode coupled with the magnesium offers the greatest utility when analyzing aluminum materials used on the ET program. The sample, once mounted and introduced into the ultra-high vacuum chamber, is placed at the focal point of the electron energy analyzer. The sample is then irradiated with 250 or 300 watts each of either Mg, Zr or Mg/Zr simultaneously. These photons interact with the elements on the sample surface and eject core level photoelectrons which escape the sample surface and are passed through the electron energy analyzer and detected. Each element has its own set of characteristic photoelectrons of known kinetic energy. The kinetic energy of the ejected photoelectron is governed by the equation:

$$E_{K.E.} = h\nu - E_{B.E.} - \phi$$

where  $E_{K.E.}$  = Kinetic Energy of the Ejected Photoelectron  
 $h\nu$  = Incident X-ray Photon Energy  
 $E_{B.E.}$  = Binding Energy of the Ejected Photoelectron  
 $\phi$  = Work Function of the Electron Energy Analyzer

By knowing the analyzer work function, incident photon energy and measuring the kinetic energy of the ejected photoelectron one is able to determine the binding energy of the photoelectron to within typically 0.1 eV. ESCA not only provides the elemental identification of the elements present but also offers the ability to determine the chemical state of the atoms on a solid surface via small shifts in binding energy.

The ESCA technique is such that it can be performed easily on any solid vacuum compatible material. Consequently, another key advantage of ESCA is its ability to analyze both electrically conductive (i.e. metals, metal oxides, etc.) as well as insulating materials (i.e. powders, polymers, catalysts, etc.). ESCA is not limited by the electrical properties of the sample being analyzed.

As an example, an ESCA survey scan of a chemically processed 2219 T87 aluminum surface was analyzed (Figure 1.21). ESCA identified the presence of carbon, oxygen, fluorine and aluminum on its surface. The survey scan was acquired with the x-ray source powered at 250 watts each Mg/Zr and the spectrum normalized to zirconium at 2042.4 eV. Consequently, the kinetic energy at the 0 eV binding energy is the zirconium fermi edge.

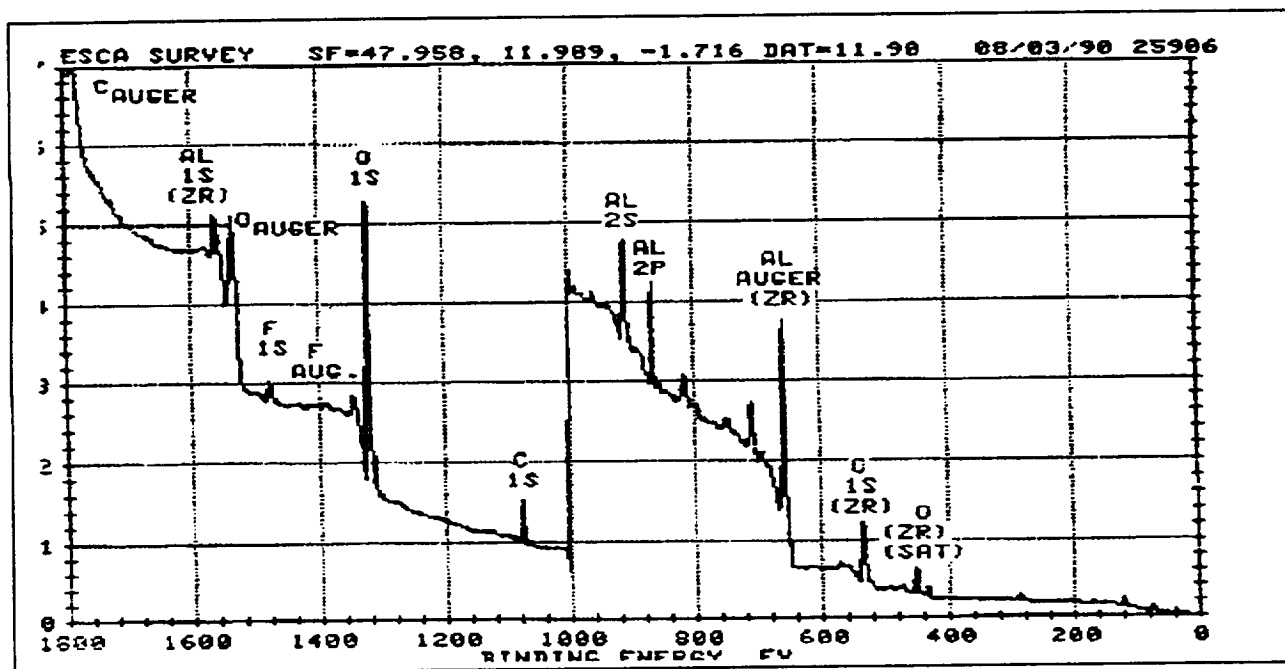

Figure 1.21. Typical ESCA survey scan of a clean chemically processed 2219 T87 aluminum surface normalized to Zr at 2042.4 eV.

Another key advantage of ESCA is the ease of quantitation with the use of developed peak area sensitivity factors. If the sample is assumed homogeneous within the analysis volume, the intensity of the photoelectron peak is given by the equation:

$$I = nf\sigma\theta y\lambda AT$$

where

- I = The intensity of the photoelectron peak
- n = Number of atoms of a element/cm<sup>3</sup>
- f = Incident x-ray flux in photons/cm<sup>2</sup>-sec
- σ = Photoionization cross-section
- θ = Instrumental angular efficiency factor
- y = Efficiency of the photoelectron process
- λ = Mean free path of a photoelectron in a solid
- A = Area of sample analyzed
- T = Detection efficiency

Thus, solving for the number density of atoms yields:

$$n = I/(f\sigma\theta y\lambda AT)$$

Defining the denominator as the Atomic Sensitivity factor (S) reduces the equation to:

$$n = I/S .$$

If we consider the ratio of two elements in a homogeneous matrix we have the expression:

$$n_1/n_2 = (I_1/S_1)/(I_2/S_2) .$$

The generalized expression for determining the atomic fraction of any element in a sample is than represented by the equation:

$$C_x = (n_x/S) / (n_i/S_i) = (I_x/S_x) / (I_i/S_i) .$$

This expression, although far from absolute, offers the ability to perform semiquantitative ESCA analysis to within 10 - 20 % on homogeneous samples. When more accurate quantitative analysis is desired, standards of known concentrations which accurately represent the samples of interest must be analyzed. In this way, escape depths, chemical effects, matrix effects, etc. are similar and thus cancel each other.

Quite often the main disadvantage of ESCA is its large analysis area. Conventional ESCA instruments have a very large analysis area. For example, some instruments have a fixed analysis area of about 12 mm<sup>2</sup>. Although most samples are sufficiently large and unaffected by this constraint, some samples are far too small for accurate ESCA measurements. One such example is pinholes in epoxy primer. The majority of these anomalies are typically about 1 mm in diameter (< 1 mm<sup>2</sup>) which is 1/12 the analysis area of the instrument. Newer instruments have been developed which render such analyses routine. These small area ESCA instruments,



have variable analysis areas and are able to analyze surface features as small as 75  $\mu\text{m}$ . The minimum effective analysis area of a small area ESCA unit is 0.004  $\text{mm}^2$  which is far below that required for the analysis of pinholes. Small area ESCA was performed on the pinhole anomaly and found to be extremely effective.

#### 1.4.2 Auger Electron Spectroscopy & Scanning Auger Microscopy

Auger Electron Spectroscopy differs from ESCA in that AES uses an electron beam for sample excitation and occurs as a result of a relaxation process (Figure 1.22).

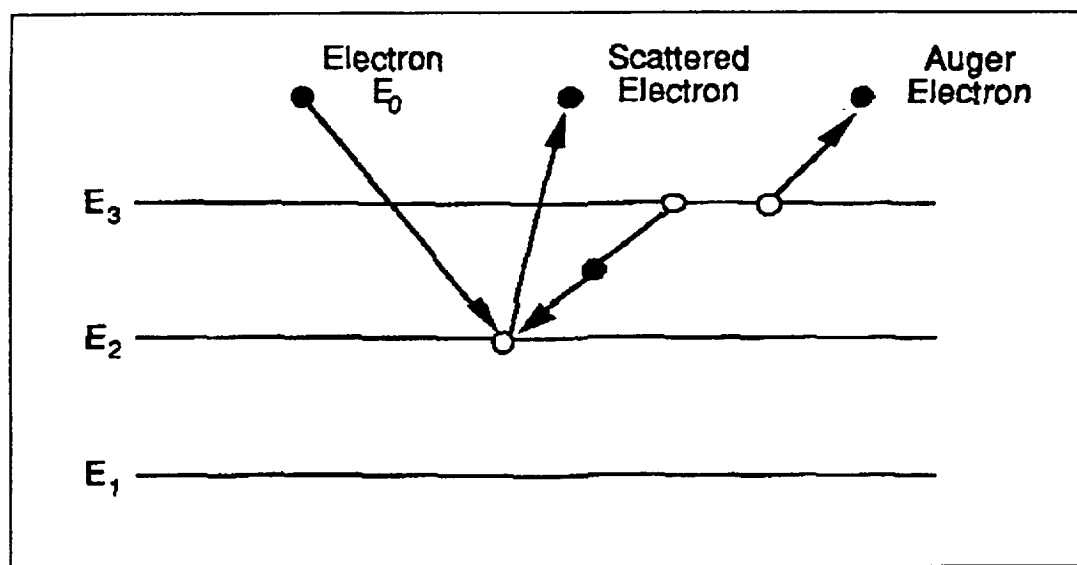

Figure 1.22. Diagram of the Auger Process. Note that AES is a Three Electron Process.

Whereas ESCA uses an X-ray source to eject photoelectrons for analysis, AES uses a finely focused electron beam to eject core level electrons thus placing the surface atoms in an excited state. The excited surface atoms relax to the ground state via radiation or the Auger process. The energy of the primary electron is typically between 3 and 10 kV. Most AES analyses are performed using 5 kV. The Auger process involves three electrons. The first electron ( $E_1$ ) is ejected by the primary electron ( $E_p$ ). A second electron ( $E_2$ ) from a higher energy level fills the core hole created by the ejection of  $E_1$ . The excess energy between  $E_1$  and  $E_2$  is translated to a third electron ( $E_3$ ). The third electron is the Auger electron. The Auger process places the atom in a doubly ionized state. The Auger process is independent of excitation source and each element beginning with lithium has its own set of characteristic Auger transitions. AES is also sensitive to 0.5 % of an atom layer or 0.1 atomic %. The Auger electrons are also passed through an electron energy analyzer and detected. The result is an elemental identification of the elements present on the sample surface.

As an example, a typical AES survey scan of the same aluminum surface discussed above identified the presence of carbon, oxygen, sulfur, chlorine, nitrogen, fluorine, copper and aluminum (Figure 1.23). The AES spectrum was acquired using a 5 kV and 1 mA electron

beam. The spectra is displayed as the derivative of the signal ( $d(N/E)/dE$ ) as a function of energy.

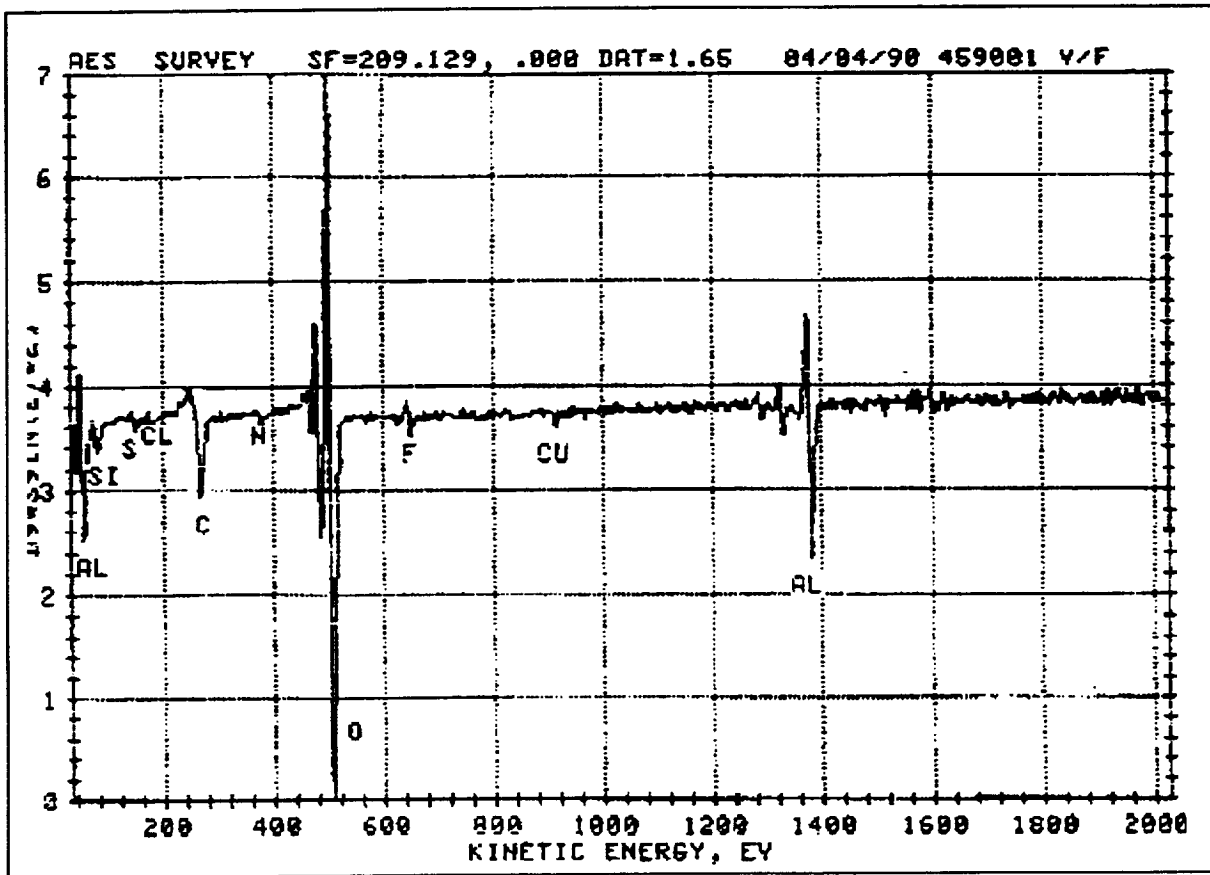

Figure 1.23. Typical AES survey scan of a clean chemically processed 2219 T87 aluminum surface acquired using a 5 kV, 1mA electron beam.

Quantitation of AES spectra is another advantage of performing AES analysis. The method employed is somewhat similar to that of ESCA, however, the derivative spectra or the peak-to-peak is used as a measure of intensity. This method for quantitation is less accurate than the peak area measurement used by ESCA.

One of the key advantages of AES over ESCA is its small analysis area. AES has a high spatial resolution due to the use of a finely focused electron beam for excitation. Older instrument models have a minimum AES analysis area of  $8 \times 10^{-7} \text{ mm}^2$  (~ 1 mm diameter), the newer commercially available instruments have analysis areas of the order of  $5 \times 10^{-10} \text{ mm}^2$ . Regardless of the instrument, AES is orders of magnitude better suited than ESCA to the elemental identification of small surface features.

Still another advantage of AES is its ability to scan the electron beam over an area of the sample and obtain maps showing the elemental distribution of differing elements. This is the SAM feature of the surface analysis instrument. Instruments can operate effectively at magnifications of 1000X. As an example, SAM was found very useful in the investigation of a

weld defect. Here samples were machined from scrapped flight hardware where defects were known from x-ray inspection to exist. The samples were then mounted, introduced into the ultrahigh vacuum analysis chamber ( $5 \times 10^{-10}$  torr) and fractured in-situ. In-situ fracture exposed the weld defects under UHV which were then analyzed by both AES point analysis and SAM. This approach allowed the identification of the contamination causing this anomalous condition.

Another example of the SAM capability was the analysis of a contaminated aluminum surface. AES point analysis found the composition of the surface to vary from point to point. Additionally, a 250X SEM image contained bright spots randomly dispersed on its surface. The elements present were aluminum, oxygen and carbon. Thus, 250X SAM elemental maps were acquired for these elements (Figure 1.24).

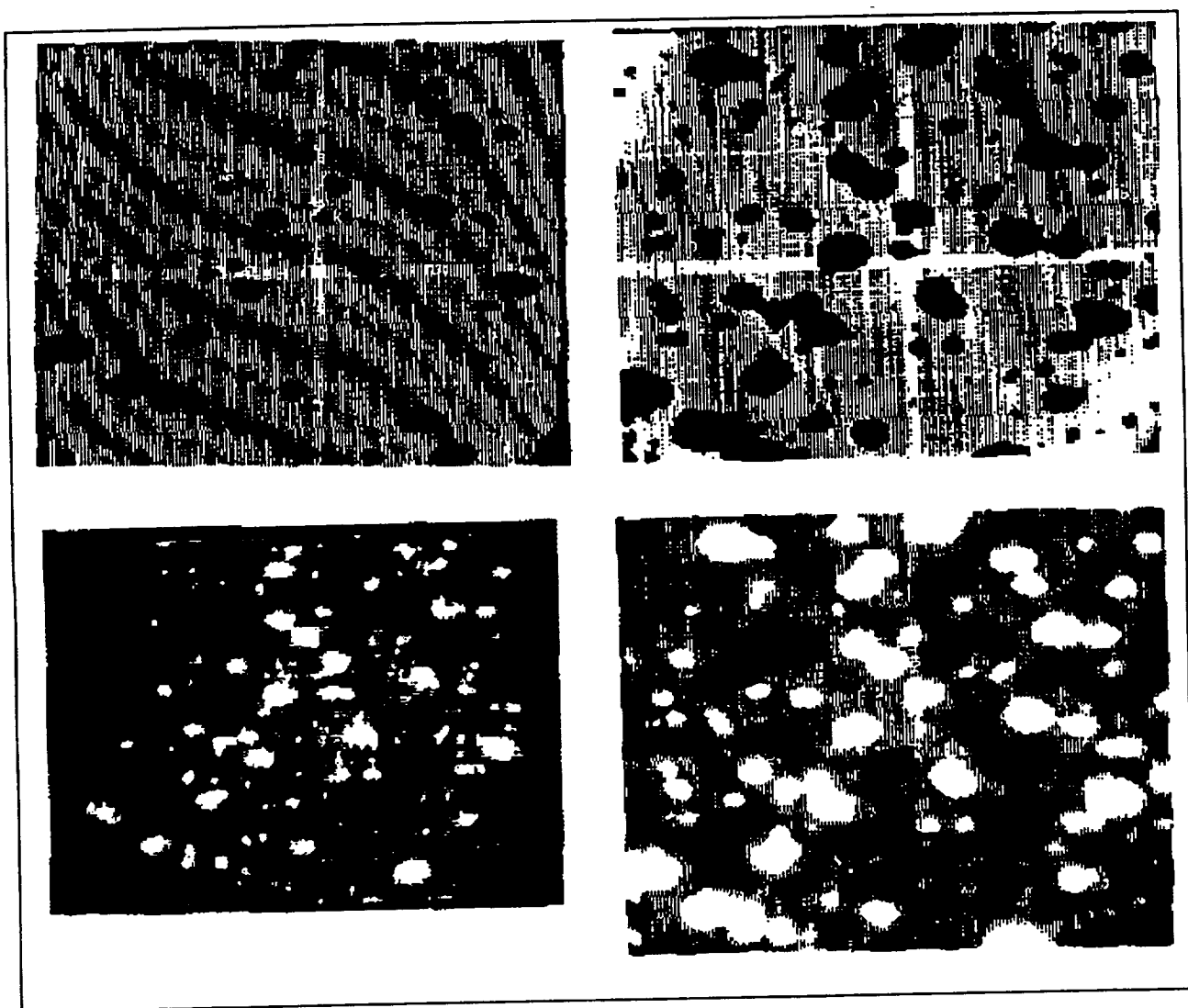

Figure 1.24. 250X SEM (bottom-left) and SAM elemental maps for aluminum (top-left), oxygen (top-right) and carbon (bottom-right).

The SAM maps revealed aluminum and oxygen surface voids which were found to be rich in carbon. The carbon was found to be dispersed islands on the surface of the sample. These analyses were performed at a magnification of 250X.

Although AES is a very powerful analytical tool, it does have disadvantages. A major disadvantage of AES is the types of samples which can be analyzed. Unlike ESCA, AES is not capable of analyzing electrically insulating materials. Due to the use of an electron gun for excitation, samples must be electrically conductive and have a conductive path to ground. Thus, AES and SAM analysis is limited to semiconductive and conductive materials. Furthermore, AES does not offer the same level of chemical state information gained by ESCA. However, AES is typically a quicker technique to perform. AES was not employed in the epoxy primer pinhole investigation due to the fact both the contamination and primer materials are non-conductive.

### 1.4.3 Secondary Ion Mass Spectroscopy

SIMS is the most sensitive of the surface science techniques to surface contamination. SIMS is typically several orders of magnitude more sensitive than either AES or ESCA. The lower detection limit for many elements by SIMS is of the order of 1 ppm. Furthermore, SIMS is the only surface science technique capable of detecting hydrogen and is sensitive to the entire periodic table of elements.

Secondary Ion Mass Spectroscopy is performed using an Argon inert gas ion gun for excitation and a quadrupole mass analyzer (QMA) for detection. The SIMS process involves the Argon being ionized and accelerated onto the sample surface with typically 0.5 to 4 kV. The incident Argon ions interact with the surface species of the sample through exchange of energy and momentum. The surface species are ejected from typically the top two atom layers of the sample ( $\sim 5 \text{ \AA}$ ) as positive ions, negative ions and molecular fragments (Figure 1.25).

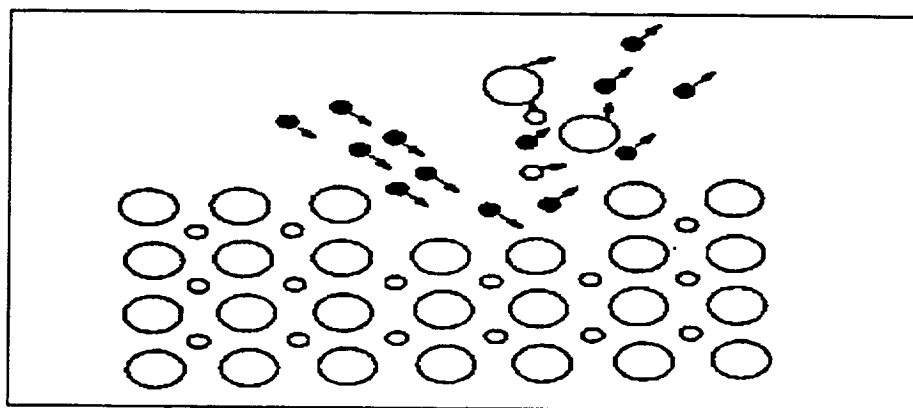

Figure 1.25 Illustration of the SIMS Process.

The emitted secondary ions and ionic fragments are then focused into an energy filter, passed through a mass analyzer and detected. The SIMS spectra are displayed as the intensity (log or linear scale) vs atomic mass unit (AMU). Similar to ESCA, SIMS analysis can be performed on both electrically conductive and non-conductive materials. One major

disadvantage of SIMS over ESCA and AES is that it is a destructive technique. Once SIMS is performed on a sample surface whether static or dynamic the original as received surface has been destroyed. Consequently, SIMS is usually the only or last technique to be performed on a sample surface.

As an example of the utility of SIMS, analysis was performed on a chemically processed 2219 T87 aluminum surface. Both positive and negative SIMS spectra were acquired (Figure 1.26).

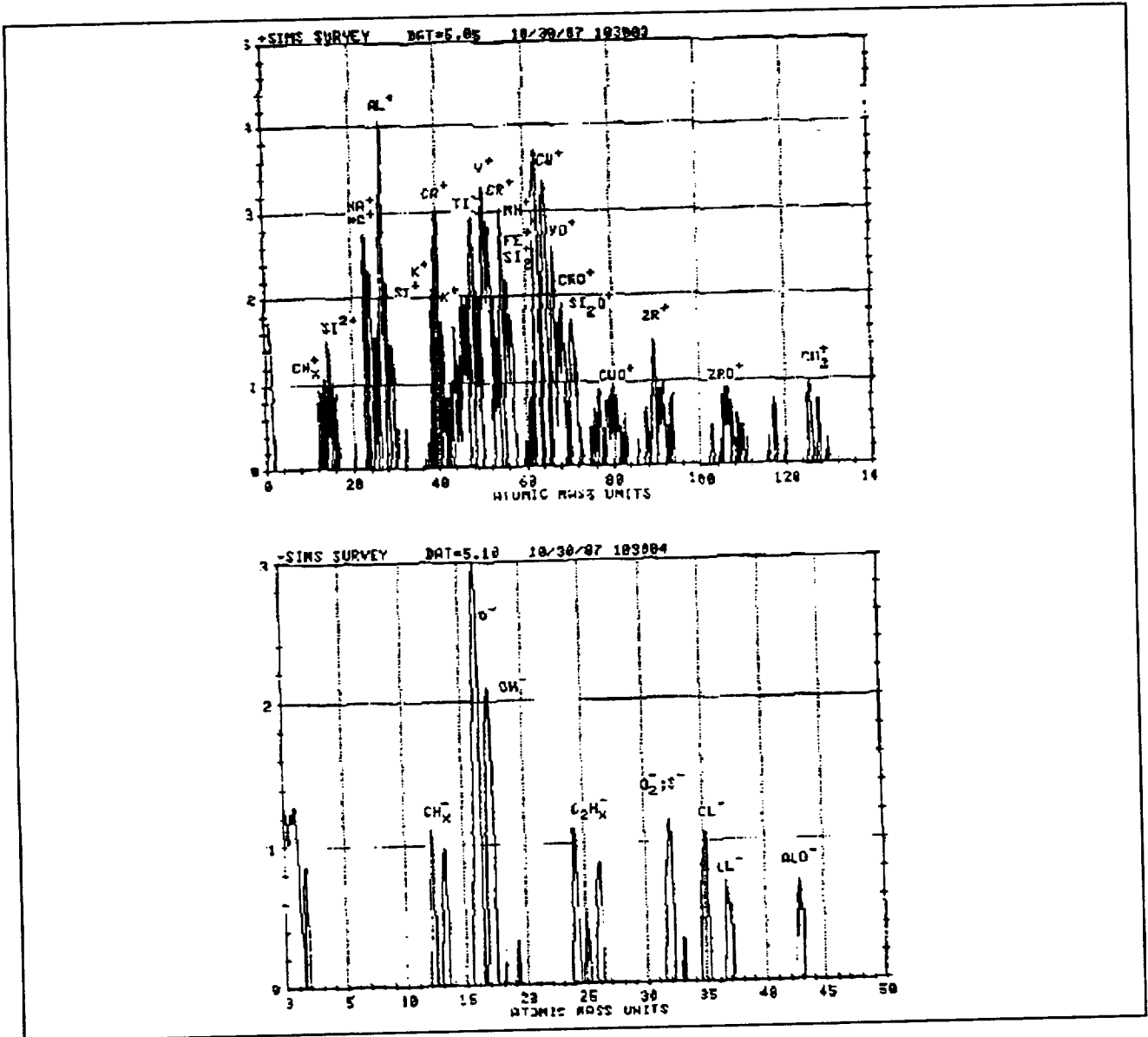

Figure 1.26. Positive (top) and negative (bottom) SIMS spectra of a chemically processed 2219 T87 aluminum surface.

The spatial resolution of SIMS is governed by the spot size or raster area of the incident ion gun. A minimum spot size of 800  $\mu\text{m}$  translates into an analysis area of 0.5  $\text{mm}^2$ . Typically, however, a 2 mm X 2 mm raster area is analyzed (4  $\text{mm}^2$ ).

Another major disadvantage of SIMS is the difficulty in the quantitation of SIMS data. This is due to the fact that the elemental sensitivities for SIMS cover a very wide range (i.e.  $10^4$ ). SIMS is an excellent complimentary technique to both ESCA and AES. Furthermore, good sample to sample or good to bad comparisons can be made of similar sample materials.

Compared to the AES and ESCA spectra discussed earlier, SIMS is far more sensitive to certain surface species. SIMS identified the presence of sodium, magnesium, potassium, calcium, silicon, titanium, vanadium, chromium, copper, iron, zirconium, and hydroxide on a similar surface analyzed by both ESCA and AES.

#### 1.4.4 Ion Scattering Spectroscopy

Ion Scattering Spectroscopy is similar to SIMS in that it uses an inert gas incident ion beam for sample excitation. ISS uses a monoenergetic low energy (0.1 to 3 kV) helium, neon or argon ion beam as its excitation source. A fraction of the incident ions interact with the sample surface and are scattered from the surface atoms by binary elastic collisions (similar to the scattering of billiard balls of different masses). The ISS process (see Figure 1.27 on the next page) is governed by the equation:

$$E_1 = \frac{E_0}{(1+\mu)} [\cos\theta + (\mu^2 - \sin^2 \theta)^{1/2}]^2$$

where  $E_1$  = Energy of the Scattered Ions  
 $E_0$  = Energy of the Incident Ions  
 $M_1$  = Mass of the Incident Ions  
 $M_2$  = Mass of the Surface Atoms  
 $\mu$  =  $M_2/M_1$   
 $\theta$  = Scattering Angle

An ISS spectrum is a measure of the energy distribution of scattered incident ions leaving the sample. ISS peaks occur at specific values of  $E_1$ . Furthermore, the scattered ion signal is proportional to the number of surface atoms for a given element, probability that the incident ions will remain ionized and differential scattering cross-section. The differential scattering cross-section increases with atomic number such that ISS is most sensitive to higher mass elements. The probability that an incident ion will remain ionized following scattering is  $10^3$  and decreases dramatically with subsurface atoms which gives ISS its unique ability to analyze the very top atom layer of a material. Thus, the primary advantage of ISS is its unique surface sensitivity.

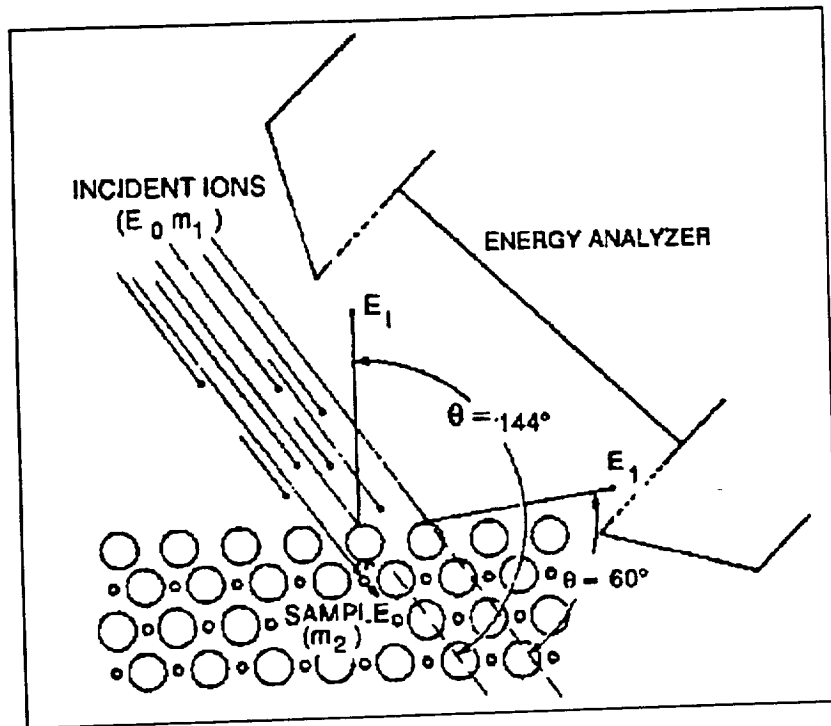

Figure 1.27. Illustration of the ISS Process.

As an example, ISS was performed in the characterization of staining of chemically processed 2219 T87 aluminum. Both AES and ESCA identified the presence of copper in the area of the stain. These techniques, however, were unable to identify the elements at the very top of the sample surface. ISS clearly identified the presence of an elevated amount of copper in the stained area compared to an unstained area (Figure 1.28).

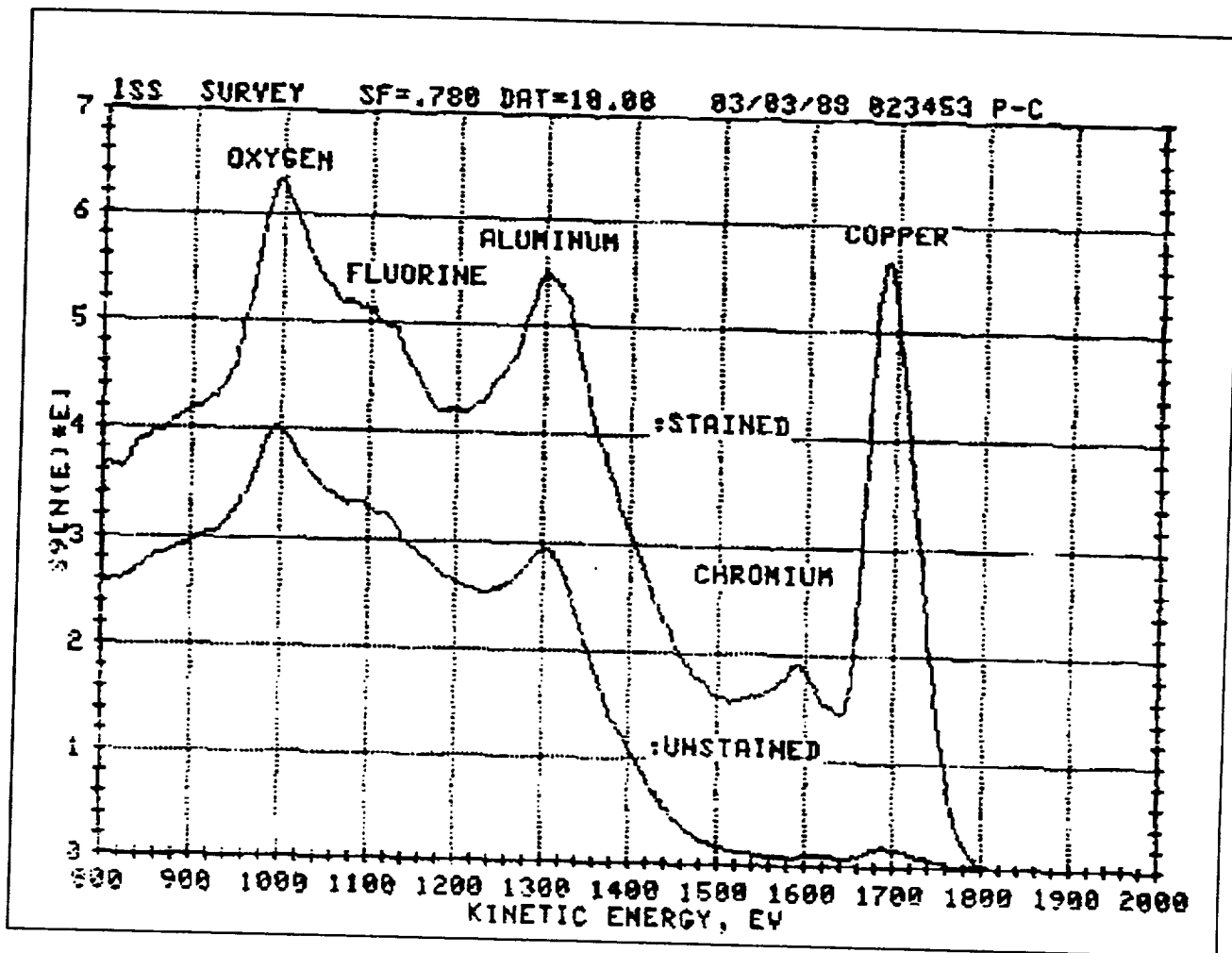

Figure 1.28. He3 ISS survey spectra of a stained (top) and unstained (bottom) chemically processed aluminum surface.

Some of the disadvantages of ISS are similar to SIMS. Quantitation is difficult and the surface of the sample may be changed due to minor sputtering of the surface species during analysis. Still another common problem encountered with ISS is its limitation in mass range and resolution with any given incident ion species. Helium is able to detect the lighter elements beginning with lithium and offers the greatest range of sensitivity. Neon is sensitive to elements greater than magnesium while argon is sensitive to elements greater than titanium.

#### 1.4.5. Technique Selection Considerations for these Techniques

The above discussions explained in some detail the four surface science techniques. It is important to keep in mind that no one technique is considered "THE" most appropriate technique for a given sample. AES and ESCA are by far the two most popular. However, the best approach to be used in a given analysis is to perform multiple techniques on a given sample. Thus, when possible, both ESCA and AES should be performed followed by either ISS and/or SIMS. To assist with the appropriate selection of techniques to be used, refer to the attached Table 1.3 on the next page.



Table 1.3 Selecting the Appropriate Surface Analysis Technique

CHARACTERISTIC	AES/SAM	ESCA or XPS	ISS	SIMS
	Auger Electron Spectroscopy Scanning Auger Spectroscopy	Electron Spectroscopy for Chemical analysis or X-Ray Photoelectron Spectroscopy	Ion Scattering Spectroscopy	Secondary Ion Mass Spectroscopy
Excitation Source	Focused Electron Beam	Mg and/or Zr X-ray source	He, Ne, or Ar ion beams	Primary - Ar ion beam Secondary - He & Ne ion beams
Spatial Resolution	1-5 Micrometers	4 millimeters	2 x 2 millimeters	800 micrometers
Depth Resolution	1 - 5 nanometers	1 - 5 nanometers	First atomic layer	Beginning with first atomic layer
Sensitivity	Good sensitivity throughout the atomic number range. Spectra become more complicated with atomic number.	Similar to AES/SAM	Higher sensitivity for larger atomic number elements	Excellent sensitivity for low atomic number elements. Also sensitive to molecular fragments and isotopes.
Detection Limit	0.1 Atomic Percent	0.1 Atomic Percent	1 atomic Percent	~ 1 ppm for many elements. Most sensitive technique.
Materials	Excellent for metals and thin metal oxide films. Materials must be somewhat conductive.	Excellent for all solid vacuum compatible materials. Least destructive of the four techniques	Best suited for metals and metal oxides. Somewhat surface destructive.	Best suited for metals and metal oxides. Applicable to both conductive and non-conductive materials. Technique is surface destructive by its nature.
Elemental Identification	Lithium through Uranium	Lithium through Uranium	Lithium through Uranium	Hydrogen through Uranium
Chemical Bonding	Very limited, e.g. Al vs Al <sub>2</sub> O <sub>3</sub>	Excellent for differentiating between chemical states of materials	Not applicable	Not applicable
Ion Etching	Excellent due to small analysis area @ .5 - 50 nm/Min.	Only fair due large analysis area @ .5 - 5 nm/min.	Poor due to low energy ions used.	Good due to small analysis area required by the very nature of the technique. 0.5 - 25 nm/min.
Depth Profiling	Excellent for elemental composition analysis as a function of depth	Poor for elemental composition as function of depth. Excellent for chemical composition as a function of depth.	Poor	Good for elemental composition as function of depth. Excellent for molecular fragment composition as a function of depth.

## 1.5 . Thermal-Mechanical Techniques

A number of thermal and mechanical methods of analysis of materials can be very useful for chemical fingerprinting purposes. Several instruments frequently used for determining materials' thermal and mechanical properties using temperature programmed analysis include high temperature differential thermal analysis, (DTA), thermogravimetric analysis (TGA), thermomechanical analysis (TMA) and differential scanning calorimetry (DSC). Included in this category of instrumentation is also the very useful technique described as rheometric dynamic spectrometry (RDS). These methods have primarily been used to characterize polymers and their precursors; however, numerous laboratories use them to characterize metals and ceramics as well. A general discussion of these methods follows.

High temperature differential thermal analysis consists of instrumentation that measures the temperature of a milligram sized specimen as heat is applied at a controlled rate. The upper limit of these systems is generally around 1500 °C. The heat capacity of the material is easily obtained, as well as latent heat effects such as phase changes or transformations and autoignition.. The normal display of the temperature changes during the programmed heating provides indication of contaminants or out-of-specification material. The critical glass temperature, which is a measure of the purity of the material, can also be a useful characteristic for the material.

Thermogravimetric analysis is performed by placing a milligram-sized sample onto a temperature programmed microbalance. The upper limit of most systems is around 1000 °C. Fingerprinting can be performed by determining whether a material's thermal weight loss is characteristic of the normal material. This technique can also be used to evaluate wiring covers, crystallinity, stabilizer addition and the thermal stability of many types of polymeric and ceramic materials.

Thermal mechanical analysis is performed by placing a sample between a vitreous silica platform and a movable silica rod and subjecting the sample to a variable load. In dilatometry, the sample is wetted with a liquid and the swelling behavior followed by the measurement of the movement of the silica rod. TMA is performed at various controlled temperatures, where characteristic properties such as thermal relaxation phenomena and tensile compliance in polymers, fibers, and powders can be obtained.

Differential scanning calorimetry is similar to differential thermal analysis, except that the temperature of the sample is monitored for a controlled heat input. The upper limit of most systems is around 500 °C when using aluminum pans to contain the samples. Fusion between the aluminum pans normally occurs when measurements are made above that temperature. Materials properties which are obtained in this technique include glass transition temperature, crystalline transition temperatures, latent heat transformations, and specific heat measurements.

Rheometric dynamics spectrometry determines the viscous and elastic properties of a material by imposing a cyclical load on the material at programmed temperatures and measuring the resultant torques and body forces. Dynamic viscosity, dynamic modulus and

loss angle can be calculated from this data. Sample temperatures can be programmed from -150 to 400 ° C.

### 1.7. Strategy for Instrument Hierarchy

Analytical instrumentation and instrumental techniques frequently used for chemical analysis and materials characterization were described in the previous section. The theoretical basis, application areas, sample requirements, and limitations of each technique were discussed. The tables and flow charts in this section were developed to serve as guides in the selection and application of instrumental techniques to solve a given analytical problem.

Before selecting specific techniques to be used, the analytical problem should be defined by asking the following types of questions:

What is the nature of the sample?

- Is it a solid, liquid, or gas?
- Is it organic or inorganic?
- Is it a mixture, or a pure substance?
- What is already known about its composition?
- Is it permissible to destroy the sample during testing?
- How much sample is available for analysis
- What is the material's history, and its future?

What kind of information about the sample is desired?

- Is an elemental or molecular analysis desired?
- Is complete identification of all species present required?
- Or, is it sufficient to identify the major and minor components?
- Which specific species or components are to be analyzed?
- What is the required precision and accuracy of the data?

A few of the questions will be immediately answered by visual observation of the sample. Others can be answered readily through discussions or correspondence with the person requesting the analysis. More information may be provided by persons experienced in the testing or processing of the material, or by the material's supplier. The remaining questions will require a physical or chemical measurement to be performed.

An analytical problem can be attacked in three ways:

- Consult with leading experts in the field
- Search the literature for a solution
- Experiment based on theoretical predictions

The first two points should not be overlooked. Do not risk reinventing the wheel by failing to consult others who may have had experience with the same type of problem. These people may be within your company, may be even in your own lab. The companies from whom you have purchased analytical instrumentation may have applications chemists available to help you. Some instrument manufacturers publish newsletters and product bulletins that may provide valuable information. A literature search may turn up the perfect solution to your problem. On the other hand, if the problem involves a proprietary material, literature searches may be of little help. When these sources of information have been exhausted, it is time to experiment.

One source of information about most materials that are used in industrial and laboratory processes that may contain chemical information is the Materials Safety Data Sheet (or MSDS). These information packages are readily available to the user to ensure that personnel safety is always maintained and necessarily do have to identify any toxic precursors which exist in the product.

Unfortunately, no single procedure exists for the selection of the most effective instrumental approach to a given analytical problem. Factors to consider include the capabilities and limitations of the available instrumentation, and the quality of the analytical results versus the cost in time and materials required to obtain them. Table 1.4 surveys the more common instrumental techniques and summarizes each technique's application areas, limitations and sample requirements. This table can be used to identify the techniques that could be applied to the problem at hand. The remaining tables and charts contain additional information that will help the analyst to "narrow the field" and arrive at specific instrumental methods that can be applied to the problem.

TABLE 1.4. COMMON INSTRUMENTAL ANALYSIS TECHNIQUES

Method	Applications	Advantages	Method Limitations	Sample Limitations	Sample Size
Atomic Absorption Spectrometry (AAS)	Quantitative and/or trace analysis of a single element for each measurement	Fast, reliable, high sensitivity for some 70 elements, relatively inexpensive	Not applicable to most non-metallic materials or simultaneous multi-element analysis. Small linear response range	Requires time-consuming dissolution of sample or graphite furnace for atomizing solids.	mg to g
Inductively Coupled Plasma-Atomic Emission Spectrometry (ICP-AES)	Quantitative multi-element analysis Determination of trace, minor and major elements	Simultaneous determination of up to 60 elements. Good for refractory materials. Large dynamic range	Limited sensitivity for nonmetals. Expensive	Requires time-consuming dissolution of sample or graphite buffer for atomizing solids.	mg to g
X-ray Fluorescence Spectrometry (XRF)	Quantitative analysis of all elements of atomic no. > 14. Qualitative determination of all elements with atomic no. > 11.	Minimal sample preparation. Inexpensive	Detection limits not as good as AA or ICP/AES	Solid or nonvolatile liquid	mg
Infrared Spectrometry (IR or FTIR)	Identification and structural determination of materials, including surface adsorbants	Applicable to most materials. Extensive libraries of reference spectra available.	Composition limited to molecular species identified. Medium sensitivity. Trace and minor components can be masked by major components.	Material must contain bonds which undergo dipole moment change during vibration	µg
Raman Spectroscopy	Identification and structural determination of materials, including surface adsorbants	Identification of non-polar functional groups. Minimal sample preparation.	Low sensitivity. Fluorescence can interfere with Raman signals. Limited libraries of reference spectra. Expensive.	Material must contain bonds which undergo polarizability change during vibration	1 to 100 mg
Nuclear Magnetic Resonance Spectroscopy (NMR)	Structural determination and identification of both organic and inorganic materials	Determination of molecular configuration and conformation	Applicable only to samples containing magnetic moment. Low sensitivity. Expensive	Sample must be liquid or soluble solid	1 - 100 mg
Energy Dispersive X-ray Spectroscopy (EDS)	Elemental inorganic identification of elements	Low level detection	Elements $\geq$ Na	Sample must be liquid or soluble solid	~ 3 cm diameter

TABLE 1.4 COMMON INSTRUMENTAL ANALYSIS TECHNIQUES (continued)

Method	Applications	Advantages	Method Limitations	Sample Limitations	Sample Size
Mass Spectrometry	Structural determination and identification of organic and some inorganic materials.	Widely applicable to most materials. Extensive on-line reference libraries available.	Slow Expensive	Sample must be volatilized.	0.01 g
Gas Chromatography (GC)	Separation of multicomponent mixtures of volatile materials.	Selectivity ranges from general to specific	Not applicable to nonvolatile and thermally unstable materials	Material must be volatile and thermally stable	µg to mg
Liquid Chromatography (LC or HPLC)	Separation of multicomponent mixtures of liquids and soluble solids	Widely applicable to nonvolatile organics. Applicable to thermally unstable materials. Separated materials can be identified by other methods.	No sensitive universal detector. Subsequent analysis by IR or MS necessary to identify components. Moderately expensive.	Must be soluble in one of many suitable solvents.	µg to mg
Ion Chromatography (IC)	Separation of complex mixtures of ionic species for quantitative analysis. Elemental analysis of organics after decomposition.	Applicable to a wide range of organic and inorganic anions and to many cations.	Analysis of trace species in presence of high concentration species is difficult. Method development is time consuming. Moderately expensive.	Must ionize in solution. Nonaqueous applications limited. Decomposition of organics time consuming.	1 to 5 mg
Size Exclusion Chromatography (SEC) Gel Permeation Chromatography (GPC)	Separation of complex mixtures based on molecular size. Determination of polymer molecular weight distribution.	Applicable to polymers. Determines molecular weight distribution.	Calibration time consuming. Moderately expensive.	Must be soluble in limited number of suitable solvents. GPC performed in water.	µg to mg.
Combined Gas or Liquid Chromatography with Mass Spectrometry (GC/MS or LC/MS)	Separation, identification and quantitative analysis of complex mixtures.	Combines separation capability of GC or LC with identification and sensitivity of MS	Slow Method development is time consuming Expensive	Same as GC, LC and MS	20 - 200 ng.

TABLE 1.5 . OTHER USEFUL INSTRUMENTAL ANALYSIS TECHNIQUES

Method	Applications	Advantages	Method Limitations	Sample Limitations	Sample Size
Differential Thermal Analysis (DTA)	Quantitative characterization of materials & contaminants Dilatometry, autoignition	Separates materials by differences in thermal properties in inert or oxidizing atmosphere Measures resistance to thermal degradation. Inert or oxidizing atmosphere.	Very few; can handle a large variety of solids and liquids, such as foams, films, powders, or fibers.	Small sections that fit in sample crucibles Sample containment can be expensive	mg
Thermal Gravimetric Analysis (TGA)	Quantitative characterization of materials, wire coatings	Measures resistance to thermal degradation. Inert or oxidizing atmosphere.	Very few; can handle a large variety of solids and liquids, such as foams, films, powders, or fibers.	Small sections; determined by size of sample pan and autobalance range.	mg
Differential Scanning Calorimetry (DSC)	Quantitative characterization of polymers & inorganics by heat absorption, $T_g$	Differences in thermal properties easily measured. Inert or oxidizing atmosphere.	Very few; can handle a large variety of solids and liquids, such as foams, films, powders, or fibers.	Small sections determined by sample pan size.	mg
Thermal Mechanical Analysis (TMA)	Semi-quantitative characterization of polymers & organics	Distinguishes materials by differences in thermo-mechanical properties.	Very few; can handle a large variety of solids and liquids, such as foams, films, powders, or fibers.	Small sections determined by sample pan size.	mg
Rheometric Dynamic Spectrometer (RDS)	Quantitative characterization of viscous and elastic properties	Measures properties with many geometries	Can handle both solid and liquid samples.	Small sections the fit into test cells.	mg
Dynamic Mechanical Analysis (DMA)	Quantitative characterization of viscous and elastic properties $T_g$ and $T_m$ .	Separates materials by differences in mechanical properties	solid samples	small sections that fit into test cell.	mg
Optical Microscopy	Qualitative analysis of Particulates	Fast Relatively inexpensive	Knowledge and experience of personnel very important	Small samples	ng
X-ray Diffraction (XDS)	compound identification of crystalline materials	Identify crystalline compounds	Slow process	Small sections of single crystal or powder	$1 \times \text{mm}^3$
Transmission Electron Microscope (TEM)	Microstructural analysis of metals, ceramics and polymers.	Very high magnification	Slow & expensive	small sections of solids Sample preparation can be difficult	$\mu$
Scanning Electron Microscope (SEM)	Surface Morphology and high spatial resolution of small samples.	Greater depth of field and resolution than optical microscopy.	Samples must withstand High vacuum	small sections of solids Sample preparation can be time consuming	$\mu$

TABLE 1.6 . COMMON SURFACE ANALYSIS TECHNIQUES

Method	Applications	Advantages	Method Limitations	Sample Limitations	Sample Size
Auger Electron Spectroscopy (AES)	Compositional analysis of conducting surfaces	High Spatial resolution. Surface sensitive in upper 10 nm.	Insensitive to He and H Semi-quantitative	Solids, must be conductive, vacuum compatible	microns down to nm.
X-ray Photoelectron Spectroscopy (XPS) and Electron Spectroscopy for Chemical Analysis (ESCA)	Elemental analysis of surfaces and coatings Chemical state identification	Nondestructive Quantitative and rapid	Interrogates only top 10 nm.	Solids, vacuum compatible	cm
Ion Scattering Spectroscopy (ISS)	Identification of elements on surfaces Depth profiling of ultrathin films	Depth profiling can analyze for elements through several thousand Angstroms.	Can be time consuming to depth profile several thousand Angstroms	Solid , vacuum compatible	down to 0.05 cm
Secondary Ion Mass Spectroscopy (SIMS)	Surface compositional analysis Trace element analysis of surfaces and thin films	Good resolution from 1 to 5 nm in depth	Analysis is destructive and can be time consuming	Solid, vacuum compatible Flat surfaces desired	cm
Low Energy Electron Diffraction (LEED)	Surface analysis of conducting materials	High resolution	Surface preparation can be expensive and difficult	Small sections of solids	



Infrared spectroscopy is usually a good place to start. Due to the variety of sampling accessories available, this technique can accommodate most types of samples. Infrared provides information about the organic and inorganic functional groups present, and an estimate of the sample's purity.

Functional groups present in a material can be identified by infrared spectroscopy with the aid of correlation charts, such as the ones pictured in Figures 1.29 and 1.30. These charts summarize the characteristic frequencies of the major functional groups. Frequencies associated with carbon-carbon and carbon-hydrogen bonds are pictured at the top of each chart. Functional groups containing oxygen and silicon atoms are featured in the middle of each chart. Characteristic frequencies of groups containing nitrogen, sulfur, phosphorus, and the halogens are shown at the bottom.

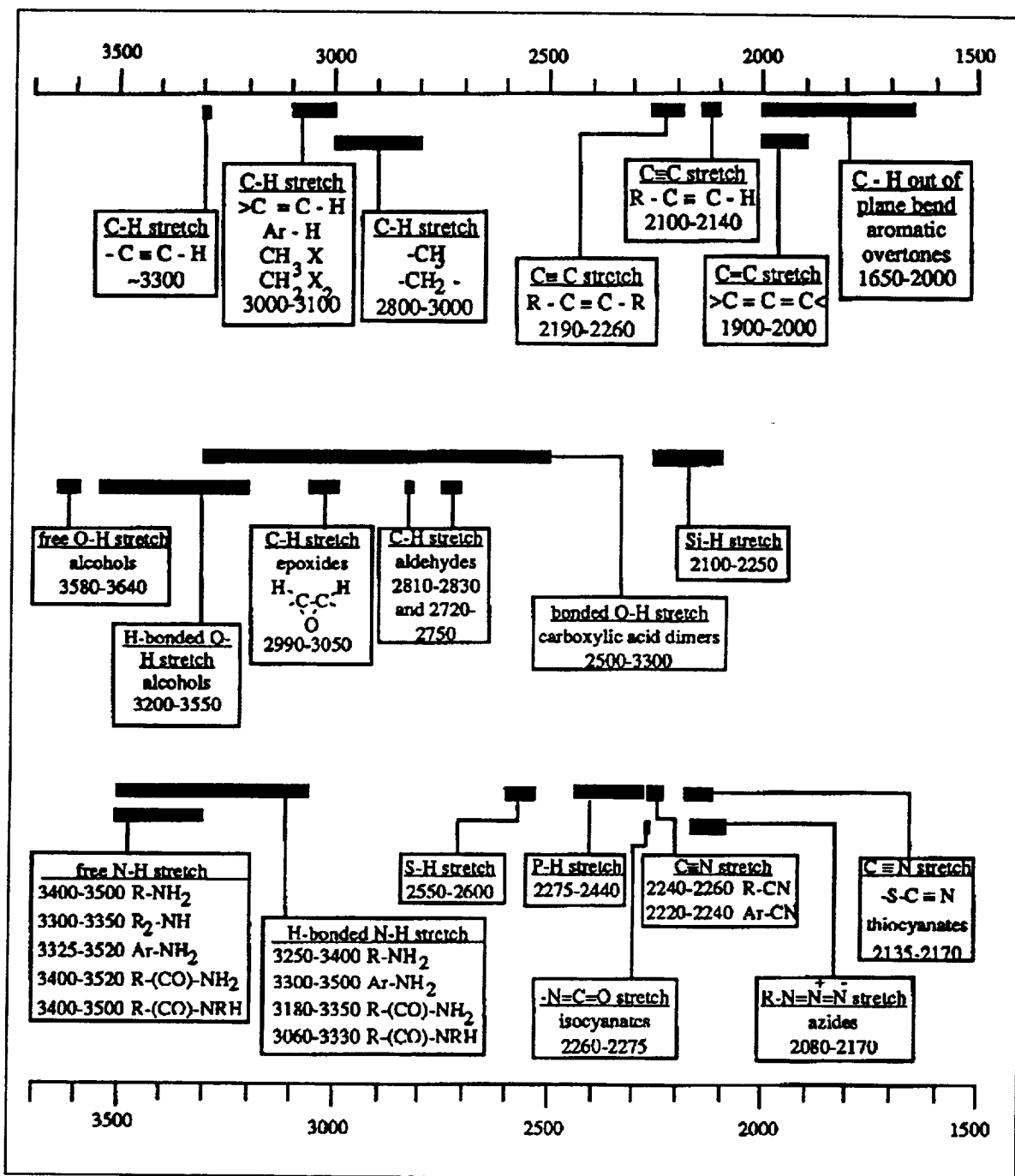

Figure 1.28. Correlation Chart of Infrared Group Frequencies, 1500-3700  $\text{cm}^{-1}$

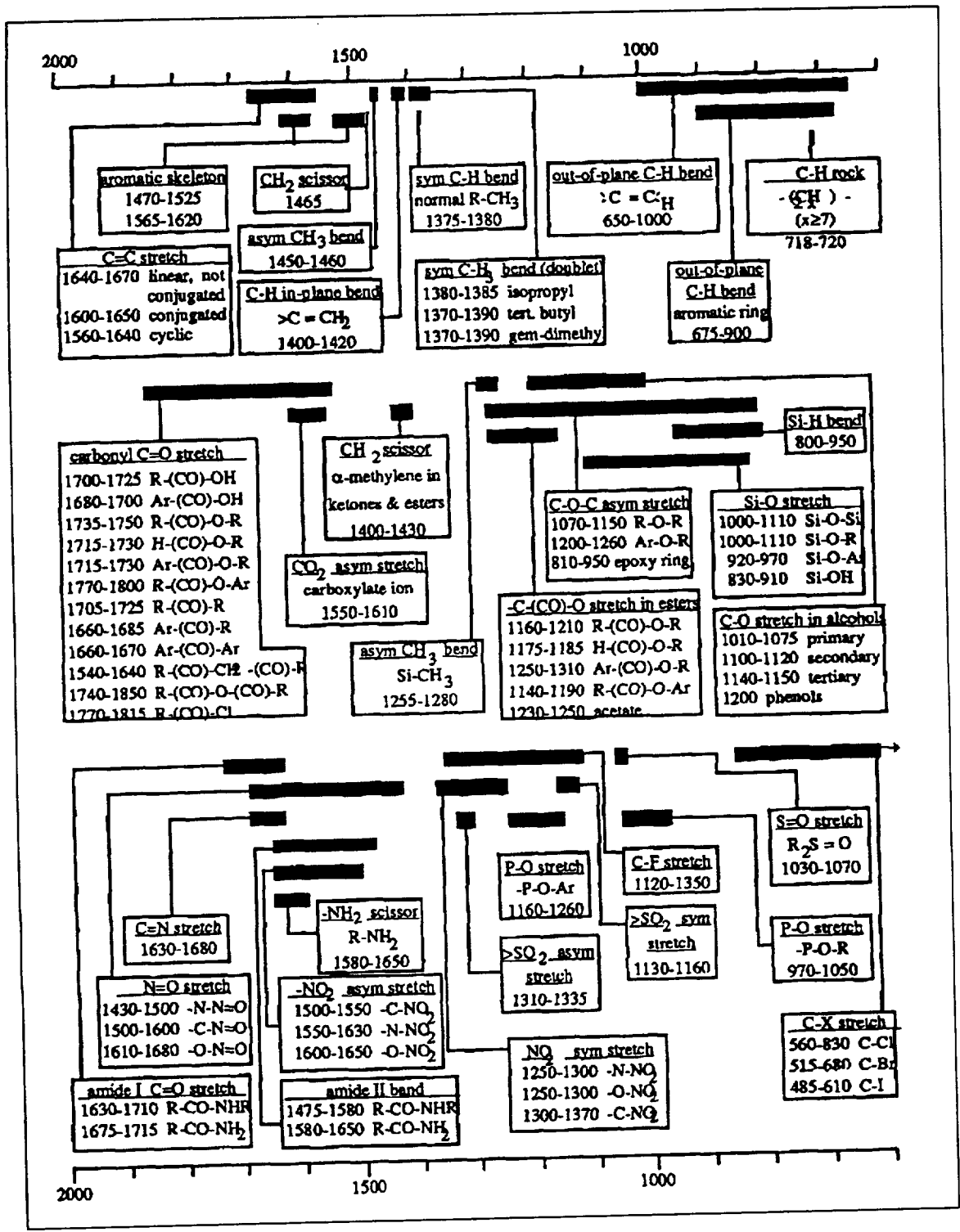

Figure 1.30. Correlation Chart of Infrared Group Frequencies, 600-2000  $\text{cm}^{-1}$

When cautiously used, correlation charts can be valuable tools in the interpretation of infrared spectra. However, correlation charts alone can seldom unambiguously establish the molecular structure or identify an unknown material. Group frequency ranges are determined empirically from a large number of samples and are

often broad. Group frequency ranges may overlap each other considerably. Because the physical state of the sample (i.e., the sampling technique) can cause band frequency shifts or broadening, the sample should be run under conditions similar to those used during compilation of the correlation chart. Throughout the interpretation process, always keep in mind all of the information known about the sample, such as its physical state, results of other analyses, and elements known to be present or absent.

If the sample is a complex mixture, it may be possible only to identify the major functional groups present. If the material is a pure compound, it can be unambiguously identified if its spectrum exactly matches the reference library spectrum of a known compound. When infrared spectral libraries are not available or no match can be found, the compound's molecular structure can sometimes be deduced by interpretation of the infrared spectrum with the aid of the correlation charts. The following general procedure may be successful:

- I. Look at the group frequency region ( $4000$  to  $1350\text{ cm}^{-1}$ ) first, concentrating in turn, on the strong bands, then on the medium intensity bands.
- II. Look at the  $2800$  to  $3300\text{ cm}^{-1}$  region to determine the presence and types of carbon-hydrogen vibrations.
  - A. No bands at  $2800$ - $3300$  indicates no C-H bonds. Consider totally halogenated organics, or inorganics.
  - B. Bands at  $3000$  to  $3300\text{ cm}^{-1}$  indicates presence of unsaturated carbon atoms or a halogenated compound.
  - C. Bands at  $2800$  to  $3000\text{ cm}^{-1}$  indicate presence of saturated carbon atoms.
- III. Now look at the rest of the group frequency region.
  - A. Bands at  $1450$ - $1465\text{ cm}^{-1}$  indicate presence of methyl ( $-\text{CH}_3$ ) or methylene ( $-\text{CH}_2-$ ) groups
    1. A band at  $1375$  to  $1380\text{ cm}^{-1}$  indicates C- $\text{CH}_3$
    2. A band at  $718$  to  $720\text{ cm}^{-1}$  indicates a string of 7 or more methylene groups
  - B. Bands at  $1470$  to  $1525\text{ cm}^{-1}$  and  $1565$  to  $1620\text{ cm}^{-1}$  indicate presence of aromatics. Use Figure 1.29 to determine substitution pattern.
  - C. Continue to interpret the strong (and then the medium) intensity bands in the group frequency region. Follow-up on each interpretation by examining other regions of the spectrum. As examples:

3400

1. A band observed at  $1715\text{ cm}^{-1}$  indicates the presence of a carbonyl (C=O) group. Is the compound a carboxylic acid, an ester, a ketone, or an amide? The presence of two bands near and  $3520\text{ cm}^{-1}$  along with a strong band near  $1600\text{ cm}^{-1}$ , would identify the compound as a primary amide.

2. A strong band is observed at  $1060\text{ cm}^{-1}$ . Is the compound an ether, a siloxane, or an alcohol? A strong band at  $3600\text{ cm}^{-1}$  would identify the compound as an alcohol.

IV. The following generalizations should be kept in mind:

A. Not all of the bands can be interpreted as group frequencies. Some bands are due to vibration of the molecule as a whole. Other bands are due to combinations of fundamental group frequencies.

B. Aromatic compounds tend to give sharp bands.

C. Spurious bands may appear (i.e., bands not attributable to the sample). For example, bands at  $3300\text{-}3700\text{ cm}^{-1}$  and  $1600\text{-}1800\text{ cm}^{-1}$  may be due to water in the sample or in the atmosphere within the sample compartment. Similarly, bands near  $2325\text{-}2350\text{ cm}^{-1}$  and  $670\text{ cm}^{-1}$  may be caused by the presence of carbon dioxide.

D. The infrared spectrum alone may not provide enough information to identify the compound. Never ignore information from other analyses.

Figure 1.32 is a guide for the selection of a chromatographic method. Selection is based on three sample properties: volatility, complexity, and polarity. Speed, resolution, and the quantity of sample should also be considered. In general, gas chromatography surpasses liquid chromatography in resolution and speed. Capillary columns (or open tubular columns) give the best resolution, but packed columns can accommodate larger samples.

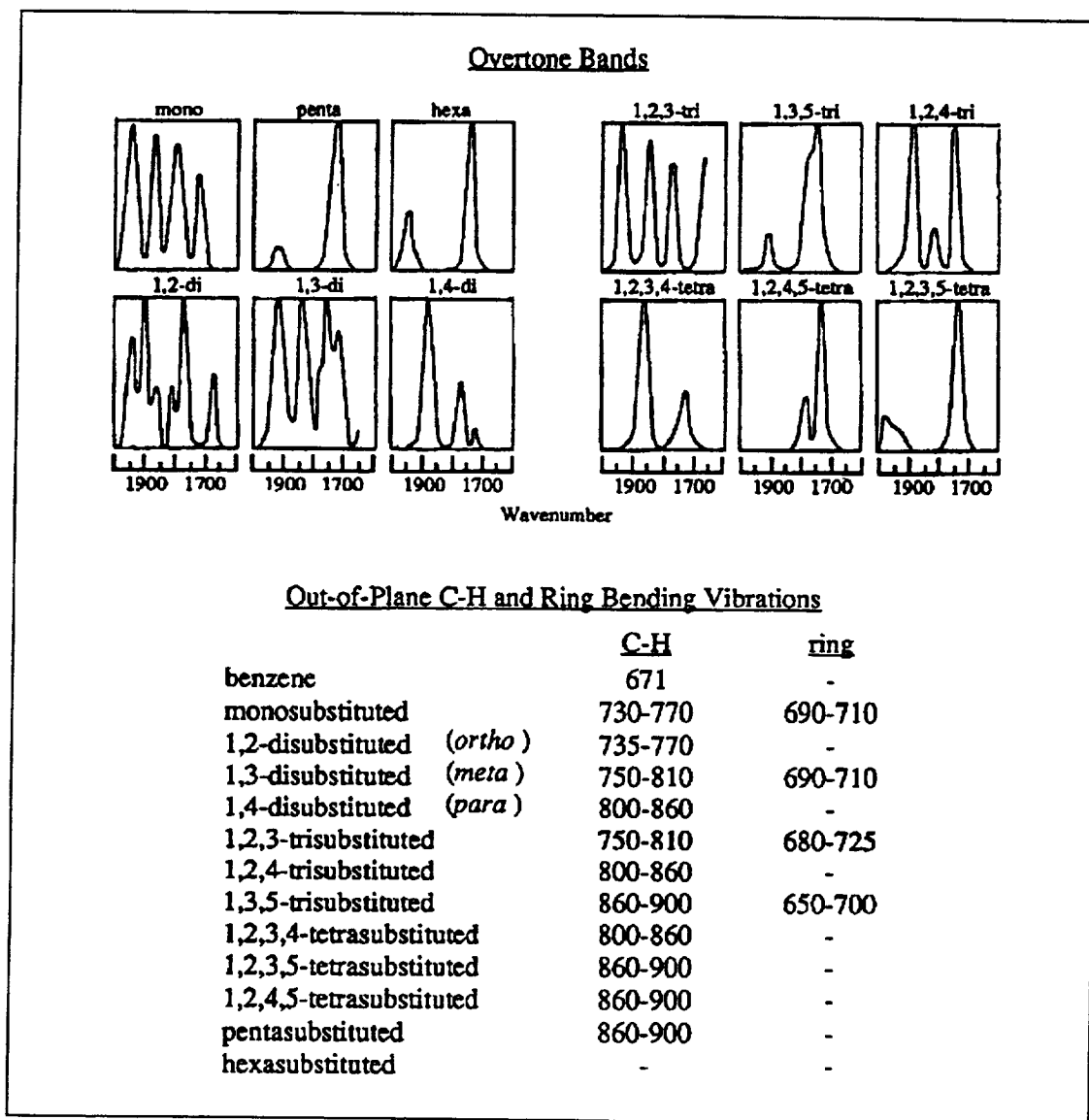

Figure 1.31. Characteristic Infrared Frequencies for Benzene Derivatives

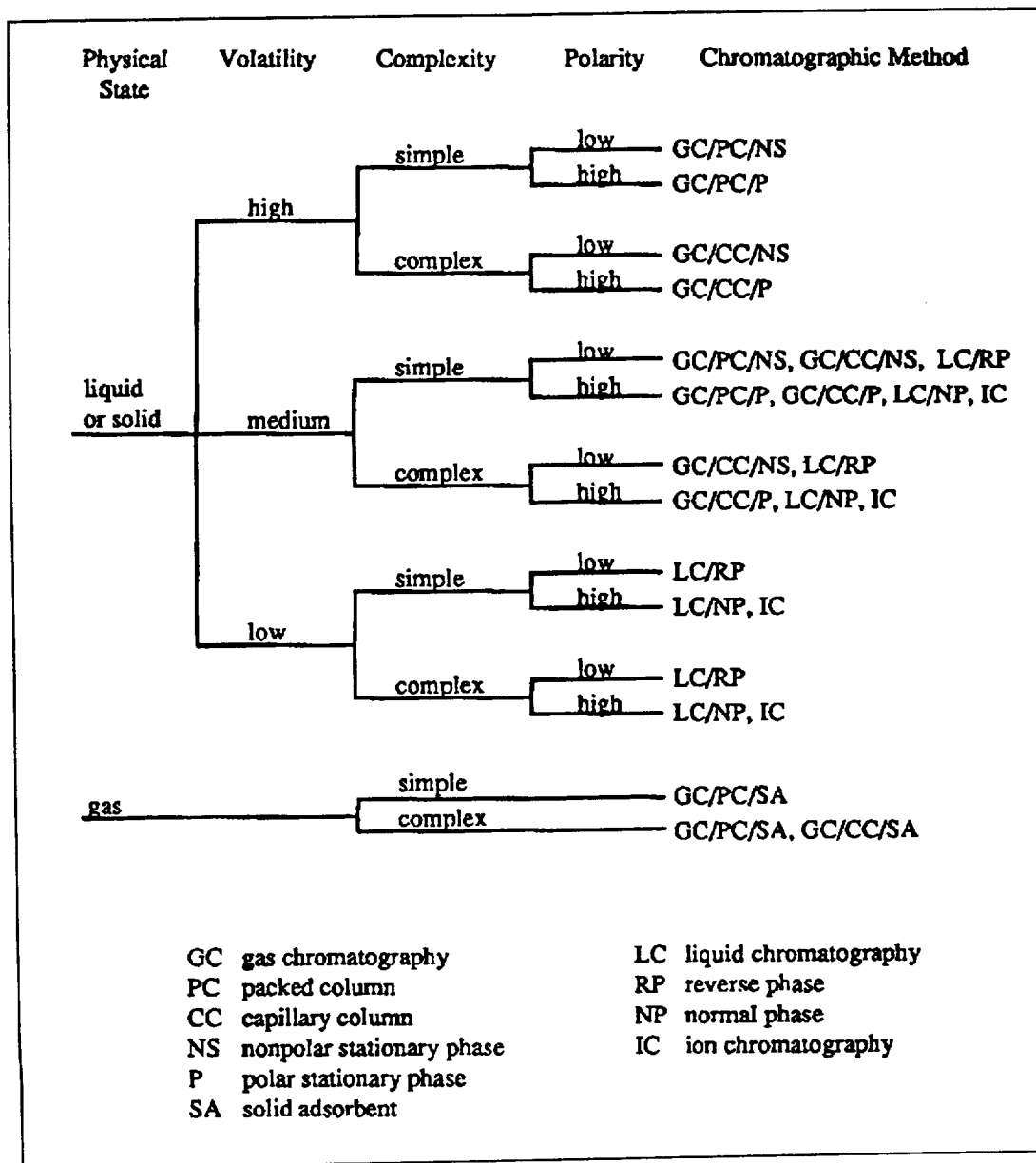

Figure 1.32. Selection of a Chromatographic Method

The sample's volatility, complexity, and polarity are often known or can be surmised based on information provided by the customer. If necessary, a microdistillation can be run to determine volatility. An infrared spectrum will identify functional groups and provide information about the sample's polarity and complexity.

If it is determined that the sample is volatile enough to be run by gas chromatography, Table 1.7 and Figure 1.33 can be used as guides for stationary phase and detector selection. If the sample is nonvolatile or thermally unstable, an LC separation mode can be selected based on the samples solubility, polarity, and molecular weight according to Figure 1.34. If the sample is believed to be composed of a wide

molecular weight range of species, or if it is thought to contain species with molecular weights over 2000, size exclusion chromatography should be considered.

Required Response Selectivity	Required Detection Limit	Appropriate Detector
universal detection (general survey)	10 ppm	TCD, thermal conductivity
nearly universal (most organics)	0.1 ppm	FID, flame ionization
compounds containing nitrogen or phosphorus	1 ppb	TED, thermionic emission or NPD, nitrogen-phosphorus
compounds containing electronegative atoms, halogenated and sulfur containing compounds, anhydrides, nitrates, nitriles, peroxides	1 ppb	ECD, electron capture
highly selective for many classes of compounds, compound identification possible	1 ppm 1 ppb	MS, mass spectrometer SIM, mass spectrometer with selective monitoring

Figure 1.33. Detector Selection for Gas Chromatography.

Types of Separations	Required Polarity	Stationary Phase Composition
hydrocarbons, gases	nonpolar	hexamethyltetracosane
general purpose (boiling point separation)	nonpolar	poly(dimethylsiloxane)
general purpose aromatics, olefins	nonpolar	poly(dimethyl(diphenylsiloxane) (80% methyl, 20% phenyl)
aromatics, phenols glycols	semipolar	poly(dimethyldiphenylsiloxane (50% methyl, 50% phenyl)
alcohols, esters, ketones carboxylic acids	polar	polyethyleneglycol

Table 1.7. Stationary Phase Selection for Gas Chromatography



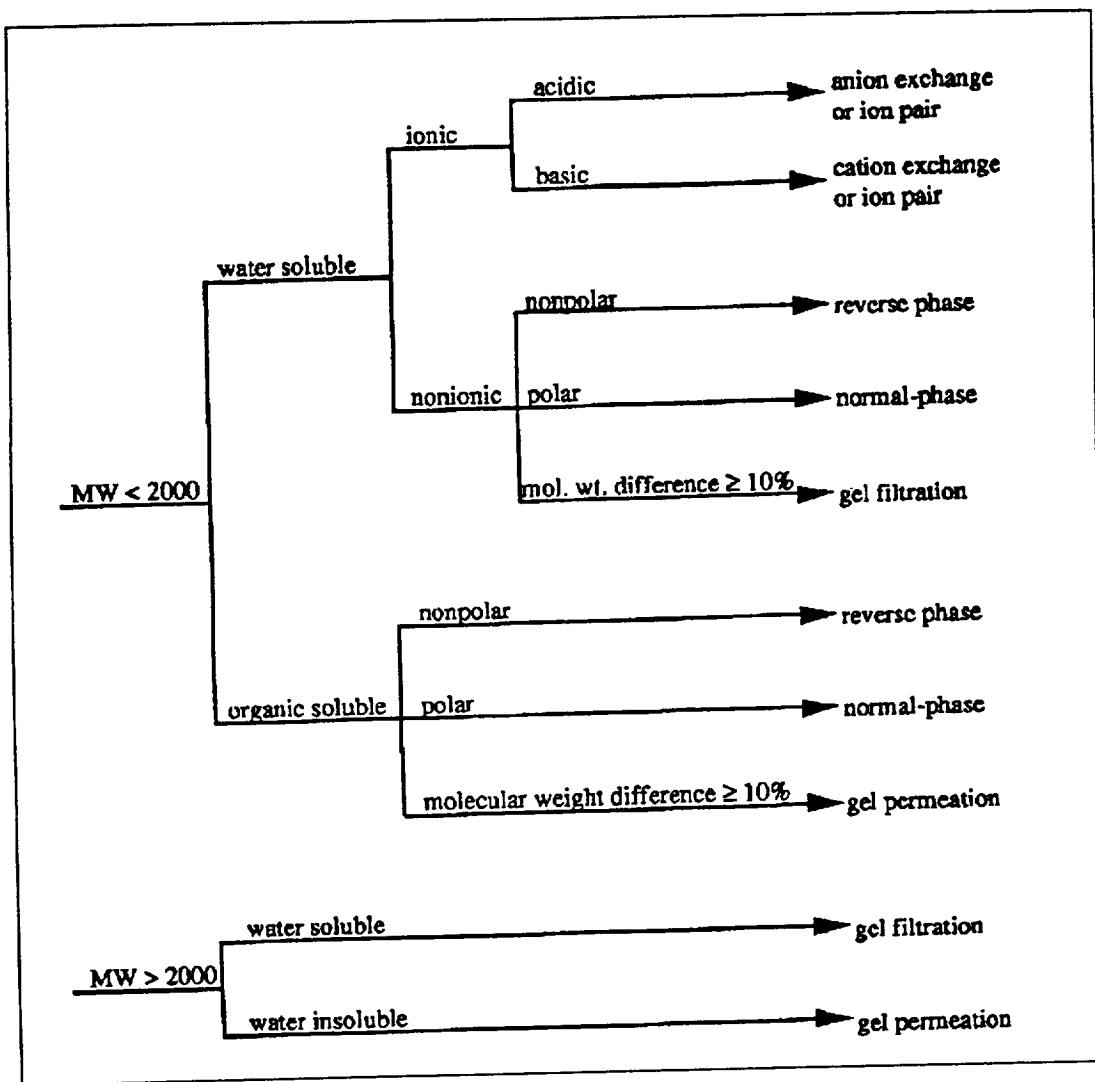

Figure 1.34. Selection of a Liquid Chromatographic Mode

Real samples cannot always be classified as totally volatile or nonvolatile. Consider, for example, a polyurethane foam formulation containing extremely volatile components, such as CFC or HCFC blowing agents, along with nonvolatile, polymeric alcohols and siloxanes. In this type of situation, it is necessary to use both gas and liquid chromatographic procedures to isolate each ingredient.

Once a chromatographic separation has been obtained, the separated components can be collected and identified by IR, MS, or NMR. Coupled, or hybrid, instrumental techniques such as GC/MS, GC/IR, or LC/MS permit both separation and identification of unknown components in a single instrumental procedure.

If the elemental composition of the sample is of interest, a qualitative survey analysis can be obtained by XRF provided the sample is nonvolatile. For quantitative elemental analyses, or for volatile samples, an atomic spectroscopic technique can be selected based on the elemental detection limits shown in Figure 1.35. In selection of an

atomic spectroscopic method, the advantages and limitations of each method (given in Table 1.4) should be kept in mind. For example, the lower detection limits provided by furnace (electrothermal) atomic absorption are accompanied by decreased precision and increased analysis time. Both ICP/AES and ICP/MS are capable of multi-element analysis, while only one or two elements can be determined simultaneously by AA.

As stated before, no single procedure exists for the selection of the best instrumental method combination to solve an analytical problem. As an example, consider a polyurethane foam material received as two components, one of which is a mixture of polyols, flame retardants, catalysts, surfactants, and blowing agent. Some of these ingredients are mixtures themselves, and some contain solvents. The ingredients differ significantly in concentration, molecular and elemental composition, and physical and chemical properties. Because of the material's complexity, a combination of instrumental methods is required. FTIR can be used to identify the functional groups present, and to monitor the composition of the polyols which are present at a high concentration level. GC can be used to monitor the more volatile constituents. Because of the wide range of volatilities and concentrations, more than one GC procedure is required. ICP/AES or other atomic spectroscopic methods can be used to measure levels of specific elements, such as phosphorus, silicon, potassium, or tin to monitor the flame retardants, surfactants, and catalysts present in the material.

Flame Atomic Absorption																							
IA																		0					
H	IA																	IB	IVA	VA	VIA	VIA	He
0.5	1																	700	C	N	O	F	Ne
U	Be																	30	Si	P	S	Cl	Ar
0.2	0.1																	80	Ge	As	Se	Br	Kr
Na	Mg	IB	IVB	VB	VIB	VIB	VIB	VIB	VIB	VIB	VIB	IB	IB	IB	IB	IB	IB	IB	IB				
2	1	20	50	40	2	1	3	6	4	4	0.8	80	Ge	As	Se	Br	Kr						
K	Ca	Sc	Ti	V	Cr	Mn	Fe	Ce	Ni	Cu	Zn	Ga	Ge	As	Se	Br	Kr						
2	2	50	300	1000	30	70	4	20	0.8	0.5	20	100	Sn	Sb	Te	I	Xe						
Rb	Sr	Y	Zr	Nb	Tc	Ru	Rh	Pd	Ag	Cd	In	Sn	Sb	Te	I	Xe							
8	8	200	2000	1000	1000	800	80	800	40	8	300	8	10	20	20	At	Rn						
Ce	Ba	La	Hf	Ta	W	Re	Os	Ir	Pt	Au	Hg	Tl	Pb	Bi	Po	At	Rn						
Fr	Ra	Ac	Flame AA detection limits were determined using dilute aqueous standard solutions with instrumental parameters optimized for each element.																				

Furnace Atomic Absorption																							
H																		He					
H	IA																	IB	IVA	VA	VIA	VIA	He
0.05	0.01																	20	C	N	O	F	Ne
Li	Be																	0.04	Si	P	S	Cl	Ar
0.05	0.004																	0.1	Ge	As	Se	Br	Kr
Na	Mg																	0.1	Ge	As	Se	Br	Kr
0.02	0.05	Sc	Ti	V	Cr	Mn	Fe	Ce	Ni	Cu	Zn	Ga	Ge	As	Se	Br	Kr						
K	Ca	Sc	Ti	V	Cr	Mn	Fe	Ce	Ni	Cu	Zn	Ga	Ge	As	Se	Br	Kr						
0.05	0.02	Y	Zr	Nb	Mo	Tc	Ru	Rh	Pd	Ag	Cd	In	Sn	Sb	Te	I	Xe						
Rb	Sr	Y	Zr	Nb	Mo	Tc	Ru	Rh	Pd	Ag	Cd	In	Sn	Sb	Te	I	Xe						
0.05	0.1	La	Hf	Ta	W	Re	Os	Ir	Pt	Au	Hg	Tl	Pb	Bi	Po	At	Rn						
Ce	Ba	La	Hf	Ta	W	Re	Os	Ir	Pt	Au	Hg	Tl	Pb	Bi	Po	At	Rn						
Fr	Ra	Ac	Furnace AA detection limits were determined using dilute aqueous standard solutions.																				

Inductively Coupled Plasma/Atomic Emission																							
H																		He					
H	IA																	IB	IVA	VA	VIA	VIA	He
0.8	0.06																	2	C	N	O	F	Ne
Li	Be																	4	Si	P	S	Cl	Ar
Na	Mg																	10	Ge	As	Se	Br	Kr
0.08	0.2	0.5	2	2	0.4	1	2	4	0.9	1	10	10	20	80	80	Br	Kr						
K	Ca	Sc	Ti	V	Cr	Mn	Fe	Ce	Ni	Cu	Zn	Ga	Ge	As	Se	Br	Kr						
0.05	0.2	0.8	3	6	20	4	20	1	1	1	30	40	80	80	Br	Kr							
Rb	Sr	Y	Zr	Nb	Mo	Tc	Ru	Rh	Pd	Ag	Cd	In	Sn	Sb	Te	I	Xe						
0.1	0.1	1	20	20	20	20	20	20	20	4	20	40	20	20	20	At	Rn						
Ce	Ba	La	Hf	Ta	W	Re	Os	Ir	Pt	Au	Hg	Tl	Pb	Bi	Po	At	Rn						
Fr	Ra	Ac	ICP/AES detection limits were determined using dilute aqueous standards with instrumental parameters optimized for each element.																				

Inductively Coupled Plasma/Mass Spectrometry																								
H																		He						
H	IA																	IB	IVA	VA	VIA	VIA	He	
0.1	0.1																	0.1	C	N	O	F	100	Ne
Li	Be																	0.1	Si	P	S	Cl	1	Ar
0.06	0.1																	0.08	Ge	As	Se	Br	1	Kr
Na	Mg																	0.08	Ge	As	Se	Br	1	Kr
10	5	0.08	0.06	0.03	0.02	0.04	0.2	0.02	0.03	0.03	0.08	0.08	0.08	0.05	0.5	1	Kr							
K	Ca	Sc	Ti	V	Cr	Mn	Fe	Ce	Ni	Cu	Zn	Ga	Ge	As	Se	Br	Kr							
0.02	0.02	0.02	0.03	0.02	0.06	0.06	0.05	0.02	0.06	0.04	0.02	0.02	0.03	0.02	0.04	0.02	Xe							
Rb	Sr	Y	Zr	Nb	Mo	Tc	Ru	Rh	Pd	Ag	Cd	In	Sn	Sb	Te	I	Xe							
0.02	0.02	0.01	0.03	0.02	0.06	0.06	0.02	0.06	0.06	0.1	0.03	0.02	0.02	0.04	0.02	At	Rn							
Ce	Ba	La	Hf	Ta	W	Re	Os	Ir	Pt	Au	Hg	Tl	Pb	Bi	Po	At	Rn							
Fr	Ra	Ac	Determined in multi-element mode using dilute aqueous standards. Values would be 3-10 times smaller if parameters were optimized for each element. F and Cl determined in the negative ion mode.																					

Figure 1.35. Atomic Spectroscopic Detection Limits (ng/mL).



## 2.0 CHEMOMETRICS

Chemometrics is a discipline within analytical chemistry concerned with the selection and optimization of instrumental methods as well as the interpretation of data from these chemical analyses. Chemometrics makes extensive use of mathematical and statistical methods with the intent of producing a maximum of concise chemical information. Given these mathematical underpinnings, this section presents a description of a number of the most useful methods together with a discussion of their application to the resolution of problems solved by chemical fingerprinting.

Chemometrics has undergone rapid evolution and proliferation due, in a large part, to the availability of computer hardware and software capable of complex calculations performed on large quantities of data. Although excellent statistical software packages (programs) running on a variety of computer platforms exist, little or no guidance is usually given for the appropriate application of the individual procedure(s). The practitioner, therefore, must employ his combined knowledge of chemistry, statistics, and the nature and source of the data to ensure that the correct computations are performed. It is the purpose of this section to offer some useful advice in these matters.

### 2.1 Basic Statistics

The purpose of any quantitative chemical analysis is to obtain a valid *estimate* of the *true value* of the chemical characteristic being measured. Variation is ever present and inevitably produces a certain amount of uncertainty in the outcome. This uncertainty is called *error*. All variation and the associated errors can be categorized into four main groups:

*Common causes* - the collection of factors which produce relatively small and random changes in results and are sometimes referred to as *system errors*. While these errors can be minimized, they generally cannot be eliminated.

*Special causes* - factors which sporadically introduce variation over and above inherent system variation. Sometimes called *assignable causes* because the source can usually be discovered and corrected.

*Structural causes* - regular systematic changes due to cyclic factors such as day/night, morning/afternoon, and seasonal changes.

*Tampering* - variation induced by unnecessary adjustments usually made in a vain attempt to compensate for inherent (common cause) fluctuations.

It is imperative that the analyst be able to distinguish between these causes as the appropriate remedial measures for each are quite different. When viewed as a process,

most analytical procedures can benefit substantially from the application of modern statistical process control (SPC) methods.

When an analytical chemist performs replicate analyses on the same sample using the same procedure(s), instrument(s), and reagent(s), the individual results will be found to vary from one to another due to common causes (system error). While these results do differ, they also exhibit a strong tendency to cluster around a certain value. This value is the *mean* or *arithmetic mean*, or simply the *sample average*. Mathematically it is sum of the individual results divided by the number of these results and is denoted by "x". This *sample mean* is a *statistic* and therefore an estimate of the *parameter* known as the *population mean* which is denoted by "μ". Note that there is a very important distinction between the *statistic* derived from sampled data and a population *parameter*. It is seldom if ever that we have available the complete set of observations for the entire population which would allow us to compute the population *parameters* (μ, s<sup>2</sup>, and s). It is, therefore, necessary to calculate estimates (*statistics*) of these *parameters* based on measurements performed on samples drawn from the population (x, s<sup>2</sup>, and s).

$$\mu = \Sigma(x_i)/N$$

$$\bar{x} = \Sigma(x_i)/n$$

Where:      x<sub>i</sub> = individual observations  
              n = number of observations  
              N = total population

The *mean* is the most useful statistic. Other statistics include the *mode*, the *median*, and the *midrange*.

The *mode* is defined as that observation which occurs most frequently in the data set.

The *median* is defined as that observation which, when the data are arranged in order of magnitude, is the middle value.

The *midrange* (MR) is defined as that observation which is halfway between the largest and the smallest observation.

$$\text{Midrange} = (x_{\max} - x_{\min})/2$$

These statistics all provide information about the location of the *center* of the data and are also known as *measures of location*. This information, while useful, is less than complete. An adequate description should also include a measure of how much the individual observations differ from the chosen measure of location. Collectively these quantities are known as *measures of dispersion* or *measures of variation* and include the *range*, the *mean absolute deviation*, the *variance*, and the *standard deviation*.

The *range* is the simplest measure of dispersion and is numerically equal to the difference between the largest observation and the smallest.

$$\text{Range} = (x_{\max} - x_{\min})/2$$

The *mean absolute deviation* is defined as the mean (average) of the absolute values obtained by the subtraction of the arithmetic mean from each observation. It is therefore a measure of how much, on average, each observation differs from the mean.

$$\text{Mean Absolute Deviation} = \Sigma |x_i - \bar{x}| / n$$

The *variance* is a measure of dispersion calculated by summing the squares of the differences of the individual observations from the mean, and then computing the mean of this sum. It must be pointed out that there are two forms of this measure: the *population variance* which is a *parameter* and denoted by " $s^2$ " and the *sample variance* which is a *statistic* and denoted by " $s^2$ ". As with the two means above, this is an important distinction.

$$\sigma^2 = \Sigma (x_i - \mu)^2 / N$$

$$s^2 = \Sigma (x_i - \bar{x})^2 / (n - 1)$$

The *standard deviation* is defined as the positive square root of the *variance* and also has two forms: the *population standard deviation* denoted by " $\sigma$ " and the *sample standard deviation* denoted by " $s$ ".

$$\sigma = [\Sigma (x_i - \mu)^2 / N]^{1/2}$$

$$s = [\Sigma (x_i - \bar{x})^2 / (n-1)]^{1/2}$$

Another term frequently encountered is the *coefficient of variation* (C.O.V.) or *relative standard deviation* and is defined as the standard deviation expressed as a percentage of the mean.

$$\begin{aligned} \text{(population)} \quad \text{relative standard deviation} &= 100 (\sigma/\mu) \% \\ \text{(sample)} \quad \text{relative standard deviation} &= 100 (\sigma/\bar{x}) \% \end{aligned}$$

Note that measure of relative dispersion cannot be used in cases where the individual observations take on both positive and negative values as, for example, after a data transformation which has placed the mean at a value of zero.

A word of explanation about the denominator " $(n-1)$ " in the above equations. This quantity (the number of observations minus one) is the *degrees of freedom* (DF) for the

*statistic* and is, in general, equal to the number of observations minus the number of constants calculated from them. Since the mean ( $\bar{x}$ ) must first be calculated before the *variance* ( $s^2$ ) can be computed, this "uses up" one degree of freedom and therefore  $DF = (n-1)$ . If "n" rather than "n-1" were used, it can be shown that the *variance* would be biased (underestimated) by a factor of  $(n-1)/n$ . It is intuitively obvious that as the number of samples increase so does our confidence in the calculated estimates. There is, however, a point beyond which additional samples produce a very small increase in confidence and this value is approximately 30 samples.

When one looks closely at the data, there appears to be a pattern of the dispersion of observations about the central location. This pattern is called a *distribution*. A distribution can be also be depicted graphically by an "X - Y" plot of the frequencies at which given observations occur ("Y" axis) versus the observation values ("X" axis). A number of distributions exist and include the *normal*, the *binomial*, the *Poisson*, the *chi-square*, the *t*, Weibull, and the *F*. By far the distribution used most often in analytical chemistry is the *normal* or *Gaussian*.

The graphical representation of a normal distribution of a large number of observations can be accomplished by grouping the observations into *classes*, each a small and consistent range of values, and then counting the number of observations belonging to each *class*. If one next constructs a series of rectangles whose width is the *class* interval and whose height is proportional to the number of observations in that *class*, then a *histogram* is created by placing the rectangles, in ascending order of *class* magnitude along the "X" axis (left to right) in a contiguous fashion (see Figure 2.1). Note that the individual areas of these rectangles are proportional to the density (number) of observations in those *classes*. To make additional observations from the population, the probability of obtaining a given value is then determined by the ratio of the area of the *class* rectangle (to which it belongs) to the total area of all the rectangles. Successive observations occur most frequently at values within the *class* intervals of those rectangles having the greatest area.

More observations can be made and placed in smaller and smaller class intervals as shown in Figure 2.1(b) - 2.1(c). In the limit, the smooth and continuous bell shaped curve of Figure 2.1 (d) is formed. This is the well known shape of the *normal* distribution and is a continuous probability density function symmetrical about a central value which is the mean " $\mu$ ". In fact, the curve (function) is described by the following equation:

$$y = [1 / \sigma (2\pi)^{1/2}] e^{-\frac{(x-\mu)^2}{2\sigma^2}}$$

Where :  $\pi = 3.14159\dots$   
 $e = 2.71828\dots$



The above equation contains two constants, " $\mu$ " and " $\sigma$ ", the values of which uniquely determine the *location* of ("X" axis) and the *shape* (peaked or broad) of the distribution. A common chemical example of this distribution is the shape of the chromatographic peak. The mathematical term for the shape of this curve is *kurtosis*; broad curves (large values of " $\sigma$ ") are *platykurtic* while narrow curves (small values of " $\sigma$ ") are *leptokurtic*. Note that the curve approaches the "X" axis asymptotically (never reaches zero probability) when moving away from the mean " $\mu$ " in either direction.

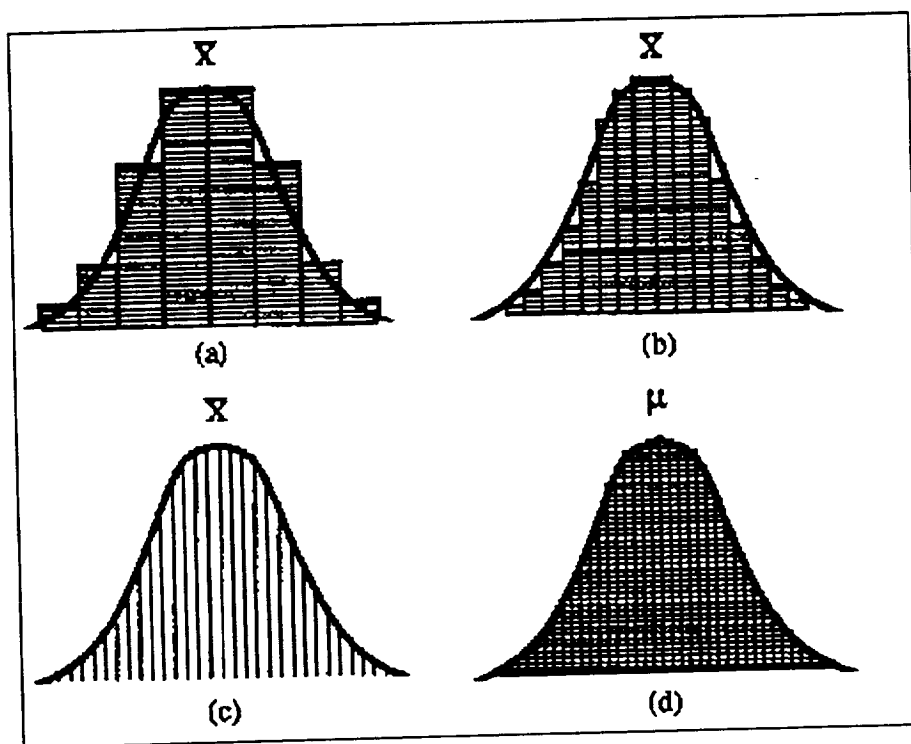

Figure 2.1 Histograms of Decreasing Cell Size

A standardized form of the normal distribution, used in many statistical tables, is created when the value of " $\mu$ " is set to zero and the value of " $\sigma$ " is made equal to one. This standard normal distribution has been extensively studied and is well documented in numerous tables. *Normality* is a remarkably valid assumption for many distributions found in both analytical chemistry and science in general.

If the standard normal distribution equation is integrated for values of "X" over the range of minus infinity to plus infinity, the total area under the curve is equal to one, the "X" axis is in units of  $\pm \sigma$  (usually denoted by "z" or "z score"), and the maximum is located at zero. Any real distribution with a known " $\mu$ " and " $\sigma$ " can be transformed into this standard normal format by this equation:

$$z = (X - \mu) / \sigma$$

This transformation is extremely useful. The area under the curve between any two values of "z" is the percentage of the population included within these values. For instance, the area under the curve between " $\mu$ " and either "+1 $\sigma$ " or "-1 $\sigma$ " is 0.3413 representing 34.13% of the population. The area between "-2 $\sigma$ " and "+2 $\sigma$ " is 0.6826 representing 68.26% of the total population. Almost all (99.73%) of the population is bounded by the interval "-3 $\sigma$ " to "+3 $\sigma$ ". Since these areas also represent probabilities, questions like: "What is the probability of obtaining an observation with a value equal to or less than " $\mu$ " minus " $\sigma$ "? can easily be answered. The answer is easily calculated to be 15.87%." This also means that in a sample containing 25 observations we would expect that four will have values less than or equal to " $\mu$ " minus " $\sigma$ ".

The ability to transform sets of observations into their equivalent "z" values provides us with a method to scale sets of very different types and numerical ranges for easy comparison. This normalizing technique is also useful in the analysis of multivariate data.

Although the mean "x" of a set of observations provides an estimate of the population mean " $\mu$ ", it is very unlikely that "x" is *exactly* equal to " $\mu$ ". There are two reasons for this: (1) the random error in the measurement and (2), the number of observations used to calculate "x". If another equal number of observations are performed on a sample from the same population, the "x" from this set will probably not equal the "x" from the first set. Repeating this process would yield a series of "x's" which would, in turn, have a normal distribution about a central value - " $\mu$ ". This is the *Central Limit Theorem* and is true even if the population from which the "x's" came is not a *normal* distribution! This distribution is known as the *sampling distribution of the mean* and has a mean of " $\mu$ " and a standard deviation equal to " $\sigma/(n)^{1/2}$ ". The term " $\sigma/(n)^{1/2}$ " is called the *standard error of the mean* and gives a measure of the uncertainty associated with estimating " $\mu$ " from "x". Since, in practice we seldom know the value of "s" and must use the estimate "s"; " $s/(n)^{1/2}$ " is usually not identical to " $\sigma/(n)^{1/2}$ ".

A statistic, "t" has been introduced to compensate for both "s" and the confidence limit we place on our estimate of " $\mu$ ". The value of "t" depends on both the confidence interval (usually 95%) and the degrees of freedom (DF) for computing "s". We can now state the range of values within which we are confident " $\mu$ " exists as follows:

$$\mu = \bar{x} \pm ts/(n)^{1/2}$$

This "t" is itself a distribution having the normal or Gaussian shape. The "t" tables are rows and columns for confidence interval and degrees of freedom respectively. As the degrees of freedom increase, the kurtosis of the "t" distribution approaches that of the normal curve.

The "t" statistic affords a means to perform tests on certain conjectures or hypotheses. For example: does a method have a systematic error when analyzing a sample of known value? In comparing two different analytical methods, do they give results (means) which differ significantly or are the differences due to chance alone? The test procedure will compare the derived 't' statistic to the table of 't<sub>critical</sub>' values or as usually called, the 't table'. If the calculated t for the sample set is higher than the critical t, then the two methods do differ significantly.

*Example.* The values from the determination of the percentage of a known analyte (38.9%) are:

38.9% 37.4% 37.1%

Is there any evidence of systematic error?

Calculations using the various software or calculators gives the values for the mean = 37.8% and for the Std. Dev. = 0.964%. Therefore the calculation for t is given by:

$$t = (38.9 - 37.8) (3/0.964)^{1/2} = 1.98$$

From the "t" Table for DF = 2 and 95% confidence level, the critical value for "t" is 4.3. Since the calculated "t" (1.98) is less than the critical "t" value (4.3) there is no reason to suspect a systematic error<sup>10</sup>.

There are also instances when, instead of comparing means, we wish to assess the precision of two different methods which amounts to a comparison of the variances ( $s_1^2$  vs.  $s_2^2$ ). Another statistical test known as the "F" test permits this kind of comparison by considering the ratio of two variances. By convention the larger of the two variances is always the numerator so that the value of "F" is always equal to or greater than one. If the differences between variances are small, the value of "F" is close to one and the differences are probably due to chance alone. Larger values of "F" imply differences too great to be attributed to random causes. The degrees of freedom for the two variances need not be equal, but both have an influence on the value of "F" and the decisions based upon it. The tables of critical values for "F" are constructed in rows and columns of DF of the numerator and denominator respectively and provide for a selection of confidence intervals as well. Performing the "F" test involves computing the "F" from the variances and for a given confidence interval and DFs, finding the critical value from the "F" tables. Once again, if the computed "F" is greater than the critical value, real (statistically significant) differences in the variances exist.

*Example .* A proposed method is to be compared to an existing method for the determination of chemical oxygen demand in a standard sample. Eight determinations by each method produced the following results:

	Mean (mg/l.)	Std. Dev. (mg/l.)
Existing Method	72	3.31 ( $s_1$ )
Proposed Method	72	1.51 ( $s_2$ )

$$F_{7,7} = (s_1)^2/(s_2)^2 = (3.31)^2/(1.51)^2 = 4.8$$

From the " $F$ " Table for  $DF_1 = DF_2 = 7$  and 95% confidence level, the critical value for " $F$ " is 3.787. Since the calculated " $F$ " value (4.8) is larger than the critical " $F$ " value (3.787), the proposed method is more precise<sup>5</sup>.

The " $F$ " statistic is also a distribution but, unlike the " $t$ ", it is a quadratic function and is skewed ("tails out") to the right.

There arise, from time to time, situations in which one or more of a set of observations appear(s) to be quite different from others in the set. The term for this observation is *outlier*. The outlier, upon examination, may be found to be the result of human error such as the transposition of numbers or the misplacement of a decimal point. Even after the correction of these errors, observations which appear to be outliers may still be present. The analyst is now faced with a difficult decision: *should these observations be retained or rejected?* The values of the statistics (" $\bar{x}$ ", " $s^2$ ", and " $s$ ") computed from the observations will depend on whether or not the outlier(s) are included in the statistical calculations. One possible reason for the presence of outliers is that our assumption of a normal distribution is not valid. In this event, a test for distribution or frequency is appropriate.

Note that in the Central Limit Theorem that multiple determinations of the sample mean " $\bar{x}$ " from samples of a population has a normal distribution about the population mean " $\mu$ " with a standard deviation of " $\sigma/(n)^{1/2}$ " which can be estimated by " $ts/(n)^{1/2}$ ." What about the distributions of the sample variance " $s^2$ " and the sample standard deviation " $s$ "? Like the " $F$ " statistic, the sample variance is a quadratic function and it follows what is called the "*chi-square*" distribution. This distribution is the basis for the "*chi-square*" test which is used to determine if an observed distribution of observations is drawn from a population having a certain theoretical distribution (*goodness of fit*). The test is performed by sorting the observations into classes of observed frequencies; calculating the "*chi-square*" statistic by taking the sum of the squared difference between the observed and expected frequencies divided by the expected frequency for each class. The degrees of freedom (DF) for this calculation is equal to the number of

classes minus one. The calculated "*chi-square*" value is then compared with the "*critical value*" found in a table at the desired confidence interval and DF. If the calculated "*chi-square*" value is less than the critical value, the theoretical distribution is considered to be valid.

If, however, the assumption of a normal distribution is valid, then there is a test called the "*Q*" test or "*Dixon's Q*" which can provide some guidance for the accept/reject decision. Like the other test statistics, the critical values for "*Q*" are given in a table. The test is performed by computing the "*Q*" ratio and then from the table finding the critical value of "*Q*" for the desired confidence interval and number of observations. If the computed value of "*Q*" is greater than the critical value, the suspect observation is rejected. The "*Q*" ratio is calculated by dividing the absolute value of the difference between the suspect observation and the observation nearest to it by the range of the observations (including the suspect value). Note that the rejection of an outlier can have a dramatic effect on the values of both the variance and standard deviation. The confidence interval implies that there is a small but finite chance of making the wrong decision, hence caution is advised in working with these concepts. If more than one observation in the set is suspect, the situation is more complex and the observations should be repeated or the problem referred to a statistician.

Most modern analytical chemical instruments can usually make accurate observations over a considerable range of values (several orders of magnitude) requiring that the data be treated in a manner that is different from the methods employed in the analysis of repeated single measurements. The usual procedure involves performing observations on samples from populations whose values are known (standards), including a blank (no analyte) sample, and span the range expected for the "unknown" samples. From these data, a "*calibration curve*" is prepared and, by interpolation, is used to determine the value(s) of the unknown sample(s). Most analytical instruments are designed such that the signal is a linear first order function of the sample value (Figure 2.2). Ideally, this straight line function should pass through the origin (no analyte, no signal) and have a steep slope ( $dy/dx$ ) as this is a direct measure of the instrument's sensitivity. This ideal relationship can be expressed in this form:

$$y = a + bx$$

Where :      a = the "Y" intercept (ideally = 0)  
                  b = the slope (ideally > 1)

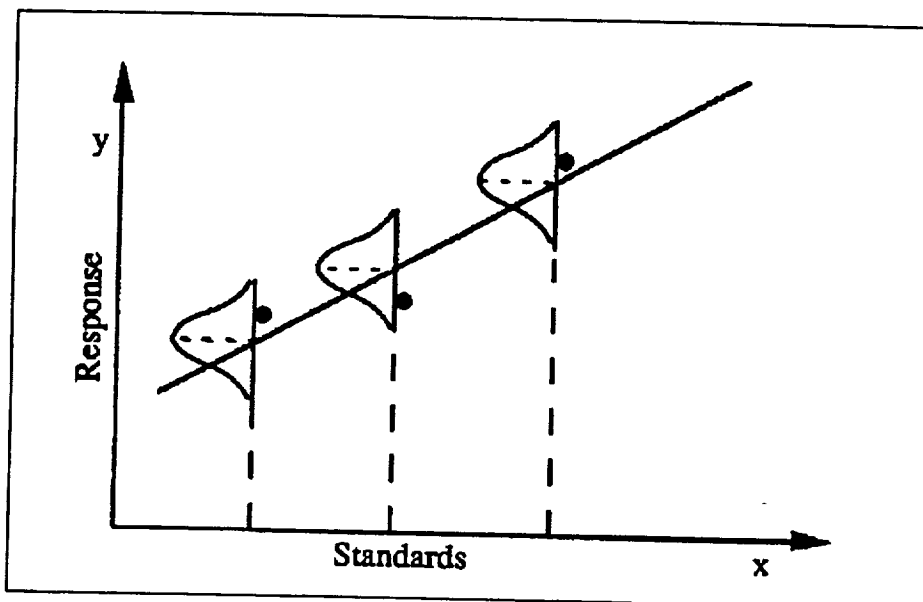

Figure 2.2 Typical Instrument Calibration

A detailed consideration of this approach raises a number of important statistical issues:

1. Since this line must be "fitted" to the experimental data, which always contains error, what is the "best line" through these data?
2. What are the error estimates for the constants "a" and "b"?
3. What are the error estimates for values predicted by the "best line"?
4. What is the least analyte value that can reasonably be determined (limit of detection)?
5. How valid is the implicit assumption that all errors are in the "Y" values and the "X" values are error-free?
6. If each of the "Y" calibration values is the mean of several observations, are the variances of these values equal?
7. Can a quantitative "figure of merit" be computed to describe how well the "Y" calibration values match the values predicted by the equation of the "best line"?

The most universally accepted answer to Issue #1 is the *method of least squares*. Using the assumption that all error is in the "Y" values (Issue #5), the "best line" is the one which minimizes the differences between the observed and predicted "Y". Since these

differences (known as residuals) can have both positive and negative values, it is customary to attempt to minimize the "sum" of the "squares" of these residuals. Most statistical software and many inexpensive pocket calculators can perform this task easily and will output values for the constants "a" and "b" as well as a value for the "correlation coefficient" (Issue #7).

It is also possible to calculate a statistic, analogous to the sample variance, for both the "a" ("Y" intercept) and the "b" (slope) constants (Issue #2). These statistics are often provided by the statistical software also.

The estimation of the error in obtaining an "X" value from an experimental "Y" value (Issue #3) is a mathematically complex undertaking and, if required, should include the assistance of an experienced statistician. Formulae for an approximation of this error do, however, exist and suggest that the error will be the least when the "Y" values are nearest to the "centroid" of the "best line."

"Limits of Detection" (Issue #4) considerations arise during trace analysis or when the "blank" standard produces a measurable instrumental response ("Y" value). There are at least two reasons, one chemical and one statistical, for this "blank" response. The chemical reason may be due to "interferences" or "matrix effects" and may be ameliorated by "spiking" of the samples using the "method of standard additions.". The statistical reason, however, is more complex and is a subject of much controversy. A reasonable working definition is very method and sample specific and should, therefore, be documented in the reported results.

Our confidence in the assumption of an error free "X" axis (Issue #5) is inexorably tied to our confidence in the accuracy of the calibration standards we use. The need for this assumption is fundamental to the method and consequently the great care and attention given to the preparation, storage, and use of these calibration standards cannot be overemphasized.

If the "Y" values (signals) are the mean of several observations (Issue #6), it is not unusual to find that the variances associated with these means increase with increasing values of the means. Clearly, the values having the smallest variances should exert a greater influence in the determination of the "best line" than those with larger variation. It is possible to assign "weights" to the "Y" values which are inversely proportional to their variances and use these "weighted values" to compute the "best line." Note that the centroid, and along with it, the zone of least error will be moved down the "best line" closer to the origin, thereby improving the accuracy of the smaller sample observations (Figure 2.3).

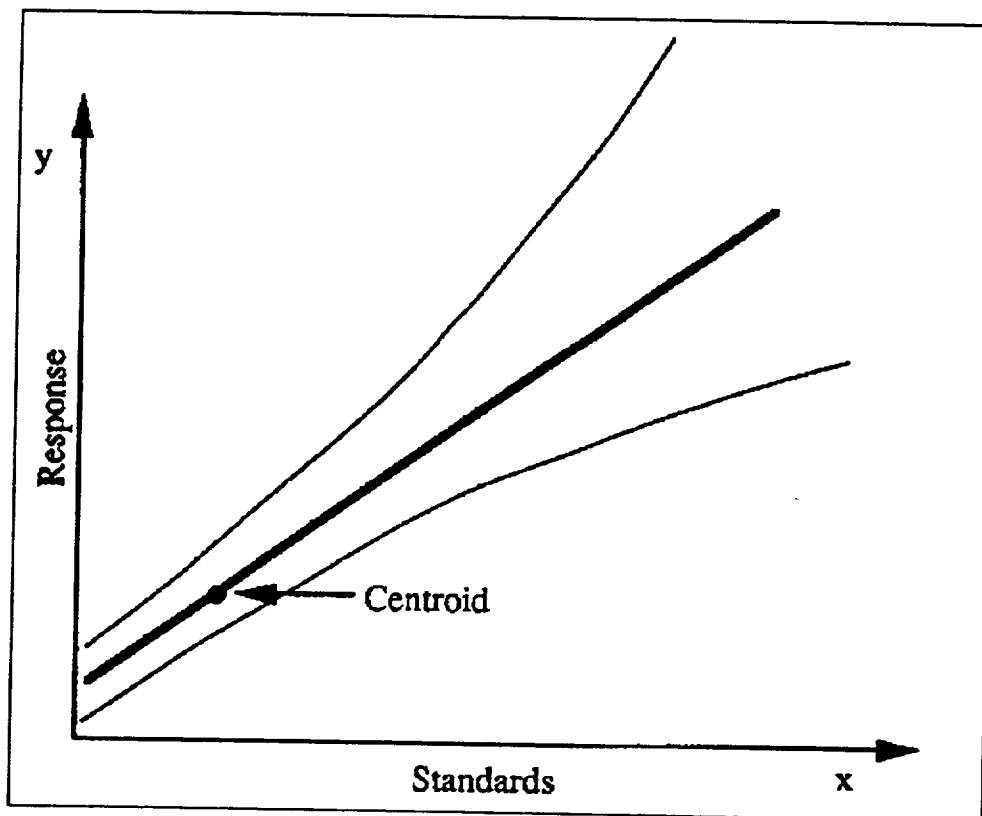

Figure 2.3 Weighted Regression Line

The "*correlation coefficient*" (Issue #7) is usually provided along with the values for "a" and "b" in the "*best line*" equation by the statistical software and is denoted by "*r*". The values for this statistic range from -1 to +1 with "*r* = +1" indicating a perfect point-by-point correlation along a "*best line*" having a positive slope ( $b > 0$ ). For "*r* = -1" a perfect negative correlation ( $b < 0$ ) exists. For "*r* = 0" there is no correlation ("X" and "Y" are independent). The square of the "*correlation coefficient*" ( $r^2$ ) is known as the "*coefficient of determination*" and is a measure of the proportion of the variation of the "Y" values accounted for by the "X" values.

## 2.2 Design of Experiments

The process of formulating an accurate, reliable, and efficient plan for the investigation of the effects of certain "*factors*" on the performance of a "*system*" is the focus of *Design of Experiments*. An analytical chemist involved in "*fingerprinting*" is faced with a task broader than just the measurement of a chemical or physical property of a material. The proposed measurements, in many cases, must be evaluated in the context of their ability to provide some or all of the information necessary to successfully *fingerprint* the product or material under investigation. Design of Experiments methodology is especially valuable for systems with multivariate relationships. Design



of Experiments is the planning activity which precedes and interacts with the phases of method development, data acquisition, data treatment/processing, and data interpretation. Design of Experiments can, and has been, successfully applied to a broad spectrum of scientific and engineering investigations.

The approach to a scientific investigation is composed of answering a number of well-phased concise questions. These questions define the analytical problem and are formulated on the prior development of a model of the system under investigation. A complex system may require more than one model, each of which may constitute an independent investigation. The models most commonly used are polynomials of the first or second degree which have been demonstrated to be adequate *descriptions* for the vast majority of systems. The model will, in turn, define the requirements for obtaining the necessary information including the data and its quality (accuracy, precision, repeatability, etc.).

The Design of Experiments strategy is generally a sequence of plans created to identify, analyze, and optimize the effects of factors on a system or analytical method under investigation. The first phase is a screening design and will identify those factors (and any interactions between them) which have a statistically significant effect on the performance of the system. The screening experiments segregate the "*vital few*" from the "*insignificant many*." The next phase will separate and elucidate the "*main effects*" from the "*interactions*." The third phase will provide a mathematical model (see above) of the "*response surface*" for the system and thereby guidance for system optimization. Figure 2.4 illustrates the methodology one might perform in carrying out such a design.

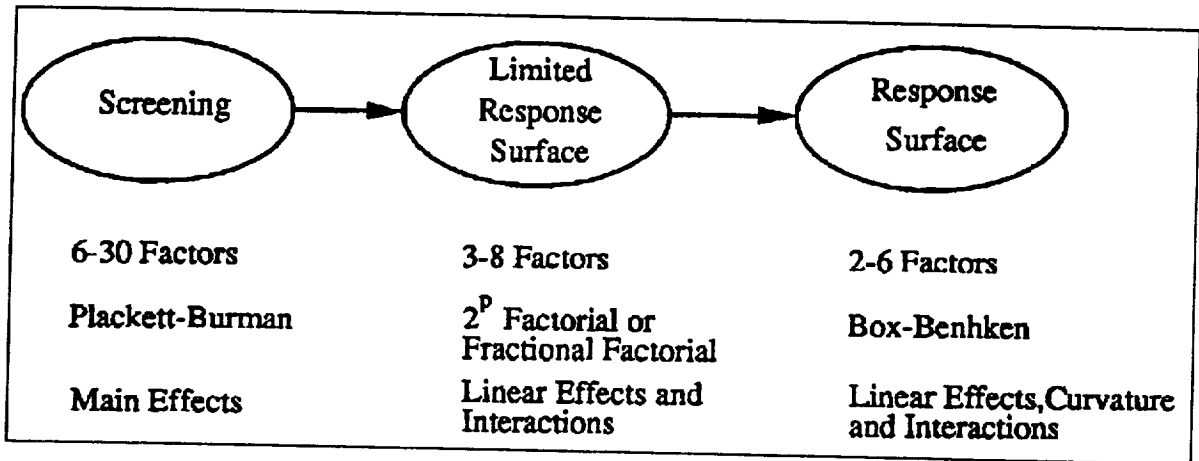

Figure 2.4 Evolution of an Experimental Program

Although all experimentation requires careful planning, some simple investigations need no special considerations (as in the case where only one factor has an effect on the system's performance). Design of Experiments, however, offers considerable advantages in both the economy of experimental resources and maximum production of information especially where there are a number of factors to be investigated. The "classical" approach in which the system's response is explored for each factor in turn while all other factors are maintained at some constant level is not as efficient nor as informative as the "factorial" method of Design of Experiments. The factorial method measures the system's response at all or some fraction of the possible combinations of the chosen (usually two or three) levels of the factors. There are two convincing reasons for the choice of the factorial over the classical method:

- 1) The factorial detects and estimates any interaction between factors while the classical method cannot.
- 2) The factorial requires fewer experiments than the classical method for the same precision.

It can be demonstrated that for "k" factors, a classical approach involves "k" times as many experiments as the factorial approach for the same precision. The factorial design approach involves measures for "k" factors with "p" levels for a total of " $p^k$ " experiments. For example, for three factors at two levels each, the factorial method requires 8 experiments, while the classical method requires 24 experiments (see Figure 2.6).

In order to understand the factorial design concept, it is necessary to introduce the idea of "measurement space." Each of the factors is assigned an *axis* orthogonal to the rest resulting in a "space filling" model encompassing the "experimental volume" of the system. For example, a system involving three factors would be represented as a three

dimensional cube (Figure 2.5). It is not possible to visualize a cube in more than three dimensions (a hypercube), however, the mathematics generalized from three dimensions are valid. An additional benefit of factorial designs is the "hidden replication" inherent in the geometry of the design. For obvious reasons, it is desirable to maximize the "experimental volume" by choosing large ranges (tempered by good judgment) for the factors. This is known as "bold" experimentation.

Factorial experiments are generally performed at either two or three levels of each factor. The two level designs are represented as  $2^k$  factorials where "k" is the number of factors. These two level designs will not detect any "curvature" in the data and are limited to linear first order applications. In many cases a "fractional factorial" design is adequate; it

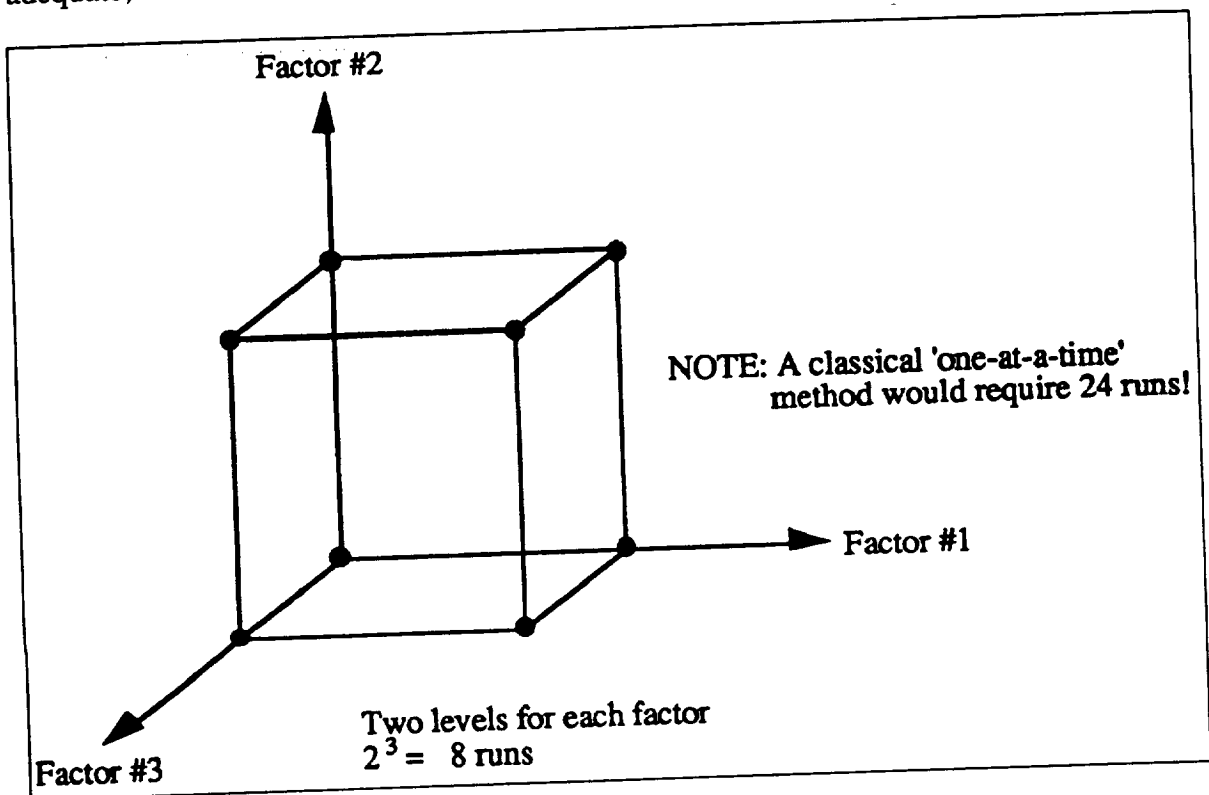

Figure 2.5 Factorial Design

is not necessary to perform the full factorial number of experiments. The fractional designs require 1/2 to 1/8 the number of experiments of the full factorial design and are well suited to the "screening" of potential factors to identify those which are critical to the selection and development of an analytical method.

The three level designs are represented as  $3^k$  factorials where "k" is the number of factors. These designs will detect "curvature" in the data and are sometimes called

"limited response surface" models. The principle of fractional factorials can be extended to the three level designs and require 1/3 to 1/27 the number of experiments of the full factorial design.

A special form of two level fractional factorial design known as "Plackett-Burman" is a very economical screening design frequently useful when the number of factors are one less than multiples of four (3, 7, 11, 15, 19, 23, 27, 31, etc.).

The design strategy uses some of the experiments from the screening phase as elements of the limited response surface design (by inclusion) and further reduces the number of required experiments. This process of "overlaying" the designs is carried on to the response surface designs with similar economy.

The preparation of any of these factorial designs is not a trivial undertaking and is usually a task for the statistician. The individual experiments are dictated by the geometry of the design and must be performed exactly as specified (even though the analyst may think the specified conditions are unrealistic). Clear written instructions and close supervision should be provided. The data analysis and interpretation are a form of "Analysis of Variance" (ANOVA) and should be performed by, or under the supervision of, a statistician. Experience has shown that success with design of experiment is only achieved by close cooperation between the analytical chemist and the statistician. Figure 2.6 presents a convenient guide for designs involving up to eighteen independent variables.

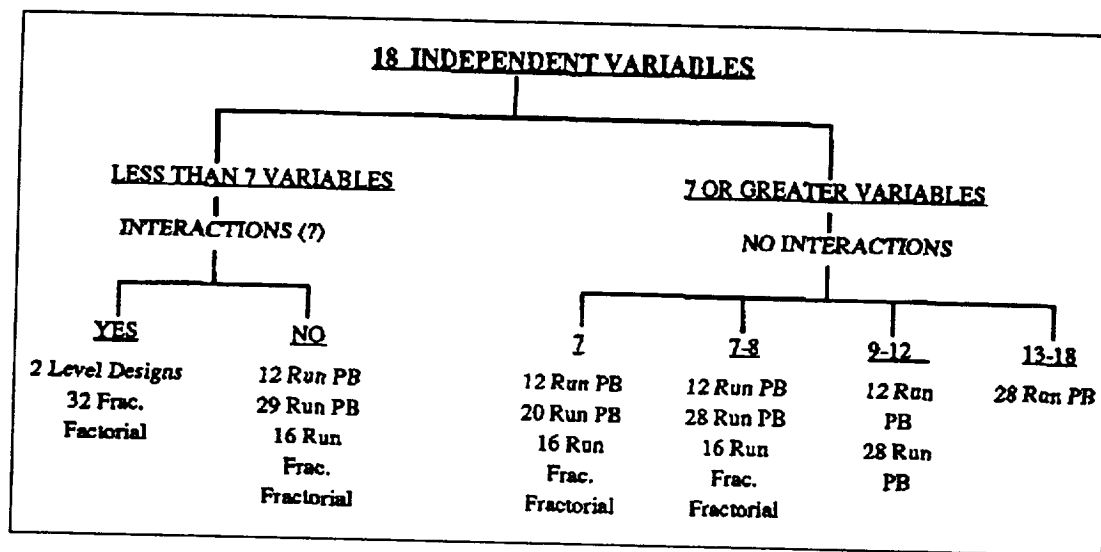

Figure 2.6 Selection Guide to Experimental Designs

It is the intent of design of experiment to provide information for the selection of factor values which will maximize the response of the dependent variable. Performing this

task is known as "*optimization*." If no significant interaction between factors exists, this task is relatively simple. In the presence of interactions, however, the task can be quite complex. As stated earlier, the description of the response surface takes the form of a first or second degree polynomial equation in the "k" factors. Visualizing the surface when "k" >2 is not possible and solving the polynomial equation for maximum response in "k" factors is computationally intense. In those situations where the objective is to reach the optimum response and a "*model*" of the response surface is not required, a procedure known as the "*Simplex Method*" is an excellent and economical approach. This "*Simplex Method*" should not be confused with the "*Simplex Technique*" of linear programming or the "*Simplex Mixture*" design of formulation problems. A "*simplex*" is a regular geometric figure whose corners (vertices) are all equidistant. For the optimization of "k" factors, a simplex of "k + 1" vertices is required. Thus for one factor, the simplex is a line segment; for two factors, it is an equilateral triangle; and for three factors, it is a tetrahedron.

A useful concept for determining where to start in a Design of Experiments approach to improving quality in manufacturing operations has evolved through the *Taugchi approach*. This methodology has become popular in today's quality engineering strategies for achieving target values in production and identifying variables which can be controlled so as to reduce performance variations. A more extended analysis usually requires the use of the approaches shown in Figure 2.6 to optimally determine the responses of factors in an analytical program.

### 2.3 Multivariate Methods

As the title implies, multivariate methods deal with bodies of data representing observations of several (usually more than three) variables on each sample. These data may be composed of measurements of very different kinds including both continuous and discrete variables and may be expressed by a variety of units encompassing a wide range of values. These observations are usually summarized in a data matrix of "p" variables (columns) measured on "n" samples (rows). Thus the data can be considered to describe "n" points (objects) in "p" dimensions (space). Obviously, if "p" is greater than three, visual display of the data becomes a challenge.

		<u>"p" variables</u>			
		x <sub>11</sub>	x <sub>12</sub>	x <sub>13</sub>	x <sub>14</sub> .....x <sub>1p</sub>
		x <sub>21</sub>	x <sub>22</sub>	x <sub>23</sub>	x <sub>24</sub> .....x <sub>2p</sub>
		x <sub>31</sub>	x <sub>32</sub>	x <sub>33</sub>	x <sub>34</sub> .....x <sub>3p</sub>
		x <sub>41</sub>	x <sub>42</sub>	x <sub>43</sub>	x <sub>44</sub> .....x <sub>4p</sub>
<u>"n" objects</u>	:	:	:	:	:
	:	:	:	:	:
	:	:	:	:	:
	:	:	:	:	:
	:	:	:	:	:
		x <sub>n1</sub>	x <sub>n2</sub>	x <sub>n3</sub>	x <sub>n4</sub> .....x <sub>np</sub>

*"Chemical fingerprinting"* is a methodology designed to provide a detailed description of complex chemical formulations for which no single measurement provides adequate information. It is, therefore, a multivariate approach based on measurements developed in designed experiments and addresses four important issues:

- reduction of dimensionality*
- multivariate correlations*
- multivariate classification*
- data summarization.*

It is important to keep in mind that the multivariate methods applied to these issues are not always exclusive in that, for example, a method for the reduction of dimensionality may also provide useful information on possible classifications. Graphical presentation of the results of an analysis is a vital and common feature in all of these methods and can often provide the analyst with important new insights.

It is the aim of all multivariate analyses to gain some insight into the structure and information content of these data. The efforts to achieve this aim are generally directed to a few broad issues:

1. Reduction of "dimensionality" - can fewer than "p" dimensions (variables) describe (graph) the data without significant loss of information?

2. Multivariate correlations - are there significant correlations between some of the "p" variates?
3. Multivariate classification/discrimination - are there "natural" groupings in the data and can individual samples be "assigned" to one of these groups?
4. Summarization and presentation of results - what are the "best" methods for conveying the information content of the data?

Prior to actually performing multivariate analysis on experimental data sets, one should consider the following issues:

1. In the beginning, it is not always known exactly which direction the analysis should take and a good deal of data exploration may be required.
2. Given data of many different types and value ranges, should the data be "normalized" prior to analysis and, if so, by which means?
3. If some of the "p" variables are more important than others, a scheme for "weighing" the variables must be selected and applied.
4. In most cases the selection of the "p" variables is based on scientific intuition and imposes a limit on how much analysis can be performed.
5. The nature of the problem and available experimental resources determine the ratio of "n" to "p" (ideally 10:1). This places constraints on the extent of the analysis.
6. Quite often, the human inability to visualize graphically more than three orthogonal axes prevents the analyst from obtaining a necessary "feel" for the data and, hence, a notion of what to do next.
7. Multivariate methods are computationally intense and the "number crunching" capacity of most available computers sets an upper limit on "p", "n", or both.
8. Unlike univariate points on a line, points in "p" space do not have a unique linear ordering and the human desire to impose this condition may result in a misleading view.

Close cooperation between the analytical chemist and the statistician can overcome most, if not all, of the above difficulties and produce insights and understandings of complex multidimensional objects (samples) which would, in the absence of these methods, be obscured.

In the section 2.2 Design of Experiments, the idea of "*measurement space*" was

introduced and this concept is a fundamental component of the multivariate approach. The individual objects (samples) can be seen as "*points*" in a space of "*p*" dimensions. The location of the points (in "*p*" space) is specified by a set of coordinates which are the values of the "*p*" variables for that object (sample). An equivalent description is that the "*points*" are the terminations of "*vectors*" whose components are the same "*p*" variables. Now it is possible to understand that "*points*" which are close to each other in this "*p*" space are also "*close*" in their measured variables; the "*distance*" between them being a measure of their "*similarity*." If all of the "*p*" variables are of the same kind (concentration, absorbance, mass abundance, wavelength, etc.) there is no difficulty with this simple model. If, however, the variables are of a mixture of kinds with quite different "*values*," the simple model may be distorted by the larger "*values*" and consideration should be given to "*scaling*" the variables by some "*normalizing*" technique. By far the most common normalizing technique is the "z score" method whereby the variables are each transformed to have a mean of zero and a variance of one. The effect of this transformation is to place all of the variables on an equal basis and if this is not the case (all variables equally important), the variables must then be individually assigned "*weights*" by the analytical chemist (here, the statistician can only provide advice). These decisions concerning "*normalization*" and "*weighing*" of the variables are important data "*pre-treatment*" considerations, but, given the preservation of the original "*raw data*," are not irrevocable.

For those conditions where "*p*" is greater than three, visual examination of the vector terminations (or points) is not possible. However, the principles of Euclidean Geometry are also equally valid for vectors in "*p*" dimensions. The true length of the vector is equal to the square root of the sum of the squares of its coordinates. The Euclidean distance "*d*" between the terminations of any two vectors is simply the square root of the sum of the squares of the difference between their respective "*p*" coordinates. These relationships are summarized for 2, 3, and "*p*" dimensional space in Figures 2.7, 2.8, and



$$R_1 = [(x_1)^2 + (y_1)^2]^{1/2}$$

$$R_2 = [(x_2)^2 + (y_2)^2]^{1/2}$$

$$d = [(x_2 - x_1)^2 + (y_2 - y_1)^2]^{1/2}$$

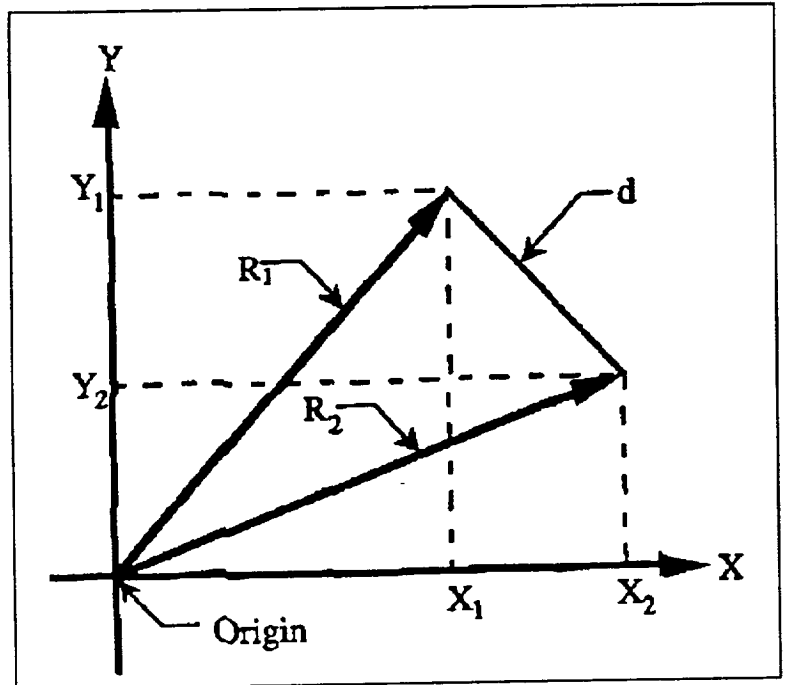

Figure 2.7 Two Dimensional Case (Plane Geometry)

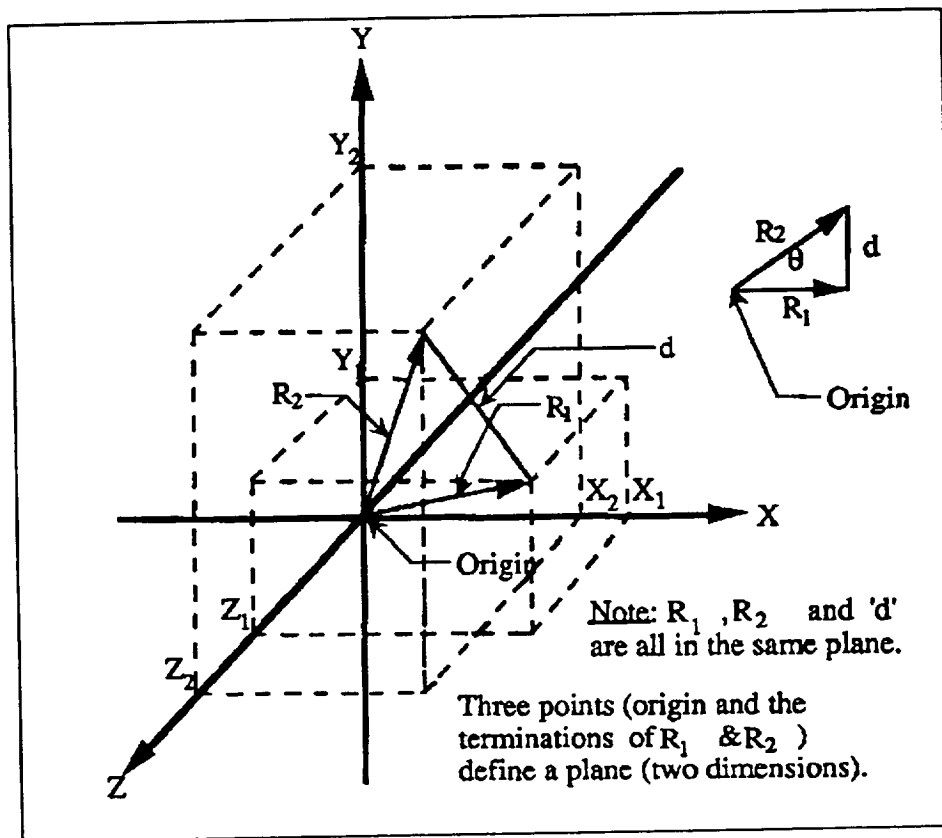

Figure 2.8. Three Dimensional Case (Solid Geometry)

2.9. Note that the two vectors ("R<sub>1</sub>" and "R<sub>2</sub>") and the distance line "d" in each case form a triangle and only requires two dimensions to display the graphical features. This holds for the comparison of any two objects (points) in "p" dimensional space. Given a set of "n" objects (samples) defined by "p" variables, it is possible to calculate all of the n(n-1)/2 pairs of "d" distances between the objects.

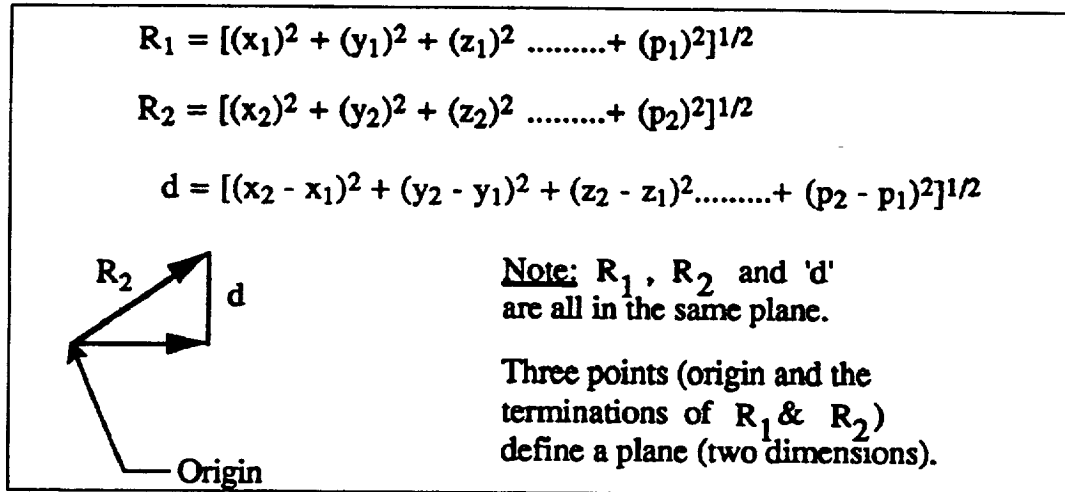

Figure 2.9 Multi (p) - Dimensional Case (Hyperspace)

A distance between variables can also be calculated by means of a transformation of the correlation matrix. The correlation matrix is a square symmetrical matrix providing for each pair of variables, a correlation coefficient "r". The diagonal of the matrix is unity for all self-correlations. The most direct transformation is made by subtracting the absolute value of the individual correlation coefficients from one (1). If negative correlation coefficients are to be considered an indication of dissimilarity, then one should use the signed values in place of the absolute values. Having done this we now have a *pseudo distance table* for the variables.

The Euclidean distance measure discussed above is only one of many possible metrics or measuring systems. If each of the "p" variables are normally distributed (which is most often the case), then the points in "p" space have a characteristic form or pattern. This pattern is dependent upon both the individual variances and the correlations between the variables. If, for instance, "p" = 2, "r" (correlation coefficient) = 0 (no correlation) and the variances are equal, the locus of points equidistant from the centroid of the pattern is a *circle*. Given some degree of correlation between variables and/or unequal variances, the locus becomes an *ellipse*. With "p" > 2, the locus of points equidistant from the centroid is the surface of an *ellipsoid* ("p" = 3) or *hyperellipsoid* ("p" > 3). Note that the major diameter of the ellipse (or ellipsoid) is in the direction of greatest variance. The Euclidean metric defines the locus of points equidistant from the centroid to be a *circle* ("p" = 2), the surface of a *sphere* ("p" = 3), or a *hypersphere* ("p"

> 3) and distances (to the centroid) based on this metric can, in a statistical sense, be misleading. A metric which does take into account these statistical considerations (unequal variances and correlations) is the *Mahalanobis* distance. Although this metric is often superior to the Euclidean, its computation is more complex and involves matrix algebra to find the matrix inverse of the covariance matrix: a job best left to a statistician and computer.

A closer look at the multivariate ideas and techniques having the most relevance to the search for chemical "*fingerprints*" and signatures is now in order.

#### Issue #1. Reduction of dimensionality

Two techniques, Multi-Dimensional Scaling (MDS), and Principal Component Analysis (PCA), have direct applications to the "*fingerprinting*" problem in that both provide a picture in two or three dimensions of the similarities (or differences) between the *signatures* of the samples. These methods not only facilitate interpretation, but simplify the mathematics (fewer dimensions or variables to handle). Additional benefits include the elimination of redundancies (correlations) in the original data and the possibility that the abstract "*new*" dimensions (variables) may have some "*real*" physical significance (reification).

The technique of MDS is designed to produce a "*map*" depicting the relationships between the objects (samples) based on a table (see above) of *distances* between all pairs of objects. As noted above, these distances are usually expressed in the Euclidean metric, but not exclusively so. The MDS procedure first finds from the table the two objects which are maximally distant. These objects are then plotted on the map's central horizontal axis at maximum separation. Next, the object at maximum distance from the first two is identified and, by an arbitrary convention, is plotted either above or below the central horizontal axis to form a triangle whose sides are the distances between the three objects. The remaining objects are then in turn "*fitted*" into this triangular configuration. An initial "*goodness of fit*" between these *configuration* distances and the distance table is then calculated and used iteratively to change each object's map coordinates until no further improvement in "*fit*" can be made. At this point the final map is drawn. Most MDS software give the user some control of:

1. Map dimensionality (usually 1, 2, or 3)
2. Assignment of "*weights*" for the variables
3. Choice of "*normalizations*" for the variables
4. Choice of the *distance* metric
5. The maximum number of allowed iterations
6. Map "*convergence*" parameters

## 7. Map editing - size, position, and rotation

The method of Principal Component Analysis (PCA) is a transformation of the original variables into a completely new set with reduced dimensionality, the principal components. While there exist the same number of new principal components as original variables, there is also the expectation that the first few principal components (2 or 3) will account for most or possibly all of the information content in the original data set. PCA is general in its scope, makes no assumptions about the nature of the original variables, and uses no mathematical model. The principal components (PCs) generated by the procedure have the following properties:

1. Each PC is a linear combination of the original variables. That is, each is equal to a sum of the original variables each having unique coefficients.
2. For each PC the sum of the squares of the coefficients is unity.
3. The first PC is that linear combination having the greatest variance.
4. The succeeding PCs are uncorrelated with previous PCs and contain the greatest amount of the remaining variance.

A consequence of 3 and 4 above is a set of variables (PCs) which are uncorrelated with one another and, therefore, mutually orthogonal and are arranged in decreasing order by the percentage of the total variance they contain.

The PCA procedure can be explained in geometric terms. If the original "p" variables are all normally distributed, the collection of the "n" points (samples) in "p" space will be a hyperellipsoid having a definite centroid located at the coordinates of the common mean. Finding the PCs corresponds exactly to finding the principal diameters of the hyperellipsoid and placing them in decreasing order of length. The locations of the projections of the "n" points onto these diameters as measured from the centroid are the individual PCs.

One should understand that the PCA method is not independent of the scale of the original variables and the application of "*weightings*" to some of these variables can have a profound effect on the results. If the original variables are of quite different types, of different units, or of different scales, consideration should be given to normalizing or standardizing these data prior to PCA. If a correlation analysis reveals that the original variables are all uncorrelated, or nearly so, there is little to be gained from a PCA as the probable result would be a computationally expensive coordinate transformation.

In practice, the entry point for the PCA is the matrix of correlations between the original variables (or a variance/covariance matrix). The matrix is a square ("p" x "p") symmetrical about the diagonal. Mathematical operations are performed on this matrix

and result in "p" *eigenvalues* together with "p" *eigenvectors* whose "p" components are the coefficients described in 1 and 2 above. The percentage each eigenvalue has of the sum of all the eigenvalues is the percentage of the total variance it contains.

### Issue #2 - Multivariate Correlations

In the section *Basic Statistics* we discussed briefly the calibration of an analytical instrument using the *method of least squares*. That is we developed the equation:

$$y = a + bx$$

where: a = the "y" intercept, b = the slope

This is an example of a *univariate linear regression*. We also calculated a "*figure of merit*" for this equation called the *correlation coefficient "r"* with values ranging from -1 through 0 to +1. Recall that large absolute values of "r" indicate a close relationship (correlation) between "x" and "y".

In the section *Design of Experiments* an extension of this idea was presented when the "fitting" of a "model" was used to define the response surface. In fact, using a first degree polynomial equation in the "k" factors to predict the value of the dependent variable (response) is an example of a *Multiple Regression Analysis*. Multiple regression analysis is a very useful and general statistical procedure for the study of the relationship (correlation) of a single variable (response) to a linear combination of two or more other variables (predictors), including a constant term and a random error term.

$$y_1 = b_0 + b_1x_1 + b_2x_2 + b_3x_3 + b_4x_4 \dots + b_px_p + e_p$$

Where:  $y_1$  = response variable

$b_0$  = constant term

$x_1 \dots x_p$  = predictor variables

$b_1 \dots b_p$  = regression coefficients

$e_p$  = random error term (residual)

An example of a chemometric application of this method is the study of possible relationship of a measured physical property of a material (tensile strength, viscosity, hardness, etc.), to a group of chemical measurements made on the same sample of the material.

As with the univariate regression above, a "*figure of merit*" can be computed for the result of a multiple regression analysis and it is known as the *coefficient of determination ("r<sup>2</sup>")* and its values range from 0 to 1. The exploration of these correlations is complicated by the large number of *possible* linear combinations of the predictor variables and many statistical software programs provide a means to automate the search for an optimum combination. There are usually three approaches to the problem and all are based on a user supplied criterion (rule) for the determination of the

optimum combination:

1. A *forward* selection of predictors.
2. A *backward* elimination of predictors.
3. A *stepwise* regression (a mixture of #1 and #2).

Having completed these searches, it is left to the user to make the important decision on which linear combination of predictors and coefficients will become the model. The software can provide some assistance in the form of "F" statistic values and sometimes graphical plots of the predicted values versus the measured values for each combination can be examined.

Example: Determination of the component ratio for polyurethane foam insulation for an aerospace system.

An important requirement in the preparation of a cured thermal protection polyurethane foam material is the control of the two part component ratio A and B. A study to determine the true relative amounts of the 'A' Component (isocyanate) and the 'B' Component (polyol) was conducted using instrumental analytical methods (FTIR, ICP, and TGA) to determine the true ratio of these components after cure has been completed. The application of these analytical methods together with the use of multivariate linear regression techniques permit the determination of the true 'A':'B' ratio with an error of less than ten percent (10%).

Fingerprinting work performed on this foam material has demonstrated that FTIR, ICP, and TGA are the instrumental methods best suited to the ratio determination.

A single lot of foam material for which the results from the full complement of acceptance tests were available was used to prepare accurately weighed "cup" samples (in triplicate) of 0.60:1.00, 0.80:2.00, 1.00:1.00, 1.20:1.00 and 1.40:1.00 'A':'B' ratios. A complement of "production sprayed" samples were also prepared for correlation analysis. The ability to produce these samples (cured foam material) from such extreme ratios is a testimonial to the robust nature of this formulation. The individual samples were then each subjected to FTIR, ICP, and TGA analyses. Both a forward and backward stepwise multiple linear regression analysis was performed on the results from each method and on a composite of all of the results. The resulting predicting equation are of the form:

$$Z = a + b_1x_1 + b_2x_2 \dots + b_ix_i$$

where: Z = 'A':'B' ratio  
a = intercept (forced to zero)  
b = regression coefficient  
x = predictor variable

From the analysis of fourteen wavelengths in the infra-red spectrum,  $1510\text{ cm}^{-1}$  and  $1067\text{ cm}^{-1}$  were identified as the critical predictor variables. These two intensities remained the critical predictors in the composite regression analysis. Partial "f" tests and "t" tests confirmed the significance of these two predictors at the 95% confidence level. The final prediction equation defines a three dimensional plane (See Figure 1.):

$$Z = 0.02349x_1 - 0.02494x_2$$

where:  $x_1 = 1510\text{ cm}^{-1}$   
 $x_2 = 1067\text{ cm}^{-1}$

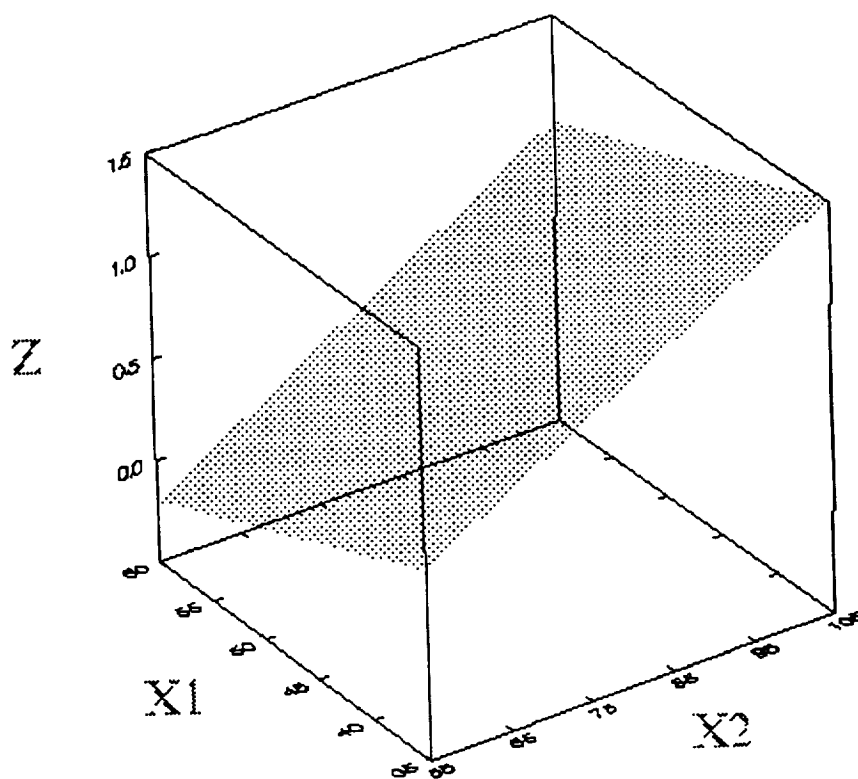

Figure 2.10 Response surface for two wavelengths used in this study.

This equation produces an adjusted coefficient of determination  $r^2 = 0.999$  and an interval error estimate of  $\pm 0.071$  meaning that 99.9% of the 'A':'B' ratio is explained over the entire ratio interval with a probable error no greater than 7%. The ICP and TGA regressions each had a coefficient of determination of approximately 0.95 and interval error estimates of 0.10 (10%). A graphical representation of the response surface is shown below.

#### Conclusions and Recommendations

An on-going study to determine if foam aging has a significant effect on the analytical results is being completed. Consideration will also be given to the expansion of this effort to include the correlation of the foam's physical and mechanical properties to both the 'A':'B' ratio and its analytical predictors. Alternatively, the knowledge gained in this study could be applied to the adjustment of some or all of the major material or process factors to produce the desired 'A':'B' ratio. It is now possible to accurately determine whether, in the foam application process, the desired 'A':'B' ratio has, in fact, been achieved. FTIR analysis, in particular, revealed that the ratio of infra-red light absorption be a pulverized sample of foam at  $1410\text{ cm}^{-1}$  and  $1067\text{ cm}^{-1}$  is a direct measure of the relative amounts of the 'A' and 'B' components reacted to form the cured foam.

Example. Using factor analysis to determine the reliability of a spectroscopic analysis by determining the number of significant factors

Consider the case where a spectroscopic analysis is performed in the presence of other potential absorbants and system noise. The analyst records measurements for two peaks in the absorption spectrum of the desired compound at different concentrations. This approach can be used to answer the following questions:

- (a) How many compounds are in the mixture?
- (b) What are the intensities at these wavelengths for these compounds?
- (c) What is the concentration of each compound in each experiment?

The theoretical absorption for peak 2 should be twice that of peak 1; however, the data is recorded as:

Wavelength 1	Wavelength 2
0.8404	2.0296
1.8982	4.1676
3.1831	5.8166
4.1665	7.9562
5.3620	9.8650
5.9200	11.6624
7.0987	13.8794
8.1588	16.3139
8.9828	18.0685
10.3643	20.3791

The data can be graphed according to the figure below. Note that the linear fit is not very good. Variations from the linear relationship may be due to system noise or the effects of unknown absorbants.

Ordinarily the analyst would determine the best linear fit to the data by performing a



linear regression on this data. One would then obtain the equation:

$$I_1 = 0.5063I_2 + 0.02125.$$

This equation is represented by the line drawn through the data points in the graph. In most cases this approach is satisfactory; however, there is always a lingering question about if this one fit is sufficient.

Another useful approach is to reduce the dimensionality of the data using principal components and see how many factors are needed to accurately model the data. A regression and principal component analysis using a commercial software package provides the following information:

Whole-Model Test

Analysis of Variance

Source	DF	Sum of Squares	Mean Square	F Ratio
Model 1		87.016642	87.0166	2101.656
Error	8	0.331231	0.0414	
C Total	9	87.347873	0.0000	

Note that the sum of squares for the one degree of freedom model is much larger than the error variance., hence the F ratio is very high. Obviously the analyst is able to apply the least squares fit to the data with confidence.

Further results from the analysis gives:

**Response: Wavelength 1**

<b>Summary of Fit</b>	Rsquare	0.996208
	Root Mean Square Error	0.203479
	Mean of Response	5.59748
	Observations (or Sum Wgts)	10

The response parameters show an  $r^2 = 0.996$  for the 10 data points. Hence the linear fit is good. The response curve for this data set also shows a good fit in the plot:

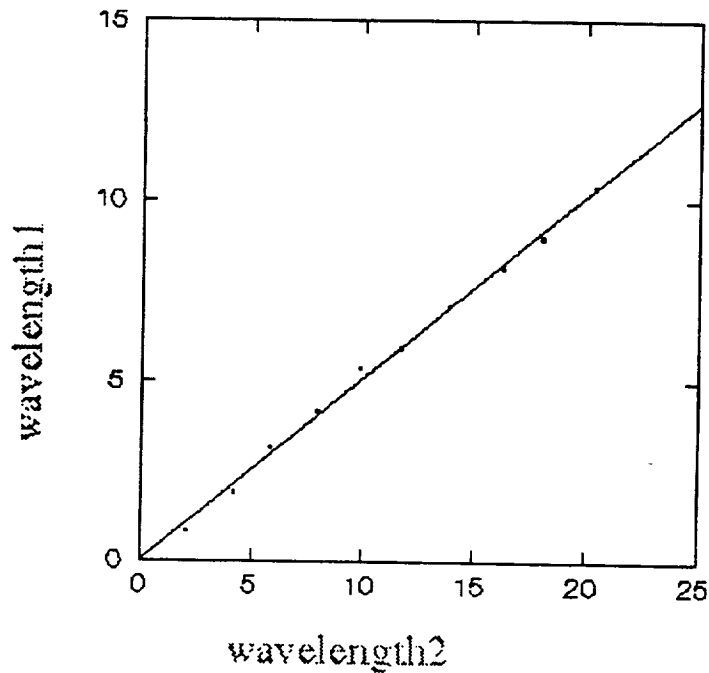

Figure 2.11 Regression fit for spectrometric calibration.

For the principal components portion of the analysis, one then decomposes the original data into principal components of the form:

$$\begin{aligned}
 X_1 &= x_1 \cos f + x_2 \sin f \\
 X_2 &= -x_1 \sin f + x_2 \cos f.
 \end{aligned}$$

This analysis reveals the following information:

Eigenvalue	1.9981
Percent:	99.9051

which indicates that the principal component at wavelength1 accounts for 99.9 % of the information, thereby confirming the earlier observations.

### Issue #3 - Classification and Discrimination

The method of *Cluster Analysis* is directed to the task of identifying groups of similar objects based on the observational data. This analysis is usually performed to search for the existence of some *natural* grouping in the data. The method is relatively simple, straight forward, and produces an easily understood *dendrogram* or hierarchical *tree*. Cluster analysis, like MDS, is based on *distances* and can be applied to the study of the relationships between individuals (samples) as well as variables.

There are two basic approaches to the clustering problem:

1. The *divisive* approach which begins with all of the objects in a single cluster and proceeds to subdivide this cluster into separate clusters based on *dissimilarities*.
2. The *agglomerative* approach which begins with each object in its own cluster and proceeds to form other clusters based on *similarities*.

By far, the agglomerative approach is the most popular and, therefore, the one we will examine. The method requires measures of *similarity* between all objects being studied and this is usually a distance matrix. Any data which can be used to create such a matrix is, therefore, suitable and the previous comments on the distance metric apply. The four general steps in the clustering procedure are:

1. Assign each object to its own unique cluster.
2. Locate the *shortest* distance in the matrix and merge these two clusters.
3. Update the distance matrix for this cluster's distance to the remaining clusters.
4. Repeat steps #2 and #3 until there is only one cluster.

During this procedure a *linked list* is generated which contains, in order, the mergings (fusions) and the distance at which they occurred. This list is then used to draw the dendrogram or *tree*. The rules by which the distance matrix is updated in step #3 above are known as the *clustering algorithm* and there are five popular ones:

1. The single linkage algorithm
2. The complete linkage algorithm
3. The average linkage algorithm
4. The centroid algorithm
5. Ward's method

Implementation of these algorithms on a single data set will generally produce five distinct dendrograms and this raises the question "Which is best?" The *best* will usually be the dendrogram with the most faithful reproduction of the original distance matrix. The distance between any two clusters (objects or groups) is the distance level at which they both first appear in the same cluster (fusion level). With this understanding, a distance matrix can be constructed from the dendrogram and then compare the corresponding entries to the ones in the original distance matrix and even calculate a *goodness of fit* in much the same (RMS Error) way as for the MDS map. In fact both cluster analysis and MDS constitute *summaries* (in different visual forms) of the information contained in a distance matrix.

The analyst must make many of the same basic decisions prior to a cluster analysis as

was necessary for MDS, namely:

1. Should the variables be normalized?
2. Should "weights" be assigned to the variables?
3. Should principal components be used and if so, how many?
4. Which algorithm should be used?
5. If variables instead of samples are being studied, how should the distance matrix be calculated?
6. Which "goodness of fit" calculation should be used and what is the *decision value*?

A major criticism of cluster analysis is that it will by its very design always find clusters even when "*homogeneous*" or "*clusterless*" data are analyzed. Any clusters identified by this method should be confirmed by MDS and scatter plots. The analyst should be aware that the results of cluster analysis depend a great deal on the distance matrix and the particular algorithm used.

The method of *Discriminant Analysis* deals with the problem of developing an optimal separation rule to distinguish between two or more known (*a priori*) groups of objects (samples) based on the measurements of several variables on all of the objects. The method could be used, for example, to investigate how well samples of acceptable and unacceptable materials can be separated using a number of chemical measurements applied to both. The intent is to develop a rule which would, on the basis of the chemical measurements, correctly allocate a subsequent sample to one or the other group (acceptable or unacceptable). While the advantages of such a rule are great, there is a certain probability of misallocation and the rule must be chosen to minimize this risk.

There are a number of ways to view this task. First, it can be seen as an extension to multivariate observations of the method of *analysis of variance* wherein the "between group" variances are maximized while at the same time the "*within group*" variances are minimized. Like multiple regression analysis, discriminant analysis is concerned with finding an optimal linear combination of the original variables (or a subset thereof) which satisfies these variance objectives. That is to say, the optimal linear combination (an equation having a constant term and coefficients for all included variables) would, when applied to all objects in both groups, yield *means* for the groups which have the greatest possible numerical difference and *variances* for each group that are as small as possible. Application of this rule would then create a condition where the centers (means) of the groups are far apart and there is minimal overlap between their distribution curves (minimum variances). The calculated numerical result for any individual object (sample) is known as a discriminant score and the equation's individual

coefficients can be viewed as *weights* for their respective variables.

$$DF = b_0 + b_1x_1 + b_2x_2 + b_3x_3 + b_4x_4 \dots + b_px_p$$

Where:DF = discriminant function

$b_0$  = constant term

$x_1 \dots x_p$  = variables

$b_1 \dots b_p$  = discriminant coefficients

An equivalent geometrical interpretation is to find the centroids of the hyperellipsoids of the groups in "p" (or less) space which are maximally distant from one another. It is preferred that the distance be the *Mahalanobis* distance based on the normalized (z-scored) variables. Then the degree to which the hyperellipsoids interpenetrate each other sets the limit on the method's ability to properly allocate an object to a given group. Having located the group centroids and objects in "p" (or less) space, the simple method of "k" *nearest neighbors* can be used to assign a new object to the proper group. The method assigns the new object to the group having the largest percentage of the "k" neighbors closest to it. The value of "k" is usually taken to be a small odd number in order to prevent "tie" votes. Given a rather large number of assigned objects in the groups, this method is rapid, straight forward, and makes good statistical sense. The other methods of making assignments require the calculation of discriminant score value known as the *cutting score* and this can be a complicated matter if the population size of the groups differ significantly.

Since the mechanics of discriminant analysis and multiple regression analysis have mathematically much in common, the statistical software programs usually provide the same types of options for exploring the data: "forward" selection, "backward" elimination, and "stepwise" operations on the original variables. Here too, it is sometimes possible to examine a graphical plot of the separation results.

#### Issue #4 - Presentation of Results

While it cannot be denied that tables and listings of calculations and results efficiently present the *essential* hard facts, graphical displays or other visual representations of multivariate data are extremely useful tools for their examination and presentation. Contour maps (response surfaces), similarity maps (multidimensional scaling and principal components analysis), dendrograms/trees (cluster analysis), and scatter plots (regression analysis) are all intuitive and easily understood by everyone. A deep understanding of the mechanics behind the generation of these visualizations is not a prerequisite to reading the information they contain and this should be a major consideration when presenting results to the non-statistician. Frequently a picture is not only the *best*, but the *only* way to convey the complex relationships between multivariate objects. Beyond their value in data presentation, the graphical techniques are indispensable in the exploring and formulating stages of analysis. A great deal of good and practical advice on the design and preparation of a variety of charts and graphs is contained in the book by W. S. Cleveland and the two books by E. R. Tufte (see

Reference Materials).

### Final Comments and Advice

With most multivariate data sets there are almost always a variety of alternative analytical approaches. The choice of which method is most appropriate depends on the data type(s) and the objective(s) of the analysis. Unfortunately, no one method or technique is necessarily the *best* choice and it is often wise to use several methods to explore different facets of the data. There are two ways to view the data set: as the *relationships* between the *individuals* (samples) as defined by the *variables* and their values, and as the *relationships* between *variables* defined either by their pairwise correlations or their variance/covariance structure. In the first case we examine the "n" individuals in the "p" variables space while in the second we see the "p" variables in "n" space.

Before undertaking any multivariate analysis, the univariate summary statistics for each variable should be thoroughly studied. The *mean*, *variance*, *standard deviation*, *range*, the *skew*, the *kurtosis*, and the z-scores can all be easily calculated using available software. This variable by variable "quick look" should be supplemented by histograms to verify distribution assumptions and to screen for "*outliers*." Next, the correlation matrix should be created and examined, followed by a scrutinizing of the scatter plots of all pairs of variables. The correlation matrix contains only the simple linear correlations and if the relationships are more complex, the scatter plots together with "eye-brain" device may uncover them. Recall that if the variables are all relatively uncorrelated, a principal components analysis is probably pointless. The degree to which some of the variables are correlated will give some guidance in the investigation of possible linear combinations. At this point it is advisable to consider the question of normalization of the variables and whether some of the variables should be assigned *weights*.

A statistical computer software program will obligingly perform any of its analyses on a data set whether or not the method is appropriate. Consider the problem to be solved and your objectives, then use common sense (the computer has none).

Just as in the univariate case, multivariate *outliers* can exist and if scanning the data by eye fails to detect them, consider using the *Mahalanobis* distances from the common centroid as a discriminator.

Finally, recognize that multivariate analyses do not always give "*text book*" answers, even after a great deal of exploration. It is also very difficult to know when one has exhausted all of the many possible approaches. One of the best ways to develop skills and gain experience in these methods is to use available software to analyze the *classical* (known) data sets (many of the data sets are included in the books listed in the Reference Materials).

### 3.0 REFERENCES

1. Roush, P. B., *The Design, Sample Handling and Applications of Infrared Microscopes*, ASTM Special Technical Publication 949, ASTM, Philadelphia, PA, 1987
2. Krishnan, K., and Hill, S. L., *FTIR Microsampling Techniques*, Note No. 73, BioRad Digilab Division, Cambridge, Massachusetts, Academic Press, 1990
3. *The Microscope*, McCrone Institute, Chicago, Illinois
4. Gerrard, D. L., and Maddams, W. F., "Polymer Characterization by Raman Spectroscopy," *Applied Spectroscopy Reviews*, **22** (2 & 3), 251 (1986)
5. Ballinger, D., Lloyd, A. and Morrish, A., *Analyst*, **107**, 1047 (1982)

#### Other Reference Materials

This section contains recommended books that we have found beneficial. They are listed according to topic.

#### Chemometrics

Brereton, Richard G., *Chemometrics*, Ellis Horwood, New York, 1990

Burgard, D. R. and J. T. Kuznicki, *Chemometrics: Chemical and Sensory Data*, CRC Press, Cleveland, OH, 1990

Kowalski, B. R., *Chemometrics: Theory and Application*, American Chemical Society, Washington D. C., 1977.

Massart, D. L., Vandeginste, B. G. M., Deming, S. N., Michotte, Y., and Kaufman, L., *Data Handling in Science and Technology*, Vol 2, "Chemometrics: A Textbook," Elsevier, New York, 1988.

#### Computers

Smardzewski, R. R., *Data Handling in Science and Technology*, Vol 1, "Microprocessor Programming and Applications for Scientists and Engineers," Elsevier, New York, 1984.

Valkó, P., and Vajda, S., *Data Handling in Science and Technology*, Vol 4, "Advanced Scientific Computing in BASIC with Applications in Chemistry, Biology, and Pharmacology," Elsevier, New York, 1989.

### Design of Experiments

Box, G. P., Hunter, W. G., and Hunter, J. S., *Statistics for Experimenters - An Introduction to Design, Data Analysis, and Model Building*, John Wiley & Sons, New York, 1978.

Breyfogle III, F.W., *Statistical Methods for Testing, Development and Manufacturing*, Wiley and sons, New York, 1991

Deming, S. N., and Morgan, S. L., *Data Handling in Science and Technology*, Vol 3, "Experimental Design: A Chemometric Approach," Elsevier, New York, 1987.

Montgomery, D. C., *Design and Analysis of Experiments*, Second Ed., John Wiley & Sons, New York, 1984.

### Graphical Methods

Cleveland, W. S., *The Elements of Graphing Data*, Wadsworth Advanced Books and Software, California, 1985.

Tufte, E. R., *Envisioning Information*, Graphics Press, Connecticut, 1990.

Tufte, E. R., *The Visual Display of Quantitative Information*, Graphics Press, Connecticut, 1983.

### Instrumental Analysis

Gardiner, D. J., and Graves, P. R., *Practical Raman Spectroscopy*, Springer-Verlag, New York, NY, 1989.

Griffiths, P. R., *Chemical Infrared Fourier Transform Spectroscopy*, John Wiley & Sons, New York, 1975.

Miller, J. M., *Chromatography: Concepts and Contrasts*, John Wiley & Sons, New York, NY, 1988.

Robinson, J. W., *Atomic Spectroscopy*, Marcel Dekker, New York, NY, 1990.

Skoog, D. A., *Principles of Instrumental Analysis*, Third Ed., Saunders College Publishing, Fort Worth, TX, 1984.

Skoog, D. A., West, D. M., and Holler, F. J., *Fundamentals of Analytical Chemistry*, Fifth Ed., Saunders College Publishing, Fort Worth, TX, 1988.



Smith, A. L., *Applied Infrared Spectroscopy. Fundamentals, Techniques, and Analytical Problem-Solving*, John Wiley & Sons, New York, 1978.

Strobel, H. A. and Heineman, W. R., *Chemical Instrumentation: A Systematic Approach*, Third Ed., John Wiley & Sons, New York, NY, 1989.

Willard, H. H., Merritt Jr., L. L., Dean, J. A., and Settle Jr., F. A., *Instrumental Methods of Analysis*, Seventh Ed., Wadsworth Publishing, Belmont, CA, 1988.

#### Microspectroscopy

Krishnan, K., and Hill, S. L., *FTIR Microsampling Techniques*, Notes No. 73, BioRad Digilab Division, Cambridge, Massachusetts, April 1990.

Messerschmidt, R. G., Harthcock, M. A., *Infrared Microspectroscopy*, Marcel Dekker, Inc. New York, 1988.

Roush, P. B., *The Design, Sample Handling and Applications of Infrared Microscopes*, ASTM Special Technical Publication 949, ASTM, Philadelphia, PA, 1987.

#### Multivariate Analysis

Hawkins, D. M., *Topics in Applied Multivariate Analysis*, Cambridge University Press, New York, 1982.

Chatfield, C. and Collins, A. J., *Introduction to Multivariate Analysis*, Chapman and Hall, New York, 1980.

Everitt, B. S., *Graphical Techniques for Multivariate Data*, North-Holland, New York, 1978.

Flury, B. and Riedwyl, W., *Multivariate Statistics, A Practical Approach*, Chapman and Hall, New York, 1988.

Gnanadesikan, R., *Methods for Statistical Data Analysis of Multivariate Observations*, John Wiley & Sons, New York, 1977.

Hair Jr., J. F., Anderson, R. E., and Tatham, R. L., *Multivariate Data Analysis with Readings*, Second Ed., Macmillan Publishing Company, New York, 1987.

Jackson, J. E., *A User's Guide to Principal Components*, John Wiley & Sons, New York, 1991.

Kaufman, L. and Rousseeuw, P. J., *Finding Groups in Data. An Introduction to Cluster Analysis*, John Wiley & Sons, New York, 1990.

Malinowski, E.R., *Factor Analysis in Chemistry*, Wiley-Interscience, New York, 1991

Manly, B. F. J., *Multivariate Statistical Methods - A Primer*, Chapman and Hall, New York, 1986.

Martens, H. and Naes T., *Multivariate Calibration*, Wiley and Sons, New York, 1989

Marriott, F. H. C., *The Interpretation of Multiple Observations*, Academic Press, New York, 1974.

Schiffman, S. S., Reynolds, M. L., Young, F. W., *Introduction to Multidimensional Scaling-Theory, Methods and Applications*, Academic Press, New York, 1981.

#### Spectral Interpretation

Silverstein, R. M., Bassler, G. C., and Morrill, T. C., *Spectrometric Identification of Organic Compounds*, John Wiley & Son, New York, 1974.

Sternhell, S. and Kalman, J. R., *Organic Structures from Spectra*, John Wiley & Sons, New York, 1986.

#### Spectral Interpretation - ESCA/Auger

Davis, L. E., MacDonald, N. C. Palmberg, P. W., Riach, G. E., and Weber, R. E., *Handbook of Auger Electron Spectroscopy*, Second Ed., Physical Electronics Division, Perkin-Elmer Corp., 1976.

Wagner, C. D., Riggs, W. M., Davis, L. E., Moulder, J. F., and Muilenberg, G. E., *Handbook of X-ray Photoelectron Spectroscopy*, Physical Electronics Division, Perkin-Elmer Corp., 1979.

#### Spectral Interpretation -Infrared and Raman

Colthup, N. B., Daly, L. H., and Wiberly, S. E., *Introduction to Infrared and Raman Spectroscopy*, Academic Press, New York, 1975.

Nakamoto, K., *Infrared and Raman Spectra of Inorganic and Coordination Compounds*, Fourth Ed., John Wiley & Sons, New York, 1986.

Pouchert, C. J., *The Aldrich Library of FTIR Spectra*, First Ed., Vols 1 and 2, Aldrich Chemical Co., Inc., Wisconsin, 1985.

#### Spectral Interpretation - Mass Spectra

Heller, S. R., Milne, G. W. A., *EPA/NIH Mass Spectral Data Base*, Parts 1-9, NSRDS-NBS 63, National Bureau of Standards, Washington, D. C., 1978.

McLafferty, F. W., *Interpretation of Mass Spectra*, Third Ed., University Science Books, California, 1980.

McLafferty, F. W., Venkataraghavan, R., *Mass Spectral Correlations*, Second Ed., American Chemical Society, Washington, D. C., 1982.

Mass Spectrometry Data Center, *Eight Peak Index of Mass Spectra*, Second Ed., Vol 1, 2, 3, 4, Pendragon House, Inc., Palo Alto, California, 1974.

#### Spectral Interpretation - NMR

Levy, G. C., Lichter, R. L., and Nelson, G. L., *Carbon-13 Nuclear Magnetic Resonance Spectroscopy*, John Wiley & Sons, New York, 1980.

#### Statistics

American Society for Quality Control, Statistics Division, *Glossary and Tables for Statistical Quality Control*, American Society for Quality Control, Wisconsin, 1983.

Beyer, W. H., *CRC Standard Probability and Statistics Tables and Formulae*, CRC Press, Boston, 1991.

Marriott, F. H. C., *A Dictionary of Statistical Terms*, Fifth Ed., John Wiley & Sons, New York, 1990.

Miller, J. C., and Miller, J. N. *Statistics for Analytical Chemistry*, Second Ed., John Wiley & Sons, New York, 1988.

Wadsworth Jr., H. M., *Handbook of Statistical Methods for Engineers and Scientists*, McGraw-Hill Publishing Co., New York, 1990.

#### Surface Science

Briggs, D., and Seah, M. P., *Practical Surface Analysis by Auger and X-ray Photoelectron Spectroscopy*, John Wiley & Sons, New York, 1983.

Casper, L. A., and Powell, C. J., *Industrial Applications of Surface Analysis*, American Chemical Society, Washington D. C., 1982.

#### Quality Assurance - Quality Control

Taylor, J. K., *Quality Assurance of Chemical Measurements*, Lewis Publishers, Inc., Michigan, 1987.

### List of Acronyms

<b>AAS</b>	Atomic absorption spectroscopy
<b>AES</b>	(1) Atomic emission spectroscopy, (2) Auger electron spectroscopy
<b>AFS</b>	Atomic fluorescence spectroscopy
<b>AA</b>	Atomic absorption
<b>AI</b>	Artificial Intelligence
<b>AMU</b>	Atomic mass unit
<b>ANOVA</b>	Analysis of variance
<b>ASCII</b>	American Standard Code for Information Interchange
<b>ESCA</b>	Electron spectroscopy for chemical analysis
<b>ATR</b>	Attenuated total reflectance
<b>AUFS</b>	Absorbance units full scale
<b>CC</b>	Capillary column
<b>CFC</b>	Chlorofluorocarbons
<b>CI</b>	Chemical ionization
<b>CILO</b>	Computer Integrated Laboratory Operations
<b>COV</b>	Coefficient of variation
<b>CPU</b>	Central processing unit
<b>CRT</b>	Cathode ray tube
<b>DF</b>	Degrees of freedom
<b>DOE</b>	Design of experiments
<b>DSC</b>	Differential scanning calorimetry
<b>DTGS</b>	Deuterated triglycine sulfate
<b>ECD</b>	Electron capture detectors
<b>EDS</b>	Energy dispersive X-ray Spectroscopy
<b>EI</b>	Electron impact
<b>ES</b>	Expert Systems
<b>ET</b>	External Tank
<b>FAAS</b>	Flame atomic absorption spectroscopy
<b>FAB</b>	Fast atom bombardment
<b>FES</b>	Flame emission spectroscopy
<b>FID</b>	Flame ionization detector
<b>FTIR</b>	Fourier transform infrared spectroscopy
<b>GC</b>	Gas chromatograph
<b>GC/FID</b>	Gas chromatographic with a flame ionization detector
<b>GC/MS</b>	Gas chromatography/mass spectrometry
<b>GLC</b>	Gas-liquid chromatography
<b>GSC</b>	Gas-solid chromatography
<b>HCFC</b>	Hydrochlorofluorocarbons

<b>HPLC</b>	High performance liquid chromatography
<b>IC</b>	Ion chromatography
<b>ICP</b>	Inductively coupled plasma
<b>ICP/AES</b>	Inductively coupled plasma/atomic emission spectroscopy
<b>IEC</b>	Ion-exchange chromatography
<b>IR</b>	Infrared spectroscopy
<b>IRE</b>	Internal reflection element
<b>ISS</b>	Ion scattering spectroscopy
<b>LAN</b>	Local area network
<b>LC</b>	Liquid chromatography
<b>LLC</b>	Liquid-liquid chromatography
<b>LIMS</b>	Laboratory Information Management System
<b>LHDS</b>	Laboratory Host Data System
<b>LNTB</b>	Laboratory Network Test Bed
<b>LSC</b>	Liquid-solid chromatography
<b>MAD</b>	Mean absolute deviation
<b>MAPTIS</b>	Materials and Processes Technical Information System
<b>MCT</b>	Mercury cadmium telluride
<b>MR</b>	Midrange
<b>MS</b>	Mass spectrometer
<b>NMR</b>	Nuclear magnetic resonance
<b>NPD</b>	Nitrogen-phosphorus detector
<b>NP</b>	Normal phase (LC term)
<b>NS</b>	Nonpolar stationary phase (GC term)
<b>P</b>	Polar stationary phase (GC term)
<b>PC</b>	(1) Personal computers; (2) Packed column (GC term)
<b>PMT</b>	Photo multiplier tube
<b>QC</b>	Quality control
<b>QEL</b>	Quality Evaluation Laboratories
<b>QLI</b>	Quality Laboratory Instructions
<b>QMA</b>	Quadrupole mass analyzer
<b>RDS</b>	Rheometrics dynamic spectrometry
<b>RI</b>	Refractive index
<b>RP</b>	Reverse phase (LC term)
<b>SA</b>	Solid adsorbent (GC term)
<b>SAM</b>	Scanning Auger microscopy
<b>SEC</b>	Size exclusion chromatography
<b>SEM</b>	Scanning electron microscopy
<b>SFC</b>	Supercritical fluid chromatography
<b>SIMS</b>	Secondary ion mass spectroscopy
<b>SIM</b>	Selective ion monitoring
<b>SOP</b>	Standard operating procedures
<b>SPC</b>	Statistical process control
<b>SRM</b>	Standard Reference Materials
<b>TCD</b>	Thermal conductivity detector

<b>TED</b>	Thermionic emission detector
<b>TGA</b>	Thermo-gravimetric analysis
<b>TMA</b>	Thermal Mechanical analysis
<b>UV</b>	Ultra-violet
<b>XPS</b>	X-ray photoelectron spectroscopy
<b>XRF</b>	X-ray fluorescence spectroscopy



