

1N-54-CR
NASA-4435-141641
P.83

PAX PERMANENT MARTIAN BASE

Space Architecture for the First Human Habitation on Mars

Space Architecture Monograph Series, Vol. 5

Research, Design, and Graphics

- Adam L. Demler
- Peter J. Froelich
- Andrew John Haynes
- Renee Marie Jankuski
- Scott E. Maner
- Janis Huebner-Mothes
- Kerry Lynn Paruleski
- Cory W. Peterson
- Patrick John Rebholz
- Amy Lynn Schwalbach
- Scott Patrick Starks

Teaching and Research Assistants/Authors

- Janis Huebner-Mothes
- Joseph P. Fieber
- Patrick J. Rebholz
- Kerry L. Paruleski

Instructor/Project Director/Editor

Gary T. Moore

Space Architecture Design Group
 Department of Architecture and
 Center for Architecture and Urban Planning Research
 University of Wisconsin-Milwaukee

June 24, 1992

(NASA-CR-192042) PAX PERMANENT
 MARTIAN BASE: SPACE ARCHITECTURE
 FOR THE FIRST HUMAN HABITATION ON
 MARS, VOLUME 5 (Wisconsin Univ.)
 83 p

N93-18156

Unclas

G3/54 0141641

PAX PERMANENT MARTIAN BASE:
Space Architecture for the First Human Habitation on Mars

Janis Huebner-Moths, Joseph P. Fieber, Patrick J. Rebholz & Kerry L. Paruleski (edited by Gary T. Moore).

ABSTRACT

America at the Threshold: Report of the Synthesis Group on America's Space Exploration Initiative (the "Synthesis Report," sometimes called the Stafford Report after its astronaut chair, published in 1991) recommended that NASA explore what it called four "architectures," i.e., four different scenarios for habitation on Mars. The Advanced Design Program in Space Architecture at the University of Wisconsin-Milwaukee supported this report and two of its scenarios—"Architecture 1" and "Architecture 4"—during the spring of 1992. This report investigates the implications of different mission scenarios, the Martian environment, supporting technologies, and especially human factors and environment-behavior considerations for the design of the first permanent Martian base. The report is comprised of sections on mission analysis, implications of the Martian atmosphere and geologic environment, development of habitability design requirements based on environment-behavior and human factors research, and a full design proposed (concept design and design development) for the first permanent Martian base and habitat. The design is presented in terms of a base site plan, master plan based on a Mars direct scenario phased through IOC, and design development details of a complete Martian habitat for 18 crew members including all laboratory, mission control, and crew support spaces.

**OTHER MONOGRAPHS IN THE
SPACE ARCHITECTURE MONOGRAPH SERIES**

1. *Space Architecture: Lunar Base Scenarios*, by Anthony J. Schnarsky, Edwin G. Cordes, Thomas M. Crabb & Mark K. Jacobs (edited by Edwin G. Cordes, Gary T. Moore & Stephen J. Frahm). ISBN 0-938744-59, R88-1, 1988; pp. vi + 80, illus.; \$10.00.
2. *Genesis Lunar Outpost: Program/Requirements Document for an Early Stage Lunar Outpost*, by Dino J. Baschiera & 12 others (edited by Edwin G. Cordes). ISBN 0-938744-61-5, R89-1, 1989; pp. xix + 89, illus.; \$10.00.
3. *Genesis Lunar Outpost: Criteria and Design*, by Dino J. Baschiera, Joseph P. Fieber, Timothy L. Hansmann, Janis Huebner-Moths & Gary T. Moore (edited by Timothy L. Hansmann & Gary T. Moore). ISBN 0-938744-69-0, R90-1, 1990; pp. xii + 107, illus.; \$10.00.
4. *Genesis II: Advanced Lunar Outpost*, by Joseph P. Fieber, Janis Huebner-Moths & Kerry L. Paruleski (edited by Gary T. Moore). ISBN 0-938744-74-7, R91-2, 1991; pp. xvi + 72, illus.; \$10.00.

**PUBLICATIONS IN ARCHITECTURE AND
URBAN PLANNING**

Center for Architecture and Urban Planning Research
University of Wisconsin-Milwaukee
P.O. Box 413
Milwaukee, WI 53201-0413

Report No. R92-2
ISBN-0-9-38744-79-8

Additional copies of this monograph are available for \$10.00 prepaid by writing to the above address.

EXECUTIVE SUMMARY

America at the Threshold: Report of the Synthesis Group on America's Space Exploration Initiative (Stafford, 1991; called the "Synthesis Report") recommended that NASA explore what it called four "architectures," i.e., four different scenarios for habitation on Mars.

The Advanced Design Program in Space Architecture at the University of Wisconsin-Milwaukee supported this report and two of its scenarios--"Architecture 1" and "Architecture 4"--during the spring of 1992. This Space Architecture Design Group investigated the implications of different mission scenarios, the Martian environment, supporting technologies, and especially human factors and environment-behavior considerations for the design of the first permanent Martian base.

The following report is comprised of sections on mission analysis, implications of the Martian atmosphere and geologic environment, development of habitability design requirements based on environment-behavior and human factors research, and a full design (concept design and design development) for a first permanent Martian base and habitat. The design is presented in terms of a base site plan, master plan based on the Zubrin "Mars direct" scenario phased through IOC, and design development details of a complete Martian habitat for 18 crew members including all laboratory, mission control, and crew support spaces.

Our thinking, based on an integration of the Synthesis Report and a document from the Exploration Program Office (Wheeler, 1992), suggested the likelihood of the following four mission scenarios: (1) *precursor telerobotic missions* around 1998, (2) *expeditionary landings* around 2005 to 2014 on the order of 500 days total trip time with a stay of 30 to 100 days, (3) longer duration missions on the order of 1,000 days with a typical stay time of 500 to 600 days between 2007 and 2016 to establish *human-tended outposts*, and (4) long-duration missions to establish the initial operating configuration of the first *permanent base* (IOC) between 2009 and 2022. There are significant environment-behavior issues of habitation to be explored and solved in a long-duration permanent Martian base. The focus, therefore, of our current research and design work--and this report, the fifth in the Space Architecture Monograph Series--has been on the environment-behavior determinants of a long-duration *permanent base*.

Our work built off what the Synthesis Report referred to as the Mars "Waypoint" (by which is meant Mars planetary activities for human exploration of Mars and the Solar System, i.e., as a waypoint to later exploration into the Solar System). We accepted the Synthesis Report recommendations of a crew size of 6 crew members for the initial human-tended outpost and the ExPO recommendation of a crew size of 18 for the permanent IOC base. The base is designed assuming a mostly closed-loop life support system (closed except for food, which will be produced on an experimental basis in a pair of biotrons or Martian greenhouses) and remote automatic emplacement, checkout, and verification of the habitat and life support system.

The Mars waypoint assumes significant transfer of learning from orbital and lunar facilities including evaluation of lunar habitats. Our previous work in the USRA Advanced Design Program was instructive. An early phase of our Martian work was an analysis and critique of the five lunar habitats' designed by the Space Architecture Design Group since 1989--especially the two habitats taken into design development--for positive lessons to be transferred to the design of the first Martian habitat. Additional issues considered in this report include the following: mission scenario analysis; implications of the Martian atmosphere and geologic environment; changeability, replaceability, and expandability; supporting technologies; and especially human factors and environment-behavior considerations and design requirements for permanent Martian bases and habitats.

Until recently, human and environment-behavior considerations were not viewed as significantly important elements for successful extraterrestrial exploration. Instead, science and engineering were paramount in the eyes of the designers. "There is now an increased awareness on the part of planners that design does affect behavior" (Fisher, Bell, & Baum, 1978). By studying the effects of human

¹ This critique was presented at the American Institute for Aeronautics and Astronautics Aerospace Design Conference, Irvine, California, February 1992 (Moore & Rebholz, 1992) and at the Environmental Design Research Association 22nd Annual Conference, Boulder, Colorado (by the student TAs). A set of resulting design requirements for human habitation of extraterrestrial planets was presented at the American Society of Civil Engineers' Space 92 Conference, Denver, Colorado, May 1992, and published in their proceedings (Moore, Paruleski, Huebner-Moths, Fieber, & Rebholz, 1992).

behavior in isolated and confined environments and then creating design requirements, it is expected that human factors can have a profound impact on the success of extraterrestrial space exploration.

A permanent Martian base will provide for a multi-national, multi-racial, mixed-gender crew for stay times as long as two years. The base will include mission related facilities such as research labs, mission operations workstations, airlock and dust-off chamber, storage for logistics, and life-support system. It will also contain crew-support facilities such as crew quarters, individual and group passive recreation areas, an active exercise facility, wardroom for eating or teleconferencing and meetings, hygiene facilities, health maintenance facility, as well as special places for privacy and psychological retreat.

Emphasis in our work and in this report is placed, therefore, on human factors and environment-behavior requirements that impact on habitability for long-duration habitation. A full range of issues must be investigated, from pragmatic issues of productivity and functionality to more abstract issues of imagery and symbolism. Considerations included but were not limited to anthropometric effects of 1/3rd gravity, safety, astronaut satisfaction and productivity, minimizing or alleviating stress, perceptual variety, efficiency, functionality, orientation and wayfinding, perceptual variety, efficiency, functional convenience, and place and identity--the quality of "home."

A modular space frame construction system will provide the protective shelter for the habitat itself, called Pax (for the international Peace Settlement, opposite of the Latin name of the planet, Mars, the God of War), situated at the middle of a north-south axis to the base as a whole. This framing system will combine open square and triangular geometries to produce a roof and column support system. The proposed frame system is a kit of components, redundant in size and shape, that will allow the astronauts relative ease of construction. The system will consist of a structural space frame, column support system, textile regolith containment and radiation shielding system, and Martian regolith.

The habitat, or central portion of Pax, will be constructed in several stages. Construction can commence when two rigid modules and six crew members are on site, and their equipment, rovers, and logistics are in place. Additional modules and their crew will arrive, bringing the full complement of rigid modules to four, and the number of crew members to twelve.

It is proposed that the final habitat, at IOC, will be comprised of five operational modules, each two floors in height: a 9-m hard-module entry module for dust-off, suit stowage and maintenance, and full recreation and exercise center in the lower level; two 12-m inflatable modules, one for laboratories and mission command and the other for crew quarters and the crew support facility; and two additional 9-m hard modules serving as two Martian greenhouses. The last hard module, part of the initial deployment, will be transferred elsewhere on the Martian surface as a hazardous laboratory.

Design development of all the interior habitat spaces--laboratories, mission control spaces, greenhouses, and all crew quarters and support spaces--makes up the majority of this report.

In conclusion, several critical design features of Pax are summarized, together with major strengths and limitations of this design and directions for future research and design development.

PREFACE AND ACKNOWLEDGEMENTS

Faculty and students of the University of Wisconsin-Milwaukee School of Architecture and Urban Planning (UW-Milwaukee) have been actively involved in the research, analysis, and design of extraterrestrial environments since 1987. In 1987 the School began working with the Astronautics Corporation of America, a worldwide aeronautics and aerospace company headquartered in Milwaukee, to define space design issues and criteria. In the fall of 1987, the Department of Architecture offered its first studio in "Space Architecture: Lunar Base Scenarios." The studio resulted in the first of our Space Architecture Monograph Series (Schnarsky, Cordes, Crabb & Jacobs, 1988). The School's Center for Architecture and Urban Planning Research (CAUPR) hosted a series of lectures and workshops by leading members of the aerospace industry and nationally recognized experts, made slide and video presentations at national meetings including the 3rd through the 8th Annual Summer Conferences of the Universities Space Research Association and wrote a series of articles about space research and design (e.g., Schnarsky, 1988).

In 1989 CAUPR was awarded a \$115,000, three-year grant from NASA/Universities Space Research Association (NASA/USRA) to conduct an Advanced Design Program in Space Architecture. Created as a result of that grant, the Space Architecture Design Group has been responsible for research and technical papers, lectures, talks, and exhibits at local, state, and national conferences, and has received six research and design awards (for a complete listing of available publications, please see Appendix B). We have subsequently been awarded a minimum three-year sustaining grant from USRA for the 1992-95 period.

A selected group of 29 environment-behavior and human factors issues formed the basis for the Martian base design for 1991-1992. The issues selected have their origins in previous design work and research of lunar bases completed by the Space Architecture Design Group. This report summarizes those issues, discusses the design criteria, and presents a design proposal, named *Pax*, based upon accumulated research and design trade studies.

The Space Architecture Design Group would like to express appreciation for the continued support, encouragement, and opportunities the Advanced Design Program (ADP) has provided. We thank NASA and USRA for sponsoring the project, and Vicki Johnson, ADP Director, Barbara Rumbaugh, ADP Administrator, and their staff, for their contin-

ued support, and our growing array of Mentors and colleagues at NASA Johnson Space Center, including John Connolly, Kris Kennedy, Wendell Mendell, Deborah Neubek, and Michael Roberts, for their advise and insights. Our thanks also to Brent Hellickson, Mark Galertner, and Cheri Morrow of the University of Colorado, Michael Pogue of Johnson Engineering, and Marc Cohen of NASA-Ames Research Center, whose critiques of our lunar work very much influenced the current work. We would like to thank the following for critical feedback and suggestions during the project:

Edward Beimborn, UW-Milwaukee Department of Civil Engineering
Uriel Cohen, UW-Milwaukee Center for Architecture and Urban Planning Research
John Connolly, Planet Surface Systems Office, NASA Johnson Space Center
Vincent A. Cronin, UW-Milwaukee Department of Geosciences
Robert Greenstreet, UW-Milwaukee School of Architecture and Urban Planning
Mary Guzowski, UW-Milwaukee Department of Architecture
Thomas Hubka, UW-Milwaukee Department of Architecture
Calvin Huber, UW-Milwaukee Department of Chemistry
Robert A. Jones, UW-Milwaukee Graduate School Office of Research and Sponsored Programs
Thomas A. Kaminski, Astronautics Technology Center, Astronautics Corporation of America
Michael Roberts, Design Systems Office, NASA Johnson Space Center
Douglas C. Ryhn, UW-Milwaukee Department of Architecture
Irvin Ross, UW-Milwaukee Office of Industrial Research and Technology Transfer
Kathryn Scott, Design Resource Center
Mark Sothmann, UW-Milwaukee Department of Human Kinetics
Dale Thomas, UW-Milwaukee Office of Industrial Research and Technology Transfer

We would like to acknowledge the continuing support of local television, news media, and publications personnel. With their efforts, the Advanced Design Program has continued to generate enthusiasm for the space program and its benefits within academic and public audiences. The NASA/USRA Teaching Assistants and Faculty Advisor for 1991-1992 would like to express appreciation to the Spring Space Architecture Design Studio for their diligence in the pursuit of research, creativity, and design, toward the final product, *Pax*.

Janis Huebner-Mothes, Joseph P. Fieber, Patrick J. Rebholz, Kerry L. Paruleski
NASA/USRA Teaching Assistants

Gary T. Moore
Faculty Advisor and Project Director

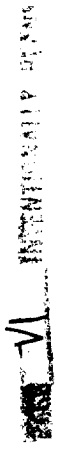

TABLE OF CONTENTS	
EXECUTIVE SUMMARY	iii
PREFACE AND ACKNOWLEDGEMENTS	v
LIST OF TABLES AND FIGURES	ix
1. OBJECTIVES	1
1.1 Mars Mission Scenarios	1
1.2 Mars Environment	1
1.3 Human Factors and Environment- Behavior Considerations	1
1.4 Changeability, Replaceability, and Expandability	2
2. PROCEDURE	3
2.1 Organization/Mission Scenario	3
2.2 Base Design Research	3
2.3 Concept Design Exploration	4
2.4 Habitat Design Research and Requirements	4
2.5 Habitat Schematic Design	4
2.6 Interior Design Development	4
2.7 Design Integration and Presentation	4
2.8 Presentations and Reports	6
3. DESIGN ISSUES AND REQUIREMENTS	7
3.1 Mars Mission Scenario	7
3.1.1 Published Scenarios	7
3.1.2 Mission Scenario Integration	9
3.2 Character of the Martian Environment	10
3.2.1 Surface and Atmospheric Analysis	10
3.2.2 Radiation and Radiation Shielding	12
3.2.3 Martian Gravity and Reduced Gravity Effects	13
3.2.4 Site Planning Considerations	13
3.3 Human Factors and Environment- Behavior Considerations	14
3.3.1 Anthropometrics	14
3.3.2 Personalization and Productivity	15
3.3.3 Environmentally-Induced Stress	16
3.3.4 Interpersonal Space and Territoriality	16
3.3.5 Optimal Circulation	17
3.3.6 Efficiency, Functionality, and Spatial Variety	18
3.3.7 Zoning	21
3.3.9 Sense of Arrival, Sense of Place	25
3.4 Changeability, Replaceability, and Expandability	25
3.5 Special Considerations	26
3.5.1 Color	26
3.5.2 Lighting	27
3.5.3 Materials	27
4. PAX: PERMANENT MARTIAN BASE	29
4.1 Site Selection	29
4.2 Site Planning	29
4.3 Master Plan and Construction Sequence Including Expansion Capabilities	30
4.4 Permanent Base Initial Operating Configuration	33
4.4.1 Habitat Design Organization	33
4.5 Habitat Components	40
4.5.1 Entry Module	41
4.5.1.1 Central Entry, Dust-off, Suit Stowage, and Maintenance	41
4.5.1.2 Active Group Recreation Area	42
4.5.1.3 Exercise Facility	42
4.5.2 Laboratory/Mission Operations Module	43
4.5.2.1 Mission Control	43
4.5.2.2 Research Laboratories	45
4.5.2.3 Health Maintenance Facility	46
4.5.3 Crew Support Module	47
4.5.3.1 Wardroom	47
4.5.3.2 Galley	47
4.5.3.3 Group Recreation Area	48
4.5.3.4 Laundry	48

PRECEDING PAGE FILMED

4.5.3.5 Crew Quarters49
4.5.3.6 Personal Hygiene Facilities50
4.5.4 Greenhouse Modules52
4.5.4.1 Carbon Dioxide Greenhouse53
4.5.4.2 Oxygen Greenhouse53
4.5.4.3 The Chapel53
4.5.4.4 The Library54

5. SUMMARY AND CONCLUSIONS57

5.1 Critical Design Features of Pax57
5.1.1 Site Selection57
5.1.2 Base Layout57
5.1.3 Habitat Basic Concept57
5.1.4 Construction Sequencing57
5.1.5 Overall Design Organization of the Habitat58
5.1.6 Interior Design including Considerations
of Color, Lighting, and Materials59
5.2 Major Strengths and Limitations of the Design59
5.3 Areas for Future Research and Design Development61

APPENDICES65

Appendix A: Space Architecture III
Design Studio Description 65
Appendix B: Monographs, Reports, and
Papers on Aerospace Architecture 69

REFERENCES73

LIST OF TABLES AND FIGURES

Figure 2-1	The 1992 timeline.	Figure 3.3.5-2	The principle of clear circulation.
Figure 3.1.1-1	A summary of three published Mars scenarios.	Figure 3.3.5-3	Circulating through a continuous pathway will allow a crewmember the ability to take a walk through the Martian habitat.
Figure 3.1.2-1	A recommended integration of previously published Mars scenarios.	Figure 3.3.6-1	Efficiency will allow the base all needed functions, but with reduced space and mass.
Table 3.2.1-1	Martian Atmospheric Composition.	Table 3.3.6-1	Square Meterage of Lunar Base Proposals.
Table 3.2.1-2	Comparative Facts between Earth and Mars	Figure 3.3.6-2	Convenience and functional proximity should lead to efficiency in space and functional performance.
Figure 3.2.1-1	Diagram of Martian wind convections.	Figure 3.3.6-3	Spatial variety can create different feelings within spaces, and help avoid monotony throughout the habitat.
Figure 3.2.1-2	Martian surface temperatures.	Figure 3.3.7-1	Quiet and noisy spaces should be separated to ensure crew satisfaction.
Figure 3.2.1-3	Distinctive streaks on the martian surface. The dark areas represent wind erosion, light centers where bright, fine particles deposit and collect (assumptions based on wind tunnel simulations).	Figure 3.3.7-2	The overlay of the noisy to quiet and public to private gradients. The proposed spaces and functions necessary for human habitation support are placed upon the gradients.
Figure 3.2.1-4	Channel network on Martian surface.	Figure 3.3.7-3	Bubble diagrams emerge when two functional spatial zoning gradients are overlapped.
Figure 3.2.1-5	Poona Crater. One of several types of craters found on the Martian surface.	Figure 3.3.7-4	Adjacency matrix for required Martian habitat spaces.
Figure 3.3.1-1	Projected body size of a 40-year old Japanese female in the year 2000.	Figure 3.3.9-1	A sense of arrival is important in distinguishing between circulation and functional space.
Table 3.3.1-1	Anthropometric Changes Between 0-G and 1-G.	Figure 3.3.9-2	A sense of place is critical in portraying a particular atmosphere.
Figure 3.3.1-2	Projected body size of a 40-year old American male in the year 2000.	Figure 3.4-1	The use of modular partitions and racks increases the flexibility of a martian habitat.
Figure 3.3.3-1	An example of architecturally induced stress is excessive noise and vibration.	Figure 4.1-1	Viking 2 mission location at 45° north latitude, 251° west longitude.
Figure 3.3.5-1	Dual egress points are necessary safety precautions in the event of operational failure or environmental atmospheric threat to human safety.	Figure 4.2-1	Pax base site plan.

Pax Permanent Martian Base

Figure 4.3-1	Phase one of the Martian base construction. Six astronauts will prepare the habitat site.	Figure 4.4.1-8	Bringing a sense of "home" to Mars could be considered an important factor for the crew.
Figure 4.3-2	The footprint of the Martian habitat is excavated.	Figure 4.4.1-9	A sense of place is important in identifying and reacting accordingly to spaces.
Figure 4.3-3	The space frame and regolith habitat shelter is assembled.	Figure 4.4.1-10	The habitat is comprised of three 9 m hard modules and two 12.6 m inflatables. Each module contains two levels.
Figure 4.3-4	Laboratory and crew support modules are emplaced and inflated.	Figure 4.4.1-11	Axonometric drawing of main floor (entry level) of <i>Pax</i> , illustrating the embracing entry (center) and separation of laboratories from crew support facility (lower-left to upper right). The greenhouse modules are on the upper left.
Figure 4.3-5	Rigid entry module is emplaced and the primary entrance airlock for the habitat is attached.	Figure 4.4.1-12	Axonometric drawing of the upper floor of <i>Pax</i> , illustrating the central focus and group interaction space in each module and the creation of a sense of place and homelike environment in all spaces.
Figure 4.3-6	Dedicated greenhouse facilities will be placed underneath the shelter system.	Figure 4.4.1-13	Axonometric of the lower level of the entry module (one level down from the entry level). Contained within is the active group recreation area and exercise facility.
Figure 4.3-7	Final components of the habitat are emplaced--logistics support module and lab airlock.	Figure 4.5.1.1-1	Floor plan of the habitat, level one. Threesmaller modules contain the entry space and the greenhouse facilities. The two larger modules support the crew and laboratory functions. A logistics module and two airlocks complete the habitat plan.
Figure 4.3-8	Perspective view to the southeast of the completed habitat and shelter system.	Figure 4.5.1.1-2	Entrance and transition point for circulation and EVA functions; the main entry and airlock are to the right, translation platforms to the lower recreation level to the left, and suit stowage around and behind the half-spiral staircase.
Figure 4.4-1	Model representation of <i>Pax</i> .	Figure 4.5.1.2-1	Floor plan of the lowest level of the habitat--the active recreation area and exercise facility of the entry module. Note: While each module has two levels, only the entry module is set lower in the Martian surface so that entry is on the second level of this module, with the astronauts going down into the exercise and recreation center in the "basement" of the habitat.
Figure 4.4.1-1	Diagram of module emplacement to create a focal, embracing entry.		
Figure 4.4.1-2	Massing model of <i>Pax</i> showing set-back feature of module emplacement.		
Figure 4.4.1-3	In elevation, a model of <i>Pax</i> shows the concept of an embracing entry.		
Figure 4.4.1-4	By separating the work space from the living space, a sense of going to "work" and returning "home" may be afforded.		
Figure 4.4.1-5	Variety and efficiency of circulation paths are suggested.		
Figure 4.4.1-6	For efficiency and safety, dual egress should be incorporated into extraterrestrial habitats.		
Figure 4.4.1-7	Focal points are created at a central location within the habitat volumes.		

Figure 4.5.1.2-2	View of the active recreation area and juice bar with half-wall partitioning separating functions yet allowing visual contact with other crewmembers. Level changes demarcate the recreation area from the exercise reduced gravity countermeasure facility. Various methods of lighting allow the crew to control the spatial ambiance.	Figure 4.5.3.1-1	The wardroom is a gathering space of the entire crew for formal, communication, and social occasions. It seats 18, but the tables can separate for smaller groups for meals, cards or games, or individual pursuits.
Figure 4.5.1.3-1	The exercise facility will provide a range of exercise countermeasure stations. Individually controlled ventilation systems will provide cooling during workouts.	Figure 4.5.3.2-1	The galley is designed for ease of food preparation and maintenance, ample stowage, three separate workstations and mobile islands.
Figure 4.5.2.1-1	Floor plan of the upper level of the laboratory/mission operations module. The conference room and three mission control workstations are in the bottom segments of the plan.	Figure 4.5.3.3-1	View from the recreation area across the vegetation planter toward the wardroom.
Figure 4.5.2.1-2	Mission operations as viewed from the vertical translation area. The individual workstations are to the left, the briefing room to the right. The workstation areas combine general lighting and task lighting.	Figure 4.5.3.3-2	Casual recreation area will promote social interaction in a comfortable setting.
Figure 4.5.2.1-3	Mission control conference and briefing area. Monitoring screens allow visual access to several habitat areas as well as base functioning and surface operations. A large table allows half the crew at a time (one shift of 9) to review and coordinate mission activities.	Figure 4.5.3.5-1	Upper level floor plan of the crew support module—the crew quarters and PHIFs.
Figure 4.5.2.2-1	Floor plan of the main level of the laboratory module showing (from lower center, clock-wise) the general, chemistry, and biology labs, the HMF, and the microbiology labs.	Figure 4.5.3.5-2	Overhead view of a single crew quarter. The components can be easily moved to allow for personalization of the space by the crewmember.
Figure 4.5.2.2-2	View into the laboratories: common work surfaces visually divide the spaces; ample stowage is provided for equipment and within easy access to the crewmember. General lighting in the ceiling will be augmented by specialized task lighting at various workstations.	Figure 4.5.3.5-3	A shared crew quarter as viewed from the entrance to the space. Beds are lofted to provide additional floor space. Stowage compartments, on a modular system, are flexible and allow for room rearrangement.
Figure 4.5.3-1	Main level floor plan of the crew support module. This level consists of a wardroom, galley, and group recreation space.	Figure 4.5.3.6-1	One of the pair of personal hygiene facilities.
Figure 4.5.3-2	Primary circulation pathway through the main level of the crew support module. On the left is the entrance to the group recreation area (first) and the galley and on the right is the wardroom with capacity to seat the entire crew.	Figure 4.5.3.6-2	The transition space between the lower level and the private level of the crew module is accomplished by the use of a curved staircase. The entry to this zone is highlighted by a two-level-high ceiling.
		Figure 4.5.3.6-3	Circulation space alongside the crew quarters and visual access is permitted into the green space the recreation level below.
		Figure 4.5.4-1	Floor plan of the upper level of the two greenhouse modules. Greenhouse accessibility is from the primary circulation space of the crew support module (upper level) and the botany labs of the laboratory module (upper level).

Figure 4.5.4-2 The plant growth racks provide high density plant growth.

Figure 4.5.4.3-1 The chapel in the greenhouse allows for meditation and reflection for crew members from a variety of religious beliefs.

Figure 4.5.4.4-1 The library will provide a space to study, relax, and enjoy the growing environment.

Figure 4.5.4.4-2 Floor plan of the lower floor of the two greenhouse modules, showing the carbon dioxide greenhouse with central work area on the left, and the oxygen greenhouse with central library on the right.

1. OBJECTIVES

In 1991, the National Space Council published *America at the Threshold: Report of the Synthesis Group on America's Space Exploration Initiative* (Stafford, 1991; referred to as the "Synthesis Report"). That report recommended that NASA explore what it called four "architectures," four different scenarios for habitation on Mars based on lunar exploration and habitation.

For the spring of 1992, the Advanced Design Program in Space Architecture at UW-Milwaukee supported that report and its four scenarios, specifically "Architecture 1" and "Architecture 4." The purpose of this project was to research design, and offer a proposal to NASA for a first Martian permanent base and habitat.

Rather than responding to all the issues that ultimately would have to be considered in the design of a mature Martian base, and based on a self-critique of our last two years' work and very helpful suggestions from colleagues around the country, we decided to focus on human/environmental considerations of Martian base design. Three other sets of issues were investigated to less depth. The objectives, therefore, were to investigate and design in response to the following:

- Mars mission scenarios
- Mars environment
- human factors and environment-behavior considerations
- changeability, replaceability, and expandability

1.1 MARS MISSION SCENARIO

A Mars mission scenario outlines the activities that will occur in getting to Mars, and what will be done there. Scenarios are divided into four phases of development, beginning with precursors and continuing to a permanent Martian base. The objectives in this portion of the report will be to outline and then integrate different scenarios for getting to and staying on Mars.

1.2 MARS ENVIRONMENT

The Martian environment will have a great impact on the design of any habitat, its infrastructure, and the activities that occur in and around

it. The "environment" includes factors such as atmospheric considerations, radiation, altitude, soil composition and temperature.

Key environmental issues that will determine the location and character of a Martian base include the presence of water, distance from the origin of dust storms, elevation, geologic features, and surface conditions. All of these will impact the safety of the base and crew and the possibilities of scientific gain from the mission.

1.3 HUMAN FACTORS AND ENVIRONMENT-BEHAVIOR CONSIDERATIONS

Until recently, human and environment-behavior considerations have not been viewed as significantly important elements for successful extraterrestrial exploration. Science and engineering were paramount in the eyes of designers. "There is now an increased awareness on the part of planners that design does affect behavior" (Fisher, Bell, & Baum, 1978). By studying the effects of human behavior in isolated and confined environments and then creating design requirements, it is expected that human factors can have a profound impact on the success of extraterrestrial exploration.

A permanent Martian base will provide for a multi-national, multi-racial, mixed-gender crew for stay times as long as two years. The base will include mission related facilities such as research laboratories, mission operations workstations, airlock and dust-off chamber, storage for logistics, and life-support system. It will also contain crew-support facilities such as crew quarters, individual and group passive recreation areas, an active exercise facility, wardrobe for eating, teleconferencing and meetings, hygiene facilities, and a health maintenance facility, as well as special places for privacy and psychological retreat.

Emphasis in our work and in this report is placed on human factors and environment-behavior (HF/EB) requirements that impact on habitability for long-duration habitation. A full range of issues will be investigated, from pragmatic issues of productivity and functionality to more abstract issues of imagery and symbolism. Considerations included but were not limited to anthropometric effects of 1/3rd gravity, safety, astronaut satisfaction and productivity, minimizing or alleviating stress, social interaction and privacy, orientation and wayfinding, perceptual variety, efficiency, functional convenience, and place and identity--the quality of "home."

Though Martian bases have not been explored in any detail to date, a number of lunar base designs have appeared in technical publications (Alred, 1989; Capps & Moore, 1990; Graf, 1988; Lin, Senseney, Arrp, & Lindbergh, 1988; Moore, Baschiera, Fieber, & Moths, 1990; Moore et al., 1991; Namba, Yoshida, Matsumoto, Sugihara, & Kai, 1988; Nowak, Sadeh, & Janakus, 1992; Richter, Drake, Kumar, & Anderson, 1990; Thangavelu, 1991; Vanderbilt, Criswell, & Sadeh, 1988). The vast majority of these have been driven by mass efficiency and cost containment, adaptation of current technology, or structural considerations, not by detailed analyses of human factors/environment-behavior considerations. Yet, as Clearwater and Harrison (1990; cited in Cohen & Brody, 1991) point out, the temptation to trade cost or structural efficiency for habitability would be a major mistake. Substantial concern has been expressed about the biological needs of astronauts, including radiation and reduced-gravitational exposure (e.g., Nicogossian & Parker, 1982). In contrast, relatively little research and design consideration has been given to psychological and social adjustment to space. It is becoming increasingly acknowledged, however, that psychological and social factors are important determinants of the success or failure of extraterrestrial missions (Connors, Harrison, & Akin, 1985).

Our research since 1989, and our continued approach as explored in this project, has investigated the effect of elevating human factors and environment-behavior criteria in extraterrestrial habitat design (Moore, 1990; Moore et al., 1990, 1991; Moore & Huebner-Moths, 1991; Moore & Rebholz, 1992; Moore, Paruleski, Huebner-Moths, Rebholz, & Fieber, 1992).

A sizable amount of research has been published, conducted, or supported by NASA documenting important findings on habitability design from the human factors, psychological, sociological, and environment-behavior points of view (e.g., Connors et al., 1985; Clearwater, 1985, 1987; Clearwater & Harrison, 1990; M. Cohen, 1990; Cohen & Brody, 1991; Cordes & Moore, 1990; Harrison, Caldwell, & Struthers, 1988; Harrison, Sommer, Struthers, & Hoyt, 1988; Hewes, Spady, & Harris, 1966; Moore, 1990; Stuster, 1986). It is not the purpose of this report to present additional empirical findings, nor to review and criticize the literature to date. A primary purpose, however, is to begin the process of extracting design-relevant requirements from this literature and show their impact on Martian base design.

1.4 CHANGEABILITY, REPLACEABILITY, AND EXPANDABILITY

Changeability, modularity, replaceability, and expandability are crucial factors in the design of a Martian or any other extraterrestrial base. Modularity and replaceability not only allow ease of construction, but can contribute to the ability to easily adapt the base to changing functions over time. If the reorganization of spaces is made easy, expansion of the base becomes simpler. Allowing the crew to change the space around them will create an environment that is comfortable and may contribute to lessened stress and increased productivity. Including these factors in the design of any base and habitat will assure needed flexibility that will positively influence both the form and the function of the mission.

2. PROCEDURE

The Synthesis Report presented two mission durations for Mars exploration: long-duration missions on the order of 1,000 days with a typical stay time on Mars of approximately 500 days (1-1/3rd years, 16-17 months), and short-duration missions on the order of 500 days with a 30 to 100 day stay on Mars (1-3 months). Our thinking lead us to believe that there were significant architectural, habitation, and environment-behavior issues to be explored and resolved in a long-duration permanent Martian habitat that would contain research work stations and crew living quarters. Reviewing other published mission scenarios (Stafford, 1991; Weaver, 1992; Zubrin, Baker & Gwynne, 1991) also lead us to believe that an initial short-duration outpost will quickly be followed by one or more exploratory long-duration outposts, which in turn will be followed by a permanent long-term base. The focus of our work for 1992, therefore, was on a long-duration permanent base.

Our work built off what the Synthesis Report referred to as the Mars "Waypoint" (by which is meant Mars planetary activities for human exploration of Mars, i.e., as a waypoint to later exploration into the Solar System). Phasing the development of a permanent base, we accepted the Synthesis Report recommendations of a crew size of 6 crew members for an initial human-tended outpost for change-out durations of 500 to 600 days on the Martian surface. The first permanent base, termed *initial operational configuration* (IOC), would be accomplished by repeating the mission via a revisit of a previously explored site, emplacement of one additional 6-person outpost, and then development of a permanent base for long-duration missions with stays on the order of 500 to 600 days or longer, and this time for multiples of 6 crew members, likely a full crew of 18 crew members.

The Mars waypoint assumes significant transfer of learning from orbital and lunar facilities including utilization of lunar in-situ resources and evaluation of lunar habitats. Our work in Years 1 and 2 of the USRA Advanced Design Program is thus very instructive. An early phase of our Martian work was an analysis and critique of the five former lunar habitats-- especially the two alternatives taken into detailed schematic design--for positive and negative lessons to be transferred to the design of a Martian habitat. The Synthesis Report

recommended that the Mars habitat would be tested as a prototype on the Moon. As our previous work started with the Moon (see the four previous monographs in this series, listed in Appendix B), we expanded from our lunar knowledge base and lunar habitat design experience to generate alternatives for Martian habitation.

Thus, in the spring of 1992, the Space Architecture Design Studio designed a permanent, long-duration base for the surface of Mars. Subsequently named *Pax* (for the international Peace Settlement, opposite of the Latin name of the planet, *Mars*, the God of War), this first Martian permanent base will be capable of providing housing, research space, mission control space, and all amenities for 18 astronauts to live on Mars for durations up to two years.

The work was accomplished in an overlapping sequence of eight principle phases, as shown in the time line of Figure 2-1.

2.1 ORGANIZATION/MISSION SCENARIO

Analysis of alternative mission scenarios. As there are significant differences in the literature (Stafford, 1991; Weaver, 1992; Zubrin, et al., 1991), we elected to develop an integration of the commonalities between the three most prominently discussed mission scenarios (2 weeks-- January 6-21, 1992).

2.2 BASE DESIGN RESEARCH

Detailed scenario presentation followed by background research and development of design requirements on overall base design. A range of base design issues were explored (e.g., implications of the Mars environment) relevant to site selection, size and character of the site, site design, master plan, and sequencing of phases to IOC and NOC. Other issues were explored relevant to overall configuration of the site plan (siting of the habitat, solar array field, methane production facility, wind power facility, launch and landing facility, vehicle storage and maintenance facility, nuclear power plan, and transportation infrastructure; 3 weeks--January 23-February 11).

2.3 CONCEPT DESIGN EXPLORATION

Schematic design studies to develop and explore different base layout master and site planning concepts. The implications of four alternative concept designs for the base as a whole were explored, analyzed, and then compared at an internal preliminary design review (PDR—January 30):

- hard module habitat, partially buried and partially in the edge of a Martian crater
- inflatable habitat, partially buried and partially in the edge of a Martian crater
- Earth-like technology for Martian surface application
- space-frame construction spanning between crater edges

From the late-January PDR, considerable advantages were found for surface construction with a combination of hard module and inflatable structures (2-1/2 weeks-- January 24-February 11).

2.4 HABITAT DESIGN RESEARCH AND REQUIREMENTS

- Accomplished in two parts:
- literature research on the full range of human factors and environment- behavior considerations in habitat design, including but not limited to crew quarters, crew support facility, mission operations, research workstations, biosphere, wardroom, recreation spaces, hygiene facility, and research laboratories;
 - development of design requirements based on accumulated research (3 weeks-- February 4-20).

2.5 HABITAT SCHEMATIC DESIGN

Schematic designs developed for each space (laboratories, crew quarters, etc.) in response to the design requirements. Design directions and objectives were established for the complete schematic design of each activity space, the habitat as a whole, and the base site

and master plan. Design attention was paid, however, to the habitat interior design in order to respond most directly to the human factors and environment-behavior requirements. Following an internal PDR (March 3), a formal intermediate design review (IDR) was conducted (April 3) to review the results of individual schematic designs and set priorities for the continuing work. Special guest reviewers from the UW-Milwaukee Department of Architecture, from the local profession, and from NASA- Johnson Space Center offered critical comments and recommendations for continued design development (7 weeks--February 13-April 3).

2.6 INTERIOR DESIGN DEVELOPMENT

Design development of all interior spaces, refinement of design details, response to raised criticisms, and beginning of integration across the habitat as a whole. The layout of the base site and master plan were refined and solidified during this time. The overall conceptual design for the habitat as a whole, in response to a set of environment-behavior derived design principles, was integrated at this time. The final designs for each module and their subspaces was refined and consolidated. A not-quite-final design review (NQFDR, April 16) was conducted of the design development to identify areas needing fine-tuning (e.g., materials handling within the laboratories) and issues of integration across the habitat or base as a whole (e.g., lighting, color and material selection and coordination; 6 weeks-- March 5-April 16).

2.7 DESIGN INTEGRATION AND PRESENTATION

In response to this final, internal self-evaluation, final design development and design integration occurred. The presentation of the results of the project--in mid-fidelity models for each floor of each module with lighting, colors, and textures, a mid-fidelity model of the habitat and regolith-containment space- frame structure, and drawings of site selection, site plan, and construction sequence to IOC and NOC--was developed. Slides were taken of all models and drawings, and of diagrams to explain the environment-behavior bases of habitat and base design (3 weeks--April 16- May 7).

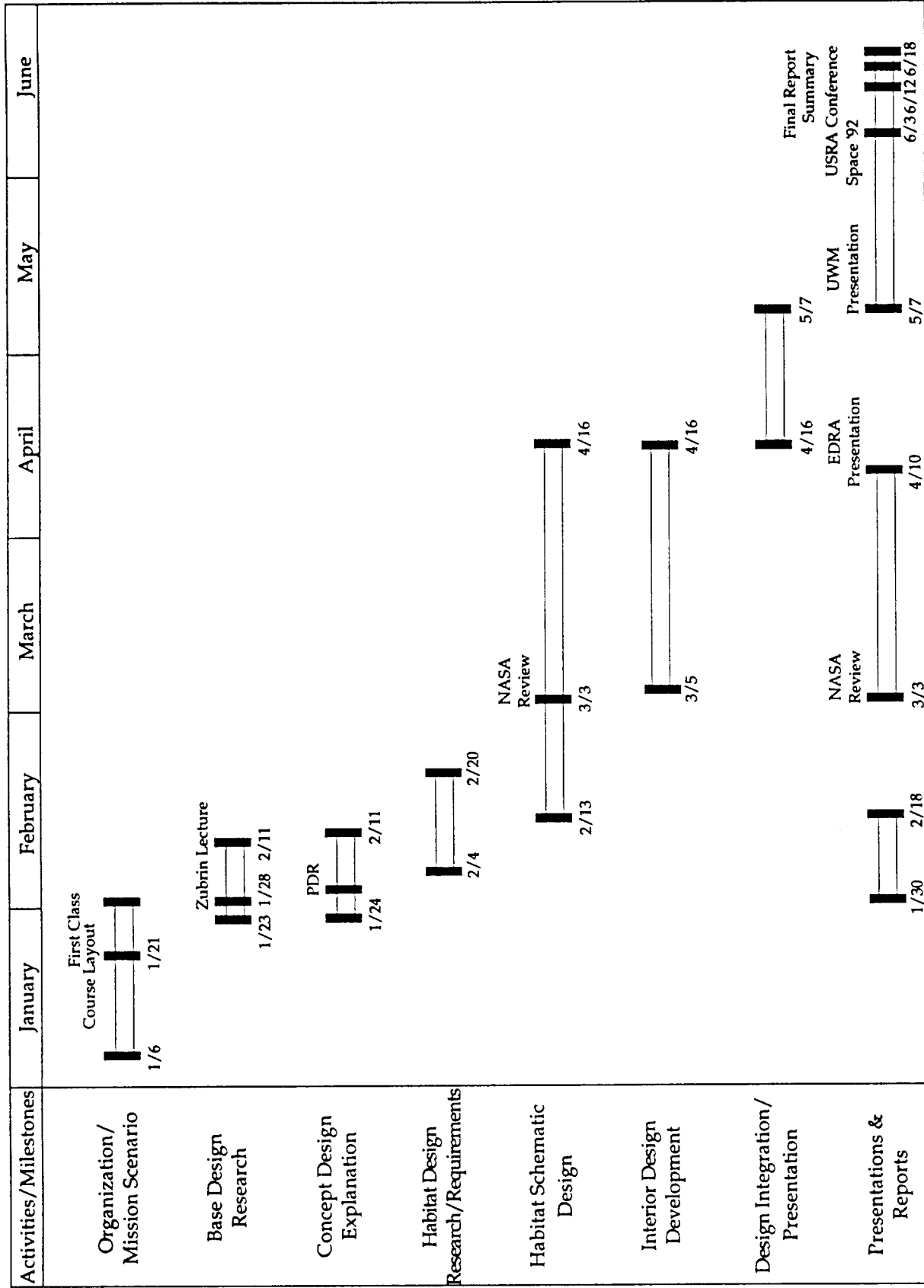

Figure 2-1. The 1992 timeline.

2.8 PRESENTATIONS AND REPORTS

Preliminary reports were written during the project and were reviewed at the NASA PDR and other times. The final product is a slide presentation based on photographs of large take-apart models, together with this final report. The project was and will be reviewed on several occasions in different forums: final internal design review at UW-Milwaukee School of Architecture and Urban Planning, invited presentation at the American Society of Civil Engineers Space 92 Conference in Denver and at the Annual NASA/USRA Summer Conference in Washington, D.C., and exhibition at the Wisconsin Space Conference.

3. DESIGN ISSUES AND REQUIREMENTS

3.1 MARS MISSION SCENARIO

A *scenario* is an outline of the sequence of activities that will take place in the exploration of the Martian planet. Scenarios consist of a complex set of issues, organized to achieve mission goals. The study of existing scenarios created a base for the scenario leading to *Pax*.

3.1.1 PUBLISHED SCENARIOS

The first scenario studied is the scenario of Zubrin, Baker, and Gwynne (1991). This scenario, called "Mars direct," is primarily directed at the exploration of Mars.

Its plan focuses on exploring Mars to decrease the cost of the Space Exploration Initiative. Over 200 assemblies in low-Earth orbit (LEO) would be needed to recoup the expenses of a LEO construction infrastructure. Therefore, there is no construction in LEO in the Mars direct *scenario*. Secondly, missions to Mars are limited to ones that provide maximum scientific return. A third suggested way to decrease costs is extensive in situ resource utilization in all missions.

The Mars direct scenario assumes that transportation from Earth to Mars can be accomplished in steps. With the use of a Aries heavy-lift launch vehicle (HLLV), equipment and crew can be lifted into orbit and put on the journey to Mars without assemble in LEO. There will be two launches for every mission to Mars—the first a cargo mission, followed by the crew in approximately two years. The two flights will be aerobraked to the surface of Mars.

The cargo missions will consist primarily of a habitat, nuclear power plant, and in situ fuel production capabilities. The inclusion of fuel production is to lower the costs of the mission. This produced fuel will supply ground transportation, the ascent vehicle, and Earth return transportation.

The second launch will place the crew in direct transit to Mars with a short travel time to minimize the high radiation effects of space travel.

There are two basic flight classes: conjunction and opposition. The basic properties of the conjunction class is longer total mission time, longer surface stays, and lower Earth to LEO masses. The

opposition class has a longer flight time with larger masses needed in LEO. Various reasons are given by Zubrin et al. for the choice of the conjunction class for Mars missions:

- smaller delta-V (velocities)
- lower radiation effects by shortening the duration of space travel
- unknown Og affects on the body are minimized
- time spent exploring the planet surface is 15 times greater than the opposition class trajectory

In the Mars direct scenario, the first crew could launch from Earth in 1999. Upon reaching Mars, the crew of four will have a surface stay for 600 days (approximately). Exploration will be done with combustion engines, supplied with fuel from a precursor mission employed production plant that will have been making fuel for two years.

Progression past this to a permanent base is only suggested. It is stated that future missions could connect habitats to provide a larger surface presence.

The second scenario studied is the Synthesis Report, *America at the Threshold* (Stafford, 1991). This government-funded report discusses the options for America's Space Exploration Initiative. It broadly proposes all possible aspects of America's involvement in space over the next 30 years.

Two Mars scenarios are defined in this report. Between them there are several commonalities; closed-loop life support systems, and lowering the cost of missions by lowering logistics demands.

A Synthesis Report mission proposes placing humans on the surface of Mars for approximately 30 to 100 days. This stay is created from an opposition trajectory.

The report addresses the pragmatic issues of their Martian scenario. The first human presence on Mars is suggested to be 2014. The mission will be a opposition class flight. After two of these missions, conjunction class missions will be used to increase exploration capabilities.

The habitation waypoint suggests requirements for different levels of human presence on the surface. The first requirements are for the closure of life support systems. Essentially, when a permanent base is achieved on a planet surface, the systems should be closed with the exception of food which will only partial closed. The closure of food cycles demands large amounts of growing volume. The second requirement is the size of the crew for particular missions. Missions less than six months will have crews of six, while missions

Pax Permanent Martian Base

up to two years will have a crew of 12. Later missions with stays of two years, will have crews of 20 to 24.

A third scenario was presented at the NASA-JSC ExPO Technical Interchange Meeting on January 7, 1992 was entitled "SEI Reference Mission" (Weaver, 1992). It concentrates on lunar human presence, but is applicable to Martian scenarios.

This third scenario presents staged development similar to the above-mentioned Mars scenarios. At the "human-tended" stage, the surface stay duration is similar to the opposition-class mission to Mars. It recommends a crew of four to seven. These numbers are congruent with the Mars direct and Synthesis Report scenarios. The next stage of human presence echoes *America at the Threshold*, and there must be a closed life support systems, with the exception of food.

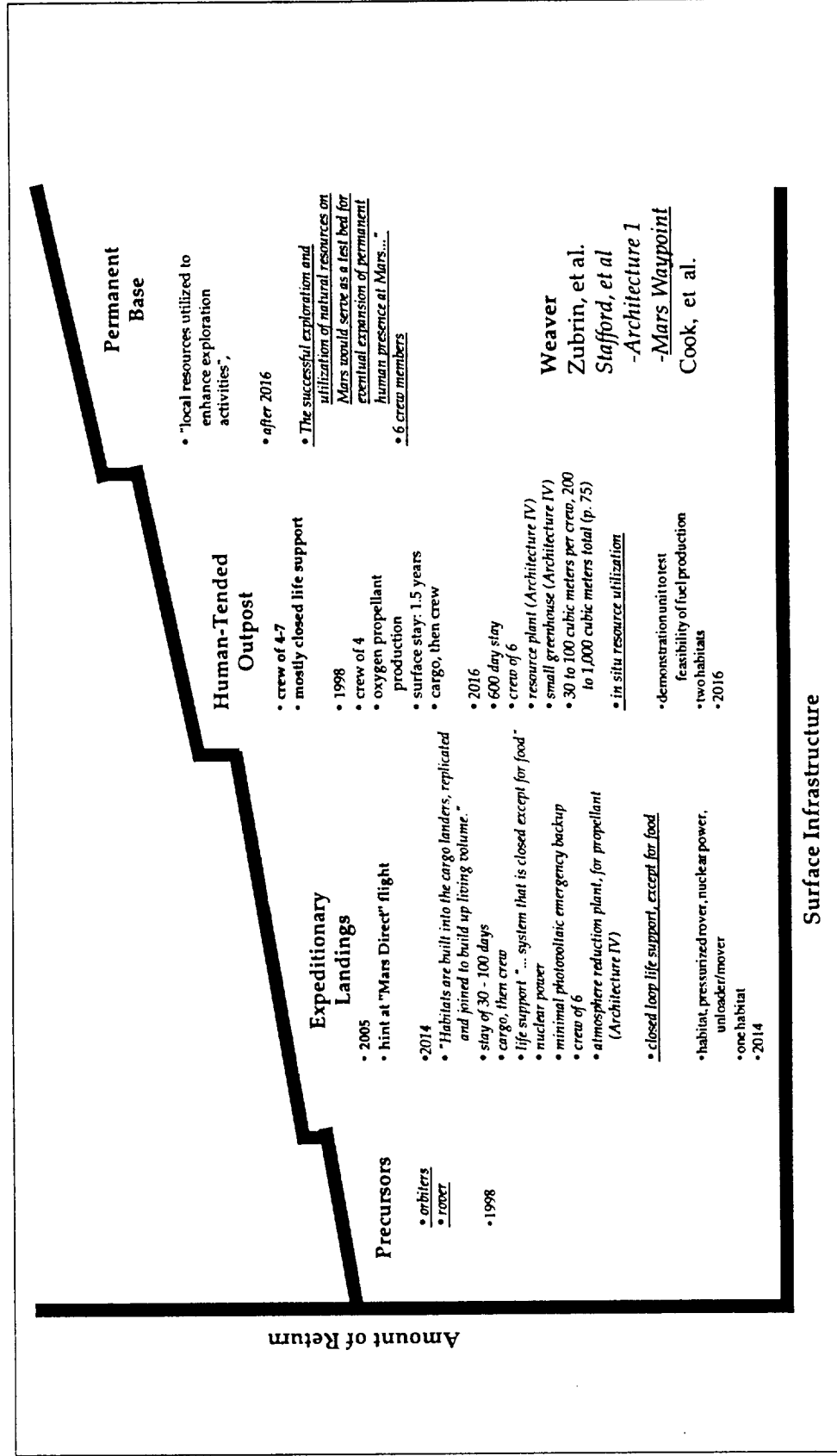

Figure 3.1.1-1. A summary of four published Mars scenarios.

3.1.2 MISSION SCENARIO INTEGRATION

The above Mars scenarios have been integrated into a single scenario that will be adopted in this report. Our analysis suggests four phases to the exploration of Mars:

- Precursor robotic missions
- Expeditionary landing missions

- Human-tended outpost missions
- Permanent base mission

The precursor missions are robotic exploration. This will consist of mapping Mars, basic exploration, and sample returns. The Viking landings started Martian exploration. One reason further robotic missions are needed is to limit the variety of locations for human exploration and habitat emplacement.

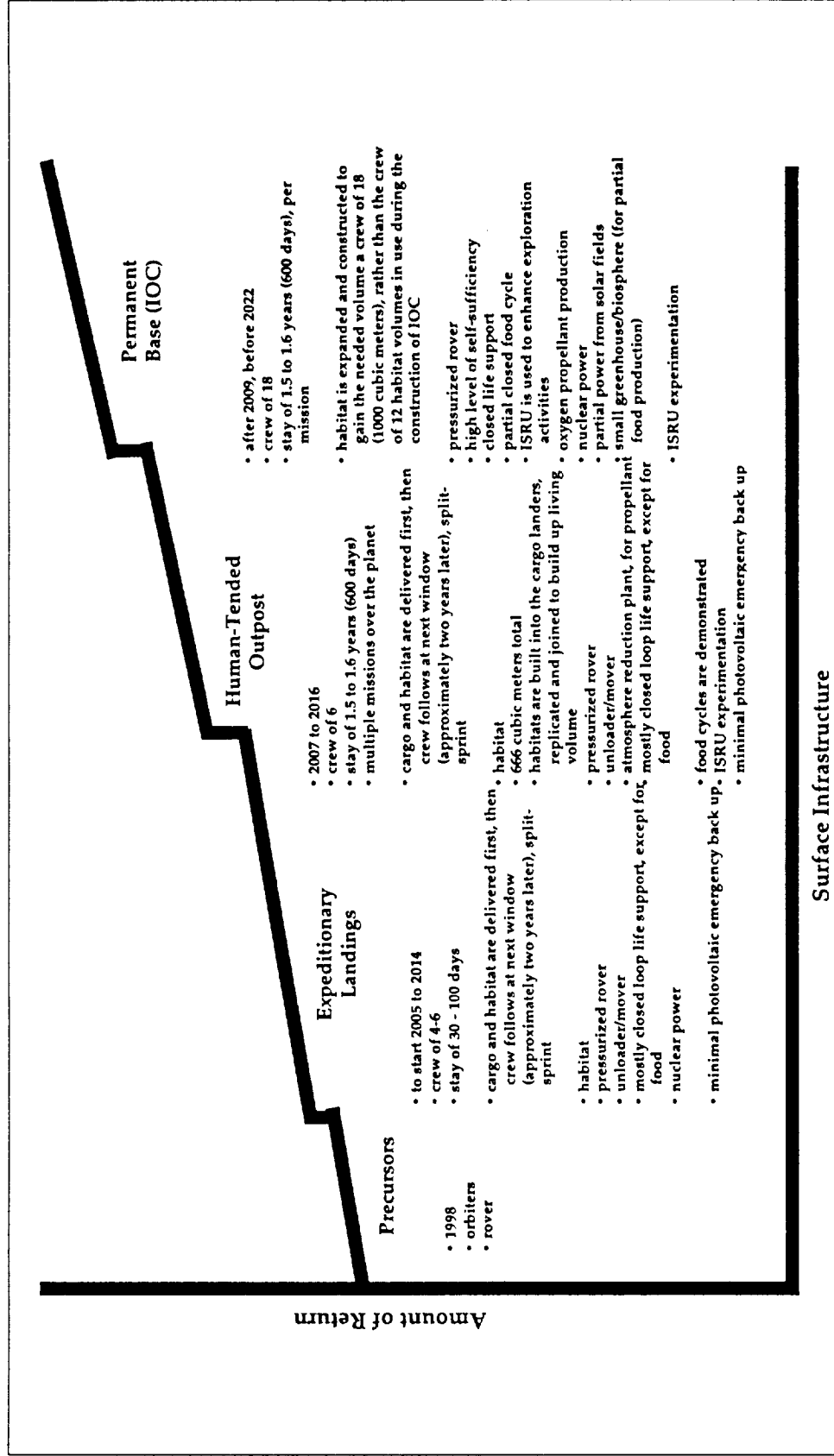

Figure 3.1.2-1. A recommended integration of previously published Mars scenarios.

After the precursor missions, humans will set foot on Mars. Expeditionary missions can achieve benefits similar to those achieved in the first Apollo missions — a “large step for humankind.” These missions will test our ability to have humans visit Mars. Due to the short surface stay of 30 days, the scientific benefits will be limited.

The human-tended outpost missions will begin to provide noticeable scientific benefits. A surface stay of 600 days will provide the time for in-depth scientific activities. Developing several outposts at different locations on the planet will optimize this phase. The choice of locations will be determined by their potential scientific benefit (see section 3.2). This step is also necessary because it will generate a location for a permanent base. The permanent base will use elements from one or more outposts in a permanent habitat.

The fourth phase of Mars exploration is the permanent base mission. It provides the largest scientific benefits and begin to provide commercial benefits. Its location will stem from one of the human-tended outpost locations. The chosen location will be the one which will provide optimal scientific and commercial benefits.

Growth beyond a permanent base is possible. This evolution would provide primarily commercial benefits. Work done within the aerospace industry has not concentrated on this evolution, primarily because of its distant realization.

This integrated scenario, an outline of the exploration on Mars leading up to a permanent base, is shown in Figure 3.1.2-1.

3.2 CHARACTER OF THE MARTIAN ENVIRONMENT

The Martian environment is undiscovered territory. Many features will be the subjects of intense investigation. To be able to gain the greatest insights, and given the broad scope of missions, the following areas of scientific investigation are expected to be:

- volcanoes
- possible water sites
- craters
- channels

Design Requirements:

- The base should be located in a geologically varied region
- Base should be near possible water locations
- Base should be located at a low elevation
- The base should be located in the northern hemisphere
- The habitat should be shielded from dust contamination and wind

3.2.1 SURFACE AND ATMOSPHERIC ANALYSIS

The Martian atmosphere is predominantly composed of carbon dioxide. An annual event occurring between fall and winter is the forming of clouds composed of carbon dioxide ice particles. This takes place in the polar regions where the gas condenses out of the atmosphere, so much so that the atmospheric pressure decreases nearly 30% in that time frame. At the northern pole, the decrease is less due to the smaller north cap during the winter.

Table 3.2.1-1. Martian Atmospheric Composition

Carbon Dioxide (CO ₂)	96.5%
Molecular nitrogen (N ₂)	1.8%
Argon (Ar)	1.5%
Molecular oxygen (O ₂)	0.1%
Carbon monoxide (CO)	0.05%
Water vapour (H ₂ O)	0.02%
Neon (Ne)	0.0001%
Krypton (Kr)	0.00003%
Xenon (Xe)	0.00002%

Note: Measurements are fraction by weight. The CO and H₂O amounts are uncertain and variable.

The Martian atmosphere has a similar chemical composition to Earth. Primarily carbon dioxide, the atmosphere is thin and hazy. The day/night cycle is comparable—annual mean temperatures range from -50 degrees C at the Equator to nearly -130 degrees C at the poles, and the summer temperatures rise above 0 degrees C at midday. Mars also has seasons. This is evident in the growth and recession of the polar carbon dioxide “ice” caps. Winds are responsible for suspending dust in the atmosphere causing light to scatter and create a haze (Spitzer, 1980).

Dust storms have been observed to originate in the southern hemisphere, growing in intensity until nearly the entire planet is engulfed. Geologic features are again comparable to our home planet. Enormous canyons are carved into the surface, large dry river beds suggest past flooding, and volcanoes rise to greater heights than known elsewhere in the solar system. Given that Mars is approximately half the size of Earth, and twice the size of the Moon, these features are grander in scale.

Mars is a rich experimental laboratory. Answers to questions centuries old may be determined when exploration of the planet resumes in earnest.

The chart below compares general information about Earth and Mars.

Table 3.2.1-2. Comparative Facts between Earth and Mars.

Earth	Mars
12,756 km.	Diameter 6787 km.
149.5 x 10 ⁶ km.	Distance from Sun 227.8 x 10 ⁶ km.
23 27'	Inclination 23 59'
24 hr. 00 min.	Length of Day 24 hr. 40 min.
365 days	Length of Year 686 days
1013 mb	Atmospheric Pressure 7 mb
1	Known Satellites 2

The Martian surface offers a variety of landforms suggesting wind-related formation and processes. Most notable of these wind activities are the surface streaks that occur in the southern hemisphere during the summer. These happen when the winds are the strongest, creating major dust storms (Carr, et al., 1980).

The channels etched into Mars are fascinating as well as controversial. Of particular interest is whether these channels could have been formed by water. A very different climate, warmer with a denser atmosphere, would have had to exist to produce these features. The possibility that wind and lava are the cause is being speculated (Carr, et al., 1980). Detailed and finer structures within the channels suggest water was once prevalent. These structures, when compared to Earth-like features, are similar to "teardrop-shaped islands, longitudinal grooves, terraced margins, and inner channel cataraacts" (Carr, et al., 1980) found in large Earth flood plains.

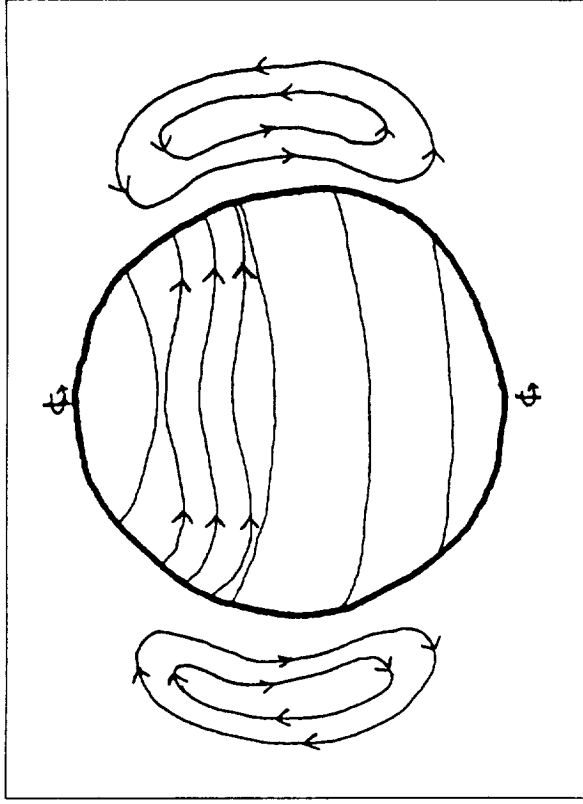

Figure 3.2.1-1. Diagram of Martian wind connections.

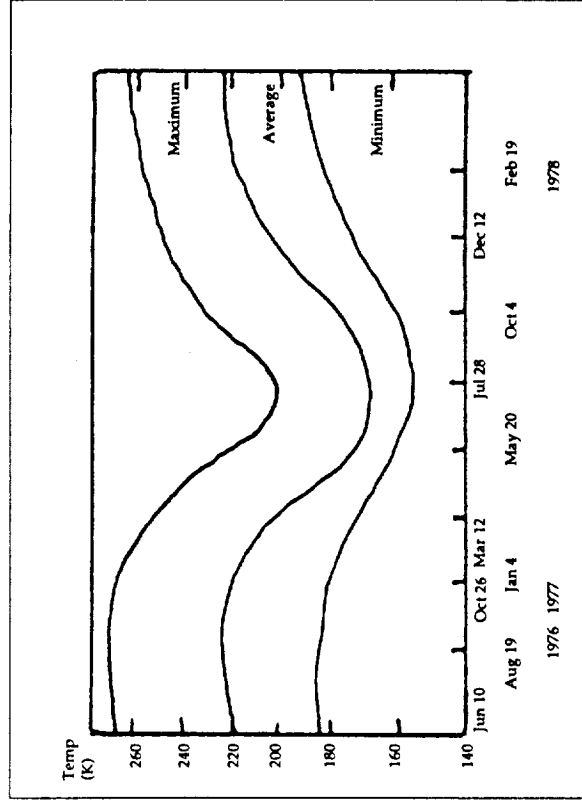

Figure 3.2.1-2. Chart of surface temperatures.



Figure 3.2.1-3. Distinctive streaks—the dark areas represent wind erosion light centers where bright, fine particles deposit and collect (assumptions based on wind tunnel simulations). (Spitzer, 1980)



Figure 3.2.1-4. Channel network on Martian surface. (Spitzer, 1980)



Figure 3.2.1-5. Poona Crater. One of several types of craters found on the Martian surface. (Spitzer, 1980)

Although much of Mars' surface consists of rather simple plains, craters do occur over the entire planet. The composition of the surface is hinted at by the particular type of crater, and its resultant or lack of resultant surface process alteration. The southern hemisphere is more heavily cratered than the northern. Crater densities suggest slow resurfacing processes as compared to Earth.

3.2.2 RADIATION AND RADIATION SHIELDING

The thin atmosphere of Mars does not provide enough protection from radiation to allow the habitat to remain unprotected. The intensity of the radiation is dependent upon location and elevation. Those regions located in lower elevations will have a somewhat greater measure of protection (Zubrin, 1991). There is reason to speculate that less-intensive shielding for structures and equipment will be necessary. Mars does not possess an intrinsic magnetic field with the ability to repel galactic cosmic rays (GCRs). Due to this,

GCRs reach the outer atmosphere. Simple solar wind particles do not pierce the atmosphere, but GCRs will. The dose of radiation the crew will receive while on the Martian surface will depend on season and elevation. As on the lunar surface, solar flare events will require impenetrable shelter.

One plan to protect the crew from injury stems from Gregor'yev (1976, cited in Nicogossian & Parker, 1982)). This could consist of one or more of the following:

- increasing spacecraft shell thickness
- using equipment as shelter or shadow
- using electronic or magnetic fields
- protective clothing worn by astronauts
- prophylactic pharmaco-chemical protection

Shielding for the habitat can occur by more than one method. A protective exterior covering over the entire habitat can be used. This might consist of a frame system and advanced technology textile. The Martian regolith might be used to reinforce the protection by introducing a sandbag system. A framing system would be necessary to support the bags and free the habitat structures from undesirable weight. Locating the habitat in an underground facility is possible. It needs to be determined whether a viable geologic structure such as a lava tube exists. Excavating the Martian surface is another option, yet this option would be EVA-intensive for machinery and crew.

Design Requirements:

- Provide radiation protection with safehavens within the habitat that will completely repel solar flare emittants
- Provide additional radiation protection on the base exterior by using regolith and a textile covering system supported by a space frame

3.2.3 MARTIAN GRAVITY AND REDUCED GRAVITY EFFECTS

Long-term habitation of Mars will have an effect on all physiological systems of the human body. Deconditioning will occur without the gravitational "pressure" necessary for our species. Calcium retention for the skeletal system is lessened. To date, sufficient calcium cannot be supplemented in the diet to counteract the prob-

lem. It has been determined that pressure on the long bones of the body can assist in controlling calcium loss. To retard muscle atrophy, exercise regimes are being created and tested. As experience in space habitation increases, the long-term effects will be discovered and appropriate measures can be enacted.

Since the gravitational pull of Mars is one-third that of Earth, movement will also be affected. This will have design implications for habitation and laboratory facilities. Locomotion will be affected, as well as traction, speed, cornering, and stopping. Studies of movement on the lunar surface might be conducted. Conclusions drawn from future studies may show a relationship between the movement of the human form in 1/6 gravity and 1/3 gravity.

Design Requirement:

- Provide exercise countermeasure equipment and an exercise countermeasure facility to maintain astronauts' physical conditioning

3.2.4 SITE PLANNING CONSIDERATIONS

Site planning for a Martian base will depend on a number of critical factors. Precursors missions will narrow the locational possibilities by searching for a varied region to support science and exploration. Scientists are interested in the activity of the Martian volcanoes. A location within the range of a pressurized rover will allow investigation of these surface features.

Dust storms originate in the southern hemisphere. Locating the base away from the origin will assist in protecting the habitat and astronauts. Water location possibilities are theorized to be in the northern hemisphere at approximately 45 degrees N latitude (Carr, et al., 1986).

An issue critical to the safety of the crew is radiation protection. Although the atmosphere is thin, locating the base in a lower elevation may provide additional radiation protection (Zubrin, et al., 1991).

The entire world will witness the endeavors upon the surface of Mars. The astronauts and the population on Earth may need to have an "image" portrayed that will state the intentions of the countries involved in Martian exploration (Hansmann & Moore, 1990). As

Pax Permanent Martian Base

there will be little or no colonization, the astronauts will need a recognizable image of their home on Mars (Hansmann & Moore, 1990). Another important consideration will be the care of the pristine Martian environment (Hansmann & Moore, 1990).

Design requirements:

- Base location should be away from dust storms of the southern hemisphere, ie. locate the base in the northern hemisphere
- Locate the base near to an anticipated water supply, ie. north of 45°N
- Locate at as low an elevation as possible
- Locate the base within rover distance of a volcano
- Terrain for launch and landing should be flat to assist transportation
- Base should portray acceptable appearance for transmitted images
- Should be recognizable as village, outpost, or home
- Base should observe care of Martian environment
- Location should allow for base expansion

3.3 HUMAN FACTORS AND ENVIRONMENT-BEHAVIOR CONSIDERATIONS

Primary environment-behavior considerations were dealt with in making Pax as humane as possible. Humanistic considerations such as a sense of place, zoning, solving spatial demands, optimal circulation, interpersonal space, territory, stress and, anthropometrics were studied in making the habitat as livable and productive as possible.

3.3.1 ANTHROPOMETRICS

The measurement of the human form has a relationship to the built environment. Coupled with the economic constraints of space endeavors, anthropometrics should guide the designer to an efficient, accessible environment. As well, future studies of the human form and its movement in 1/3 gravity will dictate dimensioning of heights and stairs and the use of flooring materials to improve traction.

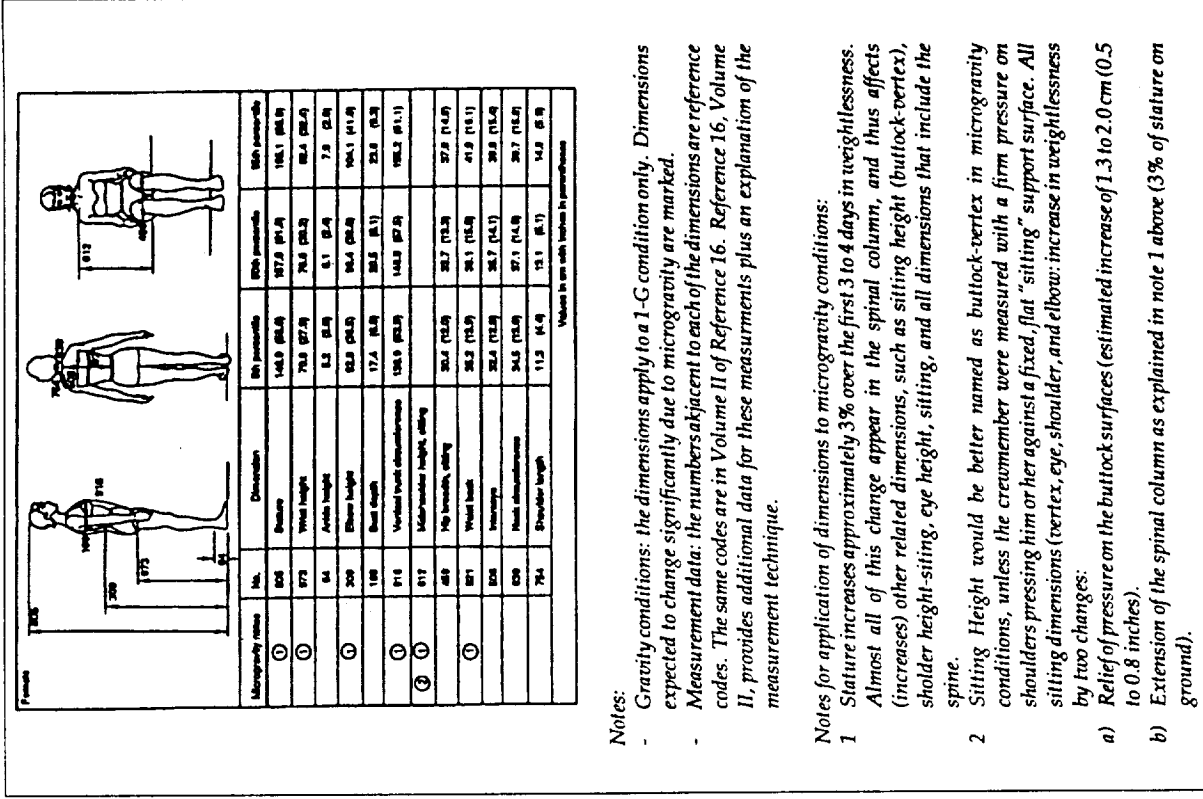

Figure 3.3.1-1. Projected body size of a 40-year old Japanese female in the year 2000 (NASA, 1987).

Table 3.3.1-1 Anthropometric Changes Between 0-G and 1-G.

Parameter	Atropometric change	
	Short-term studies (1 to 14 days)	Long-term studies (over 14 days)
Height	Height increased during the work day 1.5 to 0.8 in. Height returns to normal P.O.D. Increases caused by spine lengthening.	Pro vs. post-mission. Returns to normal on P.O.D.
Circumference	Circumference changes in chest, waist, and limbs. See Figure 3.3.1-2 for chest and waist changes. Changes due primarily to fluid shifts.	
Mass	Weight loss occurs during the first 3-4 days, about 2% of the lean body mass. After 3-4 days, the remainder of the weight loss is due to loss of lean body mass and fat. Center of mass shifts forward and downward. See Figure 3.3.1-2 for center of mass shift. See Paragraph 3.3.1-2.1 for details.	Fluid weight with dehydrated 3-4% during first 3 days. Post-flight, weight gradually returns to pre-mission level. Some weight gain may occur on P.O.D. or 2 P.O.D. Center of mass shifts backward. Approximately 3-4 cm (1-2 in).
Limb volume	Weight loss volume decreases during the first 3-4 days. Post-flight, limb volume up to 10% above pre-mission level. Returns to pre-mission level.	Limb volume increases by 10% during first 3 days. Post-flight, limb volume returns to pre-mission level.
Posture	Intermediate measurement of neutral posture. See Paragraph 3.3.1-1.	Fluid weight to pre-mission posture.

Note: The figure numbers in the chart refer to other figures in NASA-STD-3000. It is expected that some of these changes, in lesser degrees, will also occur in the 1/3-G of Mars (NASA, 1987).

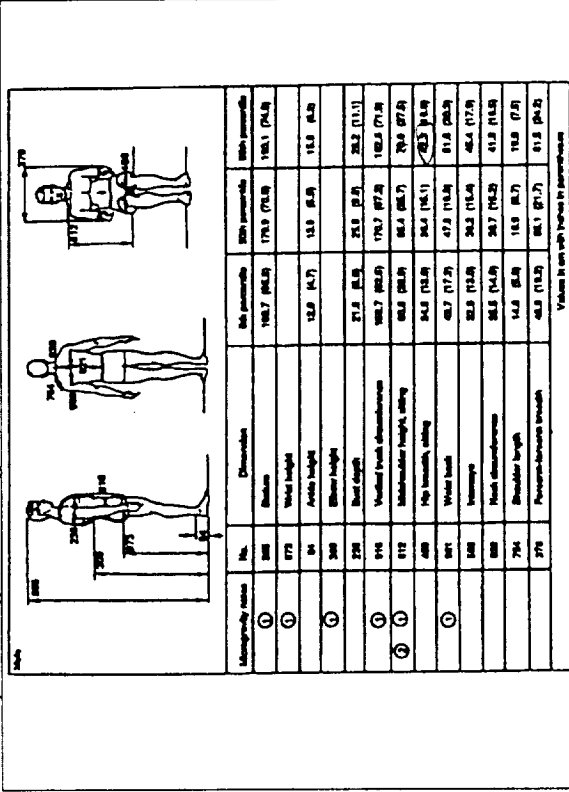

Figure 3.3.1-2. Projected body size of a 40-year old American male in the year 2000. Note: notes same as those in Figure 3.3.1-7. (NASA, 1987).

To date, NASA has been guiding the design of space-related interiors and equipment to accommodate a range of body sizes. This range is from the 5th percentile Japanese female to the 95th percentile American male. Approximate heights relating to this range are 1.6 m to 1.9 m (NASA, 1987).

The human body will react to the lesser gravitation attraction. Table 3.3.1-1 summarizes the anthropometric changes that are expected to occur between 0-gravity and 1-gravity. Data has not yet been calculated for 1/6G; in the absence of empirical data, our work has assumed a linear interpolation.

Design Requirements:

- Provide for a system of working and living spaces to accommodate a range of individuals from 1.5 m to 1.9 m in height
- Volume configuration should allow for ease of accessibility of equipment
- Circulation should allow for anticipated changes in human locomotion
- Stair heights and ceiling heights should reflect the 1/3-g of Mars

3.3.2 PERSONALIZATION AND PRODUCTIVITY

One theory has suggested that an adequate work environment does not substantially enhance job satisfaction, but a substandard environment leads to dissatisfaction (Herzberg, et al., 1957; Herzberg, Mausner, & Snyderman, 1959; McCormick & Tiffen, 1974; all cited in Fisher, Bell, & Baum, 1978). Physical comfort and safety in terms of noise control, proper ventilation, or lighting contribute to productivity (Fisher et al., 1978). Should these considerations be lacking or substandard, for example, the lighting be too low or the environment dangerous, a reduced level of production may result.

Personalization of workstations assists in identifying a space as one's own. The addition of personal items can make the space more pleasant, in turn making the user feel better when in the space (Fisher, et al., 1978). The anticipated resultant "good mood" seems to increase people's willingness to help each other (Sherrrod, et al., 1977; cited in Fisher, et al., 1978).

Personalizing the workstations may also assist the astronauts in completing their tasks according to specific training prior to the mission. Pieces of equipment dedicated to that task mark an area as belonging to an individual. Personalization of the crew quarters not only delineates personal space and territory. It can also be a place to retreat, rejuvenate, or tend to personal necessities. Private communication with family members may also occur. All crew members must have space dedicated solely to them.

Design Requirements:

- The work environment must be safe
- Astronauts should be able to personalize their workstations
- The work environment should be properly lit
- Buffers should be provided for unnecessary and distracting noise
- Adequate ventilation should be provided
- Each crewmember should have personal space

3.3.3 ENVIRONMENTALLY-INDUCED STRESS

The habitat, as a volume in which people live, has the potential to induce stress. Nine months travel time from home, confinement to a limited volume, and intense work are just three of the many stresses placed on a crew on a mission to Mars. Environmentally-induced stress is derived from stressors acting within terrestrial buildings. It is commonly known (in the architectural world) that a building can cause stress to its occupants. Since people will be occupying buildings on Mars, it may be possible to assume that those volumes will cause stress to their occupants as well.

Many terrestrial stresses may cause stress in a Martian habitat. Therefore, those known stressors should be studied first.

Design Requirements:

- Provide an environment to lessen sensory deprivation
- The environment should not cause sensory over stimulation
- The design should promote protection of personal rights
- Allow control of the environment by the astronauts

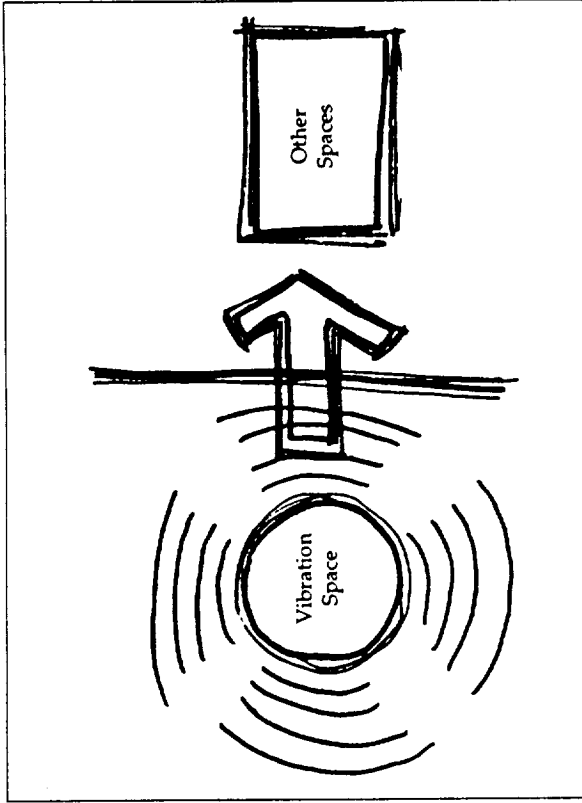

Figure 3.3.3-1. An example of architecturally induced stress is excessive noise and vibration.

3.3.4 INTERPERSONAL SPACE AND TERRITORIALITY

The physical setting of the habitat should promote social interaction among the crew, yet allow for retreat and privacy when desired. The environment should provide for the ability to claim territory by the user, and spaces must allow for desired levels of privacy (Murtha, 1976; cited in Bell, Fisher, & Loomis, 1978).

Space can be defined in terms of territories. The territories can be divided into three categories: tertiary, secondary, and primary. Tertiary areas are sometimes personalized, not owned, control over them is difficult to assert, and they are utilized by a large number of people (Fisher, et al., 1978). A tertiary space will be an open, easily accessible space used by anyone (Alexander, 1977). Secondary territory is used by smaller groups. It may be personalized, is not owned, and will be utilized by a number of qualified users (Altman, 1975, Fisher, et al., 1978). It is a space within an open area that should be partially shielded from public activities (Alexander, 1977). A primary territory is extensively personalized; the owner has complete control, and intrusion is serious (Fisher, et al., 1978). Private or primary spaces are

considered a place where one can retire alone (Alexander, 1977). With these guidelines produced by environment-behavior researchers, and although they are terrestrially-based in origin, their implications for human interaction are necessary and pertinent. Territory will regulate who will interact; personal space will regulate how closely individuals will interact (Sommer, 1969; cited in Bell, et al., 1978).

The need for privacy and solitude is to avoid, for example, overstimulation (Evans, 1974; cited in Bell, et al., 1978). Personal space allows for avoidance of a variety of stresses (Evans, 1974) or for maintaining adequate privacy and an appropriate level of intimacy (Altman, 1975; cited in Bell, et al., 1978).

The promotion of social interaction, intimacy, and privacy can be achieved by:

- Primary, secondary, and tertiary territories
- The ability to personalize space
- A place to escape and relax privately

Design Requirements:

- Provide a built environment that will promote social interaction
- Physical space must be divided into primary, secondary and tertiary spaces
- Astronauts must be able to personalize their personal territories
- Provide spaces for private escape, retreat, and relaxation

3.3.5 OPTIMAL CIRCULATION

Circulation is required to connect the spaces of a habitat. The issues involved with circulation will affect the mission. First is safety, quick wayfinding, and orientation. Second is the issue of minimizing the space designated for the sole purpose of circulation. A third issue, directly opposing the second, is architectural variety and interest often accompanying the circulation routes (see section 3.3.6).

The safety of the crew is a high priority, especially in an emergency. A linear corridor that terminates on exits may be a good solution. That may obviously not be the best solution with respect to the other human factors issues such as spatial variety.

Efficient circulation is required. In relation to terrestrial buildings, the cost of unused, pathway space in a Mars habitat is enormous. A habitat that has an excessive amount of circulation is unacceptable.

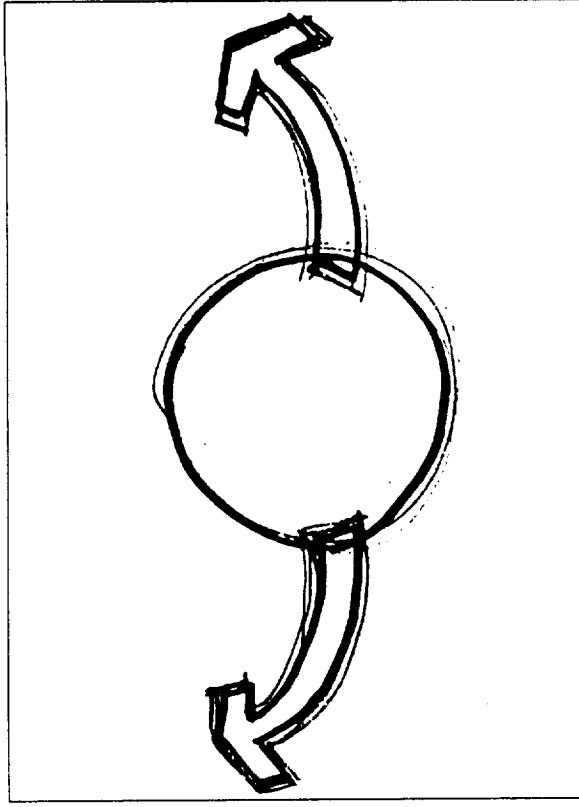

Figure 3.3.5-1. Dual egress points are necessary safety precautions in the event of operational failure or environmental atmospheric threat to human safety.

The standard terrestrial percentage of efficient circulation in a building is 25%. Because of the great difference in the basis of the structures, the percentage is relevant, but only used as a guideline.

Other issues in the design of optimal circulation within a habitat are architectural interest and the conceptual idea of "a continuous walking path." The idea and need to escape and "go for a walk" should be accommodated. The ability to get away by walking will require some circulation paths to be looped allowing a variety of paths and destinations. Architectural variation of the spaces will add interest.

Design Requirements:

- Primary circulation should be linear
- Frequently used spaces should adjoin primary circulation
- Circulation should terminate with exits
- Circulation should allow for dual emergency egress
- Circulation should be efficient in terms of area
- Circulation should allow for architectural variation and interest
- Circulation should promote leisurely "walking" throughout the habitat

3.3.6 EFFICIENCY, FUNCTIONALITY, AND SPATIAL VARIETY

With transportation to the Martian surface being costly, efficiency becomes a critical issue. Crew comforts need to be supplied, but in the smallest, lightest volume possible. The ability to have a space serve more than one function is one way to be efficient. Equipment with multiple functions is another. Efficiency can also refer to the way the space is used. Dedicated circulation space should be minimized. This can be done by dual functioning it with usable space within an activity space.

Closely tied to the efficiency of space is the actual amount of space that exists. Volumes must be minimized. Not only does extra volume create extra mass, but it increases the amount of surface area that must be upkept, and the amount of air that must be transported to the base. This results in increased ECLSS equipment to filter and distribute the air, which in turn requires even more volume, and results in more mass.

The volumes within the base should be kept to a minimum while still allowing full functionality and habitability. The actual size of the spaces will depend on a number of factors. Since there are no existing

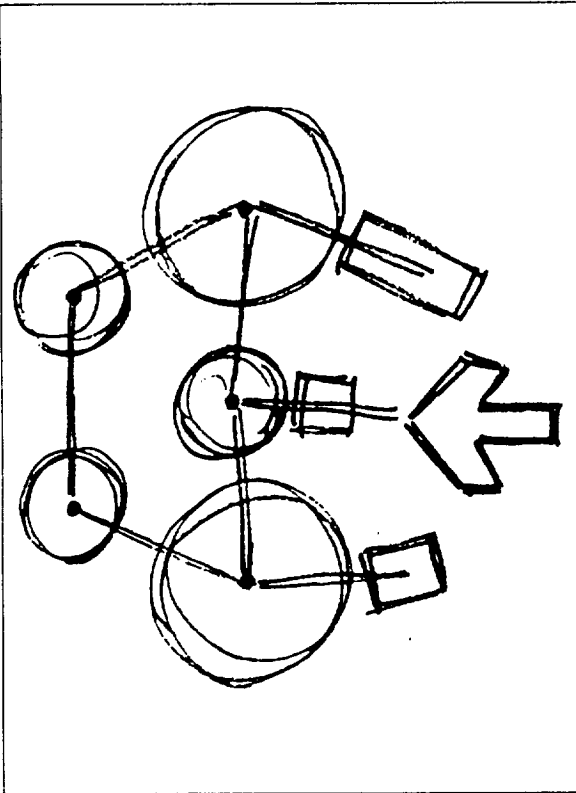

Figure 3.3.5-2. The principle of clear circulation.

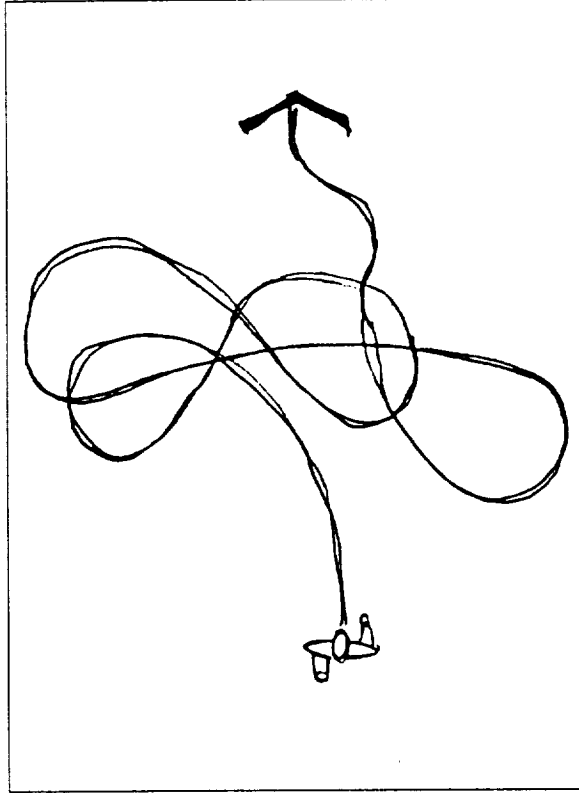

Figure 3.3.5-3. Circulating through a continuous pathway will allow a crew member the ability to take a walk through the Martian habitat.

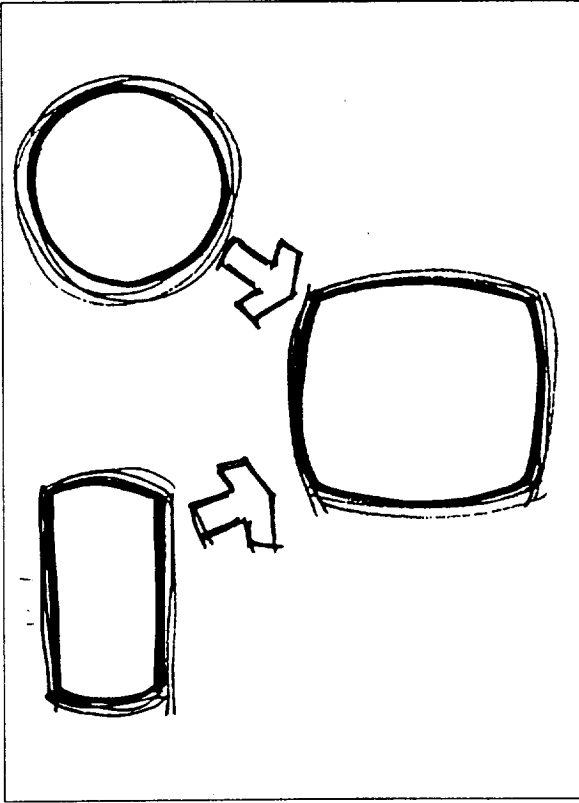

Figure 3.3.6-1. Efficiency will allow the base all needed functions, but with reduced space and mass.

Martian bases that can be used as a precedent, proposals for analogous situations can be used to arrive at average spatial requirements. These can be used as a base-line which can be adjusted according to the actual situation.

The nature of a Martian base requires the spaces to be compact. The human requirements are just the opposite, having the need for some

expansive spaces. Their are many ways to make a small space seem larger than it really is. One way of doing this is to use curvilinear forms as opposed to very linear spaces (cited in Harrison, Caldwell, et al., 1988). This will create a room in which all surfaces cannot be seen at once, which can make the room seem larger. Allowing visual access between spaces makes them seem larger by extending the sight line of the user.

Table 3.3.6-2. Square Meterage of Lunar Base Proposals

	LUNAR OUTPOST (ALRED, 1989,12C)	GENESIS II (FIEBER, 1990,11C)	PARTIAL GRAVITY (SICSA, 1990, 12C)	Max Int. (12C)	Max IOC (18C)
LABORATORIES					
General Lab		21.00	16.40	18.70	28.05
Biochemical Lab		16.00	13.10	14.55	21.83
Microbiology Lab		21.00	16.40	18.70	28.05
Plant Growth Lab		27.00	21.30	24.15	36.23
MISSION CONTROL					
Telebotic Workstations	44.40			44.40	66.60
Command	22.20			22.20	33.30
CREW QUARTERS					
Personal Crew Quarters		45.20		45.20	67.80
Personal Hygiene Facilities	17.30	17.50		17.40	26.10
CREW SUPPORT					
Galley		9.90		9.35	14.03
Food Storage				7.90	11.85
Wardroom	22.20	18.70	15.10	18.67	28.00
Recreation	47.40	48.00	37.70	44.37	66.55
Health Maintenance	47.40	5.80	4.24	19.15	28.72
Laundry		3.90	2.30	3.10	4.65
Exercise		8.30	6.06	7.18	10.77
Exterior View			1.97	1.97	2.96
Viewing Area			20.00	20.00	30.00
SERVICE					
Maintenance	12.70		6.20	9.45	14.18
Safehaven		56.00	28.90	42.45	63.68
Storage				25.00	37.50
EVA Storage		18.75		18.75	28.13
NET SIZE	318.30	329.95	218.97	532.43	798.65
MULTIPLIER @ 25%				133.11	199.66
GROSS SIZE				665.54	998.31

The functionality of the efficient spaces relates to their convenience and functional proximities. As mentioned earlier, space is at a premium on Mars. By closely relating spaces for similar functions, sharing equipment or dual functioning an area, smooth performance of the suggested function may be obtained.

A place that has many spaces of the same relative size and shape can become monotonous. If a person must spend an extended time in this space the problem is made worse. Spatial variety refers to the creation of spaces that differ from each other in shape and size. By designing a variety of spaces within the base, varying atmospheres can be created, and monotony can be avoided.

With transportation to the Martian surface being costly, efficiency becomes a critical issue. All the comforts the crew requires need to be supplied, but in the smallest, lightest volume possible. The ability to have a space serve more than one function is one way to be efficient. Equipment with multiple functions is another. Efficiency can also refer to the way the space is used. Dedicated circulation space should be minimized. This can be done by dual functioning it with usable space within a room.

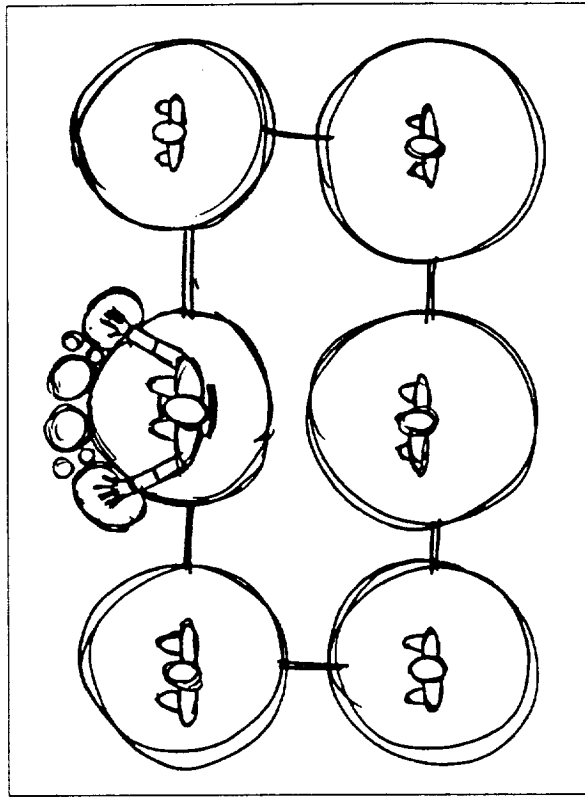

Figure 3.3.6-2. Convenience and functional proximity should lead to efficiency in space and functional performance.

Varying floor heights and ceiling heights can also affect the way a space feels. Using light colors in spaces can increase the apparent size of the room by making the enclosure less noticeable. Lighting can also affect the way a space feels. Washing the walls with light can make them appear lighter, which may make them seem further away. Combinations of these methods should be used to not only make the spaces seem larger, but make them more dynamic and pleasing to the user.

The nature of a Martian base requires the spaces to be compact. The human requirements are just the opposite, having the need for some expansive spaces. There are many ways to make a small space seem larger than it really is. One way of doing this is to use curvilinear forms as opposed to very linear spaces (cited in Harrison, Caldwell, et al., 1988). This will create a room in which all surfaces cannot be seen at once, which can make the room seem larger. Allowing visual access between spaces makes them seem larger by extending the sight line of the user. Varying floor heights and ceiling heights can also affect the way a space feels. Using light colors in spaces can increase the apparent size of the room by making the enclosure less noticeable. Lighting can also affect the way a space feels. Washing the walls with light can make them appear lighter,

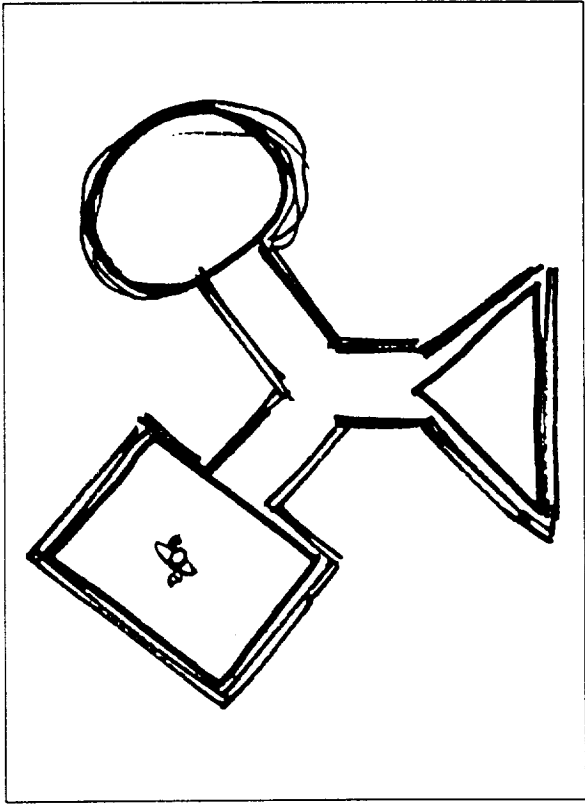

Figure 3.3.6-3. Spatial variety can create different feelings within spaces, and help avoid monotony throughout the habitat.

which may make them seem further away. Combinations of these methods should be used to not only make the spaces seem larger, but make them more dynamic and pleasing to the user.

Design Requirements:

- A variety of spaces should be created
- Spaces should dual function
- Equipment should have multiple functions
- Circulation should dual function with usable space in a room
- Volume should be minimized
- Curvilinear spaces should be used
- Visual access should be allowed between spaces
- Floor and ceiling heights should be varied
- Light colors should be used
- Lighting should be used to make a space seem larger

3.3.7 ZONING

For human habitation and scientific endeavors to be sustained on Mars, space for various functions need to be designed. To support science, laboratories and associated equipment will be needed. To support human life, a place to live, perform personal duties, eat, and engage in social interaction are necessary. It is suggested that the following spaces be designed to address the human and scientific requirements:

- General Laboratory
- Biochemical Laboratory
- Microbiology Laboratory
- Plant Growth Laboratory
- Telerobotics Control
- Command Center
- Landing Operations
- Crew Quarters
- Hygiene
- Galley
- Food Storage
- Wardroom
- Recreation
- Health Maintenance

- Laundry
- Exercise
- Exterior Viewing Area
- Maintenance
- Safehaven
- Storage
- EVA Stowage

Zoning, the separation and grouping of spaces, provides an important organizing element to a Martian base. For example, spaces may be separated for specific uses. Various spaces can have similar uses and requirements and, therefore, be zoned closely. On a macro level, the Martian base should be comprised of habitation, power, and launch and landing zones. These functions should be separated for safety reasons. On a micro level, the habitat should be zoned by defining the spaces and associated functions from noisy to quiet and public to private.

By separating the noisy and quiet functions, stress in the isolated, confined environment may be minimized. Unwanted sound is considered noise and should be removed from quiet areas (Fisher, et al., 1978). Loud, unpredictable, or sudden noises can cause mistakes

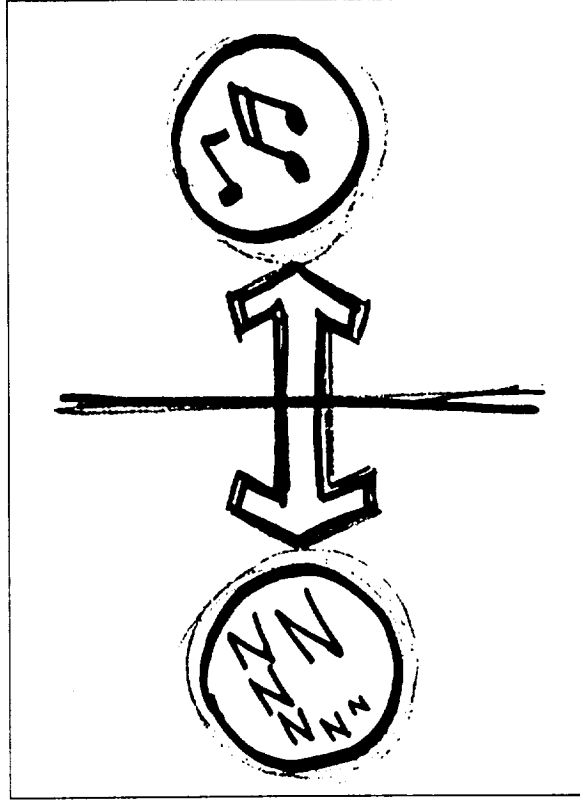

Figure 3.3.7-1. Quiet and noisy spaces should be separated to ensure crew satisfaction.

Pax Permanent Martian Base

on high concentration tasks (Broadbent, 1954; cited in Fisher, et al., 1978). By zoning the noisy and quiet-functioning spaces away from each other, the crew may be able to work or relax and not be adversely affected by adjacent spaces.

Another method of zoning for the Martian base habitat should be by defining the spaces according to public versus private factors. Public spaces, such as workstations, laboratories, or group gathering

spaces should be placed away from private areas. Suggested private areas might be crew quarters or personal hygiene facilities. In order for zoning spaces to be successful, it has been found that work and relaxation spaces should be separate (Ferguson, 1970). By dividing work and crew support functions, a clear boundary is established and will result in reducing stress. In this way crew working will not disturb crew that might be sleeping or just resting. Noise is a major

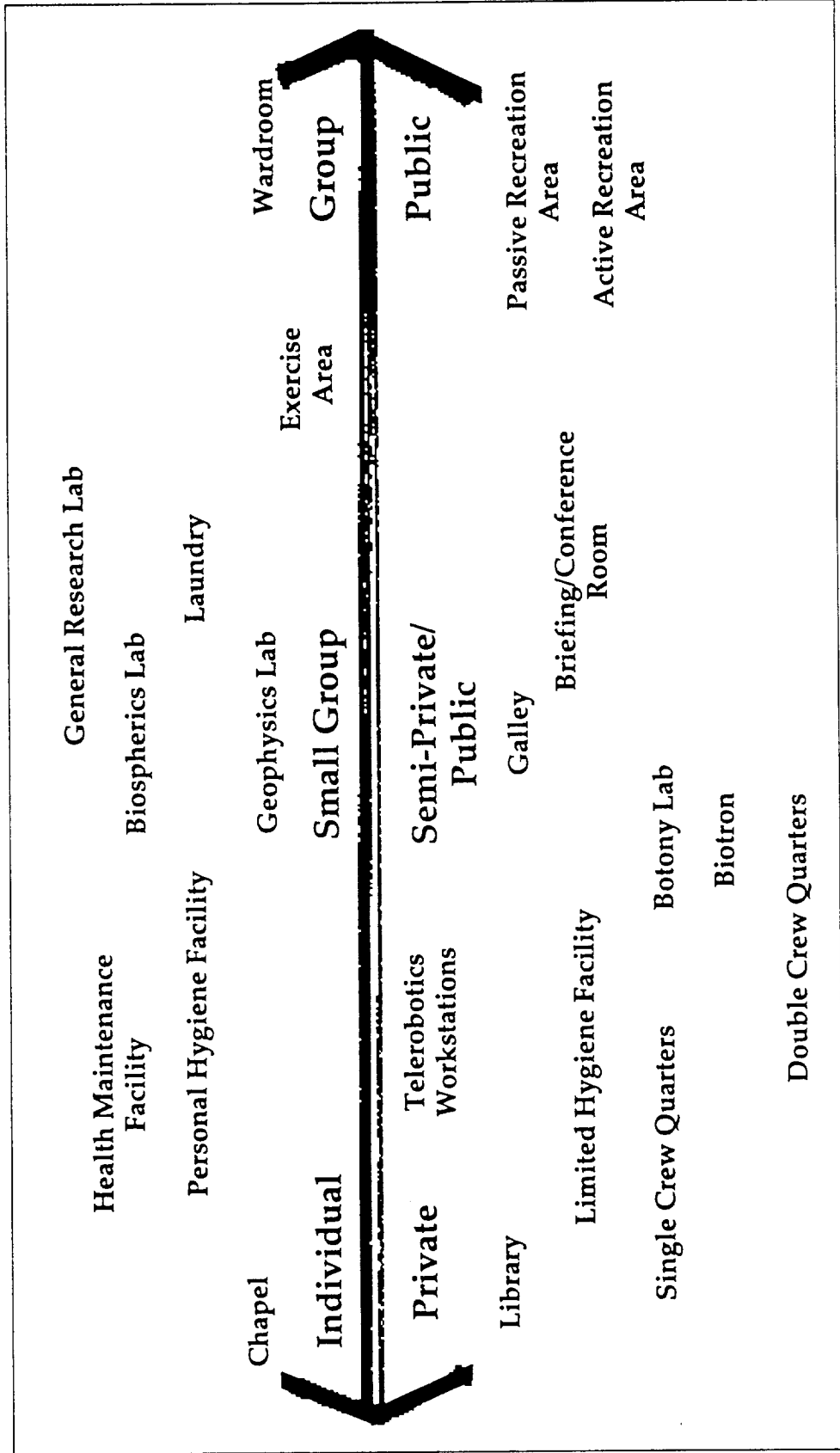

Figure 3.3.7-2. The zoning of public to private on a gradient. The proposed spaces and functions necessary for human habitation support are placed upon the gradient.

contributor of stress and by creating a separation of work and recreation this dilemma is resolved. This leads into a second way of dividing spaces according to functions.

A fine-tuning of zoning gradients, and their associated bubble diagrams, is achieved by the construction of an adjacency matrix. An adjacency matrix is a tool for arraying all spaces in a habitat. These spaces that require close functional proximity (movement of materi-

als, shared equipment, etc.) are so marked. Those spaces that should be separated (due to danger, health, or inappropriate proximity, e.g., galley to personal hygiene) are so marked. Interpretation of this matrix will be an essential component for the suggested habitat layout solution.

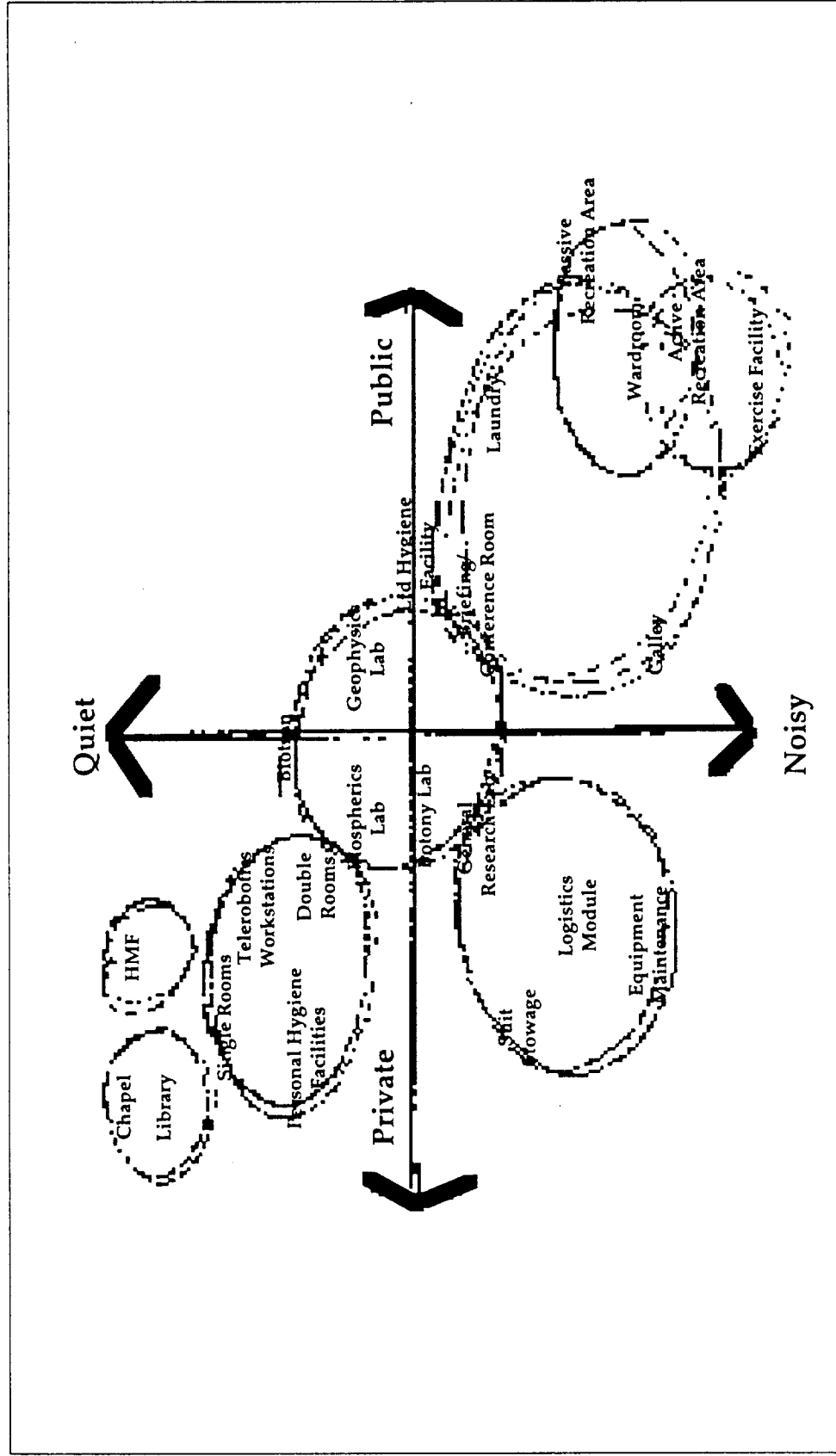

Figure 3.3.7-3. Bubble diagrams emerge when two functional zoning gradients are overlapped.

Pax Permanent Martian Base

Design Requirements:

- The base should be separated by habitat, power, and launch and landing zones
- Work and relaxation activities should be separated from each other
- Habitat functions should be zoned from noisy to quiet
- Habitat functions should be zoned from public to private
- Functional proximities should be determined by creating and then allocating spaces according to a functional proximity matrix

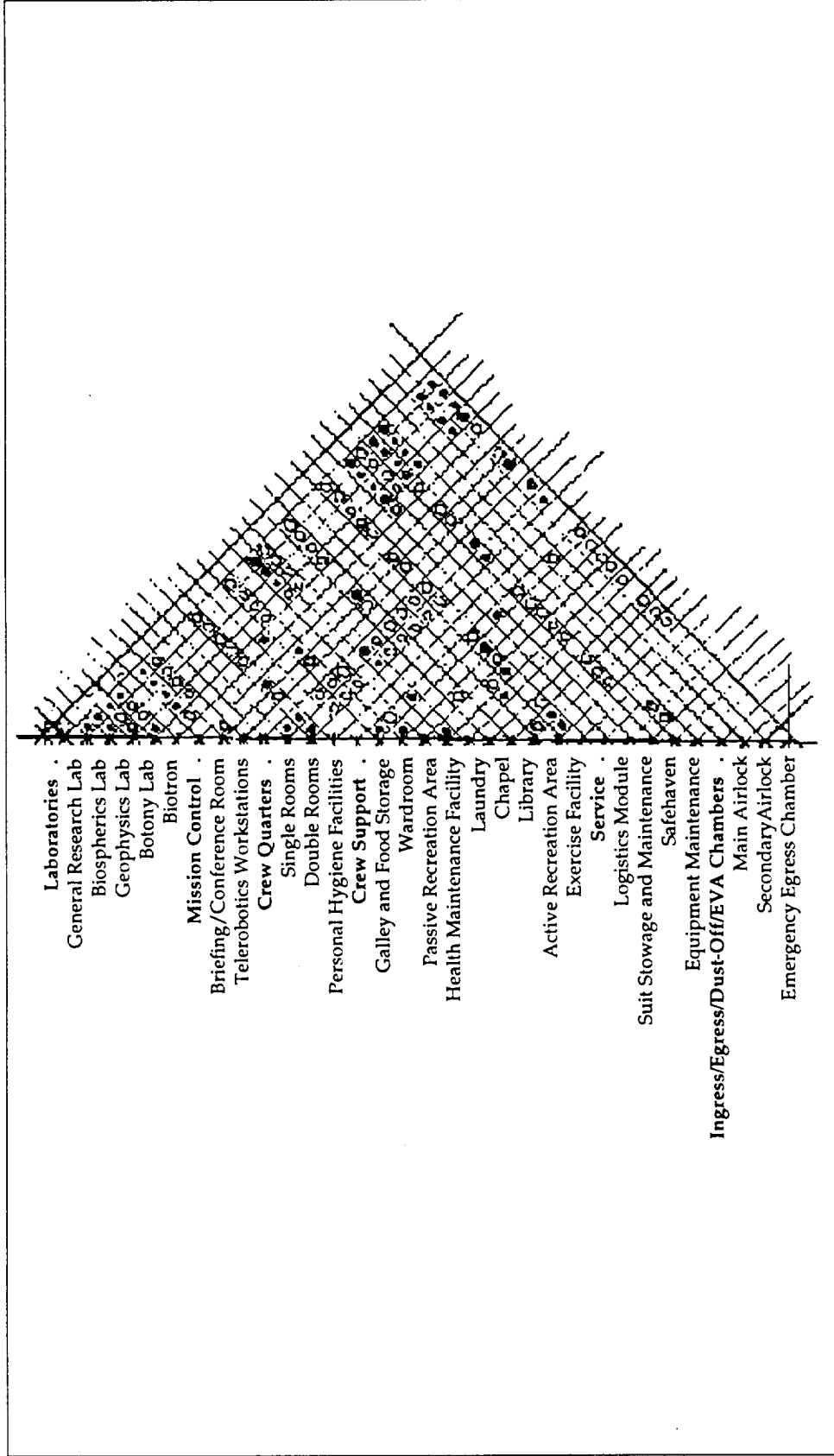

Figure 3.3.7-4. Adjacency matrix for required Martian habitat spaces.

3.3.9 SENSE OF ARRIVAL, SENSE OF PLACE

A sense of arrival and overall sense of place are ephemeral but believed also to be important human factors.

The sense of one reaching a space is key to distinguishing between circulation and functional areas. The crew might find translating between spaces without an obvious sense of entering monotonous. Suggestions that a new area has been entered, rather than a continuous and nonchanging space, may make wayfinding easier. Modules and inflatables should therefore be designed to show a clear sense of entry.

Once crewmembers arrive at their destination, a sense of place should be perceived. In the designing of individual spaces, the intent is to portray a particular atmosphere. This can be achieved by indicators of color, lighting, and ceiling height changes. These serve as signals for the different spaces as well as the space's image and function. The sense of place may be achieved by the personalization of spaces. Crewmembers may well bring reminders of home. This has occurred on previous space missions, most notably on the Russian spacecraft Salyut and space station Mir. Here personal items delineated personal territory (Bluth, 1987).

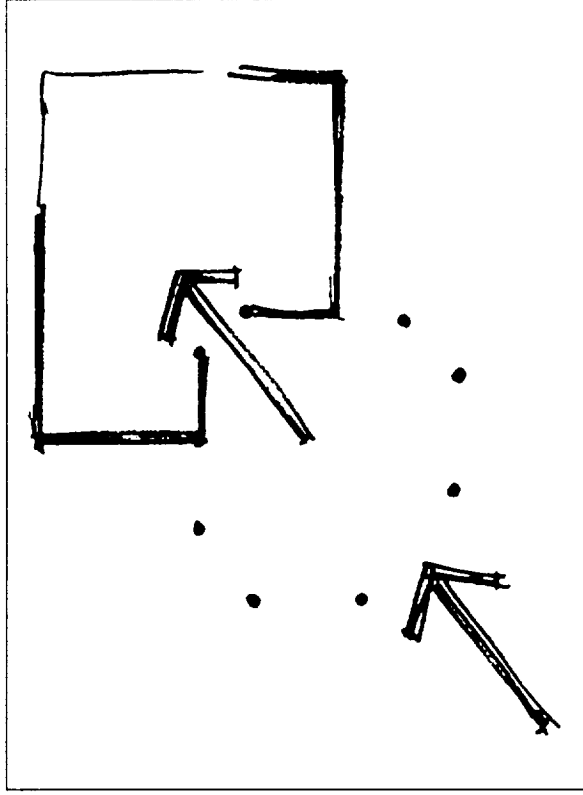

Figure 3.3.9-1. A sense of arrival is important in distinguishing between circulation and functional space.

Design Requirements:

- living and working spaces should allow display of personal items
- habitat should be designed with a clear sense of entry into major and minor spaces

3.4 CHANGEABILITY, REPLACEABILITY, AND EXPANDABILITY

A Martian base will be constantly changing. As crew changes occur, the entire function of the base can change also. The base could function as a headquarters for studying Martian geology for a time, and then be switched over to the commercial production of fuel. Because of this constant changing, the base must allow for rearrangement or replacement of existing facilities, and for expansion of the base to add future facilities.

Ways of allowing for changeability and replaceability include the use of a modular system of interior partitions and racks. These will allow rearrangement of spaces and equipment. The spaces within the habitat can be created by the placement of partitions and

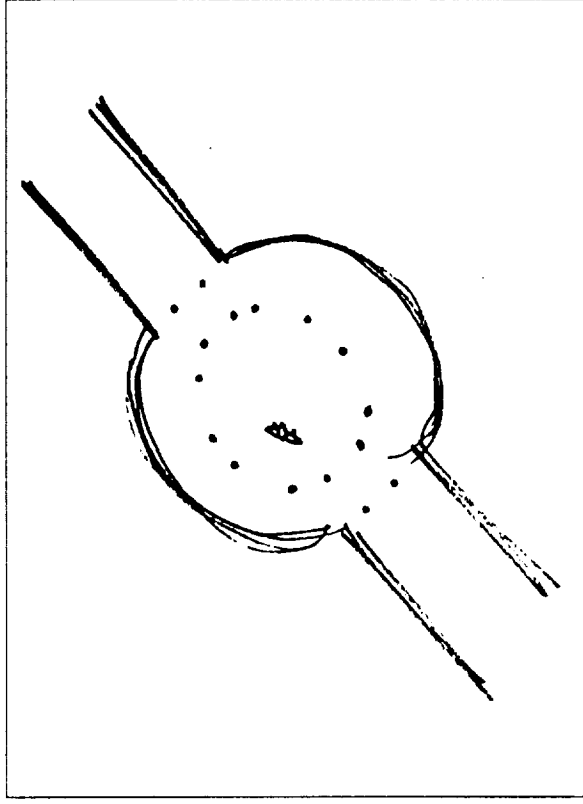

Figure 3.3.9-2. A sense of place is critical in portraying a particular atmosphere.

racks that divide up the interior. They can become the defining elements of all spaces throughout the habitat. Since these partitions and racks will be used throughout the entire habitat, they must be modular to accommodate all situations. This modularity will also allow ease of replacement and flexibility in the way spaces can be rearranged.

Both partitions and racks should be based on a standard module size that will allow easy transportability and movability. Partitions should allow variations that will make full walls and half walls possible. The racks themselves should also be flexible in their construction. By using modular pieces to form racks, many sizes and options can be created which add even more flexibility to the system.

Expansion of the base can be allowed by providing connecting ports in convenient locations, and a support structure that will accommodate additional structures.

Design Requirements:

- A modular system of interior partitions and racks should be used
- Convenient connecting ports should be provided

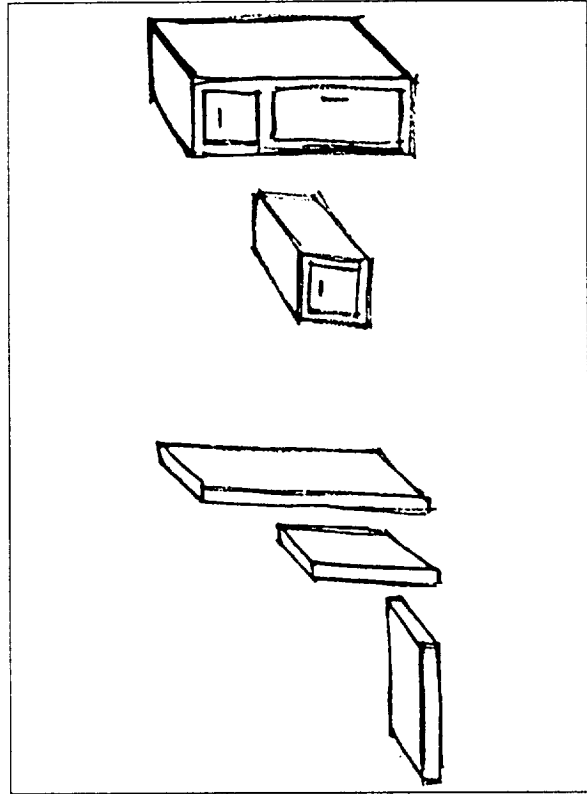

Figure 3.4-1. The use of modular partitions and racks increases the flexibility of a martian habitat.

- Support structure should be able to accommodate additional facilities
- Partitions and racks should be modular
- Partitions and racks should have a standard size
- Partitions should allow full and half wall configurations
- Racks should be comprised of modular pieces

3.5 SPECIAL CONSIDERATIONS

3.5.1 COLOR

“a measure of the degree to which an environment promotes the productivity, well-being, and situationally desirable behavior of its occupants” (Clearwater, 1986). Color has been known to have an effect on human beings. The behavioral issues regarding color selection have been discussed within the aerospace community. Shown is that color “interacts with illuminants” and affects the following:

- human psychology
- physiology
- behavior (arousal, fatigue, relaxation)
- the circadian rhythm
- visual performance
- perceptual judgments
- information processing and transfer
- perceived spaciousness
- perceived temperature
- emotional well-being
- public image and product identity” (Clearwater, 1986).

The proper selection of colors in interior environments can enlarge a room visually. Space habitats will be confined and isolated. Colors should be used that will enhance the constrained living and working environments. Warm surface colors can cognitively change perceived temperatures by nearly 0.83 degrees C (Clearwater, 1986). Moods, excitement level, boredom or depression can be changed with the use of color. Food and human skin tone are affected and can be enhanced.

Based upon the color design and recommendations from NASA-ARC, the selection of color for *Pax* is selected according to three activity area definitions. A high activity area includes space for a single individual or a group. Suggested are larger wall spaces and surfaces in light, lively warm earth tones and warm pastels. Moderate activity areas are the designated work areas. Calm, low saturation colors augment the spaces. A low activity space creates a quiet, cozy environment yet perceptually increase the space. Light blues and grays are be appropriate.

The general effect of colors can be summarized in the following manner: warm colors energize; cool colors are calming and restful. *Pax* makes liberal use of gray tones, pale blue-grays, burgundies, taupes, off-whites, silvers, deep blues, and terra cottas. A basic color scheme is chosen for a particular space. The effect upon adjacent spaces is considered if those spaces flow into one another. Providing a continuity of color from one area to another relieves the habitat from appearing "chopped up" and discontinuous. Bright color highlights certain special features, either architecturally or visually. Color also augments the translation pathways throughout the habitat.

Design Requirements:

- Bold color should be limited
- Shades and pastels should be used in larger surfaces
- Use contrasting color to break monotony
- Highly reflective colors should be placed above the user
- Allow the personal control and flexibility of color by the crew

3.5.2 LIGHTING

Lighting greatly influences how space is perceived. It allows for:

- a change in the mood of a space
- an alteration of the surface colors
- a perception of spaciousness

Pax incorporates a number of lighting systems to increase visual stimulation, add variety, and augment the tasks to be performed. Each area of the habitat that contains special architectural featuring endeavors to highlight that feature. Control by the user is of great importance. Combinations of uniform lighting, uniform wall light-

ing and warm-toned sources are utilized. Custom fixtures in walls, structural elements, in the floor components and activity areas defines the spaces and their intended use.

Design Requirements:

- Visual stimulation should be provided
- Adequate lighting for the general and specific tasks should be provided
- Emergency egress pathways should be delineated

3.5.3 MATERIALS

Suggested material usage comes from the NASA Man-Systems Integration Standards of 1986. Any material will have gone through a complex testing phase to determine whether outgassing from the product is detrimental to humans or the space environment.

Depending on the space and its use, materials are chosen to facilitate the task at hand. For example, surface materials in the general laboratory allow for ease of the task and easy maintenance. The material's reflective ability will be studied for its appropriateness in a designated area. Surfaces that will not contaminate, discolor, or unintentionally harm the user are investigated. The durability is another key issue. With economic constraints in space endeavors, rapid deterioration is not desirable. A variety of materials with textural surfaces can be permitted to vary the environment and stimulate visually and tactility. Again, the key to material usage is durability and performance.

Design Requirements:

- Materials should be easily maintained
- Materials should not be toxic to systems or humans
- Materials should be durable
- Reflective surfaces of materials should enhance the space

4. PAX: PERMANENT MARTIAN BASE

4.1 SITE SELECTION

Pax was chosen to be constructed at the Viking 2 landing site on Mars. Viking 2 landed at 45 degrees N latitude, 251 degrees W longitude. The area is proximal to varied geologic features available for investigation. This geographic location is known as Utopia Planitia.

The site is located in the northern hemisphere, away from the origination of the dust storms during the southern summer season. It should be noted, however, that the site must be protected from these storms that grow in intensity, sometimes engulfing the entire planet. Moderate wind activity across the surface is suggested by the sand dunes and deflation hollows on Mie Crater. This crater is located approximately 200 km east-northeast from the Viking 2 site.

The terrain in the area appears level as determined by Viking 2 photos. Given the need for a smooth area for a transportation system and launch and landing facility, Utopia Planitia solves this requirement.

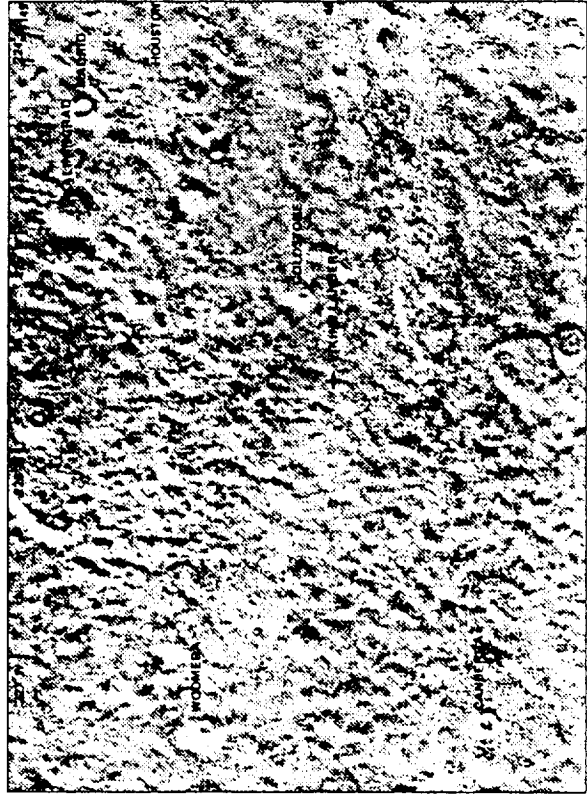

Figure 4-1-1. Viking 2 mission location at 45° north latitude, 251° west longitude.

The elevation of the site is relatively low with respect to the other features on the surface. Thus there is a resulting greater depth to the thin atmosphere, which may provide some radiation protection. Additional sheltering, however, must be provided for human and equipment safety.

Current theory on water location (Carr, 1980) suggests the search be conducted near the north pole. The site for *Pax* is south of where the northern polar cap advances in the winter season.

4.2 SITE PLANNING

Four major components are necessary to sustain the Martian base. These include a human habitation facility, power source(s), and launch and landing facilities. A transportation system will link these three areas.

These functional areas will be zoned from one another on a north-south axis for safety. Centrally located is the habitat. Adjacent to the habitat is a solar array field. Situated 2.5 km north of the habitat is the nuclear power facility. A distance of 2.5 km to the south of the habitat will be the launch and landing facility. Landing spacecraft will not have to fly over the habitat or power areas while on final approach to Mars.

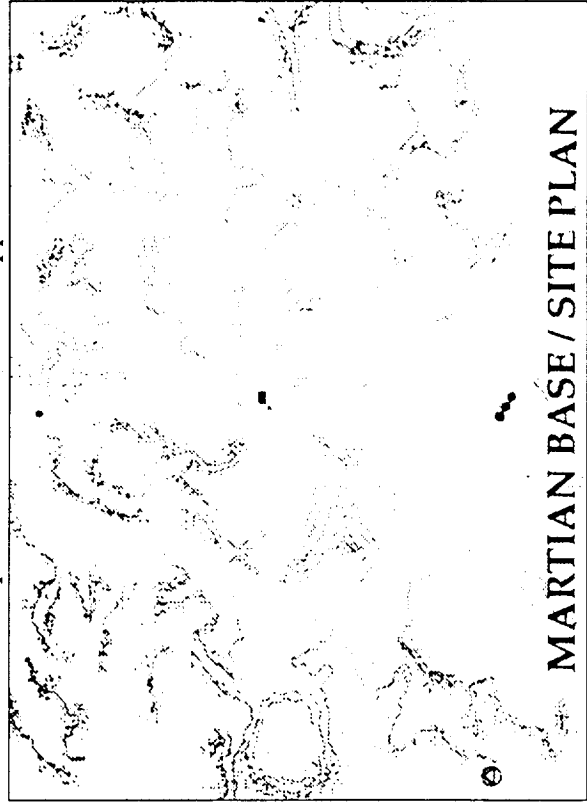

Figure 4-2-1. Pax base site plan.

4.3 MASTER PLAN AND CONSTRUCTION SEQUENCE INCLUDING EXPANSION CAPABILITIES

A modular space frame construction system will provide the protective shelter for the habitation and laboratory modules. This framing system will combine open square and triangular geometry's to produce a roof and column support system. Due to a smaller gravitational pull, the known terrestrial spanning distances are increased. The frame system itself will be a kit of components, redundant in size and shape, and will allow the astronauts relative ease of construction. The system will consist of:

- structural space frame
- column support system
- textile regolith containment and radiation shielding system
- Martian regolith

The habitat, the central portion of *Pax*, will be constructed in several stages. Construction can commence when two rigid modules and 6 associated crew members are on site, and their equipment, rovers and logistics are in place. Additional modules and their crew will arrive, bringing the full compliment of rigid modules to four, and the number of crewmembers to twelve.

The area for the habitat must be cleared to allow depressions excavated for five separate modules three of the initial four hard modules and two newly transported inflatables. Once the excavating is completed, the components for the space frame and habitat shelter will be arranged.

All components of the framing will be assembled on the ground. The framing configuration resembles a square with side panels. The side panels, or space frame curtains, will be inclined at 30 degrees, corresponding to the anticipated slump angle of the regolith.

Once the frame is complete and the regolith containment system is finished, the entire center portion, under which the habitat will be located, will be raised to a predetermined height. This height will allow uncomplicated ingress of the three rigid modules, and inflation of the two remaining components. Enough "headroom" above the modules will provide ease of accessibility for maintenance and repair of the module skins. The approximate measure of this headroom is

2 m. The space frame curtains will move into their final positions as the center portion is lifted. One section of the curtain will be lifted while construction of the habitat components takes place.

A permanent entry will be located on the northern portion of the habitat. A closure system resembling a sliding door will be utilized. The construction sequence continues with the placement and inflation of the crew support and laboratory facility modules.

The rigid entry module is between these two inflatables. Flexible connections will join the inflatables and module. The entry module will have an airlock docked to it for surface access. This airlock will be the primary ingress/egress point for the habitat.

Utilizing a lift and trailering system, the fourth and fifth components, both rigid modules dedicated to greenhouse functions, are transported underneath the space-frame shelter. Flexible connections will be placed between the crew support module and greenhouse, between the two greenhouses, and from the greenhouse to the laboratory module.

Once the greenhouses are secured, two additional rigid modules will be docked. A logistics module, which will serve as an emergency airlock, will be docked to the crew support inflatable. A third airlock, for egress as well as laboratory support, will be docked to the laboratory inflatable.

Ample space is provided for the parking of unpressurized and pressurized rovers under the space frame. There is sufficient space to maneuver the vehicles, allow for docking against the airlocks, and transporting supplies or equipment.

Expansion of the base would be feasible utilizing existing hatches. The most logical expansion would commence after removal of the logistics module or the laboratory facility airlock. From this point, excavation could occur to prepare for an additional inflatable module.

Should the planning include expansion greater than what the space frame could accommodate, the process then becomes more complicated. It would entail side curtain removal, expansion of the framing and column system, and reattaching the side curtain at the new location. One suggestion may be that *Pax* represent one research base supporting 18 crew members and a larger base for a greater population or expanded functions be created as a separate facility on an adjacent or separate site.

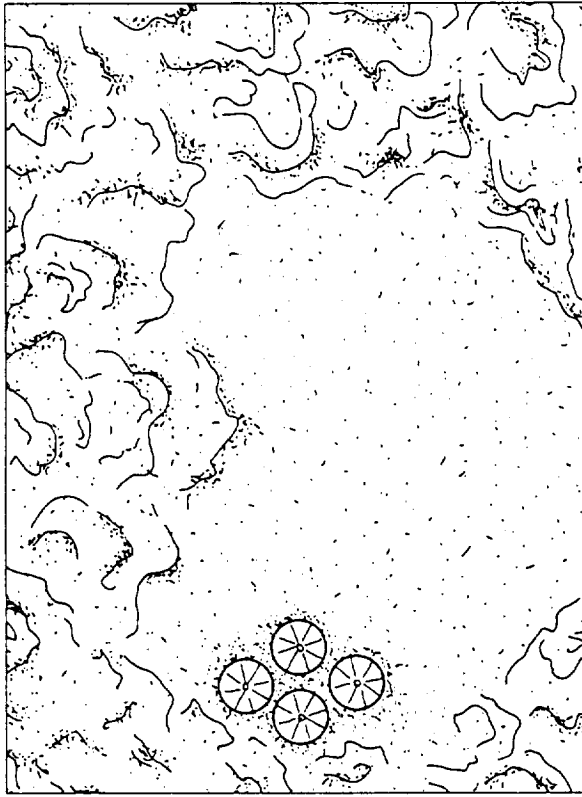

Figure 4.3-1. Phase one of the Martian base construction. Six astronauts will prepare the habitat site.

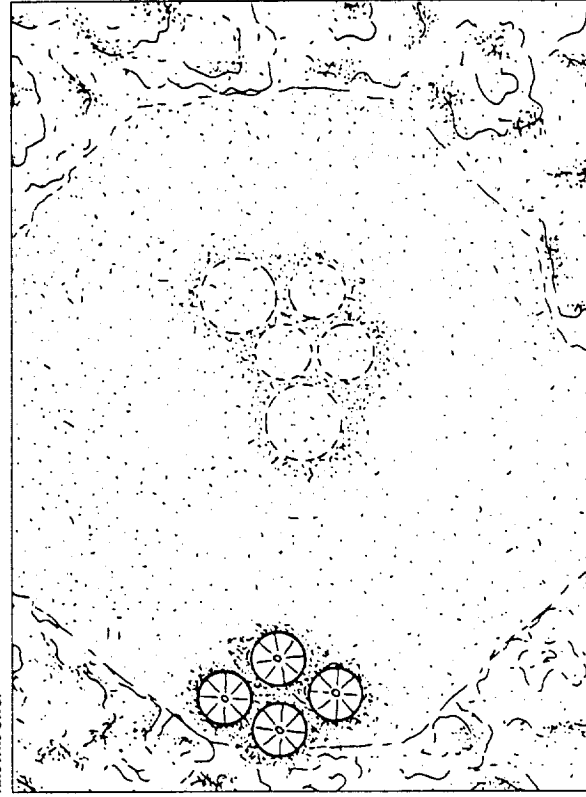

Figure 4.3-2. The footprint of the Martian habitat is excavated.

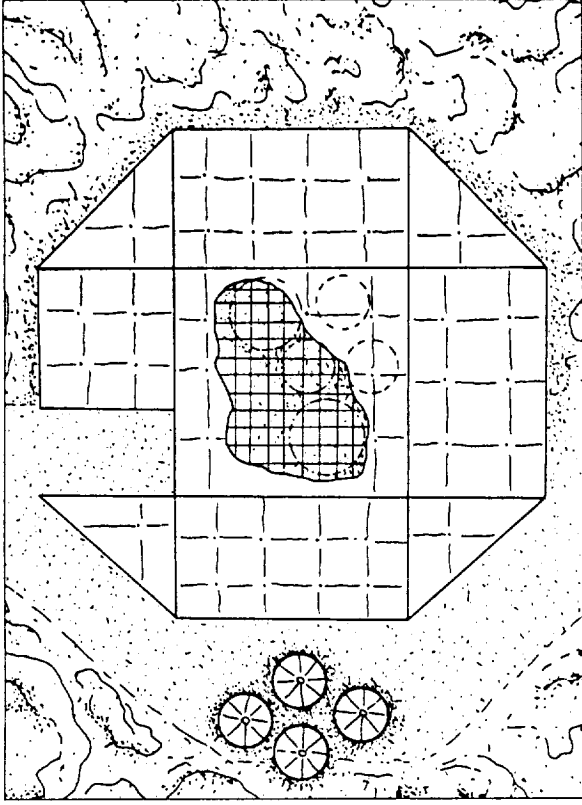

Figure 4.3-3. The space frame and regolith habitat shelter is assembled.

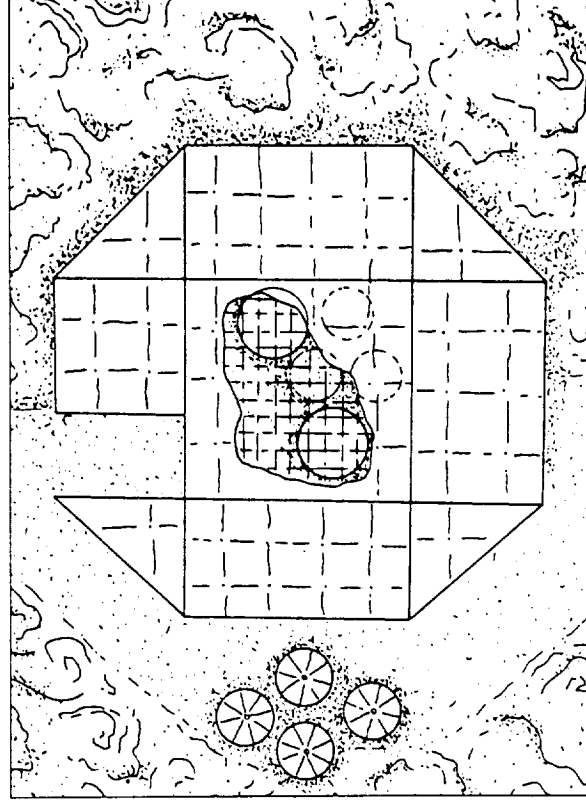

Figure 4.3-4. Laboratory and crew support modules are employed and inflated.

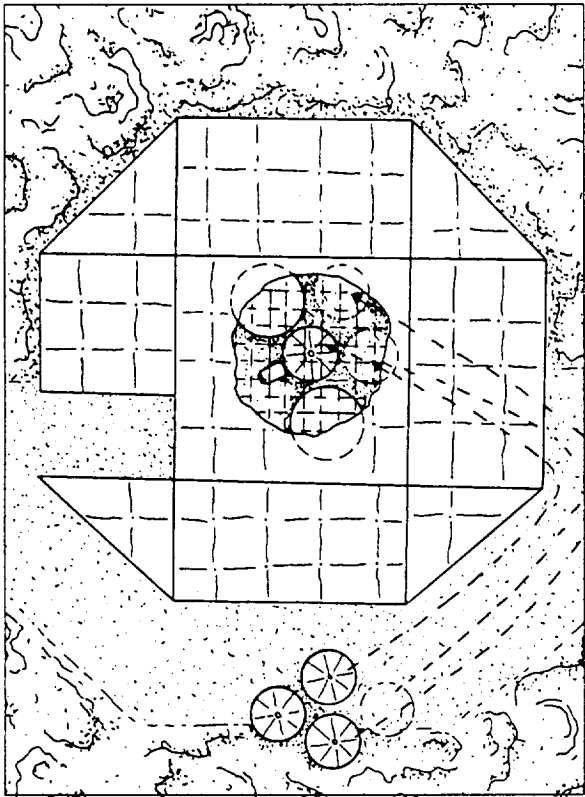

Figure 4-3-5. Rigid entry module is employed and the primary entrance airlock for the habitat is attached.

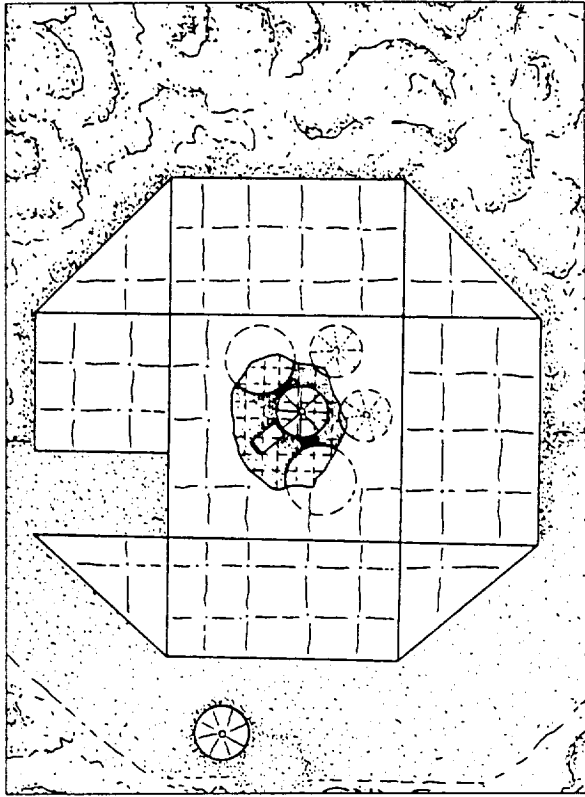

Figure 4-3-6. Dedicated greenhouse facilities will be placed underneath the shelter system.

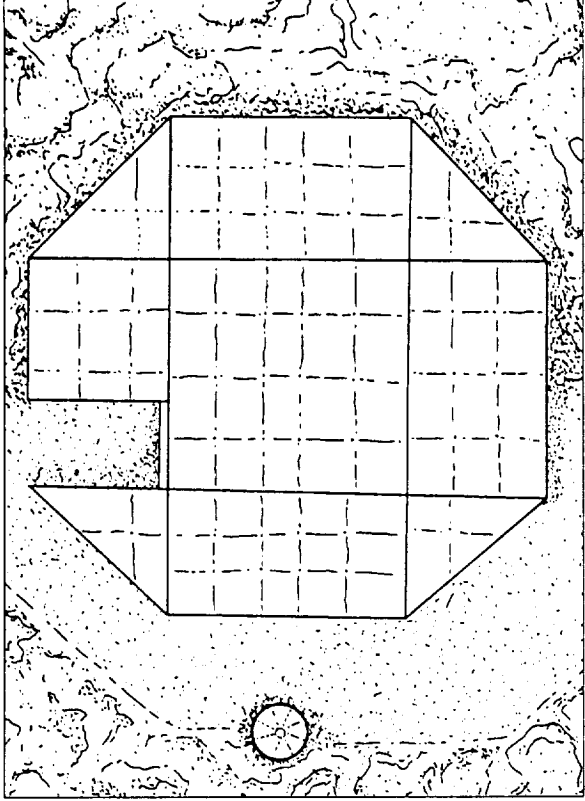

Figure 4-3-7. Final components of the habitat are employed—logistics support module and lab airlock.

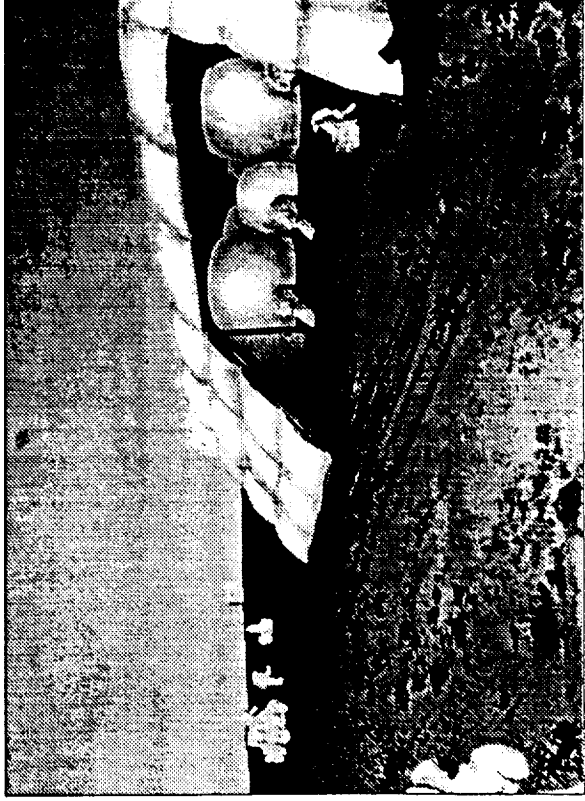

Figure 4-3-8. Perspective view to the southeast of the completed habitat and shelter system.

4.4 PERMANENT BASE INITIAL OPERATING CONFIGURATION

Once the base has reached initial operating configuration (IOC), a cohesiveness must exist between modules. The base also relies on the individual habitat volumes operating independently of each other in the event of a system failure.

4.4.1 HABITAT DESIGN ORGANIZATION

There are seven factors that went into creating the conceptual framework governing the overall concept design of Pax. They are:

- embracing entry
- a separation of work and play
- circulation efficiency
- dual egress
- central focus in each module or inflatable
- homelike environment
- sense of place

Because Pax is to be the astronauts' "home" for two years or more, a designated entrance will mark the "front door" to home. By situating the modules in an embracing formation, slightly set back in the center, the crewmember will have a sense of "moving within." The indented area is intended to mark a focal point in the habitat. The embracing feature is evident in both the plan and elevation of the habitat. From the surface of Mars, entry into the habitat is a sequential process. The crew will enter under the shelter system to the primary airlock. From this airlock, the crew will pass through a dust-off chamber before entering the primary circulation space.

The concept of designing Pax through a separation of "work" and "play" can help the crew differentiate their activities. By physically separating the laboratory spaces and crew support spaces, the crew may feel as though they were going to work similar to on Earth. They have the opportunity to "leave work" and "go home" for peace and recreation.

The habitat is organized in an efficient manner. From module to module there are clear linear circulation paths. Time will not be wasted by excessive walking. As discussed in Chapter 3 clear

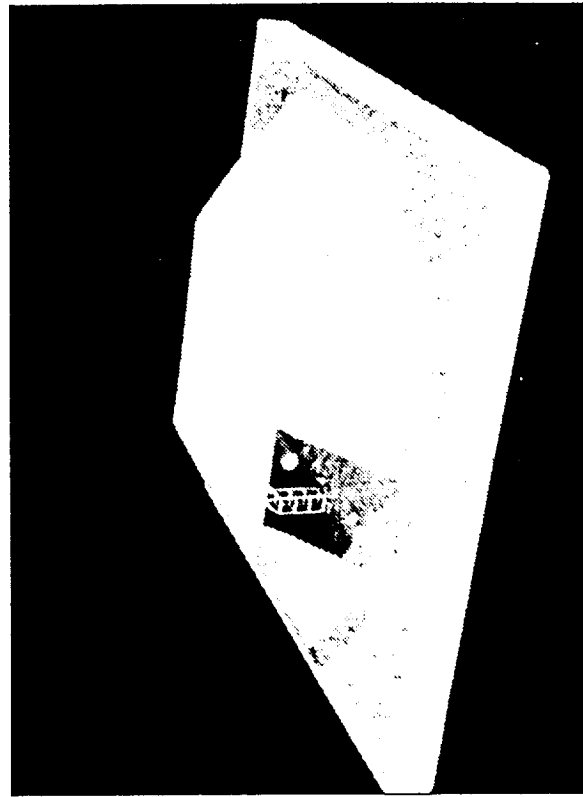

Figure 4.4-1. Model representation of Pax.

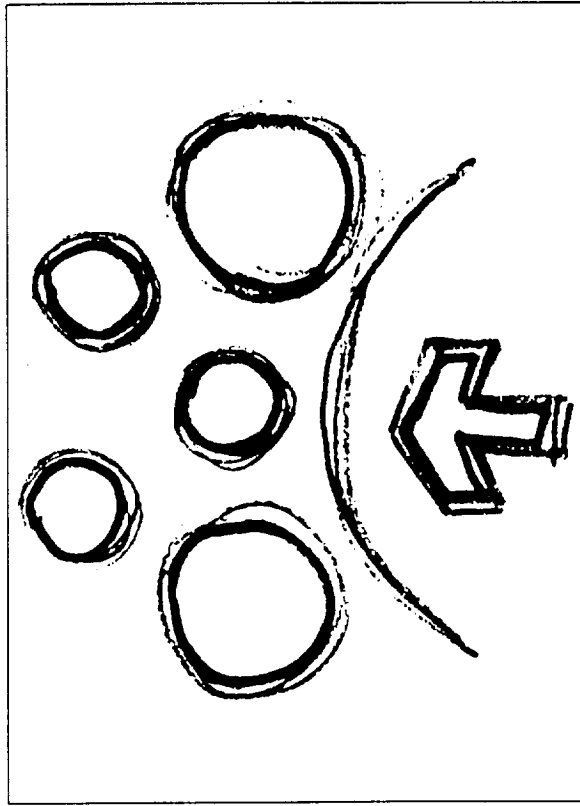

Figure 4.4.1-1. Diagram of module emplacement to create a focal, embracing entry.

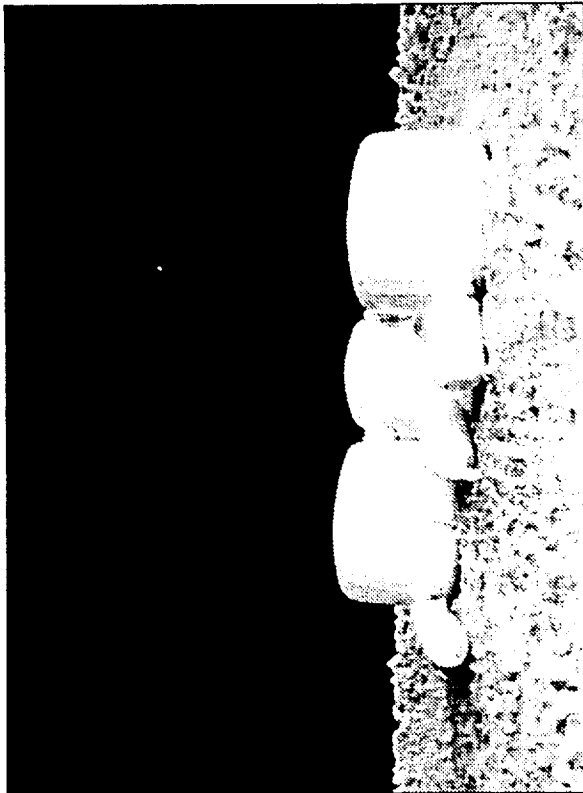

Figure 4.4.1.2. Massing model of Pax showing set-back feature of module emplacement.

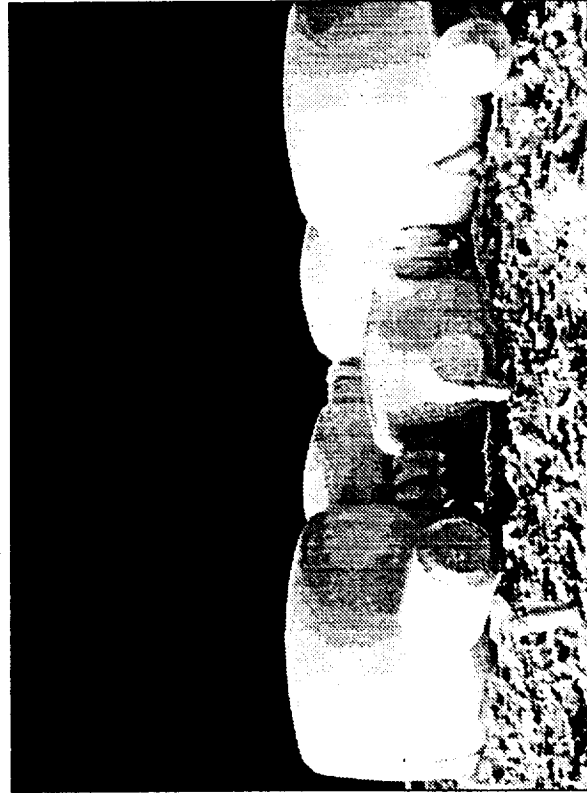

Figure 4.4.1.3. In elevation, a model of Pax shows the concept of an embracing entry.

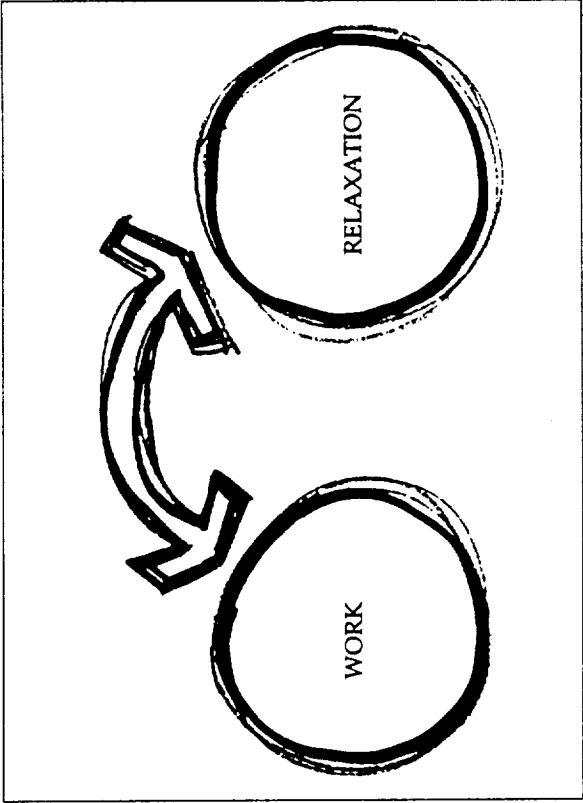

Figure 4.4.1.4. By separating the work space from the living space, a sense of going to "work" and returning "home" may be afforded.

circulation and wayfinding are important in keeping stress levels down. Situating the individual habitat volumes in a straight line would be far too monotonous. Pax is formed in a continuous, looped path. This allows for a variety of circulation paths while still being efficient. As an example, vertical circulation is located either in the center of a module or along the perimeter; the horizontal circulation is in the shape of an arc in the crew support module and vertical in the laboratory module.

Dual egress is another important element in extraterrestrial living. In the event of an emergency, the crew must be able to emergency exit any of the habitat volumes in two opposite directions. Two means of egress are required in building on Earth. This should be the same in extraterrestrial situations. Suits and EVA chambers are located in three areas to permit suited egress to the outside.

The entry module acts as the central focus for the habitat as a whole. Creating a central focus in each of the modules and inflatables is considered an important link in making Pax livable. It unifies the volume. Each of the five components also have designated focal

points in which the crew can gather. Within each volume personalization also acts as a humanizing factor.

The ability for the crew to personalize the spaces can provide for a more productive mission. As discussed in Chapter 3, allowing the crew the luxury of bringing pieces of "home" with them is important in keeping stress levels down. The Martian living environment will be different than that of Earth. Yet the crew should live in a comfortable and familiar way. The crew will be able to bring with them a "sense" of home. For example, the library will be filled with books that the crew has requested, and the crew quarters can each be decorated to suit individual tastes.

In designing individual spaces, the intent is to portray a particular atmosphere. To create a sense of place appropriate to the functions occurring is an important element. For example, the galley should give the impression that it is a galley and not mission operations. The private crew quarters should appear different than that of a laboratory. This may help the crew in adapting to isolated living conditions.

By incorporating all of the aforementioned concepts into the design of Pax, it is hoped that living on Mars will be comfortable and provide a productive environment for the crew. Each designed space,

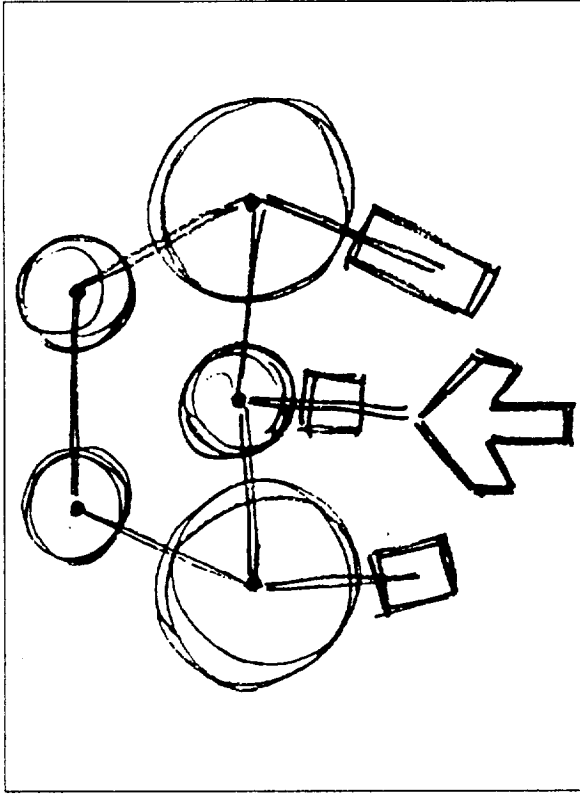

Figure 4.4.1-5. Variety and efficiency of circulation paths are suggested.

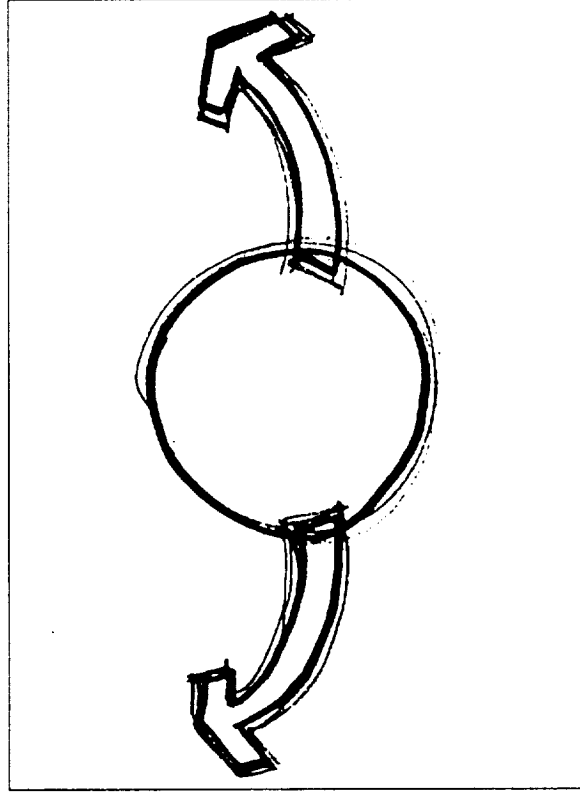

Figure 4.4.1-6. For efficiency and safety, dual egress should be incorporated into extraterrestrial habitats.

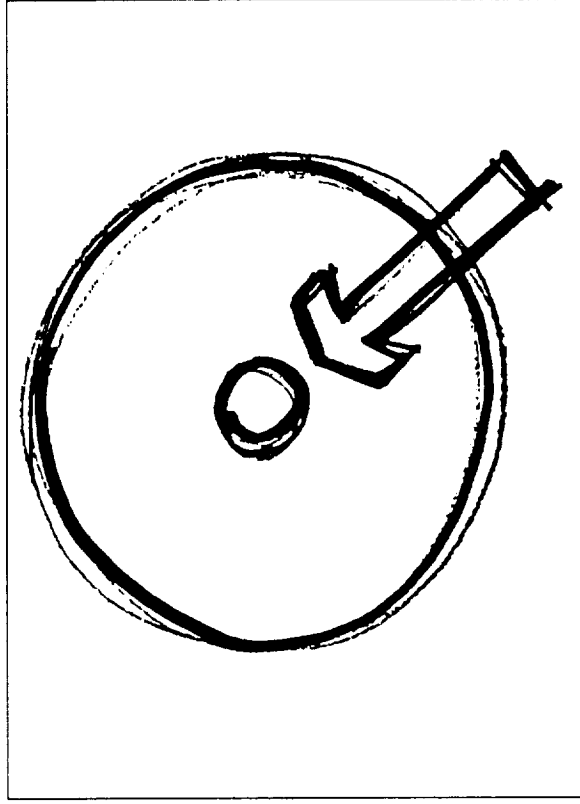

Figure 4.4.1-7. Focal points are created at a central location within the habitat volumes.

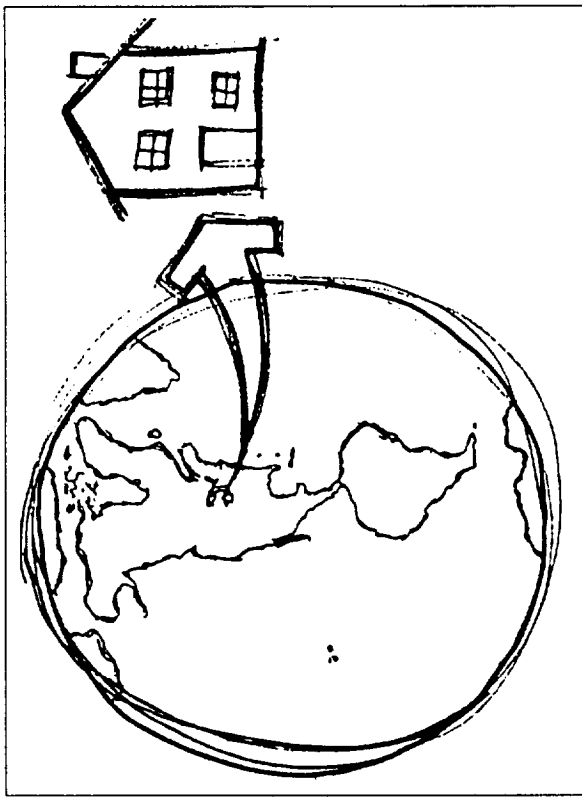

Figure 4.4.1-8. Bringing a sense of "home" to Mars could be considered an important factor for the crew.

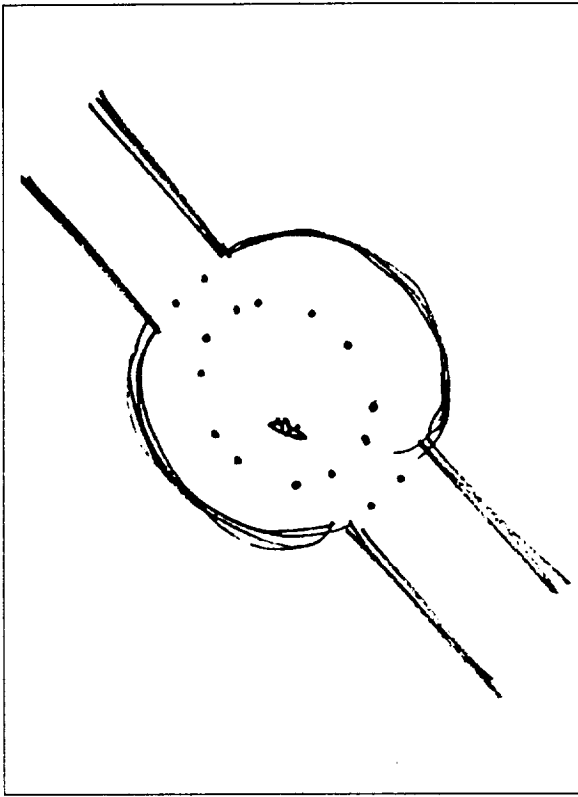

Figure 4.4.1-9. A sense of place is important in identifying and reacting accordingly to spaces.

discussed in the following pages, integrates design issues and requirements with the intention of making each space productive, habitable, and comfortable.

Pax contains five main components. It consists of three, 9 m hard modules, and two 12.6 m inflatables. Two of the hard modules house the greenhouses and the third is the entry and suit stowage module. The two larger inflatables hold the majority of the functions—predominantly the crew support and the laboratory areas. Three EVA chambers and a logistics module (space station-derived) make up the balance of the habitat.

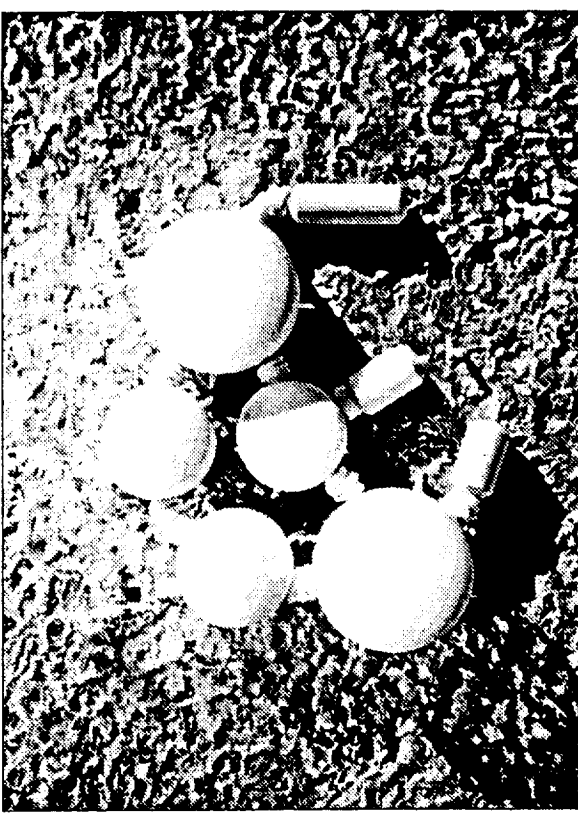

Figure 4.4.1-10. The habitat is comprised of three 9 m hard modules and two 12.6 m inflatables. Each module contains two levels.

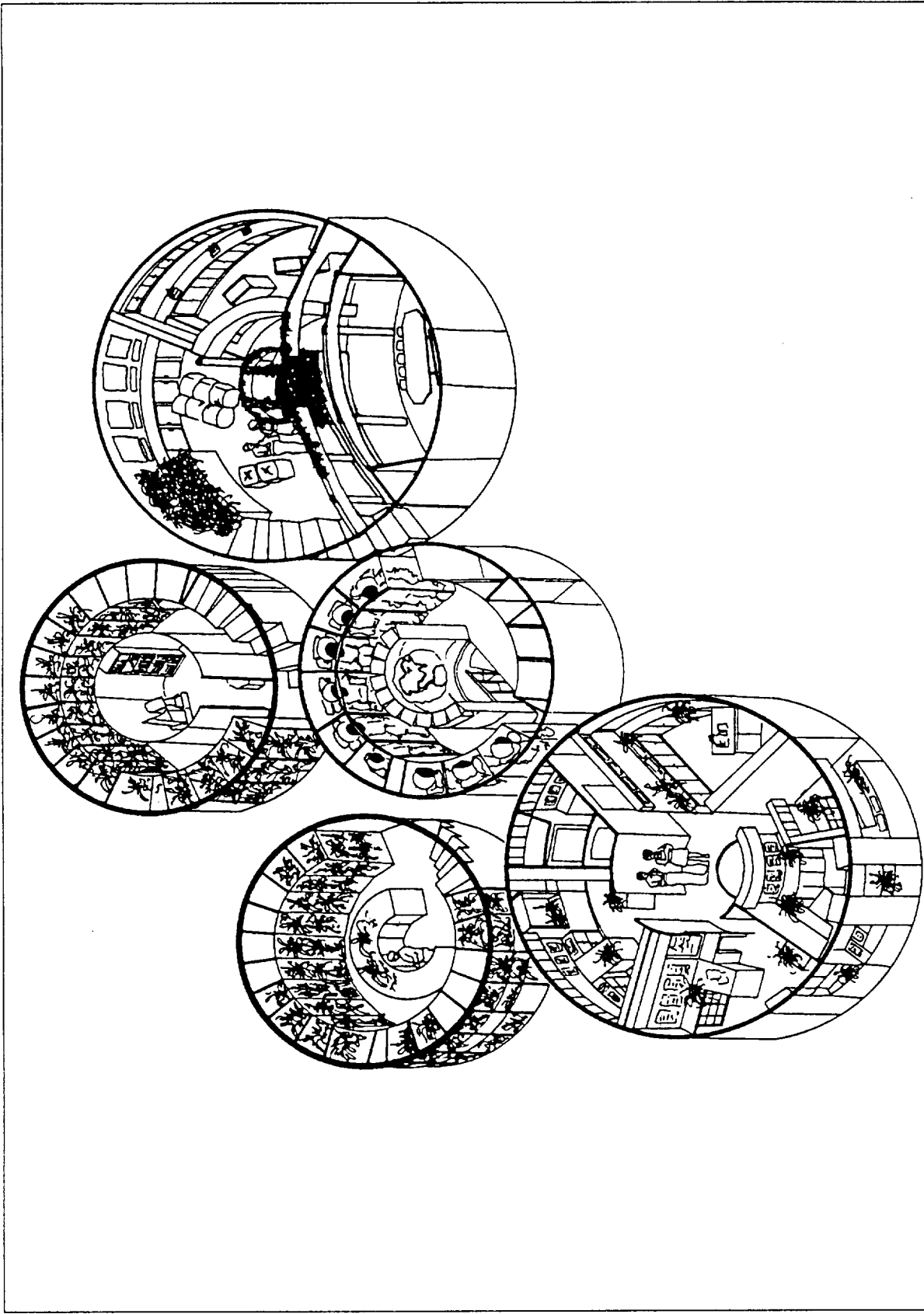

Figure 4.4.1-11. Axonometric drawing of main floor (entry level) of Pax, illustrating the embracing entry (center) and separation of laboratories from crew support facility (lower-left to upper right). The greenhouse modules are on the upper left.

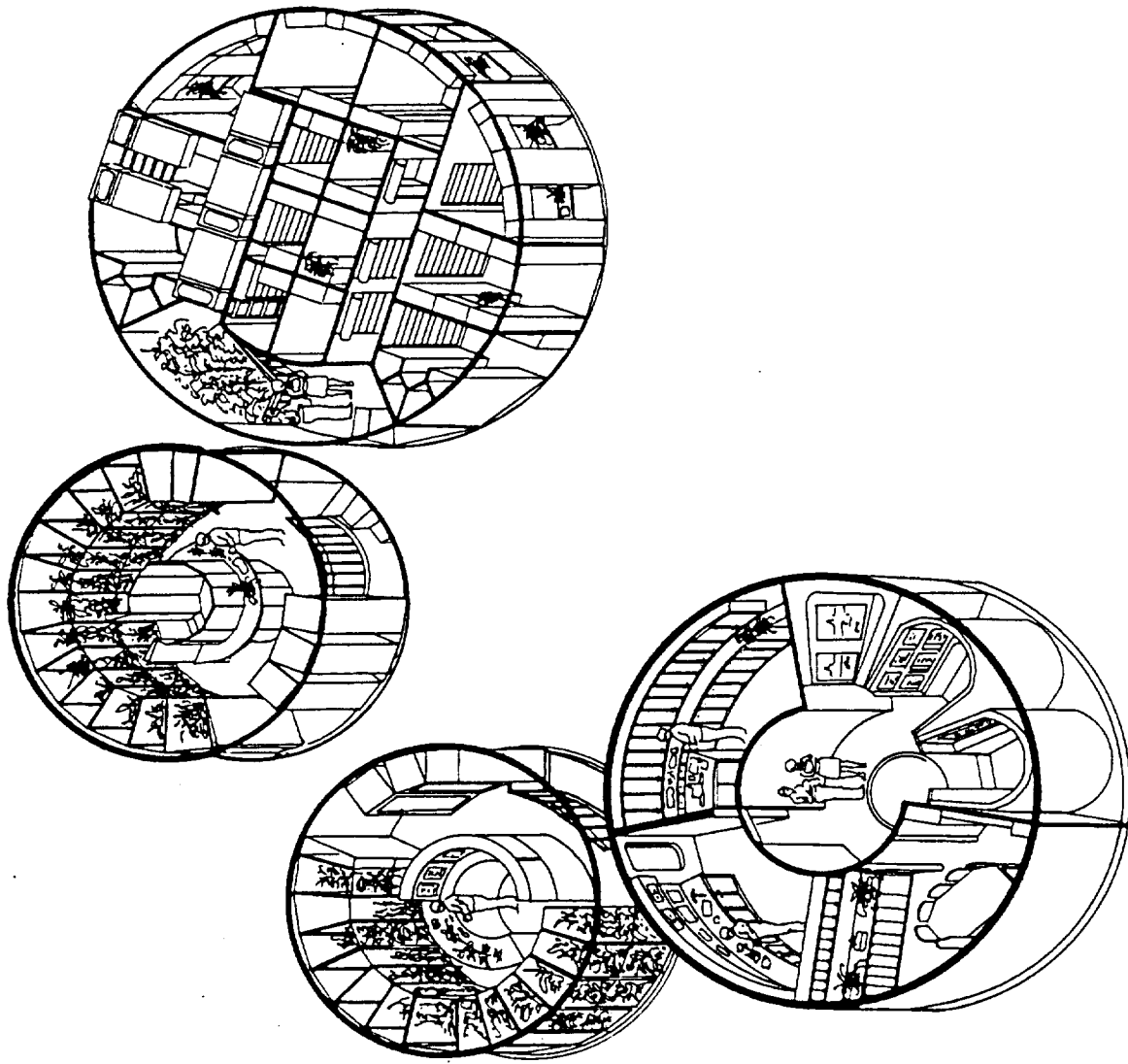

Figure 4.4.1-12. Axonometric drawing of the upper floor of Pax, illustrating the central focus and group interaction space in each module and the creation of a sense of place and homelike environment in all spaces.

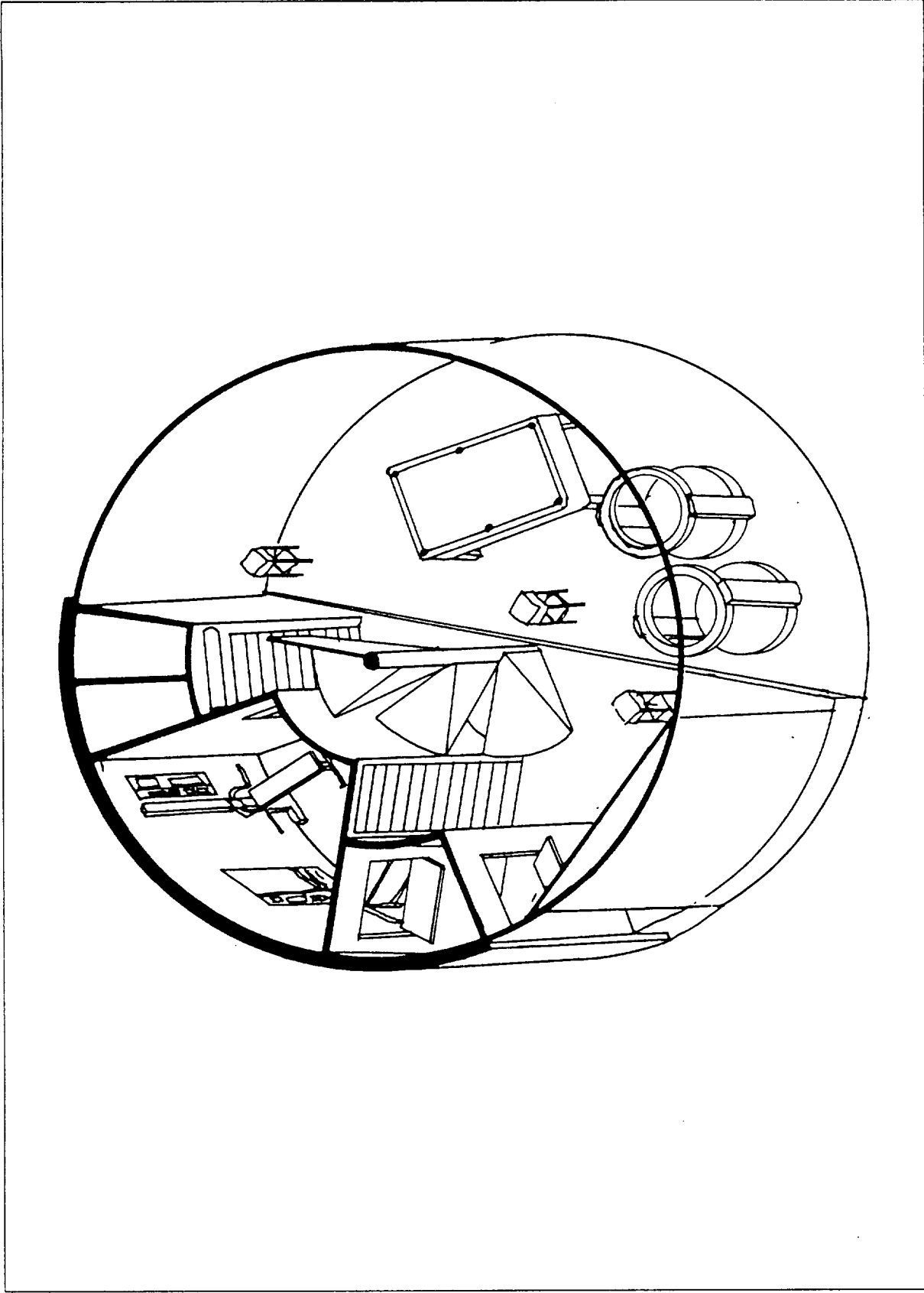

Figure 4.4.1-13. Axonometric of the lower level of the entry module (one level down from the entry level of Figure 4.4.1-11). Contained within is the active group recreation area and exercise facility.

4.5 HABITAT COMPONENTS

There are five primary components to the proposed habitat--referred to as the entry module (a 9 m hard module), the laboratory and crew modules (both 12 m inflatables), and two greenhouse

modules (the other 9 m hard modules). Each will be described and illustrated in turn, with reference back to the EB requirements summarized in Chapter 3 that generated their layout, character, and design.

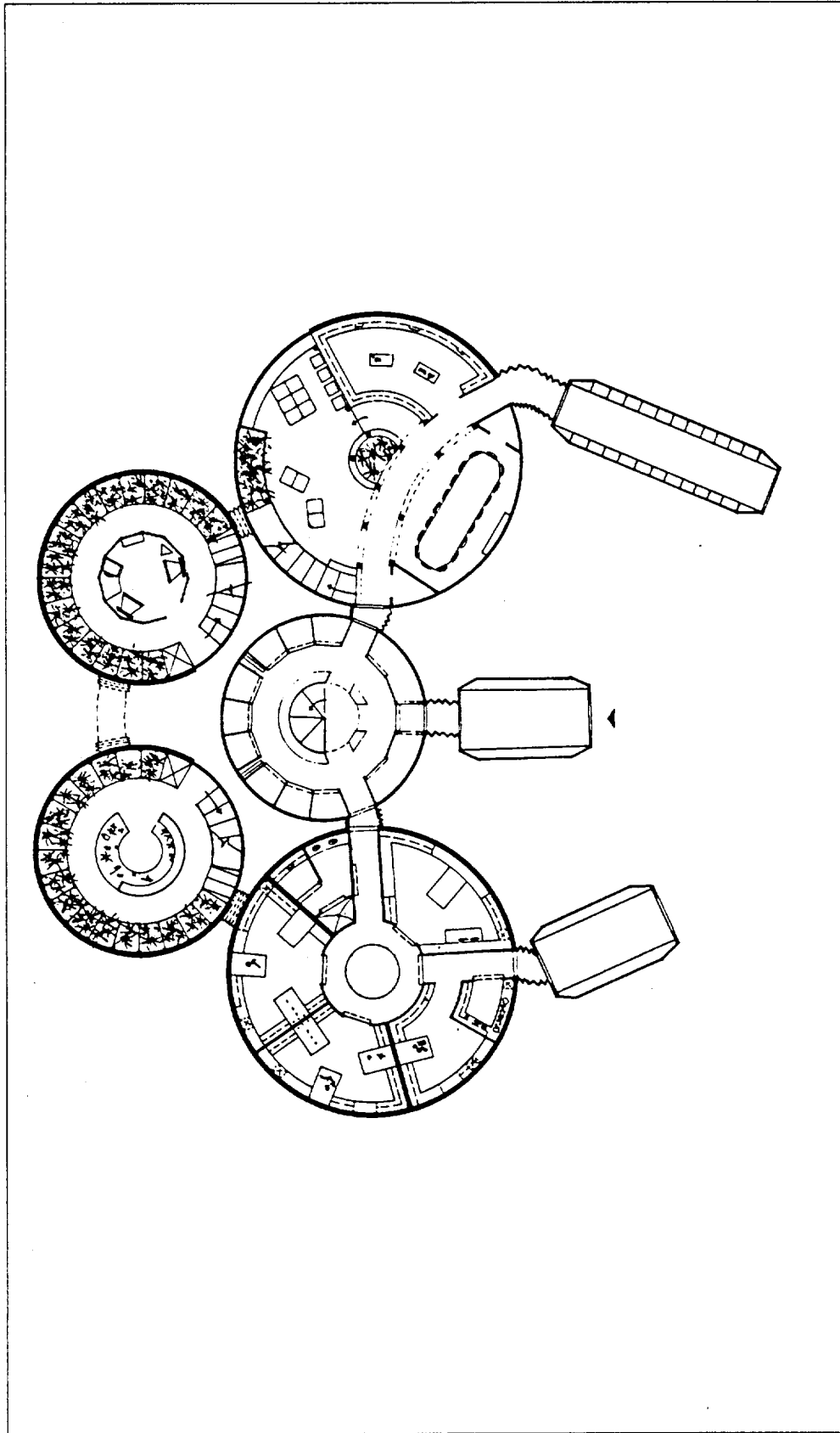

Figure 4.5.1.1-1. Floor plan of the habitat, level one. Three smaller modules contain the entry space and the greenhouse facilities. The two larger modules support the crew and laboratory functions. A logistics module and two airlocks complete the habitat plan.

4.5.1 ENTRY MODULE

4.5.1.1 Central Entry, Suit Stowage, and Maintenance

This 9 m hard module will serve several purposes. Dedicated as a major entry point, the module combines utility with a sense of first impression. Safety, cleanliness, and the sense of entry are incorporated. This area also serves as a decision point for translation to the laboratory and crew modules. The entire crew will utilize this space.

The entry module is central and flanked by the two larger inflatable components. It is linked to these inflatables by flexible connectors. Composed of two levels, entrance from the surface of the planet will be into the upper level the entry module.

After a staged entry through the airlock and dust-off chambers, the crew will arrive at the focal point of the module. This central space triple functions for translation, suit maintenance and stowage, and entry to the lower-level recreation activities. This area is one of decision and transition.

The focal point of the central module is a lively, colorful mural surrounding a half-spiral staircase. It serves as a barrier between suit maintenance, stowage, and the public circulation pathways.

The circulation pathway has been augmented by a change in flooring materials. Along the edge of the pathway, a special lighting system has been designed. Similar to the emergency lighting systems in aircraft, in the event of a system failure these lights will direct the crew to the inflatable modules or the dust-off chamber and airlock.

Special suit regeneration system chambers (SRSCs) have been designed around the perimeter of the module, behind the centered staircase. Each astronaut will have a complete extravehicular mobility unit (EMU). The built-in maintenance and stowage racks opposite the SRSCs provide easy accessibility to replacements components for the suits.

The lighting in this module will be of two types. Special lighting near the work area will highlight the work surfaces. General illumination is located in the ceiling. Special lighting has been designed for the focal point of the module. Above the staircase, the ceiling is raised, and the mural on the rear wall will be down-lit to create an ambience within the space.

Lighting will be controlled by the crewmembers, with built-in flexibility to allow several lighting combinations.

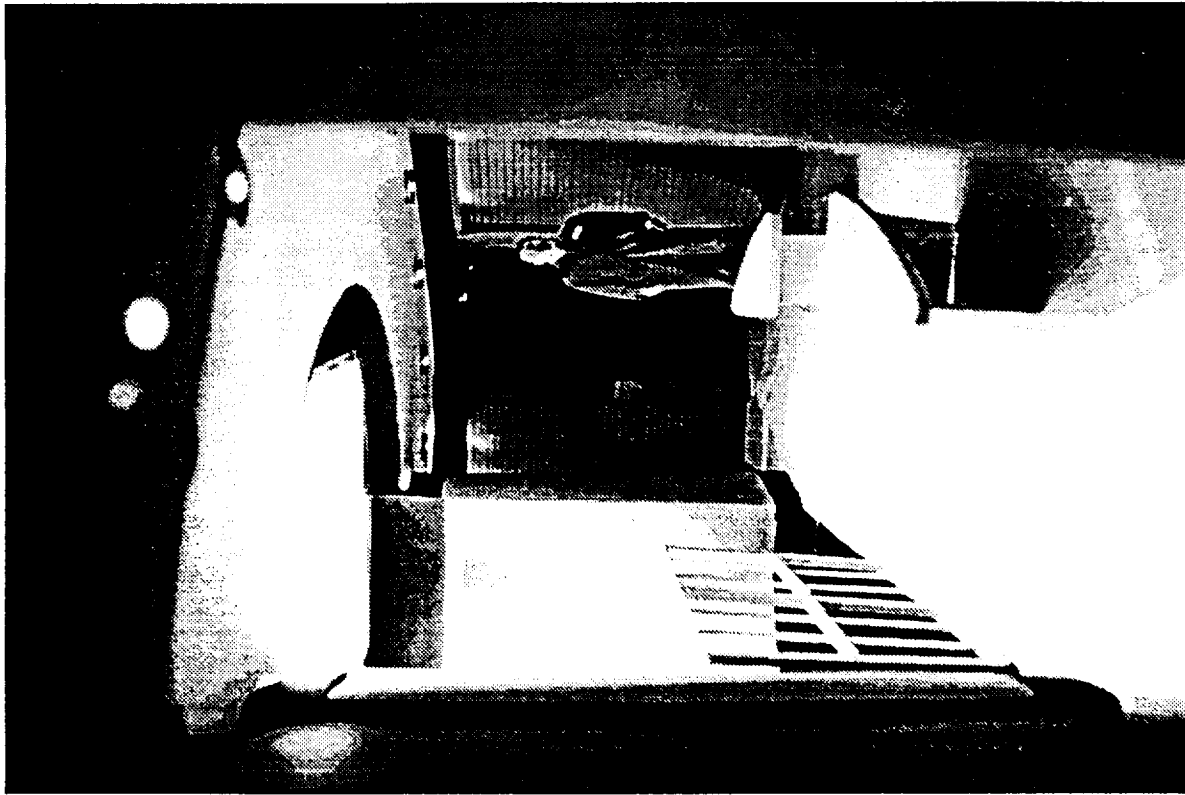

Figure 4.5.1.1-2. Entrance and transition point for circulation and EVA functions: the main entry and airlock are to the right, translation platforms to the lower recreation level to the left, and suit stowage around and behind the half-spiral staircase.

4.5.1.2 Active Group Recreation Area

The active group recreation area will allow for physical and mental recreation. It will incorporate a range of activities, and will be used by all crewmembers. This environment will encourage the crew to interact with fellow crewmembers. Access to this recreation facility is through the central entry module using the spiral staircase to the space below. On this lower level are the exercise area, juice bar, recreation space, and limited hygiene facility.

The special features of the recreation area are the billiard table, two virtual reality stations, and two dart boards. These activities will involve active mental and physical participation. The juice bar provides refreshment and an area for socialization.

The recreation space is separated acoustically from the other functions by using full and half-wall partitioning. Level changes in the floor assist in defining the various activities. As this area has the potential of being noisy and vibrant, the location in the lower level of the entrance module will isolate this space from other habitat functions.

Lighting of the recreation area will be a combination of indirect lighting and highlighting. General illumination from ceiling fixtures will provide overall light. On the walls beneath the wainscoting, specialized fixtures will direct light onto the wall behind them. Completely controlled by the crew, the atmosphere of the space can be changed as desired.

4.5.1.3 Exercise Facility

The reduced gravity countermeasure exercise facility is a dedicated space for the maintenance of the crewmembers' physical condition. Its use will be encouraged by the design of the area, and demanded by the physicians monitoring the astronauts' well-being.

Located in the lower level of the entrance module, the excess noise, vibration, and odor associated with exercise will be contained. Various exercise countermeasure equipment includes a treadmill, a rowing machine, and resistance muscle building unit. A special feature of these units will be their computer monitoring systems. These monitors will be linked directly to the main computer system of the habitat for transmission to physicians on Earth.

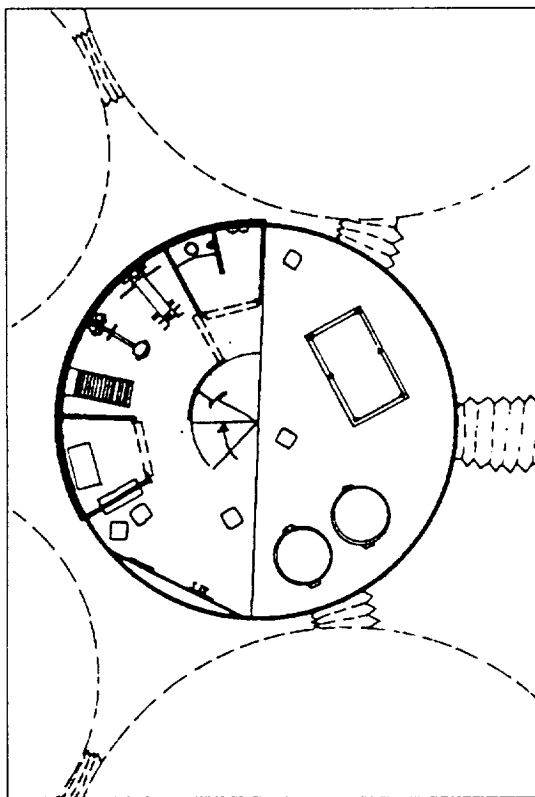

Figure 4.5.1.2-1. Floor plan of the lowest level of the habitat—the active recreation area and exercise facility of the entry module. Note: While each module has two levels, only the entry module is set lower in the Martian surface so that entry is on the second level of this module.

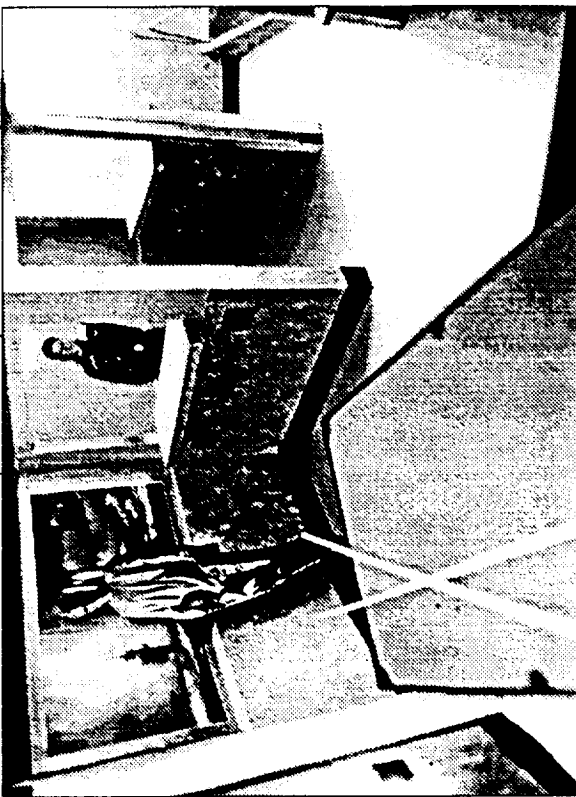

Figure 4.5.1.2-2. View of the active recreation area and juice bar with half-wall partitioning separating functions yet allowing visual contact with other crewmembers. Level changes demarcate the recreation area from the exercise reduced gravity countermeasure facility. Various methods of lighting allow the crew to control the spatial ambience.

For the comfort of the crew, a ventilation system is installed above the exercise machines. Air movement is controlled with a series of nozzles above the machines. The crewmembers will have the option of controlling the quantity of air flowing over their bodies. The rowing machine and treadmill will have display screens on the wall in front of the equipment. The crew will have a wide selection of video recordings to choose from in order to add interest to their workout.

To assist in partial post-exercise body care, a limited hygiene facility is located adjacent to the exercise area. The wall between these spaces is mirrored.

The lighting of the exercise space is a combination of general illumination and specialized task lighting. While on the resistance equipment, the crewmember will not have to look into the light directly. Special fixtures installed in the floor will provide up-lighting and wash the ceiling surface.

4.5.2 LABORATORY/MISSION OPERATIONS MODULE

One entire inflatable module has been dedicated to the mission control and laboratory functions of the base. This 12.5 m module is composed of two levels. The laboratory and mission control inflatable is situated to the left (east) of the entry module. It is connected to the entry module by a flexible connector.

4.5.2.1 Mission Control

Mission operations will act as the heart of all base and habitat functioning. Control and monitoring of all components, systems, and storage of data will occur here. Back-up operations centers are designed into workstations, laboratories, greenhouses, and crew support in the event of failure in the mission operations command area. All crewmembers will use these spaces as dictated by the mission profiles.

Mission control, on the upper level of the laboratory/mission control module, is composed of various spaces:

- conference room
- mission control workstations
- audio-visual monitor systems
- telerobotic control systems

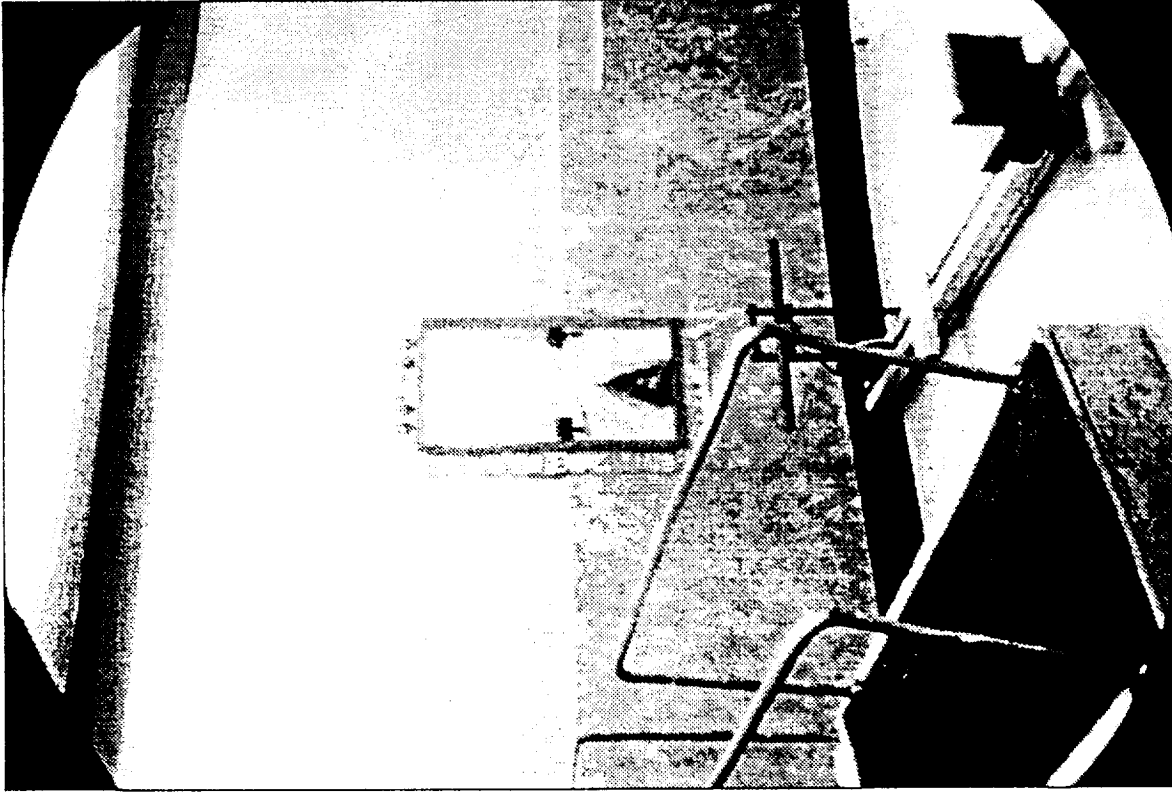

Figure 4.5.1.3-1. The exercise facility will provide a range of exercise countermeasure stations. Individually controlled ventilation systems will provide cooling during workouts.

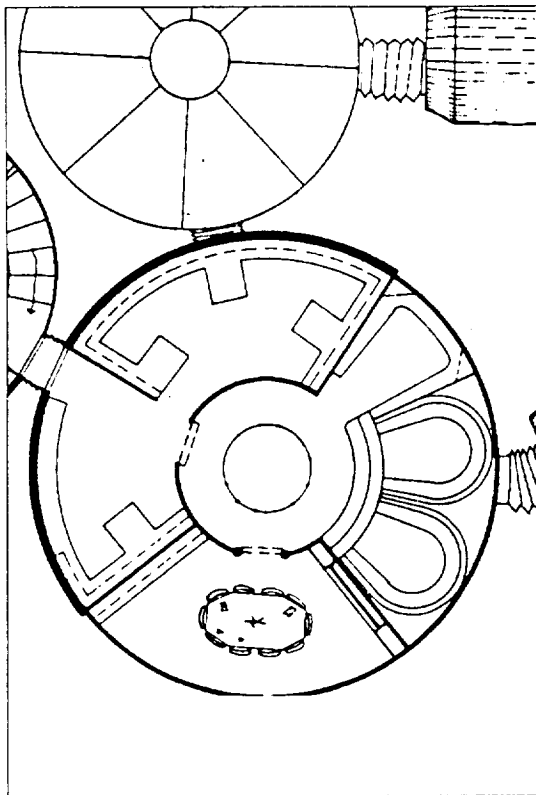

Figure 4.5.2.1-1. Floor plan of the upper level of the laboratory/mission operations module. The conference room and three mission control workstations are in the bottom segments of the plan.

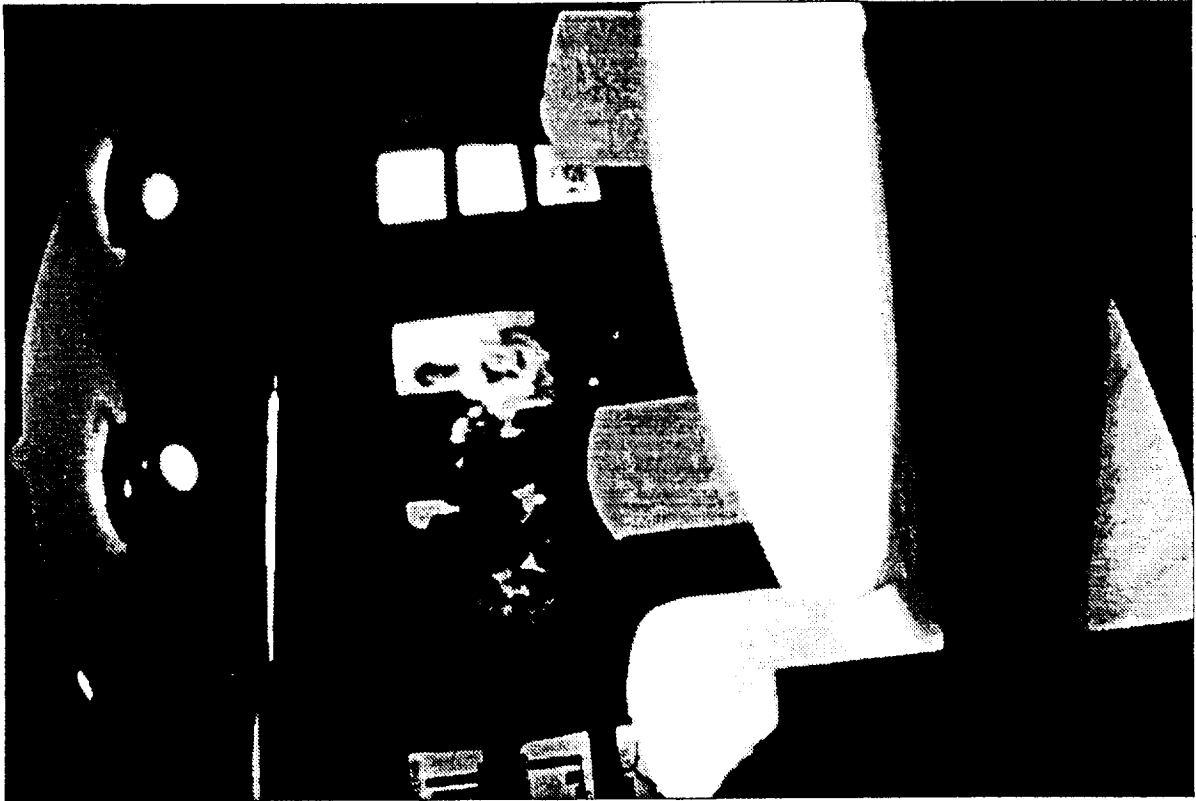

Figure 4.5.2.1-3. Mission control conference and briefing area. Monitoring screens allow visual access to several habitat areas as well as base functioning and surface operations. A large table allows half the crew at a time (one shift of 9) to review and coordinate mission activities.

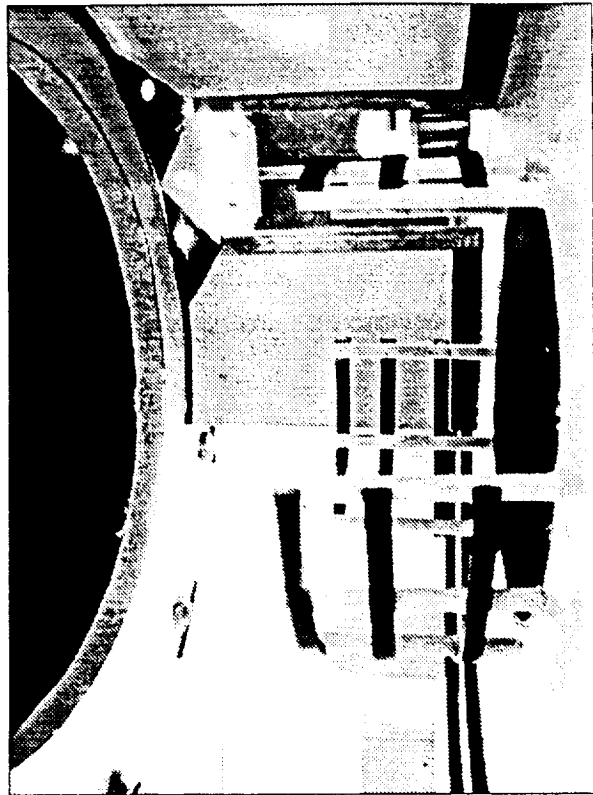

Figure 4.5.2.1-2. Mission operations as viewed from the vertical translation area. The individual workstations are to the left, the briefing room to the right. The workstation areas combine general lighting and task lighting.

Within the conference room, a large video screen dominates the space, surrounded by eight smaller screens. A portable computer terminal allows access to the system from various locations within the space. Opposite the audio-visual screening center, a service center houses a sink, a system central controller lift (SCC), and storage space. A large table can seat 50% of the crew.

The workstations are designed for one-person use. Activities monitored and directed from here are the control of launch and landings, maneuvering of robotic EVA rovers, emergency rover control, training and simulation of new products and information, and communication with Earth, spacecraft, or the Martian surface. Complete intra-base monitoring can be accomplished here as well.

The workstation area is divided into three individual stations. The general configuration for the workstations is tear-drop shaped to accommodate the user requiring minimal movement.

Two stations allow the user to function seated, the other while standing or utilizing a taller chair. Each has the option of being secluded or opened for interaction with other crew members. Those stations allowing seating have various monitors within the crew's peripheral vision. Just beyond each screen is stowage and work surfaces.

The remaining workstation, for use either standing or seated at a higher level, allows direct viewing to the planet's surface within the habitat space frame. The EVA rovers and airlocks will be in easy view. Several small monitors on either side of the window will augment the telerobotic functioning of this station.

Lighting in all stations is task lighting, completely controlled by the user. Lighting in the ceiling provides general overall illumination. The wall divisions between the workstations are highlighted with ceiling fixtures.

4.5.2.2 Research Laboratories

With science driving the primary missions of any Martian base, a general laboratory was designed as well as laboratories to support chemistry, biology, microbiology, and botany. These labs are located on both levels of the laboratory and mission operations module. This is where the crewmembers will perform most of their daily activities. The module will be a high activity space with internal as well as external surface operations being conducted.

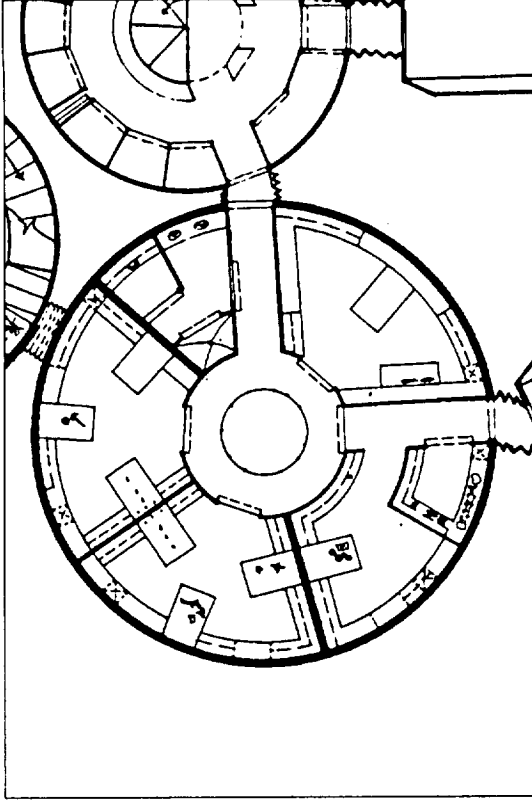

Figure 4.5.2.2-1. Floor plan of the main level of the laboratory module showing (from lower center, clock-wise) the general, chemistry, and biology labs.



Figure 4.5.2.2-2. View into the laboratories: common work surfaces visually divide the spaces; ample stowage is provided for equipment and within easy access to the crewmember. General lighting in the ceiling will be augmented by specialized task lighting at various workstations.

The general laboratory on the main level is adjacent to an airlock. Materials will be brought to this ingress point from a rover to be cut, ground, dried, baked, pressurized, depressurized, frozen, weighed, and then placed into storage containers for future testing in the other labs. This lab is divided into three sections. A self-contained grinding room prepares materials for testing. Good lighting and ventilation will be provided. This part of the lab has a dust-off chamber for dust containment. Along the perimeter wall is the second wet area. The space is designed to provide an area for a furnace, oven, and an air-dry cabinet for the testing of moisture content or volatiles. The third area of the general lab is the dry area. Housed here are measuring devices and a computer terminal. Although there are three separations, the wet and dry areas have no physical barriers, only a conceptual zoning separation to guard against water damage to electronic or other sensitive instrumentation.

Chemistry, biology and microbiology are located also on the main level of the laboratory inflatable. This location is chosen for its proximity to the EVA equipment and airlock. The chemistry and biology labs are similar to each other in plan, but contain different equipment depending on the testing required of the mission directives. Six different workstations are provided in each of these three labs. Two SCC hatches, one of which runs to the second floor, are contained in each lab.

All the labs contain refrigerators, two sinks, emergency shower and eyewash, vacuum booths and hood vents.

Two botany laboratories are located on the upper level. This location provides easy access to the greenhouse modules through the translation connectors.

4.5.2.3 Health Maintenance Facility

The health maintenance facility (HMF) serves as a wellness clinic in addition to a mini-hospital capable of surgery. Due to the distance from Earth, preparations for as many anticipated emergencies as possible will require that the area be stocked with medical supplies, diagnostic equipment, an area for surgery, recovery and quarantine, or a space to maintain a deceased crew member's body before transport to Earth. It is located on the lower level of the laboratory facility inflatable immediately adjacent to the central circulation path from the entry module and the rest of the habitat.

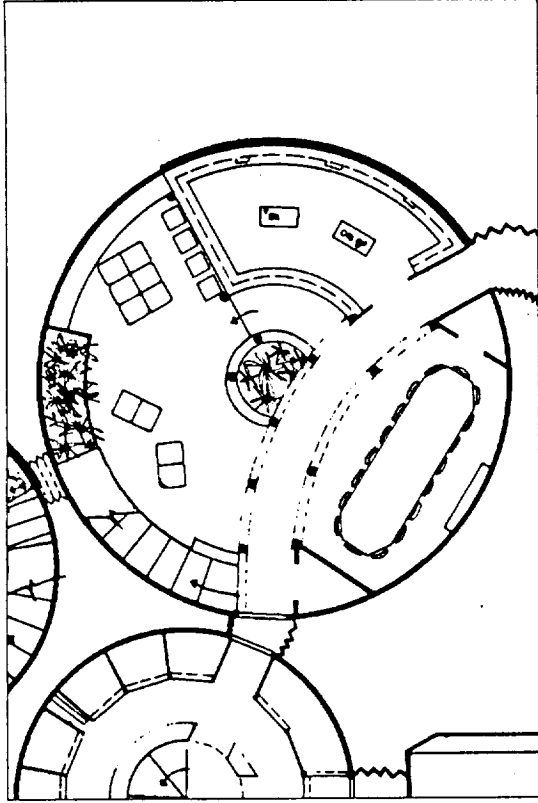

Figure 4.5.3-1. Main level floor plan of the crew support module. This level consists of a wardroom, galley, and group recreation space.

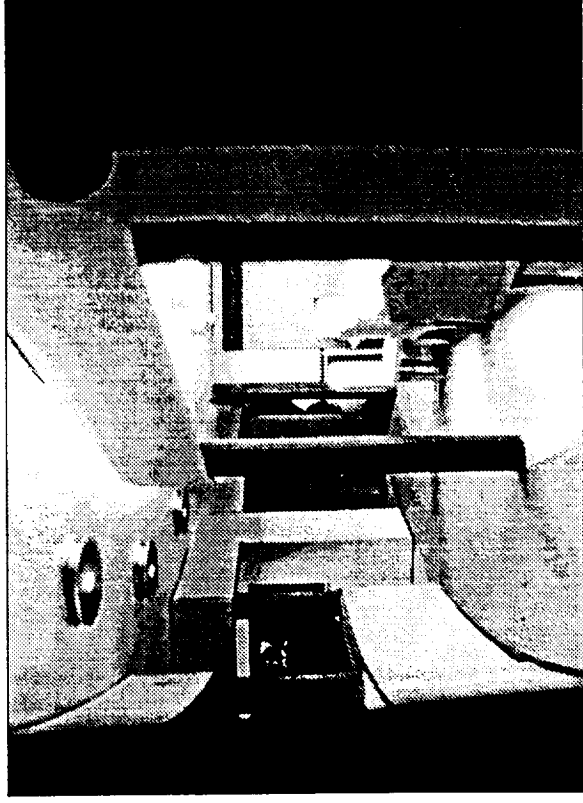

Figure 4.5.3-2. Primary circulation pathway through the main level of the crew support module. On the left is the entrance to the group recreation area (first) and the galley (second entry) and on the right is the wardroom with capacity to seat the entire crew.

4.5.3 CREW SUPPORT MODULE

The crew support module exists to accommodate the basic needs of the crew. When approaching this module from the surface of the planet, it is located to the right of the entry module. This two-level, 12.5 m habitat component is comprised of a galley, wardroom, group recreation space, laundry facility, two personal hygiene facilities (PHF) and the personal quarters for the 18 crewmembers. Access to this module is through a flexible connection on the lower level from the entry module. Additionally, a second access point is from another connector on the second level through to private contemplation spaces in the adjacent greenhouse module.

A primary circulation pathway to a docked logistics and emergency EVA module divides the functions on the main crew support floor. The pathway is highlighted by a change in flooring materials. Half walls and columns further delineate the divisions between functions, but allow visual access through the entire level.

Lighting with the ceiling fixtures will augment circulation. This can be manipulated by the crew as the need arises, by raising or lowering the lighting level with a dimmer control.

4.5.3.1 Wardroom

The wardroom is designed to provide a special atmosphere for group gathering. More formal in character than most other spaces in the habitat, this space can seat the entire crew of 18. The space will serve as a dining room, communication station, meeting area, and place for social interaction.

Located directed across from the galley, the wardroom is convenient to transport a meal for consumption. Any crewmember can see the entire level of this module from this vantage point.

The formality of the space has been created by the use of architectural detailing. A grand table occupies the center of the wardroom. Seating for 18 is provided. A special feature of this modular table is its ability to be separated into smaller tables to provide seating for smaller groups. Built-in stowage cabinets have been placed at one end of the space. A wainscoted effect is accomplished with panels installed on the walls. Columns and a two-piece panel door separate the wardroom from the circulation corridor.



Figure 4.5.3.1-1. The wardroom is a gathering space of the entire crew for formal, communication, and social occasions. It seats 18, but the tables can separate for smaller groups for meals, cards or games, or individual pursuits.

A large visual communication screen dominates the large wall behind the table. This can be utilized for mission briefings, Earth communication, and group entertainment.

Lighting in the wardroom is a combination of general illumination, spot lighting, and special wall fixtures. Lighting behind wall-mounted fixtures will allow for low level requirements during social functions.

4.5.3.2 Galley

Meal preparation and consumption is not only necessary for crew health maintenance, it is also a social event. The galley has been designed on the lower level of the crew support inflatable. It occupies one-fourth of the dedicated space on this level. Activities that will occur in the galley are food preparation, food and equipment storage, and clean up.

The galley is curvilinear in shape and provides the crew with three food preparation workstations. Each station contains counter space, a sink, and microwave and convection ovens. Two mobile islands provide additional work surfaces. The maintenance of the



Figure 4.5.3.2-1. The galley is designed for ease of food preparation and maintenance, ample storage, three separate workstations and mobile islands.

galley is performed using water dispensers, trash receptacles, trash compactors, dishwasher, handwashers, and associated dryers.

The storage of food will be in the cabinets installed on the periphery of the galley space. Counters are placed between the group recreation area and the galley. This allows convenient "pass through" capabilities for the food. Under the counters, on the group recreation side, is individual seating. Crewmembers may then eat in any of three areas: the wardroom, the group recreation space, or the galley itself.

Adjacent to the galley is the entrance to the logistics (and emergency EVA) module. This will serve as the food resupply stowage module. The entire logistics module will be replenished as the windows of transportation from Earth permit. Perishable food items will be grown in the greenhouses.

As in other locations in this module, lighting will be a combination of general illumination and task lighting. Crew control of the lighting will allow a number of combinations according to personal requirements.

4.5.3.3 Group Recreation Area

An informal, or casual group recreation area is situated next to the galley space. The function of this area is to allow casual social interaction and a place for rest and relaxation. Defining this space are a change to a lower floor level, perimeter columns, and vegetation.

Movable seating components allow any number of arrangements for the crew. The lowered floor level creates a feeling of spaciousness. The center of activity is the large screen audio-visual system for entertainment. A focal point of this space is the vegetation planters.

4.5.3.4 Laundry

An additional function to be accommodated on the lower floor of the crew support module is the laundry facility. Its location is driven by the objectives of minimizing volume and functional proximity. The laundry utilizes an otherwise awkward space. The wedge behind the wardroom becomes occupied by the laundry facilities, also making them close to the crew quarters immediately overhead.



Figure 4.5.3.3-1. View from the recreation area across the vegetation planter toward the wardroom.

Across from the laundry, and from the edge of the group recreation area, a stairway leads to the upper level of the crew module. Adjacent to this stair is a two-level greenspace. Crewmembers on the second level will be able to view portions of the recreation space, expanding the perception of spaciousness and giving the opportunity for previewing the recreation spaces before coming down the stairs.

4.5.3.5 Crew Quarters

The crewmembers' personal quarters allow for retreat and privacy. Accommodations for all 18 astronauts are on the upper level of the crew support module. These quarters are a combination of single and double-occupied settings. They are grouped along two corridors, allowing for more privacy for the expected split shift work organization.

The design of the crew quarters emphasizes minimizing volume and maximizing personalization. Six of the quarters are designed as double occupancy; six are designed for a single crewmember each. Being located along the periphery of the circular module allows for interesting design variations. The components in the quarters—the

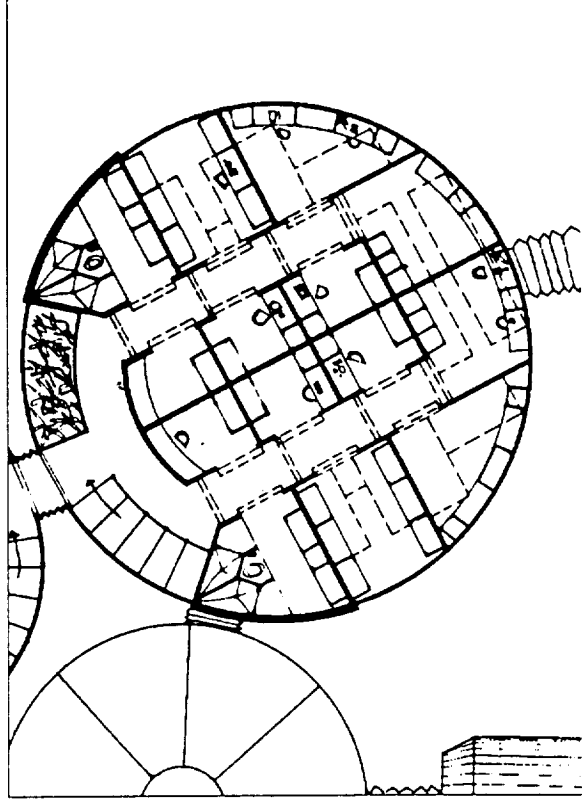

Figure 4.5.3.5-1. Upper level floor plan of the crew support module—the crew quarters and PHFs.

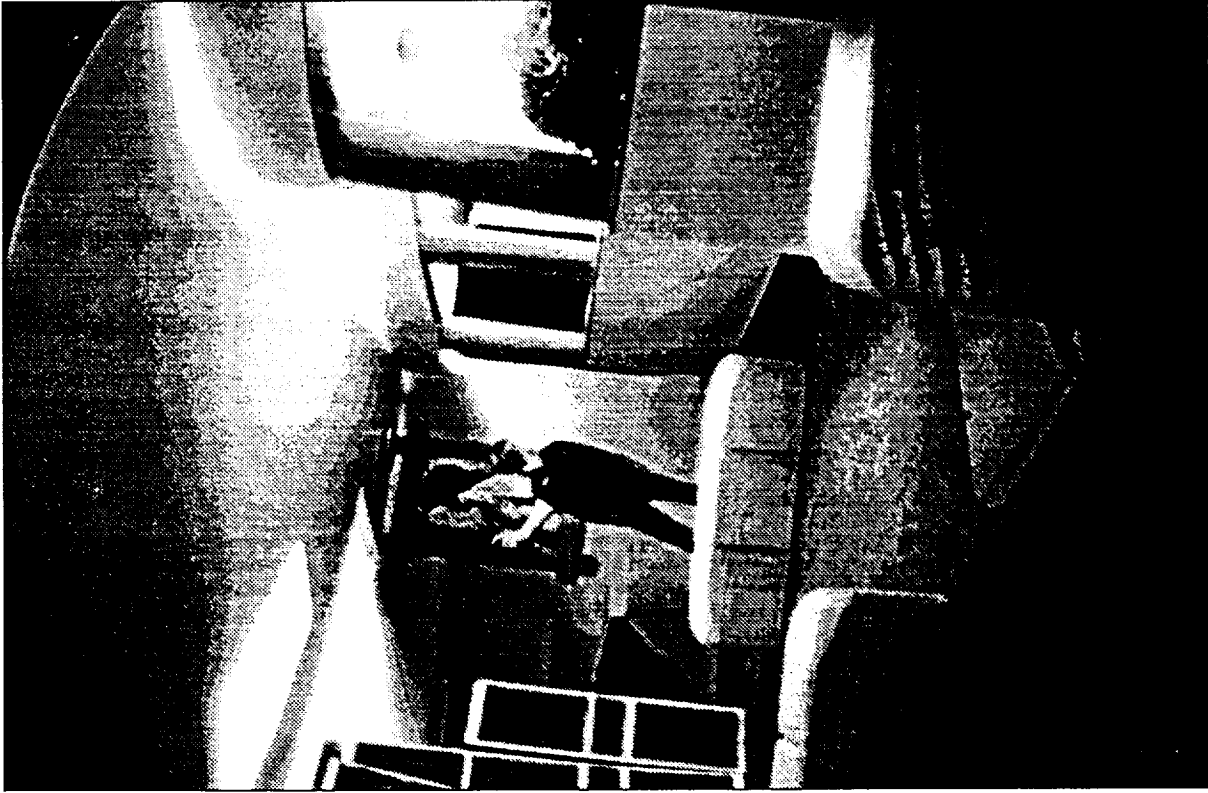

Figure 4.5.3.3-2. Casual recreation area will promote social interaction in a comfortable setting.

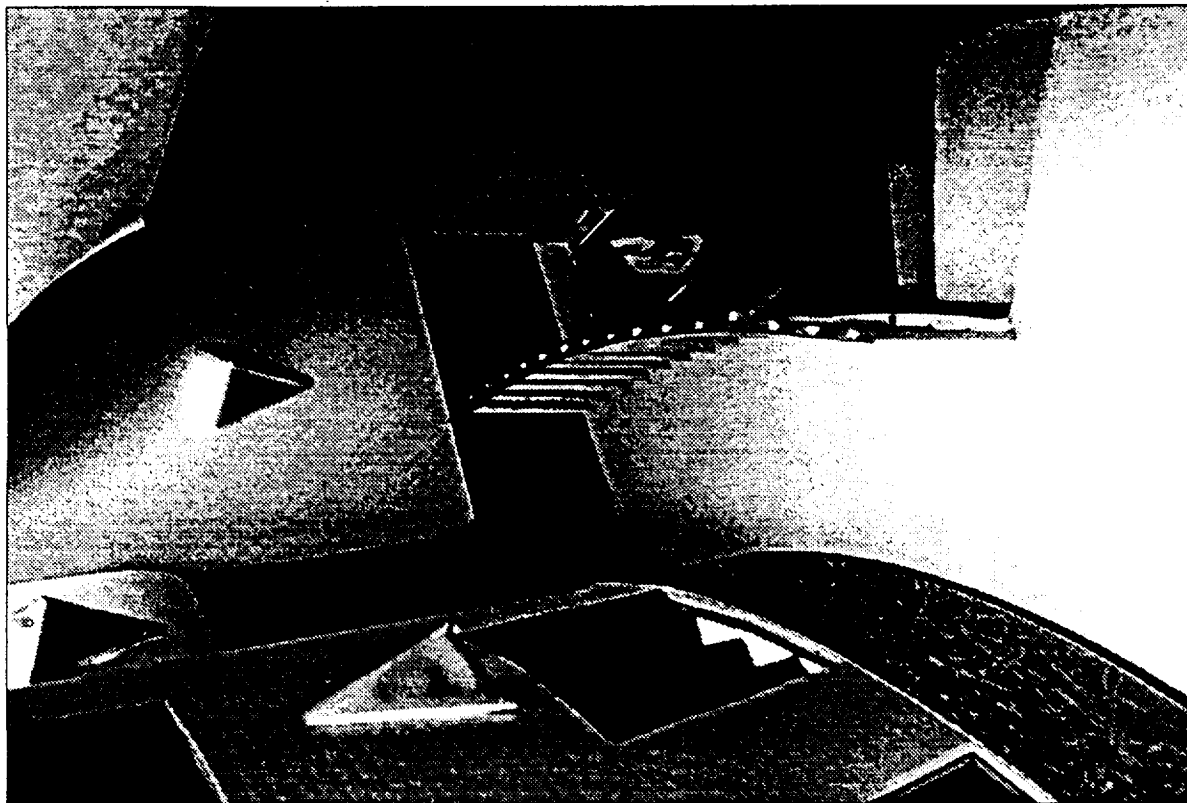

Figure 4.5.3.6-2. The transition space between the lower level and the private level of the crew module is accomplished by the use of a curved staircase. The entry to this zone is highlighted by a two-level-high ceiling.

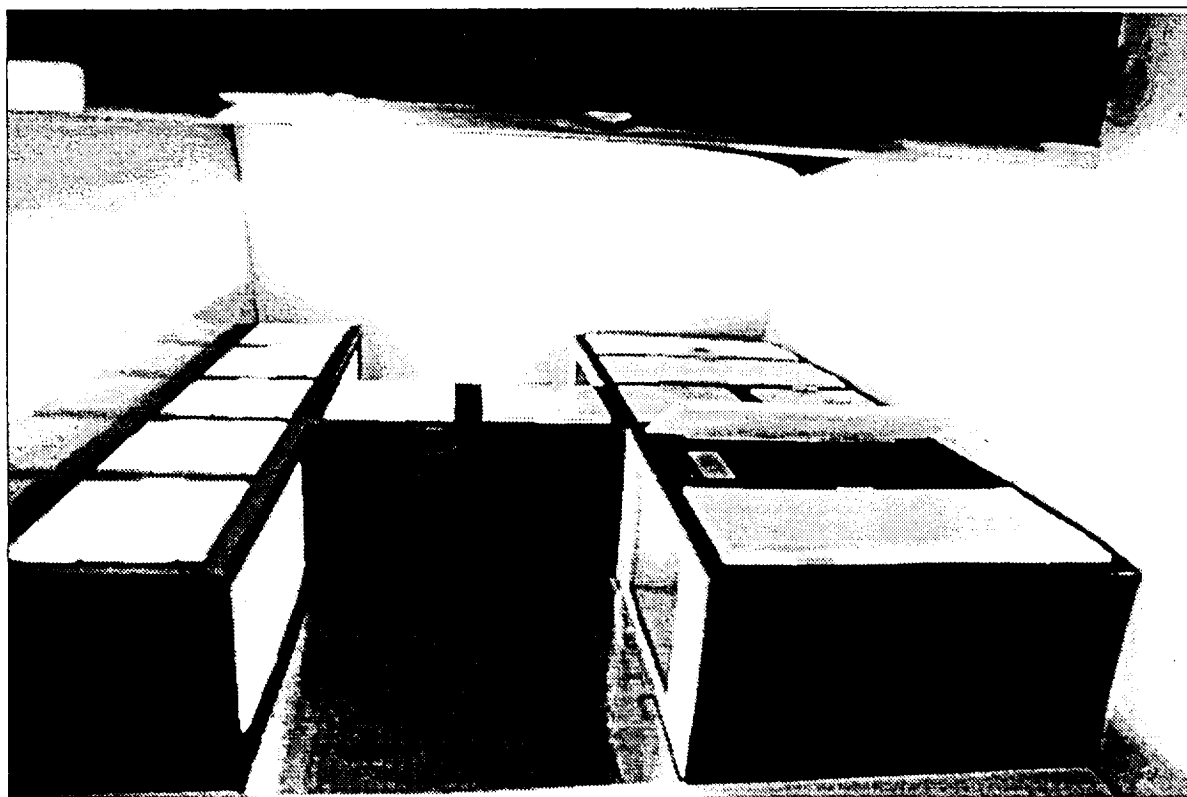

Figure 4.5.3.6-1. One of the pair of personal hygiene facilities.

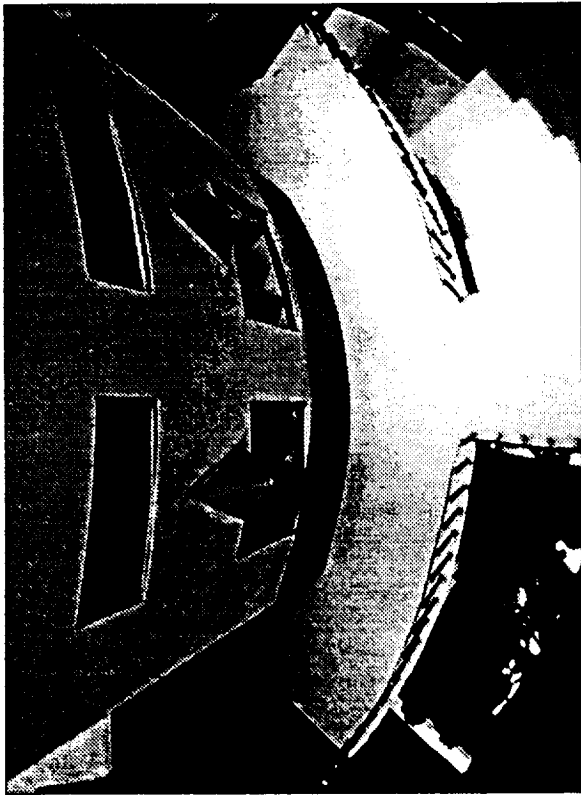

Figure 4.5.3.6-3. Circulation space alongside the crew quarters and visual access is permitted into the green space the recreation level below.

quarters with an associated PHF. In peak usage, one PHF will not suffice, and the second PHF can be utilized at this time. The location of the PHF will not disturb the crewmembers occupying their quarters even though they share a common wall. The more noisy functions have been placed on the wall opposite the common wall. Within the crew quarter, stowage compartments are against the common wall.

Anticipated functions within the PHF will be waste management, daily washing, showering, and a preparation area. Lighting within the PHF is both task and general.

4.5.4 GREENHOUSE MODULES

The two greenhouse modules will decrease the dependency on fresh food supplies from Earth and provide human factor benefits from living plants. There are two distinct emphases for the greenhouse modules. One will concentrate on food production and the other will address research and, to a lesser degree, the humanistic values of plants.

Both greenhouse modules are supplied with a rack system to

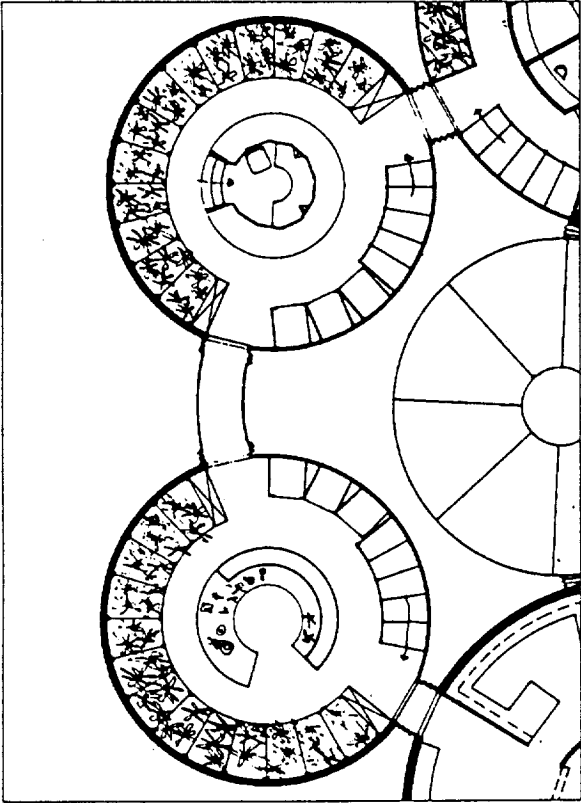

Figure 4.5.4-1. Floor plan of the upper level of the two greenhouse modules. Greenhouse accessibility is from the primary circulation space of the crew support module (upper level) and the botanical labs of the laboratory module (upper level).

allow for ease of viewing and plant maintenance. Multiple trays on each rack can be removed for harvesting or replanting. The accordion-like compact shelving of a library is the concept behind the plant growth rack system. Without the use of this system, there would be a 50% reduction in the amount of usable research area. The adjustability of the three shelves in the rack allows maximum illumination throughout the plant life cycle. The amount of light striking a plant leaf decreases with the square of the distance. The shelf can be adjusted so the light is always at the optimal distance from the leaves.

A hierarchy of circulation satisfies many requirements while adding habitability. Emergency wayfinding and efficient ergonomics are exhibited in the primary circulation that cuts from hatch to hatch on the second floor. Secondary circulation is sized for carrying the plant racks and creating intimate pathways. This secondary circulation surrounds the central focal point of each floor. This accommodates the requirement of "go for a walk." Vertical circulation is accentuated by the vertical movement of wall sconces. By placing the circulation between the hatches, the ratio of plant growth racks to open spaces ratio is maximized.

The finer detail designed in both greenhouses is the color. The color of the interior accents the green plants. Grays and whites are used to enhance the organic life.

4.5.4.1 Carbon Dioxide Greenhouse

The carbon dioxide greenhouse is adjacent to the laboratory module. This is due to the proximity to the botany laboratories. This greenhouse is a high-growth, experimental chamber. All crewmembers will have access to this volume, yet the primary users will be the scientists engaged in plant growth studies. It is the intention to produce fresh food.

The plant growth racks are installed at the perimeter of the module. The center portion of the area has counter space designed for maintenance. Any of the growth rack trays can be removed and taken to the counter work areas.

The atmosphere of this greenhouse will be predominantly carbon dioxide. This will result in an increase in plant growth production. Those individuals at work in this area will be required to wear oxygen mask life support systems. One consideration will be in the event of a system failure emergency. Since this space requires limited life support, and dual egress is a requirement of all modules in the habitat, there may be a concern about the safety of a crewmember passing through the carbon dioxide module. The distance from hatch to hatch is 8 m and therefore can be quickly traversed in an emergency.

4.5.4.2 Oxygen Greenhouse

The design of the oxygen greenhouse is similar to that of the carbon dioxide module. The emphasis in this greenhouse is human factors. As well as being a second research greenhouse, it is designed to become the "garden" of the habitat. The crew will have space made available for them to individually tend to their own plants.

4.5.4.3 The Chapel

Within the oxygen greenhouse, an area has been dedicated to a chapel. This place of meditation is centered on the second level. The entrance to the chapel is opposite the egress hatches from the crew

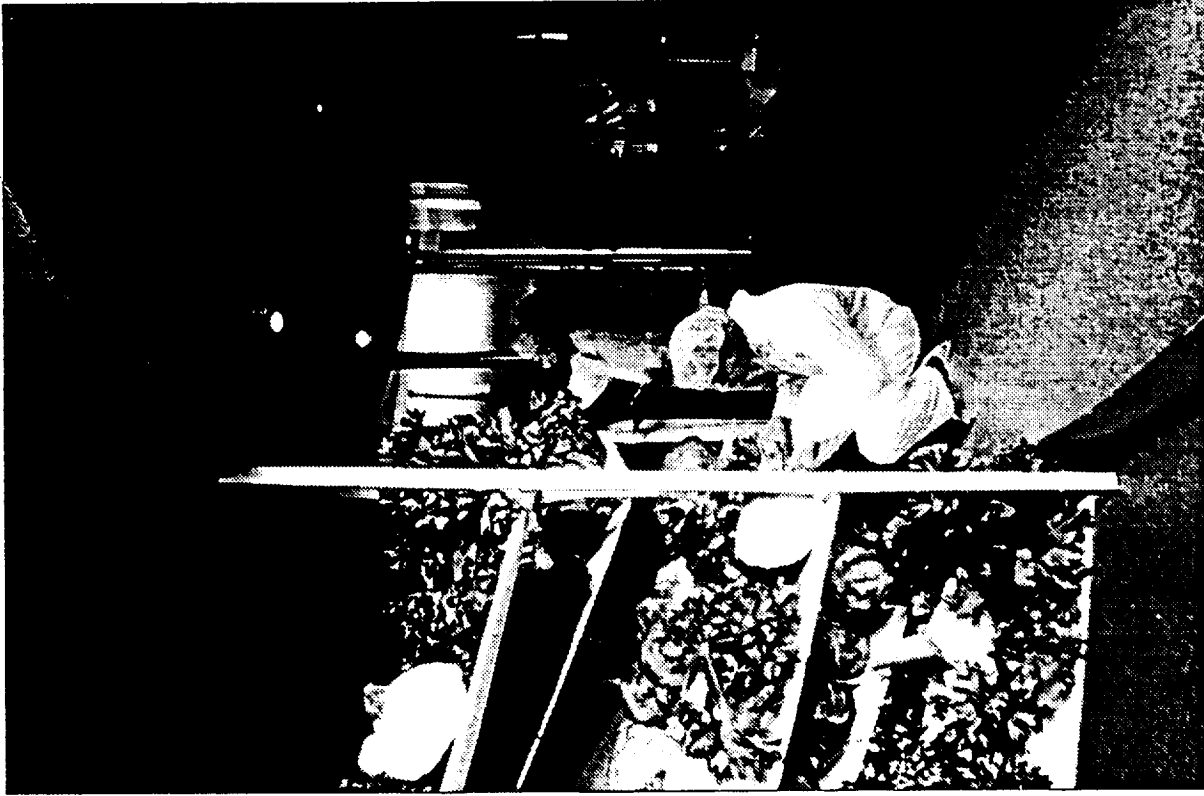

Figure 4.5.4-2. The plant growth racks provide high density plant growth.



Figure 4.5.4.3-1. The chapel in the greenhouse allows for meditation and reflection for crew members from a variety of religious beliefs.

quarters, allowing a sense of arrival. Inside the chapel, the domed ceiling creates a spatial experience available only in this portion of the habitat.

4.5.4.4 The Library

The lower level of the greenhouse module provides the crew with a library. It is located directly below the chapel. The entrance to this facility is directly across from the stairway landing.

The library can accommodate three crewmembers at once. Soft ambient lighting illuminates the area. Additional indirect lighting covers in the center and recessed canister lighting on the perimeter complete the system. The walls are of a reflective glass, allowing the crewmember an impression of being completely surrounded by plant life.

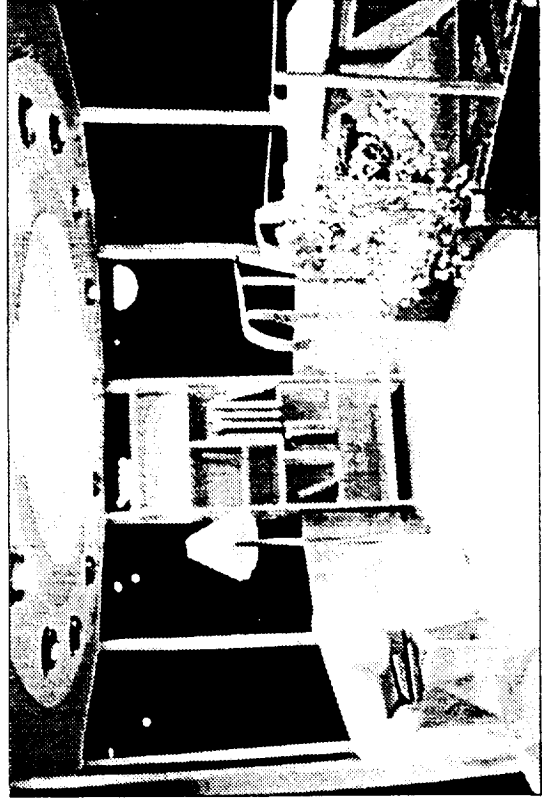

Figure 4.5.4.4-1. The library will provide a space to study, relax, and enjoy the growing environment.

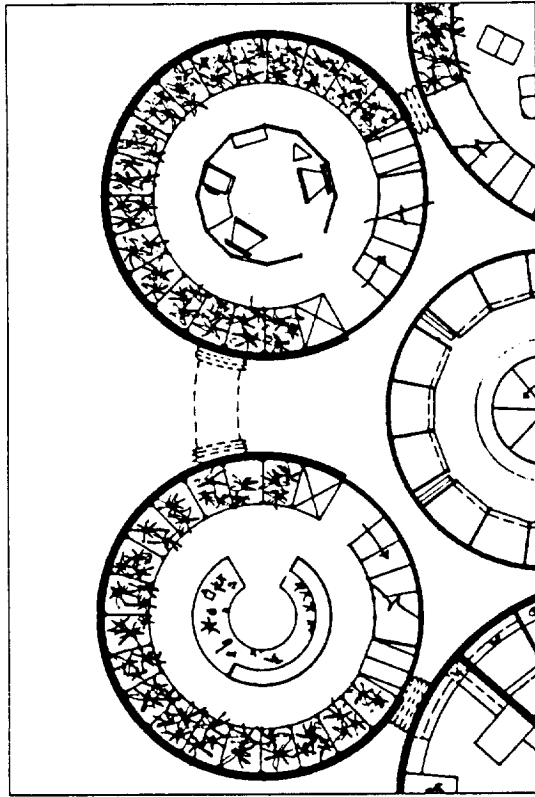

Figure 4.5.4.4-2. Floor plan of the lower floor of the two greenhouse modules, showing the carbon dioxide greenhouse with central work area on the left, and the oxygen greenhouse with central library on the right.

56 INTENTIONALLY BLANK

5. SUMMARY AND CONCLUSIONS

5.1 CRITICAL DESIGN FEATURES OF PAX

A number of design features of the proposed *Pax* permanent Martian base and habitat deserve attention. It is the contention of this research and design group that, based on our preliminary analysis of Martian habitats, these features may be critical for habitat success, and deserve further research and design analysis.

5.1.1 SITE SELECTION

It is proposed that *Pax* be constructed at the Viking 2 landing site, 45 degrees N latitude, 251 degrees W longitude, known as *Utopia Planitia*. The site is near varied geologic surface features important for research. The site is located in the northern hemisphere, away from the origination of southern dust storms during the summer season. The terrain in the immediate area, generally level according to Viking 2 photos, is appropriate for a transportation system and launch and landing facility. The elevation of the site is relatively low with respect to the other features on the surface, thus providing some radiation protection from the accumulated, albeit thin atmosphere. Finally, current theory on water location (Carr, 1986) suggests the search be conducted near the north pole. The site for *Pax* is south of where the northern polar cap advances in the winter season.

5.1.2 BASE LAYOUT

The base layout follows a north-south axis, with the habitat, solar array fields, and radiator fields being in the center, the auxiliary nuclear power plant 2.5 km to the south, and the launch and landing facility 2.5 km to the north. Winds are from the west and south-west; launch and landing patterns will not endanger the habitat, and any possible nuclear residue will be carried away from the base and habitat.

5.1.3 HABITAT BASIC CONCEPT

Schematic design studies were conducted early in the research and design process of this project to explore different base layout master and site planning concepts. The implications of four alternative concept designs were explored, analyzed, and then compared at a PDR. They were:

- hard module habitat partially buried and partially set in the edge of a Martian crater
 - inflatable habitat partially buried and partially set in the edge of a Martian crater
 - Earth-like technology for Martian surface application
 - space-frame construction spanning between crater edges
- The advantages and limitations of each concept design were analyzed. An attempt was made to combine the best of each concept design. From the PDR, it was found that there are considerable advantages for surface construction with a combination of hard module and inflatable structures covered with a space frame regolith containment system. This was the integrative concept that was adopted and developed throughout this project.

5.1.4 CONSTRUCTION SEQUENCING

The whole issue of sequencing from initial lift-off from Earth to IOC and NOC is a critical, and early, mission and design decision to be made. Based on our analyses, the advantages of Zubrin's "Mars direct" mission scenario, or mission "architecture" as NASA calls it, became apparent. Adopting large segments of this scenario suggested a split-sprint mission, with cargo transportation and initial robotic emplacement preceding the first landing of humans on Mars. Thus the construction sequencing we have recommended proceeds in seven phases:

1. Landing of two 9-m hard modules as the initial campsite or outpost, followed by six crew members who begin to prepare the site for further development.
2. Excavation of the footprint for the IOC Martian habitat.
3. Landing of two additional 9-m hard modules as the second phase outpost, followed by six additional crew members who begin assembly and raising of the space frame and regolith containment system.

4. Emplacement and inflation of the two 12-m inflatable crew support and laboratory facility modules.
5. Rigid entry module moved from campsite location and connected to the inflatables together with a primary entrance airlock to the habitat.
6. Utilizing a lift and trailer system, the fourth and fifth components, both rigid modules dedicated to greenhouse functions, transported underneath the space frame shelter, and flexible connections attached to the laboratory and crew inflatables.
7. Two additional rigid modules docked: a logistics module, which will serve as an emergency airlock, docked to the crew support inflatable; and a combination laboratory logistics and emergency egress airlock, docked to the laboratory inflatable. This completes IOC.
8. Expansion of the base as necessary to various NOCs, e.g., removal of the crew or laboratory logistics module/airlocks, and excavation and emplacement of an additional 12 m or larger inflatable module.

5.1.5 OVERALL DESIGN ORGANIZATION OF THE HABITAT

There are seven factors that went into creating the basic parti or conceptual framework, governing the overall concept design of *Pax*. They are:

- embracing entry
- a separation of work and play
- circulation efficiency
- dual egress
- central focus in each module or inflatable
- homelike environment
- sense of place

Because *Pax* is to be the astronauts' "home" for two years or more, a designated entrance will mark the "font door" to home. By situating the modules in an embracing formation, slightly set back in the center, the crewmember will have a sense of "moving within." The indented area is intended to mark a focal point in the habitat. The embracing feature is evident in both the plan and elevation of the habitat. From the surface of Mars, entry into the habitat is a sequential process. The crew will enter under the shelter system to the primary airlock. From

this airlock, the crew will pass through a dust-off chamber before entering the primary circulation space.

Since the crew does not egress the habitat to conduct IVA, the concept of designing *Pax* through a separation of "work" and "play" can help the crew differentiate their activities. By physically separating the laboratory spaces and crew support spaces, the crew may feel as though they were going to work similar to on Earth. They have the opportunity to "leave work" and "go home" for peace and recreation.

The habitat is organized in an efficient manner. From module to module there are clear linear circulation paths. Time will not be wasted by excessive walking. As discussed in Chapter 3 clear circulation and wayfinding are important in keeping stress levels down. Situating the individual habitat volumes in a straight line would be far too monotonous. *Pax* is formed in a continuous, looped path. This allows for a variety of circulation paths while still being efficient. As an example, vertical circulation is located either in the center of a module or along the perimeter; the horizontal circulation is in the shape of an arc in the crew support module and vertical in the laboratory module.

Dual egress is another important element in extraterrestrial living. In the event of an emergency, the crew must be able to emergency exit any of the habitat volumes in two opposite directions. Two means of egress are required in building on Earth. This should be the same in extraterrestrial situations. Suits and EVA chambers are located in three areas to permit suited egress to the outside.

The entry module acts as the central focus for the habitat as a whole. Creating a central focus in each of the modules and inflatables is considered an important link in making *Pax* livable. It unifies the volume. Each of the five components also have designated focal points in which the crew can gather. Within each volume personalization also acts as a humanizing factor.

The ability for the crew to personalize the spaces can provide for a more productive mission. As discussed in Chapter 3, allowing the crew the luxury of bringing pieces of "home" with them is important in keeping stress levels down. The Martian living environment will be different than that of Earth. Yet the crew should live in a comfortable and familiar way. The crew will be able to bring with them a "sense" of home. For example, the library will be filled with books that the crew has requested, and the crew quarters can each be decorated to suit individual tastes.

In designing individual spaces, the intent is to portray a particular atmosphere. To create a sense of place appropriate to the functions occurring is an important element. For example, the galley should give the impression that it is a galley and not mission operations. The private crew quarters should appear different than that of a laboratory. This may help the crew in adapting to isolated living conditions.

By incorporating all of the aforementioned concepts into the design of *Pax*, it is hoped that living on Mars will be comfortable and provide a productive environment for the crew. Each designed space, discussed in the following pages, integrates design issues and requirements with the intention of making each space productive, habitable, and comfortable.

Pax contains five main components. It consists of three, 9 m hard modules, and two 12.6 m inflatables. Two of the hard modules house the greenhouses and the third is the entry and suit stowage module. The two larger inflatables hold the majority of the functions—predominantly the crew support and the laboratory areas. Three EVA chambers and a logistics module (space station-derived) make up the balance of the habitat.

5.1.6 INTERIOR DESIGN INCLUDING CONSIDERATIONS OF COLOR, LIGHTING, AND MATERIALS

Seldom have lunar and, even more so, Martian designs been taken to a level of design development where the particulars of interior configuration and how the configuration will impact on human productivity and satisfaction can be examined. An important part of our design work, especially in this project for a first Martian habitat, has been to investigate interior architecture and how it impacts on habitability.

The configuration of all the spaces in *Pax* has been described and discussed above, and related to human factors and environment-behavior reasons for design decisions.

But in addition, careful consideration has been given to technical details, color, lighting, and materials based upon color and material design recommendations from NASA-Ames Research Center. The selection of color for *Pax* was based on three activity area definitions. High activity areas contain larger wall spaces in light, lively, warm

earth tones and warm pastels. Moderate activity areas e.g., designated work areas, are finished in calm, low saturation colors. Low activity spaces—quiet, cozy environments—are done in light blues and grays. Pure colors are used rather than drab colors. Bold colors are limited. Shades and pastels are used on larger surfaces. And contrasting colors are used to break monotony.

Pax therefore makes liberal use of gray tones, pale blue-grays, burgundies, taupes, off-whites, silvers, deep blues, and terra cottas. A basic color scheme was chosen for particular spaces, with the effect upon adjacent spaces considered if those spaces flow into one another. A continuity of color was provided from one area to another to relieve the habitat from appearing "chopped up" and discontinuous. Bright colors were used to highlight certain special features, either architecturally or visually. Color also augments the translation pathways throughout the habitat.

Similarly, *Pax* incorporates a number of lighting systems to increase visual stimulation, add variety, and augment the tasks to be performed. Lighting was used to highlight special architectural features in each area of the habitat.

Suggested material usage came from the NASA Man-Systems Integration Standards. Materials will go through sophisticated testing to determine whether outgassing from the product is detrimental to humans or the space environment. Materials were chosen to aid mission activities and tasks. For example, surface materials in the general laboratory allow for ease of the task and easy maintenance. While reflective properties, not contamination and non-discoloring properties, durability and deterioration were considered, a variety of materials with textural surfaces are included to vary the environment and to stimulate the confined astronauts visually and tactually.

5.2 MAJOR STRENGTHS AND LIMITATIONS OF THE DESIGN

Uncountably many decisions go into any design. All decisions that are made have the overall objectives of the design as their driver and, hopefully, empirical research as their justification. Sometimes these design decisions conflict with each other. This design, as in all designs, has strengths and limitations. Following are some of the most notable.

- One of the first strong points is economic in nature. The habitat uses rigid modules that were on-site from the initial exploratory landing. The four pre-landed hard modules make up over half of the habitat. Taking advantage of these saves extra mass that would otherwise need to be delivered.
 - Another of the large scale elements of the base that works well is the radiation shielding. Its design allows it to be in place before the modules of the base are put in place, providing shielding during the bases construction. A protected area is provided around the modules giving easy access for maintenance. The structure—being an encompassing space frame—also allows for easy expansion.
 - The general zoning of the habitat works very well. Work is separated from leisure, public from private, noisy from quiet, and active from passive. This can be seen in the functions of the individual modules, and in the difference in the floor levels within each.
 - Within the habitat, a number of spaces are allowed that provide privacy, a place for a crew member or small group to get away. The crew quarters are the primary place a crew member can escape to. Passive recreation also can allow privacy. The chapel and library are two more areas that allow for this important need for occasional isolation.
 - Spatial variety is another way this design excels. Supplementing the rigid modules with inflatable modules adds variety to the spaces that are created. Although all of the enclosures of the habitat are generally the same shape, a number of different types of spaces are created within. While some shapes may be pie shaped, others are rectangular, and still others are curvilinear. A variation in ceiling height and floor levels helps further to create this variety of spaces throughout the habitat.
- Some other issues that made an impact on the design in a positive way include:
- Active recreation is isolated from other functions within the base, preventing excess noise and vibration created in the space from becoming a problem.
 - The entry EVA chamber is separated from other spaces, helping to keep dust from spreading throughout the habitat.

- Dual egress is allowed throughout the habitat; there are always two ways of escaping any area.
 - The modular rack system allows easy changeout, replacement, and rearranging throughout the habitat, not only at IOC, but if the habitat is expanded to various NOCs.
 - Using a number of enclosures (modules) allows containment of trouble areas in the event of an emergency, yet allows large spaces and easy connection of associated functions.
 - The loft-type crew quarters make efficient use of vertical space.
 - The connection of the crew quarters to the greenhouse allows convenient access to quiet spaces for the crew during off-hours.
 - Situating the library and chapel within a greenhouse adds to the comforting environment of all.
 - Having two greenhouse modules, each with it's own atmosphere, adds to the scientific benefit and productivity of the base.
- There are also limitations, other issues on which the base and habitat could use improvement:
- The habitat may be larger than necessary for 18 crew members. It could be optimized to a smaller volume.
 - Spaces exist with no function (e.g., the center of the first floor in the crew support module). While these are desirable aesthetically, they may be extraneous in terms of efficiency, mass at lift-off, and economics.
 - Even though the radiation shielding makes views possible, views out of the base are limited to one window in a mission command workstation.
 - A drawback of the structure is its complexity. A large amount of mass, hundreds of pieces, will need to be delivered to the Martian surface. The structure will likely involve extensive EVA time in assembling the truss-work.
 - Their is an over redundancy of equipment and spaces within the labs; dual functioning could cut down on the amount of space and equipment needed.
 - The vertical circulation throughout the habitat needs more thought (e.g., convenience, comfort, practicality, extent of use).

- The nature of the laundry facilities (closet-like) and location (on a major circulation intersection) make it problematic.
- A more direct connection between the galley and wardroom would be desirable.
- The idea of a split-shift within these tight quarters needs more thought.
- The airlock attached to the labs may be used as much as if not more than the entry EVA. This airlock should therefore have suit storage and a preparation area outside of the equipment lock.

5.3 AREAS FOR FUTURE RESEARCH AND DESIGN DEVELOPMENT

A number of areas suggest themselves for future research and design development.

1. More attention needs to be given to the development, and human factors and environment-behavior justification, for design requirements for all scales of Martian campsites/outposts and permanent bases including their habitats. Some work has been done on this for lunar bases (e.g., Moore, et al., 1992; ongoing work by Joyce Carpenter and Deborah Neubek at NASA-JSC), but as far as we can determine, not for Martian environments.
2. Minimally necessary activity spaces, and their minimally necessary sizes both in terms of m² of floor plan and m³ of volume. Our work to date has suggested a minimally necessary set of laboratory and crew support spaces, but considerably more work needs to be done to refine this list. Similarly, our work to date has begun to suggest possible

A number of these suggestions have come from our various reviewers, at internal PDRs, and at the presentation of our work at conferences of the American Institute for Aeronautics and Astronautics, American Society of Civil Engineers, and Environmental Design Research Association. We thank all of our colleagues for their insights and recommendations for the continued evolution of our program of research and design.

spatial allocations for each of these spaces (for 12 and 18 crew members), but again, the work has only scratched the surface, indicating the importance of careful human factors analyses—and perhaps terrestrial simulations—of these quantitative requirements.

3. Site location requirements need to be studied more thoroughly, and more quantitative parameters given for each.
4. The implications of different power sources need to be analyzed (solar, nuclear, wind), as well as the implications of all the other factors that influence the overall site plan for the base, including radiator fields, methane production facility, launch and landing facility, mining sites, vehicle storage and maintenance facility, and transportation infrastructure to the immediate base facilities and to remote mining and research facilities.
5. Within the habitat/laboratory zone itself, careful study needs to be given to the overall size of an appropriate habitat/laboratory structure. Various published reports have suggested a range from 227.03 m², 349.13 m², 552.56 m², up to 1,185.03 m² for permanent lunar habitats for 18 people. The range itself shouts the need for careful research to begin to narrow the range to acceptable figures.
6. The implications of mining sites, possible industrial zones, and in-site resource utilization on the design of the base, and on the habitat itself, need to be studied.
7. While not studied in the present work, structural and construction systems and material selection must ultimately be integrated with considerations of human habitability. As mentioned in the introduction, the vast majority of work from other labs and centers to date has focused on the engineering aspects of lunar and Martian habitats. The background of our center, our researchers, and our design students, together with the lack of previous habitability research and design efforts for Martian habitats, drove the

present enterprise in an attempt to discover some of the ramifications of elevating human factors and environment-behavior considerations in the design decision making process. Ultimately, however, the base is one base, the habitat one habitat, and all habitability, structural, construction, material selection, and economic considerations have to be integrated.

8. The design concepts expressed in this report could be subjected to independent investigation and corroboration. Any design is made up of a variety of design concepts, not just one overarching *parti*. The concepts, sometimes called patterns, are generic, or, at least, the central idea is generic, though the particular form a pattern takes depends on contextual circumstances. These, and other, patterns could be articulated, assessed qualitatively against existing research literature, and then subjected to empirical test in simulated environments (using experimental or quasi-experimental methods). This would result in a series of tested principles that could be applied to the design of any Martian (and perhaps) lunar base and habitat.

9. The implications of the need for flexibility, changeability, and expandability deserve further attention.

10. Studies need to be conducted of bounding platforms, their spacing and sizing, and whether ladders will work for movement of materials in 1/3 gravity.

11. The tradeoff between variety (in spaces, lighting, color, materials) versus cost need to be looked at quantitatively.

12. The implications of the need for mechanical, electrical, and air-handling space, as well as feed and return lines for CELSS operations need to be investigated. In the present design, space is left over for those functions, but no studies have been found on the amount of space needed for different crew sizes and mission profiles, and we have not yet done any such analyses.

13. An efficiency analysis needs to be done to determine the

most efficient spaces and subspaces for different mission functions.

14. Trade-off studies need to be conducted on the viability of using conventional architectural principles applicable on Earth, versus near-term technology options, versus less conventional limits of possible technological development.

15. Detailed analyses need to be conducted on how geophysical laboratories would operate on an extraterrestrial body, what functional relationships are necessary, what equipment would have to be housed, even what the most likely mission objectives might be, and their design implications, etc.

16. The implication of different crew compositions deserves study, including volumetric studies, design implications of assuming the 5% Oriental female and the 95% American male, the efficient and creative use of confined spaces, and living accommodations for different mission lengths.

17. The implications of the sociology of small groups over long-duration confinement needs to be understood, and the implications translated into design directives.

18. The implications of designing for flexibility versus designing for specific functions needs to be addressed more clearly.

19. The implications of minimizing crew time possibly devoted to maintenance needs to be considered in future designs.

20. The implications of different images for the likely crew compositions needs to be considered, for example, are high-tech environments appropriate for NASA and related space agency highly trained, highly self-selected crews, or are more homey, Earth-like environments more appropriate? There is a type of ideological assumption in our work to date, but it has not been tested, that bring home to Mars is appropriate. The importance of this assumption needs to be questioned, Antarctica and other simulation research needs

to be checked, and perhaps first-hand empirical research needs to be conducted with current and recent American, Russian, and other astronauts on the appropriateness or lack of appropriateness of this assumption.

21. The design of Martian greenhouses, or biotrons, needs more careful study, including a more careful determination of how much space is required for production, not just research, for various crew sizes.
22. The implications of noise and vibration in a tight environment needs more careful design study.
23. Various notions of regolith containment systems need to be investigated more fully. It may well be that as the Martian soil does not have much strength, the lateral loads put on a canopy structure from the severe Martian winds may make this type of regolith containment system inappropriate.
24. Research needs to be done profiling the personality characteristics of astronauts likely to go to Mars (e.g., possibly a variation of an environmental response inventory with characterization of environmental dispositions), and then base design decisions on these profiles and preferences.

25. While we have begun some work developing habitability requirements for long-duration missions (this report as well as Moore et al., 1992), the first missions will be 14 to 42 day missions to the Moon, which will more than likely be a test-bed for future Martian exploration and habitation. Habitability requirements for 14 to 42 day lunar missions need to be investigated and articulated. A most interesting issue here, suggested to us by a NASA-JSC reviewer at the American Society of Civil Engineers Space 92 meeting, would be to investigate, first, the quantitative space demands and then the qualitative habitability requirements for short-duration missions, and how they would change for increasing numbers of crew members and for increasing mission durations. One part of this would be the definition

of usable space (e.g., the tables in NASA-STD-3000 on usable volumes), and how it should vary with crew composition, mission profiles, and mission durations. Similarly would be the analysis of usable to gross space, and usable to surface area (i.e., correlated to mass at lift-off), which analysis we have begun to do (Moore & Rebholz, 1992), but needs to be taken much further.

A fundamental dilemma underlies all of this needed research and design investigation. First is the advisability of thoroughly investigating a narrow range of issues (human factors/environment-behavior issues) versus a more comprehensive analysis of habitability and construction technology, for instance, or simultaneous consideration of two or three different prototypes, the latter allowing the exploration of the possibility of major changes during the life of the base, and the possibility of taking concept designs into further design development before capitalizing on certain alternatives while abandoning others. Another way to put it is to ask is it more important at this stage of Martian design exploration to "design society" or to focus on research and the solution of manageable, knowable issues?

64 INTENTIONALLY BLANK

APPENDIX A

**HUMAN HABITATION ON MARS
SPACE ARCHITECTURE III DESIGN STUDIO
DESCRIPTION**

Architecture 166-690 - Section 801

Department of Architecture
University of Wisconsin-Milwaukee
NASA/USRA Advanced Design Program in Space Architecture
in conjunction with
NASA-Johnson Space Center
Spring 1992

Instructor Gary T. Moore

NASA/USRA Teaching and Research Assistants

Joseph P. Fieber Janis Huebner-Moths
Kerry L. Paruleski Patrick J. Rebholz

Visitors and Visiting Critics

Edward Beimborn, UW-Milwaukee Department of Civil Engineering
Uriel Cohen, UW-Milwaukee Center for Architecture and Urban Planning
Research
John Connolly, Planet Surface Systems Office, NASA Johnson Space Center
Vincent A. Cronin, UW-Milwaukee Department of Geosciences
Robert Greenstreet, UW-Milwaukee School of Architecture and Urban Planning
Mary Guzowski, UW-Milwaukee Department of Architecture
Thomas Hubka, UW-Milwaukee Department of Architecture
Calvin Huber, UW-Milwaukee Department of Chemistry
Robert A. Jones, UW-Milwaukee Graduate School Office of Research and
Sponsored Programs
Thomas A. Kaminski, Astronautics Technology Center, Astronautics Corpora-
tion of America
Michael Roberts, Design Systems Office, NASA Johnson Space Center
Douglas C. Ryhn, UW-Milwaukee Department of Architecture
Irvin Ross, UW-Milwaukee Office of Industrial Research and Technology
Transfer

Kathryn Scott, Design Resource Center
Mark Sothmann, UW-Milwaukee Department of Human Kinetics
Dale Thomas, UW-Milwaukee Office of Industrial Research and Technology
Transfer

Course
Architecture 166-690 (U/G), La 801 (6 credits)

Location
Engelmann B58; reviews and seminars in Engelmann 128 and 157

Time
Tuesdays, Thursdays, and Fridays 1:30-5:20. Everyone is expected to be present during these times. There will be other scheduled events for special guests, seminars, and reviews.

Office and Hours
Gary Moore / Eng 172 / T 8:30-12:00 (recommended by appointment)
TAs / Studio / during class times

Design Program
The Department of Architecture, through its 6-year Advanced Design Program grant from NASA/USRA, is conducting a series of seminars (fall semester) and design studios (spring semester) on space architecture. The Department is one of only three architecture schools in the 41-university NASA/USRA Advanced Design Program. We are working in cooperation with the College of Engineering and Applied Science. The program stresses the systems approach to design in which we work together like an interdisciplinary A/E professional firm on a major real world project for NASA.

Purpose and Support
Students at UW-Milwaukee have become involved in an interdisciplinary research and design program to work with and present their ideas to a real client-NASA, and to learn about areas of design related to health and safety, psychological and social issues, habitability, underground architecture, interior architecture, construction technology, hi-tech materials, mechanical systems, structural analyses and structural systems, energy systems, site planning, and long-range master planning.

1992 Design Studio Description

In 1991, the National Space Council published *America at the Threshold: Report of the Synthesis Group on America's Space Exploration Initiative* (Stafford, 1991; called the "Synthesis Report").

The Synthesis Report presented two mission durations for Mars exploration: long-duration missions on the order of 1,000 days with a typical stay time on Mars of approximately 500 days (1-1/3rd years, 16-17 months), and short-duration missions on the order of 500 days with a 30 to 100 day stay on Mars (1-3 months). Our thinking lead us to believe that there are more architectural, habitation, and environment-behavior issues to be explored and solved in a long-duration permanent Martian habitat with full research work stations and crew living quarters for living durations up to 1-1/2 or more years. Reviewing other published mission scenarios, our thinking also lead us to believe that an initial short-duration outpost will quickly be followed by one or more exploratory long-duration outposts, which in turn will be followed by a permanent long-term base. The focus of our work for 1992, therefore, was on the long-duration permanent base.

Our work built off what the Synthesis Report referred to as the Mars "Waypoint" (by which is meant Mars planetary activities for human exploration of Mars, i.e., as a waypoint to later exploration into the Solar System). Phasing the development of a permanent base, we accepted the Synthesis Report recommendations of an initial crew size of 18 crew members for the initial human-tended outpost for change-out durations of 500 to 600 days on the Martian surface, assuming a closed-loop life support system and remote automatic emplacement, checkout, and verification of as much of the habitat and life support system as possible for turnkey operations by the crew when they arrive.

Thus, in the spring of 1992, the Space Architecture Design Studio designed a permanent, long-duration base for the surface of Mars. Subsequently named *Pax* (for the international Peace Settlement, opposite of the Latin name of the planet, *Mars*, the God of War), this first Martian permanent base will provide housing, research space, mission control space, and all amenities for 18 astronauts to live on Mars for durations up to or exceeding 1-1/2 years. An important part of the capstone design studio is the inclusion of experts— aerospace engineers, architects, human factors experts, and NASA scientists and engineers—to advise and critique the work at preliminary design reviews (PDRs). We also used grant funds to allow one or two people to attend important national conferences to bring back state-of-the-art information to the studio.

Structure

The studio was structured in six segments:

1. Readings, lectures by the instructor and TA/RAs, seminar discussions, and lectures and events (field trips) that required travelling. Starting immediately and throughout the semester, but with heavy emphasis through the middle of February. 4 weeks. Reviews of student progress at periodic intervals (graded on understanding of subject matter, familiarity with literature, and class participation—20%).
2. Two-part charrette sketch design. 1 week, January 23 and 30. First Preliminary Design Review (PDR), i.e., PDR-IA, January 23 in studio and PDR-IB, January 30, Room 128, 3:30 p.m. by instructor and TAs (equivalent to pin-ups in other studios—not graded).
3. Schematic design—master and site plans. Detailed scenario presentation (TAs) followed by research and schematic design studies to develop and explore different full base layout master and site planning parti. 1 week, February 4-11. PDR-II (graded) on February 11 (place TBA) by instructor and visiting critics (this would be equivalent to a project due date and jury in other studios—10%).
4. Schematic design—particular spaces. Research and schematic design studies of particular spaces, e.g., wardroom, crew quarters, recreation spaces, hygiene facility, research labs, translation spaces, etc. 4 weeks, February 13 to March 3. Pin-up on February 20 in Room 128 at 1:30 p.m.. PDR-III (graded) on March 3 at 1:30 p.m. in the Exhibit Space by instructor and visiting critics (another equivalent project due date—25%).
5. Design development and integration of master plan, site plan, and detailed designs for different parts of the permanent, long-term Martian base. 4 weeks, March 5 to April 14. Pin-ups on March 12 and April 2 at 1:30 p.m. in Room 128. PDR-IV (graded) on April 14 at 1:30 p.m. in the Exhibit Space with national guests (25%).
6. Presentation. 3 weeks, April 16 to May 7. Final Design Review/Final Jury (FDR), Thursday, May 7, 1:00 noon to 5:30 p.m., in Room 128 (with dinner and a party following—20%).

Schedule

January 21	Introduction History of the US Space Program Scenarios for Studio	Gary Jan Jan	Studio Studio Studio	1:30 2:00 3:00
January 23	About Mars Site Selection Criteria and Recommendations Sketch Design IA PDR-IA Pin-up	Renee Jan, Renee & Andy	Room 157 Room 157 Studio Studio Madison	1:30 2:30 3:00 4:30 3:00
January 28	Madison AIAA Field Trip and Robert Zubrin Lecture		Madison	3:00
January 30	Sketch Design IB PDR-IB Pin-up		Studio	1:30
February 4	Master and Site Planning Considerations Detailed Scenario Presentation Start Part Development/Full Base Master Plan and Site Plan (GTM & PJR presenting paper at AIAA)	Joe & Kerry TAs	Room 128 Room 128 Studio Studio	3:30 4:30 1:30 2:30
February 6	Research Questions and Diagrams		Room 157	after
February 11	PDR-II Base Layouts/Schematic Design		Room 128	1:30
February 13	Human/Environment-Behavior Factors Start Preliminary Design/Particular Spaces	Gary & Pat	Room 157 Room 157 Studio	1:30 1:30 after
February 18	Human/Environment-Behavior Factors		Room 157	1:30
February 20	Schematic Design/Spaces Pin-up (GTM in Moscow reviewing Russian Space Architecture work--February 24-29)	Joe NASA Reviewers	Room 128 Exhibit Space Studio	1:30 1:30 1:30
March 3	PDR-III Particular Spaces/ Schematic Design		Exhibit Space	1:30
March 5	Start Design Development/Entire Base Mid-term		Studio	1:30
March 10	Design Development Pin-up		Room 128	1:30
March 12	Design Development Pin-up		Room 128	1:30
April 2	(TAs presenting paper at EDRA--April 9-11)		Room 128	1:30
April 14	PDR-IV Entire Base/Design Development		Room 128	1:30
April 16	Start Final Presentation		Studio	1:30
April 21	Arch 302 AHB Lecture on Space Architecture/Human Factors	TAs	Studio	9:00
May 7	FDR/Final Review and Jury Dinner and Party After	University Reviewers	Room 128 Moore's	1:30 5:30

Key A/E Design Issues

Based on a self-critique of our last two year's work, and very helpful suggestions from colleagues around the country, we decided to focus on the human/environmental factors dictating design decisions. The studio stressed an environment-behavior or human factors approach to design. In addition, we also subjected ourselves to several formal architectural critiques, considered the Martian environmental context of our design decisions, and learned from and borrowed the results being developed by other universities in the USRA net.

Eligibility/Prerequisites

The studio was open to undergrad and grad architecture and engineering students. Junior standing is necessary (senior or grad preferable). Students from architecture (undergraduate and graduate) and from engineering (especially mechanical, structural, and industrial/systems) were welcome to join the studio. No previous space architecture experience was needed. The most important prerequisites were previous design experience equivalent to the Level II sequence in the Department of Architecture and a commitment to aerospace studies. It was strongly recommended to have also taken Arch 302, Architecture and Human Behavior. The course counts as studio credit in both the undergraduate and master's programs in the Department of Architecture.

Enrollment is limited to 12 students; if more than 12 preregister, selection is based on qualifications before the first class. Final 1992 enrollment included one graduate student, one second-degree undergraduate student, nine undergraduate students, and one 6-credit independent study graduate student pursuing two independent but related projects.

Instructor and TAs

The instructor, Gary Moore, Ph.D., is Professor of Architecture and Project Director of the NASA/USRA Advanced Design Program in Space Architecture. The RA/TAs, Joseph Fieber, Jan Huebner-Moths, Kerry Paruleski, and Pat Rebholz are advanced undergraduate and graduate students in the Department of Architecture; all have worked for the aerospace industry (Fieber/Paruleski/Rebholz at NASA-Johnson Space Center and Huebner-Moths at Orbitec in Madison); and all are part of the Space Architecture Design Group. Each year, we are joined by special lecturers and visiting critics invited from the Advanced Programs Office at NASA-JSC, NASA/USRA, McDonnell Douglas, Astronautics Corporation, Orbitec, and private A/E firms. Other faculty from the UW-Milwaukee Departments of Architecture, Mechanical and Civil Engineering, Geosciences, and Human Kinetics also serve as guest critics. Reviews at key milestones (preliminary, intermediate, and final design reviews) are conducted by the studio faculty and these visiting critics.

Readings

It is critical that all students—new and old—prepare themselves thoroughly in the first four weeks by carefully reading and analyzing the case materials prepared for this course. Knowledge of the material in readings will be a portion of the final grade. Other critical documents are the four reports from previous years. Copies are available in studio, and are available for purchase from the Center for Architecture and Urban Planning Research. All readings are to be done prior to the seminar or slide lecture at which they will be discussed.

Assignments

The principle assignments are the three design projects plus the readings, periodic assigned papers or reports, and the final presentation.

Final Products

The final product was a slide presentation based on photographs of models, together with this final report. Several supplementary reports may be written on specialized engineering designs for component parts (e.g., workstation designs, structural system, etc.).

Conferences

The final slide presentation together with representative drawings and a final model will be presented by the students at the annual NASA/USRA Summer Conference in Washington, DC, supported by the NASA-Goddard Space Flight Center, June 15-19, 1992. Additional papers were presented at the AIAA Aerospace Design Conference in Irvine, California in February, EDRA Conference in Boulder, Colorado in April, and ASCE Space '92 Conference in Denver.

Evaluation

Evaluation was based on how much students personally developed over the semester, and was based on evidenced mastery of the material from the readings and lecture/seminars including seminar participation (20%), schematic base layout design (PDR-II; 10%), schematic design of particular spaces (PDR-III; 25%), design development (PDR-IV; 25%), and contribution to the final presentation and product (FDR; 20%). Final grades were assigned by the instructor from using the internationally recognized grading criteria of the University of Toronto.

Funding

The Advanced Design Program in Space Architecture is being underwritten by a grant from NASA/USRA which supports the RA/TAs and will pay for out-of-pocket expenses on the project and most of the travel expenses to the mid-June USRA conference for selected students (B+ / A- grade requirement).

Special Conditions

This course is very different from any that students have taken previously. The course is three things: a learning studio, a federally funded research and design project, and a group of aerospace nuts working and having fun together. The instructor's commitment is two-fold, and they are equal: to student education as a professor; and to the project and NASA as a principal investigator. Student commitment needs also to be two-fold—to education and to the project—and it needs to be a very real commitment. This is a team project—we all (instructor, TAs, and other students) must pull our oars equally. I do not tolerate slackards; I have been known to ask students to drop the course. On the other hand, the TAs and I all give a tremendous amount of time to the course, not only during class periods, but evenings, weekends, entire weeks if that is what it takes. The work is never done until it is done right. The project is demanding, perhaps more so than any course or studio you have ever taken. But it will also be rewarding, and it should be fun, perhaps more so than any course or studio you have ever taken. Already we have planned involvement in a regional conference that will include nationally recognized aerospace speakers (you'll have a chance to meet them over dinner, and to have them review your work at a late-night soiree). The best students will represent the project at the NASA/USRA conference in Washington in June. During the last two years we were interviewed by radio, newspapers, and TV, and made presentations at a variety of local events. We prepared an exhibit of our work which was displayed twice in Wisconsin and once in Illinois—and now is on permanent exhibit in a state-wide science museum in Madison. The students have received three design awards for their work, two from the Environmental Design Research Association (EDRA) and one from the School of Architecture and Urban Planning, along with lots of informal very positive feedback from national experts, scientists, and engineers.

Further Information

The syllabus for this studio was published in a collection of innovative architecture courses. For further information, the reader is referred to Moore (1991b).

APPENDIX B

MONOGRAPHS, REPORTS, AND PAPERS ON AEROSPACE ARCHITECTURE¹

Space Architecture Design Group²

Department of Architecture
and

Center for Architecture and Urban Planning Research
University of Wisconsin-Milwaukee

Research and Technical Reports

Schnarsky, A.J., Cordes, E.G., Crabb, T., & Jacobs, M. (1988). *Space architecture: Lunar base scenarios* (ed. by E.G. Cordes, G.T. Moore, & S.J. Frahm). Milwaukee: University of Wisconsin-Milwaukee, Center for Architecture and Urban Planning Research, Space Architecture Monograph Series No. 1, Report R88-1. ISBN 0938744-59-3. Pp. vi + 80; figures charts, and 8 design projects. \$10.00

Cordes, E.G. (1989). *Lunar base studies*. Unpublished M.Arch. thesis, School of Architecture and Urban Planning, University of Wisconsin-Milwaukee. Pp. iv + 42; diagrams, plans, and computer-aided design illustrations.

Cordes, E.G. (1989). *Project Newton: A variable gravity research facility* (2 vols.). Strasbourg, France: International Space University/European Space Agency Publication.

Hansmann, T. (1989). *Inflatable lunar habitat mission operations level*. Final report prepared for the NASA/USRA Advanced Design Program, Johnson Space Center, Houston, Texas.

¹ Due to interest in this work, most monographs, reports, and papers are available at the costs indicated, prepaid, from the Center for Architecture and Urban Planning Research, University of Wisconsin-Milwaukee, Milwaukee, WI 53201-0413.

² Supported by an Advanced Design Program Grant from the Universities Space Research Association (NASA/USRA).

Baschiera, D.J., Fieber, J.P., Moths, J.H., Paruleski, K.L., & others (1989). *Genesis Lunar Outpost: Program/requirements documents for an early stage lunar outpost* (ed. by E.G. Cordes & G.T. Moore). Milwaukee: University of Wisconsin-Milwaukee, Center for Architecture and Urban Planning Research, Space Architecture Monograph Series No. 2, Report R89-1. ISBN 0-938744-61-5. Pp. 91; figures, charts, tables. \$10.00.

Hansmann, T., & Moore, G.T. (Eds.) (1990). *Genesis Lunar Outpost: Criteria and design*. Milwaukee: University of Wisconsin-Milwaukee, Center for Architecture and Urban Planning Research, Space Architecture Monograph Series No. 3, Report R90-1. ISBN 0-938744-69-0. Pp. xiv + 107; plans, illustrations, tables, references. \$10.00.

Connell, R.B., Fieber, J.P., Paruleski, K.L., & Torres, H.D. (1990). *Design of an inflatable habitat for NASA's proposed lunar base*. Final report prepared for Universities Space Research Association and NASA Johnson Space Center. Pp. iv + 50.

Fieber, J.P. (1990). *An investigation of technological options in lunar construction*. Independent study report, Advanced Design Program in Space Architecture, Department of Architecture, University of Wisconsin-Milwaukee. Pp. xi + 47.

Moore, G.T., Haberman, D., & others (1990). *Inflatable habitable modular space structure* (4 vols.). Proposal to the Lawrence Livermore National Laboratory in cooperation with Astronautics Corporation of America, Marquette University, Amalga Composites, Inc., and Global Outpost, Inc. Milwaukee: University of Wisconsin-Milwaukee, Center for Architecture and Urban Planning Research. Vol. 1, Technical/Management Proposal, pp. xviii + 48; plus 3 backup volumes.

Paruleski, K.L. (1990). *A comparative analysis of analogous situations, previous space exploration, simulated situations, and future conditions*. Independent study report, Advanced Design Program in Space Architecture, Department of Architecture, University of Wisconsin-Milwaukee. Pp. vi + 56.

Rebholz, P.J. (1991). *Vertical inflatable habitat*. Final report prepared for Universities Space Research Association and NASA Johnson Space Center. Pp. i + 29.

Huebner-Moths, J. (1991). *Environmental conditions of the moon and Mars*. Independent study report, Advanced Design Program in Space Archi-

- ture, Department of Architecture, University of Wisconsin-Milwaukee. Pp. iii + 28.
- Fieber, J.P., Huebner-Moths, J., & Paruleski, K.L. (1991). *Genesis II: Advanced Lunar Outpost* (ed. by G.T. Moore). Milwaukee: University of Wisconsin-Milwaukee, Center for Architecture and Urban Planning Research, Space Architecture Monograph Series No. 4, Report R91-2. ISBN 0-938744-74-7. Pp. xvi + 70; plans, illustrations, tables, references. \$10.00.
- Jankuski, R. (1991). *About Mars*. Independent study report, Advanced Design Program in Space Architecture, Department of Architecture, University of Wisconsin-Milwaukee. Pp. iii + 22; Moore, G.T. (1992, in preparation). *Space Architecture in Russia*. Special issue of Lunar Toons (UW-Milwaukee) (forthcoming).
- Published Papers**
- Cordes, E.C. (1988). Computer-aided design and space architecture. *Academic Computing*, September, Vol. 3(2), Cover, 18-21, 49. \$1.00.
- Schnarsky, A.J. (1988). CAD as a tool of change: Architecture a changing profession. *Academic Computing*, September, Vol. 3(2), 22-24. \$1.00.
- Schnarsky, A.J. (1988). From the near side of the moon. *Wisconsin Architect*, July, 14-16. \$1.00.
- Moore, G.T. (1990). Environment-behavior issues in extraterrestrial space. In H. Pamir, V. Imamoglu, & N. Teymur (Eds.), *Culture, space, history: Proceedings of the 11th international conference of the International Association for the Study of People and their Physical Surroundings*. Ankara, Turkey: Middle East Technical University Press. Vol. 5, pp. 387-403. \$11.00.
- Moore, G.T. (1990). An evolutionary habitat for the moon. *Wisconsin Architect*, September/October, 18-19. \$1.00.
- Moore, G.T. (1991). *Genesis lunar habitat*. In American Institute of Aeronautics and Astronautics, *Final Report to the Office of Aeronautics, Exploration, and Technology, National Aeronautics and Space Administration on Assessment of Technologies for the Space Exploration Initiative (SEI)*. Washington, DC: American Institute of Aeronautics and Astronautics. Log No. 284.
- Moore, G.T. (1991b). Space architecture design studio. In G. Bizios (Ed.), *Architecture Reading Lists and Course Outlines*, Vol. 2, Architectural Design, Human Behavior, Special Topics. Durham, NC: Eno River Press. Pp. 138-144. \$1.00.
- Moore, G.T., Baschiera, D.J., Fieber, J.P., & Moths, J.H. (1990). *Genesis lunar outpost: An evolutionary lunar habitat*. In NASA/USRA Advanced Design Program (Ed.), *NASA/USRA University Advanced Design Program: Proceedings of the 6th Annual Summer Conference*. Houston: Lunar and Planetary Institute. Pp. 241-254. \$2.00.
- Moore, G.T., Fieber, J.P., Huebner-Moths, J.H., & Paruleski, K.L. (1991). *Genesis II: Advanced lunar outpost*. In NASA/USRA Advanced Design Program (Ed.), *NASA/USRA University Advanced Design Program: Proceedings of the 7th Annual Summer Conference*. Houston: Lunar and Planetary Institute. Pp. 329-334. \$2.00.
- Moore, G.T., Fieber, J.P., Moths, J.H., & Paruleski, K.L. (1991). *Genesis advanced lunar outpost II: A progress report*. In R.C. Blackledge, C.L. Redfield & S.B. Seida (Eds.), *Space--A Call for Action: Proceedings of the Tenth Annual International Space Development Conference*. San Diego, CA: Univelt. Pp. 55-71. \$2.00.
- Moore, G.T., Huebner-Moths, J., Rebholz, P.J., Fieber, J.P., & Paruleski, K.L. (1992). Lunar base requirements for human habitability. In W. Z. Sadeh, S. Stuse, & R.E. Miller (Eds.), *Engineering, construction, and operations in Space III: Space 92: Proceedings of the American Society of Civil Engineers*. Vol. 1, pp. 224-239. New York: American Society of Civil Engineers. \$2.00.
- Moore, G.T., & Huebner-Moths, J. (in press). *Genesis II advanced lunar outpost: Human factors design response*. In L. Bell (Ed.), *Proceedings of the First International Design for Extreme Environments Assembly*. Houston: University of Houston, College of Architecture. \$2.00.
- Moore, G.T. (under review). Psychological and social issues in the design of lunar habitats. Tentatively accepted by the *Journal of Architecture and Planning Research*. \$2.00.
- Moore, G.T., Rebholz, P.J., Fieber, J.P., Huebner-Moths, J., & Paruleski, K.L. (under review). Aerospace architecture: A comparative analysis of five lunar habitats. Submitted to the *Journal of Spacecraft and Rockets*. \$4.00.

Research Papers at Scientific and Professional Meetings

- Cordes, E.G., & Lovett, T.J. (1988). Lunar base designs. Video presentation. NASA/Universities Space Research Association 4th Annual Advanced Design Conference, Kennedy Space Center, Cocoa Beach, Florida, May.
- Cordes, E.G., & Moore, G.T. (1988). Space architecture and computer-aided design applications. Video presentation. A/E/C Systems '88 Space Station Design and Development Conference, Chicago, May.
- Cordes, E.G., & Patton, C.V. (1988). Space exploration: Feasible roles for planners. Association of Collegiate Schools of Planning Conference, Buffalo, New York, October.
- Cordes, E.G. (1989). Lunar base studies. CAD-based video presentation. NASA/Universities Space Research Association 5th Annual Advanced Design Conference, Marshall Space Flight Center, Huntsville, Alabama, June.
- Cordes, E.G. (1989). Technology transfer for the human environment: Space systems design and the role of architects. Midwest Space Development Conference, West Lafayette, Indiana, October.
- Moore, G.T. (1989). Industry/university cooperation in space architecture. Astronautics Corporation of America, Milwaukee, Wisconsin, November.
- Moore, G.T. (1989). Environment-behavior issues in extraterrestrial space. Escuela de Arquitectura, Universidad de Puerto Rico, San Juan, Puerto Rico, December.
- Moore, G.T., Moths, J.H., & Baschiera, D.J. (1990). Extraterrestrial habitats and how they will effect our futures. Wisconsin Young Astronauts Aviation and Aerospace Conference, Waukesha, Wisconsin, March.
- Baschiera, D.J., Gruenberger, M., Moths, J.H., Paruleski, K.L., Schroeder, C.W., & Crabb, T.M. (1990). Architects explore the final frontier. Environmental Design Research Association 21st Annual Conference, Urbana-Champaign, Illinois, April.
- Baschiera, D.J., Fieber, J.P., Graff, P., Gruenberger, M., Kinde, M.R., Moss, S.E., Moths, J.H., Paruleski, K.L., Schleicher, S.A., & Schroeder, C.W. (1990). *Genesis* lunar outpost: Design project. Environmental Design Research Association 21st Annual Conference, Urbana-Champaign, Illinois, April.
- Moths, J.H., Fieber, J.P., Gruenberger, M., & Paruleski, K.L. (1990). *Genesis* lunar outpost. National Aeronautics and Space Administration/Universities Space Research Association Advanced Design Program 6th annual summer conference, NASA Lewis Research Center, Cleveland, Ohio, June.
- Moore, G.T. (1990). Environment-behavior issues in extraterrestrial space. 11th biennial conference of the International Association for the Study of People and their Physical Surroundings, Middle East Technical University, Ankara, Turkey, July.
- Moore, G.T. (1991). Space architecture. College of Architecture, Georgia Institute of Technology, Atlanta, February.
- Fieber, J.P., & Paruleski, K.L. (1991). *Genesis* lunar outpost: 1990 USRA project. Wisconsin Young Astronauts Aviation and Space Conference, Brookfield, Wisconsin, March.
- Fieber, J.P., Moths, J.H., & Paruleski, K.L. (1991). *Genesis* advanced lunar outpost II: A progress report. National Space Society 10th Annual International Space Development Conference, San Antonio, Texas, May.
- Gorski, G.S., Kishony, D., Maner, S., Rebholz, P., & Schroeder, C.W. (1991). *Genesis II: Advanced lunar outpost*. National Aeronautics and Space Administration/Universities Space Research Association Advanced Design Program 7th Annual Summer Conference, NASA Kennedy Space Center, Florida, June.
- Fieber, J.P., & Rebholz, P.J. (1991). History of the Advanced Design Program in space architecture. Milwaukee Lunar Reclamation Society, Milwaukee, Wisconsin, November.
- Moore, G.T., & Huebner-Moths, J. (1991). *Genesis* advanced lunar outpost II: Human factors design response. International Design for Extreme Environments Assembly, Houston, Texas, November.
- Moore, G.T., & Rebholz, P.J. (1992). Aerospace architecture: Five proposals for lunar habitats. American Institute of Aeronautics and Astronautics Aerospace Design Conference, Irvine, California, February.
- Moore, G.T. (1992). The genesis of space architecture. Moscow Architectural Institute, Moscow, Russia, February 1992.

Pax Permanent Martian Base

- Moore, G.T. (1992). Technical seminar on aerospace architecture. Moscow Architectural Institute, Moscow, Russia, February 1992.
- Huebner-Moths, J., Paruleski, K.L., & Rebholz, P.J. (1992). Extraterrestrial space architecture: Two proposals for lunar and Martian habitats. Environmental Design Research Association 23rd Annual Conference, Boulder, Colorado, April.
- Moore, G.T., Huebner-Moths, J., & Rebholz, P.J. (1992). The Wisconsin Space Grant Program: Aerospace architecture. Lynde Bradley Science Group, Allen-Bradley, A Rockwell International Company, Milwaukee, April.
- Moore, G.T., Huebner-Moths, J., Rebholz, P.J., Fieber, J.P., & Paruleski, K.L. (1992). Lunar base requirements for human habitability. American Society of Civil Engineers Space 92 Conference, Denver, Colorado, May.
- Huebner-Moths, J., Rebholz, P.J., Fieber, J.P., & Moore, G.T. (1992). PAX Martian permanent base: Human factors and environment-behavior considerations. American Society of Civil Engineers Space 92 Conference, Denver, Colorado, May.
- Moore, G.T. (1992). Universcape: Extraterrestrial habitats. Invited Keynote Talk, International Association for People-Environment Studies, Thessaloniki, Greece, July.
- Exhibits**
- Genesis*: Space architecture (1990). Exhibit at the 1990 Aviation and Aerospace Conference, Brookfield and Waukesha, Wisconsin, March.
- Space architecture: Laboratory and habitation modules for the moon (1990). Exhibit at the Environmental Design Research Association 21st Annual Conference, Urbana-Champaign, Illinois, April.
- Genesis* Lunar Outpost (1990). Exhibit at the National Aeronautics and Space Administration/Universities Space Research Association Advanced Design Program 6th Annual Summer Conference, NASA/Lewis Research Center, Cleveland, Ohio, June.
- Genesis II* Advanced Lunar Outpost (1991). Exhibit at the National Aeronautics and Space Administration/Universities Space Research Association
- Advanced Design Program 7th Annual Summer Conference, NASA/Kennedy Space Center, Cocoa Beach, Florida, June.
- Genesis I* Lunar Outpost and *Genesis II* Advanced Lunar Outpost (1991). Exhibit at the Wisconsin Space Grant Consortium Annual Seminar, Regents' Conference Facility, University of Wisconsin System, Madison, July.
- Genesis II* Advanced Lunar Outpost (1991). Exhibit After Friday Afternoon Live, School of Architecture and Urban Planning, University of Wisconsin-Milwaukee, October.
- Genesis II* Advanced Lunar Outpost (1992). Exhibit at North Division High School's African-American Aviation and Aerospace Career Days, North Division High School, Milwaukee, February.
- Genesis II* Advanced Lunar Outpost (1992). Exhibit at Gateway to Science and Technology Exposition, University of Wisconsin-Milwaukee's Student Union, Milwaukee, February.
- Extraterrestrial space architecture: Two proposals for lunar and Martian habitats (1992). Environmental Design Research Association 23rd Annual Conference, Boulder, Colorado, April.
- Aerospace Architecture: The UW-Milwaukee Advanced Design Program in Space Architecture (1992-ongoing). Permanent exhibit, Space-Place, University of Wisconsin-Madison, Madison, Wisconsin.
- Aerospace Architecture: The UW-Milwaukee Advanced Design Program in Space Architecture (1992). Exhibit at the Wisconsin Space Grant Consortium Wisconsin Space Conference, Experimental Aircraft Association Conference Facility, Oshkosh, Wisconsin, August.

REFERENCES

- Alfred, J., Bufkin, A., Kennedy, K., Petro, A., Roberts, M., Stecklein, J., Sturm, J. (1989). *Lunar Outpost*. Houston, TX: National Aeronautics and Space Administration, Johnson Space Center, Advanced Programs Office.
- Alexander, C. (1977). *A Pattern Language*. New York: Oxford University Press.
- Altman, I. (1975). *The Environment and Social Behavior*. Monterey, CA: Brooks/Cole.
- Bluth, B. J. (1986). Soviet Space Stations as Analogs. NASA Grant NAGW-659. Washington, D.C.: National Aeronautics and Space Administration.
- Broadbent, D.E. (1958). *Perception and communication*. Oxford, England: Pergamon.
- Capps, S., & Moore, N. (1989). Partial gravity habitat study, with applications to lunar base design. Unpublished report, Sasakawa International Center for Space Architecture, College of Architecture, University of Houston.
- Carr, M.H. (1987). Scientific objectives of human exploration of Mars. In C. Stoker (Ed.) *The Case for Mars III: Strategies for Exploration-General Interest and Overview*. San Diego, CA: American Astronautical Society. Pp. 267-275.
- Carr, M.H., Baum, W.A., Blasius, K.R., Briggs, G.A., Cutts, J.A., Duxbury, T.C., Greeley, R., Guest, J., Masursky, H., Smith, B.A., Soderblom, L.A., Veverka, J., Wellman, J.B., & Spitzer, C. (Ed.) (1980). *Viking Orbiter Views of Mars*. Washington, DC: National Aeronautics and Space Administration.
- Clearwater, Y. (1985). A human place in outer space. *Psychology Today*, July, 34-43.
- Clearwater, Y. (1986) *Space Station Habitability - Interior Color Team, An Introduction*. Moffett Field, CA: National Aeronautics and Space Administration, Ames Research Center, Habitability Research Group.
- Clearwater, Y.A. (1987). Human factors design of habitable space facilities. Paper presented at the 38th Congress of the International Astronautical Federation, Brighton, England, October, Paper IAF-IAA-87-549.
- Clearwater, Y., & Harrison, A.A. (1990). Crew support for an initial Mars expedition. *Journal of the British Interplanetary Society*, 43, 513-518.
- Cohen, M.M. (1990). Designing space habitats for human productivity. Paper presented at the 20th Intersociety Conference on Environmental Systems, Williamsburg, VA, July.
- Cohen, M.M., & Brody, A.R. (1991). Human factors issues for interstellar spacecraft. Paper presented at the 28th Space Congress, Cocoa Beach, FL, April.
- Cook, D.R., Weary, D.P., & Kaplan, D.I. (1991) *Analysis of the Synthesis Group's Mars Exploration Architecture (EX-91-001)*. Houston, TX: National Aeronautics and Space Administration, Johnson Space Center, Lunar and Mars Exploration Program Office.
- Connors, M.M., Harrison, A.A., & Akins, F.R. (1985). *Living Aloft: Human Requirements for Extended Spaceflight*. Washington, DC: NASA Scientific and Technical Information Branch, SP-483.
- Cordes, E.C., & Moore, G.T. (1990). Safety: Problems and design issues. Unpublished manuscript, Department of Architecture, University of Wisconsin-Milwaukee, December.
- Evans, G.W. (1974). An examination of the information overload mechanism of personal space. *Man-Environment Systems*, 4, 61.

- Franklin, H.A. (1992). Construction issues on the Moon. Paper presented at the American Institute of Aeronautics and Astronautics 1992 Aerospace Design Conference, Irvine, CA, February, Paper AIAA 92-1033.
- Fisher, J., Bell, P., & Baum, A. (1978). *Environmental Psychology*. (2nd Ed.). New York: Holt, Reinhart and Winston.
- Graf, J. (1988). Construction operations for an early lunar base. In S.W. Johnson & J.P. Wetzel (Eds.), *Engineering, Construction, and Operations in Space: Proceedings of Space 88*. New York: American Society of Civil Engineers. Pp. 190-201.
- Greeley, R. (Ed.) (1990) *Mars Landing Site Catalog*. Tempe, AZ: University of Arizona, Department of Geology.
- Grigoryev, Yu.G. (1976). *Radiation Safety of Space Flights* (translated by SCITRAN under contract NASW-2791). Washington, DC: National Aeronautics and Space Administration, NASA TTF-16,853.
- Gurovsky, N.N., Kosmolinsky, F.P., & Mel'nikov, L.N. (1981). *Designing the Living and Working Conditions of Cosmonauts* (translated from Russian). Washington, DC: National Aeronautics and Space Administration, TM-76479.
- Hansmann, T., & Moore, G.T. (1990). *Genesis Lunar Outpost: Criteria and Design*. Milwaukee: University of Wisconsin-Milwaukee, Center for Architecture and Urban Planning Research, Research Report R90-1.
- Harrison, A.A., Caldwell, B., & Struthers, N.J. (1988). *Incorporation of privacy elements in space station design*. Unpublished final report N88-21242, National Aeronautics and Space Administration, Ames Research Center, Moffett Field, California, May.
- Harrison, A.A., Sommer, R., Struthers, N., & Hoyt, K. (1988). *Implications of privacy needs and interpersonal distancing mechanisms for space-station design*. Unpublished NASA Contractor Report 177500, National Aeronautics and Space Administration, Ames Research Center, Moffett Field, California, August.
- Herzberg, F., Mausner, B., Peterson, R.O., & Capwell, D.F. (1957). *Job Attitudes: Review of Research and Opinion*. Pittsburgh: Psychological Service of Pittsburgh.
- Herzberg, F., Mausner, B., & Snyderman, B. (1959). *The Motivation to Work*. New York: Wiley.
- Hewes, D.E., Spady, A.A., Jr., & Harris, R.L. (1966). *Comparative measurements of man's walking and running gaits in Earth and simulated lunar gravity*. Unpublished NASA Technical Note TN D-3363, Langley Research Center, Hampton, VA.
- Koelle, H.H. (1989). *The First 1000 Days of a Future Lunar Base*. Berlin, Germany: Technisch Universitat, Institut fur Luft-und Raumfahrt.
- Lin, T.D., Senseney, J.A., Arr, L.D., & Lindbergh, C. (1988). Concrete lunar base investigation. In S.W. Johnson & J.P. Wetzel (Eds.), *Engineering, Construction, and Operations in Space: Proceedings of Space 88*. New York: American Society of Civil Engineers. Pp. 146-155.
- McCormick, E. U., & Tiffin, J. (1974). *Industrial Psychology* (6th ed.). Englewood Cliffs, NJ: Prentice-Hall.
- Moore, G.T. (1990). Environment-behavior issues in extraterrestrial space. In H. Pamir, V. Imamoglu, & N. Teymur (Eds.), *Culture, Space, History: Proceedings of the 11th Conference of the International Association for the Study of People and their Physical Surroundings*. Ankara, Turkey: Middle East Technical University Press. Vol. 5, pp. 387-403.
- Moore, G.T., Baschiera, D.J., Fieber, J.P., & Moths, J.H. (1990). *Genesis lunar outpost: An evolutionary lunar habitat*. In C.J. Hopf (Ed.), *NASA/USRA University Advanced Design Program: Proceedings of the 6th Annual Summer Conference*. Houston: Lunar and Planetary Institute. Pp. 241-254.

- Moore, G.T., Fieber, J.P., Huebner-Moths, J., & Paruleski, K.L. (1991). *Genesis II: Advanced lunar outpost*. In P. Thompson (Ed.), *NASA/USRA University Advanced Design Program: Proceedings of the 7th Annual Summer Conference*. Houston: Lunar and Planetary Institute. Pp. 329-334.
- Moore, G.T., & Huebner-Moths (1991). *Genesis II advanced lunar outpost: Human factors design response*. Paper presented at the First International Design for Extreme Environments Assembly, Houston, TX, November.
- Moore, G.T., & Rebolz, P.J. (1992). *Aerospace architecture: A comparative analysis of five lunar habitats*. Paper presented at the American Institute of Aeronautics and Astronautics 1992 Aerospace Design Conference, Irvine, CA, February, Paper AIAA 92-1096.
- Murtha, D.M. (1976). *Dimensions of User Benefit*. Washington, DC: American Institute of Architects.
- Namba, H., Yoshida, T., Matsumoto, S., Sugihara, K., & Kai, Y. (1988). *Concrete habitable structure on the Moon*. In S.W. Johnson & J.P. Wetzel (Eds.), *Engineering, Construction, and Operations in Space: Proceedings of Space 88*. New York: American Society of Civil Engineers. Pp. 178-190.
- National Aeronautics and Space Administration (1987/1989). *Man-Systems Integration Standards: NASA-STD-3000*, Vol. 1 (Rev. A, 1989). Washington, DC: National Aeronautics and Space Administration.
- Nicogossian, A., & Parker, J.F. (1982). *Space Physiology and Medicine. Part IV: Physiological Adaptation to Space Flight*. Washington, DC: NASA Scientific and Technical Information Branch, NASA SP-447.
- Nowak, P.S., Sadeh, W.Z., & Janakus, J. (1992). *Inflatable structures for a lunar base habitat*. Paper presented at the American Institute of Aeronautics and Astronautics 1992 Aerospace Design Conference, Irvine, California, February, Paper AIAA 92-1031.
- Richter, P.J., Drake, R.M., Kumar, R.P., & Anderson, T.L. (1990). *Concepts for lunar outpost development*. *Journal of Aerospace Engineering*, 3(4), 241-250.
- Ride, S.K. (1987). *Leadership and America's Future in Space: A Report to the Administrator*. Washington, DC: National Aeronautics and Space Administration.
- Schmitt, H.H. (1988). *Constraints on lunar base construction*. In S.W. Johnson & J.P. Wetzel (Eds.), *Engineering, Construction, and Operations in Space: Proceedings of Space 88*. New York: American Society of Civil Engineers. Pp. 35-45.
- Sherrod, D.R., & Downs, R. (1974). *Environmental determinants of altruism: The effects of stimulus overload and perceived control on helping*. *Journal of Experimental Social Psychology*, 10, 468-479.
- Sommer, R. (1969). *Personal space*. Englewood Cliffs, N.J.: Prentice-Hall.
- Stafford, T.P. (1991). *America at the Threshold: Report of the Synthesis Group on America's Space Exploration Initiative*. Washington, DC: US Government Printing Office, Superintendent of Documents.
- Stuster, J.E. (1986). *Space Station Habitability Recommendations based on a Systematic Comparative Analysis of Analogous Conditions*. Washington, DC: NASA Scientific and Technical Information Branch, NASA Contractor Report 3943.
- Thangavelu, M. (1991). *Maleo: Modular assembly in low Earth orbit - Alternate strategy for lunar base development*. *Journal of Aeronautical Engineering*, 4(3), 256-273.
- Vanderbilt, M.D., Criswell, M.E., & Sadeh, W.Z. (1988). *Structures for a lunar base*. In S.W. Johnson & J.P. Wetzel (Eds.), *Engineering, Construction, and Operations in Space: Proceedings of Space 88*. New York: American Society of Civil Engineers. Pp. 352-374.
- Weaver, D. (1992). *SEI reference mission*. Paper presented at the ExPo Technical Interchange Meeting, Exploration Programs

Pax Permanent Martian Base

Office, National Aeronautics and Space Administration, Johnson Space Center, February.

Zubrin, R.M., Baker, D.A., Gwynne, O. (1991) Mars Direct: A Coherent Architecture for the Space Exploration Initiative. Paper presented at the AIAA/SAE/ASME 27th Joint Propulsion Conference, Sacramento, CA, Paper AIAA 91-2333.

