

TDA Progress Report 42-110

August 15, 1992

12844
N93-19424

DSS-13 Beam Waveguide Antenna Frequency Stability

T. Y. Osho and M. M. Franco
Ground Antennas and Facilities Engineering Section

Measurements made on the frequency stability of the DSS-13 34-m-diameter Beam Waveguide (BWG) antenna showed that at 46.5- and 37-deg elevation angles, the BWG antenna stability at 12.2 GHz was between 1.3 and 2.2×10^{-15} for $\tau = 1024$ sec and good weather conditions. These frequency stability values apply to the portion of the antenna that includes the main reflector, subreflector, tripod legs, and the six BWG mirrors. The test results reported in this article are believed to be the first known successful measurements of the stability of the microwave optics portion of a large antenna to a level of 1 or 2 parts in 10^{15} .

I. Introduction

As was pointed out in a previous article [1], attempts have been made in past years to measure the frequency stability of a large antenna using various techniques including (1) a probe on the reflector surface method, (2) a spacecraft Doppler measurement method, (3) a collimation tower method, and (4) very long baseline interferometry (VLBI) methods. Most of these methods have been unable to measure frequency stabilities to better than a few parts in 10^{14} or had other disadvantages discussed in [1].

A new method proposed in 1991 [1] involved the reception of far-field signals from geostationary satellites positioned at various elevation angles. The proposed method had the advantages of being simple and inexpensive to implement and could enable stability data to be obtained in a short time frame. Except for a new fiber-optic subsystem, most of the components and instruments required were already available. Since the antenna now remains the limiting factor that would prevent successful gravitational wave experiments to be performed in the near future, there existed an urgency to obtain antenna stability data that could help establish realistic performance requirements for new DSN antennas.

In addition to the goal of obtaining data in a short time frame, another goal of the new method was to demonstrate that fiber-optic cables could be used to carry microwave frequencies over long distances with negligible degradation to amplitude and phase stability. This article presents data that demonstrates the new method was successfully employed, and that all of the primary goals have been met for good weather conditions. BWG antenna stability data, applicable for inclement weather conditions, are not yet available.

II. Methodology

Figure 1 shows a block diagram of the test configuration. The method involves the use of far-field signals in the 11.7–12.2-GHz region from geostationary satellites, a stable reference antenna, and a phase detector Allan deviation measurement instrument. One of the main advantages of the test method is that it does not require reference signals that are coherent with the station clock. By receiving the far-field signals simultaneously with a reference antenna and the 34-m antenna under test, the phase variations common to both paths tend to cancel at the

output of a mixer contained in the Allan deviation measurement instrument [2].

For the proposed BWG antenna stability measurement method to yield useful and accurate data to the 1×10^{-15} level, it is required that the 12-GHz reference path have a fractional frequency stability of better than 1 or 2×10^{-16} for $\tau = 1000$ sec. The fulfillment of this requirement by the fiber-optic system has been reported in [3].

A Ku-band test package [4] is installed at the pedestal room focal point F3. For this test configuration, the portions of the BWG antenna being tested are the instabilities of the main reflector, subreflector, tripod legs, and six mirrors of the BWG system.

Specific satellites selected for this method are positioned at 47-, 37-, and 12-deg elevation angles. Minor antenna-pointing corrections, of about ± 50 mdeg maximum during a 24-hr period, are required to keep the antenna beam peak pointed at the satellite. Although these antenna pointing changes are small compared with those involved in an actual spacecraft track, phase change measurements could uncover problems associated with antenna pointing due to hardware or software. The method is intended primarily to measure instabilities of the BWG antenna due to outside air temperature and wind conditions.

Even though the measurements are made at Ku-band, the information can be inferred back to mechanically related changes and is therefore useful for determining stability at other frequencies.

III. Test Results

Figure 2 shows the block diagram of the test configuration that was used to measure the stability of the BWG antenna at a 46.5-deg elevation angle. The DSS-13 BWG antenna was pointed at a 46.5-deg elevation angle and a 156.9-deg azimuth for receiving a 12.2-GHz beacon signal from the geostationary satellite GSTAR I owned by the GTE Corporation. The signals from the reference antenna via the fiber-optic system and the 34-m antenna under test are connected to the Allan deviation measurement instrument, which contains a microwave phase detector. Band-pass filters (centered at 12.2 GHz) were used to remove unwanted signals.

Figure 3 shows the Allan deviation plots obtained March 4 and 5, 1992 for two 9-hour-long runs. The first was from 4 p.m. to 1 a.m. PST and the second was from 5 a.m. to 2 p.m. PST. The Allan deviations for $\tau = 1024$

sec were 2.16×10^{-15} for the first run and 1.64×10^{-15} for the second run. These results were about a factor of 3 better than expected.

Also shown in Fig. 3 is the fiber-optic-system-only stability value of 1.64×10^{-16} for $\tau = 1024$ sec. The fiber-optic-only path is the baseline reference that sets the lower limit of stability that can be measured for the 34-m BWG antenna. Descriptions of the fiber-optic-only path and test procedures were described previously in [3].

For interest, Fig. 4 is presented to show the raw phase data corresponding to the Allan deviation result of the above 5 a.m.-2 p.m. run. In addition, the outside air temperature and wind conditions that prevailed during the tests are shown in Figs. 5 and 6, respectively. It can be seen from Fig. 6 that the air temperature varied from about 6 to 15 deg C and the wind was typically less than 30 km/hr. A graphic description of the wind data (Fig. 7) shows that the wind was blowing both into the back and into the front of the main reflector surface at angles of about 16 deg (back side) and 52 deg (front side) off the main z -axis direction.

Figure 8 shows the block diagram of the test configuration used to measure the stability of the BWG antenna at a 37-deg elevation angle. The DSS-13 BWG antenna was pointed at a 37-deg elevation angle and a 132.9-deg azimuth so as to receive a 12.2-GHz beacon signal from the geostationary satellite Satcom K1 owned by the GE American Communications Corporation. This test configuration differs slightly from that shown in Fig. 2 in that one additional 12.198-GHz filter and 20-dB gain amplifier were used. For these tests and all subsequent tests, a new calibration procedure was developed for verification of the test setup. The calibration procedure was to move the subreflector in ± 0.1 -in. offset in the z -axis axial direction from the nominal setting. It is known from previous work [5], that the effective pathlength change was approximately 1.77 times the z -axis offset subreflection position on a 64-m Cassegrain antenna. At 12.2 GHz, this pathlength change, Δ_{pl} , corresponds to a phase change in degrees of

$$\delta_{ph} = \frac{360}{\lambda} (1.77 \Delta_{pl}) \quad (1)$$

where λ = free-space wavelength in centimeters. For $\Delta_{pl} = 0.254$ cm (0.1 in.), then $\delta_{ph} = 65.9$ deg. With the 34-m BWG antenna having shaped main- and subreflector surfaces, the 1.77 factor might be closer to 1.7 so that $\delta_{ph} = 63$ deg. The measured phase changes resulting from moving the subreflector ± 0.1 in. was about ± 60 deg

as shown in Fig. 9. This procedure provided a means of verifying that, for a particular test configuration, phase changes that occurred in the antenna path above F1 were actually observed and correctly measured.

Figure 10 shows the Allan deviation plot obtained when the DSS-13 BWG antenna was pointed at a 37.0-deg elevation angle. The Allan deviations measured for $\tau = 1024$ sec was 1.26×10^{-15} for a 9-hour time period between 4 p.m. to 1 a.m. the next morning.

For interest, the raw phase data for the first run between 4 p.m.-1 a.m. are shown in Fig. 11 along with outside air temperature and wind data in Figs. 12 and 13, respectively. It can be seen from these figures that the air temperature varied between 12 and 7 deg C and the wind was typically less than 24 km/hr. As depicted in Fig. 14, the wind was blowing into the face of the main reflector surface, but at a direction between 29 to 53 deg off the main reflector z-axis.

IV. Future Test Plans

Comparisons of the results showed that for the 4 p.m.-11 a.m. runs, the Allan deviations were 2.16×10^{-15} and

1.26×10^{-15} for $\tau = 1024$ sec at a 46.5- and 37-deg elevation angles, respectively. For future tests, it would be of interest to perform 9-hour runs between 8 p.m. and 5 a.m. when the least amount of air temperature variations generally occur.

For the future, plans are being made to obtain data at the 12-deg elevation as well. It is also of interest to obtain data for the more severe (>32 km/hr) wind conditions that were shown in Figs. 6 and 13.

V. Conclusions

The initial test results presented in this article show that the proposed methodology was successfully employed and the goals were met. Data have been provided to the gravitational wave experimenters in a relatively short time frame (about 14 months) from conception of a new method, followed by the procurement, fabrication, and installation phases, and then the test phase. More data still have to be obtained to determine the stability of the BWG antenna under more severe weather conditions. However, this article has presented the first known stability data obtained on a large microwave antenna to a level of 1 or 2 parts in $\times 10^{15}$ for τ of approximately 1000 sec.

Acknowledgments

D. Bathker of the Ground Antennas and Facilities Engineering Section provided technical and management support on this project, as well as a needed Ku-band feed design for the reference antenna. B. Seidel provided technical information on Ku-band geostationary satellites. Technical discussions with both D. Bathker and B. Seidel concerning the feasibility of the far-field methodology and test strategies were helpful.

The authors are grateful to A. Bhanji, B. Conroy, and R. Perez of the Radio Frequency and Microwave Subsystems Section for the loan of the Allan Deviation Measurement instrument, as well as the technical information on the use of the instrument and data reduction software.

The reference antenna and 12-GHz fiber-optic system were key components that helped to make the measurements successful. J. Garnica, J. Ney, and L. Smith of DSS 13 did most of the work on the fabrication, installation, and checkout of the 10-ft reference antenna. The successful operation of the 12-GHz fiber-optic system was primarily due to G. Lutes and R. Logan of the Communications Systems Research Section.

The support provided by the entire DSS-13 crew during all phases of the testing at DSS 13 is greatly appreciated. C. Goodson and G. Bury provided the DSS-13 management support needed to work out workforce rescheduling problems. Frequent periods of rain and bad weather caused some tests to be cancelled, but due to the excellent station support, the needed test data were ultimately obtained.

References

- [1] T. Y. Otoshi, "A Proposed Far-Field Method for Frequency-Stability Measurements on the DSS 13 Beam-Waveguide Antenna," *TDA Progress Report 42-107*, vol. July-September 1991, Jet Propulsion Laboratory, Pasadena, California, pp. 81-87, November 15, 1991.
- [2] B. L. Conroy and D. Le, "Measurement of Allan Variance and Phase Noise at Fractions of a Millihertz," *Rev. Sci. Instruments*, vol. 61, no. 6, pp. 1720-1723, June 1990.
- [3] T. Y. Otoshi, M. M. Franco, and G. F. Lutes, "Performance of a 12-GHz Fiber-Optic System for Beam-Waveguide Antenna Stability Testing," *TDA Progress Report 42-109*, vol. January-March 1992, Jet Propulsion Laboratory, Pasadena, California, pp. 105-113, May 15, 1992.
- [4] T. Y. Otoshi, S. R. Stewart, and M. M. Franco, "A Portable Ku-Band Front-End Test Package for Beam-Waveguide Antenna Performance Evaluation," *TDA Progress Report 42-107*, vol. July-September 1991, Jet Propulsion Laboratory, Pasadena, California, pp. 73-80, November 15, 1991.
- [5] T. Y. Otoshi and L. E. Young, "An Experimental Investigation of the Changes of VLBI Time Delays Due to Antenna Structural Deformations," *TDA Progress Report 42-68*, vol. October-December 1981, Jet Propulsion Laboratory, Pasadena, California, pp. 8-16, April 15, 1982.

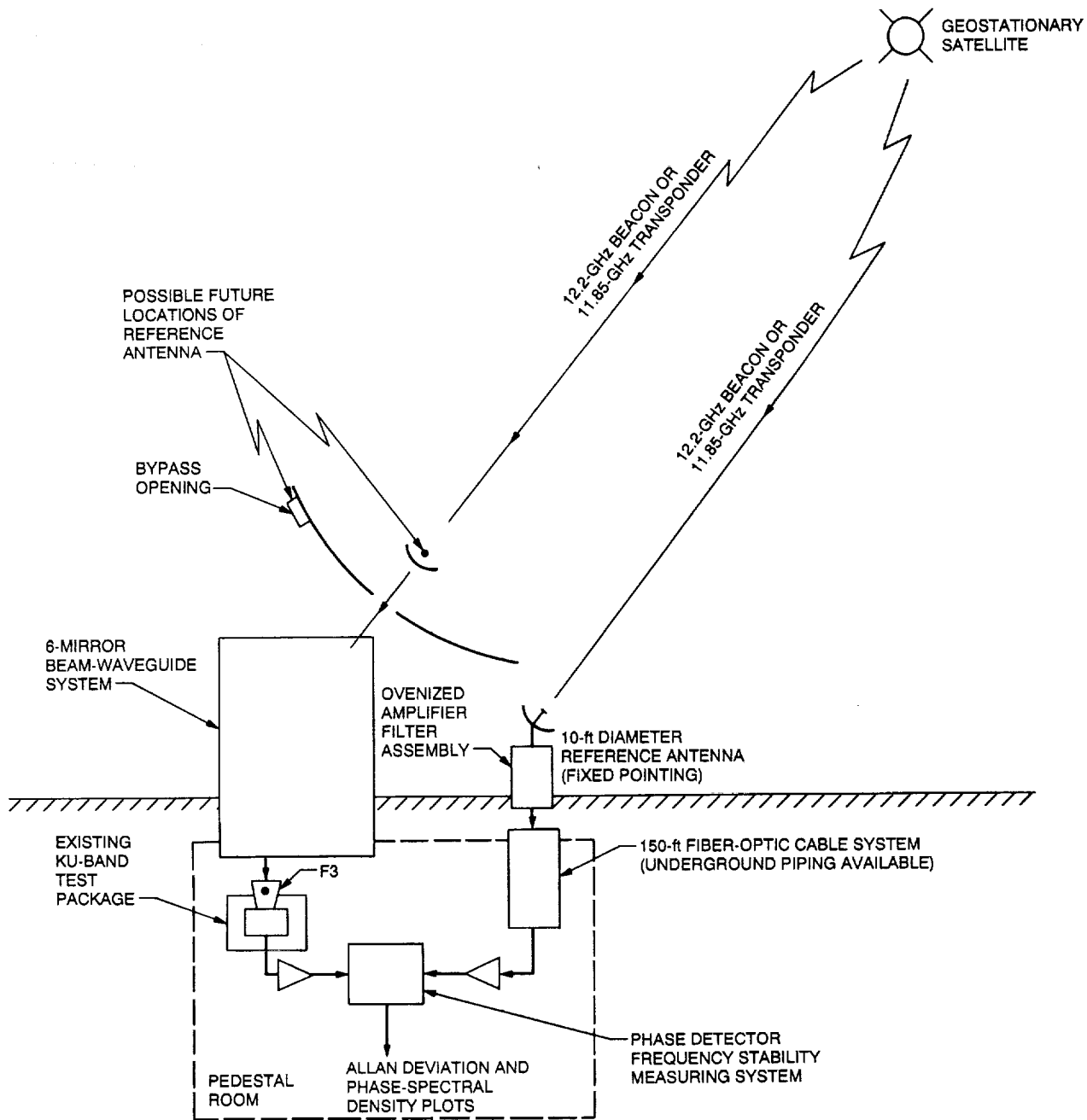

Fig. 1. Test configuration for measurement of the frequency stability of the DSS-13 BWG antenna.

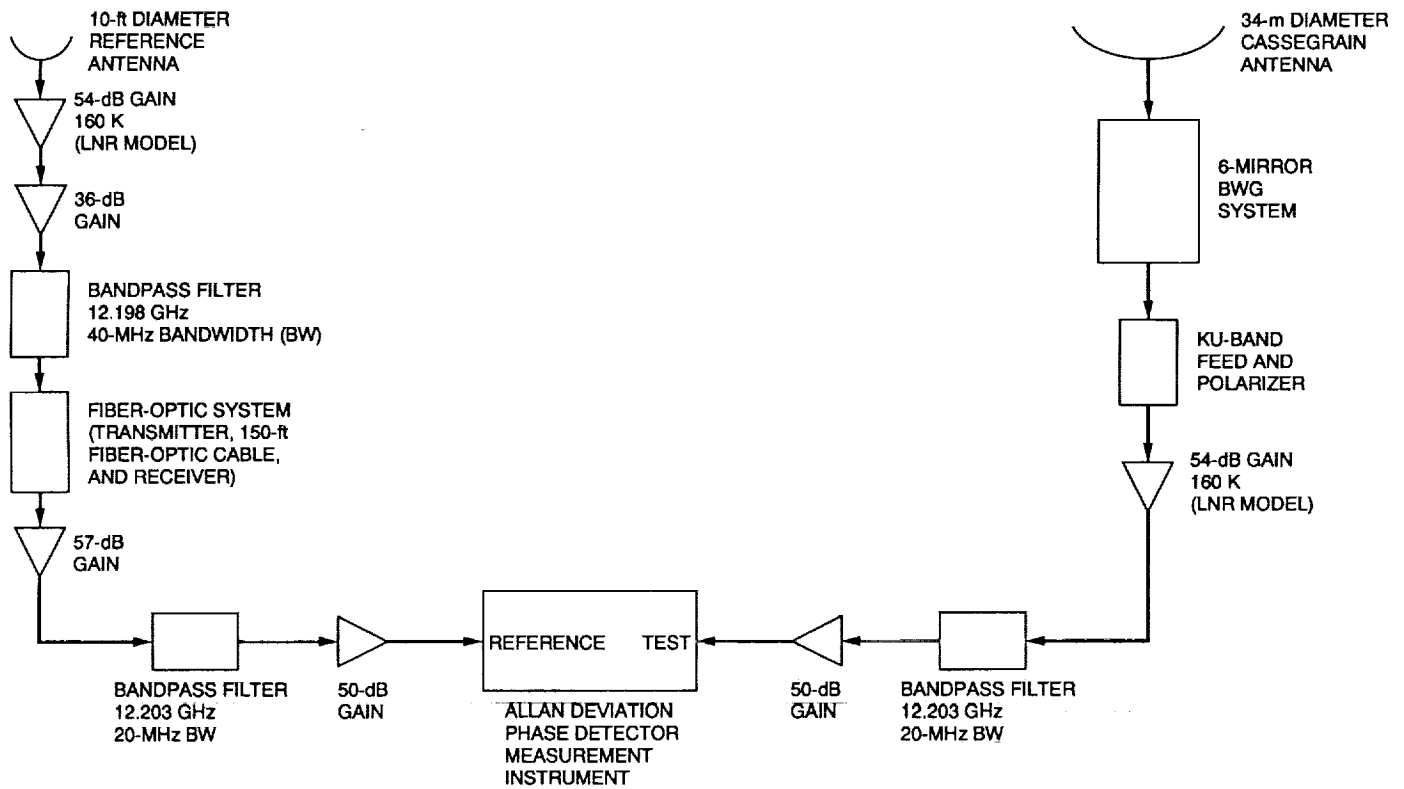

Fig. 2. The test configuration involving the use of the 12.2-GHz beacon signal from the GSTAR I geostationary satellite at a 46.5-deg elevation angle.

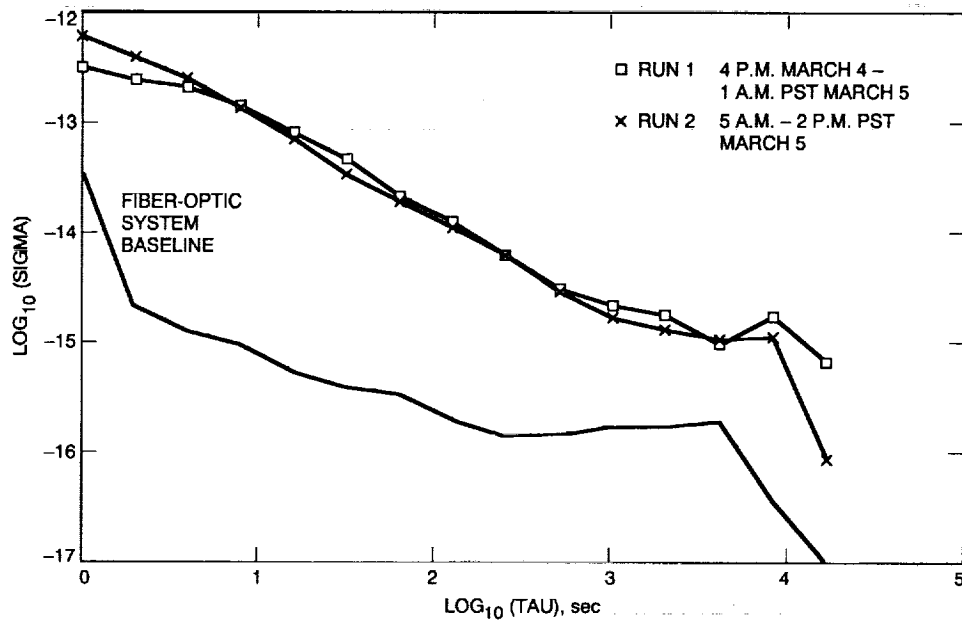

Fig. 3. Allan deviation plots of the DSS-13 BWG antenna stability on March 4 and 5, 1992. The DSS-13 BWG antenna was pointed at a 46.5-deg elevation angle and a 156.9-deg azimuth, receiving a 12.2-GHz beacon signal from GSTAR I.

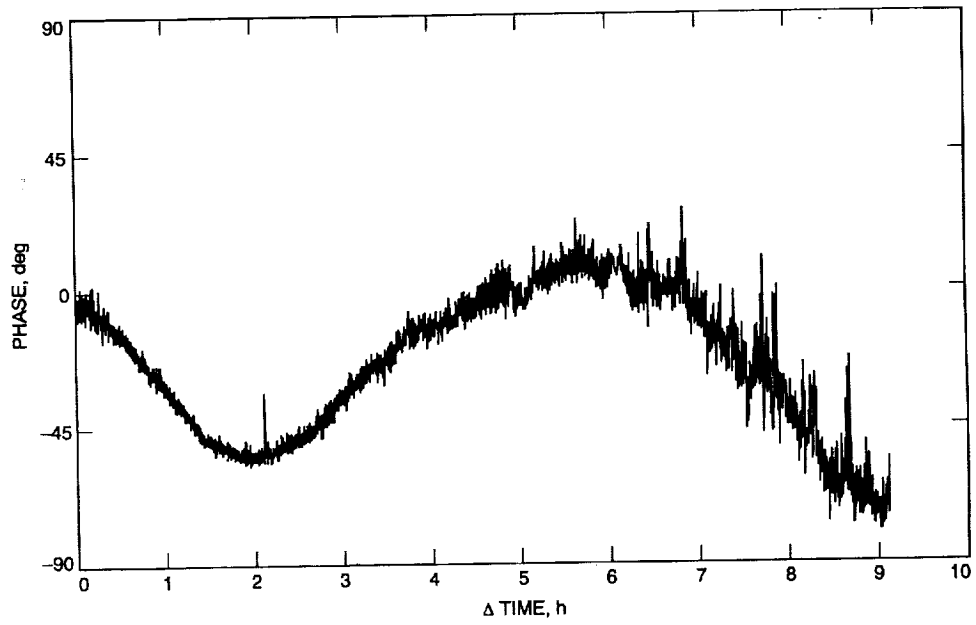

Fig. 4. Phase change plot corresponding to the 5 a.m.-2 p.m. run of Fig. 3.

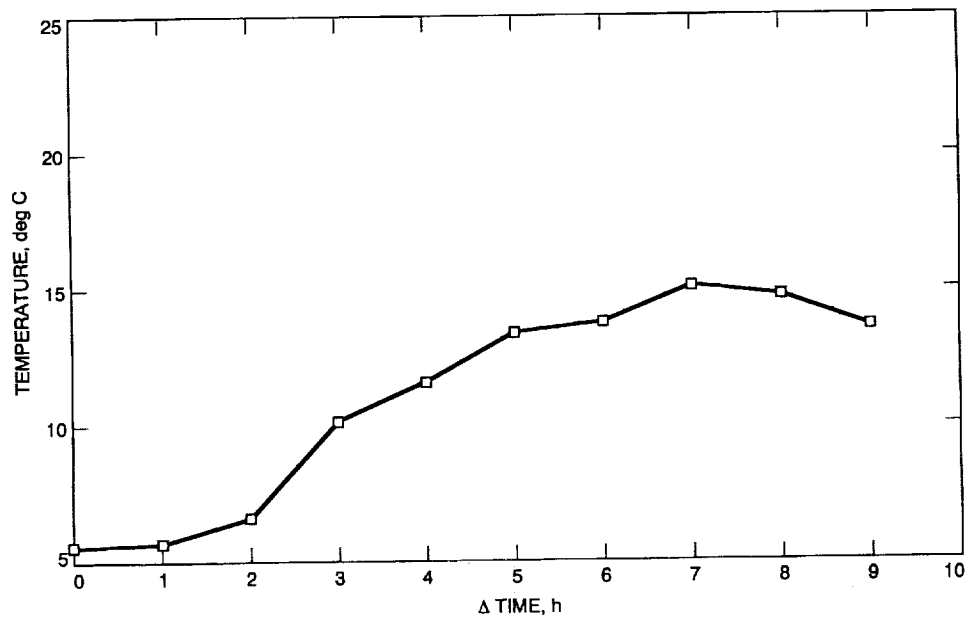

Fig. 5. Outdoor ambient temperature change during the 5 a.m.-2 p.m. run of Figs. 3 and 4.

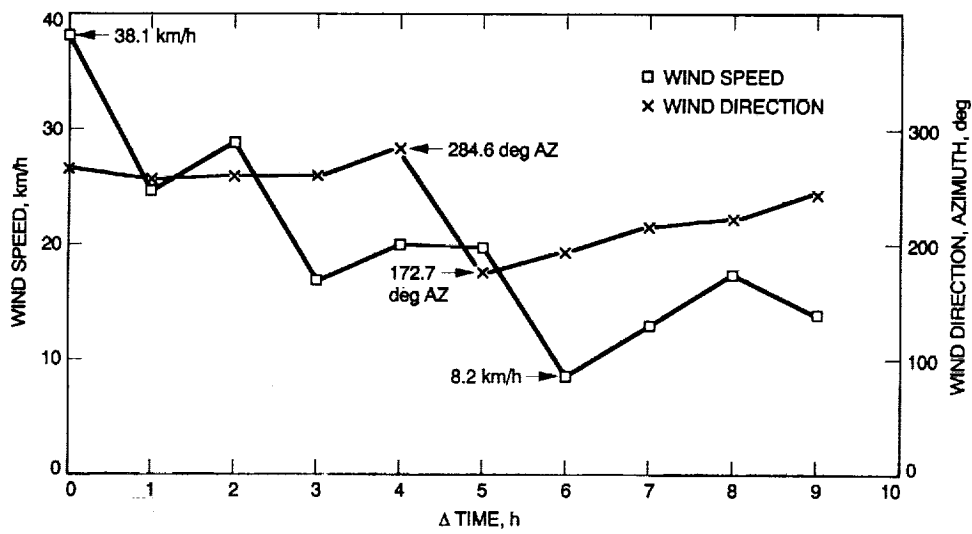

Fig. 6. Outdoor wind data during the 5 a.m.–2 p.m. run of Figs. 3 and 4.

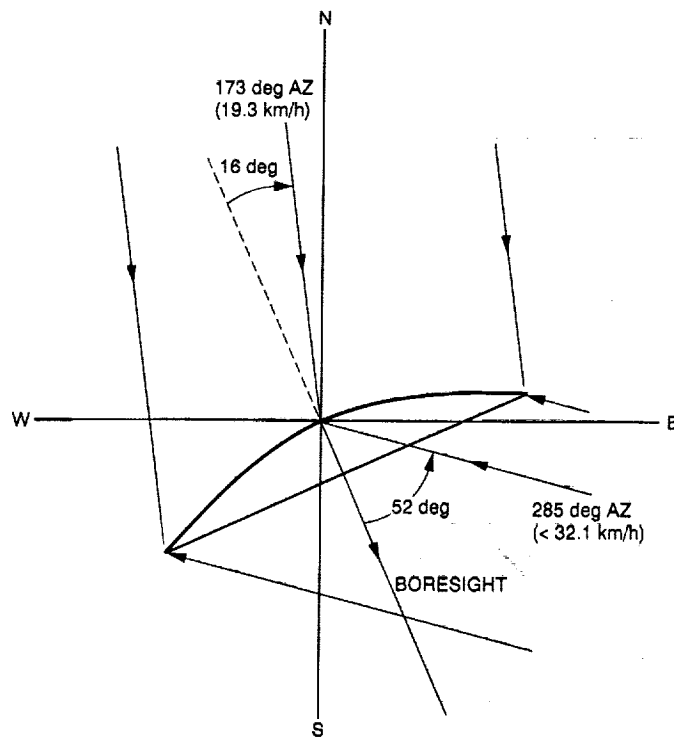

Fig. 7. Wind direction relative to the BWG antenna main axis during tests with the GSTAR I geostationary satellite.

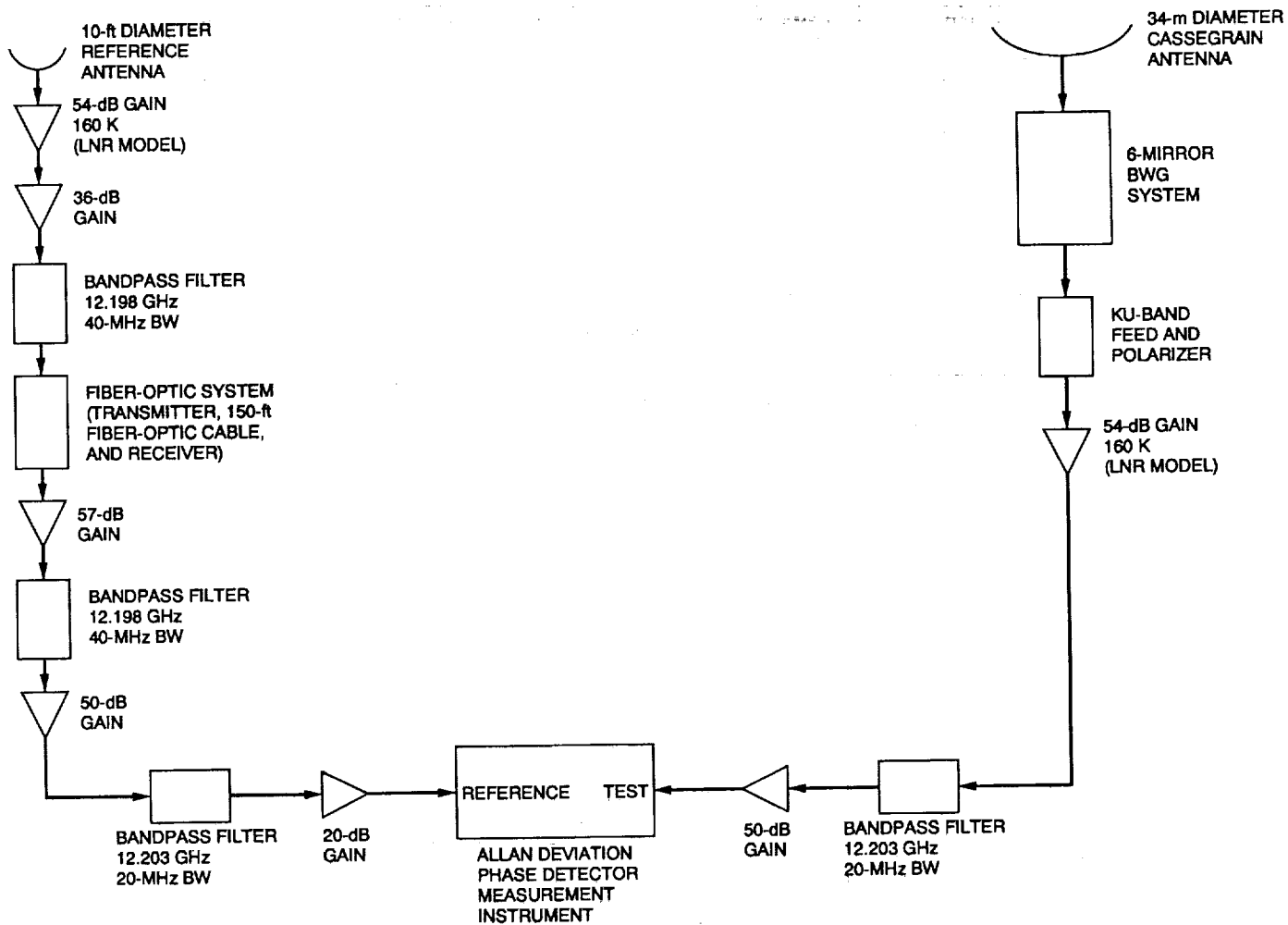

Fig. 8. The test configuration involving the use of the 12.2-GHz beacon signal from the Satcom K1 geostationary satellite at a 37-deg elevation angle.

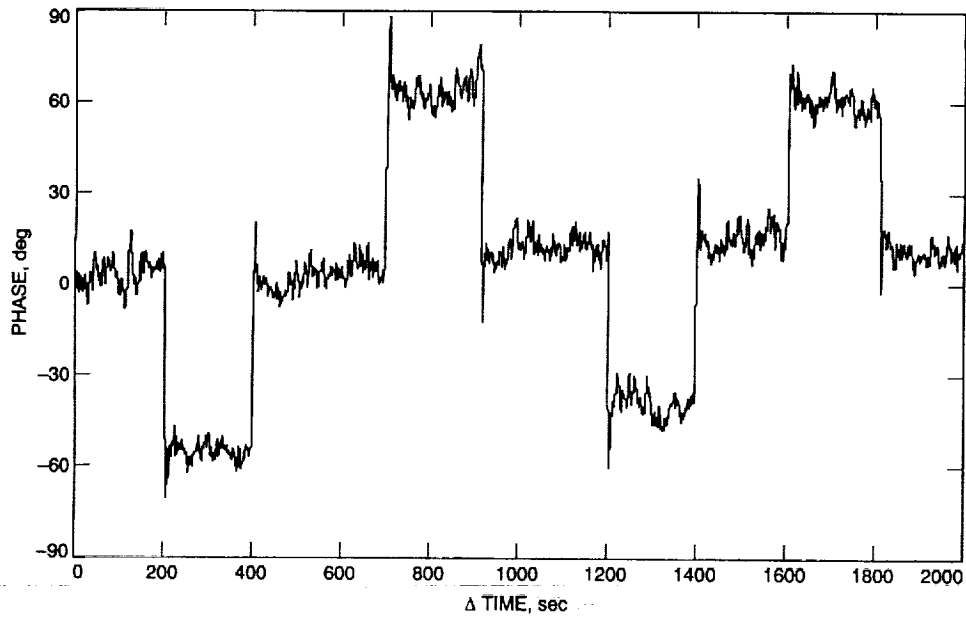

Fig. 9. Subreflector phase change plot as part of the precalibration procedure to verify test setup on 1992 day of year 66. The DSS-13 BWG antenna was pointed at a 37-deg elevation angle and a 132.9-deg azimuth, receiving a 12.2-GHz beacon signal from Satcom K1.

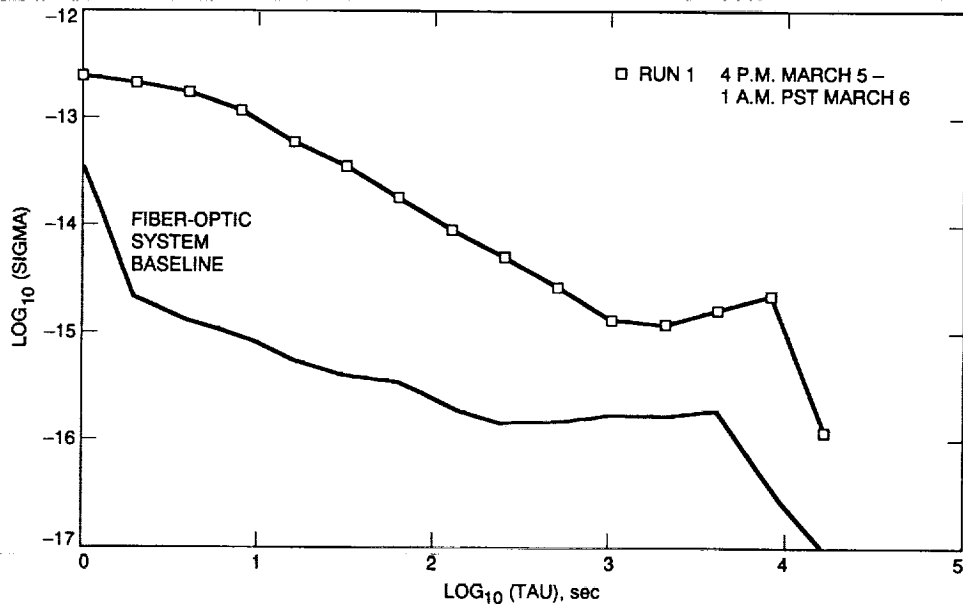

Fig. 10. Allan deviation plot of the DSS-13 BWG antenna stability on March 5 and 6, 1992. The DSS-13 BWG antenna was pointed at a 37-deg elevation angle and a 132.9-deg azimuth, receiving a 12.2-GHz beacon signal from Satcom K1.

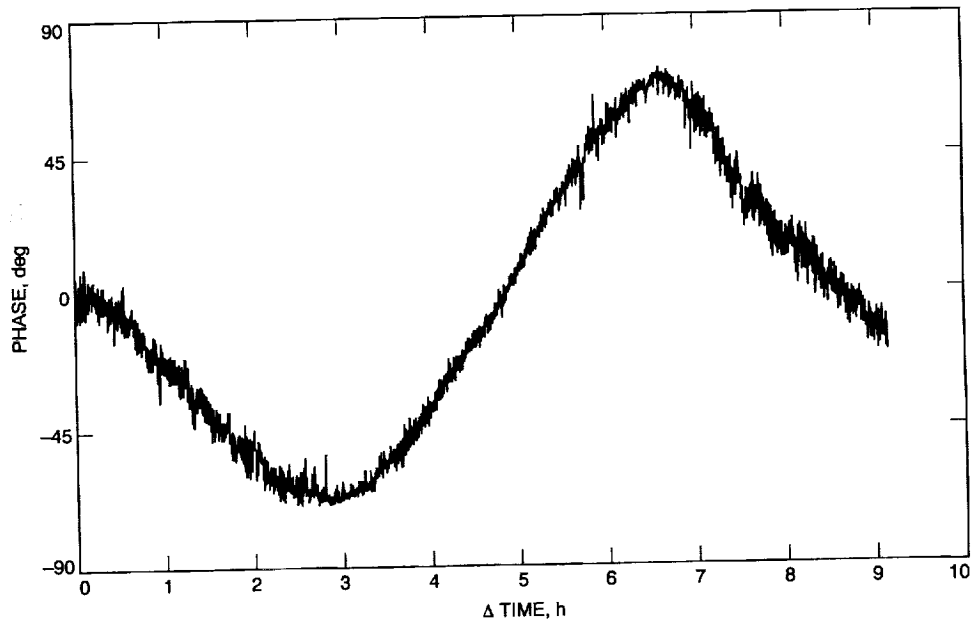

Fig. 11. Phase change plot corresponding to the 4 p.m.-1 a.m. run of Fig. 10.

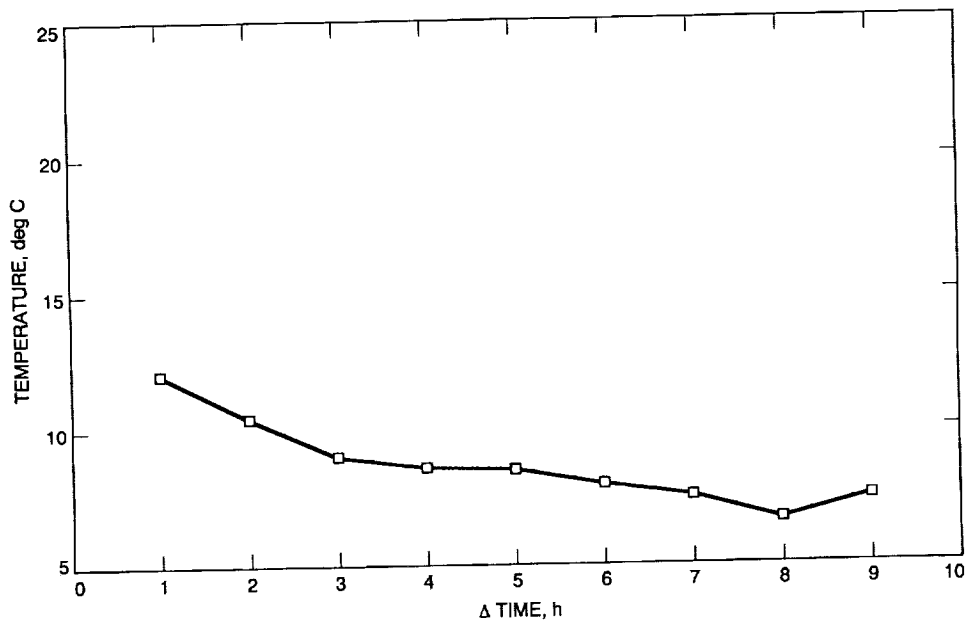

Fig. 12. Outdoor ambient temperature change during the 4 p.m.-1 a.m. run of Figs. 10 and 11.

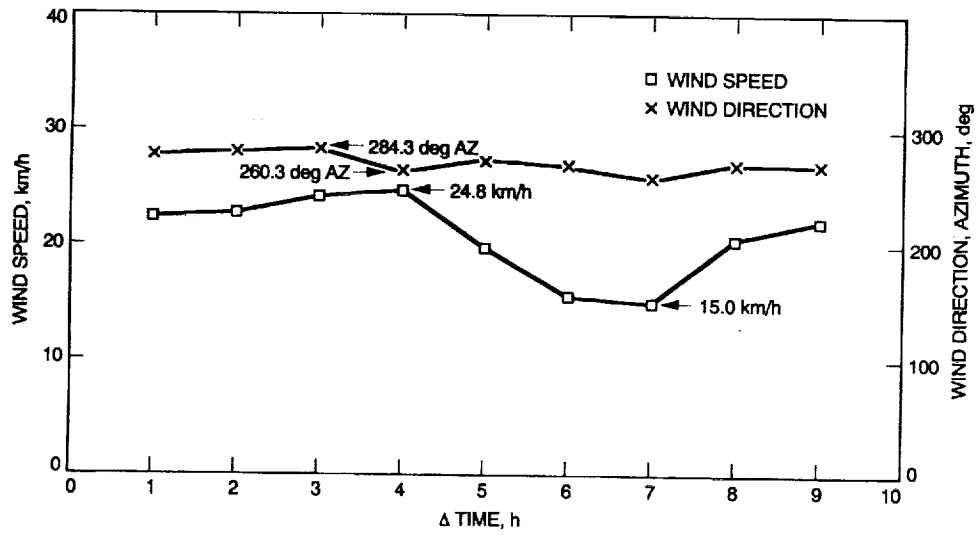

Fig. 13. Outdoor wind data during the 4 p.m.–1 a.m. run of Figs. 10 and 11.

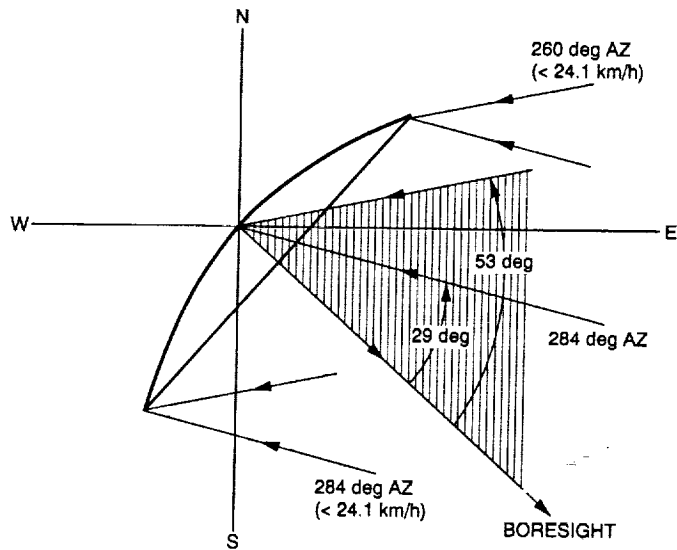

Fig. 14. Wind direction relative to the BWG antenna main axis during tests with the Satcom K1 geostationary satellite.