

MIT
Space
Engineering
Research
Center



646

52 12
158312

N 9 3 - 2 5 8 3 5

THE MODE FAMILY OF ON-ORBIT EXPERIMENTS:

THE MIDDECK ACTIVE CONTROL EXPERIMENT (MACE)

Prof. Edward F. Crawley	MIT
Dr. David W. Miller	MIT
Dr. Javier de Luis	PSI
Mr. Mel Waldman	LMSC
Dr. Andy Bicos	MDSSC

November 1990

ABSTRACT

A flight experiment entitled the Middeck Active Control Experiment (MACE) proposed by the Space Engineering Research Center (SERC) at the Massachusetts Institute of Technology is described. This is the second in a family of flight experiments being developed at M.I.T. The first is the Middeck 0-Gravity Dynamics Experiment (MODE) which investigates the nonlinear behavior of contained fluids and truss structures in zero gravity. The objective of the MACE program is to investigate and validate the modeling of the dynamics of an actively controlled flexible, articulating, multibody platform free floating in zero gravity. A rationale and experimental approach for the program are presented. The rationale shows that on-orbit testing, coupled with ground testing and a strong analytical program, is necessary in order to fully understand both how flexibility of the platform affects the pointing problem, as well as how gravity perturbs this structural flexibility causing deviations between 1- and 0-gravity behavior. The experimental approach captures the essential physics of multibody platforms, by identifying the appropriate attributes, tests, and performance metrics of the test article, and defines the tests required to successfully validate the analytical framework.

OUTLINE

MODE family of experiments

Overview of the Middeck Zero-Gravity Dynamics Experiment

The Middeck Active Control Experiment (MACE)

Objectives, rationale and focus mission

Science development approach

On-orbit tests

Summary

THE MODE FAMILY OF EXPERIMENTS

The MODE family of experiments is a series of small, relatively inexpensive dynamic and control experiments designed to exploit the interactive, shirt sleeve environment of the STS Middeck. The first facility uses a reusable dynamic test facility to investigate the nonlinear behavior of fluids and truss structures in zero gravity. The second flight modifies the dynamics test facility to include the capability for performing closed-loop active control experiments. This modified, reusable facility is used to investigate the gravity dependent behavior in the closed-loop performance of a flexible, multi-payload platform.

THE MODE FAMILY OF EXPERIMENTS

Fluid Test Article (FTA)

Coupled Non-Linear
Dynamics of Fluids and
Structures in Zero
Gravity

Structural Test Article (STA)

Non-Linear Dynamics of
Jointed Truss Structures in
Zero Gravity

MACE Test Article

Influence of Gravity on the
Active Control of a
Multibody Platform

Flight # 1:
August 1991

Flight #2:
September 1993

MACE is part of a logical sequence of cost-effective flight experiments designed to advance technology of interest to NASA in the area of controlled structures.

THE MIDDECK 0-GRAVITY DYNAMICS EXPERIMENT (MODE)

MODE consists of two elements: the experiment support module (ESM) containing the equipment typical of a generic dynamic test facility and the two types of test articles. The ESM, which is contained in one Middeck locker, houses the experiment control computer, data acquisition and storage system and sensor and actuator electronics which can be reconfigured to accommodate various test articles. For the first flight of MODE, the test articles will consist of several fluid test articles (FTA's) and several geometries of a structural test article (STA).

THE MIDDECK 0-GRAVITY DYNAMICS EXPERIMENT (MODE)

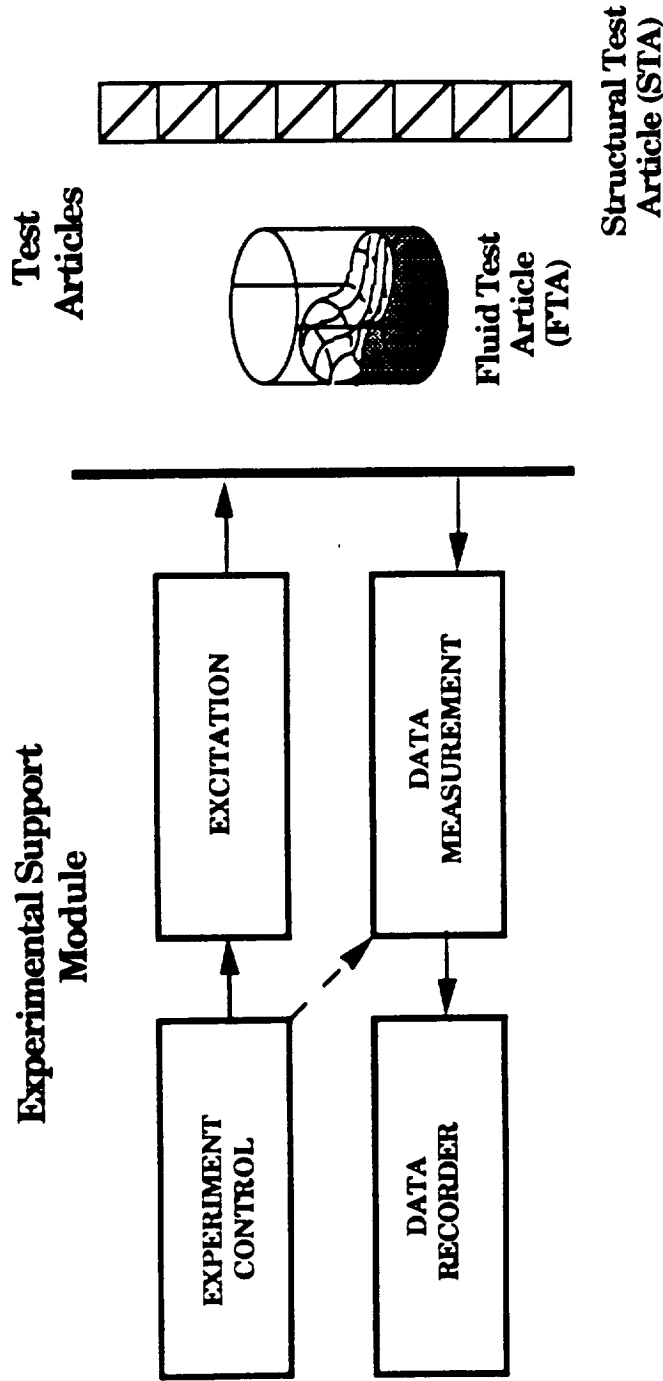

MODE provides a reusable dynamics test facility which will be used on the first flight to test two rather different types of test articles.

FTA OBJECTIVES, REQUIREMENTS AND APPROACH

A rationale justifying the performance of the FTA experiment on-orbit has been developed and is explained on this viewgraph.

FTA OBJECTIVES, REQUIREMENTS AND APPROACH

- Engineering science objective is to characterize fundamental 0-g slosh behavior and obtain quantitative data on slosh force and spacecraft response for correlation of numerical model.
- Requirements
 - Scaled tank
 - Properly modelled fluid
 - Simulation of coupled spacecraft mode
 - Harmonic excitation
 - Measurement of slosh force
- Modelling approach
 - Find fluid flow potential and free surface motion solutions.
 - Express kinetic and potential energies in terms of generalized coordinates.
 - Derive governing differential equations by applying Lagrange's Principle.
 - Solve nonlinear equations subject to harmonic excitation.
 - Verify predictions with MODE flight and ground test results.

FTA CONFIGURATION

The FTA assembly, which is stored in a separate locker for launch and landing, is attached to the front panel of the ESM. An umbilical, which is not shown, connects the various FTA sensors and the linear shaker to the ESM electronics. The shaker harmonically excites the force balance, to which the FTA is attached, through both an increasing and decreasing frequency sweep which encompasses the two resonances associated with the slosh motion of the fluid coupled with an electronically synthesized spacecraft mode. This sweep is performed at three different forcing levels to reveal the nonlinear characteristics.

Two geometries of FTA's are used: a flat bottom cylinder and a spherical bottom cylinder. Two different types of fluids will be tested: silicon oil and water. This requires that a total of four FTA's be flown.

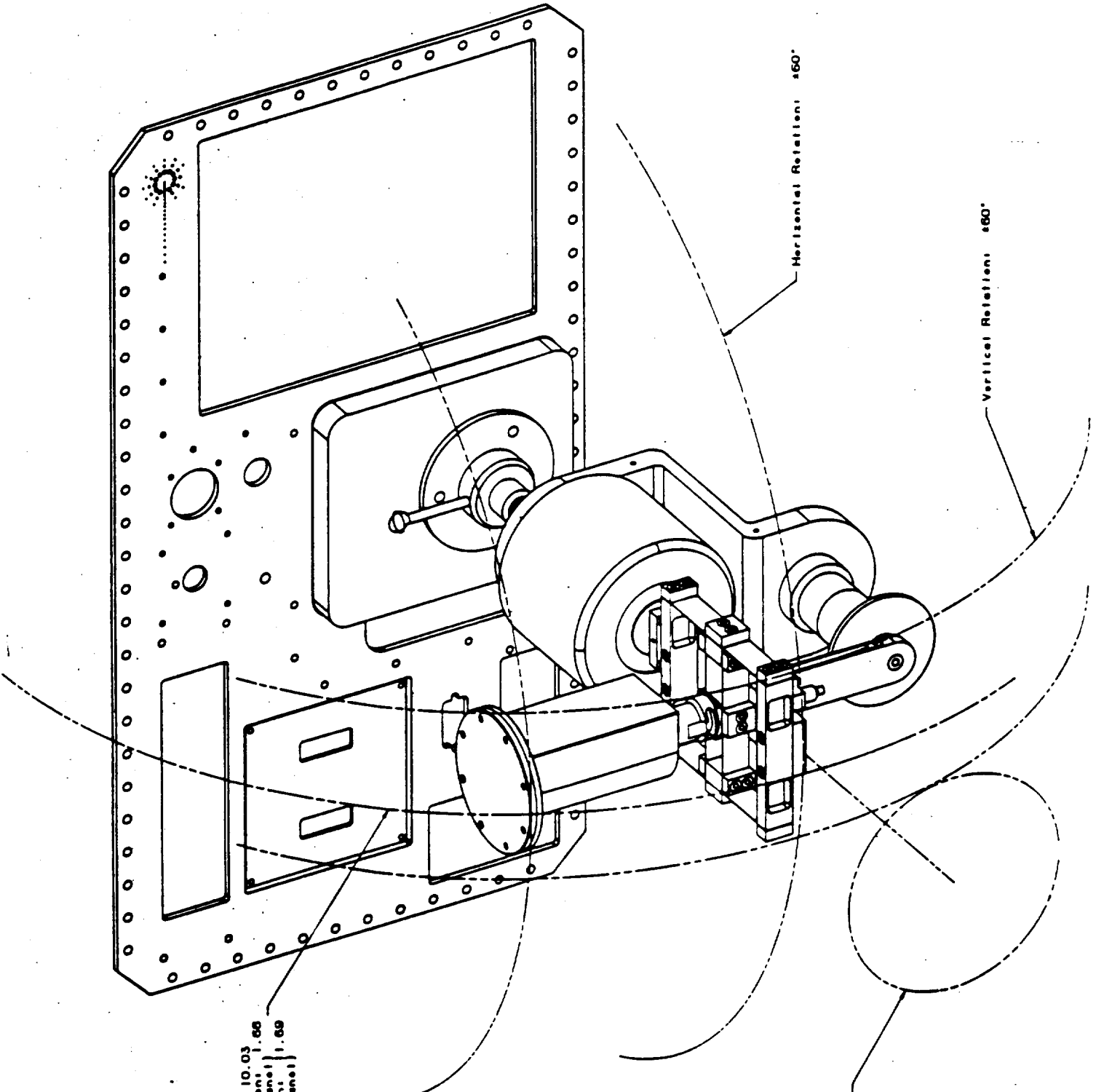

Horizontal Rotation: ±60°

Vertical Rotation: ±60°

Axial Rotation: ±180°

Maximum Radius:	10.03
Center of Rotation:	1.66
Maximum Extension:	1.69

(In Front of Panel)
(In Front of Panel)

STA OBJECTIVES, REQUIREMENTS AND APPROACH

A rationale justifying the performance of the FTA experiment on-orbit has been developed and is explained on this viewgraph.

STA OBJECTIVES, REQUIREMENTS & APPROACH

- Engineering science objectives are to characterize the fundamental changes in dynamics in 0-g due to absence of gravity on joints, to quantify the changes due to the absence of suspension and gravity load on members, and to obtain quantitative data for correlation with numerical models.
- Requirements
 - Truss structure containing elements of future space structures.
 - Nonlinear joints with variable pre-load to test nonlinear behavior in several gravity/joint pre-load conditions.
 - Reconfigurable truss with deployable and erectable bays.
- Modelling approach
 - Develop global linear model using FEM and modal test data.
 - Develop Force-State Map of non-linear sub-components.
 - Develop describing functions from Force-State Map.
 - Insert describing functions into global model and solve for forced response using Harmonic Balance Method.
 - Verify predictions with MODE flight and ground test results.

STA CONFIGURATIONS

The STA consists of five types of elements: two four bay deployable truss assemblies; two erectable truss bays; an alpha joint assembly; rigid end masses and a flexible appendage. This viewgraph shows the four different configurations in which the STA will be tested. The ring in three of the four configurations is an alpha joint and the large black dots indicate the nodes of the erectable bays. All deployable bays have preload tension cables. The tension in the cables on one of the deployable bays is adjustable. Testing will involve frequency sweeps at three different forcing levels to identify the nonlinear characteristics of the STA's forced behavior.

STA CONFIGURATIONS

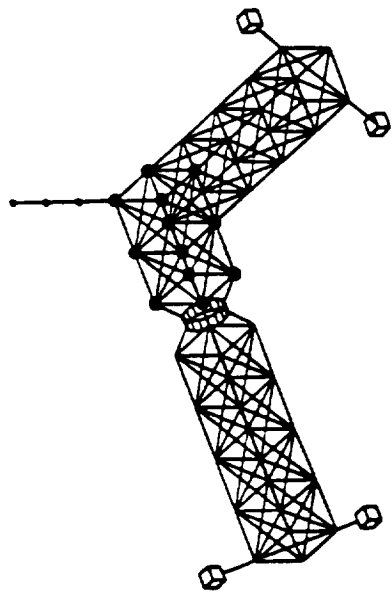
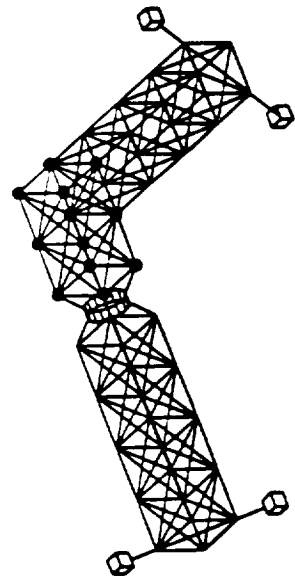
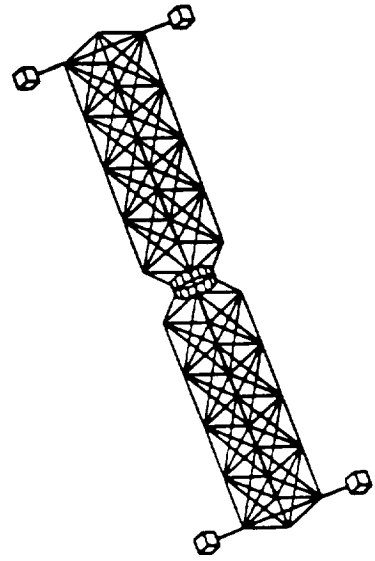
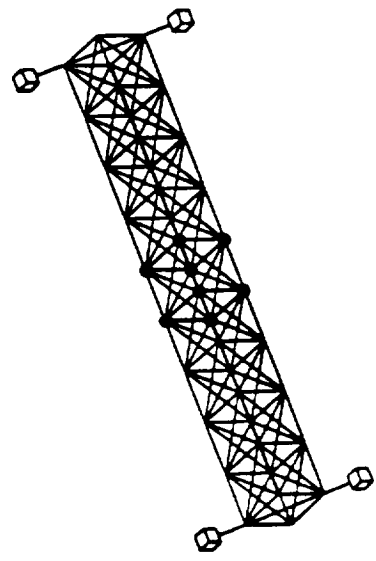

THE MIDDECK ACTIVE CONTROL EXPERIMENT (MACE)

MACE employs the same concept as MODE. An ESM is used to test a multibody platform representative of high mass fraction, multiple payload platforms. The shaded boxes in the ESM are components which also exist in the MODE ESM. The unshaded boxes are components which are unique to the MACE ESM: the realtime feedback control computer and the control actuator drive electronics.

THE MIDDECK ACTIVE CONTROL EXPERIMENT (MACE)

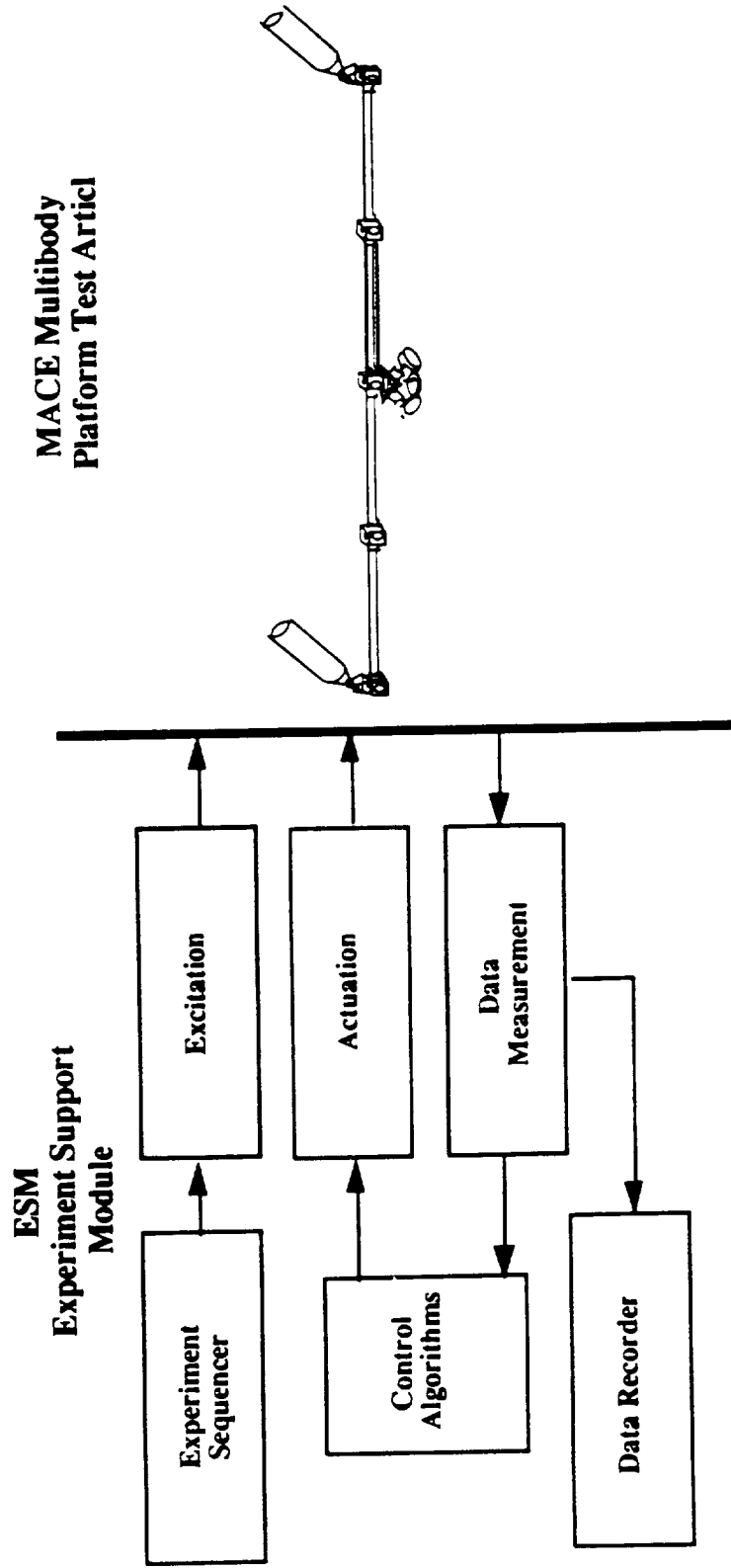

- Substantial commonality of ESM hardware/software
- Significant savings in integration/certification process.

OBJECTIVES AND RATIONALE

MACE differs from MODE in the sense that MACE investigates the accuracy with which the on-orbit closed-loop behavior can be predicted whereas MODE investigates the accuracy with which on-orbit, open-loop behavior can be predicted. The fundamental difference between the two is that no measure of open-loop model accuracy is sufficient to guarantee accurate prediction of closed-loop behavior at arbitrarily large levels of control authority.

OBJECTIVES AND RATIONALE

Objective: to develop a well verified set of tools that will allow designers to either be able to predict on-orbit behavior or allow sufficient versatility in the design to allow identification and tuning of the structure on orbit.

- Since the model fidelity required for stability and performance robustness is intimately related to the level of applied control authority, closed-loop testing is required.
- Vehicle qualification testing will most likely occur on the ground where suspension and direct gravity effects will cause the 1-g and 0-g dynamics to differ.
- Differences between the ground and on-orbit environment cause perturbations which can substantially alter closed-loop behavior.
- Therefore it is essential to perform on-orbit closed-loop testing for comparison with ground testing and analytical predictions to develop these tools.

CAPTURING THE ESSENTIAL PHYSICS: TEST ARTICLE REQUIREMENTS

Several types of proposed mission vehicles were reviewed. These included interferometric telescopes, deformable optical surfaces, multiple payload platforms and robotic devices. Multiple payload platforms were selected as the mission focus for the MACE test article because large angle scanning of multiple payloads presented about the most difficult to test on the ground and therefore accurately predict on orbit. This viewgraph lists some of the essential characteristics of a test article representative of a multiple payload platform.

CAPTURING THE ESSENTIAL PHYSICS: TEST ARTICLE REQUIREMENTS

The simulation of a vehicle with payloads and articulating appendages with pointing and positioning requirements, necessitates a test article with the following attributes:

- appropriately scaled to fit in the middeck while preserving the essential performance requirements.
- two gimbaling payloads to enable implementation of multiple interacting control systems with independent objectives.
- two rigid payloads and a flexible appendage, representative of compact high-mass fraction devices and a robotic servicer.
- flexible bus with resonances within the controller bandwidth and to exhibit suspension coupling, gravity stiffening and droop.
- sufficiently complex geometry such that the test article undergoes full 3-D kinematic and coupled flexible motion.

GROUND BASED ENGINEERING MODEL TESTBED

The purpose of the Engineering Model (EM) is to develop science. The EM is presently being fabricated at M.I.T. The segmented bus, which is the structural interconnect between the payloads and the inertial platform, is being dynamically tested. The three torque wheel assembly is completed and the first of two two-axis gimbals is being tested. Fabrication and assembly of the EM should be complete by the beginning of 1991.

GROUND BASED ENGINEERING MODEL TESTBED

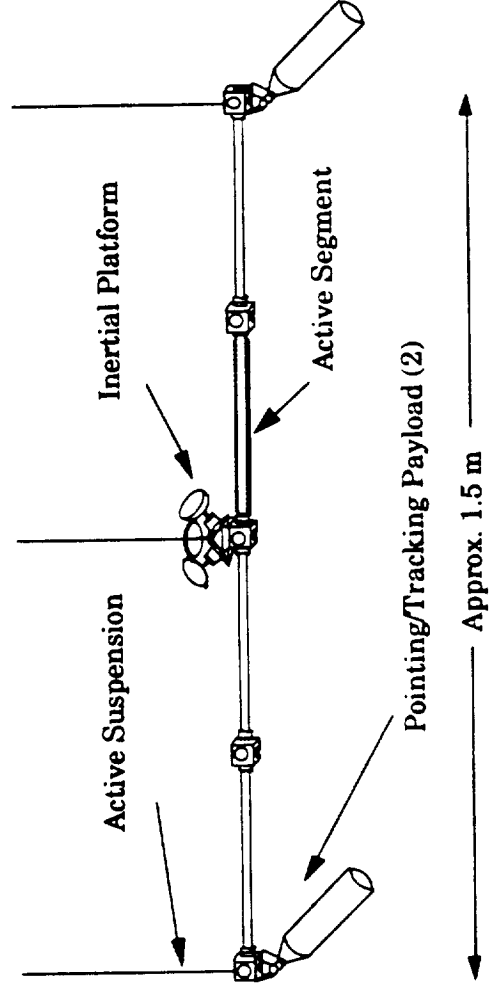

- Three zero spring rate pneumatic/electric suspension devices from CSA engineering with maximum stroke of 63.5 mm.
- AC100 real time control computer from Integrated Systems, Inc.

MACE SCIENCE DEVELOPMENT APPROACH

Six different avenues are being pursued in the development of the MACE science. At first glance, these avenues infer a vast analysis and test matrix. In reality, only a subset will be pursued for the first flight.

- 1) *Control objectives* refer to studying various combinations of single and multiple payload pointing and scanning.
- 2) *Control topologies* refers to the feedback paths which are allowed to exist due to different systems integration constraints. *Hardware suites* refers to exploring the performance and robustness improvement obtained as additional suites of hardware become available.
- 3) *Control approach* refers to the method by which the control algorithms will be derived.
- 4) *Model complexity* refers to the accuracy and complexity of the models on which these control formulations will be exercised. In other words, the lowest fidelity model provides fundamental insight while the highest fidelity model is used to derive algorithms for implementation.
- 5) *More complex test article geometries* can be used to further challenge ground testing.
- 6) Fundamental to the flight experiment is the understanding or *gravity influences* on the problem.

MACE SCIENCE DEVELOPMENT APPROACH

The MACE program will pursue six different avenues in developing controllers for multiple payloads on a flexible bus structure.

- 1) Control objectives
- 2) Control topologies and sensor/actuator suites.
- 3) Control approach to the pointing and scanning problems.
- 4) Evolution of structural model fidelity.
- 5) Evolution of structural configuration to more complex geometries.
- 6) Influence of gravity on closed-loop behavior.

**SCIENCE DEVELOPMENT APPROACH:
CONTROL OBJECTIVES**

Viewgraph is self-explanatory.

SCIENCE DEVELOPMENT APPROACH: CONTROL OBJECTIVES

Control Objectives:

- **Pointing** performance of single and multiple payloads.
- **Scanning** performance of single and multiple payloads.

Performance Metrics:

- **Stability**--RMS 2-axis angular position about pointing line of sight or scanning reference profile.
- **Jitter**--RMS 2-axis angular rate about pointing line of sight or scanning reference profile.
- **Slew response time**--time required to complete maneuver.
- **Percent degradation**--reduction from single payload performance associated with addition of an interacting, controlled payload.

SCIENCE DEVELOPMENT APPROACH: TOPOLOGIES AND HARDWARE SUITES

Four topologies will be investigated. The first called *central* has the payloads clamped to the bus and the torque wheels are used to control the attitude of the assembly. The closed-loop poles are in a Butterworth pattern with a bandwidth equal to one-tenth of the first flexible mode. This "central" topology is used as the low gain baseline against which other designs are compared.

The *localized* topology assumes that payload control design is independent of bus design. Therefore, all payload feedback loops are closed locally and the inertial attitude of the payload is measured locally.

The *centralized* topology requires that the payload infer its inertial attitude from a measurement of the inertial attitude at the center of the bus and other available sensors.

The *global* topology places no constraints on the allowable feedback loops and provides inertial attitude measurements on the bus and on the payload. This topology is used as the high performance scenario for comparison purposes.

First, the control hardware is limited to existing pointing and scanning hardware such as torque wheels, gimbals, rate gyros and angle encoders. Then, sensors whose sole function is to measure the flexibility in the bus become available. Finally, actuators used to control flexibility are added. The purpose of this progression is to investigate the cost/benefit of each additional suite.

SCIENCE DEVELOPMENT APPROACH: TOPOLOGIES AND HARDWARE SUITES

Localized

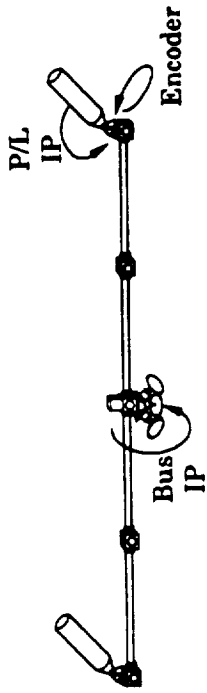

Centralized

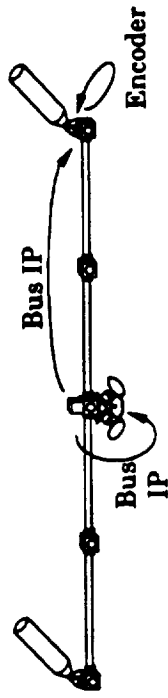

Existing Hardware

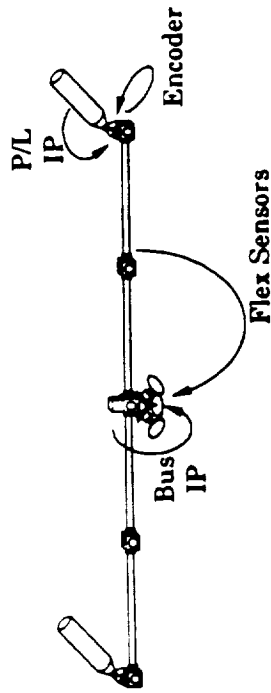

Flexibility Sensors

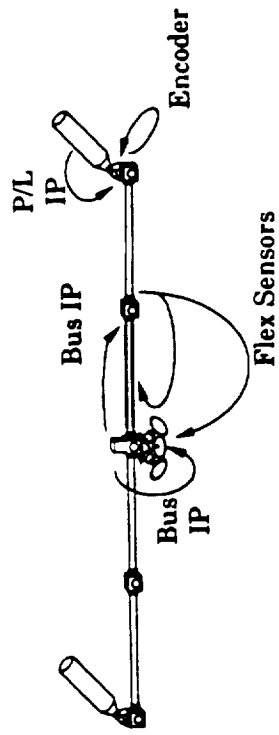
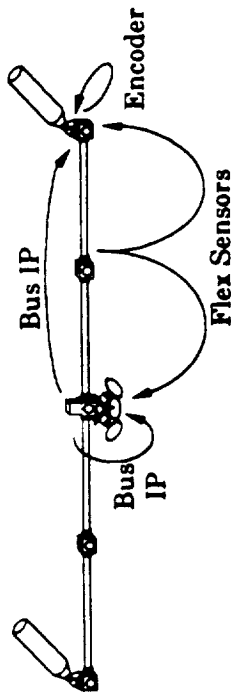

Flexibility Actuators

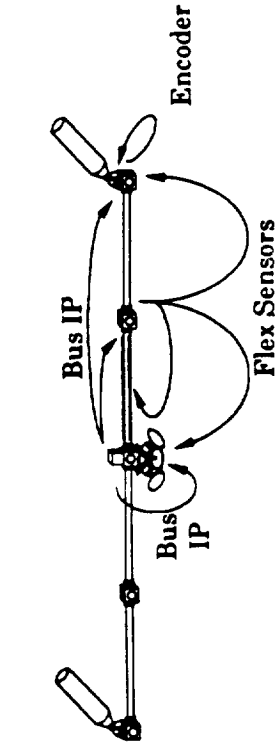

SCIENCE DEVELOPMENT APPROACH: CONTROL APPROACH

There are basically two control objectives: pointing and scanning. The pointing problem falls more directly under linear control. Depending on the amount of motion and deformation, the scanning problem may have to be handled with nonlinear techniques.

There already exists some techniques to generate linear control algorithms with simplified structure. Most of these rely on decoupling properties inherent to the system. Such decoupling properties include weak subsystem coupling or time scale separation. Successive loop closure, Nyquist Array, Inverse Nyquist Array and perturbation techniques rely on these decoupling assumptions. Direct optimization is another way to approach the problem. It relies less on understanding the properties of the system and is easier to derive for more complex systems with stronger coupling.

The scanning objective is a classic example of a servomechanism problem. The linear techniques used in the pointing problem may be applicable to this problem. However, the important transformation in the dynamics due to large slews of significant fractions of the spacecraft may render a linear approach inadequate. Therefore, nonlinear control design methods may be required such as gain scheduling, sliding mode control or more generic adaptive control schemes.

SCIENCE DEVELOPMENT APPROACH:

CONTROL APPROACH

- **Pointing**
 - Successive loop closure
 - Nyquist Array, Inverse Nyquist Array methods
 - Perturbation techniques (weak coupling, connective stability)
 - Constrained architecture LQG and other direct optimization techniques
- **Scanning**
 - Linear servomechanism methods (similar to above)
 - Nonlinear methods if necessary
 - Gain scheduling (slow scanning, wide range)
 - Sliding mode control (require numerous, high quality sensors)
 - Adaptive control

SCIENCE DEVELOPMENT APPROACH: MODEL COMPLEXITY

The *typical section* model is used to study the fundamental problem of pointing and scanning a non-center of mass mounted payload attached to a flexible bus. This is a lumped-inertia model of the problem.

The *planar sample problem* is more representative of the actual test article. However, motion is restricted to lie within the plane defined by the model's geometry. This greatly simplifies the complexity of the model allowing easier interpretation of the effectiveness of a particular control architecture. This planar sample problem is available as a document to enable interested researchers to submit control designs.

The *nonlinear three-dimensional model* is a detailed model of the actual EM which has been verified experimentally. This model is used to formulate the control algorithms that are actually implemented on the EM.

SCIENCE DEVELOPMENT APPROACH MODEL COMPLEXITY

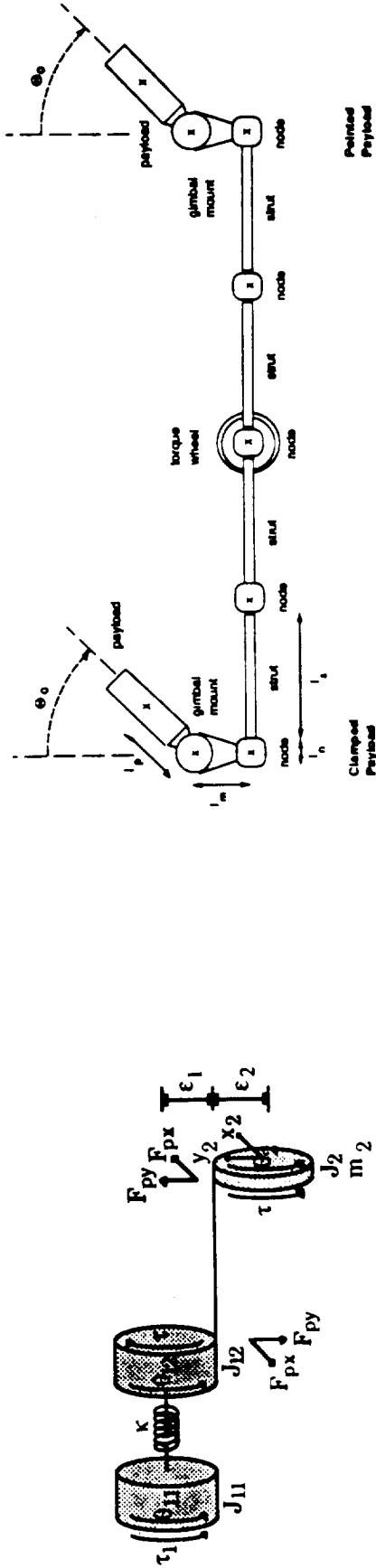

Typical Section

Planar Sample Problem

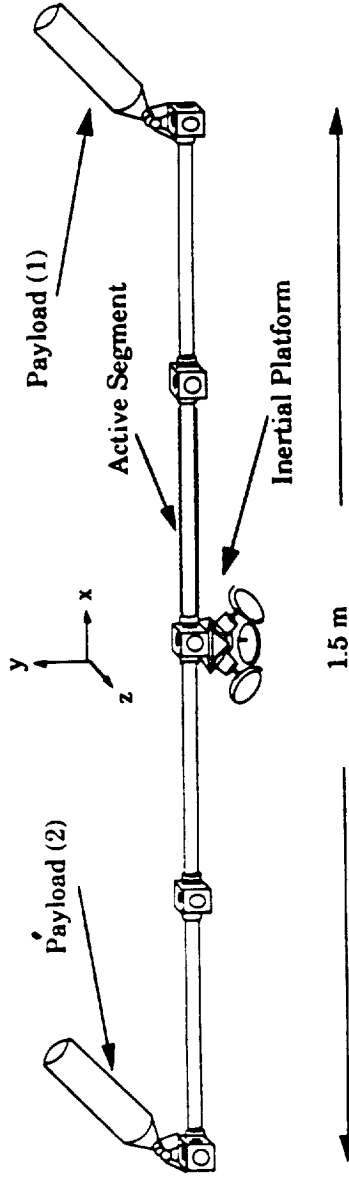

Nonlinear Three-Dimensional Model

SCIENCE DEVELOPMENT APPROACH: EVOLUTIONARY CONFIGURATIONS

The EM bus is composed of removable struts and nodes. This enables assembly of the EM in various geometries. More complex geometries are harder to test on the ground because they couple more with the suspension and gravity effects.

The *baseline* configuration is the one that will be studied.

The *three-dimensional* configuration has an 'L' and a rectangular cross-section strut designed to cause bending/torsion coupling and both in- and out-of-plane bending.

The *flexible appendage* configuration includes a flexible articulating payload, representative of a robotic servicer, and two flexible appendages, representative of the roll/bending coupling caused by solar panels.

SCIENCE DEVELOPMENT APPROACH: EVOLUTIONARY CONFIGURATIONS

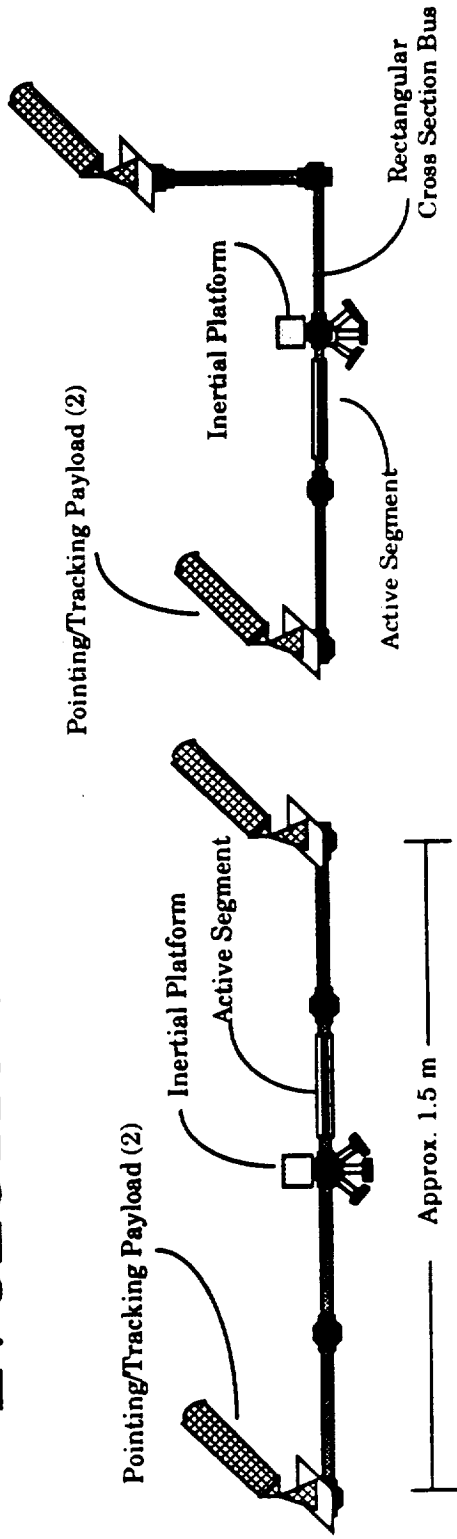

Baseline

Three-Dimensional

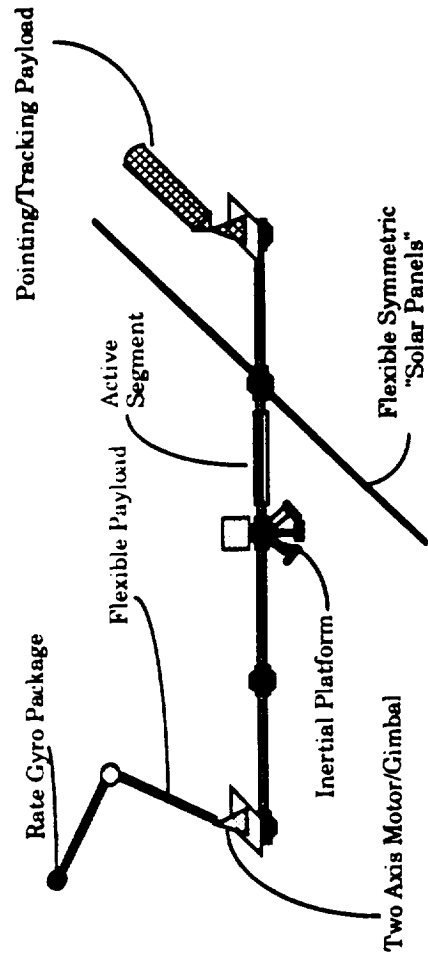

Flexible Appendage

**SCIENCE DEVELOPMENT APPROACH:
GRAVITY INFLUENCES**

Viewgraph is self-explanatory.

SCIENCE DEVELOPMENT APPROACH: GRAVITY INFLUENCES

Objective:

Identify and quantify the magnitude of the perturbation effects of a gravity field and a suspension system on the dynamics of the MACE test article.

Approach:

- Identify the distinct types of gravity/suspension perturbations.
- Identify a non-dimensional gravity or suspension influence parameter for each important effect and perform a parametric analysis of the effect on the system dynamics.
- Compare analytical results with finite element results.
- Rank the effect types in order of impact on the structural dynamics based on the non-dimensional system parameters.

SCIENCE DEVELOPMENT APPROACH:

GRAVITY INFLUENCES

A gravity effect can be characterized as either a direct gravity effect or an indirect gravity effect. Direct gravity effects are shown in the left column and are characterized by the application of distributed body forces on the structure. Indirect gravity effects are characterized as suspension loads on the structure. These are indirect because the suspension system, which is the influencing factor, is essential in the testing of structures in the one-gravity environment.

SCIENCE DEVELOPMENT APPROACH: GRAVITY INFLUENCES

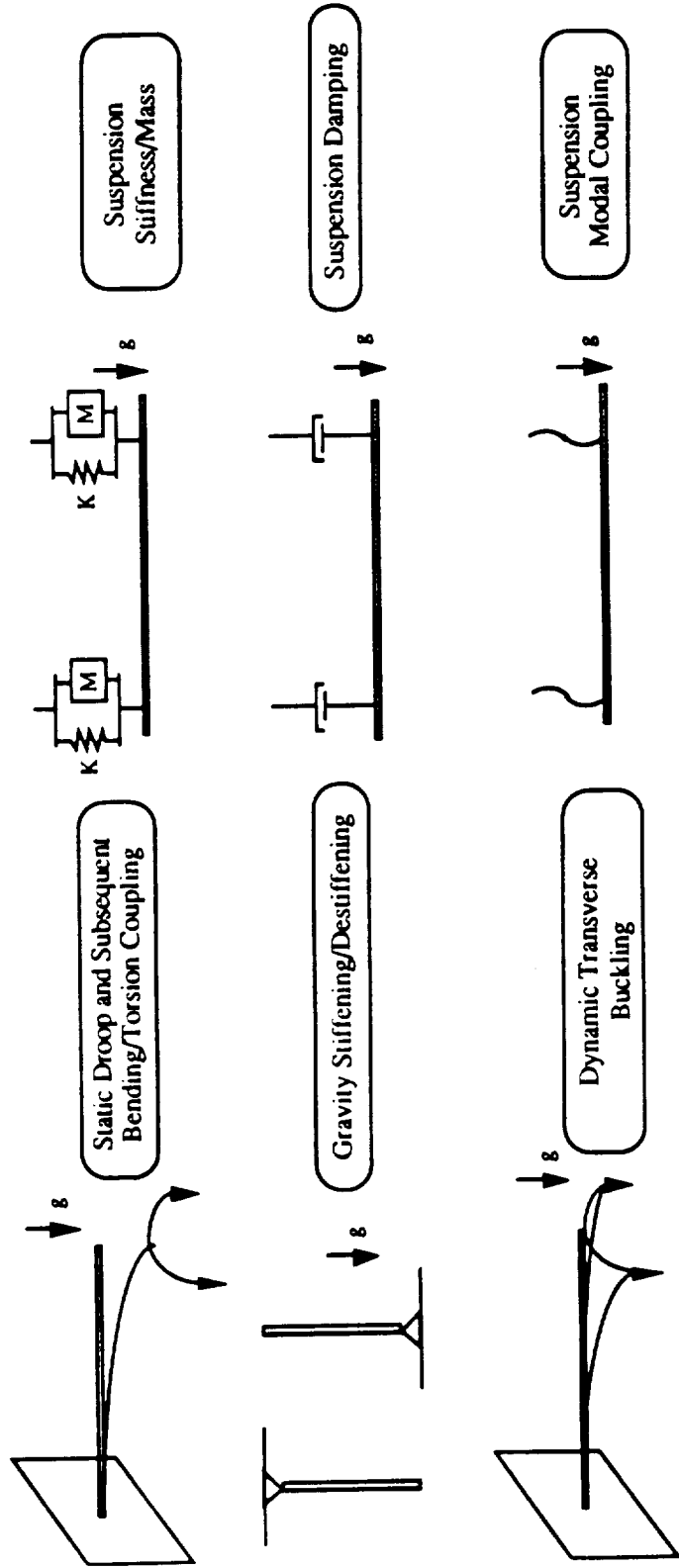

THREE CLASSES OF CONTROL ALGORITHMS WILL BE IMPLEMENTED ON ORBIT

The on-orbit tests are designed to achieve the three MACE objectives. First, the gravity effects which most influence the problem will be identified and the level of control authority where they become significant will be determined. Second, the ability to predict on-orbit closed-loop behavior will be determined. Third, the ability to tune the test article on orbit will be tested.

THREE CLASSES OF CONTROL ALGORITHMS WILL BE IMPLEMENTED ON ORBIT

- 1) Implement same algorithms as implemented on the ground
 - Algorithms based on model which includes gravity and suspension effects.
 - These tests help identify what gravity perturbations are important and when (what gain) they become important.
- 2) Implement algorithms based on model of predicted 0-g behavior.
 - The gravity parameter in the 1-g model is set to zero and the control algorithms are rederived.
 - These tests determine the accuracy to which 0-g closed-loop performance can be predicted.
- 3) Implement algorithms based upon on-orbit identified model.
 - First test is an open-loop ID of the structural dynamics.
 - Uplink/downlink capability is being developed to enable downlink of open-loop identification and uplink of associated control algorithms.
 - These tests identify the ability to which the test article's control algorithm can be tuned on orbit.

VALIDATION OF THE ANALYTICAL FRAMEWORK

Three different control algorithms will be implemented on orbit based upon three different models of the test article. The first model is the model of the test article with gravity and suspension effects. Control algorithms based upon this model identify the types of gravity effects which are important and at what level of control authority they become important. The second type of model uses the one-gravity model with gravity terms set to zero. Control algorithms based upon this model identify the ability to predict on-orbit behavior. The third type of model is one that is based upon on-orbit identification of the test article dynamics. Control algorithms based upon this model reveal the ability to tune the test article on orbit.

VALIDATION OF THE ANALYTICAL FRAMEWORK

- Ground testing will include suspension and gravity effects, typical of preflight qualification testing.
- Realistic goal is to improve pointing/scanning performance by 40 dB over open-loop value.

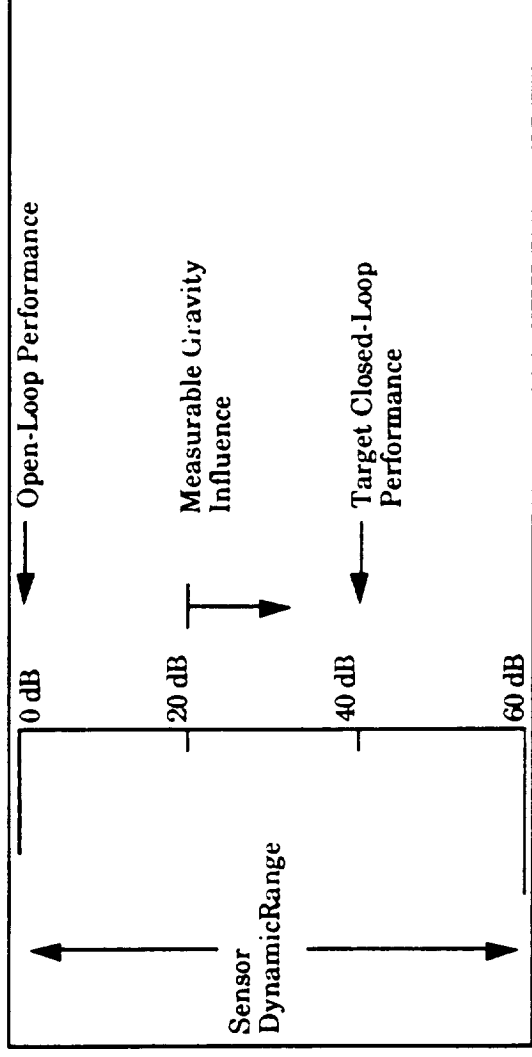

- Independent of absolute performance level, this demonstrates CST effectiveness.
- Sensor dynamic range of 60 dB is typical.

SUMMARY

Viewgraph is self-explanatory.

SUMMARY

- The MODE family of flight experiments is designed to verify analytical tools developed to predict the gravity dependent behavior of proposed space structures.
- The MODE family of flight experiments uses reusable dynamic and control tests facilities and exploits the unique environment on the STS middeck.
- MACE investigates gravity dependent phenomena pertinent to the closed-loop dynamics of proposed space structures.
 - By comparing performance as a function of control authority between ground and on-orbit testing, perturbations in the dynamics due to the change from 1 to 0-g will be identified.
 - By noting the level of control authority where these performance deviations occur, either analytical predictive capabilities or on-orbit identification procedures can be refined.



M.I.T. SPACE ENGINEERING RESEARCH CENTER

Semi-Annual Report: August 1990

Prof. Edward F. Crawley, Director

Dr. David W. Miller, Research Associate

December 1990

SERC # 17-90-R

(Under the Sponsorship of NASA)

