

1993017223

N93-26412
p. 3-1

csc

Lunar Regolith and Structure Mechanics

Stein Sture

Third Annual Symposium
November 21 & 22, 1991

A NASA Space Engineering Research Center at the University of Colorado

LUNAR REGOLITH AND STRUCTURE MECHANICS

Frank Barnes
Hon-Yim Ko
Stein Sture

Tyrone R. Carter
Kraig A. Evenson
Mark P. Nathan
Steve W. Perkins

- MODELING OF REGOLITH-STRUCTURE INTERACTION IN
EXTRATERRESTRIAL CONSTRUCTED FACILITIES
- DENSIFICATION OF LUNAR SOIL SIMULANT
- VIBRATION-ASSISTED PENETRATION OF LUNAR SOIL
SIMULANT

MINERALOGY AND PHYSICAL PROPERTIES OF LUNAR REGOLITH AND MLS ARE VERY CLOSE

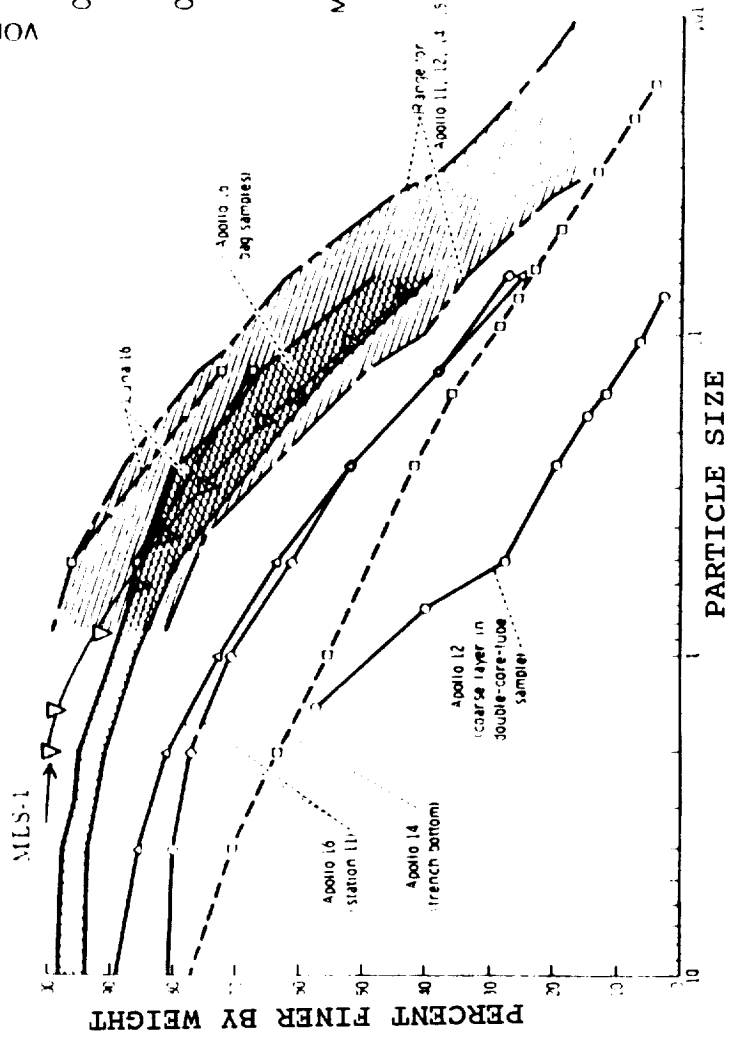

Grain Size Distribution Curves for Apollo Samples and Recombined MLS-1

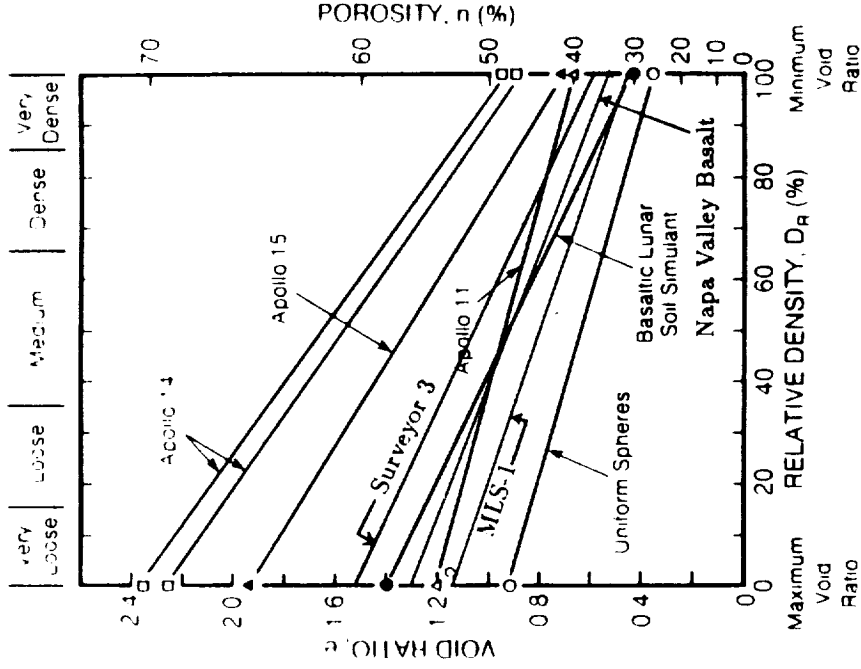

Maximum and Minimum Void Ratio for Lunar Soil and Simulants

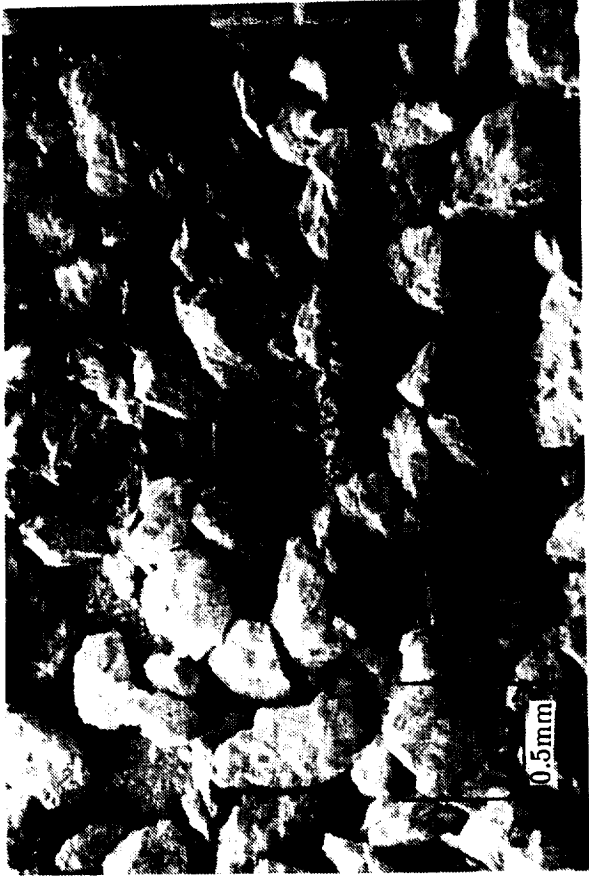

REGOLITH

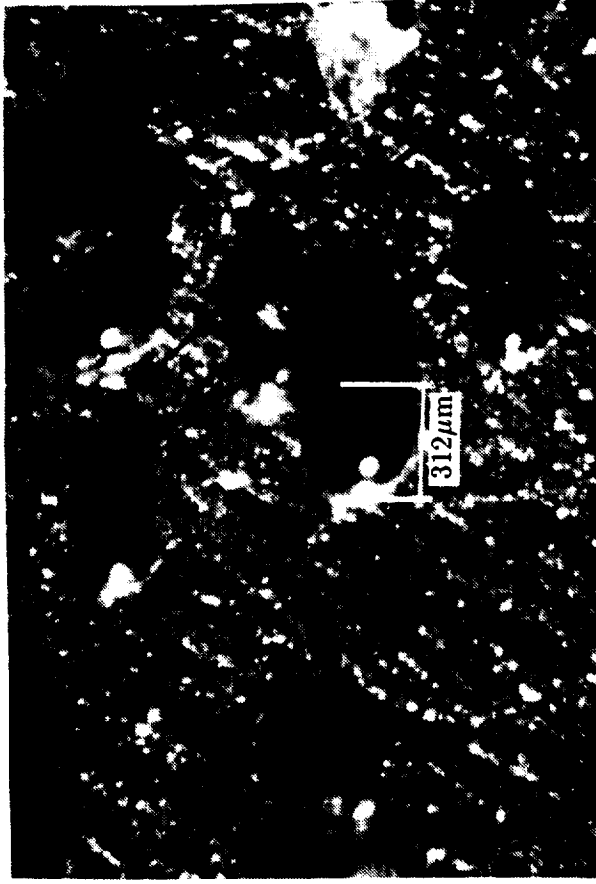

SPHERULES

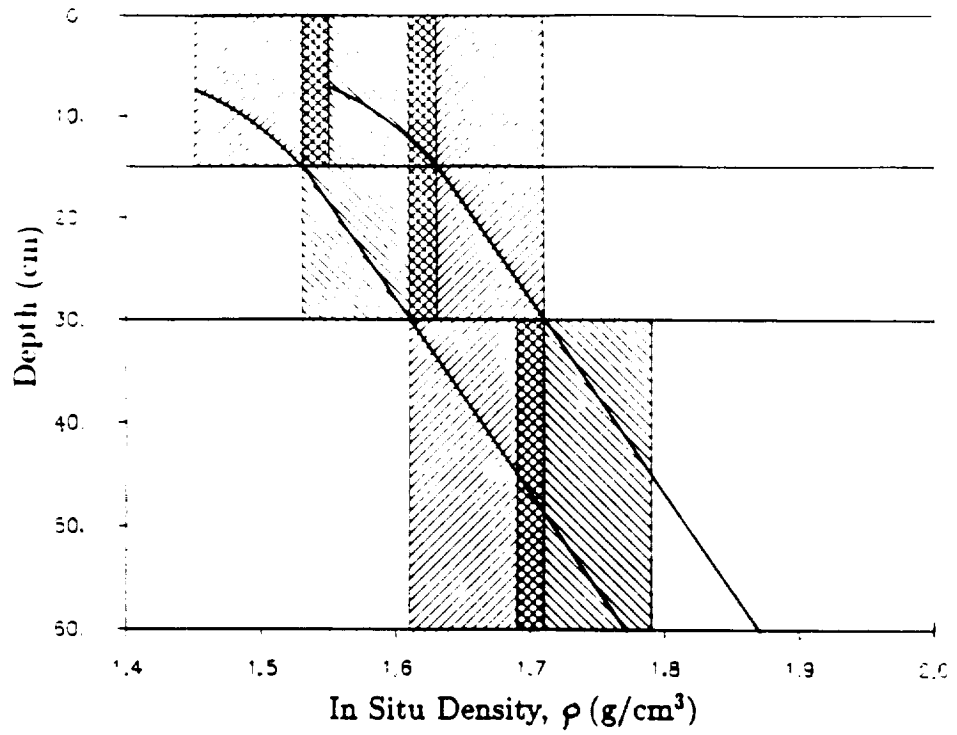

Best Estimates of Lunar Soil In Situ Density Versus Depth (data after Carrier, 1990)

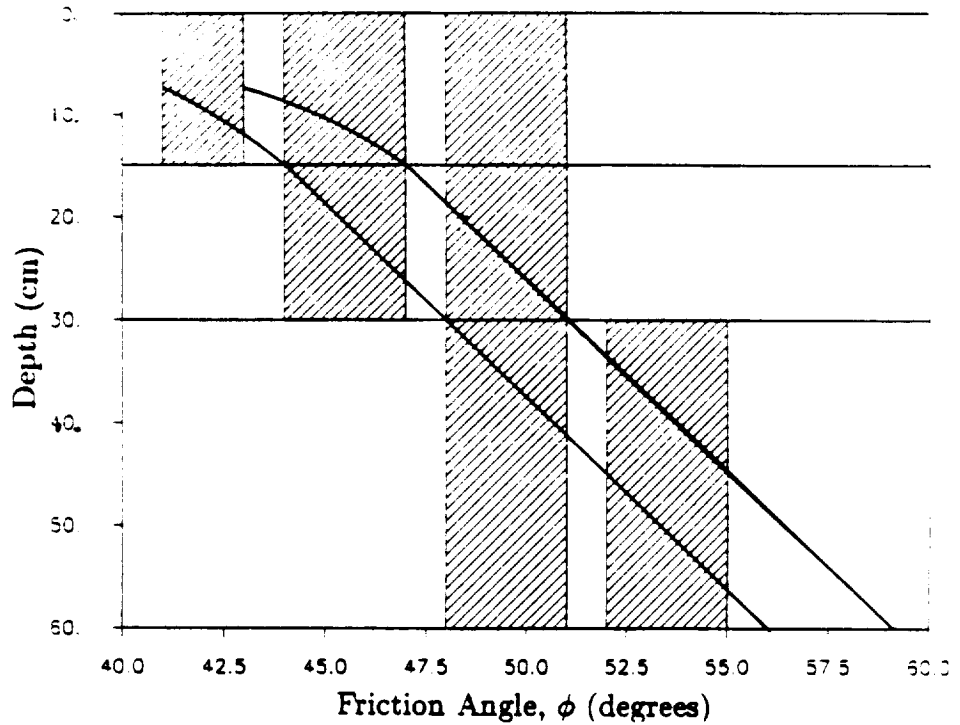

Best Estimates of Lunar Soil Friction Angle Versus Depth (data after Carrier, 1990)

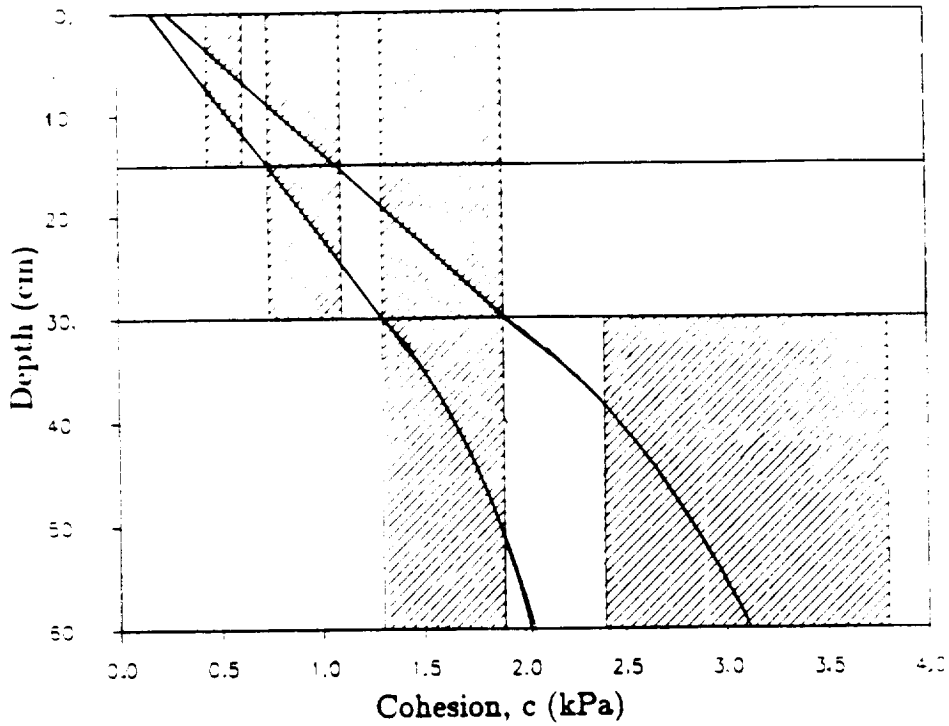

Best Estimates of Lunar Soil Cohesion Versus Depth (data after Carrier, 1990)

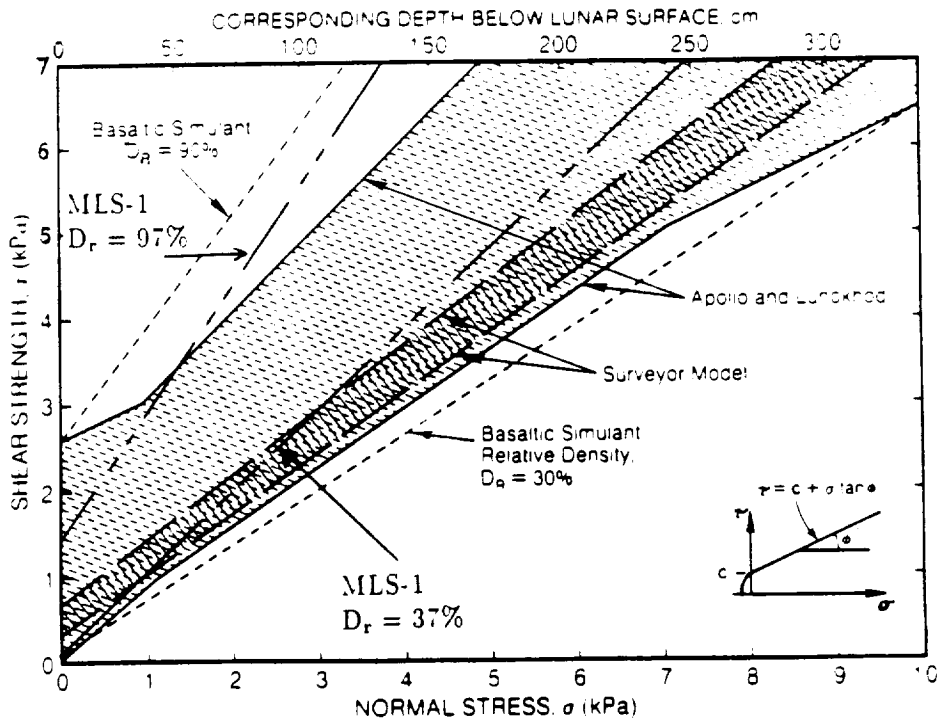

Mohr-Coulomb Peak Strength Envelopes for Lunar Regolith and MLS-1 (after Carrier et al., 1991)

MECHANICAL PROPERTIES OF A SIMULATED LUNAR SOIL

TRIAxIAL COMPRESSION EXPERIMENTS (MLS)

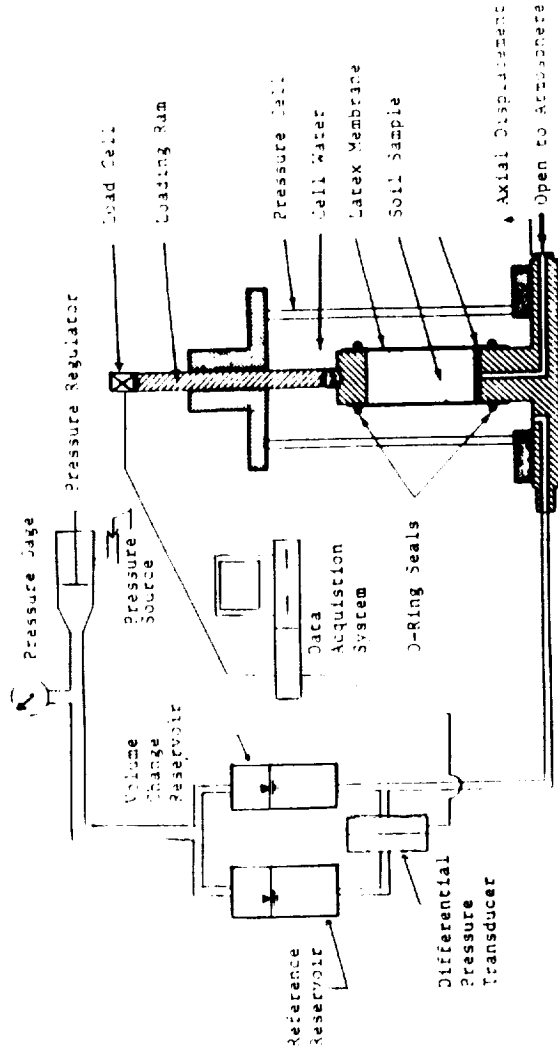

Schematic Diagram of the Triaxial Testing System

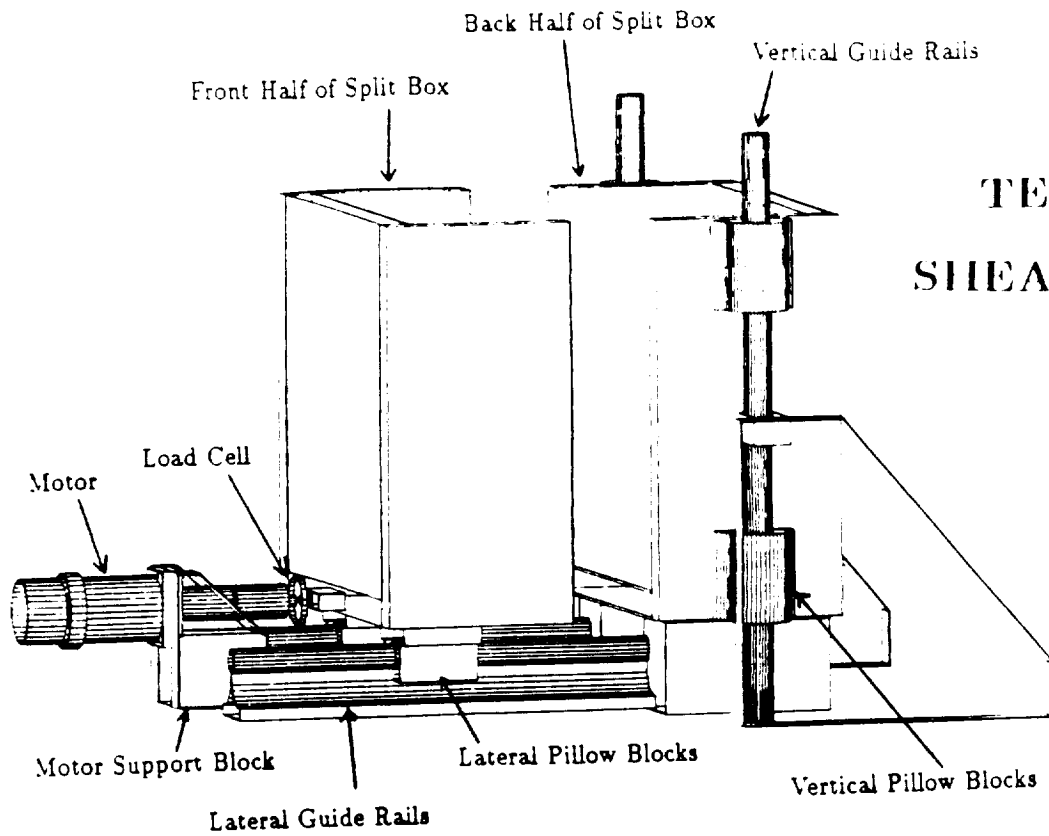

TENSION-SHEAR DEVICE

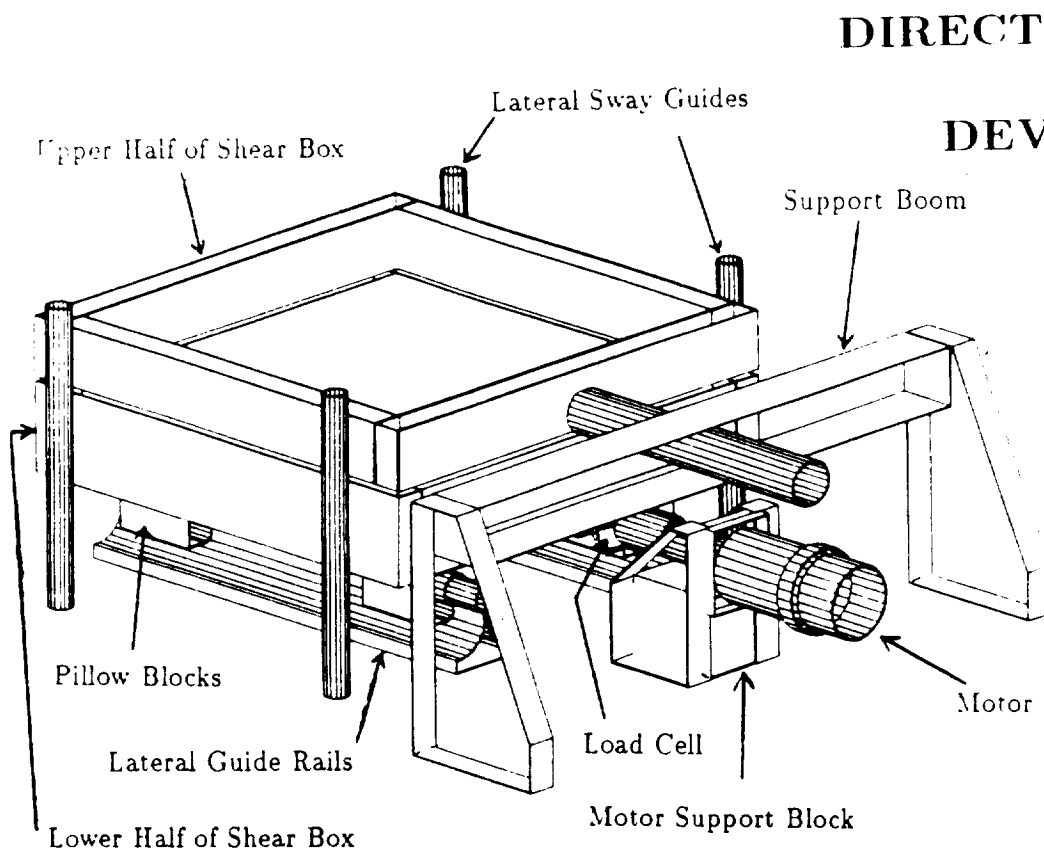

DIRECT SHEAR DEVICE

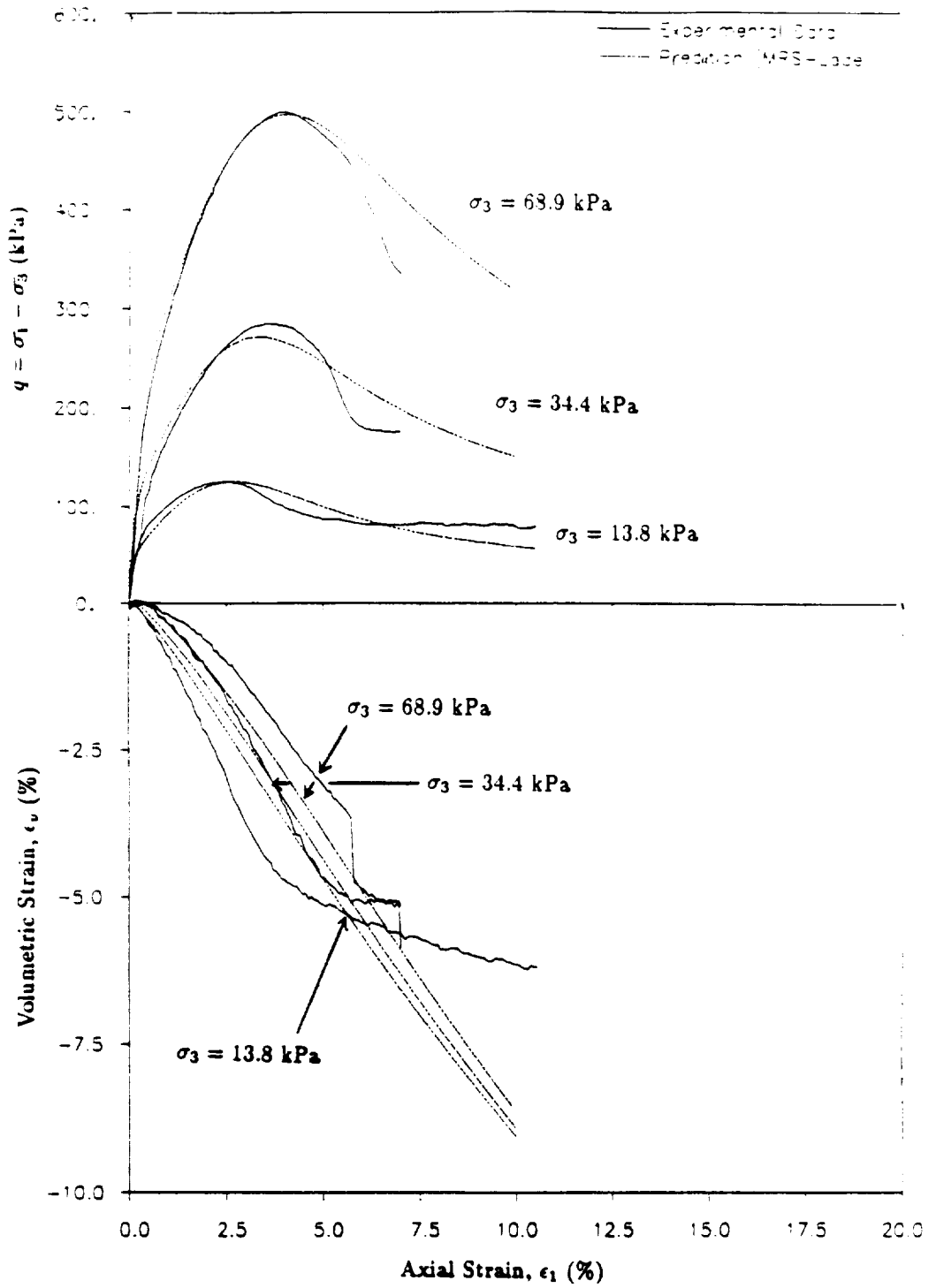

CTC Experimental Results and Predictions For "High" Confining Stress Levels (Dense)

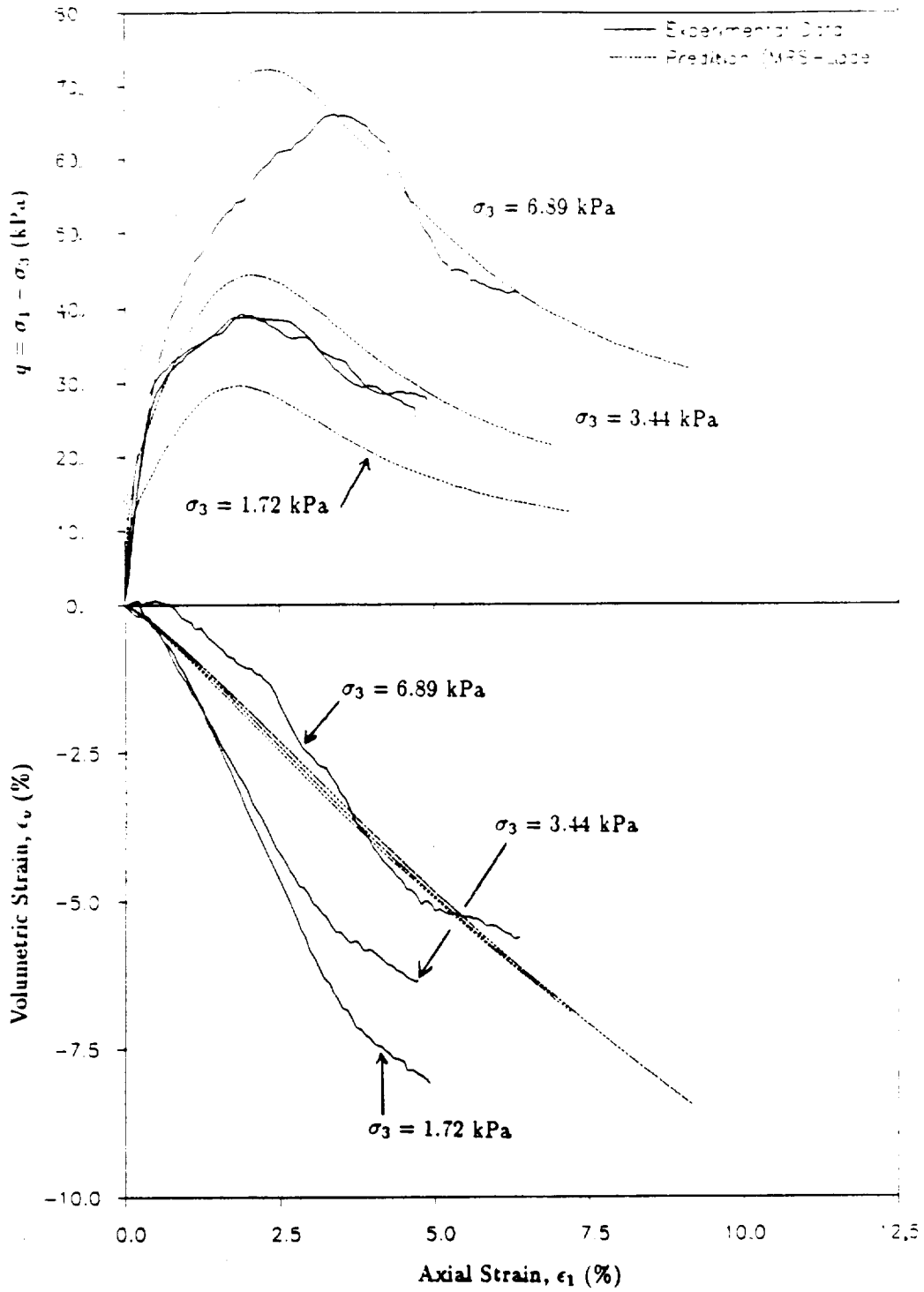

CTC Experimental Results and Predictions For "low" Confining Stress Levels (Dense)

ORIGINAL PAGE IS OF POOR QUALITY

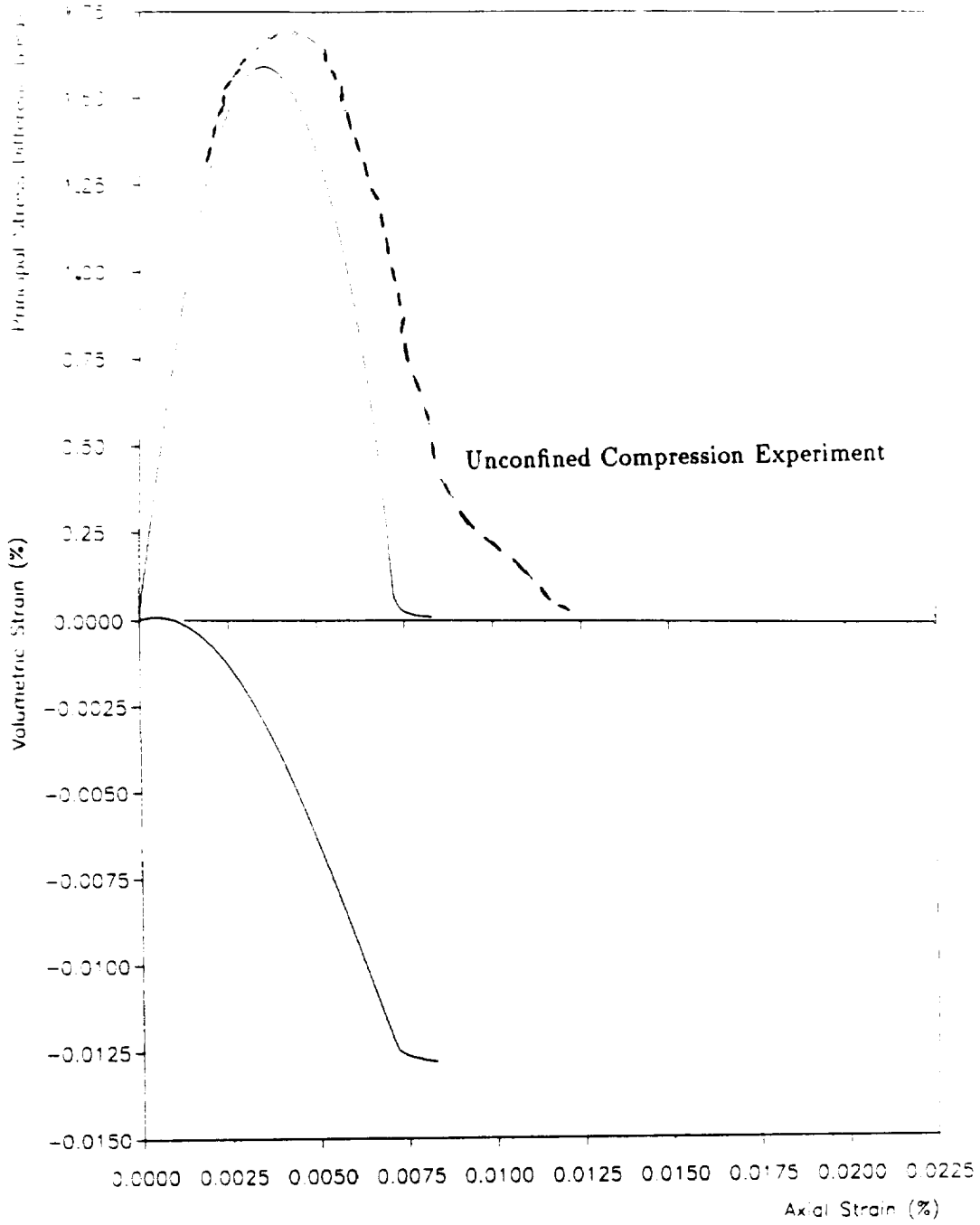

MRS-Lade Prediction for Unconfined Compression Test From Calibration at Ultra-Low Stress Levels

CSC

TENSILE STRENGTH EXPERIMENT

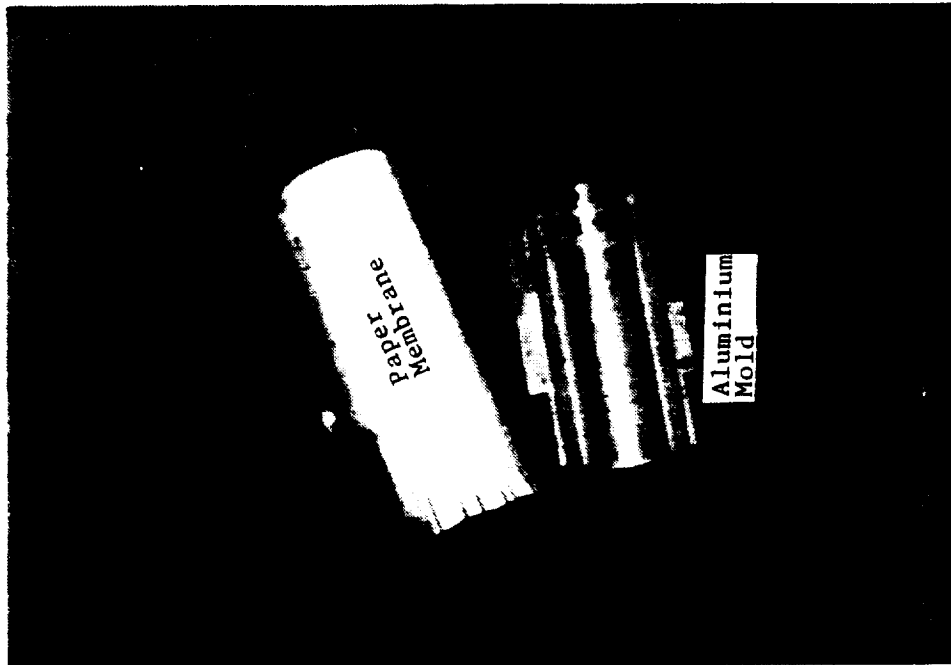
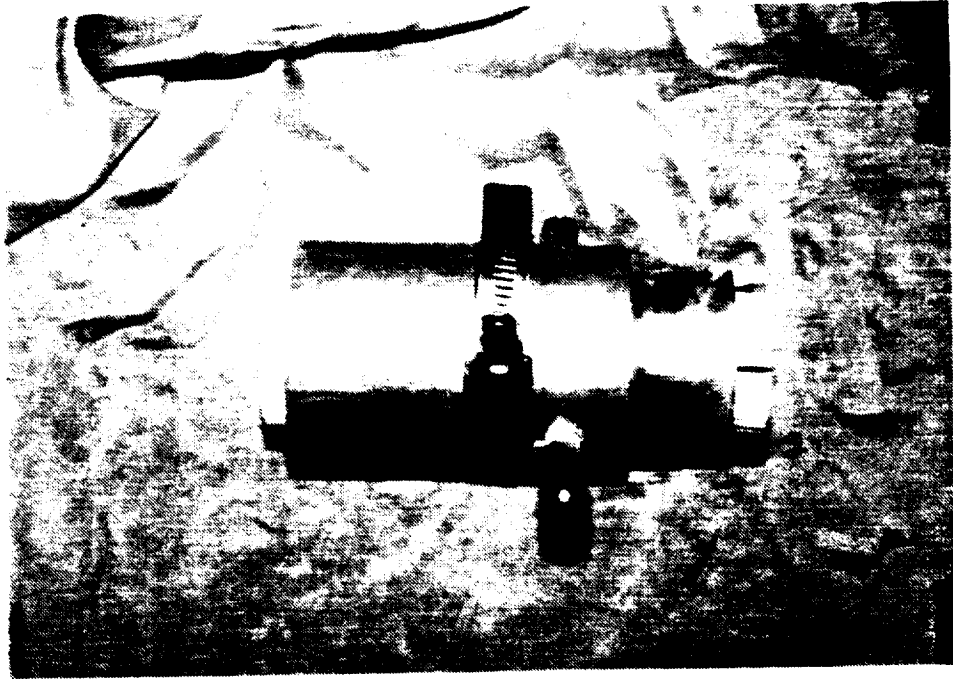

ORIGINAL PAGE
BLACK AND WHITE PHOTOGRAPH

CSC

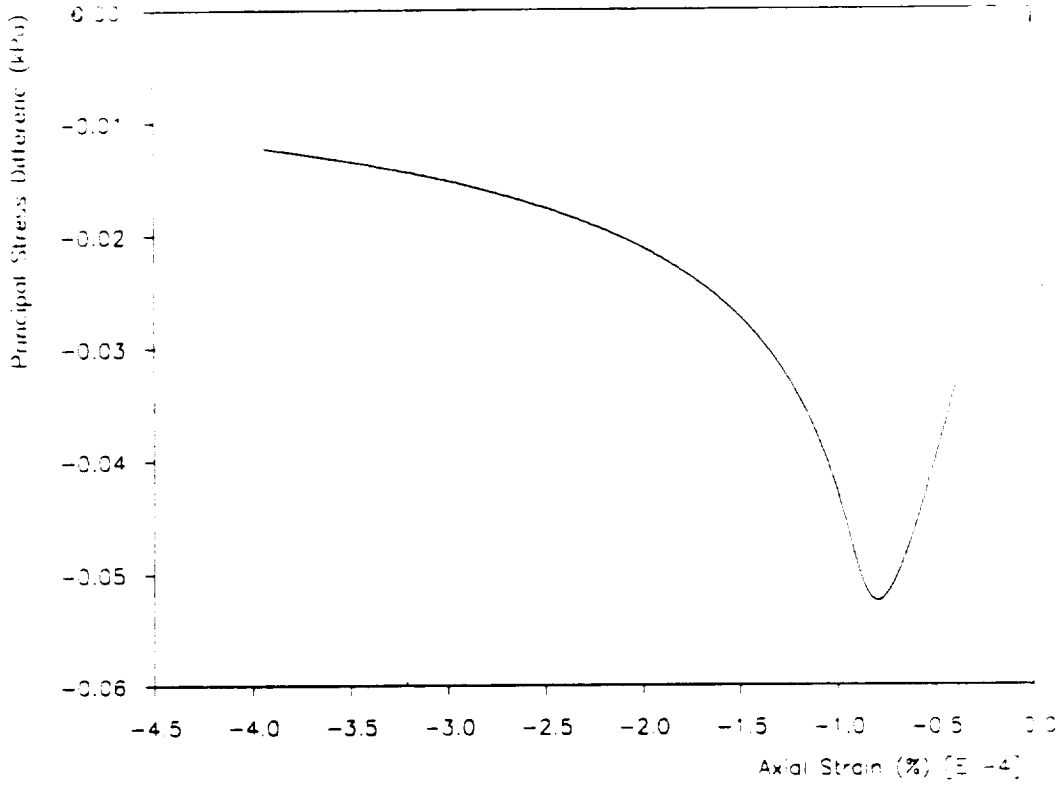

MRS-Lade Prediction for Unconfined Tension From Calibration at Ultra-Low Stress Levels

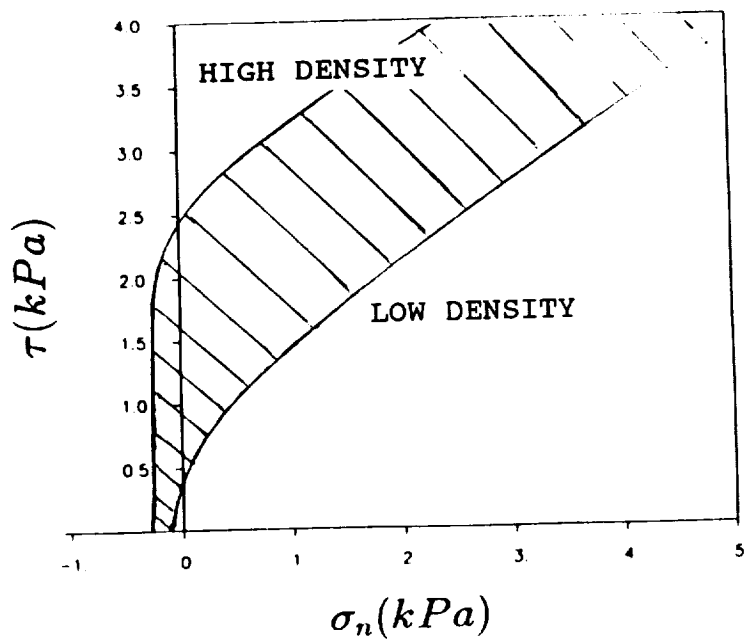

ULTIMATE STRENGTH ENVELOPE FOR MLS-1

TYPICAL RANGES OF ENGINEERING PROPERTIES FOR DRY TERRESTRIAL COHESIONLESS SOILS AND LUNAR REGOLITH (REAL AND SIMULATED)

	Terrestrial Soils	Lunar Regolith and M.L.S
• ADVANTAGES		
– Increased Strength	30-38	44-56
– Increased Stiffness	0	0.05-4.50
– Subsurface Homogeneity	2.7	3.1
• DISADVANTAGES		
– Electrostatic Attraction To All Non-Geologic Matter	1.4-1.9	1.8-2.2
– Difficult To Excavate	14-19	2.9-3.6
	8-45	27-1810
	0.5-15	1-10 ⁴

CENTRIFUGE MODELING OF REGOLITH-STRUCTURE INTERACTION

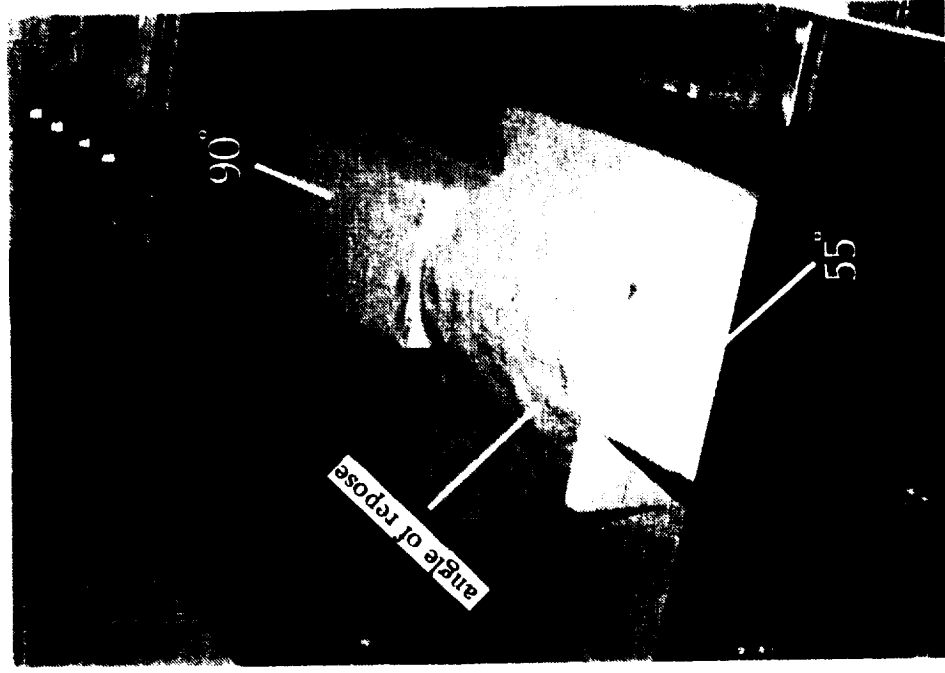
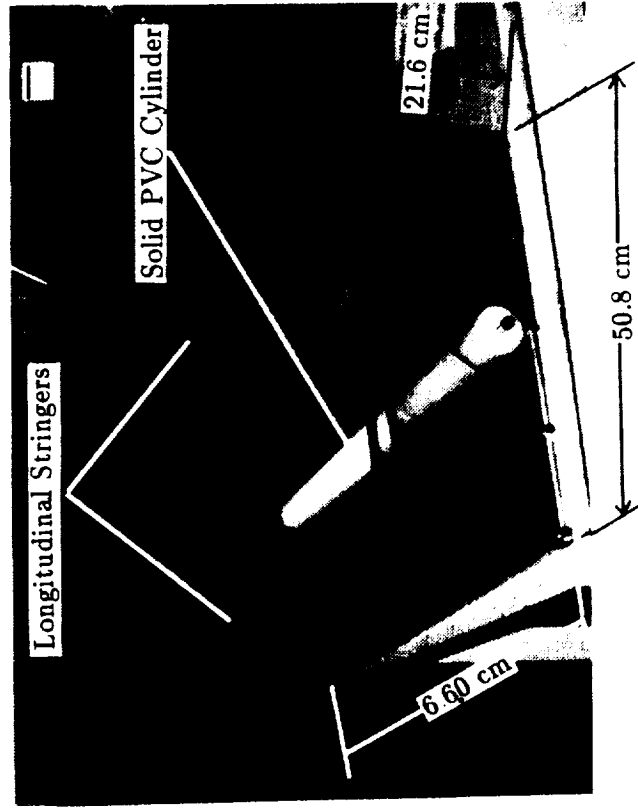

MODEL

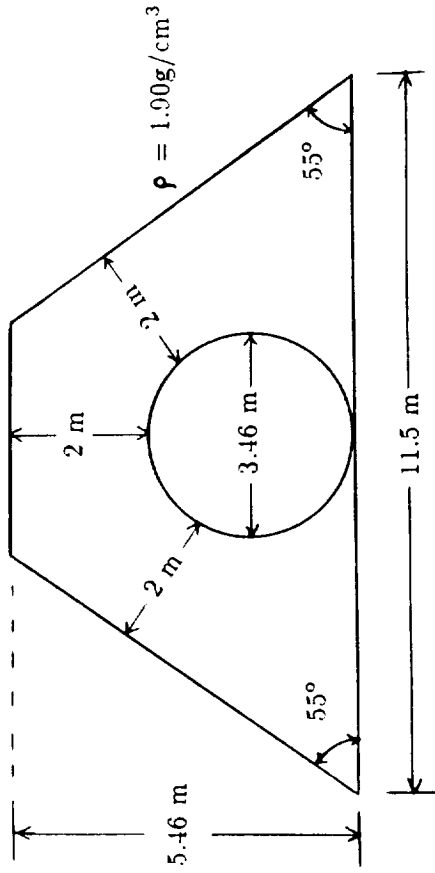

SLOPE ANGLE	VOLUME [m ³]
30°	1,245
55°	705
90°	690

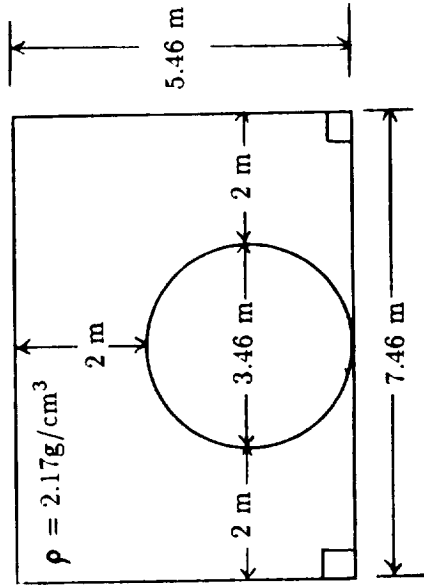

Lunar Prototype II.II.M. Dimensions

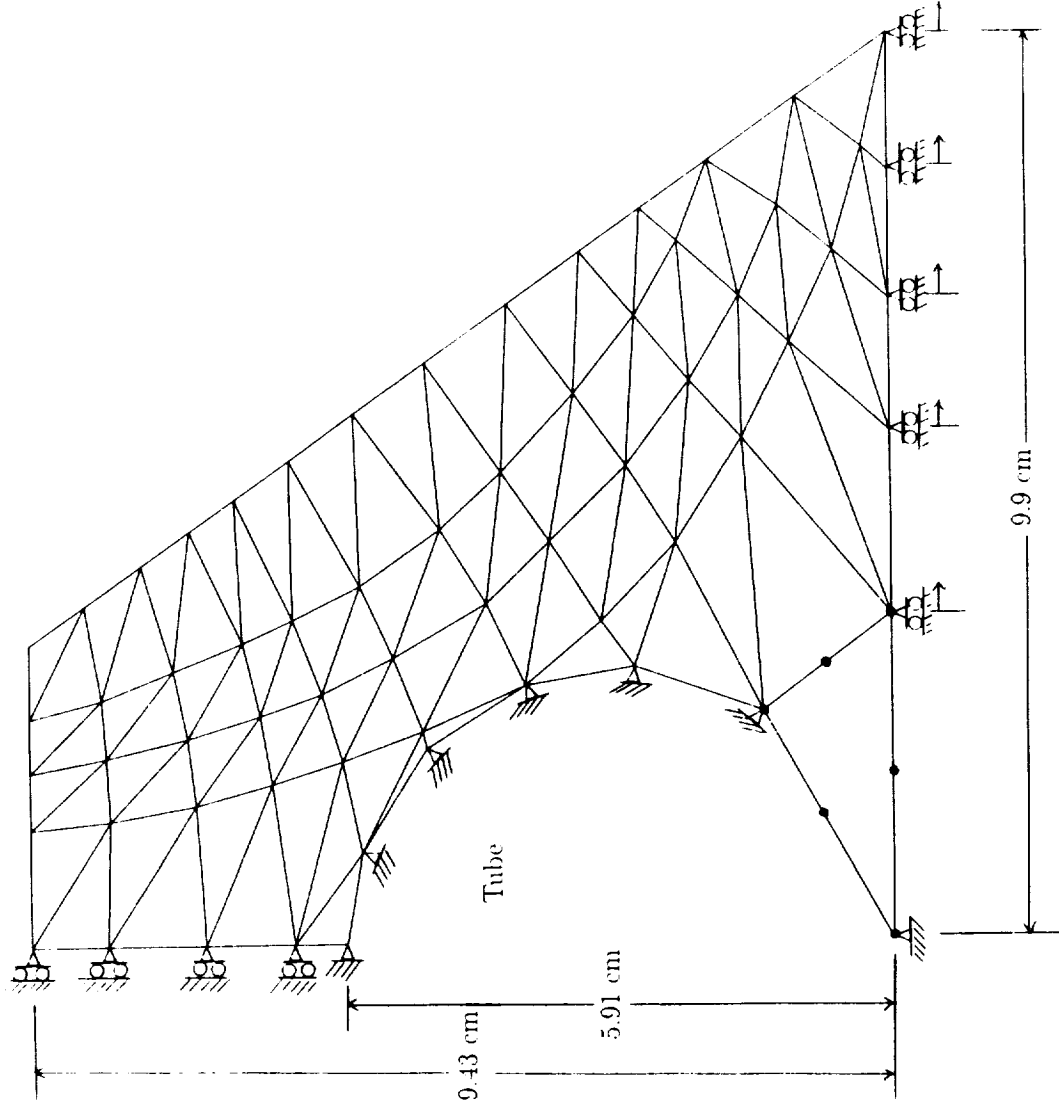

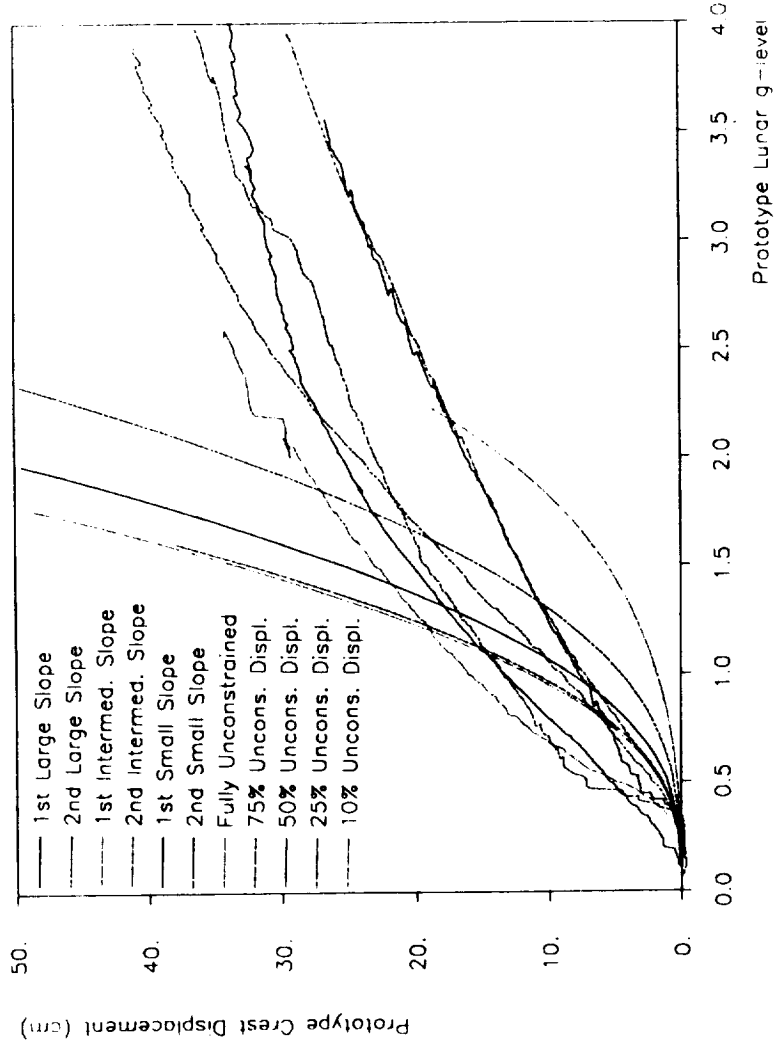

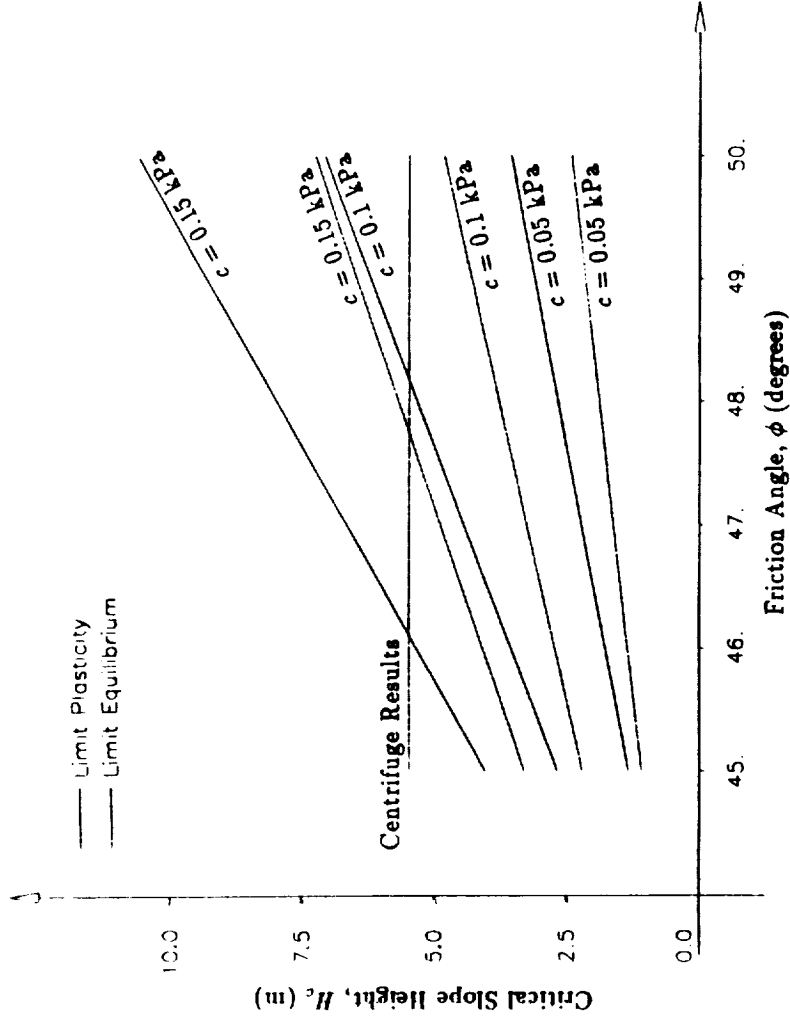

Comparison of Conventional Slope Stability Solutions To Centrifuge model

DENSITY OF LUNAR REGOLITH

LAMINAR CONTAINER TO SIMULATE FREE FIELD MOTION

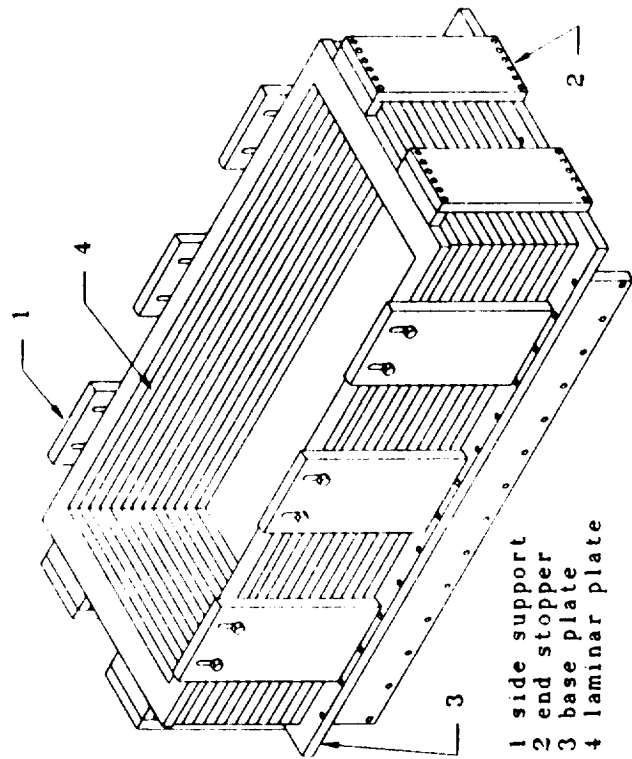

BEFORE SHAKING

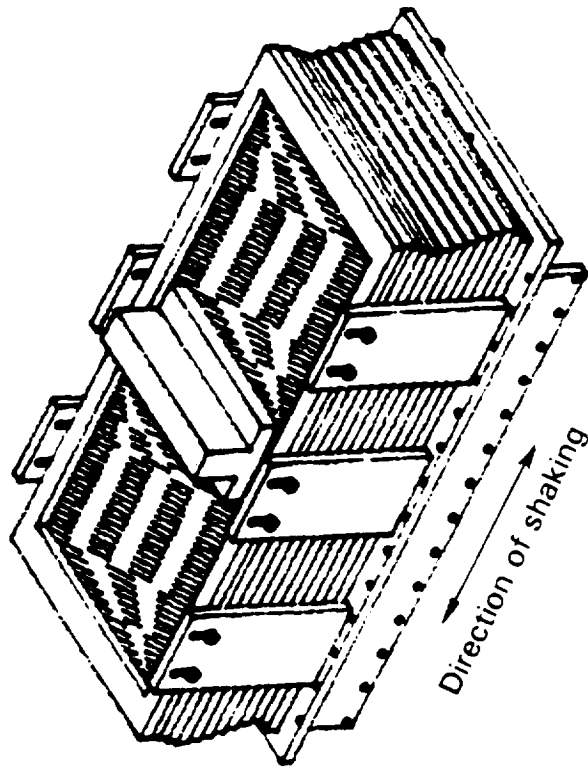

DURING SHAKING

PHYSICAL PROPERTIES OF LUNAR REGOLITH

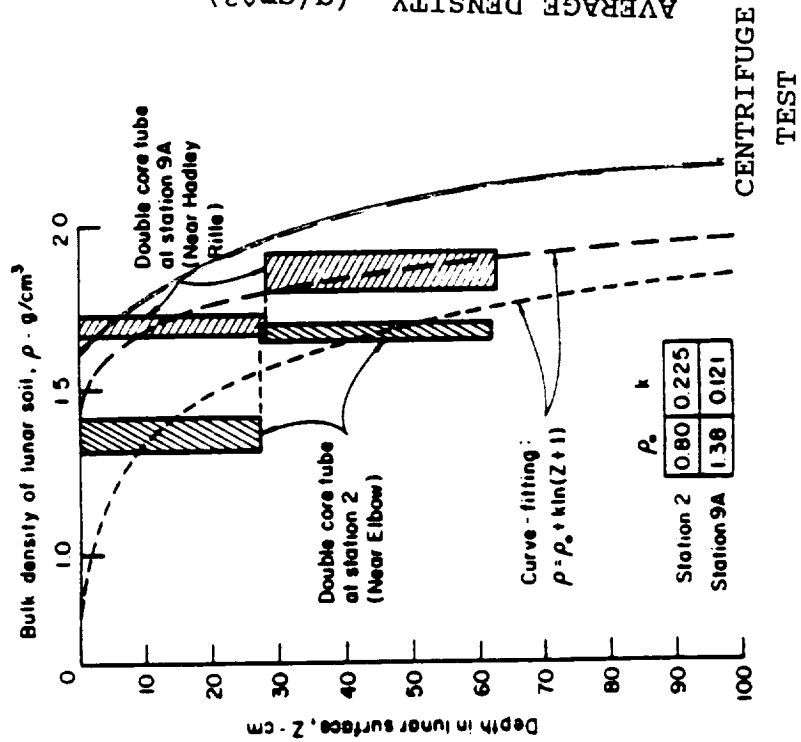

APOLLO 15 CORE TUBE SITES

(Mitchell et al., Proc. 3rd Lunar Sci. Conf., 1972)

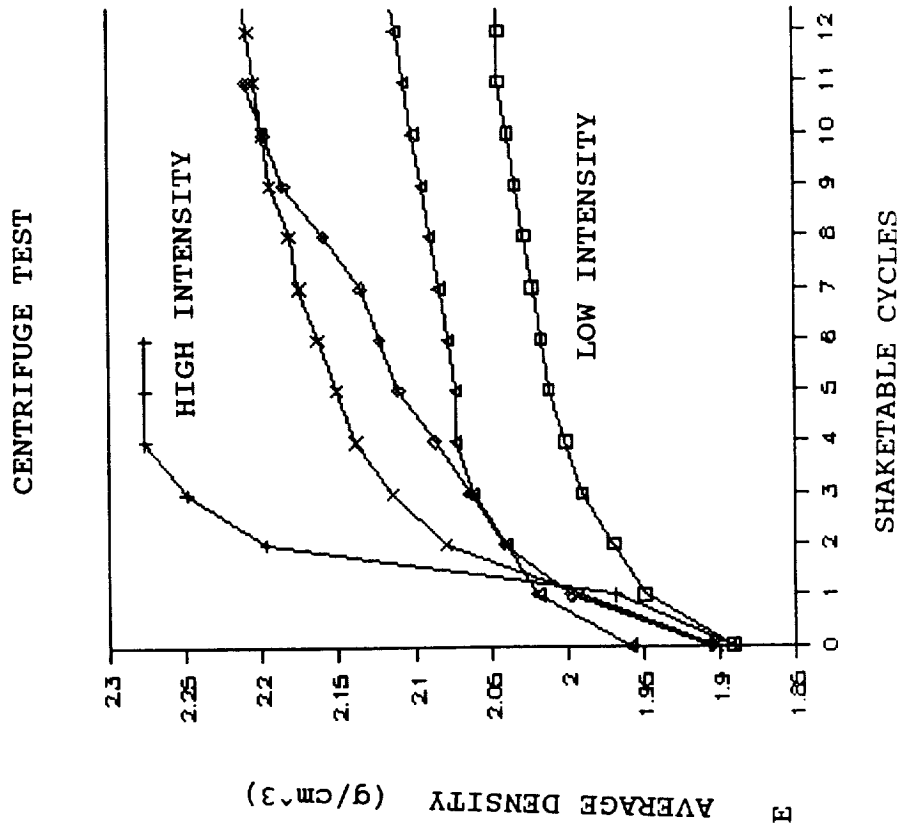

(5 TESTS AT DIFFERENT INTENSITIES)

LUNAR CRANE CAN PROVIDE EXCAVATING CAPABILITY USING A VIBRATING EXCAVATOR

(After Martin Mikulas)

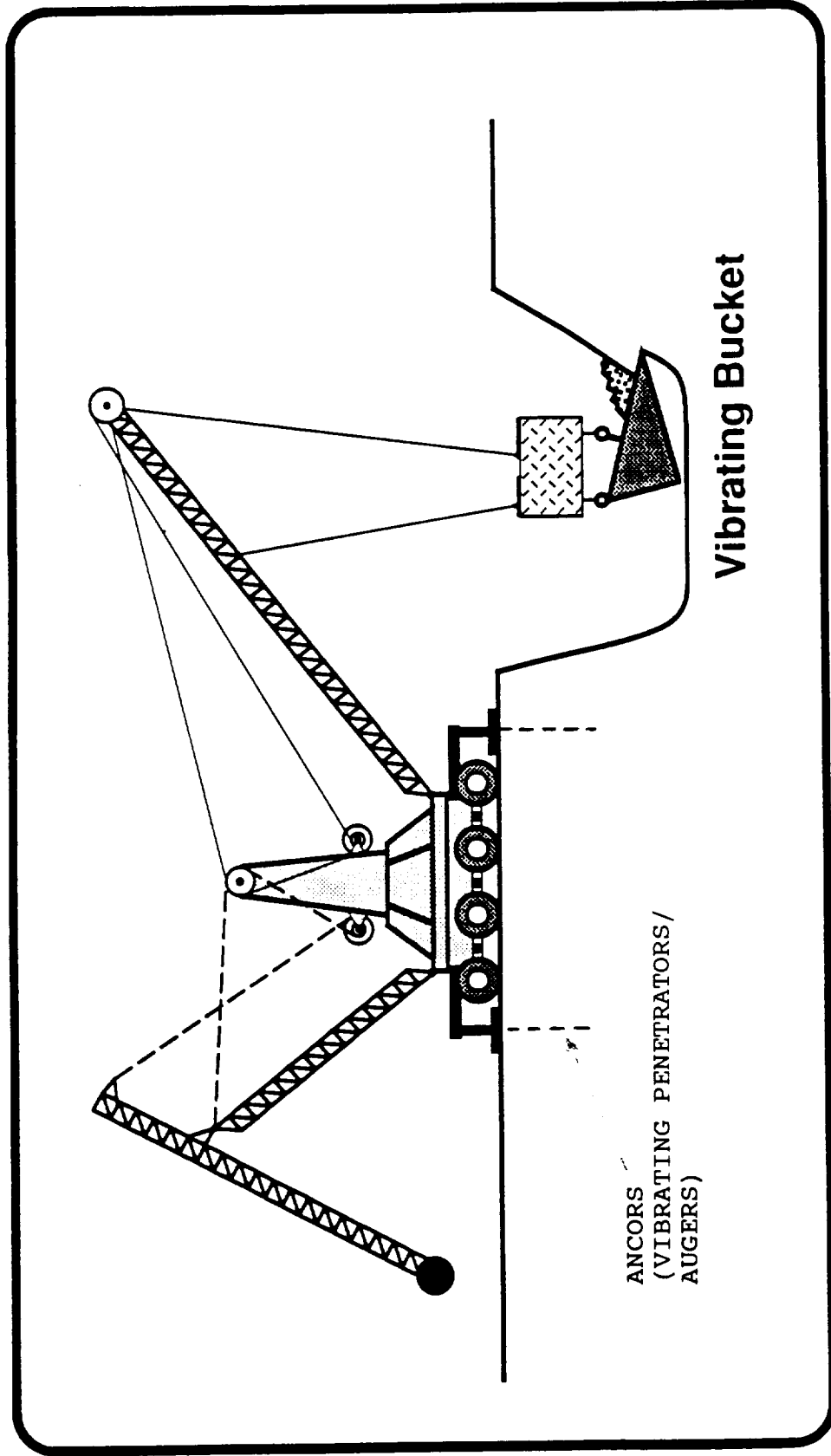

CENTRIFUGE MODELING OF PENETRATOR PERFORMANCE

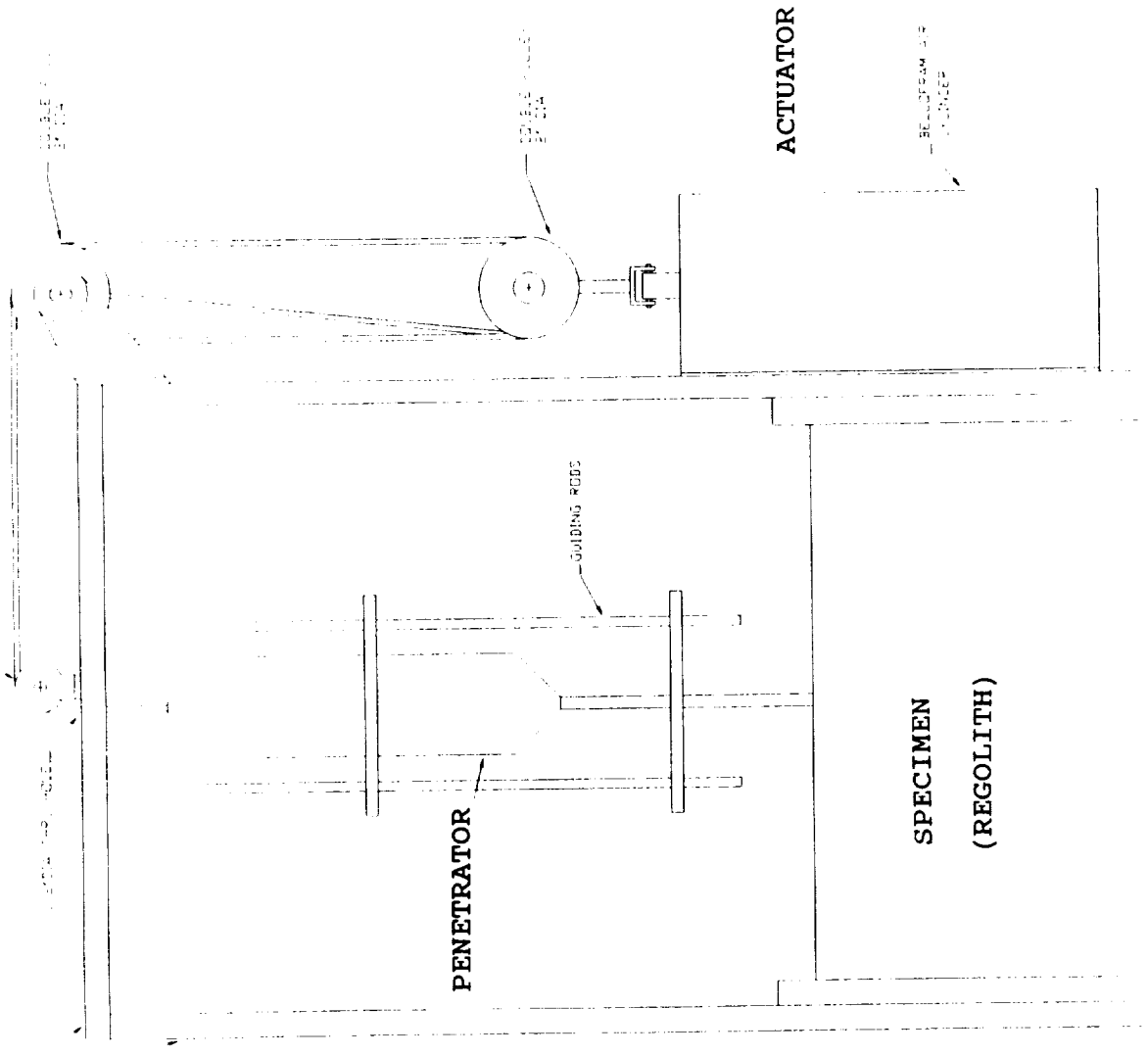

Static Vs. Vibration Assisted Penetration

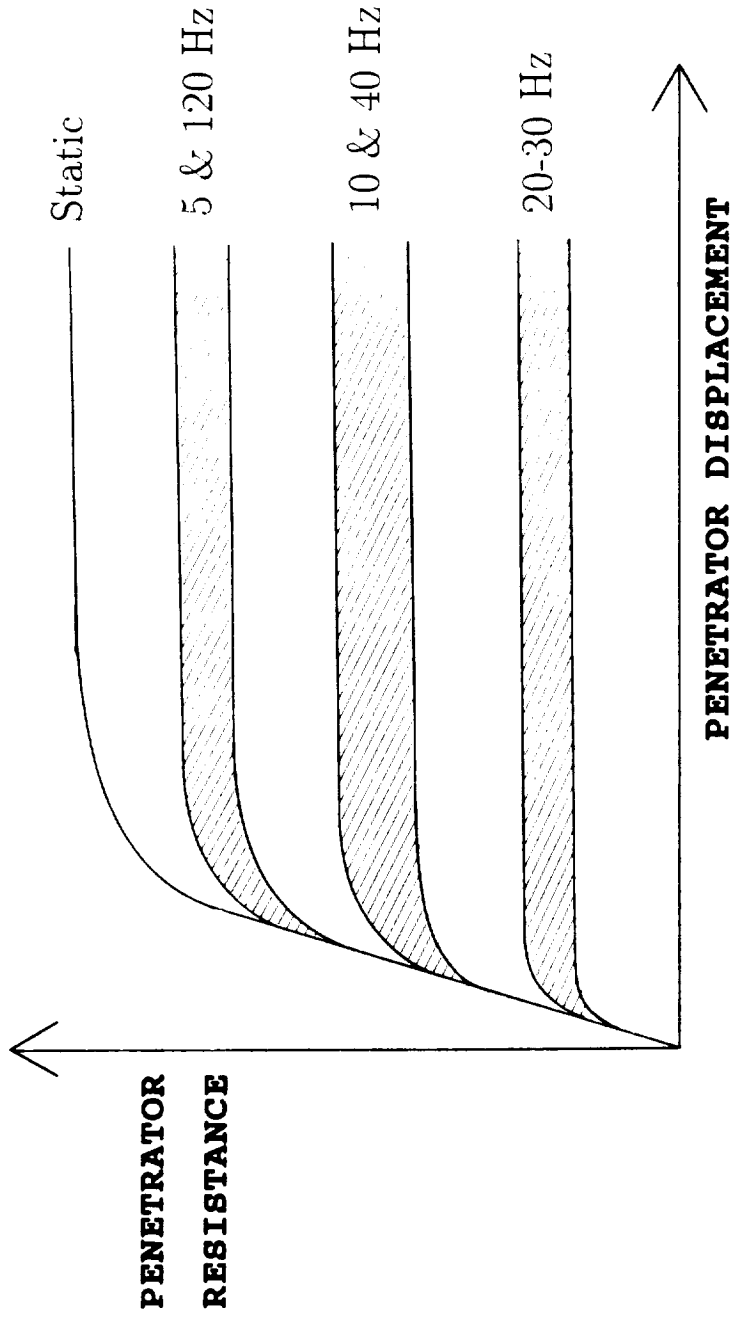

Average Depth - 6" Steel Tip Rod

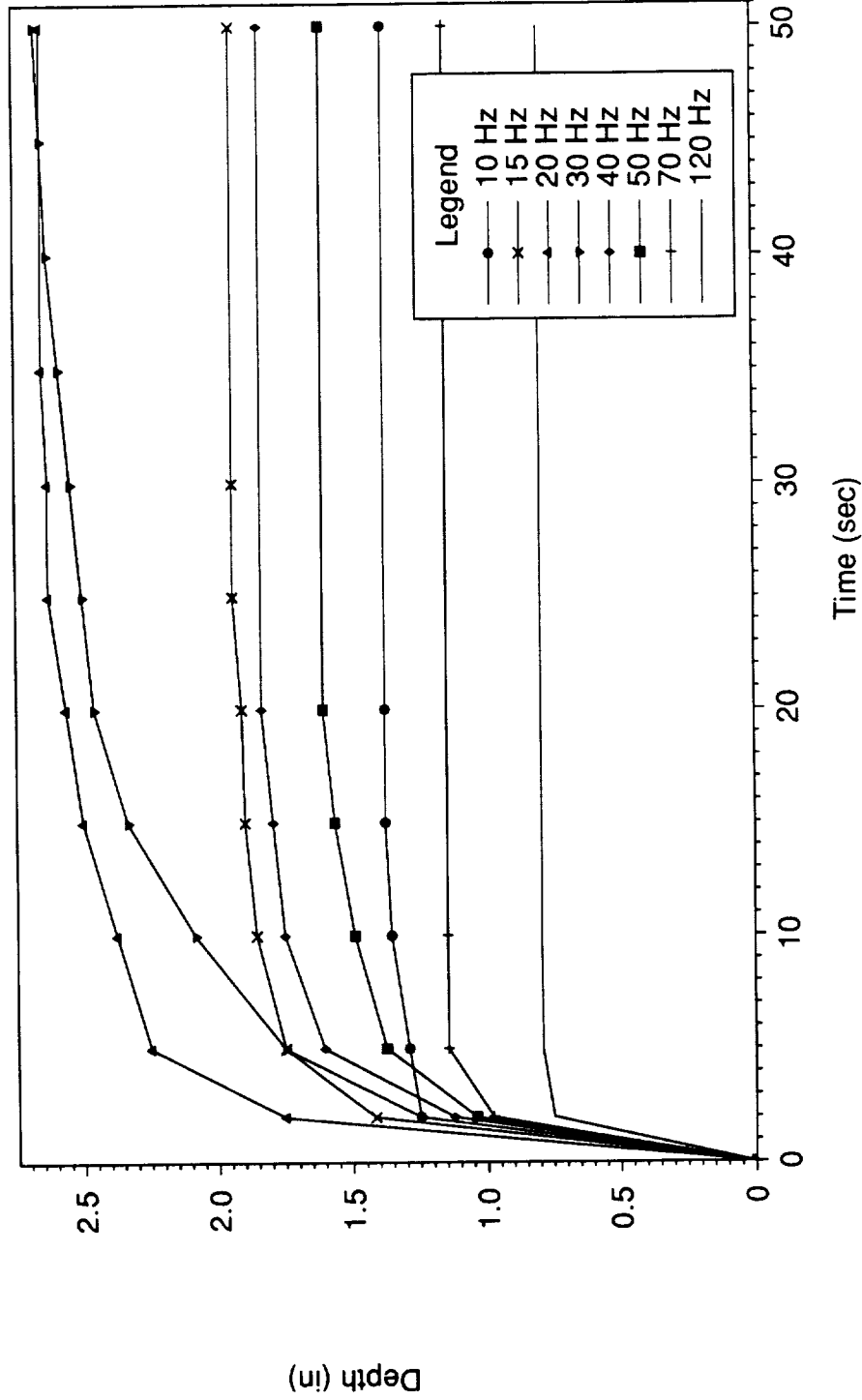

Average Depth - 9" Steel Tip Rod

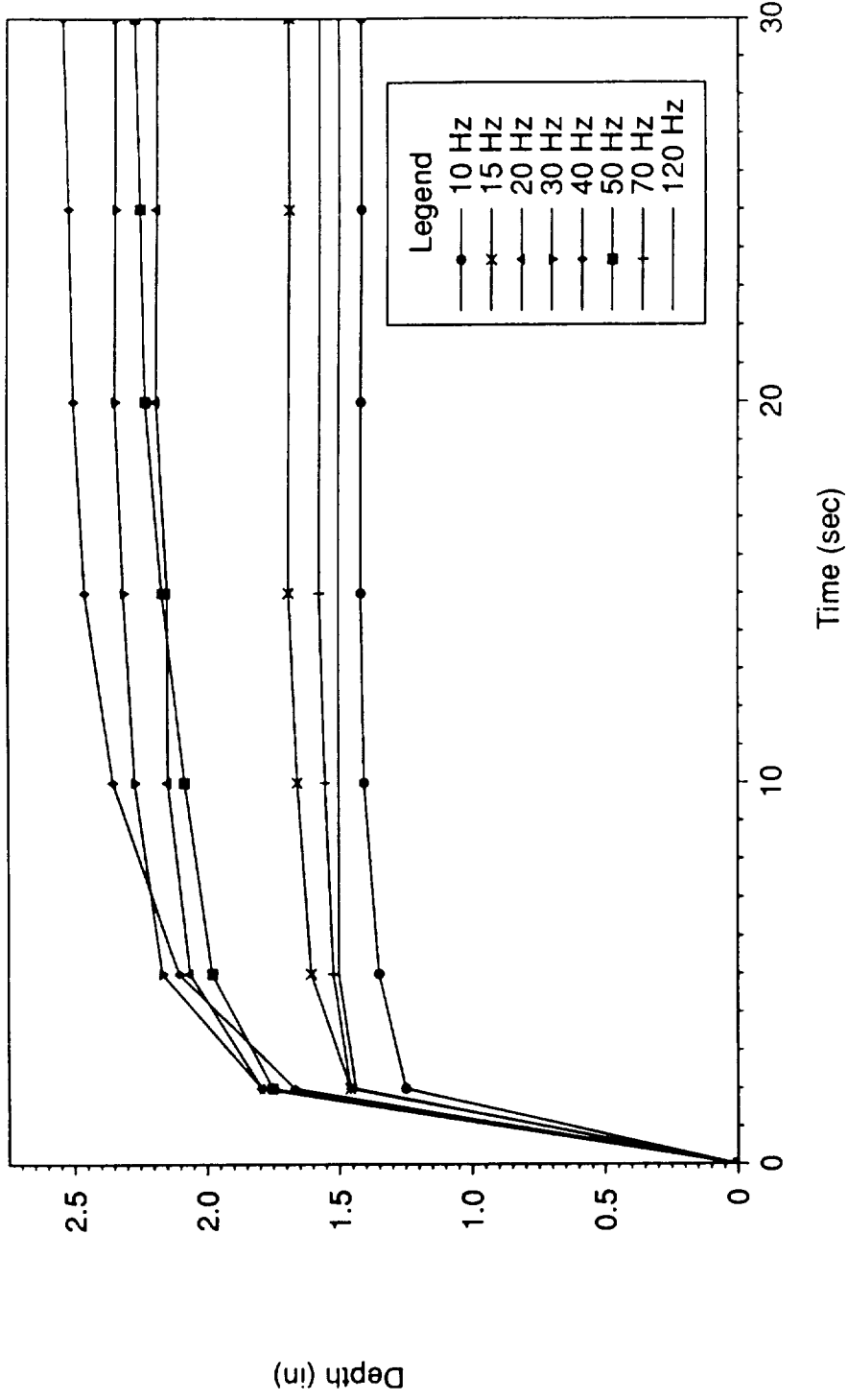

RESPONSE OF 6 IN. STEEL PENETRATOR

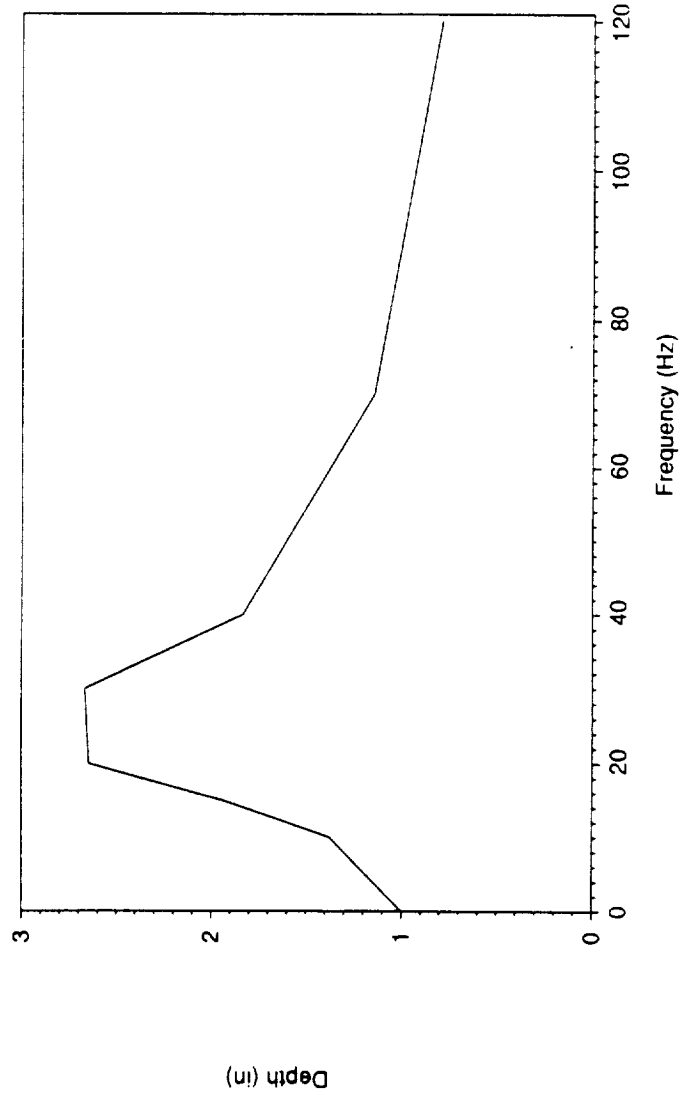

RESPONSE OF 9 IN. STEEL PENETRATOR

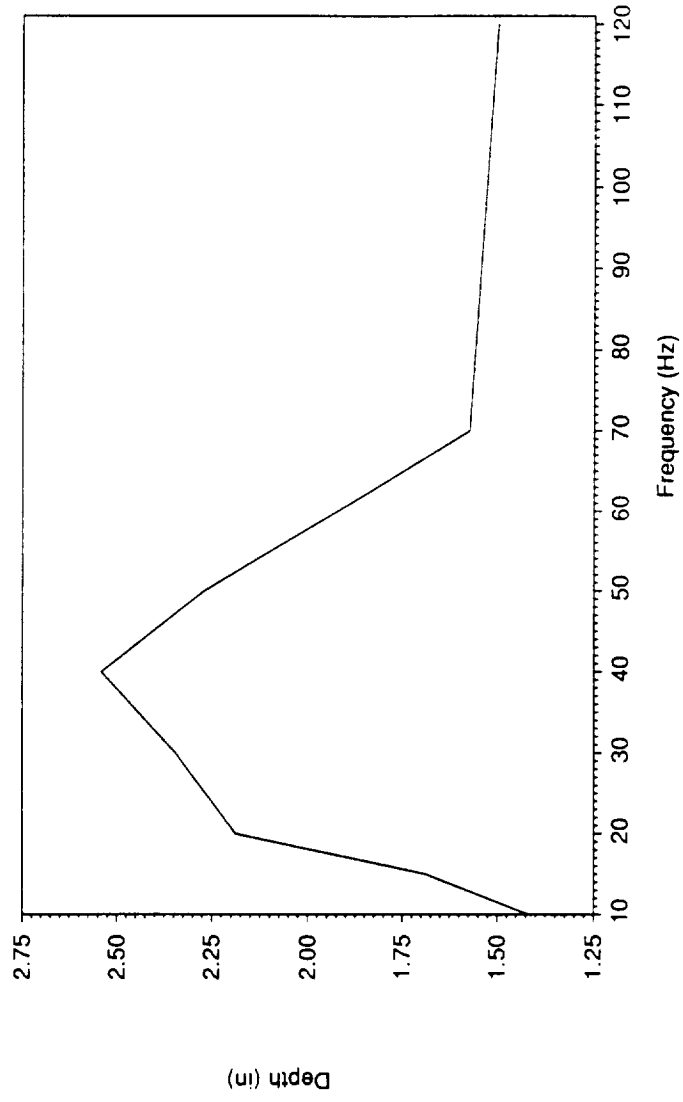

Power Input - 6" Steel Tip Rod

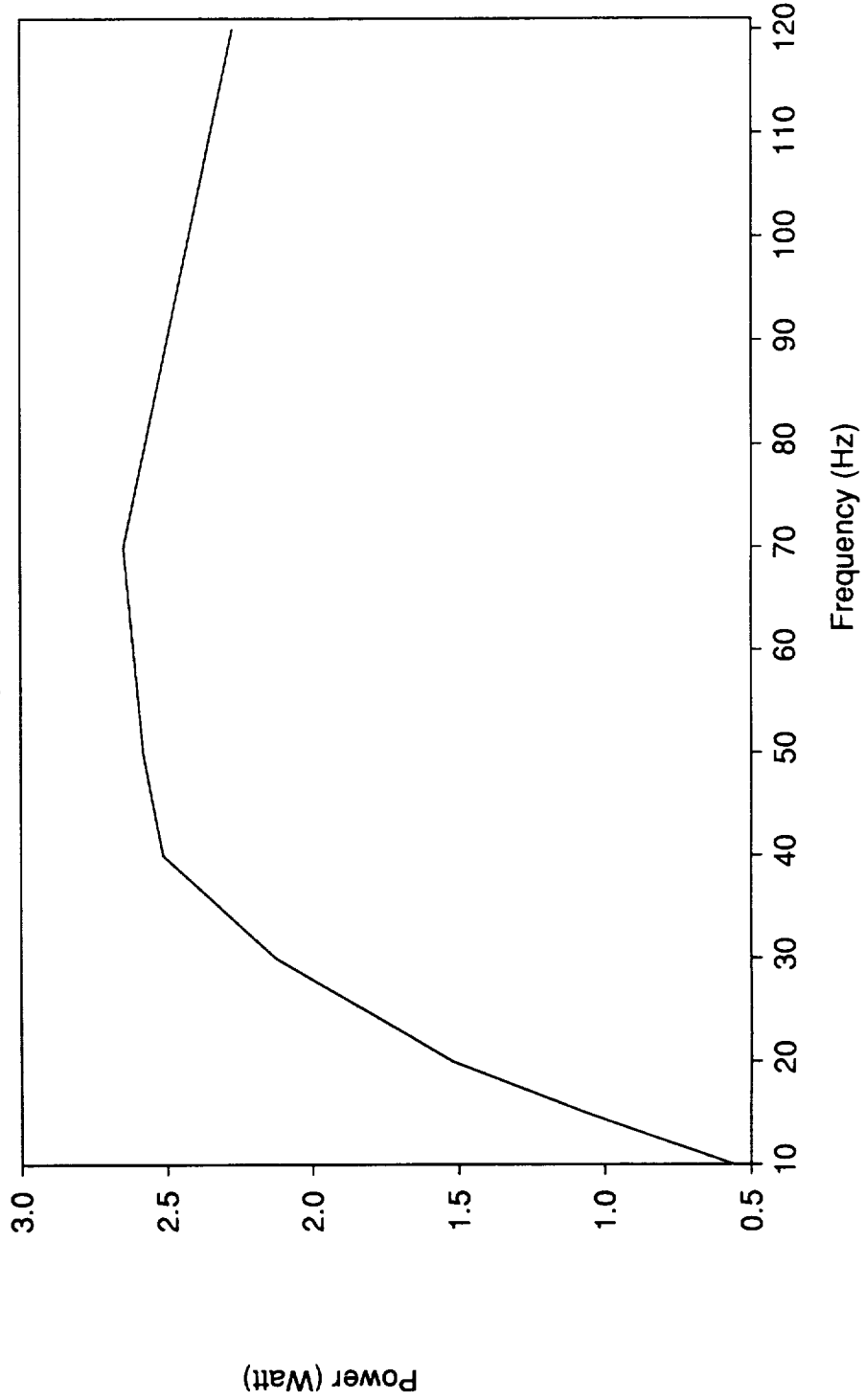

PENETRATION VS TIME

Testbeds One & Two

