

NASA-CR-192881

NASA for
SPACE utilization
ENGINEERING of local
RESEARCH planetary
CENTER resources

1630



(NASA-CR-192881) PROCEEDINGS OF
THE LUNAR MATERIALS TECHNOLOGY
SYMPOSIUM (Arizona Univ.) 363 p

N93-27956
--THRU--
N93-27988
Unclas

G3/91 0158314

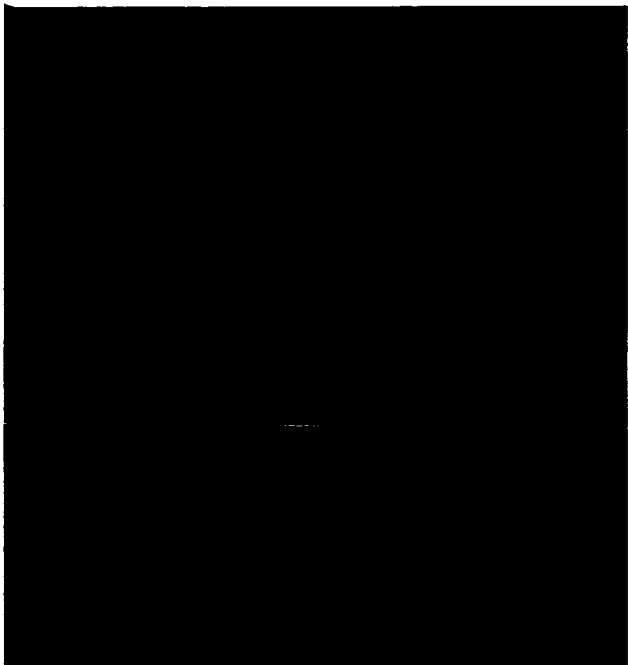

**The Third Annual Symposium of the University of Arizona/NASA
Space Engineering Research Center**
for Utilization of Local Planetary Resources

and the

**First Annual Symposium of the Indigenous Space Materials Utilization
Advisory Panel**

**LUNAR
MATERIALS TECHNOLOGY
SYMPOSIUM**

Proceedings

**February 20-22, 1992
Hotel Park Tucson
5151 E. Grant Road
Tucson, Arizona**

CONTENTS

	Page
Introduction	i - <i>21211 0111</i>
Resource Characterization	
The Challenges and Benefits of Lunar Exploration <i>Aaron Cohen</i>	I-1-1
Return to the Moon: Lunar Robotic Science Missions <i>Lawrence A. Taylor</i>	I-7-2
Characterization of Lunar Surface Materials For Use in Construction <i>Stewart W. Johnson and Jack O. Burns</i>	I-17-3
An Engineer/Constructor's View of Lunar Resource Development <i>Carleton H. Jones</i>	I-23-4
Energy Management	
Energy for Lunar Resource Exploitation <i>Peter E. Glaser</i>	II-1-5
Advanced Photovoltaic Power Systems Using Tandem GaAs/GaSb Concentrator Modules <i>L.M. Fraas, M.S. Kuryla, D.A. Pietila, V.S. Sundaram, P.E. Gruenbaum, J.E. Avery, V. Dinh, R. Ballantyne, and C. Samuel</i>	II-9-6
An Evolution Strategy for Lunar Nuclear Surface Power <i>Lee S. Mason</i>	II-22-7
Earth to Space Power Beaming: A New NASA Technology Initiative <i>John D.G. Rather</i>	II-36-8
Fuel Cell Technology for Lunar Surface Operations <i>Henry J. DeRonck</i>	II-37-9
Electrical Power Integration for Lunar Operations <i>Gordon Woodcock</i>	II-41-10
Materials Processing	
Oxygen Production on the Lunar Materials Processing Frontier <i>Barbara H. Altenberg</i>	III-1-11
Magnetic Beneficiation of Lunar Soils <i>R.R. Oder, J. Graf, L.A. Taylor, and D.S. McKay</i>	III-15-12
Propellant Production and Useful Materials: Hardware Data From Components and the System <i>Kumar Ramohalli</i>	III-24-13
Metals Production <i>Theodore R. Beck</i>	III-41-14

Materials Processing (cont.)

- Glasses, Ceramics, and Composites From Lunar Materials
George H. Beall III-54-15
- Lunar Materials Processing System Integration
Brent Sherwood III-67-16
- The On-site Manufacture of Propellant Oxygen from Lunar Resources
Sanders D. Rosenberg III-80-17

Environment Control

- Options for a Lunar Base Surface Architecture
Barney B. Roberts IV-1-18
- Engineering Design Constraints of the Lunar Surface Environment
D.A. Morrison IV-16-19
- Closed Ecological Systems: From Test Tubes to Earth's Biosphere
Robert J. Frye and George Mignon IV-18-20
- SPE Water Electrolyzers in Support of the Lunar Outpost
J.F. McElroy IV-37-21
- Assessment of the State of the Art in Life Support Environmental Control For SEI
Charles H. Simonds and Gary P. Noyes IV-57-22
- Dust Protection for Environmental Control and Life Support Systems in the Lunar Environment
Susan Fuhs and Jeffrey Harris IV-71-23

Automation and Communications

- Intelligent Robots for Planetary Exploration and Construction
James S. Albus V-1-24
- Flexible Control Techniques for a Lunar Base
Thomas W. Kraus V-16-25
- The Use of Automation and Robotic Systems to Establish and Maintain Lunar Base Operations
Lyman J. Petrosky V-24-26
- Considerations for Lunar Colony Communications Systems
Richard P. Dowling V-30-27

Poster Presentations

- Regolith Thermal Energy Storage for Lunar Nighttime Power
Brian Tillotson VI-1-28
- Lunar Base Thermal Management/Power System Analysis and Design
Jerry R. McGhee VI-9-29
- Rectenna Thermal Model Development
Murali Kadiramangalam VI-21-30
- Choice of Antenna Geometry for Microwave Power Transmission From Solar Power Satellites
Seth D. Potter VI-34-31

PRIMARY

INTRODUCTION

The Third Annual Symposium of the University of Arizona/NASA Space Engineering Research Center (SERC) was held February 20-22, 1992, in Tucson. Because of common interests in promoting In-Situ Resource Utilization (ISRU) and Indigenous Space Materials Utilization (ISMU), the Symposium was sponsored jointly by the UA/NASA SERC and the Indigenous Space Materials Utilization Advisory Panel, founded by the Lunar and Planetary Institute in October 1990.

The meeting was organized around a possible Lunar Outpost scenario, featuring industrial technologies, systems, and components applicable to the extraction, processing, and fabrication of local materials. Structuring the Symposium in this novel way grew out of discussions between the UA/NASA SERC and the ISMU Advisory Panel. Detailed planning by a subcommittee that included members from both groups resulted in a specific description of an initial Lunar Outpost (reproduced below) in all its aspects, including crew, structural, power, transportation, and supply requirements. Industrial technologies applicable to the processing of local resources were to be stressed.

From this organizational structure grew a most unusual list of participants. In addition to acknowledged space resources experts, the Symposium brought together investigators from outside the field whose knowledge could be applied to space development activities. Presentations came from a variety of specialists in fields such as minerals processing, environmental control, and communications.

The three days were divided into sessions devoted to five major topics; their titles are indicative of the diversity this Symposium offered. The first day opened with a session on *Resource Characterization* that included presentations delivered by experts from NASA Headquarters, Southern Methodist University, the Lunar and Planetary Institute, Bechtel Inc., BDM International, and the Institute for Space Science and Technology. Dr. S. Fred Singer, Distinguished Research Professor with the Institute for Space Science and Technology, delivered a luncheon address on "Project SPACE (Solar Power and Climate Equalizer): SPS Used for Global Climate Modification." The second session of the opening day focused on *Energy Management*; featured were presentations by representatives from Arthur D. Little, Boeing, International Fuel Cells Corp., NASA Headquarters, and NASA Lewis.

The morning session of day two was entitled *Materials Processing*, which brought together specialists from Rockwell International, Bechtel National, EXPORTech Inc., Corning, Electrochemical Tech, Boeing, and UA/NASA SERC. Dr. William L. Smith of NASA Headquarters delivered the luncheon address, "Precursor Missions to Mars." The afternoon session, *Environment Control*, included presentations by experts from Lockheed, NASA Johnson, the Environmental Research Laboratory, Hamilton Standard, and Allied Signal Aerospace. Dr. Louis Friedman, the Executive Director of the Planetary Society, spoke on "International Prospects for Planetary Exploration" at the evening banquet.

Day three opened with a session entitled *Automation and Communications*. Papers were delivered by experts from the National Institute of Standards and Technology, Intec Controls, Westinghouse Electric, Creativision Consulting, and GCI. A *Recommendations* session followed. The distinguished Enabling Technologies Panel consisted of Hubert P. Davis of Davis Aerospace; Benton Clark of Martin Marietta; Murray Hirschbein from NASA Headquarters; Daniel J. Lancaster of Fluor Daniel; John S. Lewis, UA/NASA SERC Co-director for Science; and Gordon Woodcock of Boeing. The luncheon address, "Lunar Materials for the Space Economy" by Dr. James R. Arnold of the

University of California, San Diego, concluded the Symposium. Throughout the three days, *Poster Presentations* from Boeing, Aerojet Propulsion Division, New York University, UA/NASA SERC were available to Symposium participants.

The Third Annual Symposium was clearly successful in achieving its aim. The somewhat unconventional list of experts who spoke provided a refreshing diversity of approaches to some old problems, as well as a variety of new ideas. The format of the Symposium served to introduce specialists representing a wide spectrum of industrial expertise to space resources experts in government and academia. This meeting and others like it may well provide the groundwork for future collaborations to develop extraterrestrial resources. As the recognized meeting place for experts working in the field of space resources development, the UA/NASA SERC will continue to provide opportunities such as this to insure a stimulating and creative exchange of ideas among government, the private sector, and academia.

The following pages contain the papers delivered at the Symposium. Some authors were unable to provide copies of their addresses; in those cases their abstracts have been included in these Proceedings.

-- T. Triffet
Director, UA/NASA SERC

Lunar Outpost Scenario

To focus the presentations it is assumed that: (1) this will be an evolving facility with growing capabilities and needs tended by 5, increasing to 10, astronauts and mission specialists. (2) The initial base will consist of a landing area, a shelter, a solar or nuclear power area, and science and engineering experimental areas. (3) This will require 50 to 100 kw of electrical power; but when permanent occupation begins, probably within two years, a larger habitat and several hundred kilowatts to a megawatt of power will be needed. (4) A utility vehicle that can be used for transporting crew and supplies, as well as for digging, scraping, and lifting, will be available.

(5) The crew will conduct a variety of science and materials utilization experiments. The first of the latter type will include demonstrations of the production of oxygen from soils and rocks, of the extraction and collection of solar wind-implanted gases such as hydrogen, carbon dioxide, and nitrogen, of the fabrication of ceramic bricks, and of the production of various metals and composite materials.

(6) These early basic experiments will be replaced by small pilot plants capable of producing useful amounts of oxygen, volatiles, ceramics, metals, and composites, as well as a few simple products such as bricks of several types, beams, columns, pipes, and membranes.

(7) Oxygen production rates will grow from pilot plant rates of 5-10 tonnes/year to mature plant rates of 25-50 tonnes/year -- enough to fuel a lander to and from lunar orbit. Production of construction materials will grow to rates of hundreds of tonnes/year -- materials that will be used for the construction of shelters, for radiation shielding, for paving landing pads and roads, and erecting blast shields. Eventually local materials will be used to build complete habitats, new power systems, and other essential infrastructure.

Back to the Future

A.I. in Space: Past, Present, and Possible Futures
Donald D. Rose and Jonathan V. Post

VII-1 - 32

Panel Discussion

Summary of Discussions: Enabling Technologies Panel
Hubert P. Davis
Contribution to the Panel Discussion
John S. Lewis

VIII-1

VIII-5

INVITED PRESENTATIONS

THE CHALLENGES AND BENEFITS OF LUNAR EXPLORATION

Aaron Cohen

Director, NASA Johnson Space Center

N 93-27957

158315

P-6

Abstract

Three decades into the Space Age, the United States is experiencing a fundamental shift in space policy with the adoption of a broad national goal to expand human presence and activity beyond Earth orbit and out into the Solar System. These plans mark a turning point in American space exploration, for they entail a shift away from singular forays to a long-term, evolutionary program of exploration and utilization of space. No longer limited to the technical and operational specifics of any one vehicle or any one mission plan, this new approach will involve a fleet of spacecraft and a stable of off-planet research laboratories, industrial facilities, and exploration programs. The challenges inherent in this program are immense, but so too are the benefits. Central to this new space architecture is the concept of using a lunar base for in-situ resource utilization, and for the development of planetary surface exploration systems, applicable to the Moon, Mars, and other planetary bodies in the Solar System. This paper discusses the technical, economic, and political challenges involved in this new approach, and details the latest thinking on the benefits that could come from bold new endeavors on the final frontier.

THE CHALLENGES AND BENEFITS OF LUNAR EXPLORATION

I am pleased to be with you today, and honored to open this first session of what I am sure will be an exciting Lunar Materials Technology Symposium.

I would like to talk with you about the broader issues which will, in the next few years, surround the work that all of you have come to Tucson to discuss. Thanks to your research, we have a very good idea of the kinds of processes, techniques, and industrial applications with which we will begin to utilize the abundant resources of the Moon. We know what is there, we have a fairly sophisticated view of where to look for it, and we are investing time and effort in developing the tools necessary for the job.

We can even tell the skeptics why. Several people who are here at this conference, and several others, have shown that the downstream economic return from renewed lunar activity could be profound, to say nothing of the scientific return from having research facilities on the Moon. So the entire notion of returning to the Moon and extracting oxygen and hydrogen, among other things, or of exporting solar power to the Earth, or extracting Helium-3 for the fusion reactors of the 21st century, is an entirely reasonable and doable enterprise to consider.

But, as the talents we have honed for the last thirty years are applied on the surface of the Moon, there will be a broader context of issues arising from the very nature of the endeavor itself. If the history of the Space Age can be our guide -- and I think it can -- the greatest challenge facing renewed lunar exploration in the future will be a combination of the political and the technical, and the greatest benefits arising from it will sweep across our entire culture. They will be societal in nature.

So, here at the outset, let us consider some of the larger implications of what a return to the Moon could mean. For the space program itself, it will be a turning point. After more than three decades of space exploration, the United States will be undertaking a fundamental shift in its national space policy. The goal will be to expand human presence beyond Earth orbit and out into the solar system. Such a plan marks a significant change for American space exploration because it entails a shift away from highly-focused, one-of-a-kind missions, such as Projects Gemini and Apollo, to a long-term, evolutionary approach to the exploration and utilization of space, along the lines of what we have just begun to do with the Space Shuttle and Space Station programs.

It will mean that we are no longer limited to the technical and operational specifics of any one vehicle or any one mission plan, and over time it will involve a fleet of diverse spacecraft and a stable of off-planet research laboratories, industrial facilities, and exploration architectures. This is pretty major stuff, in other words, and we should remember that, politically speaking, the place where the rubber will first hit the road is in the initiative to return to the Moon. Of course, there are some heavy questions associated with these things. Will the Congress support it? What kind of a line item will this be in the Fiscal Year '01 budget?

Clearing these political and budgetary hurdles; bringing new launch systems and space transportation vehicles on line; developing better methods for maintaining the health and productivity of flight crews; and learning to live and work amidst the extraordinarily hostile environment of the Moon are just a few of the challenges this effort will face. We should recognize that here is an enterprise that not only has to navigate in space, but also has to steer through that somewhat murky realm where capabilities, budgets, policies, politics, and the news media all meet. If I might

suggest an axiom here, it would be that the greatest challenges we face are not on the Moon, but in getting to the launch pad. We have to get the hardware on the launch pad first.

And we are talking about a great deal of hardware. Our best estimate is that in order to return to the Moon to set up permanent scientific and industrial facilities, we will have to be able routinely to place about a half-million pounds of equipment and provisions into low Earth orbit. Thus, the size, capability, and availability of launch vehicles becomes paramount -- and this is where history begins to repeat itself.

In the 1960s, the size of the launch vehicle was the same variable as today, having a profound ripple effect across the length and breadth of the Apollo program. In that era, the choice was between the Saturn V, capable of delivering 250,000 pounds of mass to low Earth orbit, and a much larger Nova booster, which would have been capable of lofting nearly 1 million pounds of mass into low Earth orbit. The selection of one or the other of the two boosters was related to a choice between three different approaches for sending humans to the Moon: direct ascent from the surface of the Earth to the surface of the Moon, Earth-orbit rendezvous, and lunar-orbit rendezvous. The eventual choice of lunar-orbit rendezvous matched it to the capabilities of the Saturn V.

In much the same fashion, the size of America's next-generation launch vehicle will determine the pacing and structure of renewed flights to the Moon, subsequent voyages to Mars, and our ability -- or inability -- to engage in the kind of resource utilization programs we have gathered here to discuss. For example, the geosynchronous orbit Solar Power Satellite (SPS) reference concept was closely studied by NASA and the Department of Energy from 1977 to 1980. Although the so-called reference concept was intended to show only conceptual and technical feasibility, it was reliant on an enormous launch and assembly capability that even today would seem many years in the future. The analysis in the NASA-OOE study was based on construction of two 50,000-ton satellites each year for thirty years, each of which produced 5 gigawatts of power on Earth. Under that plan, the heavy-lift requirement from Earth to low Earth orbit was calculated at eight 425-ton cargo shipments each week, or about 400 each year.

But the use of lunar materials to build even that reference system -- an option that could become more practical given the inherent capabilities of a country with the wherewithal to establish a lunar base -- would reduce by up to fifty-fold the number of launches required from Earth. Mining lunar materials to produce raw rock, fabricating finished products on the Moon, and then transporting all of that to geosynchronous Earth orbit for such uses as an SPS would have significant synergism with other activities we already know will have to be performed on the Moon as the exploration program proceeds. The launch hardware choices we make today, however, could greatly influence such capabilities tomorrow. The threads of the future will be woven about this kind of technical and political tapestry.

And then there are the societal implications.

The next question we should ask ourselves is: "What will a renewed program of lunar exploration mean for the people of Earth? What will be the effect on our society and our culture?" I think, first of all, that an overall change of perspective is likely, and while it will be of a fundamental nature, it also will have an intangible effect in many ways, and something the historians will be best suited to measure many years from now. But what do I mean by a change of perspective?

More than two thousand years ago, Socrates wrote, "Man must rise above the Earth, to the top of the atmosphere and beyond, for only thus will he fully understand the world in which he lives." In 1948, British astrophysicist Fred Hoyle wrote, "Once a photograph of the Earth, taken from the

outside, is available -- once the sheer isolation of the Earth becomes plain -- a new idea as powerful as any in history will be let loose."

I think Apollo 8 proved both men right. In December 1968, after a really tough year in Vietnam, the world experienced a few days of magic. During the Christmas season came the flight of Borman, Lovell, and Anders on humanity's first circumnavigation of the Moon. We sat entranced and watched views of the Moon and the distant Earth unfold that were breathtaking to behold, and on Christmas Eve the crew read from the Book of Genesis in the Bible. *The Washington Post*, in an editorial, said, "At some point in the history of the world, someone may have read the first ten verses of the Book of Genesis under conditions that gave them greater meaning than they had on Christmas Eve. But it seems unlikely.... This Christmas will always be remembered as the lunar one."

When the crew of Apollo 8 returned, they carried with them a precious set of images. Who can forget those views of the good and bountiful Earth, in gibbous phase, rising above the desolate limb of the Moon. That perspective changed our thoughts and our outlook on the Earth forever. One of those images was displayed just above Walter Cronkite's shoulder every night on the *CBS Evening News*.

American Poet Laureate Archibald MacLeish was moved to write, "To see the Earth as it truly is, small and blue and beautiful in that eternal silence where it floats, is to see ourselves as riders on the Earth together, brothers on that bright loveliness in the eternal cold -- brothers who know now that they are truly brothers." The rise of an ecological movement in this country, and the first observance of Earth Day in April 1970, is attributed by many to those photographs. John Caffrey of the American Council on Education wrote in the March 20, 1970, issue of *Science* that, "the views of the Earth from that expedition and from the subsequent Apollo flights have made many of us see the Earth as a whole, in a curious way -- as a single environment in which hundreds of millions of human beings have a stake. I suspect that the greatest lasting benefit of the Apollo missions may be, if my hunch is correct, this sudden rush of inspiration to try to save this fragile environment -- the whole one -- if we still can"

So that was the reaction more than twenty years ago. What can we expect in the future? How might our outlook evolve? Consider, if you will, a recent news story. I'm sure most of you have heard or read of the young man who recently announced that his father, who worked in the Apollo Program, had bequeathed him a small sample of lunar dust which came from one of the astronauts' space suits. The young man made news when he offered to sell the dust to the highest bidder in order to finance his college education. The suggested retail price of this dust was somewhere between \$20,000 and \$30,000.

In Houston, I saw a couple of articles each in the *Chronicle* and the *Post*, I know that the wire services reported the story, and in January, Larry King had the young man on his live CNN talk show. So this obviously did make some news, and was all the more interesting initially because NASA's chief legal counsel announced that the Agency took a dim view of private ownership of lunar samples, and the Inspector General promised to look into the matter.

The IG let the matter drop after a few days, and the young man was left to make his best bargain and pursue his education. However, the point here is that nowhere in the discussion did I ever hear anyone point out that the dust samples, from the perspective of a collector, are a very dubious investment in the first place. When you think about it, the point of collecting things and determining their value over time -- whether it be stamps or coins or comic books -- is based on their rarity. Generally, the rarer the coin, and the older it is, the more it is worth, and that worth keeps increasing as the years roll by.

Not so with lunar samples. They are very valuable now, because we and the Russians have acquired less than 900 pounds total, but if the endeavors imagined by all of us go forward, in not very many years we will be awash in the stuff. I would say that young man's lunar dust has a financially lucrative half-life of just a decade or two, which is not such a wonderful long-term investment.

Again, in large ways and small, the very existence of a program to explore the Moon will shape our outlook and our course as a great nation. And in this sense history offers some interesting perspectives. We live in interesting times. Today, February 20, 1992, for instance, is the 30th anniversary of John Glenn's historic first U.S. orbital flight. At the time, in the winter of 1962, this seemed the most extraordinary of technological feats. The youngsters of that day -- now known as the Baby Boomers -- became the first generation in history to view space flight as a complete reality of their time. When asked what they wanted to be when they grew up, they could respond, quite viably, "an astronaut." Today we are rearing the first generation in history to have access, from an early age, to the well-developed capabilities of the personal computer, camcorders, cellular phones, FAX machines, and Nintendo games. And we can only guess how that will affect their judgment, their talents, and their outlook thirty or forty years from now when they come into positions of responsibility and authority.

Another cycle of history takes fully two centuries to develop. It is the story of exploration and the opening of a new frontier, and comes to mind with the approaching bicentennial in the year 2003 of the Lewis and Clark Expedition. Actually, according to Gary Moulton, editor of the first new edition in almost ninety years of the journals of Lewis and Clark, "the roots of the expedition. . . were already lengthy by the time of the Louisiana Purchase in April 1803." For at least twenty years, since as early as 1783, Thomas Jefferson had been thinking about an expedition to explore the upper reaches of the Missouri River.

When he became President, Jefferson wasted no time. "It would be arbitrary," Moulton writes, "to distinguish between his 'practical' and 'scientific' goals, for Jefferson, a true son of the Enlightenment, believed all knowledge to be of some benefit." Their "Corps of Discovery," as it was called, was charged to "observe and record the whole range of natural history and ethnology of the area and the possible resources for future settlers." Jefferson also expected them to open a highway of commerce to the West. While the expedition was presented to the French and the Spanish as merely a scientific enterprise, the Congress authorized it under the commerce clause of the new Constitution. The expedition was funded by a \$2,500 allocation from the War Department budget at a time when total federal expenditures, less debt repayments, amounted to \$7.8 million. That is entirely analogous to a Voyager- or Galileo-class expedition today.

From the perspective of history, we can see that the journeys of Lewis and Clark had little immediate practical effect on the course of the nation. But those who read of their travels were excited, and the imagination of a young nation could begin to contemplate the realities of a vast, untamed frontier. Over time, this vision of the west took hold, but the development of a practical infrastructure to explore and utilize the frontier took another twenty or thirty years. Only in the 1820s, through such programs as Henry Clay's "National System," did the Congress begin to legislate internal improvements such as roads, canals, and developed natural waterways. And it was still another sixty years before the railroads joined the continent together.

In that time, of course, the great Indian horse cultures of the plains disappeared, and by the end of the 19th century the American frontier had passed into history. That sense of frontier, of elbow room and exploration, has for two centuries now been fundamental to the American psyche, to our ideas of ourselves and our national culture.

I think it is most compelling to consider this in light of our recent past. In many ways, the voyages of Apollo are analogous to the Lewis and Clark expedition. Now here we are, twenty years after Apollo, and the tides of government policy are steering us toward the development of an infrastructure to explore and to utilize the Moon we first surveyed. And in the end, of course, we will arrive back where we started, 200 years later. We will have an American frontier once again.

In closing, I would leave you with the perspective of Carl Sagan, who has written that, "in the long view, the greatest significance of space exploration is that it will irreversibly alter history, "

This is where the adventure will take us, ladies and gentlemen, and on behalf of all of us at the Johnson Space Center, we wish you well as you and we pursue that dream.

N 9 3 - 2 7 9 5 8

RETURN TO THE MOON: LUNAR ROBOTIC SCIENCE MISSIONS

Lawrence A. Taylor

**Department of Geological Sciences
University of Tennessee**

S₃-91
158316

P-10

ABSTRACT

There are two important aspects of the Moon and its materials which must be addressed in preparation for a manned return to the Moon and establishment of a Lunar Base. These involve its geologic science and resource utilization. Knowledge of the Moon forms the basis for interpretations of the planetary science of the terrestrial planets and their satellites; and there are numerous exciting explorations into the geologic science of the Moon to be conducted using orbiter and lander missions. In addition, the rocks and minerals and soils of the Moon will be the basic raw materials for a lunar outpost; and the In-Situ Resource Utilization (ISRU) of lunar materials must be considered in detail before any manned return to the Moon. Both of these fields -- planetary science and resource assessment -- will necessitate the collection of considerable amounts of new data, only obtainable from lunar-orbit remote sensing and robotic landers.

For over fifteen years, there have been a considerable number of workshops, meetings, etc. with their subsequent "white papers" which have detailed plans for a return to the Moon. The Lunar Observer mission, although grandiose, seems to have been too expensive for the austere budgets of the last several years. However, the tens of thousands of man-hours that have gone into "brainstorming" and production of plans and reports have provided the precursor material for today's missions. It has been only since last year (1991) that realistic optimism for lunar orbiters and soft landers has come forth. Plans are for 1995 and 1996 "Early Robotic Missions" to the Moon, with the collection of data necessary for answering several of the major problems in lunar science, as well as for resource and site evaluation, in preparation for soft landers and a manned-presence on the Moon.

The exciting possibility exists of a mission to the Moon in early 1994. The project "Clementine" by SDI and NASA plans for long-life testing of sensor technology in the realistic, stressing, space environment, but will also fly to the Moon and go into polar orbit for two months. Its remote sensors will collect chemical, mineralogical, and physical data about the surface of the Moon. All these studies are part of the basic geoscientific characterization of the Moon as a planet, as well as a means of finding the Moon's best available resources. Such studies will affect our general understanding of the nature and origin of the Moon and of its resources. Most of the homework has been done for a timely return to the Moon. It remains to be done.

Introduction

On July 20, 1989, on the twentieth anniversary of Neil Armstrong's first small step onto the Moon, President Bush stated the goals of "returning to the Moon, this time to stay" and "the first human mission to Mars." This effectively started the Space Exploration Initiative and set us back on course for manned exploration of these nearby planets. However, studies, strategies, and plans for just such an initiative have been a part of a subset of NASA's agenda since Apollo.

This paper will review some of the important plans for a return to the Moon in the immediate future. However, in order to put these plans into proper perspective, I will present a brief discussion of the science rationale of such a return and a historical review of several workshops and plans and preparations that have not come to fruition, yet have laid the groundwork for the present endeavors. A significant portion of the following has been taken from my files of reports from numerous workshops and committee meetings which have not been formerly published. I gratefully acknowledge use of these sources and thank one and all of the authors. In particular, the recent efforts of the members of the Lunar Exploration Science Working Group (LEXSWG) have provided substantial input to this review endeavor.

Scientific Importance of the Moon

Before we went to the Moon and returned with samples, some postulated that its composition and consistency was similar to a green-colored dairy product. With the first examination of the rocks and soils brought back by the Apollo 11 mission, these conjectures were dispelled. And then began detailed dissection of these precious samples, which in turn led to theories for the origin and evolution of the Earth's sister planet. It was soon realized that the Moon's thermal budget rapidly decreased such that almost all of the magmatic activity was concluded after 1.5 billion years. What we are seeing today is the "death mask" of the Moon from about 3.0 Ga. Although the Earth and Moon are the same age, the Earth has maintained its thermal budget and has continued to evolve, erasing to a large degree any remnants of its early history. Inasmuch as the Earth and Moon are thought to have undergone approximately the same types of early evolution, it is felt that the Moon provides an invaluable "window into the Earth's past". Indeed, **the Moon plays a key role in planetary science**, a "role model" for the terrestrial planets. The Moon's origin is intertwined with that of Earth: its craters preserve a record of meteoroid fluxes through time, which relates to extinctions of life on Earth; it preserves a detailed record of its early evolution. The Moon is an ideal body on which to study the processes, such as impact, that have shaped the other solid bodies in the solar system.

The Moon is the only extraterrestrial body from which we have samples from known locations. The six U.S. Apollo and three Soviet Luna Missions samples nine distinctly different portions of the Moon. Granted, they were all restricted to the nearside equatorial belt. Based upon intense scientific study of these lunar samples, we have been able to reconstruct the birth and adolescent development of this planet. And **the Moon is the most accessible body in the Solar System making its exploration easier to achieve.**

The lack of an effective atmosphere (about 10^{-12} torr) on the Moon has permitted solar-wind particles to hit the surface of the Moon and to become imbedded in the soil. And as the soil was formed and "gardened" by micrometeorite impacts, layers developed within the upper regolith leading to the soil profiles which were sampled by the numerous corings and brought back to Earth. The various particles from the Sun provide us with detailed information of the evolution of its nuclear past. It has been said that **lunar soil preserves a 4 billion-year record of the Sun's history** – "the Moon is a solar telescope with a tape recorder".

With as much as we have learned about the Moon, there remain many unsolved problems in lunar science. Table 1 lists many of the questions which remain to be answered concerning the Moon. This list is not meant to be "all inclusive", but is meant only to refresh your memory about some of the most important lunar science issues. A perusal of this list amply demonstrates that, although we have come a long way in our understanding of the Moon, we have a ways to go. And many of these questions can only be answered from new data, both remotely sensed and from direct sample investigations.

TABLE 1. Fundamental Questions in Lunar Science

- o What is the origin of the Moon and its relationship to Earth?
- o What is the nature of primordial crust and mantle?
- o What is the magmatic history of the Moon and how does lunar evolution set constraints for small planets?
- o Was there a magma ocean, and what was its nature?
- o What is the full range of highland rock types and how are they related to each other?
- o What is the full range and ages of mare basalt compositions and what are the spatial relationships of various basalt types?
- o What is the nature, origin, and regional extent of KREEP?
- o What is the nature of impact processes and how is material redistributed on local, regional, and global scales?
- o Was there a cataclysmic bombardment 3.9 billion years ago?
- o Is there water at the poles?
- o What is the nature and evolution of regolith for airless bodies?
- o What are the thicknesses and maturities of lunar soils?
- o Does the Moon have an iron core?
- o What is the origin of lunar paleomagnetism?
- o What are the resource potentials of the Moon?

How did the Moon form? Actually we have narrowed in on the question rather well with what we refer to as the "Giant Impact Theory", wherein a large body about the size of Mars, 1/6th the mass of Earth, collided with the Earth at an early stage of its development some 4.6 BYA. The chemistry fits for such a theory and the dynamics do as well, particularly since our Moon is really far too large to be considered a true Moon - it is really a coexisting planet. **What is the evolution of the lunar crust and mantle?** This question involves establishing 1) whether the Moon really underwent an early phase of global melting to yield a magma ocean; 2) the thickness of the lunar crust, 3) the depth of early lunar differentiation; and 4) the structure and composition of the mantle. **What is the magmatic history of the Moon?** The question involves establishing 1) the nature and duration of igneous activity in the highlands; 2) the effects of early intense bombardment; and 3) the nature and duration of mare volcanism. **What is the history and nature of impact processes on the Moon?** This question involves 1) determining the depth of impact mixing in the highland crust; 2) establishing the size and shape of complex crater and basin excavation cavities; 3) determining the ratio of locally-derived material to primary ejecta in basin-continuous deposits; and 4) establishing the homogeneity or lack thereof in large basin impact-melt sheets. **Is there an iron-rich core in the Moon?** This question involves establishing 1) the siderophile element abundances in the Moon; and 2) geophysical techniques for direct detection of a core. **What is the thermal history of the Moon?** This question involves establishing 1) the mean surface heat flow; and 2) the present lunar geotherm. **What is the origin of lunar paleomagnetism?** This question involves establishing 1) direct detection of a lunar core; and 2) the orientations of regional surface magnetization as a function of surface age. **What is the nature of the lunar regolith?** This question involves improving

our understanding of 1) vertical and lateral mixing in the regolith; and 2) the details of regolith maturation. It is our knowledge of this regolith which is the basis for our proposed exploitation of lunar resources.

We have only sampled about 5% of the lunar surface, which consists of a region plus and minus some 10-20° from the equator. The highlands are virtually unexplored. Because of latitude restrictions, the polar regions were not visited. Perhaps there is permanently frozen water there! We have never been to the backside of the Moon which from remote data seems to be distinctly different in lacking large basins and maria. All in all, we have done miraculously well with the few samples we have. Can you imagine parachuting down on a half dozen places on Earth and coming up with all the answers? We have so many major unanswered questions about our own Earth, such as when and where will the next major earthquake occur?

Lunar Resources

The rocks and minerals of the Moon will be included among the raw materials used to construct a lunar base, largely because of the cost of bringing material from Earth. **The prime resources will be found in the assemblage of rocks and minerals which represent the end products of both internal and external geochemical and physical processes.** In particular, it is the relatively unconsolidated rock and mineral matter, the regolith, on the surface of the Moon which will almost assuredly provide the necessary resources for colonization. The fragmental material of the regolith is composed mostly of disaggregated rocks and minerals, but also includes glassy fragments fused together by meteorite impacts. The finer fraction of the regolith (i.e., <1 cm) is formally referred to as soil. The soil is probably the most important portion of the regolith for use at a lunar base. For example, soil can be used as insulation against cosmic rays, for lunar ceramics and abodes, or for growing plants. The soil contains abundant solar-wind implanted elements, as well as various minerals, particularly oxide phases, which are of potential economic importance. For example, these components of the soil are sources of oxygen and hydrogen for rocket fuel, helium for nuclear energy, and metals such as Fe, Al, Si, and Ti.

As the above discussion emphasizes, the soil will be the material base for most of the resource utilization. In order to "prospect" for such resources as solar-wind implanted hydrogen and helium, it necessary to have detailed knowledge of the maturity of the soils. This will necessitate an integration of chemistry and the ferromagnetic resonance measurement for the presence of single-domain native iron I_s/FeO , a value which directly relates to soil maturity. But the determination of I_s will involve actual handling of the soil. All is not lost, however. It is possible to approximate the grain-size distribution of a lunar soil by remote sensing, and the grain size is roughly correlated with maturity.

It is interesting to speculate upon the possibility of lunar **ore deposits**. At this stage in the development of lunar base concepts, it is difficult to foresee the exact needs or economics of any such lunar endeavor. It is probable that we will never mine ores on the Moon in order to bring the metals back to Earth. However, there are certain minerals known to be present on the Moon which will undoubtedly be used almost immediately by the early lunar settlements -- e.g., native iron (Fe^0) for structural purposes and ilmenite ($FeTiO_3$) for oxygen production. In addition, other oxide minerals such as chromite ($FeCr_2O_4$) and ulvospinel (Fe_2TiO_4) may be used for their oxygen or metal contents.

Most of the "ore minerals" on Earth are sulfide and oxide phases. These concentrations of minerals most commonly result from deposition by hydrothermal solutions (i.e., 100-300°C watery solutions).

However, the Moon does not possess appreciable amounts, if any, of water; therefore, the presence of ore minerals deposited by hydrothermal solutions is improbable. However, there are other means of concentrating ore minerals (e.g., chromite, ilmenite) which are based on "fractional crystallization" and "crystal settling".

Crystallizing minerals will settle within a melt if their densities are greater than the melt. On Earth, such accumulations are commonly found in "layered intrusions" and are known as stratiform deposits. In fact, the mineral chromite, FeCr_2O_4 , which constitutes the world's major source of the strategic metal, chromium, occurs in mafic strata of large igneous complexes. However, only 3 layered intrusives -- the Bushveld of Transvaal; the Great Dyke of Zimbabwe; and the Stillwater Complex of Montana -- are known to contain substantial amounts of chromite.

On Earth, particularly in remote regions, prospecting for ore deposits often entails aerial magnetic surveys. This is an advanced technology. It is possible that this can be adapted to remote sensing from an orbiting satellite such as a lunar orbiter.

Lunar Observer Mission

It should be apparent from the above discussion that we are in need of a return to the Moon for the sake of science, as well as for preparation for lunar base. Such a plan has been around since the very end of Apollo. In the mid 1970s, plans were made for LPO, a lunar Polar Orbiter mission. Each year a "new start" was not forthcoming, and these plans were moved ahead into the future. After some 10 years, the LPO lost any momentum that it had, and plans were made for the LGO, a lunar geochemical orbiter, modelled after the Mars Observer project, which was originally scheduled to start in 1984. In September, 1988, the LEXSWG (Lunar Exploration Science Working Group) was formed as an NASA advisory committee which set about promoting a **Lunar Observer**. The scope of the measurements to be made by the Lunar Observer were expanded over those of the former LGO flight package, and it had a proposed start date of 1996, using a Mars Observer backup duplicate space craft.

The science objectives of the Lunar Observer Mission were defined (Table 2). With the data gathered by such a mission, it would be possible to make major contributions to solving many of the problems listed in Table 1. The actual definition of the tasks for this mission are listed in Table 3. As can be readily seen, this orbiter was to be a "do it all at once" mission.

TABLE 2. Science Objectives of the Lunar Observer Mission

- o Estimate the composition and structure of the lunar crust in order to model its origin and evolution;
- o Determine the origin, nature, and size of the lunar magnetic field and estimate the size of a lunar core;
- o Estimate the refractory element content of the Moon by measuring the mean global heat flow and using the refractory content of the crust as a constraint;
- o Determine the nature of impact processes over geologic time and how they have modified the structure of the crust;
- o Determine the nature of the lunar atmosphere and the physical basis for its sources and sinks;
- o Assess potential lunar resources.

TABLE 3. Lunar Observer Measurements to Satisfy Science Objectives

- o Determine globally the chemical and mineralogical composition of the surface;
- o Determine globally the surface topography and gravitational field;
- o Map globally the distribution of surface magnetic anomalies and measure the magnitude of the induced dipole moment;
- o Obtain a global digital image database along with selected coverage in stereo and color;
- o Measure the microwave brightness temperature as a function of wavelength;
- o Measure globally the composition, structure, and temporal variability of the lunar atmosphere.

The Lunar Observer Mission was designed to make major contributions to the Space Exploration Initiative (SEI) of President Bush. Some of the important contributions to SEI are listed in Table 4. The science objectives of the Lunar Observer were obvious and many. This was an ambitious mission. However, it can be seen from Table 4 that the Lunar Observer also was designed to be a "precursor mission" to a manned-return to the Moon, with the establishment of a Lunar Base. In reality, **most of the needs for site evaluation for the establishment of a Lunar Base are met by the science objectives.**

TABLE 4. Lunar Observer Contributions to SEI

- o Contribution to Lunar Base/Landing Site(s) selection;
- o Lunar Base sight characterization - photography, topography, regolith properties, etc.;
- o Resource distribution;
- o Necessary for planning human and robotic fieldwork; remote station location;
- o Necessary for other disciplines:

Astronomy: meter-class altimetry for array site selection;
thick regolith for cosmic ray shielding;
low-frequency radio environment;

Space Physics: knowledge of radiation background;

Baseline characteristics of atmosphere before human operations.

The "payload" for the Lunar Observer was impressive (Table 5). It is effectively a "wish-list" of flight instruments, designed to provide major input into the objectives for lunar science, Lunar Base, and resource evaluation. In fact, the almost 20 years of study and planning had seen the addition of new objectives with the need for new measurements and new instruments. It was a mission which was an essential step in providing the wealth of scientific and engineering information which can lead to flexible and enduring human exploration of the Moon base. Because of the billions of dollars to be invested in a Lunar Base venture, site selection will be one of the most critical decisions to be made by scientists, engineers, and policy-makers in the 1990s. Furthermore, it was considered that if the Lunar Observer was launched early enough, the results could affect conceptual studies detailed design and engineering, and implementation and testing phases of the entire Lunar Exploration Program. The development and siting of future lunar bases could have been significantly enhanced by the Lunar Observer Mission. The bottom line to this proposed mission was to proceed in a timely fashion. However, **the Lunar Observer Mission seems to have "died under its own weight"** so to speak, with all the good words by everyone but without achieving a new start in NASA. This mission involved some 12 flight instruments and had become a huge billion dollar program, not feasible for the austere budgets of the early 1990s.

TABLE 5. Strawman Payload for the Lunar Observer

Instrument	Application
Imaging	Geology, Lunar Base Sites
Gamma-Ray/X-Ray Spectrometer	Surface Composition
Visual/IR Spectrometer	Surface Composition
Thermal Emission Spectrometer	Surface Composition
Laser Altimeter	Topography
Magnetic/Electron Reflectometer	Surface Fields, Induced Moment
Microwave Radiometer	Heat Flow, Regolith Properties
UV Spectrometer	Atmospheric Science, Environment
Neutral Mass Spectrometer	Atmospheric Science, Environment
Ion Mass Spectrometer	Atmospheric Science, Environment
Radio Sci. Nearside Grav. Field	O.D. and Farside Gravity Field
Radio Astronomy	MHz Survey, Experiment Design

A Return to the Moon in Retrospect

Some of the highlights in the timetable of efforts to establish programs for the return to the Moon are listed in Table 6. An interesting thing to be recognized is that the "delta" in time between the time of a start or meeting date and the proposed launch date seems to always be 4-6 years. One of the few things that seems to have stayed close to schedule is the Mars Observer, with a planned launch date of August/September 1992.

Plans were to make two Mars Observer launch vehicles and to use the second as the Lunar Observer. But this was not done exactly. The competition within the NASA community has always been between a return to Mars versus a return to the Moon. The rationale for the Mars community has been, "Why go back to the Moon? We have already been there." They want a soft landing on Mars, with possible sample return, in preparation for a manned return. Against this rationale and the conviction of NASA administration, it was not feasible to consider much of a return to the Moon, especially if it was going to be as costly a venture as The Lunar Observer.

The President's speech on July 20, 1989, sorted out the priorities that everyone had been arguing over. The birth of SEI gave renewed hope for a return to the Moon in the near future. And the excitement of the moment was seized upon by Johnson Space Center, led to a large extent by Mike Duke. Several organization meetings and workshops were convened, including the Lunar Base Site Selection Workshop. The results of this study were to establish the site selection criteria in order to encompass the three factors of 1) Resource, 2) Science, and 3) Placement/Safety/Rescue Logistics. It became obvious from these meetings that we could not select the best possible site on the lunar near-side without knowing considerably more about the Moon. And the importance of a Lunar Observer became paramount once again.

TABLE 6. Selected Dates in the Proposed Return to the Moon Timetable

Event	Calendar Time	Launch Date
GSFC LPO	March, 1975	April, 1980
JPL LPO Demise	December, 1976	October, 1980
SSEC Report	January, 1983	November, 1989
Mars Observer Start	October, 1984	December, 1991
LGO Workshop Report	March, 1986	December, 1992
LESWG Formed	September, 1988	January, 1996
LESWG 2nd Meeting	January, 1989	January, 1997
Bush Speech	July, 1989	October, 1995
LESWG 3rd Meeting	May, 1990	Oct., 1996-Mar., 1997
Lunar Base Site Workshop	June/August, 1990	1998 - 1999
"Clementine" Mission	January, 1992	Jan.-April, 1994
Early Robotic Missions	February, 1992	1995, 1996, 1997

Recent Developments

The efforts of the numerous persons at Johnson Space Center have been responsible for several developments which have had major impact on the possibility of returning to the Moon in the near future. In July, 1991, a workshop was convened at JSC entitled, "Artemis, the Common Lunar Lander. The theme of this workshop was the consideration of a series of return-to-the-Moon flights with low-budget soft landers each with total payloads of <200kg. These landers were to include rovers with various scientific instruments. And these were to be controlled robotically from Earth.

In 1991, Mike Griffin became a new Associate Administrator (AA) in charge of Exploration for NASA. His vigorous leadership has really brought flames to several smoldering programs. Griffin's endeavors are premised on the idea that, in order to return to the Moon in these times of fiscal stringency, it will be necessary to gain the attention and support of the Congress and the American people. His plan consists of three strategic horizons: 1) return to the Moon immediately with low-budget orbiter missions, 2) in five years, to send people once more to the Moon; the last half of the 1990s should also see more robotic exploration of Mars; and 3) beyond 2000, focus on sending people to Mars. This is very optimistic, yet possible with the proper support from Congress and particularly from NASA.

In February, 1992, a workshop entitled "Early Robotic Missions to the Moon" was convened by Mike Griffin and his Exploration Programs Office at JSC. The purpose of this workshop was to effectively inventory possible instruments for orbiting missions to the Moon in 1995 and 1996. The first orbiter will be called "Lunar Geodetic Scout" and the second, "Lunar Resource Mapper". Each would have but three instruments, e.g., gamma-ray spectrometer, soft x-ray spectrometer, and spectral reflectance spectrometer. If all goes as planned, an "Artemis" lander would follow these orbiters in 1997.

SDI/NASA Mission to the Moon

Early this year (1992), the Strategic Defense Initiative Office (SDIO) of the Department of Defense announced project "Clementine" with plans to send a flight package into space in order to perform a long-life test of the sensitivity of SDI instrumentation to space conditions (e.g., vacuum, temperature extremes, cosmic/galactic/solar radiation, micrometeorite impacts). A "near-Earth asteroid" flyby will provide a realistic test of sensors and autonomous navigation. NASA has

proposed that certain remote-sensing instruments also be carried aboard this craft and that initially it be put into orbit about the Moon - effectively a lunar polar orbiter. After about two months of data gathering at the Moon, the spacecraft could be powered out of orbit and sent into outer space for a rendezvous fly-by of the near-Earth asteroid "Geographos". The proposed launch date which SDIO plans is between January and April of 1994, with the fly-by occurring in August of that year.

If this combined SDI/NASA mission comes to fruition which seems likely as we go to print, NASA Exploration will be able to accomplish some of the goals of the "Lunar Geodetic Scout" and "Lunar Resource Mapper". Specifically, data on surface chemistry and mineralogy will be gathered, as well as near-side gravity from tracking data. A laser altimeter will map the global figure of the Moon simultaneously with acquisition of imaging and spectral data. In addition, the fly-by of "Geographos" will provide some of the data that was planned for the Comet Rendezvous Asteroid Fly-by (CRAF) Mission that has recently been canceled.

Summary

In spite of the great success of Apollo, major unanswered questions about the Moon abound. A substantial research effort should be made to improve our knowledge of the Moon. This should begin with global geochemical remote sensing by a "lunar observer mission", followed by more localized studies, such as a detailed study of materials that can be collected at a lunar outpost, higher resolution remote sensing, "rover-transported" geochemical sensing, and sample collection from regions determined from the global surveys to be promising. These studies are part of the basic geoscientific characterization of the Moon as a planet, as well as a means of finding the Moon's best available resources. Such studies will affect our general understanding of the nature and origin of the Moon and of its resources. Most of the homework has been done for a timely return to the Moon. It remains to be done.

CHARACTERIZATION OF LUNAR SURFACE MATERIALS FOR USE IN CONSTRUCTION

Stewart W. Johnson, BDM International, Inc.

Jack O. Burns, Department of Astronomy, New Mexico State University

S3-91

158317

p. 6

Abstract

The Workshop on the Concept of a Common Lunar Lander, which was held at the NASA Johnson Space Center on July 1 and 2, 1991, discussed potential payloads to be placed on the Moon by a common, generic, unmanned, vehicle beginning late in this decade. At this Workshop a variety of payloads were identified including a class of one-meter (and larger) optical telescopes to operate on the lunar surface. These telescopes for lunar-based astronomy are presented in an earlier section of this report. The purpose of this section is to suggest that these and other payloads for the Common Lunar Lander be used to facilitate technology development for the proposed 16-meter Aperture UV/Visible/IR Large Lunar Telescope (LLT) (Bely et al., 1989; Nein, Davis, et al., 1991) and a large optical aperture-synthesis instrument analogous to the Very Large Array of the National Radio Astronomy Observatory (Burke, 1990; Burns et al., 1990a).

The Bahcall Report (1991) noted that the Moon is an excellent site for the above-mentioned and other astronomical observatories which would there be capable of making significant advances over terrestrial-based and free-flying orbiting telescopes. The Report went on to recommend that "NASA should initiate science and technology development so that facilities can be deployed as soon as possible in the lunar program" and "NASA should develop the technology necessary for constructing large telescopes...."

Many technologies are required for establishing these large telescopes on the Moon (Johnson and Wetzel, 1989; Burns et al. 1990b; Illingworth, 1990). Listed below are seven examples of technologies for these large telescopes which we feel deserve attention in planning payloads and operations of the common lunar lander.

1. Geotechnical (e.g., soils, excavation, and foundations).
2. Mitigation of Detrimental Environmental Effects (e.g., dust).
3. Construction.

4. Contamination/Interference Control.
5. Verification of Stable Precision Structures Performance on the Moon for Telescope Applications.
6. Optical Systems and Their Performance in the Environment.
7. Test and Evaluation of Systems for Lunar Observatories.

We will discuss each of the above listed seven technologies in turn and suggest how their development could be enhanced and accelerated by the common lunar lander program.

TECHNOLOGY DEVELOPMENT FOR LARGE LUNAR-BASED OBSERVATORIES: THE ROLE OF THE COMMON LUNAR LANDER

Technologies

1. Geotechnical engineering and associated technologies are required to properly support a large telescope on the lunar regolith, to provide in situ materials for shielding of sensitive telescope components (e.g., charged-coupled devices (CCDs), and to facilitate site characterization and preparation. It is essential to learn what design limitations are imposed by the strength and load-deformation characteristics of the regolith and its stability in excavations. Much was learned from the Apollo and predecessor programs about the regolith but the engineering information is still incomplete. The regoliths on the airless, dry, lifeless Moon developed from uniquely different processes than those on Earth which formed in the presence of oxygen, wind, water, and a wide variety of life forms. On the Moon the regoliths are formed by the continuous impacts of a full range of sizes of meteoroids and incessant bombardment by charged atomic particles from our sun and the stars. Doing geotechnical engineering for the large lunar telescopes will differ substantially from terrestrial applications and the penalty for miscalculation will be immense. We suggest that acquiring the following information be addressed with the lunar lander (Carrier, 1991):

Topographic maps of potential observatory sites (Carrier suggests 10-cm contours over an area 1 km in radius).

Detailed boulder sizes and counts over the same area.

Surveys (e.g., by radar, microwave or other means) for subsurface boulders over critical areas where foundations and excavation are desired.

Surveys of depth-to-bedrock (with suitable definition and characterization of bedrock).

Trenching and bulldozing experiments that establish energy requirements and depth limitations for these operations.

Drilling and coring experiments; with energy consumption and depth limitations quantified.

Force versus depth cone penetrometer measurements to be used for siting settlement-sensitive telescope structures.

Trafficability measurements including establishing energy consumption, slope climbing capabilities, and formation of ruts or depressed surfaces by repeated traverses of unprepared surfaces.

Electrostatic charge measurements.

Some of the above listed needs can be combined with proposed geophysical investigations.

2. Mitigation of detrimental environmental effects, including dust (Johnson et al., 1991) can be the subject of investigations using the common lunar lander. Dust transport mechanisms, both natural and equipment-related, should be established by direct measurements. The amount of dust levitated at the day-night terminator as by charge differences built up by photoconductivity effects (Criswell,

1972) should be determined. Predictions of effects of the radiation environment of the lunar surface on telescope components can be verified using common lunar lander components as well as revisits of equipment left on the Moon during the 1960s and 1970s. There is a need to quantify synergistic effects of environmental factors (e.g., vacuum, ultraviolet, micrometeoroid and secondary impacts, thermal cycling, and dust) on component viability. We need to ascertain the long-term effects of the lunar environment on thermal control coatings and polished surfaces. Also needed are ways of using the common lunar lander to validate that drives, vacuum and dust-sealed bearings, and other mechanical components for large lunar telescopes (and construction equipment) will function on the Moon in the presence of dust, radiation, thermal cycling, and vacuum.

3. Construction on the surface of the Moon of a 16-meter telescope and a Lunar Optical/Ultraviolet/Infrared Synthesis Array (LOUISA) will require that the geotechnical engineering and degradation abatement considerations in paragraphs 1 and 2 above be addressed. Information gathered from common lunar lander investigations in these areas will feed directly into answering questions as to how the construction process for the large lunar telescope should be accomplished. The geotechnical data listed is essential not only for planning site leveling (preparation) and the design of the telescope foundation but also verifying designs of the construction equipment to be used at the telescope site. *Figure 1* (Chua and Johnson, 1991) shows one proposed approach to large lunar telescope construction that illustrates some of the points of this paragraph. As part of the common lunar lander program, some simplified aspects of sensing and telepresence applicable to robotic construction of a large telescope can be investigated.

4. Contamination/interference control for a large lunar telescope will be essential. The one-meter class telescopes envisioned to become payloads for the common lunar lander should be instrumented to furnish data on their contamination and interference environments which will later be of value in designing contamination/interference control measures for the large lunar telescopes. Of interest are materials interactions and outgassing on the Moon, avoidance zones for other landings, dust (as previously mentioned), the communications and data relay noise, waste heat and radiation from power sources, stray light, and natural and machine-induced ground shock and vibrations (and regolith damping of these motions).

5. Stable precision structures technology will be a part of the small telescopes initially deployed on the Moon by the common lunar lander bus. Satisfactory performance of these structures will begin to provide the data base for larger and more complex telescopes to follow. Our suggestion is to design the small telescopes and their instrumentation so that the data returned will be relevant to the decisions that must be made on structures and materials for large telescopes.

6. Design of optical systems for performance in the lunar environment raises many questions which we can begin to answer with careful attention to detail in the design of the common lunar lander program and the one-meter class telescopes to be flown to the Moon as a part of that effort. One aspect to be considered is the performance of coatings for optics and thermal control. Also, a large telescope with a segmented mirror will require many actuators, a sensor and measurement system, and controls technology. Components of this scheme (in simplified form) could be tested on the Moon in the common lunar lander program.

7. Test and evaluation technologies for large lunar telescopes (e.g., a 16-meter segmented reflector and a LOUISA) will be an even greater challenge than they were for predecessor free-flyer telescopes in Earth orbit. We believe that the common lunar lander program offers a pathway to an early and systematic start on the testing program for simplified but relevant components of large lunar telescopes. To allow this path to be followed will require a break with some traditional ways of doing business. First it will be necessary to establish that there is a plan to eventually place a

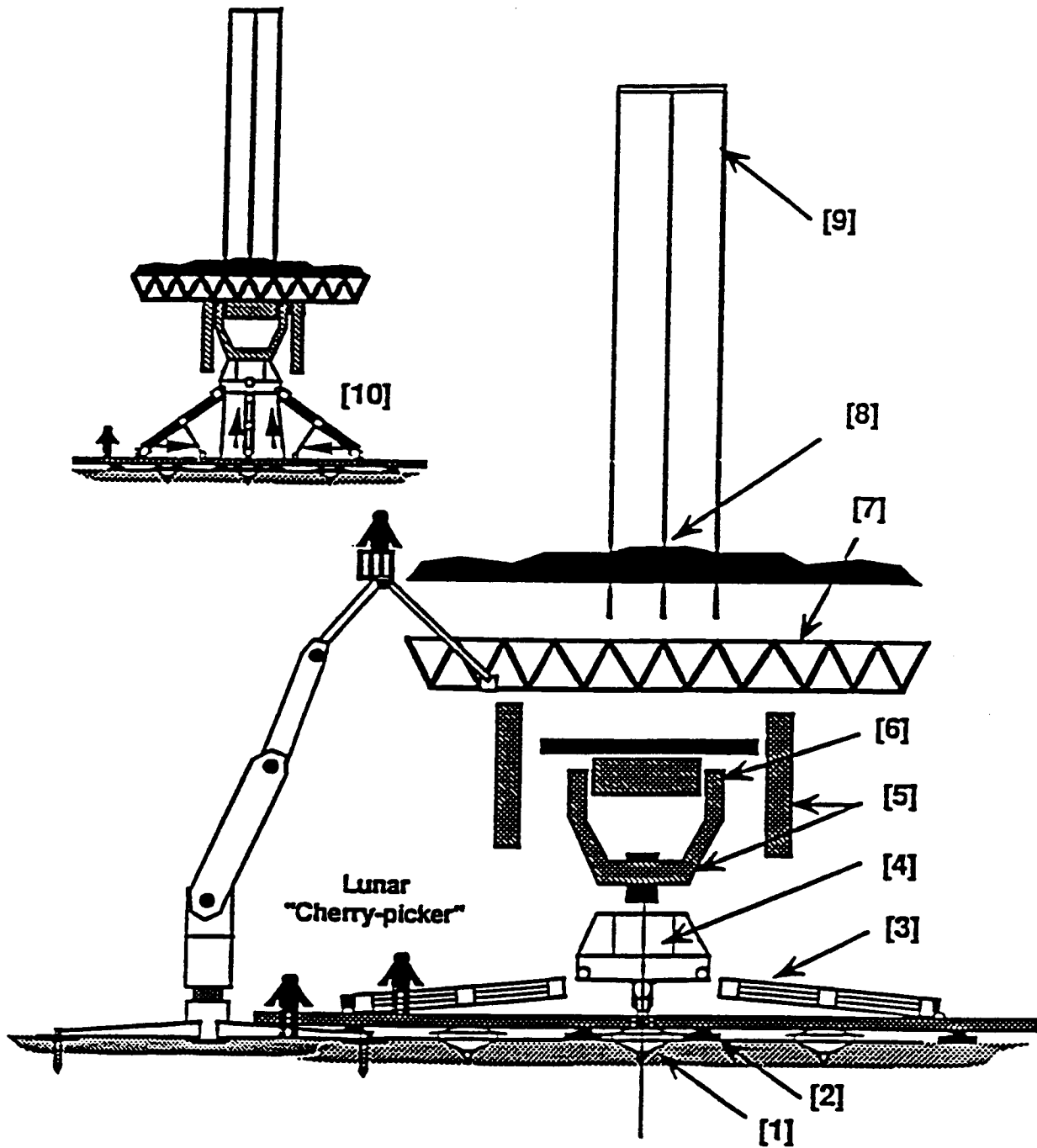

- [1] Install footings
- [2] Lay rails and temporary footings
- [3] Fabricate and place tripod legs along rails
- [4] Install azimuth drive assembly
- [5] Install yoke, shaft and counterweights

- [6] Install gimball ring and trunnion
- [7] Assemble Trusses
- [8] Place mirror assemblies
- [9] Install secondary mirror
- [10] Jack up LLT assembly

Figure 1. Proposed Construction Steps for the LLT

16-meter class telescope and a LOUISA on the Moon. It will also be necessary to have some agreement as to how these telescopes would be designed so that significant new technologies to be used could be conceptualized and (in simplified form) tested and evaluated on the Moon as part of the Common Lunar Lander Program.

Recommendation

The early lunar observatories of the one-meter class, and later lunar-based telescopes of increasing complexity, call for imaginative solutions to diverse problems in optics, controls, structures, geotechnical engineering, construction, and environmental engineering. We feel that the best pathway for solving these problems is through a long-term plan in which each step builds on the past. The common lunar lander program, as we have pointed out, offers the opportunity to take the first step.

Acknowledgements

We acknowledge the support of the National Aeronautics and Space Administration, New Mexico State University, the University of New Mexico, and BDM International, Inc. in this effort. Discussions with Max Nein and Billie Davis of NASA Marshall Space Flight Center (particularly regarding the 16-meter and precursor telescopes) have influenced our thinking in these areas.

omit

ENERGY MANAGEMENT

N 93 - 27960

AN ENGINEER/CONSTRUCTOR'S VIEW OF LUNAR RESOURCE DEVELOPMENT

**Carleton H. Jones
Bechtel National, Inc.**

54-91
ABS ONLY
158318

Abstract

P-1

A strawman lunar outpost scenario has been postulated as a special focus to guide the papers in this Symposium. This scenario describes an evolving facility with basic components, personnel and activities intended to support lunar missions that lead to a permanent occupation on the lunar surface. The engineer/constructor's view of establishing a lunar outpost is largely concerned with identifying and analyzing the logistics needed to transform the engineering designs on paper into a constructed and operating facility. This means that all aspects of the outpost design will be examined to satisfy constructability requirements and to develop a construction management plan that leads to successful facility startup and routine operations. Whether the facility is to be devoted to materials production, vehicle refueling, or science projects will influence the construction plan in its details, but the construction of all lunar facilities will be mainly governed by the difficult logistics path from Earth to the lunar surface.

ENERGY FOR LUNAR RESOURCE EXPLOITATION

Peter E. Glaser
Arthur D. Little, Inc.

55-91

158319

p. 8

Abstract

Humanity stands at the threshold of exploiting the known lunar resources that have opened up with the access to space. "Historically, wealth has been created when the power of the human intellect combined abundant energy with rich material resources. Now America can create new wealth on the space frontier to benefit the entire human community by combining the energy of the Sun with materials left in space during the formation of the Solar System."¹

America's role in the future exploitation of space, and specifically of lunar resources, may well determine the level of achievement in technology development and global economic competition.

Space activities during the coming decades will significantly influence the events on Earth. The "shifting of history's tectonic plates" is a process that will be hastened by the increasingly insistent demands for higher living standards of the exponentially growing global population. Key to the achievement of a peaceful world in the 21st century, will be the development of a mix of energy resources at a societally acceptable and affordable cost within a realistic planning horizon. This must be the theme for the globally applicable energy sources that are compatible with the Earth's ecology. It is in this context that lunar resources development should be a primary goal for science missions to the Moon, and for establishing an expanding human presence. The economic viability and commercial business potential of mining, extracting, manufacturing, and transporting lunar resource-based materials to Earth, Earth orbits, and to undertake macroengineering projects on the Moon remains to be demonstrated. These extensive activities will be supportive of the realization of the potential of space energy sources for use on Earth. These may include generating electricity for use on Earth based on beaming power from Earth orbits² and from the Moon to the Earth³, and for the production of helium 3 as a fuel for advanced fusion reactors.⁴

Lunar resource utilization will require that power be available for a wide variety of activities on the Moon. The associated power generation infrastructure and technologies would be commercialized with the combined efforts of industry and government. Innovative approaches will be required to maintain steady progress over a long-term time horizon.⁵

This will involve the evolution of an enabling legal and regulatory framework. To meet projected requirements power could be generated directly on the lunar surface, transmitted via power beaming to distant work sites, beamed from the Earth to the Moon, or from power stations in a suitable Lagrangian orbit or lunar orbit. Power beaming technologies using microwaves or lasers operating in selected portions of the electromagnetic spectrum are being developed in Europe, Japan, U.S., and U.S.S.R.⁶ Thus the architectures considered for the permanent human presence on the Moon⁷ are of increasing commercial relevance, and key to maintaining the U.S. position as a space-faring nation and gaining public support for the Space Exploration Initiative (SEI). The overarching objective for SEI should be economic advancement, societal progress, and safeguarding the Earth's ecology.

This objective should animate U.S. space policy and programs, and be in consonance with the motivations of the science and technology space community. Other nations are beginning to recognize the value of exploiting extraterrestrial energy and materials resources for an environmentally sustainable world economy. It will be done. It is just a matter of by whom.⁸

References

¹National Commission on Space. *Pioneering the Space Frontier*. New York: Bantam Books. May 1986: 3.

²P. E. Glaser. "Power From The Sun: Its Future." *Science* (162) 1968: 857-66.

³D. R. Criswell and R. D. Waldron. "Results of Analyses of Lunar-Based Power System to Supply Earth with 20,000 GW of Electric Power." *Proceedings of SPS 91 - Power from Space*. Societe des Electriciens et des Electroniciens. Paris, France. August 1991: 186-93.

⁴G. L. Kulcinski, et al. "Apollo-An advanced Fuel Fusion Power Reactor for the 21st Century." *Fusion Technology* (15) 1989: 1233.

⁵Report of NASA Lunar Energy Enterprise Case Study Task Force. *NASA Technical Memorandum 101652*. July 1989: 25.

⁶*Proceedings of SPS 91- Power from Space*. SEE, Paris, France, August 27-30, 1991.

⁷Report of the Synthesis Group, T.P. Stafford, Chairman. "America's Space Exploration Initiative." *America at the Threshold*. Washington: U.S. Government Printing Office, May 1991.

⁸Report of NASA Lunar Energy Enterprise Case Study Task Force. *NASA Technical Memorandum 101652*. July 1989: 6.

ENERGY FROM THE SUN AND MATERIALS FROM THE MOON

Humanity is facing daunting challenges as we look towards the 21st century. Among these challenges whether they be political, economic or environmental the availability of energy is key to the continued striving for acceptable living standards of the world's growing population.

Total world energy consumption has more than quadrupled since the 1950s. Nearly 90% of current energy demands are met by the combustion of fossil fuels. The inequitable availability of these fuels is resulting in widening disparities between developed and developing countries, and are the cause of increasing threats to the Earth's ecology and climate.

Exponential population growth is leading to a possible doubling of the world's population by the middle of the 21st century. This wave of humanity will have to be fed, clothed and housed to achieve a tolerable living standard. The resulting predictable and escalating deterioration of the biosphere has to be mitigated while seeking ways to advance the development of the majority of humanity. These challenges will be explored at the United Nations Conference on the Environment and Development, Rio de Janeiro, June 3 to 15, 1992.

The key to achieving this advancement is to have adequate supplies of energy at an affordable cost, and to place increasing reliance on renewable or inexhaustible energy sources that are compatible with the environment. There is a window of opportunity that may be open for only a few decades to develop energy options that no longer rely exclusively on terrestrial sources of energy. Terrestrial sources are either finite, subject to diurnal changes or weather, lead to unacceptable environmental impacts, or cannot reach the required scale to meet increasing global energy demands.

Historical developments indicate that the changes from one global energy source such as wood to coal and coal to oil, took place during successive intervals of about 75 years. This will also be the case when new energy sources are applied on a global scale. Because of these protracted time scales required for potential measures to mitigate global ecological deterioration and the potential effects of global warming, it is critical to start now developing and selecting promising energy production options that can sustain global economic growth without creating irreversible damage to the ecology. This also is the context for energy conservation measures, and human behavioral adjustments resulting from lifestyle changes.

As part of any assessment of alternative energy technologies, extraterrestrial resources deserve to be seriously considered. This will provide an understanding of the inexhaustible and renewable energy options available at various stages of global development in the 21st century. "Historically, wealth has been created when the power of the human intellect combined abundant energy with rich material resources. Now America can create new wealth on the space frontier to benefit the entire human community by combining the energy of the sun with materials left in space during the formation of the solar system."¹

More than two decades ago the solar power satellite (SPS) was proposed as a major option for the continuous generation of electricity to meet future global energy needs.² Over the intervening years the SPS has been assessed and analyzed and technical, economic and societal issues have been debated.³ Today the SPS is no longer relegated to the pages of science fiction magazines. Efforts to develop a range of technologies applicable to the SPS are under way in Europe,⁴ Japan,⁵ U.S.,⁶ and the former USSR.⁷

In the early stages of a program, such as the SPS, with potential global applications several decades in the future, it is difficult to project how an SPS program can best be pursued until information on technical, economic and societal issues from seemingly unrelated programs can be applied to guide the selection of appropriate development approaches. During this period different paths may have to be explored so that the most effective generic technologies can be identified, assessed and analyzed, and the most promising options selected. This selection must be based not only on technical criteria but also conform to economic requirements, and be in consonance with societal considerations and preferences and the legal and regulatory framework. By analogy to other technology developments that had major impacts both on a national and international scale, the success of programs such as global aviation and satellite communications and their successful applications would not have been possible without a staged development effort extending over a period of decades. A necessary prerequisite for the growth of these programs was the evolution of international agreements, national and international policies and regulations, and the increasing confidence of both public and private sector investors in the applicable technologies based on demonstration projects of increasing scale and complexity, market assessments and customer identification. Satellite programs for global communications and navigation resulted in the formation of international organizations such as Intelsat and Inmarsat which are examples of the organizational, legal and regulatory framework that will be required for the evolution of a global SPS system.

Although the concept of a global SPS system can be visualized in broad outline, it is no more possible now to describe in detail future steps beyond those which can be taken in the near term than it was possible to project, at the time the DC 3 airplane was being designed, the development of large passenger jet aircraft capable of meeting the needs of international travelers decades later.

Rather than focusing attention exclusively on a possible design of SPS that would operate in the 21st century, it is important to select near-term applications of space power to supply elements of the evolving space infrastructure, to identify markets and customers willing and able to pay for the power supplied in space,⁹ and to obtain financing for commercial applications.

Demonstration of space power beamed to meet customer requirements in space,⁹ e.g. , to the space shuttle and Space Station, will assist in the development of policies and the legal and regulatory framework which will have to be in place so that investment capital can be made available to specific space power projects including power beamed from Earth to orbiting satellites and relayed across large distances to users,¹⁰ e.g. , Australia to Japan and Africa to Europe.

However, it is necessary to recognize that planning should proceed now towards the future development of an SPS system that can meet energy needs of both developed and developing nations in the 21st century, so as to guide near-term technology development and project selection. As practical applications of space power are demonstrated in space and eventually on Earth, societal acceptance of SPS will be of increasing importance. Therefore, assessments of any adverse impacts that may be associated with a global SPS system will be essential to permit mitigation measures to be developed concurrently. The lessons learned from the development of other globally applicable energy resources including coal, oil, natural gas and nuclear power should be applied to the SPS development so that the potential for ecological deterioration will be minimized, adverse health effects avoided, and ecologically compatible energy production methods developed before an SPS system would be introduced on a global scale.

The SPS should be viewed not as a stand-alone program to meet all global energy demands. Instead, it should be part of a global effort that reconciles energy demands with human values and ecological concerns. Ultimately, a global SPS system will operate in concert with other energy

production systems. The objective is to choose the options that will meet human needs without the long-term adverse effects of existing energy production methods.

The SPS concept encompasses a broad range of possible technologies.¹¹ Some will reach operational readiness during this decade, and others only after several decades of development. SPS will at first utilize terrestrial and subsequently extraterrestrial resources, to meet an increasing share of global energy demands. For this reason, it may be necessary to consider a growth path for implementing a global SPS system extending over several decades into the 21st century, as *Figure 1* shows.

Although the SPS represents a grand vision for the future, it is not possible to anticipate the complex changes in technology, political circumstances, and economic expansion that will result in sustainable global development.

Therefore, this path for technology development should be integrated with efforts to reduce the uncertainties in climate change predictions, improve energy use efficiency, and develop effective applications of terrestrial renewable energy technologies. Demonstration of SPS-related technologies should be started in the 1990s so that the most promising technologies are selected, their economic value established, and societal concerns associated with environmental impacts assessed and mitigated. For example, technologies applicable to high-altitude, long-endurance aircraft that receive propulsive and payload power beamed from the ground are under development. A successful demonstration of a small scale aircraft was sponsored by the Canadian Department of Communications in 1987. Kyoto University's Radio Atmospheric Science Center is expected to fly a similar aircraft designed to relay radio signals for mobile communications with the express purpose to test technology applicable to the SPS, and a demonstration of a IOMW SPS is being planned for the end of this decade by Japan's Institute of Space and Astronautical Sciences.

The past three decades of the space era have demonstrated that humanity's evolutionary progress need not be confined to the Earth's surface. Satellites for communication, navigation and Earth observation are using solar energy as a means to power various systems that have already significantly affected life on Earth. All indications are that there is no limit to the uses of space technologies for the benefit of society, and achieving the vision of humanity reaching towards the stars. The capabilities of an increasingly industrialized global civilization to develop new technologies can be applied to the production of energy conversion systems in space to supply the Earth on a scale that may not be possible for such systems installed on Earth.

The challenges to develop extraterrestrial energy and material resources are formidable. International efforts and coordination will be required over a period of decades to make the transition from the current to 21st century energy production methods.

It is in this context that lunar resources development should be a primary goal for science missions to the Moon, and for establishing an expanding human presence. The economic viability and commercial business potential of mining, extracting, manufacturing and transporting lunar resource-based materials to Earth, Earth orbits, and to undertake macroengineering projects on the Moon remains to be demonstrated. These extensive activities will be supportive of the realization of the potential of space energy resources for use on Earth.

Lunar resource utilization will require that power be available for a wide variety of activities on the Moon. The associated power generation infrastructure and technologies would be commercialized with the combined efforts of industry and government. Innovative approaches will be required to maintain steady progress over a long-term time horizon. This will involve the evolution of an enabling

Figure 1: A Growth Path for the Evolution of the SPS

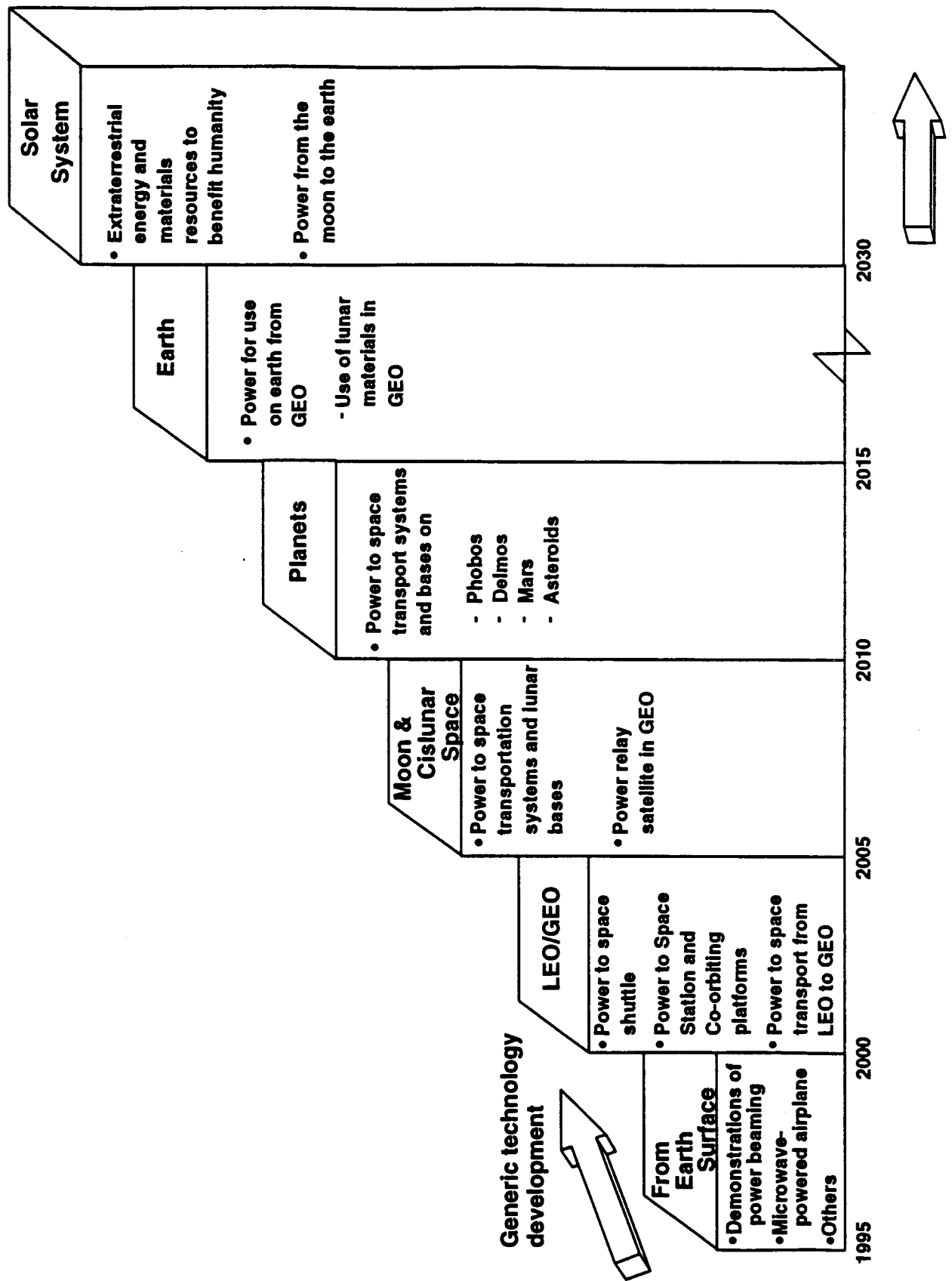

legal and regulatory framework for lunar resource exploitation.

To meet projected requirements power could be generated directly on the lunar surface, transmitted via power beaming to distant work sites, beamed from the Earth to the Moon, or from power stations in a suitable Lagrangian orbit or lunar orbit. Power beaming technologies using microwaves or lasers operating in selected portions of the electromagnetic spectrum are being developed in Europe, Japan, U.S. and U.S.S.R."

Thus the architectures considered for the permanent human presence on the Moon" are of increasing commercial relevance, and key to maintaining the U. S. position as a space-faring nation and gaining public support for the Space Exploration Initiative (SEI). The overarching objective for SEI should be economic advancement, societal progress and safeguarding the Earth's ecology.

Now is the time to take a positive view of the achievable objectives of global space endeavors, and to recognize the constructive and catalytic role that solar energy received in orbit, on the moon, and on Earth can play in sustaining the evolution of the planet Earth civilization. Strategic planning by the public and private sectors in several nations is underway now to ensure that space power will be able to make an increasingly important contribution to meet global energy demands. The challenge is not only to arrive at an unbiased assessment of viable options that can meet energy requirements at various stages of human development, but also to recognize that management of both terrestrial and extraterrestrial resources will be required on an unprecedented scale.

There may be only a limited time left, measured in a few decades, to open up the space frontier so that the contribution of space resources can be demonstrated. The space-faring nations are in a unique position to lead this effort as discussed at SPS 91. The question is no longer whether humanity will effectively use space resources but who will be in the vanguard.

The SPS represents a unique opportunity for the nations of the world to constructively use extraterrestrial energy and materials resources to advance global development efforts and to ensure that the ecological integrity of the Earth is preserved. "Five centuries after Columbus opened access to The New World we can initiate the settlement of worlds beyond our planet of birth. The promise of virgin lands and the opportunity to live in freedom brought our ancestors to the shores of North America. Now space technology has freed humankind to move outward from Earth as a species destined to expand to other worlds."⁽¹⁾

References

¹*Pioneering the Space Frontier*. National Commission on Space. New York: Bantam Books, 1986: 3.

²P.E. Glaser. "Power from the Sun: Its Future." *Science* (1968): 162, 857-66.

³*Space Power Journal*. Published by the Council for Social and Economic Studies. McLean, VA.

⁴Eurospace. "Study of Powersat Systems." Paris, France, 1992.

⁵Japan External Trade Organization. "Solar Power Satellite R & D in Japan." New Technology Japan, FY 1991, Tokyo.

⁶Report of NASA Lunar Energy Enterprise Case Study Task Force, July 1989. *NASA Technical Memorandum 101652*.

⁷A.S. Korotev. "Prospects of Development of Environmentally Safe System of Supplying Power from Space." To be presented at Session: "Power from Space, Prospects for the 21st Century." IAF World Space Congress, Washington, D.C., September 4, 1992.

⁸P.E. Glaser. "Microwave Power Transmission for Use in Space." *Microwave Journal* (Vol. 12, No. 12) 1986: 44-58.

⁹K. Chang et al. "Demonstration of Microwave Power Transmission in Space." Proceedings of SPS 91-*Power From Space*. SEE, Paris, France.

¹⁰A.M. Angelini. "On the Possibility of Intercontinental Power Transmission via Satellite." *Space Power* (7) 1988: 175-86.

¹¹P.E. Glaser and P.K. Chapman. "Survey and Documentation of Emerging Technologies for the SPS." U.S. Department of Energy, DOE/ER-0097, April 1981. Springfield, VA.

¹²*Proceedings of SPS 91 - Power from Space*. SEE, Paris, France: 27 to 30 August, 1991.

¹³Report of the Synthesis Group. T.P. Stafford, Chairman. "America's Space Exploration Initiative." *America at the Threshold*. Washington, D.C.: U.S. Government Printing Office, May 1991.

N 93 - 27962

ADVANCED PHOTOVOLTAIC POWER SYSTEMS USING TANDEM GaAs/GaSb
CONCENTRATOR MODULES

L. M. Fraas, M. S. Kuryla, D. A. Pietila,
V. S. Sundaram, P. E. Gruenbaum, J. E. Avery,
V. Dinh, R. Ballantyne, and C. Samuel

Boeing High Technology Center

56-44
158320
P-13

Abstract

In 1989, Boeing announced the fabrication of a tandem gallium concentrator solar cell with an energy conversion efficiency of 30%. This research breakthrough has now led to panels which are significantly smaller, lighter, more radiation resistant, and potentially less expensive than the traditional silicon flat plate electric power supply.

The new Boeing tandem concentrator (BTC) module uses an array of lightweight silicone Fresnel lenses mounted on the front side of a light weight aluminum honeycomb structure to focus sunlight onto small area solar cells mounted on a thin back plane. This module design is shown schematically in *Figure 3*.

The tandem solar cell in this new module consists of a gallium arsenide light sensitive cell with a 24% energy conversion efficiency stacked on top of a gallium antimonide infrared sensitive cell with a conversion efficiency of 6%. This gives a total efficiency 30% for the cell-stack. The lens optical efficiency is typically 85%. Discounting for efficiency losses associated with lens packing, cell wiring and cell operating temperature still allows for a module efficiency of 22% which leads to a module power density of 300 Watts/m². This performance provides more than twice the power density available from a single crystal silicon flat plate module and at least four times the power density available from amorphous silicon modules.

The fact that the lenses are only 0.010" thick and the aluminum foil back plane is only 0.003" thick leads to a very lightweight module. Although the cells are an easy to handle thickness of 0.020", the fact that they are small, occupying one-twenty-fifth of the module area, means that they add little to the module weight. After summing all the module weights and given the high module power, we find that we are able to fabricate BTC modules with specific power of 100 watts/kg.

An additional salient strength of these new BTC modules is their radiation resistance. This resistance arises not simply from the use of GaAs cells but perhaps more importantly from the use of thicker protective cover slides. Since the cells are small, thick cover slides can be used to protect the cells without adding appreciably to the module weight.

Finally, although the Boeing breakthrough announcement in 1989 emphasized performance improvements, the use of a sunlight concentrating lens array also promises major economic advantages. The concentrator approach substitutes easily molded inexpensive silicone Fresnel lenses for expensive single crystal semiconductor material. For example, one 4" diameter GaAs wafer will supply all the cells required to fabricate one 12 lens by 12 lens (18" by 18") BTC module. Furthermore, the 144 small concentrator cells obtained from this one wafer are easily fabricated and manipulated with high yield and without breakage. Contrast the cost of fabrication of the 121 thin (0.006") large area (1.58" by 1.58") GaAs cells required to make an equivalent area, lower power flat plate GaAs module and one can readily see the potential economic advantage of the BTC concept.

While the tandem-cell-stack efficiency values are impressive, the commercial commodity will be a power module integrating these cell-stacks. The recent focus of our efforts has been to demonstrate that concentrator power modules using tandem-cell-stacks can be easily assembled with automated equipment to produce high performance at low cost.

In the first section of this paper, we describe two types of cell-stack assembly processes. The first is the original wire-bonding technology that has been used in several of our modules. The second is a tape automated bonding (TAB) technology that we have developed for automated packaging. In the second section of this paper, we describe the assembly, testing, and performance of rugged concentrator minimodules designed for performance verification and as reference standards used to measure larger production modules.

Tandem Cell-Stack Assembly

A. Wire-bonded Cell Stacks

Boeing has fabricated the photovoltaic advanced space power (PASP) test-flight module⁸ shown in *Figure 1*. This PASP module served as a vehicle for environmental testing done in collaboration with NASA and will be launched by the US Air Force in the fall of 1992 on a test mission to prove the viability of the technology. Although this module has achieved several of our initial goals, it is still only a test module, not a production module. This flight test module is significantly smaller than the proposed production module and it was assembled largely by hand. In particular, the cell-stacks were interconnected with copper wire soldered between stacks rather than flex circuit interconnects.

Figure 2 shows a sketch of a cell-stack typical of those used on the PASP flight-test module. A GaSb cell is first die bonded onto a metalized ceramic heat spreader with a separate metal pad forming the electrical contact to the back of the cell. Wire bond connections are then made from the top of the GaSb cell to a second metal pad on the ceramic. Then, silicone rubber spacers are formed on the corners of the GaSb cell and the GaAs top cell is then bonded in place on top of the GaSb cell. Although not shown, the ends of ribbons previously bonded to the back of the GaAs cell are then bonded down to a third metal pad on the ceramic. Finally, wire bond connections are made from the top of the GaAs cell to a fourth metal pad on the ceramic. The attachment of a cover slide is then optional at this point. The above sequence is actually done in batches of nine cells a pre-scribed 2" x 2" alumina substrate with a 3 x 3 array of cell sites. Individual cell-stack assemblies are then obtained by breaking up the ceramic substrate. This cell stack has two important attributes: first, the cell-stacks are testable before module wiring, and second, this approach uses hybrid circuit board technology and equipment available at Boeing. It is quite suitable for small numbers of parts, but unfortunately it is very tedious for the production of the large numbers of parts that would be needed for a full array.

B. TAB cell stacks

Figure 3 shows a drawing of our proposed production module assembly concept. For clarity, this figure shows a representative 4 by 6 lens/cell array. A production module would contain a larger number of array elements. The key assembly concepts shown in this figure are: (1) a prefabricated lens parquet; (2) cell-stacks interconnected through a prefabricated flex circuit mounted on the front surface of the panel back plane; and (3) pretested cell-stacks excised from TAB tape and inserted onto the flex circuit cell sites.

Figure 4 shows schematically a TAB process for the production of testable cell-stacks. In this TAB process, the spacers on the GaSb chips are applied at the wafer level by photolithography or screen printing (see *Figure 5*). As the two types of wafers are diced up, die of each type are glued together to create cell-stacks. These cell-stacks are then inner lead bonded into a three-beam-set TAB tape. These lead sets contact the top and bottom of the top cell and the top of the bottom cell. The stack can then be tested in the tape by probing pads on the tape and the bottom of the bottom cell.

The above stack production process begins with the adhesive bonding of the two types of chips to form the cell-stack. There are three requirements imposed at this point: first, the bond line must be very thin for good heat transport from the top chip through to the bottom chip; second, this bond should maintain electrical isolation between the two cells; and third, the TAB bonding surfaces on the cells have to be maintained free of contamination. These three requirements are met using the spacer/dam concept shown in *Figure 5*. The 8 μm thick polyimide spacer/dam pattern shown is formed on each GaSb cell at the wafer level before testing and dicing. After testing and dicing, yielded GaSb chips are placed in an alignment jig as shown in *Figure 6a*. A pneumatic dispensing system is then used to apply a 230 ± 30 nl drop of optical adhesive at the center of each GaSb cell. Then the GaAs chips are placed onto the GaSb chips in the alignment jig as shown in *Figure 6b*. The adhesive flows outward as shown in *Figure 5*. The alignment plate containing multiple cell sites

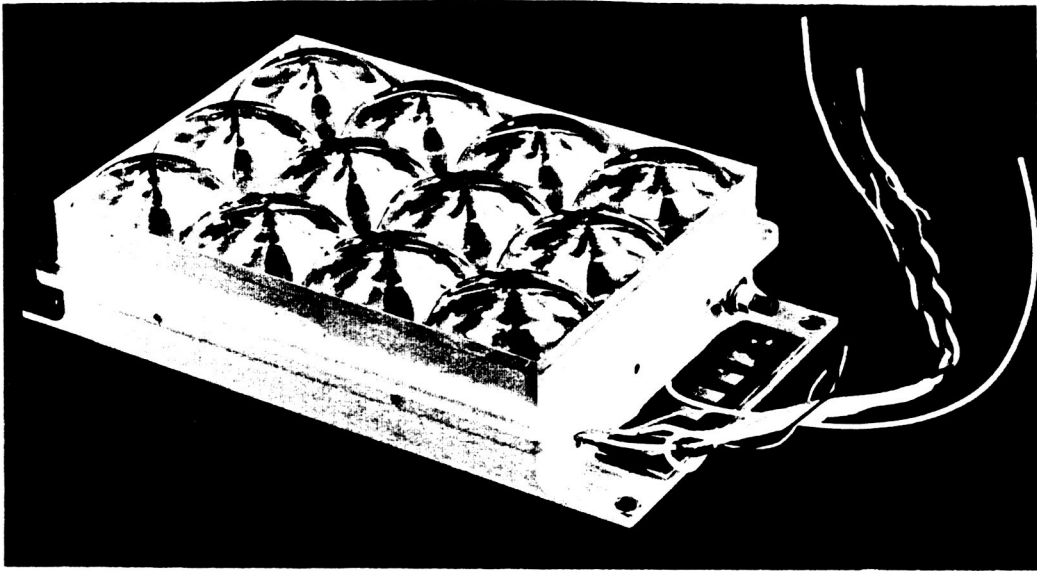

Fig. 1: Photograph of 12 lens concentrator module fabricated by Boeing for Photovoltaic Array Space Power Plus Diagnostics (PASP PLUS) flight experiment.

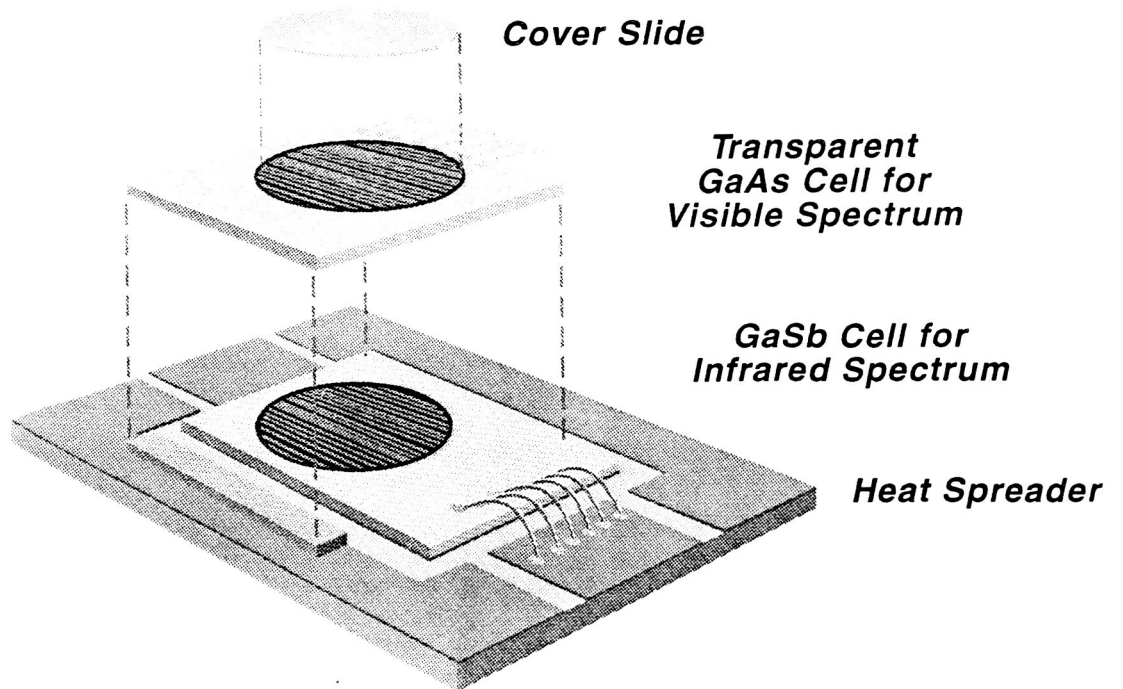

Fig. 2: GaAs/GaSb cell-stack in wire bonded form on ceramic substrate.

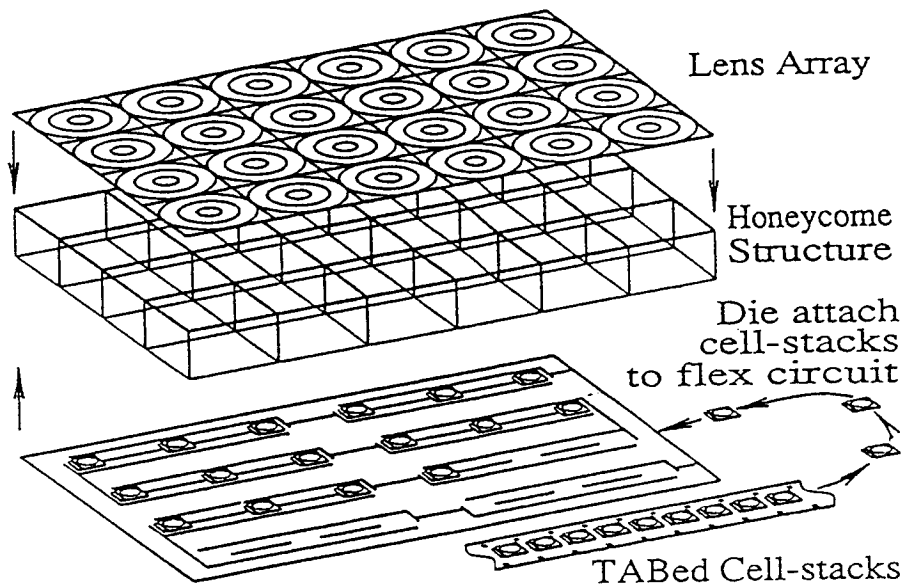

Fig. 3 A manufacturable tandem-cell concentrator module is shown schematically: consisting of a lens array, a honeycomb housing, and an array of TABed cell-stacks bonded to a flex circuit on the module back plane.

is then heated to cure the adhesive. The resulting structures are aligned cell-stacks with uniform 8 μm thick bond lines. Adhesive is kept away from the TAB bond areas by the dams shown in *Figure 5*. Chiang and Gee have calculated that the temperature drop across a 12.5 μm thick RTV adhesive bond line will be 10°C at 500 suns for terrestrial applications⁹. This implies a temperature drop of less than 1°C for our space module operating at 50 suns.

At this point in the assembly process, we have adhesive bonded cell stacks ready for inner lead bonding into TAB tape. Although inner lead bonding is a common process for IC's, there are several important distinctions associated with our tandem concentrator solar cell application. Our problem is simpler in its alignment and lead pitch aspects because each lead does not represent an isolated input or output signal. Unlike conventional IC's where bond pads are isolated from each other and recessed in a passivating layer, our bond pad configuration is a continuous planar film. This implies that 100% beam alignment and bond yield is not an absolute requirement for a functional, reliable interconnect. This also allows one to consider TAB bonding directly to the thin film metalization on the solar cell without forming the traditional bump common to TAB bonding. With bumpless bonding, special attention to the thickness of the thin film metalization is required to allow adequate mechanical compliance for the bonding process, and to achieve proper compositional control at the bond interface. The elimination of the bump offers a significant cost advantage as compared to conventional TAB. In our implementation, 5 mil leads on a 10 mil pitch are used to provide multiple interconnect redundancy, high current carrying capability, and thermal stress relief. This lead configuration is easily produced by either TAB tape suppliers or flex circuit manufacturers.

From a TAB assembly point of view, our problem appears complicated by the requirement to bond to the three separate planes presented by the front and back of the GaAs cell and the front of the GaSb cell. *Figure 7* shows a schematic of the tooling implemented to accommodate the separate bond planes. As shown in *Figure 7a*, a cell stack is placed on a die pedestal and secured with vacuum hold-down. This pedestal translates in the X, Y, and Z directions within a central square hole located in a tape carrier stage. The tape carrier stage has ramps shown schematically at the left and top of the central through hole to provide the required elevation differences for the beam leads relative to the back of the GaAs cell and the front of the GaSb cell. The tape is then secured to the stage through vacuum hold down outside of the leaded area. To position the cell stack relative to the three beam tape for bonding, a series of orthogonal motions are used between the stage and the pedestal. The first motion is illustrated in *Figure 7b*, and represents translation of the pedestal to the far right position, and up in the Z direction so that the back of the GaAs cell is at a higher elevation than the upper plane of the tape. The next motion is to translate the die pedestal back to the left and then down in the Z direction to allow the left beam lead set to lie underneath the bottom of the GaAs cell as shown in *Figure 7c*. A thermo-compression bonder is then used to gang bond the two beam lead sets to the top of the GaAs and GaSb cells. After these top side bonding operations are completed for all the sites in a TAB frame cassette or a tape reel, the cassette or reel is then turned over and the bottom GaAs beam lead set is gang bonded in a similar fashion as illustrated in *Figure 7d*.

The above inner-lead-bond (ILB) sequence has been implemented successfully using tin plated copper tape features bonded to either gold or silver thin film metalizations. It is believed that this process sequence can be implemented by a variety of commercial TAB equipment and represents a high throughput manufacturable ILB process. *Figure 8* shows a photograph of a tandem cell-stack in a three beam-lead-set TAB frame.

After inner lead bonding, the cell-stacks are tested for performance sorting. The cell-stack tape is then available for module assembly as shown in *Figure 3*. The operations involved in the cell-stack to module assembly are excising and beam lead forming, pick and place, die bonding, and outer lead bonding. As of this writing, we have not yet implemented these operations for production. However, these operations are nearly identical to standard automated assembly operations in use today in the semiconductor industry. Our efforts have been focused on the problems inherent in the

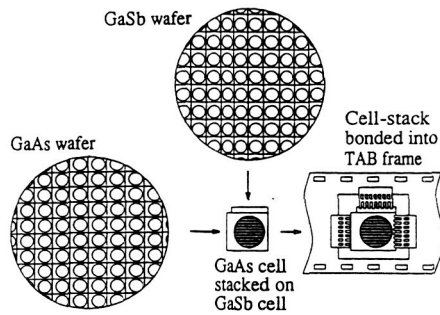

Fig. 4 Tape Automated Bonding of a cell-stack: a GaAs cell is first adhesive bonded to a GaSb cell and then inserted into a tape site for inner lead bonding.

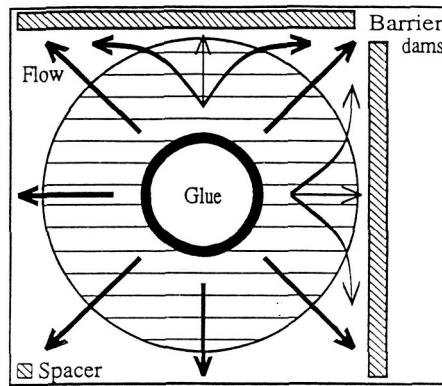

Fig. 5: The spacer and dam pattern on each GaSb chip provides electrical stand-off as well as a thin bond line for good thermal conductivity. The dams also serve to keep adhesive away from the lead bonding zones.

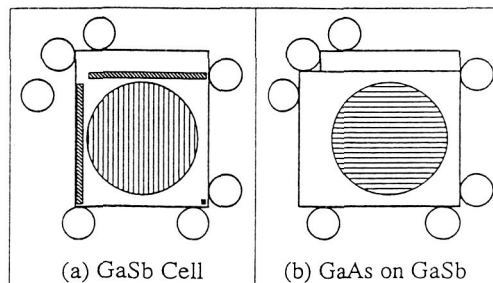

Fig. 6: The cell-stack pin alignment jig is used during adhesive bonding of the GaAs cell to the GaSb cell. The alignment fixture accommodates multiple stacking sites.

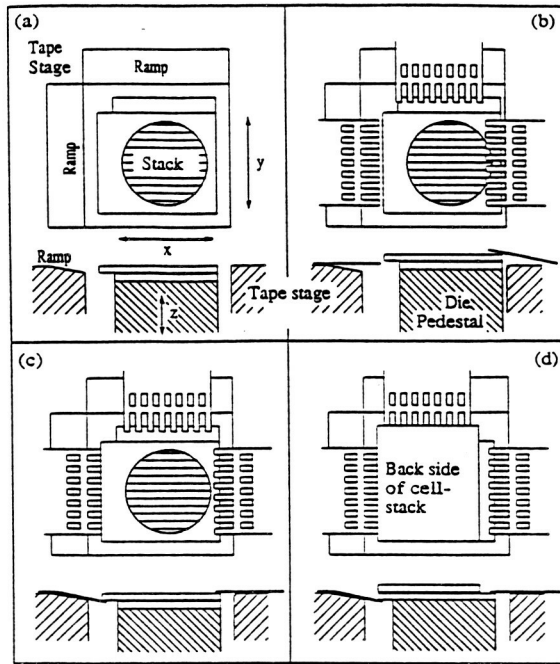

Fig. 7 3D TAB sequence is shown (a-d) for inner lead bonding of a cell-stack into a tape site. The cell-stack is mounted on a pedestal which is free to move within a square opening in the tape stage.

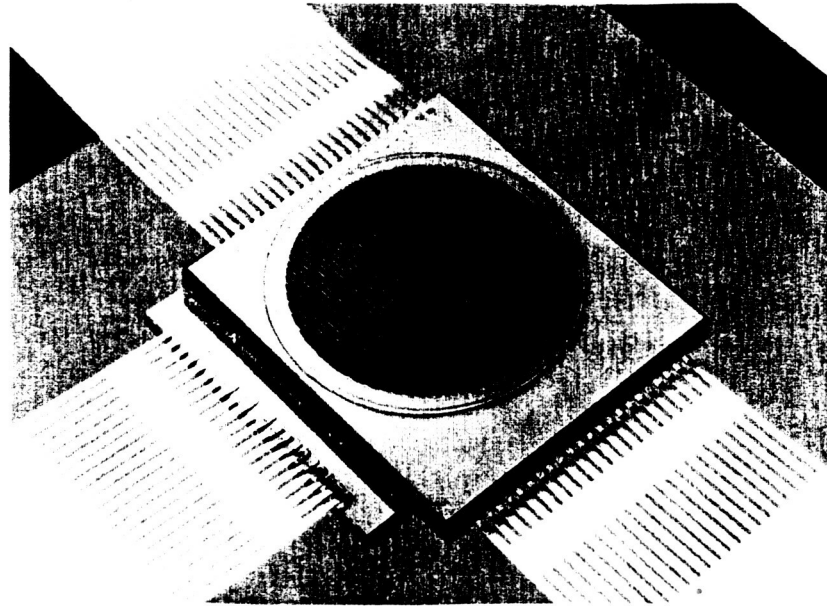

Fig. 8: A GaAs/GaSb cell-stack is shown inner lead bonded in a tape frame.

multi-planar tandem cell-stack. Once the cell-stack is inner lead bonded and tested in a TAB frame, it is no different than any other single chip in a TAB frame.

Concentrator Minimodule Assembly, Testing, and Performance

A. Minimodule assembly

In the previous section, we addressed the concentrator module assembly issues unique to the tandem cell-stack. In this section, we report the successful transfer of high cell efficiencies to high module efficiencies. The performance of a triplet minimodule is a particularly important demonstration of tandem cell technology integration at the module level. Cell stacks in a module are wired in groups of three, where the GaAs cells are connected in parallel and the GaSb cells are connected in series⁶. The triplets are two terminal devices that can be treated as if they were one solar cell with a bypass diode, and the triplet efficiency is a good indication of what the overall module efficiency will be.

Having established a cell-stack assembly process, module level assembly issues include connections between cell-stacks, heat removal, lens efficiencies, and optical alignment of components. Module testing involves analysis of the circuit performance at various temperatures, at various illumination levels with and without lenses in place, and module pointing tolerance. In addition to the fabrication and environmental testing of the PASP flight test module, we have decided to address module related issues by fabricating the rugged standard minimodules shown in *Figure 9*. These figures show both a single lens unit and a triplet. Each minimodule unit consists of two parts, a lens holder and a cell-stack housing. The lens holder fits precisely on the cell-stack housing to complete a standard assembly. A collimator assembly (not shown) replaces the lens holder on the single lens unit for lens efficiency measurements. These units serve three functions: 1) development and learning tools; 2) verification testing by outside laboratories; and 3) reference standard assemblies for calibrated performance testing of larger production modules.

The lens used in these units is the ENTECH minidome Fresnel lens described previously¹⁰. This silicone RTV lens is used as-molded without a protective glass dome or protective coating. Each square lens has an aperture area of 13.79 cm². Typical optical efficiencies for these lenses range between 87% and 90%. This lens is designed to produce a 3 mm diameter spot on our cell. For a cell active area diameter of 5.6 mm, this provides an unilluminated guard band which leads to a tracking tolerance design of ± 2 degrees.

Most of our module measurements were obtained using a flash simulator system, shown schematically in *Figure 10*. The application of our flash simulator for cell circuit testing, lens testing and module testing has been described previously¹¹. A new feature not described previously allowed for the quick acquisition of pointing tolerance data: the mirror shown has now been mounted on a robot arm so that its tilt can be programmed.

B. Tracking tolerance

Figure 11 shows the normalized current of a single lens standard assembly as a function of pointing angle. As predicted, the tolerance is ± 2 degrees. Also plotted is an example of how we were able to use a single lens standard as a learning tool for developing concentrator modules. Optical secondaries, used to relax the pointing tolerance of a concentrator module or array, have been described elsewhere for terrestrial applications¹². In space applications, a solid optical secondary also serves as a radiation shield for the cell. By molding an optical secondary out of silicone (*Figure 12*) we were able, with minimal development, to experimentally demonstrate the increased tracking tolerance achievable with an optical secondary. As *Figure 11* shows, the pointing tolerance for our space concentrator unit can be increased from ± 2 degrees to ± 3.5 degrees.

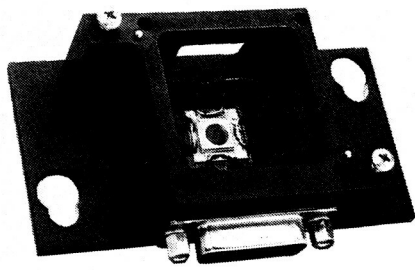

(9a) single cell-stack package

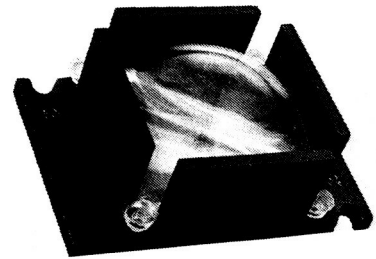

(9b) single lens holder

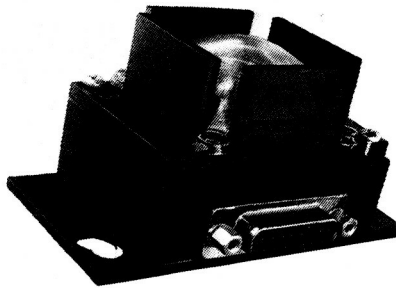

(9c) single lens-cell package

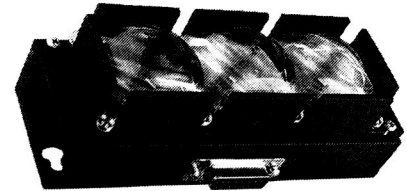

(9d) triplet lens-cell package

Fig. 9 The single and triplet tandem concentrator standard assemblies are shown (a-d). These rugged units are designed for calibration reference and performance verification. The "lens holder" (b) attaches to the "single cell-stack package" (a) to form the "single lens-cell package" (c).

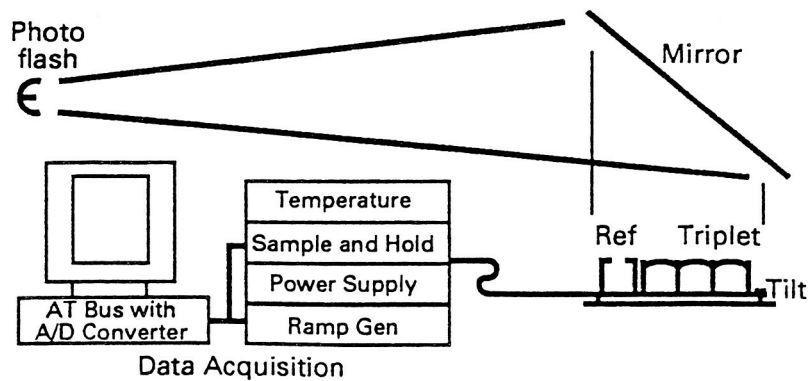

Figure 10. Flash Test Station for Measuring Concentrator Module Performance

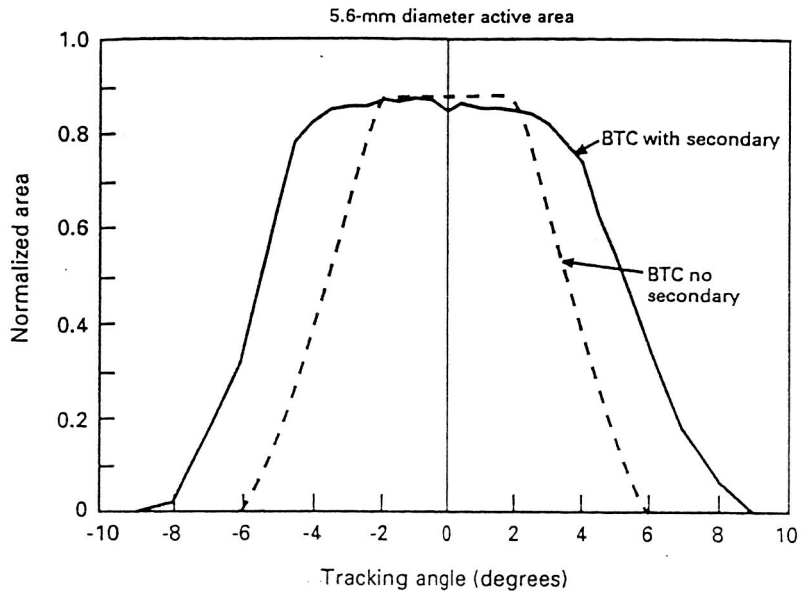

Fig. 11: The concentrator module off axis optical efficiency is shown with and without the optical secondary shown in figure 12.

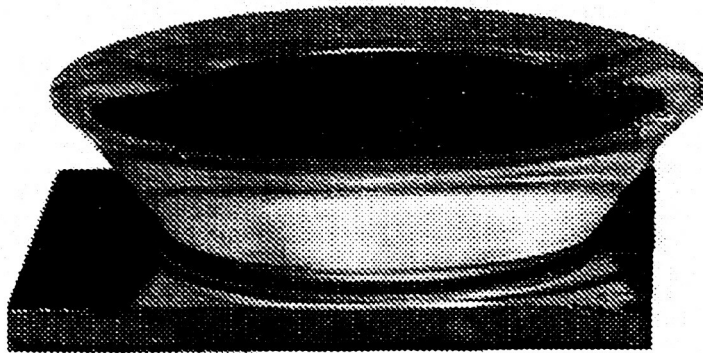

Fig. 12: Shaped cover slide for improved pointing tolerance.

	Efficiency	Fill Factor	Voc	Isc (mA)	Jsc (mA/cm²)
GaAs	20.0%	0.842	1.144	390	28.28
GaSb	5.2%	0.733	0.452	295	21.39
Combined	25.2%			3(GaAs)+1(GaSb):	[35.4]
Triplet	25.0%	0.842	1.160	1438	34.77
<p>Notes: Single Lens Area = 13.79 cm²; Triplet Lens Area = 41.37cm². Efficiencies reference, and Jsc are normalized to 1.36 kW/m² insolation.</p>					

Table 1: Lensed standard assembly performance.

C. Minimodule efficiency

We have now fabricated and tested high performance single lens and triplet minimodules. Table 1 summarizes the performance of these items (including lens losses) for space illumination conditions. The AM0 data shown in this table were obtained using our flash simulator. The flash lamp power level was first set to obtain the correct color ratio for the tandem stacked GaAs and GaSb cells. Then the lamp distance was adjusted to obtain the correct one-sun intensity using GaAs and GaSb standard cells that were calibrated to NASA Lear Jet flight standards. The minimodule power output is the maximum product of the measured I, V data pairs, e.g. 1.4 watts for the triplet under AM0. The power input is simply the illumination intensity times the total lens area, or $136 \text{ mW/cm}^2 \times 13.79 \text{ cm}^2 \times 3 = 5.6 \text{ watts}$ for the triplet under AM0. The triplet AM0 efficiency is then $1.4 / 5.6$ or 25%.

Conclusions

Mechanically-stacked concentrator GaAs/GaSb solar cells have achieved very high cell efficiencies, but have presented us with new challenges for module assembly. We have developed two separate procedures for assembling cell stacks: wire-bonding and TAB (bonding). Using wire-bonding and ceramic substrates, we have fabricated stacks for PASP and for high efficiency standard assemblies; however, this would be a difficult procedure to implement in large scale production. TAB technology is well established and easily scaled. We have demonstrated that it is feasible to bond together the two types of cells with a $8 \mu\text{m}$ thick glue line and then implement TAB techniques to make connections to three cell surfaces.

Lens/cell assemblies with 50X Entech domed Fresnel lenses were made in order to measure minimodule efficiencies. Using flash simulator testing and outdoor measurements, we have measured a triplet efficiency of 25.0% AM0 at 22°C.

Acknowledgments

The authors would like to acknowledge the assistance of Michael Fulton, Harold Soares, John Martin, Gene Fairbanks, Pat Gallagher and Bill Yerkes for antireflection coatings, cell-stack, PASP module and lens parquet assembly.

References

- ¹N.R. Kaminar et al., 20th IEEE Photovoltaic Specialist Conference (PVSC) (1988): 766.
- ²S.P. Tobin et al., 21st IEEE PVSC (1990): 158.
- ³L.M. Fraas, P.E. Gruenbaum, et al., 22nd IEEE PVSC (1992): 80.
- ⁴P.E. Gruenbaum, L.M. Fraas, et al., *IEEE Trans. Electron Devices* (1992-this issue).
- ⁵L.M. Fraas, G.R. Girard, et. al., *J. Appl. Phys.* 66 (1989): 3866.
- ⁶L.M. Fraas, J.E. Avery, et. al., *IEEE Trans. Electron Devices*, ED-37 (1990): 443.
- ⁷L.M. Fraas and J.E. Avery, *Optoelectronics-Devices & Technol.*, 5 (1990): 297.
- ⁸M.F. Piszczor et al., 22nd IEEE PVSC (1992): 1485.
- ⁹J.M. Gee and C.J. Chiang, 21st IEEE PVSC (1990): 41.
- ¹⁰M.F. Piszczor et. al., 21st IEEE PVSC (1990): 1271.
- ¹¹L.M. Fraas, J.E. Avery et. al, *ASME Solar Engineering 92* (1992): 825.
- ¹²M.S. Kuryla et al., 21st IEEE PVSC (1990): 1142.

N 9 3 - 2 7 9 6 3
97-20

158321

P 14

AN EVOLUTION STRATEGY FOR LUNAR NUCLEAR SURFACE POWER

Lee S. Mason
NASA Lewis Research Center

Abstract

The production and transmission of electric power for a permanently inhabited lunar base poses a significant challenge which can best be met through an evolution strategy. Nuclear systems offer the best opportunity for evolution in terms of both life and performance. Applicable nuclear power technology options include isotope systems (either radioisotope thermoelectric generators or dynamic isotope power systems) and reactor systems with either static (thermoelectric or thermionic) or dynamic (Brayton, Stirling, Rankine) conversion. A power system integration approach that takes evolution into account would benefit by reduced development and operations cost, progressive flight experience, and simplified logistics, and would permit unrestrained base expansion. For the purposes of defining a nuclear power system evolution strategy, the lunar base development shall consist four phases: precursor, emplacement, consolidation, and operations.

An Evolution Strategy for Lunar Nuclear Surface Power

Introduction

The production and transmission of electric power for a permanently inhabited lunar base poses a significant challenge which can best be met through an evolution strategy. Nuclear systems offer the best opportunity for evolution in terms of both life and performance. Applicable nuclear power technology options include isotope systems (either radioisotope thermoelectric generators or dynamic isotope power systems) and reactor systems with either static (thermoelectric or thermionic) or dynamic (Bryton, Stirling, Rankine) conversion. A power system integration approach which takes evolution into account would benefit by reduced development and operations costs, progressive flight experience, and simplified logistics, and would permit unrestrained base expansion. For the purposes of defining a nuclear power system evolution strategy, the lunar base development shall consist of four phases: precursor, emplacement, consolidation, and operations.

Precursor Phase

The precursor phase would precede a human return to the moon and would consist of robotic orbiters or rovers to perform mapping and site selection. Additional distributed experiment packages may be emplaced to gather information on resource extraction potential, and provide engineering data to influence future human missions. Power requirements will range from 100s of watts to several kilowatts per element. Systems will be required to deploy autonomously and tolerate the difficult lunar environment. Other requirements imposed on power systems include that they be lightweight and compact, adaptable to a wide range of applications, and utilize available technology. Power options consist of solar arrays, batteries, fuel cells, and radioisotope systems.

The precursor phase would culminate in a transitional period in which the critical elements required for the first human missions would be verified to confirm performance and reliability. The goal of such a transitional period from the power evolution perspective would be to validate the technologies necessary to achieve at least an order of magnitude increase in power level from those systems employed on initial robotic elements.

An objective in the power system evolution strategy would be to develop a standardized power module as a means of satisfying diverse payload needs while minimizing cost and development. Nuclear systems would be favored for their ability to provide uninterrupted, long lived power. Radioisotope Thermoelectric Generators (RTG) or Dynamic Isotope Power Systems (DIPS) could provide a robust and reliable source for steady-state day and night power while contributing toward an experienced base of operating nuclear systems on the lunar surface. Another advantage of isotope systems is that they are essentially insensitive to the extreme thermal environment over the lunar day/night cycle.

RTGs utilize the natural decay of plutonium-238 as a heat source for thermoelectric conversion to produce electric power. Conversion efficiency is on the order of 5%. RTGs performed extremely well during the five Apollo missions in which they were used. The five SNAP-27 RTGs had an initial power which ranged from 72 to 78 watts with a nominal specific power of 2.3 W/kg. Among the advantages associated with RTGs are long life and space operational experience. *Figure 1* shows the power history of the SNAP-27 RTGs. The current generation of RTGs, the General Purpose Heat Source (GPHS) RTG, provides about 300 We and weighs 60 Kg (5 W/kg) in the configuration used on the Galileo and Ulysses missions. RTGs would be applicable for lunar surface missions when power requirements range from several watts to about a kilowatt.

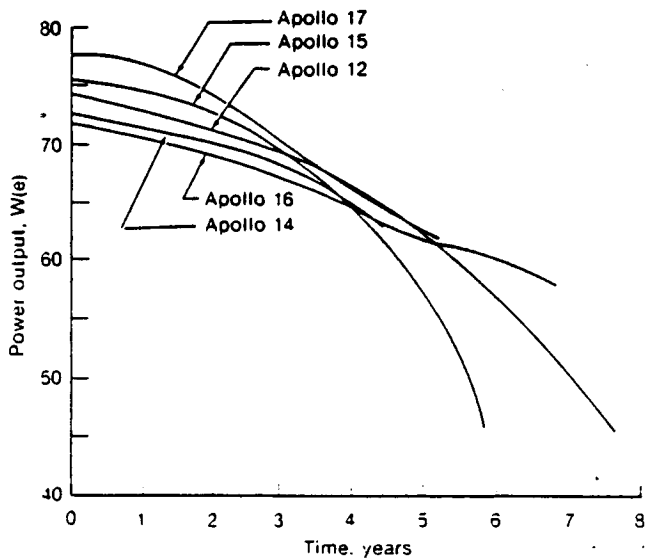

Figure 1. Power History for the SNAP-27 RTGs

DIPS uses this same plutonium heat source but converts the thermal power by means of a heat engine with conversion efficiencies on the order of 25%. The current high cost and scarcity of plutonium-238 makes the higher efficiency of DIPS very attractive. A relative cost comparison between RTGs and DIPS as a function of power level is provided in *Figure 2*. DIPS could use either Brayton or Stirling cycle conversion. Brayton is a more mature technology option based on the successful testing performed during the 1960s and 1970s. In addition, a 2 kWe solar dynamic ground test demonstration (GTD) program is underway which will utilize Brayton hardware developed in the 1970s. That program intends on refurbishing and testing the Brayton unit in combination with a solar concentrator/receiver and waste heat radiator under prototypic LEO operating conditions. *Figure 3* shows a possible Brayton DIPS concept employing a horizontal, flat-plate radiator surface and two heat source assemblies. A Brayton DIPS system similar to that shown in *Figure 3* and based on the GTD power converter design would result in a specific power of about 5.3 W/kg at 1 kWe.

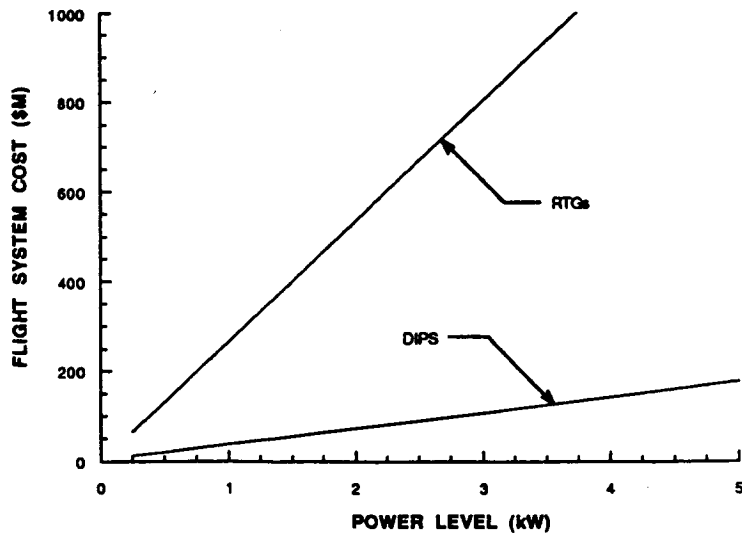

Figure 2. Relative Cost Comparison of RTGs and DIPS

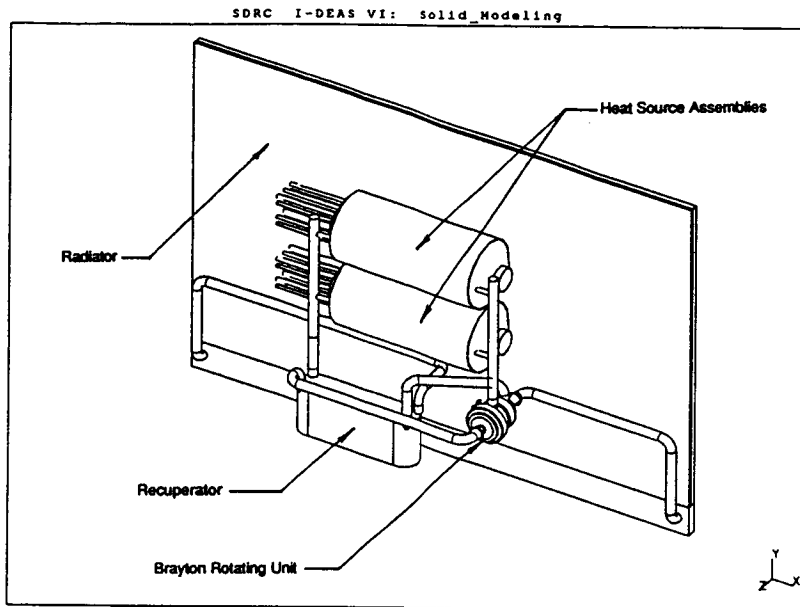

Figure 3. Brayton DIPS Concept

Emplacement Phase

The emplacement phase would initiate with the first human return to the moon. The outpost will at first resemble a modest "campsite" and not extend far beyond what was achieved on the Apollo missions. The goal of the emplacement phase will be to deliver those elements which would enable a human stay through the lunar night. The first lunar outpost might consist of a crew habitat located on a cargo lander and a series of teleoperated and crew transport rovers as well as additional science and in-situ resource utilization (ISRU) packages. Power requirements are likely to be in the 5 to 25 kilowatt range. Power systems will be required to be lightweight, easily deployable, and highly reliable. Options include photovoltaic/regenerative fuel cell (PV/RFC) systems, DIPS and small nuclear reactor systems. Nuclear systems offer a modest mass advantage over PV/RFC systems in this power range.

A modular power system concept would offer the greatest flexibility and growth potential while minimizing cost. A potential scenario for accomplishing this objective is through a multi-purpose mobile power utility cart. In an attempt to maximize return on initial investment, preference would be given to those systems or technologies which were successful in the precursor phase. DIPS technology used on precursor missions could easily be extended to the multi-kilowatt range. The advantage of DIPS over electrochemical systems such as batteries and fuel cells is that no recharging is required. As operating time is increased, the electrochemical system's mass increases substantially as shown in *Figure 4*. If plutonium availability is a concern, a common Pu-238 heat source canister design could be developed which would allow fuel change-out. In this way, the fuel inventory required of the subsequent higher power DIPS modules could be supplemented by extracting fuel canisters from earlier precursor units. A similar operations approach was used for the Apollo RTGs when the isotope fuel was carried separate from the converter in order to simplify in-transit cooling and inserted by astronauts after landing.

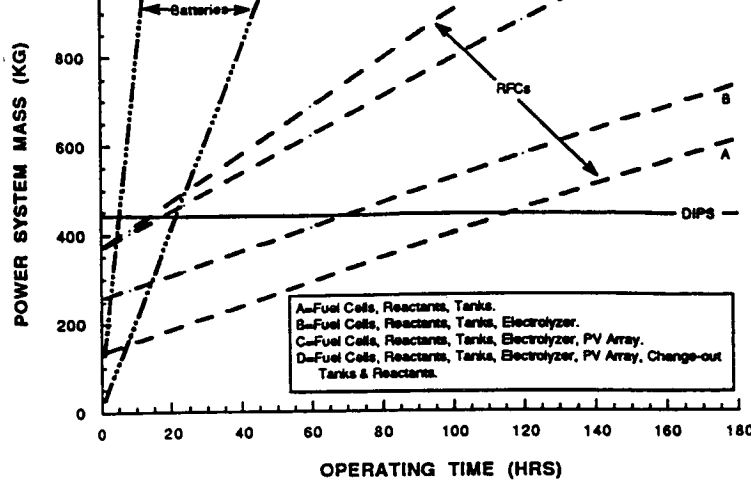

Figure 4. Comparison of Power System Options for 2.5 kW

If power requirements are closer to 25 kW, then consideration should be given to a small nuclear reactor system. In this case, development risk could be reduced by using the same power conversion technology that was used with success in the earlier isotope power systems. A modular nuclear reactor system combined with a dedicated rover platform and integral radiation shield could easily meet emplacement phase power requirements while minimizing on-site assembly. A concept for a reactor combined with Brayton cycle conversion is presented in *Figure 5*. The scenario for implementing a system of type is as follows: 1) the cart is off-loaded from the lunar cargo vehicle; 2) the rover is transported via a battery powered cart to a site approximately 1 km from the outpost; 3) a pre-connected transmission cable is unreeled from a cable spool as the cart travels away from the cargo lander; 4) radiator panels are deployed and the reactor power system is activated via earth command; and 5) the cart remains at the site over its service life. The mass of a 25 kW reactor cart was estimated to be about 5 tonnes including the man-rated radiation shield, cart structure, wheels, and battery power source. The advantage of such a system is that it could be readily adaptable to a variety of applications on the lunar surface, and subsequent systems could easily be delivered as required.

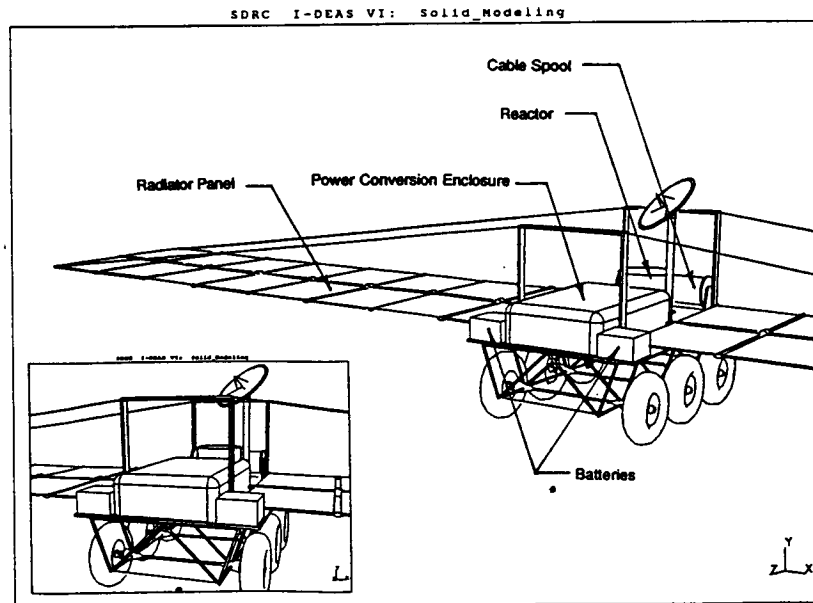

Figure 5. 25 kW Remotely Deployed Small Nuclear Reactor System

Consolidation Phase

The consolidation phase should see the emergence of a permanently occupied lunar outpost and an increased reliance on indigenous materials. A variety of resource extraction demonstrations, pilot plants, and science experiments would be established to verify regions of high resource potential. Demonstrations may be performed to investigate the feasibility of utilizing locally derived oxygen and hydrogen for propellant, cast regolith and ceramics for building materials, and He-3 for terrestrial fusion reactors. How-powered distributed experiment packages could be adequately powered by solar arrays, fuel cells, or isotope systems. Higher-powered, remote experiment sites could utilize a minimally shielded small nuclear reactor system. Construction vehicles would be introduced to facilitate the build-up of the lunar base infrastructure. Designs for power systems which could serve multiple distributed loads would be preferred as a way of reducing development, operations, and logistics costs. Power requirements will range from 50 to 100 kilowatts making nuclear reactor systems extremely desirable. Among the power users, a rover and construction vehicle recharging facility would be established to service battery and fuel cell powered vehicles.

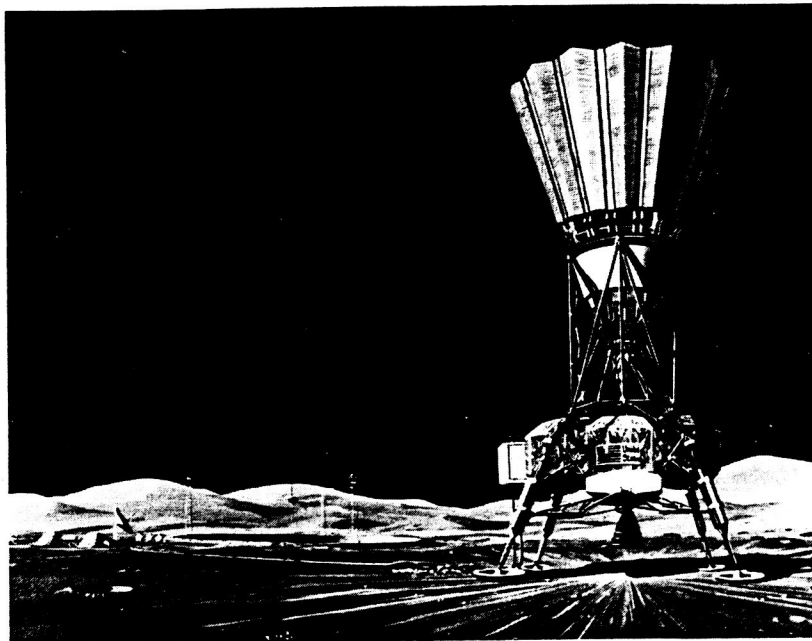

Figure 6. SP-100 Thermoelectric Lander Concept

Expanding human presence might lead to a centralized habitation and activity area and the installation of a power distribution network. At this point in the lunar base development, it might be appropriate to establish a central power system utility site. The first element within the utility site would be required to be easily deployed, reliable, and long-lived. A modular reactor power system combined with a dedicated lunar lander could be utilized to meet these requirements. *Figure 6* shows a concept for a 100 kWe SP-100 thermoelectric power system with a dedicated lander using shaped $4\text{-}\pi$ radiation shielding. The total landed weight of the thermoelectric lander is approximately 13 tonnes. A similar concept, shown in *Figure 7*, which uses Brayton conversion to supply 100 kWe would weigh about 9 tonnes. The selection of the power conversion technique would depend on how the lunar base was planned to evolve. If multiple, smaller, distributed outposts were planned,

the thermoelectric conversion technology option would be adequate utilizing individual landers at each of the outpost sites. If a single site was selected for full-scale development, dynamic conversion systems would be preferred for their ability to evolve to the multi-hundred kilowatt power plant size.

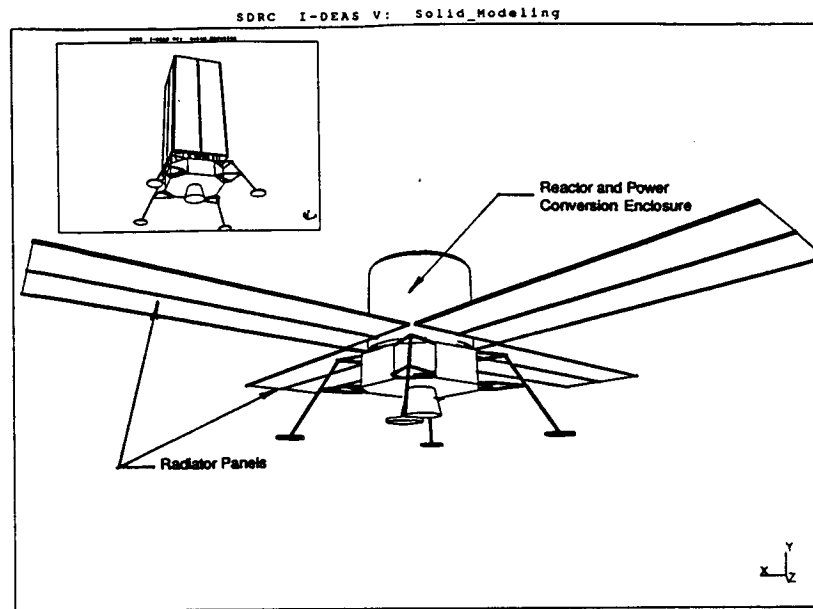

Figure 7. Lander Reactor Power System with Brayton Conversion

Operations Phase

The operations phase would be marked by a transition to base self sufficiency. Local propellant production would service all ascent and Earth return stages. Base expansion would be expedited by the use of indigenous materials for building structures. Launch and landing services would be expanded to accommodate the beginnings of colonization and the initial exportation of lunar derived resources such as He-3. Power requirements for habitation and resource production are likely to exceed several hundred kilowatts. At these power levels, PV/RFC systems become prohibitive on a mass basis. This is due to the massive energy storage system necessary to supply continuous power through the 354 hour lunar night period. *Figure 8* compares nuclear reactor systems with PV/RFC systems at various night power fractions for power levels up to 550 kWe. The operations phase of the lunar base development would require that nuclear power systems be able to meet changing requirements and accept new loads. Systems would be designed for maintainability, repair, and replacement as a means of extending service life and ensuring proper operation. In order to reduce mass, systems would utilize in-situ materials to the maximum extent possible and take advantage of previously delivered hardware.

The growing lunar base will bring about a need for a substantial rover fleet for crew transport, mining, hauling, construction and science. Mobile power requirements will be driven by operational scenarios and available infrastructure. For vehicles which can return to the central recharging facility, battery and fuel cell power systems will be adequate. For those vehicles which must operate continuously or be capable of extended duration excursions, isotope power systems would be used. RTGs and DIPS could maximize the use of previously delivered Pu-238 fuel by exchanging heat

source canisters as they are needed for various applications.

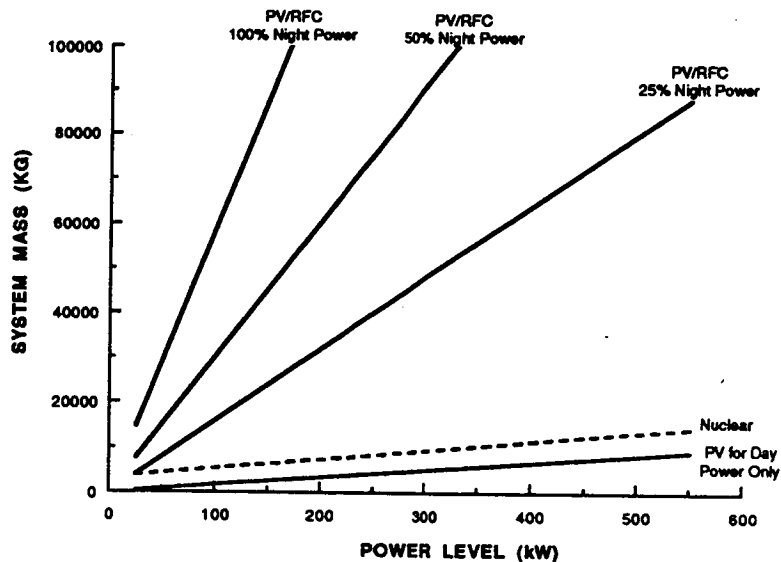

Figure 8. Comparison of Solar and Nuclear Power Systems for Lunar Base Applications

A subsequent, larger reactor power system could be delivered to the central power utility site to compliment and eventually replace the original lander system. An advantage to the central utility approach is that all the reactor systems could be located in a single remote area. This generation of reactor power systems would capitalize on experience gained from previous systems while incorporating technology enhancements such as improved materials for higher temperature operation. This power plant could have excess capacity to accommodate several years of growing power demand and could service the needs of all local lunar elements including habitats, laboratories, resource production plants, launch and landing facilities, and science platforms. Initially, the system could be operated at less than full thermal power and then ramped up to full power as power requirements increase. This strategy offers the potential for extended reactor service life while instilling confidence in system operations through incremental increases in power. The availability of crew members and construction equipment would permit the installation of an erectable reactor power system utilizing lunar regolith for radiation shielding.

Reactor power system design emphasis would be on performance, long life, and operational flexibility. *Figure 9* depicts a nuclear reactor power plant using Stirling conversion to provide as much as 825 kWe. This concept assumes the emplacement of the reactor in an excavation to provide adequate radiation protection for humans. The stirling engines and radiators are located on the lunar surface and extend radially from the reactor core. A variety of power conversion options could be employed using this design approach. *Figure 10* compares in-core thermionic systems with Brayton and Stirling systems utilizing the SP-100 reactor heat source for 550 kWe. Four thermionic cases are presented with assumptions ranging from conservative to advance with the baseline case being representative of the current Thermionic Fuel Element (TFE) Verification Program. Both a conservative, low temperature case and a more advanced, high temperature case are shown for SP-100 dynamic system options. All systems are within 30% of 12 tonnes for a specific power of about 50 W/kg. In addition to mass there are several other discriminators which will dictate the system

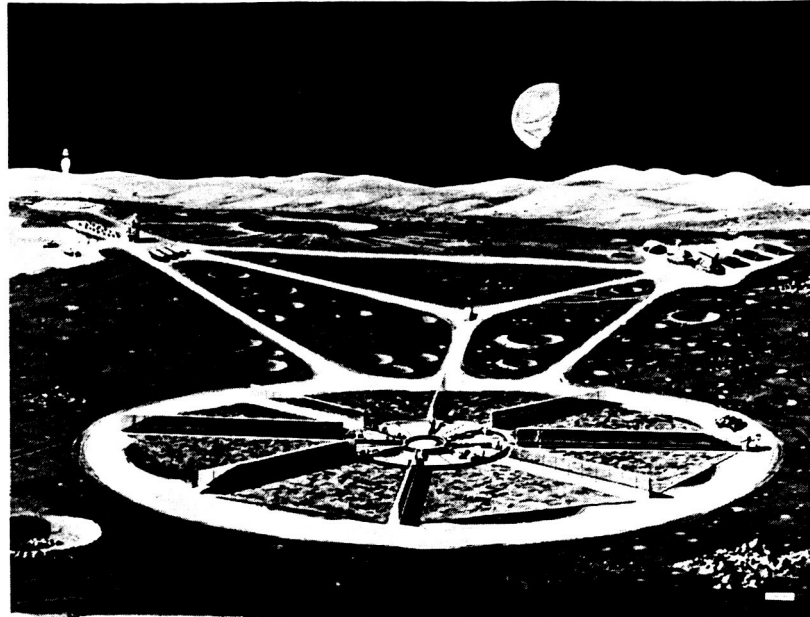

Figure 9. 825 kWe Nuclear Reactor Power Plant with Stirling Conversion

of choice including reliability, life, growth potential, deployability, and maintainability. These characteristics are at least as important as mass from an overall mission perspective.

Conclusion

The nuclear power system evolution approach described in this paper offers a variety of options and benefits. Nuclear systems offer the greatest advantage in terms of robustness, performance, and growth potential. Early, robotic missions could use RTGs and small DIPS. Initial human missions will take advantage of lessons learned on precursor missions in terms of both engineering data and hardware experience. DIPS could be extended to the multi-kilowatt level or small nuclear reactors deployed remotely by means of a mobile platform could be utilized to meet the initial outpost requirements. As the base matures, a power system network could be established which uses a modular reactor system combined with a lunar lander to serve multiple loads. Subsequent reactor systems will use in-situ materials for radiation shielding and take advantage of the crew and construction equipment for assembly.

The primary benefits to the evolution approach are: 1) reduced development and operations cost; 2) progressive flight experience; 3) simplified logistics; and 4) growth accommodation. These benefits are the result of a logical and rational planning approach. Affordable costs can be maintained by choosing technologies which are capable of meeting the widest range of missions and applications. Each step of the nuclear power system evolution will build on previous successes incorporating technology improvements and greater autonomy. The selection of a common technology with growth potential will ease logistics requirements and expedite lunar base maturation. In addition, the verification of power system performance and reliability on lunar missions will provide the framework for subsequent human missions to Mars.

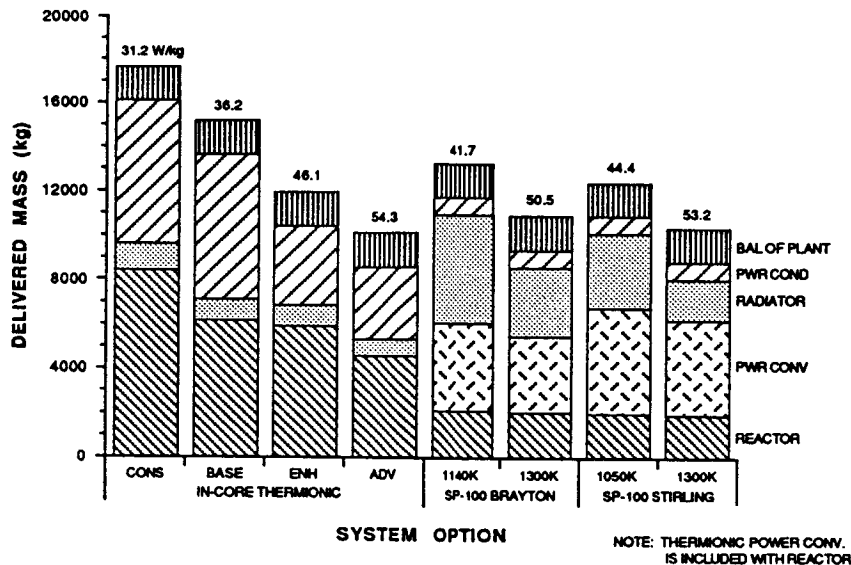
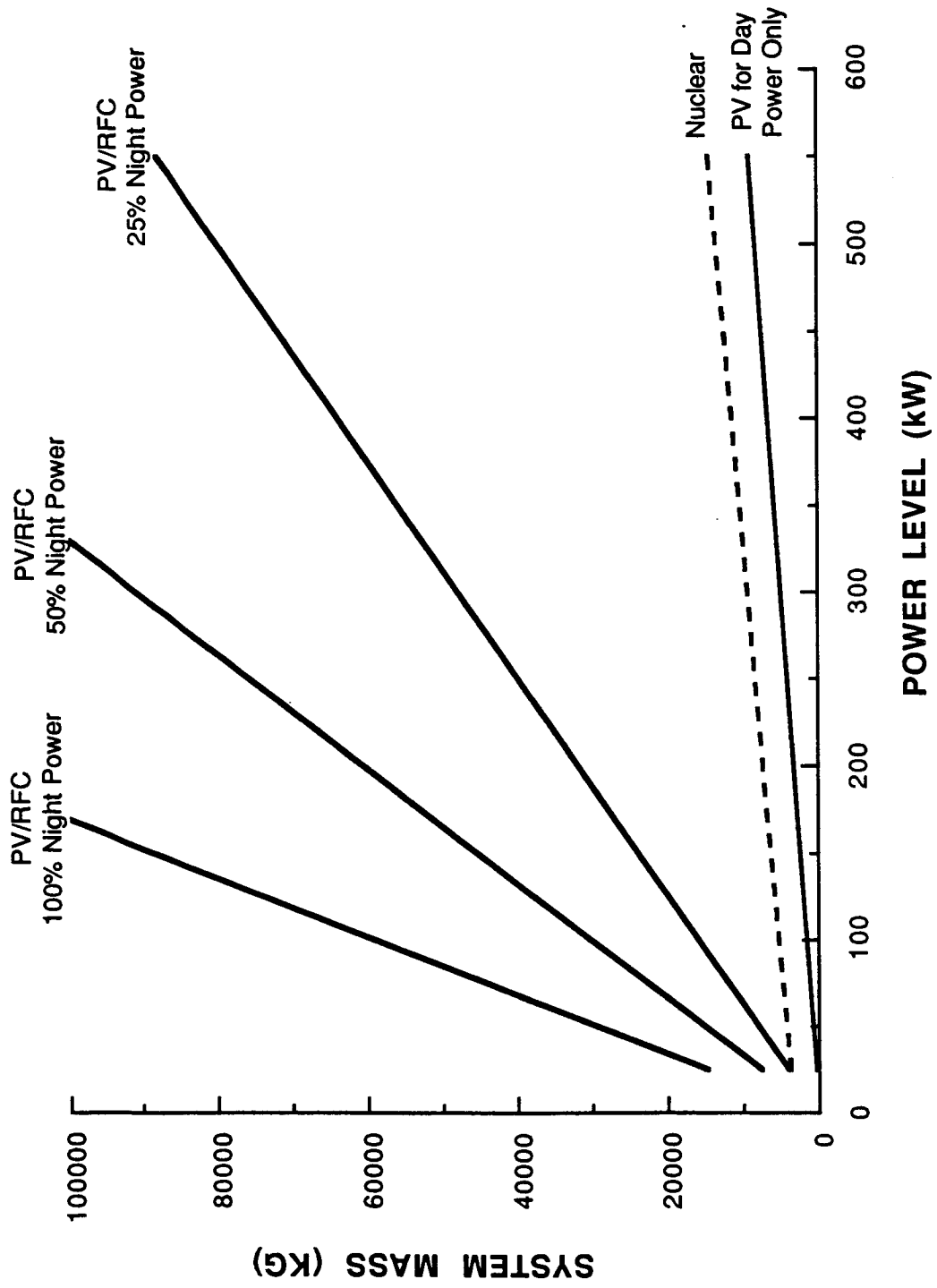
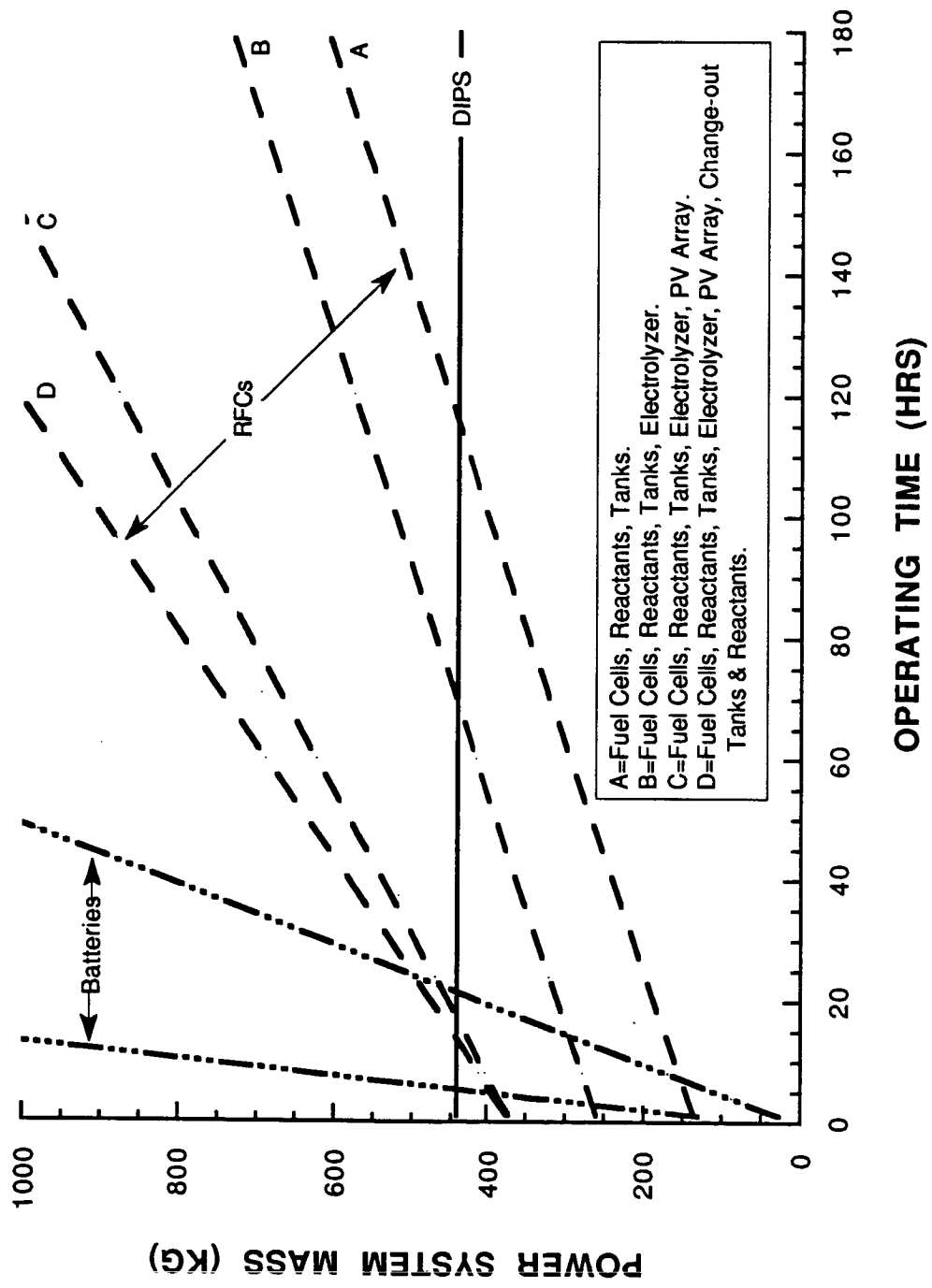

Figure 10. Comparison of Nuclear Reactor Power System Options at 550 kW

References

1. HICKMAN, J.M., BLOOMFIELD, H.S., *Comparison of Solar Photovoltaic and Nuclear Reactor Power Systems for Human-Tended Lunar Observatory*, NASA TM-102015, August, 1989.
2. MASON, LEE S., BLOOMFIELD, HARVEY S., *SP-100 Power System Conceptual Design for Lunar Base Applications*, NASA TM-102090, January, 1989.
3. PETRI, DAVE A., CATALDO, ROBERT L., BOZEK, JOHN M., *Power System Requirements and Definition for Lunar and Mars Outposts*, prepared for the 25th Intersociety Energy Conversion Engineering Conference, Reno, Nevada, August, 1990.
4. SKRABEK, EMANUEL A., *Performance of Radioisotope Thermoelectric Generators in Space*, prepared for the 7th Symposium on Space Nuclear Power Systems, Albuquerque, New Mexico, January, 1990.
5. MASON, LEE S., SCHMITZ, PAUL C., GALLUP, DONALD R., *Lunar In-Core Thermionic Nuclear Reactor Power System Conceptual Design*, prepared for the 8th Symposium on Space Nuclear Power Systems, Albuquerque, New Mexico, January, 1991.
6. SCHMITZ, PAUL C., MASON, LEE S., *Space Reactor/Stirling Cycle Systems for High Power Lunar Applications*, NASA TM-103698, January, 1991.
7. MASON, LEE S., et. al., *SP-100 Reactor with Brayton Conversion for Lunar Surface Applications*, NASA TM-105637, January, 1992.





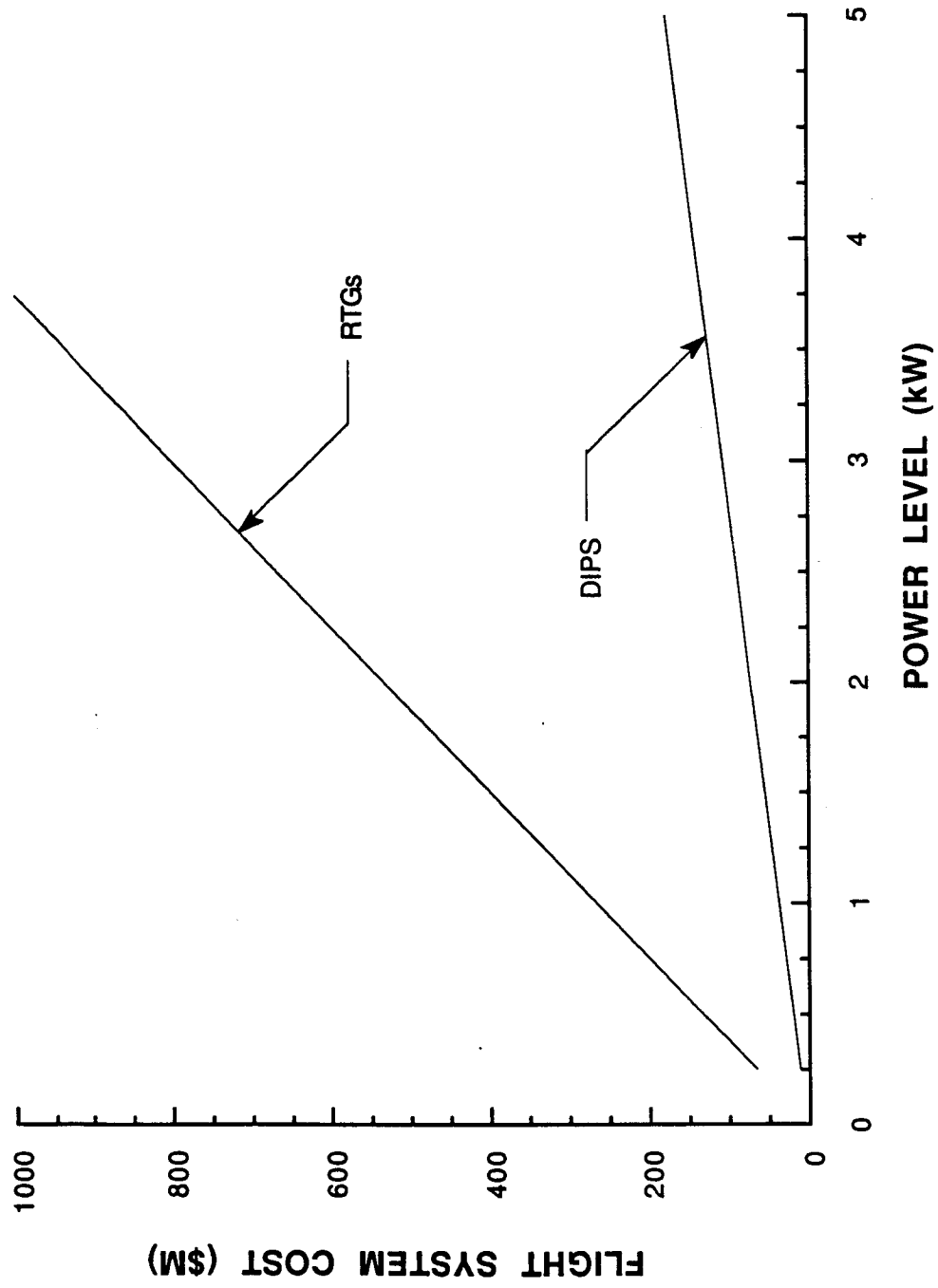

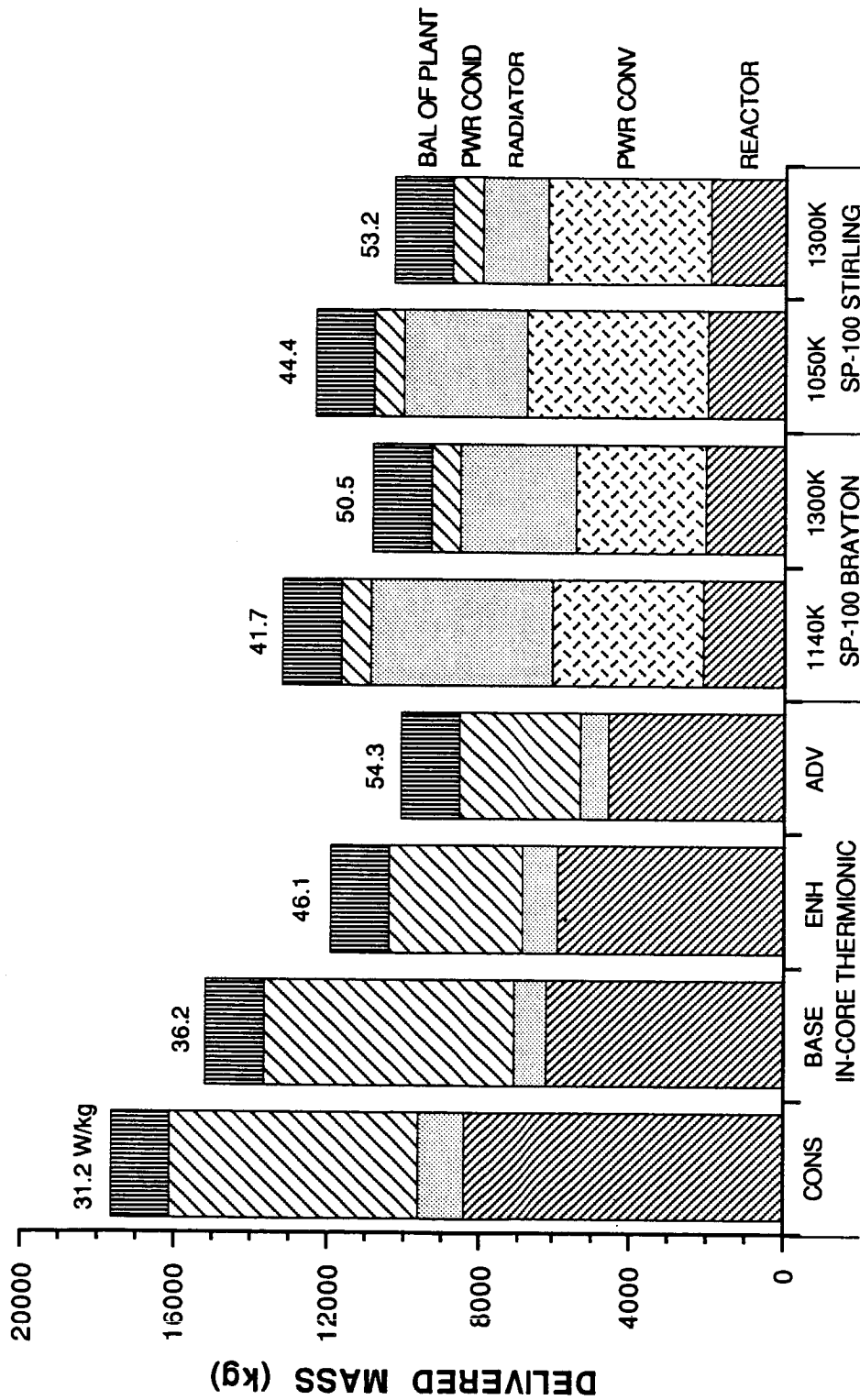

NOTE: THERMIONIC POWER CONV. IS INCLUDED WITH REACTOR

SYSTEM OPTION

EARTH TO SPACE POWER BEAMING: A NEW NASA TECHNOLOGY INITIATIVE

John D.G. Rather
NASA Headquarters

Abstract

Laser power beaming from the Earth's surface is an innovative and potentially cost-effective option for reliably providing electrical power for applications such as space transportation, Earth-orbiting satellites, and lunar development. The maturation of laser power beaming technology can support low power applications such as upgraded conventional communications satellites in the present decade. Power beaming systems to support extensive lunar base operations that may consume extremely large amounts of power can be implemented early in the 21st century. The synergistic advantages of high-thrust, high-specific-impulse electric propulsion may make enhanced, low cost space logistics an area of unique significance for laser power beaming.

Economic forces will continue as a driving factor in the selection of major system elements for both commercial applications as well as the avant-garde national space missions envisioned for the 21st century. As a result, the implementation of laser power beaming systems will only take place if they can demonstrate clear economic benefits without sacrificing performance, personnel safety, or the environment. Similarly, the development activities that are a necessary precursor to any operational system will take place only if key industry and government leaders perceive laser power beaming systems as an achievable goal with realistic payoffs in comparison to competing energy options.

This paper summarizes NASA's current research to evaluate laser power beaming systems as they apply to applications of greatest interest, and it includes a summary of the current laser power beaming program within the NASA Headquarters Office of Aeronautics and Space Technology. This research effort will quantify some key technical certainties and uncertainties pertaining to laser power beaming systems appropriate for space applications as well as establish a path of development that includes maturation of key technology components for reliable laser and millimeter wave power beaming systems during the 1990s. the program is known as "SELENE," an acronym for Space Laser Energy.

58-20
ABS. ONLY
158322

P. 1

N 9 3 - 2 7 9 6 5

FUEL CELL TECHNOLOGY FOR LUNAR SURFACE OPERATIONS

Henry J. DeRonck
International Fuel Cells Corporation

59-44
158323
p-4

Abstract

Hydrogen-oxygen fuel cells have been shown, in several NASA and contractor studies, to be an enabling technology for providing electrical power for lunar bases, outposts, and vehicles. The fuel cell, in conjunction with similar electrolysis cells, comprises a closed regenerative energy storage system, commonly referred to as a regenerative fuel cell (RFC). For stationary applications, energy densities of 1,000 watt-hours per kilogram, an order of magnitude over the best rechargeable batteries, have been projected. In this RFC, the coupled fuel cell and electrolyzer act as an ultra-light "battery." Electrical energy from solar arrays "charges" the system by electrolyzing water into hydrogen and oxygen. When an electrical load is applied, the fuel cell reacts the hydrogen and oxygen to "discharge" usable power.

Several concepts for utilizing RFCs, with varying degrees of integration, have been proposed, including both primary and backup roles. For mobile power needs, such as rovers, an effective configuration may be to have only the fuel cell located on the vehicle, and to use a central electrolysis "gas station."

Two fuel cell technologies are prime candidates for lunar power system concepts: alkaline electrolyte and proton exchange membrane. Alkaline fuel cells have been developed to a mature production power unit in NASA's Space Shuttle Orbiter. Recent advances in materials offer to significantly improve durability to the level needed for extended lunar operations. Proton Exchange membrane fuel cells are receiving considerable support for hydrospace and terrestrial transportation applications. This technology promises durability, simplicity and flexibility.

FUEL CELL TECHNOLOGY FOR LUNAR SURFACE OPERATIONS

The fuel cell is an electrochemical device in which hydrogen and oxygen react directly to produce electricity without combustion or mechanical conversion. The products of this reaction, besides electricity, are potable water and heat. The fuel cell is highly efficient; aerospace fuel cells operate at over 70% efficiency at rated power. Unlike most power sources, fuel cell efficiency increases at part power.

Fuel cells have been utilized in the U.S. manned space programs because their high efficiency and high energy density provide the lowest-mass means of generating electrical power. Other beneficial characteristics of the fuel cell include: freedom from noise, vibration, and torques; the capability for instantaneous power transients (both up and down); and the absence of any effluents other than potable water. Three IFC fuel cell power plants provide all on-board electrical power for the NASA Space Shuttle Orbiter, and were previously utilized on the Apollo Command and Service Module.

Another beneficial characteristic of fuel cells is the relationship between power and energy. A fuel cell powerplant is sized based on the system power requirements; this results in a fixed powerplant mass independent of energy. Energy needs are met by providing the hydrogen and oxygen reactants (and storage tanks), which are extremely light compared to other forms of energy storage. In the case of the Orbiter, this results in a power system energy density of over 500 watt-hours per pound.

While there are several types of fuel cell technologies (differentiated by the cell electrolyte), only two are relevant to space applications: alkaline and proton exchange membrane (PEM). The alkaline cell utilizes an aqueous potassium hydroxide (KOH) solution as the electrolyte, while the PEM cell employs a perfluorosulfonic acid polymer membrane. Each technology offers certain advantages for particular applications, as is discussed following. The alkaline technology is more mature, as evidenced by its use on the Orbiter. However, PEM is receiving considerable support for terrestrial and hydrospace applications and is approaching operational powerplant status.

Alkaline cells intrinsically have the highest efficiency. However, the concentration of the aqueous electrolyte must be controlled with relative precision, which necessitates a sophisticated control system. The alkaline technology is particularly well-suited to longer-duration missions, where its high efficiency results in pronounced reactant mass savings. Also, the alkaline cell is capable of large-magnitude power pulses (ten or more times nominal). The current state of the art in alkaline fuel cells is the 12-kw Orbiter powerplant, which has accumulated over 27,000 hours of operation in 45 missions. In SEI, alkaline fuel cells are envisioned primarily for efficiency-critical baseload or power sharing applications, where they will operate continuously for long periods with few start/stop cycles.

The PEM fuel cell, with its solid electrolyte, requires a simpler control system, affording ease of start/stop. Because the electrolyte is a non-corrosive solid, PEM cells can utilize less sophisticated materials than are required for alkaline cells. The simplified controls and materials result in a powerplant which is projected to be lower in cost. Further, the absence of a corrosive electrolyte enables extended durability. The PEM cell does, however, have somewhat lower efficiency than the alkaline cell at comparable conditions. These characteristics make PEM most suited to missions where repeated start/stop and durability are the prime factors. In SEI, PEM cells are envisioned for use in rovers or other installations where frequent start/stop and relatively short operating periods are necessary.

Numerous studies have indicated that regenerative fuel cells (RFCs) are a key element in a lunar surface power system. An RFC is created by coupling a fuel cell with an electrolyzer and tankage to act as an ultra-light battery. The electrolyzer is also an electrochemical device, which acts as the reverse of a fuel cell: the application of electric power to the cell causes the dissociation of water

into its hydrogen and oxygen constituents. In the RFC, the electrical power available from a solar photovoltaic array during the lunar day is used to electrolyze water. The resulting H₂ and O₂ are stored as high-pressure gasses. Then, in lunar night, the reactants are supplied to the fuel cell to produce electric power. The product water is collected and stored, to be electrolyzed during the next lunar day. Thus the RFC is a totally closed system, requiring only an initial charge of either water or reactants.

RFCs are considered for use in several modes. In a photovoltaic system, the RFC would be the sole source of power during lunar night. However, if a nuclear-based system is eventually established, the RFC would be used to provide peak load shaving and emergency backup power. For stationary equipment, such as a habitat or outpost, the fuel cell and electrolyzer would be integrated as a single unit. However, when it is desired to have mobile power, such as a rover, the fuel cell and electrolyzer can be decoupled. The electrolyzer would be located at the base, where it would deliver reactants to storage tanks. The fuel cell would be on the rover, which would return to the base "gas station" to refuel and return its product water for electrolysis.

RFCs have a significant mass advantage over batteries. In a study¹ for NASA, Los Alamos National Laboratory sized an RFC systems for a 25-kW 14-day lunar night mission; this resulted in a system mass of 8300 kilograms. By comparison, a battery system, using 50 watt-hour per kilogram batteries, would have a mass of 84,000 kilograms. Thus the RFC provides a mass saving of 75,000 kilograms.

The choice of fuel cell technologies (between alkaline and PEM) is still undecided. The alkaline system is space qualified and more efficient, but at present, its durability is limited due to corrosion of the cell materials by the electrolyte. The PEM system, while potentially simpler and less costly, is not operational and has not demonstrated space/lunar compatibility. The choice (if in fact it is necessary to make a single choice) will depend on mission/application requirement and on the state of the art at that time. It is possible, however, that both technologies will be used in different applications to take advantage of their unique capabilities.

The major issue in the alkaline cell is durability due to corrosion. Recent work in high power density fuel cells for SDI applications has identified and demonstrated new materials which significantly extend cell life. Incorporation of these materials into the Orbiter (or an Orbiter-derivative) powerplant would allow projection of a 20,000 - 40,000 hour service life. In addition, the compatibility of the alkaline fuel cell with PEM electrolyzers (the probable choice for SEI) has been demonstrated. An Orbiter powerplant was operated with a PEM electrolysis unit, as a breadboard RFC, for extended periods by NASA-JSC.²

In PEM, the key issue is to adapt the soon-to-be-operational terrestrial/hydrospace cell and powerplant to the space/lunar environment. While nothing in this cell and system design is inherently incompatible, the efficacy in a 0g or low-g vacuum environment has yet to be demonstrated. Further, the terrestrial PEM applications are not mass-critical, so the cell may require engineering to reduce mass. Additional effort to improve efficiency may also be necessary.

Despite the key role assigned to RFCs in the space exploration scenario, there is at present no ongoing government-sponsored activity to test or develop the RFC. Nor is there any activity to improve the Orbiter fuel cell or adapt the PEM cell to space. Thus, although RFC concepts are well-defined, and have been tested as a breadboard, there is little depth of knowledge regarding integration issues. While the existing state of the art may be adequate for early lunar missions, a strong, focused development effort will be necessary to insure readiness for a permanent lunar presence.

REFERENCES

¹Huff, J., Vanderborgh, N., and Hedstrom, J. (Los Alamos National Laboratory). "Technology Assessment and Trade-Off Study of Fuel Cell and Electrolyzer Technologies for the Project Pathfinder Energy Storage System." Prepared for the National Aeronautics and Space Administration, Lewis Research Laboratories, Cleveland, OH. Report number A-UR-90-3244 (February 1, 1991).

²Saucier, D., "Hybrid Regenerative Fuel Cell Systems for Space Applications." Proceedings of the 23rd Intersociety Energy Conversion Engineering Conference, Denver, CO (July 31 - August 5, 1988).

ELECTRICAL POWER INTEGRATION FOR LUNAR OPERATIONS

Gordon Woodcock
Boeing Defense and Space Group

S10-20

158324

P-15

Abstract

Electrical power for future lunar operations is expected to range from a few kilowatts for an early human outpost to many megawatts for industrial operations in the 21st century. All electrical power must be imported -- as chemical, solar, nuclear, or directed energy. The slow rotation of the Moon and consequent long lunar night impose severe mass penalties on solar systems needing night delivery from storage. The cost of power depends on the cost of the power system, the cost of its transportation to the Moon, operating cost, and, of course, the life of the power system. The economic feasibility of some proposed lunar ventures depends in part on the cost of power. This paper explores power integration issues, and costs and affordability in the context of the following representative lunar ventures:

1. Early human outpost (10 kWe)
2. Early permanent lunar base, including experimental ISMU activities (100 kWe)
3. Lunar oxygen production serving an evolved lunar base (500 kWe)
4. Lunar base production of specialized high-value products for use on Earth (5 kWe)
5. Lunar mining and production of helium-3 (500 kWe)

The schema of the paper is to project likely costs of power alternatives (including integration factors) in these power ranges, to select the most economic, to determine power cost contribution to the product or activities, to estimate whether the power cost is economically acceptable, and, finally, to offer suggestions for reaching acceptability where cost problems exist.

LUNAR ELECTRIC POWER INTEGRATION

Introduction: Sources and Uses of Power on the Moon

Past lunar missions have used battery power (the Apollo Lunar Module), solar power (Surveyor), and RTG power (the ALSEP instruments left on the lunar surface by Apollo). Future missions, as indicated in *Figure 1*, may use all of these and in addition nuclear and beamed power, the latter transmitted by microwave or laser. Laser beaming can achieve narrow enough beams to transmit power from Earth; microwave transmission would be limited to the L1 point (about 55,000 km. towards the Earth from the near side of the Moon), or closer. Uses of power on the Moon include life support for people, operation of scientific instruments and equipment, infrastructure including habitats, transportation, communications, and other subsystems. Several industrial uses have been proposed, from making oxygen for lunar transportation systems to production of energy or energy supplies for Earth. The lunar module produced and used about 1 kW electric power. Future uses, in the far future, could go to thousands of megawatts.

Figures 2 and 3 summarize ranges of power consumption for the uses cited in *Figure 1*.

Life Support systems use power to recycle and purify water, to regenerate oxygen after it has oxidized food to H₂O and CO₂, to provide thermal control to the crew cabin and circulate air, to process wastes, and to control the cabin atmosphere and remove trace contaminants. Future lunar crew missions will use partially or fully closed systems. Partially closed systems recycle water. Regeneration of oxygen for a "fully closed" system roughly doubles the power requirement. A life support system is not entirely closed unless it also regenerates food. Since plant photosynthesis is not energy efficient, regeneration of food with man-made energy through artificial lights is power intensive. Food regeneration also requires extra pressurized volume. Natural sunlight is available on the Moon during the lunar day. The problem is that the lunar day and night are each about 14 Earth days long. Plants are likely to die, or at least not be productive, if deprived of light during the lunar night. Therefore, some artificial light will be required and must be produced during the lunar night when sunlight is not available for power generation. How much artificial light is needed, or should optimally be provided, is the subject of current research and is not presently known. Saving power tends to increase volume since plants grow more slowly with less total light per unit time. A "best guess" for bioregenerative life support today would be about 6 kWe per person.

Most **science** missions require relatively little power. Large-scale drilling projects might require up to tens of kW but would be intermittent in nature. Telescopes need less than one to a few kW. Science projects demanding high power can be imagined but none are presently in NASA's planning.

Infrastructure refers to all the other systems and subsystems, in addition to ECLS, required on the Moon to keep a base operational. The 5 kWe initial value provides for basic data processing, controls and displays, and communications. As more crew are added power increases for lights, crew systems such as galleys and toilets, additional data processing and displays, airlock operations, and other miscellaneous uses.

Initial lunar **surface transportation** will have at least one pressurized rover and later operations may have up to several unpressurized and pressurized rovers. Mining and construction operations can range from small experimental systems to large industrial systems. A 12-person base will probably have enough crew labor available to support only very modest mining and construction operations

such as production of lunar oxygen for the lunar space transportation system.

The bottom of *Figure 2* presents a typical calculation. The first line is 5 for initial infrastructure, 2 + 1 life support and infrastructure per person, 25 for science, 5 for unpressurized rovers and 10 for two pressurized rovers. The bioregenerative example uses 6 kWe per person for life support.

Figure 3 describes industrial uses. A typical 12-person base might produce 50 t. oxygen per year, for 1.5 million kWh per year, an average of 171 kWe. Particular specialized products have not been identified. The extremely high vacuum and dry environment on the Moon could, for example, lead to specialized opto-electronic products. Depending on the processing required, the energy cost per unit mass can be high. Production would likely be quite small. At 1 t. of specialized products per year, for example, and 267,000 kWh per ton, the power is about 30 kWe.

Scenarios for energy supply to Earth involve processing of large amounts of materials and need large amounts of power, up to hundreds of megawatts or more. These scenarios have severe limits on affordability and must consider energy payback. Laser power transmission from the Earth to the Moon, while an attractive option for lunar power levels up to a few megawatts, may prove so inefficient as to be not viable for Earth energy scenarios. This depends on the energy consumption on the Moon needed to produce a given amount of Earth energy, a value for which only very poor estimates exist. Clearly, it does not make sense to supply energy to Earth with a system that consumes more energy on Earth than it produces.

Costs and Economic Considerations

Supply of electric power on the Moon can best be evaluated on the basis of cost of the power produced, and whether the cost can be reasonably borne by the planned uses. A major component of the cost of any lunar power system is the amortization of the cost of delivering the power system or its constituents from Earth.

Figure 4 illustrates representative cost estimates for lunar cargo transportation from Earth. A large heavy-lift vehicle (HLV) of the type contemplated for early use in the SEI program is estimated to have a delivery cost to low Earth orbit of about \$2500/lb. (We use cost per pound here because it is the most commonly quoted value. \$2500/lb is \$5.5 million per metric ton.) If conventional cryogenic rocket propulsion is used for delivery from low Earth orbit to the Moon, the cost multiplier is about eight, mainly because the payload delivered to the lunar surface is about 1/6 the payload to low Earth orbit. The cost estimate shown here considers a small amount for operations costs. This presumes that operations for HLV launches are conducted by crews that will perform other duties when not working the infrequent HLV launches. If crews are dedicated or if launch preparation and mission operations become elaborate, the operations cost contribution could easily be several times the estimate shown.

At higher launch rates hardware production costs as well as operations benefit from economies of scale. When lunar transportation operations mature and become routine it will be economical to use a smaller, frequently launched HLV with reusable lunar in-space transportation hardware and Earth orbit operations for re-use turnaround. Finally as launch rates exceed a few tens, partially to fully reusable launchers become economic. Shown here is a reusable booster, reusable core stage propulsion/avionics module, expendable core tank design approach identified as optimal for launch rates in the 100 to 200 range by several studies including the Space Transportation Architecture Study (STAS) conducted a few years ago for the Air Force. Transport costs to the Moon are further reduced by advanced reusable cargo delivery systems such as the electric propulsion lunar transfer

vehicle referenced in the *Figure*. The power cost estimates to follow used the transportation cost values (20,000, 2500, 1500, and 400 dollars per pound) shown in this *Figure* as appropriate to the lunar activity level considered.

Cost Estimates for Lunar Power

Given estimates for transportation cost it is possible to estimate the cost of lunar power alternatives in a manner similar to estimating the cost of power from utility powerplants. *Figure 5* presents such estimates for a wide range of power sources and lunar scenarios. All of these estimates are for cost and do not include profit. Since most of the investment in the power plant is at the beginning of life and the power is delivered over a period of years, it is necessary to include a cost of money which in all cases was set at 10% per annum. In each case the transportation cost was selected based on the power output considered and the presumed level of lunar transportation activity appropriate to that power output.

It is perhaps important to comment further on the cost of money. Cost of money is calculated the same way as return on investment. ROI is often quoted as a total return including cost of money plus additional profits. Cost of money is usually quoted as the return available on low-risk investments. This is the interest rate paid for borrowed funds by a secure borrower, and of course also the interest rate an investor can obtain without taking appreciable risk. Private investors will demand a much higher return on a risky project. A cost of money equal to the interest rate the government normally pays should be assessed against a project funded by the U. S. government. If a utility company were to make the investment in a lunar power system, it would demand a much higher rate of return than is usual for the relatively safer investment in an Earth-based power plant. The 10% used here is somewhat high for government-paid interest and somewhat low for the return that would likely be sought by a utility.

The Apollo lunar module was battery powered. The cost of its electric power was something like the \$200,000/kWh quoted here. Since the lunar module delivered less than 100 kWh during its lunar surface mission, the resulting \$20 million cost for power on the Moon was a small fraction of the total cost of an Apollo flight. Fuel cells provide about an order of magnitude greater power density (per unit mass) and therefore yield an order of magnitude lower cost. Nuclear power plants by comparison have enormous power density. Even a small nuclear plant can deliver power on the Moon a thousand times cheaper than batteries.

As nuclear power plant size increases and transportation cost comes down with the much greater scale of lunar operations appropriate to the higher power levels, nuclear power cost estimates come down to a few dollars per kWh. The lowest nuclear values shown are within a factor of 100 of utility power on Earth. The cost of the largest nuclear plant shown includes a hefty charge for on-site construction on the Moon. This is an exceedingly uncertain cost since the amount of construction is not known (concepts are not well enough defined to make rational estimates) and the cost of the components of a lunar construction operation, such as labor costs, are also not known. The cost of providing fabricated uranium reactor core elements is also shown, to indicate that it is a modest fraction of the estimated total nuclear power cost. Fusion fuels (deuterium and helium-3) are available on the Moon. The extraction cost is poorly defined. Solar electric costs are estimated lower than nuclear cost if the solar power is used only during the lunar day when the sun shines, and several times higher if night-time storage must be provided for continuous loads. This is an important factor to be considered by a potential power user, especially before large-scale continuous lunar power systems are emplaced: a day-only power user may get off considerably cheaper.

It has been observed that a large-scale continuous solar power system could be installed at either of the lunar poles. The Moon's polar axis is inclined only about 1 degree to the ecliptic. Consequently, a ring-wall solar array installed around a lunar pole would be continuously illuminated with the effective illumination area 1/# times the cylindrical array area. A transmission line would need to be installed to the points of use but at high enough power consumption levels, if the transmission line could be made from lunar materials, the cost could be very competitive.

The final set of estimates is for laser beam power projected to the Moon from beaming stations on Earth. This source of power is estimated to be cost competitive with nuclear systems in the range about 100 kWe to 10 MWe, with uncertainties in costs for both sources of power much too large to ascertain a winner. At power levels 100 MWe or above, the economies of scale for large nuclear plants presently show a preference for nuclear power. Laser power beaming, however, is in its infancy and major improvements in system efficiencies or new laser technologies could change this result.

Figure 6 illustrates that the problem of large-scale lunar industrialization is much broader than just electric power. The figure is a mass distribution estimate, developed by an input/output analysis, for a lunar industrial plant capable of Producing 40,000 metric tons of metals and lunar glass fiber structural materials per year. The total estimate for the plant mass was also about 40,000 t., a product-to-mass ratio of one. This, by the way, puts it in the competitive range. The point is that for this lunar plant, with total mass like that of an aircraft carrier, the 100 MWe power plant at 10 kg/kWe is a small portion of the total installation. The plant mass included a mass driver (electromagnetic catapult) for launching finished product to a lunar libration point. Most of the power consumption, however, is for reduction of lunar rocks to metals. Large-scale lunar industrialization will require major advances on a broad front of planetary resource utilization and economic space operations.

Affordability of Lunar Power

Figure 7 attempts to put the results obtained here into perspective. On the left are ranges of "reasonable" costs of power for several applications. (The units for each application are different; see curves.) For example, the cost of power to support crew operations can range from a few hundred millions per man-year to as low as a million for large-scale operations. The cost of a man-year on the Moon for Apollo was something like sixty billions. We will not pay such a high price in the future. The projected cost for NASA's proposed First Lunar Outpost is on the order of \$3 billion per man-year. This drops to about 200 million for a 12-person permanent base and further to a few millions per man-year for a larger industrial operation. Consequently we set the target value for power cost at a fraction of these figures, a high of about 300 million and a low of 1 million.

The bottom of the chart shows costs for power with ranges for the various technologies from the estimates in this paper. Chemical energy for electric power, for example, is shown as marginally within the top of the range for crew support and too high for the other applications. Solar/RFC hits the middle of the range for crew support; nuclear and (laser) beamed power both extend to the bottom of the crew range.

Cost range rationales for the other applications were as follows: Oxygen shipped from Earth early in lunar operations will cost several times \$10,000 per pound. The upper end of the range is set at \$10,000. Earlier we indicated a possibility for lunar transportation to drop almost two orders of magnitude by the time of large-scale lunar operations; a corresponding drop in power cost for lunar oxygen is shown. There is no good estimate for special products. I took the view that these would be highly specialized raw materials for which manufacturing processes and properties would benefit

from the extreme lunar vacuum and state of desiccation. An appropriate raw materials cost is in the range of a few dollars per gram. Finally, Earth energy (electric; all current lunar energy for Earth scenarios produce electric energy on Earth) presently costs its producers from less than one cent to a few cents per kWh.

All of the prime candidates for lunar power fall somewhere in the competitive range for lunar oxygen and special products. Solar day only is promising for those processes that can afford to operate only during the lunar day. However, the cost of getting only 50% duty from a processing plant must be taken into account in assessing the economics of solar day-only energy. Earth energy supply demands a lunar power cost on the order of \$1 per kWh; only nuclear and solar polar options offer potential to reach this range, with very large uncertainties presently attached to solar polar power.

Concluding Remarks

An orderly evolution in lunar power production is indicated; many alternative evolutionary paths are possible with, in most cases, no clear choice among them from today's vantage point. Solar/RFC is a clear choice for early Lunar Outpost operations simply because other alternatives are too expensive (chemical) or not available (nuclear, beamed). Solar day-only may find a niche if the cost penalty for day-only operations is not too high. Nuclear and laser beamed power options are indicated as competitive, with both holding considerable promise for costs one to two orders of magnitude less than solar/RFC at adequately large scales. Solar polar is only practical on a very large energy scale. Its eventual costs will depend heavily on cost outcomes for lunar industrial development since to be practical it must be produced and installed mainly by a lunar industry.

In this paper we have shown that lunar power requirements are attainable and that the cost of power can be commensurate with the costs of the activities supported. It will be necessary to develop nuclear or laser-beamed power for lunar development to go beyond modest permanent science bases. It is clear that electrical power engineering for the Moon can meet the challenges of lunar development.

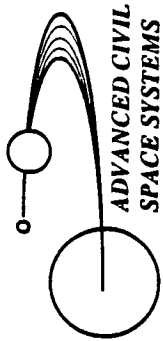

Lunar Electric Power Integration

BOEING

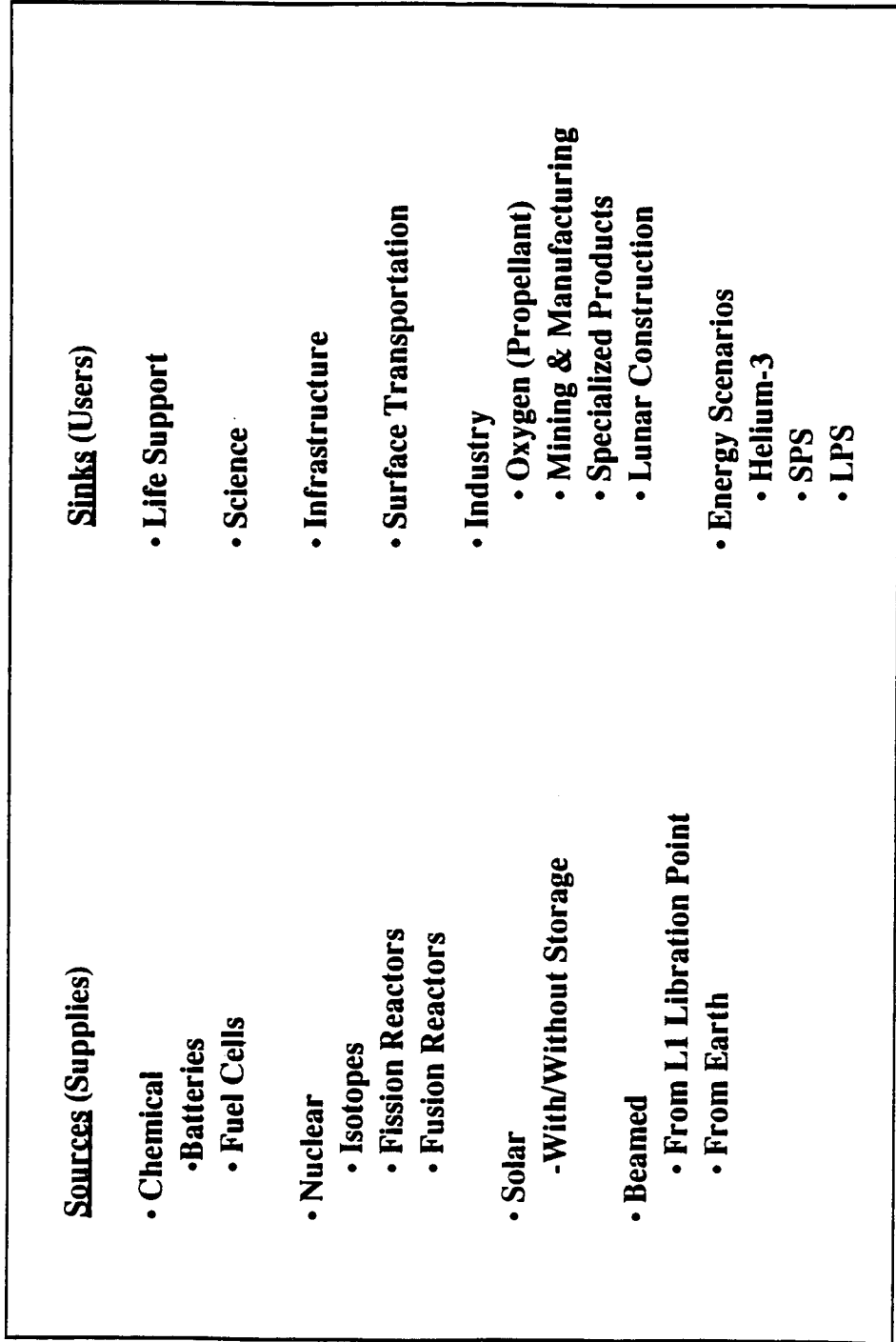
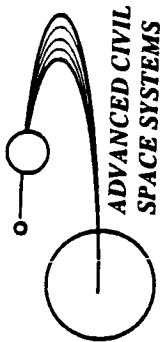

FIGURE 1



Use Quantities (Sinks)

BOEING

Life Support	<p>Partially open ~ 1 kWe/person Closed ~ 2 kWe/person Bio Regen Up to 10kWe/person; depends on use of natural light</p>
Science	<ul style="list-style-type: none"> • Most current concepts are modest = 25kWe or less • One can imagine massive projects, e.g. accelerator around lunar equator
Infrastructure	Roughly 5kWe + 1 to 2 per person
Surface Transportation	<p>Unpressurized rover 1-2 kWe Pressurized, 100km range ~ 10kWe Pressurized, 1000km range ~ 25kWe Mining/construction a few kWe per vehicle Typical construction 10t/yr-person</p> <p style="text-align: right;">} Duty cycle 25% or less</p>
For Example:	<p>12-Person base, some science, 100km rover 5 +(2+1) 12+25 + 5+10 =81kWe, closed ECLSS 5 +(6+1) 12+25 + 5+10 =129kWe, Bio-regen</p>
	Modest construction would add 50 to 200 kWe

FIGURE 2

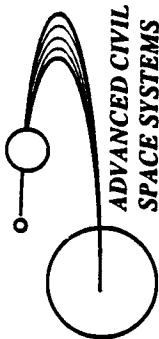

Use Quantities (Sinks) continued

BOEING

Industry

- Oxygen roughly 30,000kWh/ton
- Metals similar
- Glass & ceramics; cast basalt, etc.
- Miners & haulers don't use much energy
- Specialized products highly variable, up to >100,000 kWh/ton

Not additive; one may be byproduct of the other

~ 5000 kWh/ton; varies widely

Examples (1) Heat to 2000°C at 10% efficiency; (2) 50ev/molecule @ MW=50 & 10% efficiency

(1) 4000 cal/g = 17 MJ/kg = 4700 kWh/ton

(2) $50 \text{amu} \cdot 1.6 \cdot 10^{-19} \text{J} \cdot \frac{6 \cdot 10^{26} \text{amu}}{\text{kg}} \cdot \frac{10\% \text{ efficiency}}{3.6 \cdot 10^6 \text{J/kWh}} = 267 \text{kWh/kg} = 267,000 \text{kWh/ton}$

- May be able to sustain fairly high prices

Energy Scenarios - Supply to Earth

- Run to hundreds of megawatts and up
- Cannot sustain high prices
- Must consider energy payback

FIGURE 3

Lunar Transportation Cost Ranges

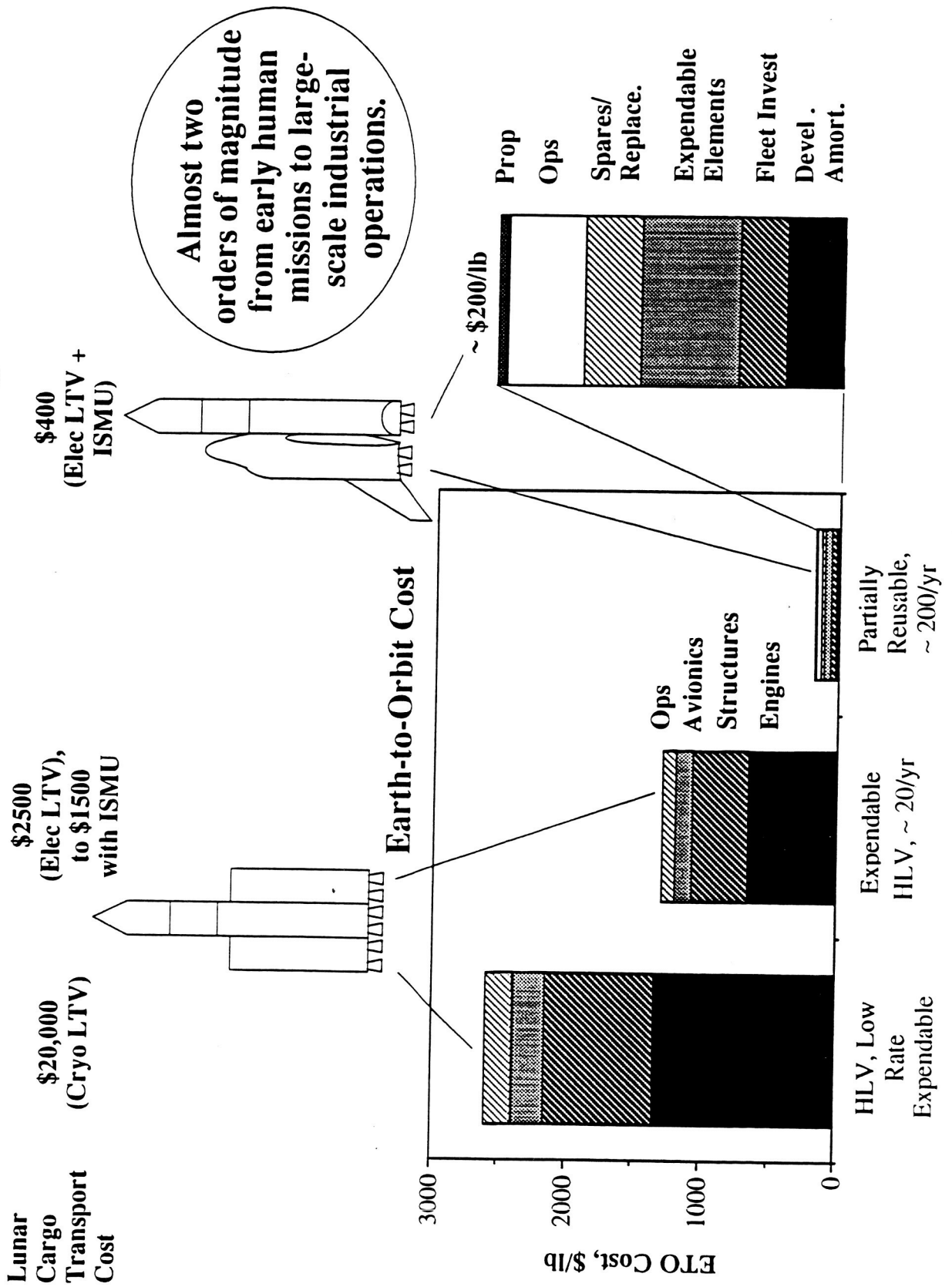

FIGURE 4

FIGURE 5

Power Sources

<u>Type</u>	<u>Performance Notes</u>	<u>Assumed Trans. Cost</u>	<u>Cost Ranges</u>
<u>Chemical</u>			
Batteries	< 0.1 kWh/lb	\$20,000/lb	> \$200,000/kWh
Fuel Cells	1 kWh/lb	(same)	\$20,000/kWh
<u>Nuclear</u>			
SP-100 Class (100kWe)	20t. pre-integrated cost \$200M. 7-year life 10% Cost of Money (COM) No backup	\$20,000 \$ 2,500	\$250/kWh \$70/kWh (x2 with backup)
SP-100 with dynamic conversion (500kWe)	25t. pre-integrated cost \$500M. 7 year life 10% Cost of Money (COM) One backup	\$ 2,500	\$60/kWh
Multi-megawatt plant (100MWe)	10kg/kWe = 1000 t. (No reserve) Cost, \$5B-10B Requires lunar construction \$4.5 Billion 30 year life 10% COM - 40% Reserve	\$ 1,500 \$ 400	\$ 2.00 to \$ 2.80 \$ 1.70 to \$ 2.45

FIGURE 6

Power Sources

<u>Type</u>	<u>Performance Notes</u>	<u>Assumed Trans. Cost</u>	<u>Cost Ranges</u>
<u>Nuclear Fuel</u>			
<u>Fission</u>	<p>Core 20% U 50% enriched 10% burnup = 1% fissionable 20% conv. effy $200 \text{ MEV} * \frac{6 \times 10^{26} \text{ fissions}}{235 \text{kg fissile}}$</p>	\$ 20,000	< 50¢/kWh
	$\frac{1 \text{ kwh}}{3.6 \times 10^6 \text{ j}} \times \frac{1.6 \times 10^{-19} \text{ j/ev}}{\text{kWh/kg}}$ <p>= 45000 kWh/kg</p>		
<u>Fusion</u>	Available on the Moon.		
<u>Solar-Electric</u>	25% array, 1350w/m ² solar, 45% duty cycle, 5kg/m ² \$2000/watt, 30y life, 10% COM	\$ 20,000 \$ 1,500	\$66/kWh \$51/kWh (Array cost dominates)
<u>Solar-Electric RFC</u>	Same array, 3kW array/kWe 600kg/kW RFC system 100% duty cycle	\$ 20,000 \$ 1,500	\$470/kWh \$175/kWh (Transportation dominates at high cost)

FIGURE 7

Power Sources

<u>Type</u>	<u>Performance Notes</u>	<u>Assumed Trans. Cost</u>	<u>Cost Ranges</u>
<u>Solar Power</u> at Poles (Not including transmission line system) (Transmission line to Equator, est. 50,000t; 500kV @ 200 MWe, 2700km)	25% array 1350 w/m ² solar, cylinder aspect (1/π), 5kg/m ² , 100%d.c., 30 year life 10% COM. \$2000 & \$20/watt	\$ 1500 \$ 400 Lunar built	\$71.75 & 2.45/kWh \$70.50 & \$1.20 \$70/kWh to 70¢/kWh
<u>Beam Power</u> 200 kWe	60m dia array @ \$700,000/m ² (950kWe solar equivalent) = \$2B = \$200m/yr 4-1.5 MW, 2% eff. laser @ \$100m 30 yr. life 10% COM 2¢/kWe for Earth power 75MWe = \$13m/yr	\$ 20,000 \$ 2,500	175/kWh 140
10 mWe (1 link capacity)	Same array @ \$2 billion 46,000kg transport to Moon 12-10 MW _L lasers @ \$250m \$350 m/yr for electric power	\$ 20,000 \$ 2,500	(Dominated by array cost) \$ 12.00 \$ 10.00 (Dominated by laser cost)

Mass Distribution for Large Lunar Industrial Plant

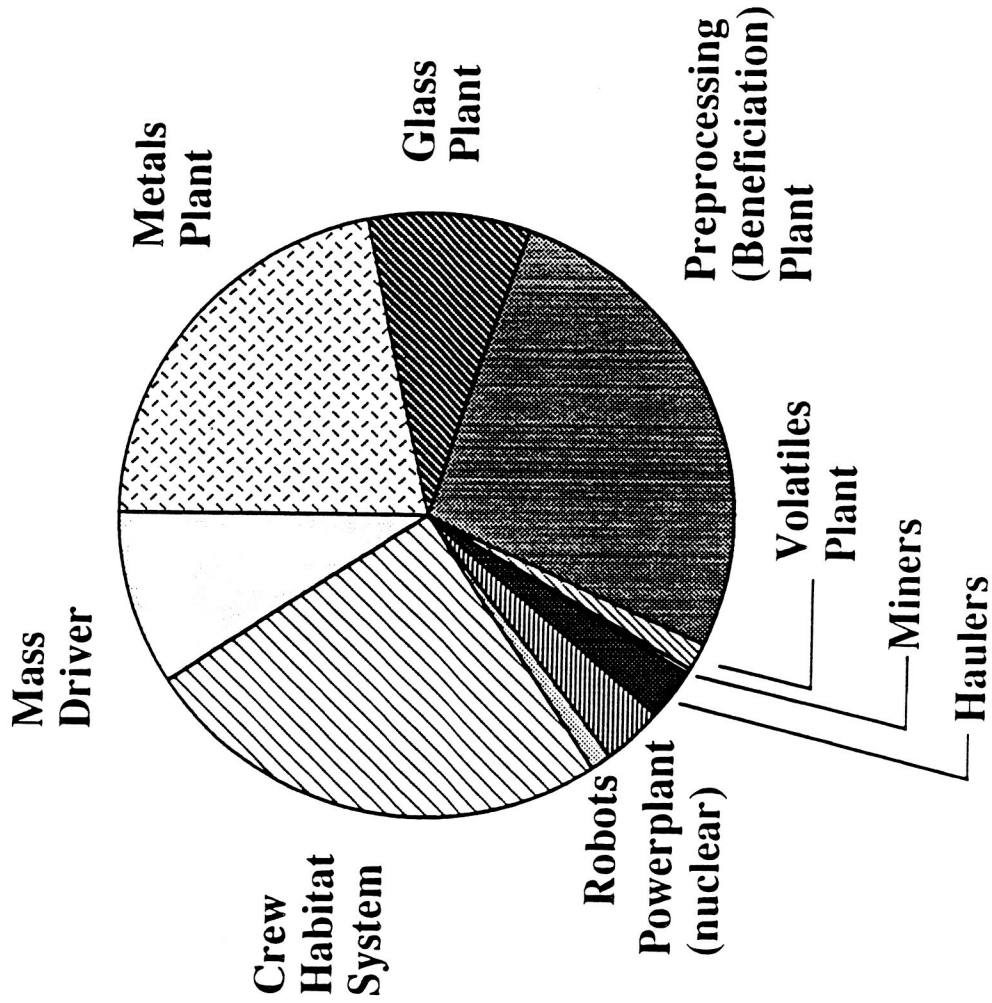

Total Mass \approx 40,000 t.

FIGURE 8

C-2

Cost of Power on the Moon: Does it Matter?

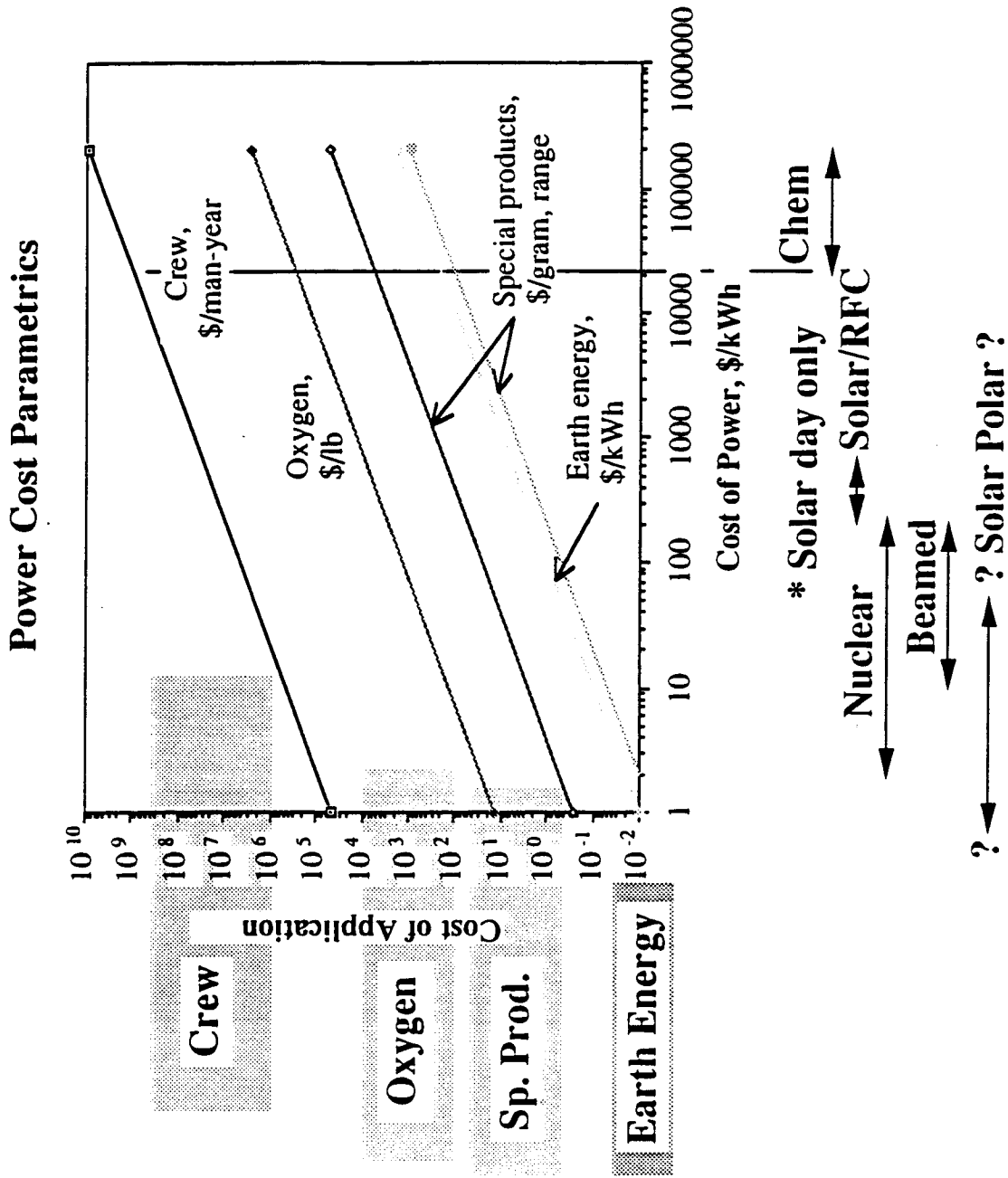

omit

MATERIALS PROCESSING

N 9 3 - 2 7 9 6 7

Oxygen Production on the Lunar Materials Processing Frontier

**Barbara H. Altenberg
Bechtel Group, Inc.**

511-54
158325
p. 14

Abstract

During the pre-conceptual design phase of an initial lunar oxygen processing facility it is essential to identify and compare the available processes and evaluate them in order to ensure the success of such an endeavor. The focus of this paper is to provide an overview of materials processing to produce lunar oxygen as one part of a given scenario of a developing lunar occupation.

More than twenty-five techniques to produce oxygen from lunar materials have been identified. While it is important to continue research on any feasible method, not all methods can be implemented at the initial lunar facility. Hence, it is necessary during the pre-conceptual design phase to evaluate all methods and determine the leading processes for initial focus. Researchers have developed techniques for evaluating the numerous proposed methods in order to suggest which processes would be best to go to the Moon first. As one section in this paper, the recent evaluation procedures that have been presented in the literature are compared and contrasted.

In general, the production methods for lunar oxygen fall into four categories: thermochemical, reactive solvent, pyrolytic, and electrochemical. Examples from two of the four categories are described, operating characteristics are contrasted, and terrestrial analogs are presented when possible. In addition to producing oxygen for use as a propellant and for life support, valuable co-products can be derived from some of the processes. This information is also highlighted in the description of a given process.

Introduction

This paper summarizes the points which were addressed at the plenary lecture for the session on Materials Processing at the Conference on Lunar Materials Technology which was sponsored by the University of Arizona/NASA Space Engineering Research Center for Utilization of Local Planetary Resources, held on February 20 - 22, 1992. The focus of the symposium was to present ideas related to an initial lunar outpost. With the scenario given, technology concerns in the areas of resource characterization, energy management, materials processing, environmental control, and automation and communications were presented. With the abundance of resources reported to be available in the lunar regolith, the potential for processing many different materials exists.

Recoverable lunar resources are classified as either volatiles or metals. The volatiles of possible interest include oxygen, hydrogen, helium, and nitrogen. These can be used for biosupport, as propellants, thermal fluids, processing reagents, purge gases and fuel for power. Various metals: iron, aluminum, silicon, magnesium, calcium, and titanium can also be retrieved from mining the Moon. These are useful as structural materials, cement additives, electrical conductors, thermal conductors, magnetic materials, refractories, ceramics and more. The focus of this paper is to look at lunar oxygen production as one part of a given scenario of a developing lunar occupation.

Overall Elements of Oxygen Production

A conceptual mining and processing facility on the lunar surface to produce oxygen for use as liquid propellant should contain the same elements as a terrestrial mining and processing facility. Part of the scheme should include excavation equipment, feed preparation facility, chemical processing plant for oxygen production, and facilities for purification, liquefaction, and storage. In addition, in support of such a facility, landing and transportation capabilities and power generation and transmission facilities are also required. The successful design, engineering, and construction of a lunar oxygen production plant will depend on the integration of all of these aspects of operation.

Figure 1 identifies five major elements of lunar oxygen production: surface mining, beneficiation, oxygen production, liquefaction, and storage. Minor, but noteworthy components of lunar oxygen production not shown in this figure include dealing with by-products and supplying energy. Later in this paper two processes for producing oxygen are described in more detail, but first it is necessary to discuss the environment on the lunar surface and some of the mining concerns.

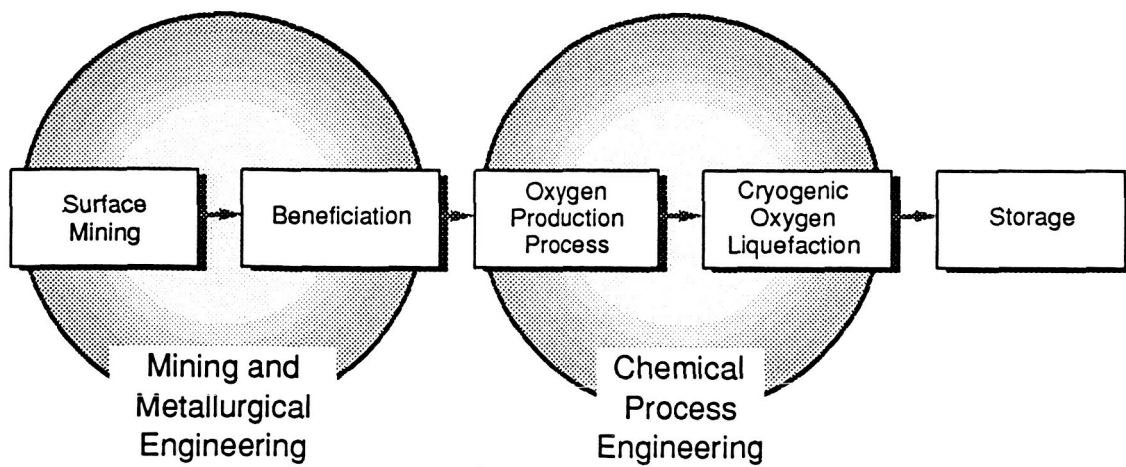

The engineering challenges associated with oxygen production on the Moon are directly related to the harsh environment found on the Moon. The rocks and soil of the lunar regolith are very stable. It will not be easy to process such material. A major challenge in manufacturing lunar oxygen propellant from indigenous lunar resources involves understanding the lunar environment and knowing how to factor in these extreme conditions in the design of lunar facilities.

Indeed, when the first lunar base is constructed, it will be the lunar environment which will present the most difficult challenges. The extreme fluctuations in temperature may cause material embrittlement. The reduced gravity conditions on the Moon will greatly effect standard engineering practices such as material handling and process operation, i.e. gas-solids and liquid transport phenomena. The lack of atmosphere and near vacuum conditions also affect process operation by outgassing from lubrication used around the bearings and seals in mechanical equipment.

For the successful design of a lunar oxygen production facility it is essential that precursor studies take place now. Through remote sensing and ground truth exploration missions, one can identify a good location to mine. Recent work performed at the University of Arizona's Lunar and Planetary Laboratory has produced titanium oxide abundance maps [Johnson, et. al. (1990), (1991)]. Regions of highest titanium oxide concentrations are specified at greater than 8 weight percent in the Western Mare Tranquillitatis and the Oceanus Procellarum. Obtaining remote sensing data such as this will aid in finding the best mining site.

Using three-dimensional representation of the lunar surface in combination with a three dimensional model of a conceptual lunar oxygen production plant will facilitate the design of the lunar oxygen production facility. Engineers at Bechtel have constructed an image of the Taurus Littrow Valley from data brought back from the Apollo program. The simulation was developed with Bechtel's Walk-Thru® system and is accurate to a 10 meter contour interval.

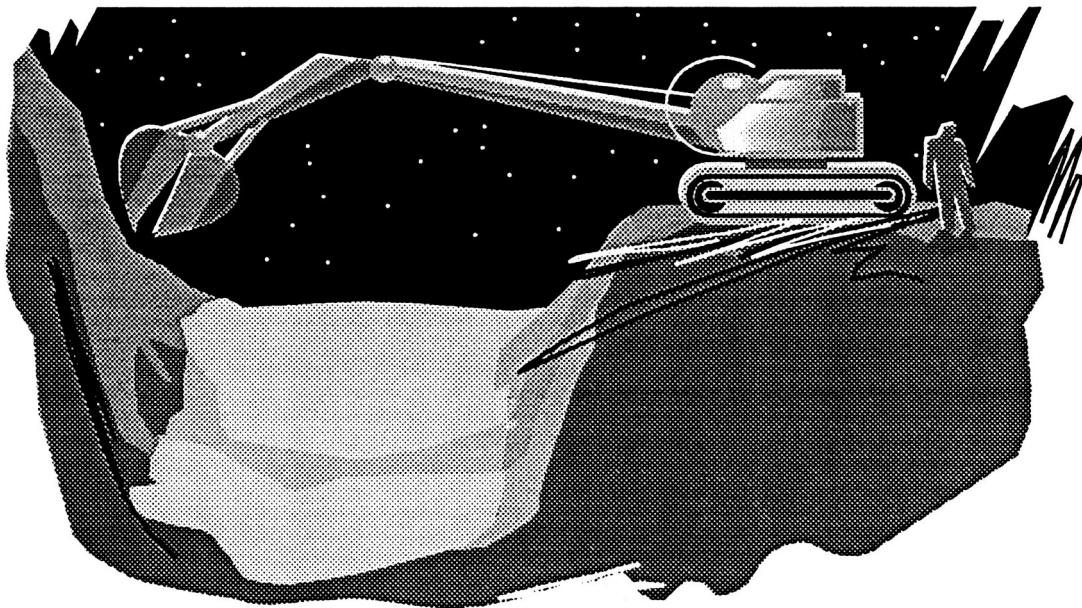

Figure 2: Surface Mining Using an Opposing Claw Excavator

Determining the best excavating equipment will be essential to a successful mining operation. Terrestrial mines such as at the San Miguel Lignite Project in Texas use a backhoe and a dragline to mine lignite for use in a coal production process. It is not obvious how to dig the regolith. Perhaps an opposing claw excavator like the one shown in *Figure 2* will be able to successfully dig the regolith given the lunar surface conditions.

Once a feedstock location has been specified, it will be essential to prepare the feed for the selected oxygen production process. Examples of beneficiation schemes include grinding in a ball mill, separating by cyclone, by electrostatic, or by electromagnetic means. A simplified electromagnetic separator is shown in *Figure 3*.

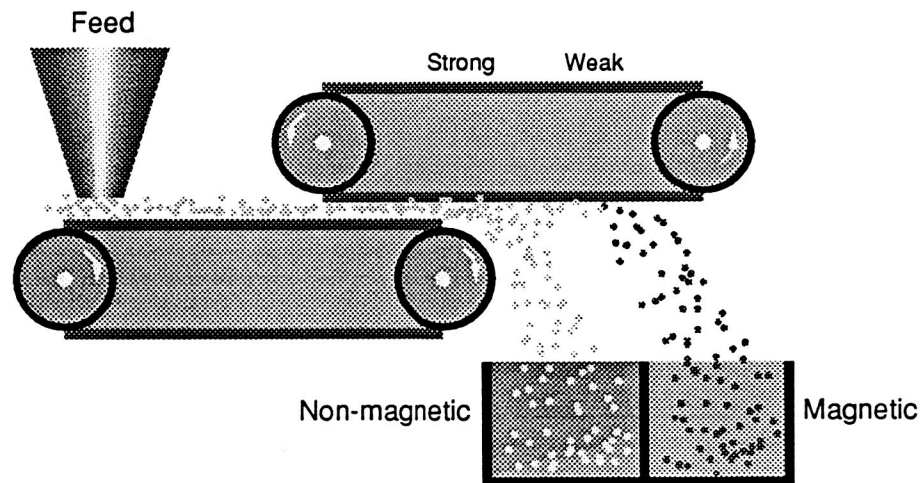

Figure 3: Dry Magnetic Separation

Oxygen production on the lunar surface will depend on the process selected. At least 25 different processes have been identified for the production of lunar liquid oxygen propellant [Altenberg (1990), Christiansen et. al. (1988), Taylor et. al. (1991), Waldron (1988, 1990)]. All of these processes have terrestrial analogs and generally fall into four categories of reaction: (a) thermochemical processes, such as solid/gas reaction in a fluidized bed (b) reactive solvent techniques, such as leaching and dissolution (c) electrochemical processes like those used in metal production processes and (d) pyrolysis techniques which can be considered advanced smelting methods. Once oxygen is produced it will be necessary to purify, liquefy, store, and transport the liquid oxygen product.

Producing Lunar Oxygen

In deciding to return to the Moon to set up a habitat suitable for occupation and for manufacture of useful products derived from indigenous resources, one realizes that it is an overall engineering challenge in which many aspects need to be integrated. It is valuable to tap into our terrestrial engineering experience in order to gain insight into making seemingly impossible projects happen.

Engineering construction firms have a history of success in the design, engineering, and construction of truly isolated production plants. For example, a successful lead and zinc mine and processing plant which processes 2250 short tonnes per day of ore is located in Canada 90 miles north of the Arctic Circle (600 miles from the North Pole) on Little Cornwallis Island. The mine is called the Polaris Mine and was built by Bechtel, Canada for COMINCO Corporation. Located in a very harsh, remote far away place, facilities for personnel are included where they grow plants, live, shop, and exercise in comfortable surroundings.

Techniques to Evaluate Lunar Oxygen Production Processes

There exist over 25 different techniques to obtain lunar liquid oxygen. How does one select a process to use for in-situ lunar oxygen production? It seems appropriate to evaluate all of the processes and determine which processes would be the best for use on the Moon.

Recent literature contains information about four methodologies which have been developed in order to sort through the numerous processes and determine which ones are the most feasible for implementation in a lunar oxygen production plant.

Taylor and Carrier (1992) have recently evaluated 20 processes and categorized them into 5 classes. For each of the processes information describing plant and mine characteristics (through-put, plant mass, energy, and ore required) was assembled. A technique for ranking the processes was presented which is based on technology readiness, number of process steps, process conditions, and feedstock. While the authors felt that the ranking was somewhat subjective, they also felt that the ranking did indicate that 8 of the 20 processes were more feasible for an initial lunar oxygen production plant than the remaining 12 processes. The top 4 processes as ranked by Taylor and Carrier were: (a) vapor pyrolysis (b) glass reduction with hydrogen (c) molten silicate electrolysis, and (d) ilmenite reduction with hydrogen.

Waldron and Cutler (1992) also looked at a large number (twenty-six) of different processes which could be used to make lunar liquid oxygen. A procedure to rank the processes based on benefit, cost and risk is described. The paper goes into detail explaining the methodology for evaluating the various oxygen production processes, and then concludes that sufficient information is not available to perform a reliable ranking of the proposed material processing and refining systems. It is recommended that reliable estimates of benefit, cost, and risk parameters for the proposed processes be obtained in part from a program to test processes in order to specify the parameters.

Cutler and Waldron (1992) propose another ranking method for selecting the most feasible processes to make lunar liquid oxygen. In this study the authors feel that comparisons among processes which are not in the same category of reaction can not be compared against one another. For example it is not a fair comparison to use the same criteria to rank hydrogen reduction of iron bearing feed to reduction of iron bearing feed by a reactive solvent such as sulfuric acid. Instead a preliminary ranking of processes within a single class is made. The processes studied ranked most feasible in the order given next: (a) hydrogen reduction of mixed feeds (b) hydrogen reduction of olivine (c) hydrogen reduction of pyroxene and (a) hydrogen reduction of ilmenite.

Altenberg (1990) examines sixteen processes for oxygen production and identifies the processes which would lend themselves well to producing oxygen on the lunar surface. An evaluation was performed which compiled existing quantitative information about feedstock quantities, oxygen yield, by-product production yields, number of major unit operations, operating temperatures, amounts of required reagents, energy requirements, and estimated weights of process units. A number of important parameters were considered, including: amount of research available, lab scale testing results, existence of terrestrial analogs, availability of feed material, reaction rate, number of

processing steps, oxygen yield, required reagents, catalysts, anodes, and /or fluxing material, energy required, temperature, materials of construction, amount of equipment required, ease of automation, potential for coproduct processing, and potential for a miniplant. A delphi survey of engineers (who were familiar with lunar materials processing technologies) was made in order to independently assign weighting factors to reflect their relative importance. Based on these factors, the processes were ranked. The results of the ranking show the top three most feasible processes for lunar liquid oxygen production are (a) vapor phase reduction, (b) magma electrolysis, and (c) hydrogen reduction of ilmenite.

Two processes: hydrogen reduction of ilmenite (which falls in to the first category) and vapor pyrolysis (which falls into the fourth category) are examined in more detail in the following.

Oxygen Production by Thermochemical Reduction

While there are many ways to engineer a process which uses the hydrogen reduction of ilmenite reaction, a simplified block flow diagram of a possible configuration is shown in *Figure 4*. Ilmenite feedstock FeO-TiO_2 reacts endothermically with hydrogen gas to produce water. A reaction temperature of $700\text{-}1000^\circ\text{C}$ has typically been reported as necessary to achieve rates of reaction. Product water vapor with excess hydrogen is then electrolyzed or thermally split to regenerate reactant hydrogen and liberate oxygen. Direct electrolysis of water vapor is shown in the figure; however, this type of electrolysis is not in current commercial use. Therefore, it may be necessary to condense the water vapor before electrolyzing it.

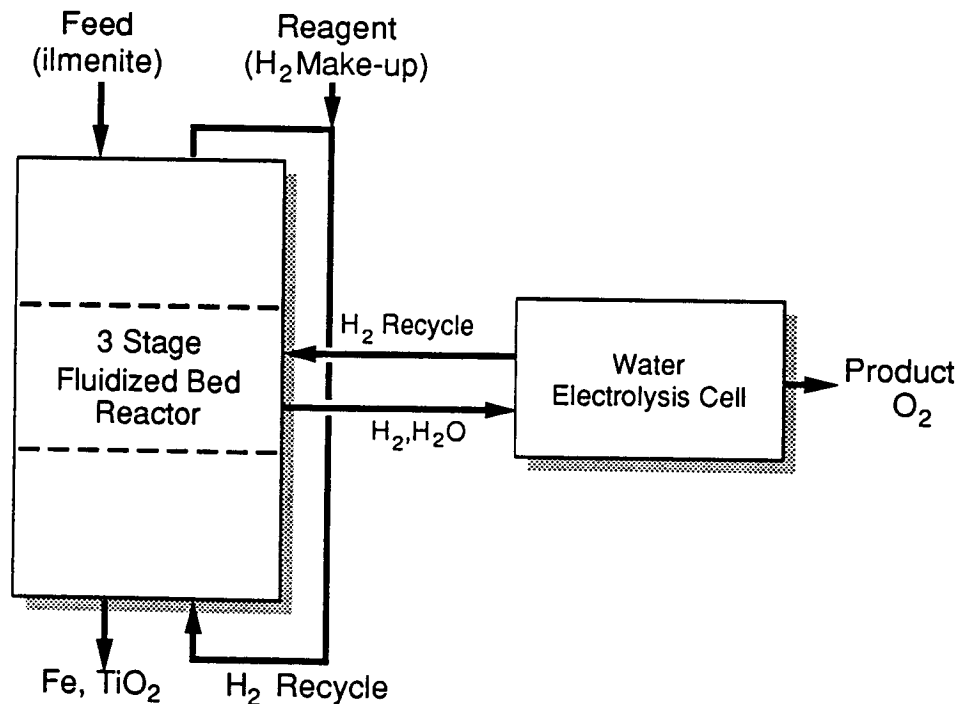

Figure 4: Hydrogen Reduction of Ilmenite

By performing Gibbs free energy minimization calculations, the effects of temperature and pressure were studied (Hernandez, 1992). It was important to find out if the reaction could be carried out practically at lower temperatures. If so a substantial savings in terms of energy to heat the process could be realized. *Figure 5* shows the effect of temperature (at a fixed pressure of 10 bar) on the conversion of hydrogen to water. A specified efficiency, also called figure-of-merit for the process was arbitrarily defined as the ratio of product water vapor to the amount of input hydrogen gas. It is evident that at temperatures less than 700°C, the conversion of hydrogen to water is very small. After that the conversion improves steadily and at 900°C the graph seems to level off. Higher than 900°C may improve the conversion, but there is the risk that the ilmenite will agglomerate and sinter.

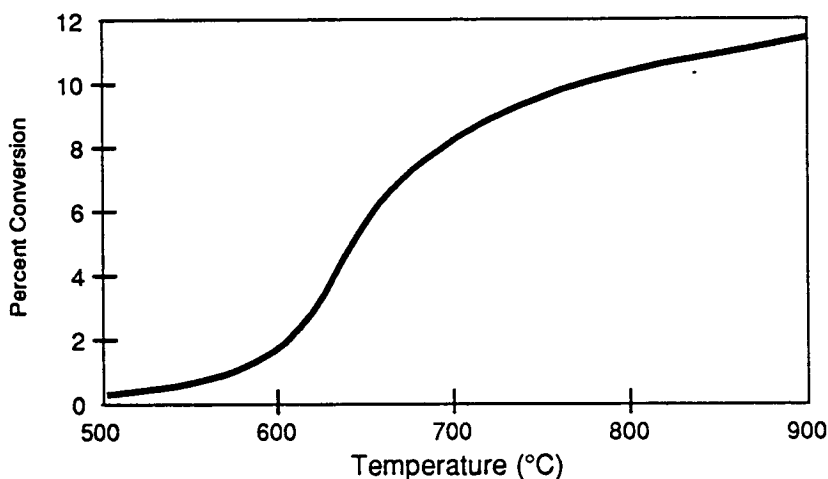

Figure 5: Conversion of H_2 to H_2O for HRI Process as a Function of Temperature

For comparison purposes, a closed-loop, fluidized bed reactor which operates in batch mode was used to generate the data in Table 1. Calculations were performed to quantify the amount of energy required to produce 1000 metric tonnes/yr of O_2 by the hydrogen reduction of ilmenite process. Analysis of the effects of operating pressure indicate that at lower pressures less feed, less reagent, and less energy are needed to produce a given amount of oxygen. However, a larger reactor is required translating to increased weight costs. Typical of fluidized beds on Earth, a superficial gas velocity of 1 ft/sec was used to determine associated reactor sizes for various operating conditions. The total energy required includes heat of reaction, heat loss, electrolysis, and energy for recycle compressor. While this analysis argues for lower operating pressure, a continuous fluidized bed operation in which water vapor is continuously extracted may favor higher operating pressures.

The phenomena of the effect of operating pressure on the hydrogen reduction of ilmenite reaction is very interesting. If one looks at the overall reduction reaction of ilmenite with hydrogen, there is the same number of moles of reactant gas present as there is product gas. This suggests that pressure should not affect the reaction. However, kinetics studies (Knudsen et. al., 1989) have shown that changes in pressure affect the rate at which the ilmenite reduction reaction occurs.

Table 1: Summary of Feed and Energy Requirements for the Hydrogen Reduction of Ilmenite Process

Operating Pressure (bar)	Required Ilmenite Feed (tonnes/yr)	Total Required Hydrogen (tonnes/yr)	Reactor Diameter (ft)	Total Energy Required (MWhr/yr)
1	50,540	626	7	14,285
10	90,981	1137	3	20,010

Thermodynamic equilibrium computer simulation studies using the HSC microcomputer code (Roine, 1989) have predicted that changes in pressure affect the equilibrium point of the ilmenite reduction reaction (Hernandez, 1992). In these simulations the functional conversion of hydrogen to water increased as operating pressure was lowered. This phenomena is now being investigated further.

The chemistry of the hydrogen reduction of ilmenite process is not complicated but lunar ilmenite could contain various amounts of chemical impurities such as sulfur, carbon, MgO, and Cr₂O₃. Impurities in a feed material such as ilmenite are of concern in designing a process to make lunar liquid oxygen, because they may induce side reactions and lower the desired conversion of hydrogen to water.

The thermodynamic equilibrium computer code was used to address the issue of potential impurities in ilmenite feed in the hydrogen reduction of ilmenite process (Hernandez, 1992). The effect of impurities on the conversion of hydrogen to water in the reduction of ilmenite process are summarized in *Figure 6*. The presence of Cr₂O₃ tends to enhance the conversion of hydrogen to water in the hydrogen reduction of ilmenite process. When small amounts of either sulfur or MgO are present in the system, the conversion of hydrogen to water is lower than the case in which no impurity is present; however, as the amount of impurity increases, the conversion shows an increase. Carbon impurity shows the most significant effect by lowering the conversion to less than 8 percent. As the amount of carbon impurity is increased the efficiency of the process decreases. The effect of these impurities on the process is important information to ascertain. Note that these examples are by no means considered exhaustive. If, however, one could conclude that the presence of these impurities do not severely poison the reaction, then it would be possible to use an 'impure' feed. Assuming that this is just one of many process configurations, the fact that H₂S

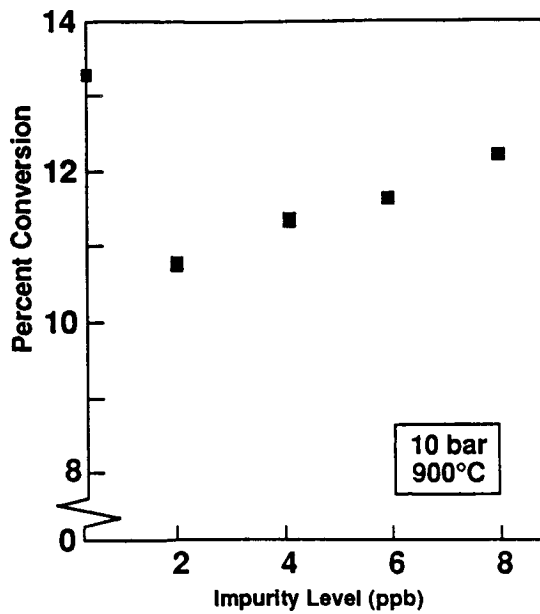

(a) Effect of Sulfur

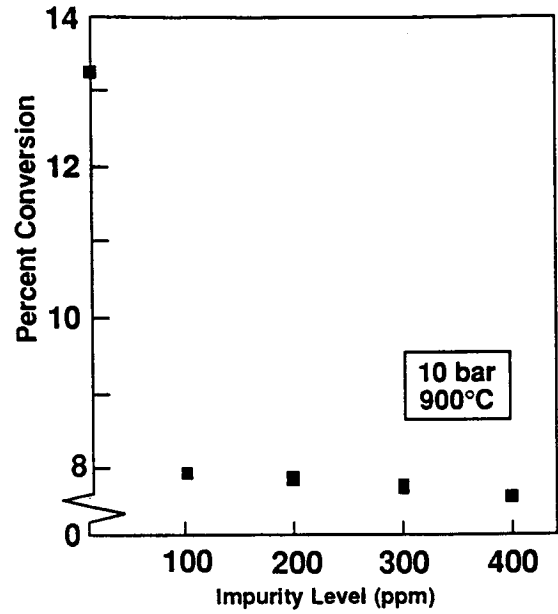

(b) Effect of Carbon

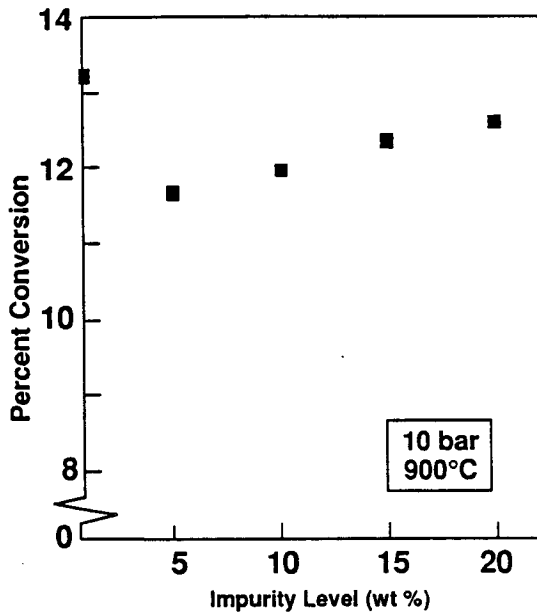

(c) Effect of Magnesia

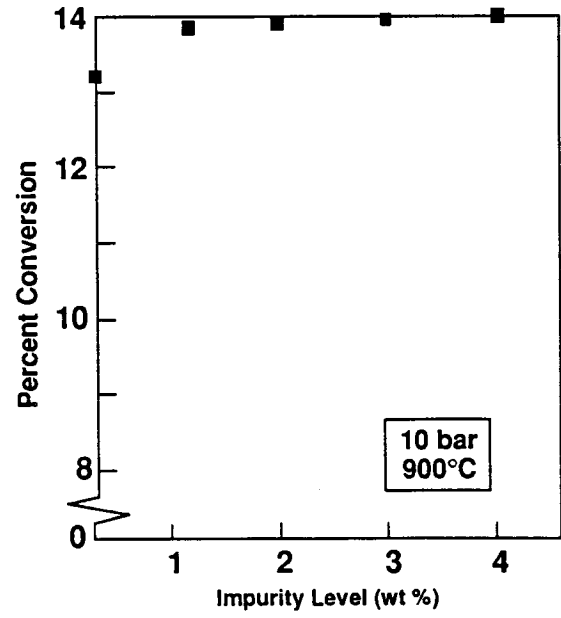

(d) Effect of Chromia

Figure 6: Effect of Impurities on Hydrogen Reduction of Ilmenite Process

and Mg may result in the product is an issue which needs to be addressed. In particular, what are the down stream requirements to purify the process?

In 1990 Bechtel completed detailed engineering, procurement, and construction management services to a new process plant capable of producing 45,000 tonnes per year of titanium dioxide pigment. The Tiofine plant in the Netherlands uses a process which consists of fluid bed chlorination

of rutile, followed by various unit operations including condensation, purification, oxidation, recovery of chlorine and raw pigment, finishing and packaging. This is an example of an existing plant which uses fluidized bed technology. This particular process is similar to the hydrogen reduction of ilmenite process which can be used to win oxygen from ilmenite in the lunar regolith.

Oxygen Production by Vapor Phase Pyrolysis

Another process which is feasible for the production of lunar liquid oxygen is vapor pyrolysis. This process consists of heating granulated lunar soil to a temperature of about 3000 K at very low pressure. At this high temperature the material is fully vaporized and the vapor dissociates into oxygen, sub-oxides, and free metals. Subsequent rapid cooling of the dissociated vapor to a discrete temperature causes condensation of the suboxides and metals, while the gaseous oxygen remains intact and can be collected downstream after some further purification. A schematic of this process is shown in *Figure 7*.

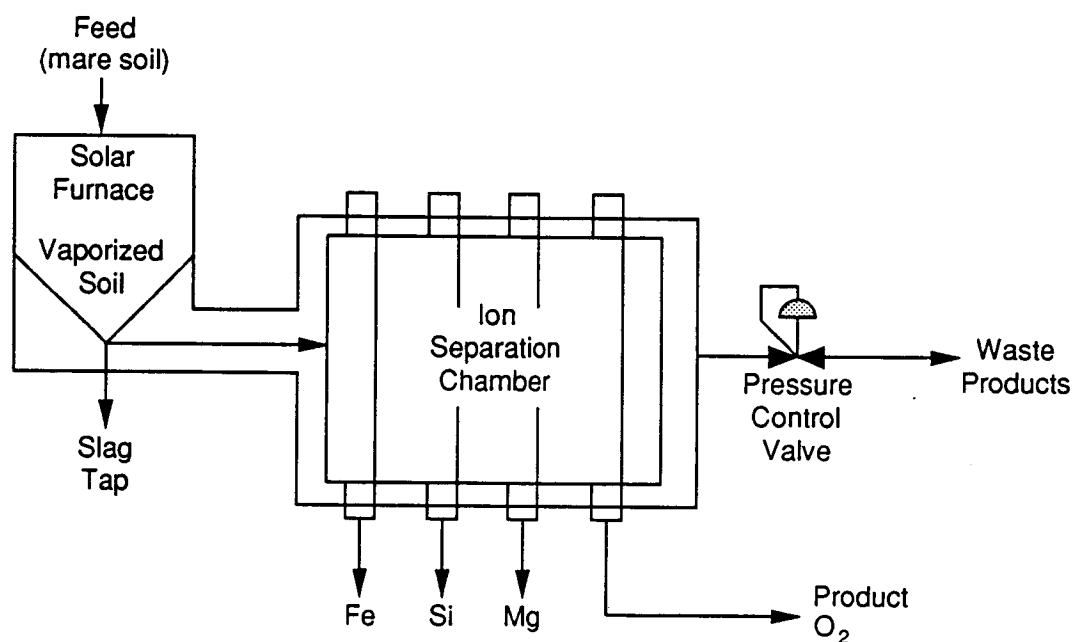

Figure 7: Vapor Pyrolysis

A solar furnace may be feasible to heat the regolith up to the desired reaction temperature. There exists a 1000 kw solar furnace on a mountain top in the Pyrenees in Odiello, France. The facility uses heliostats to track the sun and focus the sunlight into the parabolic reflector. The parabolic reflector concentrates the sun's rays onto a target area. Although a furnace such as this is very large, the pyrolysis process lends itself well for a solar furnace.

Because the lunar soil composition can vary significantly from one site on the Moon to another, the amounts of oxygen, sub-oxides, and metals that are produced can vary. Therefore, the analysis of several bulk lunar regolith compositions is necessary to assess the raw material requirements as

well as energy requirements for the process. The types of regolith selected for analysis were mare, highland, low titanium mare, high titanium mare, and lunar basalt. From equilibrium calculation results, the amount of product oxygen was calculated for each of the lunar regolith compositions. Table 2 summarizes these results. Although the amount of oxygen produced varies from 27 gm /1000 gm regolith to 33 gm /1000 gm regolith doesn't seem dramatic, Table 3 shows that substantial differences exist in energy required to produce 1000 metric tonnes/yr of O₂ by pyrolysis. Note that the type of regolith can have an effect on the energy requirements of the process. The difference translates to almost 4000 MWhr/year.

Table 2: Oxygen Production by Pyrolysis for Various Soil Compositions	
Lunar Regolith Type	Product Oxygen (gm/1000 gm regolith)
mare regolith	29.7
highlands soil	32.9
low titanium mare	30.0
high titanium mare	29.6
lunar basalt	27.6

Conclusions

It is important to continue studying processes which could be used to make liquid oxygen from feed materials which can be found on the lunar surface. Experimental data needs to be collected for a spectrum of processes which fall into different categories of reaction (thermochemical, reactive solvent, electrochemical, and pyrolytic). Data collection should include information about reaction chemistry, operating conditions, and energy requirements, as well as specifications on equipment. Understanding potential feed materials in terms of where ore deposits may be found, the soil mechanic characteristics of these feeds, and the necessary pre-treatment or beneficiation of the feed needs to be made. Equally important is the need to develop process design information based on computer models. Theoretical information, such as thermodynamic data which can be obtained from computer models, can be useful in specifying operating conditions as a function of required energy for a given process chemistry. These parameters can, for example, provide relative information about equipment vessel sizes. Downstream processes for oxygen purification, storage, and recovery need also be defined.

Table 3: Energy Required to Produce 1000 tonnes/yr Oxygen by Pyrolysis				
Type of Lunar Regolith	Required Heating Energy (MWhr/yr)	Required Cooling Energy (MWhr/yr)	Required Mechanical Energy (MWhr/yr)	Required Total Energy (MWhr/yr)
mare regolith	15,448	66,449	1,290	23,187
highlands soil	16,862	7,834	1,567	26,263
low titanium mare	15,627	7,893	1,579	25,100
high titanium mare	15,466	6,362	1,272	23,100
lunar basalt	14,999	6,362	1,272	22,633

To determine a way to make oxygen on the lunar materials processing frontier, it is valuable to rank the processes which have been identified as feasible methods. Several researchers have been doing this and the results indicate that a few processes appear to be more favorable than others. Hydrogen reduction of feed materials and vapor phase pyrolysis are two processes which at this point in time appear to be leading processes, even when the methods used to rank the processes are fundamentally different.

REFERENCES

- Altenberg, B. H., "Processing Lunar In-Situ Resources", Bechtel Technical Research and Development Project Job No. 90634-002, Final Report, San Francisco, CA, December, 1990.
- Christiansen, E. L., et. al., "Conceptual Design of a Lunar Oxygen Pilot Plant", Eagle Engineering, NASA Contractor Report No. NAS9-17878, Houston, TX, July, 1988.
- Cutler, A. H., Waldron, R. D., "Evaluation of Processing Options for Lunar Oxygen Production", ASCE Space '92 Conference, June 1992.
- Hernandez, L., "Chemical Analysis of Lunar Oxygen Processes: Part I", Bechtel Technical Research and Development Project Job No. 90634-002, Final Report, San Francisco, CA, June, 1992.
- Johnson, J. R., Larson, S. M., Singer, R. B., "Determination of Lunar Ilmenite Abundances from Remotely Sensed Data", Section III, p. 3-15, NASA Space Engineering Research Center for Utilization of Local Planetary Resources, University of Arizona, Tucson, AZ, Annual Report (1989-90).
- Johnson, J. R., Larson, S. M., Singer, R. B., "Remote Sensing of Potential Lunar Resources 1. Near-Side Compositional Properties", Journal of Geophysical Research, Vol. 96, No. E3, pages, 18,861-18,882, October 25, 1991.
- Knudsen, W. K., Gibson, M. A., "Lunar Oxygen Production via Fluidized Bed Iron Oxide Reduction", American Institute of Chemical Engineers Symposium on Non-Traditional Applications of Chemical Reaction Engineering, 1988 Annual Meeting, Washington, D. C., November 27 - December 2, 1988.
- Roine, A., Talonen, T., Syvajarvi, T., "HSC- Gibbs Program Ver. 6.42C, For Multiphase Equilibrium Composition Calculations", Outokumpu Oy, Outokumpu Research Centre, Pori, Finland 1974-89.
- Taylor, L. A., Carrier, W. D., "Oxygen Production on the Moon: an Overview and Evaluation", Resources of Near-Earth Space, University of Arizona Press, Tucson, AZ (submitted 1991, in press).
- Taylor, L. A., Carrier, W. D., "The Feasibility of Processes for the Production of Oxygen on the Moon", ASCE Space '92 Conference, June 1992.
- Waldron, R. D., "Lunar Manufacturing: A Survey of Products and Processes", Acta Astronautica, Vol. 17, No. 7, pp. 691-708, Pergamon Press, Great Britain, 1988.
- Waldron, R. D., "Recent Developments in Lunar Resource Process Evolution and Evaluation", AIAA Space Programs and Technologies Conference, Huntsville, AL, September 25-28, 1990.
- Waldron, R. D., Cutler, A. H., "A Reassessment of Criteria Development Methodology for Comparative Rating of Refining Processes for Non-Terrestrial Resources", ASCE Space '92 Conference, June 1992.

Johnson, J. R., Larson, S. M., Singer, R. B., "Remote Sensing of Potential Lunar Resources 1. Near-Side Compositional Properties", *Journal of Geophysical Research*, Vol. 96, No. E3, pages, 18,861-18,882, October 25, 1991.

Knudsen, W. K., Gibson, M. A., "Lunar Oxygen Production via Fluidized Bed Iron Oxide Reduction", American Institute of Chemical Engineers Symposium on Non-Traditional Applications of Chemical Reaction Engineering, 1988 Annual Meeting, Washington, D. C., November 27 - December 2, 1988.

Roine, A., Talonen, T., Syvajarvi, T., "HSC- Gibbs Program Ver. 6.42C, For Multiphase Equilibrium Composition Calculations", Outokumpu Oy, Outokumpu Research Centre, Pori, Finland 1974-89.

Taylor, L. A., Carrier, W. D., "Oxygen Production on the Moon: an Overview and Evaluation", *Resources of Near-Earth Space*, University of Arizona Press, Tucson, AZ (submitted 1991, in press).

Taylor, L. A., Carrier, W. D., "The Feasibility of Processes for the Production of Oxygen on the Moon", ASCE Space '92 Conference, June 1992.

Waldron, R. D., "Lunar Manufacturing: A Survey of Products and Processes", *Acta Astronautica*, Vol. 17, No. 7, pp. 691-708, Pergamon Press, Great Britain, 1988.

Waldron, R. D. , "Recent Developments in Lunar Resource Process Evolution and Evaluation", AIAA Space Programs and Technologies Conference, Huntsville, AL, September 25-28, 1990.

Waldron, R. D., Cutler, A. H., "A Reassessment of Criteria Development Methodology for Comparative Rating of Refining Processes for Non-Terrestrial Resources", ASCE Space '92 Conference, June 1992.

MAGNETIC BENEFICIATION OF LUNAR SOILS

R.R. Oder
EXPORTech Company, Inc.

J. Graf
Department of Geology, Michigan Technological University

L.A. Taylor
Department of Geological Sciences, University of Tennessee

D.S. McKay
NASA Johnson Space Center

512-91

158326

P-9

Abstract

We will present a review of recent laboratory results obtained in dry magnetic separation of one gram samples of the minus 1 mm size fraction of five lunar soils of widely differing maturities. Two highland soils were investigated as potential sources of low iron content feedstocks for space manufacture of metals, including aluminum, silicon and calcium. Pure anorthite was separated from the diamagnetic fraction of immature highland regolith. Three high titanium mare soils were investigated as potential sources of ilmenite for production of hydrogen and for recovery of ^3He . Ilmenite and pyroxene were separated from the paramagnetic fractions of the mare basalts. Agglutinates and other fused soil components containing metallic iron were separated from the strongly magnetic fractions of all soils.

We will present conceptual magnetic separation flow sheets developed from the laboratory data and designed for production of anorthite from highland soils and for production of ilmenite from mare soils. Using these flow sheets, we will discuss problems and opportunities associated with the magnetic separation of lunar soils. Separation of high-grade anorthite or other diamagnetic components at moderately high recovery can be achieved in processing immature highland soils. Similarly, small amounts of glassy components rich in metallic iron can be separated into the still be discussed. Further, while magnet weight is always an issue in magnetic separation technology, recent developments in both low temperature and high temperature superconductivity present unusual opportunities for magnet design specific to the lunar environment.

MAGNETIC BENEFICIATION OF LUNAR SOILS

Lunar regolith contains lithic, mineral, and fused fractions which can serve as sources of important materials including oxygen, refractories, and metals for use in space. Realization of the economic advantages of using indigenous resources may involve the operations of minerals preparation and beneficiation. One objective of this paper is to focus attention on the emerging opportunities and challenges in beneficiation of extraterrestrial materials through a discussion of one technology, magnetic separation, which has been applied in the laboratory to specific applications in the beneficiation of lunar soils. Another objective of this paper is to review the status of recent work on magnetic beneficiation of lunar soils. That work has led to several general conclusions of a practical nature which are presented here.

Magnetic Beneficiation of Highland and Mare Soils: In earlier work (Oder and Jamison, 1989; Oder, Taylor, and Keller, 1989; Oder and Taylor, 1990; Taylor and Oder, 1990 a, b, c) we have shown that dry magnetic separation is a viable method for beneficiation of lunar soils because it is adaptable to dry processing of finely divided, weakly magnetic, granular material in the low-gravity, atmosphere-free environment of space. Diamagnetic anorthite, $\chi = -0.39 \mu\text{cc/gm}$, paramagnetic ilmenite, $\chi \approx 60 \mu\text{cc/gm}$, and ferromagnetic glass-encased metallic iron, apparent susceptibility $\chi_a > 130 \mu\text{cc/gm}$, have been separated from the <1mm size fraction of the lunar soils. Conceptual designs based on these results indicate that a wide variety of modern methods for large scale separation of fine sized and weakly magnetic particles which combine advanced magnet design with proven commercial minerals processing technology are available for lunar application (Oder, 1992).

Contrary to the belief of some (Lewis, 1992), the limitation in magnetic separation of paramagnetic material such as ilmenite will not be imposed by the "weak magnetism" of the product but by the nature and physical state of the extraterrestrial material. Source materials which have been modified by natural or other processes to the point where their individual components (such as ilmenite, anorthite, etc.) have lost their identities will not be good candidates for beneficiation by any technology. The need now is to identify extraterrestrial materials which are good candidates for physicochemical separation and to proceed with testing specific beneficiation technologies such as magnetic separation. This paper presents a practical method of identifying lunar soils which are best suited for physical beneficiation by magnetic methods.

Effect of Soil Maturity on Magnetic Separation: The earlier work showed that the magnetic susceptibility at which separation is achieved is not affected by the maturity of the soil (Oder, 1991). It is a function of the magnetic susceptibility of the material to be separated. This is illustrated in the left portion of *Figure 1* for separation of diamagnetic anorthite from highland soils of widely differing maturities and in the left portion of *Figure 2* for separation of paramagnetic ilmenite from mare soils of differing maturities.

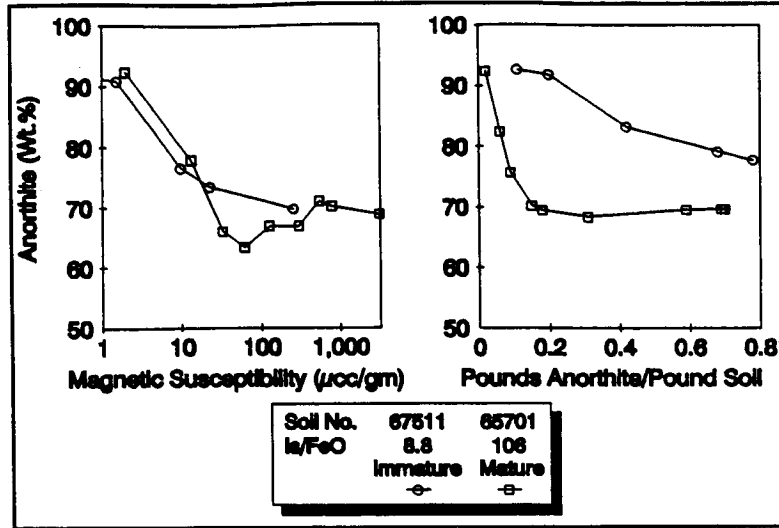

Fig. 1. Concentration of anorthite vs. magnetic susceptibility and recovery for two highland soils.

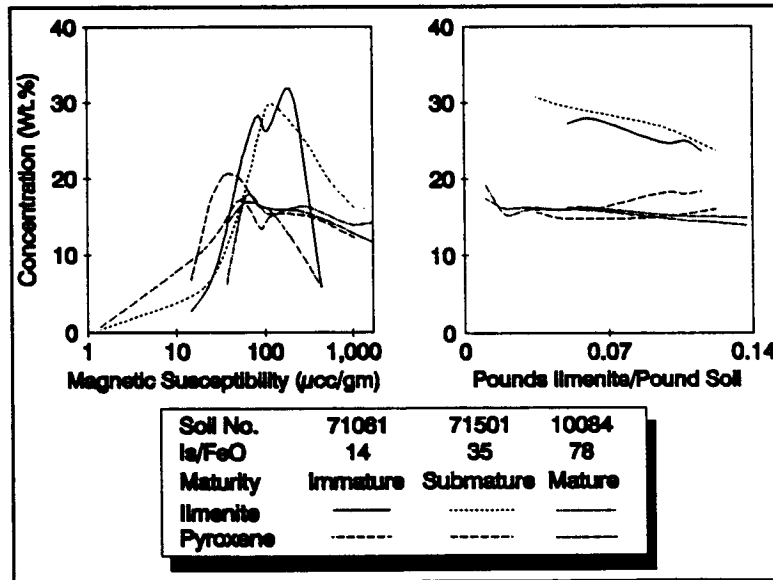

Fig. 2. Concentration of ilmenite and pyroxene vs. magnetic susceptibility and recovery for three mare soils.

The recovery of lunar soil components in magnetic processing is strongly affected by the maturity of the soil, however (Oder, 1991). Our work has shown that the distribution of lunar soil components in different magnetic susceptibility intervals changes significantly with soil maturity. This is illustrated in the MagnetoGraphs of Figure 3 for two highland soils of widely differing maturities.

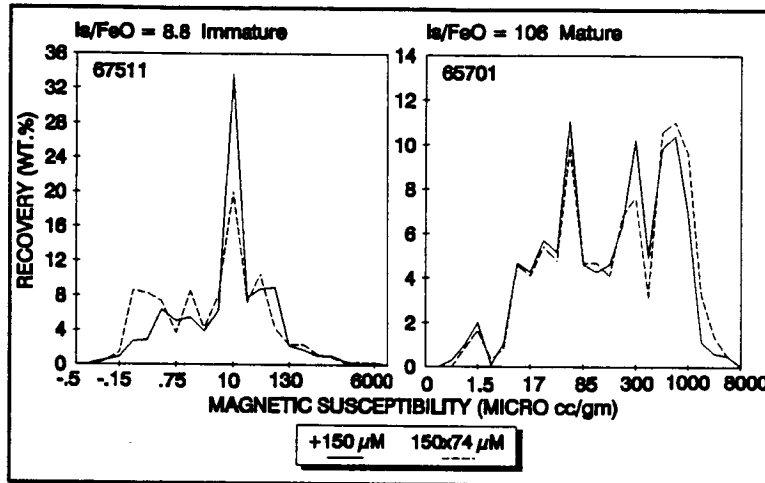

Fig. 3. MagnetoGraphs for two size fractions of anorthitic lunar highland soils 67511 and 65701.

In *Figure 3*, the distribution of sample weights vs. magnetic susceptibility is shown for two size fractions of immature soil 67511 and mature soil 65701. The maturity of a soil is represented by the intensity of single-domain iron (as determined by FMR) divided by the iron oxide composition -- I_s/FeO (Taylor, 1988). The higher the value, the greater the maturity. These soils have I_s/FeO values of 8.8 and 106 respectively (Morris, et al., 1983). Because the breadth of the distribution increases with maturity, the amount of material separated in the low susceptibility interval, nominally $<130 \mu cc/gm$, must decrease. As is apparent in the figure, this has an adverse effect on recoveries of paramagnetic and diamagnetic soil components. Conversely, the weight recovered in the $+130 \mu cc/gm$ magnetic susceptibility interval indicates increased magnetism for the mature soil.

The effects of soil maturity on recovery of anorthite and ilmenite are illustrated in the right portions of Figures 1 and 2, respectively. **Soils of lowest maturity are the best candidates for magnetic separation for all materials ranging from diamagnetic aluminosilicates to paramagnetic iron oxides such as ilmenite or pyroxene (Taylor and Oder, 1990).**

Loss of efficiency in magnetic separation of mature lunar soils can occur in several ways.

◆ First, while physical separation may be aided by size reduction associated with micrometeorite impacts (liberation), it may also be hampered by destruction of rock components by fusion and other thermo-chemical reactions occurring as a consequence of the micrometeorite impacts. Fusion can also disseminate fine sized materials in a manner which makes mechanical separation impractical.

◆ Secondly, the apparent magnetism of subsidiary fused soil components produced by the impacts can range from diamagnetic to ferromagnetic. A very small amount of metallic iron in a glass matrix can overwhelm the magnetism of most lunar materials. As the metallic iron concentration increases with maturity, soils become more magnetic (see *Figure 3*). This has the effect of lowering the recovery in magnetic susceptibility intervals containing the diamagnetic and paramagnetic components.

Soil Magnetism and Metallic Iron Content: Lunar aluminosilicate rocks are diamagnetic in nature. Paramagnetism is generally associated with Fe^{2+} found in minerals such as ilmenite $FeTiO_3$ and pyroxene $(Ca,Mg,Fe)SiO_3$. The specific susceptibilities of these minerals generally range from $40 \mu cc/gm$ to $100 \mu cc/gm$. Fe^{3+} is nonexistent in lunar materials so magnetite is not present. The lunar rocks we have investigated are generally less magnetic than are the soils sampled from the same area. The strong magnetism of lunar soils is associated with single-domain sized metallic iron (Fe^0 , native iron) found in vesicular glassy agglutinates, splash glasses, melt rocks, and other fused soil products of the energetic micrometeorite impacts (Nagata et al., 1972). A large portion of the metallic iron in agglutinates is also sub-domain in size. This material is super-paramagnetic and is a major contributor to the magnetism of lunar soils. Agglutinates are unique to the surface of the Moon.

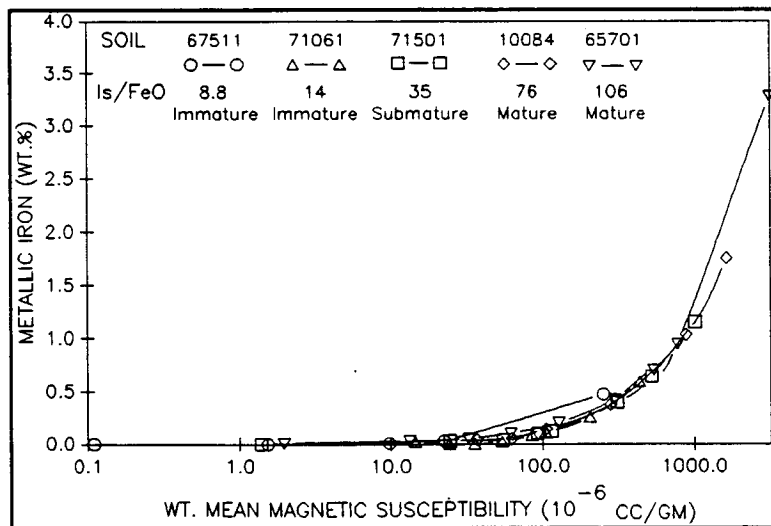

Fig. 4. Magnetic susceptibility dependencies of the concentration of metallic iron separated from five lunar soils.

The concentration of metallic iron determined from the magnetism and the chemistry of the highland and mare soils is shown in *Figure 4* vs. magnetic susceptibility. When the apparent magnetic susceptibility is greater than that of the most strongly paramagnetic minerals, nominally 100 $\mu\text{cc}/\text{gm}$, there is little else other than iron to account for the magnetism of the soils (Senftle et al., 1964). The extent to which the points extend upward along the curve depends only on the soil maturity; the more mature, the greater the metallic iron content and consequently, the greater the apparent magnetic susceptibility.

Rocks versus Soils

Measurements are now underway to test the effects of soil maturity on magnetic separation, suggested by our earlier work (Oder, 1991). Fresh samples of immature and mature mare soils and rock samples, taken from the same area, have been procured for testing in this new study, which is still at a preliminary stage. The rocks have been crushed and screened into size fractions similar to those of the soils. The rock and soil size fractions have been subjected to magnetic separation of ilmenite. The gross chemistry and modal analysis by electron microscopy of the magnetic isolates prepared by EXPORTech Company, Inc., are being carried out using the facilities of the Microprobe Laboratory at the Department of Geological Sciences at the University of Tennessee at Knoxville (Taylor, et al., 1992).

Figure 5 compares the MagnetoGraphs for the immature and the mature soils and their associated rocks. The comparison shows graphically that the mature soil is more magnetic than the immature soil; there is also a significant difference in the magnetism of the rocks and their associated soils. Separation of ilmenite from mature mare soil 10084 was not as good as that from the associated rock, 10058. Note that the peak in the MagnetoGraph corresponding to the interval from which ilmenite is to be separated is significantly higher for the rock than for the soil, indicating a larger weight recovery. The MagnetoGraphs for immature soil 71061 and its associated rock, 71055, are similar. The peak near susceptibility 300 $\mu\text{cc}/\text{gm}$ represents the minus 20 micron fraction of the soil. This fraction contains the most native iron. The degree of separation of ilmenite is expected to be closer for the immature soil and its associated rock than for the case of the mature soil; here ilmenite separation from the rock is expected to be much better than from the soil. The manner in which the soil maturation process shifts the magnetism of the lunar material and destroys the tendency toward separation of paramagnetic and diamagnetic components is apparent in the figure.

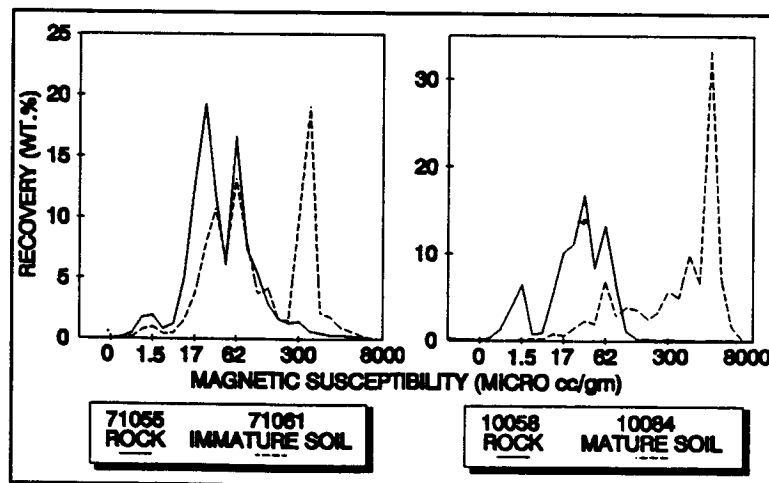

Fig. 5. Comparison of MagnetoGraphs for mare rocks and associated soils.

Magnetic Susceptibility and Soil Maturity: Soil maturity and magnetism are synonymous. The more mature soils are more magnetic. Magnetic susceptibility is a convenient measure of the maturity of the soil (Oder, 1991). The data of Table I summarize our measurements of the magnetic and chemical characteristics of the soils investigated. The values for the maturity parameters, I_s/FeO , have been taken from the Handbook of Lunar Soils (Morris, et al., 1983).

Table I
Magnetic and chemical parameters
for minus 1 mm fraction of lunar soils (Oder, 1991)

Soil	χ (ucc/gm)	Iron Oxide (Wt.%)	Fe^0 (Wt.%)	I_s/FeO
67511	147.5	14.16	0.08	8.8
71061	196	13.84	0.24	14
71501	434	16.54	0.49	35
10084	786	14.15	0.87	78
65701	433	4.9	1.55	106

The ratio of apparent magnetic susceptibility to iron oxide content is plotted against the maturity parameter in *Figure 6*. Magnetic susceptibility and FeO are each directly measured. No chemical, image analysis, or magnetic interpretations are employed. The excellent correlation between the susceptibility and conventional maturity parameters suggests that the magnetic susceptibility is a good indicator of soil maturity.

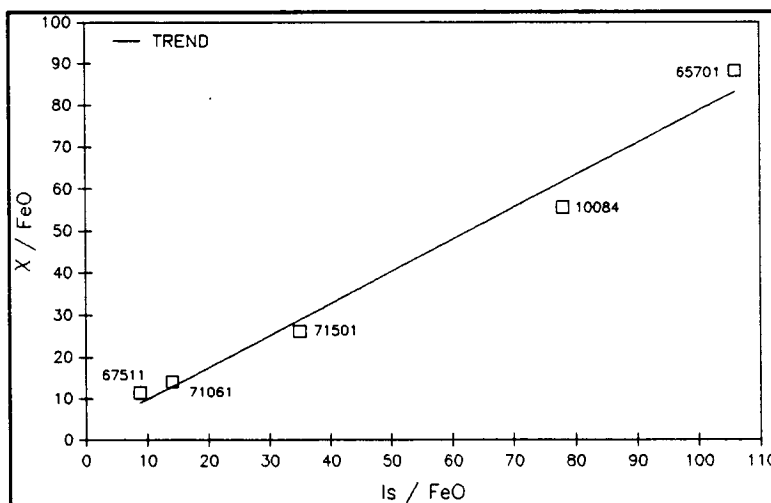

Fig. 6. Comparison of soil maturities inferred by magnetic susceptibility and by magnetic resonance.

SUMMARY

- ◆ We have separated feebly magnetic material from the highland soils. This material can serve as a source of anorthite for manufacture of cement and recovery of metals and oxygen by electrolysis.
- ◆ We have separated intermediate magnetic susceptibility material from hi-titanium mare basalts; this material can serve as a source of ilmenite for oxygen production by chemical reduction. We have also separated intermediate magnetic susceptibility material from the associated mare soils but achieved a lesser grade and yield.
- ◆ We have separated metallic iron from all soils.
- ◆ The lowest maturity soils are the best candidates for beneficiation by magnetic separation.
- ◆ The magnetism of lunar soils increases with maturity because of the inclusion of disseminated metallic iron which is concentrated in the finest size and highest susceptibility fractions.
- ◆ Magnetic susceptibility is a convenient measure of soil maturity and should be incorporated into the instrumentation package carried by lunar rovers to identify candidate soils for resource utilization. Generally speaking, instrumentation to measure magnetic susceptibility is less expensive and more widely available than that used to measure magnetic resonance.

REFERENCES

- Lewis, J. S., 1992, "Processing Non-Terrestrial Materials," Preprint 92-17, SME Annual Meeting, Phoenix, AZ, February 24-27.
- Morris, R. V., Score, R., Dardano, C., and Heiken, G., 1983, Handbook of Lunar Soils, Parts I and II, NASA Johnson Space Center, Planetary Materials Branch, Publication 67.
- Nagata, T., Fisher, R. M., and Schwerer, F. C., 1972, "Lunar Rock Magnetism," Moon 4, pp. 160-186.
- Oder, R. R., 1991, "Beneficiation of Lunar Soils: Case Studies in Magnetism," Preprint 91-137, SME Annual Meeting, Denver, CO, February 25-28.
- Oder, R. R., 1991, "Magnetic Separation of Lunar Soils," IEEE Transactions on Magnetism 27, No. 6, pp. 5367-5370.
- Oder, R. R., 1992, "Beneficiation of Lunar Soils: Case Studies in Magnetism," to be published in Minerals and Metallurgical Processing, August.

Oder, R. R. and Jamison, R. E., 1989, "Magnetic Beneficiation of Lunar Soil," Phase I Final Report, NASA Small Business Innovation Research Program Contract NAS-9-18092.

Oder, R. R., Taylor, L. A., and Keller, R., 1989, "Magnetic Characterization of Lunar Soils," Lunar & Planetary Science XX, Houston, TX, March, pp. 804-805.

Oder, R. R. and Taylor, L. A., 1990, "Magnetic Beneficiation of Highland and Hi-Ti Mare Soils: Magnet Requirements," Engineering Construction and Operations in Space II, Proc. of Space 90, Vol. 1, edited by S. W. Johnson and J. P. Wetzel, American Society of Civil Engineers, New York, 133-142.

Senftle, F. E., Thorpe, A. N., and Lewis, R. R., 1964, J. Geophys. Res. 69, p. 317.

Taylor, L. A., "Generation of Native Fe in Lunar Soil," Proc. Space 88, American Society of Civil Engineers, pp. 67-77.

Taylor, L. A., McKay, D. S., Graf, J., Patchen, Al, Wentworth, S., Oder, R., and Jerde, E., 1992, "Magnetic Beneficiation of High-Ti Mare Basalts: Petrographic Analyses," Lunar & Planetary Science XXIII, Houston, TX (March).

Taylor, L. A. and Oder, R. R., 1990a, "Magnetic Beneficiation of Highlands Soils: Concentrations of Anorthite and Agglutinates," Lunar Planet. Sci. XXI, LIP (in press).

Taylor, L. A. and Oder, R. R., 1990b, "Magnetic Beneficiation of Hi-Ti Mare Soils: Concentrations of Ilmenite and Other Components," Lunar Planet. Sci. XXI, LIP (in press).

Taylor, L. A. and Oder, R. R., 1990c, "Magnetic Beneficiation of Highland and Hi-Ti Mare Soils: Rock, Mineral, and Glassy Components," Engineering Construction and Operations in Space II, Proc. of Space 90, Vol. 1, edited by S. W. Johnson and J. P. Wetzel, American Society of Civil Engineers, New York, 143-152.

**PROPELLANT PRODUCTION AND USEFUL MATERIALS:
HARDWARE DATA FROM COMPONENTS AND THE SYSTEMS**

Kumar Ramohalli

University of Arizona/NASA Space Engineering Research Center

Abstract

Research activities at the University of Arizona/NASA Space Engineering Research Center are described; the primary emphasis is on *hardware* development and operation. The research activities are all aimed toward introducing significant cost reductions through the utilization of resources locally available at extraterrestrial sites. The four logical aspects include lunar, Martian, support, and common technologies. These are described in turn. The hardware realizations are based upon sound scientific principles which are used to screen a host of interesting and novel concepts. Small-scale feasibility studies are used as the screen to allow only the most promising concepts to proceed. Specific examples include: kg/day-class oxygen plant that uses CO₂ as the feedstock, spent stream utilization to produce methane and "higher" compounds (using hydrogen from a water electrolysis plant), separation of CO from the CO₂, reduction of any iron bearing silicate (lunar soils), production of structural components, smart sensors and autonomous controls, and quantitative computer simulation of extraterrestrial plants. The most important feature of all this research continues to be the training of high-quality students for our future in space.

Introduction

The virtues of in-situ resource utilization (ISRU) in introducing significant cost savings in space missions have received extensive attention in recent years.⁽¹⁻¹⁰⁾ Following this general acknowledgment of the potential for cost effectiveness, several studies have examined a theoretical "mission architecture" that could incorporate the ISRU components.⁽¹¹⁻¹⁵⁾ An interesting, and important, development has been the serious attention paid by industry to these resource utilization missions.⁽¹⁶⁻¹⁹⁾ This interest by industry signifies the recognition of long-term benefits of a tangible nature.

Important as these studies are, they are unlikely to be sufficient in themselves to render ISRU as an integral part of future missions; what is missing is technology development and hardware demonstrations under realistic conditions for extended durations of operation. Understandably, these need support and commitment that have not always been available.

We have been fortunate in receiving NASA support for five-year periods to pursue the scientific, engineering, and technological aspects of ISRU at The University of Arizona's Space Engineering Research Center. The overall plan has included a well-knit team of scientists and engineers, who are carrying innovative concepts through idea generation, feasibility screening, test-tube-scale realization(s), followed by realistic scale-up. The basic aim of all of these activities is to prove the engineering, and technological, feasibility of production plants for extraterrestrial use, so that future missions can confidently incorporate ISRU as a mainstream component and, indeed, a regular feature during planning and flight execution.

The initial (pre-award) activities and a general summary of the Center's activities have been reported earlier.^(20,21) The present paper is a logical next step in the sequence of technical reports from the Center.⁽²²⁻²⁴⁾

The overall "game plan" at the Center is shown in Table 1. At regularly scheduled weekly meetings, innovative ideas are discussed in an open forum consisting of scientists, engineers, undergraduate and graduate students, faculty, and administrators. This free exchange of ideas results in a list of possible candidates for further pursuit. The promising ones are subjected to several reviews: internal reviews by the three Directors, semi-annual reviews by the Center Advisory Committee, and annual reviews by the NASA Technical Representative Committee. In addition, our concepts and results are always subjected to peer review in journals, symposia, and external meetings. Those concepts that survive these reviews are selected for small-scale feasibility demonstrations; this is the first place where hardware experiments are committed. After extensive tests involving several operation scenarios that go beyond the expected boundaries of operation in applications, the more promising ones are selected for table-top units that now produce reasonably realistic quantities of end products. Understandably, only two or three concepts reach this stage because of resource requirements at these larger-scale production stages. Those that continue to prove promising at this stage are selected for breadboard development and testing at the highest level of technology demonstration, or TRL 5 in NASA terminology.

Another important aspect of our activities is our willingness and ability to apply basic knowledge and expertise to important specific national needs. Two such examples are discussed here: one is our design and demonstration of a common lunar lander (Artemis) concept that involves robotic processing of unbeneficiated lunar soils for oxygen (and construction materials) production, and the other is a portable oxygen plant that uses carbon dioxide as its feedstock (with obvious applications to Mars). The latter has already been delivered to NASA Lewis Research Center for demonstration purposes.

The activities at the Center are all aimed at ISRU for introducing significant cost savings and mission simplicity; the specific projects are logically divided into four major categories, or disciplines: (1) lunar, (2) Martian, (3) support, and (4) common technologies. In the lunar category, we are pursuing soil reduction through hydrogen and carbothermal processes, innovative non-equilibrium plasma processing for compact energy efficient reactors, solar processing through direct photon absorption, and some other specific studies that involve soil processing into dishes. In the Martian category, we are processing carbon dioxide to produce oxygen, using the spent (hot) stream to produce hydrocarbons (the hydrogen comes from a water electrolysis unit), and have an overall system design using modern software. A recent study has been started to explore the permafrost and its safe bearing capacity (in support of platforms and structures).

In the support technologies category, we are exploring mechanical properties, general-purpose software development for mission optimization, in-situ mechanical property measurements, and quantitative visualization through CAD.

In the common technologies category, we are developing intelligent semi-autonomous controls with smart sensors, self-contained modular designs, quantitative bill of materials, compatibility testing, and an overall cost-benefit analysis that includes an examination of historical mission data.

This paper concludes with a brief description of two applications: the common lunar lander and the portable oxygen plant that uses carbon dioxide.

The Component Activities

Lunar Resources

Lunar resources include various soils and ores. Initial studies were confined to the (much-studied) ilmenite processes.²³ A major breakthrough in 1992 extended the work to any iron-bearing silicate. The vapor deposition of a monolayer of (imported) carbon enabled the reduction of iron-bearing silicates. One representative result is shown in *Figure 1*. This forms the basis for our Artemis design. In our quest for high-tech efficient reactions, we are exploring cold plasma reactions of lunar ores and direct photon enhancement of chemical reactions. The non-equilibrium plasma enables high electron temperatures to be achieved while maintaining very low translational, rotational, and vibrational (sensible) temperatures; this fact results in good thermal efficiency in reactor design. Besides, the photon-electron interactions have a greater cross section than photon-molecule cross sections; this enables the direct deposition of solar energy into the reaction stream. The results are shown in *Figure 2*. The cold plasma in operation is shown in *Figure 3*. The general nature of the experimental setup for the microbalance investigation of lunar soils is shown in *Figure 4*. Details on the plasma reactor are given in reference 25.

Some of the beams and struts made from (authentically) simulated lunar soils are shown in *Figure 5*. The mechanical properties and their modifications through the use of small (<2% by total mass) quantities of fibers (in this scheme, to be imported from Earth, but in a subsequent scheme to be manufactured on the Moon from glassy silicates) were reported earlier.²³ More recent results have included the production of silicon-based polymers that could be used as the substrates for amorphous photovoltaic cells.

Martian Resources

Our basic work continues to develop newer technologies for oxygen production from carbon dioxide. The 16-cell unit that utilizes yttria-stabilized zirconia is shown in *Figure 6*. The screening matrix and the mass and energy needs are shown in Tables 2 and 3, respectively. A major breakthrough occurred in the alternative disc technology. Compared to the earlier tube geometry,

the discs have a far greater effective area. The results are shown in *Figure 7*; a dramatic comparison is shown in *Figure 8*. The effective area in the tube is clearly revealed in the IR thermogram of the tube in *Figure 9*.

A highly sensitive area of importance is the seal between the ceramic (ZrO_2) and the metal (inconel) that houses the overall system. Major advances were made in recent months using shape-memory alloys that improve the seal at higher temperatures. Results are shown in *Figure 10*. Several in-house technologies of solid electrolytes, catalysts, and electrodes were all proven to be superior to what is commercially available. Generous support from JPL, where three of our students were hosted this summer, is acknowledged. This process of Martian CO_2 reduction is also studied in reference 26. Our early work was reported in reference 27.

The spent stream is rich in carbon dioxide and carbon monoxide. If separated, the carbon monoxide can be a valuable fuel on Mars. The separation process has been refined in the last few months. The basic scientific principle involves pressure cycling or temperature cycling. The adsorption/desorption is on a copper-based substrate. The results are shown in *Figure 11*.

Another use of the spent stream could be for the manufacture of hydrocarbons, if hydrogen can be made available. We have a water electrolysis system (WES), loaned to us by United Technologies, Hamilton Standard of Windsor Locks, Connecticut. The WES is shown in *Figure 12*. The principle of the WES is applicable to Martian plants, which could use water from the soil, polar caps, or even from the atmosphere. The hydrogen, so produced, is used in a Sabatier reactor (*Figure 13*). The overall scheme is shown in *Figure 14*, and the principal results are shown in *Figure 15*. Martin-Marietta is expected to fund a small grant at SERC for the study of "higher" chemistry from the hydrocarbons that can be produced starting from methane and hydrogen; it should be acknowledged that the initial construction of the Sabatier reactor was through an earlier MM grant to SERC.

Support Technologies

These include the intelligent controls and smart sensors. The overall view is shown in *Figure 16*. The controls have proven their applicability in several hundred-hour runs that were conducted during severe thunderstorms in Tucson, which resulted in natural (mains) power outages. The full-system operation was reported in reference 23.

Common Technologies

These include ceramics from local soils, mechanical properties of beams and struts made from soils, and quantitative CAD and visualization. The principal results arising from the ceramics research using lunar soil are shown in *Figure 17*.

Specific Applications

The general knowledge base and hardware experience present at The University of Arizona's Space Engineering Research Center have been applied to several national needs, of which two are described here.

Artemis (Lunar Lander)

This project involves the demonstration of a completely self-contained lander that weighs under 65 kg. The basic process is a reduction of any iron-bearing silicate. The reactor, made of a light ceramic, is capable of carbothermal or hydrogen reduction. The overall plant is shown as a scale model in *Figure 18*. A half-scale robotic unit has been built and demonstrated, using solar thermal energy. The full-scale unit's mass and energy balance are shown in Table 4. The sequence of operations is shown in Table 5. The unit is currently undergoing thorough testing and will be

developed through TRL 5 in the coming year (*Figure 19*).

Portable Oxygen Plant

A small-scale (1 lb/day class) oxygen plant was designed and constructed using indigenous electrodes, catalysts, and electrodes. The completed unit is shown in *Figures 20* and *21*. The performance characteristics are shown in *Figures 22* and *23*; the unit has been shipped to NASA Lewis Research Center and is expected to be used in demonstrations in conjunction with a rocket motor that will burn the CO and O₂ so produced.

Since this unit is meant for thorough characterization at Lewis Research Center, only the proof-of-working data were obtained at the temperature of 800°.

These medium-temperature data must be interpreted with caution. The high temperatures (1000°C) will yield much higher O₂ production rates.

Summary and Conclusions

At The University of Arizona's Space Engineering Research Center, various activities are carrying novel ISRU concepts through idea generation, scientific screening, feasibility demonstrations, and full-system hardware. Several plants have been built and operated under realistic conditions for extended durations. It is expected that these hardware realizations of scientifically sound ISRU concepts will inspire confidence in mission planners, who could gain substantial cost benefits and acceptability by the general (tax-paying) public, who would then recognize that space ventures need not be costly if we use the local resources "out there."

Acknowledgments

The author thanks Drs. Robert Hayduk and Murray Hirschbein (Code RS, NASA HQ) for their support and the entire team at SERC for the data.

References

- ¹*Pioneering the Space Frontier*. Report by the (Presidential) National Commission on Space, New York: Bantam Books, 1986.
- ²Ash, R. L., Dowler, W. L., and Varsi, G. "Feasibility of Rocket Propellant Production on Mars." *Acta Astronautica* (5) 1978: 705-34.
- ³French, J. R., Norton, H. N., and Klein, G. A. "Mars Sample Return Options." *Aerospace America* (23) 1985: 50-53.
- ⁴Ash, R. L., Richter, R., Dowler, W. L., Hanson, J. A., and Uphoff, C.W. "Autonomous Oxygen Production for a Mars Return Vehicle." IAF-82-210, 1982.
- ⁵Carroll, W. F. (Ed.), *Research on the Use of Space Resources*. JPL Publication 83-86: 1983.
- ⁶Ash, R. L. and Cuda, V., Jr. "Technology Status Report for In Situ Propellant Production." Report to Jet Propulsion Lab. (1984).
- ⁷Frisbee, R. H. and Jones, R. M., "An Analysis of Alternate Hydrogen Sources for Lunar Materials to Earth Orbit." AIAA Paper 83-1344 (1983).

- ⁸Ramohalli, K. N., Dowler, W., French, J., and Ash, R. "Novel Extraterrestrial Processing for Space Propulsion." *Acta Astronautica* (15) 1987: 259-73.
- ⁹Ramohalli, K. N., Dowler, W., French, J. and Ash, R. "Some Aspects of Space Propulsion With Extraterrestrial Processing." *Journal of Spacecraft and Rockets* (24) 1987: 236-44.
- ¹⁰Ramohalli, K. N., Lawton, E., and Ash, R. "Recent Concepts in Missions to Mars -- Extraterrestrial Processing." *Journal of Propulsion and Power* (5) 1989: 181-87.
- ¹¹Stancati, M. L., Jacobs, M. K., Cole, K. J., and Collins, J. T. "In Situ Propellant Production: Alternatives for Mars Exploration." Rept. SAIC-91/1052. Schaumburg, IL: Science Applications International Corp., 1991.
- ¹²Friedlander, A. and Cole, K. "Power Requirements for Lunar and Mars Exploration Scenarios." Rept. SAIC-89/1000. Schaumburg, IL: Science Applications International Corp., 1989.
- ¹³Sullivan T. A. and McKay, D. S. "Using Space Resources." Houston, TX: NASA Johnson Space Center, 1991.
- ¹⁴Duke, M. B. and Keaton, P. W. (Editors). "Manned Mars Missions," A Working Group Report. NASA M001. Los Alamos National Laboratories, 1986.
- ¹⁵Bon, Ranko (Instructor). "Settling the Asteroids." MIT4.58, Space Habitat Design Workshop. Massachusetts Institute of Technology, Cambridge, MA, 1989.
- ¹⁶Fluor Daniel. "Effective Lunar Facility Construction Concepts." Presentation to NASA Office of Exploration. Fluor Daniel, Irvine, CA., 1988.
- ¹⁷Altenberg, B. "Processing Lunar In-Situ Resources." Final Rept. Job No. 90634-002. Bechtel Group, Inc. San Francisco, CA, 1990.
- ¹⁸Alred, J. W., Kline, J. M., and Snauffer, M. J. "Indigenous Space Materials Utilization Experiment Design for the Common Lunar Lander." IAA-92-0160, 43rd Congress of the International Astronautical Federation, Washington, DC, 1992.
- ¹⁹Rosenberg, S. D. and Redd, L. R. "Lunar Propellant Manufacture and Its Economic Benefits for Space Transportation." IAA-91-637, 42nd Congress of the International Astronautical Federation, Montreal, Canada, 1991.
- ²⁰Office of the Vice President for Research. "Refineries in Space." *Report on Research* (4) No. 2: 19. Tucson: The University of Arizona, 1987.
- ²¹Ramohalli, K. "Mining the Air; Resources of Other Worlds May Reduce Mission Costs." *The Planetary Report* (11) 1991: 8-9, 11.
- ²²Lewis, J. S., Ramohalli, K., and Triffet, T. "Extraterrestrial Resource Utilization for Economy in Space Missions." Paper IAA-90-604, 41st Congress of the International Astronautical Federation, Dresden, West Germany, 1990.
- ²³Ramohalli, K. N. R. "Technologies of ISRU/ISMU." IAA-91-659, 42nd Congress of the International Astronautical Federation, Montreal, Canada, 1991 (to appear in *Acta Astronautica*).

²⁴Ramohalli, K. and Sridhar, K. R. "Extraterrestrial Materials Processing and Related Transport Phenomena." *J. Propulsion and Power* (8) 1992: 687-96.

²⁵Bullard, D. E., Lynch, D. C., and Davenport, W. G. "Non-Equilibrium Plasma Processing of Ores." *Thermal Plasma Applications in Materials and Metallurgical Processing* (N. El-Kaddah, ed.) Warrendale, PA: The Minerals, Metals & Materials Society, 1992: 175-91.

²⁶Bowles, J. V. and Tauber, M. E. "Propellant Production from the Martian Atmosphere." *Journal of Propulsion and Power* (8) 1992: 907-09.

²⁷Colvin, J., Schallhorn, and Ramohalli, K. "Propellant Production on Mars: Single Cell Oxygen Production Test Bed." AIAA 91-2444. AIAA/ASME/SAE/ASEE 27th Joint Propulsion Conference, Sacramento, CA, 1991. Accepted for publication in *AIAA J. Propulsion and Power*.

FIGURE 1

PROVEN OXYGEN PRODUCTION solid carbon mixed with (simulated) lunar soil

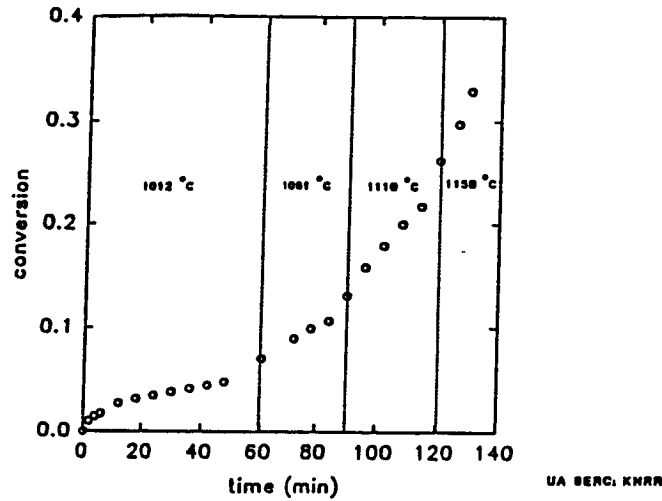

Reduction of Fayalite ($Fe_{1.3}$) with deposited carbon

FIGURE 2

Graduate Students: Dan Bullard & Gary Thomas

Intent

Recovery Of Oxygen From Lunar Resources Using A Hydrogen Plasma

Major Achievements

- Improved Efficiency In Hydrogen Utilization Over Conventional Heating
- Recovery of 1.5 atoms Of Oxygen Per Molecule Of $FeTiO_3$ Possible
- Evaluation Of Plasma Variables On extent Of Reaction

Comments

- Energy Efficiency For Production Of Plasma Can Approach 85 To 90%
- Particles 10 μm In Diameter & Smaller Can Be Reacted - Also Possibly Larger Particles
- Plasma - Solid Reaction Complete Within 2 Minutes At 700 °C And Below

Future Work / Work In Progress

- Design Of Fluidized Bed Plasma Reactor (50 To 100 g) To Improve Plasma - Solid Contact And Achieve Greater Efficiency In Hydrogen Utilization
- Evaluation Of Fundamental Kinetic Parameters
- Scale up

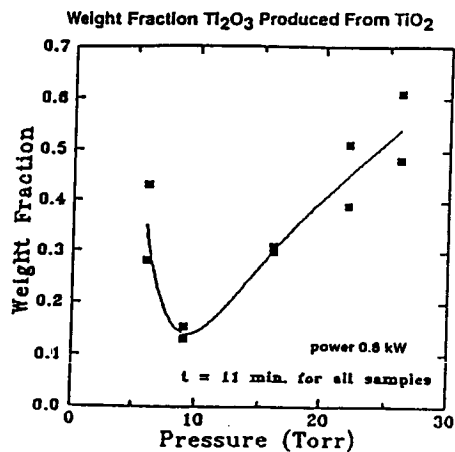
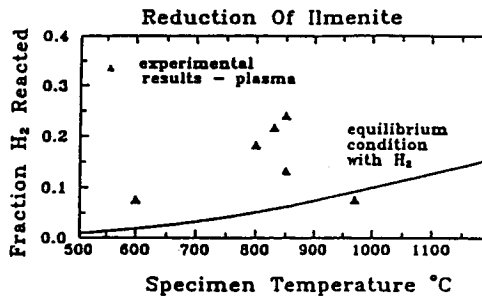



FIGURE 3. COLD PLASMA OPERATION.

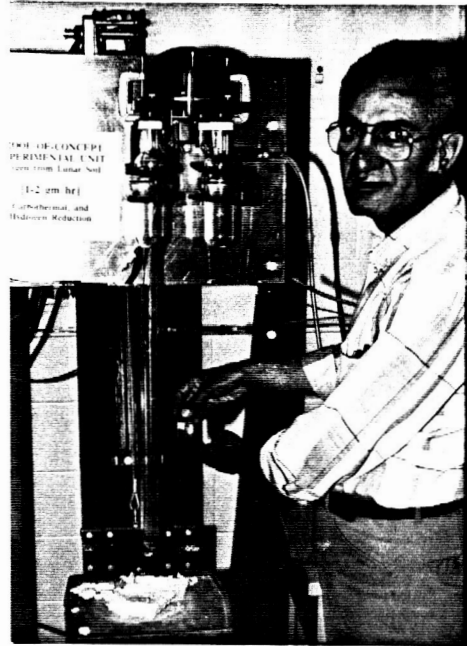

FIGURE 4. SETUP USED FOR MICROBALANCE INVESTIGATION.

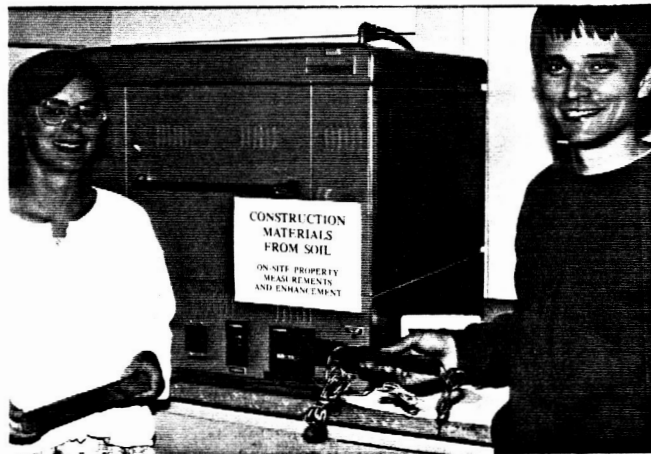

FIGURE 5. BEAMS AND STRUTS MADE FROM SIMULATED LUNAR SOILS.

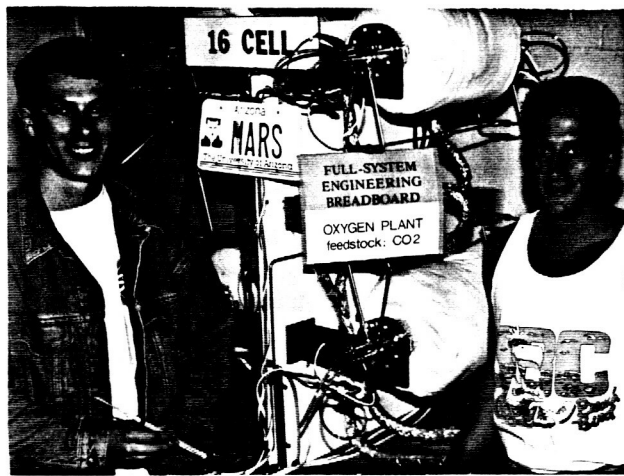

FIGURE 6. SIXTEEN-CELL UNIT USED TO PRODUCE OXYGEN FROM YTTRIA-STABILIZED ZIRCONIA.

IN-HOUSE DISK RESULTS

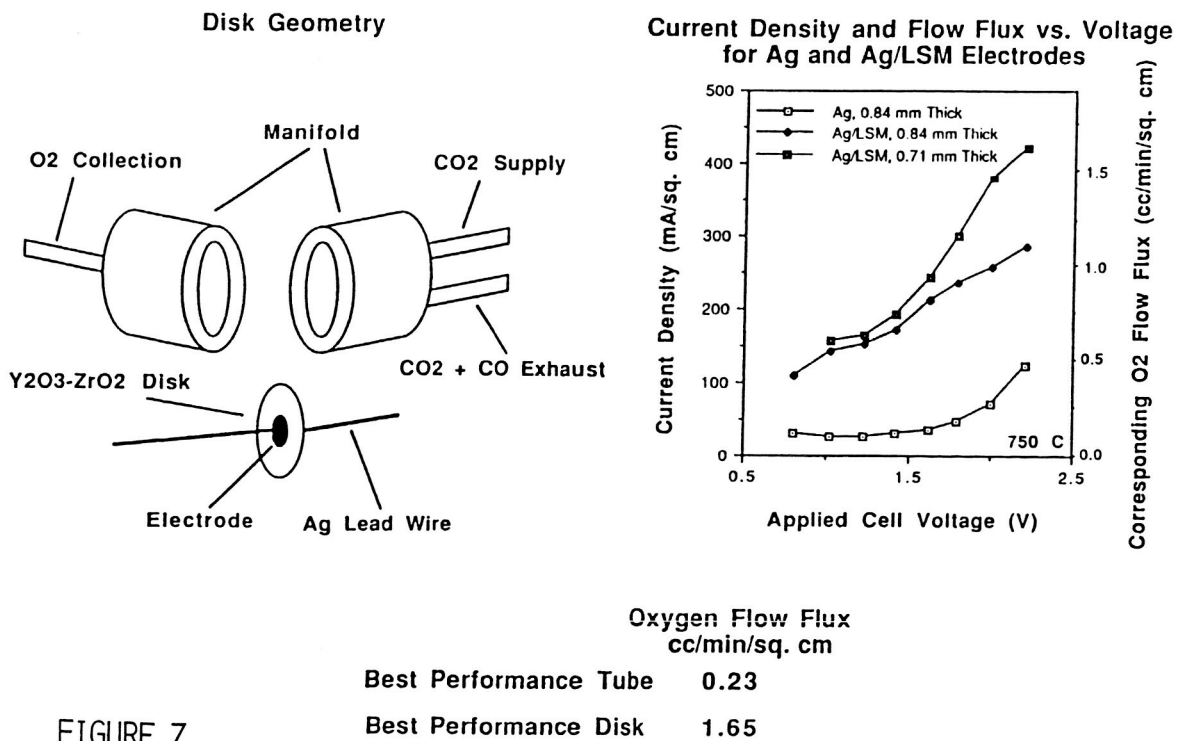

FIGURE 7

FIGURE 8

Measured Oxygen Flow vs Time

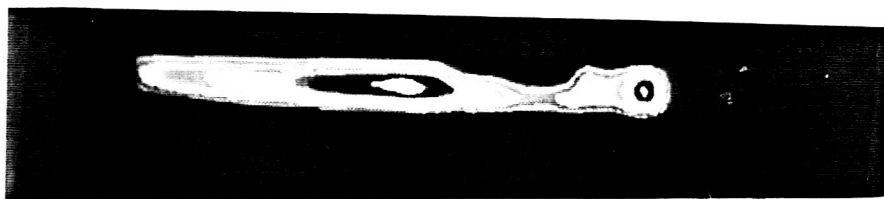
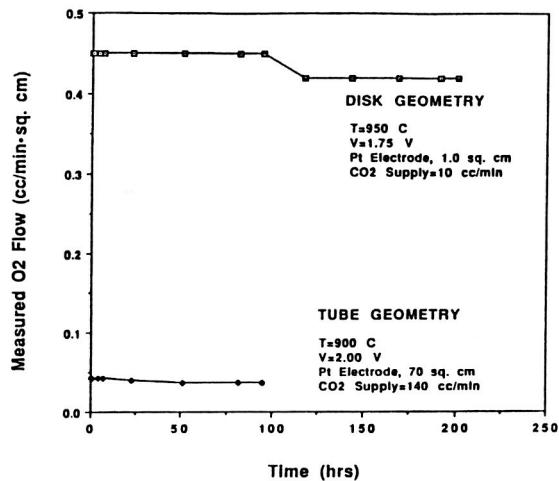
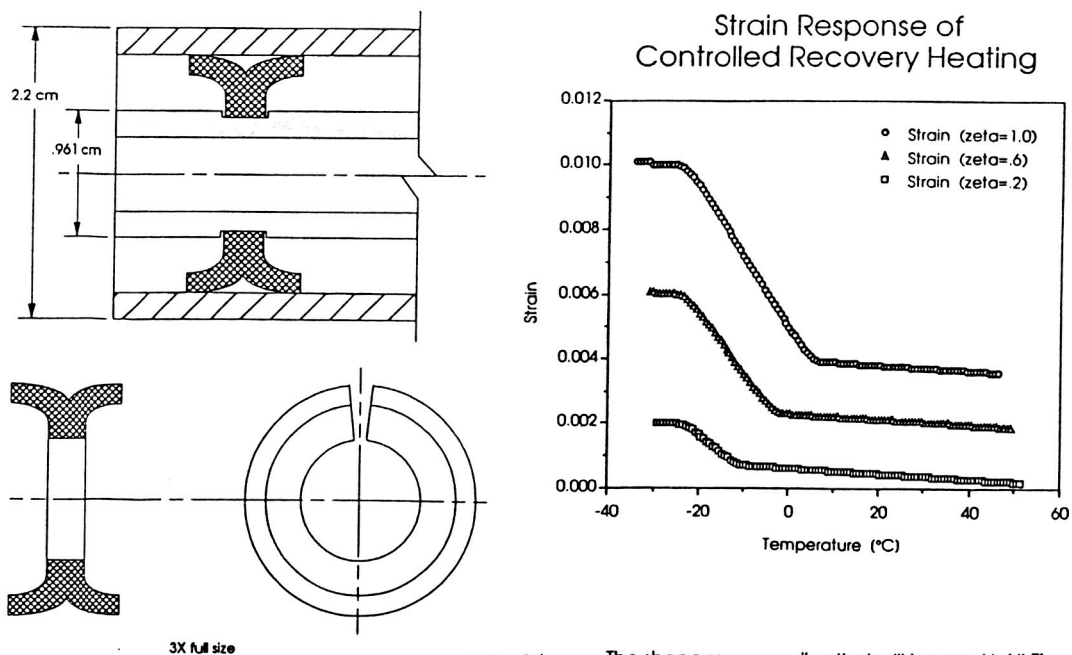

FIGURE 9. INFRARED THERMOGRAM SHOWING EFFECTIVE AREA OF THE TUBE ELECTROLYTE (ZrO₂).

FIGURE 10

High Temperature Seal using a Shape Memory Alloy



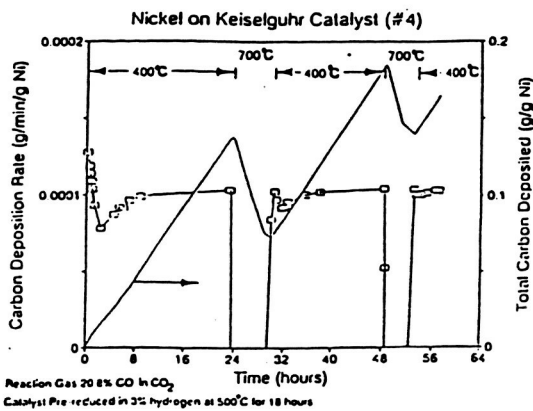

FIGURE 13. SABATIER REACTOR SETUP.

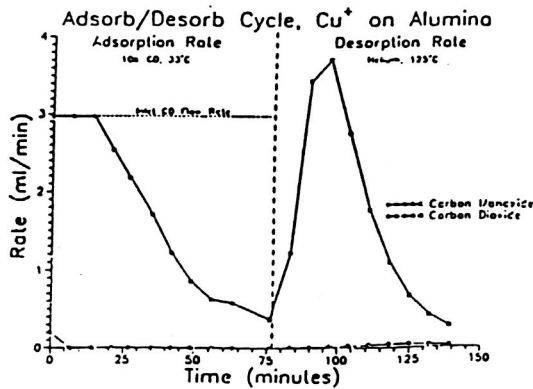

FIGURE 14

Sabatier "Test Tube" Reactor

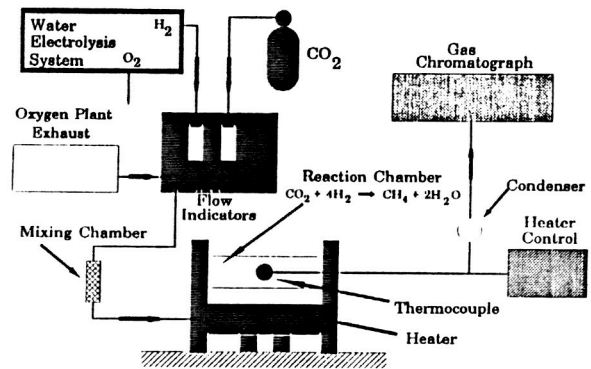

FIGURE 15

METHANE PRODUCED

O/F = 0.25, P = 1 atm

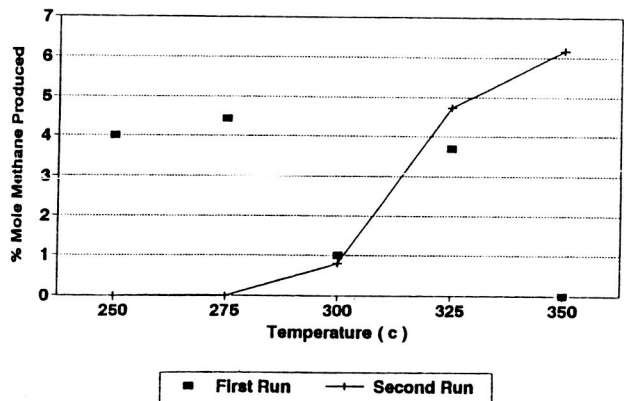
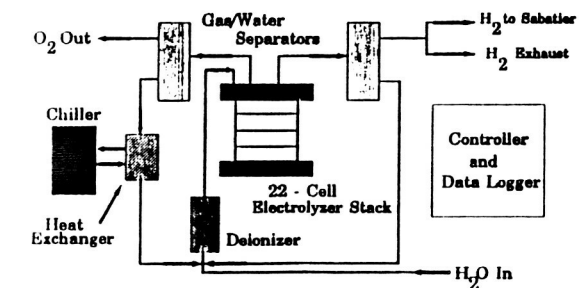

Fig. 11. Carbon monoxide removal from electrochemical cell discharge gas.

FIGURE 12

WATER ELECTROLYSIS SYSTEM



Experimental Mass and Flow Rates as a function of Electrolysis Current

Stack Amps	Oxygen Out kg/day	Oxygen Out cc/min	Hydrogen Out kg/day	Hydrogen Out cc/min
8	0.72	376	0.09	760
15	1.86	970	0.24	1940
30	4.34	2275	0.56	4560



FIGURE 16. SUPPORT TECHNOLOGY SETUP, WITH SMART SENSORS AND DEDICATED ADAPTIVE CONTROLS.

Processing of Ceramics from Lunar Resources

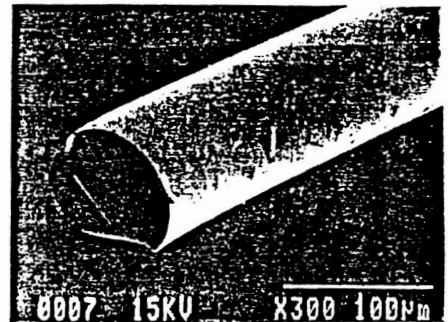
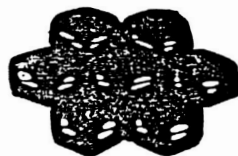
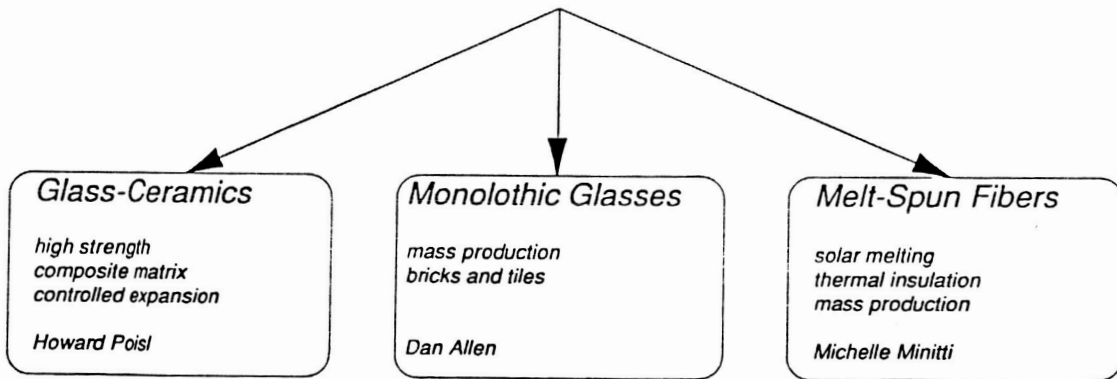

FIGURE 17

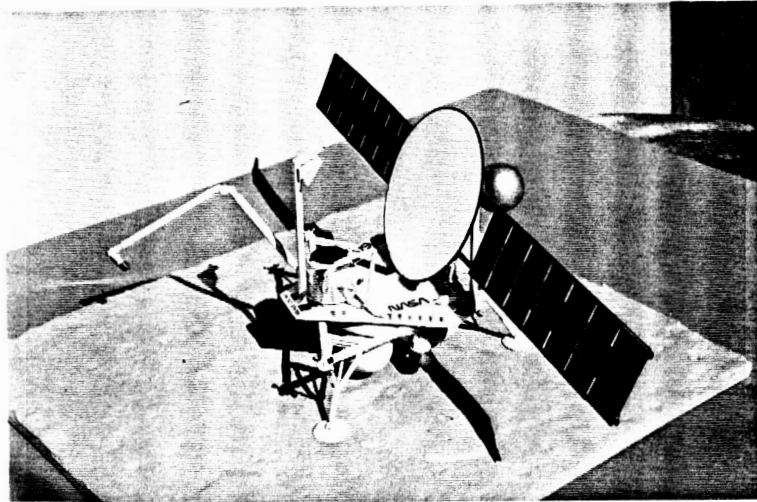

FIGURE 18

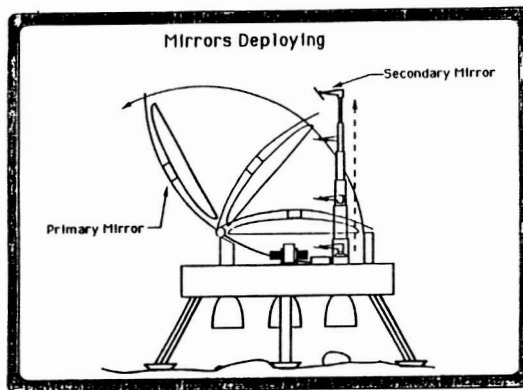

FIGURE 19

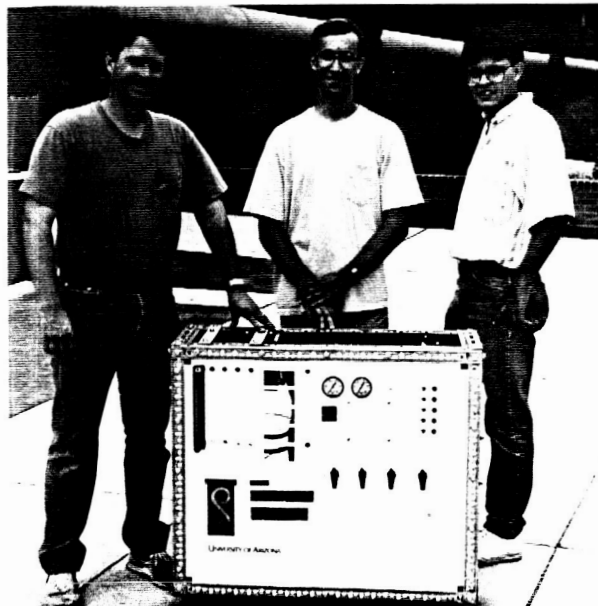

FIGURE 20. PORTABLE OXYGEN PLANT ($\text{CO}_2 \rightarrow \text{O}_2$).

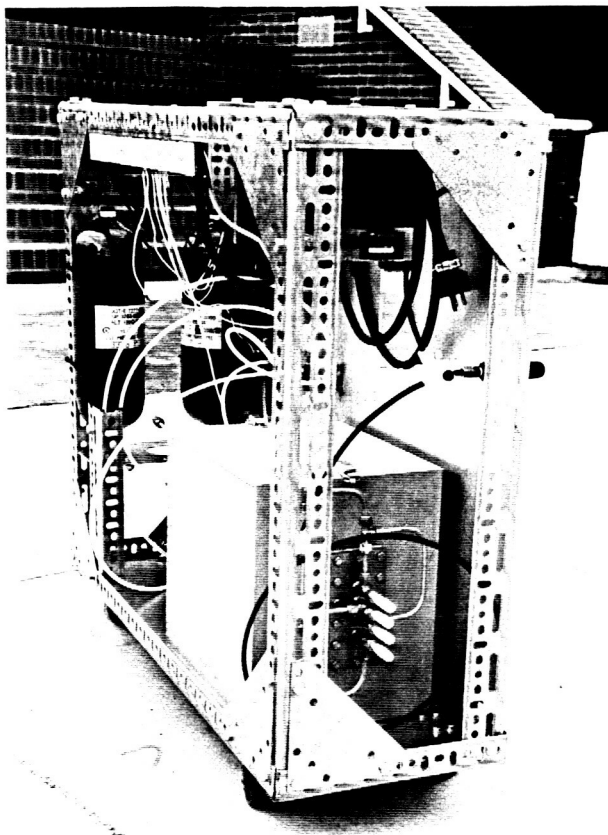

Fig. 21. Portable oxygen plant (cover removed).

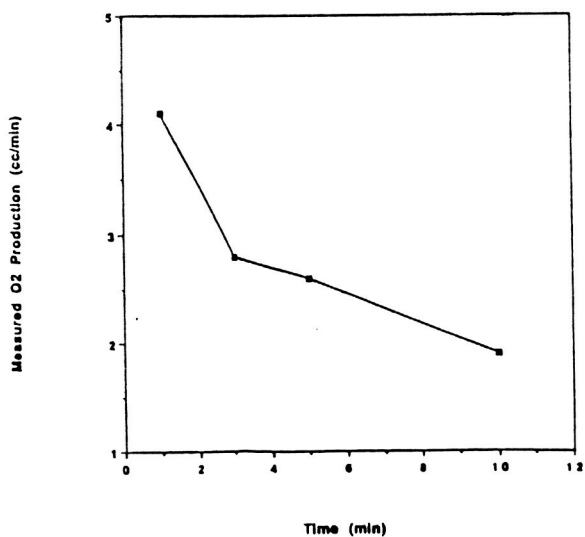

Fig. 22. Oxygen production versus time ($T = 800^{\circ}\text{C}$, $V = 2.00\text{ V}$, LSM/Pt electrode).

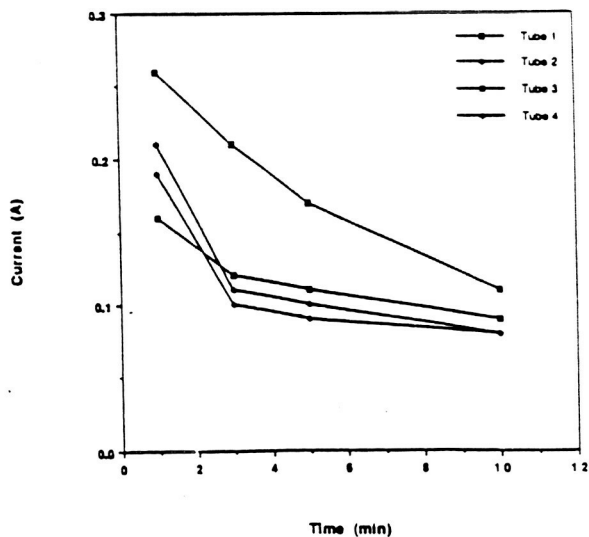

Fig. 23. Current versus time for Lewis unit tubes ($T = 800^{\circ}\text{C}$, $V = 2.00\text{ V}$, LSM/Pt electrode).

Table 1. The basic game plan for in-situ resource utilization.

NOVEL CONCEPTS IN HIGH TECHNOLOGY: "Anything Goes"
FEASIBILITY STUDIES: "Back-of-the-Envelope Calculations and "Test-Tube" Evaluations
SMALL-SCALE PROOF-OF-CONCEPT: Mathematical Models, Computer Simulations, First Hardware
BREADBOARD ENGINEERING DEMONSTRATIONS: Realistic Full-Size System at Realistic Production Rates
HIGHEST TECHNOLOGY READINESS LEVEL: Plans and Software Delivered to NASA and Industry

Table 2. Screening matrix for yttria-stabilized zirconia.

Tube	Electrode	Temperature (°C)	Applied Voltage	Oxygen Yield (cc/min)
C-4	Proprietary	825	2.40	11.75
C-6	Proprietary	825	2.98	12.90
C-7	Proprietary	825	2.37	7.0
SERC1	Ag/LSM	800	2.62	5.0
SERC2	Pt/LSM	1000	2.00	3.8
SERC3	Pd/LSM	850	2.00	2.9
SPECIAL	Undisclosed	900	2.00	22.4

Table 3. Mass and energy needs for oxygen production utilizing yttria-stabilized zirconia.^a

	Single-Cell Unit	4-Cell Unit 0.1 kg/day	16-Cell Unit 0.4 kg/day	Full-Scale Prototype 1-2 kg/day
Mass (kg)	4.08	13.15	52.16	113.0
Dimensions ^b (cm)	20×20×28	30×30×46	120×120×46	30×46×36
Power Needs: Thermal (kw)	0.37	0.50	2.00	4.80
Electrical (w)	3.0	12.5	50.0	150.0

^a Immediate Applications: portable 0.1 kg/day demo unit for LeRC; prove ability to engineer; package and operate at sites other than SERC.

^b ZrO₂ subsystem only.

Table 4. Summary of mass and power needed for integrated oxygen production.

	Mass (kg)	Power (w)
Communications	3.5	10/120
Computer	4.25	16
Sensors/Actuators		
Servo motors (8)	6.4	480.0
Flow meters (2)	0.8	7.5
Pressure sensors (2)	0.1	0.2
Force/torque sensors (2)	1.0	*
Proximity sensors; strain gauge	*	*
Flow control valves (2)	1.2	2.4
Thermocouples (2)	*	*
CCD camera (1)	0.2	3.0
Mass spectrometer (1)	0.5	2.0
	10.2	495.1

*Negligible.

Table 5. Integrated oxygen production:
task decomposition.

Soil Sample Acquisition

- Move arm and gather soil
- Deposit in crucible through sieve

Reactor Operation

- Mix solid carbon powder with soil
- Insert crucible at the focus
- Control heating (mirror adjustment)
- Measure/identify gases
- Remove and store residue (tiles from slag)

Data Management

- Obtain measurements and store data

Telemetry and Upload

- Adjust antenna/transmit data
- Upload code and data

N 9 3 - 2 7 9 7 0
514-91 -

158328

p. 13

METALS PRODUCTION

**Theodore R. Beck
Electrochemical Technology Corp.**

Abstract

Existing procedures for design of electrochemical plants can be used for design of lunar processes taking into consideration the differences in environmental conditions. These differences include: 1/6 Earth gravity, high vacuum, solar electrical and heat source, space radiation heat sink, long days and nights, and different availability and economics of materials, energy, and labor. Techniques have already been developed for operation of relatively small scale hydrogen-oxygen fuel cell systems used in the U.S. lunar landing program. Design and operation of lunar aqueous electrolytic process plants appears to be within the state-of-the-art. Finding or developing compatible materials for construction and designing of fused-magma metal winning cells will present a real engineering challenge.

Introduction

Electrochemical processes are candidates for exploiting lunar rocks to obtain oxygen, metals of construction, and by-product glasses and ceramic materials. Since the Apollo landings, NASA has supported some preliminary studies on electrochemical processing of lunar rocks. One of the first was a laboratory investigation at the Bureau of Mines by Kesterke on electrowinning of oxygen from silicate rocks.¹ Electrolyses were performed with volcanic scoria, fluxed with fluorides to obtain operating temperatures in the range of 1050° to 1250°C, and a current of about 50 amperes. Oxygen was obtained at a current efficiency of about 55%. Solid cathode deposits were formed consisting of metal dendrites of iron, aluminum, silicon, etc., in an electrolyte matrix.

Waldron, Erstfeld, and Criswell reviewed the role of chemical engineering in space manufacturing in 1979.² Various suggested processes which might be used on the lunar surface included: electrolysis of molten silicates, carbothermic/silicothermic reduction, carbo-chlorination process, NaOH basic-leach process, and HCl and HF acid-leach process. Aqueous electrochemical processes could be used with the leach process for metals and oxygen recovery. A judgment was not made regarding the optimum route, but it was pointed out that manufacturing in space will require rigorous recycling of materials available only from Earth. Difficulty of recycling probably rules out carbothermic and carbo-chlorination processes.

Haskin and Colson have been evaluating physical-chemical properties of silicate melts and magma electrolysis without fluoride additions.³ They conducted microscale experiments in the range of tens of milligrams or grams at 1200° to 1500°C. They deposited iron dendrites and silicon-iron phases at the cathode and oxygen at the anode. Waldren and McCullough also reported small-scale silicate melt experiments at 1200°-1400°C in which iron dendrites were deposited on a Kanthal wire or iron was deposited into an iron-silicon melt.⁴ Keller, et al., have studied electrolysis of magnetically beneficiated anorthite, from which most of the iron minerals were removed. Electrolysis at 1425°C and 2 amperes yielded aluminum-silicon alloy.

The purpose of the present paper is to describe the methods to scaleup laboratory data to full-scale cell and plant designs. Preliminary design of full-scale plants at an early stage in the technology development can guide research to answer the right questions needed to implement the technology.

Electrochemical Engineering

The design of electrochemical reactors has unique aspects related to the passage of electric current. Electrochemical engineering of cells may be divided into fundamental and applied aspects as shown in Table 1. Through the leadership of academic researchers such as Tobias,⁶ over the past four decades, knowledge and methods exist for the quantitative design of electrochemical cells. Availability of modern digital computers has made practical the quantitative treatment of the complex interrelationships of the fundamental aspects in Table 1. The applied aspects of cell and plant design have been elegantly described in MacMullin's classic paper.⁷

Table 1

ELEMENTS OF ELECTROCHEMICAL ENGINEERING

FUNDAMENTAL ASPECTS

Thermodynamics
Kinetics
Transport Processes
Potential and Flux Distribution
Mass and Energy Balance
Scaling Laws

APPLIED ASPECTS

Construction Materials
Cell and Plant Design
Economics, Optimization
Laboratory and Pilot Plant Experimentation
Process Control

Under fundamental aspects the following summary descriptions may be given. Thermodynamics tells what reactions are possible at given electrochemical potentials. Electrode kinetics describes the overpotentials required at electrode surfaces for given reaction rates or current densities. The topic of kinetics also includes sequential and parallel homogeneous reaction in the electrolyte. Transport processes describe the rates that reactants and products and heat can be transported to or from an electrode. Mass transport phenomena can become quite complex with simultaneous convection, diffusion and ionic migration and with effects of gas bubbles, porous electrodes, and simultaneous electrolyte reactions. Potential and flux distribution deal with current distribution on various electrode shapes as determined by solution of Laplace's equation for ionic conduction as modified by potential boundary conditions imposed by kinetics and mass transport. The combination of these fundamental components determine the mass and energy balance and scaling laws for cells.

The applied aspects of cell and plant design involve a larger degree of art than do the fundamental aspects. In general, the design of electrochemical cells is limited by available materials of construction, to be illustrated further on by a description of an aluminum reduction cell. Optimization of a cell and plant design is always economic in the last analysis. Quantitative formulation of the fundamental aspects with materials and design considerations provide the basis for economic optimizations. Application of mathematical modeling of cell systems will provide guidance for defining the essential problems in the research and development phase. Selection of required process control methods is aided by quantitative understanding of process dynamics.

MacMullin² presented an outline for electrochemical process development, shown on Table 2, that is also applicable to lunar processes. In step 1 for the case at hand, NASA is the overall program manager and defines through its procedures the objectives of the lunar mission and thus the envelope within which an electrochemical metal producing and oxygen producing plant must operate. NASA assigns qualified personnel in step 2 through its contacting procedures. Steps 3 through 14 are carried out by the contractor with review by NASA at designated milestones. The contractor must have access to documentation of prior work sponsored by NASA and have

communication with others who are conducting laboratory studies on electrochemical processing of lunar materials.

It is not necessary to describe in detail each of the steps 3 through 14 in Table 2, but it is important to emphasize that such a design procedure should be initiated at an early stage in the program of lunar electrochemical processing. The reason is that this scheme identifies key problem areas not necessarily apparent when working up from the laboratory scale one small incremental step at a time. Sensitivity analyses in the technical and economic models will aid in prioritizing the most fundamental information needed. Existing process analogies such as manufacture of aluminum can be very useful for preliminary design of lunar fused salt processes.

Table 2

OUTLINE FOR ELECTROCHEMICAL DEVELOPMENT⁷

1. Ascertain the objectives of management
2. Assign qualified personnel and/or consultants.
3. Make a search of the literature, including patents.
4. Determine what fundamental information is lacking.
5. Estimate the extent to which analogies can be made as a first approach to design.
6. Draw up a tentative process flow sheet for full-scale plant, including feed preparation, electrolysis, recovery of products, and power supply. This frequently narrows down the conditions under which electrolysis is to be carried out.
7. Make a preliminary economic evaluation of full-scale plant, based on what is known or can reasonably be guessed. This investigation involves the following:
 - (A) Preliminary cell design and cost versus cell size.
 - (B) Circuit design and overall circuit cost versus cell size.
 - (C) Total capital cost, manufacturing cost, and return on investment, on conservative basis.

IF THE EVALUATION JUSTIFIES FURTHER EFFORT, ADDITIONAL STEPS ARE TAKEN AS FOLLOWS:

8. Secure the missing or doubtful fundamental data in the laboratory.
9. Scale down the preliminary commercial cell to an experimental size and provide for varying the parameters and materials of construction.
10. Test the cell, modify as required, and record all meaningful data.
11. Interpret results and make complete material, voltage, and energy balances.
IF THE RESULTS STILL MAKE SENSE, PROCEED TO:
12. Extract the significant design factors for scale-up.
13. Reassess the original "commercial" cell and modify as required.
14. Scale down to the next experimental size, which will be also a scale-up of the last model tested.

REPEAT UNTIL OBJECTIVE IS REACHED (OR HAS TO BE ABANDONED).

Steps 9 and 14 warrant some elaboration because of an important concept advocated by MacMullin, "scale-down by dissection." Generally, for economic reasons, electrolytic cells are operated close to their mass transport limiting current densities. Natural convection of electrolyte, driven by density differences caused by concentration changes or by gas bubble evolution, is often the critical factor. In such a case the critical dimension, for example, electrode height in a copper refining cell, is preserved and the two horizontal dimensions are scaled down.

Design of Lunar Electrochemical Processes

Conditions on the lunar surface, different from Earth, that affect electrochemical cell and plant design are listed in Table 3. The $1/6$ -Earth gravity would decrease natural convection and limiting mass transfer rates at electrodes and thus could require larger cells than on Earth. The high vacuum would require sealed gas producing cells and plant or operation in a building pressurized with an artificial atmosphere. A solar energy source of heat and electricity, the space radiation heat sink, and the long day/night cycle cause special problems. Either the electrochemical cells are operated intermittently on a 28-Earth-day cycle or large-scale energy storage is used. The alternates of nuclear energy or energy beamed from Earth as discussed in this symposium⁸ could provide power for continuous operation. The space radiation heat sink favors higher temperature processes for minimum radiator area, but would require mechanism for lunar day/night constant cell temperature control. Finally, the economics of materials, energy, and labor would be vastly different on the Moon, requiring novel approaches to cell and plant design and, most importantly, integration into the overall lunar enterprise. Optimization of the electrochemical plant will be strongly linked to economic optimization of the whole enterprise.

Table 3

CONDITIONS ON MOON DIFFERENT FROM EARTH AFFECTING ELECTROCHEMICAL CELL AND PLANT DESIGN

1/6 Earth Gravity
 High Vacuum
 Solar Energy Source - Heat, Electricity (or alternates of nuclear or beam from Earth)
 Space Radiation Heat Sink
 Lunar Day = 28 Earth Days
 Different Economics - Materials, Energy, Labor
 Materials - Earth Supply vs Lunar Source (water, hydrogen, and carbon are scarce)
 Energy - Intermittent Solar vs Nuclear or Beamed
 Labor - Mechanization vs Human Labor

Table 4

CONTINUOUS LUNAR ROCK ELECTROLYSIS CELL - REQUIREMENTS

Insoluble Long-Life Lining
 Inert Anode
 Inert Cathode
 Electrically Conducting Path to Cathode
 Operating Temp. above Melting Point of Alloy Product
 Operating Temp. High Enough to Decrease melt Viscosity
 Thermal Insulation
 Methods of Startup and Shutdown
 Methods of Feeding Reactants and Removing Products Cost Effectiveness

Gravity is an important force in the design of terrestrial electrochemical processes. Copper refining cells, mentioned in one of the papers in this symposium,⁹ are operated near their mass transport limiting current density. This limiting current density is determined by natural convection established by concentration density differences near the vertical anode and cathode surfaces. In chlor-alkali cells the disengagement of H₂ and Cl₂ gas bubbles at the electrodes and the gas buoyancy pumped electrolyte circulation are affected by gravity. The Hall-Heroult aluminum reduction cell depends for its operation on a stable, gravity-dependent, interface between the horizontal molten aluminum cathode on the bottom of the cell and the electrolyte above it. Much effort has been expended to maintain a stable interface as reduction cells have become larger, but the cells continue to operate on the verge of instability. Terrestrial Hall-Heroult cells would operate with extreme difficulty on the 1/6-Earth-gravity lunar surface.

To obtain a quantitative feel for the effect of 1/6-Earth-gravity on an electrochemical process, an estimate is made on the size of a copper refining cell with natural convection circulation. The mass transfer coefficient for this system is correlated by¹⁰

$$Sh = 0.67 (Gr Sc)^{1/4} \quad (1)$$

in which

Sh = Sherwood number, kL/D

Gr = Grashof number, $gL^3 \Delta\rho / \rho\nu^2$

Sc = Schmidt number, ν/D

k = mass transfer coefficient $cm \cdot s^{-1}$

L = electrode height, cm

D = diffusion coefficient, $cm^2 \cdot s^{-1}$

g = acceleration of gravity, $cm \cdot s^{-2}$

ρ = density of electrolyte, $g \cdot cm^{-3}$

$\Delta\rho$ = difference in density of electrolyte between bulk and close to electrode

ν = kinematic viscosity, $cm^2 \cdot s^{-1}$

For the same electrode height and electrolyte properties, 1/6 gravity decreases the mass transfer coefficient to 64% of the terrestrial value so that 57% more electrode area would be required.

Two aqueous electrochemical systems have been highly engineered to operate in space vacuum and microgravity on space vehicles; the Apollo fuel cell system and a water electrolysis system.¹¹ Both systems use capillary forces in electrodes and membranes to control the aqueous phases. Design and operation of aqueous electrolytic process plants appears to be well within the state-of-the-art. Larger scale aqueous electrolytic processes may require heat pumps, though, for efficient heat rejection through space radiators.²

Fused magma electrolytic processes appear to offer certain advantages in metals and oxygen production over aqueous processes and NASA has supported preliminary investigations in this area.^{(1) (3-5)} Fewer physical and chemical pretreatment steps are apparently required and the processes would operate at temperatures more optimum for heat rejection. On the other hand, finding or developing compatible materials of construction and operation of fused-magma metal winning cells is beyond the state-of-the-art and will present a real engineering challenge. The remainder of this paper is devoted to preliminary considerations about scaling up fused-magma electrolytic cells.

In conformance to MacMullin,⁷ a process analogy, the terrestrial Hall-Heroult aluminum reduction cell may be used as a first approach to design. A liquid metal cathode greatly simplifies materials handling compared to removing and separating metal dendrites produced at a cathode. The Hall-

Heroult technology has been refined over the past one-hundred years and, in spite of hundreds of millions of dollars spent on development of alternate processes by the industry, it has not been displaced.

The essentials of a Hall-Heroult cell are shown on the schematic cross section in *Figure 1*. A carbon cathode lining holds the molten aluminum cathode and the molten cryolyte electrolyte (bath). Consumable carbon anodes project into the bath from above. Electric current passes down through the anodes, bath, aluminum cathode, carbon lining, and out steel collector bars. Alumina powder dissolved in the bath is electrolytically decomposed to give oxygen which reacts with the anodes to give carbon dioxide and aluminum which is deposited into the metal pad. The overall reaction is

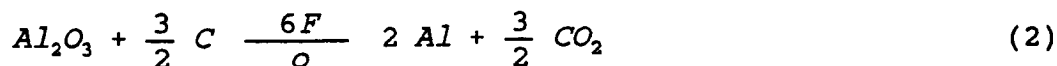

in which six Faradays of electricity are used per two gram atomic weights of aluminum produced.

The design of the aluminum reduction cell has been dictated by available materials of construction. To date no completely satisfactory nonconsumable anode that will liberate oxygen instead of CO_2 has been developed. This fact has dictated the vertical entering consumable anodes which are adjusted downward as consumed to maintain the desired anode-cathode distance. Very few materials that are electrical conductors will stand up to the combined corrosive effects of molten cryolyte and aluminum; even the carbon linings have a limited life.

Some requirements for a continuous lunar magma electrolysis cell for producing metals and oxygen are presented in Table 4. With the exception of added necessity for an inert anode, the requirements are essentially the same as for terrestrial aluminum electrolysis. It may be added that the aluminum industry has done considerable R & D on inert anodes, but has not quite achieved commercial success.

A preliminary example lunar magma electrolysis cell based on the Hall-Heroult design is shown in *Figure 2*. A discussion of its utility follows. The example illustrates some of the considerations in scaling up a specific process.

The most important possible electrochemical reactions in a lunar molten magma cell are shown in Table 5. Thermodynamic reversible potentials at an example 1900 K (1627°C) calculated from the oxide standard free energies of formation¹³ are also shown. The relatively large potential difference between the iron and silicon potentials indicates that iron could be selectively deposited from a basalt as has been found experimentally on a laboratory scale.^(3,4) The smaller potential difference between silicon, titanium, magnesium, and aluminum indicate that it will be difficult to avoid codeposition of these metals as was found on a laboratory scale.⁵

Some physical properties of metal and bath important to the design of a magma electrolysis cell are compared to those in the Hall-Heroult cell in Table 6. For iron from basalt magma the metal will sink to the bottom as in the Hall-Heroult cell. For silicon and aluminum from anorthite the alloy will float to the top and the *Figure 2* cell has to be modified. The viscosities of both magmas are much higher than that of cryolyte in the Hall-Heroult bath and gas lift circulation rates would be much smaller, particularly on the 1/6-gravity lunar surface. Ionic conductivities of the magmas are considerably smaller so that anode-cathode distance must be considerably smaller than the 5 cm in the Hall-Heroult process to achieve reasonable voltage efficiency. The Hall-Heroult processes after

Table 5
 POSSIBLE ELECTROCHEMICAL REACTIONS IN MOLTEN MAGMA CELL
 TEMPERATURE 1900 °K (1627 °C)

	<u>E° (V)</u>
$FeO \quad (c) \xrightarrow{2e^-} Fe \quad (\ell) + 1/2 O_2$	0.761
$SiO_2 \quad (c) \xrightarrow{4e^-} Si \quad + \quad O_2$	1.479
$TiO_2 \quad (c) \xrightarrow{4e^-} Ti \quad (c) + \quad O_2$	1.557
$MgO \quad (c) \xrightarrow{2e^-} Mg \quad (\ell) + 1/2 O_2$	1.767
$\alpha Al_2O_3 \quad (c) \xrightarrow{6e^-} 2Al \quad (\ell) + 3/2 O_2$	1.845
$CaO \quad (c) \xrightarrow{2e^-} Ca \quad + \quad 1/2 O_2$	2.191

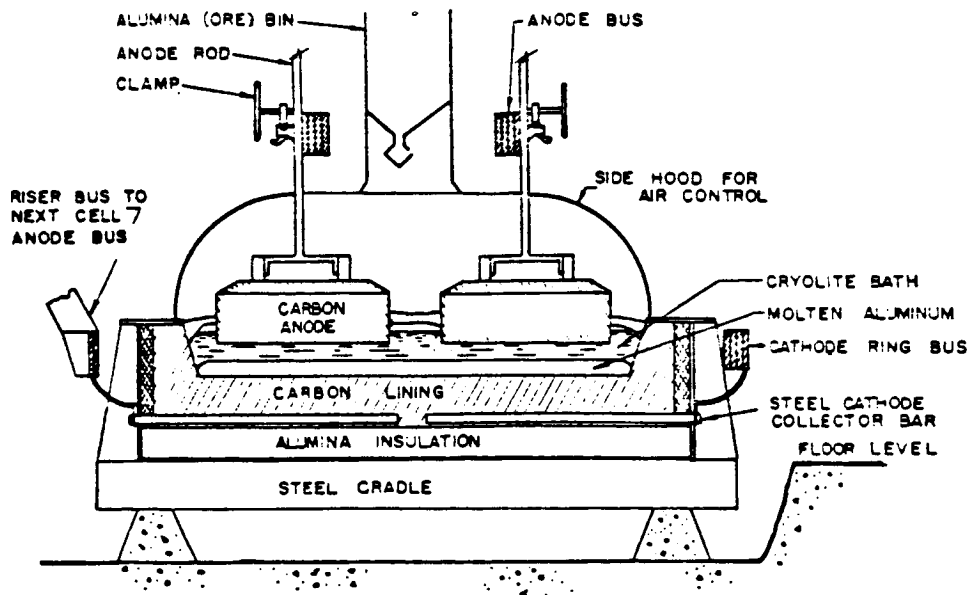

FIG. 1 SCHEMATIC CROSS SECTION OF A HALL-HEROULT ALUMINUM REDUCTION CELL (Ref. 12)

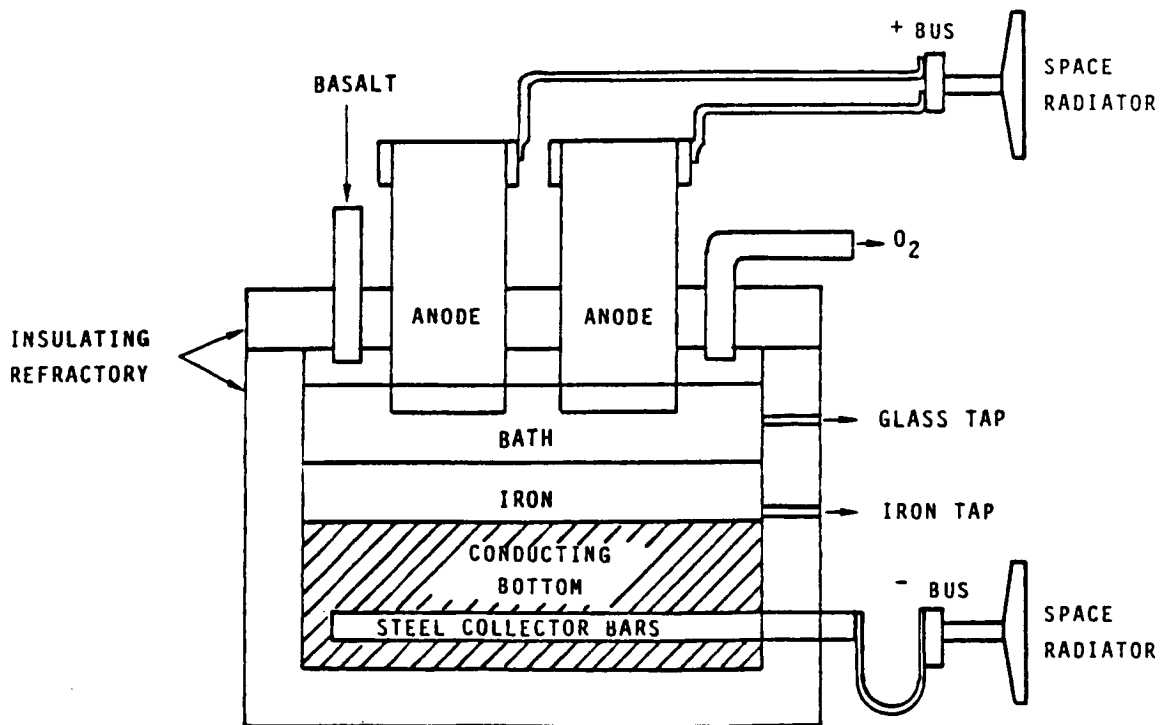

FIG. 2 SCHEMATIC BASALT ELECTROLYSIS CELL BASED ON HALL-HEROULT CELL DESIGN.

one-hundred years of development has an energy efficiency of 40 to 50%. It seems unlikely that a magma electrolysis process with higher temperature, higher-viscosity, and lower conductivity operating at 1/6 gravity would have a higher energy efficiency than 40%.

Table 6
SOME PHYSICAL PROPERTIES OF MAGMA METALS AND BATH
COMPARED TO THE HALL-HEROULT PROCESS

	Aluminum Hall-Heroult Process ¹⁴	Iron from Basalt	Si and Al from beneficiated anthorite
Temp °C	950	1600	1400
Bath density g/cm ³	2.2	*2.8-3.7 (15)	*-3 (15)
Metal density g/cm ³	2.3	-7 (16)	-2 (16)
Bath viscosity poise	0.03	-2.5 (15)	-200 (15)
Bath conductivity S/cm	2	** <0.5 (3)	** <0.5 (3)
Energy Efficiency, %	40-50	<40	<40

Table 7 lists some melting points of potential cell materials for a preliminary screening. Iron melts at 1535°C, which sets a lower limit for a liquid cathode basalt electrolysis cell. An operating temperature above 1535°C decreases the basalt viscosity. Graphite might first appear to be a suitable cathode material in the *Figure 2* cell, but it reacts with iron to form a eutectic at 4.3 wt% carbon with a melting point of 1130°C.¹⁷ This reaction would consume the cathode and give an unsatisfactory alloy. Silicon carbide was used apparently satisfactorily by Kesterke¹ and may be considered a candidate material. The thickness of the bottom must be sufficient to obtain a temperature at the steel collector bars below their melting point. Space radiators will be required for the cathode and anode to obtain the appropriate heat fluxes out of the cell. Anode materials may be the most difficult problem area. Platinum has been used with mixed low and high corrosion results in lunar magma electrolysis.^(3,5) If the corrosion mechanism could be identified and eliminated, platinum anodes might be considered. Other potential electrodes are tin oxide and nickel ferrite which have been tested for aluminum electrolysis. The anode materials listed in Table 7 would set an upper limit of cell operating temperature. Kesterke¹ found boron nitride an acceptable material for the cell lining at least for short runs. Fused alumina, magnesia, or lunar spinels³ might be considered for cell linings.

Table 7
MELTING POINTS OF SOME POTENTIAL CELL MATERIALS

COMPONENTS	TEMP (°C) Ref. 16 (except as noted)
------------	--

<u>Bath and Metal</u>	-1200 (15)
Basalt	
Iron	1535
Silicon	1410
Aluminum	660
<u>Cathodes</u>	
Graphite	-3652
SiC	-2700
<u>Anodes</u>	
Platinum	1772
SnO ₂	1630
NI ferrite	-1600 (18)
<u>Cell</u>	
Boron nitride	-3000 subl.
Al ₂ O ₃	2040
MgO	2825

An alternate cell configuration which might be used for the fused anorthite electrolysis is shown in *Figure 3*. The aluminum silicon alloy floats up to the top of the bath. Vertical parallel, slab anodes and cathodes allow better bath convection by gas bubble buoyancy. Only two of many electrode pairs, as would be used in aluminum electrolysis¹⁹ if a suitable inert anode were available, are shown. Oxygen bubbles would penetrate through the alloy to escape and be collected. Lunar rock chunk feed would also have to penetrate the alloy layer from above. The possible lower temperature of operation of the anorthite electrolysis system could be less corrosive on cell material.

In the early phases of manufacturing on the Moon, solar cells could be the only power source, and batch electrolysis may be the only viable alternative. A concept to produce iron from iron-rich regolith is shown in *Figure 4*. The regolith is put in a suitable vessel with lid. A mushroom-shaped iron starter cathode and current lead comes in from the bottom and an anode projects in from the top through the lid. A refractory bottom prevents the molten iron cathode from melting down through the regolith. At startup of the cycle, the in-place regolith may be melted with a solar concentrator before the lid and anode are put in place. Additional regolith is then dumped into the cell after electrolysis is started. The top of the mushroom cathode grows by deposition from the molten bath between it and the anode. The regolith serves as the source of bath material and as thermal insulation. The anode is moved up as the top of the mushroom cathode grows. Oxygen is collected from a port in the lid. At the end of the 14-Earth-day electrolysis phase the lid and anode are removed and the cell cools by radiation to space. The cell vessel is inverted and the enlarged mushroom cathode, solid glass, and unmelted regolith are removed for further processing. The cell is then reloaded for the next cycle. Graphite and silicon carbide electrothermic furnaces operate on Earth with batch cycles.^(21,22)

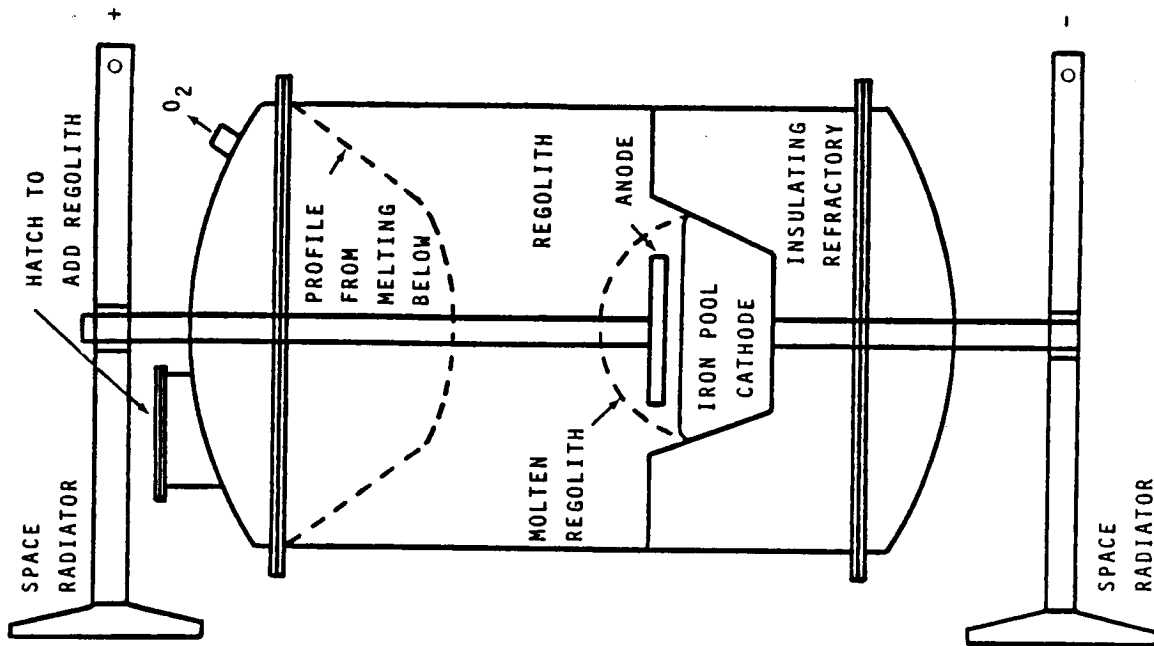

FIG. 4. CONCEPTUAL BATCH REGOLITH ELECTROLYSIS CELL.

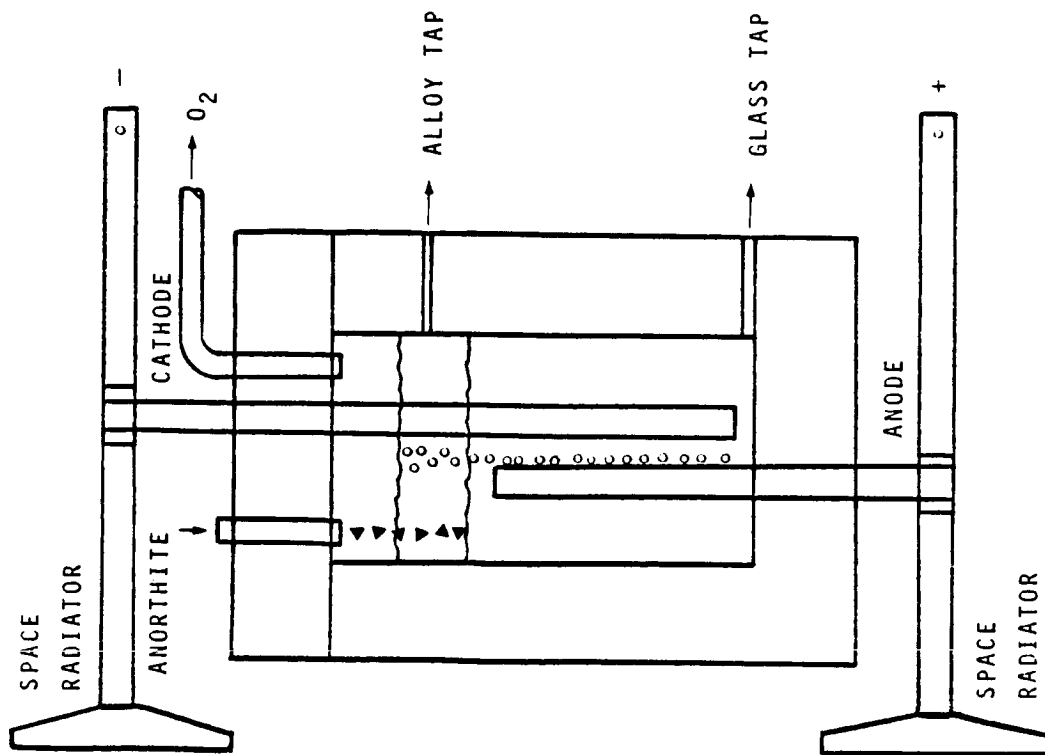

FIG. 3 CONCEPTUAL ANORTHITE ELECTROLYSIS CELL.

Whatever the cell configuration used for metal and oxygen production on the Moon, it is evident that considerable engineering development will be required. The engineering analysis should begin at an early stage and be carried out in collaboration with the small scale laboratory studies to help define the most critical data needed for cell and plant design.

Acknowledgement

Electrochemical Technology Corp. supported the preparation of this paper.

References

- ¹D.G. Kesterke, "Electrowinning of Oxygen from Silicate Rocks," RI 7587, U.S. Bureau of Mines, 1971.
- ²R.D. Waldron, T.E. Erstfeld, and D.R. Criswell, "The Role of Chemical Engineering in Space Manufacturing," *Chemical Engineering*, p 80, Feb. 12 (1979).
- ³L.A. Haskin and R.O. Colson, "Physical-Chemical Properties of Silicate Melts and 'Magma' Electrolysis," reported at a State-of-the-Art Workshop, Sponsored by The University of Arizona/NASA Space Engineering Research Center, Tucson, AZ, August 8-9, 1991.
- ⁴R.D. Waldron and E.D. McCullough, "Lunar ISRU Via Magma Electrolysis, Preliminary Results," in same place as Ref. 3.
- ⁵R. Keller, et al., "MISM Experiments at EMEC Consultants," in the same place as Ref. 3; "Products from Lunar Anorthite," 9th Biennial SSI/Princeton Conference on Space Manufacturing, May, 1989.
- ⁶C.W. Tobias, "The Coming Age of Electrochemical Engineering," in *Tutorial Lectures in Electrochemical Engineering and Technology*, R.C. Alkire and T.R. Beck, Eds., AIChE Symposium Series No. 204, volume 77, New York, 1981.
- ⁷R.B. MacMullin, "The Problem of Scaleup in Electrolytic Processes," *Electrochemical Technology*, 1, 5 (1963).
- ⁸J.D.G. Rather, "Earth to Space Power Beaming: A New NASA Technology Initiative," this conference.
- ⁹C.N. Jones, "An Engineer/Constructors View of Lunar Resource Development," this conference.
- ¹⁰J.R. Selman and C.W. Tobias, "Mass-Transfer Measurements by the Limiting Current Technique," in *Advances in Chemical Engineering*, Drew, et al., Eds., Vol. 10, Academic Press, New York, 1978.
- ¹¹J.F. McElroy, "SPE Water Electrolyzers in Support of the Lunar Outpost," this conference.
- ¹²R.A. Lewis, "Aluminum Electrowinning" in *The Encyclopedia of Electrochemistry*, C.A. Hampel, Ed., Reinhold, New York, 1964.
- ¹³JANAF Thermochemical Tables, 2nd Ed., Nat. Stand. Ref. Data Ser., Nat. Bur. Stand. (U.S.), No. 37, 1971.
- ¹⁴K. Grjotheim, et al., "Aluminum Electrolysis," Aluminum-Verlag, Dusseldorf, 1982.
- ¹⁵"Handbook of Lunar Materials," R.J. Williams and J.J. Jadwick, Eds., NASA Reference Publication 1057, 1980.
- ¹⁶"CRC Handbook of Chemistry and Physics," 58th, R.C. Weast, Ed., CRC Press, Cleveland, 1977.
- ¹⁷"Smithells Metals Reference Book," 6th, E.A. Brandes, Ed., Butterworths, London, 1983.
- ¹⁸J.D. Weyand, et al., "Inert Anodes for Aluminum Smelting," Final Report, DOE/CS/40158, Alcoa Laboratories, February, 1986.
- ¹⁹T.R. Beck and R.J. Brooks, "Electrolytic Reduction of Alumina," U.S. Patents No. 4,865,701, 1989, and 5,006,209, 1991.
- ²⁰W.G. Krellner and P. Smisko, "Graphite, Electrothermic Production" in Hampel, Ref. 12.
- ²¹J.C. McMullen, "Silicon Carbide," in Hampel, Ref. 12.

GLASSES, CERAMICS, AND COMPOSITES FROM LUNAR MATERIALS

George H. Beall
Corning Incorporated

S15-91
158329
P-13

Abstract

A variety of useful silicate materials can be synthesized from lunar rocks and soils. The simplest to manufacture are glasses and glass-ceramics. Glass fibers can be drawn from a variety of basaltic glasses. Glass articles formed from titania-rich basalts are capable of fine-grained internal crystallization, with resulting strength and abrasion resistance allowing their wide application in construction.

Specialty glass-ceramics and fiber-reinforced composites would rely on chemical separation of magnesium silicates and aluminosilicates as well as oxides titania and alumina. Polycrystalline enstatite with induced lamellar twinning has high fracture toughness, while cordierite glass-ceramics combine excellent thermal shock resistance with high flexural strengths. If sapphire or rutile whiskers can be made, composites of even better mechanical properties are envisioned.

Glasses, Ceramics, and Composites from Lunar Materials

1. Introduction

The Moon is composed primarily of a suite of basic igneous rocks of largely basaltic, gabbroic, and anorthositic types. Because of the lack of weathering and erosion, the lunar soil or regolith reflects the composition of the underlying rocks as resulting from eons of meteoritic bombardment. Both the soils and rock can be used in a chemical extraction, melting, and sintering process to manufacture a variety of glass and ceramic materials.^(1,2) This paper will be concerned with the production of glass and glass-ceramic materials from lunar basalts as well as refined glass-ceramics based on the minerals enstatite and cordierite. It will also explore the possibility of producing fiber-reinforced glass-ceramics using oxide fibers and whiskers from refined lunar materials.

2. Glass and ceramic materials based on basalt

Glasses are easily made from terrestrial basaltic compositions containing >40 wt % silica.³ Typical lunar mare soils such as high titania A11 and low titania A12 (Table 1), analyzing between 42 and 47 wt. % silica, are easily melted and quenched to form glass.

Considerable materials research and pilot scale product development was carried out at Corning Incorporated on the terrestrial tholeiitic basalt from Westfield, Massachusetts. Although this material is somewhat higher in silica and alkalis and lower in titania and iron oxides, as compared to the lunar materials, it is nevertheless generally similar in crystalline constitution and melting characteristics. Glass articles, glass fibers, and foams were all made from the Westfield basalt. High quality glass fibers of 10 mm diameter were continuously drawn from platinum spinnerets and showed good strength and chemical durability, particularly in alkaline environments. In fact, the elastic modulus of Westfield basalt glass was 90 GPa, about 10% higher than standard commercial E fiber-glass, accounting for its higher strength.

It was found that partial recrystallization of basaltic glasses could improve many properties including abrasion resistance, strength, thermal stability, and chemical durability.³ Controlled crystallization of basaltic glass requires internal nucleation. Internal nucleation can be achieved in iron-rich silicate glasses, including basalt, through the thermal precipitation of spinels of composition along the join Fe_3O_4 (magnetite)- Fe_2TiO_4 (ilvospinel). In terrestrial basalts, such as the Westfield material, fine internal precipitation of spinel close to magnetite in composition is observed when the glass made from this basalt is sufficiently oxidized. If chunks of basalt are melted in a neutral atmosphere, the resulting glass will not precipitate sufficient magnetite for efficient nucleation because the $\text{FeO}:\text{Fe}_2\text{O}_3$ ratio is too low, reflecting that of the original rock, about 2.5:1. If melted in a reducing atmosphere, no internal nucleation is achieved because FeO (wustite) is never precipitated. Instead, only surface oriented crystallization develops accompanied by pits, voids, and deformation, and useful glass-ceramics cannot be formed.

If, however, the glass is melted in an oxidizing atmosphere, or an oxidizing agent such as ammonium nitrate is added to the melt, the redox ratio in the glass is reversed with Fe_2O_3 the predominant oxide (see Table 2). Under these conditions, efficient nucleation of spinel is achieved upon reheating above the glass transition ($\sim 650^\circ\text{C}$), and, as the glass is further heated to 880°C , clinopyroxene forms on the magnetite spinel nuclei (Figure 1). The final percent crystallinity at this point is roughly 55.

In the case of the lunar basalts, Fe_2O_3 is not present and normal melting would occur under reducing conditions. Therefore, low titania compositions such as the A12 mare soil would not

Table 1. Composition of Typical Tholeiitic Basalt vs. Some Lunar Mare Soils

	THOLEIITIC BASALT WESTFIELD, MASS.	MARE SOILS	
		HIGH Ti (A-11)	LOW Ti (A-12)
SiO ₂	52.6	42.5	46.2
Al ₂ O ₃	14.1	13.8	13.7
TiO ₂	1.0	7.7	3.1
MgO	6.4	8.2	9.9
CaO	9.3	12.1	10.6
FeO	8.6	15.8	15.4
Fe ₂ O ₃	3.4	-	-
Na ₂ O	3.2	0.4	0.5
K ₂ O	1.2	0.2	0.3
P ₂ O ₅	0.2	0.1	0.3
Cr ₂ O ₃	<0.1	0.3	0.4
MnO	<0.1	0.2	0.2

Table 2. Oxidation State in Westfield Basalt
(1450°C-4 hrs: Electric furnace air atmosphere, covered crucible)

Form	Additions	% FeO Anal.	% Fe ₂ O ₃ Calc.	Total Iron as Fe ₂ O ₃ Anal.	Fe ₂ O ₃ to Total Iron Oxide Ratio	Grain* Size (μm) Anal.	Normative Fe ₃ O ₄ Calc.
Chunks	None	8.4	4.1	13.3	0.31	1.0	6.0
		8.0	4.0	12.8	0.31	1.0	5.8
Powder	None	8.3	5.1	14.2	0.36	0.5	7.4
	2% NH ₄ NO ₃	7.9	6.2	14.9	0.42	0.2	9.0
	4% NH ₄ NO ₃	4.8	10.0	15.3	0.65	0.1	14.5
Powder	1% sugar	8.6	3.4	13.0	0.26	2.0	4.9
	2% "	-	-	-	-	>100.0	-
	4% "	11.4	0.7	13.3	-	~1.0	1.0
	4% TiO ₂						

* Ceram secedule: 4hrs 650°C, 1 hr 880°C

- For effective internal nucleation, at least 5% Fe₃O₄ spinel required

- For Fe₂TiO₄ spinel nucleation in reduced basalt, at least 4% TiO₂ is required



Figure 1

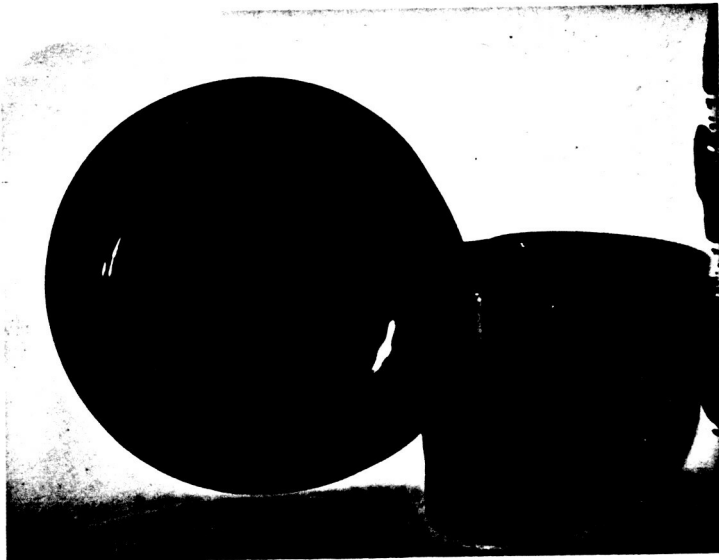

Figure 2

provide sufficient nucleation to achieve a fine-grained glass-ceramic. High titania compositions such as A11, however, with 7.7 wt. % TiO_2 , do not require oxidation to form good internal nucleation because Fe_2TiO_4 (ülvospinel) precipitates on heating glasses of this composition. In fact, an experiment was recently made at Corning with reduced Westfield basalt containing 4% dextrose added to the melt. In this case, only scattered magnetite was precipitated and the grain size of the glass-ceramic when heated to 850°C was in excess of 100 μm . The resulting material was not only coarse grained but severely deformed on crystallization because of the low viscosity of the glass and longer time required to crystallize it in the absence of densely concentrated nuclei. When 4% titania was added to the Westfield basalt and it was melted under the same reducing conditions, fine internal nucleation and crystallization was achieved. The final glass-ceramic had a grain size of approximately 1 μm , did not deform and contained no voids. In this case, a solid solution of ülvospinel and magnetite (primarily the former) produced abundant spinel precipitation and internal nucleation. This result confirmed our belief that at least 4% titania is required in a reduced basalt glass to achieve fine-grained internal crystallization analogous to an oxidized glass. Table 2 shows the results of the effective oxidation state on the grain size of crystallized Westfield basalt. From these experiments with this basalt, it can be inferred that the lunar high titania soils or basalts such as A11 contain more than sufficient titania for spinel nucleation and fine-grained internal crystallization to be achieved in the glass-ceramic process. The resulting materials should have good abrasion resistance and chemical durability, abraded flexural strength at least 100 MPa, thermal expansion coefficients in the $75 \times 10^{-7}/^\circ\text{C}$ range, and thermal stability above 800°C (Table 3). These inexpensive materials could be used as construction materials, e.g., piping, tile, etc., chemically resistant ware and fibers for use in various hostile thermal and chemical environments. Figure 2 shows some glass-ceramic articles made from oxidized Westfield basalt.

Whereas the crystallization of the high titania lunar basalts is expected to be similar to that of either oxidized basalt or reduced basalt with titania additions, the glass-forming characteristics may be significantly different. Figure 3 shows the viscosity temperature curve for the Westfield basalt. This glass can be worked down to temperatures of about 1100° where the viscosity is >1000 poise. Thus, rolling and pressing as well as spinning and casting can be considered viable glass-forming techniques. Because of the lower silica content of the lunar basalt, however, the viscosity curve may be lower and perhaps rolling and gob pressing may not be feasible. Certainly casting or spinning of pipe, tableware, tiles, or spun sheet would be practical, however.

Cast basalt ceramics have been made from very fluid and rapidly crystallizing materials.⁴ Cast basalt does not require glass formation, but since the crystallization occurs directly on cooling at low viscosities, the grain size is coarse and surface pits and internal voids form from rapid shrinkage on densification. Large forms can be made with strengths somewhat better than concrete, but the materials are weak in comparison to the basalt glass-ceramics (40 MPa vs. 100 MPa in flexural strength).

3. Refined glass-ceramics

Glass-ceramics based on enstatite and cordierite can be manufactured from high magnesia glasses in the systems $\text{SiO}_2\text{-MgO-Al}_2\text{O}_3\text{-CaO-TiO}_2$ and $\text{SiO}_2\text{-Al}_2\text{O}_3\text{-MgO-TiO}_2$, respectively. The processing of lunar materials to produce various oxides or purified minerals necessary to serve as raw materials for these glasses have been described by Waldron.²

3.1 Enstatite glass-ceramics

Refractory, tough, and fine-grained glass-ceramics based on enstatite have been produced in the $\text{SiO}_2\text{-MgO-ZrO}_2$ and $\text{SiO}_2\text{-MgO-Al}_2\text{O}_3\text{-Li}_2\text{O-ZrO}_2$ systems.⁵ These materials contain from 50-85 weight percent enstatite with auxiliary phases zircon, β -spodumene solid solution, minor tetragonal zirconia, and small amounts of glass. A representative composition from each system is listed in Table 4,

Table 3. Properties of Oxidized Basalt Glass-Ceramics

Mechanical

M.O.R. (abraded)	115 MPa
Young's Modulus	105 GPa
Shear Modulus	45 GPa
Poisson's Ratio	0.21
Hardness (Knoop)	850

Thermal

C.T.E. (0-300°C)	$73 \times 10^{-7}/^{\circ}\text{C}$
Annealing Temperature	850°C
Strain Point	800°C

Table 4. Enstatite glass-ceramics: compositions and properties

	E-1	E-2
SiO ₂	58.0	54.0
Al ₂ O ₃	5.4	-
MgO	25.0	33.0
Li ₂ O	0.9	-
ZrO ₂	10.7	13.0
Glass crystallization treatment	800°C/2 h 1200°C/4 h	800°C/2 h 1400°C/4 h
Phase assemblage	Enstatite (proto, clino), β -spodumene, tet. zirconia	Enstatite (proto, clino), zircon, minor tet. zirconia, cristobalite
Abraded MOR (MPa)	193 ± 15	200 ± 15
Fracture toughness (MPa m ^{1/2})	3.5 ± 0.4	4.6 ± 0.6
Refractoriness (°C)	1250	1500
CTE (0-1000°C) ($\times 10^{-7}/^{\circ}\text{C}$)	68	80

Table 5. Commercial Cordierite Glass-Ceramic (Corning 9606)

Composition		wt%	mol%	Phases
SiO ₂	} x1	56.1	58.1	Cordierite Cristobalite Rutile
Al ₂ O ₃		19.8	12.1	
MgO		14.7	22.6	
CaO		0.1	0.1	Mg-dititanate
TiO ₂	n	8.9	6.9	
As ₂ O ₃	f	0.3	0.1	
Fe ₂ O ₃		0.1	0.1	
Use: Radomes				

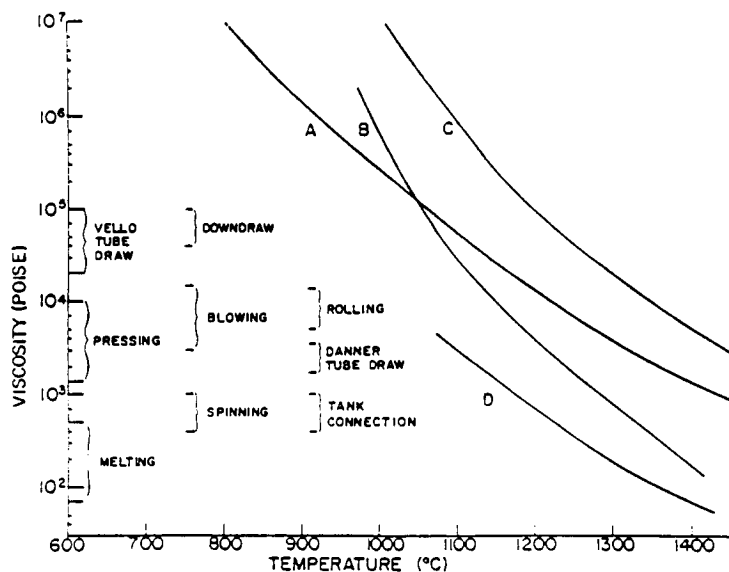

Figure 3. a) Lithium aluminosilicate glass used to make rolled sheet.
 b) Magnesium aluminosilicate glass used to make Code 9606 cordierite radomes.
 c) Lithium aluminosilicate glass used to make CORNING WARE®
 d) Westfield basalt glass.

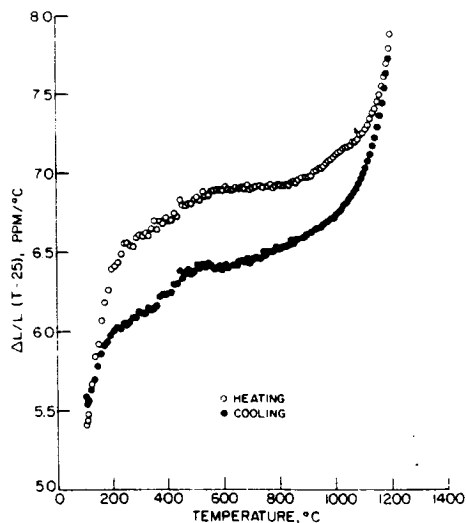

Figure 4. Thermal expansion hysteresis in enstatite glass-ceramic E-1.

along with crystallization schedule, phase assemblage, and key properties.

Enstatite is found in three structural polymorphs: orthorhombic forms protoenstatite and orthoenstatite, and the monoclinic form clinoenstatite. The structure of these polymorphs and the nature of the transformations between them have been extensively studied,^(5,6) but early efforts at applying these transformations to toughening glass-ceramics in poorly nucleated compositions were not very successful.⁶

Protoenstatite is stable above 980°C and converts to either the stable ortho or metastable clino forms on cooling. The former is a relatively slow order-disorder transition, while the latter is rapid and martensitic. Although protoenstatite has been described as nonquenchable in large crystals (≈ 1 cm) such as those found in meteorites, the fine grains typical of well-nucleated glass-ceramics (≈ 1 mm) only partially transform to clinoenstatite and retain much of the protoenstatite x-ray diffraction pattern on normal cooling from above 1000°C. Moreover, the thermal expansion behavior of enstatite glass-ceramics shows considerable hysteresis through the ortho to clino conversion (*Figure 4*). Even on slow cooling, e.g. 50°C per hour, the fine crystals form twinned clino rather than ortho, underscoring the sluggish nature of the proto-to-ortho transformation. The proto-to-clino inversion is accompanied by a 4% volume shrinkage, so toughening is not believed related to the metastable presence of the proto form in simple analogy to toughening from partially stabilized tetragonal zirconia. The actual toughening mechanism appears to involve crack deflection from the fine polysynthetic twinning, resulting from the partial transformation and possible energy absorption from the development of penny-shaped cracks along twin boundaries (see *Figure 5*). Further transformation to clino under the shear stress preceding fracture may be a possible accompanying mechanism, as suggested by hysteresis observed in stress-strain curves from these materials. Splintering due to the intersection of cleavage (110) and twin planes (100) in clinoenstatite is observed in fracture micrographs (*Figure 6*) and is also believed a factor in toughening. Fracture toughness values as high as $5 \text{ MPa m}^{1/2}$ were measured in composition E-2. The flexural strengths of enstatite glass-ceramics are also high ($\approx 200 \text{ MPa}$), in part due to their high elastic modulus ($\approx 140 \text{ GPa}$).

Although zirconia and lithia are rather rare on the Moon, enstatite glass-ceramics similar to E1 (*Table 4*) can be made by substitution of CaO for Li₂O and TiO₂ for ZrO₂ in roughly equivalent molar proportions. The resulting glass-ceramic has a phase assemblage of enstatite, anorthite, and rutile instead of enstatite, β -spodumene, and tetragonal zirconia. The strength and fracture toughness will be similar, but the refractoriness and the coefficient of thermal expansion will be compromised. The effect of rutile instead of zirconia in the phase assemblage will reduce the high temperature use to below 1200°C. The replacing of β -spodumene solid solution, which has a very low coefficient of thermal expansion, approximately $10 \times 10^{-7}/^\circ\text{C}$, by anorthite with a thermal expansion of $55 \times 10^{-7}/^\circ\text{C}$, will cause the thermal expansion coefficient to be increased from $68 \times 10^{-7}/^\circ\text{C}$ to about $80 \times 10^{-7}/^\circ\text{C}$.

Enstatite glass-ceramics could be pressed or cast and would find application where mechanical toughness, thermal stability, and good dielectric properties are required.

3.2 Cordierite

Glass-ceramics based on the hexagonal form of cordierite, sometimes referred to as indialite, are strong, have excellent dielectric properties, and good thermal stability and shock resistance. Corning Code 9606, whose composition is given in *Table 5*, is the standard glass-ceramic used for radomes. It is a multiphase material nucleated with titania, but based on a cordierite of composition $\text{Mg}_2\text{Al}_4\text{Si}_5\text{O}_{18}$ with some solid solution toward "Mg-beryl" (i.e., $\text{Mg}^{2+} + \text{Si}^{4+} + 2\text{Al}^{3+}$).⁷ This major phase is mixed with cristobalite, rutile, magnesium dititanate, and minor glass, which is isolated at grain-boundary nodes. The mechanical properties of these glass-ceramics have been studied



Figure 5. Replica electron micrograph of the fracture surface of enstatite- β -spodumene-zirconia glass-ceramic E-1. Twinning in the enstatite is seen to influence the fracture path; spodumene grains are smooth.



Figure 6. Fracture surface (REM) of enstatite-zircon glass-ceramic E-2 showing interlocking twinned enstatite grains and nodular zircon. Note the step splintering effect of the intersection of cleavage and twinning.

extensively.⁸ A Weibull plot of flexural strength data on transverse-ground bars hewn from a slab of this commercial composition is shown in *Figure 7*. Other important properties include a coefficient of thermal expansion (0°-700°C) of $45 \times 10^{-7}/^{\circ}\text{C}$, fracture toughness (K_{IC}) 2.2 MPa m^{1/2}, thermal conductivity 0.009 cal/scm°C, Knoop hardness 700, dielectric constant and loss tangent at 8.6 GHz: 5.5, and 0.0003, respectively.

One of the difficulties in crystallization of glass-ceramics involves relieving stresses due to change in density accompanying phase transformation. This is well illustrated by Code 9606. Table 6 shows the phase assemblage and corresponding density when the parent glass is heated to various temperatures for two hours. There is a significant increase in density from glass to dense metastable crystalline assemblage up to 1010°C, followed by a volume expansion to cordierite above this temperature. Clearly, to avoid extreme stresses and cracking, the heat-treatment schedule must be carefully adjusted to minimize extremes in metastable phase density and allow sufficient plastic glassy phase at various stages to prevent cracking. The final desired assemblage developed at 1260°C has good thermal stability toward grain growth and will not revert to other phases when held at lower temperatures.

The choice of composition or Code 9606 was based primarily on glass-forming considerations. To optimize viscosity at the liquidus, the lowest ternary eutectic in the refractory system MgO-Al₂O₃-SiO₂ was approached with little compromise in the key properties of cordierite by maintaining it as the major crystalline phase. Some cristobalite had to be incorporated, which had the adverse effect of raising thermal expansion. This phase, however, allowed a post-ceram surface leaching treatment with hot caustic to be effective in producing a porous silica-deficient skin which tends to prevent mechanical flaw initiation.

The viscosity-temperature curve for the parent glass of Code 9606 appears as curve B in *Figure 4*. Because the liquidus temperature is near 1350°C, close to the ternary eutectic temperature, and the glass is relatively low in silica (58 mol %) and therefore fluid, only such forming processes as spinning or other types of casting can be used. Fortunately, the radome shape is particularly amenable to centrifugal casting, as would piping, flat slabs, and other symmetrical shapes. Cordierite-based materials would be useful on the Moon wherever thermal stability, thermal shock resistant, or dielectric materials are required.

4. Fiber reinforced glass-ceramics

Over the last decade, an intense effort to produce ceramic materials with high strain at rupture, fracture toughness values approaching metals, and graceful failure has developed. The key concept involves continuous fiber of high strength, elastic modulus and thermal stability embedded in a glass or glass-ceramic matrix. One approach which has yielded particularly promising results has been the use of polymer melt spun amorphous silicon oxycarbide fibers (Nicalon, Nippon Carbon Company) as a reinforcing agent in Corning glass-ceramic matrices based on lithium aluminosilicate (LAS) or calcium aluminosilicate (CAS) glass-ceramics.^(9,10) The achievement of high fracture toughness (~20 MPa m^{1/2}) in these brittle composite materials requires both strain tolerance to fracture and fiber pullout at rupture, thus producing a graceful failure. This requires a fiber matrix interface which is characterized both by some inherent resiliency and some inherent strength. The strength criterion is a sensitive one. The interface must be strong enough to allow load transfer from the matrix to the relatively stronger, stiffer fiber and yet not overly strong or the fiber pullout at failure will be prohibited and the composite will display the brittle behavior of normal monolithic ceramic materials.

The highest modulus oxide fibers which could be envisioned as being manufactured from lunar materials are based on alumina and titania. These oxides both have Young's moduli near 30 GPa

Table 6. Phase Assemblages during Crystallization of Glass-Ceramic 9606

Temp. (°C)	Density	Phases
700	2.64	Glass
800	2.67	Glass, MgTi ₂ O ₅
900	2.75	β-quartz ss, MgTi ₂ O ₅ , glass
1010	2.95	α-quartz, sapphirine, enstatite, MgTi ₂ O ₅ , rutile
1260	2.60	Cordierite ss, rutile, MgTi ₂ O ₅

Table 7. Lunar Glass-Ceramic Materials

<u>BASALT</u>	<u>MATERIALS</u>	<u>MANUFACTURING PROCESS</u>	<u>USEFUL PROPERTIES</u>	<u>KEY LIMITATIONS</u>
Glass	Basalt	Melt*, Fiberize	Strong Fibers	-
Glass-Ceramics	Hi-Ti Basalt	Melt*, Rapid Forming (Spin, Roll, Press, Cast)	Moderate Strength, Abrasion Resistance	Brittle
Cast Ceramic	Basalt	Melt*, Cast, Slow Cool	Large Forms, Some Toughness	Weak, Pits, Voids
<u>REFINED GLASS-CERAMICS</u>				
Enstatite	Refined Pyroxene	Melt**, Rapid Forming (Press, Spin, Cast)	Strong, Tough, Dielectric	Require Purified Composition
Cordierite	MgO, Al ₂ O ₃ , SiO ₂ , TiO ₂	Melt**, Rapid Forming (Roll, Press, Spin, Cast)	Strong, Thermal Shock Resistant, Dielectric	Require Purified Composition
<u>FIBER REINFORCED GLASS-CERAMICS</u>				
	Coated Al ₂ O ₃ , TiO ₂ Fibers, Whiskers, Aluminosilicate Glass Frit	Fiber Growth, Melt Frit, Pre-Preg, HIP	Strong, Tough, Refractory, Non-Brittle	Complex Manufacturing Process

* In Fe-Cr Alloy, or In-Situ

** High-Al₂O₃ Refractory

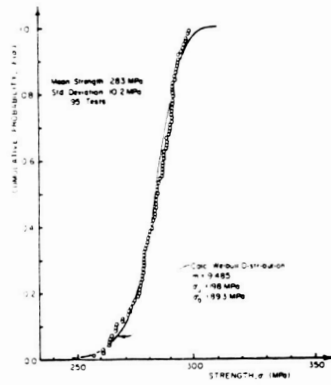

Figure 7. Flexural strength distribution of transverse ground bars of Corning Code 9606 glass-ceramic (after Lewis et al).

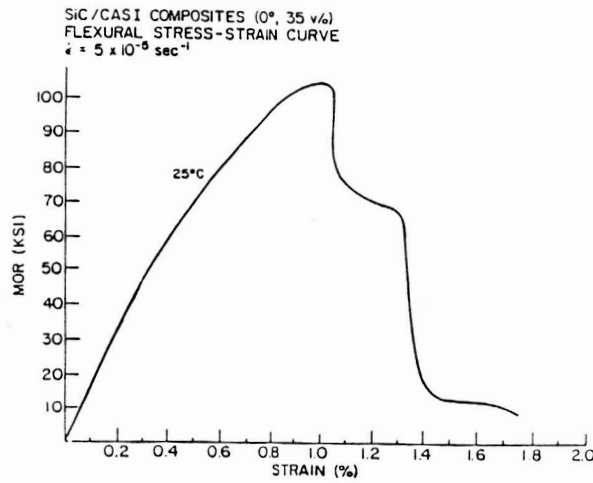

Figure 8.



Figure 9. Non-brittle fracture mode of Nicalon®/glass-ceramic matrix composites.

and would, therefore, serve as functional reinforcement agents if the bonding between these fibers and the powdered glass used to make the composite could be intermediate in strength after the matrix is crystallized. The control of the bonding between fibers or whiskers of sapphire or rutile and a calcium aluminosilicate (anorthite: $\text{CaAl}_2\text{Si}_2\text{O}_8$) matrix has not been studied, but if measures could be taken to control the strength of this bond, a refractory and tough composite could certainly be envisioned.

Figure 7 shows a typical stress strain curve for a ceramic matrix composite with a lithium or calcium aluminosilicate matrix using about 50 percent uniaxially oriented silicon oxycarbide fibers. The process here involves coating the continuous fiber with a glass frit slurry, forming a prepreg tape, by hot isostatic pressing. During the hot pressing, the glass frit sinters and crystallizes, yielding the glass-ceramic matrix. The strain at rupture in this case, in the range of 1%, is unique among ceramic materials and reflects the fracture pullout of the fibers as depicted in Figure 8. The maximum stress is in excess of 600 MPa at 25°C and can be almost 500 MPa at 1000°C in the most oxidation resistant composites. These materials may replace superalloys in engine components. Higher use temperatures and lower densities are perceived advantages.

5. Conclusions

It is clear that a wide variety of glass and ceramic materials from simple glass to complex fiber reinforced glass-ceramics could be made using lunar materials. Their advantages and limitations are summarized in Table 7.

Basalt can be melted to a glass and subsequently fiberized or foamed to produce insulating or reinforcing components. Glass-ceramic articles can be made from high titania mare basalts using spinning, pressing, rolling, or casting processes. Useful properties include good strength and abrasion resistance. Cast ceramic forms can be made from basalt, but these would have modest mechanical properties similar to high grade cements or concretes.

Refined glass-ceramics can be made based on enstatite and cordierite, both magnesium-rich minerals, the constituents of which could be developed from lunar soils. After melting and forming, glass-ceramics with good strength, toughness, thermal shock resistance, and dielectric properties can be developed by simple thermal treatment.

At the extreme end of sophistication would be single crystal alumina or titania fibers and whiskers of high mechanical strengths which might be developed from lunar materials. These fibers would then be coated with a glass designed to crystallize with intermediate bonding to the fibers. A hot isostatic pressing process would be required to make shapes. The resulting materials could be strong, tough, refractory, and non-brittle, if the strength of fiber-matrix bond can be controlled.

References

- ¹D.R. Criswell and R.D. Waldron. *Lunar Utilization in Space Industrialization* (vol. 2). Ed. by B. O'Leary. CRC Press, 1982: 1-53.
- ²R.D. Waldron. Lunar Manufacturing. *Acta Astronautica* (v. 17 [7]) 1988: 691-708.
- ³G.H. Beall and H.L. Rittler. Basalt Glass Ceramics. *Am. Ceram. Soc. Bull.* (55 [6]) 1976: 579-582.
- ⁴L. Kopecky, L. and J. Voldan. The Cast Basalt Industry. *Ann. N.Y. Acad. Sci.* 1964: 1086-1105.
- ⁵J.R. Smyth. *Am. Mineralogist* (59) 1974: 345.
- ⁶W.E. Lee and A.H. Heuer. *J. Am. Ceram. Soc.* (70) 1987: 349.
- ⁷W. Schreyer and J.F. Schairer. *J. Petrol.* (2) 1961: 324.
- ⁸D. Lewis III. *Am. Ceram. Soc. Bull.* (56 [5]) 1977: 474.
- ⁹K. Chyung, K.P. Gadkaree, R.L. Stewart, and M.P. Taylor. Reinforced Calcium Aluminosilicate Glass-Ceramics. U.S. Patent 4,755,489. July 5, 1988.
- ¹⁰R.F. Cooper and K. Chyung. *J. Mater. Sci.* (22) 1987: 3148-60.

N 9 3 - 2 7 9 7 2

LUNAR MATERIALS PROCESSING SYSTEM INTEGRATION

Brent Sherwood
Boeing Defense & Space Group

516-31
158330
p/13

Abstract

The theme of this paper is that governmental resources will not permit the simultaneous development of all viable lunar materials processing (LMP) candidates. Choices will inevitably be made, based on the results of system integration trade studies comparing candidates to each other for high-leverage applications. It is in the best long-term interest of the LMP community to lead the selection process itself, quickly and practically.

The paper is in five parts. The first part explains what systems integration means and why the specialized field of LMP needs this activity now. The second part defines the integration context for LMP -- by outlining potential lunar base functions, their interrelationships and constraints. The third part establishes perspective for prioritizing the development of LMP methods, by estimating realistic scope, scale, and timing of lunar operations. The fourth part describes the use of one type of analytical tool for gaining understanding of system interactions: the input/output model. A simple example solved with linear algebra is used to illustrate. The fifth and closing part identifies specific steps needed to refine the current ability to study lunar base system integration. Research specialists have a crucial role to play now in providing the data upon which this refinement process must be based.

SYSTEM INTEGRATION

Among technical specialist, System Integration (SI) is often considered an "impure" form of engineering, consisting principally of "paper studies". But SI is a vital part of the engineering process, without which the whole of a project reverts to a mere sum of its parts. SI's function is to tie together all the specialty engineering, ensuring that what results is a coherent, well-balanced project or design. SI is therefore a technical activity one logical type higher than the specialty engineering disciplines. Subsuming all of them, it addresses issues beyond the scope of any one specialty.

Specifically, SI coordinates the unique needs and contributions of the project's distinct parts. It clarifies the resulting interactions among them, revealing and resolving conflicts and mismatches in their performance and their resource needs. By working in the "spaces between" the specialty fields, SI identifies and exploits opportunities for synergy that might otherwise remain unknown in a partitioned field of specialties. By nudging each piece into a seemingly nonoptimal state, it seeks to create a balanced system, one which is overall optimal and yields a cost-effective use of system resources.

Figure 1 tabulates the life cycle phases of a space project, starting with the end product and working backwards to outline what each phase consists of and what it tries to accomplish. Success in each phase requires the coordination that SI provides. *Performance* is the driver during project execution, where achievement within resource constraints is the measure of success. Here SI limits recurring costs by optimizing "value added" and facilitating "total use". The approach of value added attempts to derive multiple benefits from work performed, and to avoid doing the same job more than once. A lunar materials processing (LMP) example is the value added to a grain of regolith merely by having moved it. Even if that grain is part of the "tailings" rather than the "ore", taking advantage of the unavoidable investment in its processing facilitates a more efficient overall operation. Mechanical work (transportation) and state changes (thermal and chemical treatments) should be captured by subsequent disposition. In the limit, this kind of conservation leads to total use. The operation capitalizes on the investment of limited resources, maximizing the incorporation into useful products of anything to which value has already been added. On the Moon, disposal becomes stockpiling; refuse is really an already partially-processed resource. In the example above, the sieved but then rejected fraction of regolith feedstock becomes valuable as well-sorted radiation shielding.

For the planning phase of a project, *synergy* is the driver, enabling selection of cost-effective capital options favored for project implementation. SI facilitates synergy in four ways. First, it matches performance to requirements in a balanced way across all component systems. An LMP example is the proper sizing and duty factor of surface operations equipment for modestly scaled oxygen (LLOX) production. Roughly 100 t of LLOX enables four lander round trips. Even with a poor-yield process like ilmenite reduction, a 100t/yr production rate translates to an excavation rate of about 2 kg/s, roughly equivalent to "two good guys with shovels" operating continuously. For this purpose, the typically imagined lunar "bulldozer" may be a nonoptimal miner concept. Second, SI tries to achieve commonality and standardization across systems where practical. Designing modular power packs -- using dynamic or thermophotovoltaic isotope sources, for example -- into mobile applications allows both ganging (for power-intensive applications) and interchangeability (which maximizes duty factor for these limited-half-life subsystems and simplifies redundancy scenarios).

Third, SI seeks to incorporate or adapt existing systems, which can save money and time over baselining "clean sheet" designs. Adapting Space Station *Freedom* modules for lunar outpost habitation takes advantage of national investments in engineering development and qualification testing. Fourth, SI determines the resulting tradeoffs -- as between expediency and optimization -- by assessing the performance penalties of non-optimal solutions. LMP will generate many cases for which less efficient or less elegant solutions may nonetheless trade favorably against high-

Project Phase	What Goes On	Objective
Execution	<ul style="list-style-type: none"> • Fabrication & testing • Launch & flight • Deployment • Operations • Data collection & evaluation 	<ul style="list-style-type: none"> • Capable, robust system emplaced successfully • Every kg, W, min enhances return • Longevity, knowledge, progress
Conception & Planning	<ul style="list-style-type: none"> • Requirements development • Trade studies • Preliminary design • Experimental validation • Detailed design & system specification 	<ul style="list-style-type: none"> • Good system selections • Designs with "think ahead" responsiveness • Incorporation of multiple paths to success • Efficient use of project resources (time, \$)
Enabling Research	<ul style="list-style-type: none"> • Basic research • Application development • Proof-of-concept 	<ul style="list-style-type: none"> • Discover interesting things • Identify and pursue promising options • Understand performance characteristics

Figure 1 Success in all three project lifecycle phases requires the coordination which SI provides.

Objective	Description	Basic Needs	LMP Focus
Operations Enhancement	<ul style="list-style-type: none"> • Reduced transp. cost • Improved base efficiency • Reuse/recycling of imported material 	<ul style="list-style-type: none"> • Modest quantities of propellant • Simple paving, sheltering 	<ul style="list-style-type: none"> • Primarily LLOX; perhaps Al, sw-H2 • Simple bulk feedstock or <i>in situ</i> processing
Lunar Settlement	<ul style="list-style-type: none"> • High human traffic rate • Large population • Long-distance surface transp. • Productive economy 	<ul style="list-style-type: none"> • Large habitable volume • High-rate, precision manuf. and recycling infrastr. 	<ul style="list-style-type: none"> • Life elements (HCNOP) • Structure systems • Wide spectrum of technological products • Agricultural substrate
Interplanetary Industrialization	<ul style="list-style-type: none"> • Provides high-value exports (energy, precious products or large supplies of mat'l) • Advanced automation • Regular space transportation 	<ul style="list-style-type: none"> • Large specialized <i>in situ</i> industry, and/or... • High mining rate • High efficiency, rapid-fire launch 	<ul style="list-style-type: none"> • 3He; solar power plant materials • Special-purpose processing in lunar environment

Figure 2 Potential LMP-supporting lunar base functions introduce alternative dominant LMP requirements.

performance options. For example, simple, inefficient amorphous silicon photocells will probably be manufacturable *in situ* on the Moon earlier than "better" cells. Their increased installation size, deployment and maintenance costs, and consequent infrastructure requirements may be worthwhile.

For the research phase -- where LMP is now -- *priority* is the driver. This is the time when the range of possibilities is widest, when selection among them is most difficult, and when changing direction is least expensive but most leveraging. Many LMP candidates have been proposed so far. Most appear workable in some way, and several have been proved empirically at small scale or by terrestrial process analogy. The relative importance of the various options remains unknown, however. Each has dedicated professional advocates, and program funding and development time are both severely limited.

Establishing research priorities over the coming decade is essential to make real progress despite resource limitations. Serial implementation of lunar materials processes in a well-structured program requires careful development sequencing. The government-funded SEI cannot afford to dissipate its resources across all LMP candidates; some will win and most will not. One way or another, priorities will be set and followed. Given proof of feasibility, the primary filter will be practicality, and system integration engineering will provide the analyses to enable informed prioritization. Thus SI is essential to the incorporation of LMP into SEI.

Context

The role of LMP in the evolution of lunar basing will depend critically on the purpose of the basing activities. *Figure 2* consolidates the potential applications of LMP according to three candidate objectives: (1) enhancing the operations of a primarily scientific lunar effort by increasing performance and reducing cost; (2) providing the material needs for lunar surface development, settlement and population growth; and (3) industrializing the Moon for export purposes. All proposed purposes of lunar exploration are covered by these three options. The figure characterizes each, describes its salient seeds, and outlines the focus of LMP activities most essential to support it. This distillation begins to clarify a likely evolution among LMP options. Regolith-moving for construction, and LLOX production, will precede the recovery of significant quantities of adsorbed volatiles and the large-scale conversion of regolith into agricultural soil. These in turn will probably precede the industrialization of exotic products like ${}^3\text{He}$ and high technology components.

At all stages on this evolutionary path, it is the flow of critical resources (*Figure 3*) that defines the interaction among base elements. Each element -- a habitat, a mobile crane, a process plant -- is a system "user" competing for these resources with other users, but also producing resources they need. Importation of resources energy, equipment, crew, and so forth is rate-constrained and therefore governs the system productivity. Key measures of overall system efficiency are how closely user needs are matched to resource supply, and how thoroughly each import unit is utilized before being discarded.

One SI responsibility is to determine where surpluses of some resources can productively be used to compensate for insufficiency in others. For example, configuring the system to provide an energy-rich operating environment may enable the use of process plants which are more energy-wasteful but simpler, more-reliable, lighter, and easier to deliver and maintain. Along with everything else, materials processing activities must sacrifice self-centered optimization in favor of the overall optimization of the entire base they support. The constraints which emerge from folding individual element operation into base operation then become key design drivers for the elements. *Figure 4*

<ul style="list-style-type: none"> • Delivered Mass • Energy Supply • Material Supply • Time to Function • Space to Occupy • Transportation Service 	<ul style="list-style-type: none"> • Maintenance Activity • Environmental Conditioning • Energy Disposal • Spare Parts • Communication Bandwidth & Duty Factor • Computation Capacity
---	---

Figure 3 The interactions among base elements are defined by the flow of these critical resources among them.

Base Functions	Imposed by LMP	Imposed on LMP
Science	<ul style="list-style-type: none"> • Necessity of schedule adherence • Capability to mobilize serendipitous investigations 	<ul style="list-style-type: none"> • Production-scale operations paced by <i>in situ</i> exp'ts • Environmental contamination management • Possible excavation slowdowns to allow investigation
Space Transportation	<ul style="list-style-type: none"> • Delivery of relatively large, heavy, complex plant components 	<ul style="list-style-type: none"> • Fixed, limiting delivery capacity and rate • Package volume premium • Rough ETO ride, erosive LEO environment
Surface Transportation	<ul style="list-style-type: none"> • Sessile plant requires feedstock supplied • Efficiency & reliability favor plant assembly of few, large sections • Volatiles collection requires processing relatively vast quantities of regolith 	<ul style="list-style-type: none"> • Raw material conveyance rate & periodicity • Equipment positioning accuracy
Energy Production & Disposal	<ul style="list-style-type: none"> • Lots of energy to decompose rocks • Consistency & reliability favor continuous operation 	<ul style="list-style-type: none"> • Nighttime power premium • Exclusively radiative thermal rejection: <i>380K daytime environment</i>
Resupply	<ul style="list-style-type: none"> • Reliable resupply of critical materials: <i>reagents; replacement parts & catalysts</i> 	<ul style="list-style-type: none"> • Periodic (rather than continuous) delivery • Good foreknowledge of stock needs • Downtime contingency planning • Commonality: <i>plant design for cannibalization</i> • LMP recycling of refuse desirable
Robot Capabilities	<ul style="list-style-type: none"> • Heavy work, fine work • Continual monitoring & inspection • Sophisticated sensors/telemetry 	<ul style="list-style-type: none"> • Design-for-maintenance: <i>modularity, non-cascading access, in-line mounting, maneuvering room</i> • Machine limits: <i>strength, range, dexterity, intelligence</i> • Available time
Crew Capabilities	<ul style="list-style-type: none"> • Special skills onsite • Break-in period, time to resolve bugs 	<ul style="list-style-type: none"> • EVA limitations: <i>stamina, dexterity, strength, reach</i> • Operations & maintenance procedure safety • Available time
Life Support	<p><i>(Not a driver to first order, since LS requirements are relatively independent)</i></p>	<ul style="list-style-type: none"> • LS priority for all services: <i>power, transp., etc.</i> • GCR shielding uses lots of regolith • Guaranteed supply if ISMU for consumables <i>(for large scale settlement)</i>

Figure 4 LMP is just one of many base functions all of which constrain, and are constrained by, each other.

identifies some of the integration constraints imposed both by and on LMP in the context of a complete lunar base, broken down into functional categories derived from the list of critical resources in *Figure 3*. This summary hints at the range and complexity of tradeoffs which must be performed to achieve a practical, balanced system design.

Calibration

The LMP roles outlined in *Figure 2* can only evolve as project resources permit; for the foreseeable future, those resources consist of public money and governmental projects. Inescapably, the sequence and pace of development is largely independent of the stridency with which particular LMP options might be advocated. A realistic assessment of the likely extrinsic program constraints is essential to effective LMP system integration efforts.

All projects can be characterized according to the three programmatic dimensions of scope, scale and timing. *Scope* is what the program consists of how much it includes. For the present purpose, that means the types of LMP it needs. It is useful to employ a taxonomy of six LMP types, ordered by their intrinsic difficulty and energy cost: (1) siteworks (like paving, radiation shielding, ejecta barriers, and thermal buffers) require only physical material handling like excavation, fractionating, transportation and deposition; (2) recovery of adsorbed volatiles (for fuel, atmosphere and biogenic resources) requires relatively simple physical and thermal processing, and gas handling, albeit at large scales for effective utilization; (3) extraction of iron (for simple structural elements) requires magnetic separation, probably beneficiation, and at least primitive forging to be useful; (4) manufacture of ceramic-based objects requires beneficiation, physical preparation and application of high energy densities; (5) production of large amounts of oxygen (for propellant oxidizer and life-support makeup) requires chemically and/or thermally mediated reduction of lunar minerals and subsequent cryogenic management; and (6) advanced extraction of refined Si, Al, Mg, Ca, Ti and other less abundant elements (leading to complex fabrication of useful products) requires sophisticated, multi-step, energy-intensive infrastructure. It is interesting to note in passing that oxygen production in most commonly discussed product for early implementation falls toward the more challenging end of this spectrum. The LMP program scope is set by how many of these processing types are invoked.

Scale is how much of the program there is -- its size or, in this case, the extent of LMP, independent of which LMP types it uses. Thus, for an early, small lunar exploration and development project, LMP might be just a scientific phenomenon (an opportunity to learn). Or, it could be a practical enhancer (for example, producing oxygen to offload the Earth-to-orbit lift capacity required to maintain a certain level of base operations). Beyond that, it might be utilized as a growth enabler, by providing a significant fraction of the material mass required to increase the planetary "toehold". Ultimately, LMP might become the driving activity (for instance, by supplying built resources vital to the large-scale, space-based industrialization of terrestrial energy supply). The scale at which LMP will be implemented partly controls the selection of appropriate processes and infrastructure.

Timing is how fast the project happens -- here, how soon a particular LMP option comes on line (even a large-scale program can happen gradually over time). At one extreme is the "go as you pay" SEI prescription, in which the timing of project milestones is a variable dependent on program funding rate. The opposite alternative is deadline-driven, in which the milestone timing is the independent variable (the classic example of this is Project Apollo). In any case, fixing the timing of basing milestones sets the corresponding demand schedule for appropriate LMP capabilities. An LMP program scoped for siteworks and experiments, and scaled for science and modest enhancement, matches the reconnaissance/outpost phase. Later on, including production of structural elements, at a scale capable of enabling basing growth, matches a true

consolidation/utilization phase. An eventual industrialization phase would be matched by advanced, complex processes implemented at high-yield scale. Identifying when these very different phases are likely to occur enables prudent LMP planning by avoiding premature, unaffordable development.

Figure 5 shows a strawman timeline based on one projection of government-funded lunar development. Outright prediction of the future is of course perilous. Each detail of the strawman schedule is thus individually arguable, however the integrated result appears valid based on the history of spaceflight programs and the evolution of the role of space exploration in world events. A few points are noteworthy. First, the first decade matches current planning by NASA's Exploration Programs Office. Second, beginning about the year 2015, a zero-sum choice may occur between focusing limited resources on the human exploration of Mars or on the expansion of lunar development. Third, if lunar development proceeds, it is difficult to come up with a viable lunar scenario that does not lead one way or another to settlement by large numbers of people, supporting large-scale, export-based industrialization.

Lunar surface operations are ten years away. Another decade appears required for LLOX to enhance operations routinely; yet a third decade is likely to pass before LLOX leverages real operations growth. In the meantime, the current generation of LMP professionals will be at least retired. The sobering point of the schedule exercise is that many of the fascinating processes which the LMP community could pursue now have little to do with collapsing this schedule. They will not likely become important for another quarter century because of the inevitable *timing* of the *scale* required for their practical implementation. An important "wild-card", though, is the potential for private investment. The entire 1992 NASA budget is about \$15 B, whereas the commercial airplane industry -- which really came into existence only two generations ago -- is a \$50 B/yr enterprise. Development of lunar-based commercial markets could dramatically foreshorten the schedule.

SI helps planners maintain perspective by verifying that the efforts expended match the results obtained. For a simple illustration, consider the problem of resupplying nitrogen to an early lunar outpost. A typical habitat module designed to support a crew of four for several months holds about 400 m³ of atmospheres. At 10.2 psi, 70% of that is nitrogen. One repressurization's worth is 220 kg, about the same amount lost to leakage over a year's time. At issue, then, is how to resupply 220 kg/yr of nitrogen per module. Supplying it from Earth ready-to-use would cost about \$1.3 M, given an ETO cost of \$1 k/kg and a 6x multiplier for transportation cost to the lunar surface from LEO. Alternatively, the nitrogen could come from solar-wind volatiles adsorbed in lunar regolith. At an average abundance of 80 ppm and recovery efficiency of 80%, we would have to process 3500 t of regolith. So the issue reduces to one of identifying the LMP production rate at which the required infrastructure could cost less (emplaced) than \$6000 per kilogram of nitrogen recovered. Clearly that rate is far greater than the 200 kg/yr level. Which decreases faster the cost of emplaced LMP infrastructure or the delivery transportation cost? Can the cost of LMP-supplied nitrogen ever be competitive? This simple example illustrates the kind of caution that must be applied when considering LMP scenarios.

Input-Output Modeling

System integrators use a variety of methods to analyze system behavior. The three primary tools are feasibility/practicality checks, parametric models, and integrated point-design analysis. Feasibility/practicality checks are used to determine if an idea is worth pursuing. They provide a rough-order-of-magnitude (ROM) sense of how a system will behave, or a confirming "sanity check" to see if a system concept is at all practical. Typical approaches include using existing analogs for comparison, and performing ROM calculations based on simplifying assumptions (like the nitrogen example of the last section).

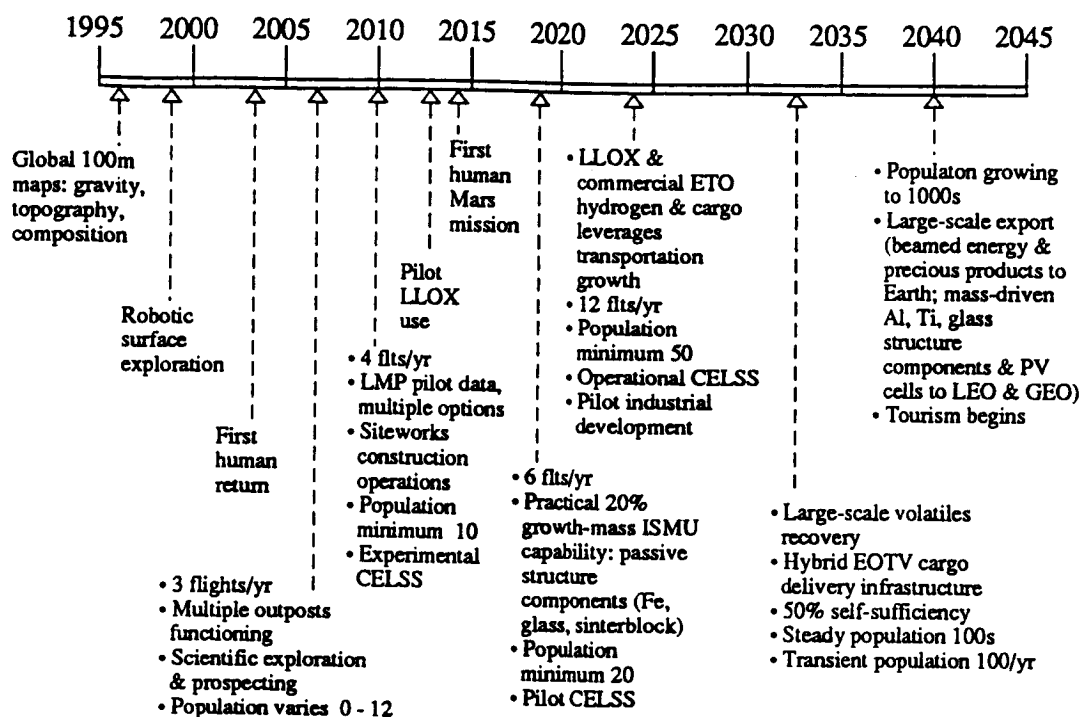

Figure 5 A strawman lunar timeline helps ascertain when LMP products might become essential to further growth.

Inputs		System Element	Outputs
Common	Particular		
• Delivery/transportation service	• Propellants consumed • Prepared surface area	Lander	• Mass delivery and return
	• Prepared surface area • Equipment upgrades • Gas makeup	Habitat	• Controlled environment • Low-grade heat
• Deployment/construction activity	• Controlled environment • Oxygen, water, food	Crew	• Operations time/skill • Data, interpretation • Low-grade heat • CO ₂ , water, solid wastes
• Power consumed	• Crew operations time	Robots	• Operations time/skill • Data
• Parts/consumables	• Prepared surface • Access to sunlight • Reactants, or fissile fuel	Power Plant	• Power produced • Heat • Water
• Maintenance time, skills & tools	• Feedstock consumed • Reagent makeup	Materials Plant	• Value-added regolith • Elemental products (oxygen) • Structural components • High-tech products
	• Crew operation/supervision time	Miner-Transporter	• Carrying service • Operations time

Figure 6 The first I-O modeling step is to identify the system elements of interest, and the resources they consume and produce.

Parametric modeling is a more sophisticated and flexible approach used to understand multivariate relationships among system elements and functions. Just as an algebraic equation enables deeper insight than an arithmetic solution, parametric methods allow the generalization of system performance estimates. Requiring convergence in such a model establishes values -- or ranges of values -- for the driving quantities which are mutually consistent. Parametric modeling can also explore the effects of varying system drivers throughout their valid range. By experimenting with a numerical system model, comparing its behavior as key quantities are changed, the analyst can determine which parameters the system is most sensitive to. Such sensitivity analysis leads to an understanding of system robustness and operating margins. (Input-output models, the type of parametric models used for high-order multivariate systems, are discussed in detail below.)

The third kind of tool is full-blown, integrated point-design analysis. This uses a broad suite of specialized engineering design and analysis capabilities to drive out potentially crucial details of the system's dependencies. Because it is a step closer to the hardware phase of a project, its results are more reliable than the other methods. However, this greater detail sacrifices generality and adaptability, and obtaining it is slower and more expensive. Consequently this kind of analysis is usually reserved until parametric modeling has identified the proper design "neighborhood".

Input-output (I-O) modeling is a cost-effective way to find the right neighborhood, and to grasp and manipulate parametrically the performance of an entire system. It integrates the needs and products of key system elements, reconciling them with each other. In so doing, it validates the mutual compatibility of the various elements' design capabilities. I-O modeling facilitates system-wide sensitivity analyses, and can determine the break-point regions for important driving parameters -- those regions of their range which result in step-function-like behavior elsewhere in the system. The understanding gained helps build confidence in the validity of system sizing and scaling factors useful to designers. Finally, because numerical modeling is cheaper than experimenting with real systems, I-O modeling allows SI to compare different system designs quickly. I-O models can be as simple as desired or as complex as needed, depending on their purpose. Simple ones can be solved on programmable calculators or PC spreadsheets. Large ones with thousands of parameters are best implemented on mainframe computers. In the remainder of this section, a simple, linear I-O model illustrates the power of this tool.

The linear procedure follows seven steps: (1) list the critical system elements and resources; (2) qualify the pair-wise mutual resource dependencies among the elements using an N^2 format; (3) quantify each dependency algebraically using scaling quotients specific to the paired elements; (4) formulate the resulting matrix equation system; (5) select the output drivers of interest; (6) iterate the system parameters to achieve first a consistent, and then a desirable, integrated solution set; and (7) vary the parameters systematically to perform sensitivity analyses.

Figure 6 lists the kinds of top-level resource inputs and outputs pertinent for system elements typical of a lunar base which includes LMP. Note that all elements require delivery, power, parts, and attention in the form of setup and maintenance activity. Note also that some output (like delivery capability, maintenance time, power or material product) are desirable, whereas some (like waste heat, waste products, or broken parts) are undesirable losses to the system which must nonetheless be accommodated by the integration model. Advanced basing scenarios can capture some of these waste streams, for example by recycling value-added or scarce materials. However, waste heat is always eventually rejected, just as energy is ultimately imported.

Figure 7 illustrates a quantified N^2 dependency matrix. This format provides a framework for capturing all key, pairwise interactions among the selected elements. The example models just six base functions: habitation, crew presence, power production, thermal rejection capacity, surface

transportation capacity, and resupply capacity. Setting up even such a simple model already forces attention to fundamental but often-overlooked aspects. For instance, how much equipment can one person maintain continuously? What is the annualized transportation requirement to keep different kinds of equipment supplied with replacement parts? How much habitat, and how much power, are required to support one person on the Moon indefinitely? Implicit relationships are embedded in the matrix: one example is the requirement for a 2 kW of thermal rejection for each 1 kW of power used, which captures the ~50% conversion inefficiency incurred by using regenerable fuel cells for nighttime power storage.

Figure 8 shows how to develop a system equation set using the N^2 relationships. Examining the second row, for instance, shows each term to define the crew required by a particular base function. The units are all quotients because each coefficient is a unit-specific value, not an absolute number. Multiplying the habitat-specific term by the total tonnage of habitat in the base, the power-specific term by the total kilowattage of power in the base, and so on, and then summing these products yields the total number of crew required to run the base. Similarly, the other rows describe the other system parameters as implicit sums. The problem, of course, is to find the consistent set of all these required totals simultaneously. The problem can be written algebraically as follows.

Let A be a square matrix with off-diagonal numerical coefficients taken from the N^2 matrix. Let each diagonal entry be -1 (with the same units as the units numerator common to all other entries in the row). Let x be the column vector consisting of the (unknown) total quantities of each system element (tonnes of habitat, number of total crew, kilowatts of power provided, etc.) required to "make the system work." That is, these are element values which define an overall system consistent with the multivariate relationships expressed in A . The equation $Ax = 0$ then models the system, and can be solved to find the element vector x . If no solution exists, it means that no combination of element values satisfies the system behavior embodied by the N^2 relationships. Iterating matrix coefficients until convergence occurs leads to a permissible system description.

Such a homogeneous equation is fine if the purpose is simply to find out how much of each function it takes to enable all the other functions. This situation would apply to a fully modeled system -- one in which a functional "free body diagram" drawn around the modeled system has no net inputs or outputs. More useful is the formulation of the inhomogeneous equation $Ax = b$, where $b \neq 0$. This now represents a system which yields net product, appearing as an excess of the system elements on the right hand side. Algebraically, the column vector b , with the same units as x , consists of the opposites of the desired system outputs. Extracting one equation from the set and rearranging it shows simply that the sum of the requirements levied on that particular element by the other system functions, plus any desired excess of that element, equals the total amount of that element required to make the system consistent.

The inhomogeneous formulation allows partial system modeling. For example, the simple model illustrated here has no expression for crew to perform scientific duties, only crew to maintain the base function. However, specifying $b^T = \{0, -6, 0, 0, 0, 0\}$ requires the model to "produce" a net "output" of six excess crew, who could perform science. Solving the system then leads to $x = \{104 \text{ t habitat, } 10 \text{ total crew, } 80 \text{ kWe power, } 162 \text{ kWt thermal control, } 10 \text{ t surface transportation, } 32 \text{ t/yr resupply}\}$.

Linear I-O models can be used for many systems if the parameter coefficients are kept within well-controlled ranges. Within those ranges the solution vector is scalable (doubling all the element values still yields a consistent system). The advantage of linear models is that linear algebra can be used to solve them; matrix inverters are available on pocket calculators. More advanced methods

...does it take to enable these?

How much of these...

	Habitat	Crew	Power	Thermal Control	Surface Transport	Resupply
Habitat	—	10t of habitat to support 1 crew	—	—	—	—
Crew	1 person to maintain 100t of habitat	—	1 person maintains 100t of power system	1 person maintains 100t of thermal mg't system	1 person maintains 33t of transporters	1 person performs 50t/yr of the resupply function
Power	—	6kW power for activities and LS for 1 person	—	1kW power runs 20kW-worth of thermal mg't system (e.g. pumps)	1kW power recharges 1t of transporters	—
Thermal Control	—	150W thermal rejection for each person	2kW thermal rejection for use of 1kW power	—	—	—
Surface Transport	5t pressurized transportation per person	1t transportation constructs 20t of habitat	1t transportation deploys 100t of power system	1t transportation deploys 100t of thermal system	—	(Resupply function uses transporters already required by other functions)
Resupply	5%/yr replacement, upgrade parts	2t/yr provisions per person	5%/yr replacement parts	1%/yr replacement parts	1%/yr replacement parts	—

Figure 7 Simplified example shows how the quantified N² format can capture selected pairwise element dependencies.

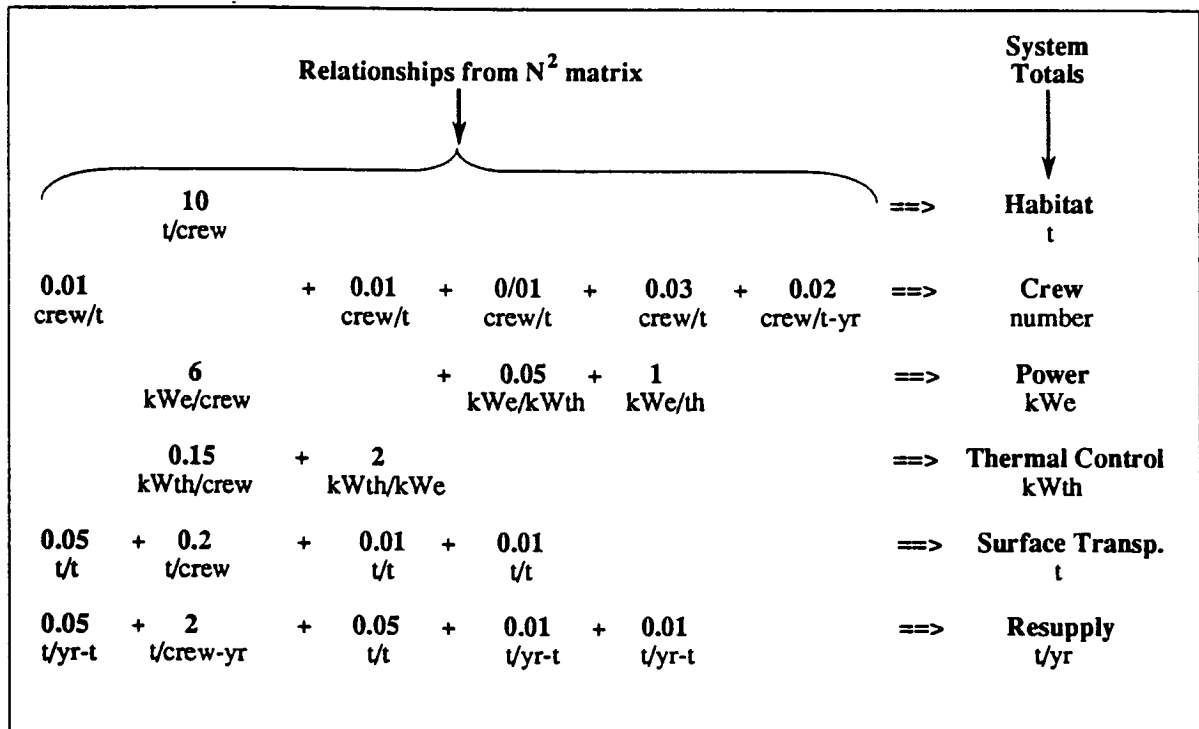

Figure 8 The dependency coefficients allow a simultaneous accounting of all the elements in the model.

are useful, though. The linear example above models base resupply as a system byproduct. The exponential rock equation could be used to include the space transportation delivery system behavior in the model as well. Doing so would preclude a linear algebraic solution, however. Computer-based iteration techniques work well to solve nonlinear models, or very large models with thousands of parameters.

For all I-O models, finding a consistent solution is really just the beginning of integration understanding. The true behavior of the system is revealed through sensitivity analyses. Observing the effect on the system element solution set as the matrix coefficients are varied around their nominal values indicates which parameters are principal drivers. Desirable values of the driving parameters then become technology development goals. Knowing how sensitive each is helps establish performance margin tolerances which can be used as design guidelines. For lunar base models, the maintenance-time requirement is typically an especially strong driver, because it leverages the total requirement for very expensive crew presence.

Next Steps

This paper's primary purpose in discussing SI methods is to clarify for the LMP technical community how the data they generate are used in system models to support the program decision-making process. The preceding section makes apparent the importance of quotient-based system metrics, especially early in the program. For an oxygen plant, parameters like oxygen produced per tonne of plant, or power consumed per tonne of product, and an understanding of their scale-dependence, are far more important than single-unit measures (like mass) of any given point design.

SEI will benefit by the LMP research community addressing the metrics that matter the most. To a specialist researcher working on a particular process, approaching the theoretical conversion efficiency may pose a scientifically challenging problem. However, to the system integrator, that research target may be moot if the process in question is half as practical as a competing one. For space systems in general, system elements involving crew presence (or analogous skills) are very important. Onsite astronaut attention is the most expensive kind for setup or maintenance, and genuinely capable robots -- if possible -- are expensive to develop. For lunar systems in particular, system elements with cascading mass-leverage are very important. LMP elements are consistently strong model drivers, because the space transportation cost of delivering an LMP plant is exacerbated by the derivative-transportation cost of delivering the associated power system, surface transportation capacity, replacement parts and maintenance crews to make it work.

Useful modeling requires good metrics; on the validity of the parametric coefficients hinges the validity of any system model. Both a practical range and a preferred value within that range should be known for each parameter. Such knowledge evolves over time. Typically, first-generation models are built using parameter estimates based on terrestrial analogs or extrapolations. The next generation updates these by anchoring them with point data taken in laboratory experiments designed by approximate certain aspects of the proposed end-use. Third-generation refinement is enabled by integrated testing of developmental hardware systems as the program progresses. Finally, the validity of model parameters is confirmed through the accumulation of statistically meaningful quantities of empirical data from the real system operating in the field. This database then enables a new generation of analog-based modeling to begin for other applications.

LMP is currently in the transition from the first to the second generation. Knowledge confidence for many crucial metrics remains poor. *Figure 9* characterizes a few representative system parameters to indicate the types that can benefit most from laboratory data now. Reviewing even this short list highlights several important investigations: dusty thermal-vacuum prototyping of miner mechanisms;

contextual, end-to-end simulation of processes; quantitative assessments of practical system equipment candidates for substitution by LMP-derived components; and environmental breadboarding of robotic systems using specific LMP-relevant tasks.

Presently our concepts outstrip our supporting data. More data, particularly parametric datasets and experimental results, are needed. Specialist technology researchers are in the best position to provide such data. Thus the SI community needs help from the LMP research community in three ways. First, the LMP community needs to be aware that system metrics will be used to set priorities, given the zero-sum nature of limited governmental funding for SEI. Second, LMP researchers need to understand that process prioritization will consider effects both by and on other system elements and functions, and that many promising processes must nonetheless await later phases of lunar base development to be practical. Finally, the LMP community must work together, focusing on the nearest-term, most-likely process options, to pursue both improved accuracy and peer validation for the highest-leverage, worst-confidence metrics. Together the three measures outlined here can help produce a taut, lean, responsive and progressive LMP program for SEI. Such discipline will facilitate the earliest possible implementation of keystone processes, and hence ultimately of all viable process candidates.

Metric Confidence Classification	Fairly well-characterized	Changing with technology, experience	<i>Terra incognita</i>
Examples	<ul style="list-style-type: none"> • Habitat mass per person • Consumables mass per person • Pressurized rover mass per person • Lunar surface delivery mass ratio t/t-LEO 	<ul style="list-style-type: none"> • Solar array kW/m² • ETO launch \$/kg • %/yr replacement for electro-mechanical systems in lunar environment • Feasible EVA hrs/wk 	<ul style="list-style-type: none"> • Online duty factor for regolith mining equipment • Achievable recovery efficiencies for lunar materials processes • % infrastructure mass practical for ISMU substitution • Maintenance factors for LMP plants of all kinds • Reasonable ratio of robotic/crew maintenance activity

Figure 9 Current knowledge of important system metrics is uneven, and can benefit greatly from new, focused data.

ON-SITE MANUFACTURE OF PROPELLANT
OXYGEN FROM LUNAR RESOURCES*

N 93-27973

517-31

158331

p-11

Sanders D. Rosenberg
Aerojet Propulsion Division

Abstract

The Aerojet Carbothermal Process for the manufacture of oxygen from lunar resources has three essential steps; the reduction of silicate with methane to form carbon monoxide and hydrogen; the reduction of carbon monoxide with hydrogen to form methane and water; and the electrolysis of water to form oxygen and hydrogen. This cyclic process does not depend upon the presence of water or water precursors in the lunar materials; it will produce oxygen from silicates regardless of their precise composition and fine structure.

Research on the first step of the process was initiated by determining some of the operating conditions required to reduce igneous rock with carbon and silicon carbide. The initial phase of research on the second step is completed; quantitative conversion of carbon monoxide and hydrogen to methane and water was achieved with a nickel-on-kieselguhr catalyst. The equipment used in and the results obtained from these process studies are reported in detail.

*This paper was originally published in 1966. It is republished in this volume so that more recent researchers in the field of lunar resource utilization can have easier access to the results of this research.

S.D. Rosenberg, G.A. Guter and F.E. Miller. *Chemical Engineering Progress Symposium Series*. 62[61] (1966): 228-234.

Background Information

At the present time the Mobile Systems Department of Aerojet-General's Chemical Products Division is carrying out a research program for the Office of Advanced Research and Technology of the National Aeronautics and Space Administration, Washington, D.C. This program is devoted to research on processes for utilization of lunar resources, particularly the manufacture of oxygen from lunar materials. Although the precise composition of the lunar surface and immediate subsurface is unknown at the present time, it is generally agreed that these areas are composed of metallic silicates and that these silicates are widely distributed and are relatively readily available. We have designed a chemical process which will produce oxygen from silicates, regardless of their precise composition and fine structure. We have avoided dependence on the presence of water or water precursors in the lunar materials. However, the process will produce water as by-product if water, in any form, is present in the lunar materials.

The Aerojet Carbothermal Process for the manufacture of oxygen from lunar materials has three essential steps: the reduction of silicate with methane to form carbon monoxide and hydrogen; the reduction of carbon monoxide with hydrogen to form methane and water; and the electrolysis of water to form oxygen and hydrogen. The process is cyclic in nature and is exemplified by these reactions:

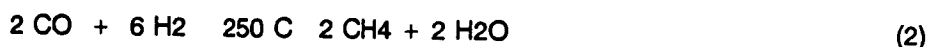
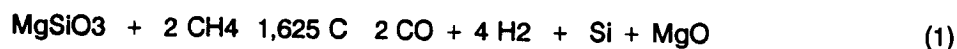

Any water present in the silicate, either as hydrate or hydroxide ion, is obtained as a by-product in the first step.

Equipment Development for Reduction of Silicates

The equipment for the study of the reaction of methane with molten silicates was designed with the following guidelines: induction heating, 450 kc., 10-kw, maximum loading; minimum reaction chamber volume to obtain the best possible material balances using 0.25 lb of rock melt; standard off-the-shelf items, particularly ceramic crucibles and tubes; minimum use of glass for safety of operation; minimum use of metal within the induction current field, except for the tungsten susceptor; and adequate insulation around the reactor to permit the use of thermally sensitive bell jar seals. *Figure 1* is a schematic flow diagram of the silicate rock reduction furnace being used in this program.

Reduction of Igneous Rock with Carbon and Silicon Carbide

A series of reactions of basalt and granite with carbon and silicon carbide was carried out to determine the temperature profile for the reduction reactions which may occur during the reduction of igneous rock with methane. The results of three of these runs are illustrated in *Figure 2*.

In the reaction of basalt (50 g) with carbon (5 g), the initial evolution of carbon monoxide resulted from the reduction of iron oxide. The basalt contained 11.86% of iron oxide (as Fe_2O_3); the reduction of this oxide would require 1.34 g of carbon if present as Fe_2O_3 . The carbon monoxide evolved during the first 2.5 hr represented 1.0g of carbon. Other reducible materials

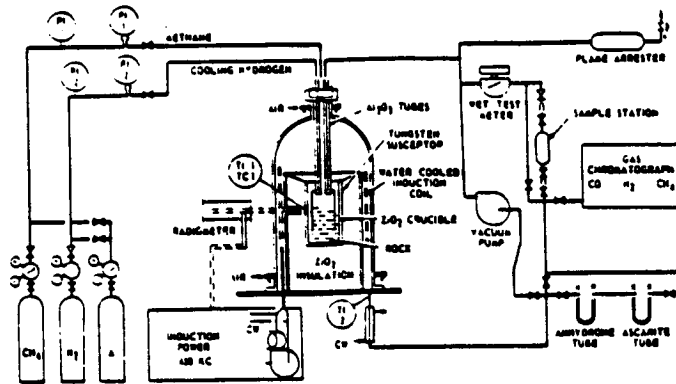

LEGEND
 TI TEMPERATURE INDICATION
 TC TEMPERATURE CONTROL
 PI PRESSURE INDICATION
 FI FLOW INDICATION
 CW COLD WATER

Fig. 1. Schematic flow diagram of silicate reduction furnace.

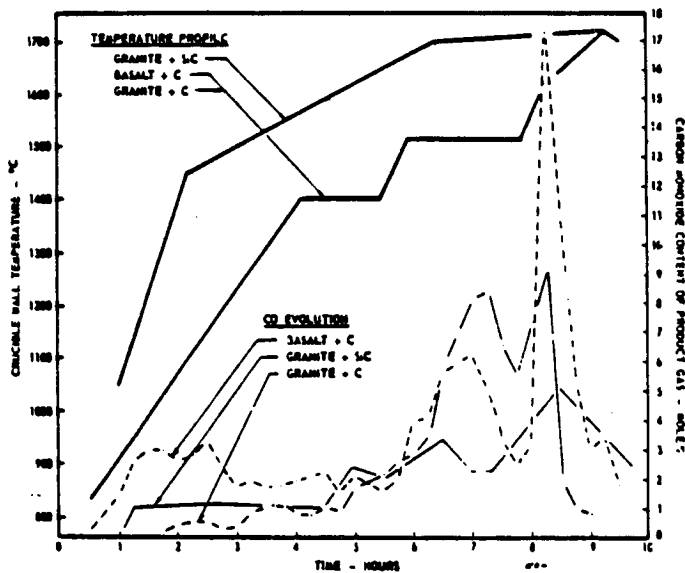

Fig. 2. Reduction of igneous rock with carbon and silicon carbide.

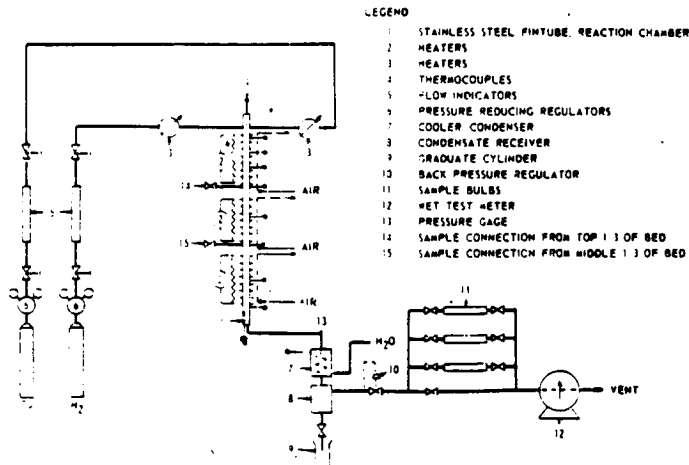

Fig. 3. Schematic flow diagram of hydrogen-carbon monoxide reactor.

present in the basalt were titanium oxide (2.47% as TiO_2) and sodium oxide (3.73% as Na_2O). These oxides would consume 0.43 g of carbon. Consequently, only 35% of the carbon could have been oxidized by materials other than silica. The recovery of 89.1% of the carbon charged as carbon monoxide indicates that a considerable portion of the silica present in the basalt was reduced at temperatures as low as 1,550 C.

Three solid products were obtained; slag and metal remained in the zirconia crucible and sublimate was found at the top of the bell jar. The slag was composed mainly of alumina; the metal contained 82% iron, 13% silicon, and minor amounts of vanadium, titanium, nickel, and copper. The sublimate contained 61% of the highly volatile sodium.

In the reaction of granite (50 g) with carbon (5 g), much less carbon monoxide was produced at low temperature. This is due to the lower percentage of reducible oxides in the granite, that is, iron oxide (2.05% as Fe_2O_3), sodium oxide (3.10%), and potassium oxide (4.90%). These oxides would require 0.85 g (17%) of the carbon charged for complete reduction. A total of 73% of the carbon charged was recovered as carbon monoxide; silica reduction accounts for most of the carbon monoxide evolved at 1,550 C and higher.

The lower carbon balance may be due to reaction of silicon with carbon to form silicon carbide. The slag had nonmagnetic pieces of metal dispersed throughout and contained 2.3% carbon, that is, 20% of the carbon charged.

In the reaction of granite (37.5 g) with silicon carbide (12.5 g), almost no reaction occurred below 1,100 C; about 7% took place between 1,100 and 1,500 C. As the temperature was increased from 1,500 to 1,740 C, the reaction rate gradually increased and then rapidly decreased as most of the carbon was consumed. About 83% of the carbon in the silicon carbide was recovered as carbon oxides. The dark, metallic looking slag contained an additional 10% of the carbon charged. The analysis of the metal recovered from the melt gave 59% iron, 28% silicon, and minor amounts of titanium, vanadium, nickel, and copper; the slag was composed mainly of alumina and silica.

These results indicate that if silicon carbide is formed by reaction of granite and carbon, excess granite will react with the carbide to produce silicon and carbon monoxide. The rate of the granite-silicon carbide reaction at 1,740 C is comparable with that of the graphite-carbon reaction at 1,625 C.

Equipment Development for Reduction of Carbon Monoxide

A schematic flow diagram of the hydrogen-carbon monoxide reactor used in this program is shown in *Figure 3*. The equipment was designed to allow maximum flexibility in operating conditions. Type 316 stainless steel was used as the reaction chamber metal because of its high temperature strength, resistance to corrosion, and nickel content.

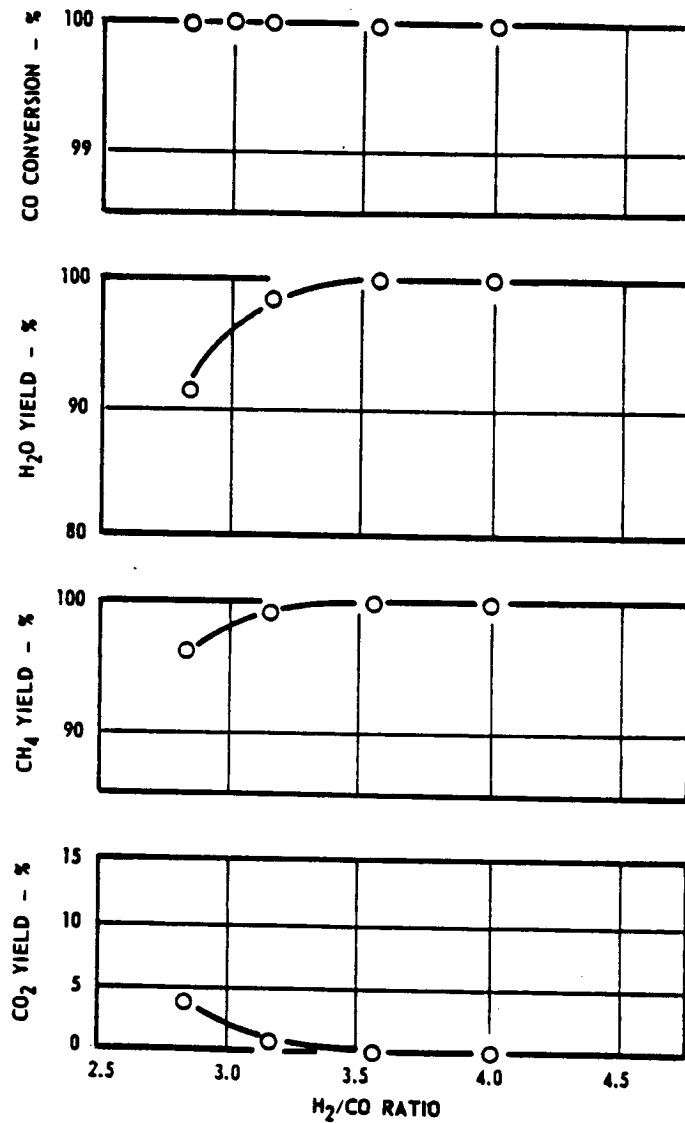

Fig. 4. Carbon monoxide conversion and yields vs. hydrogen-carbon monoxide mole ratio (1,000 hr.⁻¹ space velocity; 250° C.; 1.0 atm.).

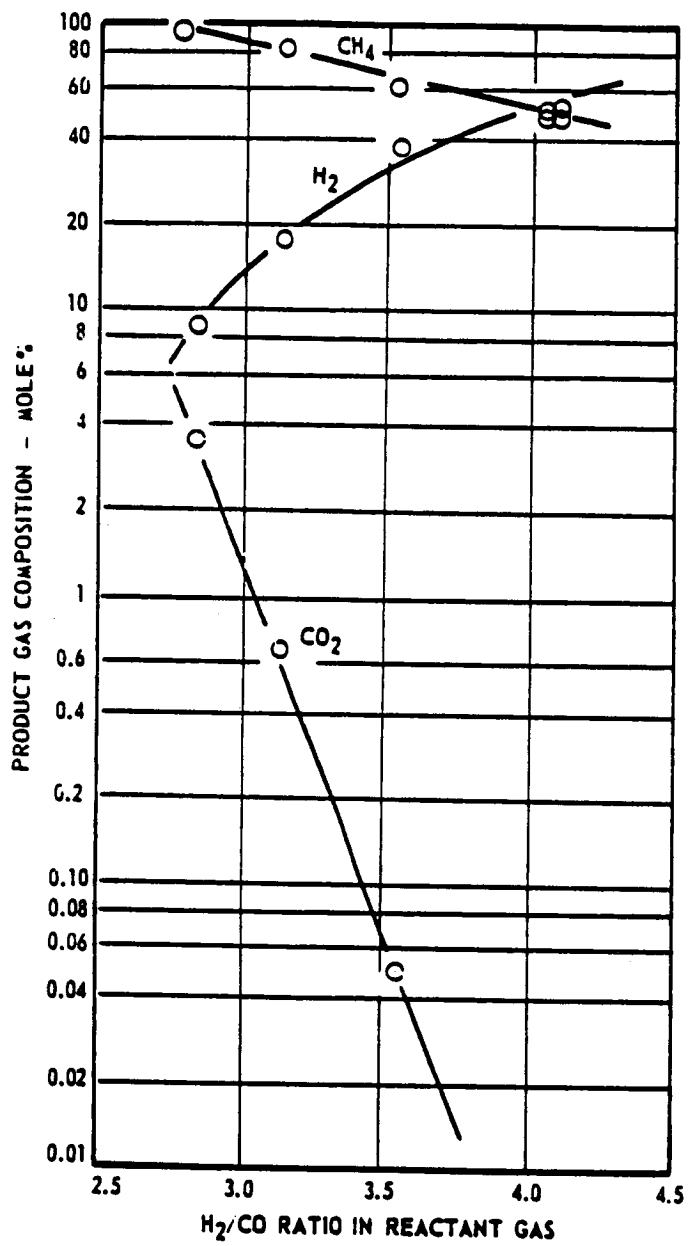

Fig. 5. Product gas composition vs. hydrogen-carbon monoxide mole ratio (1,000 hr.⁻¹ space velocity; 250° C.; 1.0 atm.).

TABLE 1. REDUCTION OF CARBON MONOXIDE WITH HYDROGEN
(CARBON MONOXIDE CONVERSION AND PRODUCT YIELD)

Run. No.	H ₂ /CO mole ratio	Space velocity, hr. ⁻¹	Catalyst bed pressure, atm.	Catalyst bed temp., °C.	Material balance, %	CO conversion, mole %	Normalized product yield, mole %		
							H ₂ O	CH ₄	CO ₂
45	4.00	500	1.0	250	101.0	100.0	100.0	100.0	0.0
46	4.00	750	1.0	249	93.3	100.0	100.0	100.0	0.0
47	4.10	1003	1.0	252	99.0	100.0	100.0	100.0	0.0
48	3.96	1481	1.0	253	95.3	100.0	99.8	99.9	0.1
49a	4.06	1000	1.0	251	101.0	100.0	100.0	100.0	0.0
51	4.15	2010	1.0	265	98.6	100.0	100.0	100.0	0.0
52b	2.84	810	1.0	248	98.1	100.0	91.1	96.2	3.7
53	3.56	1000	1.0	254	94.5	100.0	100.0	100.0	0.0
54	3.14	998	1.0	254	95.0	100.0	98.3	99.1	0.8
55	3.03	1000	6.1	253	96.9	100.0	99.2	99.4	0.4
56	3.01	1500	6.1	231	95.4	100.0	97.3	98.5	1.3
57	3.02	1500	6.1	353	94.8	100.0	94.8	97.1	2.5

TABLE 2. REDUCTION OF CARBON MONOXIDE WITH HYDROGEN (PRODUCT GAS ANALYSIS)

Run No.	Composition of product gas, vol.%				
	H ₂	H ₂ O	CO	CH ₄	CO ₂
45	49.4	1.20	0.0	49.4	0.00
46	49.4	1.15	0.0	49.4	0.00
47	51.5	1.15	0.0	47.3	0.00
48	48.4	1.15	0.0	50.4	0.05
49a	50.8	1.15	0.0	48.1	0.00
51	53.0	1.15	0.0	45.9	0.00
52b	8.9	1.14	0.0	91.5	3.50
53	38.5	1.14	0.0	60.4	0.00
54	17.7	1.14	0.0	80.5	0.65
55	9.3	0.20	0.0	90.2	0.35
56	12.0	0.20	0.0	96.6	1.27
57	18.9	0.20	0.0	78.6	2.25

TABLE 3. REACTANT GAS CARBON DIOXIDE CONTENT VS. CATALYST BED DEPTH

Run No.	Space velocity, hr. ⁻¹	H ₂ /CO mole ratio	CO ₂ analysis, vol.%		
			Top third	Mid third	Outlet
45	500	4.0	0.4	0.0	0.00
46	750	4.0	1.6	0.0	0.00
47	1000	4.1	2.7	0.3	0.00
48	1481	4.0	4.6	0.8	0.05
51	2010	4.1	3.8	0.2	0.00
55	1000	3.0	4.9	1.0	0.35
57	1500	3.0	6.1	3.6	2.25

Heat dissipation is one of the major problems associated with the reaction as it is highly exothermic. This problem was minimized by making the reaction chamber small in diameter (0.527 in. ID) in relation to its length (38.5 in.). This design provided a large surface area for cooling and a minimum distance for the reacting gases to travel from the center of the chamber to the cooling surface. Fins were provided on the outside of the tube to furnish additional cooling surface. For convenience, air was used as the cooling fluid. In a lunar installation, a fluid such as Dowtherm or a molten salt, would be recirculated through an exchanger or radiator to dissipate the heat of reaction.

REDUCTION OF CARBON MONOXIDE WITH HYDROGEN

The reaction of carbon monoxide with hydrogen to form methane and water was studied using a nickel-on-kieselguhr catalyst. The data for these runs are presented in Tables 1 to 5, and Figures 4 to 6. The various parameters which were studied are detailed in the following paragraphs.

Temperature

Some catalyst activity was noted as low as 200 C; the catalyst was found to be very active at 250 C, so that very excellent conversions were obtained. Therefore, all the runs were made at a nominal catalyst bed temperature of 250 C, except Run 57 which was made at 350 C. An attempt was made during Run 57 to increase the conversion by increasing the temperature at a 3:1 hydrogen-carbon monoxide mole ratio and a 1,500-hr⁻¹ space velocity; the conversion of carbon dioxide to methane and water decreased as the temperature was increased.

Pressure

The first nine runs were made at atmospheric pressure. The conversions were nearly complete at a 4:1 mole ratio even with space velocities of 1,000 hr⁻¹. It was only at lower hydrogen-carbon monoxide mole ratios that the conversions decreased sufficiently to require raising the catalyst bed pressure. The last three runs were made at 6.1 atm to approach complete conversion at a 3:1 ratio. In comparing Runs 54 and 55 (see Table 1), it can be seen that increasing the pressure from 1 to 6 atm decreased the carbon dioxide yield from 0.8 to 0.4% and correspondingly increased the yield of water and methane.

Hydrogen-Carbon Monoxide Mole Ratio

The effect of hydrogen-carbon monoxide mole ratio on conversion and yields can be seen in *Figure 4*. At a space velocity of 1,000 hr⁻¹, at 250 C and 1.0 atm, the catalyst gave complete conversion of carbon monoxide and carbon dioxide until the hydrogen-carbon monoxide mole ratio was decreased to less than 3.5:1. The carbon monoxide conversion remained complete but the carbon dioxide yield increased; at a 3:1 ratio, the carbon dioxide yield was approximately 2%.

TABLE 4. REDUCTION OF CARBON MONOXIDE WITH HYDROGEN
(CARBON MONOXIDE CONVERSION AND PRODUCT YIELD)

Run No.	Impurity mole % in H ₂ stream	H ₂ /CO mole ratio	Space velocity, hr. ⁻¹	Catalyst bed pressure, atm.	Catalyst bed temp., °C.	Material balance, %	CO conversion, mole %	Normalized product yield, mole %		
								H ₂ O	CH ₄	CO ₂
63b	None	3.00	1000	6.1	254	99.5	100.0	97.6	99.0	0.95
64c	0.1 COS	3.00	1000	6.1	254	97.1	100.0	96.4	98.2	1.65
66b	1.0 NO	2.98	1005	6.1	255	98.8	100.0	98.6	97.2	1.87
66c	1.0 NO	3.44	1120	6.1	252	100.8	100.0	100.0	100.0	0.00
67b	0.5 PH ₃	3.09	1024	6.1	249	100.6	100.0	97.2	98.2	1.52

TABLE 5. REDUCTION OF CARBON MONOXIDE WITH HYDROGEN (PRODUCT GAS ANALYSIS)

Run No.	Composition of Product Gas, vol. %						
	H ₂	H ₂ O	CO	CH ₄	CO ₂	NH ₃	N ₂
63b	6.0	0.20	0.0	92.9	0.9	—	—
64c	5.0	0.20	0.0	93.2	1.6	—	—
66b	4.0	0.20	0.0	93.3	1.8	0.2	0.5
66c	21.8	0.20	0.0	77.2	0.0	0.3	0.5
67b	10.0	0.20	0.0	88.4	1.4	—	—

The effect of hydrogen-carbon monoxide mole ratio on the product gas composition can be seen in Figure 5. No carbon monoxide could be detected in the outlet gas for any of these runs. Within this range, the carbon dioxide content of the gas increased logarithmically as the hydrogen-carbon monoxide mole ratio was decreased below 3.5:1 (to about 1.5% at 3:1). The theoretical product yield at a 3:1 ratio is 100% methane, 0% hydrogen. The catalyst gave 86% methane, 13% hydrogen at the 3:1 ratio.

Space Velocity

At a 4:1 mole ratio, no carbon dioxide was formed at space velocities up to 2,000 hr⁻¹. At a 3:1 ratio, the carbon dioxide yield increased rapidly as the space velocity was increased above 1,000 hr⁻¹.

Material Balance

With the exception of two runs, all overall material balances for the runs (see Table 1) were under 100%. Most of the low material balances can be attributed to low water recoveries. Because the catalyst is known to be a good absorbant for water, it has been hypothesized that some of the water is slowly adsorbed on the catalyst. In order to prove that this was the case, a long duration run (Run 49) was made (see Figure 6). The water production, which fluctuated about 0.5 g/hr, gradually increased throughout the run (dotted line). After 30 hr, the liquid water production rate was 19.2 g/hr (about 96% of theoretical). At the rate of increase of water production (0.01 g/hr), it would have taken about 100 hr before the actual water production rate equalled the theoretical production rate. For long runs, the water balance should be no problem and it is hypothesized that the small amount of water adsorbed on the catalyst may help to prevent carbon formation.

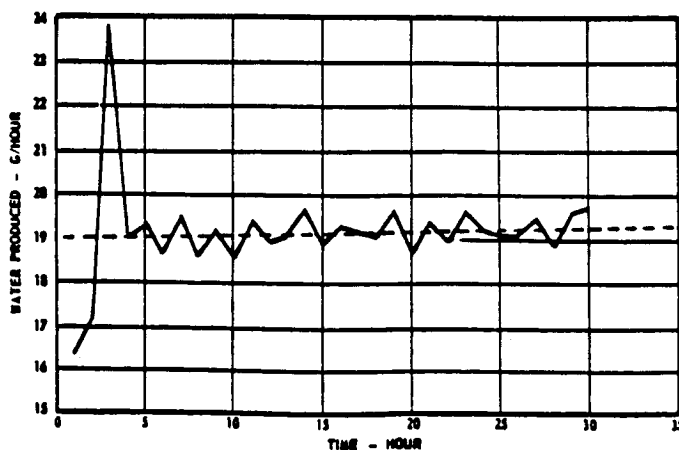

Fig. 6. Water production rate vs. time for Run 49 (1,000 hr⁻¹ space velocity; 250° C.; 1 atm.; 4:1 mole ratio).

Sulfur

Almost any form of sulfur in the reactant gases will be converted to nickel sulfides and thereby poison the catalyst and reduce its activity. Carbonyl sulfide (COS) was selected for evaluation for convenience and its stability in steel gas cylinders. A high concentration of sulfur in the hydrogen reactant gas (0.1 vol% COS or fifty-nine grains of sulfur per 100 std cu ft) was used in these tests. This concentration is approximately 1,000 times the normal allowable limit of sulfur in the feed gas to Fischer-Tropsch units and permitted the extent of sulfur poisoning of the catalyst to be determined in a relatively short time (22 hr).

Run 63b (see Tables 4 and 5) was made with freshly reduced catalyst to provide a basis for comparison at a fairly high space velocity and a low hydrogen-carbon monoxide mole ratio. Run 64 was made with 0.1 vol% COS in the hydrogen stream. The data for Run 64c (see Table 4) were taken after 22 hr of operation with 0.1 vol% carbonyl sulfide in the hydrogen stream. In this length of time, 3.08 g of sulfur, equivalent to 3.9 wt% of the nickel in the catalyst, was charged to the catalyst bed, and the product gas composition had changed only slightly (CH₄ yield dropped from 98.9 to 98.2%, H₂O yield dropped from 97.5 to 96.4%), and CO₂ yield increased from 0.95 to 96.4%). During the progress of the run, the activity in the top 6 in. of the catalyst bed was observed to gradually decrease. This was evident by the downward movement on the catalyst column of the major temperature peak. Analysis of the catalyst after the run showed that almost all the sulfur was removed in the first 6 in. of the bed, leaving the balance of the 32 in. for near-normal conversion.

Oxides of Nitrogen

A newly reduced batch of catalyst was used for Run 66 (see Tables 4 and 5) in which 1 vol% nitrogen oxide (NO) was added to the hydrogen stream. The data for Run 66b were taken after approximately 7 hr of operation; at a 2.98:1 hydrogen-carbon monoxide mole ratio, good conversion was obtained (for this low ratio). The data for Run 66c were taken after about 10 hr of operation; at a 3.44:1 mole ratio, conversions were 100% to methane and water, showing that the catalyst was not damaged. The temperature peak did not progress down the column during the run. It was, therefore, concluded that this nitrogen oxide would not injure the catalyst. The nitrogen oxide was reduced under the conditions of the reaction. About 2 wt% ammonia was found in the water condensed out from these runs. Additional nitrogen and ammonia were also found in the vapor phase. The nitrogen material balances showed that about 75 wt% of the nitrogen oxide was converted to ammonia, the balance being converted to nitrogen.

Phosphorus

In Run 67 (see Tables 4 and 5), 0.5 vol% phosphine (PH₃) was added to the hydrogen stream. This run was stopped after less than 3 hr of operation, at which time the catalyst activity was falling and the pressure drop across the reactor was increasing rapidly (0 to 30 in. vP in 30 min). In Run 76b, in which the data were taken after about 2 hr of operation, the conversion was still good but it was starting to drop off rapidly. Inspection of the catalyst from the run showed that the majority of the phosphorus was deposited on the first third of the bed; the second third of the bed contained some phosphorus, and the bottom almost none. The data show that phosphorus is a most active catalyst poison and it will have to be removed from the reactants prior to contact with the nickel catalyst.

Other Impurities

Time did not permit the study of other possible poisons. High concentrations of water in the reactants are known to affect adversely column equilibrium if not actually to poison the catalyst. Carbon dioxide is not a poison; it is normally present to some extent in the product gases. Nitrogen gas and ammonia have also been present in low concentrations without damage to the catalyst.

Heat Balance

In all runs, the majority of the heat was released in the top third of the bed; however, in several runs at high space velocity (1,500 or 2,000 hr⁻¹) and/or low hydrogen-carbon monoxide mole ratios (3:1), enough heat release took place in the second third of the catalyst bed to require some cooling. At the highest space velocities, temperature control was very difficult, due to the large amount of cooling air required (up to 100 std cu ft/hr) to maintain the nominal catalyst bed temperature. In future designs, this problem will be solved either by providing multiple carbon monoxide entry points or by providing multiple cooling fluid entrances.

PRESSURE DROP

The pressure drop across the catalyst bed with the catalyst was excellent. It did not go up with time even at hydrogen-carbon monoxide mole ratios as low as 3:1. Run No. 49 was continued for 31 hours without shutdown; the pressure drop did not increase a measurable amount during this prolonged period. The absence of a pressure buildup indicated no carbon deposition and a long, useful catalyst life.

Catalyst Life

The catalyst was still active when it was removed after fourteen runs (110 hr). As can be seen from the tabulation below, analyses on the catalyst before and after use showed no carbon deposition.

Time, hr	Carbon content of catalyst C-0765-1001-1, wt%
0	5.08
110, Top one-third	5.02
110, Mid one third	5.11

As stated previously, there was no pressure buildup during the run, so this would not be a limiting factor on the life of the catalyst. However, impurities in the feed (discussed later) may prove to be the limiting factor in the life of this catalyst. Temperature control is also very vital because carbon is definitely deposited on the catalyst at higher temperatures (400 C and up). Catalyst life would probably be extended if the catalyst bed operating temperatures were started low when the catalyst is new and active and then gradually raised as the catalyst activity declines.

Catalyst Bed Depth

At low space velocities, only the top inch or two of the catalyst bed was involved in the major portion of the reaction. As the space velocity was increased, more and more of the bed was involved until, at very high space velocities and low hydrogen-carbon monoxide mole ratios (Runs 55 and 57), the full length of the catalyst bed was not able to achieve complete conversion of carbon dioxide into methane and water. This is best shown by carbon dioxide gradients in the reactor taken for the various runs as reported in Table 3. Two additional advantages of a deep catalyst bed are: it allows for a margin of safety as the catalyst ages and becomes less active; and it allows the top of the bed to act as a guard chamber to remove various catalyst poisons.

Impurities in the Feed Gas

Most catalysts are subject to poisoning by various impurities. Nickel is known to be poisoned by sulfur and phosphorus. Therefore, it was necessary to determine the extent that these and other poisons can be tolerated in the reactant gases.

omit

ENVIRONMENT CONTROL

OPTIONS FOR A LUNAR BASE SURFACE ARCHITECTURE

Barney B. Roberts
NASA Johnson Space Center

518-91

158 332

p. 15

Abstract

The Planet Surface Systems Office at the NASA Johnson Space Center has participated in an analysis of the Space Exploration Initiative architectures described in the Synthesis Group report. This effort involves a Systems Engineering and Integration effort to define point designs for evolving lunar and Mars bases that support substantial science, exploration, and resource production objectives. The analysis addresses systems-level designs; element requirements and conceptual designs; assessments of precursor and technology needs; and overall programmatic and schedules.

This paper focuses on the results of the study of the Space Resource Utilization Architecture. This architecture develops the capability to extract useful materials from the indigenous resources of the Moon and Mars. On the Moon, a substantial infrastructure is emplaced which can support a crew of up to twelve. Two major process lines are developed: one produces oxygen, ceramics, and metals; the other produces hydrogen, helium, and other volatiles. The Moon is also used for a simulation of a Mars mission. Significant science capabilities are established in conjunction with resource development. Exploration includes remote global surveys and piloted sorties of local and regional areas. Science accommodations include planetary science, astronomy, and biomedical research. Greenhouses are established to provide a substantial amount of food needs.

The following identifies the major phases of development, the systems and elements involved, and the physical layout and evolution of the base. Significant alternatives and options are also discussed.

Introduction

For the past eight years, NASA has been, once again, examining the options and alternatives for the surface systems that reside on the surface of the Moon. These studies have range of goals and objectives for surface activity that range from minimum local science experiments to significant bases capable of independent operation for extended periods of time without Earth support. *Figure 1* displays the surface system architectures that have been studied over this period of time. The figure illustrates the scope and scale of each architecture in general, and somewhat arbitrary, terms. The two major categories classify the architectures into those that are resource scarce, "Mission Push", and those that are resource rich, "Mission Pull". The Mission Pull category is the collector of those architectures having only the minimum set of surface assets necessary to accomplish the specific objectives of a predetermined set of missions; that is, the mission objectives 'push' the need for the specific assets. The latter category, Mission Push, is the collector of architectures that are focused on the development of surface capabilities which, in turn, will enable missions; that is, the capabilities provided by the surface assets 'pull' or define and enable the missions.

ARCHITECTURES STUDIED TO DATE	MISSION PUSH		MISSION PULL	
	Expeditions	R&D Outposts	Self- Sustaining	Self- Sufficient
1984 JSC Lunar Base Studies		✓	✓	✓
1986 NASA/Los Alamos Mars Studies	✓			
PSSMAT, AMWG Studies	✓	✓	✓	✓
NCOS			✓	
Ride	✓	✓		
FY 88 OEXP Case Studies				
◦ Phobos Exploration	✓			
◦ Mars Expedition	✓			
◦ Lunar Observatory		✓		
◦ Lunar-to-Mars Evolution			✓	
FY 89 OEXP Case Studies				
◦ Mars Expedition	✓			
◦ Lunar Evolution			✓	
◦ Mars Evolution				✓
90-Day Study		✓		
Post 90-Day "White Papers"				
◦ Expedition	✓			
◦ Exploration	✓			
◦ Evolution		✓		
◦ Expanding Human Presence			✓	
Synthesis Group Architectures				
◦ Mars Exploration		✓		
◦ Resource Utilization				✓
◦ Science Emphasis for Moon and Mars		✓		
◦ Moon to Stay, and Mars Exploration			✓	

Figure 1. Architectures studied to date.

The subcategories provide some finer gradations to help in characterizing the architectures. The subcategories of "Expedition" and "Research and Development Outposts" are self-explanatory, however the other two require some additional explanation. "Self-Sustaining" is that set of architectures that have an end goal of being able to survive for long periods of time without Earth support. "Self-Sufficient" is that set of architectures that can not only survive but can grow without Earth support. The locations of the check marks are no more than relative judgements of scale between architectures.

Many different surface system assets have been conceptualized over this period of time. *Figure 2* is a partial listing of those assets studied. Many of the more mature elements and systems are further defined in the "Planet Surface System Elements and Systems Data Base".

Surface Systems

- °Mass Drivers
- °Tether Slings
- °Rock-melter Tunneling Devices for Hab Volumes
- °Inflatable Habitats
- °Lava Tubes for Hab Volumes
- °Mars Airplanes
- °Locally Produced Propellants
 - Many different chemical fuels from lunar soil
 - Mars chemical fuels from atmosphere, or Martian moons
- °Nuclear Power
- °Solar Dynamic Power
- °Beamed Power
- °Communications Architectures Using Halo Satellites in Libration Points
- °Lunar Volatile Collectors Including ^3He for "Safer" Fusion
- °Building Materials from Ceramic Plant Concepts
- °Lunar Concrete and Lunar Fiberglass Demos
- °Lunar Hoppers
- °Lunar Based Solar Power for Earth
- °Geo Solar Power Satellite System from Lunar Materials

Figure 2. Summary of systems studied to date.

It would be impossible to discuss every option in detail, therefore only one was chosen for further discussion in the sections to follow. Since there are so many similarities between each architecture, particularly in the early phases, the discussion of one architecture of somewhat aggressive capability, should yield an understanding of all. The one chosen is the latest work done by the Space Exploration Team and is from the NASA Synthesis Group recommendations. This particular architecture has been labeled "Space Resource Utilization". It is divided into phases of Initial Operational Capability (IOC), and Next Operational Capability (NOC) -1, -2 and so on.

Planetary Surfaces Systems Overview

The Space Resource Utilization Architecture focuses on developing the capability to extract useful materials from the resources of the Moon. On the Moon, a substantial infrastructure is emplaced which can support up to 12 crew. Two major process lines are developed, one which produces oxygen, ceramics, and metals, and another which produces hydrogen, helium, and other volatiles.

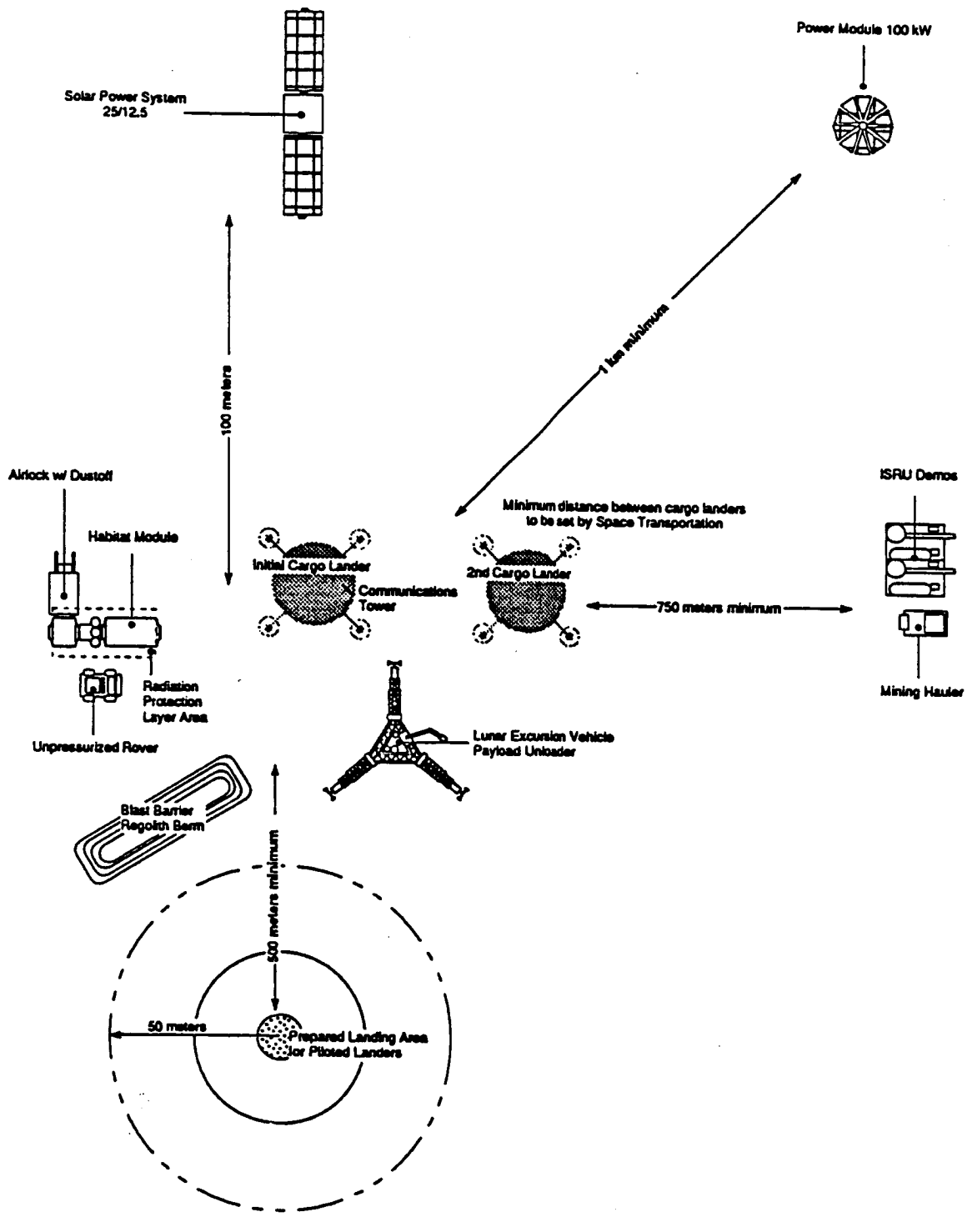

Figure 3 Space resource utilization Architecture
Lunar IOC.

A simulation of a Mars mission is also carried out on the Moon.

System Description

Following is a phase-by-phase description of the systems emplaced on the surfaces of the Moon, together with a discussion of what capability is provided and some of the reasoning behind the choices made. Further information on the surface elements can be found in JSC-45107.

Lunar IOC

Lunar IOC established the basic infrastructure to support five crew on the surface during the lunar day. Demonstration packages for candidate resource extraction processes are deployed. See *Figure 3*.

A single, integrated habitat which can support five crew for 14 days is provided. The habitat is a Space Station Freedom (SSF)-derived cylindrical module, with an airlock attached to one end and a docking adapter on the other end. Due to the down-mass limitations of the cargo lander, the module is 2/3 the length of a full SSF module, with length 8.2 meters and diameter 4.5 meters. Two such modules are needed to meet the crew requirements of the later lunar missions. A single, fully integrated module for six-crew missions of up to 90 days would weigh approximately 40 metric tons: this exceeds the capability of the lander.

The pressure shell is essentially identical to that of a SSF module, with leveling legs and deployable regolith-shielding retention devices. Internal systems of the habitat include life support, thermal control, power management and distribution, crew accommodations, limited health care equipment, science accommodations, and utilities distribution. The life support system is an advanced SSF regenerative system, with greater than 98% oxygen recovery, hygiene water processor, and non-expendable water polisher/bacteria barrier. Thermal control is provided by coatings, heat pumps, and composite reflux radiators with a two-phase non-toxic working fluid.

The airlock is a SSF-derived system which enables egress/ingress and also provides extravehicular activity (EVA) suit storage, checkout, and recharge. The airlock system is composed of an equipment lock, a crew lock, an EVA dust-off porch, and adjustable legs for leveling. The airlock's life support and thermal control systems are tied into the habitat. The EVA dust-off porch is side-deployed and a docking adapter for later use by the pressurized rover is attached on the end opposite the habitat (see *Figure 3*). Ideally, the airlock is delivered pre-attached to the habitat, in order to avoid the difficult operation of connecting the two in-situ.

A nuclear system for primary power, and a photovoltaic array (PVA) regenerative fuel cell (RFC) system for backup, are employed during IOC. The PVA consists of 150m² of sun-tracking panels. The cells are of amorphous silicon. The PVA/RFC system can provide 25 kW during the lunar day and 12.5 kW at night. The nuclear system consists of an SP-100 reactor fitted with four Stirling engines (two in use, two in reserve), providing 100 kW of electrical power continuously. It is designed for easy deployment, with little or no human intervention required. Limited shielding is provided on the reactor to enable short-duration proximity operations by humans. Additional shielding is provided by placing the reactor in a pre-excavated hold. The system is fully autonomous and employs fault detection, isolation, and recovery systems which result in a reliable, long-lived (nominal 15 year lifetime) unit.

Extravehicular Mobility Units (EMU) are provided for each crew member on the lunar surface. An EMU consists of a pressure suit, a Portable Life Support System (PLSS), and communications

subsystem. The suites are of back-entry, hybrid (fabric and hard components), 5.85 psi design. The PLSS is a regenerable system which provides for 8 hours of EVA. EMU accessories include helmet-mounted video cameras and lighting systems.

Radio frequency equipment and associated electronics are integrated into the habitat. A deployable tower and dish antenna are located near the habitat (they might remain on an expended lander). The system provides UHF communications to and from the tower, satellite communications (K-band) to Earth, S-band communications to the landers, a long range navigation-type means for navigation of surface rovers and landers (within 12 km of the outpost), and internal habitat communication.

A six-wheeled, unpressurized rover is provided. The rover can seat four suited astronauts, or can carry two together with a removable, self-contained extended life support package. The segmented chassis is composed of a light-weight tube framework, with independent drive on each wheel. Power is recharged from the base's power system. Thermal control is provided by a heat pump with metallic reflux radiators, enabling the rover to operate anytime during the lunar day. The range of the rover is 50 km from the outpost, or 150 km total traverse.

A multipurpose construction vehicle is also provided. The Lunar Excursion Vehicle Payload Unloader (LEVPU) is a three-strut, con-wheeled, teleoperated gantry crane. It is capable of unloading cargo from the lander, transporting cargo (up to and including an integrated habitat), and emplacing elements on the lunar surface. A set of implements and attachments designed for its three-joint manipulator arm enable the LEVPU to perform various other tasks, including light excavation (e.g. boulder clearing, regolith smoothing, and/or trenching), and precision surface element alignment and attachment. The choice of a LEVPU plus attachments avoids the need to deliver several specialized construction vehicles. The LEVPU's primary structure consists of open web, aluminum alloy members with telescoping struts, and independently driven and controlled wheel assemblies. The power and thermal control subsystems are similar to those on the unpressurized rover.

A mining hauler, loaded by the LEVPU, is used to transport loose regolith to the volatiles demo. It utilizes many of the same subsystems as the unpressurized rover, but is of heavier construction and operates autonomously or by teleoperation.

Two ISRU demonstration packages are emplaced and operated in IOC. The first is robotically deployed and operated and tests two-three different processes for extracting oxygen and metals from the lunar regolith, and forming ceramic materials from the resulting process slag. The second, delivered with the first crew, tests processes for extracting volatiles (hydrogen, CO/CO², nitrogen, helium, etc). Both units are self-contained, needing only power from the base and regolith feedstock (provided by the payload unloader and mining hauler). They operate for one-two years and the knowledge gained is used in the design and construction of subsequent pilot plants.

Some of the oxygen and hydrogen produced is used to re-load the fuel cells in the unpressurized rover, in a demonstration of the direct application of locally derived resources in base operations.

A small verification unit for demonstrating the storage of cryogenic liquids on the lunar surface is emplaced and operated at the initial outpost. It operates autonomously with monitoring from Earth, and conducts tests of systems to control cryogen boiloff by the use of thermodynamic vents, vapor cooled shields, low conductivity support, and refrigeration and reliquifaction equipment.

Limited crew time, power, and habitat volume is available for science activities. However, the LEVPU can deploy scientific instruments on the lunar surface, and the unpressurized rover can be used for geological traverses.

In addition to the systems described above, a warning system for solar flares is also emplaced near the habitat. It consists of an autonomously controlled system for monitoring the particle and electromagnetic output of the sun. Threshold alarms are included which alert the crew when the incident solar radiation exceeds a predetermined value, so that they may take shelter until the flare subsides. This system is a backup to solar monitoring stations on the Earth and in space.

Consumables pallets are delivered on each crew flight. Consumables include food, life support expendables, clothing, hygiene supplies and housekeeping items. The pallets provide pressurization and thermal control where required for the consumables.

Lunar NOC 1

Lunar NOC 1 extends the surface infrastructure in order to support crews of up to 12. Surface transportation range and functions are expanded. The capacity to produce significant quantities of locally derived gases and materials is developed.

During this phase, a second habitat unit is emplaced. This habitat is delivered with an interconnect node (similar to the SSF design) attached to one end, and a docking adapter on the other. It is externally identical to the initial habitat and is connected to the adapter on the end of the habitat away from the airlock (see *Figure 4*). Its critical internal systems can operate independently of the initial habitat, providing separate pressurized volumes in case of difficulty in either habitat. It differs only in its internal outfitting: crew quarters, galley, etc., are located in the initial habitat, while the second habitat contains an expanded crew health-care facility, scientific/workshop accommodations, and storage space for the consumables required during long term (30-90 day) missions. With the addition of this second habitat, and the emplacement of the requisite regolith shielding, the outpost can support 6-person crews for up to 90 days.

The second habitat is followed by a laboratory/workshop module (with attached airlock), connected to the node and oriented at a right angle to the other two modules (see *Figure 4*). This module's critical systems are also identical to those of the other modules. Its internal outfitting consists of storage, science racks, and a workshop area for servicing and repair of base machinery.

Across the interconnect node from the lab/workshop, a greenhouse is constructed. The greenhouse structure is composed of cast basalt produced by the ISRU plant. The interior is sealed by the installation of a double-layered bladder. Access is restricted/controlled by hatches in the node, since the greenhouse will operate at elevated CO² levels. The greenhouse tests the use of regolith as a root matrix, obtaining nutrients from a drip-emitter irrigation system.

The last cargo flight of this phase delivers another module, similar to the first habitation module, which is connected to the node in-line with the other habitats. This module constitutes one-half of the Mars simulation structure utilized in NOC 2. Since its internal outfitting is primarily crew accommodations, the addition of this module expands the capability of the base to 12 crew.

The power capability of the outpost is upgraded by the emplacement of two 55 kW nuclear systems whose delivery is phased with the increasing power demand of the ISRU plants. These plants are similar to the 100 kW system deployed in IOC. They employ an SP-100 type reactor placed in a hole in the regolith, with eight Stirling engines arranged on the surface around the hole. The Stirling engines operate at a higher temperature than on the 100 kW system (1300 K vs. 1050 K). The system is delivered in several packages and gross assembly is performed by teleoperation of the LEVPU. Final connections and checkout are performed by EVA. System health is monitored from the habitat.

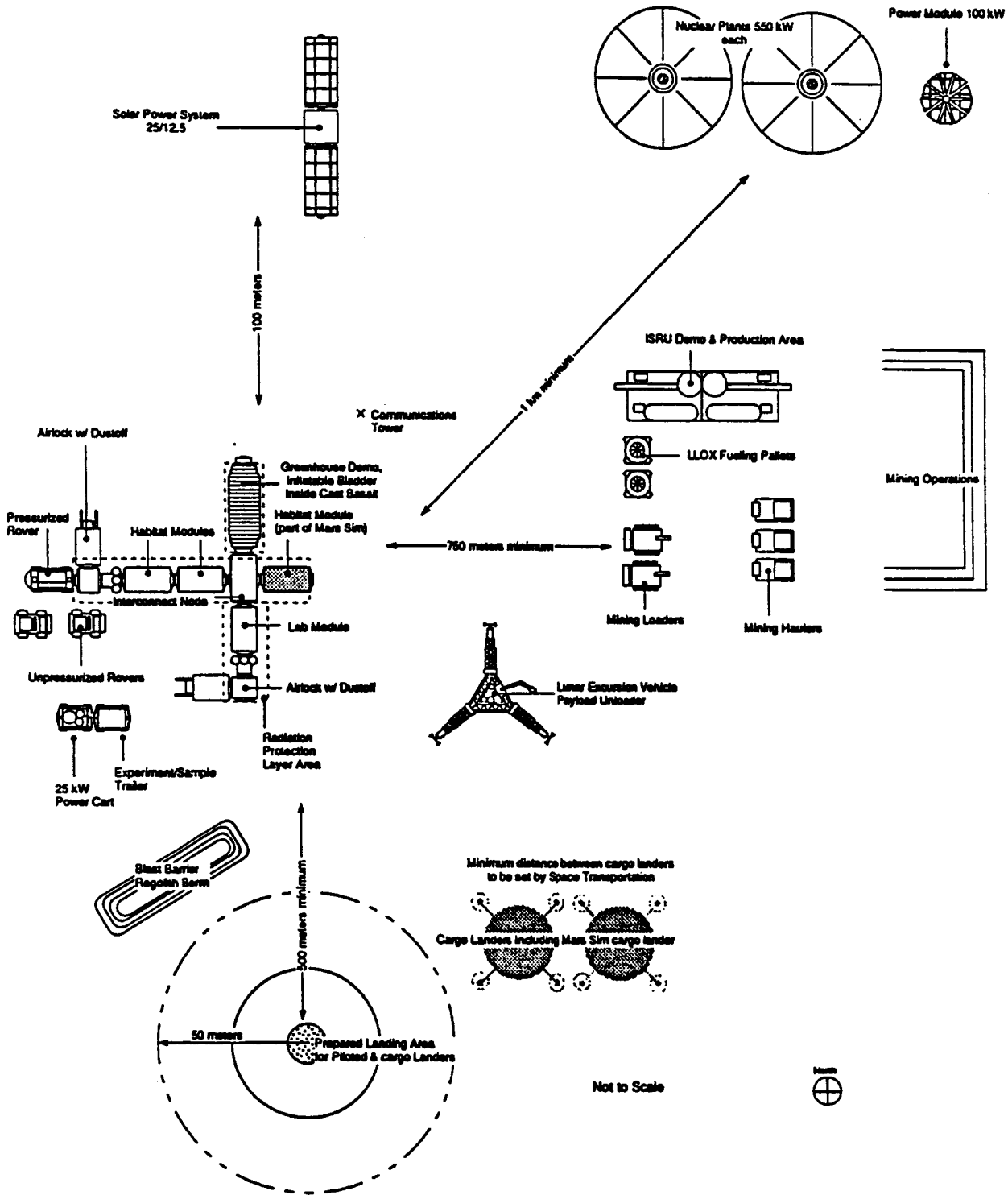

Figure 4 Space resource utilization Architecture Lunar NOC 1.

A pressurized rover system is delivered for use in this and subsequent phases. The pressurized rover itself has limited capability (on the order of 50 km from the base), but with the addition of an auxiliary power cart and an experiment/sample trailer, this extended to a range of 100 km from the base, for two crew members for up to six days. The rover has twin manipulator arms for geologic sample collection and intravehicular activity (IVA) access to surface equipment. Power is provided by regenerative fuel cells, thermal control is provided by coatings and a two-phase heat pump. The life support system is partially closed with storage of wastes for return to the base.

Three additional mining haulers and two mining loaders are delivered as the mining rate increases. The front-end mining loaders are fuel cell-powered vehicles with chassis similar to those of the haulers. They relieve the LEVPU of mining duties.

Two years after the oxygen/ceramics/metals demo, a pilot plant which produces eight metric tons of oxygen per year is deployed. This is followed two years later by a larger plant which produces 60 tons of oxygen per year. These plants also produce a variety of metal and ceramic items. The oxygen is first used in the fuel cells on the surface vehicles, then later in propulsion systems of the landers and as life support system make-up. Ceramic blocks (produced by hot-pressing or melting regolith) can be used as paving stones to control the dust around the base, or in building simple structures. Other uses for ceramics, and the metals produced, are subjects for further study.

The year after the oxygen pilot plant is emplaced, a volatiles pilot plant which each year produces five metric tons of hydrogen, 5 t helium, 5 t nitrogen, and 20 mt CO/CO² is delivered. This is followed three years later by 15 t helium, 15 t nitrogen, and 60 t CO/CO² per year. The hydrogen is used in the fuel cells on the surface vehicles and in the propulsion systems of the landers. Any excess can be used to make water for the crew or for plant growth. Nitrogen is used in the atmosphere of the habitats and in plant growth. CO/CO² can be used in methane/oxygen propulsion systems, and in the greenhouse. Helium-3 is separated from the helium produced, and exported to Earth for use in fusion reactors.

Liquifaction and storage of locally produced gases is provided by systems delivered with the plants. Transfer of the gases is achieved by delivering transfer pallets, transportable by the LEVPU, which utilize tanks scavenged from expended landers.

Support for reusable landers on the lunar surface is provided by an excursion vehicle-servicer package. This surface unit provides power, thermal control, and reliquifaction of the vehicle's cryogenics. Heat rejection is provided by a heat pump with composite radiators, and reliquifaction is accomplished by Heyland cycle machinery. A tent structure is provided for covering the lander: this provides micrometeoroid protection and reduces the heating and cooling loads. Refueling of the landers is accomplished by using the transfer pallets described above.

Expanded science accommodations are available in the second habitat, the hab/lab/storage module, and the Mars simulation habitat. The pressurized rover extends the range of surface exploration.

Lunar NOC 2

Lunar NOC 2 emplaces habitats to be used in a simulation of a Mars mission. These are connected to the existing habitats, and become part of the base following the simulation.

An additional habitat/airlock assembly is delivered and connected in line with the first Mars simulation habitat emplaced at the end of NOC 1. Together, these two modules house the Mars

simulation crew. They differ from the other habitats in the life support system used: the Mars simulation will utilize the same life support technology as will be used for the Mars mission. In this implementation, this is an advanced SSF regenerative system which incorporates waste processing, to reduce consumables usage. To maintain the fidelity of the Mars simulation, the hatch between these modules is kept closed while the test is being conducted. After the simulation, the Mars habitats are used by lunar crews as crew quarters, science stations, and consumables storage.

The Mars simulation uses the power systems already existing at the base.

The simulation crew brings an unpressurized rover like the one described previously. They use the pressurized rover delivered to the base during NOC1. *Figure 5* schematically depicts the layout of the lunar base.

Mission Profile

Lunar Flights 1 & 2 (Cargo), 2003

A cargo lander delivers the payload unloader, unloader attachments, PVA/RFC power system, communication equipment, cryotank verification unit, the O²/Ceramics/Metals demonstration unit, and flare warning system. A second cargo lander delivers the integrated habitat/airlock plus the 100 kW nuclear power supply. Delivering all of these systems on a single cargo lander would be preferable, but the total would exceed the capability of the current lander design. The unloader operates under supervised autonomy (autonomously, with supervision and intervention as needed from Earth). It self-deploys from its lander, and utilizing various attachments, it clears and levels areas for the habitat, power supplies, and ISRU demo. Other surface preparations include the excavation of hole for the nuclear power supply, and piling of a 1.5 m high regolith berm between the habitation area and the preselected crew landing site (in order to protect base elements from most of the blast ejecta from the landers).

By straddling the first lander the unloader removes the solar power system and ISRU demo, transports them to the prepared sites, and lowers them to the surface. The cryotank verification unit and flare warning system are similarly positioned.

By straddling the second lander the unloader removes the habitat/airlock, transports it to the prepared site, and lowers it to the surface. Next the nuclear power supply is moved to the excavation, already prepared. After it is placed into the excavation, its radiator panels self-deploy. The necessary connections are made by the unloader between the power supplies and the various surface elements. At the completion of this period of un-manned lunar operations, all systems are in their final positions and their integrity is verified from Earth to the extent possible. Once the unloader is freed from these duties, it is employed in supplying the O₂/Ceramics/Metals demo with the needed regolith feedstock.

Lunar Flight 3 (Piloted), 2004

A crew of five lands near the outpost at the beginning of lunar day bringing with them EMU's and the required consumables. They also bring the ³He Volatiles demonstration unit and two surface vehicles to support their operations -- an unpressurized rover and a mining hauler for the ISRU demonstrations. A limited set of geological exploration equipment is also delivered. The crew lives out of the lander for two-three days, performing EVAs to verify the proper deployment and connection of the photovoltaic array and the nuclear power supply to the habitat and ISRU demo delivered on Flight 1. The ISRU demo, flare warning system, and cryotank verification unit are

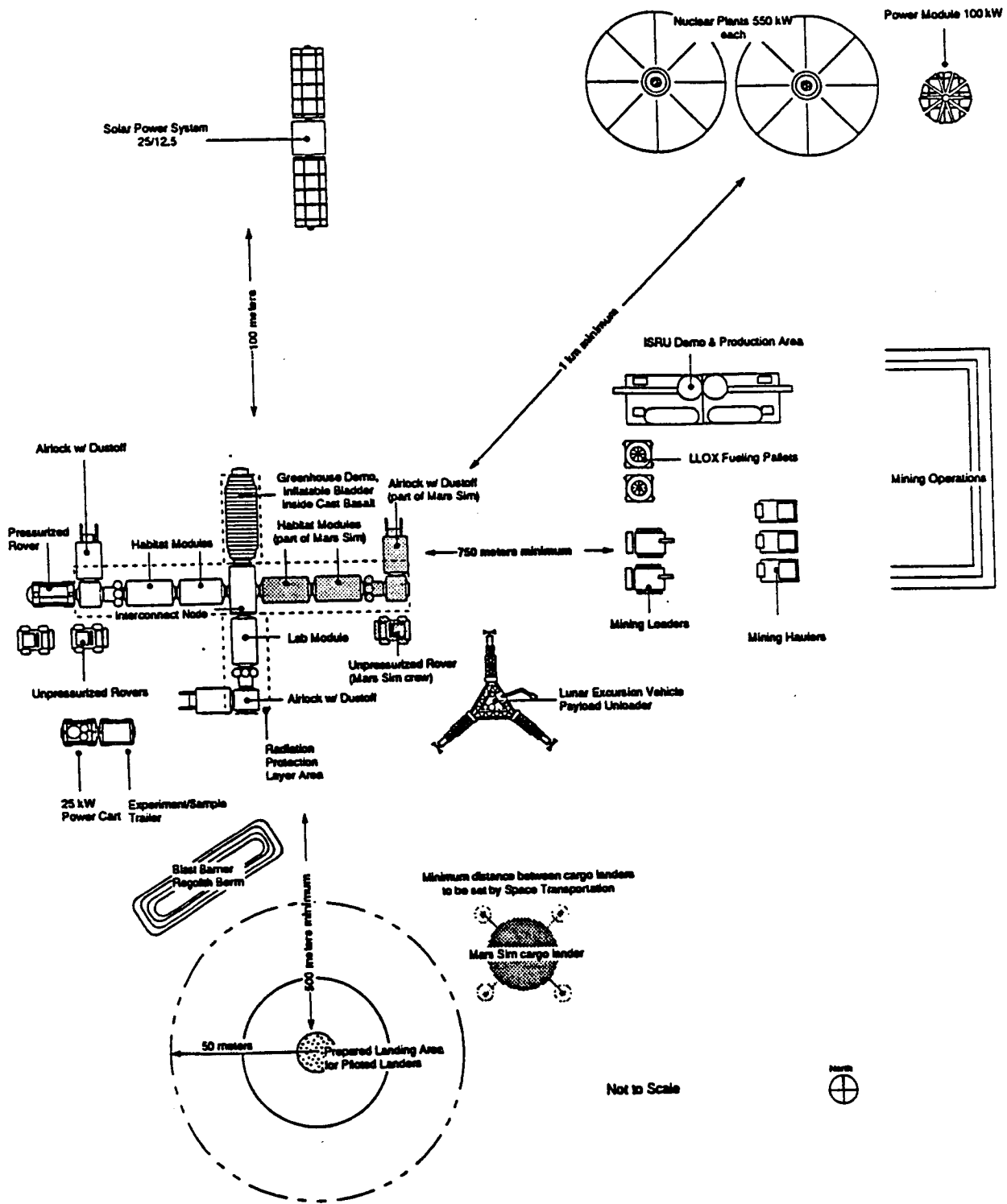

Figure 5 Space resource utilization Architecture Lunar NOC 2.

inspected and adjusted if necessary. After activating the verifying the habitat's internal systems, they occupy the habitat for the remainder of the 14-day stay.

Local geological exploration is carried out near the outpost and via the unpressurized rover, as time permits. A geophysical monitoring station is deployed within walking distance of the outpost.

At the completion of the 14-day stay, the crew powers down the habitat, placing it in standby mode until the next mission, and departs in the lander. With the completion of this flight a presence has been established on the lunar surface which marks the achievement of Lunar Initial Operating capability.

Lunar Flights 4 & 5 (Cargo), 2005

A cargo lander delivers the second habitat unit accompanied by an interconnect node. This flight also delivers the pilot plant for O₂/Ceramics/Metals production. The unloader transports the habitat and node (which are already docks together) from the lander and places them in the proper orientation to the existing habitat. The mating of the two is carried out under supervision from Earth. The unloader then removes the pilot plant and transports it to the same area of the demo previously delivered. Finally, the unloader uses various implements to emplace the regolith shielding layer over the habitats and excavate a hole for the next nuclear power supply.

Another lander delivers a 550 kW nuclear power plant, a LLOX fueling pallet, and supporting surface transportation vehicles – a pressurized rover system and another mining hauler accompanied by a mining loader for the pilot plant operations. On command from ground control, the payload unloader moves the nuclear power plant pieces from the lander to the prepared site. After placing the reactor into the excavation, the other major subsystems are arranged in position. The unloader also lowers the pressurized rover and its power cart from the lander to the lunar surface. Teleoperated from Earth, the rover train moves to the vicinity of the outpost.

Lunar Flight 6 (Piloted), 2006

A crew of six arrives with science equipment, consumables for a 45-day stay, and spares and needed replacement parts for base systems. They also bring a ³He/Volatiles pilot plant. They verify the outpost systems and move into the habitat.

After occupying the base, the crew performs the necessary EVA to complete the assembly of the nuclear power plant and connect it to the power distribution system. The reactor is then remotely activated. This operation is followed by installation and startup of the volatiles pilot plant. Mining and resource production operations are assisted as necessary, until they can be controlled completely from Earth.

Science operations are carried out via the pressurized and unpressurized rovers, as maintenance and contingency requirements permit. Locally produced oxygen and hydrogen can be used to replenish the fuel cells of the rovers, if needed.

After 45 days, with the two ISRU pilot plants up and running and the habitation area now able to support crews for stays of 45-90 days, the crew powers down the habitat, placing it in standby mode until the next mission, and departs in the lander.

Lunar Flight 7 & 8 (Cargo), 2007

A cargo lander delivers and O₂/Ceramics/Metals production plant, two mining haulers, a mining loader, another LLOX fueling pallet, a lunar excursion vehicle servicer, and equipment necessary to conduct a power beaming demonstration. An experiment/sample trailer for the pressurized rover is also carried. On command from ground control, the payload unloader removes the production plant from the lander and transports it to the vicinity of the other ISRU units. The same is done with the fueling pallet. The mining vehicles are unloaded and driven to the mining area. The beamed-power demo is moved near the power supplies, and the LEV servicer is left near the landing areas.

Another cargo lander brings a laboratory module/airlock assembly, and an additional 550 kW power supply. The power supply components are positioned as described previously. The unloader transports the lab/airlock from the lander to the other habitats and performs the mating operation. The unloader then proceeds to emplace the regolith shielding over the new element.

Lunar Flight 9 (Piloted), 2009

A crew of six arrives with science equipment, EMU's, consumables for a 90-day stay, spares, and needed replacement parts for base systems.

The crew in combination with the unloader, utilizes the LEV servicer to safe the lander. After occupying the base, they perform the necessary EVA to complete the installation of the second nuclear power plant. They then complete the installation of the O₂/Ceramics/Metals production plant and initiate its operation. The crew uses the pressurized rover to explore outside of the vicinity of the base and carry on maintenance of emplaced systems, particularly in the ISRU production area.

IVA science activities are carried out in the habitats. EVA science, together with routine maintenance and contingency repairs, are carried out on foot and via the rovers.

With the power system at full capability, the ISRU units up and running, and the habitation area now able to support crews for stays of 180 days, the crew powers down the habitat, placing it in standby mode until the next mission, and departs in the lander.

Lunar Flight 10 (Cargo), 2009

A cargo lander delivers a He³/Volatiles production unit and outfitting for a demonstration greenhouse, plus needed spares. The unloader offloads and integrates the production unit into the ISRU area and the power network already in place. The greenhouse outfitting is also offloaded and delivered to the habitat area.

Lunar Flight 11 (Piloted), 2010

A crew of six arrives with EMU's and consumables for a 180-day stay. The crew, in combination with the unloader, utilizes the LEV servicer to safe the lander. After occupying the base, they perform the necessary EVA to verify the proper installation and operation of the new volatiles production unit.

Their next major activity is the construction of the greenhouse. The unloader is used to partially construct a cast-basalt structure adjacent to the interconnect node, utilizing pieces fabricated nearby. A bladder package is moved inside and mated to the node. The external structure is completed and the bladder inflated. Finally, the crew completes the internal outfitting of the greenhouse, and initiates plant growth experiments.

The remainder of the stay time is spent performing needed base maintenance operations and science investigations. After a stay of 180 days, the crew places the base in standby mode and departs.

Lunar Flight 12 (Cargo), 2010

A cargo lander delivers the first habitat for the Mars simulation. The unloader transports it to the base and mates it to the interconnect node, in-line with the two existing habitat modules. Installation of this module brings the base's crew capacity to 12, marking the achievement of Lunar NOC

Lunar Flight 13 (Cargo), 2011

A cargo lander delivers the second habitat for the Mars simulation, together with an airlock and science equipment. The unloader transports and mates this module to the one delivered on the previous flight. Regolith shielding is then placed over both Mars simulation habitats.

Lunar Flight 14 (Piloted), 2011 (Arrives in 2012)

After a stay in lunar orbit (to simulate the Mars transit), the Mars simulation crew of six arrives with EMU's, an unpressurized rover, a suite of science equipment and experiments, and consumables for a 40-day surface stay. They check and then occupy the Mars simulation portion of the base. While on the surface, they demonstrate as many of the operations to be performed at Mars as is practical. This may include weighting of the crew to simulate the effects of Mars-like gravity loads on the crew members immediately following the long zero-g transfer phase. The pressurized rover previously delivered to the base is also available for their use.

All operations are carried out while a support crew is present at the base. The support crew lends assistance as necessary to complete the simulation. At the end of their 40-day stay, the simulation crew may power down and save the simulation habitats, or this may be left to the support crew.

Lunar Flight 15 (Piloted), 2012

Six crew arrive at the base some 25 days prior to the landing of the simulation crew. In addition to checking out the base for reoccupation, they verify that the Mars simulation habitats are properly positioned and ready for the simulation crew. When the Mars simulation crew is on the surface, they lend whatever assistance is required to maximize the usefulness of the simulation. After the Mars crew departs, they remain for an additional 25 days servicing base systems, monitoring the ISRU plants, performing science activities, and working the greenhouse.

The completion of Mars simulation marks the achievement of Lunar Next Operating Capability 2. What is subsequently done with the substantial assets of the lunar base is a subject for further study.

Issues for Further Study

Issue: Logistics and Resupply

Because this architecture is aggressive in its buildup, there is a greater need for efficient delivery and distribution of logistics and resupply materials. The large number of surface elements, and the complex tasks they perform will make supportability vitally important.

Recommended focused studies: Supportability concepts incorporating logistics strategies.

Issue: Spares Philosophy/Maintenance Burden

The makeup of spares inventories and the requirements for maintenance operations on planetary surfaces have only been roughly estimated to date.

Trend analysis, to date, project that conventional design practices will require an order of magnitude for more man-hours than available for maintenance.

Recommended focused studies: Maintenance burden studies and spares analysis for surface elements.

Issue: Optimization of Lander Concept & Unloading Concept

The current Lander Concept requires design of mobile gantry crane that can "Straddle" payload on top of lander. This results in a heavy design with risky operational procedures.

Recommended focused study: Combine lander design requirements to optimize design of both.

N 93 - 27975

ENGINEERING DESIGN CONSTRAINTS OF THE LUNAR SURFACE ENVIRONMENT

D. A. Morrison
NASA Johnson Space Center

519-31

ABS ONLY

158333

P 2

Abstract

Living and working on the lunar surface will be difficult. Design of habitats, machines, tools, and operational scenarios in order to allow maximum flexibility in human activity will require paying attention to certain constraints imposed by conditions at the surface and the characteristics of lunar material.

Primary design drivers for habitat, crew health and safety, and crew equipment are: 1) ionizing radiation, 2) the meteoroid flux, and 3) the thermal environment. Secondary constraints for engineering derive from: 1) the physical and chemical properties of lunar surface materials, 2) rock distributions and regolith thicknesses, 3) topography, 4) electromagnetic properties, and 5) seismicity.

Protection from ionizing radiation is essential for crew health and safety. The total dose acquired by a crew member will be the sum of the dose acquired during EVA time (when shielding will be least) plus the dose acquired during time spent in the habitat (when shielding will be maximum). Minimizing the dose acquired in the habitat extends the time allowable for EVAs before a dose limit is reached. Habitat shielding is enabling, and higher precision in predicting secondary fluxes produced in shielding material would be desirable. Means for minimizing dose during a solar flare event while on extended EVA will be essential. Early warning of the onset of flare activity (at least a half-hour is feasible) will dictate the time available to take mitigating steps. Warning capability affects design of rovers (or rover tools) and site layout. Uncertainty in solar flare timing is a design constraint that points to the need for quickly accessible or constructible safe havens.

The meteoroid flux imposes some constraints. Hypervelocity primary particles impact with an average angle of incidence of 45 degrees from the local vertical. Surfaces that are not exposed to the sky are not affected by primaries but may be affected by secondaries accelerated from the lunar surface at a variety of angles by primary impact. Secondaries may dominate the flux for particles producing craters of 7 microns diameter and less and shielding will be required even for surfaces protected by geometry from primaries.

The thermal properties of the regolith and at the lunar surface were measured during the Apollo program. The conductivity of the regolith varies with depth - it is an order of magnitude less in the upper two cms than at deeper depths - and varies according to whether or not the regolith is disturbed. Apollo heat flow measurements apply to undisturbed regolith. Disturbed regolith ("fluffed" by handling?) has lower thermal conductivities, resembling the upper two cms of undisturbed regolith.

The physical, chemical, and electromagnetic properties of lunar surface materials are relatively well characterized, and it is unlikely that properties with major design impacts remain seriously underdetermined. Soil mechanics and trafficability parameters were investigated during Apollo. Some uncertainties remain in the trafficability of very large vehicles, and in the ease of excavation of the regolith at depth, and it may be useful to explore these issues further. Rock distributions in the regolith are known imprecisely but the abundances of rocks in regoliths typically are very low. Regolith thicknesses, important in mining, are not well characterized for pyroclastic terrains or for relatively young terrains but otherwise are on the order of 3 meters or greater.

Seismicity of the Moon is extremely low but a Richter Scale 5 seismic event once per 100 years is not out of the question and is a design constraint.

The above properties and others are summarized in the Lunar Engineering Model.

CLOSED ECOLOGICAL SYSTEMS: FROM TEST TUBES TO EARTH'S BIOSPHERE**Robert J. Frye and George Mignon****Environmental Research Laboratory, University of Arizona****Abstract**

Artificially constructed closed ecological systems (C.E.S.) have been researched both experimentally and theoretically for over 25 years. The size of these systems have varied from less than one liter to many thousands of cubic meters in volume. The diversity of the included components has a similarly wide range from purely aquatic systems to soil based systems that incorporate many aspects of Earth's biosphere. While much has been learned about the functioning of these closed systems, much remains to be learned. In this paper we compare and contrast the behavior of closed ecological systems of widely different sizes through an analysis of their atmospheric composition. In addition, we will compare the performance of relatively small C.E.S. with the behavior of Earth's biosphere. We address the applicability of small C.E.S. as replicable analogs for planetary biospheres and discuss the use of small C.E.S. as an experimental milieu for an examination of the evolution of extra-terrestrial colonies.

S₂₀-54
158334
p. 19

Introduction

The Biosphere 2 project has recently engendered much discussion on closed ecological systems and indeed has constructed the worlds largest artificial closed ecological system. The research reported here includes some of the data generated in association with the Biosphere 2 project in addition to independent research conducted at the University of Arizona.

Several questions will be addressed in this paper. Are closed ecological systems (C.E.S.) composed of soil and higher plants stable and resilient? Folsome and his colleagues (Folsome and Hanson, 1986; Kearns, 1983; Kearns and Folsome, 1981, 1982; Obenhuber, 1985; Obenhuber and Folsome, 1984, 1988) have demonstrated remarkable persistence of aquatic closed systems, do soil based systems show similar stability and resilience? Do soil based closed ecological systems demonstrate regular and predictable behavior explainable by testable hypotheses? And lastly, can metrics of a predictive value be derived from the study of closed ecological systems which have applicability to Earth's biosphere, the largest known closed ecological system? Lastly, can small closed ecological systems be used to examine the basic functioning of bioregenerative life support systems?

We shall attempt to at least partially answer these questions using data from soil based closed ecological systems of widely different sizes. While we believe that this research represents a promising beginning to the wider acceptance of closed ecological systems research we recognize the very preliminary nature of our work.

Materials and Methods

Closed Ecological Systems

Table 1 lists the closed ecological systems used in this study. The total volume of systems considered in this study varies over five orders of magnitude, from less than 0.02 m³ to almost 400 m³.

Table 1. Characteristics of Closed Ecological Systems

C.E.S. #	Closing Date	Opening Date	Duration of Closure (Days)
Large Closed Ecological System (400 m³)			
1	12/31/86	03/21/87	81.00
2	04/02/87	06/21/87	80.00
3	06/25/87	10/25/87	123.00
4	11/16/87	01/03/88	48.00
5	02/05/88	07/04/88	150.00
Small Closed Ecological Systems (0.03 m³)			
11	11/02/88	03/13/89	131.00
15	11/02/88	03/13/89	131.00
19	11/02/88	03/13/89	131.00
23	11/02/88	03/13/89	131.00
12	11/02/88	03/13/89	131.00
16	11/02/88	03/13/89	131.00
20	11/02/88	03/13/89	131.00
24	11/02/88	03/13/89	131.00
13	11/02/88	03/13/89	131.00
17	11/02/88	03/13/89	131.00
21	11/02/88	03/13/89	131.00
25	11/02/88	03/13/89	131.00
14	11/02/88	03/13/89	131.00
18	11/02/88	03/13/89	131.00
22	11/02/88	03/13/89	131.00
26	11/02/88	03/13/89	131.00
40	08/31/89	12/17/89	108.00
41	08/31/89	12/17/89	108.00
42	08/31/89	12/17/89	108.00
43	08/31/89	12/17/89	108.00
44	08/31/89	12/17/89	108.00
45	08/31/89	12/17/89	108.00
46	08/31/89	12/17/89	108.00
47	08/31/89	12/17/89	108.00
51	03/29/90	----	----
52	03/29/90	----	----
53	03/29/90	----	----
54	03/29/90	----	----

Small Closed Ecological Systems

The smallest closed ecological systems used was a 0.003 m³ polycarbonate jar which was 24 cm. high and 16.5 cm. in diameter. These were used in constructing closed ecological systems # 51 and 52. Polycarbonate jars of 0.03 m³ which are 30 cm. tall and 30 cm. in diameter were used to construct closed ecological systems #52 and #54. Poly carbonate jerricans were used to construct all other small closed ecological systems reported here. These jerricans were approximately 0.03 m³ in volume with dimensions of 35 cm. x 22 cm. x 30 cm. Atmospheric sampling was through either a simple septum (closed ecological systems #11-47) or through a more permanent Mininert Valve which allows septum replacement without loss of the internal atmosphere.

The atmospheres of the small closed ecological systems were sampled periodically using hypodermic needles and 10 ml. plastic syringes. Duplicate 10 ml. samples were withdrawn and injected into a Hach-Carle gas chromatograph fitted with a 80% Porapak N + 20% Porapak Q column for determination of carbon dioxide. Known standards were run to determine carbon dioxide concentrations. Standard curves were determined for a range of known standards from 0 ppm to 50,000 ppm CO₂. The atmosphere in closed ecological systems #51-54 is currently being sampled using 600 microliter samples to conserve the atmosphere of the systems.

Closed ecological systems were placed under artificial lighting in a laboratory or in greenhouses located at the Environmental Research Laboratory. Soil used in these experiments was commercial potting soil. In closed ecological systems #11 - #26 only one species of plant was used, banana. The other small closed ecological systems were constructed using up to five different species of common house plants.

Large Closed Ecological Systems

The largest closed ecological system reported here was a 400 m³ sealed greenhouse (Test Module) located at the Biosphere 2 site near Oracle, Arizona. This structure is approximately 3.4 x 3.4 x 3.5 m. and is connected to a variable volume 'lung' used to maintain a positive internal pressure. The structure included automatic watering systems and an automated data acquisition and control system. A detailed description of the facility is reported in Nelson, et. al. (1992).

During the experiments reported here over 100 channels of data were recorded. Instruments for measuring temperature, photosynthetic photon flux density (PPFD), black body radiation, and relative humidity sampled the atmosphere inside the Test Module continuously and every 15 minutes the average was computed and recorded. Carbon dioxide concentrations were determined by a PRIVA infrared detector. Data used in this study were hourly averages calculated from these data.

Soil used in the Test Module experiments included both commercial potting soil and a local soil that had been amended with compost. No attempt was made to sterilize the soils used in these experiments. Over 50 plant species were used. Species included C3, C4, and CAM photosynthetic pathways distributed among species from a variety of different habitat types which include fog desert, rain forest, and savanna. In addition, over 20 different cultivars of agronomic species were included during Experiments #2-#5. Plants were grown either in pots or in a large wood planter. Between experimental closures plants were repotted as necessary.

Results and Discussion

CO₂ Dynamics in Closed Ecological Systems

Figure 1-3 are the hourly average carbon dioxide levels, temperature and total daily PFD recorded in the first three experimental closures of the large closed ecological system. An examination of these figures reveals that the carbon dioxide levels respond to changes in both temperature and PFD. In addition, it appears that all three experimental closures reached an equilibrium level of atmospheric carbon dioxide prior to the termination of the experiment. This can be seen more clearly in *Figures 5 - 7* which plot the standardized normal variables of CO₂, temperature and PFD for each experiment at 0600. As standardized normal variables each has a mean of zero and a standard deviation of one. Any trend in the variables will be apparent from these plots. *Figure 5* indicates that while there appears to be some periodicity in the CO₂ levels there is no consistent trend. *Figure 6* and *7* also do not show a consistent trend.

The results of the first three closures contrast clearly with the results of the fourth experimental closure (*Figure 4*). It is apparent from this figure that at the termination of the experiment, the composition of the atmosphere was not in equilibrium, CO₂ was continuing to increase. *Figure 8* plots the standardized normal variables for experimental closure #4. The trend in CO₂ apparent in *Figure 8* indicates that this system had not reached an equilibrium level of atmospheric CO₂ when the closure was terminated. When contrasted with *Figures 5 - 7*, the standardized normal variables of carbon dioxide, temperature and PFD for the first three closure experiments, the lack of equilibrium in atmospheric concentrations of CO₂ during the fourth experiment is apparent.

What was the difference in the starting conditions of these four experiments that may have lead to these results? Between experimental closures number 3 and number 4 approximately 6 m³ of additional soil was placed into the Test Module to investigate the use of a soil ecosystems as a scrubber for atmospheric contaminants (Frye & Hodges, 1989). During experiments 1 - 3 a total of about 2 m³ of soil was used in the Test Module. The additional soil placed into the Test Module produced CO₂ at a greater rate than the photosynthetic biomass could fix it; thus, atmospheric concentrations of CO₂ increased. Clearly the quantity of respiratory and photosynthetic biomass are important in determining the carbon cycle dynamics of closed ecological systems.

Figure 9 is the carbon dioxide, temperature and PFD data for the last and longest experimental closure with the Test Module. For this closure experiment the soil volume was reduced to about 5 m³. From *Figure 10* it is clear that the change in respiratory and photosynthesizing biomass was sufficient to allow the atmosphere to reach an apparent equilibrium. *Figure 10* is a plot of the standardized normal variables for CO₂, PFD, and temperature. Notice that even though an increasing trend in temperature and PFD are evident no consistent trend in CO₂ is apparent.

All five experiments also displayed regular diurnal patterns in carbon dioxide concentrations which can be seen in *Figure 14*. Plotted in *Figure 14* are the hourly mean carbon dioxide concentrations for each experiment plus the standard error of the mean. Experiments #1 - #3 show similar maximum and minimum levels but do show regular variation of the time of maximum carbon dioxide. This variation is caused by the seasonal progression of the time of sunrise. The larger standard errors in Experiment #4 reflect the increasing levels of carbon dioxide through the experiment.

Small closed ecological systems were set up and run under laboratory conditions to facilitate the use of replicated experimental design. The first experiment performed with small closed ecological systems examined the effect of variations in starting respiratory biomass and photosynthetic

biomass on atmospheric composition and the probability that small systems would not be persistent over time. When these experiments were initiated no experiment using soil and higher plants had been published. Theoretical evidence suggested that the smaller a closed system the higher the probability that the system would fail. It was believed that smaller reservoirs of cycling nutrients would permit less resilience in response to environmental perturbations. *Figure 11* shows the results from this experiment where sixteen small systems were constructed with soil mass/plant biomass (S/P) ratios varying from less than five to over 700. In these experiments we used soil mass as an indication of respiratory biomass. The expected result was that the systems constructed with initially high S/P ratios would have high carbon dioxide concentrations and would be more likely to fail. Failure was defined as the death of the photosynthetic portion of the system. Of the sixteen systems of *Figure 11*, five systems appeared to have not reached an equilibrium level of atmospheric CO₂ at the time the experiment was terminated; *Figures 11a, c, f, j, and l*. Of these, plant death occurred in systems of *Figure 11a, c and f*. Though the other two systems had not reached an equilibrium level of CO₂, the plants within them remained alive. The reason for the change in photosynthetic activity of these systems is not known.

Two additional experiments have been conducted using small closed ecological systems. In the first, eight closed systems with similar respiratory biomass-photosynthetic biomass ratios were distributed within four different localities at our laboratory. Two locations had high light levels (PFD > 300 $\mu\text{moles m}^{-2} \text{s}^{-1}$) and two had low light levels (PFD < 150 $\mu\text{moles m}^{-2} \text{s}^{-1}$). The influence of light level on atmospheric composition of these systems is shown in *Figure 12*. Plotted are the mean and standard errors of the CO₂ concentrations of the eight systems. From the figure it is evident that higher light levels had the effect of reducing the initial rise in CO₂ levels. Interestingly, final CO₂ levels were similar.

The last experiment using small closed ecological systems discussed here shows a similar effect of light. *Figure 13* shows the CO₂ levels in four small closed systems. These systems have been closed for over 2 years and appear to have a stable atmospheric concentration of CO₂. *Figure 13* shows the levels of CO₂ just prior to sunrise and just prior to sunset. Though all four systems had similar initial soil mass - plant biomass ratios, two systems had greater absolute amounts of soil (*Figure 13a & c*). This greater amount of soil mass is presumably the reason for the higher peak CO₂ levels attained in these two systems. In addition, it appears that these systems had not reached an equilibrium atmospheric composition when they were sampled some 504 days after closing for at that time the CO₂ level in both systems was over 60,000 ppm. On the 510th day of closure all four systems were moved from a low light level laboratory to a laboratory where light levels were about three times greater. The effect on CO₂ levels is apparent from *Figure 13*. All four systems showed a decline in CO₂ levels. Currently these systems show a daily fluctuation in CO₂ concentrations between 0 and 1500 ppm.

One of the questions originally posed concerned the derivation of metrics which could be used for predictive value. *Figure 15* is an example of one such metric. In this figure we have plotted the mean weekly carbon dioxide concentrations (and the standard errors) of the closed systems reported here as a function of the initial soil mass to plant biomass ratios. The carbon dioxide concentrations plotted are from the last six weeks of closure from each experiment. An analysis of covariance indicated that both large and small closed systems did not differ in their response to the soil mass plant biomass ratio. Further, we found that we could explain 77% of the variance in carbon dioxide concentrations with the soil mass to plant biomass ratios.

Can small closed ecological systems be used as analogs for the functioning of Earth's biosphere? We have shown that small closed systems behave in a regular and predictable manner. In addition, we have shown that they behave in ways very similar to Earth's biosphere and its component

systems. The primary difference between these systems and Earth's biosphere is the greatly reduced diversity in biogeochemical pathways and the smaller reservoir sizes. We believe, however, that small closed systems are representative of the important biogeochemical pathways of the terrestrial component of Earth's biosphere and as such can be utilized to examine the atmosphere-plant-soil interactions. The advantage of these small systems is their rapid equilibration rate after perturbation. Experimental studies cannot be done on Earth's biosphere in a reasonable time span. Experimental studies of small closed ecological systems can be undertaken relatively inexpensively and quickly.

What can small closed ecological systems teach us about bioregenerative life support systems? While the systems developed to date do not directly simulate bioregenerative life support systems, they do incorporate the major biological units which will make up research colonies located on other planets. Thus, we feel, by studying the behavior of these and other systems constructed using a variety of different biological and technological entities, we can begin to understand the atmospheric dynamics and the biogeochemical cycles of closed systems which will be constructed to support man's endeavors in space.

Conclusions

The CO₂ dynamics in both large and small closed ecological systems show very similar patterns. Both large (*Figure 14*) and small closed systems show regular diurnal fluctuations (*Figure 13*). Earth's biosphere shows similar patterns of variation in carbon dioxide levels. Within intact ecosystems it has been seen that carbon dioxide concentrations will show a diurnal pattern similar to what we have observed (Galoux, et. al., 1973; Keeling, 1961; Odum and Jordan, 1970; Reicosky, 1989; Schnell, et. al., 1981; Wofsy, et. al., 1988). In addition, both large and small systems show similar sensitivity and response to variations in light level as does Earth's component ecosystems (Grulke, et. al., 1990; Idso and Baker, 1968). Lastly we have shown that metrics with predictive value can be derived from the study of closed ecological systems.

References

- Folsome, C. E. and Hanson, J. A. 1986. The Emergence of Materially-closed-system Ecology. In: *Ecosystem Theory and Applications*, N. Polunin, ed. John Wiley & Sons.
- Frye, R. J. and Hodges, C. N. 1989. Soil Bed Reactor Work of the Environmental Research Lab of the University of Arizona in Support of the Research and Development of Biosphere 2. In: *Biological Life Support Technologies: Commercial Opportunities*. NASA Conf. Publ. 3094. Pp 33-40.
- Galoux, A., Benecke, P., Gietl, G., Hager, H., Kayser, C., Kiese, O., Knoerr, K., Murphy, C., Schnock, G., Sinclair, T. 1973. Radiation, Heat, Water, and Carbon Dioxide Balances. In: *Dynamic Properties of Forest Ecosystems*, Reichle, D. E., ed. Cambridge Univ. Press, Cambridge.
- Grulke, N. E., Riechers, G. H., Oechel, W. C., Hjelm, W. C., Jaeger, C. 1990. Carbon balance in tussock tundra under ambient and elevated atmospheric CO₂. *Oecologia* 83:485-494.
- Idso, S. B., Baker, D. G. 1968. The naturally varying energy environment and its effect on photosynthesis. *Ecology* 49:311-316.
- Kearns, E. A. 1983. *Efficiency of Energy Utilization in Thermodynamically Closed Ecosystems*. Unpubl. PhD. Diss., Univ. Hawaii, Honolulu, Hawaii. 139 pages.

- Kearns, E. A. and Folsom, C. E. 1981. Measurement of Biological Activity in Materially Closed Microbial Ecosystems. *BioSystems* 14:205 - 209.
- Kearns, E. A. and Folsom, C. E. 1982. *Closed Microbial Ecosystems as Gas Exchange Units in CELSS*. SAE Technical Paper Series 820857.
- Keeling, C. D. 1961. The Concentration and Isotopic Abundance of Carbon Dioxide in Rural and Marine Air. *Geochim. Cosmochim. Acta* 24:277-298.
- Nelson, M. T., L. Leigh, A. Ailing, T. McCallum, J. Allen, N. Alvarez-Romo. 1992. Biosphere 2 Test Module: A Ground-Based Sunlight-Driven Prototype of a Closed Ecological Life Support System. *Adv. Space Res.* 12:151-156.
- Obenhuber, D. 1985. *Carbon Cycling as a Measure of Biological Activity in Closed Ecological Systems*. Unpubl. PhD. Diss., University of Hawaii, Honolulu, Hawaii. 125 pages.
- Obenhuber, D. C. and Folsome, C. 1984. Eucaryote/Procaryote Ratio as an Indicator of Stability for Closed Ecological Systems. *BioSystems* 16:291-296.
- Obenhuber, D. C. and Folsome, C. 1988. Carbon Recycling in Materially Closed Ecological Life Support Systems. *BioSystems* 21:165-173.
- Odum, H. T., Jordan, C. F. 1970. Metabolism and evapotranspiration of the lower forest in a giant plastic cylinder. In: *A Tropical Rainforest*, Odum, H. T., Pigeon, R. F., eds. NTIS TID-24270.
- Schnell, R. C., Odh, S. A., and Njau, L. N. 1981. Carbon Dioxide Measurements in Tropical East African Biomes. *J. Geophys. Res.* 86:5364-5372.
- Reicosky, D. C. 1989. Diurnal and Seasonal Trends in Carbon Dioxide Concentrations in Corn and Soybean Canopies as Affected by Tillage and Irrigation. *Agric. Forest Meteor.* 48:285-303.
- Wofsy, S. C., Harriss, R. C., Kaplan, W. A. 1988. Carbon Dioxide in the Atmosphere Over the Amazon Basin. *J. Geophys. Res.* 93:1377-1387.

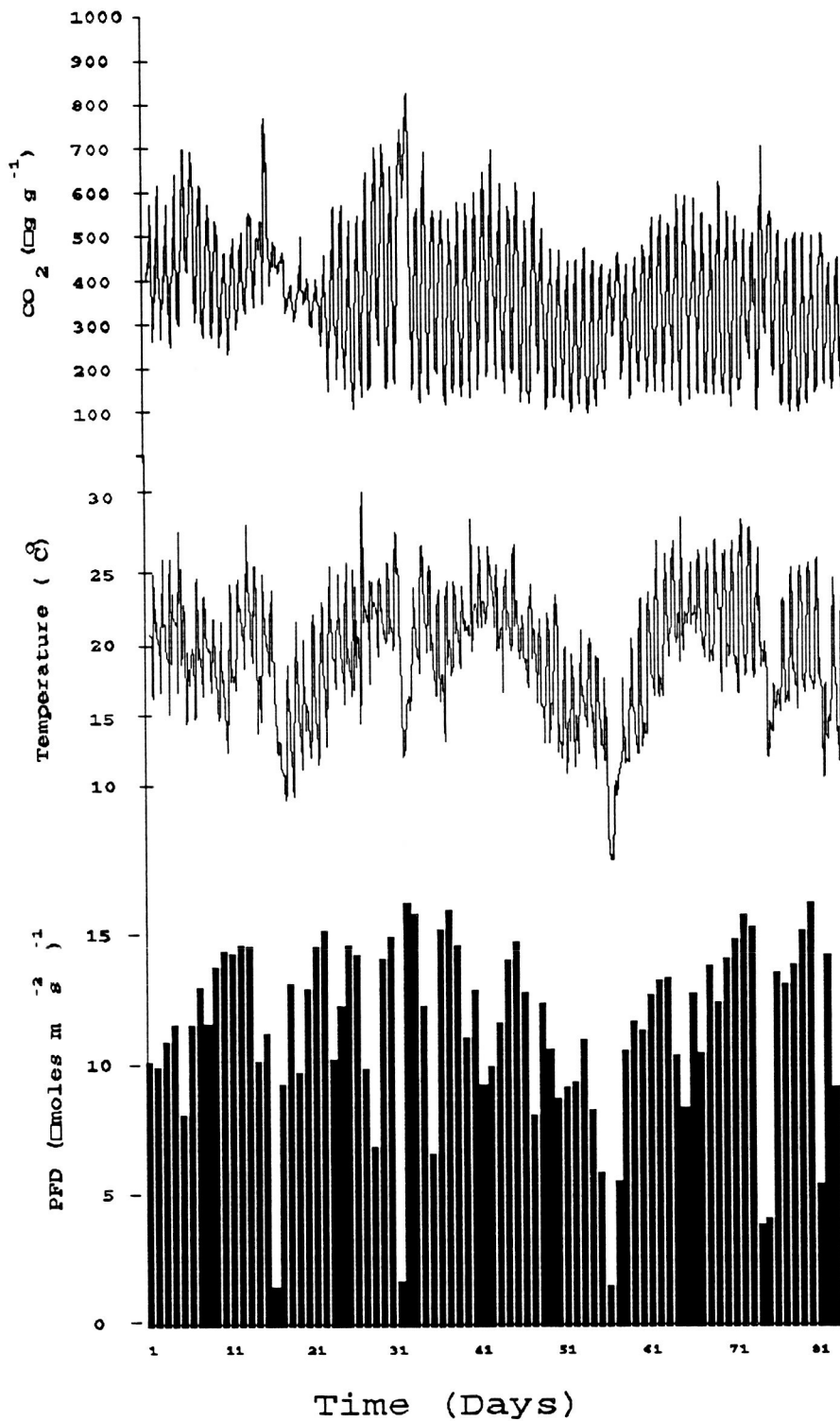

Figure 1. Hourly CO₂, Temperature, and Photon Flux Density for Large C.E.S. Experiment #1.

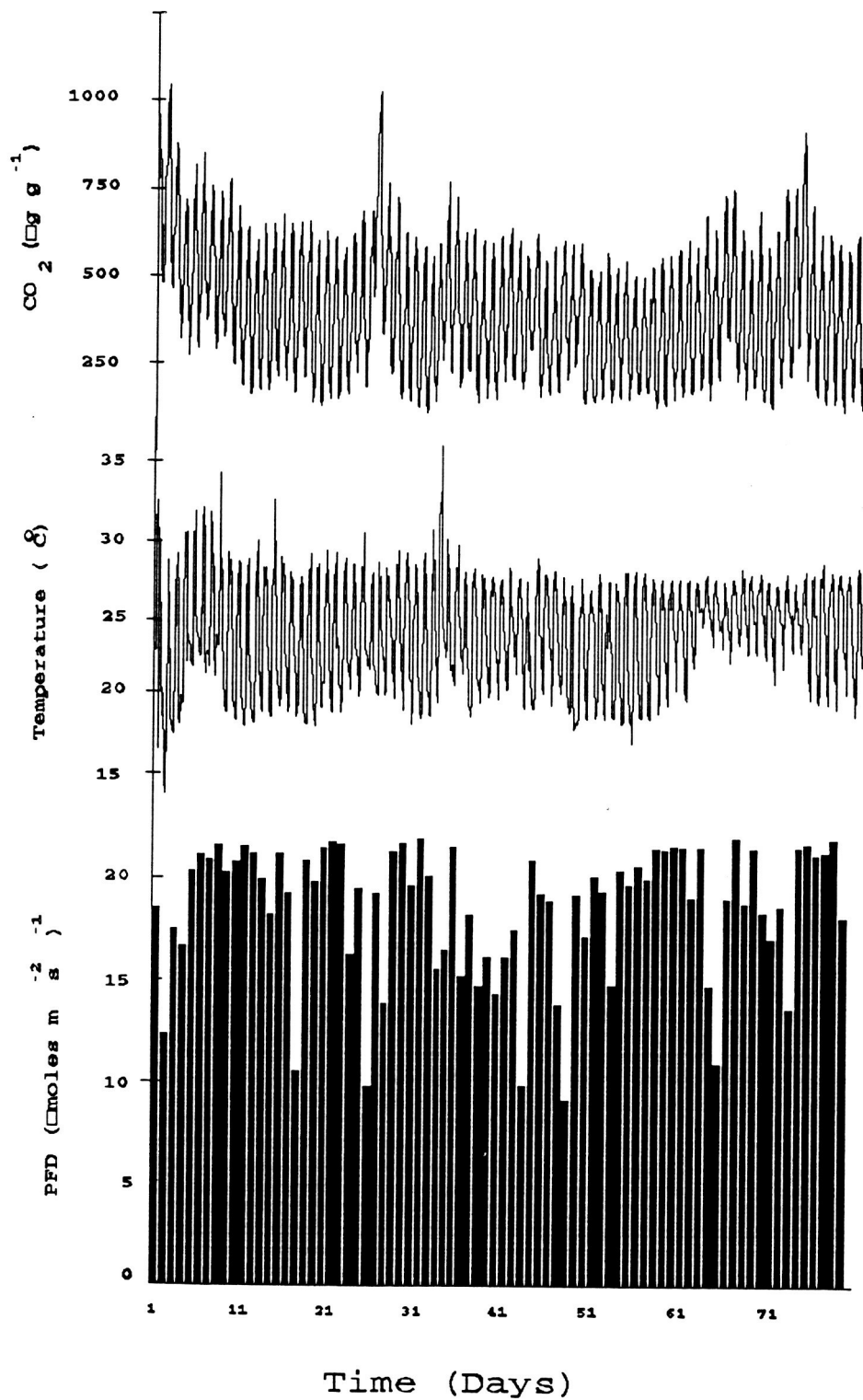

Figure 2. Hourly CO₂, Temperature, and Photon Flux Density for Large C.E.S. Experiment #2.

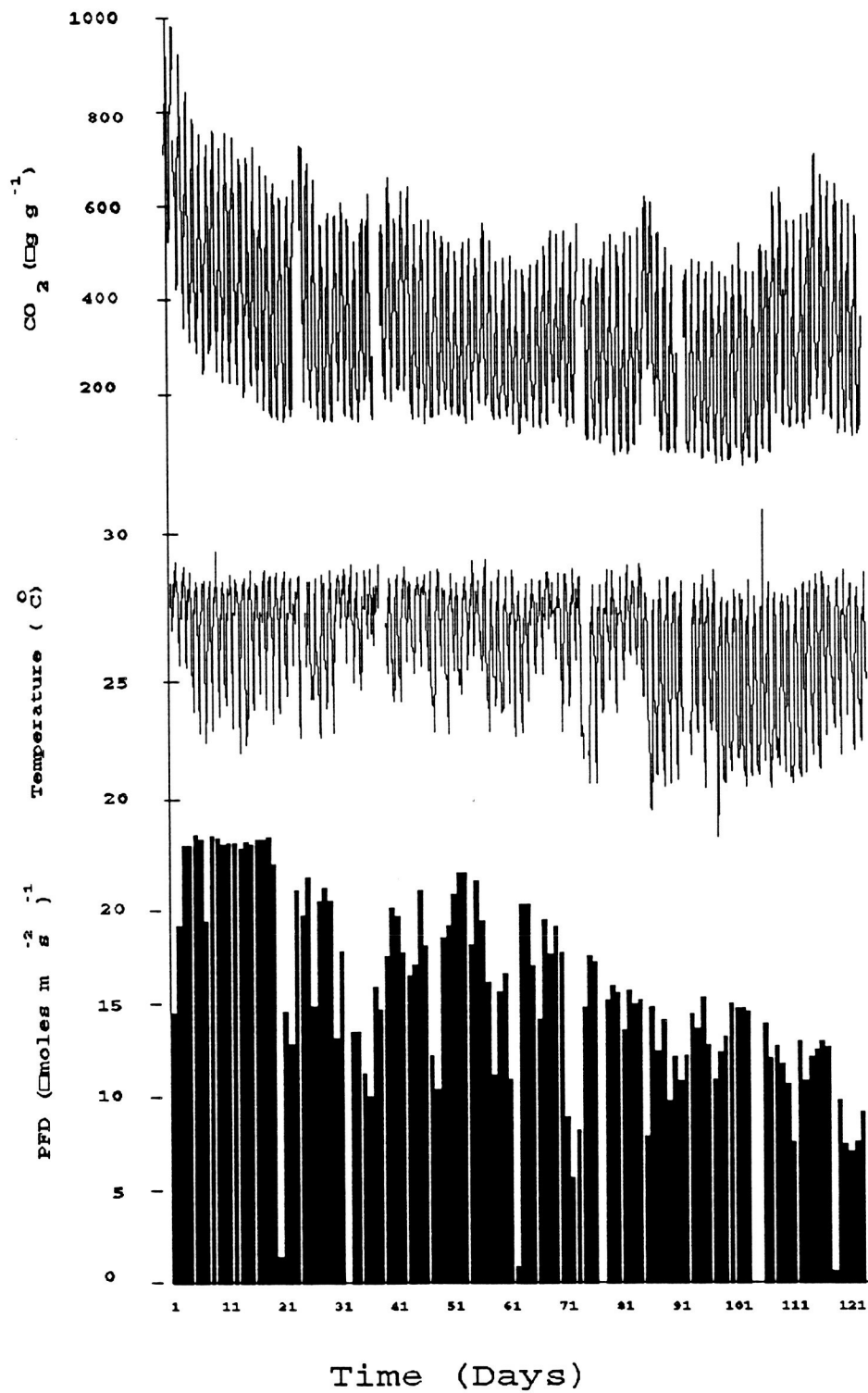

Figure 3. Hourly CO₂, Temperature, and Photon Flux Density for Large C.E.S. Experiment 3.

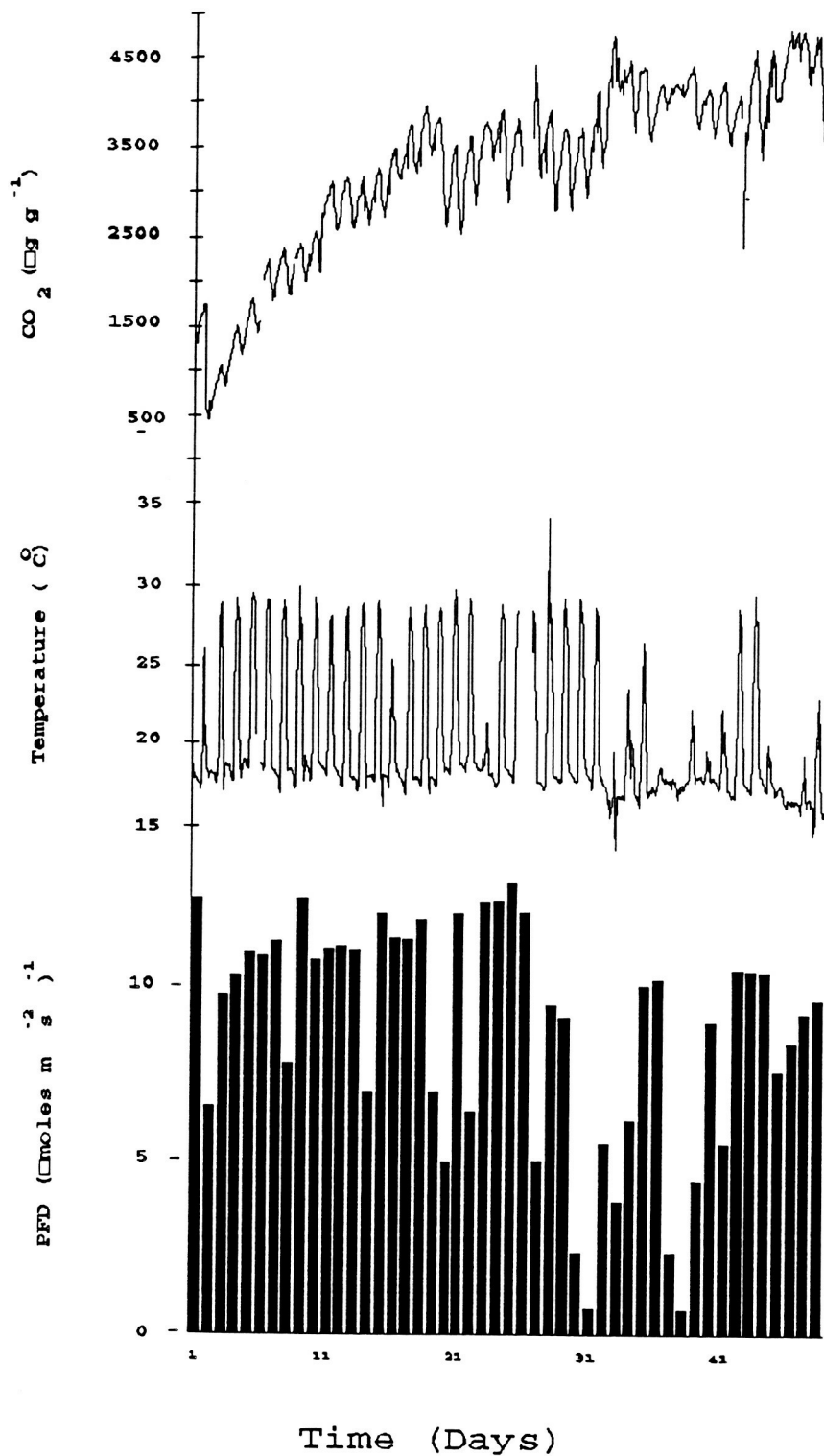

Figure 4. Hourly CO₂, Temperature, and Photon Flux Density for Large C.E.S. Experiment #4.

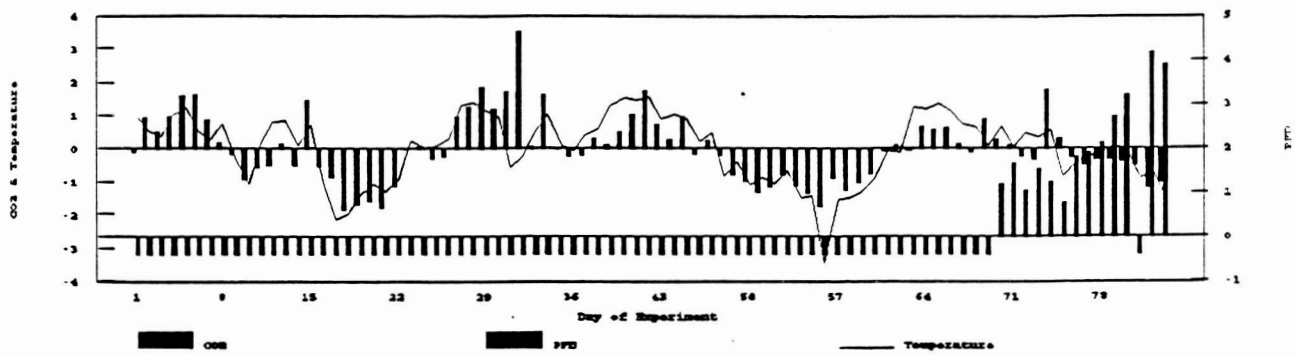

Figure 5. Standardized Normal Variables of CO₂, Temperature, and Photon Flux Density for Large C.E.S. Experiment #1.

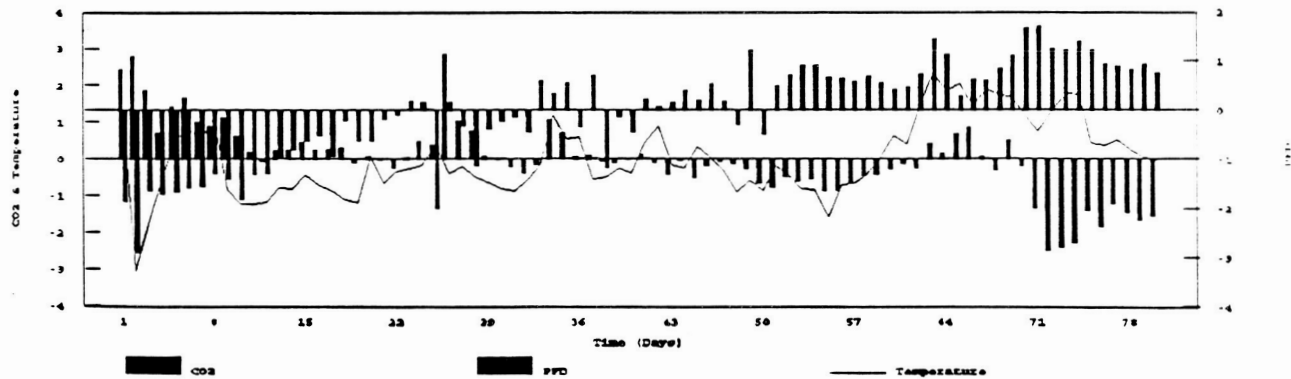

Figure 6. Standardized Normal Variables of CO₂, Temperature, and Photon Flux Density for Large C.E.S. Experiment #2.

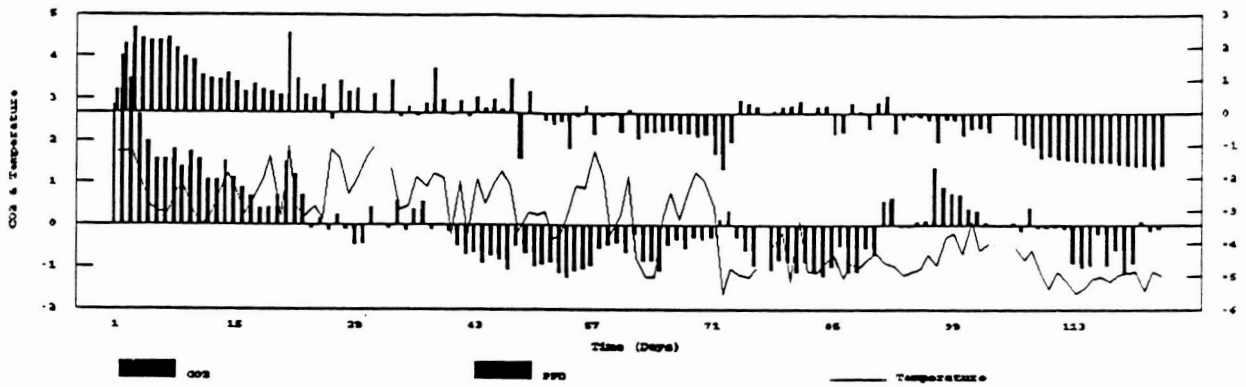

Figure 7. Standardized Normal Variables of CO₂, Temperature, and Photon Flux Density for Large C.E.S. Experiment #3.

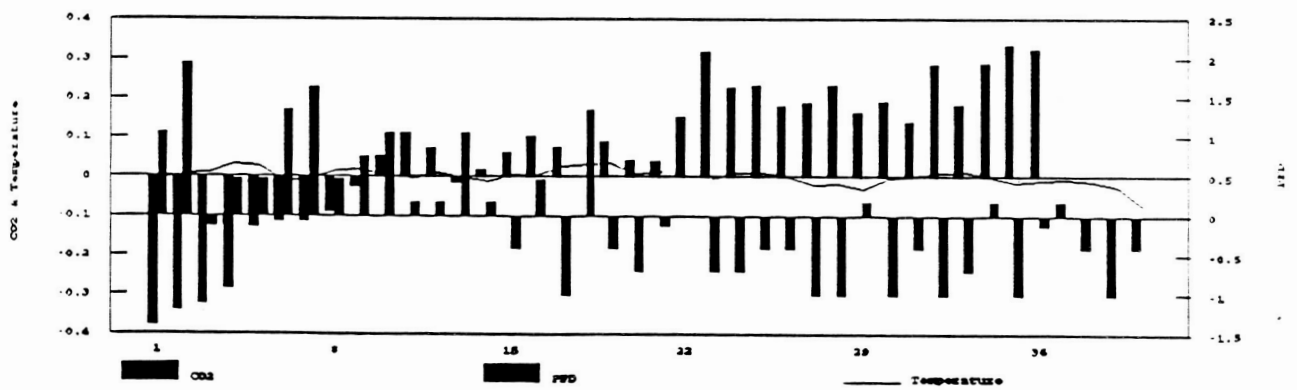

Figure 8. Standardized Normal Variables of CO₂, Temperature, and Photon Flux Density for Large C.E.S. Experiment #4.

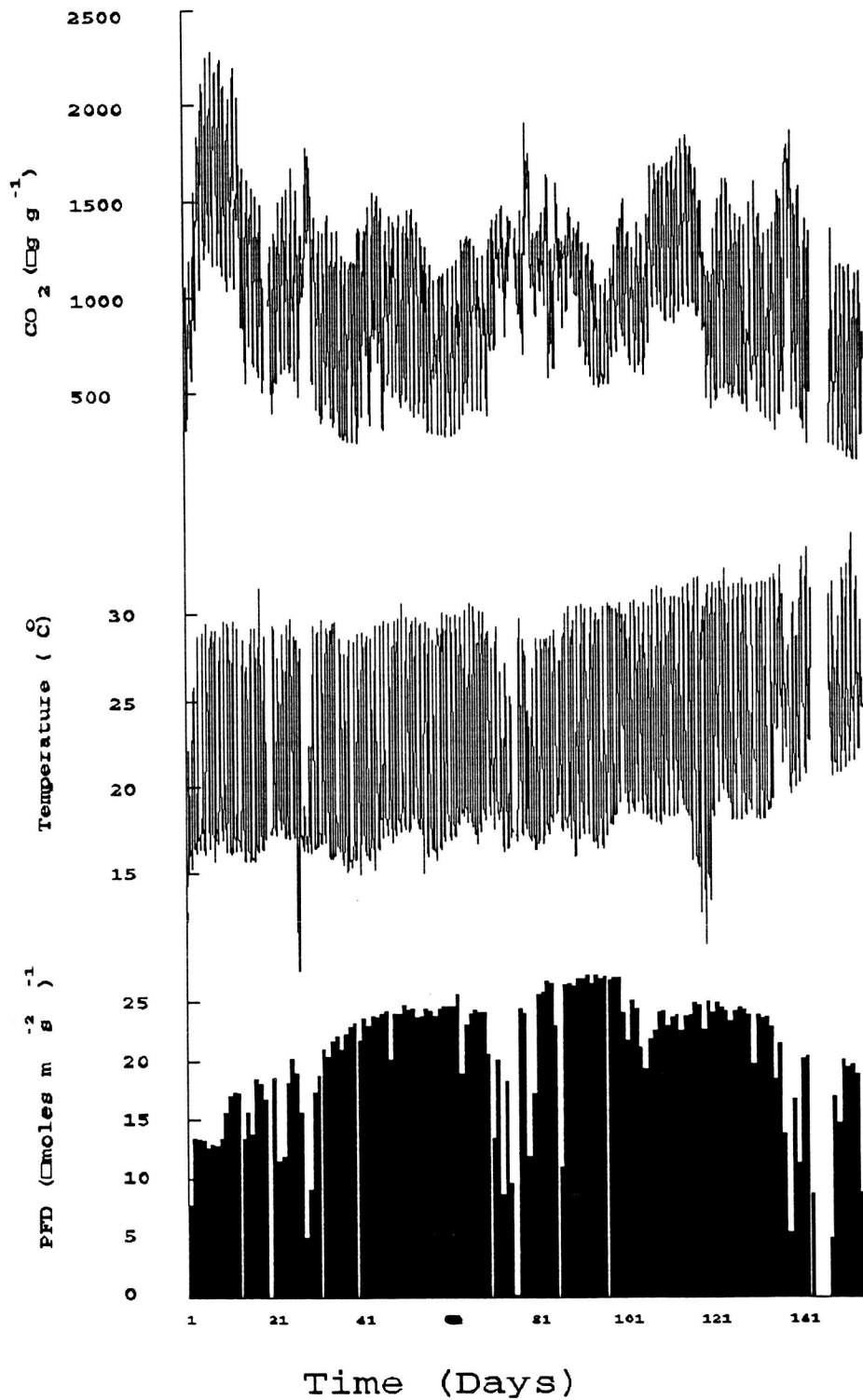

Figure 9. Hourly CO₂, Temperature and Photon Flux Density for Large C.E.S. Experiment #5.

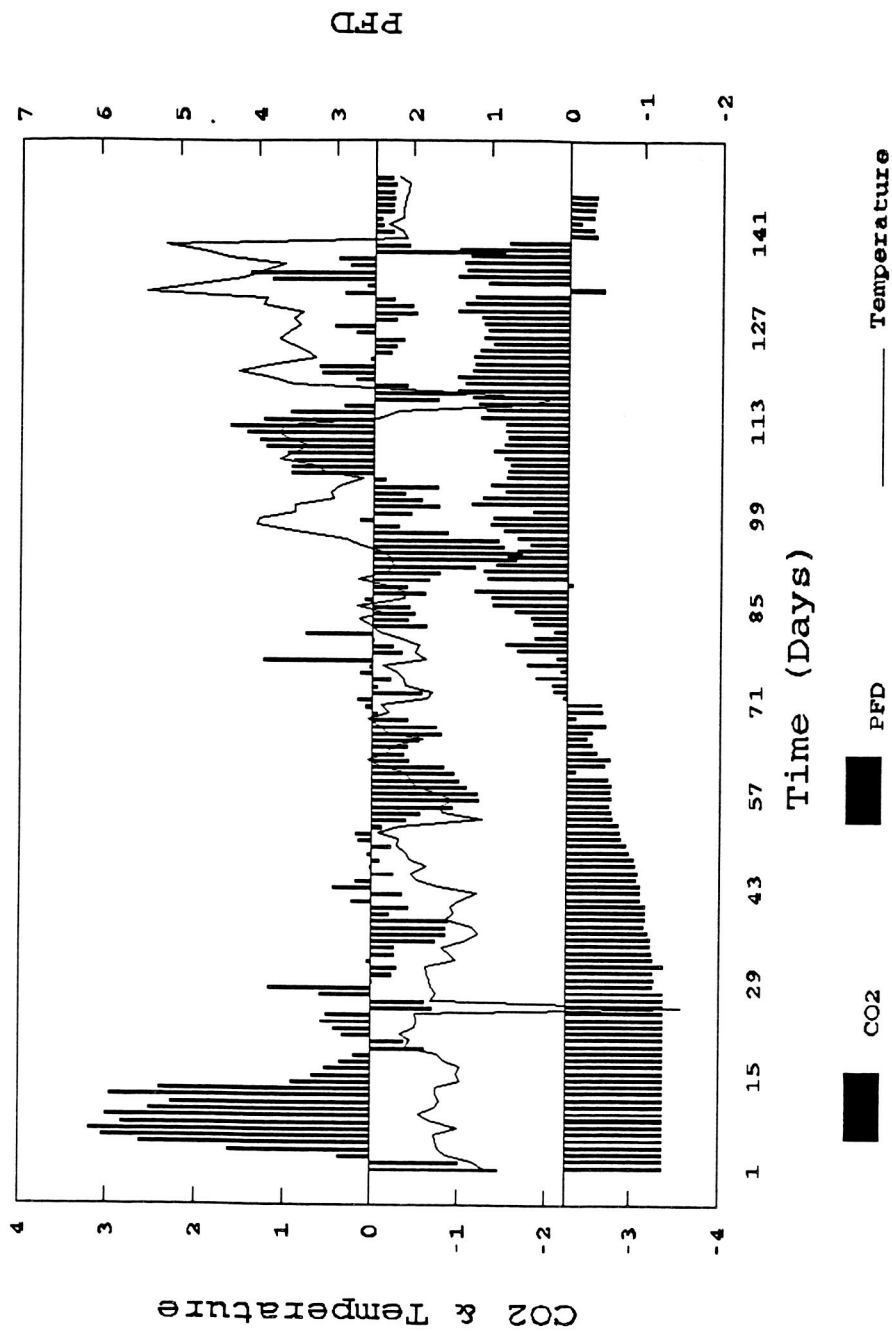
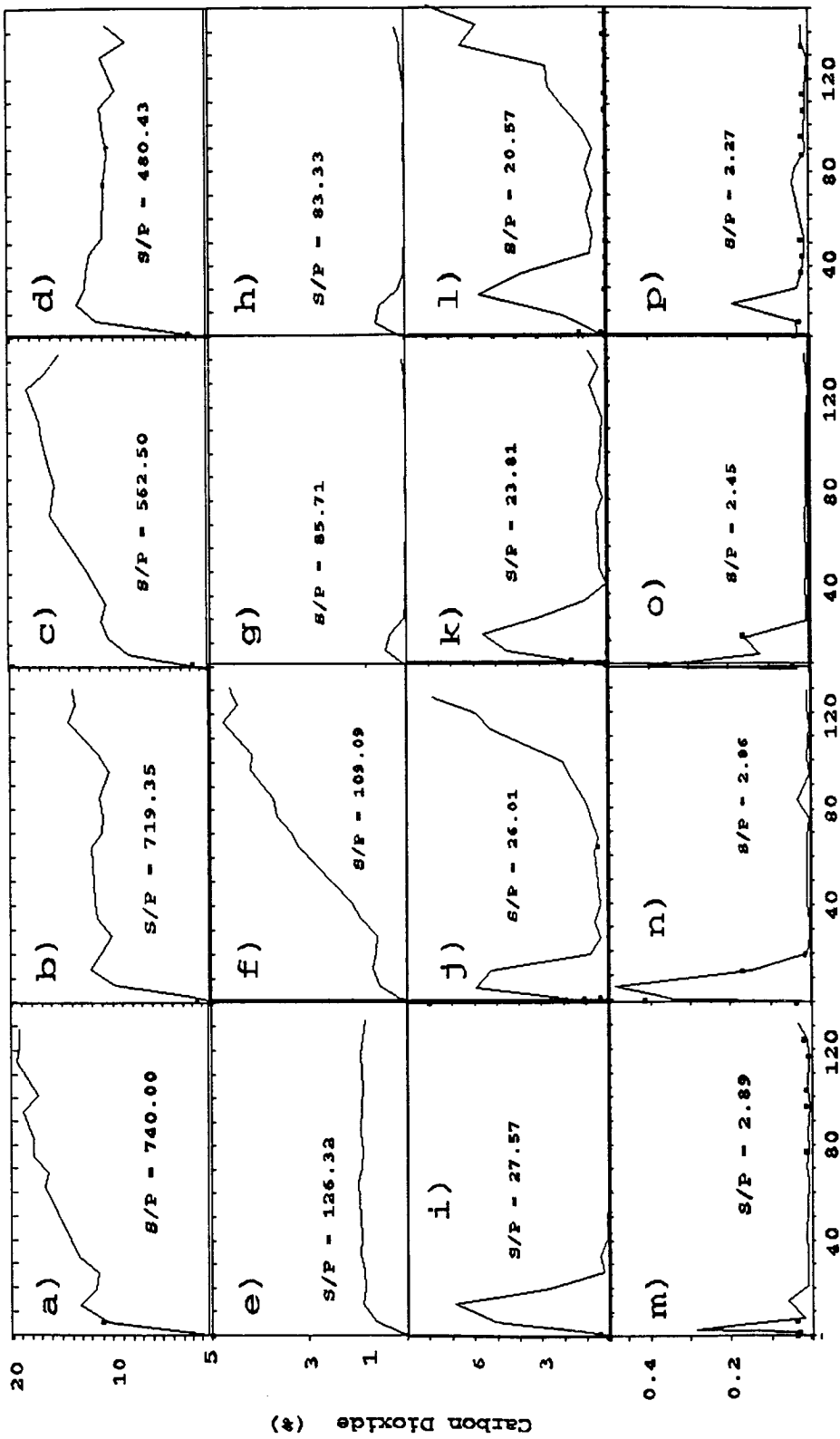

Figure 10. Standardized Normal Variables of CO₂, Temperature, Photon Flux Density for Large C.E.S. Experiment #5.



Days Closed

Figure 11. CO₂ Concentrations in Sixteen Small C.E.S.

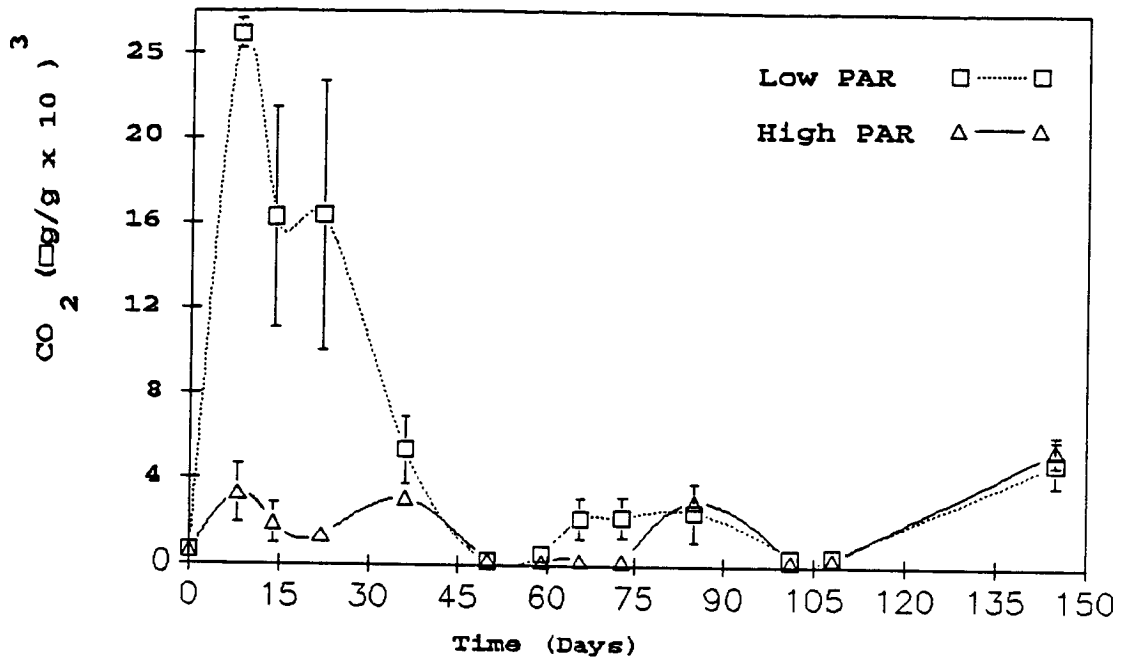

Figure 12. Effect of Photon Flux Density on CO₂ Concentrations in Small C.E.S.

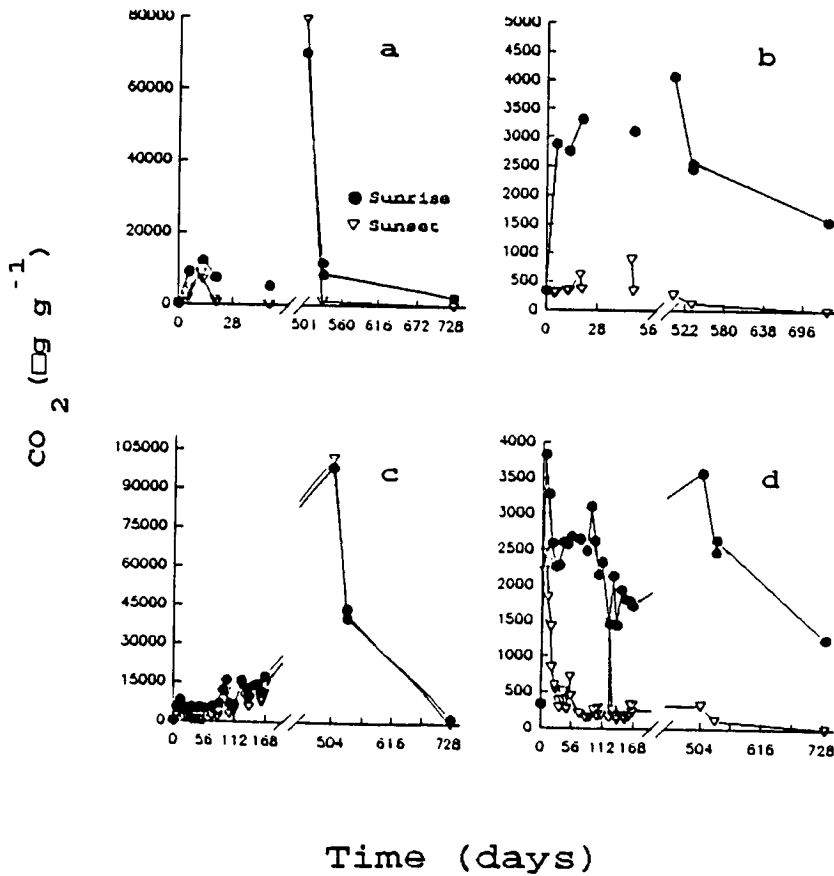

Figure 13. CO₂ Concentrations of Four Small C.E.S.

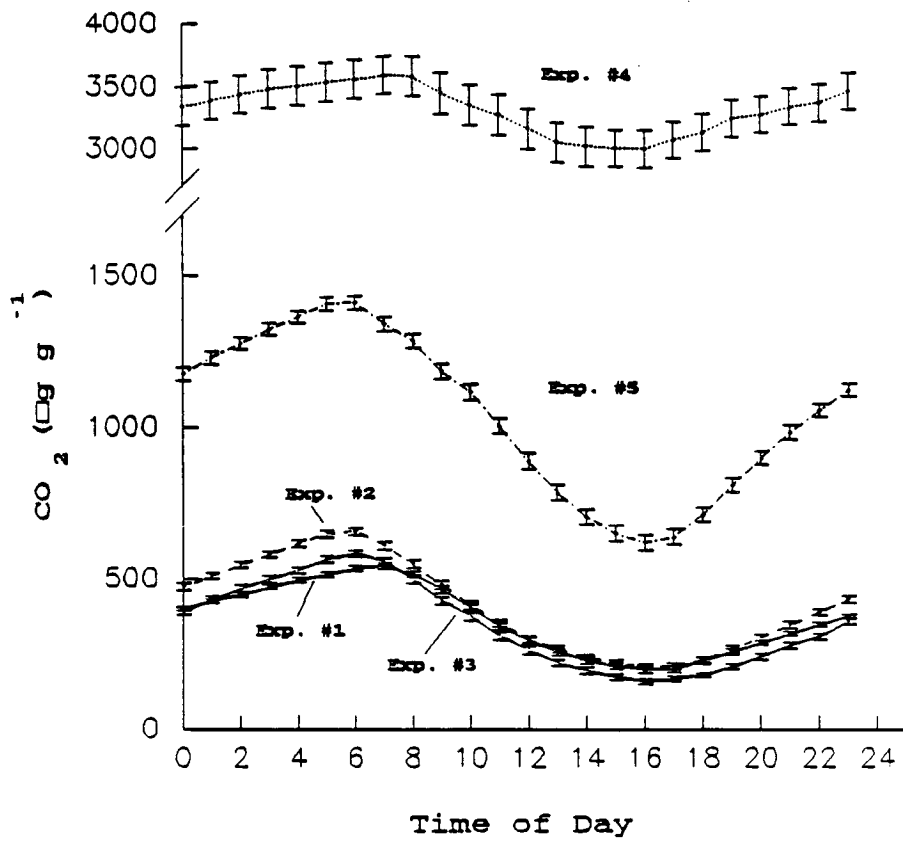

Figure 14. Mean Diurnal CO₂ Concentrations for the Five Large C.E.S. Experiments.

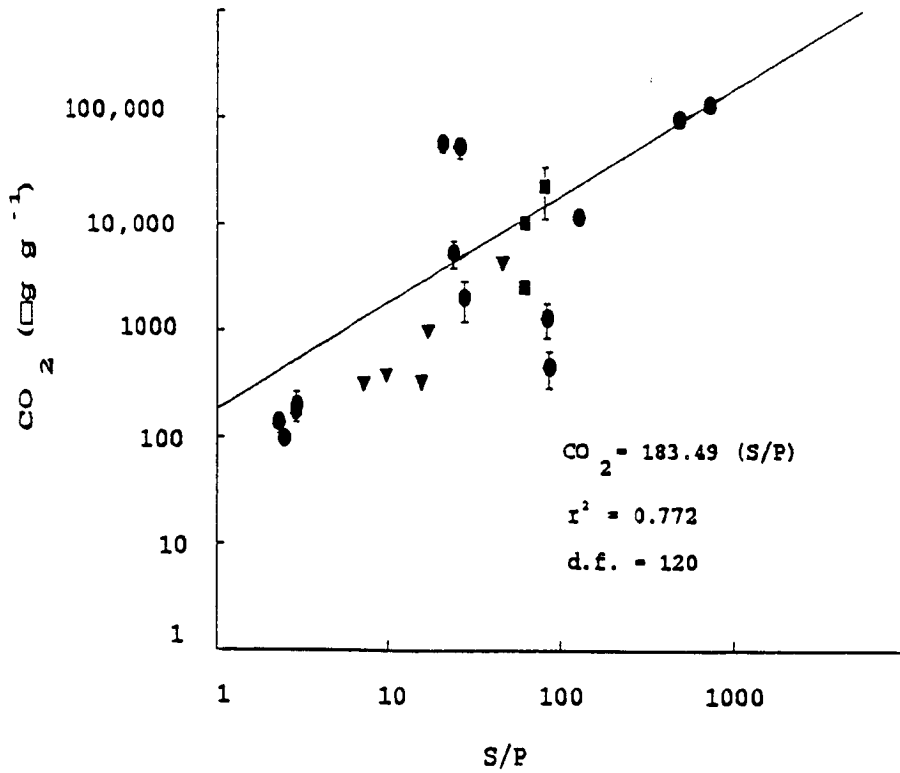

Figure 15. Final CO₂ Concentrations of C.E.S. as a Function of Initial Soil Mass to Plant Biomass Ratios.

N 9 3 - 2 7 9 7 7

SPE® WATER ELECTROLYZERS IN SUPPORT OF THE LUNAR OUTPOST

J.F. McElroy

Hamilton Standard Division, United Technologies Corporation

521-54

158335

P. 20

Abstract

During the 1970s, the SPE water electrolyzer, which uses ion exchange membranes as its sole electrolyte, was developed for nuclear submarine metabolic oxygen production. These developments included SPE water electrolyzer operation at up to 3,000 psia and at current densities in excess of 1,000 amps per square foot. The SPE water electrolyzer system is now fully qualified for both the U.S. and U.K. Navies with tens of thousands of system hours accumulated at sea.

During the 1980s, the basic SPE water electrolyzer cell structure developed for the Navies was incorporated into several demonstrations for NASA's Space Station Program. Among these were:

- The SPE regenerative fuel cell for electrical energy storage
- The SPE water electrolyzer for metabolic oxygen production
- The high pressure SPE water electrolyzer for reboost propulsion reactant production

In the 1990s, one emphasis will be the development of SPE water electrolyzers for the Lunar Outpost. Currently defined potential Lunar Outpost applications for the SPE water electrolyzer include:

- SPE water electrolyzers for metabolic oxygen and potable water production from reclaimed water
- SPE water electrolyzers operating at high pressure as part of stationary and mobile surface energy storage systems

SPE® is a Registered Trademark of Hamilton Standard Division, United Technologies Corporation.

SPE WATER ELECTROLYSIS TECHNOLOGY OVERVIEW

The heart of the SPE water electrolyzer is the electrolysis cell which consists of an ion exchange membrane with Teflon bonded, finely divided metal electrodes. Figure 1 shows this arrangement along with the water electrolysis reactions. Since the fixed acid ion exchange membrane has neither a traditional bubble point nor free electrolyte, operating pressures and hydrogen-oxygen differentials are limited only by the surrounding structures. This affords a significant safety factor in maintaining positive separation of the hydrogen and oxygen products.

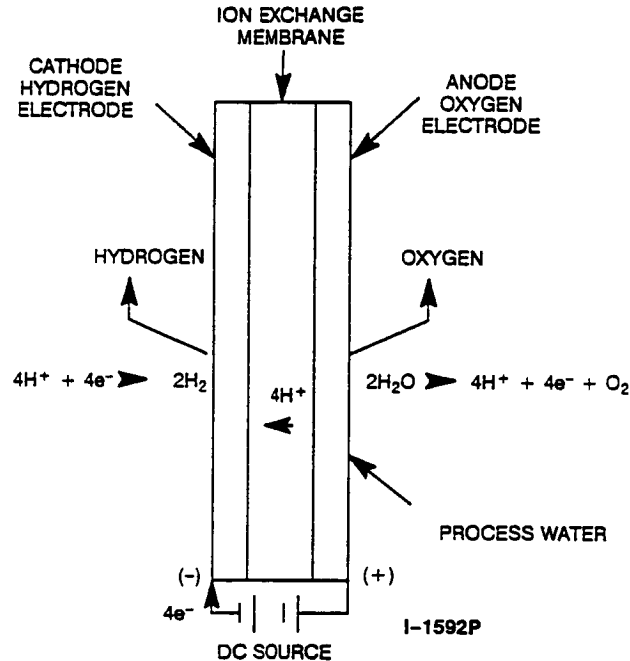

FIGURE 1. SPE WATER ELECTROLYZER REACTIONS

The introduction of the perfluorocarbon cation exchange membrane in the late 1960's enabled the development of the SPE electrolyzer. In prior years, water electrolyzers made with existing ion exchange membranes had useful lifetimes of only a few hundred hours. With the use of perfluorocarbon ion exchange membranes, the SPE water electrolyzer cell life has been demonstrated to be in excess of 13 years and projected to over 30 years depending on operating conditions. Figure 2 displays the longest lifetime SPE water electrolyzer cell at its 100,000 hour milestone in 1989. This cell and two others have now accumulated in excess of 110,000 operational hours without disassembly or modification. These three cells continue to accumulate additional operational hours.

In most practical applications, a number of cells are stacked in a filter press arrangement with as many as 100 or more cells electrically connected in series while the fluids are passed through the cells in parallel. Figure 3 displays a pair of SPE water electrolyzers, each with 81 cells, in a filter press arrangement. Without any free electrolyte, the parallel fluid flows can be conducted without fear of shunt currents inducing stray water electrolysis and its potentially deleterious result of product gas mixing. The purity of the product gases from SPE water electrolyzers is typically greater than 99.99%.

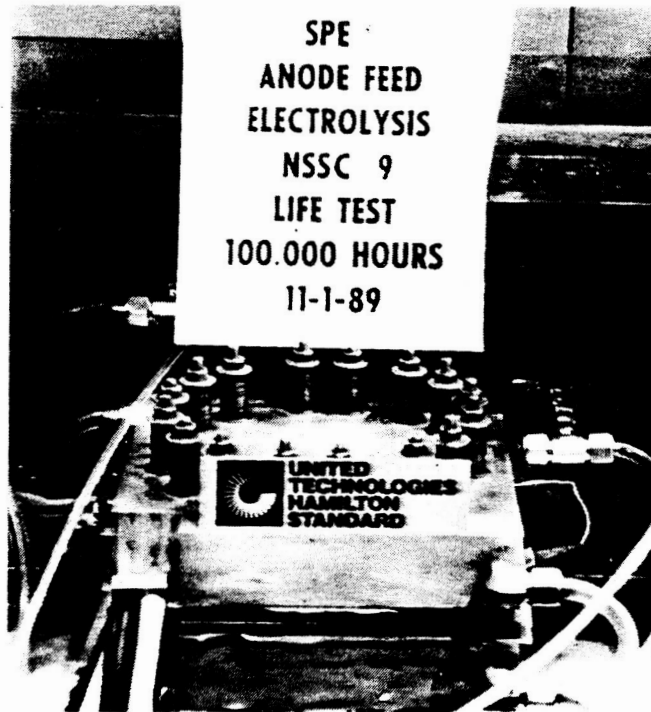

FIGURE 2. SPE ELECTROLYZER LIFE TEST

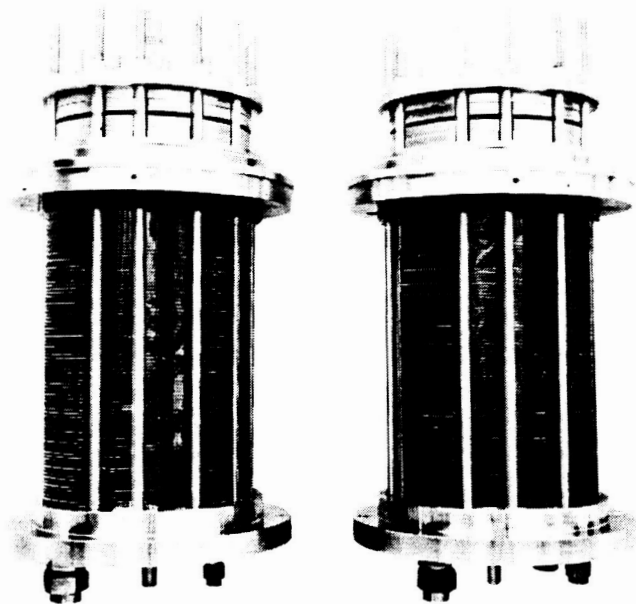

FIGURE 3. SPE WATER ELECTROLYZER MODULES

NUCLEAR SUBMARINE OXYGEN GENERATORS

Both the U.S. Navy and U.K. Royal Navy have sponsored the development of SPE water electrolyzers for oxygen generation in nuclear submarines. In the case of the U.K. Royal Navy, the SPE water electrolyzer system is fully qualified with more than 35 systems delivered to date. The SPE water electrolyzer module equipment is supplied by Hamilton Standard and the supporting system equipment supplied by CJB Developments of Portsmouth, England. The modules previously shown in Figure 3 are the type used in the U.K. Royal Navy system and the overall oxygen generation system itself is depicted in Figure 4. The operational experience of the SPE water electrolyzer has been exceptional with over 69,500 operational system hours without a single malfunction. The longest operational service for any single 150 psia SPE electrolyzer module is 13,900 hours as of December 31, 1991.

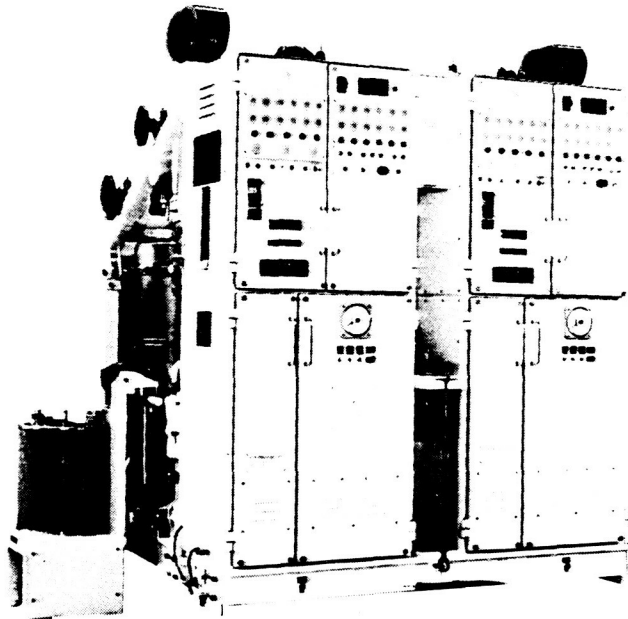

FIGURE 4. A DUPLEX LOW PRESSURE ELECTROLYZER (LPS)

The U.S. Navy SPE water electrolyzer system, which operates at pressures up to 3000 psia, has passed all qualification testing, including shock, vibration and sea trials. The U.S. Navy SPE water electrolyzer modules and overall oxygen generation plant are shown in Figures 5 and 6 respectively.

During the course of developing the two Naval oxygen generation systems and the subsequent operation in the U.K. Royal Navy, over 10 million cell hours have been accumulated on the basic 0.23 ft² cell design. This high level of maturity is further described in Table 1.

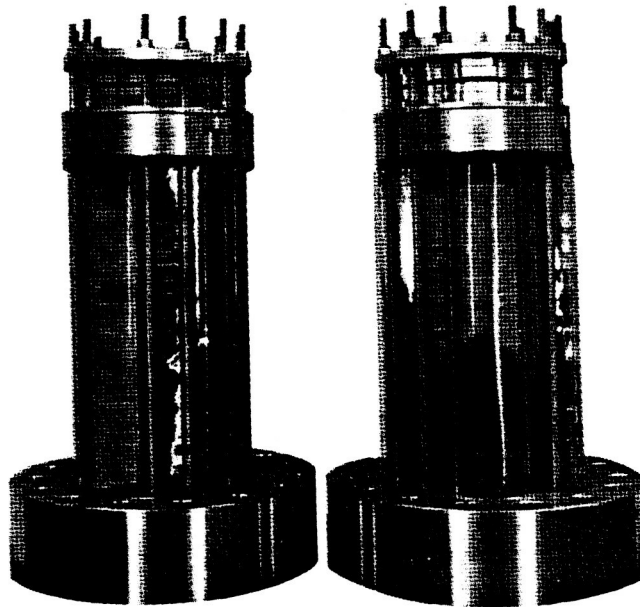

FIGURE 5. 225 SCFH U.S. NAVY SPE OXYGEN GENERATOR MODULES

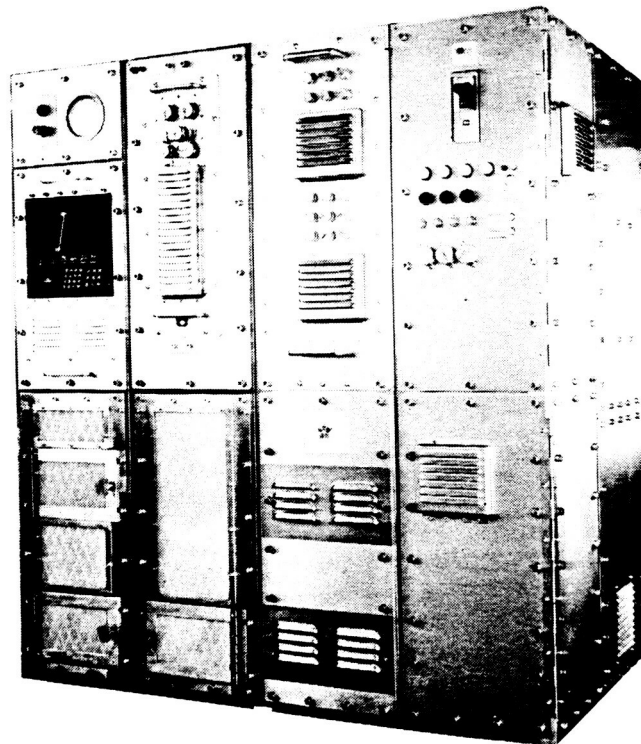

FIGURE 6. HIGH PRESSURE OXYGEN GENERATING PLANT (OGP) FOR NAVAL USE

TABLE 1
DEMONSTRATED MATURITY-NUCLEAR SUBMARINE SPE WATER ELECTROLYZERS
AS OF DECEMBER 31, 1991

Type of Service/ Product Description Navy Electrolyzers	Electrolysis Rate lbs/hr H ₂ O	Cell Area ft ²	Operating Pressure PSI	Number of Stacks	Number of Cells Per Stack	Total Number of Cells	System Hours	Stack Hours	Cell Hours
U.S. Navy:									
3000 psi System Qualification Unit (OGP #2)	21	0.23	300 to 3000	2	100	200	6,325	6,325	632,500
3000 psi System Preprototype (OGP #1)	21	0.23	300 to 3000	2	100/83	183	10,000	13,000	1,181,000
Development System (Breadboard)	21	0.23	300 to 3000	2	100	200	14,000	28,000	2,800,000
Development Stack OGP Program	1	0.23	300 to 3000	1	5	5	1,900	1,900	9,500
Development Stack OGP Program	2	0.23	300 to 3000	1	10	10	1,500	1,500	15,000
Development Stack OGP Program	4	0.23	300 to 3000	1	20	20	2,500	2,500	50,000
Development Stack OGP Program	7.4	0.23	300 to 3000	1	35	35	3,900	3,900	136,500
Development Stack NSSC 4	0.2	0.23	ambient	1	1	1	115,600	115,600	115,600
Development Stack NSSC 7	0.2	0.23	ambient	1	1	1	111,600	111,600	111,600
Development Stack NSSC 9	0.2	0.23	ambient	1	1	1	116,900	116,900	116,900
United Kingdom Navy									
Development Stack S/N #1	12.5	0.23	150	1	58	58	3,000	3,000	174,000
Development Stack S/N #2	15	0.23	150	1	70	70	6,000	6,000	420,000
Production Stacks:									
Various Production	15 to 17	0.23	150	38	70 or 81	2,850	69,500	69,500	5,212,500
Longest Life UK Stack	15 to 17	0.23	150	1	81	81	13,900	13,900	1,125,900
TOTAL				53		3,474	462,725	478,725	10,975,100

With over 10 million cell hours of successful operation, the SPE 0.23 ft² cell design is well established.

SPACE STATION DEMONSTRATORS

During the decade of the eighties, a series of demonstrators were fashioned, delivered and tested at NASA. Each of these demonstrators made use of the identical 0.23 ft² SPE water electrolyzer design with its naval maturity.

SPE Regenerative Fuel Cell

The SPE regenerative fuel cell for electrical energy storage was the first of the demonstrators to be delivered to NASA in support of Space Station Freedom. Figure 7 shows the three subsystems making up the demonstrator as follows:

- SPE fuel cell subsystem
- SPE water electrolyzer subsystem
- Microprocessor controller

The SPE fuel cell module consists of eight cells, each of an active area of 1.1 ft². The SPE water electrolyzer module contains 22 cells, each of the 0.23 ft² design.

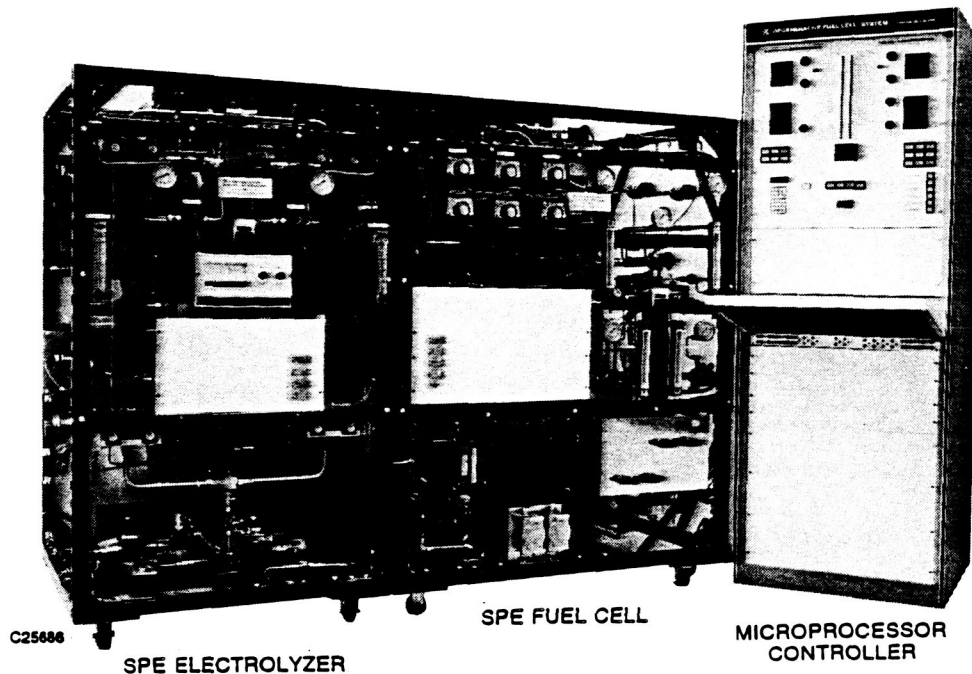

FIGURE 7. SPE REGENERATIVE FUEL CELL DEMONSTRATOR

The SPE regenerative fuel cell demonstrator, with its 1 to 2 kW rating, underwent parametric testing at the factory prior to its delivery to NASA/JSC. NASA/JSC conducted extensive testing of the system accumulating 1,630 simulated low earth orbit charge/discharge cycles [1]. Including the pre-delivery factory cycles, over 2,000 cycles were accumulated on the combined SPE water electrolyzer and SPE fuel cell.

Other demonstrated features included:

- Closed system fluid cycle balance
- Direct solar array/electrolyzer voltage/current control compatibility (i.e., no power conditioning required)
- An electric energy storage efficiency of 48% recorded with the SPE water electrolyzer at ambient temperature.

At the successful conclusion of the SPE regenerative fuel cell demonstration, the SPE fuel cell was replaced with a Space Shuttle alkaline development fuel cell subsystem. This hybrid of alkaline fuel cell and acid SPE water electrolyzer was operated by NASA through an additional 100 low earth orbit charge/discharge cycles [2]. Both subsystems displayed stable performance throughout the 100 cycles and proved the compatibility of the hybrid approach.

Following the 100 cycle hybrid testing, the SPE water electrolyzer module was retrofitted with two high performance cells using a membrane manufactured by Dow Chemical. After the factory modifications, the SPE water electrolyzer module with 20 standard 0.23 ft² cells and the two high performance 0.23 ft² cells underwent parametric testing at NASA/JSC [3]. The testing at various temperatures and pressures showed a significant performance improvement with the Dow membrane cells, especially at the higher current densities. The curves in Figure 8 are typical of the improvement.

The most recent activity with the SPE water electrolyzer subsystem was to upgrade the electronic controls. Checkout of the subsystem with the new controls was shown to be nominal. Following the checkout, the SPE water electrolyzer subsystem was loaned to the University of Arizona. At the university the subsystem is currently being used as a demonstrator for valuable gas production from extraterrestrial resources.

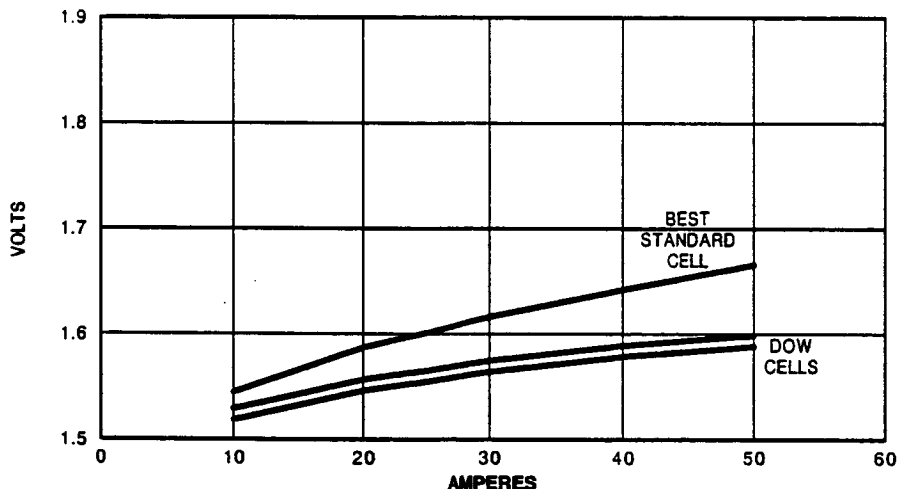

FIGURE 8. COMPARISON OF CELLS AT 150 PSI AND 105°F

SPE Metabolic Oxygen Generator

Under contract to the Boeing Aerospace and Electronics Company, an oxygen generator assembly technology demonstrator was constructed and is being evaluated. The heart of the oxygen generator is a 12 cell SPE water electrolyzer module of the identical 0.23 ft² SPE cell configuration used on the Navy programs. Figure 9 displays the oxygen generator assembly technology demonstrator with its SPE electrolyzer module. The operating pressure, temperature and current density of the technology demonstrator are well within the technology maturity established by the Navy experiences. Where this technology demonstrator differs from the Navy data base is in the need to operate in a microgravity environment and to use processed hygiene water as the feedstock.

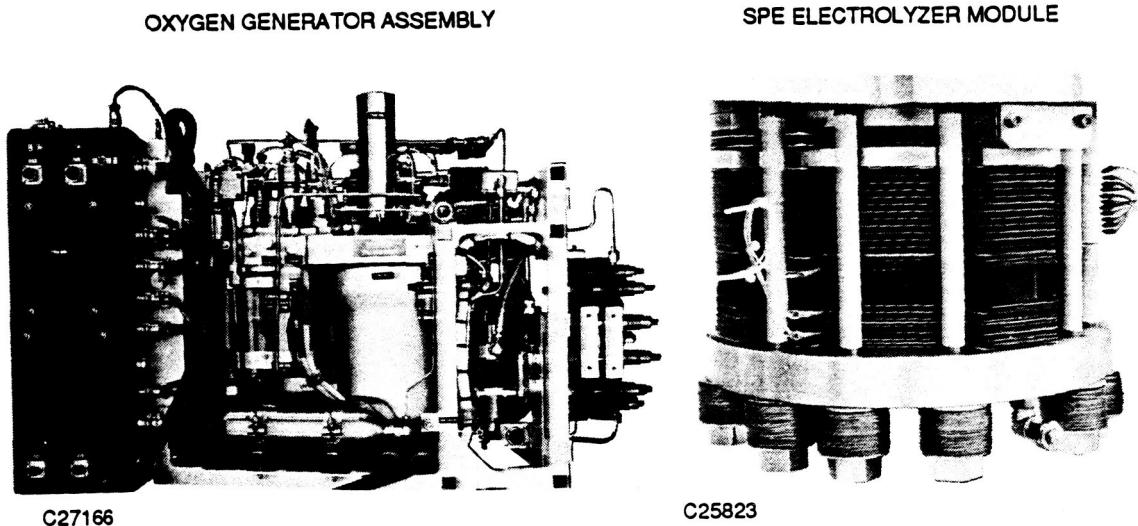
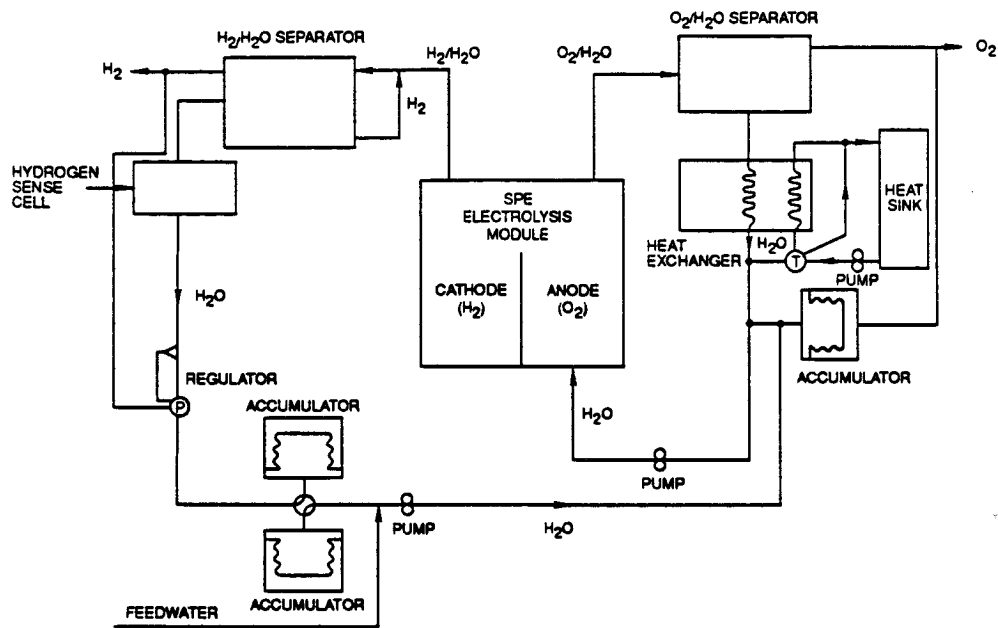

FIGURE 9. OXYGEN GENERATOR ASSEMBLY TECHNOLOGY DEMONSTRATOR

In the normal operation of the SPE water electrolyzer, liquid water is circulated through the oxygen anode. This loop requires a phase separator as an oxygen/water mix is discharged from the module. Also, as hydrogen protons pass through the cell membranes, water is carried to the hydrogen cathode and thus a phase separator for hydrogen/water is required.

In the microgravity situation, the functions of gravity type pressure vessel phase separators must be accomplished by other means in order to make use of the high performance SPE water electrolyzer. Prior designs have performed the microgravity function of the one gravity pressure vessel phase separator with a combination of bellows accumulators and motor driven centrifugal devices. Although this arrangement has been used successfully, the drawbacks include lower reliability and higher power consumption. The approach taken in the Boeing Technology Demonstrator utilizes two membrane static phase separators to replace the pressure vessel phase separators. This arrangement is displayed in Figure 10.



MFC743.020

**FIGURE 10. SIMPLIFIED MICROGRAVITY FLUID SCHEMATIC
(SPE ELECTROLYZER SYSTEM)**

Three basic types of membranes are used in the construction of the membrane phase separators:

- **Hydrophillic Membrane** - This membrane easily passes liquid water with a small differential pressure but blocks the passage of gas up to the bubble point of the membrane.
- **Hydrophobic Membrane** - This membrane easily passes gas with a small differential pressure but blocks the passage of liquid water up to the water intrusion pressure of the membrane.
- **Ion Exchange Membrane** - an ion exchange membrane with attached electrodes is a very efficient hydrogen separator/compressor for removing dissolved hydrogen from water. With an applied voltage of between 0.5 and 1.0 volt, hydrogen is rapidly transferred through the membrane at a rate proportional to the electrical current draw.

The Technology Demonstrator was activated at NASA/MSFC in November 1990 and, in operating for 529 hours, exceeded the test objective of 450 hours. The water electrolysis was conducted at an eight-man rate, with both deionized water and shower water processed through an ultrafiltration/reverse osmosis subsystem. Throughout the operation of the Technology Demonstrator, the microgravity phase separators worked in a very satisfactory manner. After a year of storage, the technology demonstrator was reactivated for checkout purposes. All system components, including the electrolysis module and phase separators, performed at the prestorage level.

SPE Propellant Generator

Under contract to NASA/JSC, a 3,000 psi hydrogen-oxygen generator based on the Naval 0.23 ft² SPE water electrolyzer cell configuration was designed and delivered. The purpose was to demonstrate the feasibility of producing 3,000 psi hydrogen and oxygen on orbit for periodic rocket motor firing to maintain Space Station Freedom orbital altitude.

In high pressure SPE electrolyzers, a pressure vessel is used to enclose the module. Filling this pressure vessel with high pressure nitrogen precludes the necessity of designing cell seals to withstand the high pressure differential.

To reduce the mass and decrease the volume, as compared to the U.S. Navy design, several configuration changes were made to the supporting pressure vessel and fluid manifold. The resultant SPE propellant generator demonstrator is significantly smaller and lighter.

In the SPE propellant generator demonstrator, the pressure vessel is two torispherical domes opposed on either side of a central fluid plate. This configuration is shown in Figure 11. The domed design allows for a wall thickness of as low as one quarter of an inch when using Inconel or other high strength materials.

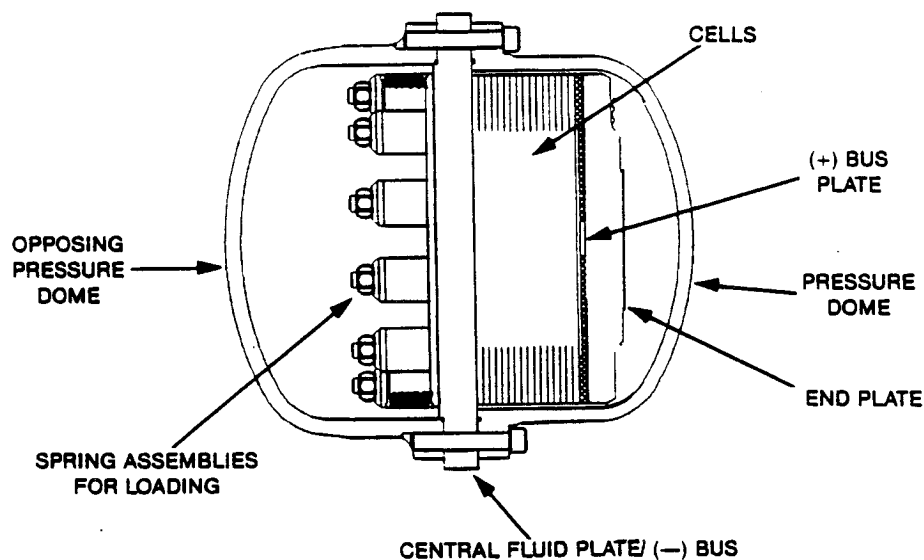

FIGURE 11. CROSS-SECTION, SPE PROPELLANT GENERATOR DEMONSTRATOR

The fluid plate manifold is pressure balanced between the two pneumatic domes, eliminating the need for a thick plate to resist the pneumatic load, as is used in the U.S. Navy hardware. The demonstrator fluid manifold is only one inch thick. In the demonstrator, the cell stack is located on one side of the fluid plate within the volume of one dome.

Compression springs are located in the volume of the opposing dome. Volume is available for incorporation of gas/water phase separators and/or other system ancillaries, allowing for additional savings in system weight and volume. In addition, the cell stack incorporated edge electrical connections to a low profile positive terminal plate instead of using a plate and post assembly for additional mass and volume savings.

The SPE propellant generator demonstrator is shown in Figures 12 and 13. The dimensions of the demonstrator are 13 inches across the domes and 13 inches in diameter at the dome flanges. The total weight of the cell stack for space station propulsion is 193 lbs or 20% of the naval version. The volume is reduced 70% from the naval stack.

The demonstrator is designed to produce 2 pph normal rate/4 pph emergency rate of propellant (i.e., oxygen and hydrogen) gas at 3000 psia, 120°F at an efficiency of greater than 70%. Performance is shown in Figure 14 for conditions of 3,100 psia and 120°F. This performance was established at the factory prior to delivery to NASA/JSC in 1990.

This demonstrator has been set up and operated intermittently at NASA/JSC over the last two years having accumulated over 850 hours of operation at 3000 psia. NASA personnel have expressed a high degree of satisfaction with the demonstrator performance.

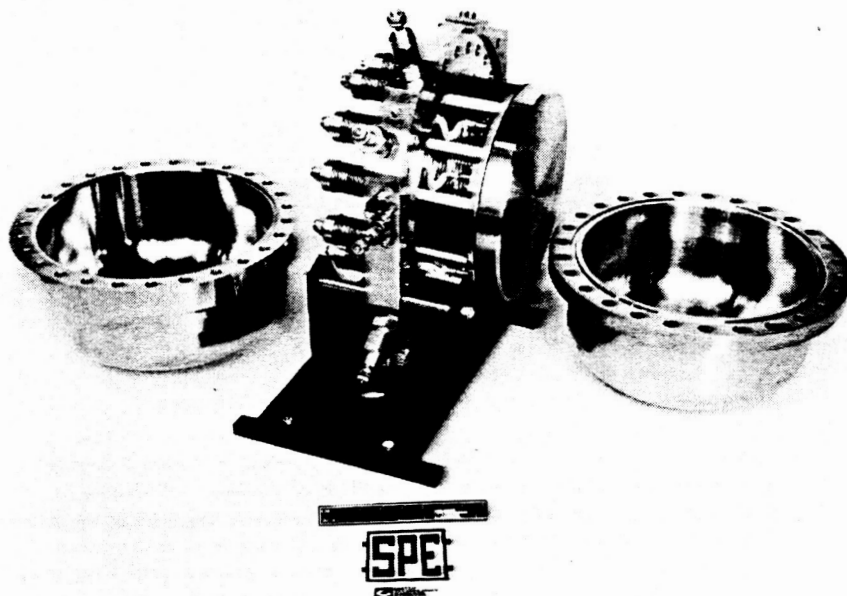

FIGURE 12. SPE PROPELLANT GENERATOR, DOMES REMOVED

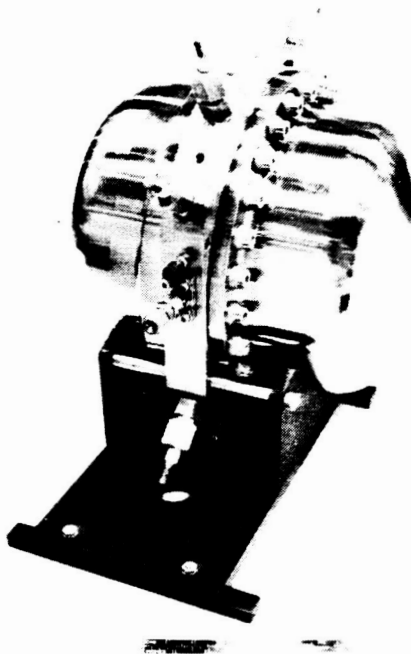

FIGURE 13. ASSEMBLED SPE PROPELLANT GENERATOR

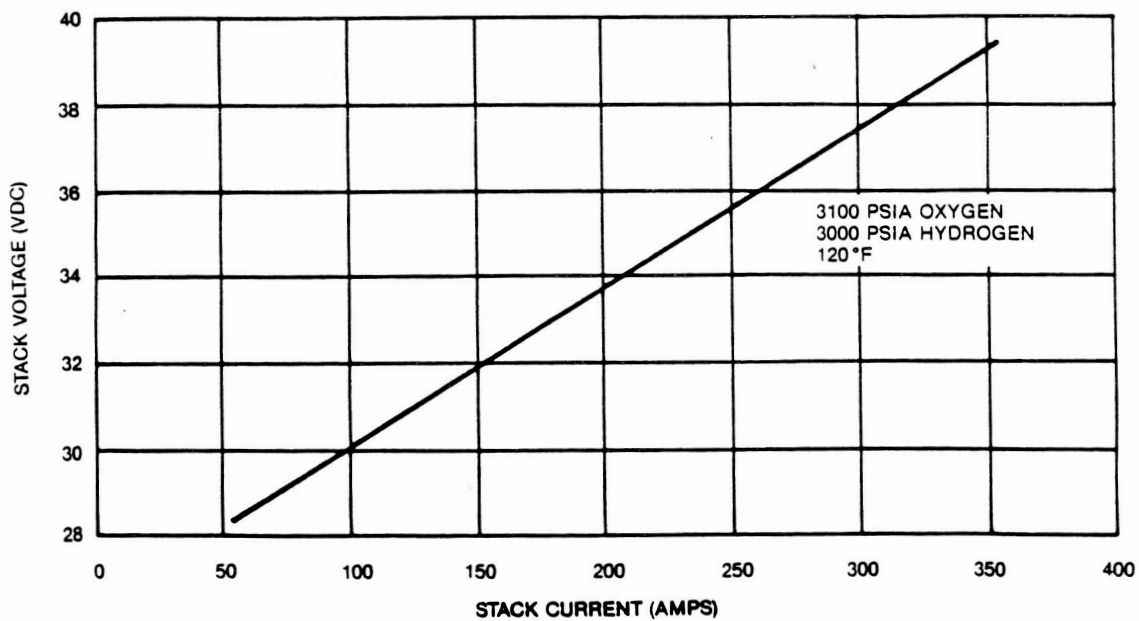

FIGURE 14. SPE PROPELLANT GENERATOR PERFORMANCE (STACK VOLTS VS. AMPS)

LUNAR OUTPOST APPLICATIONS

The technology maturity gained from the 10 million cell hours of operation of the 0.23 ft² Naval electrolysis hardware, combined with the experience obtained from the Space Station Freedom demonstrators has placed the SPE water electrolyzer in position to support the lunar outpost. Three potential applications for the SPE water electrolyzer are described in the following sections:

Metabolic Oxygen and Potable Water Production

The production of metabolic oxygen for space applications has been under investigation for a number of years. Recently, water feedstock with various organic contaminants have been tested with the SPE water electrolyzer to assess the impact on the voltage stability. In these tests, the contaminated water feedstock has been introduced into the oxygen anode chamber in the same fashion as the Naval SPE water electrolyzers.

Tests conducted on the quality of the water at various points in the system indicated that organic species were being oxidized within the oxygen chamber and that the proton pumped water was free of any detectable organics. These observations have led to the speculation that the SPE water electrolyzer can be configured to produce potable water as well as metabolic oxygen from reclaimed water. Figure 15 displays the metabolic oxygen generator schematic as modified to show delivery of potable water. The rate of protonically pumped water is such that up to eight pounds of potable water can be delivered for each pound of oxygen produced. For the Lunar outpost, a combined oxygen generator and potable water processor could have significant mass advantages.

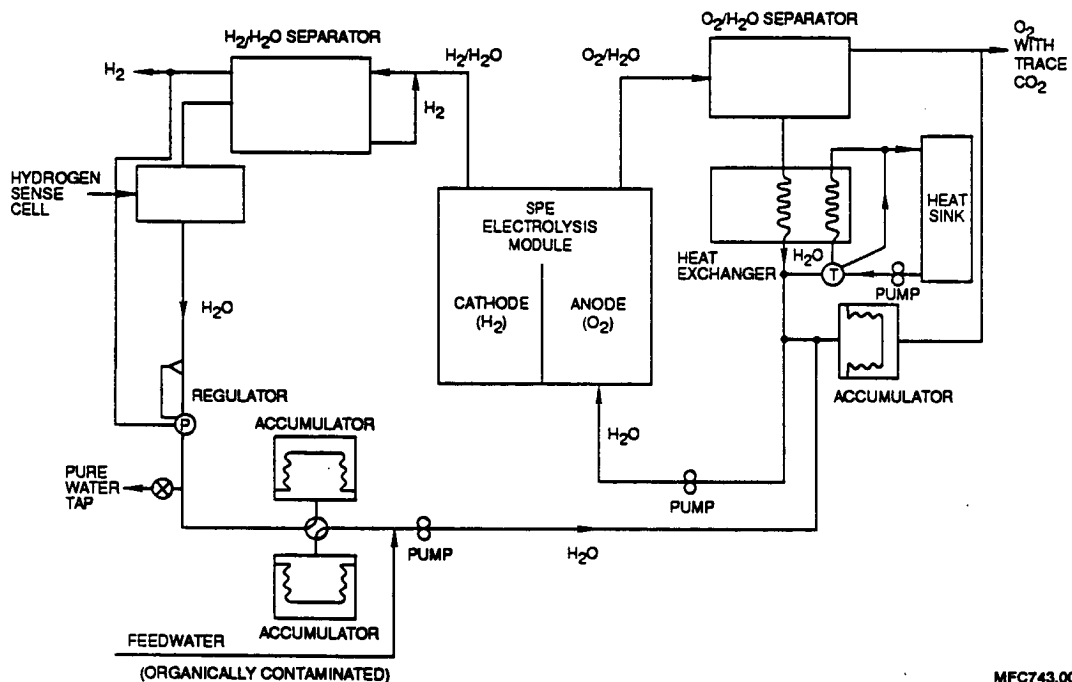

MFC743.001

FIGURE 15. METABOLIC OXYGEN/POTABLE WATER GENERATOR SCHEMATIC

Energy Storage

Recent stationary power system studies have shown that, short of nuclear power, solar energy combined with an oxygen-hydrogen regenerative fuel cell is a mission enabling and preferred technology for Lunar and Mars bases [4]. Figure 16 displays the relative mass of three leading candidates for electrical energy storage as presented by NASA Lewis Research Center. The long occult periods for the lunar outpost, 14 days, make the separation of power and energy in the oxygen-hydrogen regenerative fuel cell decisive. In Figure 17, showing an overall power plant schematic, energy storage mass is related to the tankage and stored fluids whereas the power rating mass is related to the modules and thermal management. The electrolysis and fuel cell modules can be of either the alkaline or acid type; however, the acid SPE water electrolyzer, of the Naval 0.23 ft² configuration in particular, has demonstrated the life, stability, reliability required of a lunar outpost energy storage system.

The schematic for 3000 psi SPE water electrolysis is much the same as the low pressure schematic except that the electrolyzer module is enclosed in the nitrogen filled pressure vessel. Figure 18 displays the overall SPE water electrolyzer efficiency at various temperatures. The 1000 amps per square foot (ASF) current density, which is below the Naval design point of 1300 ASF, will provide an efficiency in excess of 70% at the 20,000 hour end-of-mission point.

A fuel cell operating at 70% overall fuel cell efficiency will require approximately 21.6 pounds per hour of hydrogen-oxygen reactants in a 1 to 8 weight ratio to produce 25 kW direct current. If one assumes an equal charge discharge time for the lunar outpost application, the electrolyzer will have to convert a maximum of 21.6 pound per hour of water into hydrogen and oxygen. The mass of the SPE water electrolyzer subsystem with 138 cells would be about 200 kg using the proven cell structure with DuPont's Nafion® 120 ion exchange membrane. Figure 19 shows that a decreased mass can be obtained by the use of higher performance membranes and/or advanced cell structures. However, the low mass is gained at the expense of design maturity.

A single SPE water electrolyzer subsystem would probably not be considered because of reliability aspects. Over a five-year period, the loss of a pump or gas regulator is predicted. These difficulties can be overcome by redundancy within the subsystem at a small weight penalty. Reliability is further enhanced by having multiple SPE water electrolyzer subsystems. Preliminary estimates show that three subsystems, each with selected component redundancies, would be highly reliable for a multiple year mission.

A second lunar outpost energy storage application for the SPE water electrolyzer involves mobile power. A payload unloader, a mining excavator/loader and a regolith hauler have all been identified as potential applications for the oxygen-hydrogen regenerative fuel cell (see Figure 20). Two basic charging approaches have the water electrolyzer subsystems located either at a central fixed refueling station, or on-board the individual vehicles.

TECHNOLOGY IMPACTS
25kW SURFACE POWER SYSTEM

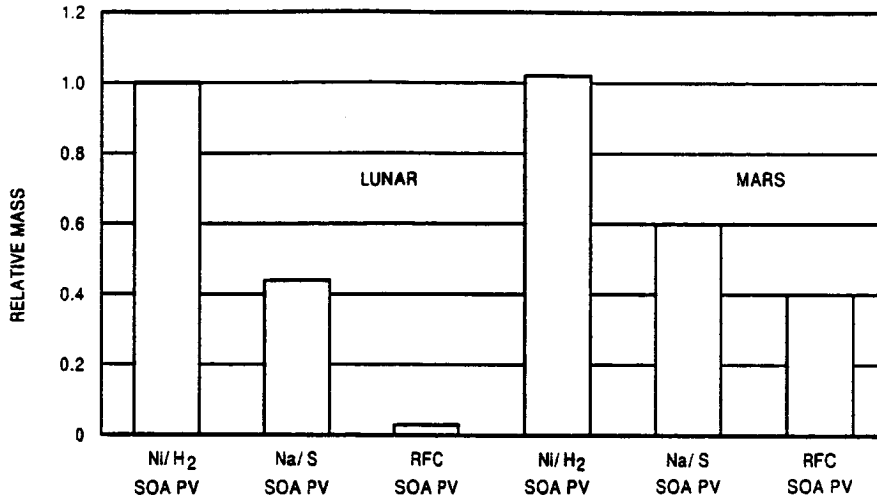

FIGURE 16. RELATIVE MASS OF ENERGY STORAGE TECHNOLOGIES

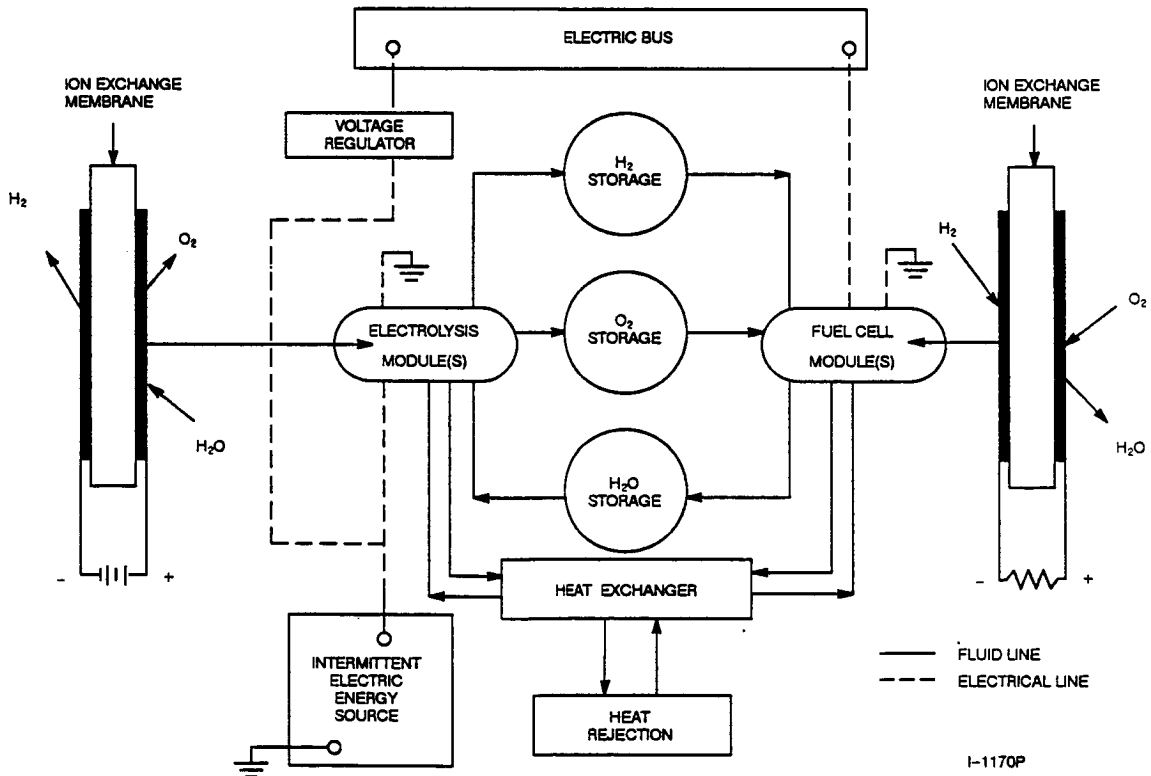

FIGURE 17. POWER PLANT FUEL SCHEMATIC INCLUDING HYDROGEN/OXYGEN REGENERATIVE FUEL CELL ENERGY STORAGE SYSTEM

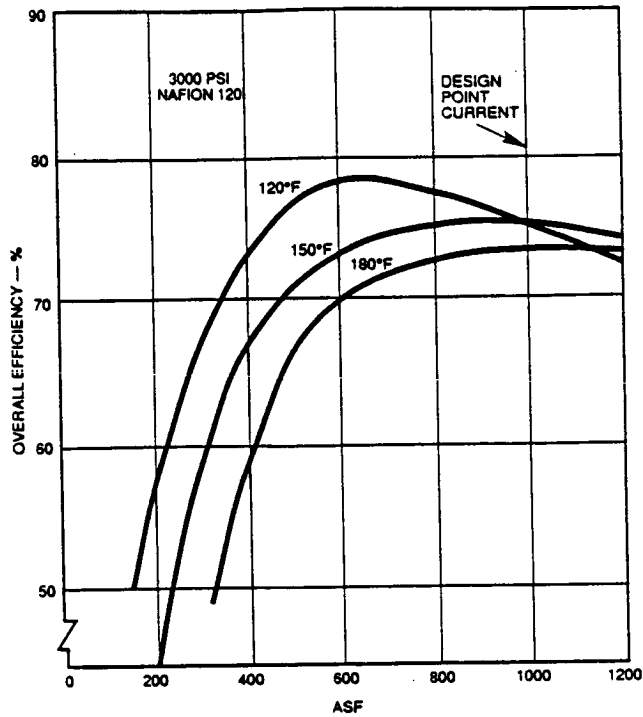

FIGURE 18. OVERALL SPE WATER ELECTROLYZER EFFICIENCY AT 3000 PSI

ELECTROLYZER SUBSYSTEM DESCRIPTION	NAFION 120 MEMBRANE		NAFION 125/117 MEMBRANE		ADVANCED MEMBRANE	
	LBS	KG	LBS	KG	LBS	KG
"STATE OF THE ART" WITH STATIC SEPARATORS	439	200	383	165	324	147
ADVANCED DESIGN WITH STATIC SEPARATORS	347	158	316	144	301	137

- BASED ON:
- 21.6 HR IF WATER ELECTROLYZED
 - 70% THERMAL EFFICIENCY FOR 20,000 HRS
 - 3,000 PSIA GAS GENERATION PRESSURE
 - THERMAL VACUUM COMPATIBLE
 - EQUAL CHARGE/DISCHARGE TIMES

- NOTES:
- ONLY NAFION 120 HAS THE PEDIGREE
 - ADVANCED DESIGN NEEDS DEVELOPMENT VERIFICATION

FIGURE 19. SPE WATER ELECTROLYZER SUBSYSTEM MASS SUMMARY FOR 25 KW SYSTEM

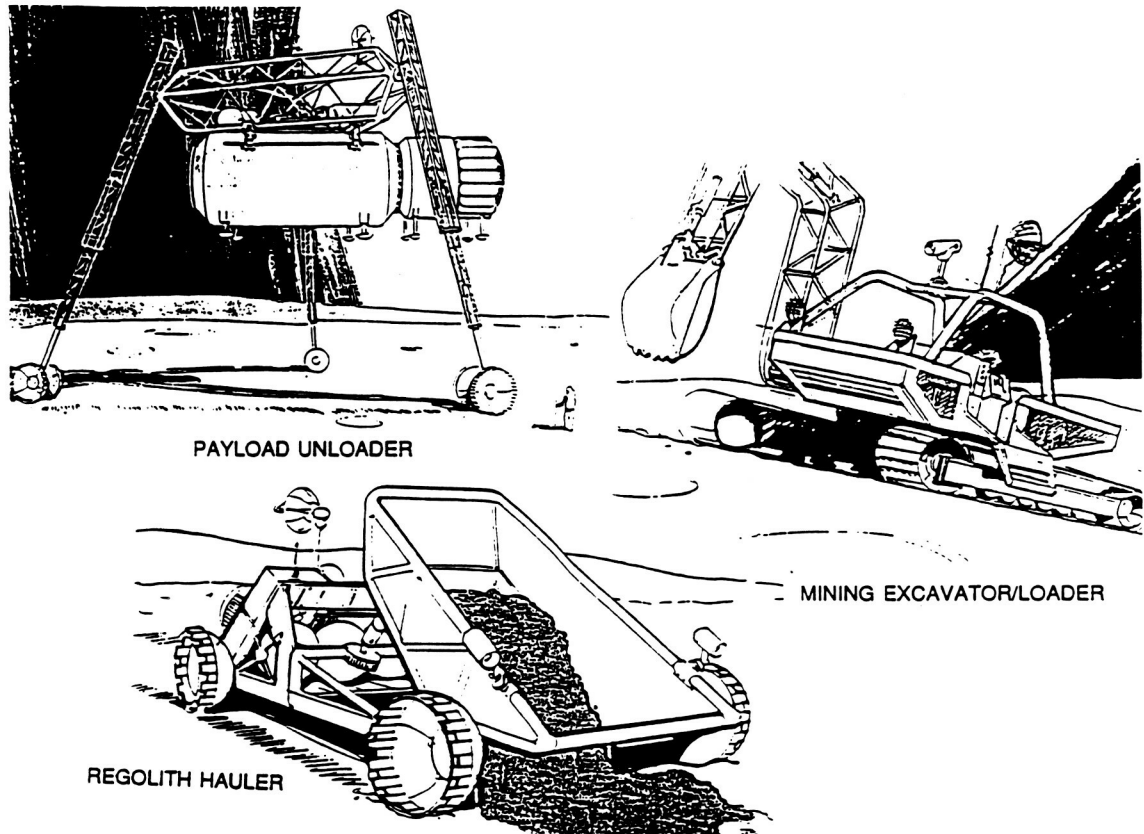

**FIGURE 20. POTENTIAL ENERGY STORAGE APPLICATIONS
FOR SPE WATER ELECTROLYZERS**

The central fixed refueling station approach would have a large electrolyzer subsystem continuously electrolyzing water during the lunar day. Each vehicle would be refueled by connecting up to the fixed hydrogen and oxygen storage and performing a pressure transfer of the gases. Simultaneously, the product water from the prior mission would be pumped from the vehicle back to the central station to be re-electrolyzed.

With an electrolyzer on board each vehicle, the refueling is accomplished by connecting the vehicle to the electrical grid and reforming hydrogen and oxygen from the on-board product water. The majority of this recharging would also be performed during the lunar day when the direct solar photovoltaic energy is available.

Each of the two approaches have significant advantages over the other. However, two advantages, one for each approach, appear to be overriding:

- Major refueling station advantage - this approach allows a rapid recharge of each vehicle.
- Major on-board electrolyzer advantage - this approach has a closed fluid system with only an electrical hook-up required.

The SPE water electrolyzer could be easily sized for either approach. However, from a system viewpoint, the automatic making and breaking of fluid connections in a dusty environment is judged to be very troublesome. For this reason, many analysts believe that the on-board electrolyzer is the right choice.

Indigenous Gas Production

Many approaches have been suggested for the recovery of valuable gases from indigenous lunar materials. These gases include oxygen, hydrogen, carbon dioxide and nitrogen. The source of the oxygen would be the chemical compounds within the lunar soils and rocks whereas hydrogen, carbon dioxide, and nitrogen would be solar wind-implanted in the lunar soil.

In several of the chemical processes proposed to garner oxygen from the lunar soil an intermediate product is water. This water is split into hydrogen and oxygen; the product oxygen gas is delivered to storage; and the hydrogen gas is returned for reuse in the chemical process. The SPE water electrolyzer would be a viable candidate for many of these processes.

The principles of the SPE electrolyzer can have additional, not so obvious, application in the recovery of valuable gases. For example, a process could produce a mixture of hydrogen, carbon dioxide and nitrogen by operating on the solar wind-implanted species. An SPE hybrid cell, part water electrolyzer and part fuel cell, could operate on the mixture to electrochemically produce purified hydrogen. The principles behind the SPE hydrogen separator hybrid cell is displayed on Figure 21.

The electrochemical separation of hydrogen from other gases has been demonstrated using a feed stock of hydrogen and nitrogen. In addition to separating the hydrogen from a mixture, the same SPE hybrid cell can electrochemically compress the separated hydrogen. In a similar manner, oxygen gas can be separated electrochemically from a mixture and be compressed by means of an SPE hybrid cell. The SPE oxygen separator/compressor principles are shown on Figure 22.

SUMMARY

Although the Lunar Outpost is still in the early planning stage, several unique and potentially enabling uses of the SPE water electrolyzer have been identified. The maturity of the SPE water electrolyzer cells gained from the Naval applications should give mission planners the confidence to take advantage of the leveraging effects of the SPE cell technology. Although the inherent capabilities of this technology have been proven, significant development effort remains to package these cells for the Lunar Outpost applications.

REFERENCES

- [1]: NASA/JSC Internal Note Document No. JSC-22044, dated 04/28/86
- [2]: NASA/JSC Internal Note Document No. JSC-22632, dated 09/30/87
- [3]: NASA/JSC Internal Note Document No. JSC-24411, dated 07/25/90
- [4]: NASA Conference Publication 3016; September 12-13, 1988, p. 206

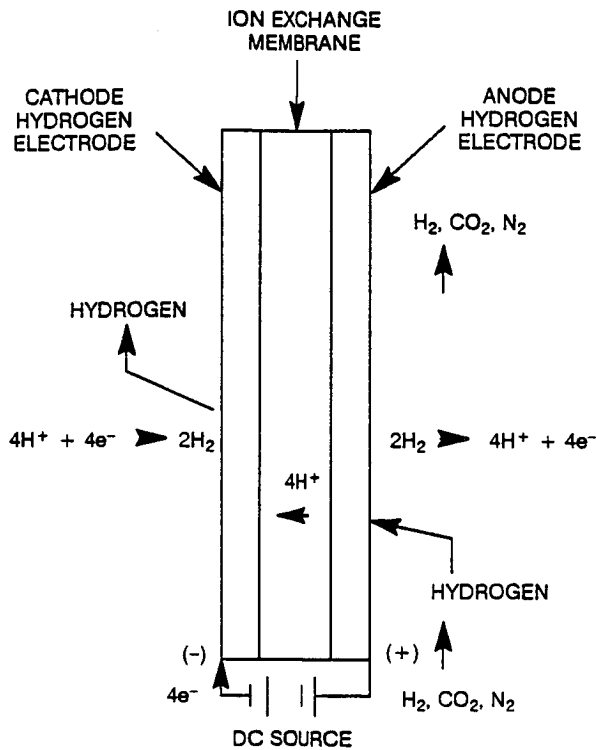

FIGURE 21. PRINCIPLES OF THE SPE HYDROGEN SEPARATOR/COMPRESSOR

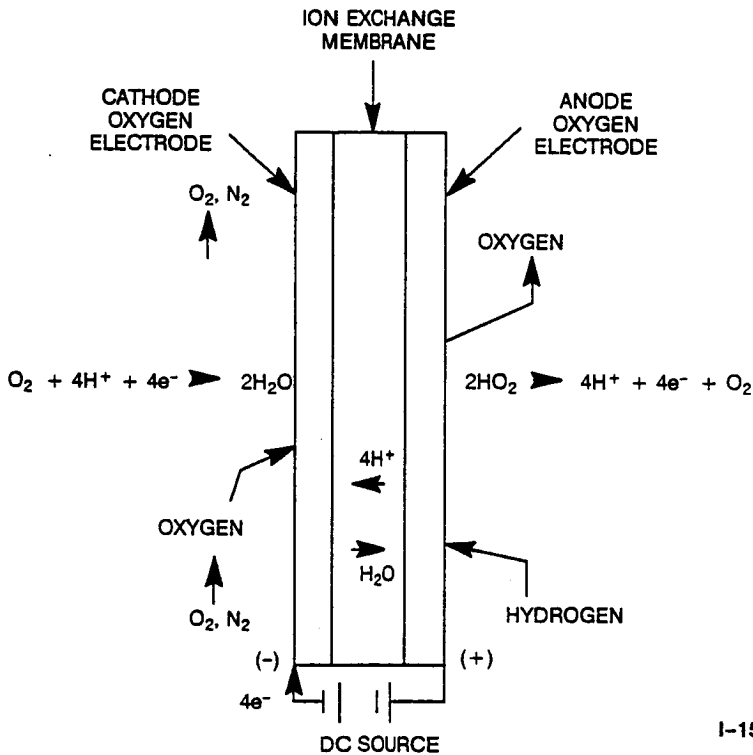

FIGURE 22. PRINCIPLES OF THE SPE OXYGEN SEPARATOR/COMPRESSOR

N 9 3 - 2 7 9 7 8

ASSESSMENT OF THE STATE OF THE ART IN LIFE SUPPORT ENVIRONMENTAL
CONTROL FOR SEI

Charles H. Simonds and Gary P. Noyes
Lockheed Life Support Development Laboratory

522-54
158336
P-14

Abstract

This paper defines the types of technology that would be used in lunar base for environmental control and life support system and how it might relate to In Situ Materials Utilization (ISMU) for the Space Exploration Initiative (SEI). There are three types of interaction between ISMU and the Environmental Control and Life Support System (ECLSS):

1. ISMU can reduce cost of water, oxygen, and possibly diluent gasses provided to ECLSS. A corollary to this fact is that the availability of indigenous resources can dramatically alter life support technology trade studies.
2. ISMU can use ECLSS waste systems as a source of reductant carbon and hydrogen, and
3. ECLSS and ISMU, as two chemical processing technologies used in spacecraft, can share technology, thereby increasing the impact of technology investments in either area.

Functions of Life Support

Sustaining life in space for long periods of time requires at a minimum (Humphries et al. 1990):

- 1) Maintenance of a breathable atmosphere with a partial pressure of O₂ of .2-.3 bars, in a diluent gas with a total pressure of up to 1 bar. Leakage (only a few kg per day) must be replenished even on large spacecraft. A minimum of 2 kg is lost every time the crew exits an airlock.
- 2) Circulation of the atmosphere at velocity of ~3 m/sec to flush exhaled CO₂ away from the face. Forced circulation is required to compensate for the lack of natural convection in micro-g environments. The circulation rate for Space Station Freedom (SSF) will be about 1.36 m³/second or 142,000 kg per day.
- 3) Removal of the 1 kg/man-day of CO₂, and 1.8 kg of vaporized H₂O/man-day plus additional CO₂ and H₂O produced by research animals and equipment.
- 4) Control and removal of noxious trace constituents in the atmosphere.
- 5) Control of cabin temperature to 20-30 degree C and rejection of 4.4 kw-hr of heat per man-day, plus equipment loads, which generally are orders of magnitude larger.
- 6) A supply of potable water of about 2.6 kg per man-day.
- 7) Disposal of waste, including urine and fecal matter, with about 1.5 kg of moisture and 0.1 kg of solids.
- 8) A supply of food with a dehydrated equivalent to about 0.75 kg per man-day.
- 9) Disposal of packaging materials, about 0.8 kg/man-day.
- 10) Provision for personal hygiene and changes in clothing.

Design Solutions

System Closure and Physical Chemical Recycling

The history of spacecraft environmental control development has been one of using physical-chemical approaches to progressively increase the degree of closure and recycling of fluid constituents as mission durations became longer and longer. The availability of indigenous space resources may reverse this trend by providing an alternative to resupply of make up fluids from Earth. *Figure 1* shows the major mass flows of the life support system.

Even short duration missions like Mercury, Gemini, and Apollo recirculated the cabin atmosphere, the largest ECLSS mass flow (Diamant et al. 1990). CO₂ was removed from recirculated air by a non-regenerative LiOH cartridges and H₂O was removed by condensing heat exchangers. Skylab used a regenerative approach. Humidity control was provided by condensing heat exchangers and zeolites (molecular sieves) removed both H₂O and CO₂ using a pressure swing batch process. The gases were vented to space after the beds were modestly heated to enhance desorption. Ullage losses in such a system are quite large, since air equal in volume to the unfilled porosity in the bed is vented each cycle. Losses can be reduced by pumping air trapped between the moi sieve pellets back to cabin pressure. Even Shuttle uses the LiOH-condensing heat exchanger approach.

However, for the Extended Duration upgraded Columbia Orbiter, and amine stabilized in pellet form serves as absorbent in a pressure swing batch process.

Numerous emerging technologies can be made available for CO₂ and H₂O removal from air for the Space Exploration Initiative (SEI). Good system engineering practice as well as sound economic theory demands that the Figure of Merit on which to base technology selections for future programs is Life Cycle Cost. *Figure 2* shows a modification of the Lockheed view of Life Cycle Costs, adapted from the original form designed for unmanned Earth orbiting spacecraft. The modified diagram is appropriate to manned spaceflight with resupply sorties and possibly ISMU.

Four factors dominate considerations in life support technology selection for SEI:

1) First is the relative value of recovered gases versus the value of additional equipment required for their recovery. If there are no provisions to extract O₂ from CO₂, there is little incentive to recover CO₂. Similarly if the installation is water rich due to abundant water from H₂-O₂ fuel cells or importation of abundant H₂O in food, recovered water is of little value. If, on the other hand, photovoltaic or nuclear power is provided, water electrolysis is implemented and/or CO₂ is supplied to live plants or chemical reactors, then recovery of these gases may trade favorably on the basis of Life Cycle Cost.

2) The second factor is the relative savings from reducing heat rejection loads versus recovery of the gases. The latter is particularly significant for the small life support systems in space suits. Space suit systems must be particularly light, and heat rejection is one of the heaviest subsystems. The heat of condensation of H₂O plus the heat of CO₂ absorbent reactions represents about a third of the system heat rejection load. Relieving the heat rejection system of this 150-watt load allows radiator-based heat rejection to remove virtually all of the load in Earth orbit and a significant fraction of the load on the Moon. These radiator based approaches trade favorably on the basis of Life Cycle Cost.

3) The third factor is the relative cost of electric power versus makeup fluids. Almost all technologies that recover and recycle fluids require electrical energy. The trade between energy intensive air revitalization and low power venting approaches is dramatically affected by the cost of the electrical power. The cost of the power is in turn affected by the generation and storage technologies selected. Nuclear power generation is smaller and cheaper on a Life Cycle Cost basis than photovoltaic power, assuming that the energy is stored in regenerative fuel cells for power through the 14 day lunar night.

4) A fourth major factor is the relative cost of ISMU produced fluids and the cost of the recovery and purification by ECLSS. If the ISMU fluids are relatively inexpensive, then venting approaches are economically favored for base as well as space suit air revitalization.

One factor that can be of significance in ECLSS trades sits outside the framework of Life Cycle Cost modeling. That factor is the negative impact of venting gases on the scientific research of the mission. Recovery of the gases, despite an increase in Life Cycle Cost, may be appropriate if the performance of scientific experiments, particularly infrared-sensitive telescopes, is jeopardized by plumes of waste gases. The negative economic impact may be minimized if only intermittent curtailing of venting is required while the experiments are actually collecting data. If the cloud of waste gas can dissipate rapidly enough it will not obscure the telescope's critical operational spectral bands.

A critical emerging technology in venting gas purification uses hollow fiber membranes. Integrating membranes with facilitated transport in CO₂ solvents is being developed by both a Lockheed-AiResearch team and Hamilton Standard for NASA space suite applications. The membrane approaches depend on the differences in solubility and diffusivity of H₂O and CO₂ from N₂ and O₂ to effect a high degree of separation. The space suite membrane systems vent the CO₂ and accompanying moisture to space vacuum. The systems have the advantage that O₂ and N₂ permeation through the membranes is significantly less than ullage losses with zeolite or amine packed beds. However, in larger spacecraft the gases could be recovered with a vacuum pump for further processing.

The ECLSS developed for SSF recovers both CO₂ and H₂O, although the initial installation will use a venting batch molecular sieve until SSF has enough power to run the CO₂ recovery and electrolysis systems. *Figure 3* illustrates the three alternative CO₂ reduction technologies developed in anticipation of Space Station needs (Noyes 1988). Space Station Freedom will mature the Sabatier process for CO₂ reduction sometime after Permanently Manned Capability (Carrasquillo et al. 1991). Alternative approaches with integrated electrochemically driven separation and CO₂ decomposition have been tested at the breadboard scale.

In systems which have an excess of water and a deficiency in oxygen, water electrolysis provides a well developed set of techniques. The excess water comes from importation of moisture in food as well as H₂ and O₂ for fuel cells. Most of the moisture or respiration and perspiration by the crew finds its way into the air and eventually the condensing heat exchanger. In most spacecraft, the highest-purity source of raw recycled water comes from condensing heat exchangers in the air revitalization circuit. Water electrolysis, described in the companion paper by McElroy (1992), is the method of choice for converting high purity water to oxygen. Limited processing is required to purify condensate to the standards needs by the electrolysis units. *Figure 4* illustrates the merits of three alternative approaches to water electrolysis. Space Station Freedom baselined the low temperature, low pressure aqueous KOH process (Carrasquillo et al., 1991). However, it is not scheduled for implementation until sometime after Permanently Manned Capability.

For shorter duration lunar mission, such as the proposed First Lunar Outpost with a maximum 45 day stay time, venting approaches to air revitalization are favored in Life Cycle Cost based trades. In conducting a trade study of application of a candidate approach using hollow fiber membranes to a lunar surface EMU for an extensive multi-year program of lunar exploration, Simonds et al (1991) used quantitative decision analysis methodology. *Figure 5* presents an inference diagram for the trade. Details on the use of inference diagrams are found in Howard and Matheson, 1984. *Figure 6* shows the results of the trade in terms of histograms of the risk adjusted present value of developing the membrane technology. In conducting the study the membrane approach was contrasted with the approach which recovered and recycled all of the moisture and CO₂ produced in the space suit. A condensing heat exchanger was used to recover the water and pelletized AgO was used to recover the CO₂. The dominant factor affecting the trade is the availability of relatively low cost water and oxygen from ISMU.

Trace contaminants in recirculated air are removed by activated carbon as well as by the condensing heat exchangers. The activated carbon can be treated with phosphoric acid and catalysts to broaden the range of compounds removed from the air stream. In terrestrial practice the carbon can be regenerated by heating a mildly oxidizing environment. However, the regeneration process has yet to be matured for space applications.

The least mature ECLSS technology is waste process. Most of the preferred solutions involve oxidation of the C-H-O compounds to CO₂ and H₂O, which in turn are decomposed to C, H₂ and

O₂. In so doing, the waste is sterilized and toxic organic compounds are destroyed. For most oxidation technologies, system size is inversely correlated with operating temperature. Higher temperature systems, such as for wet oxidation at conditions slightly in excess of the critical temperature and pressure (termed Supercritical Wet Oxidation), are smaller because residence time in the reactor can be reduced to a few minutes. However, higher temperature approaches require thick-walled pressure vessels and an assortment of control, material and safety obstacles which to date have not been completely overcome. One of the most severe problems identified during testing has been the buildup of insoluble inorganic salts in the reactor and associated plumbing (Armellini et al., 1990).

No fundamental first order problems are known to stand in the way of developing physical-chemical processes for the lunar phases of an SEI program. However, much of the technology is still at a low level of maturity. The less developed items will require successful testing of preprototype and prototype hardware prior to freezing of technology selections for any lunar application. Life support equipment is generally mechanically complex due to: 1) The necessity of minimizing design margins to a fraction of those appropriate in industrial process equipment from which much of it is derived; and 2) the complex valving and control systems necessary to remain fully operational after one or more failures. The final design, fabrication, and assembly of approved designs for flight hardware has proved slower than many other major spacecraft systems. For example, the life support equipment has been a pacing item in assembly of Shuttle Orbiter 105.

Sources of Technology

NASA's ECLSS R&D has emphasized development and packaging of ECLSS equipment, rather than starting with conceptual or immature technologies. The practice is quite appropriate, because there are well-supported programs to develop fundamentally new separation or transformation techniques in the chemical process, mineral processing, and synthetic fiber/membrane industries. These industries are dynamic and well funded because of the large market for municipal and industrial waste treatment and pollution control equipment.

There are numerous non-NASA government-sponsored programs that use physical chemical ECLSS devices. One of the major sources is the Navy's nuclear submarine life support development program. The submarine program has supported the development of water electrolysis such as the units described in the companion paper by McElroy. The submarine programs also have developed a range of CO₂ scrubbing and trace contaminant detection and removal technologies. Both the space and submarine applications require very high reliability hardware which can run for long periods of time with little maintenance or servicing. The principal difference between the requirements of a spacecraft and submarine is that spacecraft have much more restricted allocations of weight, electrical power, and heat rejection than nuclear submarines. Aircraft Environmental Control has been a major proving ground for fans, motors and regulators that can be used on spacecraft. However, because jet aircraft simply compress atmosphere as their source of breathing air and bleed air from the engine's compressors to run air cycle cooling, most of the major components have little commonality between aircraft and spacecraft. Armored ground vehicle environmental control also has been a source of contamination removal technology.

In addition to development of new unit processes, a vast improvements seem possible in reducing weight by material replacement. Many of the most significant reductions in spacecraft weight have been the result of improvements in advanced materials and fabrication techniques. As in the case of the development of fundamentally new life support processes, NASA programs can piggyback on well-funded programs of the synthetic fiber/membrane industry, fiber reinforced composite industry, metals industry, and the high technology ceramics manufacturers. Particular interest exist

in use of lightweight composites in reducing the mass of fluid handling components, tubing and valves.

Bioregenerative Recycling

Bioregenerative systems would use plants, generally higher plants such as agricultural crops, (e.g. wheat, rice, lettuce, tomatoes) to remove the carbon dioxide from air and decomposition of wastes to make oxygen. Considerable detail in this area is presented in the preceding paper on Closed Ecological Life Support System (CELSS) development. CELSS technology is considerably less mature than the competing physical-chemistry approaches that have been studied for many years and have been implemented in a variety of test facilities. Man-rated CELSS test facilities are in development. The bioregenerative life support technology development process, like the physical-chemical processes, piggybacks on development funded elsewhere.

Role of Indigenous Space Materials Utilization

Many of the processes proposed for extraction of O₂ from lunar materials as well as gases adsorbed on lunar soil (H₂, He, N₂, C) lend themselves to integration with life support. The most obvious applications are as a source of gases to make up for leakage, ullage losses in devices like pressure swing molecular sieves, and losses during the reduction of H₂O and CO₂. A potentially more significant integration of resource extraction and life support is to utilize the 0.8 kg of trash and 0.1 kg of solids in urine and feces to provide a significant source of reducing agents that can be used in an ilmenite reducing process. These materials provide each day about 1.4 kg of carbon and 0.3 kg of H that can yield about 70 kg of oxygen before the reactants are lost to space as ullage with the spent soil. *Figure 7* illustrates such a concept.

Conclusions

- 1) Indigenous space resources can be integrated with life support to reduce life cycles costs.
- 2) Both ISMU and ECLSS are chemical processing in space. They can share technology.
- 3) ISMU can offset the resupply penalties of venting life support. Venting life support systems are typically lighter and less power intensive than non-venting systems. Thus ISMU can reduce the Life Cycle Cost of the providing life support to future space exploration missions.

References

- Armellini, F. J. Tester, J. W. 1990, Salt Separation during Supercritical Water Oxidation of Human Metabolic Waste: Fundamental Studies of Salt Nucleation and Growth, SAE Paper 901313, 20th International Conference on Environmental Systems, Williamsburg, Virginia, July, 1990
- Carrasquillo, R. L., Carter, D. L. Holder, D. W. McGriff, C.F. and Ogle, K.Y., ECLSS Regenerative Systems Comparison and Subsystem Selection, SAE Paper 911415, 21st International Conference on Environmental Systems, San Francisco, California, July, 1991
- Diamant, B.L. and Humphries, W. R. Past and Present Environmental Control and Life Support Systems on Manned Spacecraft, SAE Paper 901210, 20th International Conference on Environmental Systems, Williamsburg, Virginia, July, 1990
- Howard, R. A. and Matheson, J. E. eds. *Readings on the Principles and Applications of Decision*

Analysis, 2 volumes, Strategic Decisions Group Menlo Park, CA, 1984

Humphries, W. R., Reuter, J. L., and Schunk, R. G., Space Station Freedom Environmental Control and Life Support System Design, SAE Paper 901211, 20th International Conference on Environmental Systems, Williamsburg, Virginia, July, 1990

McElroy, J.F. SPE Water Electrolyzers in Support of the Lunar Outpost, paper delivered at the University of Arizona/NASA Space Engineering Research Center and Indigenous Space Materials Utilization Advisory Panel Lunar Materials Technology Symposium. Tucson, AZ, February 1992.

Noyes, G. P. Carbon Dioxide Reduction Processes for Spacecraft ECLSS: A Comprehensive Review, SAE Paper 881042, 21st International Conference on Environmental Systems, San Francisco, California, July 1988

Figure Captions

Figure 1

The major fluid and material flow streams in supporting life on a spacecraft. These flows are sized for a Space Station Freedom size spacecraft with a crew of four. The immense flow of air is required to flush exhaled gases away from the crews face in zero-g. However similar flows are typical of office space in modern buildings. A large fraction of the hygiene water flow is for bathing and cloths washing.

Figure 2

Life Cycle cost terminology modified for Life Support System trade studies for NASA Manned Spaceflight programs with possible resupply and possible ISMU.

Figure 3

Three alternative CO₂ reduction approaches evaluated for Space Station Freedom.

Figure 4

Alternative approaches to water electrolysis.

Figure 5

Inference Diagram for the decision to develop membrane based EVA Life Support Technology. Rectangular boxes represent decisions. Ovals represent chance events or events determined by forces outside the control of the decision makers. The octagon represents the decision criteria, risk adjusted net present value in this case.

Figure 6

Results of decision analysis calculations (Simonds et al. 1990) comparing development of hollow fiber membrane approaches with non-venting approaches to revitalizing space suit air. In the recover/recycle approach a condensing heat exchanger recovered moisture. Carbon dioxide is removed by reaction with AgO to form AgHCO₃. The venting approach reduces the size of space suit by reducing heat rejection loads. The venting approach also eliminated the need for complex servicing equipment to desorb the AgO canisters and drain and clean the condensate tanks.

Figure 7

Flow streams associated with integrating life support waste streams into resource extraction.

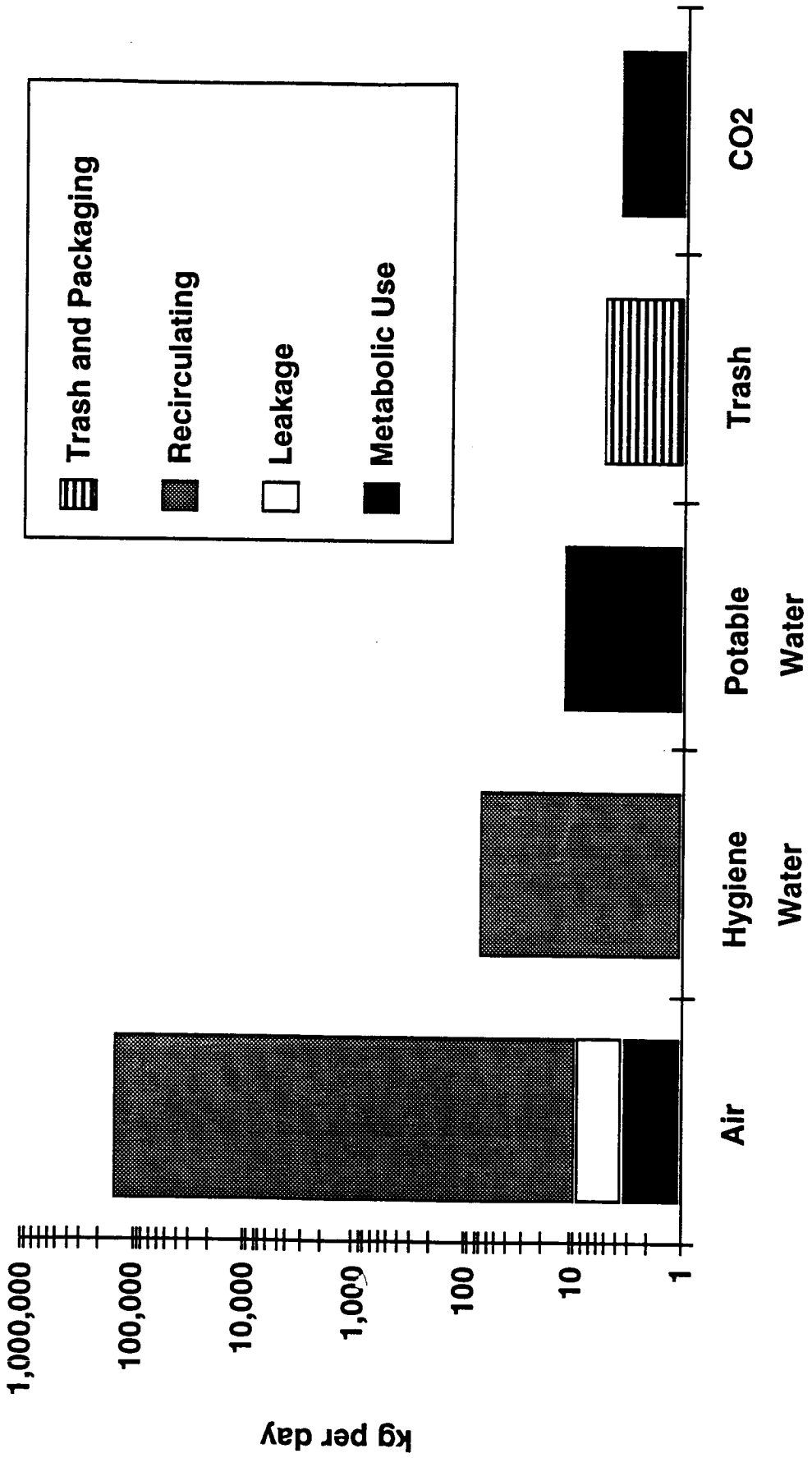
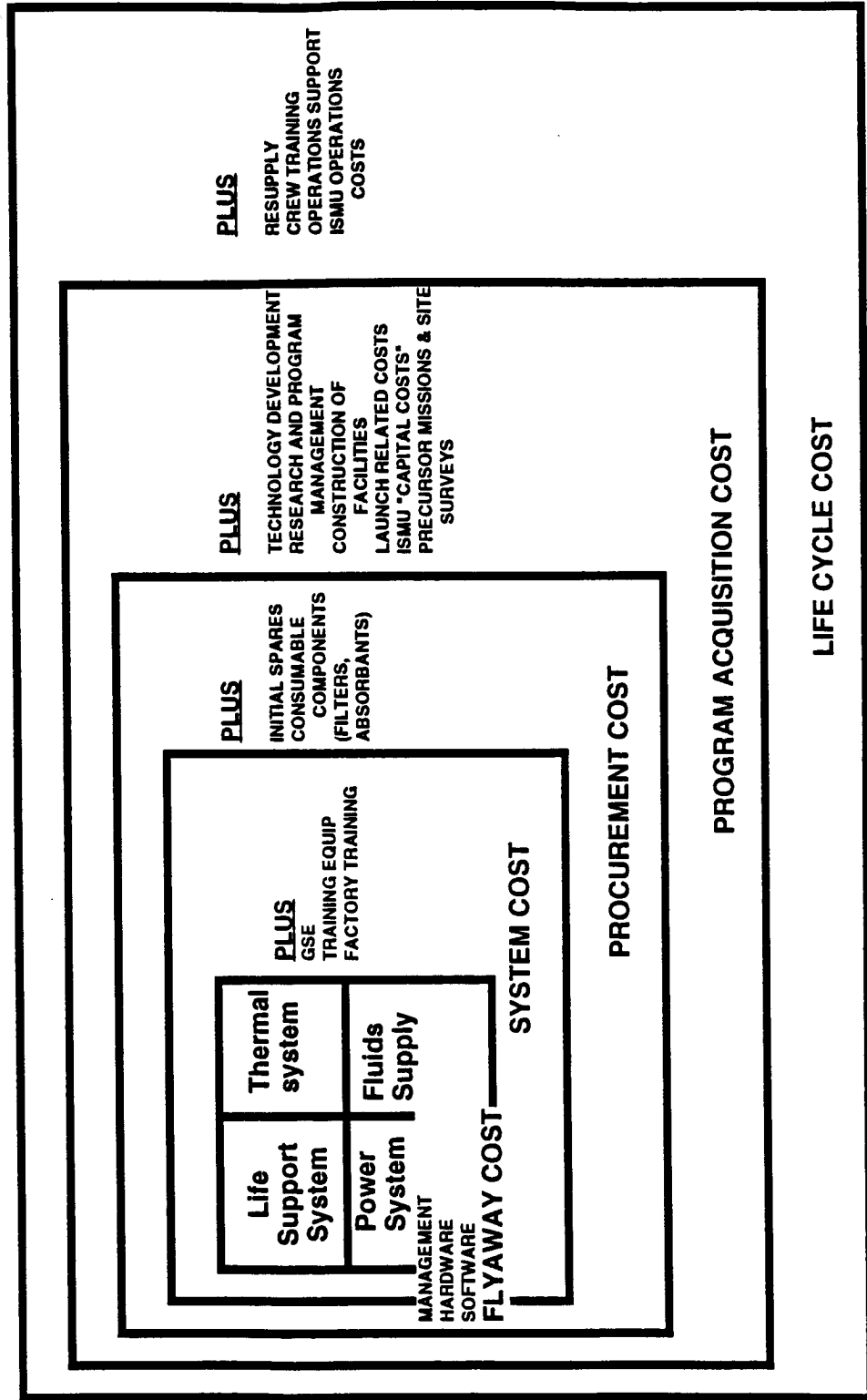

FIGURE 1

LIFE CYCLE COST DEFINITIONS AND TERMINOLOGY



CARBON DIOXIDE REDUCTION SYSTEM FUNCTIONAL BLOCK DIAGRAMS

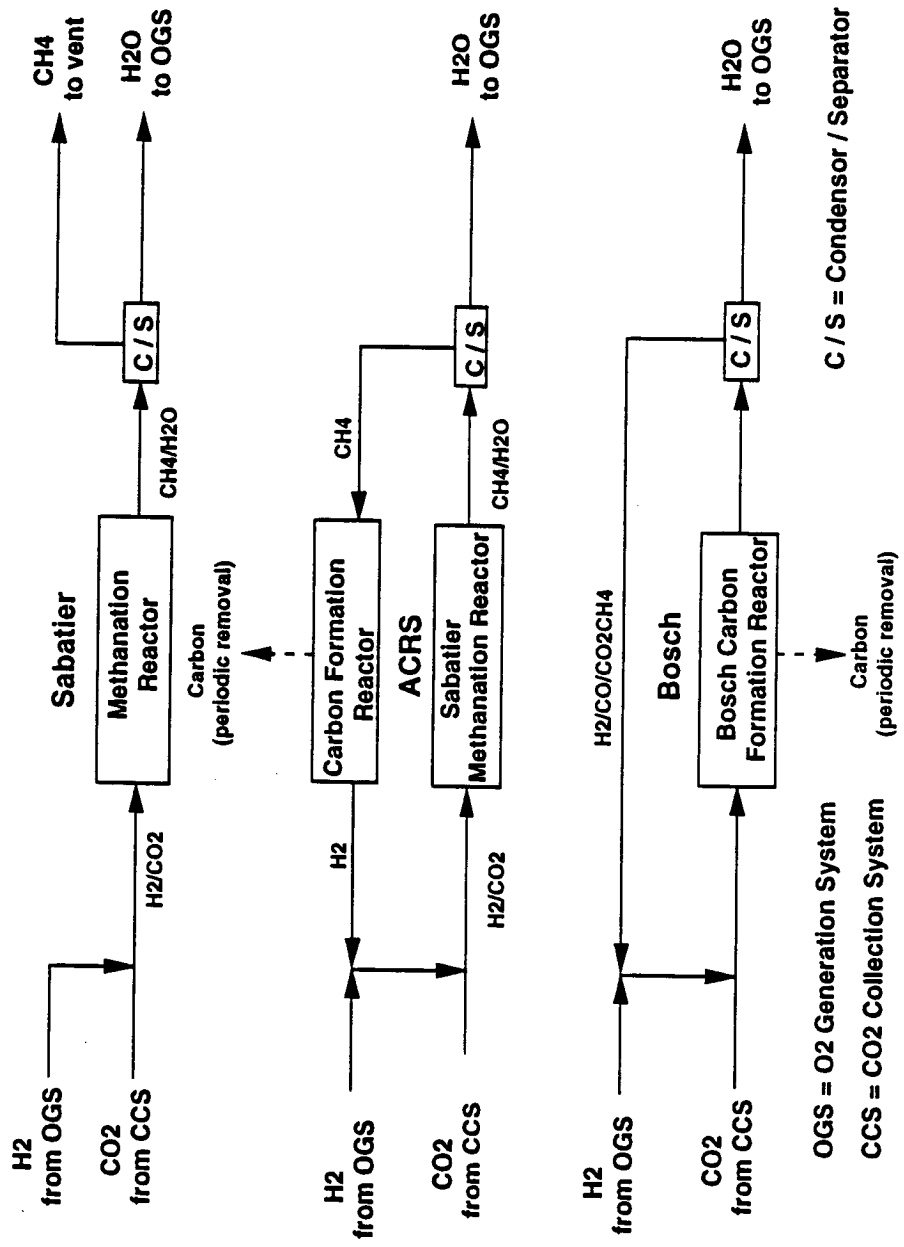

FIGURE 3

WATER ELECTROLYSIS FOR ECLS/ISRU INTEGRATION ISSUES

OPERATING MODE	LOW PRESSURE LOW TEMPERATURE	HIGH PRESSURE LOW TEMPERATURE	LOW PRESSURE HIGH TEMPERATURE	HIGH PRESSURE HIGH TEMPERATURE
ELECTROLYTE	KOH or SPE	SPE	CERAMIC	CERAMIC
ADVANTAGES	CURRENT TECHNOLOGY VERY SAFE	CURRENT TECHNOLOGY O2 DELIVERED AT HIGH PRESSURE	IDEAL FOR INTEGRATION WITH REGOLITH REDUCTION AND THERMIONIC POWER MOST EFFICIENT REDUCES CO2	POTENTIALLY SMALLEST, LIGHTEST APPROACH O2 DELIVERED AT HIGH PRESSURE REDUCES CO2
DISADVANTAGES	LARGE VOLUME AND WEIGHT REQUIRES COMPRESSOR FOR HIGH PRESSURE O2 USE	LEAST EFFICIENT PRESSURE SAFETY ISSUE	DEVELOPING TECHNOLOGY REQUIRES COMPRESSOR FOR HIGH PRESSURE O2 USE	NOT DEMONSTRATED TO DATE SERIOUS SAFETY ISSUES

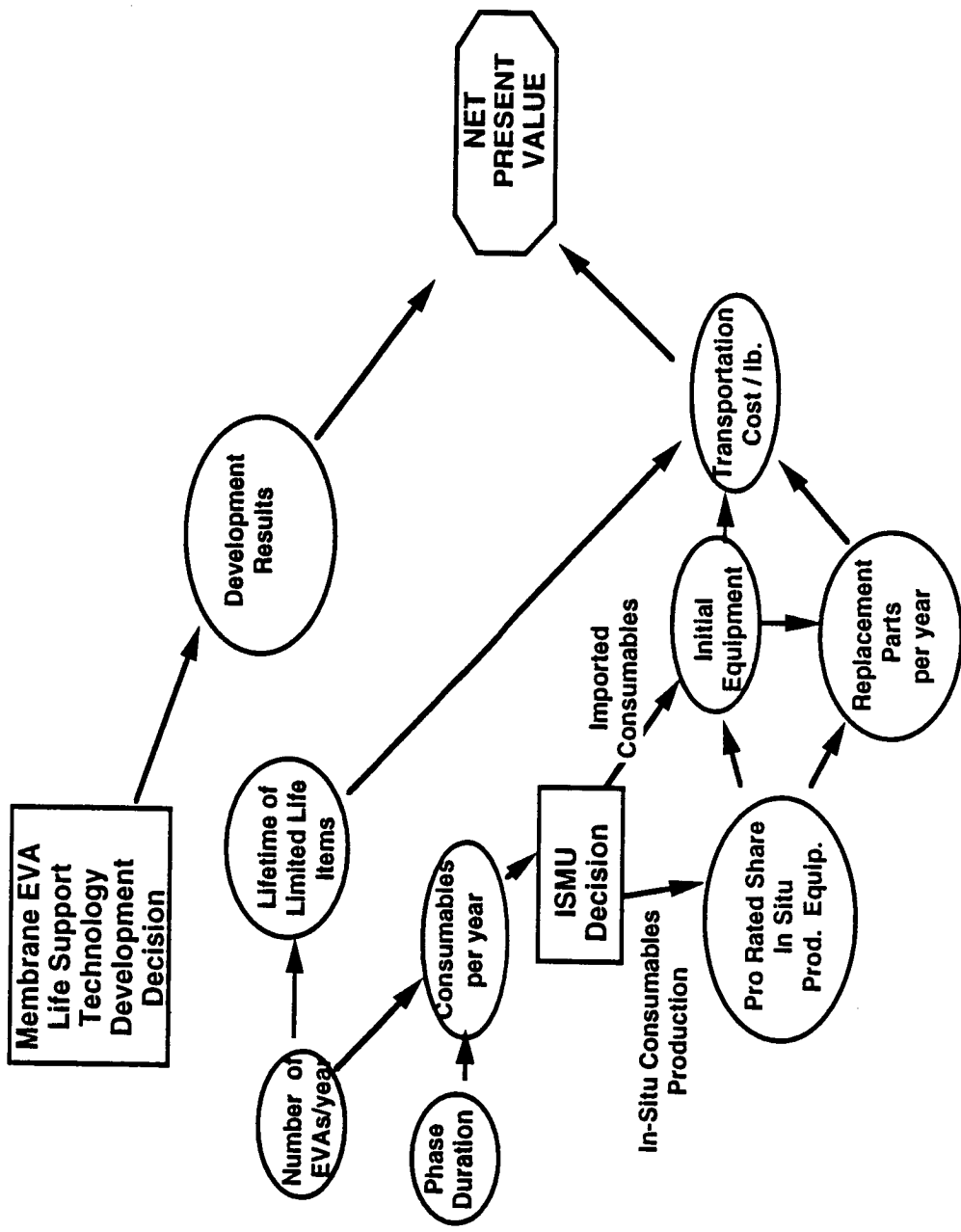
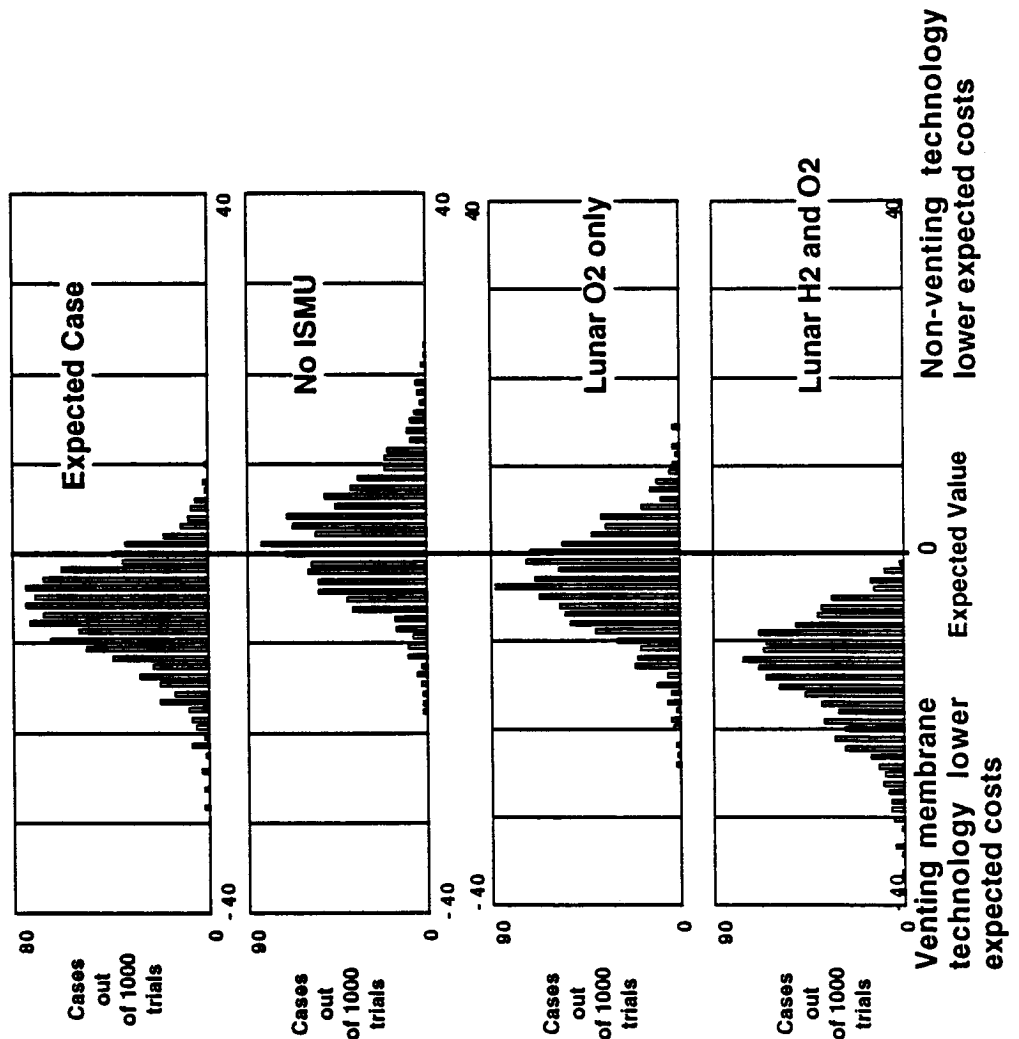

FIGURE 5

Histograms of Life Cycle Cost Reduction With Venting Membrane EMU Air Purification



INTEGRATION OF LIFE SUPPORT WASTE STREAMS INTO ISMU

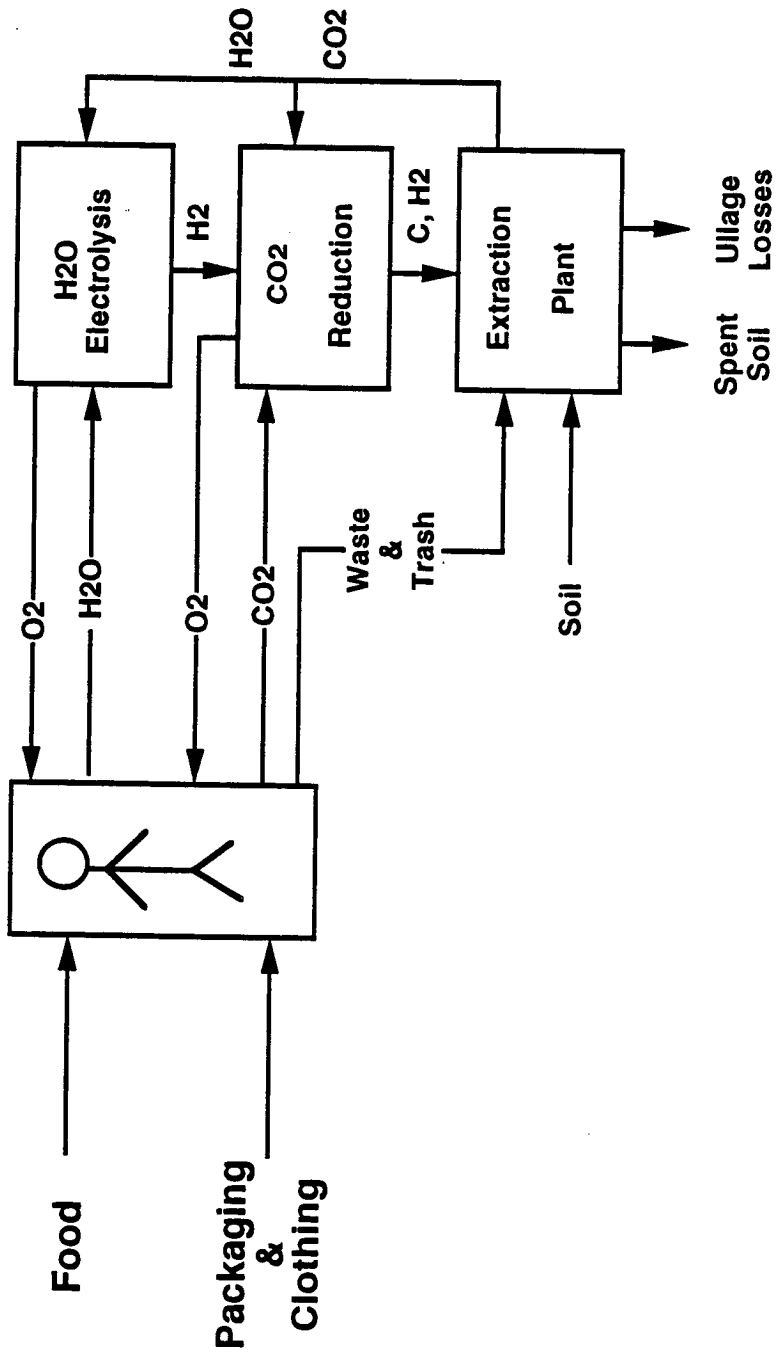

FIGURE 7

N 9 3 - 2 7 9 7 9

DUST PROTECTION FOR ENVIRONMENTAL CONTROL AND LIFE SUPPORT SYSTEMS IN
THE LUNAR ENVIRONMENT

Susan Fuhs
AiResearch, Los Angeles
and
Jeffrey Harris
Lockheed, Houston

523-54

158337

p. 12

Abstract

Lunar dust is pervasive, and requirements for dust protection will affect both hardware design and operations planning for lunar surface systems. On Earth, mechanical problems caused by particulates include erosive and abrasive effects, clogging of mechanical equipment, and impairment of seals and bonds. In addition, dust tends to degrade the heat rejection properties of contaminated surfaces. All these effects have been observed on the lunar surface as well.

This paper discusses the potential applicability of current dust protection methods to the problem of dust protection for the environmental control and life support (ECLS) systems of a lunar base, and highlights areas where development may be necessary. A review of dust problems experienced during the Apollo missions and of additional, ground-based experience with lunar dust provides a baseline for identifying operations and areas where dust may be expected to affect the ECLS systems. Current Earth-based methods of dust protection are identified and the impact of differences between the Earth and lunar environments on these methods is evaluated. Finally, integration of dust protection equipment with ECLS systems equipment is discussed.

Introduction

Lunar dust is pervasive, and poses significant challenges to crew health and to the operation of environmental control and life support (ECLS) systems on the Moon. Techniques for dust control which have been developed for Earth-based applications have varying applicability to lunar scenarios. This paper examines the problems arising from operation in the dusty lunar environment and discusses alternative approaches to solving these problems.

Lunar Dust Problem Definition

Apollo Experience

Dust contamination was one of the major operational hazards faced by the Apollo crews throughout the Apollo missions. Lunar dust clogged latches on extravehicular activity equipment, scratched visors and instrument covers, insulated heat transfer surfaces, and adhered to virtually everything. Although improvements were made in handling dust throughout the Apollo program, the problems had not been fully solved at the time of the last mission. During the Technical Crew Debriefing for Apollo 17, astronaut Gene Cernan commented:

"Dust -- I think probably one of the most aggravating, restricting facets of lunar surface exploration is the dust and its adherence to everything..."¹

Lunar Dust

Dust particles are characterized using many different measures, including mass, hardness, morphology, size, conductivity, charge, and color. Lunar dust has significant differences from dust on Earth. Since the Moon has no atmosphere, the lunar surface has been exposed to micrometeorite impacts for centuries. As a result the dust particles have reached a sort of steady state, and are more uniform in size than those on Earth. Without the weathering effects resulting from an atmosphere, the particles remain sharp. Furthermore, without the protection of the Earth's atmosphere and magnetic field, exposure to radiation results in highly charged particles.^(2,3) The small, sharp, highly charged lunar dust particles attach readily to many surfaces. Table 1 lists relevant characteristics of lunar dust.

Differences between the environment on the Earth and on the Moon result in differences in behavior of dust particles. In general, particle behavior is determined by many factors, including gravity, viscous drag, inertia, electrical forces, diffusivity, and thermophoretic forces. The reduced gravity field and the varying artificial atmospheric conditions in the lunar habitat and airlock will result in subtle differences in particle behavior on the Moon. These differences will need to be carefully considered in the design of equipment for a lunar base. Table 2 highlights differences between the environments on Earth and in the lunar habitat, airlock, and surface.

Effects on Crew Health and on Environmental Control and Life Support Equipment

The Apollo lander had no airlock. As a result, the ECLS equipment was exposed to any dust brought into the lander. In fact, there were indications that the ECLS system was acting as a sort of filter for the air inside the lander. Apollo 15 astronaut Dave Scott indicated:

"Yes, the ECS does a pretty good job of cleaning the place out. The smell was gone. When you took the helmet off, you could smell the lunar dirt...but that had all cleaned

out. By the time we got up the next morning things were in pretty good shape.²

The crew were also exposed to any dust within the lander; reported symptoms varied in severity from crew member to crew member.¹

Obviously, for long duration missions, exposure of crew and ECLS equipment to dust must be minimized. Crew health effects include irritation of the eyes, of the pulmonary ventilation system, and of the skin. For example, *Figure 1* shows an experimentally determined collection efficiency curve for particle deposition within the human lung on Earth.⁴ It can be seen that the lungs are good collectors of airborne particles, with collection efficiencies ranging from 0.4 to 1.0, depending on particle size. Although some changes in particle behavior are expected on the Moon, this curve will retain its basic shape and deposition of particles in the lung will remain a problem on the Moon.

A lunar base life support system will contain many types of equipment. Such a system will comprise, at a minimum: rotating machinery, flow control equipment, chemical process units, and heat transfer equipment. Table 3 identifies typical components which may be found in a lunar base life support system, and identifies effects of dust contamination on unprotected equipment. Dust particles will have major impacts on operation, reliability, and maintainability of ECLS equipment.

Protection Against Lunar Dust

There are several means of mitigating the effects of lunar dust on the crew and on a lunar base ECLS system. These include (in rough order of preference):

- 1) eliminating entry of dust into the habitat,
- 2) designing robust equipment which can operate in a dusty environment,
- 3) reducing exposure to dust by removal of particles from the air,
- 4) taking steps to retard contamination by dust, and
- 5) performing direct clean-up of dust in areas that have become contaminated.

Each of these approaches is discussed in the following paragraphs.

EVA operations are the primary source of dust particles within the habitat module. As a result, careful EVA operations planning is required to reduce the amount of dust passing from the airlock into the habitat and thus to reduce the exposure of crew and ECLS equipment to dust. Kennedy and Harris² provide a plan for re-entry through the airlock which will minimize the amount of dust brought into the habitat module itself. This plan is presented in simplified form in *Figure 2*. (In addition, selection of appropriate materials for EVA suits/equipment can provide benefits by inhibiting the attachment of particles and/or by facilitating removal of dust. A detailed discussion of materials properties is beyond the scope of this paper, however.)

Where dust entry can not be eliminated, such as within the airlock itself, careful design and development can produce robust equipment which can operate in a dusty environment. For example, degradation of air bearings due to particles in the air passing over the bearings can be eliminated by use of a reverse facing pitot to scavenge particle-free air for the bearings. *Figure 3* illustrates this approach. Other techniques for designing particle resistant equipment include selective use of coatings on surfaces exposed to particle impacts, shielding, or sealing. It should be noted that this type of approach is not adequate to mitigate crew exposure to particulates.

Removal of particles from air streams may be necessary. On Earth, several removal methods are available. Table 4 summarizes current approaches, and *Figures 4-8* describe the techniques.

Unfortunately, most of the approaches used on Earth are only marginally applicable to the lunar environment. For example, the large pressurized volume required for a settling chamber is not readily attainable on the lunar surface. The two most likely approaches to lunar dust removal are cyclones and filters. *Figure 2* shows dust removal capability prior to ECLS equipment in the habitat, providing additional dust protection for ECLS systems.

If removal of particles from air streams is not practical, measures can be taken to retard particle build-up in or on sensitive equipment. Selection of appropriate flow regimes and careful choices of materials can minimize impaction and retention of particles on surfaces⁵.

Finally, one must be prepared to clean up dust contaminating the airlock or habitat when necessary. Hand held vacuums or moist wipes provide clean up capability.

Conclusions and Recommendations

Design of ECLS equipment and systems for a lunar base must consider the problems associated with exposure to lunar dust. Dust control strategies will affect mass, volume, power, and performance of ECLS and EVA equipment. As a result, trade studies to determine dust control strategies must be conducted from a system viewpoint. Care must also be taken to protect the crew from exposure to dust. It should be noted that some of the techniques used to reduce the effects of dust on equipment will not mitigate effects on the crew.

Areas requiring further research and development include:

- 1) improved characterization of lunar dust,
- 2) more detailed evaluation of particle behavior in the various lunar environments: habitat, airlock, surface,
- 3) evaluation of the applicability of terrestrial dust removal techniques to lunar requirements,
- 4) determination (and development if required) of better materials to contact lunar soils, and
- 5) improved understanding of the physiological impacts of exposure to lunar dust.

References

¹NASA Manned Spacecraft Center, "Apollo 11 - Apollo 17 Technical Crew Debriefings, 1969-1973." Crew Training and Simulation Division, Houston, TX, 1969-1973.

²Kennedy, Kriss J. and Jeffrey R. Harris, "Dust Control Research for SEI." paper presented at SPACE '92: Engineering, Construction, and Operations in Space, American Society of Civil Engineers, Denver, CO, May 31 - June 3, 1992.

³Heiken, Grant H., et al. *Lunar Sourcebook: A User's Guide to the Moon*. Cambridge University Press, New York, NY, 1991.

⁴Friedlander, S. K. *Smoke, Dust, and Haze: Fundamentals of Aerosol Behavior*. John Wiley and Sons, New York, NY, 1977.

⁵Fuhs, Susan E., "Studies of Inertial Deposition of Particles onto Heat Exchanger Elements." Ph.D. thesis, California Institute of Technology, Department of Mechanical Engineering, 1988.

CHARACTERISTICS	DESCRIPTION	REMARKS
SIZE	90% < 1000 MICRONS (1 mm) 70% < 100 MICRONS (0.1 mm)	VERY SMALL WITH HIGH INGRESS AND PENETRATION
SHAPE	ANGULAR/SUBANGULAR SHARP	EMBEDS INTO FABRICS
BULK DENSITY (0-30 cm)	1.58 ± g/cm ³	HIGHER DENSITY DEEPER
HARDNESS	5-7 (MOHS SCALE)	VERY HARD MATERIAL
POROSITY (0-15 cm)	52% ± 2%	VOLUME OF VOID SPACE
COHESION (0-15 cm)	0.52 kPa	HIGHER COHESION DEEPER
TOXICITY	PRIMARYLY NON-TOXIC	-
CORROSIVENESS	NOT ACTIVE IN VACUUM	NO CHEMICAL REACTION W/O SOLUTION
ELECTROSTATIC	HIGHLY CHARGED	HIGHEST CHARGE DURING LUNAR NIGHT
MAGNETIC	38 ± GAMMAS: APOLLO 15	NOT GLOBAL, LOCAL FIELDS
THERMAL CONDUCTIVITY	0.9-1.3 W/cm ² °K	GOOD INSULATOR
COMPRESSIBILITY (LOOSE)	0.3 (COMPRESSION INDEX)	TOP 10 ± cm COMPRESSIBLE

ADAPTED FROM KENNEDY AND HARRIS, "DUST CONTROL RESEARCH FOR SEI"

IW-16021-1

Table 1. Lunar Dust Characteristics

	EARTH	LUNAR SURFACE	AIRLOCK	HABITAT
ATMOSPHERE	14.7 PSIA	NONE	VARIABLE	REDUCED PRESSURE OR 14.7 PSIA
GRAVITY	1g	1/6 g	1/6 g	1/6 g
DISTURBANCES	WEATHER, HUMAN AND MECHANICAL ACTIVITY, GEOLOGIC ACTIVITY	HUMAN AND MECHANICAL ACTIVITY, SOLAR RADIATION, MICRO-METEORITES	HUMAN ACTIVITY, PRESSURIZATION/DEPRESSURIZATION AIRFLOWS	HUMAN ACTIVITY, VENTILATION AIRFLOWS

IW-16030-1

Table 2. Earth and Lunar Environments

TYPE OF EQUIPMENT	TYPICAL COMPONENTS	POTENTIAL EFFECTS OF DUST CONTAMINATION
<ul style="list-style-type: none"> • ROTATING MACHINERY 	<ul style="list-style-type: none"> • FANS • PUMPS • COMPRESSORS 	<ul style="list-style-type: none"> • CORROSION • EROSION • CLOGGING • BEARING FAILURES
<ul style="list-style-type: none"> • FLOW CONTROL EQUIPMENT 	<ul style="list-style-type: none"> • VALVES • METERS 	<ul style="list-style-type: none"> • LEAKS • FAILURE TO OPEN/CLOSE • ERRONEOUS MEASUREMENTS
<ul style="list-style-type: none"> • CHEMICAL PROCESS UNITS 	<ul style="list-style-type: none"> • SORBENT BEDS • CATALYTIC REACTORS 	<ul style="list-style-type: none"> • PLUGGING • BREAKDOWN • EROSION
<ul style="list-style-type: none"> • HEAT TRANSFER EQUIPMENT 	<ul style="list-style-type: none"> • HEAT EXCHANGERS • RADIATORS 	<ul style="list-style-type: none"> • FOULING/INSULATION • OBSCURATION OF RADIATIVE SURFACES

IW-19139

Table 3. Effects of Lunar Dust on Unprotected ECLS Components

	MINIMUM SIZE, μm	EFFICIENCY, MASS%	LUNAR APPLICABILITY?
SETTLING CHAMBER	50	< 50	NO
CYCLONE	5-25	50-90	YES
WET COLLECTOR			
• SPRAY TOWER	10	< 80	NO
• VENTURI SCRUBBER	0.5	< 99	NO
ELECTROSTATIC PRECIPITATOR	1	95-99	POOR
FILTER	0.3	99+	YES

ADAPTED FROM FRIEDLANDER, "SMOKE, DUST, AND HAZE"

IW-16020

Table 4. Current Approaches to Particle Removal

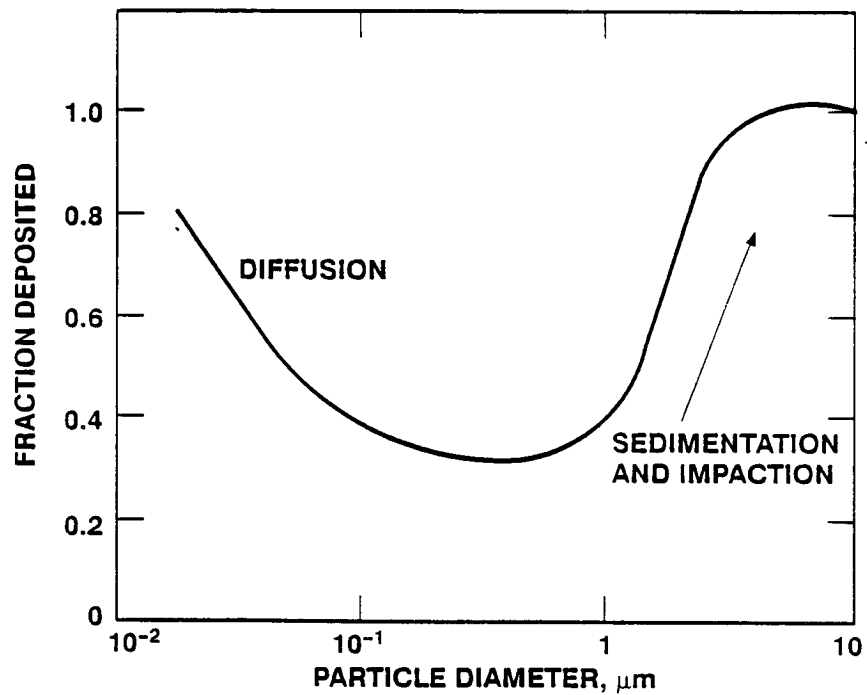

ADAPTED FROM FRIEDLANDER
"SMOKE, DUST AND HAZE"

IG-11655-1

Figure 1. Particle Deposition in the Human Lung on Earth

Figure 2. Prevention of Lunar Dust Entry into the Habitat

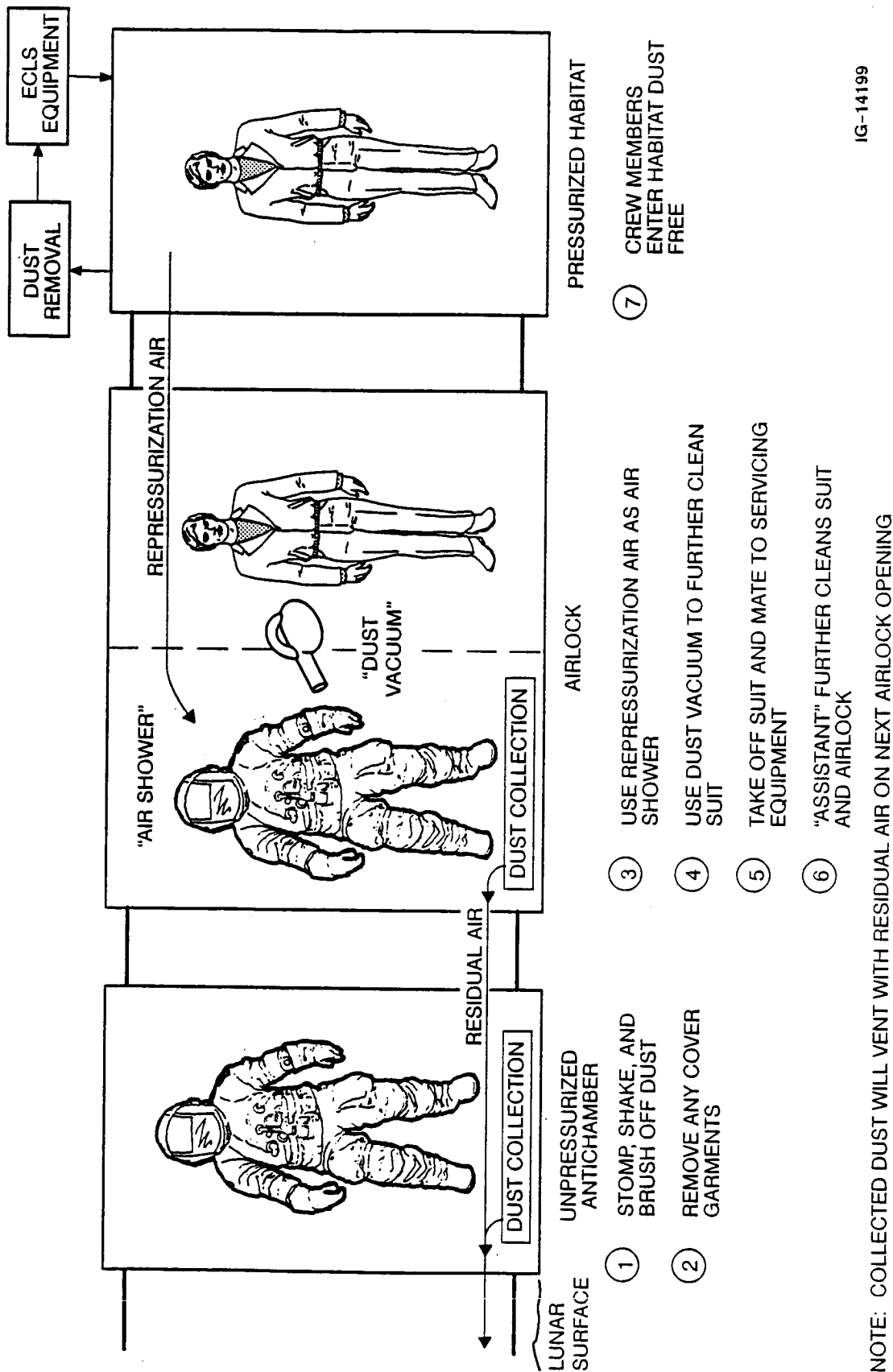

IG-14199

NOTE: COLLECTED DUST WILL VENT WITH RESIDUAL AIR ON NEXT AIRLOCK OPENING

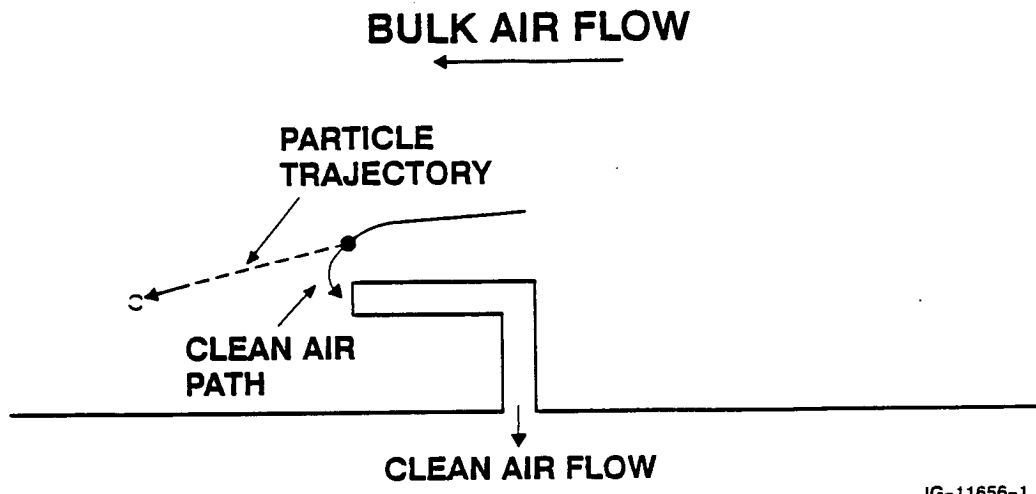

IG-11656-1

Figure 3. Use of a Reverse Facing Pitot Tube To Scavenge Clean Air Flow for Air Bearings

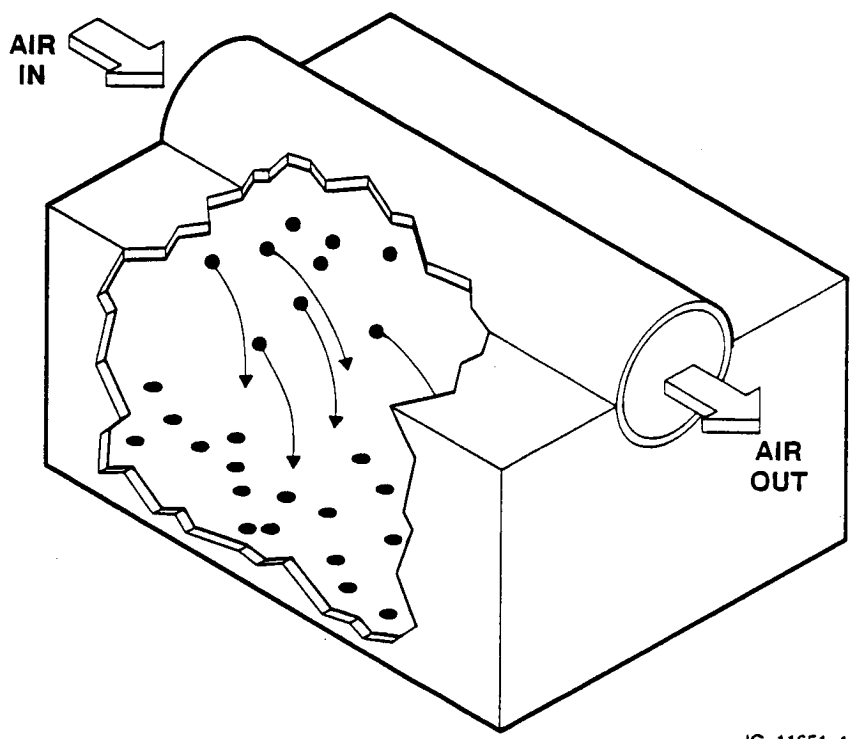

IG-11651-1

Figure 4. Settling Chamber for Dust Removal. Advantages Include Low Pressure Drop, Low Maintenance, and Simple Design. Disadvantages Include Large Volume and Low Efficiency.

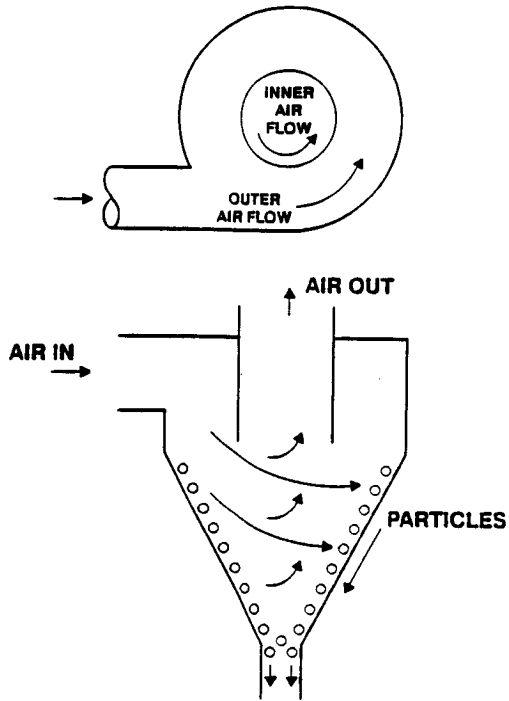

IG-11650-1

Figure 5. Cyclone for Dust Removal. Advantages Include Simple Design, Low Maintenance, Medium Pressure Drop, and High Load Capability. Disadvantages Include Large Volume and Medium Efficiencies.

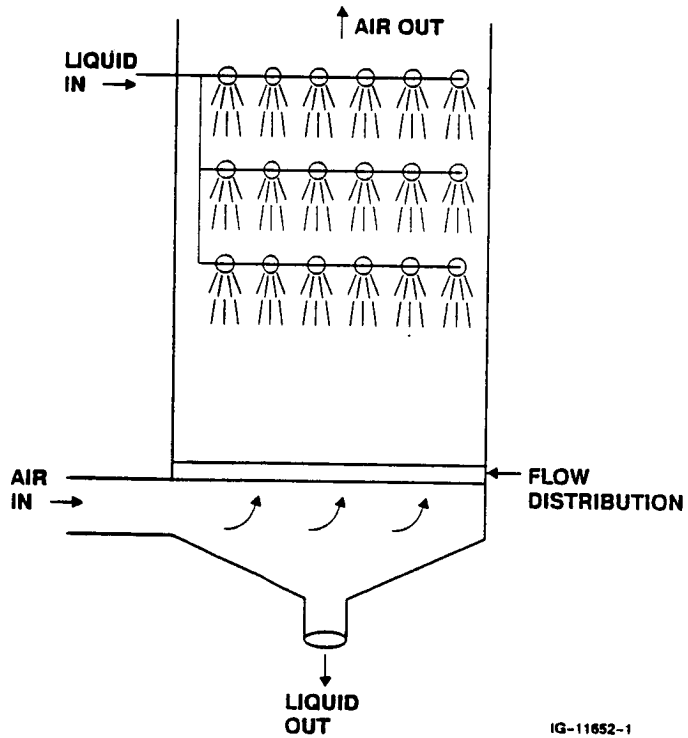

IG-11652-1

Figure 6. Wet Collector for Dust Removal. Disadvantages Include Need for Water Post-Treatment, Corrosion, and Resupply of Water to the Moon.

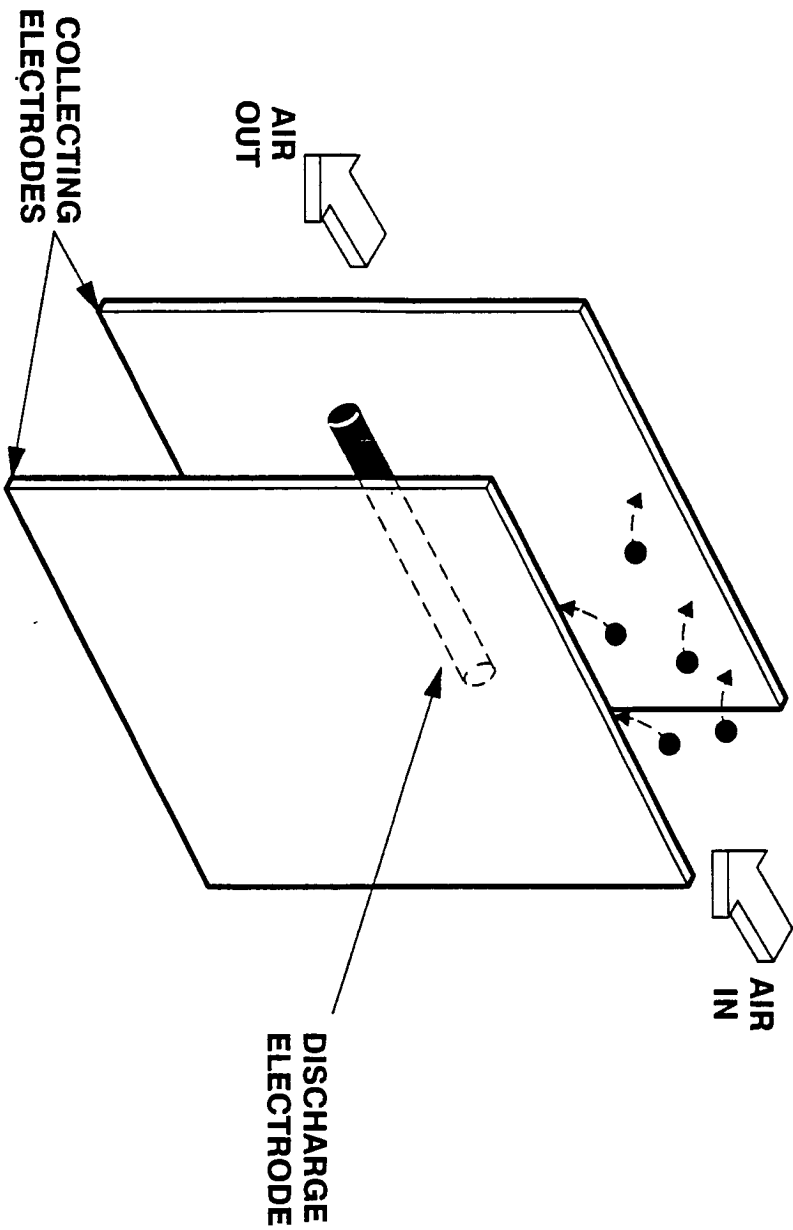

IG-11649-1

Figure 7. Electrostatic Precipitator for Dust Removal. Advantages Include High Efficiencies and Low Pressure Drop. Disadvantages Include High Voltage, Difficulties in Retaining Some Particles, and Requirements for Periodic Cleaning.

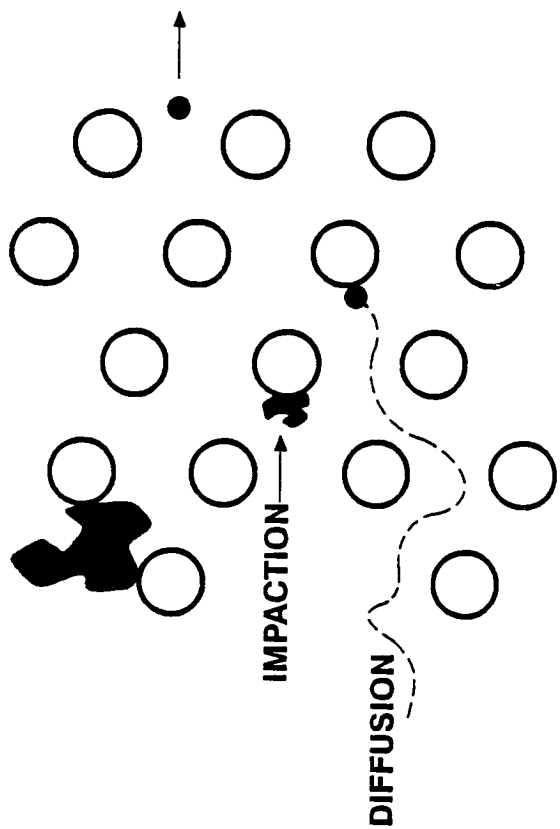

MEDIA FILTER

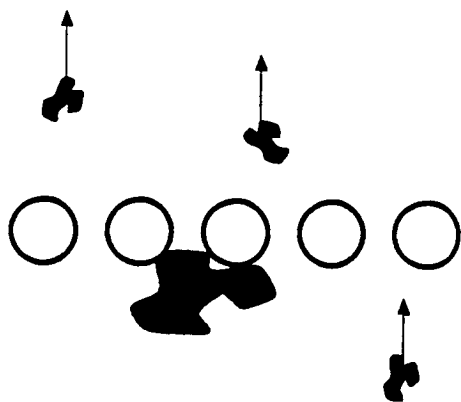

BARRIER FILTER

**ADAPTED FROM RAUBENHEIMER:
"SELECTION AND OPERATION OF
GAS TURBINE AIR FILTERS"**

Figure 8. Filters for Dust Removal. Barrier Filters Provide Absolute Size Cuts and Can Be Cleanable, but Have High Pressure Drops. Media Provide High Efficiency and Low Pressure Drops, but are Difficult to Clean, Necessitating Resupply of Media to the Moon.

IG-11648-1

omit

AUTOMATION AND COMMUNICATIONS

N 9 3 - 2 7 9 8 0

INTELLIGENT ROBOTS FOR PLANETARY EXPLORATION AND CONSTRUCTION

James S. Albus
National Institute of Standards and Technology

524-37
128338
p. 15

Abstract

Robots capable of practical applications in planetary exploration and construction will require real-time sensory-interactive goal-directed control systems. A reference model architecture based on the NIST Real-time Control System (RCS) for real-time intelligent control systems is suggested. RCS partitions the control problem into four basic elements: behavior generation (or task decomposition), world modeling, sensory processing, and value judgment. It clusters these elements into computational nodes that have responsibility for specific subsystems, and arranges these nodes in hierarchical layers such that each layer has characteristic functionality and timing.

Planetary exploration robots should have mobility systems that can safely maneuver over rough surfaces at high speeds. Walking machines and wheeled vehicles with dynamic suspensions are candidates. The technology of sensing and sensory processing has progressed to the point where real-time autonomous path planning and obstacle avoidance behavior is feasible. Map-based navigation systems will support long-range mobility goals and plans.

Planetary construction robots must have high strength-to-weight ratios for lifting and positioning tools and materials in six degrees-of-freedom over large working volumes. A new generation of cable-suspended Stewart platform devices and inflatable structures are suggested for lifting and positioning materials and structures, as well as for excavation, grading, and manipulating a variety of tools and construction machinery.

Introduction

The Real-time Control System (RCS) is a reference model architecture for intelligent real-time control systems. It partitions the control problem into four basic elements: task decomposition, world modeling, sensory processing, and value judgment. It clusters these elements into computational nodes that have responsibility for specific subsystems, and arranges these nodes in hierarchical layers such that each layer has characteristic functionality and timing. The RCS architecture has a systematic regularity, and recursive structure that suggests a canonical form.

Four versions of RCS have been developed. RCS-1 and 2 perform task decomposition using state tables similar in many respects to Brooks' behavior generators¹. RCS-2 adds model based image processing. RCS-3 introduces an explicit World Model, an operator interface, and refines the task decomposition module into a Job Assignment, Planning, and Execution triplet similar to Saridis' model.² RCS-3 was applied to space telerobotics to become NASREM.³ RCS-4, currently under development, includes explicit Value Judgment modules, as suggested by Pugh,⁴ and sophisticated multilevel tracking filter interaction between sensory processing and world modeling⁵. It also contains object-oriented entity lists and multi-resolution maps as suggested by Meystel⁶.

Systems based on the RCS architecture have been implemented more or less for a wide variety of applications that include loading and unloading of parts and tools in machine tools, controlling machining workstations, performing robotic deburring and chamfering, and controlling space station telerobots, multiple autonomous undersea vehicles, unmanned land vehicles, coal mining automation systems, postal service mail handling systems, and submarine operational automation systems.

A Machining Workstation Example

Figure 1 illustrates how the RCS-3 (i.e. NASREM) system architecture can be applied to a manufacturing workstation consisting of a machine tool, a robot, and a part buffer. RCS-3 produces a layered graph of processing nodes, each of which contains a Task Decomposition (TD), World Modeling (WM), and Sensory Processing (SP) module. These modules are richly interconnected to each other by a communications system. At the lowest level, communications are typically implemented through common memory or message passing between processes on a single computer board. At middle levels, communications are typically implemented between multiple processors on a backplane bus. At high levels, communications can be implemented through bus gateways and local area networks. The global memory, or knowledge database, and operator interface (described in reference 3) are not shown in Figure 1.

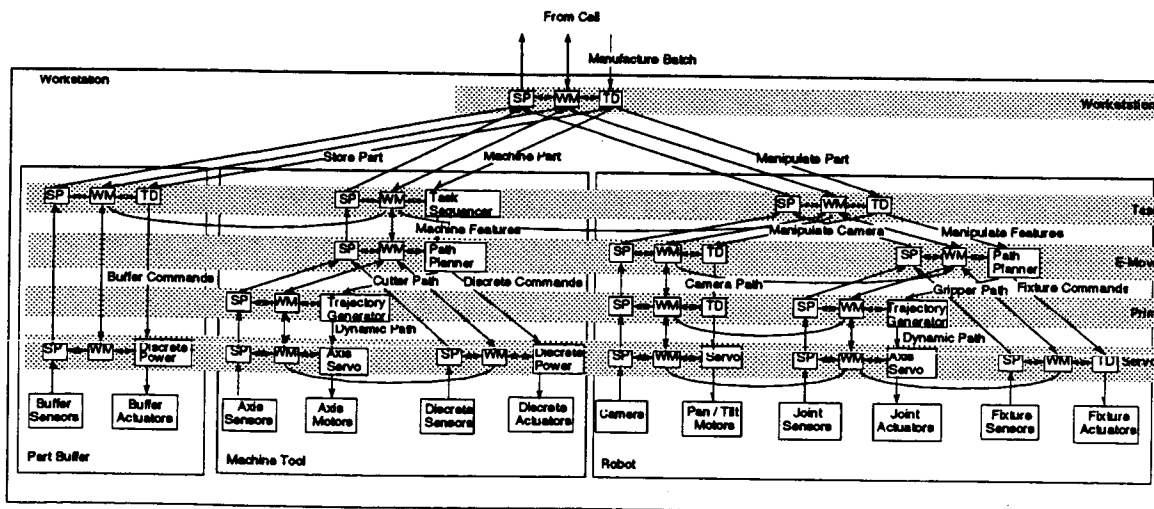

Figure 1. A RCS-3 implementation of a typical machining workstation.

Figure 1 illustrates the ability of RCS-3 to integrate discrete sensors such as microswitches with more complex sensors such as cameras and resolvers. Discrete commands can be issued to valves and fixtures, while continuous signals are provided to servoed actuators. Notice that in some branches of the control tree, nodes at some levels may be absent. For example, in the case of the part buffer, discrete commands at the Task level can be directly executed by the Servo level. In the case of the part fixture, discrete commands issued from the robot E-Move level can be executed by the Servo level. In these cases, the missing modules can be thought of as degenerate computing nodes that produce unity gain pass-through of inputs to outputs.

The branching of the control tree (for example, between the camera and manipulator subsystems of the robot), may depend on the particular algorithm chosen for decomposing a particular task. The specifications for branching reside along with other task knowledge in the task frames (defined in reference 4) of the tasks being concurrently executed in each of the TD modules. Similarly, the specifications for sharing information between WM modules within a level also are task dependent and may be specified in the appropriate task frames. In *Figure 1*, the horizontal curved lines represent the sharing of state information between subtrees in order to synchronize interacting concurrent tasks.

Functionality of RCS Levels

Levels in the RCS command hierarchy are defined by temporal and spatial decomposition of goals and tasks into levels of resolution, as well as by spatial and temporal integration of sensory data into levels of aggregation. Temporal resolution is manifested in terms of loop bandwidth, sampling rate, and state-change intervals. Temporal span is measured in length of historical traces and planning horizons. Spatial resolution is manifested in the resolution of maps and grouping of elements in subsystems. Spatial span is measured in range of maps and the span of control. The functionality of each level in the control hierarchy can be derived from the characteristic timing of that level, and vice versa. For example, in the manufacturing workstation example, the following hierarchical levels have been defined.

Level 6 – Cell

The cell level schedules and controls the activities of several workstations for about a one hour look ahead. (The specific timing numbers given in this example are representative only, and may vary from application to application.) Batches of parts and tools are scheduled into workstations, and commands are issued to workstations to perform machining, inspection, or material handling operations on batches or trays of parts. The world model symbolic database contains names and attributes of batches of parts and the tools and materials necessary to manufacture them. Maps describe the location of, and routing between, workstations. The output from the cell level provides input to the workstation level.

Level 5 – Workstation

The workstation level schedules tasks and controls the activities within each workstation with about a five minute planning horizon. A workstation may consist of a group of machines, such as one or more closely coupled machine tools, robots, inspection machines, materials transport devices, and part and tool buffers. Plans are developed and commands are issued to equipment to operate on material, tools, and fixtures in order to produce parts. The world model symbolic database contains names and attributes of parts, tools, and buffer trays in the workstation. Maps describe the location of parts, tools, and buffer trays.

Level 4 -- Equipment task

The equipment level schedules tasks and controls the activities of each machine within workstation with about a 30 second planning horizon. (Tasks that take much longer may be broken into several 30 second segments at the workstation level.) Level 4 decomposes each equipment task into elemental moves for the subsystems that make up each piece of equipment. Plans are developed that sequence elemental movements of tools and grippers, and commands are issued to move tools and grippers so as to approach, grasp, move, insert, cut, drill, mill or measure parts. The world model symbolic database contains names and attributes of parts, such as their size and shape (dimensions and tolerances) and material characteristics (mass, color, hardness, etc.). Maps consist of drawings that illustrate part shape and the relative positions of part features.

Level 3 - Elemental move (E-move)

The E-move level schedules and controls simple machine motions require a few seconds, such GO-ALONG-PATH, MOVE-TO-POINT, MILL-FACE, DRILL-HOLE, MEASURE-SURFACE, etc. (Motions that require significantly more time may be broken up at the task level into several elemental moves.) Plans are developed and commands are issued that define safe path waypoints for tools, manipulators, and inspection probes so as to avoid collisions and singularities, and assure part quality and process safety. The world model symbolic database contains names and attributes of part features such as surfaces, holes, pockets, grooves, threads, chamfers, burrs, etc. Maps consist of drawings that illustrate feature shape and the relative positions of feature boundaries.

Level 2 -- Primitive

The primitive level plans trajectories for tools, manipulators, and inspection probes so as to minimize time and optimize performance. It computes tool or gripper acceleration and deceleration profiles taking into consideration dynamical interaction between mass, stiffness, force, and time. Planning horizons are on the order of 300 milliseconds. The world model symbolic database contains names and attributes of linear features such as lines, trajectory segments, and vertices. Maps (when they exist) consist of perspective projections of linear features such as edges or lines on parts, or trajectories of tools or end-effectors.

Level 1 - Servo level

The servo level transforms commands from tool path to joint actuator coordinates. Planners interpolate between primitive trajectory points with a 30 millisecond look ahead. Executors servo individual actuators and motors to the interpolated trajectories. Position, velocity, or force servoing may be implemented, and in various combinations. Commands that define actuator torque or power are output every 3 milliseconds (or whatever rate is dictated by the machine dynamics and servo performance requirements). The servo level also controls the output drive signals to discrete actuators such as relays and solenoids. The world model symbolic database contains values of state variables such as joint positions, velocities, and forces, proximity sensor readings, position of discrete switches, condition of touch probes, as well as image attributes associated with camera pixels. Maps consist of camera images and displays of sensor.

At the Servo and Primitive levels, the command output rate is perfectly regular. At the E-Move level and above, the command output rates typically are irregular because they are event driven. Details of how RCS represents and uses task knowledge, states, entities, events, and maps have been published elsewhere.⁵

For planetary exploration and construction robots, not all the levels defined above must be implemented. An operator interface to each of the levels provides the capability for teleoperation and supervisor control. Many near term applications can be accomplished without the upper levels defined in *Figure 1*. However, the RCS architecture provides for future expansion of capabilities leading toward greater autonomy and intelligence.

Structural and Mobility Issues

Planetary exploration and construction robots must have more than intelligent controls. They must be structurally designed so that they can safely maneuver over rough surfaces at reasonably high speeds. They also must have high strength-to-weight ratios for lifting and positioning tools and construction materials over large working volumes.

The SPIDER -- which stands for Stewart platform Independent Drive Environmental Robot -- is a new type of robot crane that is well suited for many manufacturing or construction tasks, or for work in remote and hostile environments such as leaning up nuclear or toxic waste sites, or for construction and exploration tasks on the Moon or Mars.

Conventional cranes can lift heavy loads, but they cannot rigidly position those loads so as to exert large rotational torques or lateral forces. The SPIDER overcomes these deficiencies. It can rigidly support heavy loads and exert the large lateral forces and torques needed to operate excavators, chain saws, and various kinds of drilling or grinding tools.

For several years, the Robot Systems Division at NIST has been experimenting with new concepts for robot cranes.⁽⁷⁻¹²⁾ These concepts utilize the basic principle of the Stewart Platform. A unique feature of this approach is to use six cables instead of six rigid legs to form the Stewart Platform. So long as all six cables are in tension, the lower work platform (from which the robot is suspended) is kinematically constrained, and can resist perturbing forces and torques up to a threshold determined by the weight of the load. This means that the suspended robot can exert forces and torques to as to maneuver and operate tools such as drills, saws and grinders. The position, velocity, and force of tools and heavy machinery can be precisely controlled in all six degrees of freedom (x, y, z, roll, pitch, and yaw).

The basic configuration, shown in *Figure 2*, consists of a triangular work platform suspended from an upper structure by six cables controlled by six winches. In the configuration shown in *Figure 2*, an octahedron structure provides the mechanical support for the system. The top of the octahedron is an equilateral triangle. From each vertex of this triangle are suspended two pulleys, each of which supports one of the six cables.

By simultaneously controlling the winches in a coordinated fashion, the work platform can be precisely controlled. The winches can be controlled manually by a six axis joystick, such as shown in *Figure 3*, or can be automatically controlled by computer. Various combinations of position, velocity, and force control in both manual and automatic modes can be utilized. For example, x and y position can be automatically controlled and z position controlled manually, or, position can be controlled automatically and velocity controlled manually, as well as many other possible combinations.

The geometric shape of the NIST SPIDER gives it an extremely high strength-to-weight ration. All structural members are either in pure compression or pure tension (except for supporting their own weight). As a result, this SPIDER can lift and manipulate loads many time its own weight. This is an order of magnitude improvement over conventional cranes which typically weigh (including

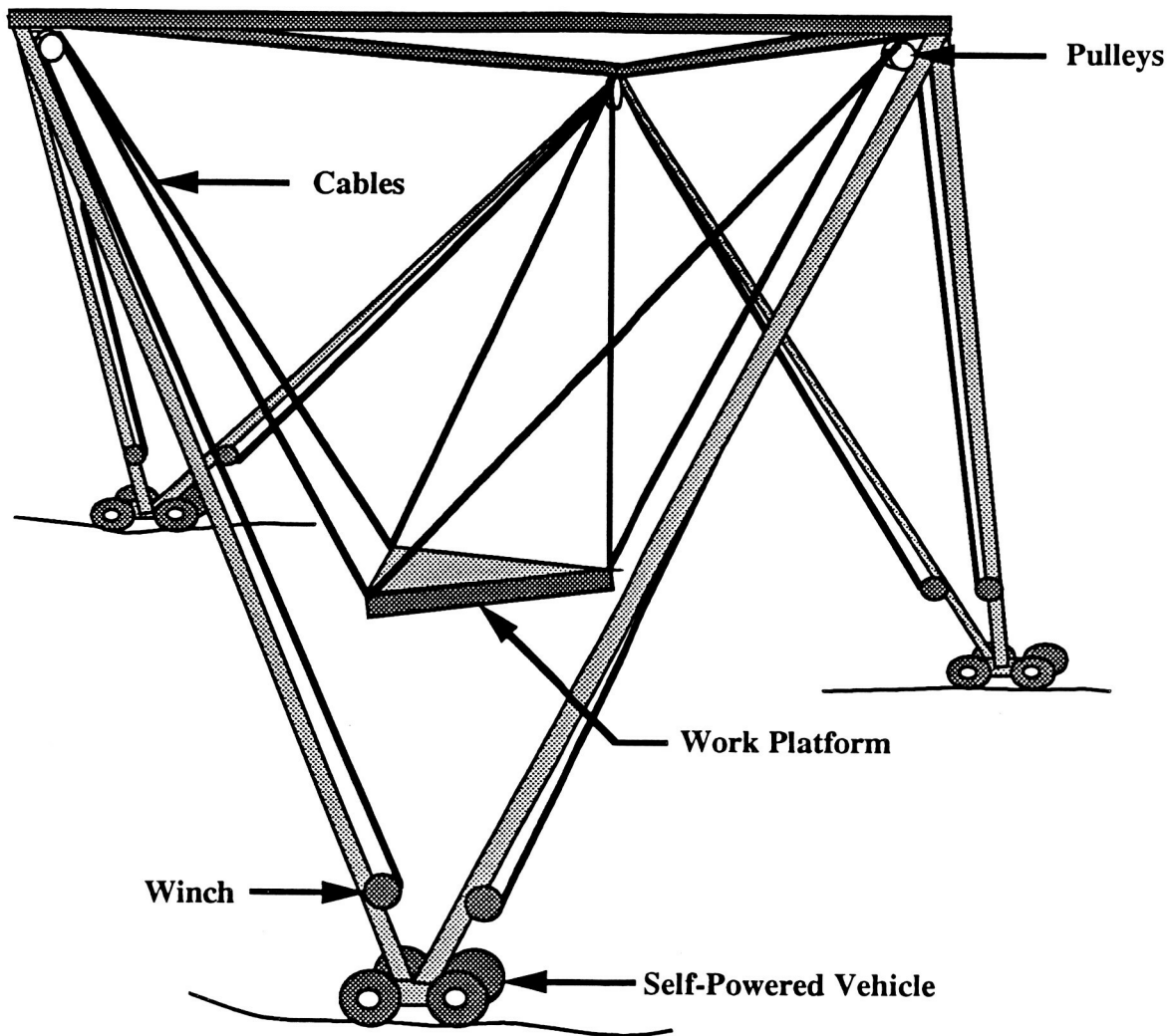

Figure 2. The NIST robot crane. An octahedron structure with an equilateral triangle at the top supports a work platform that can carry various tools or equipment. The work platform is suspended by six cables that are controlled by six winches.

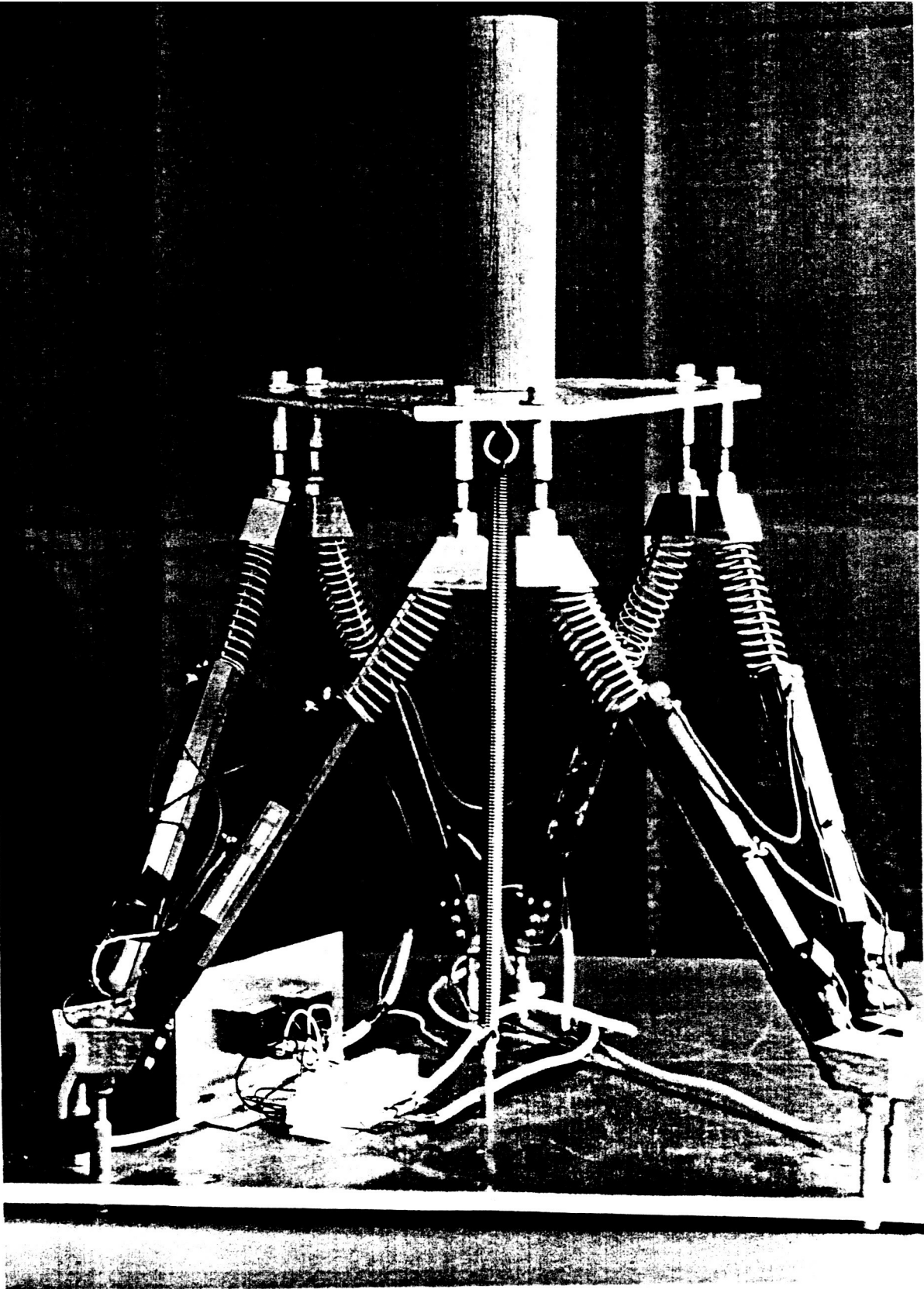

Figure 3. A Stewart Platform Joystick that can be used as a replica master for manual control, or with a computer for shared control.

counterweight) several times more than they can lift. Other configurations are possible. Designs for boom or tower cranes using six cables to stabilize and manipulate the load are possible. Designs using three towers supported by guy wires can be made up to several hundred feet on a side. This design can also be adapted to underwater applications and can be even larger.

The SPIDER scales easily to much larger sizes and versions with dimensions of several hundred feet made from cross-braced triangular trusses are feasible. Depending on the size and strength of the particular structural configuration, the work volume can range from 10 feet to over 100 feet on a side, and the lift capacity may range from 1000 pounds to over 20 tons. This makes the NIST robot crane design capable of manipulating heavy tools and machinery over large work volumes for cutting, excavating, shaping, and finishing applications.

For mobility, the three support points at the base of the octahedron can be carried by three vehicles, as shown in *Figure 3*. The light weight of the NIST robot crane and its three point suspension keeps ground pressure to a minimum. The SPIDER model shown in *Figure 3* is two meters high.

Recently the 2-meter SPIDER has been given a long neck to support a pan/tilt head with a suite of cameras as shown in *Figure 5*. This configuration has been nick-named, "The HORSE". The long neck lifts the HORSE'S head 3 meters above the ground and about two meters ahead of its front feet. This enables the HORSE to see far into the distance for mapping and path planning, as well as straight down immediately ahead so as to avoid holes and ditches. It can also see over obstacles up to 3 meters high. A laser scanner could be mounted at the base of the HORSE's neck so as to provide terrain elevation cues. Cameras mounted on the SPIDER platform suspended within the HORSE body, can be used for manipulating tools and deploying instruments.

Each of the HORSE's three legs are attached through a universal joint to a tracked vehicle. A sensor in each mounting attachment measures the orientation of the vehicle relative to the leg. The legs of the HORSE are constrained by a set of cables and springs so as to provide a flexible suspension. Sensors in the HORSE frame measure the spreading of the legs.

An operator can use a joystick to command the HORSE to move and turn. Steering algorithms were developed first on a graphics simulator, to be later implemented on the hardware model. Data from the vehicle orientation sensors are combined with data from leg position sensors and operator steering commands, and sent to a computer. The computer calculates the proper speed for each of the six tracks to make all three vehicles move and turn in a coordinated manner so as to maintain the desired spacing between vehicles while performing the commanded translation and rotation maneuvers.

The mobility characteristics of the HORSE are extremely good, because the effective wheel base is the separation between the vehicles. The center of gravity of the HORSE can be controlled by maneuvering the work platform. This can enable the HORSE to cope with 30 degree slopes, and could be used to improve the dynamic characteristics of the HORSE while traveling at high speed.

Once the HORSE has moved into position over a work site, the SPIDER work platform can be maneuvered so as to collect soil samples or deploy instruments. The SPIDER has been fitted with a tool changer and a set of power tools representative of what might be used by NASA for lunar and planetary exploration or construction tasks. The platform can be maneuvered to pick-up tools or instruments from a storage rack. Using a backhoe, the SPIDER can gather soil or loose rock samples and deposit them in a processing unit.

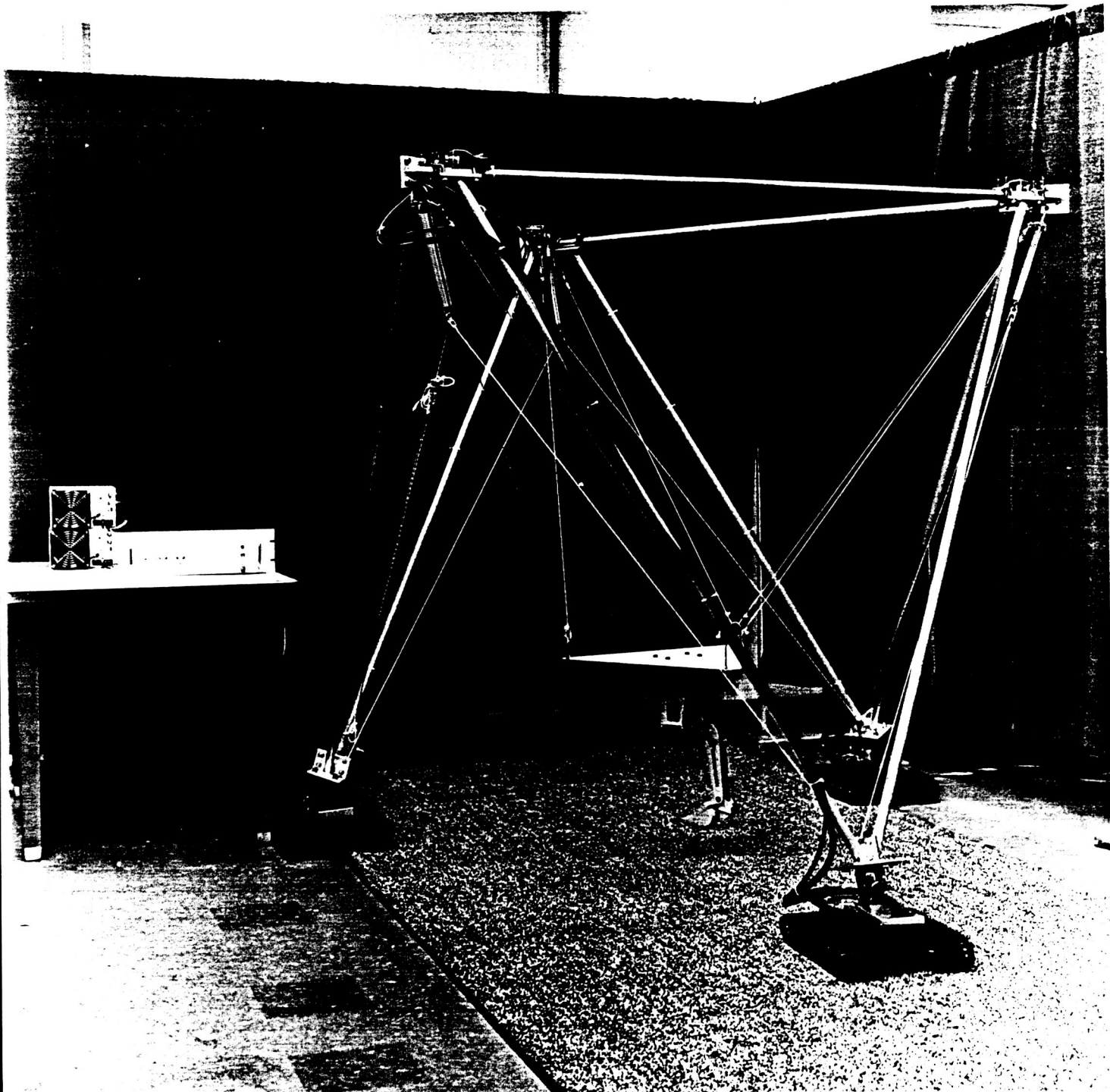

Figure 4. Photograph of a small scale model of the SPIDER using remote controlled track vehicles for mobility. The structure is made from 6-foot sections of 1 inch aluminum tubing. A remote controlled model excavator is mounted to the work platform.

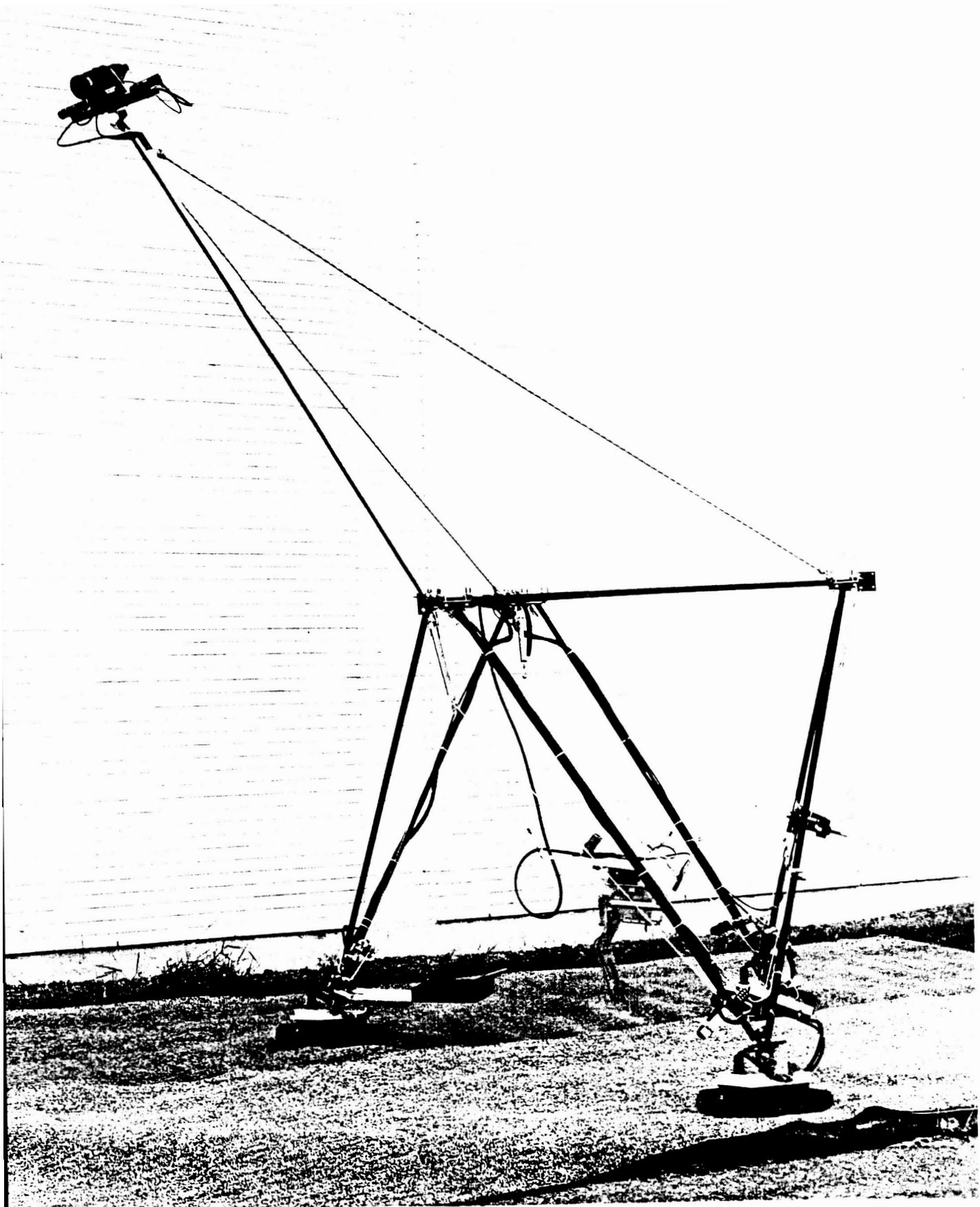

Figure 5. Photograph of the HORSE showing the mobility camera system mounted on a long neck.

Using an auger, the SPIDER can drill into the planetary surface to collect core samples or to deploy seismic sensors. Cameras mounted on the work platform are used to guide these operations.

In order to test and demonstrate heavy lift and positioning capabilities, a six meter version of the SPIDER has been constructed. This is shown in *Figure 6*. It weighs a total of 1000 pounds, and can support and manipulate a load of 2 tons.

The six meter SPIDER is constructed of four inch diameter aluminum tubing and is powered by six electric winches. The cables are 3/16th inch braided steel. They run from the winches up and over pulleys at the vertices of the upper triangle, and back down to the lower work platform. The work platform is made of aluminum I-beams.

The winches are controlled by the joystick shown in *Figure 2*. The joystick can be located remotely, or mounted directly on the platform. The operator flies the platform much like a pilot flies an airplane. Laboratory tests have shown that a linear precision of 0.125 inches and an angular precision of 0.5 degrees can easily be achieved with loads of up to 3000 pounds.

Potential Applications

Depending on what is attached to its work platform, the NIST SPIDER can perform a variety of tasks as illustrated by the following examples. In any of these applications, the robot crane motions can be controlled manually, or from computer programs such as those currently used for numerically controlled machine tools, or from databases generated by computer aided design systems.

Cutting:

The SPIDER can manipulate a variety of saws (chain saw, wire saw, or disc saw), rotary cutting tools (router, milling tool, or grinding tool), abrasive jet tools (water jet or air jet), flame cutters, or pneumatic or hydraulic cutters and chisels for cutting concrete, steel, wood, or stone. In the laboratory, NIST has demonstrated sawing an oak log with a chain saw attached to the work platform, as shown in *Figure 8*. The SPIDER can produce large forces with accuracies sufficient for many types of machining operations, including milling, routing, drilling, grinding, and polishing.

Excavating and Grading:

The SPIDER can manipulate digging devices (ditching or trenching machines, excavators, back hoes, augers, or scrapers) precisely over the ground in either a manual or computer controlled mode. Dirt, stone concrete, or asphalt can be removed from a large volume with great precision. The robot can easily maneuver loads of several tons. This implies that the robot work platform can carry a gasoline or diesel engine, power transmission system and tooling required to apply many horsepower to the task of excavating and grading. The SPIDER can also carry a large bucket for removing soil and loading it in trucks or conveyors.

Shaping and Finishing:

The SPIDER can manipulate grinders, polishers, buffers, paint sprayers sandblasters, and welding torches over large objects (ship hulls, structural steel, castings and weldments, or concrete structures). It can apply controlled amounts of force and resist perturbations in all directions.

Lifting and Positioning:

The SPIDER can be fitted with a variety of gripping devices so as to lift and precisely position heavy loads such as concrete or steel beams and pillars. The robot can exert controlled forces to mate and seat loads and can resist perturbations such as wind and inertial forces. Precision motions can easily be achieved while maneuvering large loads.

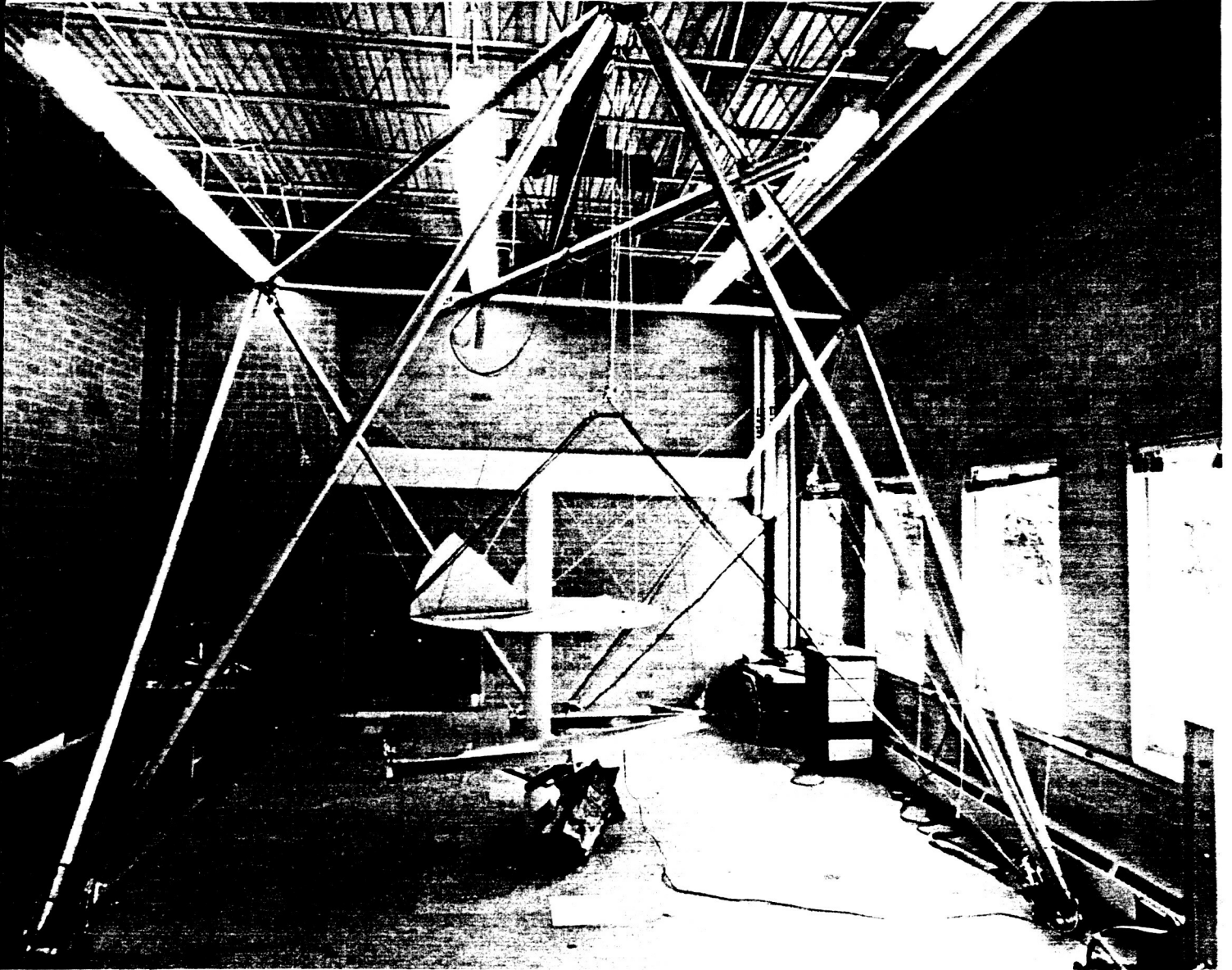

Figure 6. Photograph of a midsize scale model of the SPIDER. The structure is made from 20 foot sections of four inch aluminum tubing.

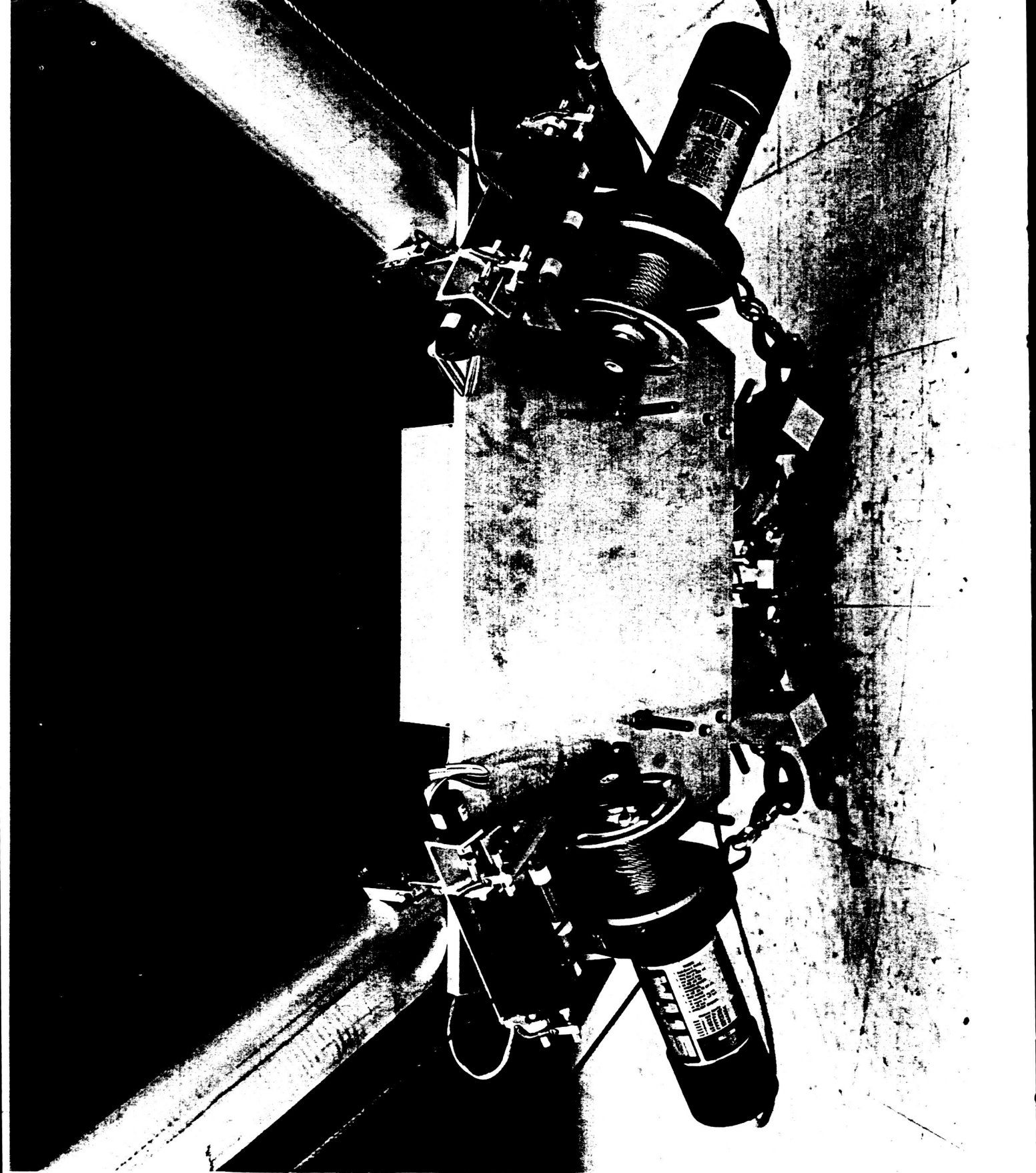

Figure 7. Photograph of a pair of winches used on the midsize scale model NIST SPIDER.

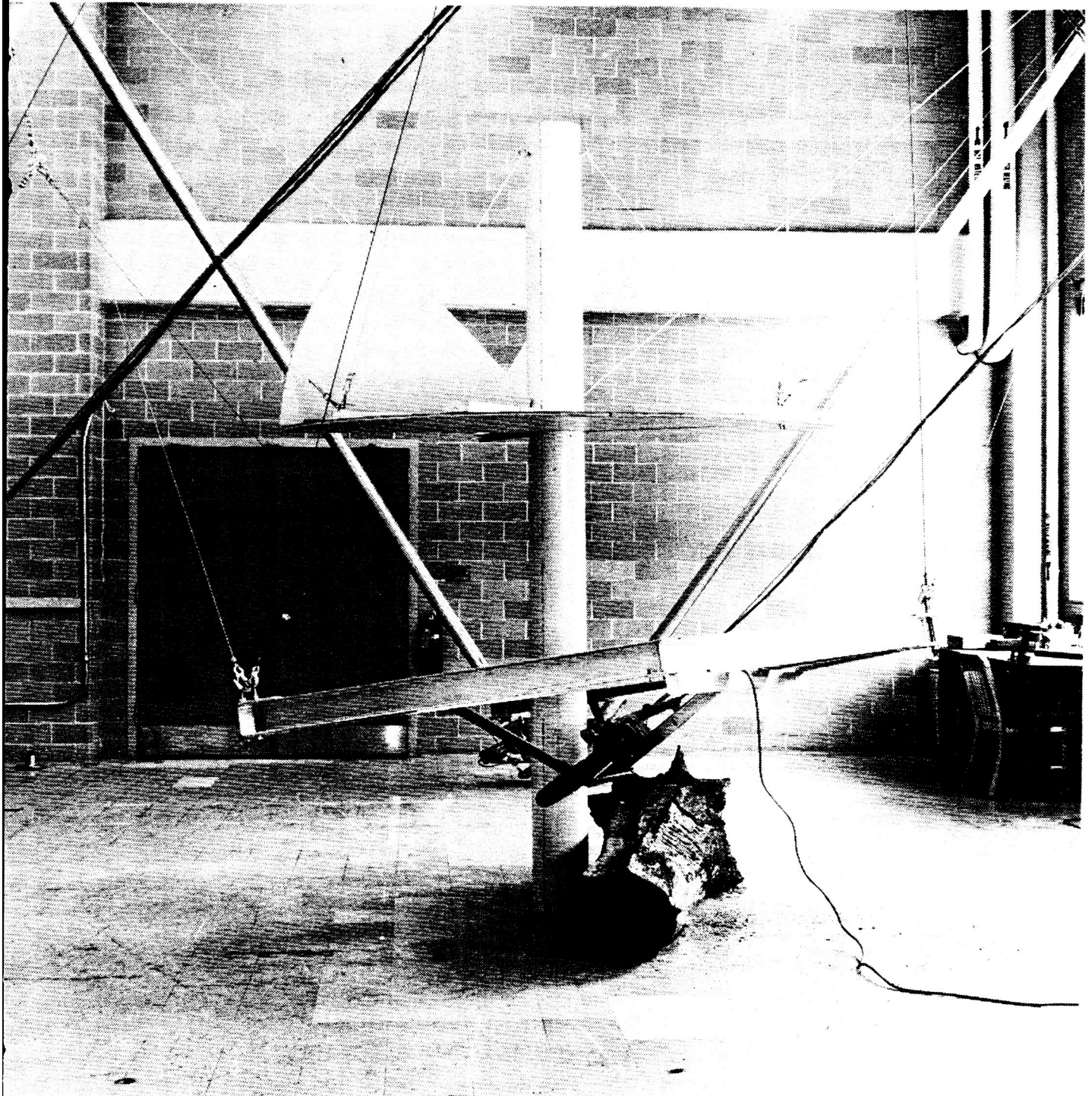

Figure 8. Photograph of a chain-saw attached to the work platform of the midsize scale model.

The work platform can exhibit sufficient stiffness to serve as a fixture for holding parts during assembly or construction operations. Parts weighing several tons can be held rigidly so as to resist forces of many hundreds of pounds and torques of hundreds of foot pounds with stiffnesses of tons per inch. An industrial robot can be mounted to the bottom of the work platform and it can, for example, perform assembly tasks on the load being positioned by the robot crane.

Summary and Conclusion

In the future as part of an on-going research program, NIST will mount a pair of arms and a pair of cameras on the SPIDER work platform. These will be used to investigate a wide variety of teleoperation and autonomous control issues. For example, force controlled manipulation, hand/eye coordination, obstacle avoidance, and active foveal/peripheral vision will be studied. The mobility of the HORSE will be improved. Image-flow, fixation, stereo, and laser scanners will be used for navigation, path-planning, mapping, and obstacle avoidance. The long term goal is to integrate the SPIDER work platform with the HORSE mobility platform into a general-purpose intelligent man-machine system. In the short term, however, the technology has already been demonstrated for teleoperated applications such as are required for lunar and planetary exploration and construction.

REFERENCES

- ¹R. Brooks, "A Robust Layered Control System for a Mobile Robot", IEEE Journal of Robotics and Automation, vol. RA-2, 1, March, 1986.
- ²G.N. Saridis, "Foundations of the Theory of Intelligent Controls", IEEE Workshop on Intelligent Control, 1985.
- ³J.S. Albus, H.G. McCain, and R. Lumia, "NASA/NBS Standard Reference Model for Telerobot Control System Architecture (NASREM)," National Institute of Standards and Technology, Technical Report 1235, Gaithersburg, MD, April, 1989.
- ⁴G.E. Pugh and G.L. Lucas, "Applications of Value-Driven Decision Theory to the Control and Coordination of Advanced Tactical Air Control Systems", Decision-Science Applications, Inc., Report No. 218, April, 1980.
- ⁵J.S. Albus, "Outline for a Theory of Intelligence", IEEE Trans. on Systems, Man, and Cybernetics, Vol.21, No.3, May/June 1991.
- ⁶A. Meystel, "Theoretical Foundations of Planning and Navigation for Autonomous Robots", International Journal of Intelligent Systems, 2, 73-128, 1987.
- ⁷Lee, J.D., Albus, J.S., Dagalakis, N.G., and Tsai, T.M., Computer Simulation of a Parallel Link Manipulator, Robotics and Computer Integrated Manufacturing, 5 (4), pp. 333-342, 1989.
- ⁸Unger, j., Dagalakis, N.G., Tsai, T.M., Lee, J.D., Optimum Stiffness Study of a Parallel Link Robot Crane under Horizontal Force, Proceedings of the Second International Symposium on Robotics and Manufacturing Research, Education, and Applications, Albuquerque, NM, November 16-18, 1988.
- ⁹Dagalakis, N.G., Albus, J.S. et al., Stiffness Study of a Parallel Link Robot Crane for Shipbuilding Applications, Transactions of the ASME Journal of Offshore Mechanics and Arctic Engineering, 111 (3), pp. 183-193, 1989.
- ¹⁰Dagalakis, N.G., Albus, J.S. Goodwin, K.R., et al, Robot Crane Technology (Final Report), NIST Technical Note 1267, National Institute of Standards and Technology, Gaithersburg, MD, July 1989.
- ¹¹Bostelman, R.V., Description of a Vibration Compensation System for the Small Scale Model Robot Crane Project, NIST Internal Report 4595, National Institute of Standards and Technology, Gaithersburg, MD, July 1991.
- ¹²Albus, J.S., Bostelman, R.V., and Dagalakis, N.G., The NIST Spider, A Robot Crane, to be published in a Special Issue of the Journal of Robotic Systems on "Parallel Closed-Kinematic Chain Manipulators and Devices", 1992.

Flexible Control Techniques for a Lunar Base

Thomas W. Kraus

Intec Controls Corporation

Abstract

525-63

158339
P. 8

The fundamental elements found in every terrestrial control system can be employed in all lunar applications. These elements include sensors which measure physical properties, controllers which acquire sensor data and calculate a control response, and actuators which apply the control output to the process.

The unique characteristics of the lunar environment will certainly require the development of new control system technology. However, weightlessness, harsh atmospheric conditions, temperature extremes, and radiation hazards will most significantly impact the design of sensors and actuators. The controller and associated control algorithms, which are the most complex element of any control system, can be derived in their entirety from existing technology.

Lunar process control applications -- ranging from small-scale research projects to full-scale processing plants -- will benefit greatly from the controller advances being developed today. In particular, new software technology aimed at commercial process monitoring and control applications will almost completely eliminate the need for custom programs and the lengthy development and testing cycle they require.

The applicability of existing industrial software to lunar applications has other significant advantages in addition to cost and quality. This software is designed to run on standard hardware platforms and takes advantage of existing LAN and telecommunications technology. Further, in order to exploit the existing commercial market, the software is being designed to be implemented by users of all skill levels -- typically users who are familiar with their process, but not necessarily with software or control theory. This means that specialized technical support personnel will not need to be on-hand, and the associated costs are eliminated. Finally, the latest industrial software designed for the commercial market is extremely flexible, in order to fit the requirements of many types of processing applications with little or no customization. This means that lunar process control projects will not be delayed by unforeseen problems or last minute process modifications. The software will include all of the tools needed to adapt to virtually any changes.

In contrast to other space programs which required the development of tremendous amounts of custom software, lunar-based processing facilities will benefit from the use of existing software technology which is being proven in commercial applications on Earth.

Introduction

Intec Controls is a seven-year-old company involved in designing, producing, marketing and selling process control software for the PC. Intec's products have been applied in many thousands of installations worldwide in a wide variety of different markets and applications. Although we have never installed any of our systems outside the planet Earth, it is important to recognize that the flexibility inherent in Intec-developed systems still applies.

This paper first covers the fundamental elements of close-looped control, pointing out that these basic concepts are as applicable on the Moon as they are on the planet Earth. Secondly, control system design is addressed, with emphasis on the flexibility that is inherent in a software package that uses graphical programming methods. Next, control hardware issues are discussed, with an emphasis on the flexibility and cost advantages of using standard hardware on a lunar base as opposed to proprietary hardware. Lastly, system reliability is addressed, pointing out the benefits of using control systems which have been heavily tested in thousands of installations on the planet Earth.

Body

Closed-loop control has been around for many decades. Through that period of time, the PID (Proportional Integral Derivative) Controller has flourished and become the main workhorse in the process industry. The PID Controller is not used as heavily when we are talking about the control of advanced aerospace guidance or propulsion systems -- there are much more modern approaches to handling these systems. However, it is important to note that the power of PID is especially apparent when we are dealing with a process system that does not have vibratory nature and is subject to many non-linearities and many perturbations. In other words, when the process dynamics are not as well understood.

With the lunar base, we are dealing with processing many types of materials, extraction of oxygen from rock and other processes which involve chemistry, mechanics and thermodynamics. The fact that PID is so heavily used in process plants presently is testimony to its robustness, and I propose, its applicability to a lunar base. It has been proven repeatedly that the PID algorithm is robust, well adapted and able to handle a variety of situations. Furthermore, when one closes a control loop around a very unknown type of process and perturbs that loop by making a setpoint change or making a load disturbance, the closed loop dynamics is typically a damped oscillation when the loop is properly tuned. The exact details of the dynamics of the process does not matter--the PID makes these different processes behave very similarly. Actually, it allows the process dead time to be taken into account as well. Let us now move on and cover the applicability of using standard software for controlling the lunar base.

The first issue I would like to discuss is graphic programming language. As we see in *Figure 1*, graphic programming involves connection: the ability to specify various types of algorithms, put these algorithms down on the computer screen, and draw lines between them to represent the flow of data. When you click on any one of the algorithms, up pops a specification box which allows you to input the specific parameters necessary for the algorithms. The ease of use of graphic programming encourages free thinking. It quickly allows engineers to make changes as need be. Furthermore, the graphic programming allows better understanding of the control system and it also allows a more reliable system because when changes are made, we have connected, tested and understood algorithms instead of working with a large amount of custom code.

Figure 2 shows a little more detail of graphic programming where a temperature control loop and a flow control loop are tied together through a low signal selector. In this particular case, we are typically controlling flow. However, if the temperature starts to rise too high, we will cut back on the flow in spite of the fact that we have not achieved it. It is this kind of graphic programming that

Figure 1

Intuitive Software for Manufacturing Excellence

DESIGN AND ENGINEERING

Graphic Programming Language

Easy to learn and use.

ADD TEMPLATE (ADD) = PCT

TAG	= FINAVG	UNITS	=	
DESC	= AVERAGE FLOWS	SCAN	=	1.000000 Sec
HI RANGE	= 100.0000	HI LIMIT	=	100.0000
LO RANGE	= 0.000000	LO LIMIT	=	0.000000
INPUT 1	= E	INPUT 2	=	E
K1	= 0.500000	K2	=	0.500000

Click the mouse or Press Escape key to exit menu.

AIN 0

AIN 0

1 ADD

2 FINAVG

ADD SUB MUL DIV AVG SQRT EXP2 LIBRARY

PC: 10/15/90 X: 1540 Y: 1728

INTEC

Figure 2

Intuitive Software for Manufacturing Excellence

CREATIVITY AND INNOVATION

Graphic Programming Language

Natural language of engineers encourages free thinking.

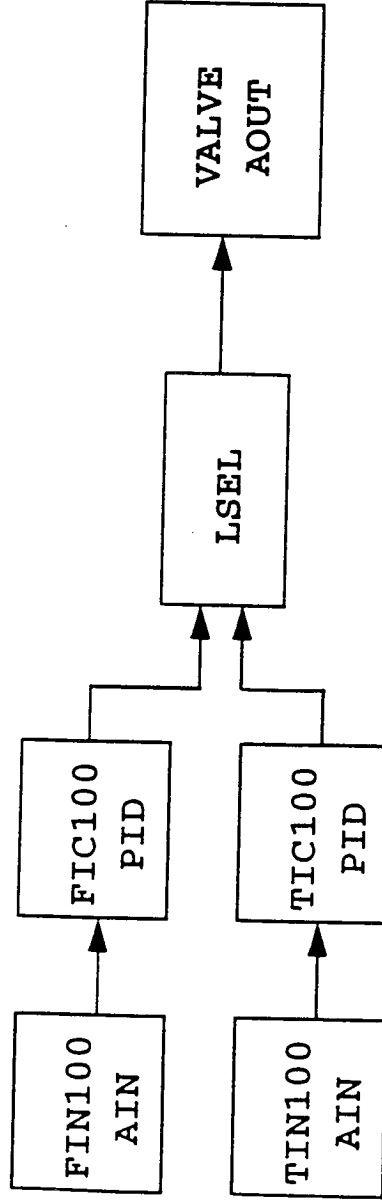

allows changes to be made by one engineer even though it was another engineer who initially specified the system and installed it years ago.

Another aspect of graphical programming is being able to nest functionality. The connected function blocks illustrated in *Figure 2* can be grouped into a single block and saved as a "compound" block. *Figure 3* illustrates how compounds can be nested inside one another. This allows engineers to construct algorithms based upon the standard function blocks, save this collection of blocks as a compound, and then use these algorithms over and over again as need be. In any system, including a lunar base, there is much symmetry. If there is one reactor, there are likely to be a half dozen or a dozen. So what we do to control one is directly applicable to the next reactor and the next one and so forth. The methods of graphic programming greatly simplify the task of replicating functionality.

What about the flexibility of standard hardware? What is meant by standard hardware is hardware that is based upon PC technology -- meaning mostly the Intel microprocessor. This paper does not attempt to comment on the details of cosmic radiation and so forth. However, it certain that by utilizing standard hardware, one is able to utilize a vast amount of standard software. By doing so, we greatly diminish not only the time to get a job done, but also the costs involved in performing a specified activity, as well as the quality and reliability of the software that goes into it.

As shown in *Figure 4*, by using standard hardware, we are even able to utilize standard local area network technology to move information from Point A to Point B in the lunar base. Furthermore, we are able to distribute processing and the CPU power necessary to make things happen. Also, such systems are upgradeable. With new technology, new hardware becomes available and you can utilize the same software or later versions of that software without having to redo the entire application. The benefits are tremendous. We are talking about 586 machines in the not too distant future.

Standard hardware also gives us a degree of openness. Openness to connect between various types of hardware, again using standard software. Functions such as alarms and reports can all be done in a straight forward manner without special coding. Standard hardware also allows us, as shown in *Figure 5*, to utilize methods and techniques that are very applicable in other industries and directly utilize them for the lunar base again where appropriate.

As discussed previously, another benefit of utilizing standard software is the reliability issue. Because such software has been tested in literally thousands of installations, one can be assured that when conditions change in the lunar base, creating situations beyond those covered by the normal testing that might have been done on commissioning of the system, it is highly unlikely that there will be some sort of severe breakdown. It is more than likely that someone has applied the system in these unexpected conditions in one of the thousands of Earthbound applications. If a system is put together just for a lunar base, it does not receive the same degree of testing -- it is impossible. So applying standard industrial software has strong advantages -- the concepts work and are very applicable to a lunar base.

Summary

In conclusion, the proven methods of control, namely the PID controller and other algorithms, still apply for a lunar base as they have applied for many years on the planet Earth. Second, graphic programming language gives a high degree of flexibility and also has a high degree of reliability from a software point of view. By utilizing standard hardware, we are able to greatly reduce the system cost and again contribute to reliability.

Figure 3

Intuitive Software for Manufacturing Excellence

DESIGN AND ENGINEERING

Compounds

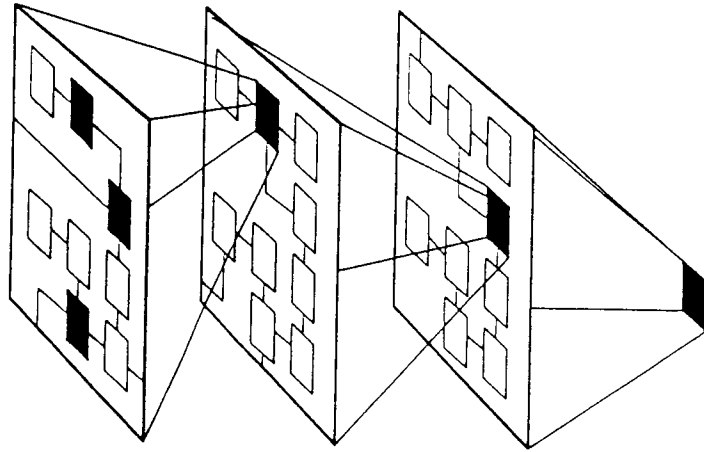

- Replicate functionality to eliminate repetitive design/testing man-hours & reduce errors.
- Store design subsets in a library to allow rapid access and sharing of designs with other jobs.
- Hierarchical top-down or bottom-up design allows easy comprehension and manipulation.



Figure 4

Intuitive Software for Manufacturing Excellence

DESIGN AND ENGINEERING

Future Growth with Minimum Re-design

- Upgradable.
- Expandable.

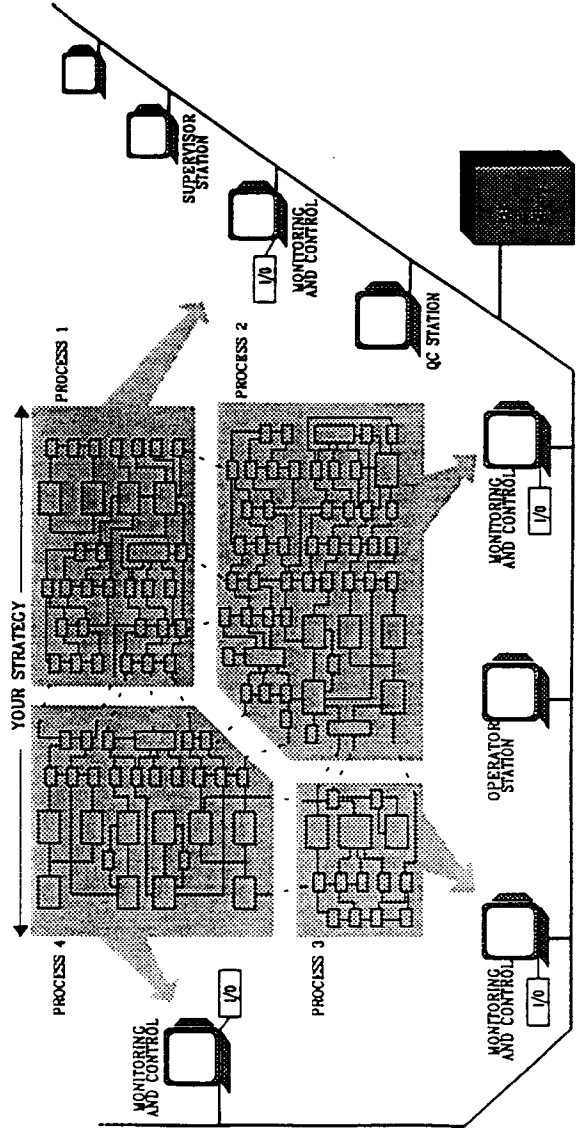

Figure 5

Intuitive Software for Manufacturing Excellence

CREATIVITY AND INNOVATION

Non-proprietary Hardware

Apply methods & techniques from other industries.

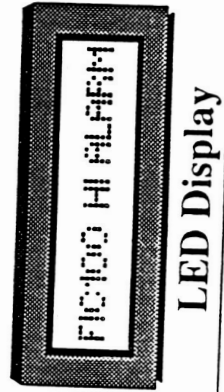
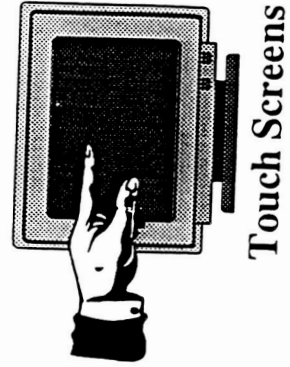
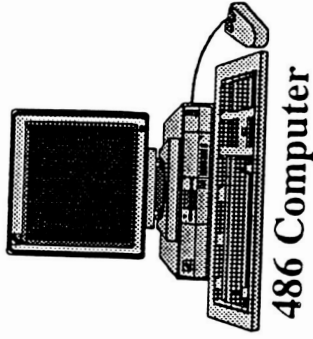
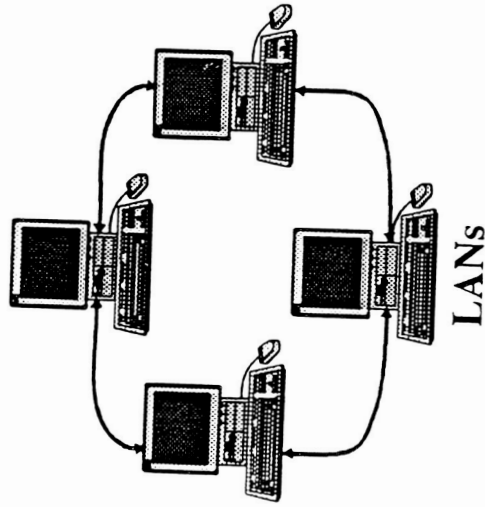
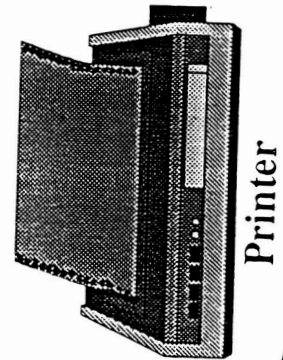
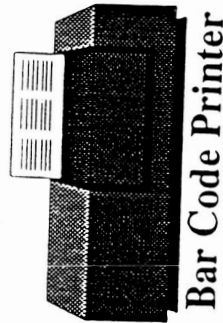
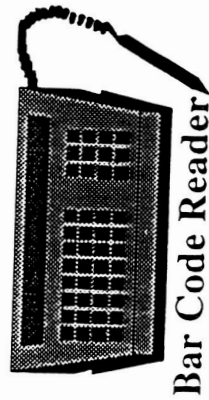

**The Use of Automation and Robotic Systems to
Establish and Maintain Lunar Base Operations**

526-63

**Dr. Lyman J. Petrosky
Westinghouse Electric Corporation**

158340

P 6

Abstract

Robotic systems provide a means of performing many of the operations required to establish and maintain a lunar base. They form a synergistic system when properly used in concert with human activities. This paper discusses the various areas where robotics and automation may be used to enhance lunar base operations. Robots are particularly well suited for surface operations (exterior to the base habitat modules) because they can be designed to operate in the extreme temperatures and vacuum conditions of the Moon (or Mars). In this environment, the capabilities of semi-autonomous robots would surpass that of humans in all but the most complex tasks. Robotic surface operations include such activities as long range geological and mineralogical surveys with sample return, materials movement in and around the base, construction of radiation barriers around habitats, transfer of materials over large distances, and construction of outposts. Most of the above operations could be performed with minor modifications to a single basic robotic rover. Within the lunar base habitats there are a few areas where robotic operations would be preferable to human operations. Such areas include routine inspections for leakage in the habitat and its systems, underground transfer of materials between habitats, and replacement of consumables. In these and many other activities, robotic systems will greatly enhance lunar base operations. The robotic systems described in this paper are based on what is realistically achievable with relatively near term technology. A lunar base can be built and maintained if we are willing.

Introduction

Robotic systems provide a means of performing many of the operations required to establish and maintain a lunar base. They form a synergistic system when properly used in concert with human activities. This paper discusses the environmental and operation characteristics of a lunar base, the various areas where robotics and automation may be used to enhance lunar base operations, and the lunar base system architectural features necessary for the successful application of robotics and automation.

Lunar Base Characteristics

A lunar base has several characteristics that strongly influence decisions regarding the use and types of automation and robotics. The most prominent of these characteristics is the hostile environment in which the base is situated. With the exception of the interior of habitats, most activities will require man or machine to withstand exposure to lunar environmental hazards that include hard vacuum, thermal extremes, dust, and radiation. Another characteristic of a lunar base is that there will be limited external support of the base. It is not practical to use Earth resupply to replace entire systems each time a component fails; therefore, it is essential that key base operations be able to continue through the use of maintenance activities. Maintenance and many other activities at a lunar base will require moving men and materials from place to place, which leads to the conclusion that extensive local surface operations will occur at the lunar base. The final key characteristic of a lunar base is that utilization of indigenous resources will be advantageous in reducing Earth resupply requirements. This leads to further surface operations to gather the necessary surface materials. In summary, the ability to perform surface operations quickly and efficiently will be essential to the success of a lunar base. Due to the severity of the lunar surface environment, automation and robotics must play a key role.

Lunar Base Operations

To determine the areas where automation and robotics would most benefit lunar base operations, we first assess the types of lunar base activities. Activities may be broken into three broad categories: habitat activities, local surface operations, and extended range surface operations. Habitat activities are those that can be performed from within a lunar base habitat where there is a controlled environment. These activities include scientific experiments and maintenance of in-habitat equipment. In this environment, automation and robotics would not be the preferred solution unless the tasks were very repetitive, hazardous, or had to be completed in the absence of human occupants. Automation of activities within a habitat is expected to be minimal, and as such will not be discussed further.

The second category of lunar base operations is the local¹ surface operations. These operations are characterized by movement of men and materials in the vicinity of the lunar base. A lunar base will require the movement of large amounts of material to handle launch (and landing) operations. To reduce the damage to the lunar base from rocket blast effects, the launch area must be located remotely from the lunar base, possibly several kilometers away. The use of soil deflection shields may make it possible to place the launch area relatively close to the lunar base; however, virtually nothing will be landed at its point of use or launched from its point of production. Therefore, regardless of the location of the launch area, all incoming and outgoing cargo will need to be transported to some other location. Because incoming equipment systems from Earth will most likely arrive fully assembled, some large modules to be transported may weigh over 10 tons even at 1/6 g. Another constituent of local surface operations is soil relocation. Soil shields are a very effective barrier to radiation and thermal extremes and their construction requires collection and movement of many tons of mass. Significantly larger amounts of soil collection and disposition will

¹Local is defined as being within the round-trip range of mobile equipment.

be required to support oxygen production utilizing lunar soil. Additional local surface operations include transporting astronauts around the base, and maintenance operations on equipment. Astronaut transportation requires a lunar rover type vehicle, either open or with a pressurized compartment, which would normally be manually driven. Maintenance operations involve some of the most complex activities that will occur on the lunar surface. These activities require a combination of mobility, positioning, sensing, tool use, task sequencing, and handling dexterity. Proper design of lunar base equipment will minimize the difficulty with these operations, and at the same time permit robotic maintenance.

The third category of lunar operations is extended range surface operations. These operations are characterized by the need for a power system independent of the lunar base and the ability to navigate long distances over rugged terrain. These operations are primarily lunar exploration activities such as geological survey, resource survey, and sample returns. Operations in this category are almost entirely performed by robotic rovers. It may also be necessary to robotic rovers to construct and resupply outposts that would act as safe way stations for astronauts conducting long-range travel.

In evaluating the above listing of lunar base operations it is possible to draw some conclusions about the role of automation and robotics in lunar base operations. First, direct human activity will dominate operations that can be performed within lunar base habitats. Second, mobile robots will dominate extended range surface activities. In local surface operations there is a less definitive choice. On Earth, humans are the primary operators (excluding the factory environment), either directly or through the use of manually controlled equipment. On the Moon, the surface environment poses a significant hazard and the need for a space suit that greatly reduces a human's dexterity. To facilitate human surface operations on lunar base equipment, particularly maintenance, all equipment will need to be designed to minimize dexterity requirements. This requirement, however, is also a prelude to the application of robotics systems. While automation and robotics cannot replace human activity, on the lunar surface they should play a very strong synergistic role.

System Requirements for Surface Automation Equipment

The primary role of automation and robotics will be in lunar surface operations, both local and extended range. This section describes the generic requirements for lunar base equipment in general, and automation systems in particular, that are to be used on the lunar surface. The requirements are broken into four categories: surface environmental hardness, modularity, autonomous operation, and system reliability.

Any equipment that is to operate on the lunar surface must contend with numerous environmental hazards. The system must be able to operate in a vacuum. This imposes severe limitations on the choices for lubrication and thermal management within the equipment. The temperature extremes on the lunar surface (± 100 C) further complicate lubrication and thermal management. Although not all equipment will be required to remain operable throughout the lunar day/night cycle, as a minimum the equipment must be capable of passive storage on the lunar surface. Another hazard is lunar dust. Despite the lunar vacuum, movement and electrostatic potentials will cause dust to coat all exposed surfaces. This is primarily a concern for moving joints and bearing surfaces where the dust can cause excessive wear and/or binding. Unlike prior space missions, equipment with exposed moving parts must function for extended periods of time with little or no maintenance. A final environmental hazard is radiation. For equipment design, this particular hazard is easily quantified and has known solutions.

Modularity will be a key requirement for lunar base equipment. This will apply to all equipment regardless of the level of automation and robotics applied to lunar base operations. Because of the difficulties in surface operations, base equipment should be easily disassembled into

man-handleable modules. This would allow either a man or a robotic system to perform the task. Such modules could be moved into a habitat through an airlock for detailed maintenance. To facilitate module removal or reattachment, the connections between the module and the base equipment should be self aligning, self sealing, and require simple translational assembly with minimal fasteners. Lead-ins for alignment should be sized to match the dexterity of the performer and the size of the module. The benefits of modularity are enhanced by standardization of modules. The more copies of a module that are utilized in the lunar base, the fewer spares are required to guarantee the operation of critical systems.

A generic requirement of lunar base equipment will be high reliability and maintainability. Reliability minimizes the number of equipment failures, whereas maintainability ensures that equipment will be on-line quickly following a failure. While high reliability is a requirement, 100% reliability is not attainable and much of the lunar base equipment will consist of large complex systems that must operate for long periods of time. To minimize the mass of equipment delivered to the lunar base, there must be a good mix of redundancy versus replaceability. Hard components such as metal frames need not be redundant, whereas failure prone components need to be redundant if they are small or be located in replaceable modules if they are large.

Equipment for automation of surface activities will require a high degree of autonomy such that a majority of the operations can be performed without direct human control. While self control and monitoring is within state-of-the-art for fixed process equipment, automation of surface operations is a challenge. As discussed earlier, many of the surface activities will require the movement of materials and maintenance of equipment. These activities require surface navigation capability and a knowledge of placement and assembly requirements. While this can be done with teleoperated systems, the productivity will be very low unless the operator is at the lunar base due to the time delays to an Earth-based operator. A fully automated robotic system with modern integrated control hierarchy, task sensing, and computer intelligence, is capable of performing all routine surface operations with minimal human supervision if the necessary features are integrated into the lunar base system architecture.

Surface Operations System Architecture

The lunar base system architecture will define base equipment and operations. The base will consist of large prefabricated equipment platforms such as habitats and lunar resource process equipment. Surface operations will be performed by astronauts in space suits and by mobile robotic equipment. Extended range surface exploration will be performed by robotic rovers. The ability of the lunar base to utilize automation and robotics for surface operations will depend on how well the overall system is integrated. The discussion that follows describes what will be required to ensure maximum utilization of automated systems.²

Utilization of automation and robotics on a lunar base and for surface operations in particular will require an integrated approach to the base architecture in which the lunar base equipment is designed with interfaces for the automated systems handling. In short, the lunar base must be designed for remote handling and maintenance. The design features leading to remotely maintainable systems have been established in the process lines for radioactive nuclear materials. Features to facilitate remote handling include standardized captive fasteners, self aligning parts, simple assembly motions, and modules small enough to be easily manipulated. *Figure 1* shows a typical captive fastener with lead-in. The lead-in greatly reduces the accuracy with which a rotary driver needs to be positioned. Making the fastener captive eliminates the need for starting threads and prevents the fastener from being dropped. Part assembly orientation is a key feature of remote maintenance design. Every part should have designated lift point(s) such that the part assumes

²Fixed, self-contained automatic equipment systems are not considered to be part of automation and robotics.

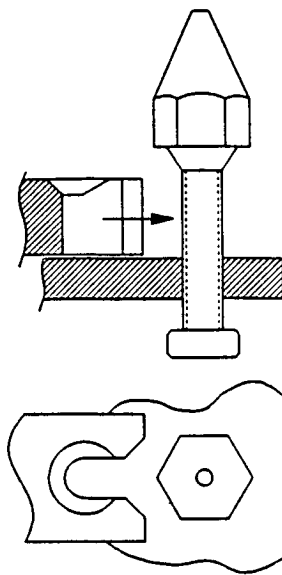

FIGURE 1 - Typical Captive Fastener

the proper orientation for assembly. This minimizes the rotational forces that must be applied concurrent with the assembly process. Assembly of a module onto an equipment platform should involve one, or at most two, translational motions to complete emplacement. The module should rest in position without supplemental support while fasteners and connections are secured.

Design features such as those listed above reduce the complexity of maintenance operations whether they performed by astronauts or teleoperated robots; however, additional design interfaces will be required to allow surface operations to be truly automated. Automated surface operation systems must possess task knowledge and mobility. The lunar base design for its part must supply navigational aids and local indexing. The task knowledge is a computerized data base which directs the automated system through the sequences necessary to perform specified operations such as acquiring parts or materials, transporting them to a designated area, and emplacing them. As implied in the previous sentence, surface mobility will be a requirement for most surface operations. Mobility requires the capability of traversing the lunar terrain with the ability to navigate without colliding with other base equipment. Autonomous navigation in the local area around the base can be greatly simplified by affixing navigational beacons at various locations through the base. The beacons (such as modulated infrared emitters) would allow mobile equipment to unambiguously determine position without resorting the machine vision. To complete an automated surface operations system, the equipment to be handled must possess fixturing to allow the automated system to accurately index to the equipment. Fixturing is a positioning aid intermediate between

lead-ins and navigational aids that provides relative positional information for the automated system at close range. Fixturing may take to form of protrusions, reflective markers, etc. Surface operations automation will best be served through the use of robotic manipulators mounted on mobile platforms. To provide full coverage of the various surface operations will require a minimum of three types of mobile platforms and manipulators. The most frequently used mobile platform will be a short-range light utility vehicle. This platform would be 3 to 4 meters long with the capability of transporting a few tons of payload. The vehicle could be configured as a manually operated manned lunar rover (with or without a pressurized cabin), as a soil mover, or as a mobile base for a robotic manipulator. As a soil mover, the platform would be equipped with a bucket and/or plow and would be capable of manual, remote, or possibly autonomous operation. As a base for a robotic system, the vehicle would be equipped to autonomously navigate around the lunar base and position the robotic manipulator as needed to perform activities such as maintenance. The dexterity and payload capabilities of the utility vehicle with manipulator would match or exceed

those of an astronaut in a space suit and would allow either to perform most activities.

The second type of mobile platform would be the lunar equivalent of a traveling crane. Much of the equipment arriving at the lunar surface will come as large preassembled equipment platforms. To disassemble, move, and reassemble large equipment platforms is both time consuming and invites malfunction. Also, it may not be feasible to design habitats that may be broken into small parts for transport. As mentioned above, it is not possible to land equipment at its exact point of use. These considerations dictate the need for a heavy lift and transport capability on the lunar surface. One appealing approach to providing this capability is to modify one or more of the lunar landers such that they possess crawler tracks on their landing pads and have a lift boom to one side. Once the lander is on the surface, its descent engine is removed and the lander itself becomes a traveling crane. This approach provides efficient utilization of the mass landed on the surface without forcing every lander to incur the mass penalty associated with adding mobility features. The traveling crane generally would be remotely manually operated and would not include a robotic manipulator. However, it may occasionally be necessary to perform detailed manipulator work at locations beyond the reach the utility vehicle platform. For this situation, the traveling crane must have the capability to act as a base for a manipulator.

The third type of mobile platform that is required is the extended range lunar rover. This platform is roughly the size of the utility vehicle, but is designed to traverse rugged lunar terrain. The distinguishing features of this vehicle are that its power source is independent of the lunar base such that it can travel over vast distances on the lunar surface, and its level of autonomy is much greater than that of the other surface automation systems. The most likely mode of operation for this lunar rover is to travel during the lunar day using sunlight for power and hibernate during the lunar night if it hasn't returned to base. This platform will support the attachment of scientific packages and of a manipulator that will be required for many of the exploratory activities such as soil sampling.

Each of the mobile platforms described above will require an attached robotic manipulator to perform at least part of their tasks. All of the manipulators used at the lunar base should follow from a single modular design. The manipulators would consist of a base mountable on any of the mobile platforms, a series of linkages, and a tool mount to hold end effectors. Ideally the links would be identical self contained units that are easily connected in series to form a robotic arm. Connections among the manipulator links will be required to support structural loads, convey power, and transmit communications. The manipulator control could be distributed with some of the control hardware located in each link; however, the higher level task control functions and sensor interpretation will need to be centralized into a more complex processor located in the manipulator base or the mobile platform to which it is attached. All the lunar base automation and robotic systems would be coordinated at the highest level by a central command center that semiautonomously directs the activities of the lunar base.

Summary

The severe lunar environment makes the use of automation and robotics highly desirable for surface operations. A considerable portion of the surface operations will involve transportation and/or maintenance (maintenance also includes initial assembly). With proper equipment design for remote handling, these activities can be performed equally well by humans or automated machines allowing for considerable flexibility in lunar operations. Automation of surface operations will require three basic mobile platforms: utility vehicle, traveling crane, and an extended range rover. These platforms combined with a man-equivalent robotic manipulator and high level machine intelligence will be able to support all the necessary surface operations at a lunar base.

N 9 3 - 2 7 9 8 3

CONSIDERATIONS FOR LUNAR COLONY COMMUNICATIONS SYSTEMS

Richard P. Dowling
GCI-Anchorage, Alaska

527-32

158341

Abstract

P-7

This paper addresses system aspects of communications for a lunar colony. Human factors are particularly noted. The practical aspects of communications infrastructure are emphasized rather than specific technologies. Communications needs for mission support and morale are discussed along with potential means of satisfying them. Problem areas are identified and some possible solutions are considered.

COMMUNICATION SYSTEM OPTIONS FOR A LUNAR OUTPOST

I. Introduction

This paper responds to the request that a commercial practitioner having experience with remote communications systems and user needs apply that background to the communications needs of a proposed lunar base which will be designed for long term occupancy. Given this charge, a systems approach which emphasizes the application of readily available technology and the longer term needs of human occupants has been given primary attention, rather than aspects similar to those of past manned missions.

II. A Few Basic Ideas

First, much shorter design cycles and greatly expanded capability could be realized by using existing and projected telecommunications technologies which can be adapted to the lunar base environment. Since software is the major investment in modern communications systems, the largest -- and riskiest -- aspect of the development effort can be retained. Adopting commercial technology should also significantly lower cost.

Second, the duration of the mission implies different communications requirements than has been the case with previous Earth orbit and lunar missions. Based on experience with remote camps, the capability for occupants of the lunar base to interact as normally as possible with colleagues, family and friends on Earth will measurably improve work efficiency and enhance morale.

Third, current trends in telecommunications indicate that bandwidth requirements, particularly on the Moon to Earth link, will be larger than might be expected. Bandwidth usage will be driven by video, Local Area Network (LAN) interconnectivity and, to a lesser degree, by Command and Control data.

III. The Case for Adapting Commercial Communication Equipment and Software for Use in the Lunar Base

Taking these three points in order let's first consider that historically NASA has stayed off of the "bleeding edge" by freezing the design of systems many years before deployment. While this may prevent most mistakes from reaching the flight hardware stage, it also results in less than state-of-the-art mission hardware and software.

It is true that NASA's traditional conservative approach may still be necessary in fields that lack a vibrantly competitive commercial marketplace. But, in areas like communications, the dynamics of the market are such that a vast amount of parallel development work is undertaken, ideas are tried out, successful products and designs are accepted, and failures or poorly executed concepts are ruthlessly weeded out. To survive in such a market is to have demonstrated real value to the user.

An additional factor that makes commercial equipment and software desirable is the trend in recent years for users of communications technology to avoid the constraints and high costs of proprietary equipment and software systems by demanding that vendors conform their equipment and software to an "Open Systems" concept. This has given rise to so-called "Standards-based" systems in which interoperability is ensured by the development of standards that all vendors must adhere to. Such standards make it increasingly difficult for vendors to lock their customers into proprietary systems. What we see is a shift instead to a competition-based system where value is added to the basic specification in the form of useful features, enhanced reliability, user friendliness and, of

course, lower prices. Today many manufacturers of computing and communications equipment, and increasing numbers of software developers, tout their particular products as being "Open" to indicate compatibility with products from other suppliers. A further benefit of the standards process is that ideas submitted for potential standardization are subjected to rigorous review by peers who are in many instances fierce competitors. While there is undoubtedly some game playing that occurs, ideas are refined into standards in a highly competent atmosphere where all stakeholders with a wide range of expertise have their say. The result is much more intense scrutiny than is often given to the specifications which drive one-off products in a non-commercial environment.

What does this have to do with selecting communications technologies for a lunar outpost? First, there is no reason to re-invent the communications wheel. The marketplace today has a rich set of equipment and software available for the mission discussed in this conference and that richness will only increase as the commencement date for the lunar mission approaches. To freeze the design too soon may place needless design constraints on other systems in the base as those systems would be unable to take advantage of as-yet undeveloped communications techniques which would exist closer to launch. Second, a higher performance communications system would result from the use of commercial communications technology since designing a system solely for use by this, or any, mission will necessarily result in taking a low-risk approach and forgoing many useful capabilities. For example, although more advanced technology was in existence at the time that the shuttle fuel cell controller was designed a safe design using relay logic was chosen. The range of capabilities would also be limited by budget constraints to only that set of technologies absolutely necessary for mission integrity. Alternatively, we can let the marketplace and vendors take the risk while we reap the benefits of being able to choose the most successful of those technologies and implementations from the widest possible array of choices.

Below are some examples of existing or emerging commercial communications technologies which may be useful in the lunar base under consideration here. These are certainly not all-inclusive but they should give an idea of what is possible.

1. Wireless and cabled Local Area Networks (LAN's) for networking both general and special purpose computers. Currently for very high bit rate LAN's fiber optics is the medium of choice using the ANSI X3T9 Fiber Distributed Data Interface (FDDI) standard which offers 100 Mb/s transport rates. (This may seem like an inordinately high rate until one considers that to transfer a 20 MByte CAD or image file at the currently popular 10 Mb/s Ethernet rate would take about 16 seconds not counting network overhead. Consider for a moment paging through a drawing suite with that kind of latency.) Wireless LAN's employing radio transmission are beginning to enter the marketplace and in the future may offer adequate transmission rates, at least for some applications such as data gathering or process control.
2. Personal Communications Networks/Systems (PCN's or PCS's). These new radio-based communications systems are one of the most hotly pursued developmental technologies today and should bring wireless telephones --estimated to cost under \$250 and having full features and long battery life to the shirt pocket by the middle of the decade. While there are several communications technologies competing in field trials today, one, Broadband Code Division Multiple Access (B-CDMA), offers both high immunity to multi-path distortion, which commonly troubles current day FM cellular phones, and very low probability of interference into other systems. As interesting as the technology itself are the applications that are being developed around it. These include (a) the concept of number portability in which

a telephone number is identified with a person rather than a location, regardless of whether that person is at home, at work, visiting another office, in transit, or, perhaps, on the Moon -- sort of like using e-mail without having to log in; (b) active locator services in which the whereabouts of the owner of the telephone number can be determined; (c) and calling party identification which can be used to selectively screen or reroute incoming calls.

3. Networking technologies such as Switched Multi-Megabit Data Service (SMDS), Asynchronous Transfer Mode (ATM) and others. With minor modifications, these may make excellent candidates for the Earth-Moon link, offering very high data rates, switching, and the ability to combine voice, data, and image communications into one stream. Bandwidth can be efficiently and automatically shared among competing bandwidth users on a moment-by-moment basis, rather than the alternative of inefficiently dedicating bandwidth to individual communications users or projects regardless of use.
4. Existing and soon to be developed satellite Earth station technology which would be able to provide virtually off-the-shelf radio frequency and digital modem equipment for the Earth-Moon link, save for the antenna and support structure which would have to be specially designed for the lunar "outdoors".

Adopting commercial technology doesn't necessarily mean using commercial packaging or even components, neither of which may be suitable for the environment due to weight, configuration, or the range of conditions found during transport to the lunar shelter. The reality is that most of the design effort that goes into modern communications products is applied to software rather than hardware. Even if some redesign of the hardware were necessary to meet the requirements of the mission, the software -- where most of the effort and development risk lies -- is usable virtually as-is.

Even for communications equipment intended for use outside the shelter on the lunar surface most apparatus can be derived from commercial units by adapting commercial chip-sets to the rigors of the "outdoor" environment on the Moon combined with specialized packaging. While it may be necessary to produce special versions of commercial chips that are able to tolerate the high radiation and near vacuum environment, this should be much less costly than designing them from scratch in most instances.

IV. Human Factors In Design of the Communications System for the Lunar Base

Our experience with remote camps in the arctic and at the South Pole indicates that people need routine contact with their colleagues, family, and friends to continue to work efficiently and to maintain high morale over extended periods. Companies serving Alaska's remote resource development outposts, such as those on the North Slope and in the Bering Sea, are routinely required to provide for "morale phone" service to workers stationed there. Careful selection of personnel and training may help in this regard but there isn't any substitute for routine, high-quality contact with others outside the isolated group. In addition access to a wide variety of entertainment and news helps lessen the burden of isolation, particularly if individuals feel that the program selection is under their own control.

Given the current state of technology and reasonable development expectations there is no reason not to provide for these as well as the more traditional communication needs of a mission. Here

is one possible hierarchy of communications technologies to meet these requirements:

- At the lowest level would be voice and data communications related to the security and integrity of the station. Included are telemetry and remote control of environmental systems and other equipment in the station as well as voice communication at a very basic command and control level. These critical needs are probably best provided for with systems similar to those used in the past which are independent of the more complex systems handling the bulk of the communications requirements.
- Next would be routine voice communication which could easily be handled on a dial-up basis. Each occupant of the lunar base could carry the equivalent of a pocket telephone supporting the features of an advanced PBX. This configuration would allow for each person to have a unique telephone number which could be called from anywhere in the world. In addition to the obvious efficiency implicit in the telephone network -- as refined over the past one hundred plus years -- integration into society would be beneficial in itself. Obviously, some method of call discipline must be imposed to prevent nuisance calls. This could be accomplished by screening on the originating caller's telephone number and/or a caller-dialed ID code. Once identified the caller would be compared against lists of authorized callers established for each person. These lists would probably vary by daily time periods such as working hours, off-duty time and sleep periods. Callers thus screened out could then be further routed to voice mail, an operator or simply denied access altogether depending on who they were. This controlled accessibility to Earthbound people, combined with the ability to simply place calls in the normal way to anywhere, including internally in the base or to personnel outside, would go far to integrating the lunar base personnel into the rest of the scientific and agency fabric which forms their resource group.

A corollary to voice access to the public switched network is computer access to both private and public switched data networks for electronic mail, data base access, information services and the other data sources which can be reached via these networks. Similar access controls to those applied to voice communication would be necessary to prevent disruptive attempts to reach outpost personnel.

- The next level of complexity acknowledges that at times visual contact between parties is helpful. (For instance, imagine that all of the presentations at this symposium were given by telephone.) The rapid growth of video conferencing attests to both its usefulness in conveying graphic information and to people's desire to be able to obtain by observation the large amount of non-verbal communication that is lacking in a voice only telephone call. Video conferencing has grown dramatically primarily due to the availability of low cost video equipment -- especially the digital coder/decoder equipment which compresses the video and audio into a smaller and cheaper digital telephone channel -- and to the growing availability of the digital channels themselves. Video conferencing is useful for operational needs such as meetings, trouble shooting sessions and one-on-one conferences as well as for off-duty-hours personal morale calls to the base occupants' families and friends. Varying needs imply access to video conferencing equipment and channels from a variety of locations in the shelter, including work areas and individual living quarters. Both portable and built-in equipment would be needed.

Some circumstances would require only one-way video. These might be lunar vehicle cameras and the occasional media event. However, the same technology could be employed to transmit video of this type as would be used for video conferencing, perhaps utilizing higher bit rates to improve motion handling. Access to normal entertainment media channels could be provided by giving the station personnel access to an urban cable system. Full access to all channels would be available, but only the selected TV or radio broadcast channel would be relayed to the viewer at the station, thus minimizing transmission requirements. While broadcast video imposes much more difficult transmission standards than video conference quality systems to accommodate transmission of full motion video, advances in compression are occurring in this field as well. These developments take advantage of the point-to-multipoint nature of broadcasting by putting complex equipment at the sending location with simple decoders at the viewers' end. This technology is driven primarily by the direct to home broadcast satellite industry where radio frequency spectrum is limited and achieving the maximum number of channels of home entertainment video on a satellite means business feasibility or higher profits. Recently Comsat transmitted Super Bowl XXVI to a number of Navy ships in the Mediterranean using a prototype system. While it was not wholly satisfactory, it displaced only six voice channels on an Inmarsat maritime satellite. It is reasonable to expect that multiple channels of broadcast video and audio could be accommodated simultaneously giving residents of the lunar base significant freedom in choosing their own information and entertainment menus. Access to print media such as newspapers and magazines would also be valuable, although presumably in facsimile form to be displayed on a screen rather than printed. (One researcher who has wintered over at the south pole reports that the AP newswire was the best contact polar scientists had with the rest of the world. The very limited telephone calling ability at the pole allowed for no privacy.)

There are, of course, at least a couple of problems that must be dealt with. First, the Moon is about 1.3 seconds away at the speed of light. This means that twice that time, or 2.6 seconds, is required between the end of a spoken phrase and the earliest time that a response can be expected. Compare this delay with the nominal 6/10 of a second encountered in satellite telephone calls, and it's clear this long delay would be disruptive to normal conversation. Adaptation to long communication system delays, even when both persons are accustomed to the delay, can be only partial. Certain data transmission protocols, will have similar problems and will have to be fooled or "spoofed" into operating normally by a hardware/software interface or a "patch" that simulates the low-delay connections they were designed for. This problem has already been addressed for some time on satellite data circuits which employ protocols expecting the short delays associated with terrestrial channels.

All transmissions to and from the lunar base should be encrypted with an algorithm sufficiently secure that the possibility of intercept is insignificant. Doing so would protect the security of the project and would allow people at both ends of the circuit to speak unguardedly and openly. Nobody likes to think that a private conversation might be listened to nor will anyone speak frankly if privacy is in question. Private morale calls or other sensitive communications might be encrypted end-to-end to ensure absolute privacy. (This very lack of privacy has been cited on more than one occasion by people as a reason for not making calls to friends and family.)

V. Bandwidth

Some of the uses of communication on the lunar outpost may drive bandwidth (bit rate) consumption to surprisingly high levels. This usage will therefore influence communication system design, including the type of protocols employed.

Computing is increasingly distributed with many, if not most, computers attached to Local Area Networks. Communication and computing are harder and harder to distinguish with a trend for files and applications to be resident throughout the network. The size of files isn't getting any smaller either now that image technologies are being incorporated into what were once text-only systems. The larger number of LAN transactions is driving the development of higher bit-rate networks, beginning with 1 Mb/s Token Ring (IBM) LAN's in the 80's and graduating through 10 Mb/s Ethernet to current 100 Mb/s FDDI fiber optic LAN's with higher speeds in the wings. Network speed has increased as dramatically, as has use, with no let-up in sight. Of course it wasn't enough to connect computers in a single building, the need was more universal than that. Thus LAN's are increasingly connected together in what are called Wide Area Networks or WAN's. This technology is in a practical state of development but is not yet mature. Several competing and complementary technologies being developed today will make extremely large networks practical and cost effective in the future.

It seems likely that there will be a number of general purpose computers at the lunar base and that they will need to be interconnected with each other and to computer networks on Earth to gain immediate access, for instance, to the complete text and image documentation files for all of the station's components. Such transfers could require significant bandwidth, perhaps 50 to 100 Mb/s for a short period so that access to large image files could be accomplished within a reasonable time.

Video, both conference quality and entertainment quality can require significant and continuous bandwidth, especially if multiple sessions are to be supported simultaneously. The good news is that bit rate requirements for video conferencing have been steadily dropping over the past decade to the point that conference and videophone communication could be transmitted at from 64 to 256 Kb/s depending on the quality required. Entertainment video currently requires something on the order of 45 Mb/s. However, technology under development for direct-to-home satellite broadcast will reduce that requirement to the 2 to 3 Mb/s range.

By comparison, voice and instrumentation data rate requirements are small but may require committed bandwidth due to the time sensitive nature of such transmissions.

All of these uses of communications system capacity can contend for bandwidth-on-demand using technologies currently being developed or deployed in terrestrial communications networks. Transmission bandwidths in these ranges are in common use on today's satellite systems and pose no particular technological difficulty.

VI. Summary

In summary, it would be practical to adapt commercial technology to the bulk of the lunar base's communications needs, and, for the most part, to modify only hardware to suit the environment while retaining already proven software. The long-term needs of the human inhabitants will require more integration into the Earth environment than have previous NASA missions have, and transmission bandwidths will need to be much larger than expected.

POSTER PRESENTATIONS

N 9 3 - 2 7 9 8 4

REGOLITH THERMAL ENERGY STORAGE FOR LUNAR NIGHTTIME POWER

**Brian Tillotson
Boeing Defense & Space Group**

528-44
158342
P-8

Abstract

A scheme for providing nighttime electric power to a lunar base is described. This scheme stores thermal energy in a pile of regolith. Any such scheme must somehow improve on the poor thermal conductivity of lunar regolith in vacuum. Two previous schemes accomplish this by casting or melting the regolith. The scheme described here wraps the regolith in a gas-tight bag and introduces a light gas to enhance thermal conductivity. This allows the system to be assembled with less energy and equipment than schemes which require melting of regolith. A point design based on the new scheme is presented. Its mass from Earth compares favorably with the mass of a regenerative fuel cell of equal capacity.

Introduction

Providing electrical power to a lunar base during the night is challenging. The long lunar night requires that energy storage systems must have great capacity. With battery technology, such as that proposed for use on Space Station Freedom, the mass of a lunar energy storage system would be prohibitively high. Regenerable fuel cell (RFC) storage systems are less massive than batteries, but would be nearly as massive as the lunar habitat modules which use the energy. Nuclear power can provide a low-mass solution, but appears costly to develop and may face political obstacles.

It has been proposed to use an indigenous energy storage medium to reduce the mass which must be transported from Earth to the Moon. In daytime, energy would be stored as heat in some form of lunar material. At night, that heat energy would be converted to electricity.

This paper presents a new concept for using thermal energy storage in indigenous lunar material. The first section discusses the problem of low thermal conductivity in lunar regolith and describes two previously proposed schemes to solve that problem. The second section describes the new scheme and computes some basic parameters. The third section derives sizing data for a point design. The final section compares the proposed system with other schemes and discusses areas for future work.

The Thermal Conductivity Problem

A major obstacle to thermal storage is that lunar regolith has very low thermal conductivity. The low conductivity is due to the fineness of the regolith particles, the small contact area between adjacent particles, and the vacuum between the particles. Low conductivity makes it difficult to pump heat in and out fast enough to provide reasonable amounts of power with a reasonably sized heat exchanger. Two general approaches have been proposed to solve this problem: using solid cast regolith, and using molten regolith.

Cast Regolith

In the cast regolith scheme,¹ regolith is melted and cast into some convenient form, typically that of a brick. A pile of such bricks is enclosed by material from Earth. Working fluid is pumped around and through the pile to heat and cool the bricks. Solid and non-porous, the bricks have much better thermal conductivity than natural regolith.

This scheme has costs beyond the equipment used to store and extract thermal energy. Making the bricks from regolith requires additional time, energy, equipment, and development effort.

Molten Regolith

The molten regolith scheme² uses concentrated sunlight to melt a patch of regolith. The molten puddle would be contained by the non-molten regolith in which it rests. As a liquid, molten regolith offers convective heat transfer as well as superior conductive transfer. Heat pipes (such as those developed to cool the SP-100 reactor) can be used to get heat in and out even more readily. Energy would be extracted either by driving a turbogenerator with a hot working fluid or by illuminating photocells with infrared radiation from the puddle.

Relatively little extra time or equipment would be needed to install a molten regolith power system. However, there are many technical uncertainties about this scheme. They include outgassing and

contamination from the molten regolith, lateral spreading of the molten puddle, and corrosion of heat pipes.

Improving Thermal Conductivity

The scheme described here uses a gas to fill the space between regolith particles and thereby improve the regolith's conductivity. This approach does not require regolith to be melted. Therefore, this approach should use less initial equipment and energy than the cast regolith scheme and face fewer uncertainties than the molten regolith scheme.

Basic Features

A schematic of the proposed energy storage system is shown in *Figure 1*. Heat is stored in the regolith pile at left. A bag holds gas within the pile. An outer layer of regolith shields the bag from meteoroid punctures and reduces the rate of radiant cooling. The solar collector at the far right heats a working fluid, which is pumped through the flexible heat exchanger in the pile. At night, the same working fluid transfers heat from the pile to the turbogenerator. The turbogenerator produces electric power and dumps waste heat to the radiator.

In addition to the energy storage system, the total power system includes a photovoltaic array for daytime power. This array is sized to meet only the daytime power needs of the lunar base; it does not provide energy to heat the regolith pile.

Regolith/Helium Mixture

The gas pressure in the regolith must be high enough to provide good thermal conductivity between adjacent grains of regolith. The conductivity across a body of gas increases with pressure until the mean free path of the gas molecules is less than the distance between solid surfaces, as shown by the arrow in *Figure 2*. For typical lunar regolith, half of the regolith's mass is comprised of particles less than 70 microns in size. These fine particles fill most of the space between larger particles. For maximum conductivity in natural regolith, the mean free path of gas molecules would have to be much less than 70 microns, so helium pressure would exceed 1 psi (6895 Pa). To reduce the required pressure, I propose to use a sieve to remove fine particles from the regolith. In the coarse remaining regolith, the mean straight line distance between solid surfaces is 70 microns. With helium, only 0.13 psi pressure (896 Pa) is needed to achieve maximum conductivity in this coarse regolith, as shown in *Figure 2*.

The thermal conductivity of the regolith/gas mix was estimated as follows. The maximum storage temperature was assumed to be 1000 K, well below the temperature at which regolith begins to sinter. The conductivity of helium at 1000 K is 3.63 mW/cm-K. The conductivity within a grain of regolith is assumed to be the same as for granite, which is 24.6 mW/cm-K.³ The void fraction in natural regolith is about 0.33, presumably higher with the fines removed, so helium fills at least a third of the volume. The thermal conductivity of the mixture depends on the geometry of the particles. If the particles were smooth and macroscopic, this mixture would have a thermal conductivity of at least 8.41 mW/cm-K with the worst geometry (granite and helium in series) and 17.6 mW/cm-K with the best (granite and helium in parallel). However, the particles are actually rough and of the same scale as the mean free path of the gas molecules, so the thermal conductivity of the mix was assumed to be only twice that of helium, i.e. 7.26 mW/cm-K. This conservative estimate is less than the worst case calculated above but is a factor of 60 times better

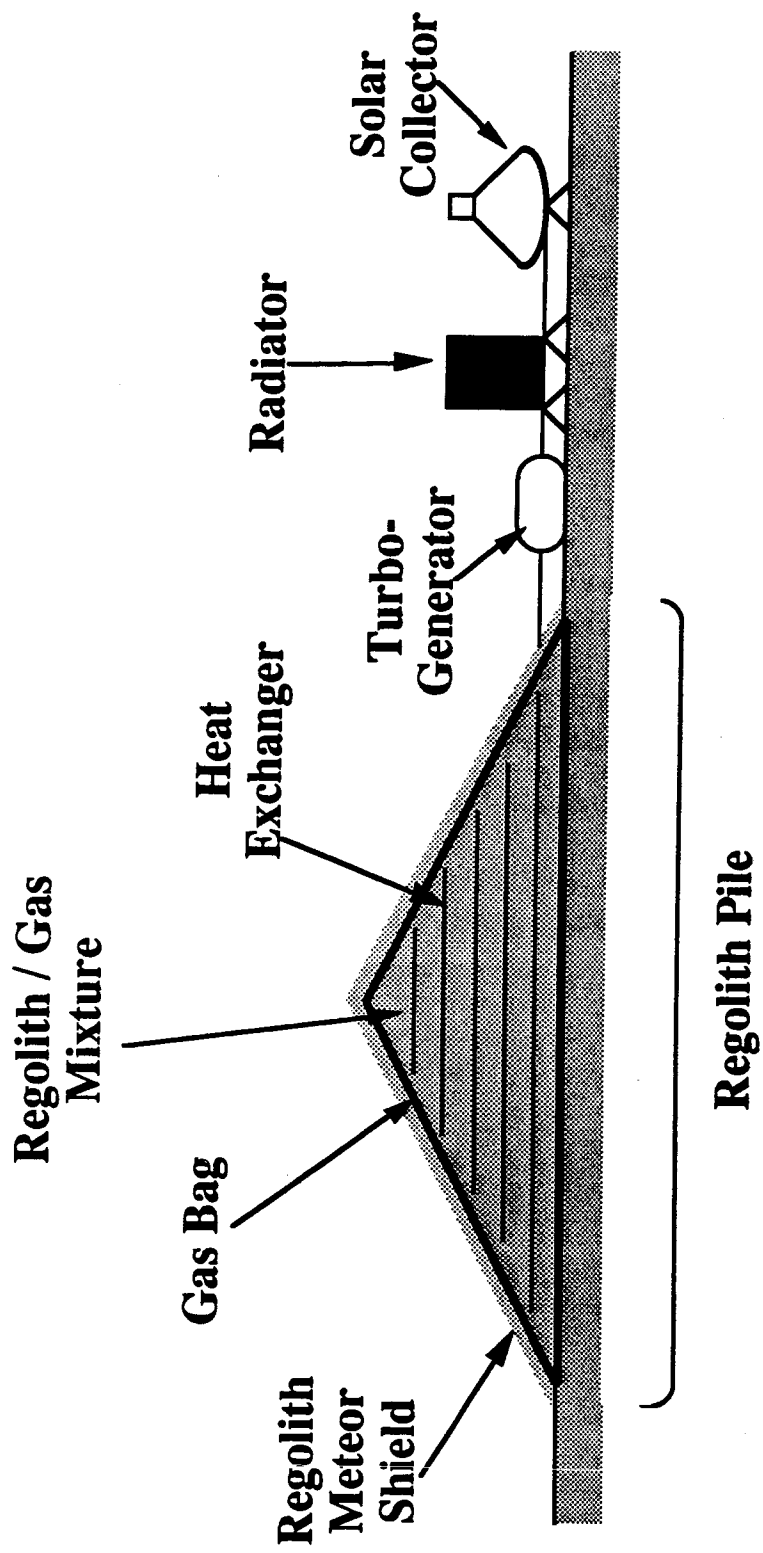

VI-4

FIGURE 1

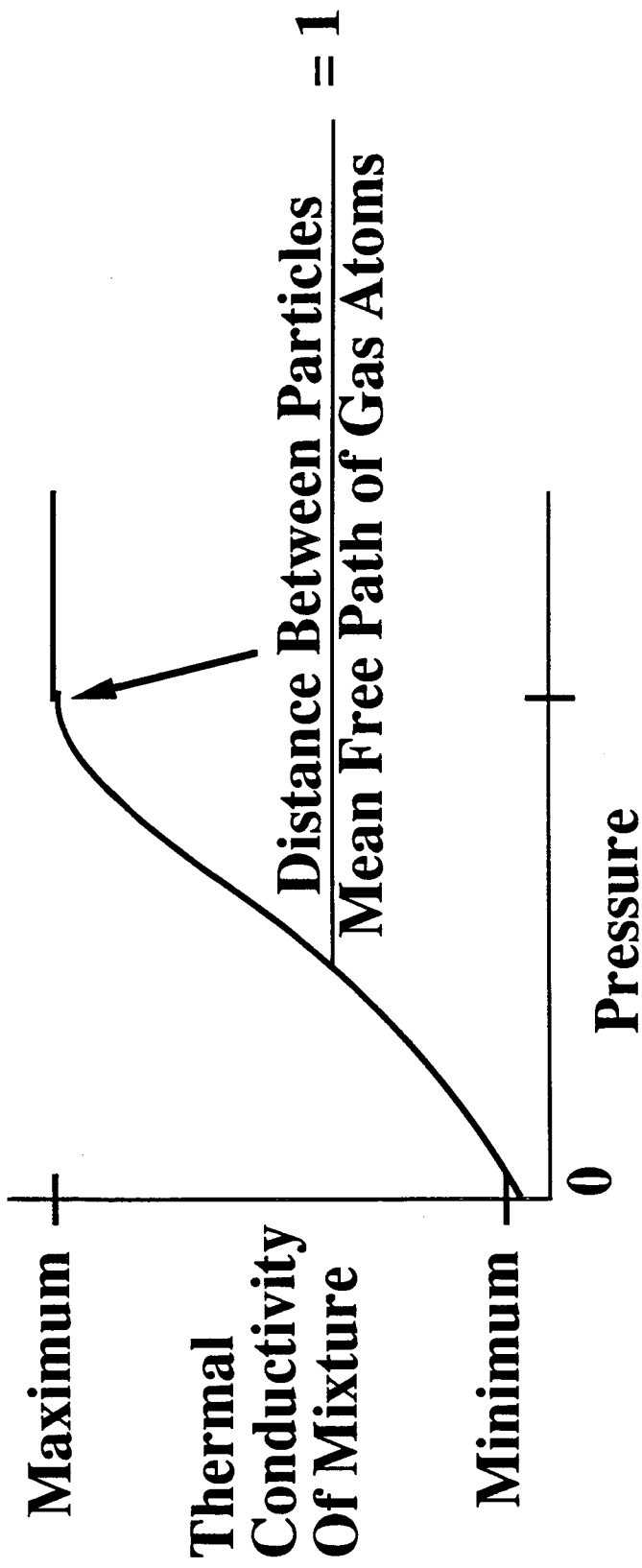

FIGURE 2

than the value for normal regolith, which is about 0.12 mW/cm-K.

Gas Bag and Heat Exchanger

The gas bag must be able to withstand the maximum regolith temperature and must be strong enough to contain the pressurized gas. The bag is assumed to be made of an alumino borosilicate fabric like Nextel⁴. A titanium-based metal foil is diffusion bonded to the fabric, preventing gas leaks through the fabric. A Nextel/titanium material will have to be developed. Nextel/aluminum material already exists, but cannot withstand 1000 K.

The regolith pile is created by dumping loose regolith, so the sides of the pile are no steeper than the angle of repose, typically 37 degrees for lunar regolith. With the pile no steeper than the angle of repose, no structural stress is imposed on the containment bag. Steeper sides would require some structure to support the pile.

The heat exchanger must be delivered as a compact package from Earth, yet must have a large contact area with the regolith. This argues for a flexible heat exchanger, so the heat exchanger uses an "air mattress" design and is made of the same material as the gas bag. The heat exchanger is buried in the pile of regolith.

Sizing

This section derives the sizing parameters for a point design that provides an average of 20 kW electric power through the lunar night.

Regolith Pile

Assuming 20% output conversion efficiency and 20 kW electric output, the thermal output must be 100 kW. Over the 340 hour lunar night, the required thermal energy is 122 GJ. I assume that the pile temperature falls from 1000 K to 900 K as the energy is extracted, and that the specific heat of regolith is comparable to granite, i.e. 1.32 J/g-K.⁵ With these assumptions, the pile must contain 924 metric tons of regolith.

Assuming the density of the uncompacted regolith is 1500 kg/m³, the volume of the pile is 616 m³. If the pile forms a circular pyramid whose sides slope at 37 degrees, then the height of the pile is 6.94 m and its diameter is 18.4 m.

The mass of helium in the pile is 266 grams.

Gas Bag

The maximum stress on the bag is at the edge of the pile, where the gas pressure of 896 Pa (0.13 psi) acts over an area of 266 m² and must be contained by a band whose circumference is 57.9 m. Nextel has a tensile strength of 2.24 GPa (325 ksi), so the average Nextel thickness must be at least 184 microns (7.24 mils). For a safety factor of 1.4, the average Nextel thickness must be 258 microns (10.1 mils). This can be accomplished with 20 mil Nextel fibers in a tight weave. To enclose the pile top and bottom, the gas bag must cover an area of 599.9 m². With the average thickness computed above, the Nextel volume is 0.155 m³. Nextel's density is 3050 kg/m³, so the mass of the fabric is 472 kg. A 254 micron (10-mil) layer of titanium (density 4.54) would add 692 kg, for a total bag mass of 1164 kg.

Heat Exchanger

The heat exchanger is made of the same Nextel/titanium combination as the gas bag, but is thinner because it need not contain pressure over large areas. I assume a loosely woven (0.75 void factor) fabric of 254 micron (10 mil) Nextel fibers with a 76 micron (3 mil) titanium layer bonded to each side. Two sheets of this material are bonded as parallel tubes to form an "air mattress" configuration. The mattress is inflated with a working fluid which flows inside the tubes.

The heat exchanger is laid between layers of regolith. The top and bottom regolith layers are 0.5 m thick, with intervening layers being 1.0 m thick. Thus the maximum distance from a regolith grain to the heat exchanger is 0.5 m. Given the size and shape of the pile, this arrangement produces 1223 m² of contact area between the heat exchanger and the regolith. With a thermal flux of 100 kW and the assumed thermal conductivity of 7.26 mW/cm-K, the thermal gradient is 113 K/m. With the maximum distance from a regolith grain to the heat exchanger being 0.5 m, the temperature difference between the working fluid and the most distant grain is no more than 56.3 K. Thus when the regolith has cooled to 900 K, the working fluid temperature will be at least 843 K, adequate to drive a turbogenerator system during the lunar night.

With an area of 1223 m², the mass of Nextel in the heat exchanger is 237 kg and the mass of titanium is 844 kg, for a total of 1081 kg.

This design assumes that helium is stationary within the regolith. If convection or a dust-resistant fan can induce currents in the helium, then heat transport would greatly improve and the mass of the heat exchanger could be substantially reduced.

Power System

The power system mass was estimated from the mass of a proposed solar dynamic power system for Space Station Freedom.⁶ The SSF system is sized to produce 25 kW in both light and dark portions of its orbit. The elements of the system are the solar concentrator which concentrates light into the receiver and which gimbals to follow the sun, the receiver which transfers the light energy to a working fluid and to a thermal storage medium, the power conversion unit which uses a Brayton turboalternator to convert thermal energy to electrical energy, the heat rejection assembly which radiates waste heat to space, and the electrical equipment assembly which controls the system and which changes the frequency and phase structure of the electric power.

Design mass of the SSF solar concentrator assembly is 1500 kg. I scale this mass by a factor of 0.5 because the lunar concentrator needs only enough area to store energy during the day, not to simultaneously provide electric power. I further scale by a factor of 0.8 because the lunar application needs 20 kW, not 25 kW. The scaled mass is thus 600 kg.

Design mass of the SSF receiver is 1760 kg. I scale by 0.5 as above because the system does not provide power during daylight, and by 0.8 because of the lower power output. The SSF receiver includes a large amount of eutectic material to provide thermal energy storage; that function is provided by regolith in the lunar system. The mass of the eutectic material is not given by Labus, et al., but from an illustration⁷ I estimate the mass at half of the overall receiver mass. Therefore, I use a further scaling factor of 0.5 to eliminate the mass of the eutectic material. The scaled mass is thus 352 kg.

The remaining elements are all scaled by 0.8 for the lower power output. The SSF power conversion unit scales from a design mass of 800 kg down to 640 kg, the heat rejection assembly

scales from 1550 kg down to 1240 kg, and the electrical equipment assembly scales down from 260 kg to 208 kg.

The total mass of the scaled power system is 3040 kg.

Results and Discussion

The estimated mass statement for the 20 kW electric power system is shown in Table 1. The total mass from Earth, 5285 kg, is substantially less than the mass of a regenerable fuel cell system of equal capacity, which is estimated to be at least 12 tons⁸. Additional savings accrue because the photovoltaic array used for daylight power need not be oversized to charge the RFC while providing power.

Item	Mass (kg)
Gas Bag	1164
Heat Exchanger	1081
<u>Power System</u>	<u>3040</u>
Total	5285

Table 1. Estimated mass statement for 20 kW system, excluding regolith.

Several areas of further work remain to be done. DDT&E, packaging, and assembly costs are undefined, so it is currently impossible to compare total costs with other power system concepts, such as the two regolith-based concepts described earlier. More detailed analysis and tests will be needed to precisely define the thermal properties of the regolith/gas mix and to optimize that mix in terms of pressure and particle size. The material proposed here for the bag/heat exchanger must be fabricated and its properties verified. It is possible that heating the regolith will release enough trapped hydrogen from the solar wind to cause embrittlement of titanium foil in the gas bag and heat exchanger. Tests will be required to determine whether this is a problem. If so, a nickel-based foil may need to be used instead.

None of the issues above appear to be show stoppers. Thus, regolith thermal energy storage is a promising area for further work.

References

- ¹Sullivan, Tom. "Process Engineering Concerns in the Lunar Environment." AIAA Space Programs and Technologies Conference, September 25-28, 1990. Paper 90-3753.
- ²Eder, Dani. "Lunar Base Logistics." *Space Manufacturing* 6, AIAA, 1987: pp. 299-301.
- ³Extrapolated from *CRC Handbook of Chemistry and Physics*, R.C. Weast, ed. Boca Raton, Florida: CRC Press (1986): p. E-14.
- ⁴Nextel is a product of the 3M Corporation.
- ⁵Extrapolated from *CRC Handbook of Chemistry and Physics*, R.C. Weast, ed., p. E-14.
- ⁶Labus, T. L., Secunde, R.R., and Lovely, R.G. "Solar Dynamic Power for Space Station Freedom." *Space Power* 8 (nos. 1/2) 1989: pp. 97-115.
- ⁷*Ibid.*, p. 106.
- ⁸Kohout, Lisa. "Cryogenic Reactant Storage for Lunar Base Regenerative Fuel Cells." *NASA Technical Memorandum 101980*. Prepared for IAF international Conference on Space Power, Cleveland, Ohio, June 1989.

LUNAR BASE THERMAL MANAGEMENT/POWER SYSTEM ANALYSIS AND DESIGN

Jerry R. McGhee
Boeing Defense and Space Group

529-54
158343
p 12

Abstract

A compilation of several lunar surface thermal management and power system studies completed under contract and IR&D is presented. The work includes analysis and preliminary design of all major components of an integrated thermal management system, including loads determination, active internal acquisition and transport equipment, external transport systems (active and passive), passive insulation, solar shielding, and a range of lunar surface radiator concepts. Several computer codes were utilized in support of this study, including RADSIM to calculate radiation exchange factors and view factors, RADIATOR (developed in-house) for heat rejection system sizing and performance analysis over a lunar day, SURPWER for power system sizing, and CRYSTORE for cryogenic system performance predictions. Although much of the work was performed in support of lunar rover studies, any or all of the results can be applied to a range of surface applications.

Output data include thermal loads summaries, subsystem performance data, mass, and volume estimates (where applicable), integrated and worst-case lunar day radiator size/mass and effective sink temperatures for several concepts (shielded and unshielded), and external transport system performance estimates for both single and two-phase (heat pumped) transport loops. Several advanced radiator concepts are presented, along with brief assessments of possible system benefits and potential drawbacks. System point designs are presented for several cases, executed in support of the contract and IR&D studies, although the parametric nature of the analysis is stressed to illustrate applicability of the analysis procedure to a wide variety of lunar surface systems. The reference configuration(s) derived from the various studies will be presented along with supporting criteria. A preliminary design will also be presented for the reference basing scenario, including qualitative data regarding TPS concerns and issues.

ROVER HEAT REJECTION SYSTEM STUDIES OVERVIEW

A top level overview is presented for the heat rejection analyses performed in support of a pressurized lunar rover definition/design study. This subject received significant attention in the studies because the problem of rejecting large amounts of heat from a pressurized module over long periods of time can be quite imposing, due to the harsh lunar day environment. Surface temperatures approach 380° K during the day, which makes rejecting heat at 275 -291° K (pressurized habitat requirements) difficult to impossible. The heat rejection system must also deal with the large temperature variations experienced in the lunar day/night cycle, which can be as high as 260° K. Past lunar heat rejection systems utilized thermal storage or water evaporator systems. Although these systems were adequate for lower rejection load levels and mission durations. The system investigated in this study was sized to actively reject ~4.71 kW of thermal load for prolonged periods. Several alternate radiator concepts were evaluated, in order to arrive at a system design which is both flexible to varying loads and conditions, and minimizes system mass and size. This accomplished by utilizing designs which have lower radiating sink temperatures (effective surrounding temp.), or increasing the radiator surface temperature artificially (i.e. heat pump).

In order to trade the various radiator options, a methodology for determining the radiator effectiveness was needed. Heat balance equations were formulated for each concept, taking into account solar, reflected and diffuse surface, and shield radiation inputs. These equations were utilized to calculate effective sink temperatures, which were in turn used to size the radiator. It should be noted that all two sided radiators were analyzed taking into account the "shading" effect of the "hot" side of the radiator on the "cold" side. This can be seen in the figure, where the left side of the radiator is shielded by the right side, so that it "sees" a lower effective sink temperature.

Radiator/Heat Transport System Size vs. Rejection Temperature Trade

In order to reject heat at the required temperatures (275 & 291° K) during the lunar day with most radiator options, a heat pump was utilized to increase the radiator rejection temperature. Since higher radiator temperatures require more heat pump power (i.e. higher system mass), but reduce radiator temperatures. An interesting note about the heat pumped system is that its heat rejection capacity may be changed at any time (within reasonable limits), by varying the heat pump compressor power level, and the fluid level in the system. The trade resulted in a range of acceptable radiator temperatures between ~330 and 400° K, before the heat pump and power system mass begin to override radiator mass savings. The selected rejection temperature, 360° K, was chosen as a reasonable compromise between radiator area and power requirements (roughly half way between endpoints). Higher or lower rejection temperatures may be required depending on design or operational requirements. The major assumptions made to carry out the trade are shown on the chart. They were chosen to represent as closely as possible the system investigated in this study. Different power levels, rejection loads, surface properties, etc. may shift the chosen temperature range.

Heat Pumped and Passive System Functional Schematic

Schematics showing fluid routing, and energy inputs are shown for the active (heat pumped) and passive (single phase pumped loop) heat rejection systems. Each system utilizes a two stage heat exchanger to provide heat removal for both the 40 and 70° F loops (275, 291° K). The passive system external loop would utilize liquid ammonia, while the active system would use Freon 11 (R11) during the daytime, and ammonia or other suitable fluid during the night when the heat pump is not required. It should be noted that the work required by the passive system pump is much

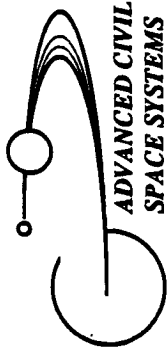

Rover Heat Rejection System (HRS) Studies Overview

BOEING

- Significantly harder to reject heat on the surface during the lunar day than during night or in space.
- Innovative radiator concepts required to reduce radiator area by dropping effective sink temperatures, and/or increasing rejection temp.
- Heat balance equations formulated for each radiator, taking into account surface, solar, and shield radiation exchange where applicable.
- Two sided radiator sink temperatures determined over range of sun angles for both shaded and lighted ('hot') sides.

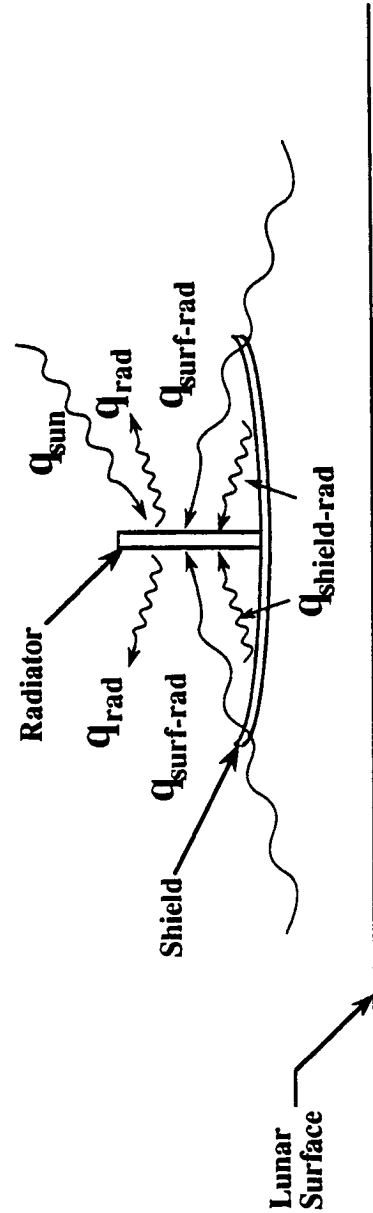

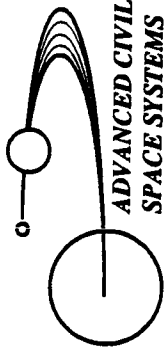

Radiator/Heat Transport System Size vs. Rejection Temperature Trade

BOEING

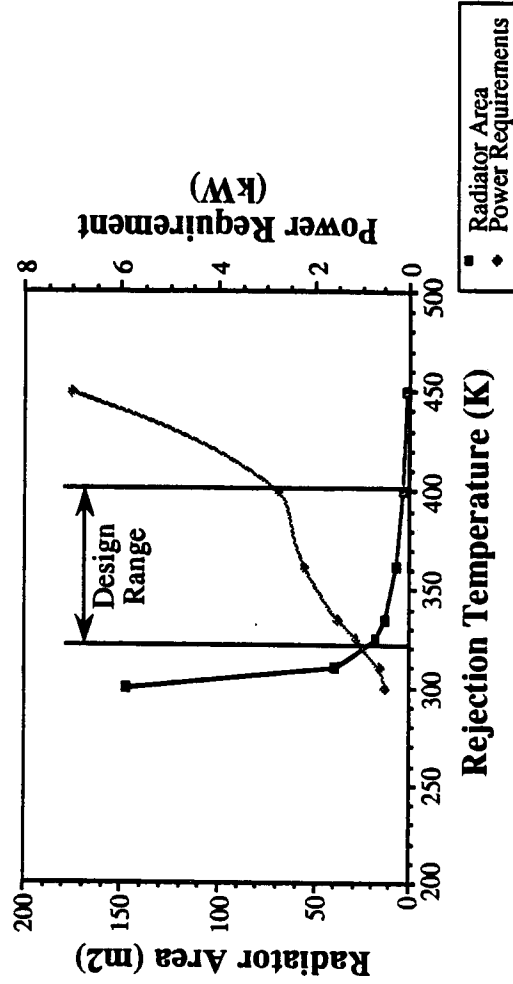
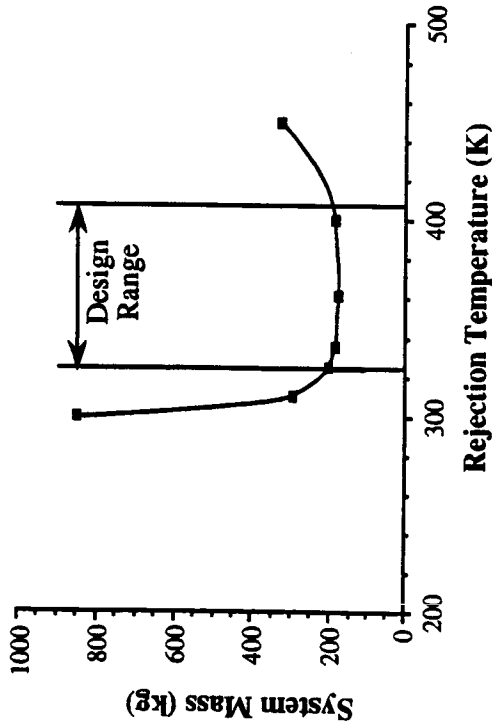

- Tsink = 296 K - Payload temp. = 275, 290 K
- R11 refrigerant
- Rejection load = 5 kW
- $\alpha=0.3, \epsilon=0.8$
- Compressor isentropic efficiency = 60 %

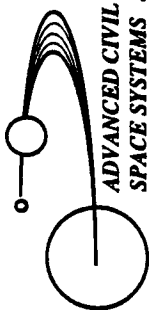

ADVANCED CIVIL
SPACE SYSTEMS

Heat Pumped and Passive System Functional Schematic

BOEING

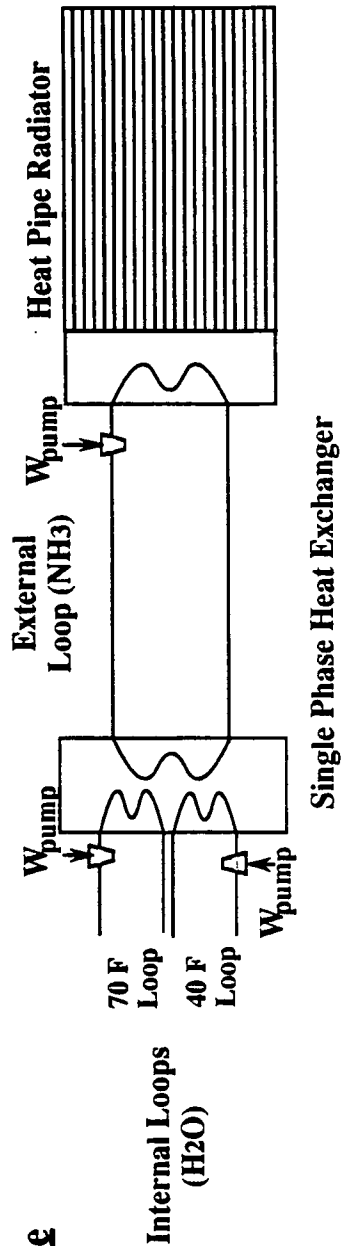
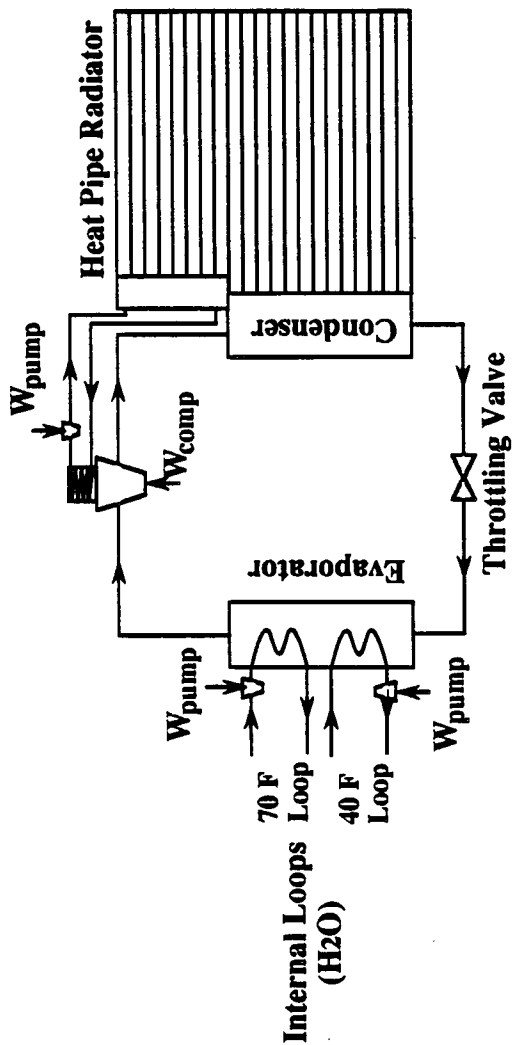

lower than that required for the active system (~200 W vs. over 2 kW).

Solar angle and Radiator/Shield Configuration

Schematics of the various radiator types investigated are shown, including relevant dimensions and explanation. In particular, the geometric and operational parameters of the selective field of view radiator are shown. The equilibrium temperatures (sides, top, sink) were determined from materials properties and a heat balance. The overall sink temperature of the conservative design was determined to be 165° K, which is only slightly below a typical effective sink temperature of a space based radiator. The bulky and heavy shielding required for the selective field of view radiator, along with its operational considerations (tracking, etc.), make it more suitable for high power, static applications (bases, processing plants, etc).

Radiator Sizing Code Capabilities

A computer program was developed to automate the sizing process developed for the rover study. The code is applicable to all lunar surface systems which utilize radiators to reject waste heat. The inputs of the code are listed, and are the same as required for the earlier study. Radiation view factors were entered into the code based on curve fits of data derived from a Monte Carlo ray trace radiation exchange computer code. The outputs of the code are the same as before, except the mass, sink temperature, etc. are calculated at each time step. The program selects the worst thermal case, and sizes the system accordingly.

Investigated Radiator Design Options

A summary of the worst case sink temperatures is presented in this chart. As stated before, the sink temperatures were different for the 2 sided options in order to account for the shielding effect provided by the radiator. The "sun" and "dark" sides of the 2 sided radiators may have to be insulated from each other to take advantage of this (MLI should be a relatively low cost option for this). This point may be more easily illustrated on the sink temperature vs. sun angle plot, shown on the next chart.

Vertical Radiator Effective Sink Temperature vs. Sun Angle

A plot is shown of the effective sink temperature for both shielded and unshielded vertical, and horizontal radiators. The hot and cold side temperatures are shown for the vertical radiator options, and as should be expected, they meet at a solar angle of 90°. The lunar surface temperature is also plotted versus sun angle as a reference. Although the horizontal radiator sees a slightly lower overall sink temperature than the vertical unshielded radiator, the vertical radiator is significantly smaller, since its radiating area is two times its platform area (radiates from both sides). The shielded radiator plot shows the effectiveness of increasing shield size. As noted on the chart, and verified with view factor calculations, the shield width effects on the sink temperature are not as great as varying shield height. The decrease in sink temperature for the largest shield ($H_s/H_r = 3$) as compared to the middle shield ($H_s/H_r = 2$) is not as great as the decrease between no shield and the smallest shield ($H_s/H_r = 1$), and between the smallest and middle sized shield.

Vertical Radiator to Shield View Factor vs. Shield Size

This chart is shown to illustrate the selection process for shield size for the vertical radiator. This graph also illustrates more clearly the relative insensitivity of the overall view factor (and therefore sink temperature) to the shield width / radiator width ratio. A view factor of 80% of the maximum

value was chosen somewhat arbitrarily, in order to choose a reasonable design point for the vertical radiator shield. As can be seen on the graph, a shield height / radiator height of ~2 resulted for all values of W_s / W_r . The selected ratio was only 1.5, however, due to operational constraints (i.e. mobility and clearance) of the manned rover. The $H_s/H_r = 1.5$ point seems to be a good design point, since it is just above where the view factor curve begins to flatten out (decreasing advantage for larger shield sizes).

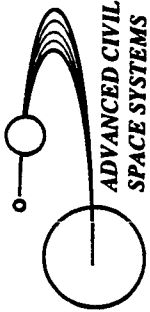

ADVANCED CIVIL
SPACE SYSTEMS

Solar Angle and Radiator / Shield Configuration

BOEING

Solar Angles for Sink Temperature Determination

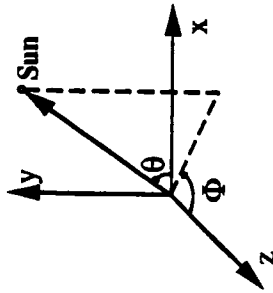

Horizontal Radiator

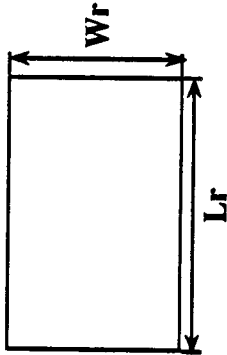

Shielded Radiator Concept

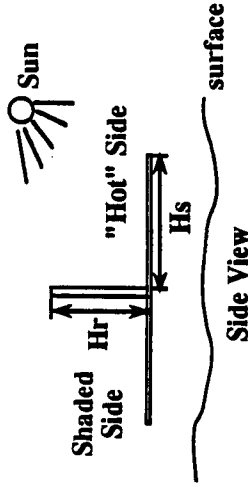

Selective Field of View Radiator Design

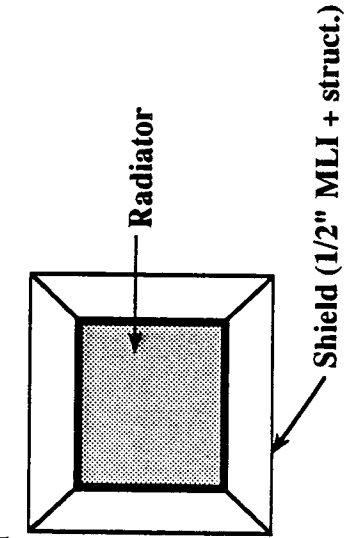
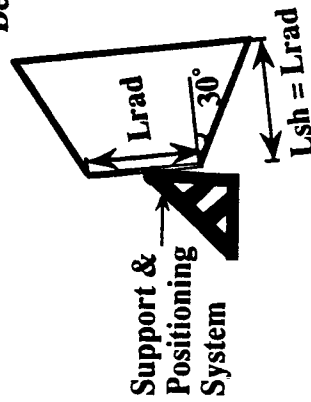

- $T_{bottom} = T_{sides} = 202^\circ \text{ K}$; $T_{top} = 255^\circ \text{ K}$
- $T_{sink} \sim 165^\circ \text{ K}$
- Spec. mass varies from 15 -24 kg/m², dep. on profile (H/W)

Top View

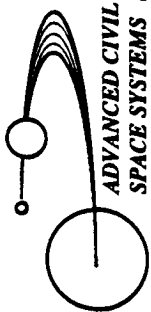

Radiator Sizing Code Capabilities

BOEING

- **RADIATOR** code developed on IR&D to automate sizing process
- Inputs include radiator & shield surface properties, radiator type, rejection temp. desired, heat load, and shield/radiator aspect ratios
- **RADIATOR** output includes:
 - radiator & shield surface areas/sink temps vs. solar angle
 - worst case areas, masses, and sink temperatures
 - shield/radiator view factors & dimensions
 - heat pump mass & power requirements

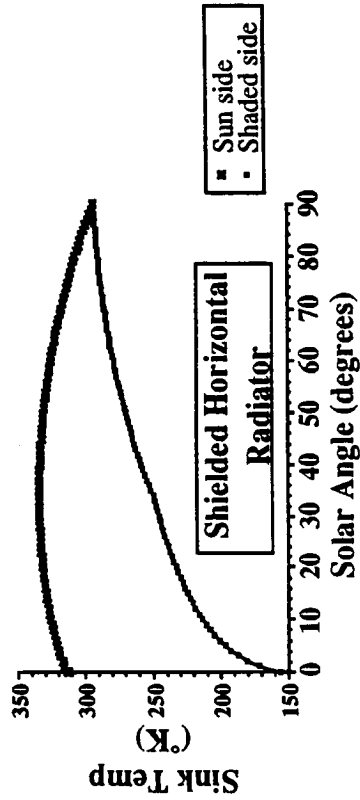
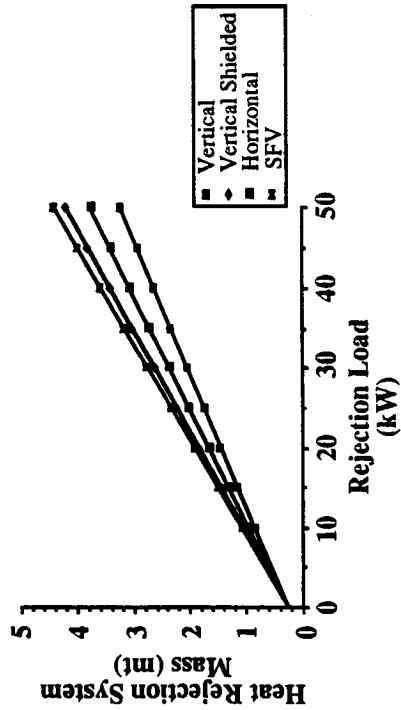

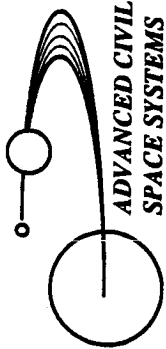







ADVANCED CIVIL
SPACE SYSTEMS

Investigated Radiator Design Options

BOEING

Radiator Concept		Approx. Tsink (°K)
	I. Vertical Unshielded (2 sided)	Hot side 321 Cold side 311
	II. Vertical Shielded (2 sided)	Hot side 310 Cold side 275
	III. Horizontal (1 sided)	303
	IV. Selective Field of View (1 sided)	165
	V. BMR - Unshielded (1 sided)	Hot side 321 Cold side 311
	VI. BMR - Shielded (1 sided)	Hot side 310 Cold side 275

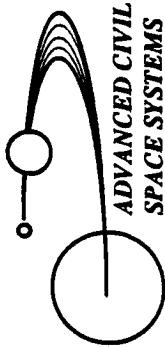

ADVANCED CIVIL
SPACE SYSTEMS

Vertical Radiator Effective Sink Temperature vs. Sun Angle

BOEING

Shielded

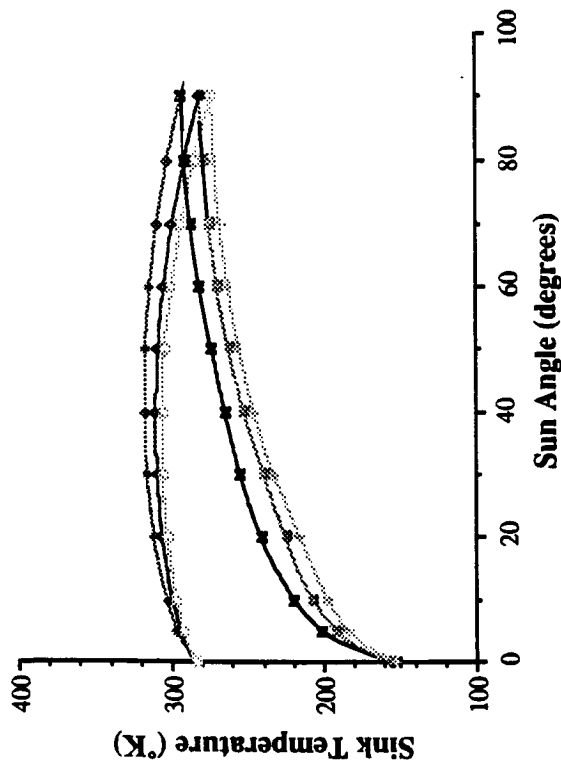

- Hs/Hr=1 Shaded side
- ◆ Hs/Hr=1 Hot Side
- ⊠ Hs/Hr=2 Shaded Side
- ◇ Hs/Hr=2 Hot Side
- ⊡ Hs/Hr=3 Shaded Side
- ⊢ Hs/Hr=3 Hot Side

Unshielded

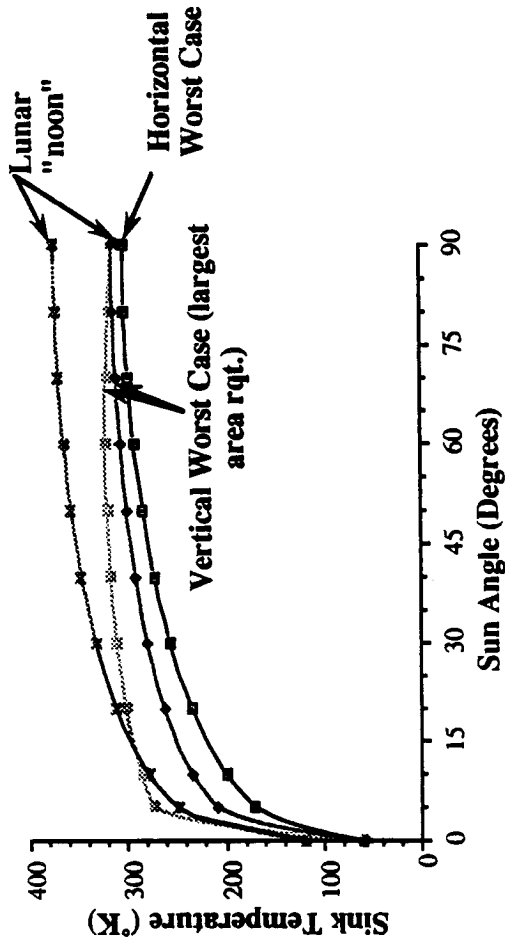

- Horiz. radiator
- ⊠ Surface Temp.
- ⊡ Vert. Radiator Hot Side
- ◆ Vert. Radiator Cold Side

- Hs/Hr ratio increase from 1 to 2 results in greater sink temp. decrease than Hs/Hr increase from 2 to 3
 - Ws/Wr increases not as effective as Hs/Hr increases in reducing effective sink temp.

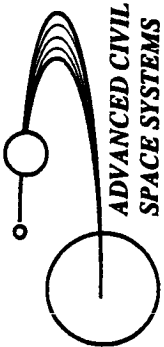

Vertical Radiator to Shield View Factor vs. Shield Size

BOEING

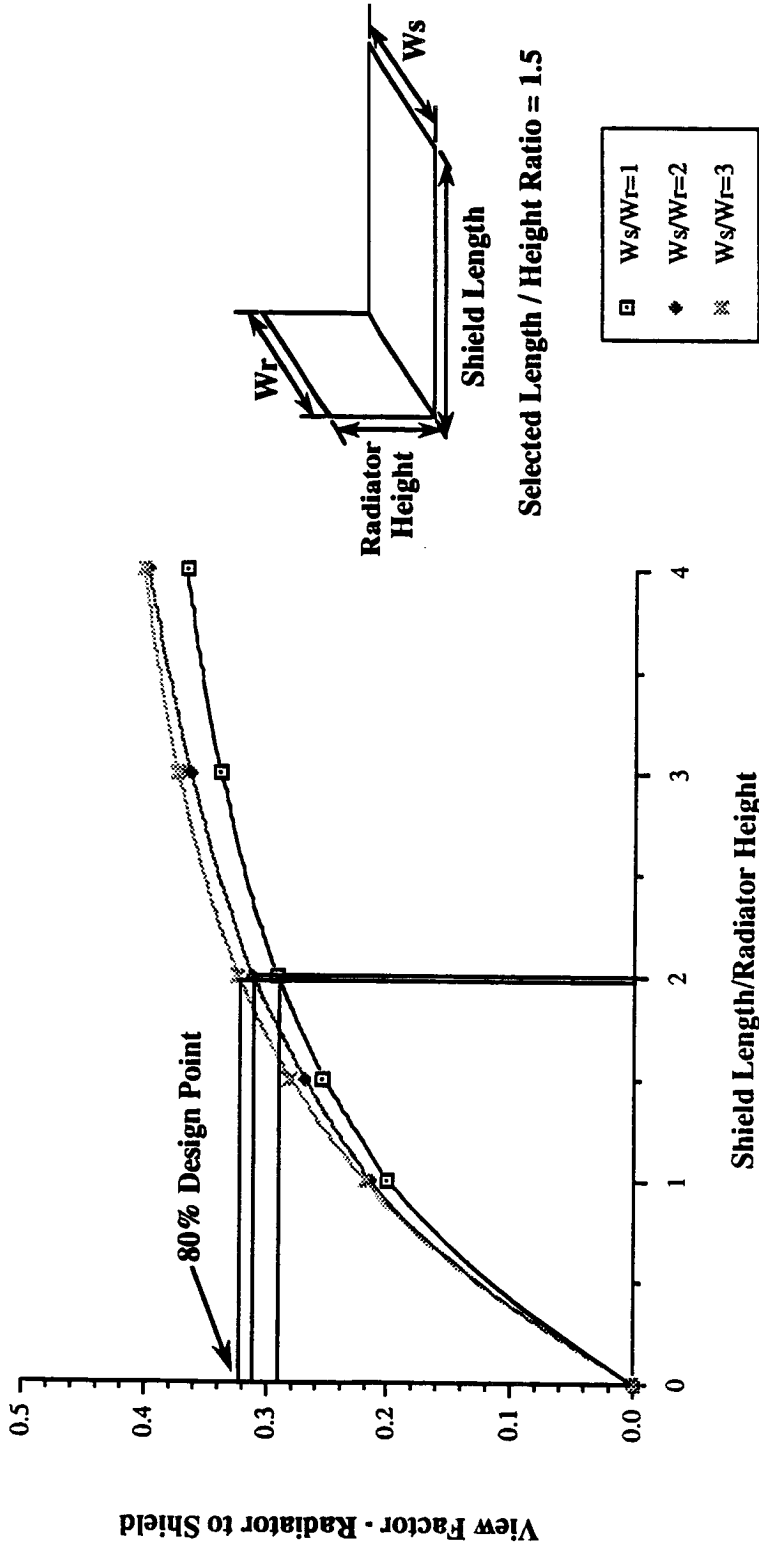

Note: 80% design point (80% of max. value) shown for reference only; slightly lower value chosen to further minimize shield size

N93-27986

530-31

158344

P. 13

RECTENNA THERMAL MODEL DEVELOPMENT

Murall Kadramangalam, New York University
Adrian Alden, Communications Research Centre, Ottawa
Daniel Speyer, New York University

Abstract

Deploying rectennas in space requires adapting existing designs developed for terrestrial applications to the space environment. One of the major issues in doing so is to understand the thermal performance of existing designs in the space environment. Toward that end, a 3D rectenna thermal model has been developed, which involves analyzing shorted rectenna elements and finite size rectenna element arrays. A shorted rectenna element is a single element whose ends are connected together by a material of negligible thermal resistance. A shorted element is a good approximation to a central element of a large array. This model has been applied to Brown's 2.45 GHz rectenna design. Results indicate that Brown's rectenna requires redesign or some means of enhancing the heat dissipation in order for the diode temperature to be maintained below 200° C above an output power density of 620 W/m². The model developed in this paper is very general and can be used for the analysis and design of any type of rectenna design of any frequency.

Introduction

One of the means of powering space missions is to transmit the power at microwave or millimeter wave frequencies. In order to receive this power and convert it to DC a rectifying antenna or rectenna is necessary at the end where it is desired to make use of this beamed power. To date rectennas have been designed and built to be used on high altitude aircraft or for the solar power satellite where they would be deployed in terrestrial environments. Space missions would require higher power densities than the applications rectennas were originally designed for. In addition in space, thermal convection which is available in terrestrial environments is absent, confining heat dissipation to radiation alone. It is thus necessary to develop a methodology to conduct thermal analysis of rectennas deployed in space environments, which can lead to a better understanding of rectenna performance in space and yield higher reliability rectennas, which is the subject of this paper.

Model of a single unit cell

A rectenna array consists of several parallel sub-arrays of rectenna elements. A typical rectenna element consists of a half-wave dipole, transmission lines, low pass filters, a Schottky barrier diode and DC buses. *Figure 1* shows a schematic representation of Brown's 2.45 GHz (referred here on to as the 2.45 LP or linear polarized rectenna) rectenna array. Each sub-array can be thought of as being composed of a repeat pattern, this being the rectenna element. The substrate on which the circuit is etched is referred to as the foreplane. Microwave power is incident on the foreplane, some of which is converted to useful DC by the circuit and the rest goes through the substrate. It is necessary to redirect as much of this power as possible to the foreplane to ensure high conversion efficiency. This is accomplished by the use of a reflecting plane which is placed approximately quarter of a wavelength (the wavelength of the microwave radiation) behind the foreplane. In order to provide structural support to the reflecting plane and prevent any electrical interaction between the circuit and the reflecting plane an electrical insulator is placed between the foreplane and the reflecting plane (known as the spacer).

A single rectenna element together with the underlying substrate, the spacer and the reflecting plane is the unit cell for the purposes of computations. In the case of the 2.45 LP rectenna the circuit is made of copper, the substrate is Kapton F, the spacer is styrofoam or polyurethane and the reflecting plane is aluminized Kapton. It is necessary to determine both the temperature distribution within each element of the sub-array and the diode temperatures of all of the elements of the sub-array. In order to be able to do this, initially a single element is modeled. A mesh of the circuit and underlying materials is constructed using the mesh generator INGRID¹ and is shown in *Figure 2*. The copper circuit is etched on the substrate and protrudes out approximately 2 mils above the substrate. The diode has two gold ribbons at either end, by which it is bonded to the circuit. The bypass filter is depicted as being above the transmission line, while it actually is located behind the foreplane. This is done purely to facilitate ease of constructing the mesh. The diode is the principle heat source in the circuit. Incident microwave not converted to DC (due to the inefficiency of the diode) gets converted to heat in the diode. The diode is an asymmetrically placed heat source in the rectenna element (unit cell) because of which there is heat flow across the edge of the unit cell. In fact other than ensuring that all the components of an element are contained in the unit cell, the choice of where to locate the unit cell boundaries is quite arbitrary. In the case shown in *Figure 2*, the boundary is chosen as an alternative to modelling the unit cell from dipole to dipole. Choosing the latter option could result in step discontinuities in the solution.

The diode is a Schottky barrier diode packaged in a ceramic casing. Brown reported² that there was only negligible heat flow from the ohmic contact side of the diode (lid side) and he suggested that repackaging the diode in the ceramic casing (as opposed to the original glass casing) would

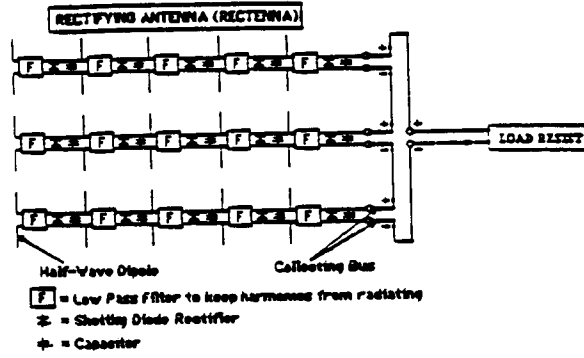

Figure 1. Schematic of Brown's 2.45 LP rectenna array. Each unit of the repeat pattern in the array is the rectenna element (unit cell). Components of the rectenna element are also shown.

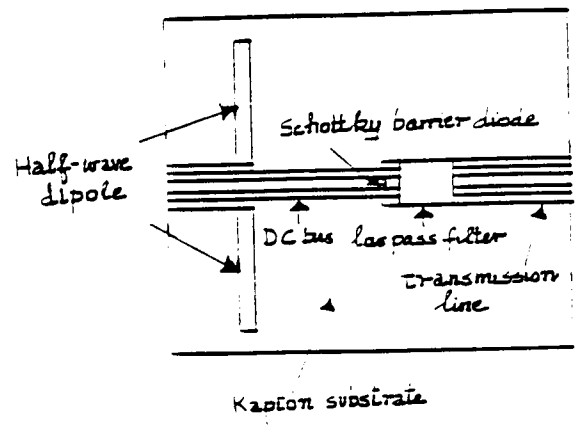

Figure 2. Mesh generated picture of the rectenna unit cell constructed using INGRID. Shown are the foreplane and circuit details. The spacer and reflector lie below the foreplane. The cartesian co-ordinate system is shown to the right, with the z direction pointing outwards from the plane of the page.

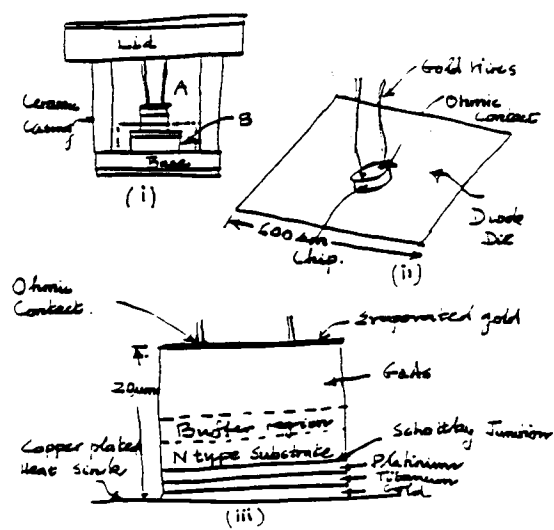

Figure 3. (i) Shows the schematic of the Raytheon Schottky barrier diode. Figure (ii) shows the diode die and the chip which is soldered to the base. Figure (iii) shows the details of the chip and the heat sink.

substantially increase the heat flow from the lid side. While the heat transfer characteristics are improved somewhat due to the repackaging, the heat flow from the lid side continues to be negligible. The diode is modeled as three separate anisotropic elements, one element each for the lid, the base and the alumina ceramic case. The two gold ribbons at each end of the diode that are used to connect the latter to the circuit are modeled as two isotropic elements. *Figure 3* shows the details of the Raytheon Schottky barrier diode. These details are compilation from various reports papers authored by William Brown and an analysis of the diode conducted by the Communications Research Centre.³ *Figure 3 (i)* shows the schematic of the diode. The diode die which is shown in *Figure (ii)* is soldered onto the base and covered with the alumina ceramic casing. The wires from the chip are then connected to the lid. Two gold ribbons are connected to the base and lid, which are soldered to the circuit. *Figure (iii)* shows the different regions of the chip and the heat sink.

Most of the heat is dissipated in the Schottky junction shown in *Figure (iii)*. The region below the junction but above the base is called region B. The region above the junction, including the chip, the ohmic contact and gold wires is termed region A. The reason that the heat flow on the lid side is poor is because of the 1 mil thick gold wires (2) which have a very large thermal resistance. The conductivity of the individual elements is determined as follows:

- (i) Total series resistance for regions A and B are determined (R_A and R_B). R_A also includes a radiant heat transfer component from the base to the lid.
- (ii) Thermal conductivities (K_x , K_y and K_z) is determined for the base, the alumina and the lid. (These three parts are in turn composed of sub-components of different materials).
- (iii) The thermal conductivities of the base, lid and the casing are changed to accommodate the change in their areas on account of modeling them as rectangular elements (as opposed to the original circular c/s).
- (iv) The resistance R_A is added to the lid, modifying the thermal conductivity of the lid in the y direction (K_y).
- (v) R_B is added to the base, thus changing K_y of the base.

The bypass filter (subsequently referred to as the interconnect) is originally located below the Kapton. However for ease of modeling it is moved over the copper transmission lines shown in *Figure 2*. From a thermal standpoint, the interconnect conducts heat from the transmission line on the base side to the transmission line on the lid side, thus doubling the effective radiant dissipation area available to the diode. In the absence of the interconnect, the heat would only be dissipated by the transmission line on the base side, resulting in substantially higher diode temperature. The interconnect in effect compensates for the fact that the diode only dissipates heat on one side (the base). The interconnect is modelled as number of anisotropic elements. The thermal conductivities of the interconnect are determined as follows:

- (i) In x and y direction the heat flow is a parallel flow. For example the thermal resistance in the x direction R_x is

$$\frac{1}{R_x} = \frac{1}{R_k} + \frac{1}{R_c}$$

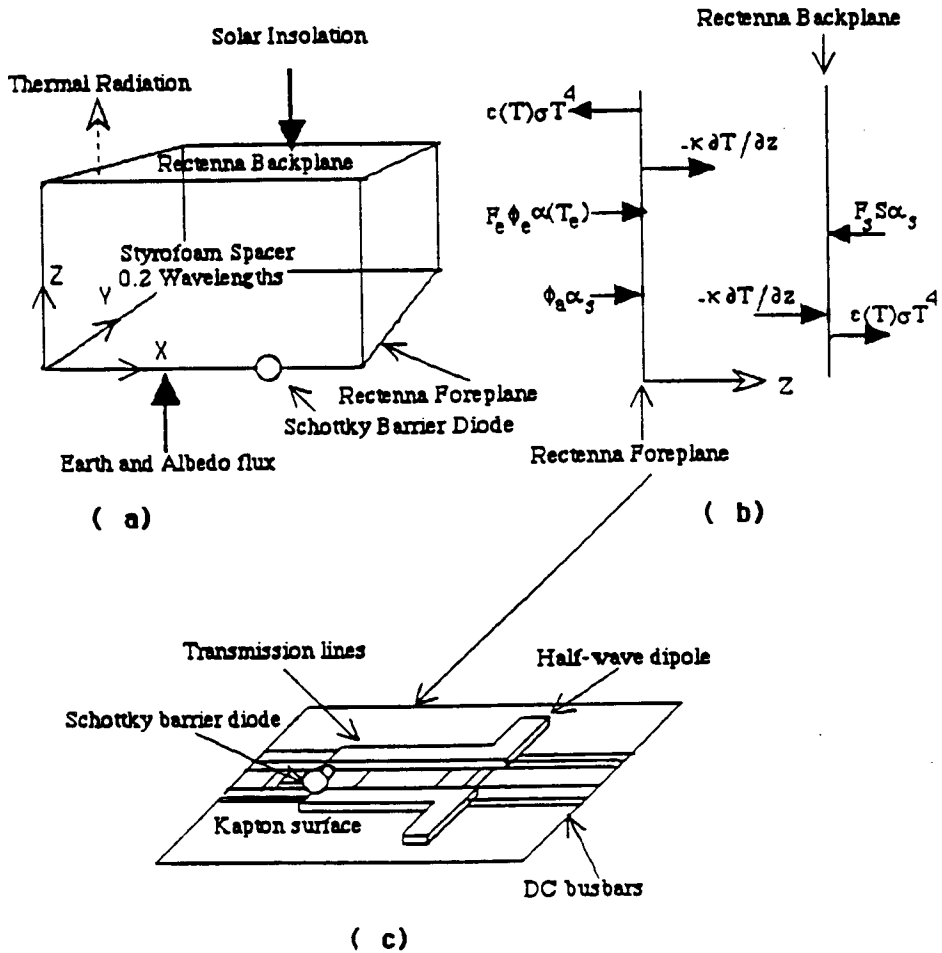

Figure 4. (a) shows a unit cell of the rectenna and the various incoming and outgoing fluxes. The Schottky barrier diode is the main source of heat in the diode. Figure (b) shows the energy balance on the foreplane and the reflector plane. Figure (c) shows the details of the circuit on the foreplane.

Where R_k and R_c are resistance of the Kapton and copper which make up the interconnect. Since the thickness of Kapton is very small, $R_k \rightarrow \infty$, therefore $K_x \approx K_c$ and $K_y \approx K_c$.

(ii) In the z direction, the heat is series flow, therefore:

$$R_z = R_k + R_c$$

Since the areas are the same and the thickness of copper and Kapton are of the same order of magnitude and $K_c \gg K_k$ therefore:

$$K_z \approx K_k$$

That is the amount of heat conducted through the interconnect is determined by Kapton, while across by copper. Besides heat dissipation in the diode, there is Joule heating in the DC buses, when current passes through them. This Joule heat is modeled as volumetric heat generation in the heat conduction equation. The rectenna itself is assumed to be in a low earth orbit, due to which solar flux is incident on the reflector plane and albedo and earth flux are incident on the foreplane. Albedo flux is the fraction of the incoming solar radiation reflected back by the clouds and is given by:

$$F_a = Sa$$

where S is the solar constant and a is the albedo coefficient (Agrawal, 1986)⁴. An annual mean value of a ($= 0.32$) is used in all calculations. The earth absorbs a part of the incoming solar radiation and emits infrared radiation ($F_e = 237 \text{ W/m}^2$) which is assumed to be incident on the rectenna foreplane. *Figure 4*, depicts the unit cell with the associated incoming and outgoing fluxes and the energy balance on the foreplane and reflector plane. A 3D finite element heat transfer code TOPAZ3D⁵ is used to solve the anisotropic heat conduction equation throughout this paper. Results (temperature contours) of a run at a power level of 218 mw (dissipated in the diode) for an unshorted unit cell are displayed in *Figure 5*. The contours are asymmetric about the x axis near the diode because of the unequal dissipation of heat close to the diode. The diode temperature is 402 K at a dissipation of 286 mw, which corresponds to about 1.76 watts of output power per diode (or about 352 W/m^2 output) corresponding to a 200 ohm load resistance.

Model of a shorted unit cell

The diode is an asymmetrically placed heat source within each rectenna element (unit cell) because of which there is heat flow across the edges of the unit cell. Thus results from modeling a single unit cell are not representative of a rectenna element in a sub-array. In order to overcome this problem, the edges of the unit cell (of the kind developed in the last section) are "shorted" together when performing the computation. Shorting is an artificial construct used just for modeling purposes and provides a means determining the temperature distribution of a rectenna element

```

c sing unshoed
time = 0.10000E+01
contours of topaz3d temperature
min= 0.298E+03 at node 803
max= 0.402E+03 at node 958

```

```

contour interval = 0.06E+02
contour labels = 0.17E+02, 0.23E+02, 0.29E+02, 0.35E+02, 0.41E+02

```

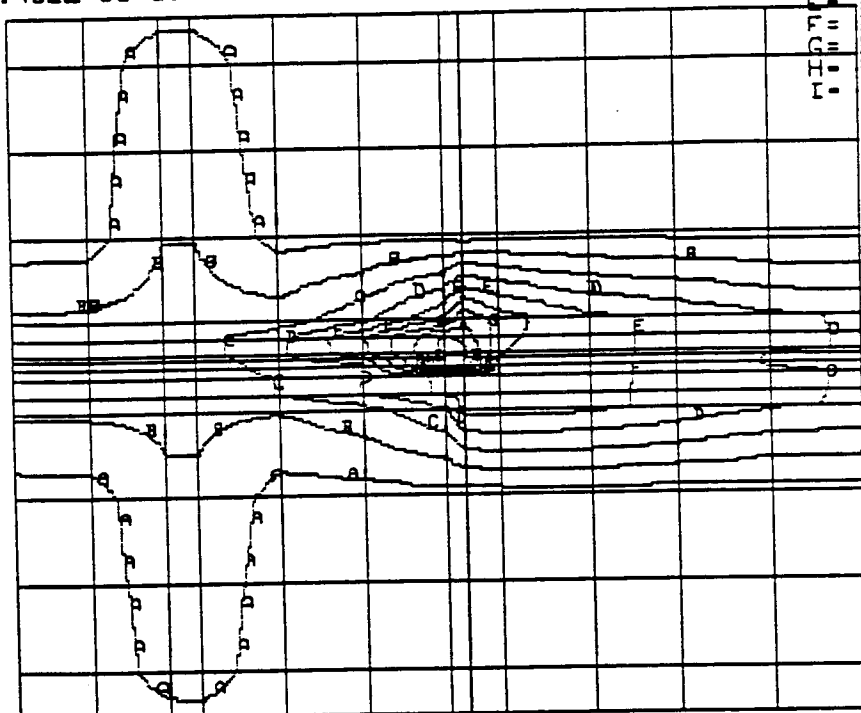

Figure 5. Temperature contours of 3D thermal model of a single rectenna unit cell. Diode temperature is 402 K for 286 mW of heat dissipation. The contours are not symmetric near the diode because of the unequal dissipation of heat on either end of the diode.

in the center of a large array. It is used in place of actually wrapping the unit cell around. Thus the short should have negligible or zero thermal resistance. Since

$$R = \frac{\Delta (xV_yV_z)}{KA} = \frac{\Delta n}{KA}$$

K is chosen large enough that $R \approx 0$.

In the case of the rectenna unit cell each of the different materials must be connected with "shorts" of thickness corresponding to that specific material. For example the outermost layer of copper must be connected by a short which corresponds to the thickness of the transmission lines. The copper short encases the shorts for the other materials, namely the Kapton and the spacer. *Figure 6* shows the mesh for all the materials with the copper short discontinuous at the top. The region where the gap occurs in the copper is deleted in the next stage and the unit cell mesh (developed in the last section is put in the place of the material removed). *Figure 7* shows the plan view of the shorted unit cell with the temperature contours superimposed on the foreplane for a dissipated power level of 286 mw. As expected the temperatures on either end of the unit cell where the short begins are equal (317 K, indicated by the contour line B in *Figure 7*) and the temperature of the diode is 399.59 K (a 3.K difference from the unshorted case at the same power level).

Model of a three cell array

In the case of large arrays, there will not be much variation in the diode temperature from element to element, except at the edges. However, in finite arrays there is expected to be variation in diode temperatures. In order to determine this temperature variation, a finite size array, consisting of three elements is modeled. The unit rectenna unit cell developed earlier is used and two more similar unit cells are created. These three cells are then connected together and appropriate coordinates are specified when linking them together. Flux and radiant boundary conditions as before are specified and the heat conduction equation is solved for the three cell array. *Figure 8* shows the mesh and the temperature contours for the three unit cell array at a dissipated power level of 286 mw. Joule heating is included in this computation. The diode temperature increase linearly from the left to the right (with the left at 399.60 K, the central diode at 400.72 K and the right at 403.37 K) at a dissipation of 286 mW in the diode. Combined results from several computations showing diode temperature versus heat dissipated for the 2.45 LP rectenna are plotted in *Figure 9*.

Conclusions

There is good agreement between the diode temperature in the shorted case and the diode in the central element of the three cell array. If one assumes that 200°C (473 K) is an upper limit on the diode temperature to ensure reliable rectenna performance, (as suggested by Brown) then from *Figure 9*, this limits the heat dissipation in the diode to approximately 546 mW or 0.55 Watts. At 85% conversion efficiency of microwave to DC, this corresponds to an output power density of 620 W/m². This suggests that for higher power densities the 2.45LP rectenna should either be redesigned to increase heat dissipation or some means of augmenting the heat transfer out of the diode should be provided. The methodology developed in this paper can easily be adapted to analyzing any kind of rectenna designs at any frequency.

References

- ¹Stillman, D.W., and Hallquist, J.O., "INGRID: A Three-Dimensional Mesh Generator for Modeling Nonlinear Systems," University of California, Lawrence Livermore National Laboratory, Rept. UCID-20506 (1985).
- ²Brown, W.C., "Design Definition of A Microwave Power Reception and Conversion System for Use on A High Altitude Platform", Prepared for NASA Wallops Flight Center by Raytheon Company, NASA CR-15866 (1981).
- ³Work performed at the Communications Research Centre, communication from A. Alden.
- ⁴Agrawal, B.N. *Design of Geosynchronous Spacecraft*, Prentice-Hall, Inc., Englewood Cliffs, New Jersey (1986).
- ⁵Shapiro, A.B., "TOPAZ3D-A Three-Dimensional Finite Element Heat Transfer Code," University of California, Lawrence Livermore National Laboratory, Rept. UCID-20484 (1985).

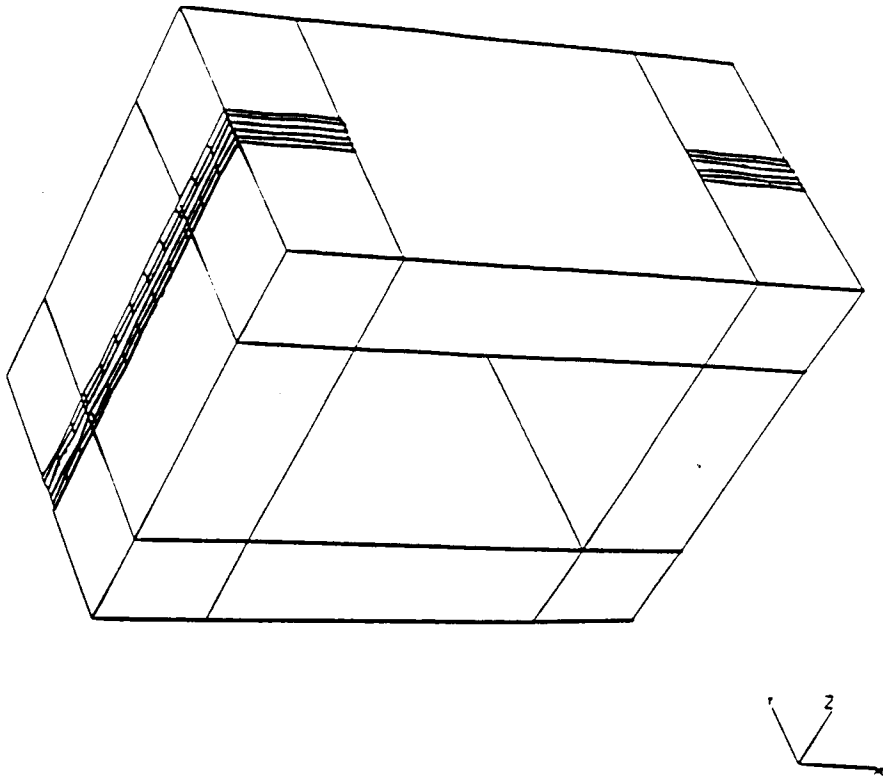

Figure 6. Mesh generated picture of the "short" for all the materials of the the rectenna unit cell developed using INGRID. The copper circuit "short" encases all other materials and the location at the top where it does not exist is the region where the rectenna unit cell is emplaced prior to computation in the case of the shorted cell.

time = 0.10000E+01
 contours of topaz3d temperature
 min = 0.290E+03 at node 753
 max = 0.400E+03 at node 936

contour values
 A = 0.06E+02
 B = 0.17E+02
 C = 0.28E+02
 D = 0.38E+02
 E = 0.49E+02
 F = 0.59E+02
 G = 0.70E+02
 H = 0.80E+02
 I = 0.91E+02

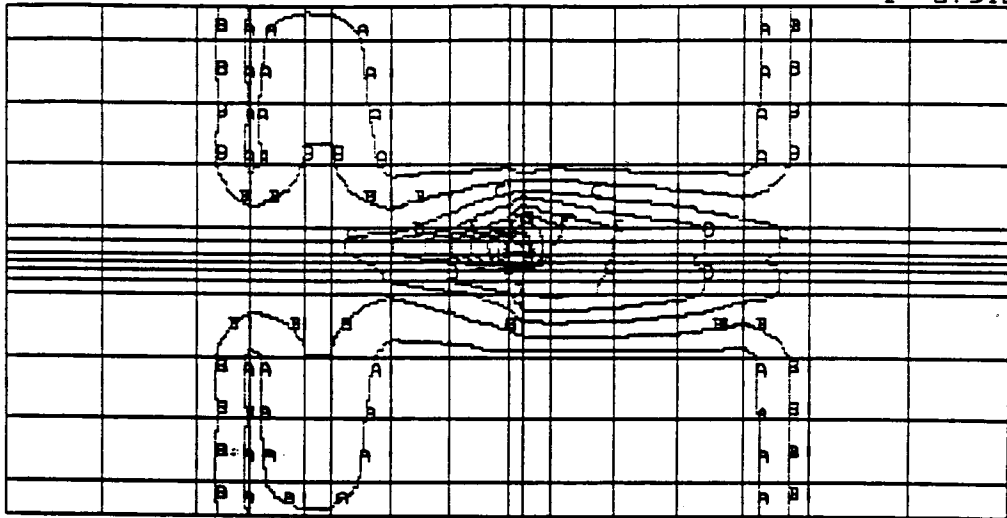

Figure 7. Plan view of the shorted unit cell and superimposed temperature contours. Diode temperature is 399.59 K for a dissipation of 286 mW. Temperatures at the either edges of the unit cell (contour B) are the same (317K) due to shorting.

```

time = 0.10000E+01
contours of topaz3d temperature
min= 0.298E+03 at node 771
max= 0.403E+03 at node 2742

```

```

contour values
A= 3.07E+02
B= 3.18E+02
C= 3.28E+02
D= 3.39E+02
E= 3.50E+02
F= 3.61E+02
G= 3.72E+02
H= 3.83E+02
I= 3.94E+02

```

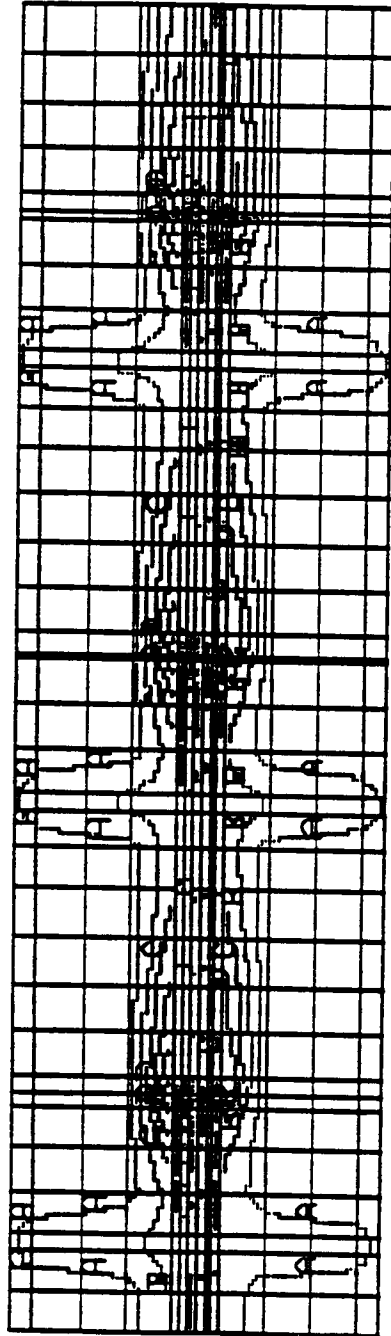

Figure 8. Temperature contours for an array of three rectenna unit cells. The computation is done for 286 mW of diode dissipation. The third diode (from left to right) has the maximum temperature of 403.37°K .

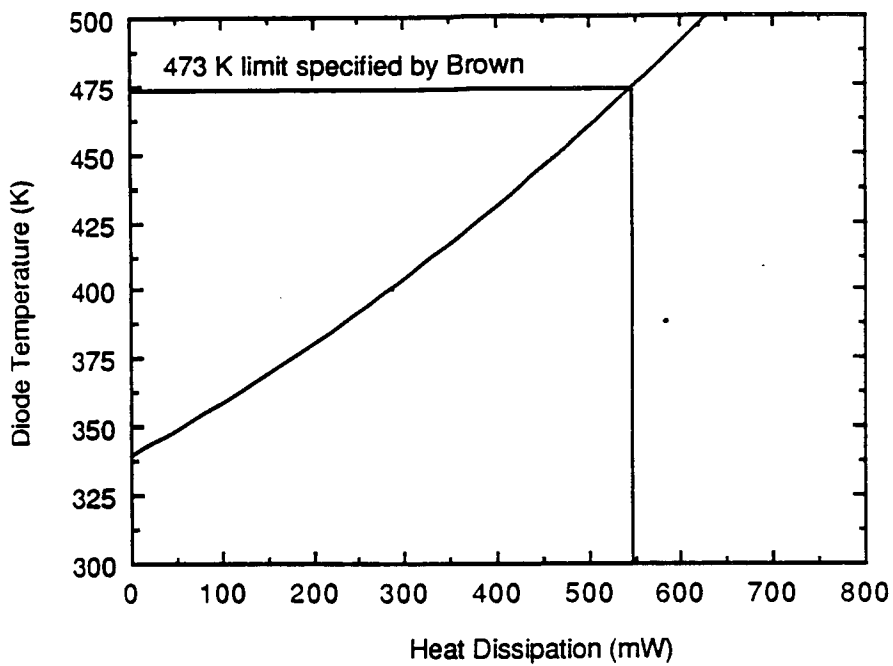

Figure 9. Combined results from many computations showing diode temperature versus heat dissipated in the diode. Also shown is the 473 K upper temperature specified by Brown and corresponding maximum dissipation of 0.55 Watts.

N 93 - 27987

CHOICE OF ANTENNA GEOMETRY FOR MICROWAVE POWER TRANSMISSION FROM
SOLAR POWER SATELLITES

Seth D. Potter
New York University

S31-20
158345
p-9

Abstract

A comparison is made between square and circular transmitting antennas for solar power satellite microwave power transmission. It is seen that the exclusion zone around the rectenna needed to protect populations from microwaves is smaller for a circular antenna operating at 2.45 GHz than it is for a square antenna at that frequency. If the frequency is increased, the exclusion zone size remains the same for a square antenna, but becomes even smaller for a circular antenna. Peak beam intensity is the same for both antennas if the frequency and antenna area are equal. The circular antenna puts a somewhat greater amount of power in the main lobe and somewhat less in the sidelobes. Since rain attenuation and atmospheric heating remain problems above 10 GHz, it is recommended that future solar power satellite work concentrate on circular transmitting antennas at frequencies roughly 10 GHz.

Introduction

In order to maximize the safety and efficiency of microwave power transmission from a solar power satellite (SPS) to the Earth, the shape of the satellite's transmitting antenna must be optimized. Previous work at New York University^(1,4) has considered a square transmitting antenna, typically 1 kilometer across. The width of the main beam lobe at the ground, and thus, the width of an economical rectifying antenna (rectenna), varies as the inverse of the frequency. It was shown that, to a good approximation, the size of the exclusion zone needed to protect people from microwave exposure is independent of frequency (see *Figures 2 and 3*). Furthermore, rain and atmospheric attenuation become significant for frequencies above 10 to 15 GHz. This was considered to be the maximum usable frequency range. Since many SPS studies have considered circular transmitting antennas², it is instructive to examine such antennas in a manner analogous to Reference 1.

Square Transmitting Antennas

It was shown that for a square phased array of side $D_t = 1$ km, at geostationary altitude $h = 35,786$ km, with $N \times N$ isotropically radiating elements uniformly spaced less than one-half wavelength apart beaming power to a rectenna at the equator, the microwave beam intensity at the rectenna, with boresight peak I_0 , is expressible as the product of the x and y distributions. Two-dimensional intensity is given by^(1,4):

$$I(x, y) = I_0 \times \left[\frac{\sin \frac{\pi \hat{x}}{2}}{N \sin \frac{\pi \hat{x}}{2N}} \right]^2 \left[\frac{\sin \frac{\pi \hat{y}}{2}}{N \sin \frac{\pi \hat{y}}{2N}} \right]^2 \quad (\text{Equation 1})$$

where

$$\hat{x} = x \left\{ \frac{2D_t}{\lambda h} \right\}, \quad \hat{y} = y \left\{ \frac{2D_t}{\lambda h} \right\} \quad (\text{Equations 2})$$

and $x, y =$ distances from the center of the diffraction pattern at the Earth's surface in the x and y directions. Note that $N > 2D_t/\lambda$, so $N \approx 20,000$ at a frequency of 2.45 GHz (see *Figure 1* for a plot of Equation 1 at this frequency). Since \hat{x} and \hat{y} are small, Equation 1 can be approximated by:

$$I(x, y) = I_0 \times \left[\frac{\sin \frac{\pi \hat{x}}{2}}{\frac{\pi \hat{x}}{2}} \right]^2 \left[\frac{\sin \frac{\pi \hat{y}}{2}}{\frac{\pi \hat{y}}{2}} \right]^2 \quad (\text{Equation 3})$$

By integrating this in two dimensions from negative infinity to positive infinity, it is seen that

$$I_o = \frac{P_t}{4} \left\{ \frac{2D_t}{\lambda h} \right\}^2 = \frac{P_t D_t^2}{\lambda^2 h^2} = \frac{P_t A_t}{\lambda^2 h^2} \quad (\text{Equation 4})$$

where P_t is the total transmitted power and $A_t = D_t^2 =$ transmitting antenna area. If Equation 3 is integrated in two dimensions over the area of the main lobe and divided by the integral over all (two-dimensional) space, it is seen that 81.5% of the energy of the main lobe is in the central maximum. The remaining 18.5% of the energy is spread out in the form of sidelobes. These sidelobes represent energy that is spread too thinly to be economically rectifiable, but, as seen in Reference 1, may be a hazard to surrounding populations. For $P_t = 5$ GW, this wasted energy is 925 MW. It is instructive to investigate if this can be improved upon with the use of a circular transmitting antenna. In addition, the independence of exclusion zone size with frequency discussed in Reference 1 is a somewhat counterintuitive result. If the exclusion zone size decreases significantly with frequency for a circular antenna, then it may pay to increase the frequency beyond 10 to 15 GHz, despite the atmospheric and rain attenuation that occurs at higher frequencies.

Circular Transmitting Antennas

The intensity of a microwave beam transmitted from a circular antenna array is given by^(5,6):

$$I(\hat{r}) = I_o \times \left[\frac{2J_1\left(\frac{\pi \hat{r}}{2}\right)}{\frac{\pi \hat{r}}{2}} \right]^2 \quad (\text{Equation 5})$$

where J_1 is the first order Bessel function of the first kind, and \hat{r} is the dimensionless distance from the center of the diffraction pattern and is analogous to \hat{x} and \hat{y} given by Equations 2. Thus,

$$\hat{r} = r \left\{ \frac{2D_t}{\lambda h} \right\} \quad (\text{Equation 6})$$

and $r =$ radial distance from the center of the diffraction pattern at the Earth's surface. Here, D_t is the diameter of the circular transmitting antenna. Equation 5 is a two-dimensional intensity, since, for a transmitter directly overhead, the diffraction pattern is azimuthally symmetric.

By integrating Equation 5, it is seen that

$$I_o = \frac{\pi P_t}{16} \left\{ \frac{2D_t}{\lambda h} \right\}^2 = \frac{P_t A_t}{\lambda^2 h^2} \quad (\text{Equation 7})$$

Here, D_t and A_t are, respectively, the diameter and area of the circular transmitting antenna, and $A_t = \pi D_t^2/4$. By comparing Equations 4 and 7, it is seen that, for square and circular transmitting antennas of equal areas, equal peak beam intensities will result. Thus, to facilitate a comparison of antenna geometries, calculations will be done for a consistent value of A_t , specifically, 1 square kilometer (used in Reference 1). Therefore, $D_t = 1000$ meters for the square antenna and 1128 meters for the circular antenna. The beam intensity at the Earth's surface for a circular antenna of this size transmitting 5 GW of power at a frequency of 2.45 GHz is plotted in *Figure 4*. The peak beam intensity is 26 mW/cm². In order to investigate the dependence of exclusion zone size on frequency for a circular transmitting antenna, an approximation to the Bessel function can be used. For large z ,

$$J_1(z) \approx \frac{1}{\sqrt{\pi z}} [\sin(z) - \cos(z)] \quad (\text{Equation 8})$$

$$\text{Beam intensity} \propto \left\{ \frac{J_1(z)}{z} \right\}^2 \approx \frac{1}{\pi z^3} [1 - 2 \cos(z) \sin(z)] \quad (\text{Equation 9})$$

In order to eliminate the oscillating term in square brackets on the right side of Equation 9, its upper bound will be used. Since the upper bound is 2, Equation 9 becomes:

$$\text{Max} \left[\left\{ \frac{J_1(z)}{z} \right\}^2 \right] = \frac{2}{\pi z^3} \quad (\text{Equation 10})$$

The dimensionless argument of Equation 10 is given by:

$$z = \frac{\pi r}{2} = \frac{\pi}{2} r \left\{ \frac{2D_t}{\lambda h} \right\} = \frac{\pi r D_t}{\lambda h} \quad (\text{Equation 11})$$

Thus,

$$I(z) = I_o \times \text{Max} \left[\left\{ \frac{2J_1(z)}{z} \right\}^2 \right] = I_o \times \frac{8}{\pi z^3} \quad (\text{Equation 12})$$

Substituting Equations 7 and 11 into Equation 12 gives:

$$k(r) = \frac{2P_t \lambda h}{\pi^3 r^3 D_t} \quad (\text{Equation 13})$$

If c is the speed of light and f is the frequency, then $\lambda = c/f$. $l(r)$ can be set equal to the microwave safety threshold I_s , and r can be set equal to the exclusion zone radius r_s . If these substitutions are made in Equation 13, and the equation is rearranged, then the approximate radius of an exclusion zone for a circular transmitting antenna is given by:

$$r_s = \frac{1}{\pi} \left\{ \frac{2P_t c h}{I_s f D_t} \right\}^{1/3} \quad (\text{Equation 14})$$

Thus, for a circular transmitting antenna, the radius of the exclusion zone r_s is proportional to the frequency to the minus one-third power.

The exclusion zone plots shown in *Figures 5 and 6* were done using Equation 5; however, Equation 14 yields values at or near the upper bounds of the curves shown in these figures. By comparing *Figures 2 and 3* with *Figures 5 and 6*, it can be seen that at a given frequency and microwave safety threshold, the circular transmitting antenna yields a smaller exclusion zone than the square transmitting antenna. Furthermore, exclusion zone size does depend on frequency for a circular antenna, though the dependence is not strong. Thus, circular antennas represent an improvement over square antennas. With the use of a circular antenna, it would be advantageous to increase the frequency from 2.45 GHz to approximately 10 GHz. The frequency should not be increased significantly more than this, because the rain attenuation and atmospheric heating problems that affect the square antenna system would have the same effect on the circular antenna system. The exclusion zone decrease would not be worth the price paid in attenuation and heating. For example, for $A_t = 1 \text{ km}^2$, $P_t = 5 \text{ GW}$, and $I_s = 1 \text{ mW/cm}^2$, the square antenna exclusion zone half-width is 7118 m for all frequencies; its area is thus $(2 \times 7118 \text{ m})^2$ or 203 km^2 . The exclusion zone area for a circular antenna with the same parameters is given by πr_s^2 , where r_s is given by Equation 14. This area is 79 km^2 at 2.45 GHz, 31 km^2 at 9.8 GHz, 13 km^2 at 35 GHz, and 7 km^2 at 94 GHz. The latter two frequencies are subject to significant rain attenuation, as well as some atmospheric heating.¹ This is true regardless of antenna geometry, since square and circular transmitting antennas of equal areas, wavelengths, and total transmitted powers have the same peak beam intensity (Equations 4 and 7).

By comparing the integral of the circular antenna pattern over the main lobe with the integral over all two-dimensional space⁵, it is seen that 83.8% of the energy is concentrated in the main lobe. Since this figure is 81.5% for the square aperture, this represents another advantage of using a circular antenna. This 2.3% difference may not seem like much, but it amounts to 115 MW if the total transmitted power is 5 GW. One hundred fifteen MW of additional energy distributed among the sidelobes is what makes the square aperture exclusion zones so much larger than those of the circular aperture. Furthermore, the size of the main lobe can be found by letting $x = y = 2$ in Equations 2, and $t = 2.440$ (Reference 5) in Equation 6, and solving for the dimensionalized distance in each case. This results in exclusion zone sizes of:

$$x = y = \frac{\lambda h}{\sqrt{A_t}} \quad \text{for the square aperture}$$

and

$$r = 1.081 \frac{\lambda h}{\sqrt{A_t}} \quad \text{for the circular aperture.} \quad (\text{Equations 15})$$

Since x and y are the half-widths of a square lobe and r is the radius of a circular lobe, the areas of the main lobe can be found as follows:

$$\text{Area of square lobe} = 4xy = 4 \frac{\lambda^2 h^2}{A_t}$$

$$\text{Area of circular lobe} = \pi r^2 = 3.671 \frac{\lambda^2 h^2}{A_t} \quad (\text{Equations 16})$$

It is thus seen that for a given A_t , the circular aperture places [(83.8% - 81.5%) / 81.5%] x 100% or 2.8% more power into a main lobe that is 8.2% smaller in area, while maintaining the same peak beam intensity. The use of circular transmitting antennas is thus more economical than the use of square transmitting antennas.

Conclusions

For square transmitting antennas, exclusion zone width is independent of frequency. For circular transmitting antennas, exclusion zone radius is proportional to frequency to the minus one-third power. The width of the main lobe is inversely proportional to frequency for both geometries (see Equations 15). At a given frequency, the circular aperture allows for somewhat smaller rectennas, much smaller exclusion zones, and somewhat higher amounts of power in the main lobe than the square aperture. Furthermore, it does so while maintaining the same peak beam intensity. It is therefore recommended that future work on solar power satellites concentrate on circular apertures. In order to take advantage of the decrease of exclusion zone and main lobe size with frequency, the frequency should be increased from 2.45 GHz to roughly 10 GHz. Rain attenuation and atmospheric heating continue to be problems above that frequency. Further attempts to concentrate more power in the main lobe and reduce power to the sidelobes should therefore concentrate on beam tapering.

References

- ¹Seth D. Potter, Murali N. Kadiramangalam, (1991) "Frequency Selection Issues for Microwave Power Transmission from Solar Power Satellites," *Space Power*, Volume 10, Numbers 3/4.
- ²*The Final Proceedings of the Solar Power Satellite Program Review*, (1980) U.S. Department of Energy, Office of Energy Research, Solar Power Satellite Project Division, Washington, DC, USA, July. See, for example, F. Carl Schwenk, pages 21-35, "Overview of Systems Definition Activities for Satellite Power Systems."
- ³Peter E. Glaser, (1986) "Environmental Implications of the Solar Power Satellite Concept," *Space Power*, Vol. 6, pages 279-285.
- ⁴M.I. Hoffert, G. Miller, M. Kadiramangalam, W. Ziegler, (1989) "Earth-to-Satellite Microwave Power Transmission," *Journal of Propulsion and Power*, Vol. 5, No. 6, pages 750-758, November-December.
- ⁵Max Born, Emil Wolf, (1980) *Principles of Optics*, Sixth Edition, Pergamon Press, New York.
- ⁶Richard C. Johnson, Henry Jasik, editors, (1984) *Antenna Engineering Handbook*, Second Edition, McGraw-Hill, New York.

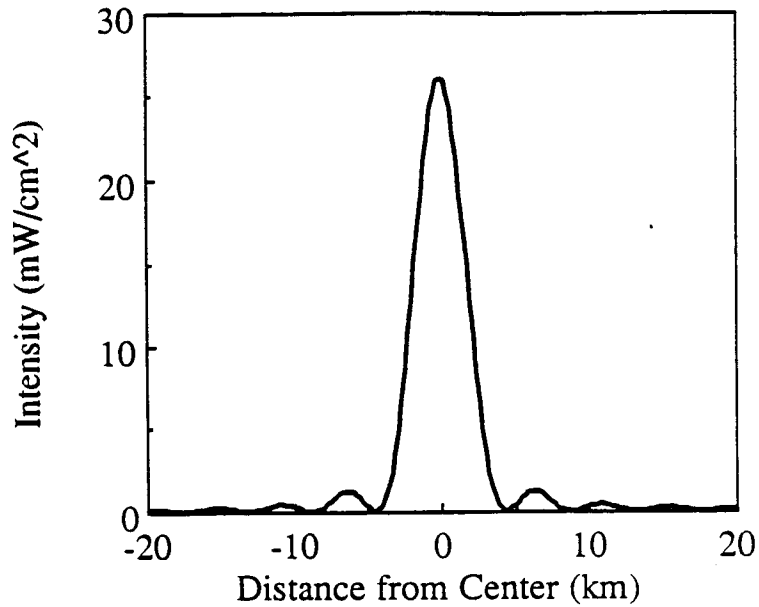

FIGURE 1. Microwave beam intensity at the earth's surface for a geostationary SPS beaming 5 gigawatts of power from a square antenna with 1000 meter sides to the equator at a frequency of 2.45 GHz. (Based on Reference 1, Figure 2.)

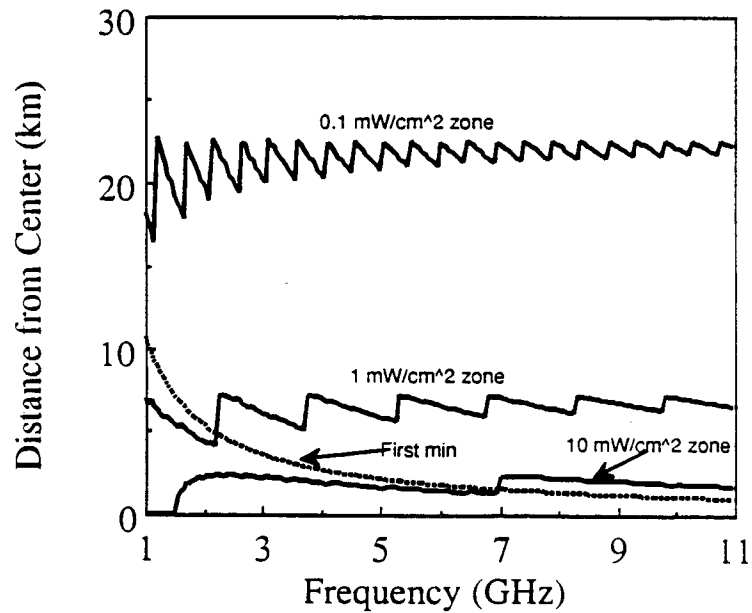

FIGURE 2. Microwave beam exclusion zones at the earth's surface for a geostationary SPS beaming 5 gigawatts of power from a square antenna with 1000 meter sides to the equator for frequencies of 1 to 11 GHz. Exclusion zones for 0.1, 1, and 10 mW/cm² safety thresholds are shown, as well as the location of the first diffraction minimum. (Based on Reference 1, Figure 3.)

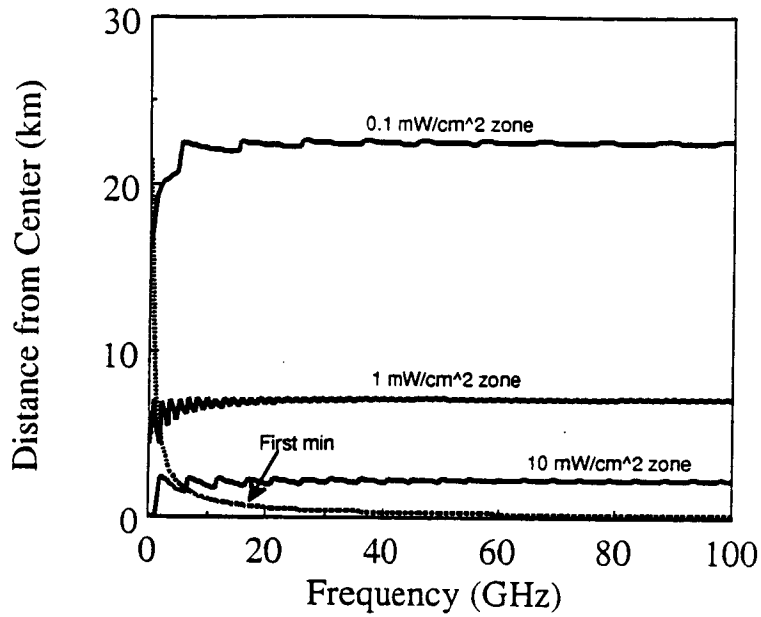

FIGURE 3. Microwave beam exclusion zones at the earth's surface for a geostationary SPS beaming 5 gigawatts of power from a square antenna with 1000 meter sides to the equator for frequencies of 1 to 100 GHz. Exclusion zones for 0.1, 1, and 10 mW/cm² safety thresholds are shown, as well as the location of the first diffraction minimum. (Based on Reference 1, Figure 4.)

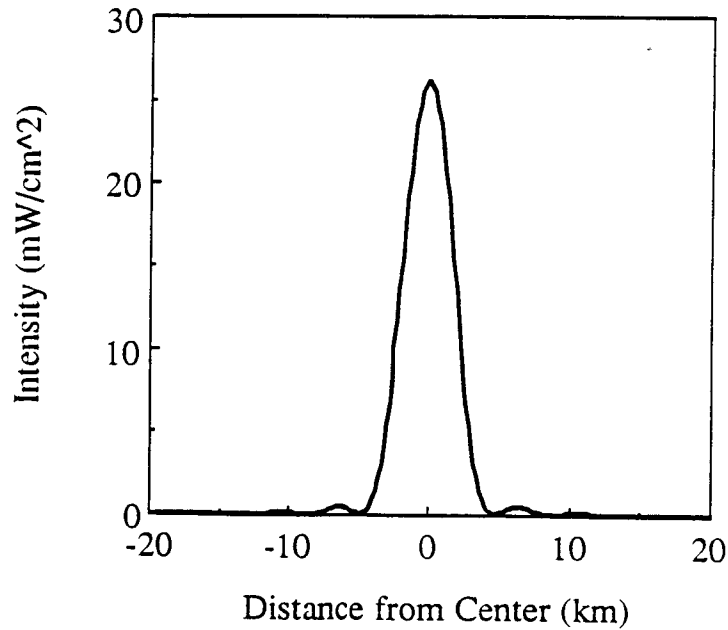

FIGURE 4. Microwave beam intensity at the earth's surface for a geostationary SPS beaming 5 gigawatts of power from a 1128 meter diameter circular antenna to the equator at a frequency of 2.45 GHz.

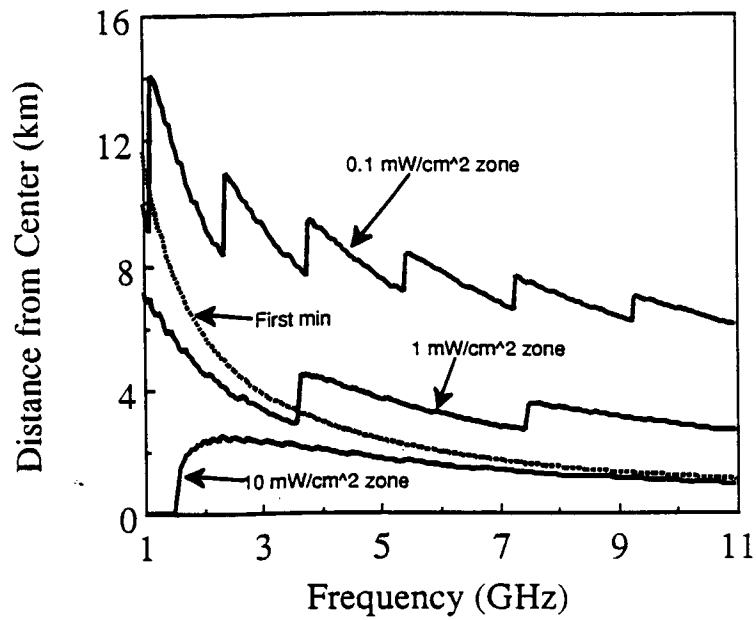

FIGURE 5. Microwave beam exclusion zones at the earth's surface for a geostationary SPS beaming 5 gigawatts of power from a 1128 meter diameter circular antenna to the equator for frequencies of 1 to 11 GHz. Exclusion zones for 0.1, 1, and 10 mW/cm² safety thresholds are shown, as well as the location of the first diffraction minimum.

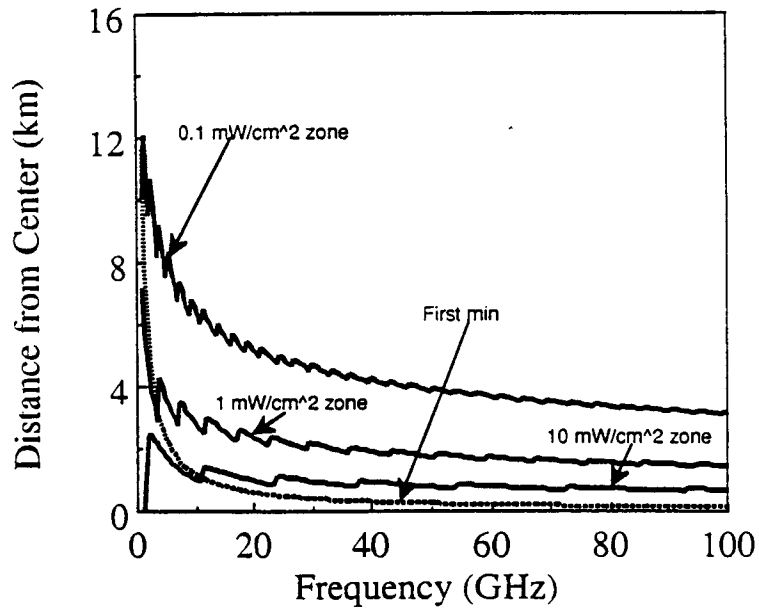

FIGURE 6. Microwave beam exclusion zones at the earth's surface for a geostationary SPS beaming 5 gigawatts of power from a 1128 meter diameter circular antenna to the equator for frequencies of 1 to 100 GHz. Exclusion zones for 0.1, 1, and 10 mW/cm² safety thresholds are shown, as well as the location of the first diffraction minimum.

omit

BACK TO THE FUTURE

N93-27988

A.I. IN SPACE: PAST, PRESENT, AND POSSIBLE FUTURES

Donald D. Rose
Creativision Consulting

Jonathan V. Post
Computer Futures, Inc.

532-63

158346

P-12

Abstract

While Artificial Intelligence (AI) has become increasingly present in recent space applications, new missions being planned will require even more incorporation of AI techniques. In this paper, we survey some of the progress made to date in implementing such programs, some current directions and issues, and speculate about the future of AI in space scenarios. We also provide examples of how thinkers from the realm of science fiction have envisioned AI's role in various aspects of space exploration.*

**Dedicated to Dr. Isaac Asimov: scientist, writer, visionary, friend.*

Introduction

As humans venture further away from Earth, the need for autonomous systems, and hence capabilities developed for **artificial Intelligence (AI)**, will increase dramatically. The increased danger inherent in longer duration missions, among other reasons, will make the role of AI essential -- e.g., to avoid or minimize the need for humans on such missions, and to augment the abilities of those humans still present. In this paper, we discuss some of the applications already developed for space applications, then venture further into the hypothetical future to discuss how various domains of space investigation might benefit from AI.

Environment Maintenance

Several AI systems have been successfully developed and deployed to **control and/or diagnose space-related environments**, e.g., to ensure that hardware and software are performing within desired parameters, and finding the cause of faults when they occur. For example, diagnosis as well as control of hardware and software has also been proven in **expert systems**, such as g2 (developed by Gensym Corp.). The latter has been used to control and diagnose environments such as BioSphere 2 (BS2) and the Space Shuttle. BioSphere 2, in particular, provides an excellent testing ground for AI systems that will soon be needed in space, especially Lunar Base applications, since BS2 is an enclosed self-sufficient habitat that happens to be on Earth. Hence, knowledge learned by applying AI code in BS2 should be almost directly applicable to upcoming Lunar Base mission, and eventually Mars habitats as well.

Whereas the above examples focus on AI applied to monitoring and diagnosis of entire environments involving several interacting systems, researchers have also developed and deployed many **subsystem-specific programs for device and vehicle diagnosis**. In fact, these make up some of the most common and successful applications of AI to space domains to date. For example, NASA has used a system called PI-IN-A BOX to automate the diagnosis of equipment failure about the Space Shuttle. Another NASA project has been automating the diagnosis of a specific Shuttle subsystem (the Reaction Control System). This latter system is currently being tested on the ground, and will probably evolve into a system for use by ground-based mission controllers - but a later more advanced version of this RCS diagnostician could wind up on the Shuttle or its descendant craft. Rockwell International has also been constructing expert systems, to diagnose other parts of the Shuttle such as its fuel cell and heaters.

In summary, AI has already made valuable contributions to this field, and increases in flight duration and craft complexity (e.g., the Space Station with its 30 year life span, as well as Lunar vehicles and habitats designed for continuous long-duration use) will make sophisticated "artificial diagnosticians" even more essential. In particular, programs will have to help unmanned vehicles repair themselves if needed, such as during unmanned rover "field trips". Current **machine learning (ML)** techniques, which have already been used to augment diagnosis systems, should help in this regard. For example, ML can be used to help predict impending faults *before* they occur, so that system disruptions and downtime can be minimized. (Fans of the film *2001* [Clarke 1968] might note that the HAL 9000 computer exhibited such a capability, when it informed its crewmates that an antenna was about to fail.) In general, the use of AI technology for diagnosis will greatly decrease the need for EVAs that are not related to purely scientific objectives.

Traversing Extraterrestrial Sites

Assuming that one's hardware and software are functioning normally, one of the most important tasks to do next is exploration. This includes deciding which site should be investigated -- e.g., deciding which areas have greatest potential for scientific results and estimating the likely danger in getting there -- and then actually traversing to the sites of interest.

Telerobotics (TR) could be used to decrease the number of human EVAs required on space missions. In fact, Marvin Minsky (a father of both AI and TR) observed that, if we had thought ahead, we could have had an inexpensive teleoperated rover doing meaningful traverses on the moon for the *two decades* that have elapsed since humans last left a footprint on our satellite. Since this indeed seems a cost effective option, especially in relation to other proposed missions, we should certainly reexamine its use today as attention is refocused on the moon.

TR is part of the larger field of telepresence, itself a subarea of **Virtual Reality (VR)**. The idea here is to put a human "virtually" in some dangerous locale (e.g., space) via one or more robots, which provide the virtual eyes and perform tasks with virtual limbs as the human remains in a safe haven. Intelligent software will be needed to develop effective telepresence capabilities - mainly via ground control in the near-term, but applicable in several space-based domains in the not-too-distant future. For instance, to decrease human risks in constructing and maintaining Space Station Freedom or remote interplanetary bases, a human could operate a robotic repair droid remotely from inside the Station, or from inside a habitat if the locale is a remote lunar or Martian site. Also note that, for relatively "terraclose" applications (ranging from Earth to locations near the Moon) one could even perform teleoperations from Earth itself without appreciable lag.

As far as longer-term longer-range robotics applications are concerned, one of the most exciting will be the return of our presence to the Moon and Mars. A major player in the latter domain is JPL, which has been developing **Intelligent robots** to roam the Martian surface or other extraterrestrial sites in a way that can maximize scientific gain while minimizing time and danger to a mission. Looking further ahead, several intriguing and challenging issues are unfolding for robotic space domains. One general issue involves deciding on the best approach to designing and deploying robots, for both nearby and remote Voyager-like space missions. One of the most common ideas has been to build one or a few robots with complex, intelligent processing onboard each one.

However, an alternate approach, favored by researchers such as MIT's Rodney Brooks, would use of tens or even hundreds of smaller, less (individually) intelligent robots per mission. One advantage of using an army of "**dumbots**" would be increased fault-tolerance. If you lose one robot, many others remain to finish the mission goals. Another approach would use one or more self-replicating robots. In fact, this latter idea might lead to a compromise between the first two approaches; one could deploy a small number of intelligent "**replibots**" which would create small dumbots during a mission, even replace those that fail as needed. The longer the duration of a mission, such as an extended stay at a lunar or Martian base, the more important replication or automated droid production becomes.

Scientific Investigation

Once a human or machine is actually at a potentially valuable site, the priorities for AI applications shift to actual scientific tasks, such as chemical analyses, deciding which samples to carry back to a habitat or spacecraft, etc.

One fruitful area of AI that applies to these and other scientific tasks is the field of **data analysis and discovery**. Several programs have been developed in this category. For example, NASA scientists have constructed and are refining the AUTOCLASS system, which automatically classifies data into meaningful groups. Its use to date has included classifying well known star classes, as well as discovering new astronomical classes (e.g., separating data into classes having only very subtle differences in spectra). Such systems not only can lead to new knowledge, as just described, but will become *essential* for sifting through the mounting quantities of mission data being gathered from space missions.

AUTOCLASS and other AI systems should aid efforts being made in the general area of "**ground-based space exploration**". Including projects such as SETI (the Search for Extraterrestrial Intelligence), which begins a vastly enhanced search in fall 1992. Sifting through mounds of extraterrestrial data and noise for meaningful intelligent signals seems like an ideal challenge for AUTOCLASS or related systems.

Past Looks Into the Future: Science Fiction and Speculation on Space AI

Science Fiction (SF) preceded science fact in most major qualitative aspects of computers -- such as artificial intelligence, robotics, and their application to space missions. (Our reference section, while extensive, represents only the tip of the iceberg.) Since SF has a long tradition of predicting ideas and inventions that ultimately materialize in our real world, we now survey some of the views SF has put forth regarding AI and its role in space exploration.

The legacy of Isaac Asimov, one of SF's best known progeny (who passed on as this paper was being prepared), includes many concepts that influenced AI, such as the invention of the word **robotics**, and the famous "Three Laws" that he (followed by countless others) felt should govern their use. Asimov also influenced generations of scientists and technologists, such as Marvin Minsky, himself one of the top experts in robotics and a pioneer of both AI and telepresence.

SF, of course, has supplied numerous other concepts that have influenced the ideas and lexicon of real AI. The original word **robot**, from the Czech "robota" (laborer), originated in a stage play [Capek 1921]. SF also provided the related term **android** (hence the contraction **droid**), meaning a robot with a humanoid appearance or, more commonly, an artificially created organic humanoid [Williamson 1936]. In addition, SF predicted teleoperation with the concept of **waldo** [Heinlein 1942], a word subsequently adopted when the technology actually came into existence years later.

Taking a more general view, SF has expanded the role of literature (and hence our cultural collective consciousness) beyond "just people", to the utilization of computers (especially those artificially intelligent) as personalities worthy of storytelling -- as well as debate and analysis.

Some examples of computers and artificial intelligences with proper names [Jakubowski 1983] who appear in stories and books include: **Abel** [Durell], **Bossy** [Clifton 1957], **Colossus** [Jones 1967], **Domino** [Budrys 1978], **Epicac XIV** [Vonnegut 1952], **Epikistes** [Lafferty], **Extro** [Bester 1974], **HAL 9000** [Clarke 1968], **Harlie** [Gerrold 1972], **Mike** [Heinlein 1966], **Multivac** [Asimov], **Proteus** [Koontz], **Shalmaneser** [Brunner 1968], **Tench 889B** [Dick], and **Unicomp** [Levin].

Some of these computer intelligences exist as faithful companions, dedicated to serving humans - while others are imagined to lead to mad, megalomaniac, or godlike capabilities. In *Destination Void* and *The Jesus Incident* [Herbert 1966; Herbert & Ransom 1979], AI systems in space evolve to a trans-human and theological power. In "Going Down Smooth" [Silverberg] a computer slips into

psychosis, but does a credible job as a psychiatrist -- a profession that certainly might prove valuable on long missions if physical human presence continues in space.

Although we have seen AI computers as fictional personalities, science fiction admits to a favoritism for intelligent robots. Here are a dozen examples: **Adam Link** [Binder], **Brillo** [Bova & Ellison], **Helen O'Loy** [del Rey], **Jasperodus** [Bayley 1974], **Jay Score** [Russell 1955], **Jenkins** [Simak 1944], **Krag** [Hamilton 1940], **Marvin** [Adams], **R. Daneel Olivaw** [Asimov 1954], **Roderick** [Slakek], **Spofforth** [Tevis], and **Tik-Tok** [Baum].

In literary roots, AI and robotics have co-existed as concepts. It is therefore fitting that AI systems for space, which are robotic in the broad sense that they are part of highly mobile vehicles (spaceships), fulfill the emotional connection of these two concepts in a century of imaginative fiction. In fact, teleoperation and telerobotics (spawned from progress in AI and robotics) are currently active themes in SF literature [Mixon 1992].

Then, of course, there are the movies and television, which arguably have had the greatest impact on how our culture has perceived the growing use of computers and AI. Several films, such as *Silent Running* and *Star Wars*, feature nonhumanoid robots assisting humans in space, a role that much of our culture seems to accept as the most likely future scenario.

However, even though our technology will likely make such human-robot scenarios feasible, the need to have humans in space *at all* will become a growing issue as AI's power increases. Such an "AI only" view (i.e., **using only artificial hardware and software in space**) has received increasing attention from SF writers today. Although this scenario would depart from our "humans conquering space by being in space" paradigm, it would likely be safer, less costly, and ultimately more democratic if combined with telepresence's ability to *let everyone share in the exploration* [Sterling 1992].

As of May 1992, the NASA channel is already being planned for wider cable access in the U>S>; perhaps this is just the first step. Future couch potatoes might spend a day making new remote space observations on Europa (using AI in the TV to alert them to images that match interesting criteria), flicking the remote (pun intended?) to see how Mars is doing, and still have time left to watch MTV. Two researchers, located on different parts of the globe (or one on Earth one on the Moon), could use VR gear to virtually explore a more distant orb together, their telepresences being in the same remote locale although they were not. Going further, if these two were a couple, they could switch to another remote planet and have sex, virtually -- without leaving their home or physically touching their partners! (Then they could complain to their artificial shrinks -- "We're just not *close* anymore, Eliza").

Note that a slightly different, darker take on this remote exploration via AI was put forth on a recent *Star Trek* episode, in which an alien artificially increased the intelligence of other races (in this case, a human on the *Enterprise*) to enable them to make inventive leaps necessary to visit the alien's world. A revised version of this seems a worthy and feasible goal for our own AI. For instance, we might be able to build robots intelligent enough to *utilize elements encountered in space to better their collective situation* -- e.g., to replicate themselves, or even to improve themselves (with tasks such as detecting and extracting more efficient fuel, or simply gaining more of their current fuel). Even if we simply send out multitudes of robots and get back lots of visual data, telepresence experiences, and returned samples, we would still be "bringing space to us" without leaving our home, as did the alien in that *Trek* episode.

While many androids have appeared in film and TV, an interesting case is Ulysses from *Making Mr Right*; this droid was designed for space travel as a safe substitute for man, superior in mental facility as well as in its immunity to loneliness and other human "frailties". However, Ulysses, once sentient, soon wants to experience love and stay on Earth. This raises an interesting question: *might AI progress to the point where an intelligence might not want to follow its programming* (i.e., its orders/mission)? This issue was also raised in *Trek*, when Data (another android longing for humanity) is ordered to be dismantled for scientific study but a court rules him to be alive, sentient, and worthy of rights. And of course there is HAL in *2001*, which decided to deviate from some of its orders as well. In short, there may come a point in the future when software designers will have the twin constraints of needing software that is intelligent enough to do vital tasks, but not smart enough to decide that these tasks are not worth doing!

But with the advent of learning algorithms today, and their inevitable improvement, will absolute control of AI programs even be possible in later years? Stanley G. [Grauman] Weinbaum was one of the first to describe intelligent beings in the solar system [Weinbaum 1934] with intelligence fundamentally different from (even unintelligible to) human beings. This strikes at the heart of the grand dream of AI; intelligence is not necessarily an imitation of human thought processes. This raises issues such as this: if advanced AI is used on a long space mission, and its knowledge is altered greatly during its duration, we might not be able to comprehend its output after a certain point in time (assuming a suitable vast capacity to learn new concept). A related theme was the heart of the first *Trek* film, in which Voyager is redesigned into a super-intelligent entity by an alien being. If we replace the alien by advanced (albeit terrestrial) learning algorithms, the potential for the evolution of a craft's knowledge beyond our understanding is at least a possibility. Such a result occurred in the film *The Forbin Project*, based on the *Colossus* novel; humans stopped eavesdropping on the superintelligent computer once it evolved a language beyond our comprehension.

Another way we might interact with our machines is by merging with them to become **cyborgs** -- cybernetic organisms -- a term invented by science fiction [Caldin] and now in general use. In particular, *The Ship Who Sang* [McCaffrey 1961] and "Scanners Live in Vain" [Smith 1963] posit the need to mechanically alter humans profoundly in order to make long-duration space flight feasible. This point of view represents a worst-case analysis, if the problems of weightlessness cannot be overcome by more conventional means (e.g., [Post 1992] argues that all it takes to avoid the biological hazards of zero gravity is to be overweight, aerobically unfit, and have high blood pressure). Another possible advantage of having humans in more direct, detailed contact with machines is greater control over how the software's knowledge evolves -- such as keeping human goals, like relevance and explainability, paramount over those the AI software might have.

Note that there is another variant on this human-machine coupling idea. [Platt 1991] examines the implications of **downloading** a human mentality into a semiconductor substrate. Perhaps future criminals, rather than face execution, might be downloaded into space-AI systems for exploring the solar system [Jennings 1989]. Of course, downloading might require slicing and destroying the original human brain, and robots might not understand why people resist such an approach to immortality [Rucker 1982]. (At least we'd still be "alive"...right?)

But remember that the need for many space travel "solutions", such as altering humans, could be eliminated if, as we mentioned near the beginning of this section, we employ remote space exploration us AI. In this regard, an irony exists in one of *Trek's* most intriguing "inventions" -- the **holodeck**, a hypothetical combination of Virtual Reality and AI (a synthesis that one author coined VRAI [Post 1990], the French word for "truth"). In a holodeck, one can sample alternate worlds (VR)

as well as interact with characters in that world (AI) that can be programmed to one's wishes. Such technology is not that far off from (real) reality today, and its advantages would be numerous for space domains. For instance, an astronaut -- or even an Earth-bound "teleexplorer" -- could try out fixes to spacecraft hardware in a holodeck *without having to alter the actual device*. In addition, stored technical experts could be "called up" out of digital hibernation and consulted even if they are physically distant (e.g., deceased). Note that an artificial expert could even be a composite of several people's knowledge and interpersonal styles -- a being who *never actually existed* in the real world (in that particular "configuration"). It is ironic that the holodeck idea, developed for use on a (fictitious) space vessel, might one day be used to enable humans to avoid actual travel at all (and perhaps may make the notion of large spacecraft obsolete). If this permutation of the initial holodeck intent eventually gets used for teleexploration, it would not be the first time an SF idea led in a nonlinear path to real payoffs. (Besides, who would have watched "Star Trek: The Stay-at-home Generation"?)

Finally, we note that the interaction between SF and real science is quite alive at the present time. One of the authors of this paper (JVP is acknowledged in [Platt 1991] for "advice on the policies and procedures of aerospace contractors", an example of how *science fiction and space AI do influence each other*. In addition, the profits from a book on how artificially intelligent solar sails may travel through or beyond the solar system will be supporting a real space flight [Post & Bradbury 1991]. Other examples abound.

Conclusions and Final Thoughts

Where will the "real" future lead us?

Given the above examples, scenarios and discussions, certain trends are more prevalent than others, and we can venture some final predictions, adding to those already presented.

The trend in robotics and AI software for space can be summarized with key words such as **small, cheap, flexible, adaptive and autonomous**, as well as **large numbers, redundancy, decentralized intelligence, remote operation and global teleaccess**.

Also, as the applications described earlier become increasingly common, powerful, and less expensive, **synergy** seems inevitable.

In both robots and AI software, the use of autonomous independent **intelligent agents** should enable an increasing number of functions to be performed continuously, with little human intervention. Such agents would be the software analog to the dumbots, in that they would represent specific specialized collections of knowledge and processes that "live" on their own, gather their own input, and communicate (to other software or to humans) when the appropriate conditions arise.

Machine learning methods should allow these agents to improve their behavior during long missions. In fact, **learning** will prove essential to deal with the unknowns of unexplored space, since no mission planner can predict all required system reactions, and instructions from Earth are impractical for long distant missions.

In time, fewer astronauts should be required per mission, increasingly replaced not only by telepresence equipment but by "astronauts on a disk". Such "**astrobots**" would have all the usual stereotypical benefits of automated workers -- more vigilant, more efficient, no sleep requirement,

faster, able to free any astronauts for other tasks, etc. The longer the duration of future missions, and the higher the chance of danger, the more valuable these automated astronauts would be to the success of such missions. In summary, astrobots should reduce human risk by decreasing the number of humans required for a given mission, and by allowing those remaining (if any) to perform tasks with greater safety and probability-of-success -- via consultation of automated expert systems, telepresence using the ship as the base (e.g., when Earth links are not feasible), and other techniques.

Perhaps Domino, the robot in *Michaelmas* [Budrys 1978], puts it in a more imaginative light:

*"My bones are made of steel
The pain I feel is rust.
The dust to which your pangs bequeath
the rots that flourish underneath
the living flesh is not for me.
Time's tick is but the breathing of a clock
No brazen shock of expiration tolls for me.
Error unsound is my demise.
The worm we share is lies."*

In summary, we presented several examples -- a survey of ideas and technologies -- to illustrate where AI has been applied in the past, some of today's issues, and ideas regarding how it might be applied to space missions of the future. AI should enable an increasing number of future missions to pose reduced risk to human lives, increase the amount of exploration that can be done without leaving Earth, and enhance the effectiveness of missions in which we or our surrogates go where no one has gone before.

Science fiction references (including additional literature with space and AI themes)

- Adams, Douglas, *Hitchhikers Guide to the Galaxy*, see film *Hitchhikers Guide to the Galaxy*, 1980
Adams, Villiers de l'Isle, *The Future Eye*, 1886
Aldiss, Brian, *Nonstop* a.k.a. *Starship*, NY: Faber, 1958
Allen, Woody & Marshall Brickman, screenwriters of *Sleeper* (film, 1973)
Anonymous, *Man Abroad*, 1886
Ashley, Mike, *The Illustrated Book of Science Fiction Lists*, NY: Cornerstone (Simon & Schuster), 1982, valuable aide in compiling these references
Asimov, Isaac, various short stories collected as *I, Robot*
Asimov, Isaac, "The Last Question"
Asimov, Isaac, *The Caves of Steel*, NY: Doubleday, 1954
Asimov, Isaac, *The Naked Sun*, NY: Doubleday, 1957
Asimov, Isaac, *Isaac Asimov's Science Fiction Magazine*, March-April 1978
Banks, Iain, *Consider Phlebas*, London: MacMillan, 1987
Battlestar Galactica, film 1978
Baum, L. Frank, *Oz* series, beginning with *The Wonderful Wizard of Oz* 1900; see also Jack Snow, *Who's Who in Oz*, 1954
Bayley, Barrington J., *The Soul of the Robot*
Bayley, Barrington J., *The Garments of Caean*
Bear, Greg, *Queen of Angels*, NY: Tor, 1991
Benford, Gregory, "Snatching the Bot", *In Alien Flesh*, NY: Tor, 1986

Benford, Gregory, *Tides of Light*, NY: Bantam, 1989
 Bester, Alfred, *The Computer Connection*, Conde-Nast, 1974,.1975
 Bierce, Ambrose, *Maxon's Master*, 1909
 Binder, Eando, *Adam Link, Robot*; (made into *Outer Limits* episode)
The Black Hole, film, 1979
Bladerunner, film, based on Dick, Philip K., *Do Androids Dream of Electric Sheep*, 1968
 Bloch, Robert, "The Tin You Love to Touch", *Other Worlds*, June-July 1951
 Bova, Ben, and Ellison, Harlan, "Brillo", see *Future Cop*
 Brown, Frederic, "The Answer"
 Brunner, John, *Stand On Zanzibar*, NY: Doubleday, 1968
 Bryant, Edward, and Ellison, Harlan, *Phoenix Without Ashes*, based on the concept for the *Starlost* TV series
Buck Rogers in the 25th Century, film, 1979
 Budrys, Algis J., *Who?*, NY: Pyramid, 1958
 Budrys, Algis J., *Michaelmas*, NY: Berkley, July 1978
 Caidin, Martin, *Cyborg*, basis for TV series *The Six Million Dollar Man*
 Campbell, John W. [Wood], "When the Atoms Failed", *Amazing*, January 1930
 Capek, Karel, *R.U.R.* [Rossum's Universal Robots], play opens in Prague, 26 January 1921
 Clarke, Arthur C., *2001: A Space Odyssey* NY: NAL, 1968; also sequels (2010: 2061)
 Clarke, Arthur C., *The Fountains of Paradise*, NY: HBJ, 1978
Clash of the Titans, film, 1981
 Clifton, Mark and Riley, Frank, *They'd Rather Be Right*, a.k.a. *The Forever Machine*, NY: Gnome, 1957; *Galaxy SF Novel 35*, 1959, based on Clifton's original "Joey" stories.
 Coblenz, Stanton, *In Plutonian Depths*, in *Wonder Stories Quarterly*, Spring 1931; NY: Avon, 1950
The Clown and the Automation, film, George Melies, 1897 (first robot on film)
 Cole, Robert W., *The Struggle for Conflict*, 1900
 Colla, Richard A., *The Questor Tapes*, made-for-TV film, 1974, Gene Roddenberry pilot novelized by Dorothy (D.C.) Fontana
 Compton, D. G., *The Continuous Katherine Mortenhoe*, a.k.a. *The Unsleeping Eye*
 Cook, William Wallace, *A Round Trip to the Year 2000*, 1903
 Daniel, Gabriel, *A Voyage to the World of Cartesius*, 1692
The Day the Earth Stood Still, film, 1951
 de Bergerac, Cyrano, *Voyage to the Moon*, 1650
 deCamp, L. Sprague, *Science Fiction Handbook*, 1953
 delRey, Lester, "helen O'Loy", In...*And Some Were Human*, Philadelphia: Prime, 1948
 delRey, Lester, "A Pound of Cure", *New Worlds #27*, September 1954
 Delany, Samuel R., *Nova*, NY: Doubleday, 1968
 Dick, Philip K., *A Maze of Death*
 Dick, Philip K., *Do Androids Dream of Electric Sheep*, 1968, see *Bladerunner*
 Durrell, Lawrence, *Tunc and Nunquam*
 Ellison, Harlan, "I have No Mouth and I Must Scream"
The Empire Strikes Back, film, 1980
 Erskine, Thomas, *Armata*, 1816
 Fanthorpe, R.L. [Robert Lionel], *The Asteroid Man*, Badger: SF35, 1960
 Fontana, D.C. [Dorothy], novelization of Colla, Richard A., *The Questor Tapes*, made-for-TV film, 1974, Gene Roddenberry pilot
Forbidden Planet, film, 1956
The Forbin Project, film (based on *Colossus* novel by D.F. Jones), 1970
 Forest, Jean-Claude, *Barbarella*, NY: Grove, 1966; tr. from French by Richard Seaver
 Forester, E.M., *The Machine Stops*, 1909
 Forward, Robert, *Rocheworld*

Future Cop, Taylor Jud, made-for-TV movie (resulted in \$285,000 settlement paid to Ellison/Bova (see Bova & Ellison, "Brillo"))
 Gerrold, David, *When Harlie Was One*, NY: Ballentine, 1972
 Gibson, William and Sterling, Bruce, *The Difference Engine*, NY: Bantam 1991
 Groves, J.W., "Robots Don't Bleed"
 Hale, Edward Everett, "The Brick Moon", *Atlantic Monthly*, October 1864, and in *The Brick Moon and Other Stories*, Boston: Little Brown, 1899
 Hamilton, Edmond, *Captain Future* series 1940 ff
 Harrison, Harry, *Captive Universe*
 Heinlein Robert A., "Waldo", 1942
 Heinlein, Robert A., *Orphans of the Sky*, UK: Gollancz, 1963; NY: Putnam, 1964
 Heinlein, Robert A., *The Moon is a Harsh Mistress*, NY: Putnam, 1966
 Herbert, Frank, *Destination Void*, NY: Berkley, 1966
 Herbert, Frank & Ransom, Bill, *The Jesus Incident*, NY: Berkley-Putnam, 1979
Hitchhikers Guide to the Galaxy, film, 1980; see Adams, Douglas
 Horner, Donald W., *Their Winged Destiny*, 1912
The Invisible Boy, film, 1957
 Jakubowski, Maxim and Edwards, Malcolm, *The SF Book of Lists*, NY: Berkley, November 1983, valuable aide in compiling these references
 Jane, Fred T., *To Venus in Five Seconds*, 1897
 Jennings, Philip C., *The Bug Life Chronicles*, NY: Baen, 1989
 Joahannesson, Olaf (pseudonym of Swedish Noble laureate cosmologist Hans Alfvén), *The Tale of the Big Computer*, Stockholm: Albert Bonniers, 1966; tr Naomi Walford, Coward-McCann, 1968; London: Gollancz, 1968; Royal Swedish Opera, 1967
 Jones, D.F., *Colossus*, London: Hart-Davis, 1966; NY: Putnam, 1967
 Knight, Damon, "Masks"
 Koontz, Dean R., *Demon Seed*
 Lafferty, R.A., *Arrive at Eastermine*
 Leiber, Fritz, "The Mechanical Bride"
 Leinster, Murray [pseudonym of Will F. Jenkins] *Proxima Centauri*
 Levin, Ira, *This Perfect Day*
 Levin, Ira, *The Stepford Wives*, novel, see *The Stepford Wives*, film 1975
 Locke George, *Voyages in Space*, valuable in compiling these references
Logan's Run, film, 1976
Making Mr. Right, film, 1987
 McCaffrey, Anne, "The Ship Who Sang", *Fantasy & Science Fiction*, April, 1961
 McIntosh, J.T., "Made in U.S.A.", *Galaxy*, April 1953
 McLeod, Shiela, *Xanthe and the Robots*
 Martinson, Harry, *Anlara*, epic poem, English edition (from Swedish)
 Melies, George, *The Clown and the Automation*, film, 1897 (1st robot on film)
 Melville, Herman, *The Bell-Tower*, 1885
Metropolis, film, re-release 1972
 Mitchell, Edward Paige, *The Man Without a Body*, in newspaper: *New York Sun*, 25 March 1877
 Mitchell, Edward Paige, *The Ablest Man in the World*, 1879
 Mitchell, Edward Paige, *The Tachypomp*, 1874
 Mixon, Laura J., *Glass Houses*, NY: Tor, May 1992
 Moore, C.L., "No Woman Born"
 Moskowitz, Sam, *Explorers of the Infinite*, 1963
 Norman, John [pseudonym], *Gor*, and its sequel
 "Nunsowe Green", *A Thousand Years Hence*, 1882
 Peabody, Joel R., *A World of Wonders*, 1838

Parmele, Mary Platt, *Ariel*, 1898
 Perce, Elbert, *Gulliver Jol*, 1852
 Platt, Charles, *The Silicon Man*, NY: Bantam Spectra, March 1991
 Post, Jonathan V., *Headcrash*, in press
 Post, Jonathan V., "Brainsails", 1990, in press
 Post, Jonathan V. and Bradbury, Ray, "To Sail Beyond the Sun: A Luminous Collage", In *Project Solar Sail* edited by Arthur C. Clarke, David Brin and Jonathan V. Post, NY: Roc (Penguin USA), April 1991
 Post, Jonathan V., "Loading Up for Liftoff", *Ad Astra* (the National Space Society magazine), March, 1992
The Questor Tapes, made-for-TV film, Colla, Richard A., 1974, Gene Roddenberry pilot novelized by Dorothy (D.C.) Fontana
Robocop, film, 1987
 Roddenberry, Gene, Colla, Richard A., *The Questor Tapes*, made-for-TV film, 1974, pilot novelized by Dorothy (D.C.) Fontana
 Rotsler, William, "Ship Me Tomorrow"
 Rucker, Rudy, *Software*, NY: Ace, 1982
 Russell, Eric Frank, *Men, Martians, and Machines*, UK: Dobson, 1955, NY: Roy, 1956
 Saxton, Josephine, "Gordon's Women"
 Scortia, Thomas N. & Zebrowski, George, *Human-Machines: An Anthology of Stories about Cyborgs*, NY: Vintage, 1975
 Sheckley, Robert, "Can You Feel Anything When I Do This?"
 Sheffield, Charles, "Georgia on my Mind", 1993 (in press)
 Sheffield, Charles, *The Web Between the Worlds*, NY: Ace, 1979
 Sheffield, Charles, *Cold as Ice*, NY: Tor, June 1992
Silent Running, film, 1972
 Silverberg, Robert, "Going Down Smooth"
 Silverberg, Robert, *Tower of Glass*
 Simak, Clifford, *City*, series in *Astounding Science Fiction*: May, 1944, July 1944, September 1944, November 1944, January 1946 November 1946, December 1947
 Simak, Clifford, *Target Generation*
 Simak, Clifford, *The Space-Born*
 Sladek, John, *Roderick and Roderick at Random*
Sleeper, film, 1973
 Smith, Cordwainer [pseudonym of Paul Myron Anthony Linebarger], "Scanners Live in Vain", In *You'll Never Be the Same*, Regency, 1963
 "Spirito Gentil", *Earth-Born!*, 1889
Star Trek, TV series (1966-69; "Next Generation": 1987-1992) and films (I-VI: 1979-1991)
Star Wars, film 1977
The Stepford Wives, film, 1975
 Sterling, Bruce, "Outer Cyberspace", *Fantasy & Science Fiction*, June 1992
 Stump, D.L., *From World to World*, 1896, revised as *The Love of Meltha Laone*, 1913
 Taylor Jud, *Future Cop*, made-for-TV movie, resulted in \$285,000 settlement paid to Ellison/Bova (See Bova & Ellison, "Brillo")
 Tevis, Walter, *Mockingbird*, also author of *The Man Who Fell to Earth*
Tobor the Great, robot in film of unknown title
 Tubbs, E.C. [Edwin Charles], *Dumarest* series starting with *The Winds of Gath*. Ace, 1967
 Vinge, Vernon, *A Fire Upon the Deep*, NY: Tor, April 1992
 "Vivenair", *A Journey Lately Performed Through the Air, In an Aerostatic Globe to the Newly Discovered Planet Georgium Sidum*, 1784
 Vonnegut, Kurt, *Player Piano* NY: Scribner, 1952

Weinbaum, Stanley G., "A Martian Odyssey", *Wonder Stories*, July, 1934 (see *Martian Odyssey and other Classics of Science Fiction*, ed. S Moskowitz, Lancer, 1962 for more on Weinbaum)
Westworld, film, 1973
Whiting, Sidney, *Hellonde*, 1855
Wilcox, Don, "The Voyage that Lasted 600 Years", *Amazing Stories*, Oct. 1940
Wilhelm, Kate, "Andover and the Android"
Williamson, Jack, "The Cometeers", *Astounding*, May, 1936
Williamson, Jack, *The Humanoids*, NY: Simon & Schuster, 1949
Wilson, Miles, *The History of Israel Jobson*, 1757
Young, Robert F., "September Had Thirty Days"

SUMMARY OF DISCUSSIONS
ENABLING TECHNOLOGIES PANEL, LUNAR MATERIALS TECHNOLOGY SYMPOSIUM

Hubert P. Davis
Davis Aerospace

Introduction

Six speakers were introduced by the final session moderator, Mr. Hubert P. Davis: Mr. Gordon Woodcock, Manager of Future Systems Studies, Boeing Aerospace Company, Huntsville, Alabama, who spoke on Systems Engineering issues and technology needs for lunar habitation; Dr. John Lewis, Professor of Planetary Science, University of Arizona, Tucson, and Co-director for Science, University of Arizona/NASA Space Engineering Research Center, who spoke of science needs for lunar materials utilization; Mr. Dan Lancaster, General Manager, Space & Defense, Fluor-Daniel Corporation, Irvine, California, who spoke of his expectations for year 2020 mining and manufacturing activities on the Moon; Dr. Benton Clark, Technical Director, Space Exploration Initiative, Martin-Marietta Corporation, Denver, Colorado, who spoke of the linkage between lunar materials utilization technologies and the later acquisition of in-situ resources on Mars; and Dr. Don Morrison, a lunar geologist of the Solar Systems Exploration Division of NASA Johnson Space Center, who spoke of the NASA activities to develop the science and engineering needs for future lunar materials use.

Mr. Davis then concluded the session with summarizing remarks and later provided both the following synopsis of the panel discussions and the "straw man" lunar materials scenario for the near term: 1992-2015.

Synopsis of Discussions

Mr. Woodcock commended the session organizers for bringing together in Tucson about 130 people who are now contributing to mankind's future use of the resources of the Moon. He outlined some of the steps we must take to assure that plans for lunar materials utilization are translated from the general ambitions and individual research activities of today into a coherent and successful program.

Dr. Lewis (whose full remarks appear below) cautioned the group against premature advocacy of any particular product stream as the singular justification for a return to the Moon, reminding the group that research on the broad array of available lunar resources has hardly begun, that geological assay of this large planetary body will require much lunar orbit and lunar surface field work to locate and quantify promising resources for a diversity of useful purposes; first to enable near self-sufficiency of future lunar prospectors and then to serve numerous economic purposes, many which cannot be identified with the limited information available today.

Mr. Lancaster provided his vision of the lunar surface infrastructure, circa 2020. He foresees widespread lunar mining, chemical processing and manufacturing, and a wealth of service facilities to provide hospitable living conditions, including large hotels, for several thousand humans. Lunar oxygen will be obtained from the regolith, and volatile materials implanted by the solar wind will be recovered to provide propellants, water, and hydrocarbon gases as feedstocks for chemical plants producing a variety of finished products. Our civil and process engineering skills will be challenged to adapt proven Earth-bound techniques and processes to the different environment of the Moon, and new technologies specific to the Moon will emerge to allow increased productivity of the lunar populace.

Dr. Clark gave his views on the rationale, history, and future of the exploration of Mars, and distinguished between the common and unique technologies that must be developed for use on the Moon and later on Mars, as a consequence of the similarities and differences of the two planetary environments, which he enumerated.

Dr. Morrison reviewed the work of the NASA Johnson Space Center Solar Systems Exploration Division, extending back to his personal participation in the reception and cataloguing for scientific evaluation of the first lunar specimens, returned to Earth by the Apollo 11 mission almost twenty-three years ago. He emphasized the use by investigators today of a national treasure -- the 400 kg or so of lunar specimens that were returned by Apollo -- regularly obtaining new scientific and engineering baseline data highly relevant to the technology issues of future lunar resource exploitation.

Mr. Davis commended the group on the progress made in the past few years by advocates of lunar resource utilization. He suggested that, with the release of the "Synthesis Group" report, this topic is now "mainstream" in planning by policy makers for an early return to the Moon. He suggested that we, as advocates of lunar materials utilization, turn our attention from describing the far future concepts to helping develop the specific near-term implementation plans, including identifying and justifying the needed technology development. He pointed out the necessity for those of us interested in space resources to communicate effectively with one another and with others, carefully reading one another's work to assure that research results are critically reviewed and, after validation, are widely distributed to be built upon by others.

He suggested that the goals for lunar materials use should be that lunar oxygen is used for the very earliest robotic sample return missions and that, additionally, lunar hydrogen and other useful products be obtained from the solar wind-implanted volatiles, only a short while later, to provide the crucial support that will enable us to lower the cost and risks to humans on the earliest piloted missions.

"Strawman": A Near-Term Materials Utilization Plan

Introduction

Plans for a return to the Moon as called for three years ago by President Bush are now underway by the National Space Council, chaired by Vice President Dan Quayle, and a new National Program Office for Space Exploration is being formed, headed by Mr. Mike Griffin of NASA. This multi-agency policy and management office will include representatives from a broad spectrum of the United States Government, including NASA, the Department of Defense, and the Department of Energy; international participation is being encouraged and explored.

Several candidate "architectures" for a return to the Moon have been defined by NASA, but no single plan has yet emerged for beginning this multi-faceted venture. Under these circumstances, there is as yet no master plan to that we can refer to in order to plan our near-term activities. The best that can be done now is to encompass a range of prospective plans in our thinking, to enable us to not only respond to policy as it emerges, but in fact to help shape it.

The risk of being too bold in our planning is probably much less than the risk of failing to exploit, and to point out to policy-makers, the real opportunities for effective use of lunar materials in pursuing national goals. Thus, an aggressive near-term scenario, which may be thought by many to be unrealistic in today's Federal Budget environment, is considered to be an appropriate present

to return samples from two of the selected sites.

In 1997, *Artemis II* flights begin to put in place two-metric-ton astronomy payloads and "pilot plant" facilities at one of the sites. Six such flights by mid-1998 provide the capability to generate and store up to five tons per year of liquid oxygen at this site. Russia provides two nuclear reactor electrical power supplies and four "*Lunakod II*" rovers to augment these capabilities, equipped with advanced manipulator systems provided by Canada and "virtual reality" capabilities from U.S. universities. ESA and Japan join in, providing advanced lunar materials pilot plants to separate metals, formulate useful ceramic materials and semiconductors, to produce finished products from the heated "tailings" of the oxygen plants, and prove processes for the deposition of amorphous silicon and electrical conductors on plastic film brought from Earth. Other payloads are delivered and automatically erected to produce 3 MWt of high quality concentrated solar energy and to reject an equivalent heat load. By 1999, an automated surface complex aggregating over twenty tons is in place at this site. *Artemis* sample return flights continue to return samples of materials produced and for tests of failed components.

In the second quarter of 1999, the United States, in cooperation with its partners, launches its first large lunar payload, a twenty-five ton lunar habitat, to the site selected for an initial lunar outpost, *Lunar Base 1 (LB-1)*. This habitat is activated from Earth, connected into the existing base complex provided by the *Artemis* missions, and shielded from natural radiation by placement of regolith into prepared bins. By the end of the third quarter of 1999, telemetry confirms that this habitat is ready for occupancy, and that five tons of lunar oxygen are in storage. Readiness to return people to the Moon is declared.

Late in 1999, the first piloted mission arrives at *LB-1*, and the crew immediately occupies the fully shielded habitat, using the utility services pre-placed by *Artemis*. The 5,500 kg payload carried on this mission includes an unpressurized "rover" with 30 km range, science experiments requiring human placement, and spare parts to restore to operation three malfunctioning *LB-1* functional units. Extensive surface geological surveys are conducted by the two planetary geologists on the mission using the rover and assay facilities previously placed. The automated equipment on the Moon is controlled by the civil engineer of the first crew to prepare thin glazed surfaces and to lay fused regolith blocks for future flight and surface vehicle operations areas to help control otherwise intolerable lunar dust formation. Near the end of the forty-two-day surface stay, a portion of the stored lunar oxygen is transferred by the crew into a tank of their Lunar Landing Vehicle (LLV), which is to be left behind. Refinement of oxygen loading procedures and noting equipment shortcomings for future correction are the purposes of this experiment.

The crew then ascends into lunar orbit, conducts final lunar orbit observations and four days later enters the Earth's atmosphere, soft landing by maneuverable parachute near White Sands, New Mexico, on President's Day, 2000.

In June 2000, the second crewed mission is launched, carrying four people and 5,500 kg of cargo to *LB-1*. The cargo includes science experiments and major augmentation of the lunar materials processing complex. In particular, equipment to correct shortcomings of the lunar oxygen production, storage, and transfer complex is delivered and installed. Dust control installations are expanded and improved.

During the latter part of their forty-two-day stay, a second large cargo delivery of twenty-five tons arrives on July 20 (the 31st anniversary of the *Apollo 11* touchdown), including an operational-scale regolith gathering and processing complex. The third and fourth nuclear electric generating plant arrive during this stay and are activated with the help of the crew. This crew returns to White Sands

stance for the lunar materials research community. As policy decisions are made, we must then support them.

Time Frame to be Considered

The long-term future of the use of lunar materials is provocative and compelling. Many of us view the future of humankind, perhaps three to five generations from today, as materially rich, with all of the people of Earth enjoying abundant and inexpensive energy from space, through construction of Solar Power Satellites (SPS) largely from lunar materials, and/or from importing ^3He from the Moon to power future, clean fusion reactors, and perhaps from huge solar power plants built on the lunar surface "beaming" their energy to hundreds or thousands of locations on Earth. Earth-crossing asteroids may also be captured and their material resources applied to extensive human activities in space, for the enrichment of people on Earth.

These gigantic projects have been found to be within the realm of technical feasibility, given the technological advancements of the past fifty years and those that can be responsibly forecast for the next fifty years. Their comparative economics, however, require consideration of much broader issues and are not yet nearly so clear. In large part, the internal problem of assessing these prospects is forecasting the time and other resources necessary for their development and acquisition.

Favorable economics can be forecast only through "bootstrapping" -- beginning small and emerging to large scale through internally supported growth. Solar Power Satellites, for example, to be affordable must be built largely of materials already in space; that is, on the Moon.

We cannot, however, expect society to provide a fullblown SPS production infrastructure on the Moon and in space -- it must grow through internal efforts. For this reason, the planning horizon of the following scenario is 2015.

A Mission Scenario

One of many possible mission scenarios is described below. At this time, it has to be considered only a reasoned speculation. It will prove to be a deeply flawed forecast in many important respects, but has as its purpose the generalized scoping of what could be the size and intensity of lunar materials use during the first two decades of the new millennia, for helping to identify the sequence, timing, and scale of lunar materials technologies.

During the 1994-1997 interval, three lunar polar orbiter (LPO) missions, each returning data for over one year, are flown. These spacecraft return multi-spectral imagery and specialized sensor data to Earth, allowing, for the first time, global mapping of the lunar features and resource concentrations discernable from a 100 km orbit.

Russia, along with three of its neighboring republics, supplements these data with a lunar polar orbiting radar spacecraft. Project *Artemis*, funded by NASA, begins placing 150 to 200 kg science and technology payloads on the Moon's surface in 1994. Thirty such missions are planned, at the rate of six per year, to reconnoiter four landing sites selected as candidates for an early lunar outpost.

Each complex of payloads includes a sensor- and grappler-equipped miniature "rover" with 10 km range; a utilities spacecraft providing electrical and thermal power, heat rejection, and communications services; a science module providing geo-physical capabilities for sample assay; a subscale regolith movement and classifying suite; and a pilot plant lunar oxygen generation plant. Early success leads to an expansion of this program with three additional flights, beginning in 1996,

on August 4, 2000.

An interval of automated operation of *LB-1* then begins, and major new mission plans are refined. Two objectives are selected: expansion of the capabilities of *LB-1* to include a permanent human presence with pressurized rovers, and establishment of extensive automated sorties to the lunar north polar region, supported by observers in lunar orbit.

To satisfy the first objective, it is found that 500 tons of additional cargo must be delivered to *LB-1* by 2015 and an additional fifteen piloted missions flown. Piloted mission (PM) return by use of stored lunar oxygen is committed for PM-4 and subsequent missions, allowing the lunar vehicle to carry sixteen tons of cargo on each mission as well as the crew and their return flight vehicle. Product improvement of the vehicle increases cargo mission (CM) capability to 30 tons per mission. The flight manifest now includes PM-3 through PM-17 and CM-3 through CM-12, as well as an additional ten *Artemis II*, twelve Russian, five ESA, and four Japanese automated flights.

Through these efforts, a permanent crew of eight persons is in place at *LB-1* by 2012, with crew rotation intervals averaging once per year. Six sites have been thoroughly explored and surveyed for future lunar industrial complexes. One of these sites is a major iron-nickel deposit, similar to that in Canada, that will be exploited for its metals.

Another site is rich in ilmenite and expected to become the hub of a global lunar oxygen pipeline system. Third and fourth sites near the lunar limbs are under review as major solar power generation sources, with major activities expected there in producing thin film solar arrays, aluminum, and foamed glass structural elements. The final two sites have been found to be unusually rich in solar-wind implanted volatiles and are to become, by 2020, the first of a series of "standard" 50-million-ton-per-year mining and processing centers, each with a crew of fifty persons.

Thus, by 2015, all preparations have been made for lunar resources to supply materials to all human space activities, including exploration of Mars, and to begin to put into place the large SPS and other energy sources for the people of Earth.

Within these activities, which can occur over a span of the next twenty years or so, have progressed major technology activities both to enable these events to occur and to enhance their productivity and return on investment.

Contribution to the Panel Discussion

John S. Lewis

University of Arizona/NASA Space Engineering Research Center

As we contemplate the possible futures of America's (and the world's) space efforts, I feel that we must take renewed interest in presenting our case to the public and to Congress. It may well be that *all* future space activity, especially long-term exploration, may rest upon demonstrating direct, short-term benefits to Earth. Expensive items such as Space Station Freedom, the Lunar Base, and Mars expeditions will be especially hard to sell unless they contribute visibly to a coherent plan for using space to the benefit of humanity. But if it is perceived that large-scale space activities can contribute to the material good of mankind, then basic research and the exploitation of space resources to defray the cost of in-space activities will also be seen as visibly serving the public good.

We should begin at once to emphasize the importance of early, careful assessment of a wide range of future options. It is tempting in dealing with the public to commit the error of excessive concreteness by championing a single scenario long before we know whether it is the most desirable. Such a lapse, in which we prematurely advocate a dud, could be the demise of space exploration and exploitation alike. The public attitudes fostered by the *Challenger* disaster, the Hubble mirror debacle, the Galileo antenna episode, etc. predispose the electorate to expect bumbling incompetence from NASA. They are perilously close to shutting down all that is good in space because of these highly visible gaffes. I can envision the public leaping at the lunar ^3He answer to Earth's energy problems, only to find out \$100 billion later that this solution might not prove economically competitive.

As part of this opening of the debate about goals in space, clearly one of the most important things we can do is to provide the public a variety of new ideas (new, at least, to them) that merit early, relatively inexpensive assessment. The issues we raise should include the best source of materials for Solar Power Satellites and where to build them, laboratory assessment of D- ^3He fusion to establish its scientific and engineering feasibility, and a comparative study of sources of ^3He fuel. We should also explore the retrieval of non-terrestrial precious and strategic metals for use on Earth, but the public is interested mainly in cheap, clean, abundant, and environmentally benign sources of energy.

There are certain obvious problems that confront humanity at this juncture, such as global warming, radioactive waste handling, the stability of the ozone layer, and acid rain from combustion products. Such projects are clearly of global importance. They are excellent vehicles for international collaborations of all kinds, in which the American scientific and technical communities can play a vital leadership role. But it is well to remind ourselves that this is also a time of tremendous opportunities. First, there is the issue of conversion of the military technology base of the Western nations to civilian pursuits. The cutting edge of Western science and engineering, traditionally whetted by military requirements, must be kept sharp in order to keep our industries competitive in world civilian markets. This industrial restructuring (better called *perestroika*) demands that a civilian niche be found – to occupy the talents of the highly skilled aerospace engineers who gave us victory in the Cold War. The logical place for such people is in a technically demanding, high-tech attack on the great problems listed above.

At the same time, the emergence of democratic governments in the fifteen republics of the former USSR and in the newly liberated nations of Eastern Europe, combined with their acute economic peril caused by seventy-four years of centralized planning and militarism, have led to the entry of a host of challenges. First, there is the much-discussed problem of what to do to prevent former Soviet nuclear weapons designers from emigrating to nations with more money than morality. In recent weeks both the American and former Soviet nuclear rocket and scramjet research programs have been declassified. It is to the mutual advantage of all countries that desire peace to see these capabilities used for civilian programs that benefit mankind. Civil space endeavors are the obvious response to this new openness (or *glasnost*) of previously classified programs.

The explorational basis for the use of materials from the Moon and other bodies is well understood: the data desired by "pure science" and by resource advocates have a large overlap. The basic science need for compositional and structural mapping of the Moon and the basic engineering need for data on the behavior of real lunar materials during physical and chemical processing in the lunar environment are well known and need not be itemized again here. The Lunar Observer program admirably addresses both sets of needs for chemical and physical mapping of the Moon. The *Artemis* program, as presently envisioned, promises an inexpensive series of missions to serve both scientific and engineering purposes, with low costs linked to frequent flights and quick response to

emergent opportunities. A well-managed program of this type is automatically responsive to changing needs and interests that result from new knowledge. This amounts to a rediscovery of the "good old way" of conducting exploration: a return to the days of the Explorer, Luna, Mariner, Venera, and Pioneer program philosophies that opened the Solar System to us in the 1960s and 1970s. Obviously this approach is not limited to the Moon: similar design philosophies should also be applied to Mars-system and asteroid missions.

There is no shortage of talent in America, no dearth of scientific curiosity or engineering know-how. We have pioneered every subject of interest here, from lunar exploration to asteroid science to the search for life on Mars; from Solar Power Satellite design to ^3He retrieval to non-terrestrial strategic metals recovery. We have all the requisite strengths -- but somehow we cannot bring ourselves to exercise these strengths. Many years ago, Victor Hugo contemplated this dilemma of human nature and explained it thus: "Man does not lack strength -- he lacks will." The will of a democracy, or of a community of democracies, can be expressed by the people. But if anything is to happen, there must be leadership, a visible, public expression of will. That is what we are lacking.

Omit
TO
END

PANEL DISCUSSION