

**N93-28733**534-173  
32 159238

p-11

**NPB CESIUM SPACE EXPERIMENT (U)**

George M. Parsons III  
US Army Strategic Defense Command  
PO Box 1500 ATTN: CSSD-DE-T  
Huntsville, AL 35807-3801

**ABSTRACT (U)**

(U) Neutral Particle Beam (NPB) Weapons systems are planned to perform the ballistic missile defense functions of nuclear weapon/decoy discrimination and warhead kill at appropriate energy levels and ion currents. Negatively charged ions are produced in a specialized ion source and focused into a high quality particle beam. NPB linear accelerators accelerate and steer the negatively charged ions using electric and magnetic fields. After acceleration and steering the neutralizer system strips away extra electrons from ions to form the electrically neutral particle beam. The neutral beam then travel through space to the target unaffected by the Earth's magnetic fields. Continuing technological advances have greatly reduced the size and weight of NPB accelerator systems. Ion current production has been enhanced by over 100 per cent with the intermittent addition of cesium at the NPB ion source device. This increase in current is essential to attain the most light weight, compact NPB platforms and minimize expensive launch costs. Addition of cesium into the ion source has been identified by the NPB community as the highest priority risk reduction space experiment necessary prior to planned NPB accelerator experiments and later weapons systems.

(U) The NPB Cesium Space Experiment is planned to successfully demonstrate controlled cesium introduction and vaporization into a simulated ion source chamber. Microgravity effects on the cesium deposition will be studied as will the effects of small amounts of cesium on high voltage accelerator components that might be susceptible to electrical insulator break downs. The experiment design will simulate as closely as possible the environmental, physical and operational characteristics of the actual NPB ion source.

## Introduction (U)

(U) The NPB systems planned for experiments and as future weapons systems all depend upon a reliable high current ion source to produce negative ions which can be accelerated to energies appropriate to the required mission. Any application of a particle beam system in a spacecraft requires that the greatest efficiency of output be attained at the lightest weight possible to minimize associated launch vehicle costs. Design developments which increase beam current output with little additional weight are sought after for system enhancement. The addition of cesium to the ion source as a catalyst for ion production has been shown to increase output by over 100% depending upon the ion source design. Cesium is added to ground based ion sources by heating a supply of cesium in an oven type device to vaporize minute amounts of the metal and supply it into the ion source cavity. This method cannot be utilized in an orbital system due to the open nature of the system. Only small amounts of cesium are required to provide the current enhancement and its intermittent introduction occurs only when current output falls after long periods of operation. Introduction of cesium must be limited to prevent the arcing of high voltage accelerator components installed downstream of the ion source.

(U) Previous experience with cesiated ion engines on spacecraft have shown that careful design of the delivery system is essential. In 1974 the Advanced Technology Satellite, ATS-6, tested station keeping ion thrusters utilizing a cesium delivery system to enhance current output. The test engines were carefully designed, built, and successfully tested on the ground and in KC-135 aircraft. On orbit the two ion engines each operated one time and then failed in a mode that suggested the cesium flow had not been properly controlled and short circuited the engines. The use of cesium for ion

thruster enhancement was apparently discontinued after this experience.

(U) NPB ion source developers at Culham Laboratory, (Abingdon, UK) and Grumman Aerospace Corporation (Bethpage, NY) have baselined a cesium delivery system design for the NPBSE that overcomes the postulated failure modes present in the ATS-6 satellite. A special study by Grumman Aerospace Corporation was authorized by the US Army Space and Strategic Defense Command to identify risk reduction experiments that would increase the confidence for the successful operation of the NPB Space Experiment (NPBSE). The contractor team identified several tests that should be performed to reduce risk for the NPBSE. The cesium delivery system experiment was identified as the most valuable space experiment. (See Grumman Report "Accelerator Component Experiment (U), Special Study NPBSE-01", prepared under US Government contract DASG60-90-C-0103)

## (U) EXPERIMENT DESCRIPTION

(U) The experiment will include a simulated ion source identical to that baselined for the NPBSE (see diagram 1). The cesium delivery system heats and supplies cesium to the ion source cavity from a metal bellows assembly under a gas pressure actuation, through a small bore (0.005 inch) capillary tube, and a heater/vaporizer assembly. Grid systems which simulate the negative ion extraction system and their associated insulators will be raised to 35 Kv to investigate their behavior with the minute cesium that will migrate to the insulators' location. Instrumentation will measure cesium delivery, chamber pressures, delivery component temperatures and extraction voltage characteristics. Data collection and experiment control will be performed by the STS GRID computer system. A mission specialist will initiate the experiment by connecting a power cord to the orbiter power system and starting the

## SUMMARY (U)

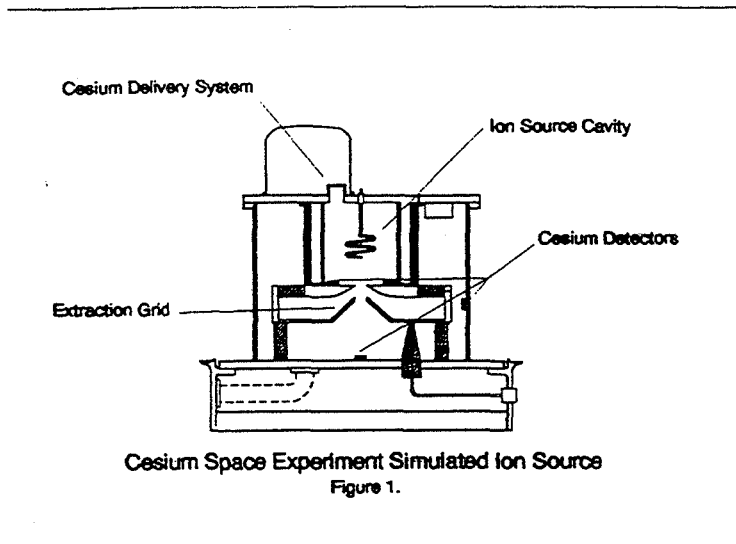

(U) The Cesium Space Experiment will perform a necessary risk reduction investigation of cesium delivery in orbit. This experiment will demonstrate that a device can deliver intermittent supplies of cesium into an ion source in the microgravity environment. Simulated accelerator system voltage will characterize the migration of the cesium within the simulated extraction grids and demonstrate that cesium breakdowns can be either avoided or controlled in a linear accelerator. The cesium delivery system will be the first flight hardware supporting the NPBSE and other NPB accelerator systems. This equipment could be useful for other similar space flight applications.

## REFERENCES (U)

controlling computer program to begin the experiment. Periodic checks will be made to assure that the experiment parameters are normal. If experiment setpoints are exceeded, alarm signals will alert the mission specialist to check the conditions and alter or terminate the experiment as is appropriate.

## STATUS (U)

(U) The NPBCSE hardware experiment container will utilize a standard previously flown NASA approved design. Some additional requalification will be done to meet current safety specifications. The container is presently being fabricated and is expected to be complete in October 1992. Early completion of the enclosure will allow the experimental apparatus developer to fit check and test the equipment within the actual size container.

(U) The experimental cesium delivery device preliminary design is completed and a functionally equivalent test device has been prepared to verify proper operation on an operational accelerator system. Documentation activities have begun that fit a typical timeline for a launch ready experiment in mid year 1994.

- [1] R. Worlock, *et al.*, "ATS-6 Cesium Bombardment Engine North-South Stationkeeping Experiment," *IEEE Transactions on Aerospace and Electronic Systems*, Vol. AES-11 no. 6, November 1975
- [2] Grumman Aerospace Corporation, "Accelerator Component Experiment (U) - Final Report prepared under USASDC Contract DASG60-90-C-0103, Technical Directive Number -001



M-920211-67U-A (C) (2273)

# NEUTRAL PARTICLE BEAM ION SOURCE CESIUM SPACE EXPERIMENT (NPBCSE)

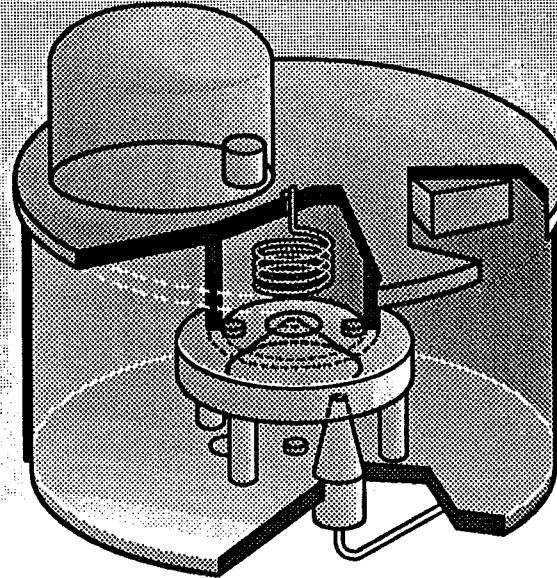

PRESENTED BY  
**G. M. PARSONS**  
U.S. ARMY STRATEGIC DEFENSE COMMAND  
DEW DIRECTORATE

UNCLASSIFIED

UNCLASSIFIED

PRECEDING PAGE BLANK NOT FILMED

UNCLASSIFIED



# NEUTRAL PARTICLE BEAM ION SOURCE CESIUM SPACE EXPERIMENT (NPBCSE) (U)



M-920419-08U-D (C) (2274)

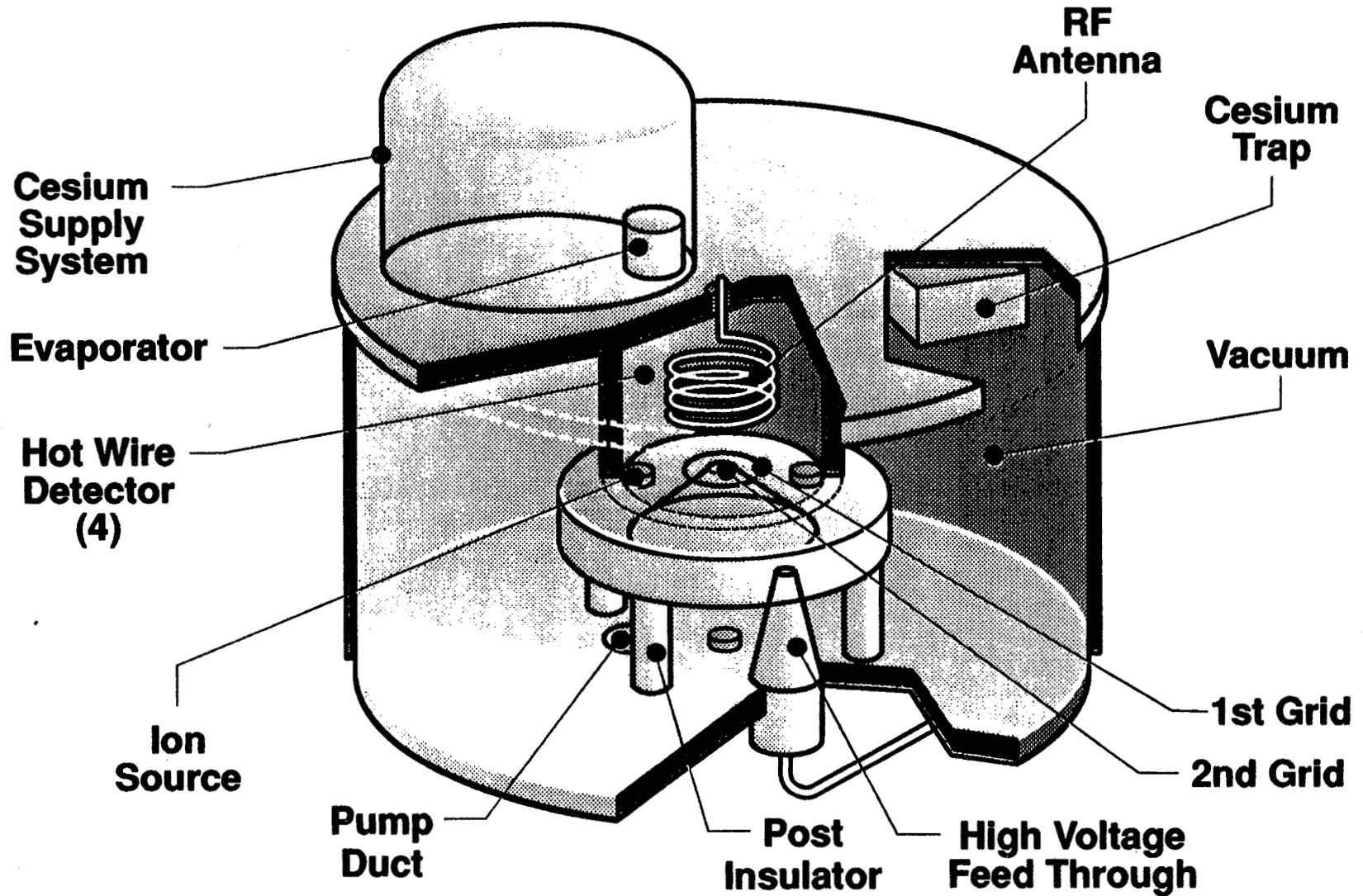

UNCLASSIFIED

UNCLASSIFIED



# NEUTRAL PARTICLE BEAM ION SOURCE CESIUM SPACE EXPERIMENT (NPBCSE) (U)



M-920419-08U-B (C) (2274)

## CONCEPTS AND OBJECTIVES

### REALISTIC MICROGRAVITY SIMULATION OF NPB ION SOURCE, INJECTOR AND ACCELERATOR TO DEMONSTRATE RELIABLE CESIUM DELIVERY AND CONTROL FOR NPBCSE RISK REDUCTION

- TWO CHAMBERS AND ELECTRONICS WILL DEMONSTRATE ESSENTIAL ION SOURCE FUNCTIONS
  - CESIUM SUPPLY PROOF-OF-CONCEPT
  - REGULATED VAPORIZATION INTO ION SOURCE
  - CONTROLLED MIGRATION AND DEPOSITION WITHIN ACCELERATOR
  - SIMULATE NPB ACCELERATOR HIGH VOLTAGE (HV) CHARACTERISTICS WITH CESIUM IN MICROGRAVITY ENVIRONMENT
- SEMI-AUTONOMOUS AFTER CREW POWER UP WITH PERIODIC MONITORING BY CREW MEMBER
  - INDEPENDENT OF GROUND CONTROL
  - REAL-TIME DIAGNOSTICS

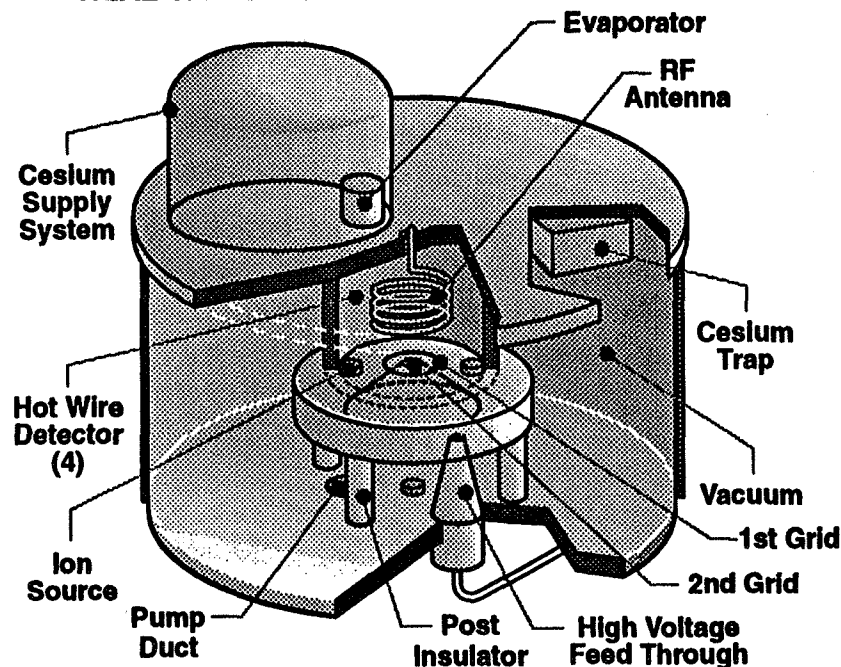

- MEASURES CESIUM MIGRATION CHARACTERISTICS
  - SURFACE DEPOSITION RATE
  - VAPOR PRESSURE
  - EVAPORATOR AND CAPILLARY TEMPERATURES
- INSTRUMENTATION RANGES:
  - HOTWIRE CESIUM VAPOR DETECTOR ( $10^{-3}$  TO 1 TORR)
  - TEMPERATURE SENSORS (0 TO 600° C AND 0 TO 100° C)
  - PIRANI GAUGE ( $10^{-6}$  TO 100 TORR)
- CHAMBERS AND INSTRUMENTATION HOUSED IN NASA-APPROVED CONTAINER REPLACING TWO MIDDECK LOCKER SPACES
  - COMPLIES WITH FLIGHT SAFETY REQUIREMENTS
- ADJOINING ELECTRONICS PACKAGE REPLACES ONE MIDDECK LOCKER SPACE

UNCLASSIFIED



UNCLASSIFIED  
NEUTRAL PARTICLE BEAM ION SOURCE  
CESIUM SPACE EXPERIMENT (NPBCSE)  
JUSTIFICATION (U)



M-920419-07U-B (C) (2274)

• MILITARY RELEVANCE

- HIGH CURRENT/ENERGY NPB WEAPONS WILL PROVIDE ESSENTIAL DISCRIMINATION AND RV KILL CAPABILITIES TO BALLISTIC MISSILE DEFENSE SYSTEMS
- CESIUM IS ESSENTIAL TO ACHIEVE THE 100%-200% INCREASE IN ION CURRENT REQUIRED FOR OPTIMUM NPB WEAPONS SYSTEM PERFORMANCE
- SUCCESS DEPENDENT ON RELIABLE PERFORMANCE OF CESIATED ION SOURCE
  - ACHIEVING CORRECT CONCENTRATION OF CESIUM IN THE ION SOURCE
  - KEEPING HV INSULATORS AND GRIDS CESIUM FREE

• COMPARISON OF ALTERNATIVES

- GROUND SIMULATION OF ON-ORBIT CONDITIONS NOT POSSIBLE - LONG TERM MICROGRAVITY REQUIRED

APPLICATIONS TECHNOLOGY  
SATELLITE (ATS-6)

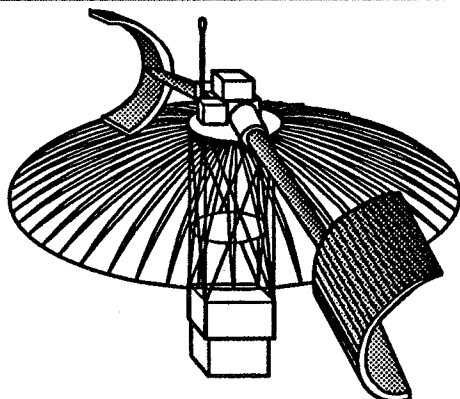

ATS-6 WAS EXTENSIVELY TESTED  
ON GROUND AND ON THE KC-135

• NEED FOR SPACEFLIGHT

- EARLY MICROGRAVITY TESTING OF THE REVISED CESIUM SUPPLY SYSTEM REQUIRED TO SUPPORT NPB PROGRAM
- NECESSARY FOLLOW-ON TO SUCCESSFUL NPBCSE BREADBOARD TESTING
- NPBCSE DESIGN ADDRESSES ATS-6 ION THRUSTER FAILURE MODES
  - INSUFFICIENT ATS-6 SUPPLY CHAMBER WETTING
  - OUTGASSING DURING ATS-6 OPERATION

UNCLASSIFIED



UNCLASSIFIED  
NEUTRAL PARTICAL BEAM CESIUM  
SPACE EXPERIMENT (NPBCSE)  
DETAILED OVERVIEW (U)



M-920419-09U-C (C) (2274)

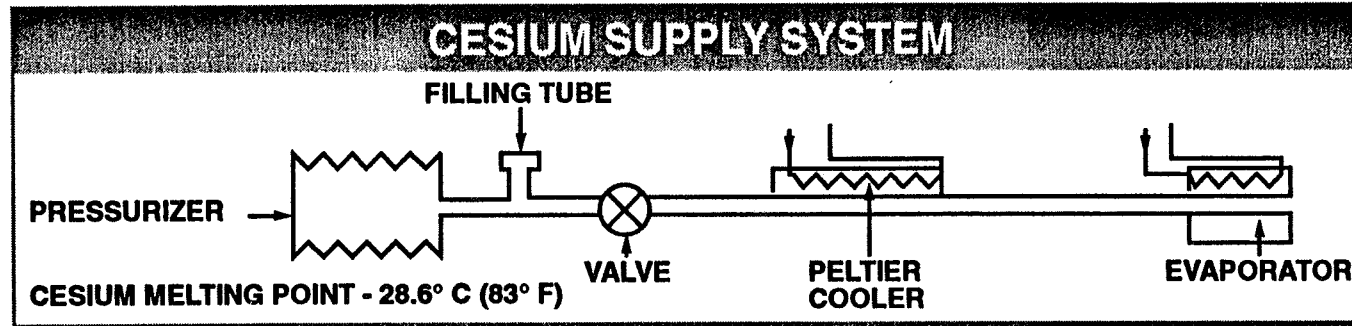

• FLIGHT DATA

- **HARDWARE IDENTICAL TO PLANNED NPBCSE INJECTOR**
- **STANDARD NASA INTEGRATION, LAUNCH, AND FLIGHT SERVICES REQUIRED**
- **COMPATIBLE WITH EXISTING MIDDECK HARDWARE**
- **8 CU.FT., LESS THAN 240 LB (INCLUDING CONTAINER AND ATTACHMENT HARDWARE)**
- **28 VDC ONLY, STANDARD VIDEO (PAYLOAD REQUIRES CONDITIONING OF ORBITER DC POWER)**
- **PASSIVE HEAT REJECTION FROM CSE CONTAINER AND ELECTRONICS PACKAGE BY RADIATION AND CONDUCTION INTO MIDDECK**
- **ALL FLIGHT DATA WILL BE STORED IN PAYLOAD FOR POST MISSION ANALYSIS**
- **MISSION SPECIALIST INITIATES, OPERATES, AND MONITORS EXPERIMENT VIA EXPERIMENT CONTROL AND DISPLAY PANEL**
- **SECONDARY PAYLOAD, ANY SHUTTLE DURATION OR INCLINATION**

UNCLASSIFIED





UNCLASSIFIED  
**NEUTRAL PARTICLE BEAM ION SOURCE  
CESIUM SPACE EXPERIMENT (NPBCSE)  
SUMMARY (U)**



M-920924-02U-A (C) (2274)

- **HARDWARE READY FOR FLIGHT MID-1994**
  - **PROPER RESOURCES APPLIED TO ENSURE EFFICIENT DESIGN, DEVELOPMENT AND INTEGRATION OF NPBCSE HARDWARE**
  - **ON-ORBIT OPERATION WILL PROVIDE PROOF-OF-CONCEPT AND FLIGHT HARDWARE TO NPB PROGRAM**

UNCLASSIFIED



UNCLASSIFIED

# EXPERIMENT CONFIGURATION CESIUM SPACE EXPERIMENT (U)



M-920915-02U (C) (2275)

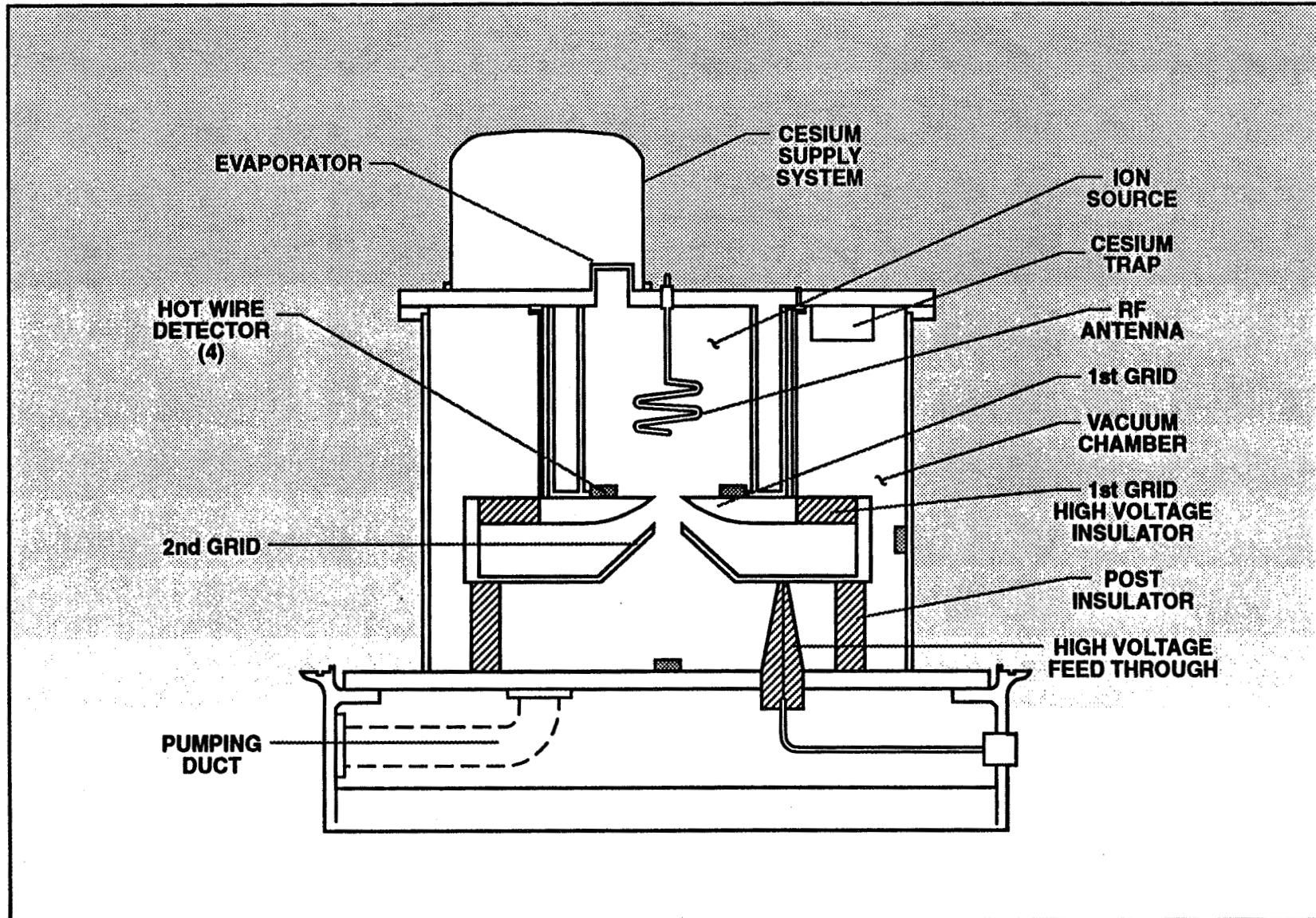

UNCLASSIFIED

UNCLASSIFIED

UNCLASSIFIED



# NEUTRAL PARTICLE BEAM ION SOURCE CESIUM SPACE EXPERIMENT (NPBCSE) (U)

M-920419-08U-D (C) (2274)

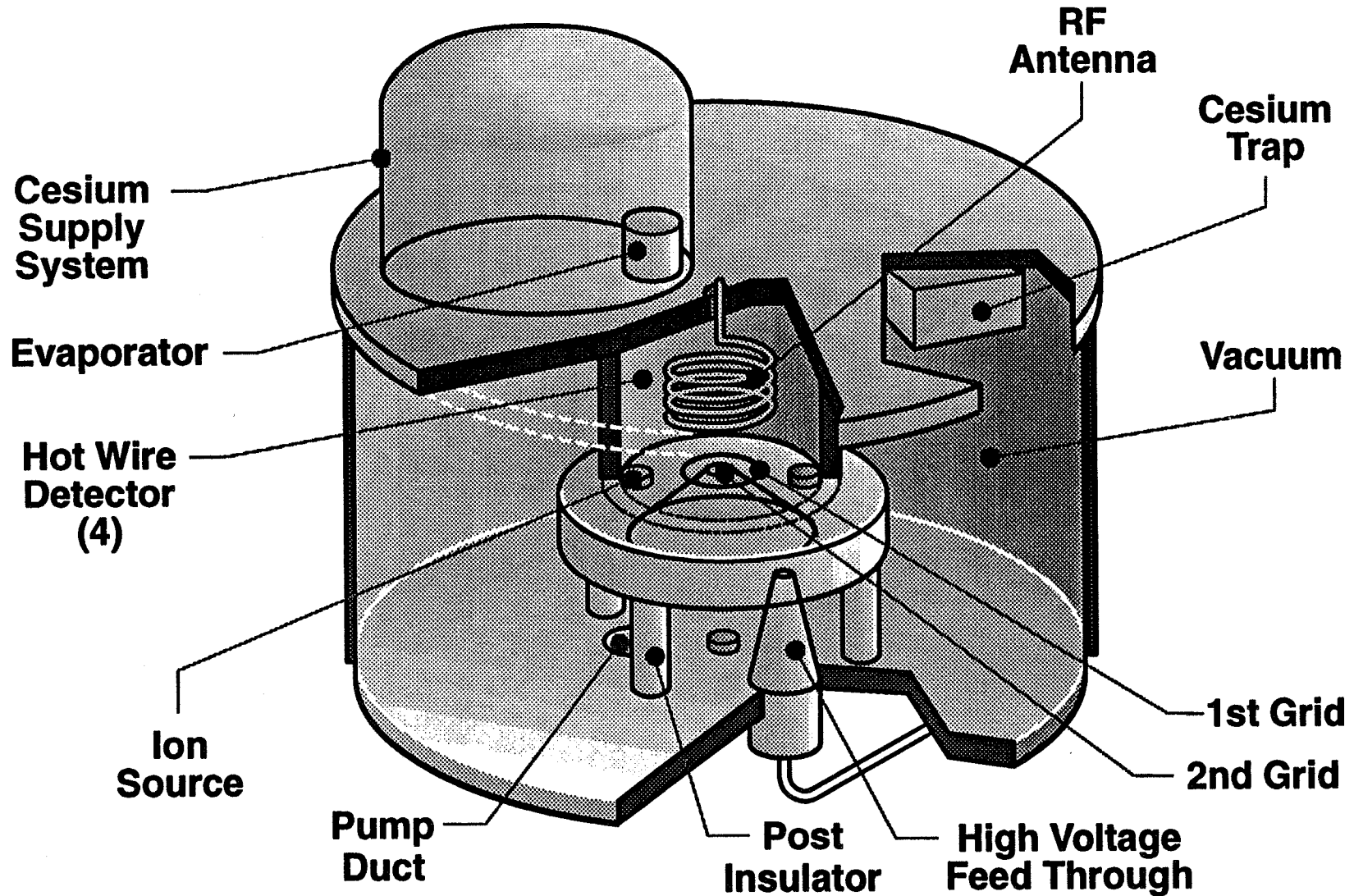

UNCLASSIFIED