

1N-20

194963

0000

NASA Contractor Report 187217

Advanced Engine Study Program

A.I. Masters, D.E. Galler, T.F. Denman, R.A. Shied, J.R. Black,
A.R. Fierstein, G.L. Clark, and B.R. Branstorm
Pratt & Whitney
Government Engines & Space Propulsion
West Palm Beach, Florida

June 1993

Prepared for
Lewis Research Center
Under Contract NAS3-23858



(NASA-CR-187217) ADVANCED ENGINE
STUDY PROGRAM Final Report (PWA)
243 p

N93-28946

Unclass

G3/20 0174963



FOREWORD

This technical report presents the results of an Advanced Space Engine Study. The study was conducted by the Pratt & Whitney Government Engines & Space Propulsion Division of the United Technologies Corporation for the National Aeronautics and Space Administration, Lewis Research Center, under Contract NAS3-23858, Task Order D.4.

The study was initiated in November 1988 and completed in January 1990. Mr. Paul Richter was the NASA Task Order Manager. The effort at P&W was carried out under Mr. James R. Brown, Program Manager, and Mr. Arthur I. Masters, Engineering Manager. Other individuals providing significant contributions in the preparation of the report were Donald E. Galler, Todd F. Denman, and Ricky A. Schied — System Performance Analysis; James R. Black and Aaron R. Fierstein — Heat Transfer; Gale L. Clark — Pump Design; and Bruce R. Branstrom — Turbine Design.

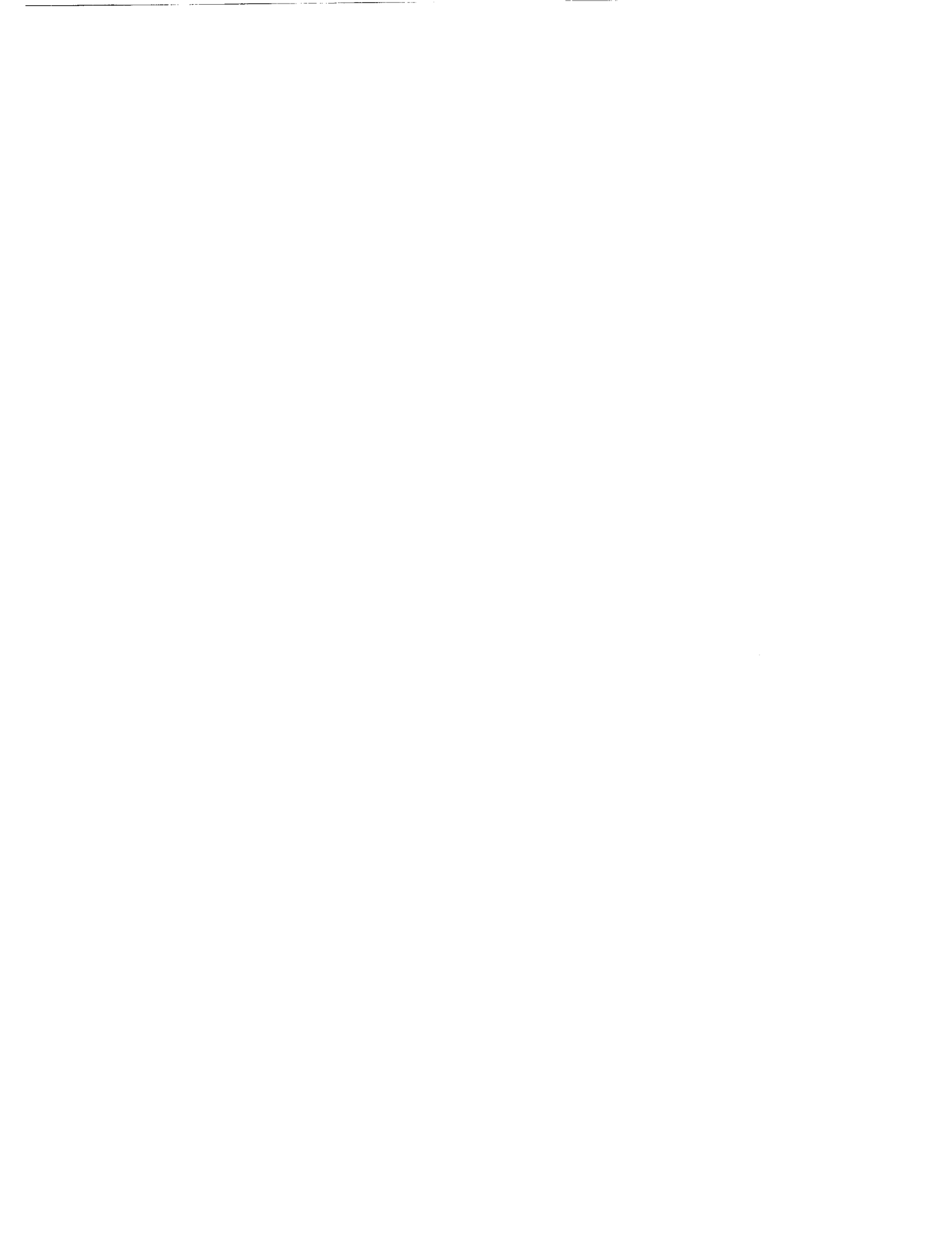

TABLE OF CONTENTS

	<i>Page</i>
I INTRODUCTION AND SUMMARY	1
INTRODUCTION	1
CYCLE COMPARISON STUDY	1
THROTTLING AND HIGH MIXTURE RATIO OPERATION	2
II DESIGN AND PARAMETRIC ANALYSIS	5
EXPANDER CYCLE COMPARISON	5
Baseline Engine Parameters	5
Heat Transfer	5
Pumps	5
Turbines	5
Turbo-pump Configurations	6
Full-Expander Cycle	6
Split-Expander Cycle	7
Dual-Expander Cycle	8
Regenerators and Enhanced Heat Transfer	9
Cycle Selection	9
PARAMETRIC DATA	9
Performance	10
Engine Envelope	11
Weight	11
Nozzle Contour Trade-Off	11
HIGHER CHAMBER PRESSURE REQUIREMENTS	12
ENGINE-VEHICLE INTERFACES	19
REFERENCES	19

	<i>Page</i>
III THROTTLING AND HIGH MIXTURE RATIO OPERATION	37
COMPONENT REQUIREMENTS	37
Combustion System	37
Thrust Chamber Cooling	38
Wide Range Control	39
Turbomachinery	40
CYCLE DATA	40
Split-Expander Cycle	41
Full-Expander Cycle With Regenerator	41
IV RECOMMENDATIONS	56
APPENDIX A — PARAMETRIC DATA	57
APPENDIX B — FULL-THRUST CYCLES	111
APPENDIX C — THROTTLED CYCLES	192
APPENDIX D — OFF-DESIGN MIXTURE RATIO CYCLES	209

LIST OF ILLUSTRATIONS

<i>Figure</i>		<i>Page</i>
1	Comparison of Achievable Chamber Pressure for Four Cycles Using Tubular Copper Thrust Chambers	3
2	Dual-Orifice Injection	4
3	Turbine Efficiency Comparisons	20
4	Back-to-Back Turbine Configurations	20
5	Full-Expander Cycle	21
6	Full-Expander Cycle Achievable Chamber Pressure	21
7	Split-Expander Cycle	22
8	Split-Expander Cycle Achievable Chamber Pressure	22
9	Thrust Chamber Wall Temperatures During Throttling	23
10	Thrust Chamber Wall Temperatures as a Function of High Mixture Ratio	23
11	Dual-Expander Cycle	24
12	Dual-Expander Cycle Achievable Chamber Pressure	24
13	Full-Expander Cycle With Regeneration	25
14	Full-Expander Cycle With Regeneration Achievable Chamber Pressure	25
15	Full, Split, Dual, and Regenerator Cycle Comparison With Tubular Thrust Chambers	26
16	Full, Split, Dual, and Regenerator Cycle Comparison With Milled Channel Thrust Chambers	26
17	Comparison of Predicted Performance (I_{spc}) With Measured Performance (I_{spm}) for the NASA Lewis High Area Ratio Nozzle (Data From Reference 1)	27
18	Pratt & Whitney — Rocket Performance Ideal Impulse Versus P_c for AR = 1000:1, O/F = 6	27
19	Bell Nozzle Truncation Performance — Length Sensitivity Based on a Maximum Payload Truncation; $P_c = 1500$, H_2-O_2 , O/F = 6.0	28
20	Bell Nozzle Truncation Performance — Weight Sensitivity Based on a Maximum Payload Truncation; $P_c = 1500$, H_2-O_2 , O/F = 6.0	28

<i>Figure</i>		<i>Page</i>
21	Advanced Split-Expander Cycle P_c Improvement With Increased Pump Efficiency	29
22	Advanced Full Expander With Regenerator Cycle P_c Improvement With Increased Pump Efficiency	29
23	Advanced Split-Expander Cycle P_c Improvement With Increased Turbine Efficiency	30
24	Advanced Full Expander With Regenerator Cycle P_c Improvement With Increased Turbine Efficiency	30
25a	Advanced Full Expander With Regenerator Cycle P_c Improvement With Increased Turbine Pressure Ratio	31
25b	Advanced Split-Expander Cycle With Regenerator Cycle P_c Improvement With Increased Turbine Pressure Ratio	31
26	Advanced Split-Expander Cycle P_c Improvement With Increased Bypass Flow Around Jacket	32
27	Advanced Full Expander With Regenerator Cycle P_c Improvement With Increased Regenerator Effectiveness	32
28	Advanced Split-Expander Cycle P_c Improvement Due to Increased Chamber Heat Transfer	33
29	Advanced Full Expander With Regenerator Cycle P_c Improvement Due to Increased Chamber Heat Transfer	33
30	Advanced Split-Expander Cycle P_c Improvement Due to Increased Chamber Length	34
31	Advanced Full Expander With Regenerator Cycle P_c Improvement Due to Increased Chamber Length	34
32	Engine Envelope	35-36
33	Coaxial Dual Area Orifice Injector	42
34	XI.R-129 Demonstrator Engine Preburner Injector With Dual Tangential Entry Injection	43
35	Tangential Entry Dual-Orifice Injection	44
36	Maximum Thrust Chamber Wall Temperature With Throttling for a Typical Cycle and for the Split-Expander Cycle	45

<i>Figure</i>		<i>Page</i>
37	Comparison of Thrust Chamber Wall Temperature Versus Mixture Ratio for Typical and Split-Expander Cycles	45
38	Coolant Exit Temperature Versus Percent Thrust for the Full-Expander Cycle With Regeneration	46
39	Jacket Wall Temperature Versus Percent Thrust for the Full-Expander Cycle With Regenerator	46
40	Space Engine Control Schematic — Split-Expander Cycle	47
41	Space Engine Control Schematic — Full-Expander Cycle With Regeneration	48
42	Typical Turbopump Head-Capacity Curve	49
43	Volute Collector With Inducer Struts Provides Head-Flow Characteristics	49
44	Thrust Chamber and Nozzle Cooling Configuration for the Full-Expansion Cycle With Regeneration and the Split-Expander Cycle	50
45	Split-Expander Cycle Throttling, Coolant Exit Temperature Versus Percent Thrust	50
46	Split-Expander Cycle Throttling, JBV Control Valve Area Versus Percent Thrust	51
47	Split-Expander Cycle Throttling, TBV Control Valve Area Versus Percent Thrust	51
48	Split-Expander Cycle Throttling, Ratio of ΔP Across Injector to P_c Versus Percent Thrust	52
49	Split-Expander Cycle Chamber Pressure, and Nozzle Heat Transfer Versus Mixture Ratio	52
50	Full Expander With Regenerator, Coolant Exit Temperature Versus Percent Thrust	53
51	Full Expander With Regenerator, TBV Control Valve Area Versus Percent Thrust	53
52	Full Expander With Regenerator, Coolant Inlet Temperature Versus Percent Thrust	54
53	Full Expander With Regenerator, Ratio of ΔP Across Injector to P_c Versus Percent Thrust	54
54	Full-Expander Cycle With Regenerator, Chamber Pressure and Chamber/Nozzle Heat Transfer Versus Mixture Ratio	55
55-107	APPENDIX A — PARAMETRIC DATA	58-110

LIST OF TABLES

<i>Table</i>	<i>Page</i>
1 Engine System Requirements and Goals	2
2 Advanced Engine Study Range of Design Point Parameters	9
3 Comparison of P&W Predicted Performance (I_{spc}) With Measured Performance (I_{spm}) for the NASA Lewis 1030 to 1 Area Ratio Nozzle	11
4 Approaches to Higher Cycle Chamber Pressure	12
5 Cycle Parameters Improvement Values	14
6 Advanced Engine Parametric Study, Split-Expander Engine	15-16
7 Advanced Engine Parametric Study, Full-Expander Engine With a Hydrogen Regenerator	17-18
8 Vehicle-Engine Interfaces	19
9-48 APPENDIX B — FULL-THRUST CYCLES	112-191
49-56 APPENDIX C — THROTTLED CYCLES	193-208
57-74 APPENDIX D — OFF-DESIGN MIXTURE RATIO CYCLES	210-233

SECTION I INTRODUCTION AND SUMMARY

INTRODUCTION

NASA mission studies have identified the future need for a new Space Transfer Vehicle (STV) Propulsion System. The new system is to be an oxygen/hydrogen expander cycle engine of 7,500 to 50,000 lbs thrust or more, and must achieve high performance via efficient combustion, high combustion pressure, and high area ratio exhaust nozzle expansion. The engine is likely to require wide versatility in terms of such characteristics as throttleability, operation over a wide range of mixture ratios, autogenous pressurization, and in-flight engine thermal conditioning and vehicle propellant settling. Firm engine requirements will include: long life, man-rating, cost effective reusability, space basing, and fault-tolerant operation.

A design and analysis study was conducted to provide advanced engine descriptions and parametric data for STVs. The study was based on an advanced oxygen/hydrogen engine in the 7,500 to 50,000 lbf thrust range. Emphasis was placed on defining requirements for high performance with engine systems capable of achieving reliable and versatile operation in a space environment. Engine system requirements and goals are listed in Table 1.

The study was divided into three technical tasks. In the first task several expander cycle variations were compared from the standpoint of their applicability to a new space engine. Parametric performance, weight and envelope data were then prepared for the selected cycles. Under the second task, the selected cycles were used to investigate requirements for wide range throttling (20:1) and high mixture ratio (O/F = 12.0) operation. The third task was to conduct reviews and coordinate performance of the work.

CYCLE COMPARISON STUDY

Four expander cycle variations were evaluated with respect to their applicability to an STV-type engine, i.e., the full-, or single-, expander cycle; the split-expander cycle; the dual-expander cycle; and the full-expander cycle with a regenerator. The four cycles were compared on the basis of: (1) maximum achievable chamber pressure, which translates to engine performance, weight, and envelope, (2) system complexity, i.e., number of components, severity of cycle condition, technology availability, and program risk (3) throttling capability, and (4) high mixture ratio operation.

The comparison of maximum achievable chamber pressure was based on technology which was judged to be readily available by the mid-1990s and included two thrust chamber cooling methods — copper chambers with milled channel construction and tubular copper chambers. The results are shown in Figure 1 for the tubular copper thrust chambers. Based on the assumption of equivalent technology, the full-expander cycle with regeneration was found to have the highest chamber pressure capability. The maximum pressure with the split-expander cycle was near that of the regenerator cycle at thrust levels above 25,000 lbs, but dropped off at low thrust. The reduced capability was due to cooling limits, not available power. The dual-expander cycle shows good chamber pressure capability at low thrust, but is the lowest of the four cycles over the range of this study. Copper tubular thrust chambers were shown to provide a significant improvement in achievable chamber pressure over milled channel chambers.

On the basis of system complexity, the full expander cycle has the fewest components, the least severe design requirements, and is the most proven. The extra heat exchangers and oxidizer environment in the oxidizer turbine make the dual-expander cycle clearly the most complex. The split-expander cycle and full-expander cycle with regeneration were judged to be equal in complexity and slightly more complex than the full-expander cycle.

The primary difference in throttling and high mixture ratio operation between the four cycles is in the ability to provide adequate thrust chamber cooling and acceptable turbine inlet temperatures over the range of

TABLE 1. — ENGINE SYSTEM REQUIREMENTS AND GOALS

Propellants	Liquid Hydrogen Liquid Oxygen
Vacuum Thrust	7,500 lbf to 50,000 lbf (Study Range)
Vacuum Thrust Throttling Ratio	10:1
Vacuum Specific Impulse	*
Engine Mixture Ratio	6.0 (design point at full thrust) 5.0 — 7.0 (operating range at full thrust)
Chamber Pressure	*
Drive Cycle	Expander
Dimensional Envelope	
Length (stowed/extended)	*
Diameter (maximum)	*
Mass	*
Nozzle Type	Bell with not more than one extendible/retractable section
Nozzle Expansion Ratio	End of regen section to 1200 (Study Range)
Propellant Inlet Temperature	
Hydrogen	37.8 R
Oxygen	162.7 R
Inlet Net Positive Suction Head	
Hydrogen	15 ft-lbf/lbm at full thrust
Oxygen	2 ft-lbf/lbm at full thrust
Design Criteria	Human Rated Aeroassist Compatible Space Based
Service Life Between Overhauls	500 Starts/20 Hours Operation (Goal)
Service Free Life	100 Starts/4 Hours Operation (Goal)
Maximum Single Run Duration	**
Maximum Time Between Firings	**
Minimum Time Between Firings	**
Maximum Storage Time in Space	**
Gimbal Requirement	
Pitch Angle	**
Yaw Angle	**
Acceleration (Maximum)	**
Velocity (Maximum)	**
Start Cycle	
* Engine Parametric Study Results	
** Vehicle/Mission Study Results	

conditions required. The split expander cycle was found to have a significant advantage over other cycles for throttled and high mixture ratio operation.

On the basis of this comparison, the split expander and full expander cycle were selected as the cycles to be used for preparation of the parametric data. These data are presented in Appendix A of this report. The split expander cycle was selected as the baseline cycle for the throttling and high mixture ratio operation study. Secondary consideration was given to throttling the full expander cycle with regeneration.

THROTTLING AND HIGH MIXTURE RATIO OPERATION

The basic requirements for wide range throttling and high mixture ratio operation are: (1) achievement of high combustion efficiency over a wide thrust and mixture ratio range without excessive system pressure drop and complexity, (2) the ability to adequately cool the thrust chamber over the wide range of conditions required, (3) achievement of wide range control without undue control system complexity, and (4) pump flow stability and avoidance of turbine flow separation at low flowrates.

A number of design features were identified for meeting these requirements; they consisted of:

- Dual-orifice injection to provide acceptable pressure drop and high combustion efficiency over the wide range of fuel and oxidizer flows required (Figure 2)
- Use of the split-expander cycle to provide extra cooling capability for off-design operation
- Novel control schemes to provide increased cooling capacity at off-design conditions
- Inducer-interstage struts and flow recirculation to provide off-design point pump stability
- Use of the split-expander cycle to reduce the turbine flow variation from full thrust to minimum thrust and, thereby, inhibit turbine flow separation at low thrust.

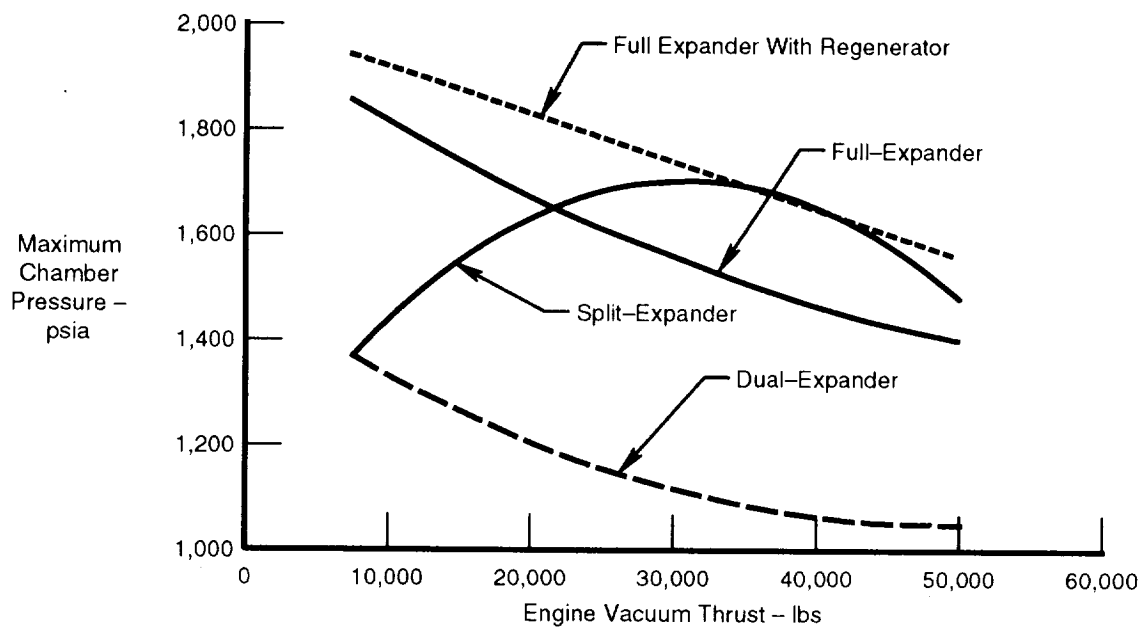

Figure 1. Comparison of Achievable Chamber Pressure for Four Cycles Using Tubular Copper Thrust Chambers

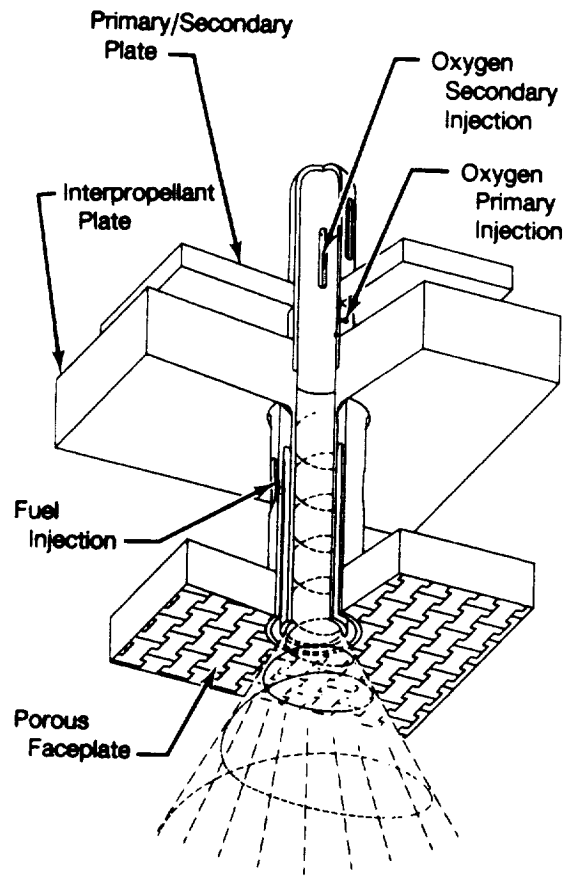

Figure 2. Dual-Orifice Injection

SECTION II DESIGN AND PARAMETRIC ANALYSIS

EXPANDER CYCLE COMPARISON

The high-performance, oxygen-hydrogen expander cycle engine has been selected by NASA as the baseline propulsion system for the Space Transfer Vehicle (STV). As a part of this study, a comparison of four expander cycle variations: the full-expander, split-expander, dual-expander, and full-expander with regeneration was conducted. Study results have provided advanced engine descriptions and parametric data for NASA's STV contractors.

In preparing these data, a technology level consistent with the early-to-mid 1990s was established as a baseline and is described below. The attainment of a given chamber pressure in an expander cycle engine is highly dependent upon this assumed technology level as well as the degree to which the cycle is optimized. Definition of the technology level for any study is always subjective. Although some assumptions may be revised as technology develops, moderate changes are not expected to compromise the validity of the cycle comparison.

Baseline Engine Parameters

(1) *Heat Transfer*

- Milled channel copper chambers and tubular copper chambers
- Haynes 230 tubular nozzles for high material strength and high-temperature operation
- Regenerative-cooling to an area ratio of 210 to 1 for the full- and split-expander
- Regenerative-cooling to an area ratio of 400 to 1 for the dual-expander
- Maximum thrust chamber wall temperature of 1460°R.

(2) *Pumps*

- Fuel pump bearing bore diameter × speed (DN) of 3.0×10^6 rpm-mm
- Maximum pump tip speed of 2100 ft/sec
- Shrouded impellers.

(3) *Turbines*

- Back-to-back vaneless main turbines (except for dual-expander cycle)
- Maximum turbine tip speed of 2000 ft/sec
- Shrouded turbine blades.

Two thrust chamber cooling concepts were used in the baseline study: conventional milled channel copper thrust chambers and tubular copper thrust chambers. The tubular chamber provides an estimated 18 percent heat transfer chamber enhancement over the grooved chamber due to the increased hot wall surface area.

The pump bearing DN limit (product of diameter and speed in rpm-mm) was set at 3.0 million for the hydrogen turbopump and 1.4 million for the oxygen turbopump. Based on Pratt & Whitney's (P&W) demonstrated capability in the Space Shuttle Main Engine Alternate Turbopump Design and XLR-129 high-pressure engine, current DN limits are 2.4 million for ball bearings and 2.7 million for roller bearings in hydrogen and 1.4 million for bearings in oxygen. Previous P&W studies have indicated that 3.0 million DN for hydrogen is achievable with modest development. Although higher effective DN's are possible with hydrostatic bearings, higher speeds

complicate the pump design and drive the turbine toward partial admission (lower efficiency). The effect of turbopump speed was evaluated independently at 25,000-pounds thrust in the full-expander cycle.

Vaneless back-to-back, oxygen-hydrogen turbopumps are the baseline design for all cycles except the dual-expander cycle. Back-to-back turbines must operate with a single turbine drive and could not be applied to the dual-expander cycle. A discussion of each of the engine cycles and some component evaluations, which were also conducted, is contained in the following sections.

Turbopump Configurations

High turbopump efficiency is an important requirement for attaining high chamber pressure. One important issue is partial-admission versus full-admission turbines. The RL10 expander cycle engine initially had a partial admission turbine (approximately 120° admission), however, beginning with the RL10A3-3, the RL10 has used a full-admission turbine with a total-to-static efficiency of over 80 percent. A parameter used in turbine design, specific speed, illustrates the maximum obtainable efficiency and the optimum type of turbine. Figure 3 presents a specific speed efficiency curve. The STV cycle requires a high specific speed and a 2-stage, full-admission configuration to provide high turbine efficiencies.

Another issue investigated was turbine configuration. Back-to-back, counter-rotating, oxygen-hydrogen turbopumps were selected for the parametric study on the basis of their high turbine efficiency and compact packaging. A schematic of the concept is shown in Configuration A of Figure 4. Such configurations are not unique; they have been used for some time in gas turbine turbofan engines, but have not as yet been used in rocket engine turbomachinery. The configuration eliminates turbine-to-turbine pressure drop and decreases the inlet and exit guide vane losses. The configuration also provides a weight reduction by eliminating one turbine housing and inter-turbine ducting.

During independent component design studies conducted by P&W, analysis indicated possible rotor dynamic instabilities with some fuel pump configurations. Development of suitable damping techniques appears practical, but an alternative approach is use of a split rotor fuel pump driven by back-to-back turbines as shown in Configuration B of Figure 4. This configuration provides much shorter fuel turbopump shaft length for improved rotor dynamics at the expense of some of the weight and performance advantages of Configuration A.

Full-Expander Cycle

In the full-expander cycle, depicted in simplified form in Figure 5, fuel is pumped to a high pressure and used to cool the chamber and nozzle assembly and drive the turbopumps. The gaseous fuel is then injected into the main chamber to mix and burn with the liquid oxygen.

An advantage of any expander cycle engine is the relatively benign turbine environment compared to the staged combustion or gas generator cycles. The expander cycle also has lower turbopump discharge pressure requirements than the staged combustion cycle and higher performance than the gas generator. An expander cycle engine is accepted as a simpler, safer, more reliable propulsion system, having fewer failure modes than other cycles. The expander engine, of which the RL10 is an example, is a flight-proven concept.

The full-expander cycle relies on heat transferred from the chamber and nozzle to provide the energy required by the turbopumps. At low design thrust levels, the energy available in the cycle is sufficient to provide high chamber pressure levels. However, as design thrust increases the maximum achievable chamber pressure declines, as shown in Figure 6 for both copper tubes and milled channel copper chambers. Above an engine design thrust of 35,000 pounds, full-expander cycle engine chamber pressures are limited to just under 1500 psia based on the assumed technology level.

Throttling the full-expander cycle through the desired 20 to 1 range presents some difficult design challenges. Using the entire fuel flow for cooling, as thrust levels decrease, the coolant exit temperatures increase. High mixture ratio operation also presents a cooling problem for the full-expander cycle. The reduced fuel flow at the higher mixture ratios increases the chamber wall temperatures, reducing the chamber design life. These limitations can be partially offset by reducing combustor length, use of overcooling at the design point, or bypassing part of the flow at the design point and using all of the flow at off-design. However, these approaches introduce additional system complexity and cycle losses.

Overall, the full-expander cycle meets STV propulsion system requirements, but cooling requirements for throttling and high mixture ratio operation would either limit operation in this regime, require cycle compromises, or require added control provisions.

Split-Expander Cycle

In the split-expander cycle, shown schematically in Figure 7, a portion of the fuel bypasses the chamber and nozzle coolant passages and most of the turbomachinery. The split-expander retains the advantages of the full-expander discussed earlier and offers an additional benefit. With approximately half of the fuel flow routed from the 1st-stage pump discharge directly to the injector, the turbopump horsepower requirements for the split-expander cycle in a typical STV cycle are decreased by approximately 15 to 25 percent.

The energy available in the split-expander cycle is the same as the full-expander cycle for a given thrust and chamber pressure level. However, since the horsepower requirements of the turbopumps are less, the split-expander cycle can achieve higher chamber pressure levels at the same technology level. As shown in Figure 8, the split-expander cycle with a tubular copper chamber can achieve engine chamber pressures above 1500 psi at engine thrust levels of 12,000 to over 50,000 pounds. The maximum chamber pressure is approximately 150 psi higher with tubular chambers than milled channel chambers.

At thrust levels below 25,000 pounds, the maximum chamber pressure with the split-expander begins to drop. This decline is due to thrust chamber cooling requirements rather than cycle limitations. The decline could be avoided by reducing the fraction of cooling jacket bypass flow, however, significant reduction in the design point bypass flow would reduce the inherent advantages of the split-expander for off-design operation.

The ability to regulate chamber and nozzle coolant flow during engine throttling and high mixture ratio operation is an important benefit of the split-expander cycle. Because of the reduced coolant flow at full thrust, the coolant exit temperature of the split-expander is higher than the full-expander. As will be discussed later, the coolant exit temperature of the full-expander cycle rises as the engine is throttled. By using the split-expander jacket bypass valve (JBV) to increase the percent of coolant flow, the coolant exit temperature can be decreased up to a point during throttling. At some fraction of rated power, 30 percent in the case studied, the JBV is completely closed and the cycle operates like a full-expander. However, because the coolant passages for the split-expander are designed for a lower flow at rated power, the combustor wall stabilizes at a lower temperature during deep throttling, as shown in Figure 9. The full-expander curve shown in that figure is for a case that has not been optimized for cooling at throttled conditions. Lower temperatures can be obtained, but not without some compromise to the design point or increase in control system complexity.

High mixture ratio operation is also enhanced with the split-expander cycle. Using the JBV to increase the percent of coolant flow, the split-expander cycle is able to operate at higher mixture ratio levels with a lower combustor wall temperature. Figure 10 shows the cooler copper tube wall temperature attained with the split-expander cycle compared to the full-expander cycle. The difference in wall temperatures at the design point is because the data are for a throttled 1000 psia condition. For a thrust chamber that has been designed at an O/F of 6.0, 1000 psia is the highest chamber pressure that can be achieved while limiting the maximum hot wall temperature in the chamber to 1060°R (the blanching limit).

The full-expander cycle wall temperatures, which were shown in Figure 10, do not represent an optimized cooling scheme for high mixture ratio operation. This optimization cannot be accomplished, however, without significant cycle penalties at normal operation. Low wall temperatures are essential at high mixture ratio operation. The maximum wall temperature range for prevention of copper oxidation is 1060 to 1260°R without coatings. Use of coatings could reduce the wall temperature, but reliable coatings are not currently available and any coating will reduce the overall heat transfer and the available cycle power.

The split-expander cycle is an untested concept, but is based on fully understood fluid dynamic and thermodynamic principles. The split-expander cycle offers an attractive alternative to the full-expander cycle, meeting STV requirements over the desired thrust range, and greatly simplifying throttling and high mixture ratio operation.

Dual-Expander Cycle

Another variation of the expander cycle is the dual-expander cycle shown in Figure 11. The dual-expander cycle uses all the fuel flow to cool the chamber and drive the fuel turbopump. Oxygen is vaporized in the nozzle or an auxiliary heat exchanger and subsequently used to power the oxidizer turbopump. This cycle offers several advantages over both the full- and split-expander cycles. The oxygen turbopump does not require a special interpropellant seal package between the pump and turbine sections. The availability of gaseous oxygen at all thrust levels, simplifies the task of maintaining combustion stability during throttling. Separate turbine drive fluids simplify mixture ratio control, but add complexity to transient control.

For a given thrust and chamber pressure level, the energy available to the dual-expander cycle is the same as both the full- and the split-expander cycles. The turbopump horsepower requirements and the fuel pressure level are comparable to the full-expander. Because oxygen is less efficient as a turbine working fluid, and there is less flexibility in the split in turbine available energy, the dual-expander cycle is more pressure limited than the other cycles. Figure 12 shows the maximum chamber pressure attainable with the dual-expander cycle for both copper tubular and milled channel combustion chambers.

Above an engine thrust level of approximately 20,000 pounds, the dual-expander cycle cannot achieve chamber pressures above 1200 psia without use of regenerators or internal heat exchangers to provide additional energy to the cycle. While regeneration is possible, the achievable pressure would always be lower than with the same enhancements in a full-expander cycle except at low thrust (below 7500 pounds). At low thrust, expander cycles are limited by the hydrogen temperature out of the cooling jacket; allowing the oxygen to absorb a portion of the energy increases the total energy available within the temperature limit.

Using liquid oxygen to cool the nozzle also provides a source of gaseous oxygen to supply tank pressurant and promote combustion stability during deep throttling, negating the need for a variable area injector or a separate heat exchanger. However, experience has shown that achieving good mixing with gaseous fuel and gaseous oxidizer over a wide range of conditions is difficult, and combustion efficiency may suffer at throttled or high mixture ratio conditions.

Like the split-expander cycle, the dual-expander cycle is an untested concept. The dual-expander cycle differences from the proven full-expander cycle also are based on understood fundamental fluid dynamics and thermodynamics. Technology questions, such as turbine material characterization in gaseous oxygen and control during deep throttling and high mixture ratio operation, need to be addressed. Despite its pressure limits at moderate thrust and more complex operation compared to other expander cycles, the dual-expander remains a candidate for the STV, but primarily at low design thrust levels.

Regenerators and Enhanced Heat Transfer

A higher chamber pressure at higher thrust levels can be achieved through use of a regenerator or enhanced thrust chamber heat transfer in the full-expander and dual-expander cycles. The split-expander cycle can also benefit from enhanced heat transfer, but the lower chamber coolant flows do not provide adequate cooling when greatly enhanced heat transfer is used below 50,000-pounds thrust. The function of a regenerator is to increase the available turbopump power by recovering heat downstream of the turbines and using it to preheat the fuel before cooling the thrust chamber (Figure 13). Enhanced chamber heat transfer increases the available power to the turbines and can be achieved by using finned cooling tubes and ribbed chamber walls.

The upper limit chamber pressure for the full-expander cycle with regeneration is shown in Figure 14. The enhancement of the full-expander cycle with the addition of a regenerator, provides a significant increase in chamber pressure over the entire thrust range.

Cycle Selection

Figure 15 compares the four cycles studied on the basis of copper tubular thrust chamber construction. Figure 16 shows the same comparison using a milled channel copper chamber instead of tubular copper chambers. The full-expander cycle with regeneration produces higher chamber pressure levels, but the higher coolant temperature at the design point aggravates the already difficult job of cooling at throttled or high mixture ratio operation. Enhanced chamber heat transfer accomplishes the same results, but also raises the same concerns. Bypassing the regenerator at off-design conditions partially alleviates this problem.

On the basis of this comparison, the full-expander cycle with regeneration was judged to have the highest chamber pressure capability over the range of thrust considered. The capabilities of the split-expander cycle and full-expander cycle without regeneration were only slightly lower over most of the thrust range. The split-expander cycle was found to have unique advantages for throttled and off-design operation. The full-expander cycle with regeneration and the split-expander cycle were therefore selected as the cycles for developing the parametric data. The split-expander cycle was selected as the baseline for the throttling and high mixture ratio evaluation and the full-expander cycle with regeneration was given secondary consideration.

PARAMETRIC DATA

Engine parametric performance envelope and weight data were generated over the range of design point parameters studied (Table 2). The data are presented in graphical form in Appendix A. All data are for an oxidizer/fuel (O/F) ratio of 6.0.

TABLE 2. — ADVANCED ENGINE STUDY RANGE OF DESIGN POINT PARAMETERS

Vacuum Thrust	7500 to 50,000 lbf
Chamber Pressure	1000 psia to cycle limit
Expansion Ratio	Regenerative terminus to 1200

The upper limit chamber pressures presented in the “cycle selection” section ranged from 1040 to 1940 psia for the various cycles and thrust levels investigated. These limits are not absolute, but rather are relative limits based upon the assumed technology level chosen for this study. Chamber pressures above 2000 psia appear possible for most cycles at most thrust levels (refer to the “Higher Chamber Pressure Requirements” section). However, an upper limit of 2000 psia was selected for developing the parametric data. The following paragraphs describe the methodology used to produce the parametric data.

Performance

In calculating the predicted impulse, an ideal impulse was calculated, and then efficiencies were applied to the ideal impulse to account for various losses. These losses include energy release losses, kinetic losses, divergence losses, and boundary-layer losses.

The ideal predicted impulse was calculated with the NASA one-dimensional chemical equilibrium computer code (ODE) analysis using engine inlet fluid enthalpies. For this analysis, an adiabatic assumption was employed with the control volume encompassing the engine. The propellants enter the control volume at the engine inlet and exit the control volume at the nozzle exit plane. The energy release losses are accounted for by applying a combustion efficiency to the ideal impulse. For this study, a constant combustion efficiency of 0.992 was used which is based on performance expected with tangential swirl injectors. The remaining losses are accounted for by applying a nozzle efficiency to the impulse that has been corrected for energy release losses. For this study, a constant nozzle efficiency of 0.982 was used which is based on a maximum payload truncated bell nozzle.

A comparison was made between the method of performance prediction used in this study and experimental data presented in Table 3 (ref. 1). To make a valid comparison between the predicted and measured performance a few assumptions were made. First, the combustion efficiency (ηC^*) that was calculated from the experimental results was used in calculating the predicted performance rather than the constant combustion efficiency that was used in the study.

Second, typical cryogenic engine inlet propellant conditions were used to calculate the ideal specific impulse instead of using the measured injector inlet conditions (ref. 1). The second assumption was made so as to maintain the validity of the adiabatic assumption that was used in this study. During the experimental performance measurements, the propellants were not maintained at cryogenic conditions, but were heated to ambient temperature by the atmosphere. Also, as the propellants were combusted and expanded, heat was removed by the water jacket that surrounded the throat region and the heat retaining capacity of the metal. The ambient heat addition to, and the water jacket heat removal from, the propellants tend to offset one another, thus validating the adiabatic assumption.

As shown in Figure 17, the comparison shows best agreement around an O/F of 5.0 for the 1030 to 1 area ratio and best agreement around an O/F of 4.0 for the 428 to 1 area ratio. The difference between the predicted and experimental performance at the lower mixture ratios is probably due to the reduction in heat flux at lower mixture ratios while the ambient heat addition remains constant.

The chamber pressure levels from the experimental cases are much lower than those investigated in this study. The study (ref. 1) indicated that a laminar boundary layer assumption showed the best agreement with the experimental data. However, subsequent studies by NASA Lewis (ref. 2) indicate that for higher chamber pressure levels (360 to 2600 psia) a transitional boundary layer occurs. Although no performance data were presented, the transitional boundary layer would probably be detrimental to performance.

The parametric analyses show that thrust level has no effect on vacuum specific impulse while chamber pressure has very little effect, i.e., less than 1 second increase in going from a chamber pressure of 1000 psia to 2000 psia (Figure 18). Area ratio is the biggest driver of specific impulse. An area ratio above 900 would be required to achieve a 480 sec vacuum I_{sp} based on the current data.

TABLE 3. — COMPARISON OF P&W PREDICTED PERFORMANCE ($I_{spc}^{(1)}$) WITH MEASURED PERFORMANCE (I_{spm}) FOR THE NASA LEWIS 1030 TO 1 AREA RATIO NOZZLE (REF 1)

<i>Reading</i>	<i>AR</i>	<i>FVAC</i>	<i>PC</i>	<i>O/F</i>	I_{spc}	I_{spm}	I_{spc}/I_{spm}
112	1030.	544.4	360.0	3.84	456.1	468.9	0.973
113	1030.	541.6	356.9	4.36	457.7	460.4	0.994
114	1030.	552.3	360.9	5.08	459.2	451.9	1.016
115	1030.	550.4	355.3	5.49	458.6	449.7	1.020
117	1030.	531.5	356.2	3.19	451.8	473.4	0.954
120	1030.	546.1	355.2	4.30	457.7	466.1	0.982
121	1030.	552.9	360.0	4.11	457.7	473.6	0.966
123	1030.	534.3	355.2	3.19	451.8	481.1	0.939
124	1030.	536.4	361.4	2.78	447.4	481.3	0.929
125	1030.	541.0	354.0	3.74	455.6	477.8	0.953
136	428.	500.9	345.6	3.04	446.7	462.3	0.966
137	428.	531.6	356.8	4.29	453.3	452.6	1.002

Notes:

⁽¹⁾ I_{spc} was calculated using one-dimensional equilibrium (with Engine Inlet Enthalpies), a constant nozzle efficiency (0.982), and the experimentally determined η^{C*} .

Engine Envelope

Engine overall lengths and exit diameters were calculated over the range of specified operating conditions. The length of the engine is from the gimbal mount to the nozzle exit plane and consists of three separate lengths. The first length is the distance from the engine gimbal mount to the injector face. This was estimated from layouts of engines of comparable thrust. The length of the combustion chamber, the second length, was held constant at 15 inches. The remainder of the engine length is the distance from the throat to the nozzle exit plane. A maximum payload bell nozzle contour was generated for the chamber pressures, thrust levels, and nozzle expansion ratios of the parametric study. The engine diameter is the exit diameter of the nozzle and is a function of the thrust level, chamber pressure, and expansion ratio.

Weight

Parametric engine weights were generated over the range of specified operating conditions. Historical thrust/weight data were used to estimate these weights with adjustments being made for size, cycle, material, and technology differences. These adjustments included nozzle weights which were calculated as a function of nozzle surface areas. The difference in weight between the split-expander cycle and the full-expander cycle with a regenerator were accounted for by adding or removing components. Analysis of the results, given in Appendix A, show a slight weight advantage for the split-expander cycle when compared to the full-expander cycle with regenerator.

Nozzle Contour Trade-off

The maximum payload bell nozzle contour, used throughout the parametric study, is a rather long nozzle that is used to attain high specific impulse. A sensitivity study was conducted to calculate the effect of nozzle contour on the trade-off of length and weight with performance. Nozzle contours from a minimum length to a maximum performance were examined for a chamber pressure of 1500 psia. The results are presented in Figures

19 and 20 for the nozzle expansion ratio range of interest and show that going to a shorter nozzle can decrease engine weight by up to 12 percent for a high area ratio (1200 to 1) engine while dropping performance only approximately 1.0 second. However, for a relatively low area ratio (210 to 1) engine, performance decrease by almost 3 seconds when a minimum length nozzle contour is used while engine weight drops by only 3.5 percent.

HIGHER CHAMBER PRESSURE REQUIREMENTS

The upper limit chamber pressures, discussed in the “cycle selection” section, were based on rather conservative assumptions of mid-1990s technology. Selection of the technology level for the cycle comparison was driven by these considerations:

- There appears to be little increase in specific impulse or system performance at chamber pressures above 1000 to 1500 psia.
- Not pushing the system design and associated technology levels to extreme limits provides margin for system flexibility, thereby simplifying throttling and high mixture ratio operation.
- Not pushing system design and technology levels to extreme limits reduces development difficulty (program risk) and helps ensure a high level of reliability.

Higher pressures are possible and may, under some circumstances, be worth the additional complication. A system sensitivity study was conducted to determine which of the cycle parameters in the original study most significantly limited chamber pressure and to show how modifying these variables could extend chamber pressure limits.

The cycle parameters used in the sensitivity study are listed in Table 4. As appropriate, the parameter sensitivity was investigated for both the split-expander cycle and full-expander cycle with regeneration.

TABLE 4. — APPROACHES TO HIGHER CYCLE CHAMBER PRESSURE

<i>Cycle Parameter Improvement</i>	<i>Cycle</i>	<i>Means of Achieving Improvement</i>
Higher Pump Efficiency	Full-Expander With Regenerator Split-Expander	Higher Pump Speed, Reduced Pump Leakage
Higher Turbine Efficiency	Full-Expander With Regenerator Split-Expander	Higher Turbine Speed, Reduced Tip Leakage
Higher Turbine Pressure Ratio	Full-Expander With Regenerator Split-Expander	Higher Pump Discharge Pressure
Coolant Jacket Bypass Flow	Split-Expander	Increase Bypass Flow to Obtain Higher Turbine Inlet Temperature
Regenerator Effectiveness	Full-Expander With Regenerator	Larger, More Effective Regenerator
Increased Thrust Chamber Heat Transfer	Full-Expander With Regenerator Split-Expander	Tubular Chamber, Increased Thrust Chamber Length

The effect of pump efficiency on maximum achievable pressure is shown in Figures 21 and 22 for the two cycles. For the split-expander cycle, an increase of 5 percent in fuel and oxidizer pump efficiency over the baseline cycle pump efficiencies (approximately 65 percent for the fuel pump and 75 percent for the oxidizer

pump) produces an increase of 150 psi in chamber pressure if all other cycle variables are held constant. Fuel pump efficiency improvements could be achieved by developing hydrostatic bearings to operate well above the baseline cycle turbopump speed (125,000 rpm for the fuel pump) or by reducing internal pump leakage below current state-of-the-art projections. For the full-expander cycle with regeneration, a 5 percent increase in pump efficiency provides a 170 psi increase in chamber pressure.

Figures 23 and 24 show the effect of increases in turbine efficiency on chamber pressure. A 5 percent increase in fuel and oxidizer turbine efficiency over the baseline values of 80 to 85 percent produces an 85 psi chamber pressure increase for the slit expander cycle and a 95 psi increase in the full-expander cycle with regeneration.

All of the cycle studies prepared under the study have been based on a turbine pressure ratio of 2.1. Pratt & Whitney experience has shown that a pressure ratio of 2.1 produces a chamber pressure that is near, but slightly below the maximum that can be achieved. However, higher turbine pressure ratios produce only slightly higher chamber pressures at the expense of a very high head rise and discharge pressure requirement on the pump. This trend is shown in Figures 25a and 25b. For the full-expander cycle with regeneration, increasing the turbine pressure ratio to 2.4 increases chamber pressure by only 90 psi, while requiring an increase in pump discharge pressure of 1000 psi. Similarly, for the split-expander cycle, where the maximum chamber pressure is achieved at a turbine pressure ratio of 2.6 the chamber pressure is increased by only 120 psi over the reference value. Yet the balanced cycle at the pressure ratio of 2.6 requires a large increase in fuel pump discharge pressure to 6600 psia compared to the reference pump discharge pressure of 5100 psia.

The split-expander cycle has a unique variable that can be optimized for maximum pressure, i.e., the fraction of the fuel that bypasses the cooling jacket and turbines. All of the unthrottled split expander cycles prepared under this study have been based on 50 percent bypass flow. At low thrust (below approximately 20,000 pounds), the optimum bypass flow for maximum chamber pressure is below 50 percent; however, 50 percent was used as a minimum in the split-expander cycle to provide flexibility for cooling with throttling or high mixture ratio operation. As shown in Figure 26, increasing the jacket bypass flow at 25,000 pounds of thrust would produce a small increase in maximum chamber pressure at the expense of a significant increase in turbine inlet temperature.

In the full-expander cycle with a regenerator, the regenerator heat transfer effectiveness is a design variable that affects available power. A relatively low effectiveness was used in the cycle comparison study because of cooling limitation at low design point thrust and problems associated with throttling with the regenerator in the cycle. At the 25,000-pound thrust level, a higher regenerator effectiveness is feasible and can provide a significant increase in achievable chamber pressure, as shown in Figure 27.

The effect of increased thrust chamber heat transfer was determined for both the split-expander cycle (Figure 28) and the full-expander cycle with regeneration (Figure 29). Chamber heat transfer enhancement with a tubular chamber has been estimated to be 18 percent over a milled channel chamber due to the increased hot side surface area. This is the value used in the cycle comparison study. The actual heat transfer enhancement with tubular chambers could be significantly more than 18 percent. An additional 10 percent increase in the predicted heat transfer (110 of 118 percent) could increase chamber pressure by 80 psia for the split-expander cycle and by 60 psia for the full-expander cycle with regeneration. The chamber heat transfer can also be increased by lengthening the thrust chamber.

The baseline length for the candidate cycle thrust chambers is 12.3 inches. Figures 30 and 31 show the impact on chamber pressure of increasing this length to 16 inches for the split-expander cycle and the full-expander cycle with regeneration, respectively. A 14.7 inch chamber length raises the achievable chamber pressure by 95 psia for the split-expander cycle engine. Above that length, however, the coolant pressure loss increase, associated with the enhanced heat transfer, exceeds its benefits and results in a lower attainable chamber pressure. The full-expander cycle with regeneration experiences an increase in chamber pressure of 54 psia for the same 14.7 inch long chamber.

Based on the above results of this sensitivity study, an extended chamber pressure limit design was generated for each cycle. Moderate levels of improvement were selected for each parameter to stay with optimistic, but not unrealistic, state-of-the-art technology for the mid-1990s. Table 5 lists the chosen improved cycle parameter values. Tables 6 and 7 present the higher chamber pressure cycle data for the split-expander and the full-expander with regeneration, respectively. The split-expander cycle achieves a chamber pressure of 2044 psia with a resulting pump discharge pressure of 6923 psia and an oxygen turbopump turbine inlet temperature of 1556°R. The full-expander cycle with regeneration attains a 2198 psia chamber pressure with a pump discharge pressure of 7572 psia and a turbine inlet temperature of 957°R.

TABLE 5. — CYCLE PARAMETERS IMPROVEMENT VALUES

	<i>Split-Expander Cycle</i>	<i>Full-Expander Cycle W/Regenerator</i>
Turbine Pressure Ratio	2.2	2.2
Pump Efficiency, %	+5	+5
Turbine Efficiency, %	+5	+5
Jacket Bypass, %	55	N/A
Regenerator Effectiveness, %	N/A	+10
Increased Chamber Length, in.	+2.4	+2.4

TABLE 6. — ADVANCED ENGINE PARAMETRIC STUDY, SPLIT-EXPANDER ENGINE

CHAMBER PRESSURE	2043.7
VAC ENGINE THRUST	25000.
TOTAL ENGINE FLOW RATE	52.07
DEL. VAC. ISP	480.1
THROAT AREA	5.99
NOZZLE AREA RATIO	1000.0
NOZZLE EXIT DIAMETER	87.34
ENGINE MIXTURE RATIO	6.00
ETA C*	0.993
CHAMBER COOLANT DP	1365.
CHAMBER COOLANT DT	1409.
NOZZLE/CHAMBER Q	17209.

ENGINE STATION CONDITIONS	

* FUEL SYSTEM CONDITIONS *	
STATION	PRESS TEMP FLOW ENTHALPY DENSITY
B.P. INLET	18.6 37.4 7.44 -107.5 4.37
B.P. EXIT	100.2 38.4 7.44 -103.2 4.39
PUMP INLET	100.2 38.4 7.44 -103.2 4.39
PUMP EXIT	2760.6 76.5 7.44 65.6 4.42
1ST STAGE EXIT	2705.4 77.0 4.09 65.6 4.39
JBV INLET	2299.6 80.2 4.09 65.6 4.14
JBV EXIT	4890.2 113.3 3.35 221.7 4.36
2ND STAGE EXIT	6922.8 145.8 3.35 369.5 4.38
PUMP EXIT	6853.6 144.3 3.35 369.5 4.36
COOLANT INLET	5489.2 1555.3 3.35 5507.4 0.61
COOLANT EXIT	5433.4 1555.6 0.17 5507.4 0.60
TBV INLET	2408.3 1577.3 0.17 5507.4 0.28
TBV EXIT	5433.4 1555.6 3.18 5507.4 0.60
O2 TRB INLET	4864.3 1517.7 3.18 5360.4 0.56
O2 TRB EXIT	4864.3 1517.7 3.18 5360.4 0.56
H2 TRB INLET	2571.6 1333.2 3.18 4645.6 0.34
H2 TRB EXIT	2507.9 1333.7 3.18 4645.6 0.34
H2 TRB DIFFUSER	2482.9 1333.7 3.18 4645.6 0.34
H2 BST TRB IN	2462.3 1331.2 3.18 4635.6 0.33
H2 BST TRB OUT	2457.1 1331.3 3.18 4635.6 0.33
H2 BST TRB DIFF	2432.6 1331.4 3.18 4635.6 0.33
O2 BST TRB IN	2421.5 1330.0 3.18 4630.2 0.33
O2 BST TRB OUT	2420.4 1330.0 3.18 4630.2 0.33
O2 BST TRB DIFF	18.6 1340.9 0.0044 4674.0 0.0026
H2 TANK PRESS	2408.3 1340.5 3.34 4674.0 0.32
GOX HEAT EXCH IN	2396.2 1341.7 3.34 4671.0 0.32
GOX HEAT EXCH OUT	2299.6 80.2 4.09 65.6 4.14
MIXER HOT IN	2276.4 622.0 7.44 2136.5 0.64
MIXER COLD IN	2276.4 622.0 7.44 2136.5 0.64
MIXER OUT	2219.5 622.3 7.44 2136.5 0.62
FSOV INLET	2197.3 622.4 7.44 2136.5 0.62
FSOV EXIT	2043.7
CHAMBER INJ	
CHAMBER	
* OXYGEN SYSTEM CONDITIONS *	
STATION	PRESS TEMP FLOW ENTHALPY DENSITY
B.P. INLET	16.0 162.7 44.7 61.9 70.99
B.P. EXIT	135.2 165.3 44.7 62.3 70.85
PUMP INLET	135.2 165.3 44.7 62.3 70.85
PUMP EXIT	5309.8 178.8 44.7 72.8 71.68
O2 TANK PRESS	16.0 400.0 0.076 204.7 0.12
OSDV INLET	3276.7 178.9 6.7 72.8 71.63
OSDV EXIT	2293.7 182.8 6.7 72.8 70.12
OCV INLET	3276.7 178.9 37.9 72.8 71.63
OCV EXIT	2295.7 182.8 37.9 72.8 70.12
CHAMBER INJ	2270.7 182.9 44.6 72.8 70.09
CHAMBER	2043.7
* VALVE DATA *	
VALVE	DELTA P AREA FLOW % BYPASS
JBV	406. 0.15 4.09 55.00
TBV	3025. 0.01 0.17 5.00
FSOV	57. 1.80 7.44
OCV	983. 0.01 44.63
* INJECTOR DATA *	
INJECTOR	DELTA P AREA FLOW
FUEL	154. 1.15 7.44
LOX	227. 0.53 44.63

TABLE 6. — ADVANCED ENGINE PARAMETRIC STUDY, SPLIT-EXPANDER ENGINE (Continued)

***** * TURBOMACHINERY PERFORMANCE DATA * *****	
***** * H ₂ BOOST TURBINE * *****	***** * H ₂ BOOST PUMP * *****
EFFICIENCY (T/T) 0.917	EFFICIENCY 0.804
EFFICIENCY (T/S) 0.688	HORSEPOWER 45.
SPEED (RPM) 41220.	SPEED (RPM) 41220.
MEAN DIA (IN) 2.18	S SPEED 3052.
EFF AREA (IN ²) 1.78	HEAD (FT) 2480.
U/C (ACTUAL) 0.553	DIA. (IN) 2.43
MAX TIP SPEED 480.	TIP SPEED 438.
STAGES 1	VOL. FLOW 740.
GAMMA 1.43	HEAD COEF 0.450
PRESS RATIO (T/T) 1.01	FLOW COEF 0.201
PRESS RATIO (T/S) 1.01	
HORSEPOWER 45.	
EXIT MACH NUMBER 0.06	
SPECIFIC SPEED 113.64	
SPECIFIC DIAMETER 0.76	
***** * H ₂ TURBINE * *****	***** * H ₂ PUMP * *****
EFFICIENCY (T/T) 0.825	STAGE ONE STAGE TWO STAGE THREE
EFFICIENCY (T/S) 0.787	EFFICIENCY 0.660 0.575 0.583
SPEED (RPM) 125000.	HORSEPOWER 1778. 740. 700.
HORSEPOWER 3218.	SPEED (RPM) 125000. 125000. 125000.
MEAN DIA. (IN) 3.30	SS SPEED 11348.
EFF AREA (IN ²) 0.18	S SPEED 680. 540. 556.
U/C (ACTUAL) 0.626	HEAD (FT) 86735. 69895. 67004.
MAX TIP SPEED 1871.	DIA. (IN) 4.12 3.78 3.78
STAGES 2	TIP SPEED 2248. 2061. 2061.
GAMMA 1.43	VOL. FLOW 755. 345. 343.
PRESS RATIO (T/T) 1.89	HEAD COEF 0.552 0.530 0.508
PRESS RATIO (T/S) 1.96	FLOW COEF 0.088
EXIT MACH NUMBER 0.13	DIAMETER RATIO 0.306
SPECIFIC SPEED 24.37	BEARING DN 3.00E-06
SPECIFIC DIAMETER 2.39	SHAFT DIAMETER 24.00
***** * O ₂ BOOST TURBINE * *****	***** * O ₂ BOOST PUMP * *****
EFFICIENCY (T/T) 0.912	EFFICIENCY 0.803
EFFICIENCY (T/S) 0.803	HORSEPOWER 25.
SPEED (RPM) 11044.	SPEED (RPM) 11044.
MEAN DIA (IN) 5.99	S SPEED 3026.
EFF AREA (IN ²) 2.45	HEAD (FT) 242.
U/C (ACTUAL) 0.553	DIA. (IN) 2.73
MAX TIP SPEED 310.	TIP SPEED 132.
STAGES 1	VOL. FLOW 283.
GAMMA 1.43	HEAD COEF 0.450
PRESS RATIO (T/T) 1.00	FLOW COEF 0.200
PRESS RATIO (T/S) 1.01	
HORSEPOWER 25.	
EXIT MACH NUMBER 0.03	
SPECIFIC SPEED 54.38	
SPECIFIC DIAMETER 1.50	
***** * O ₂ TURBINE * *****	***** * O ₂ PUMP * *****
EFFICIENCY (T/T) 0.882	EFFICIENCY 0.783
EFFICIENCY (T/S) 0.839	HORSEPOWER 662.
SPEED (RPM) 72056.	SPEED (RPM) 72056.
HORSEPOWER 662.	SS SPEED 23942.
MEAN DIA (IN) 3.30	S SPEED 1690.
EFF AREA (IN ²) 0.26	HEAD (FT) 6375.
U/C (ACTUAL) 0.541	DIA. (IN) 2.18
MAX TIP SPEED 1086.	TIP SPEED 686.
STAGES 2	VOL. FLOW 280.
GAMMA 1.43	HEAD COEF 0.436
PRESS RATIO (T/T) 1.12	FLOW COEF 0.148
PRESS RATIO (T/S) 1.12	DIAMETER RATIO 0.478
EXIT MACH NUMBER 0.06	BEARING DN 1.44E-06
SPECIFIC SPEED 37.64	SHAFT DIAMETER 20.00
SPECIFIC DIAMETER 2.05	

TABLE 7. — ADVANCED ENGINE PARAMETRIC STUDY, FULL-EXPANDER ENGINE WITH A HYDROGEN REGENERATOR

ENGINE PERFORMANCE PARAMETERS					

CHAMBER PRESSURE					2198.0
VAC ENGINE THRUST					25000.
TOTAL ENGINE FLOW RATE					52.07
DEL. VAC. ISP					480.1
THROAT AREA					5.57
NOZZLE AREA RATIO					1000.0
NOZZLE EXIT DIAMETER					84.24
ENGINE MIXTURE RATIO					6.00
ETA C*					0.993
CHAMBER COOLANT DP					1640.
CHAMBER COOLANT DT					628.
NOZZLE/CHAMBER Q					17055.
ENGINE STATION CONDITIONS					

* FUEL SYSTEM CONDITIONS *					
STATION	PRESS	TEMP	FLOW	ENTHALPY	DENSITY
B.P. INLET	18.6	37.4	7.45	-107.5	4.37
B.P. EXIT	100.9	38.4	7.45	-103.2	4.39
PUMP INLET	100.9	38.4	7.45	-103.2	4.39
1ST STAGE EXIT	2592.5	72.8	7.45	51.2	4.45
2ND STAGE EXIT	5078.0	105.2	7.45	202.8	4.54
PUMP EXIT	7572.0	135.3	7.45	351.8	4.66
COLD REGEN IN	7496.3	135.9	7.45	351.8	4.63
COLD REGEN EX	7421.4	328.4	7.45	1107.6	2.82
COOLANT INLET	7421.4	328.4	7.45	1107.6	2.82
COOLANT EXIT	5780.9	956.7	7.45	3398.4	0.99
TBV INLET	5723.1	957.1	0.37	3398.4	0.98
TBV EXIT	2534.9	977.9	0.37	3398.4	0.46
O2 TRB INLET	5723.1	957.1	7.07	3398.4	0.98
O2 TRB EXIT	5254.2	939.5	7.07	3327.0	0.92
H2 TRB INLET	5254.2	939.5	7.07	3327.0	0.92
H2 TRB EXIT	2724.4	820.0	7.07	2848.1	0.58
H2 TRB DIFFUSER	2639.3	820.6	7.07	2848.1	0.56
H2 BST TRB IN	2612.9	820.6	7.07	2848.1	0.56
H2 BST TRB OUT	2596.2	819.6	7.07	2843.6	0.55
H2 BST TRB DIFF	2585.7	819.6	7.07	2843.6	0.55
O2 BST TRB IN	2559.8	819.8	7.07	2843.6	0.55
O2 BST TRB OUT	2551.4	819.2	7.07	2841.1	0.55
O2 BST TRB DIFF	2549.6	819.2	7.07	2841.1	0.55
H2 TANK PRESS	18.6	843.1	0.0071	2869.0	0.0062
GOX HEAT EXCH IN	2536.9	827.1	7.44	2869.0	0.54
GOX HEAT EXCH OUT	2524.2	826.8	7.44	2867.6	0.54
HOT REGEN IN	2524.2	826.8	7.44	2867.6	0.54
HOT REGEN EX	2448.5	614.0	7.44	2111.1	0.69
FSOV INLET	2448.5	614.0	7.44	2111.1	0.69
FSOV EXIT	2387.2	614.3	7.44	2111.1	0.67
CHAMBER INJ	2363.4	614.5	7.44	2111.1	0.67
CHAMBER	2198.0				
* OXYGEN SYSTEM CONDITIONS *					
STATION	PRESS	TEMP	FLOW	ENTHALPY	DENSITY
B.P. INLET	16.0	162.7	44.7	61.9	70.99
B.P. EXIT	135.2	165.3	44.7	62.3	70.84
PUMP INLET	135.2	165.3	44.7	62.3	70.84
PUMP EXIT	3559.7	179.9	44.7	73.6	71.73
O2 TANK PRESS	16.0	400.0	0.076	204.7	0.12
OSOV INLET	3524.1	180.0	6.7	73.6	71.67
OSOV EXIT	2466.8	184.2	6.7	73.6	70.07
OCV INLET	3524.1	180.0	37.9	73.6	71.67
OCV EXIT	2466.8	184.2	37.9	73.6	70.07
CHAMBER INJ	2442.2	184.3	44.6	73.6	70.03
CHAMBER	2198.0				
* VALVE DATA *					
VALVE	DELTA P	AREA	FLOW	% BYPASS	
TBV	3186.	0.01	0.37	5.00	
FSOV	61.	1.67	7.44		
OCV	1057.	0.21	44.63		
* INJECTOR DATA *					
INJECTOR	DELTA P	AREA	FLOW		
FUEL	165.	1.06	7.44		
LOX	244.	0.51	44.63		

TABLE 7. — ADVANCED ENGINE PARAMETRIC STUDY, FULL-EXPANDER ENGINE WITH A HYDROGEN REGENERATOR (Continued)

***** * TURBOMACHINERY PERFORMANCE DATA * *****	
***** * H ₂ BOOST TURBINE * *****	***** * H ₂ BOOST PUMP * *****
EFFICIENCY (T/T) 0.874	EFFICIENCY 0.804
EFFICIENCY (T/S) 0.476	HORSEPOWER 46.
SPEED (RPM) 41567.	SPEED (RPM) 41567.
MEAN DIA. (IN) 1.44	S SPEED 5045.
EFF AREA (IN ²) 3.35	HEAD (FT) 2701.
W/C (ACTUAL) 0.545	DIA. (IN) 2.43
MAX TIP SPEED 367.	TIP SPEED 439.
STAGES 1	VOL. FLOW 741.
GAMMA 1.41	HEAD COEF 0.450
PRESS RATIO (T/T) 1.01	FLOW COEF 0.201
PRESS RATIO (T/S) 1.01	
HORSEPOWER 46.	
EXIT MACH NUMBER 0.08	
SPECIFIC SPEED 150.00	
SPECIFIC DIAMETER 0.54	
***** * H ₂ TURBINE * *****	***** * H ₂ PUMP * *****
EFFICIENCY (T/T) 0.866	EFFICIENCY 0.673
EFFICIENCY (T/S) 0.818	HORSEPOWER 1425.
SPEED (RPM) 125000.	SPEED (RPM) 125000.
HORSEPOWER 4792.	SS SPEED 11286.
MEAN DIA. (IN) 2.80	S SPEED 714.
EFF AREA (IN ²) 0.29	HEAD (FT) 88814.
W/C (ACTUAL) 0.442	DIA. (IN) 3.99
MAX TIP SPEED 1632.	TIP SPEED 2177.
STAGES 2	VOL. FLOW 758.
GAMMA 1.41	HEAD COEF 0.548
PRESS RATIO (T/T) 1.93	FLOW COEF 0.891
PRESS RATIO (T/S) 2.01	DIAMETER RATIO 0.314
EXIT MACH NUMBER 0.16	BEARING DN 3.00E+06
SPECIFIC SPEED 38.32	SHAFT DIAMETER 26.00
SPECIFIC DIAMETER 1.64	
***** * O ₂ BOOST TURBINE * *****	***** * O ₂ BOOST PUMP * *****
EFFICIENCY (T/T) 0.920	EFFICIENCY 0.803
EFFICIENCY (T/S) 0.719	HORSEPOWER 25.
SPEED (RPM) 11044.	SPEED (RPM) 11044.
MEAN DIA. (IN) 4.11	S SPEED 1026.
EFF AREA (IN ²) 4.76	HEAD (FT) 262.
W/C (ACTUAL) 0.565	DIA. (IN) 2.73
MAX TIP SPEED 235.	TIP SPEED 132.
STAGES 1	VOL. FLOW 283.
GAMMA 1.41	HEAD COEF 0.450
PRESS RATIO (T/T) 1.00	FLOW COEF 0.200
PRESS RATIO (T/S) 1.00	
HORSEPOWER 25.	
EXIT MACH NUMBER 0.03	
SPECIFIC SPEED 103.84	
SPECIFIC DIAMETER 0.84	
***** * O ₂ TURBINE * *****	***** * O ₂ PUMP * *****
EFFICIENCY (T/T) 0.898	EFFICIENCY 0.781
EFFICIENCY (T/S) 0.804	HORSEPOWER 715.
SPEED (RPM) 73981.	SPEED (RPM) 73981.
HORSEPOWER 715.	SS SPEED 24581.
MEAN DIA. (IN) 2.80	S SPEED 1640.
EFF AREA (IN ²) 0.48	HEAD (FT) 6872.
W/C (ACTUAL) 0.478	DIA. (IN) 2.19
MAX TIP SPEED 970.	TIP SPEED 708.
STAGES 1	VOL. FLOW 280.
GAMMA 1.41	HEAD COEF 0.442
PRESS RATIO (T/T) 1.09	FLOW COEF 0.146
PRESS RATIO (T/S) 1.10	DIAMETER RATIO 0.677
EXIT MACH NUMBER 0.08	BEARING DN 1.48E+06
SPECIFIC SPEED 45.20	SHAFT DIAMETER 20.00
SPECIFIC DIAMETER 1.56	
***** REGENERATOR DATA *****	
	COLD SIDE HOT SIDE
DELTA	74.96 25.75
DELTA	192.55 -212.81
AREA	0.40 1.72
FLOW	7.45 7.44
EFFECTIVENESS	0.31
NTU	0.45
CRATIO	0.90
DNIN	26.44
REGEN Q	5627.46

ENGINE-VEHICLE INTERFACES

The identified engine-vehicle interfaces are listed in Table 8. Redundant electrical and data connections are suggested for reliability. Each instrumentation cable will carry multiple channels. The number of channels will be determined based on the architecture of the engine-vehicle control interface.

TABLE 8. — ENGINE-VEHICLE INTERFACES

<i>Description</i>	<i>No. of Interfaces</i>
Gimbal Bearing	1
Gimbal Actuator	2
Engine Oxidizer Inlet, Liquid Oxygen	1
Engine Fuel Inlet, Liquid Hydrogen	1
Fuel Tank Pressurant, Gaseous Hydrogen	1
Oxidizer Tank Pressurant, Gaseous Oxygen	1
Electrical Power	2 ⁽¹⁾
Pneumatic	TBD (0 or 1)
Data	2 ⁽¹⁾
Notes:	
⁽¹⁾ Required for redundancy	

The gimbal mount is the primary engine attachment to the vehicle and provides the capability to gimbal the engine through two gimbal actuator attachment points located 90 degrees apart on the engine. The engine is configured with an extendable nozzle to reduce engine storage length. The engine envelope and mechanical interfaces are depicted in Figure 32. The engine lengths (x) and diameter (y) correspond to the dimensions given in Appendix A. The stored length (x') is one-half the total engine length plus 6 to 10 inches depending on engine thrust and undefined vehicle interface requirements.

REFERENCES

1. Smith, T.A.; Pavli, A.J.; and Kacynski, K.J.: "A Comparison of Theoretical and Experimental Thrust Performance of a 1030:1 Area Ratio Rocket Nozzle at a Chamber Pressure of 350 psia." NASA TP-2725, 1987.
2. Smith, T.A.: "Boundary Layer Development as a Function of Chamber Pressure in the NASA Lewis 1030:1 Area Ratio Rocket Nozzle." NASA TM-100917, 1988, AIAA-88-3301.

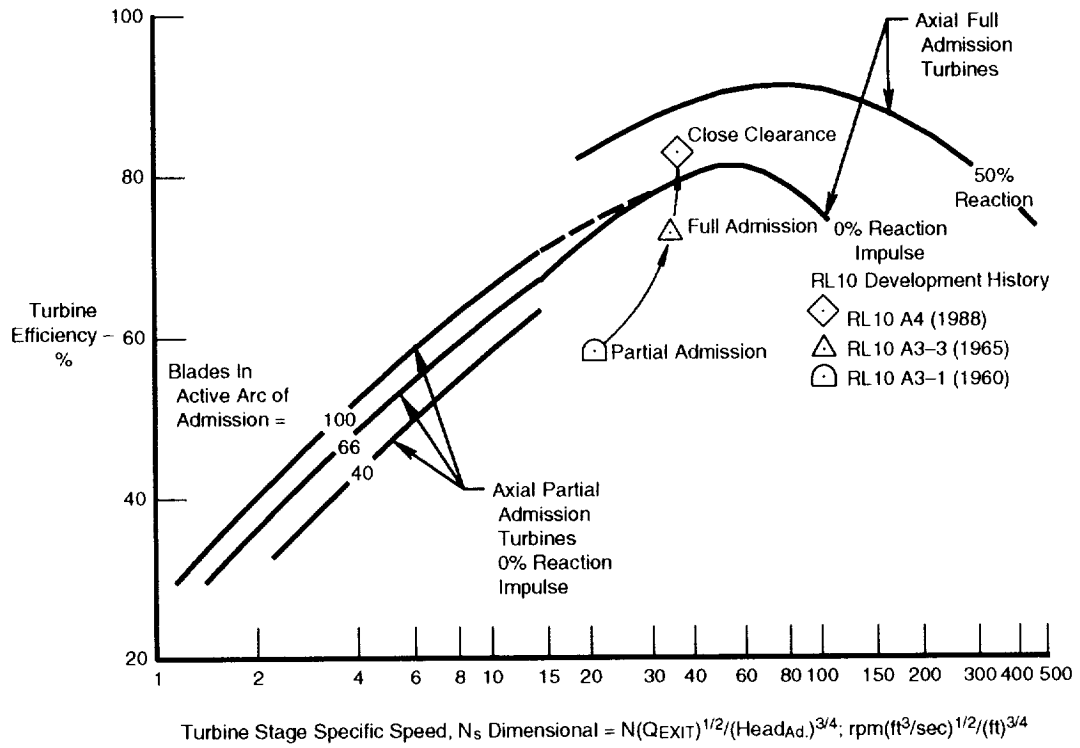

Figure 3. Turbine Efficiency Comparison

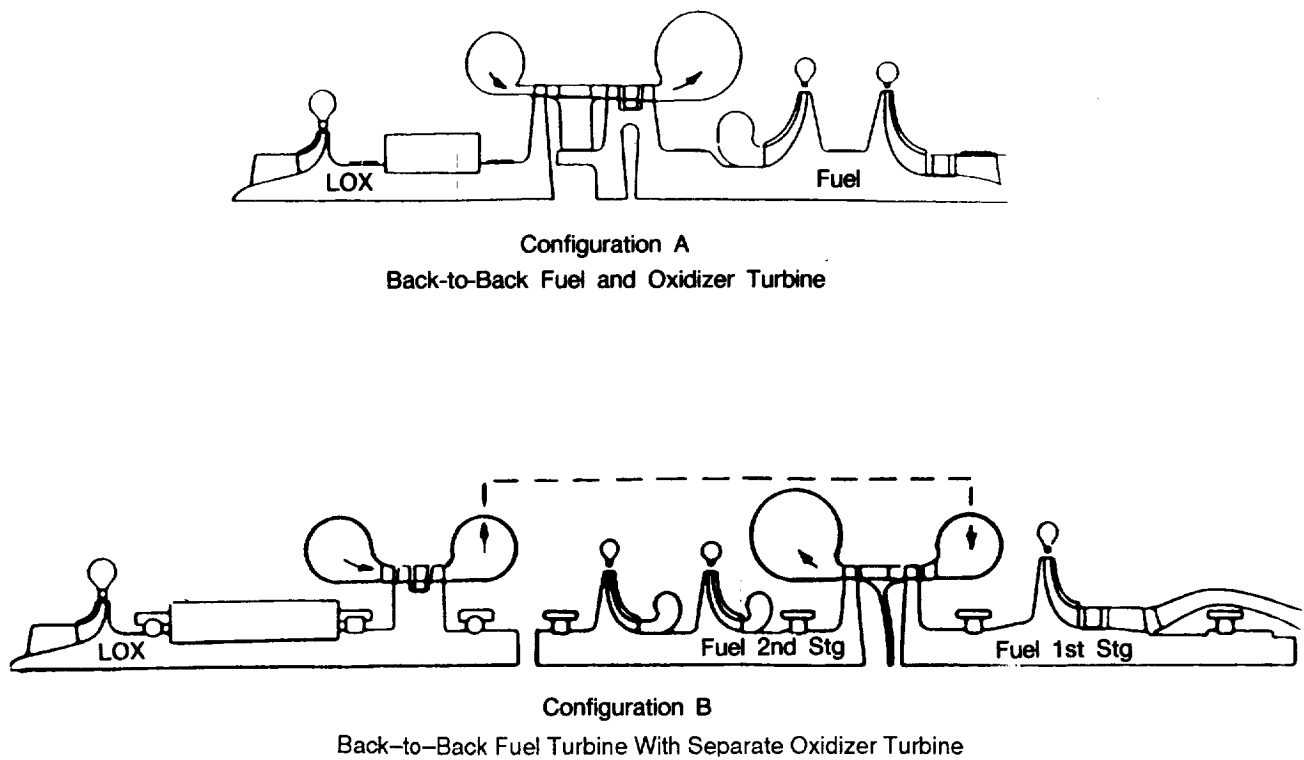

Figure 4. Back-to-Back Turbine Configurations

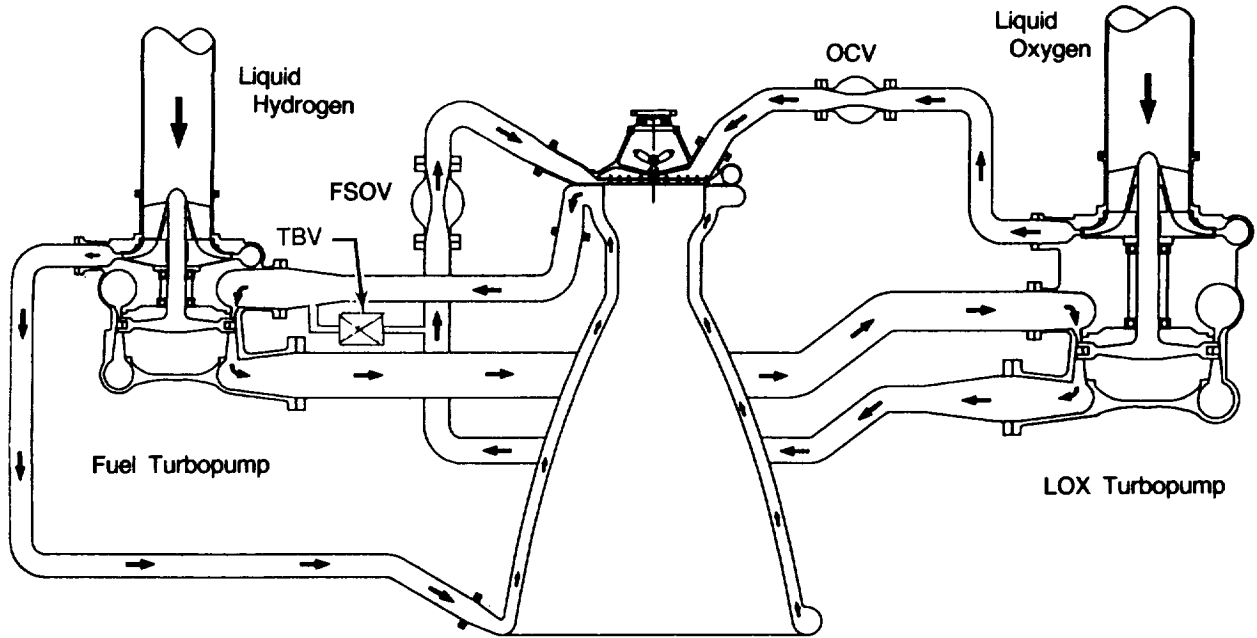

Figure 5. Full-Expander Cycle

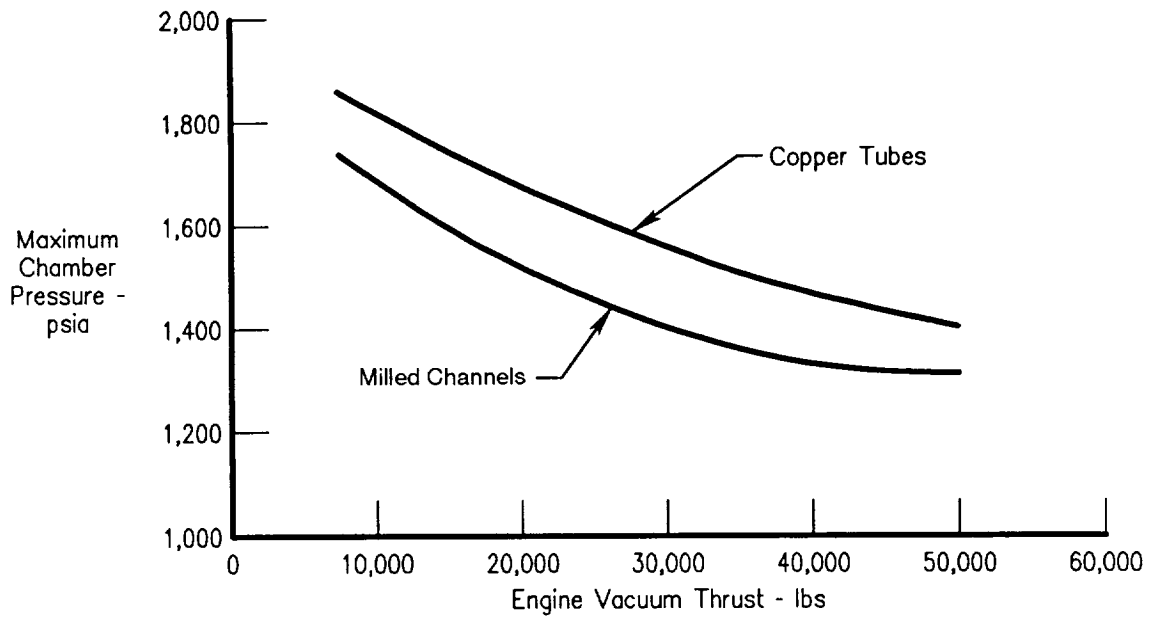

Figure 6. Full-Expander Cycle Achievable Chamber Pressure

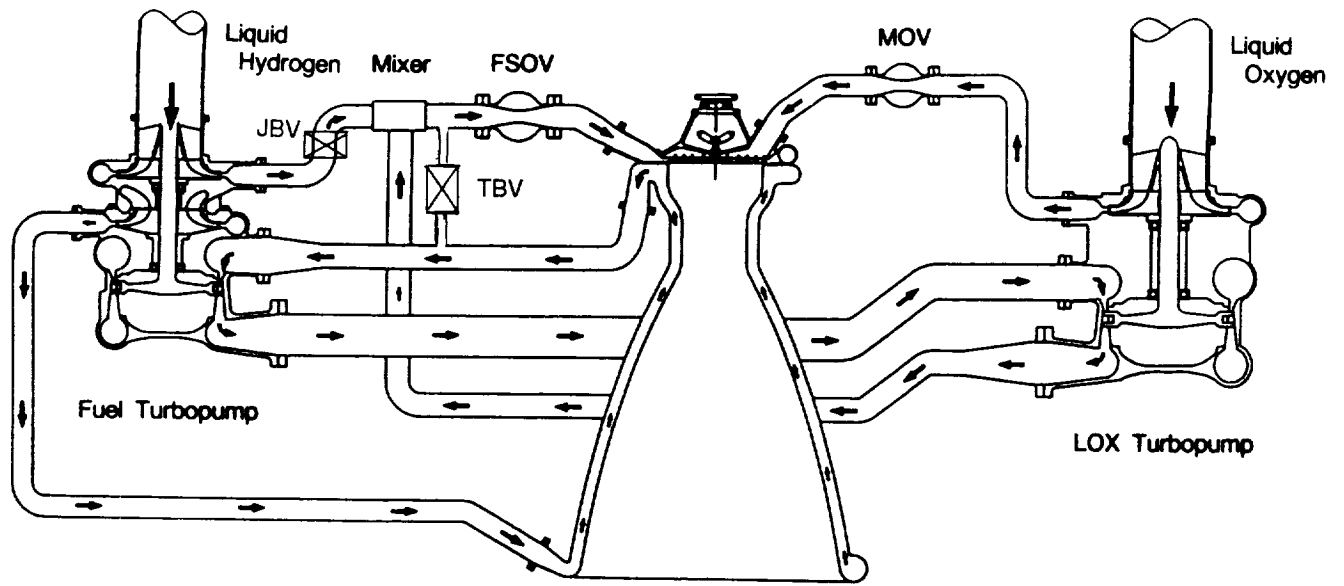

Figure 7. Split-Expander Cycle

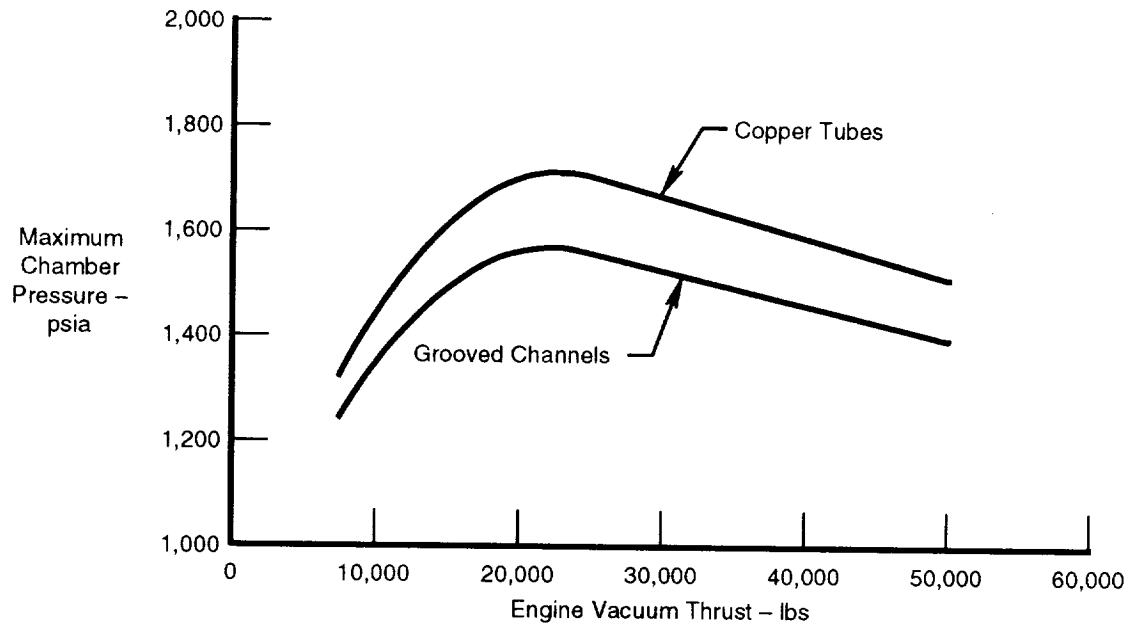

Figure 8. Split-Expander Cycle Achievable Chamber Pressure

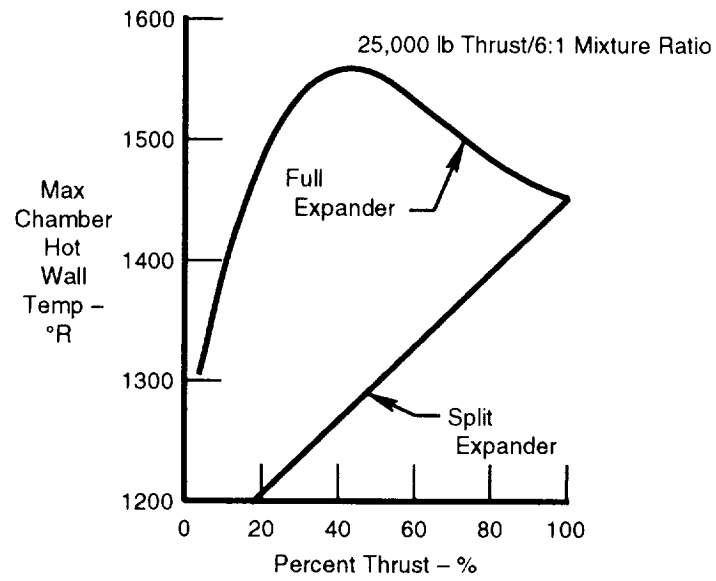

Figure 9. Thrust Chamber Wall Temperatures During Throttling

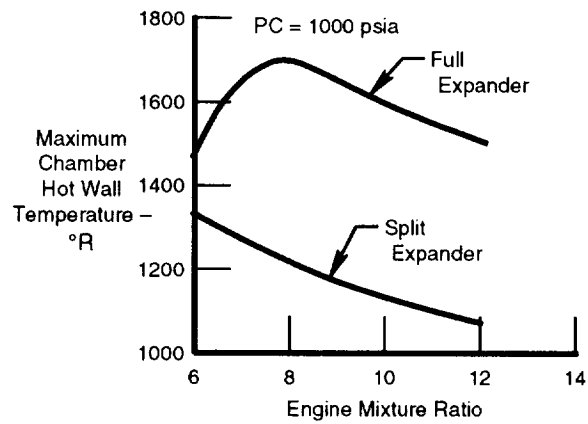

Figure 10. Thrust Chamber Wall Temperature as a Function of High Mixture Ratio

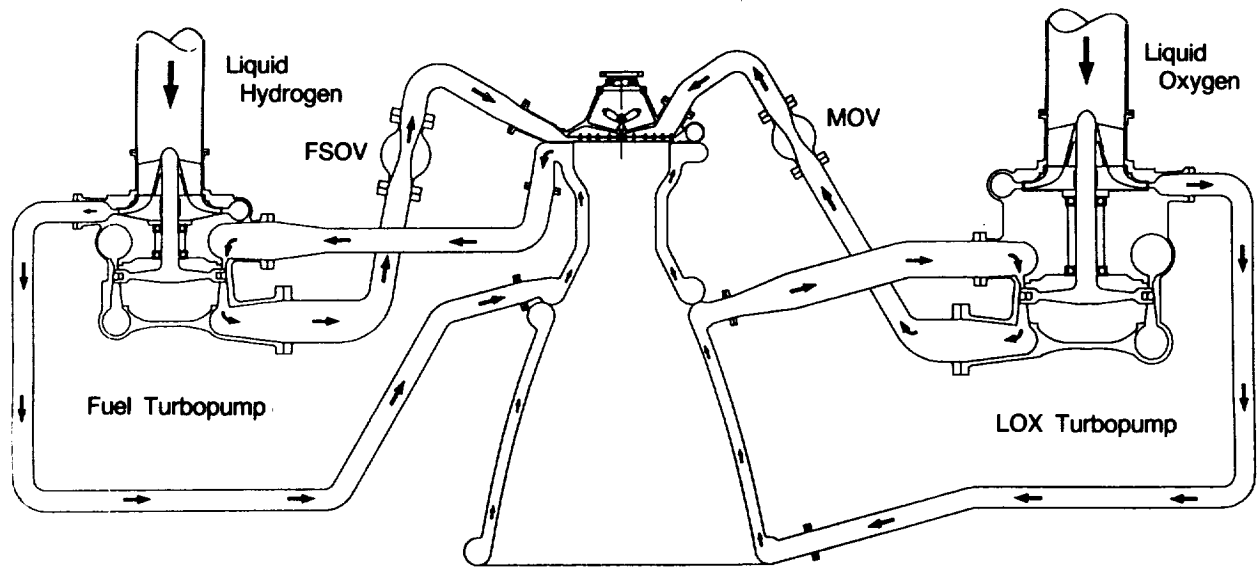

Figure 11. Dual-Expander Cycle

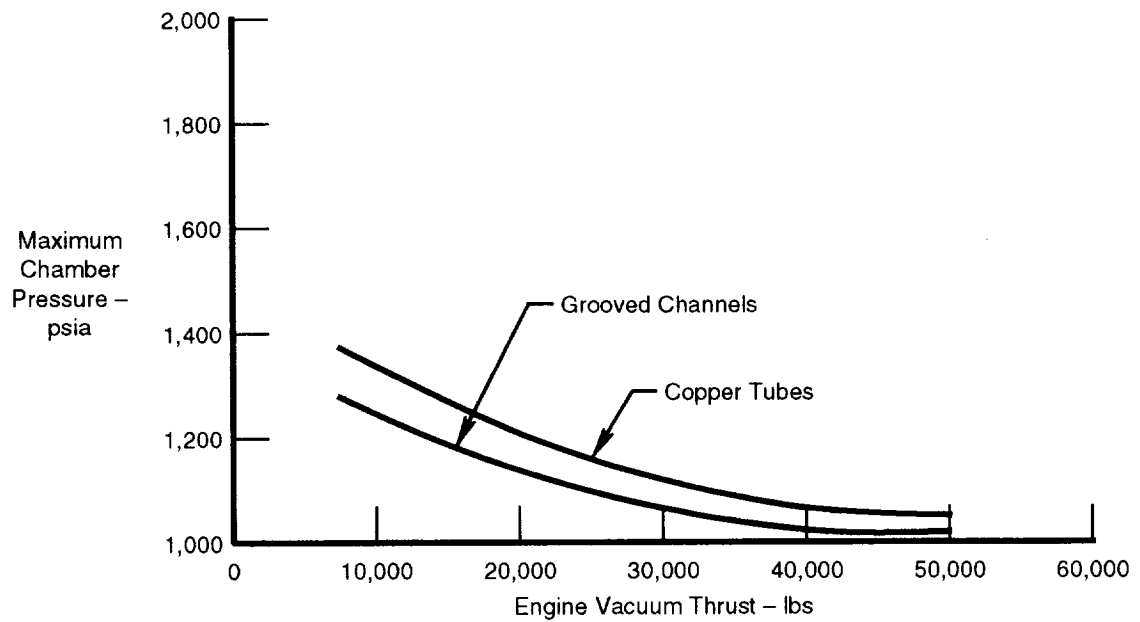

Figure 12. Dual-Expander Cycle Achievable Chamber Pressure

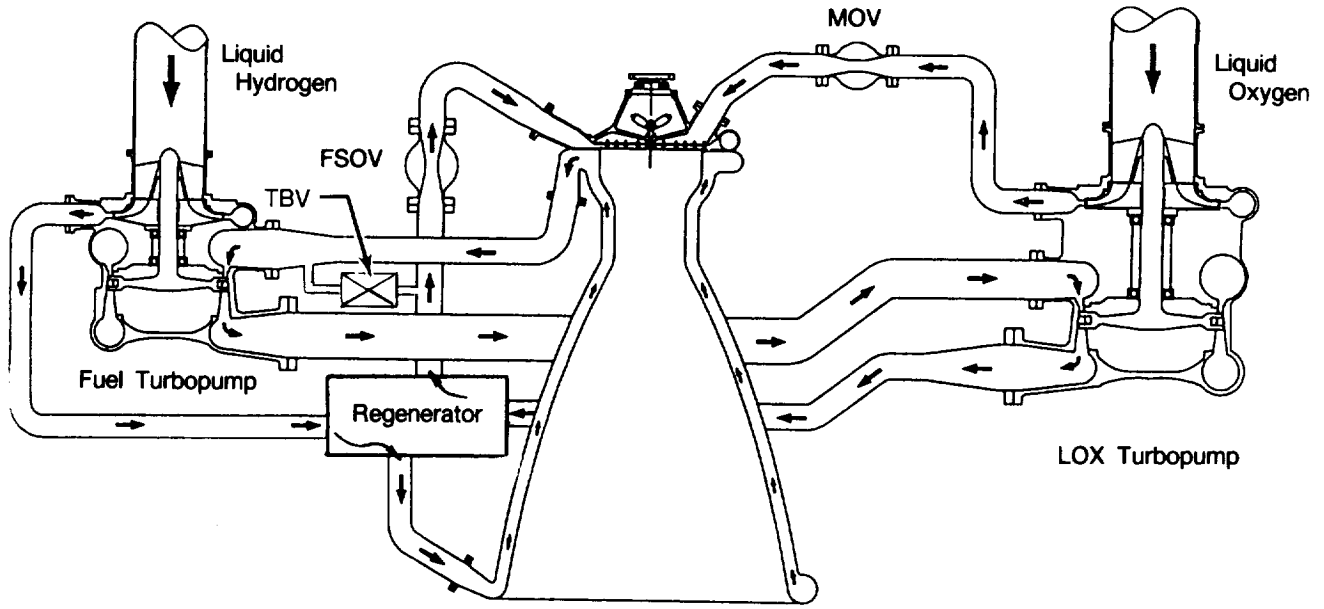

Figure 13. Full-Expander Cycle With Regeneration

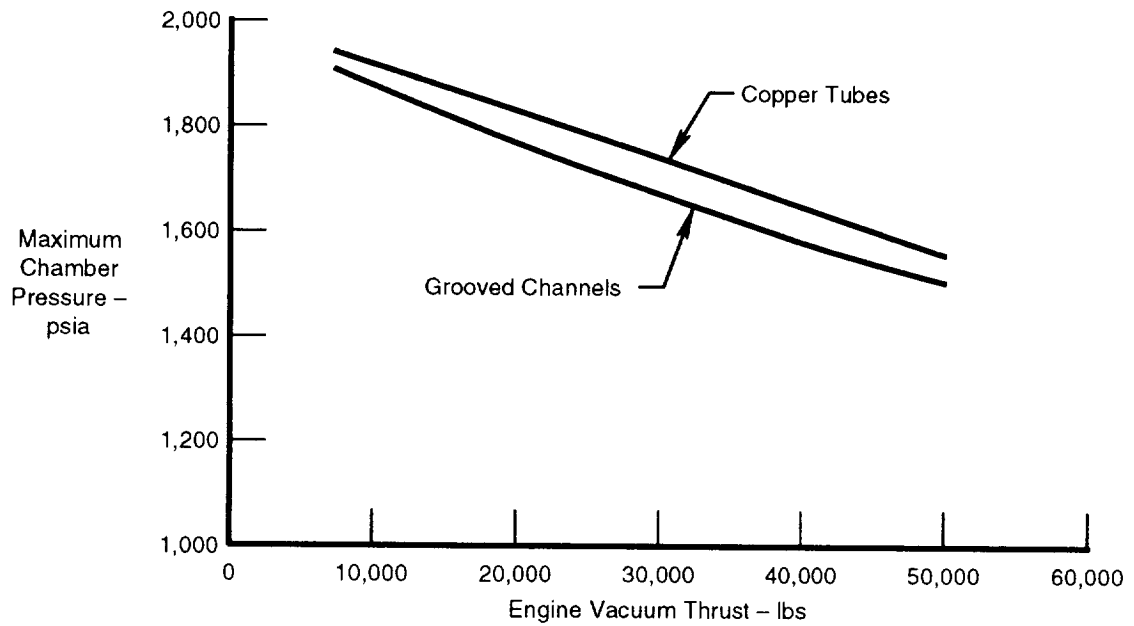

Figure 14. Full-Expander Cycle With Regeneration Achievable Chamber Pressure

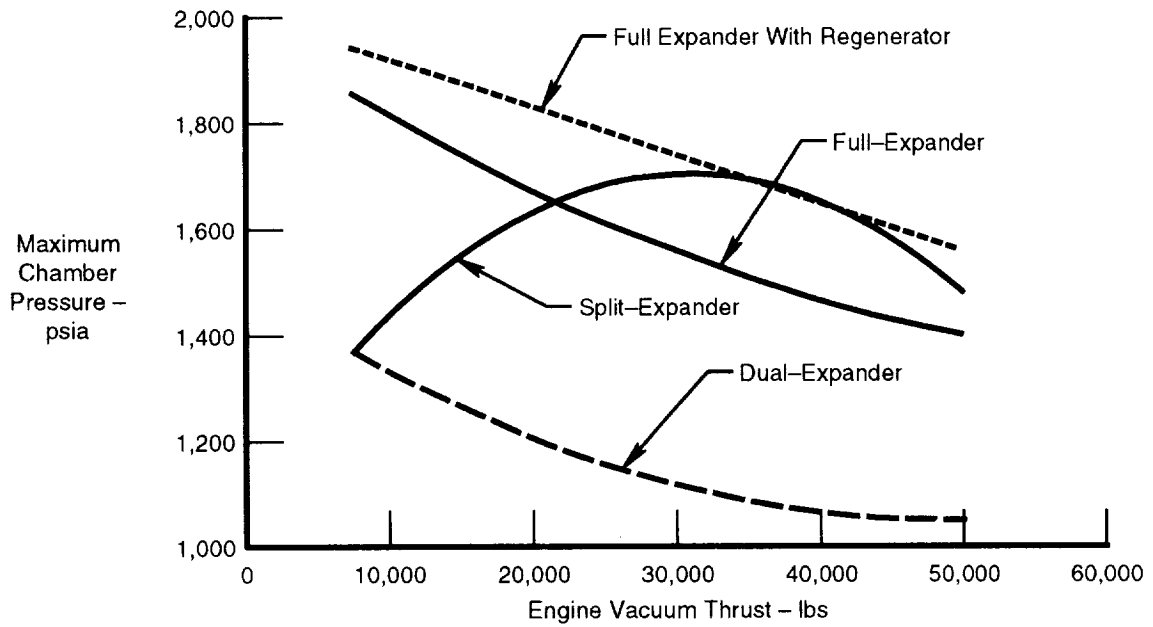

Figure 15. Full, Split, Dual, and Regenerator Cycle Comparison With Tubular Thrust Chambers

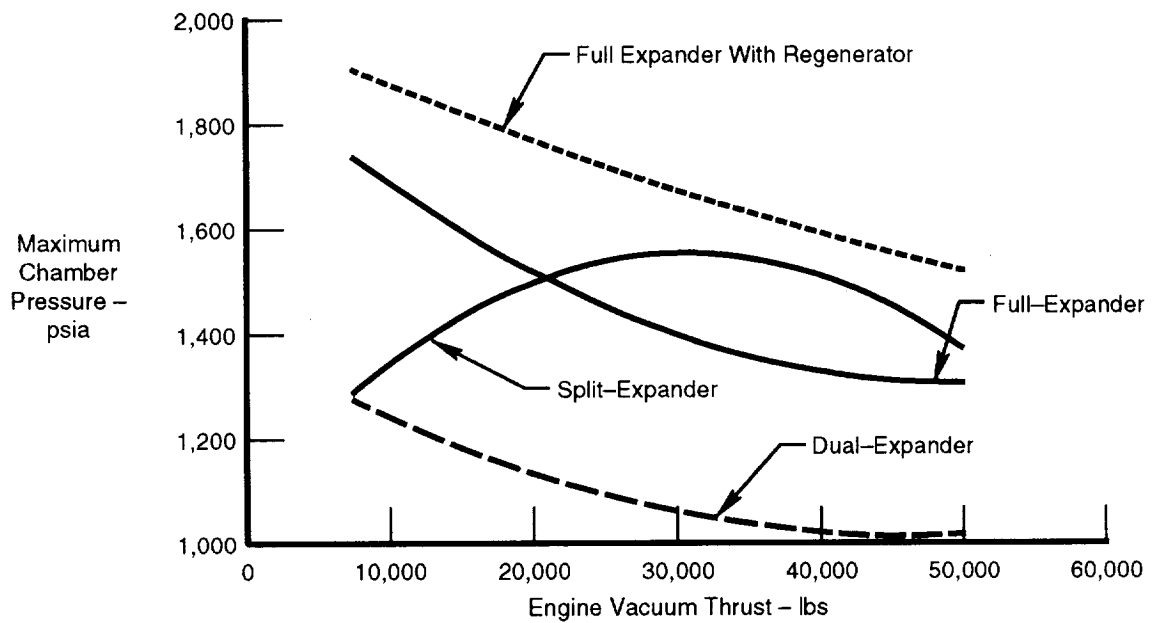

Figure 16. Full, Split, Dual, and Regenerator Cycle Comparison With Milled Channel Thrust Chambers

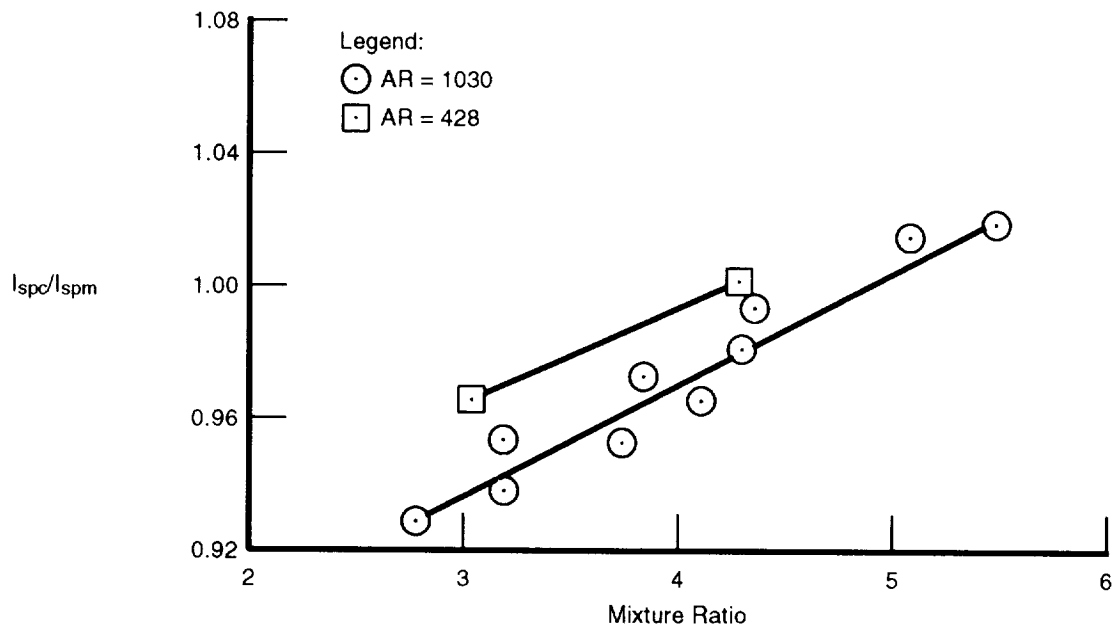

Figure 17. Comparison of Predicted Performance (I_{spc}) With Measured Performance (I_{spm}) for the NASA Lewis High Area Ratio Nozzle (Data From Ref 1)

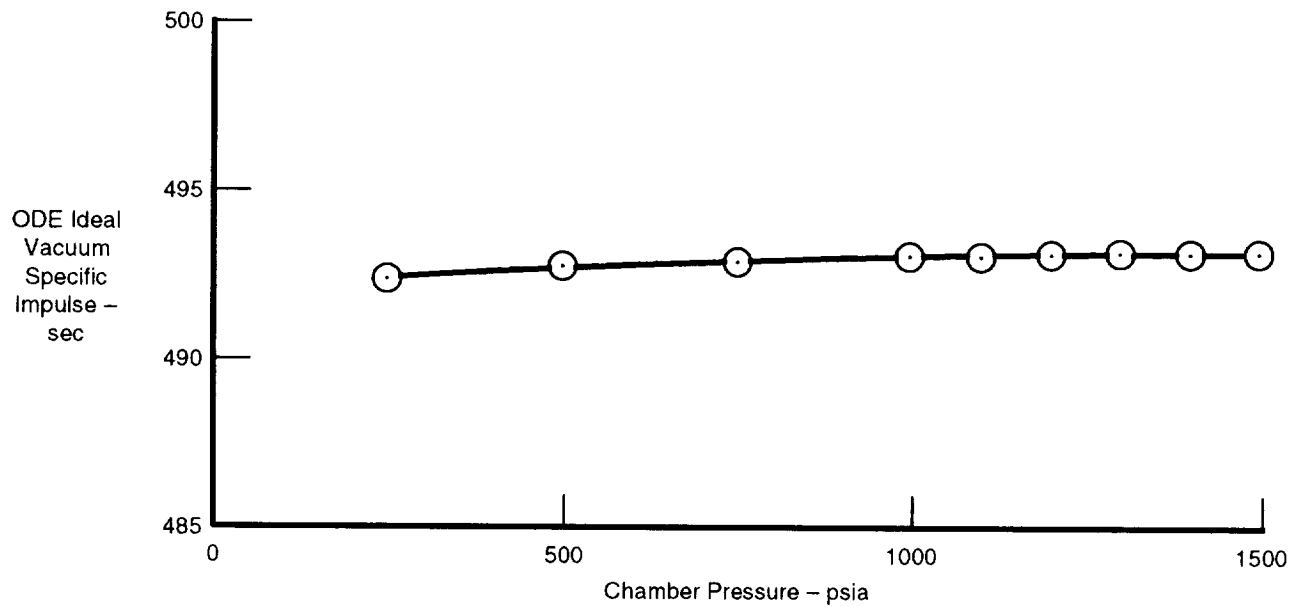

Figure 18. Pratt & Whitney — Rocket Performance Ideal Impulse Versus P_c for $AR = 1000:1$, $O/F = 6$

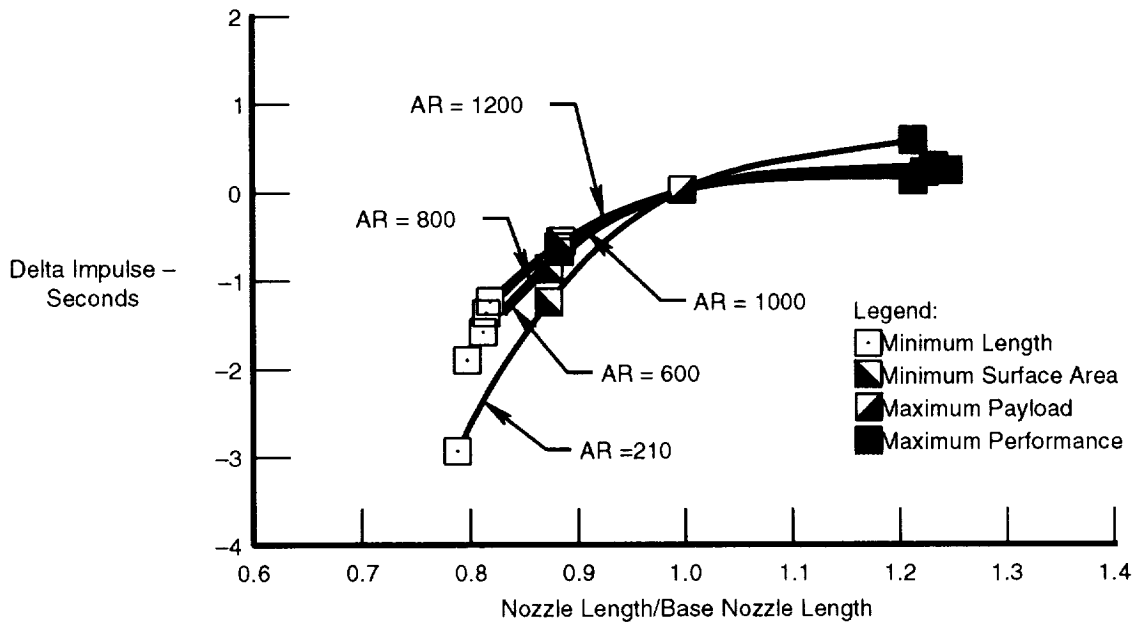

Figure 19. Bell Nozzle Truncation Performance — Length Sensitivity Based on a Maximum Payload Truncation; $P_c = 1500$, H_2-O_2 , $O/F = 6.0$

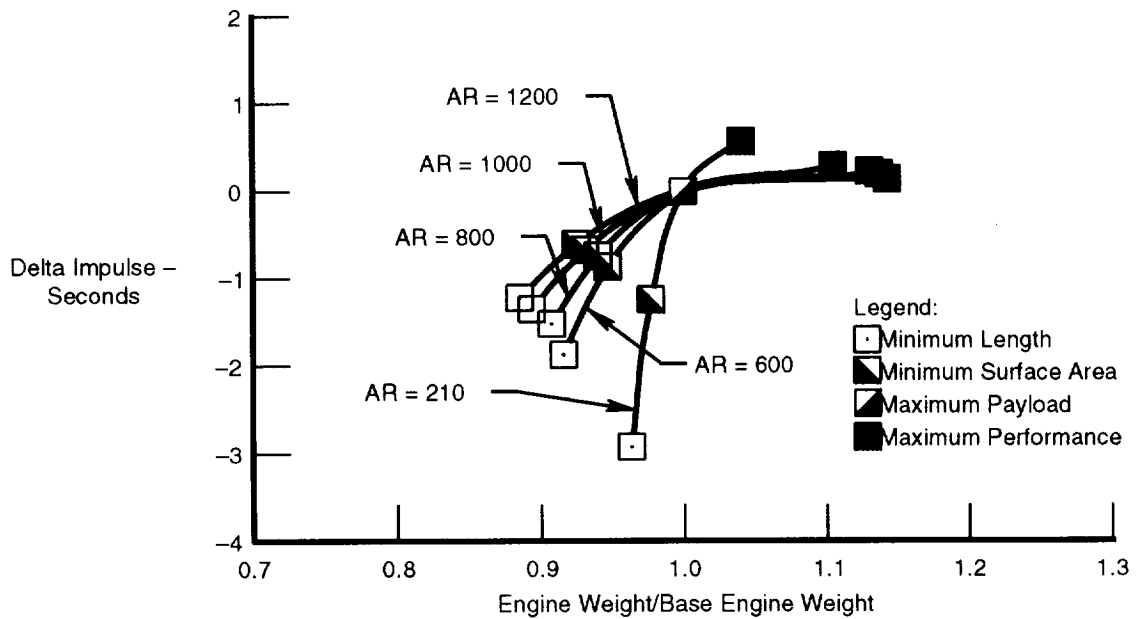

Figure 20. Bell Nozzle Truncation Performance — Weight Sensitivity Based on a Maximum Payload Truncation; $P_c = 1500$, H_2-O_2 , $O/F = 6.0$

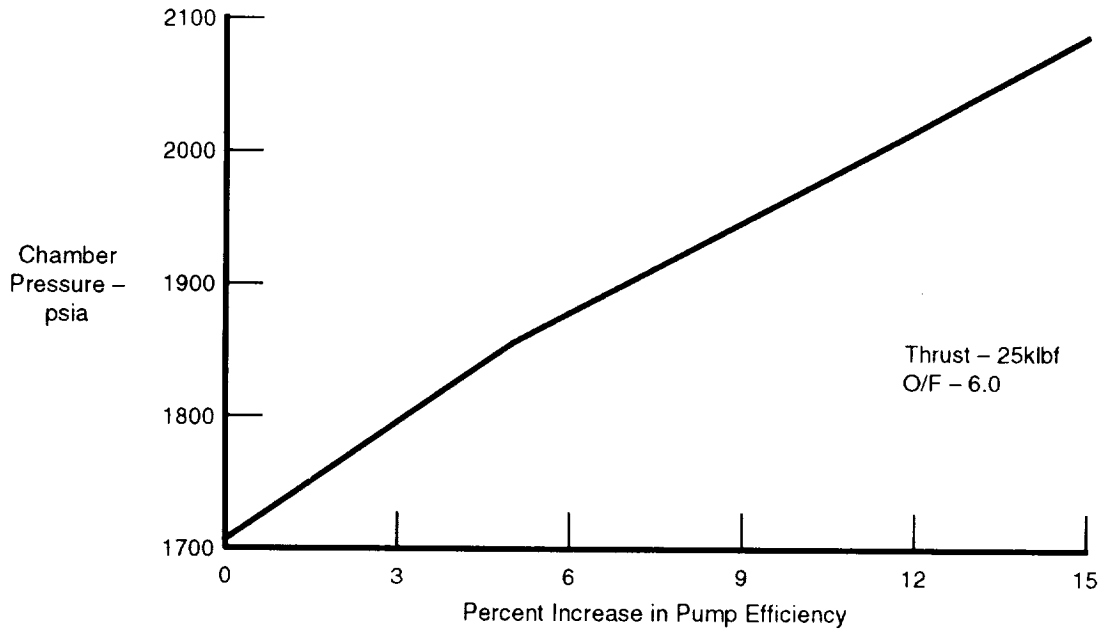

Figure 21. Advanced Split-Expander Cycle P_c Improvement With Increased Pump Efficiency

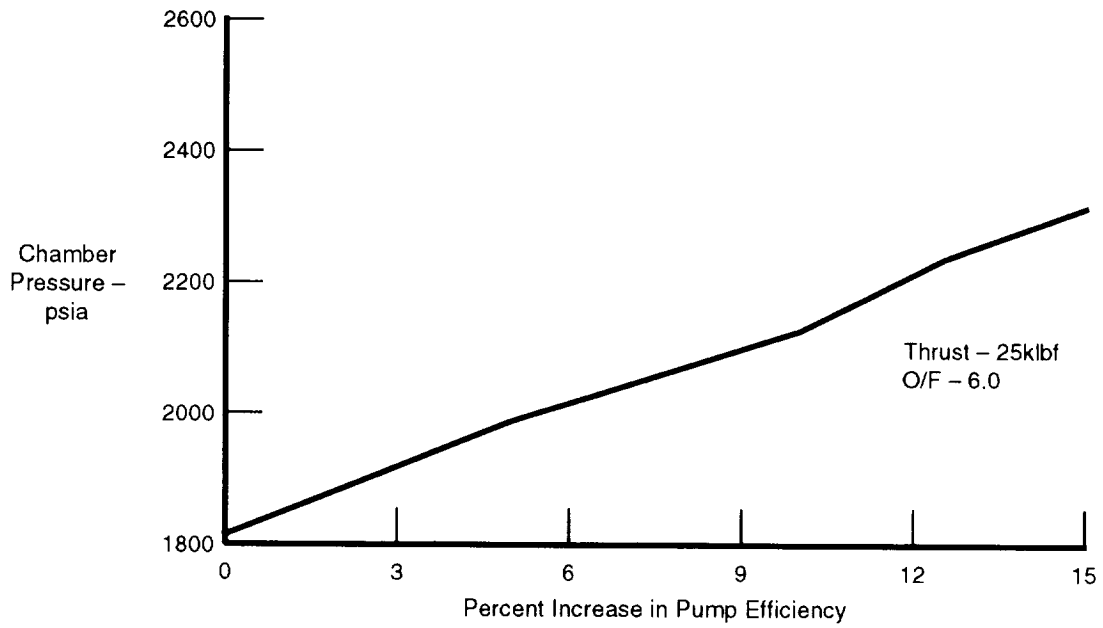

Figure 22. Advanced Full Expander With Regenerator Cycle P_c Improvement With Increased Pump Efficiency

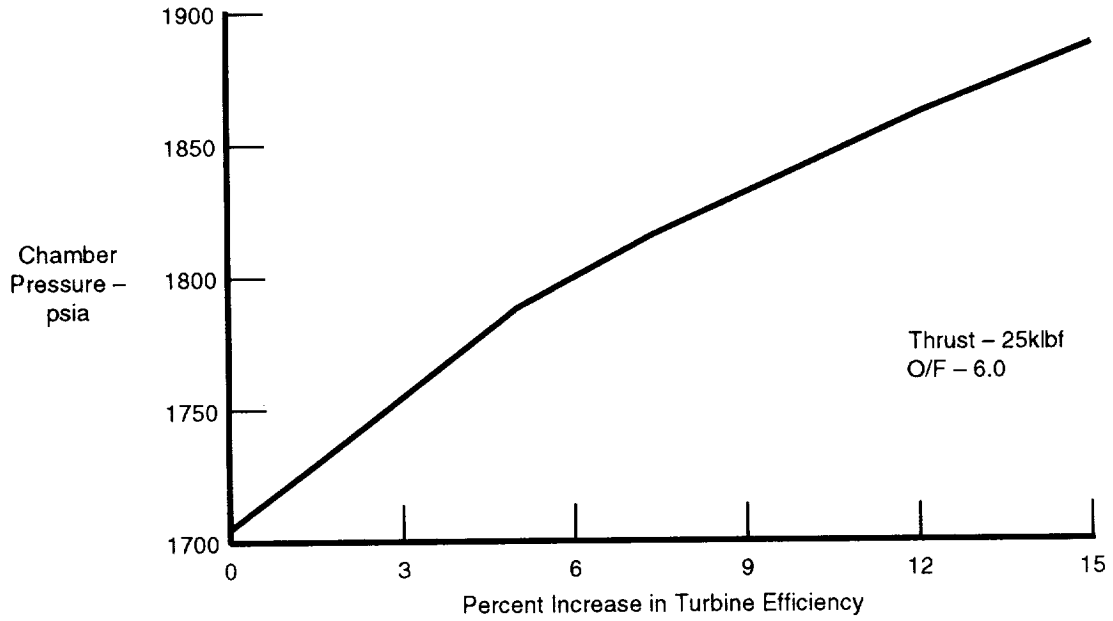

Figure 23. Advanced Split-Expander Cycle P_c Improvement With Increased Turbine Efficiency

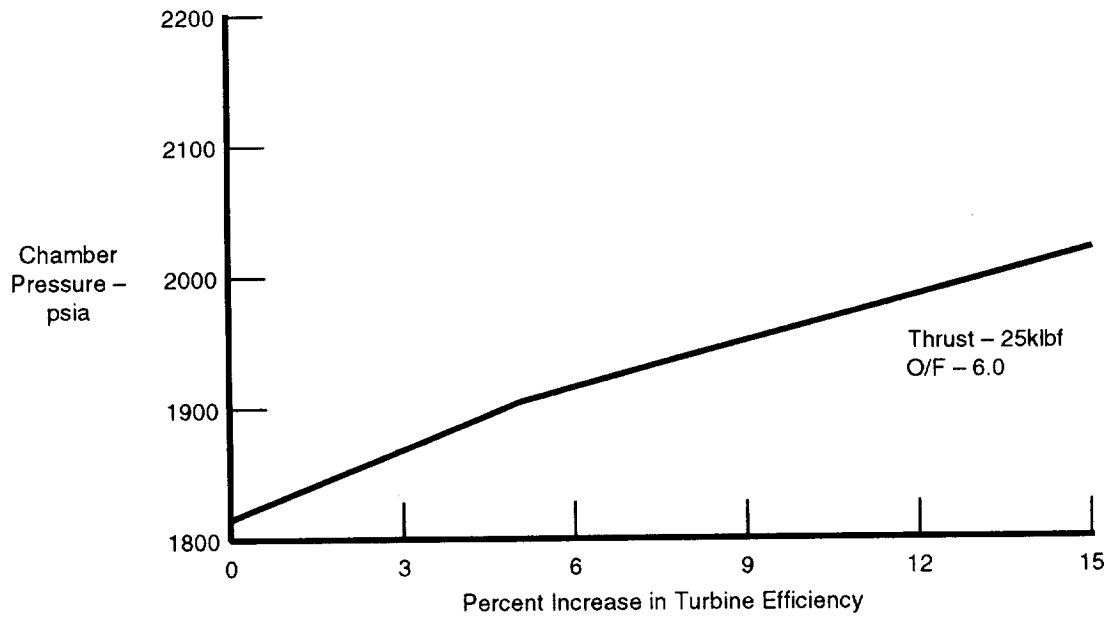

Figure 24. Advanced Full Expander With Regenerator Cycle P_c Improvement With Increased Turbine Efficiency

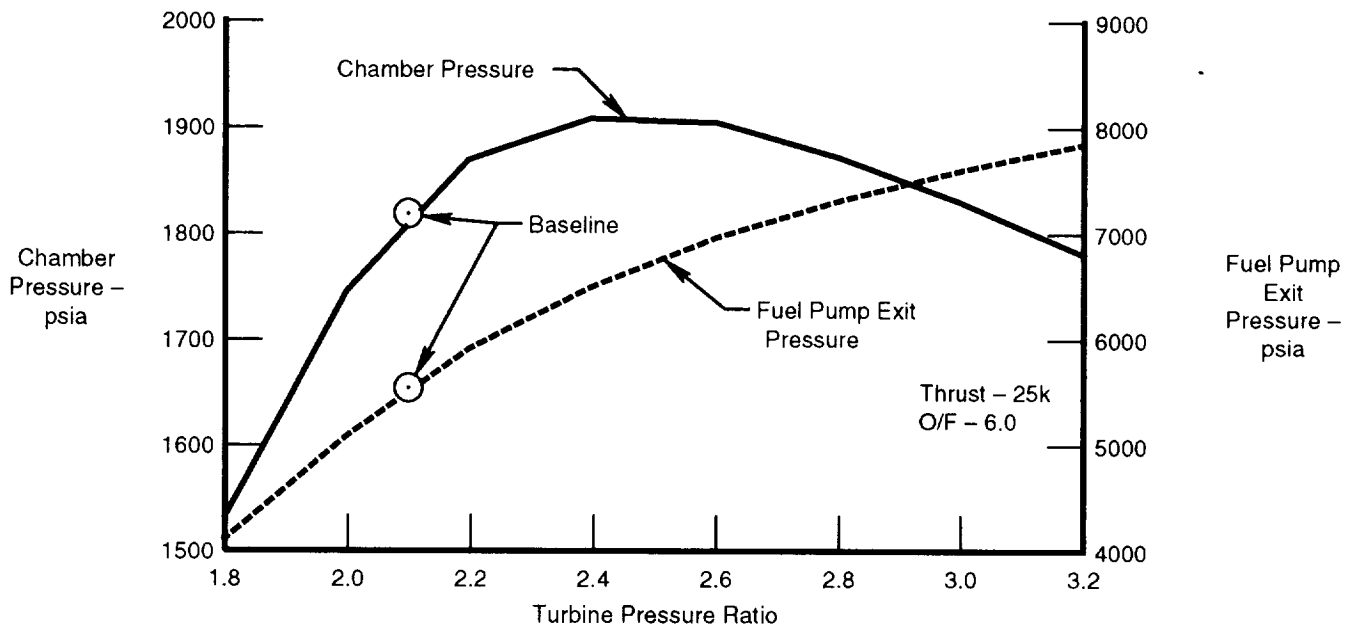

Figure 25a. Advanced Full Expander With Regenerator Cycle P_c Improvement With Increased Turbine Pressure Ratio

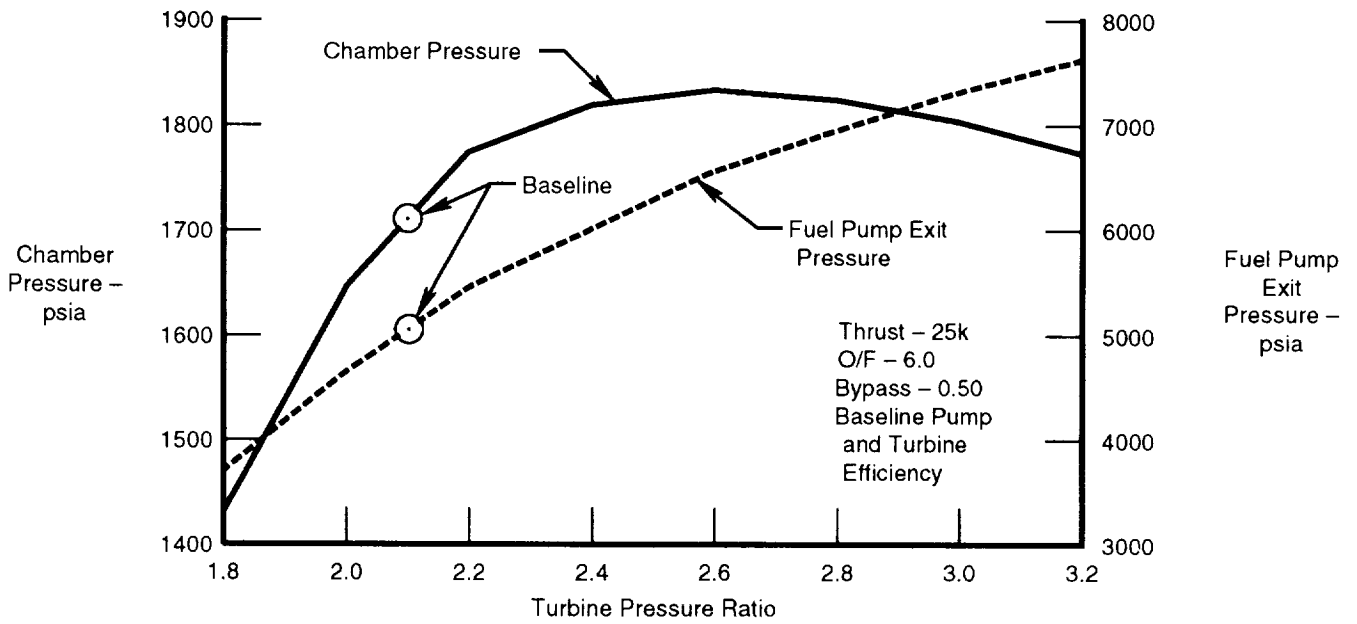

Figure 25b. Advanced Split-Expander With Regenerator Cycle P_c Improvement With Increased Turbine Pressure Ratio

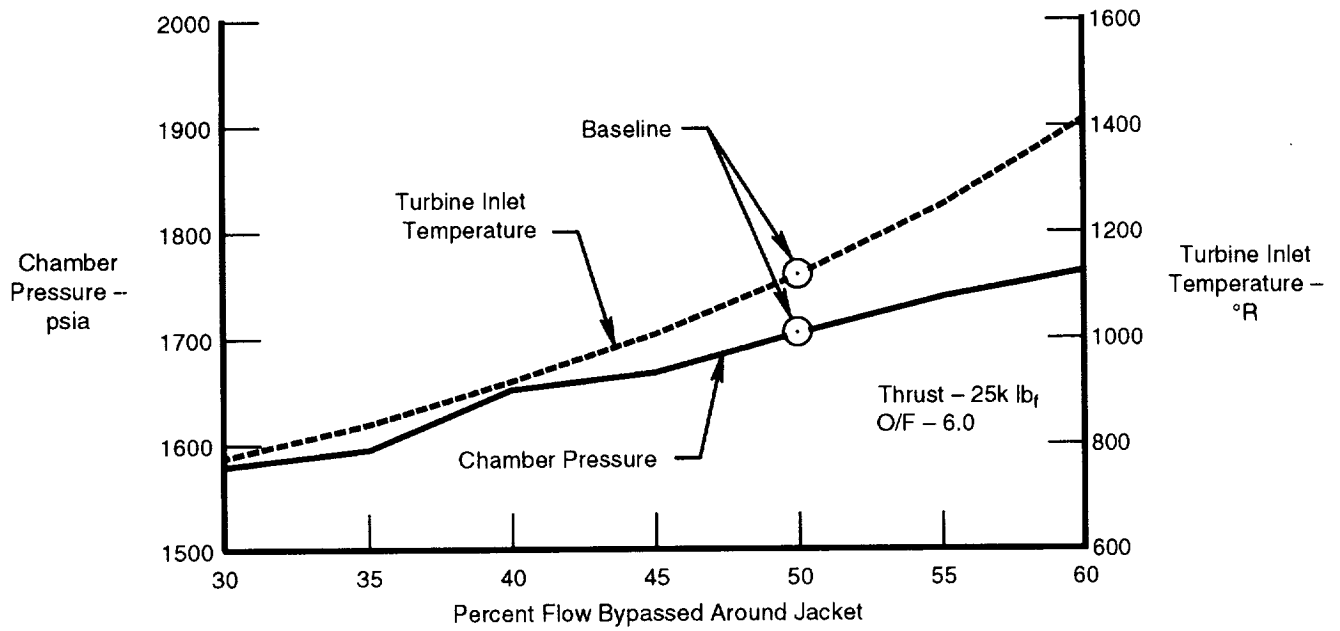

Figure 26. Advanced Split-Expander Cycle P_c Improvement With Increased Bypass Flow Around Jacket

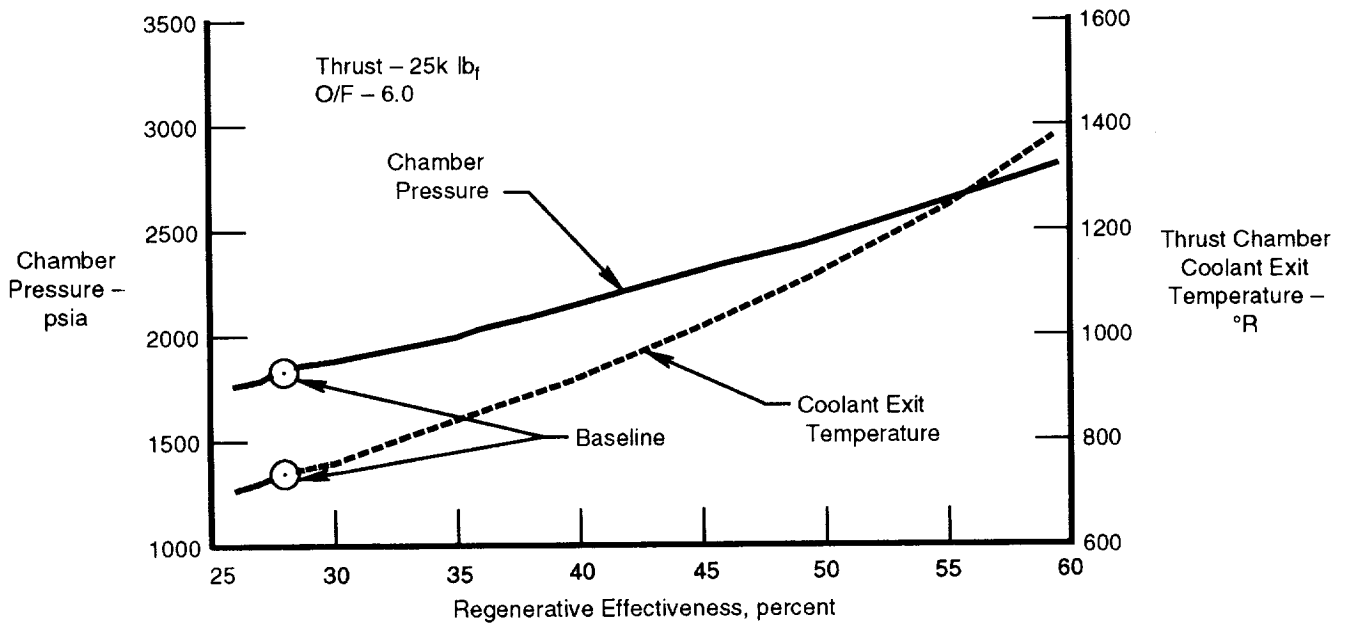

Figure 27. Advanced Full Expander With Regenerator Cycle P_c Improvement With Increased Regenerator Effectiveness

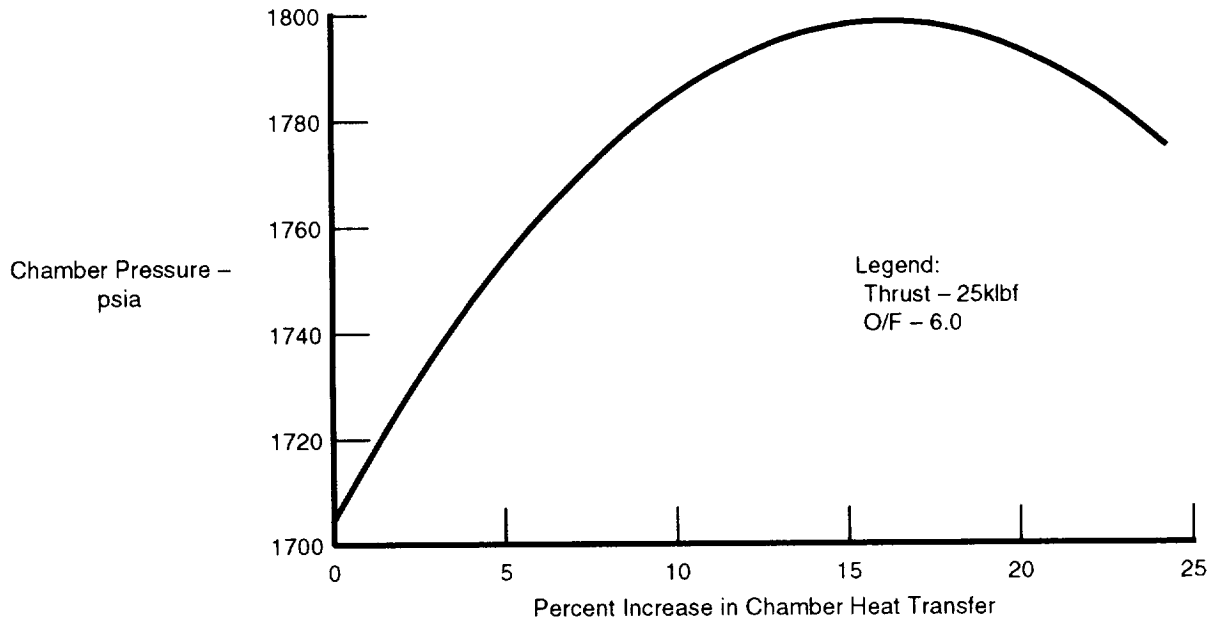

Figure 28. Advanced Split-Expander Cycle P_c Improvement Due to Increased Chamber Heat Transfer

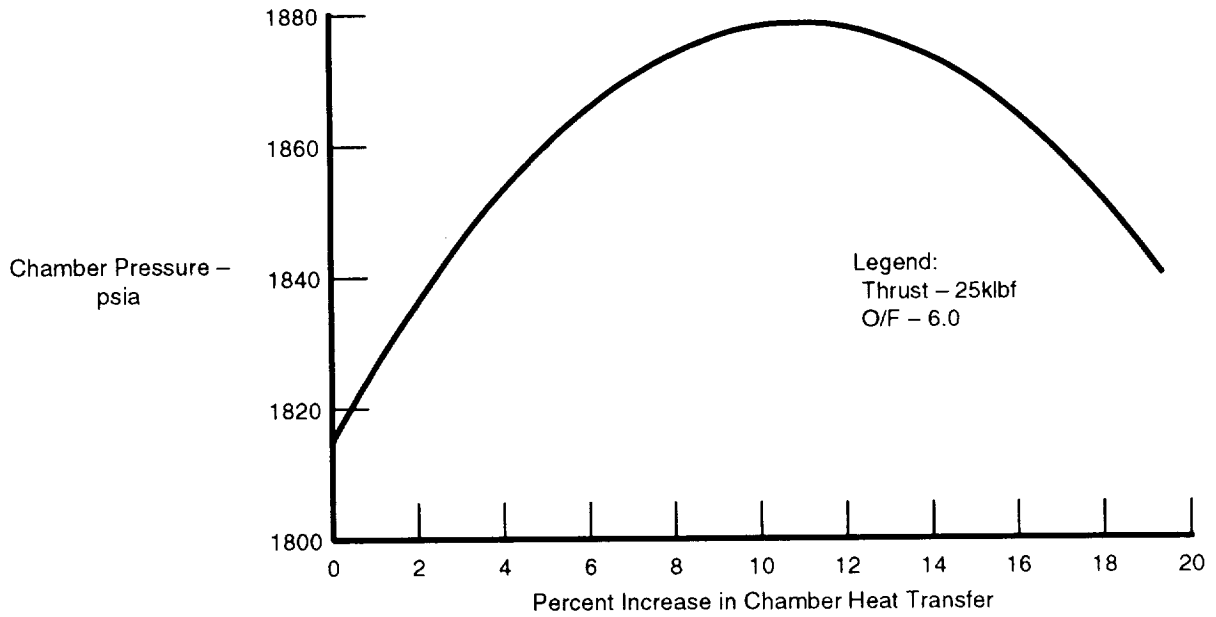

Figure 29. Advanced Full Expander With Regenerator Cycle P_c Improvement Due to Increased Chamber Heat Transfer

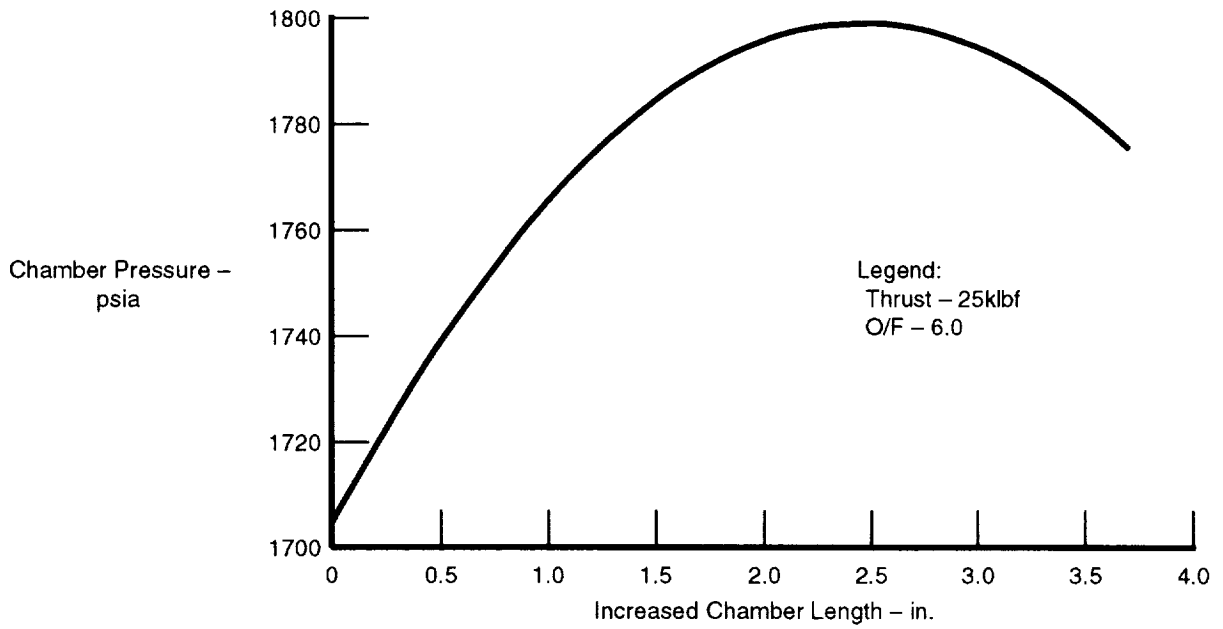

Figure 30. Advanced Split-Expander Cycle P_c Improvement Due to Increased Chamber Length

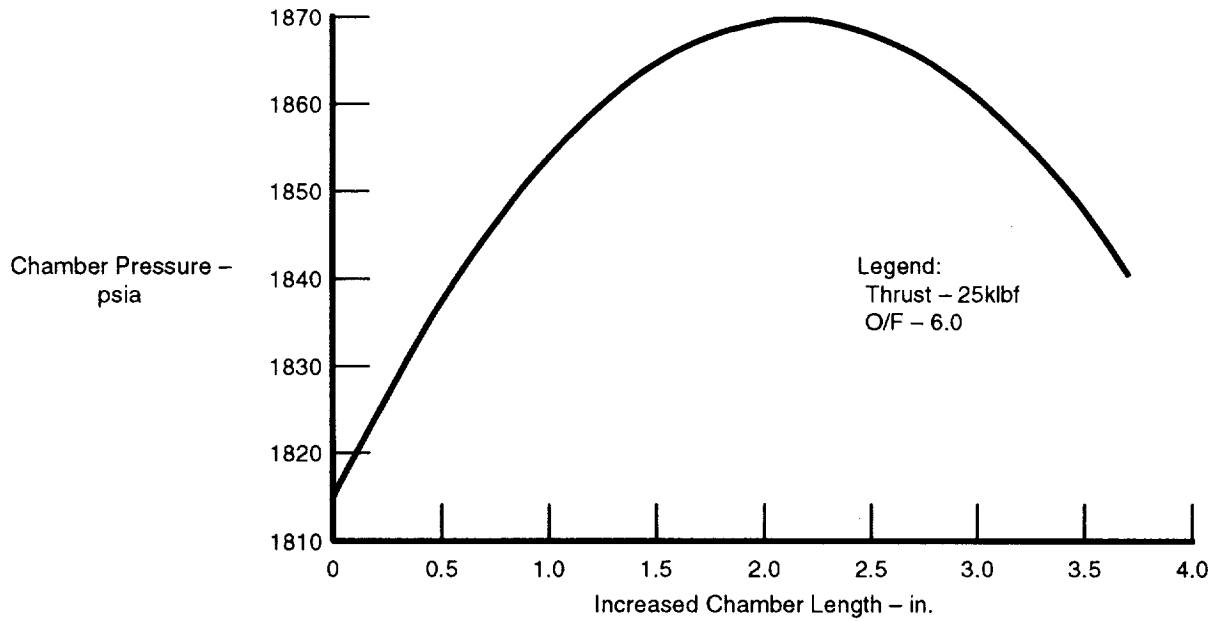

Figure 31. Advanced Full Expander With Regenerator Cycle P_c Improvement Due to Increased Chamber Length

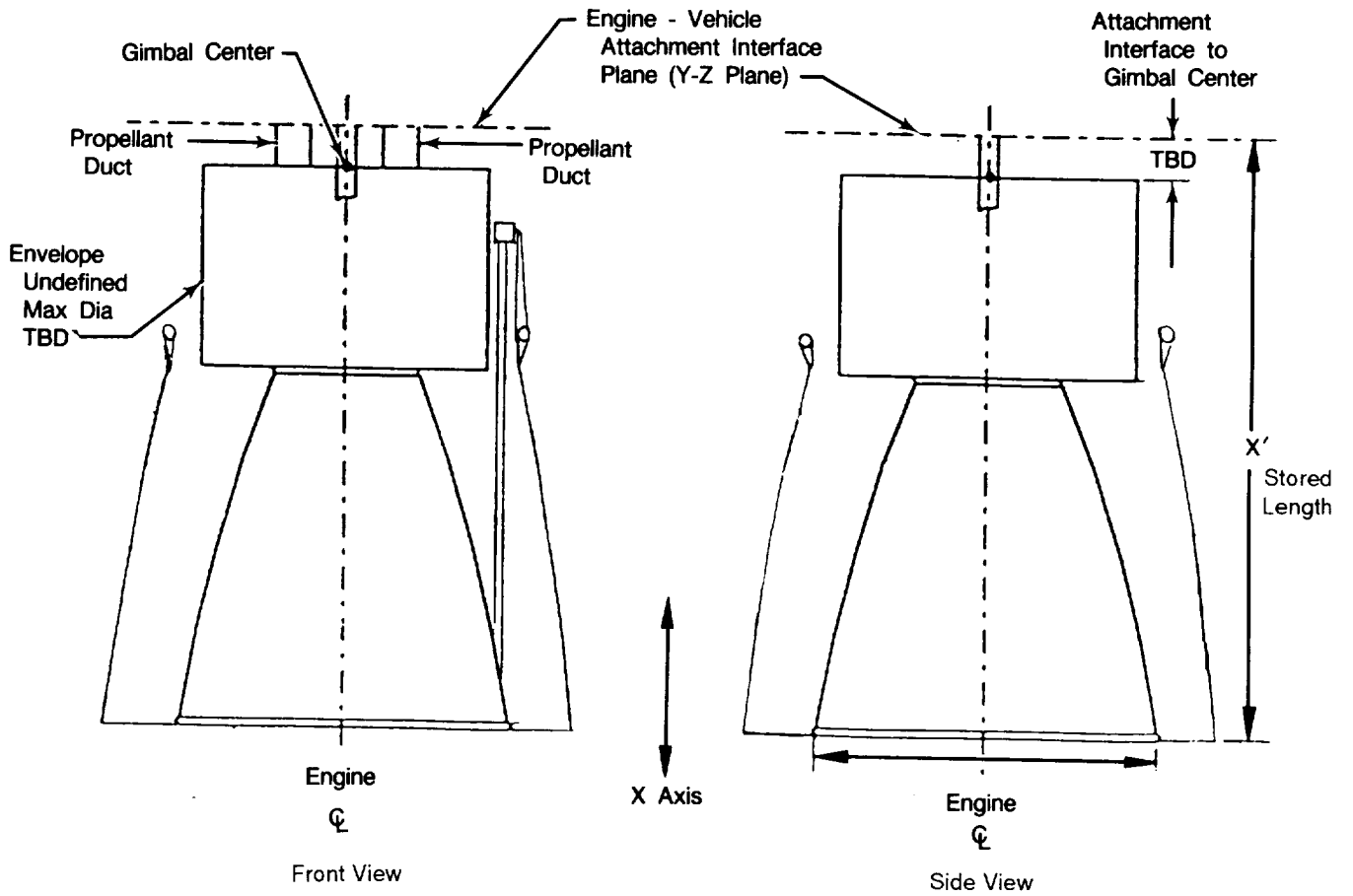
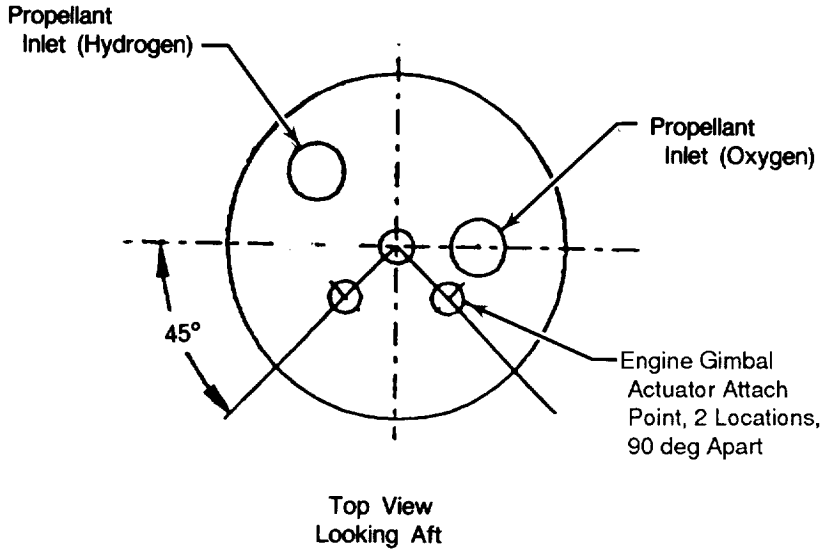

Figure 32. Engine Envelope (Sheet 1 of 2)

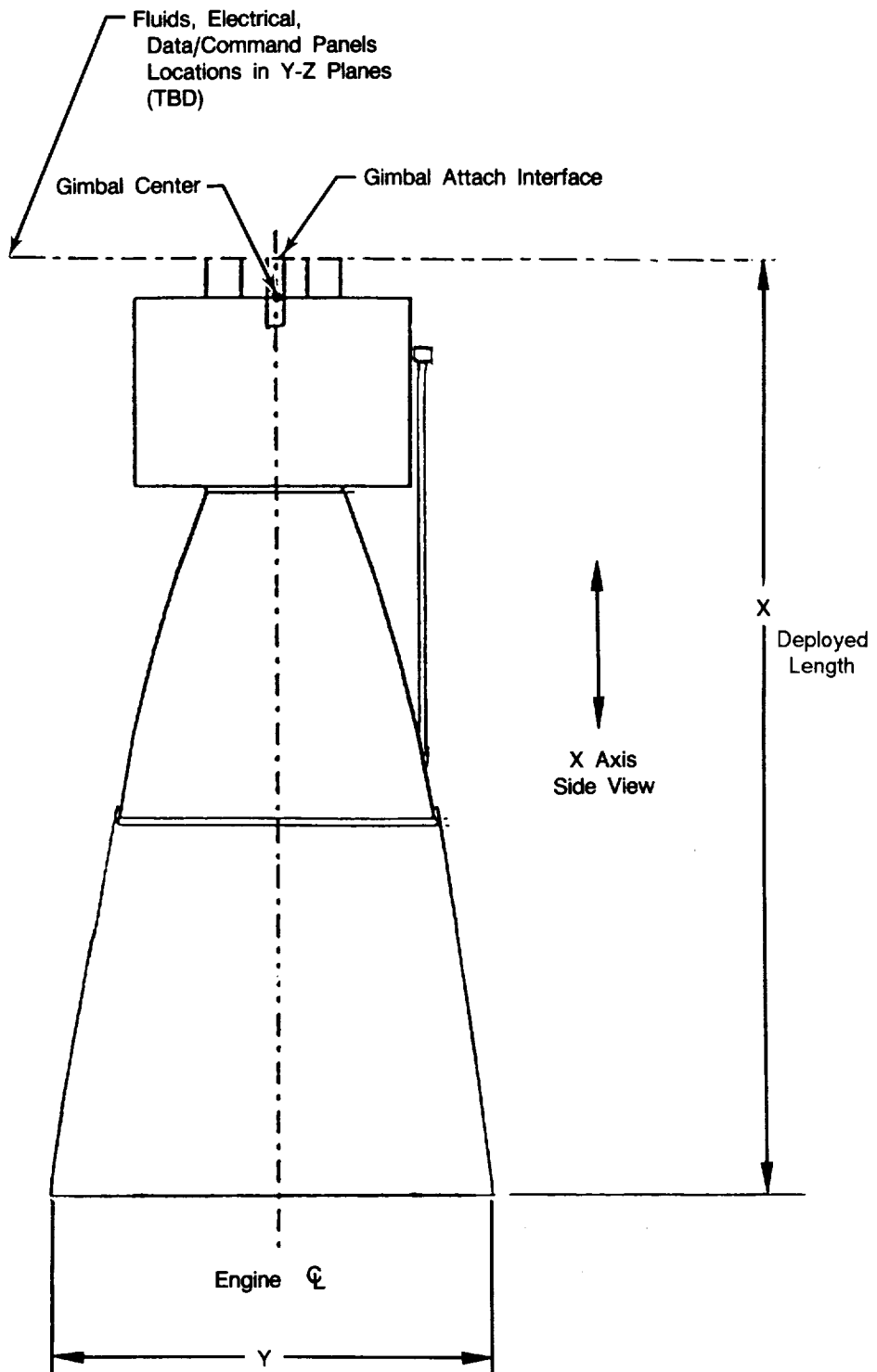

Figure 32. Engine Envelope (Sheet 2 of 2)

SECTION III THROTTLING AND HIGH MIXTURE RATIO OPERATION

COMPONENT REQUIREMENTS

The throttling requirements for the study were set at a minimum throttling capability of 10:1 and an optional requirement of 20:1. The baseline engine mixture ratio requirement was operation from 5.0 to 7.0 (6.0 ± 1.0). An optional requirement was to be able to operate oxidizer rich at a mixture ratio of 12.0. In many respects, the component requirements for wide range throttling and high mixture ratio operation are similar; therefore, the component discussion presented here covers both requirements.

The key technical issues for achieving wide range throttling and high mixture ratio operation are: (1) achievement of high combustion efficiency over a wide thrust and mixture ratio range without excessive system pressure drop and complexity, (2) the ability to adequately cool the thrust chamber over the wide range of conditions required, (3) achievement of wide range control without undue control system complexity, and (4) pump flow stability and avoidance of turbine flow separation at low flowrates. The split expander cycle was selected as the baseline cycle for the throttling and high mixture ratio operation requirements study. The full expander cycle with a regenerator was also considered. The design thrust level was 20,000 lbs.

Combustion System

Low-frequency combustion instability is the primary combustion concern when throttling a rocket engine. Low-frequency instability generally results from a low injector pressure drop being coupled to the combustion process at low thrust. Three methods have been proposed to deal with this problem: high injector pressure drop, dual-orifice injection, and gaseous injection.

The high-pressure drop injector uses a simple, fixed-area injector sized to produce an acceptable pressure loss at the lowest thrust level. However, at full thrust, with the flowrate increased twentyfold for 20:1 throttling, the injector pressure drop becomes very high, resulting in high pump discharge pressure requirements. The extra power required to meet the high discharge pressure requirements significantly reduces the achievable cycle combustion chamber pressure.

The dual-orifice injection concept provides wide range throttling capability without requiring high oxidizer injector pressure drops at full thrust or oxidizer vaporization for gaseous injection. Separate control of the primary and secondary oxidizer flow provides an adequate pressure drop through the primary at all flow conditions. At low thrust all flow is diverted through the primary orifices, and, at intermediate thrust, the primary is used to energize and atomize the secondary flow. The dual-orifice concept was derived from gas turbine engine fuel injection technology and has successfully demonstrated high performance over a wide range of conditions. Under Contracts AF-04(611)-9565, -9575, and -11611, the injector shown in Figure 33 demonstrated throttling ratios of 170:1 with fluorine/hydrogen. A similar concept using a dual-manifold tangential entry slot oxidizer element was tested in the XLR-129 oxygen/hydrogen preburner (Contract F04(611)-68-C-0002) at pressures over 5000 psia (Figure 34). The XLR-129 tangential entry dual-orifice injection concept is currently being used in the preburner for the SSME Alternate Turbopump Development (ATD) preburner injectors. Extensive spray characterization has been completed under the ATD program. Figure 35 shows a single ATD preburner injection element at 100 percent and 10 percent of design flow.

Gaseous oxidizer injection also offers an effective method of achieving low-frequency combustion stability at low-thrust levels. The dual expander cycle is aimed specifically at providing gaseous oxidizer for injection. Mixing the gaseous oxidizer with the gaseous fuel over a wide range of operating conditions, however, is more difficult than gas-liquid mixing, and lower combustion efficiency is likely to be encountered at some operating conditions.

A heat exchanger may be used with a fixed-area injector to provide gaseous oxygen at an acceptable pressure drop at low thrust while maintaining reasonable injector pressure losses with liquid oxidizer at full thrust. This concept has been proposed as a solution to low-frequency instability in earlier advanced space engines (the RL10 IIB and the OTV engine), but these engines did not have the requirement for continuous throttling. An engine using a heat exchanger in conjunction with a single-element injector would require a more complex control system to provide continuous throttling over the desired 20:1 range.

Based on this comparison, a dual-orifice injector was selected for additional evaluation for the study on the basis of its versatility and potentially high combustion efficiency at full thrust, throttled, and high mixture ratio conditions.

Thrust Chamber Cooling

Rocket engine cooling with throttling can present difficult design challenges. If the entire fuel flow is used for cooling, as thrust level decreases, the coolant exit temperature increases. The temperature increases because with a fixed-geometry thrust chamber, a reduction in thrust is accompanied by a proportional decrease in chamber pressure and coolant flow, while the heat flux is reduced by approximately chamber pressure to the 0.8 power. Under some conditions, the increasing coolant temperature can cause the thrust chamber wall temperature to increase as the engine is throttled. If the wall temperature at full thrust is near the upper limit (as is desirable to minimize coolant pressure drop), the allowable upper limit at reduced thrust may be exceeded. The upper curve in Figure 36 shows a typical example. Cooling limits can be partially offset by reducing combustion length, use of higher thrust chamber contraction ratio, use of overcooling at the design point, or bypassing part of the flow at the design point and using all of the flow at off-design condition. Each of these approaches reduces the cooling problem at throttled conditions, but each imparts a cycle loss, increased thrust chamber weight and volume, added control system complexity, or some combination of these design penalties.

The split expander provides a means of avoiding the throttling constraint associated with most other cycles. Because of the reduced coolant flow at full thrust, the coolant exit temperature of the split expander is higher than with a full-expander cycle. By controlling the split-expander jacket bypass flow to increase the percent of coolant flow, the coolant exit temperature can be decreased up to a point during throttling. At some fraction of rated power (30 percent in the case studied), the jacket bypass valve is completely closed, and the cycle operates like a full-expander cycle. However, because the coolant passages for the split expander are designed for low flowrate, the combustor wall stabilizes at a lower temperature during deep throttling, as shown in the lower curve on Figure 36.

High mixture ratio operation is also enhanced with the split-expander cycle. By controlling the coolant jacket bypass flow to increase the percent of coolant flow, operation at higher mixture ratio levels with lower combustor wall temperatures is possible. Figure 37 shows the cooler wall temperatures attained with the split expander cycle compared to a typical cycle.

Low wall temperatures are essential at high mixture ratio operation. The maximum temperature for prevention of copper oxidation is 1060 to 1260°R without coatings. Use of coatings could reduce this limitation, but proven coatings are not currently available, and any coating will reduce the overall heat flux and the available cycle power.

The full-expander cycle with regeneration also offers the potential for control of thrust chamber wall temperatures. By reducing the amount of regeneration, the thrust chamber coolant temperature is reduced. The cooling benefit of reducing the amount of regeneration is partially offset by the higher coolant density and lower cooling velocity. Thus, cooling at throttled conditions with a regenerator in the cycle is more difficult than throttled cooling with a split-expander cycle. Also, care must be taken not to reduce the amount of regeneration at low thrust to the point that unacceptably low coolant velocity results. Figure 38 compares the coolant exit

temperature for the case of all of the fuel passing through the regenerator with a case where a portion of the jacket exit flow bypasses the regenerator. (The control scheme for bypassing the regenerator is presented below.) Without partial bypassing of the regenerator, the coolant jacket exit temperature greatly exceeds the allowable copper wall temperature. With partial bypassing, the jacket wall temperature is held within acceptable limits, as shown in Figure 39.

Wide Range Control

A conceptual control system for the split-expander cycle is shown in Figure 40. The jacket bypass valve (JBV) is used to control the coolant jacket flow for throttled and high mixture ratio operation. The JBV also contributes to thrust control. The oxidizer secondary control valve controls the oxidizer flow split between the primary and secondary injector flow and provides mixture ratio control by throttling the oxidizer flow. These two valves can also provide control of thrust down to approximately 60 percent. For deep throttling, a turbine bypass valve is used to control thrust by reducing turbine power.

In the split-expander cycle, liquid hydrogen enters the engine inlet and flows through a single-stage boost pump and proceeds onto a three-stage main pump. After the first stage of the main pump, 50 percent of the hydrogen flow is diverted and routed through the JBV and to the mixer. The remainder of the hydrogen flow is sent through the second and third stages of the pump to attain the high pressure required by the cycle and is then used to cool the chamber and nozzle. A small fraction of the gaseous hydrogen leaving the nozzle coolant exit is diverted through the turbine bypass valve (TBV) and flows into the mixer. The rest of the coolant hydrogen flow first powers the main hydrogen and oxygen turbines before being routed to the hydrogen and oxygen boost turbines. The turbine flow is then used to provide energy to the oxidizer tank pressurant through a heat exchanger and enters the mixer to join the bypass flows. The combined hydrogen flow then exits the mixer, flows through the fuel shutoff valve (FSOV), and enters the injector for combustion in the main chamber. On the oxidizer side, liquid oxygen enters the engine and flows through a single-stage boost pump and a single-stage main pump. After exiting the main pump, the oxygen is split between the primary and secondary legs of the injector, with the secondary flow controlled by the oxidizer flow control valve (SOCV). The flow routed through the primary side flows through the primary oxidizer shutoff valve (POSV). The oxygen flow is subsequently injected into the main chamber to combust with the hydrogen.

Figure 41 shows a conceptual control system for the full-expander cycle with regeneration. Because the full-expander cycle has no bypass flow, thrust control is achieved entirely by the turbine bypass valve. The turbine bypass flow is routed around the regenerator heat exchanger. As thrust is reduced, the amount of bypass flow increases, thereby reducing the amount of regeneration.

In the full-expander cycle with regeneration, liquid hydrogen enters the engine inlet and flows through a single-stage boost pump and proceeds onto a three-stage main pump. After exiting the main pump, the hydrogen flows pass through a regenerator before being used to cool the chamber and nozzle. A small portion of the gaseous hydrogen leaving the nozzle coolant exit is diverted around the turbines through the turbine bypass valve (TBV). The majority of the hydrogen flow is used to power the main hydrogen and oxygen turbines before being routed to the hydrogen and oxygen boost turbines. After leaving the oxygen boost turbine, the flow travels through the regenerator and mixes with the flow which bypassed the turbines. The hydrogen then continues on through the fuel shutoff valve (FSOV) and enters the injector for combustion in the main chamber. The oxidizer side of the cycle has the same configuration as the split-expander cycle. The liquid oxygen enters the engine and flows through a single-stage boost pump and a single-stage main pump. After exiting the main pump, the oxygen flow is split between the primary and secondary legs of the injector, with the secondary flow being controlled by the oxidizer flow control valve (OCV). The flow routed through the primary side passes through the primary oxidizer shutoff valve (POSV) and is subsequently injected into the main chamber to combust with the hydrogen.

Turbomachinery

The turbomachinery concerns when throttling a rocket engine are flow stability on the pump side and flow separation on the turbine end. As the rocket engine is throttled, propellant flowrates and turbopump speeds both decrease. The main pump tends to come down an operating line like that shown in Figure 42. As the pump enters the low-capacity region, the head coefficient drops off, and the pump flow becomes unstable. One method of avoiding this is to recirculate a percentage of the flow from the pump exit to the inlet; in effect maintaining a higher volumetric flow at the low-thrust levels. However, this increases the total enthalpy entering the pump and may cause the pump to cavitate. To overcome this, the boost pump can be operated in a manner to produce a higher pressure to the main pump, which together with the recirculated flow can effectively eliminate both instability and cavitation. In addition to pump recirculation, several design features may be used to enhance pump stability with throttled operation. One method is use of an inducer-interstage strut. The inlet struts serve to minimize induced pre-swirl during throttled conditions, thereby providing a steepened headflow characteristic for improved pump stability. Figure 43 shows how these characteristics increased the head coefficient in the 350K and XLR-129 high pressure fuel turbopumps, thereby allowing significant increases in throttleability.

Vaneless pump discharge collectors should be used on all stages, as opposed to stall-prone collectors with incidence-sensitive vane or pipe diffusers. All stages should also employ low discharge blade angles to steepen the head-flow characteristics for improved stability. Various advanced seal configurations may be used to minimize parasitic leakages detrimental to pump stability at low flowrates. Moderate suction specific speed requirements have been selected at design and off-design operation to avoid cavitation-induced instabilities. Various throttle aids such as inlet back-flow collectors can also be employed.

Turbine flow separation is primarily a performance concern rather than an operational concern. The throttling analysis completed under this study showed that the 20:1 range resulted in turbines which are close to separation. One advantage that was demonstrated by the split-expander cycle is that, since the turbine is designed for only half the flow at full thrust, when the engine is throttled down to 5 percent thrust, the turbine has more flow separation margin in it than the full-expander cycle.

CYCLE DATA

The split-expander cycle and full-expander cycle with regeneration were selected for more detailed engine studies. These studies consisted of an engine throttling investigation and a mixture ratio variation study. The thrust chamber and nozzle configuration chosen for both the split expander and the full expander with regeneration is shown in detail in Figure 44. The thrust chamber is 12.3 inches long, has a contraction ratio of 4.0, and is constructed from copper tubing. The regenerative nozzle extends out to an area ratio of 210 to 1, and is built from Haynes 230 tubing. A composite material nozzle extension increases the overall area ratio to 1000 to 1. The design point selected for the throttling studies for each cycle is defined as follows:

	<u>Split Expander</u>	<u>Full Expander With Regeneration</u>
Vacuum Thrust Level, lb	20K	20K
Inlet Mixture Ratio	6.0	6.0
Chamber Pressure, psia	1612	1764

Detailed cycle sheets for the full-thrust design thrust levels are located in Appendix B for each of the engine cycles examined.

Split-Expander Cycle

A throttling investigation was performed on the split-expander cycle, with cycle points generated at 100, 50, 10, and 5 percent of the design thrust level while holding the mixture ratio constant at 6.0. (The throttled cycle sheets detailing this investigation are located in Appendix C.) During engine throttling in the split-expander cycle, the JBV, which was previously shown in Figure 40, is used to increase the percent of hydrogen flow available to cool the thrust chamber/nozzle assembly. This increased coolant flow lowers the coolant exit temperature with thrust level, as shown in Figure 45, while the JBV area decreases according to the schedule shown in Figure 46. At 10 percent thrust the JBV is completely closed, and the cycle reverts to a full expander with all of the hydrogen flow being used to cool the thrust chamber. As a result, the coolant exit temperature below 10 percent thrust increases. The TBV opens (Figure 47) as thrust level decreases, allowing a greater percentage of the coolant flow to bypass the turbine and causing system pressures and pump speeds to drop.

A major concern during deep throttling is low frequency combustion instability resulting from low oxidizer injector pressure drops ($< 5\% \Delta P/P_c$). Dual-orifice injection allows the effective injection area to be varied with thrust level, giving an acceptable average injector pressure loss both at low thrust and full thrust, as shown in Figure 48. The oxygen is injected using tangential swirl elements to promote momentum exchange between the primary and secondary streams and the net injection velocity is sufficient for good atomization and efficiency.

A mixture ratio sensitivity study was done on the split expander cycle for mixture ratios of 5 to 7 and 12 at the 20 klb thrust design level. The cycles generated for this study are given in Appendix D. A plot of chamber pressure and chamber/nozzle heat transfer versus mixture ratio is shown in Figure 49 for the 5 to 7 range.

Below the O/F of 6.0 level chamber pressure is lower than the design point chamber pressure, which can be attributed to the reduced heat flux caused by the lower combustion temperature and increased power requirements to accommodate the higher fuel flows. The reduced heat flux limits the available cycle power by decreasing the turbine inlet temperature. The TBV is closed to maintain chamber pressure. When the 5 percent margin designed into the cycle reaches 0 as the O/F is lowered, chamber pressure and, subsequently, thrust decline. Conversely, above an O/F of 6.0, there is a surplus of energy available to the turbine, and chamber pressure and thrust can be maintained by opening the TBV. On the other side of stoichiometric, at a mixture ratio of 12.0, the heat flux in the chamber is again below the design level so that the maximum chamber pressure is limited to 1250 psia. The inlet fuel flow is nearly 50 percent of design, so the JBV is closed, making all of the fuel available for use as a coolant and turbine flow. With the increased mixture ratio, the horsepower split between the fuel and oxidizer turbopumps changes and the fuel side is overpowered by the flow required by the oxidizer turbine. To compensate for this, the fuel shutoff valve (FSV) is throttled to create a higher line loss downstream of the turbines and to load the fuel system. The FSV must close to approximately 36 percent of its design flow area.

Full-Expander Cycle With Regenerator

A throttling study was also conducted for the full-expander cycle with regeneration. The throttled cycles generated were at 50, 10, and 5 percent of the 20,000 lbs design thrust at a mixture ratio of 6.0. Detailed cycle sheets for these throttled points are contained in Appendix C.

Unlike the split-expander cycle, the coolant flow cannot be controlled during throttling and, with the chamber designed for full coolant flow, the coolant exit temperature rises during engine throttling, as shown in Figure 50. At the 5 percent thrust level, the turbine inlet temperature is above 1200°R. The TBV opens during throttling (Figure 51), bypassing a greater percentage of the hydrogen flow around the turbine, dropping pump speeds and system pressures. Since the energy for the hot side of the regenerator is supplied by the turbine discharge flow, as thrust decreases, the lower flowrate results in a relatively small increase in coolant inlet temperature (Figure 52).

As with the split-expander cycle, a major concern during deep throttling is low-frequency combustion instability resulting from low oxidizer injector pressure drops ($< 5\% \Delta P/P_c$). To maintain the required pressure loss without having to vaporize the oxygen, the dual-orifice injector concept was used in the full-expander cycle studies. The dual-orifice injector allows the effective injection area to be varied with thrust level, giving an acceptable average injector pressure loss both at low thrust and full thrust, as shown in Figure 53. The oxygen is injected utilizing tangential swirl elements to promote momentum exchange between the primary and secondary streams, and the net injection velocity is sufficient for good atomization and efficiency.

Using the 20 klb thrust level as the design point, a mixture ratio sensitivity study was conducted with the full-expander cycle with regeneration. The specific O/Fs studied were from 5 to 7 and 12.0. Detailed cycle sheets for these operating points are contained in Appendix D. A plot of chamber pressure and chamber/nozzle heat transfer versus mixture ratio is shown in Figure 54. The characteristics display the same trends for the full-expander cycle with regeneration as those seen with the split expander cycle. At the lower O/F levels, the cycle runs out of power and chamber pressure falls off. The coolant and turbine flow for the full-expander cycle with regeneration, operating at high mixture ratio, is much lower than the design value; consequently, turbopump performance suffers and the achievable chamber pressure is lower. At the mixture ratio of 12.0, the chamber pressure drops to 1160 psia. As with the split-expander cycle, the FSV must be throttled to load the fuel system. The valve is closed to under 10 percent of its design value. The selected control system with partial regenerator bypass, as was previously shown in Figure 41, provides lower coolant exit temperature than achievable without turbine bypass, but temperatures are still above current acceptable limits for copper thrust chambers. Either improved materials, or a more complex control system that provides complete regenerator bypass, would be required to achieve operation at a mixture ratio of 12.0. Either approach would be expected to reduce achievable chamber pressure over some portion of the mixture ratio range.

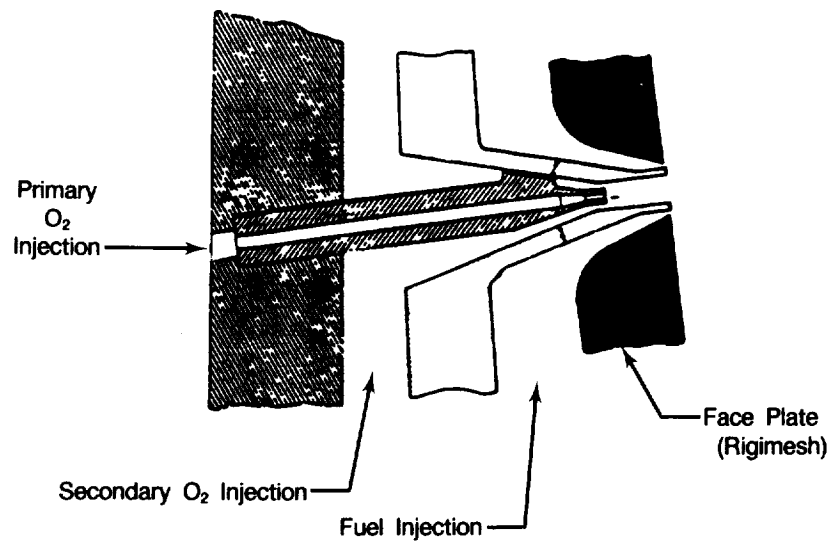

Figure 33. Coaxial Dual Area Orifice Injector

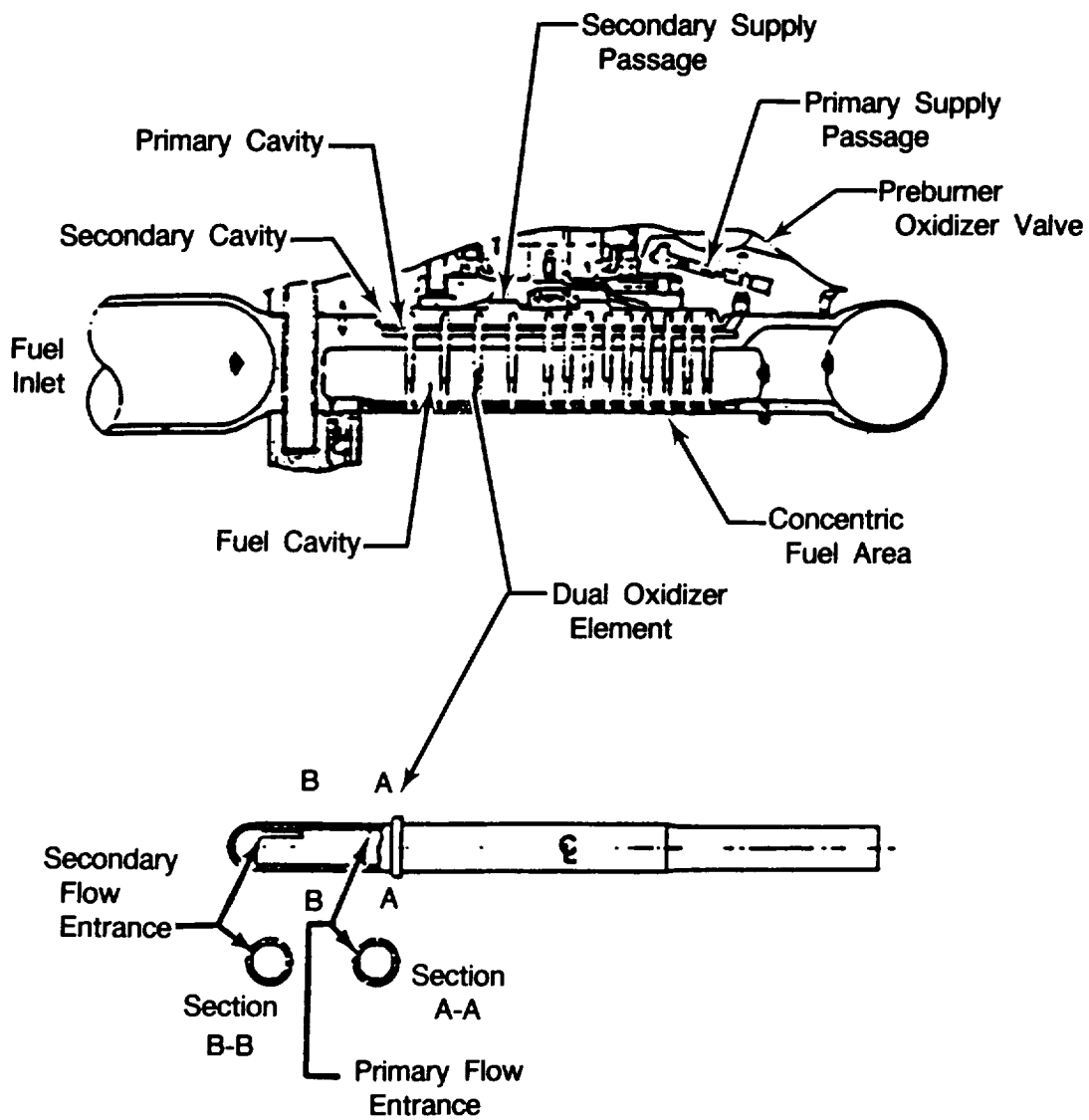
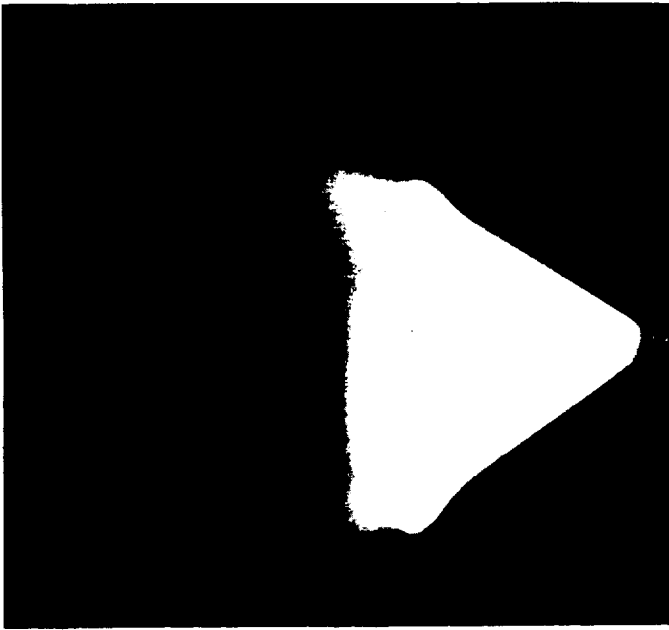
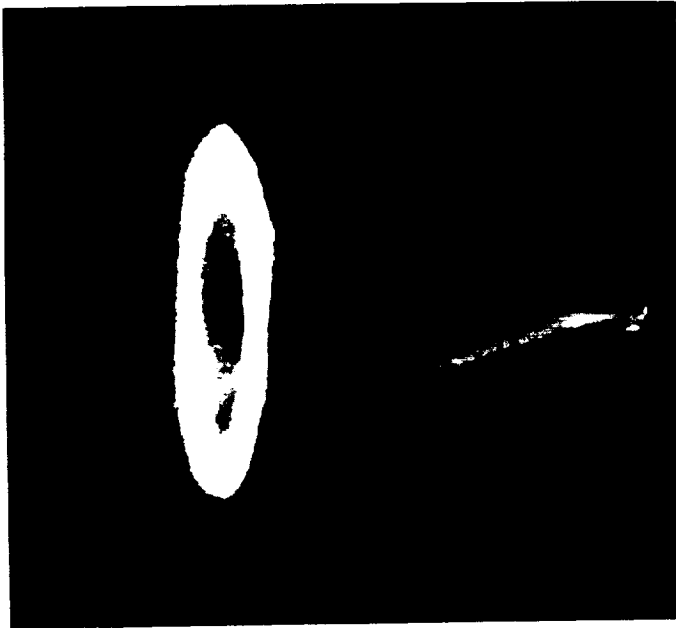

Figure 34. XLR-129 Demonstrator Engine Preburner Injector With Dual Tangential Entry Injection



100% Max Power
Flow Rate
Primary and Secondary Flow



10% Max Power
Flow Rate
Primary Flow Only

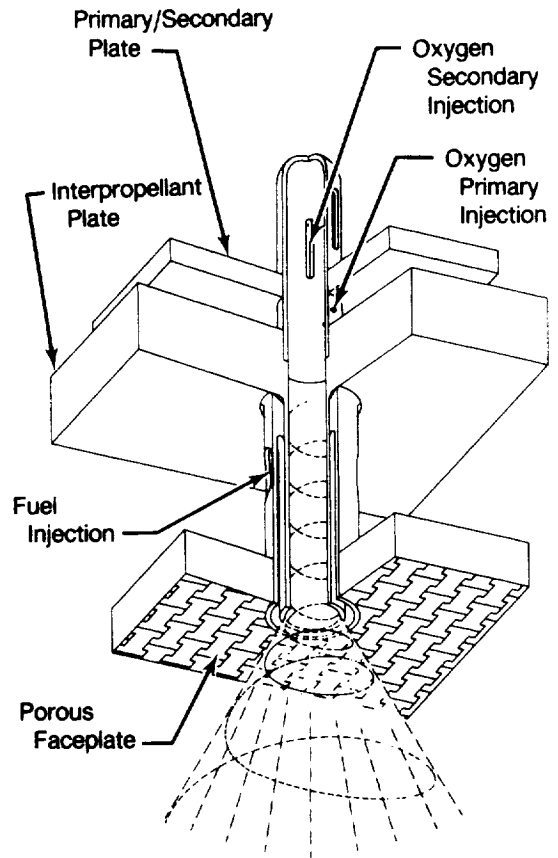

Figure 35. Tangential Entry Dual-Orifice Injection

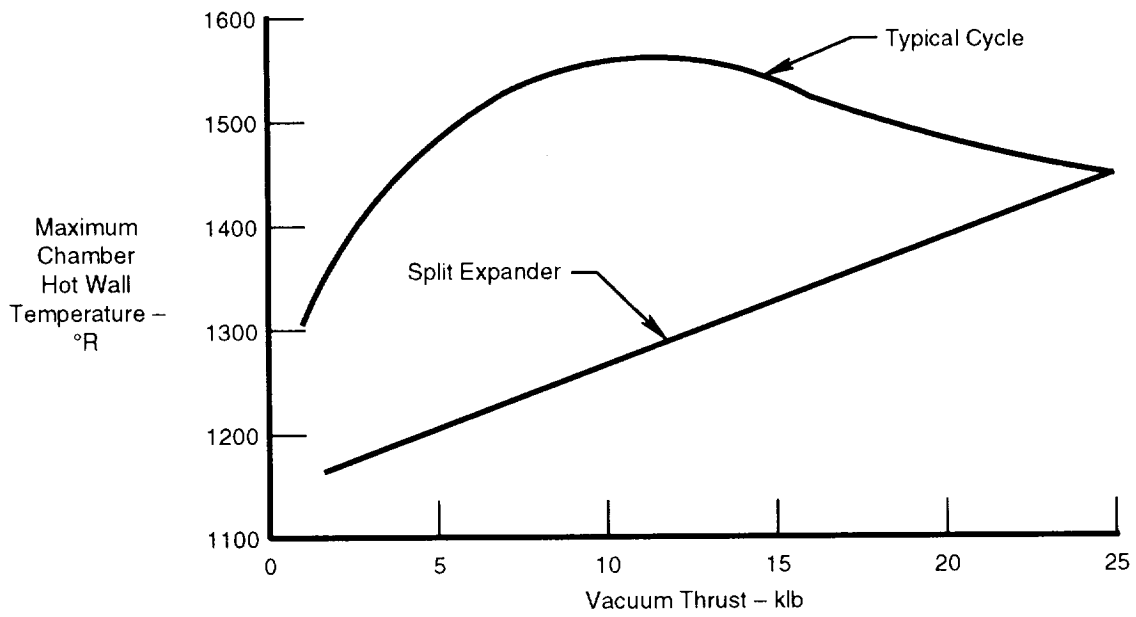

Figure 36. Maximum Thrust Chamber Wall Temperature With Throttling for a Typical Cycle and for the Split-Expander Cycle

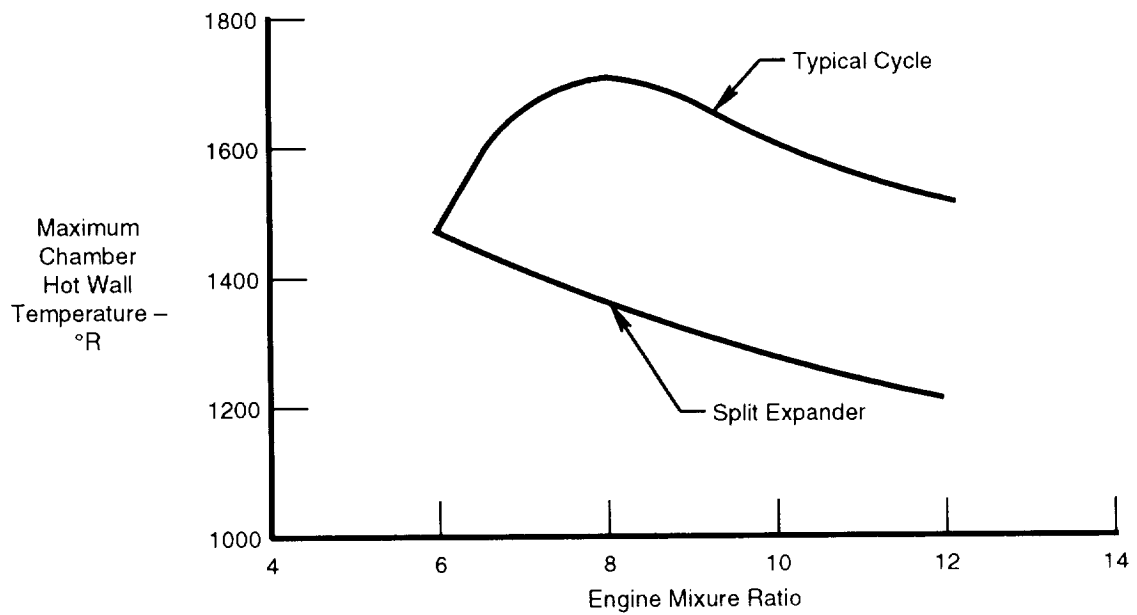

Figure 37. Comparison of Thrust Chamber Wall Temperature Versus Mixture Ratio for Typical and Split-Expander Cycles

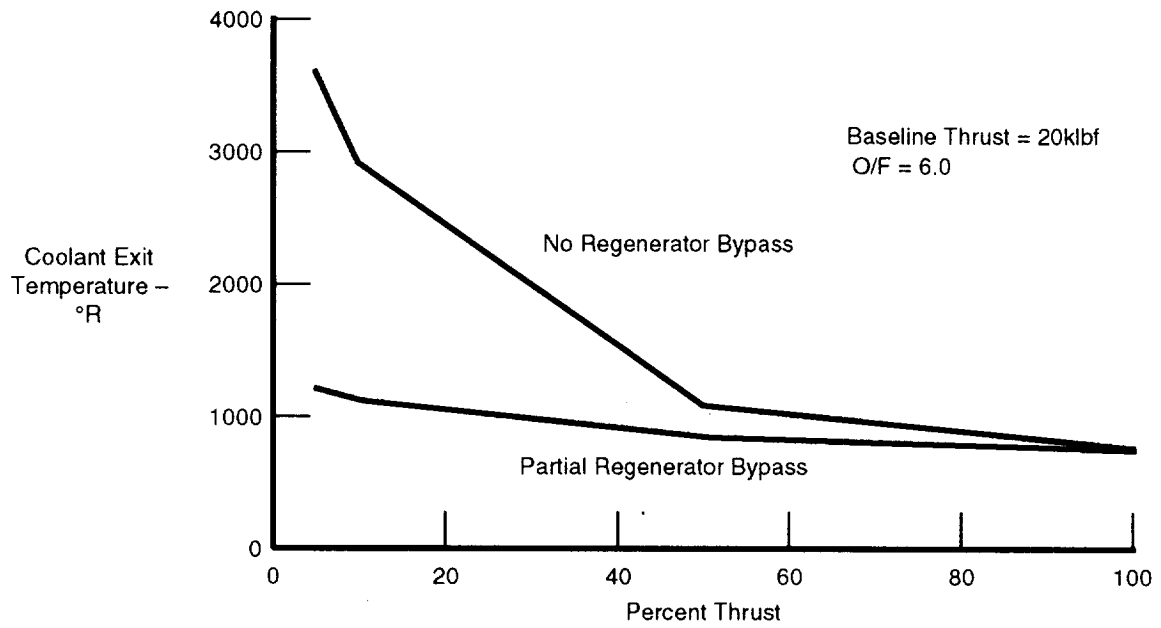

Figure 38. Coolant Exit Temperature Versus Percent Thrust for the Full-Expander Cycle With Regeneration

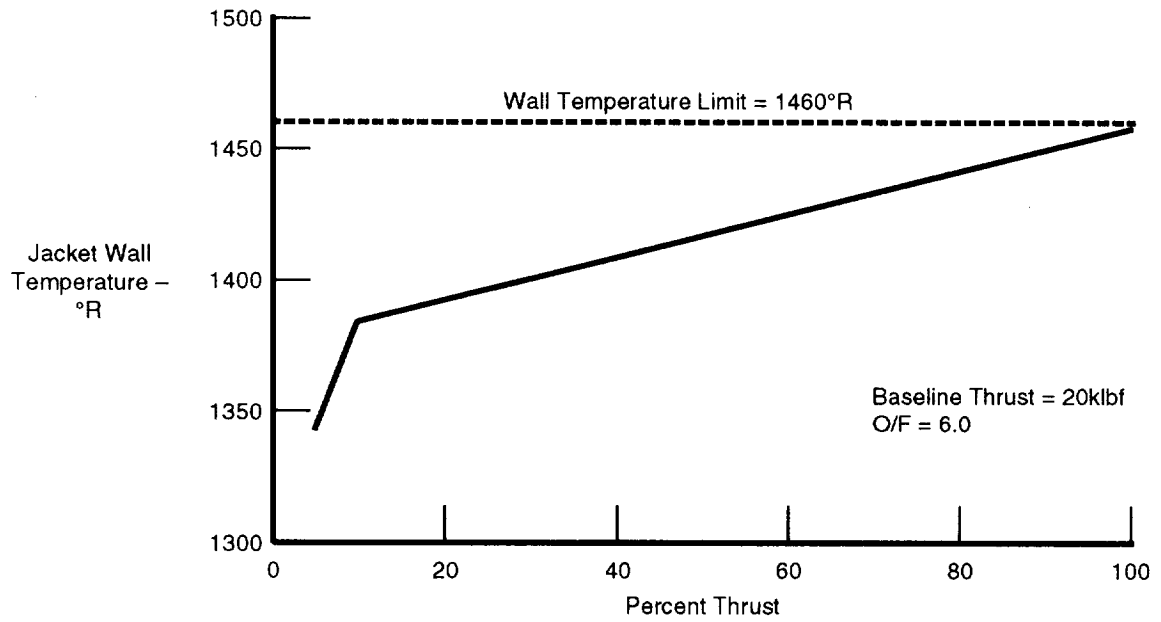

Figure 39. Jacket Wall Temperature Versus Percent Thrust for the Full-Expander Cycle With Regeneration

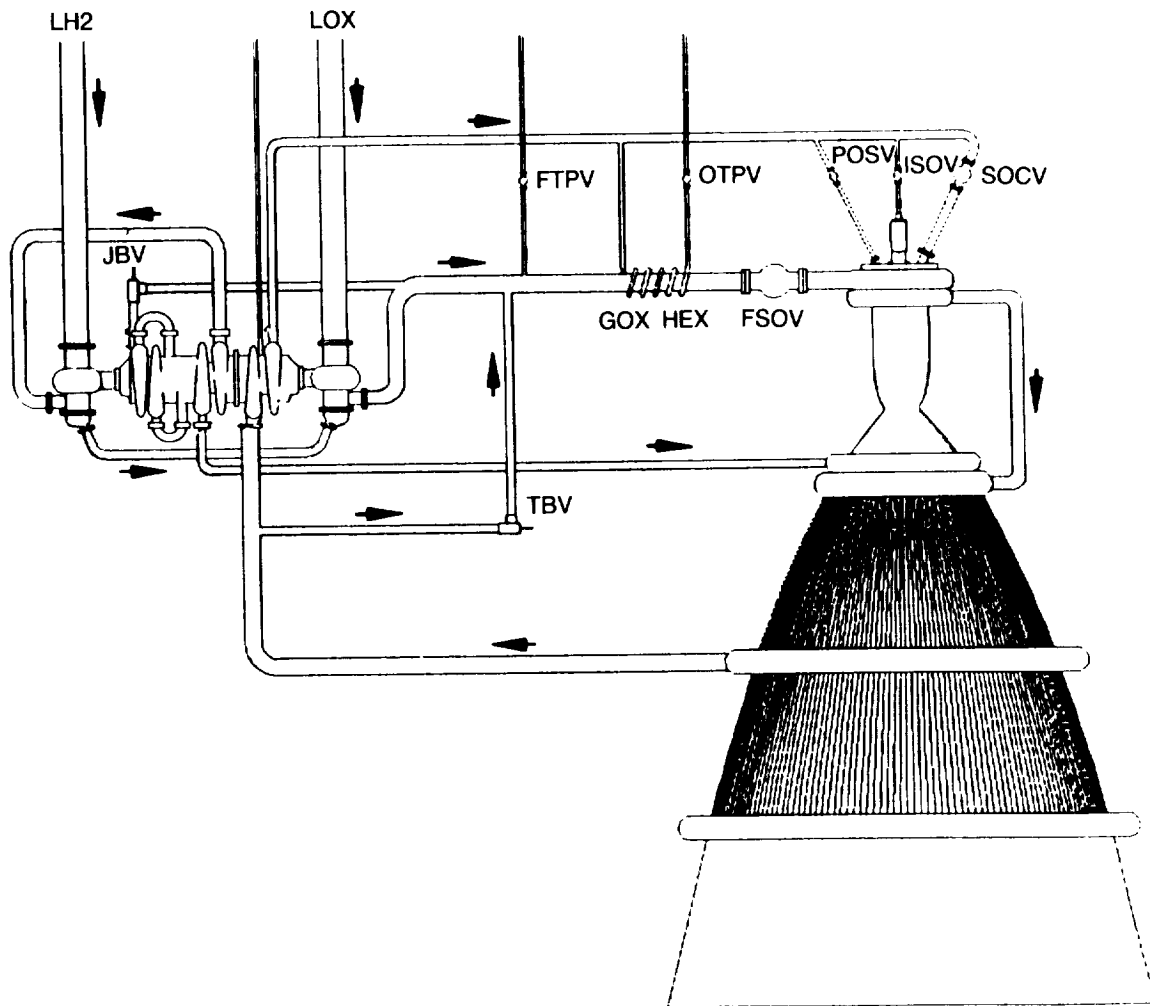

Figure 40. Space Engine Control Schematic — Split-Expander Cycle

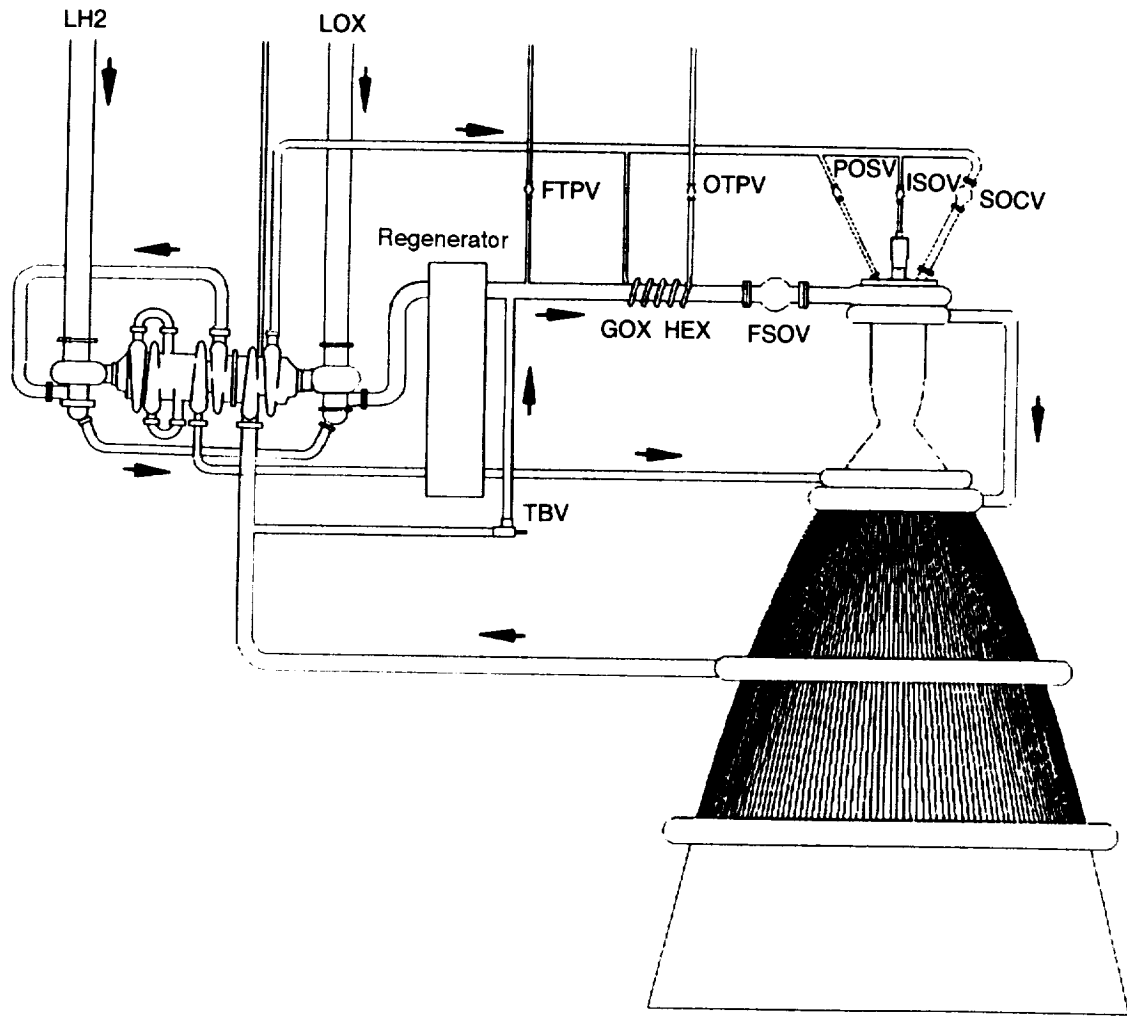

Figure 41. Space Engine Control Schematic — Full-Expander Cycle With Regeneration

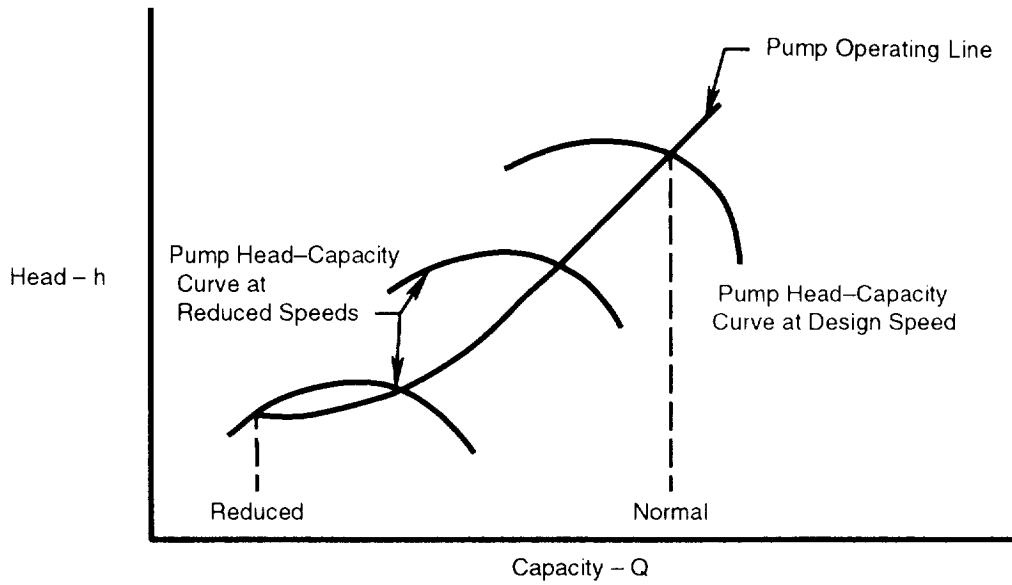

Figure 42. Typical Turbopump Head-Capacity Curve

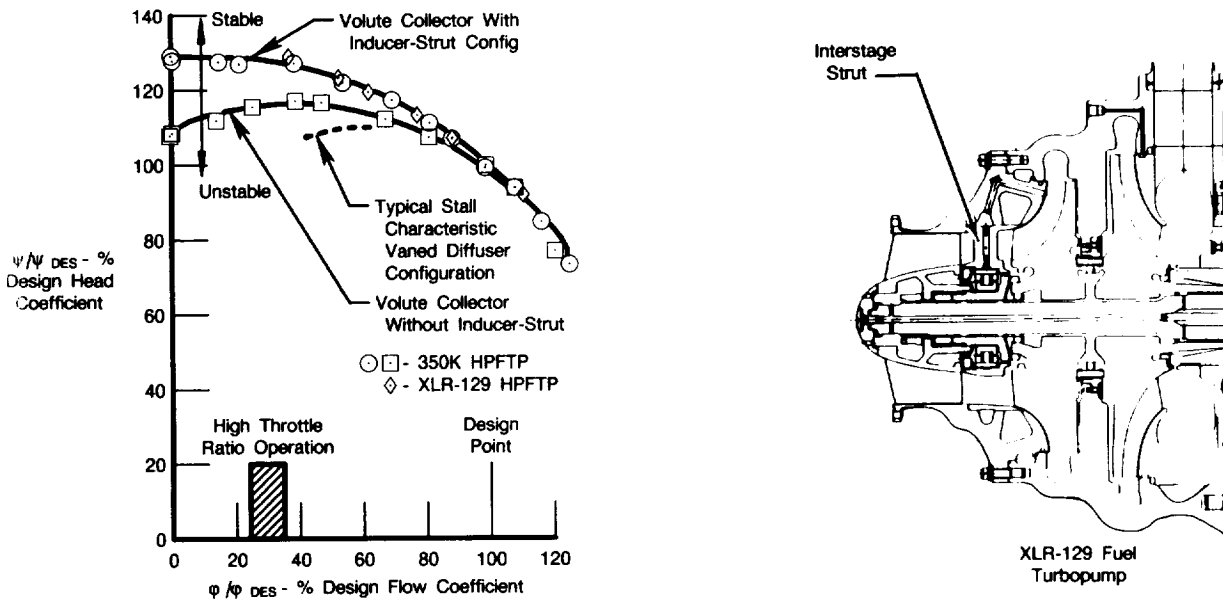

Figure 43. Volute Collector With Inducer Struts Provides Head-Flow Characteristics

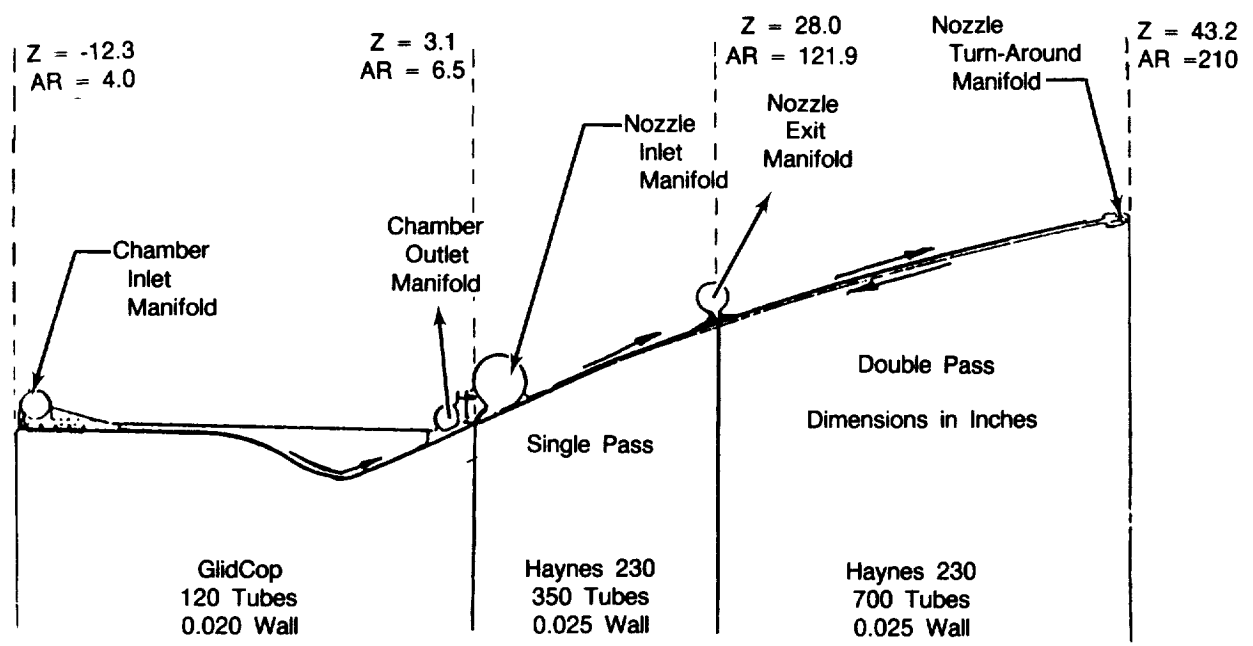

Figure 44. Thrust Chamber and Nozzle Cooling Configuration for the Full-Expansion Cycle With Regeneration and the Split-Expander Cycle

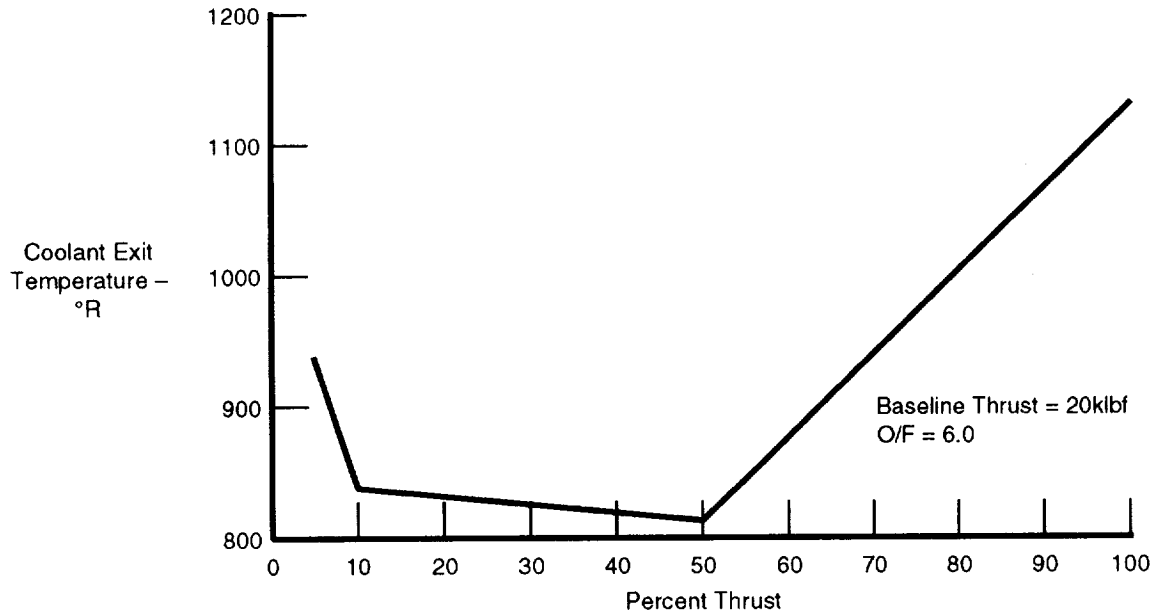

Figure 45. Split-Expander Cycle Throttling, Coolant Exit Temperature Versus Percent Thrust

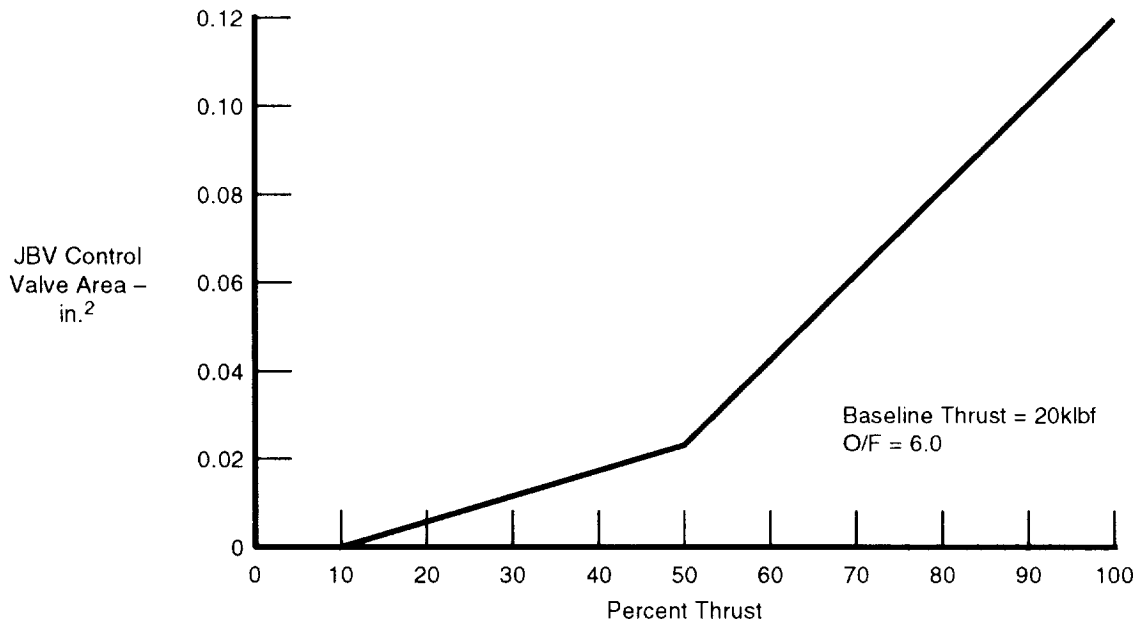

Figure 46. Split-Expander Cycle Throttling, JBV Control Valve Area Versus Percent Thrust

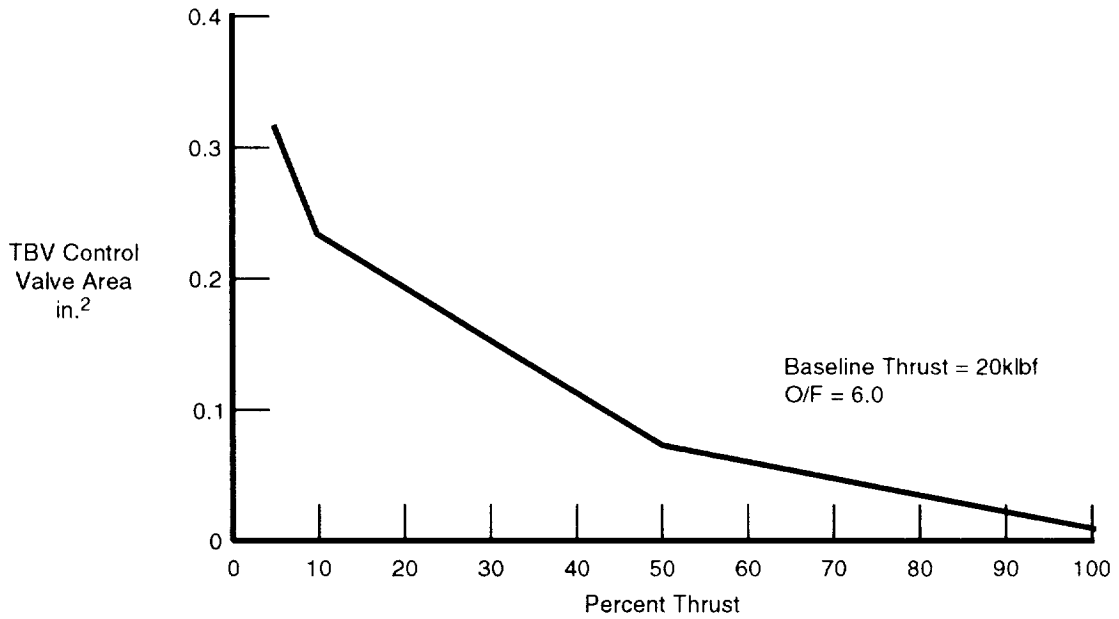

Figure 47. Split-Expander Cycle Throttling, TBV Control Valve Area Versus Percent Thrust

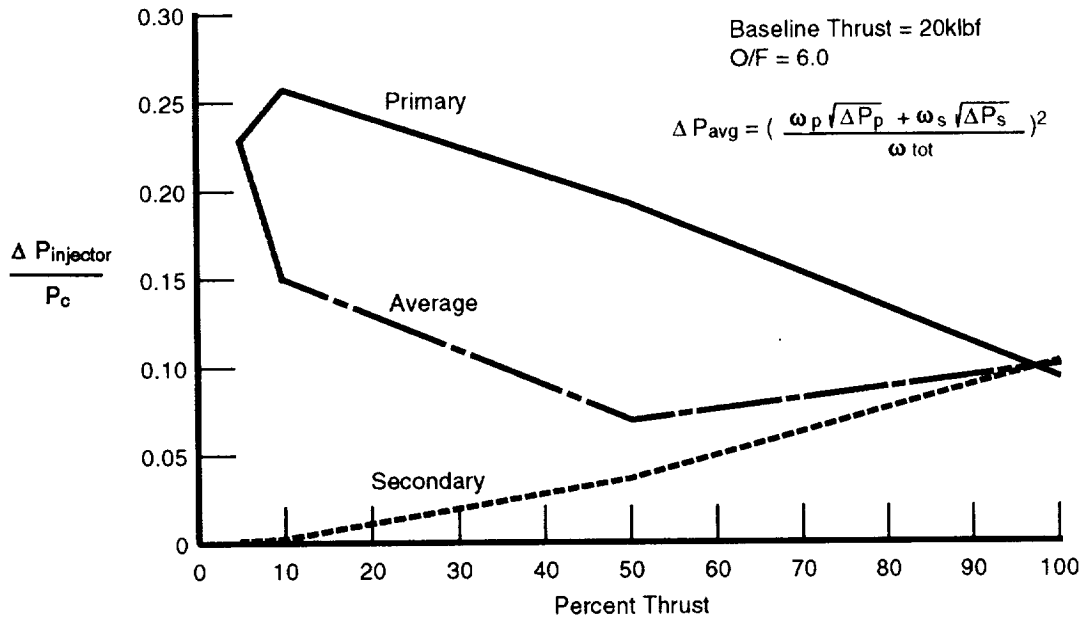

Figure 48. Split-Expander Cycle Throttling, Ratio of ΔP Across Injector to P_c Versus Percent Thrust

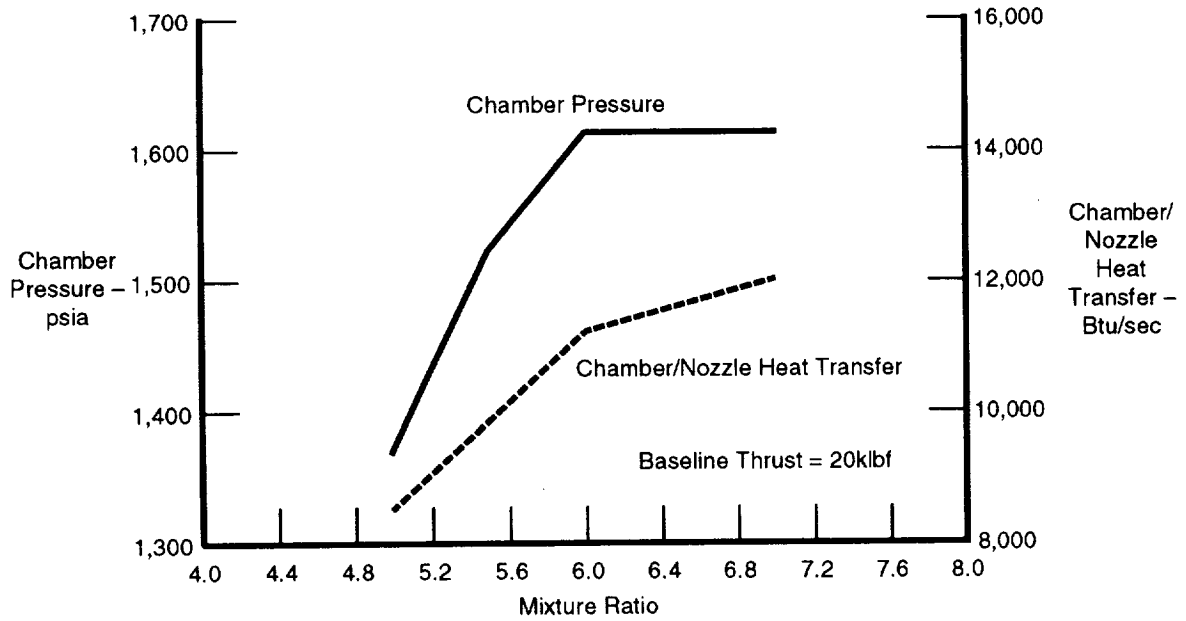

Figure 49. Split-Expander Cycle Chamber Pressure, and Nozzle Heat Transfer Versus Mixture Ratio

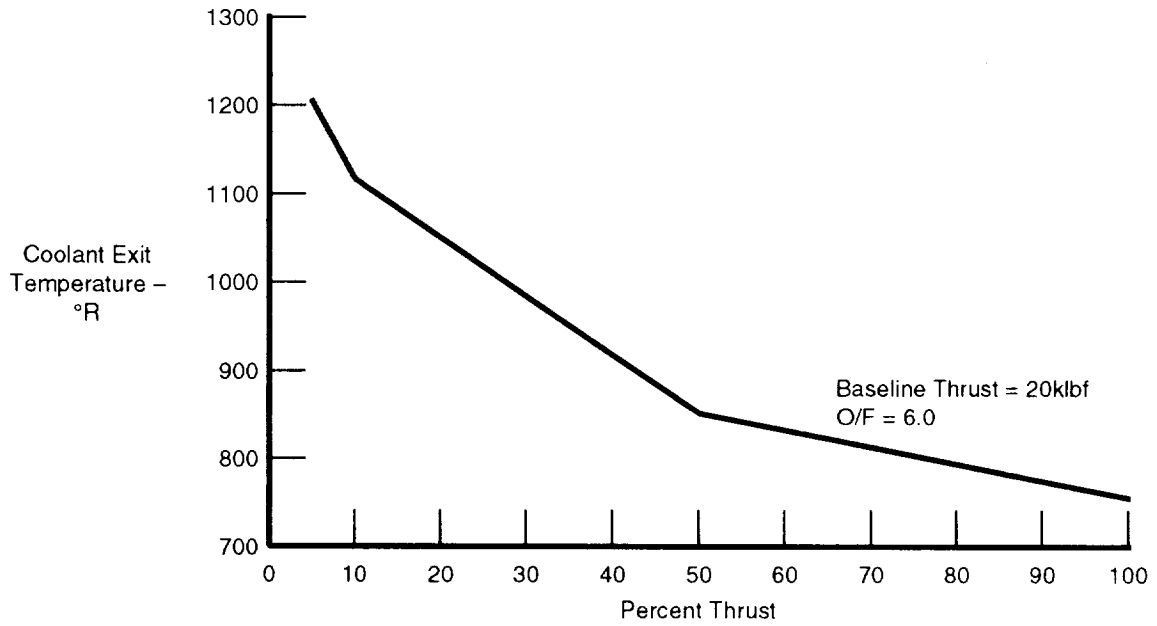

Figure 50. Full Expander With Regenerator, Coolant Exit Temperature Versus Percent Thrust

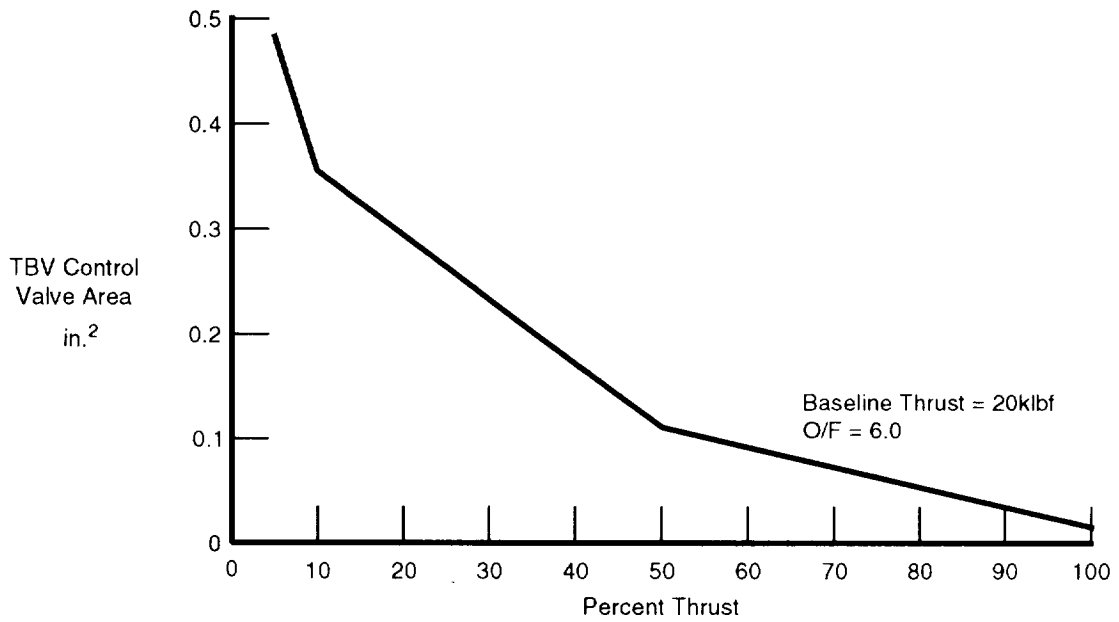

Figure 51. Full Expander With Regenerator, TBV Control Valve Area Versus Percent Thrust

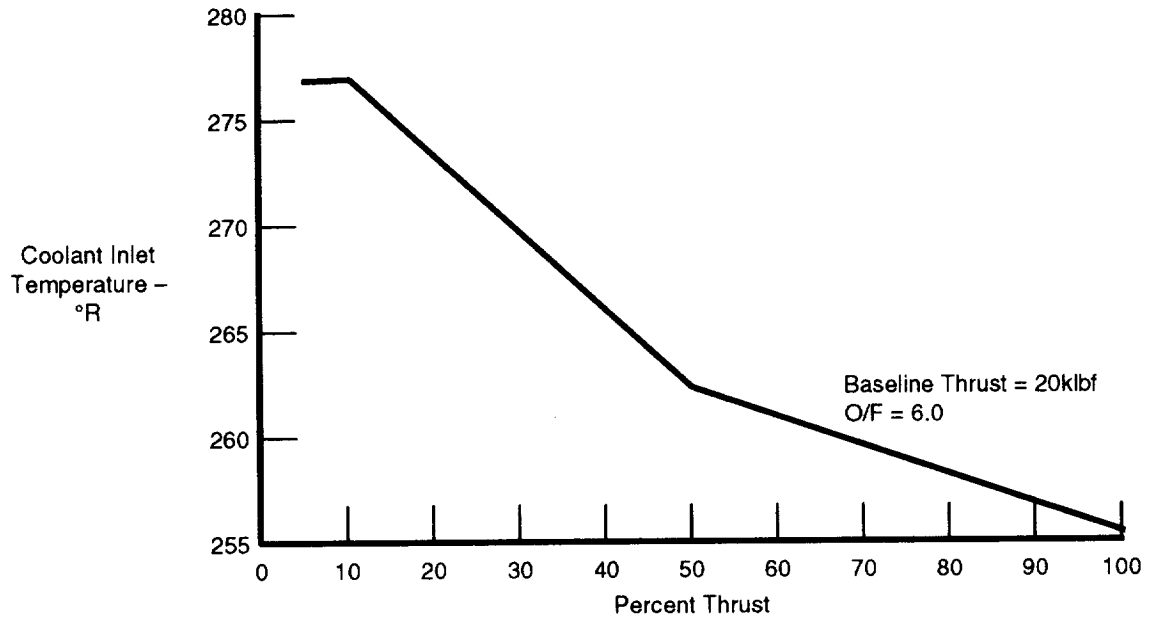

Figure 52. Full Expander With Regenerator, Coolant Inlet Temperature Versus Percent Thrust

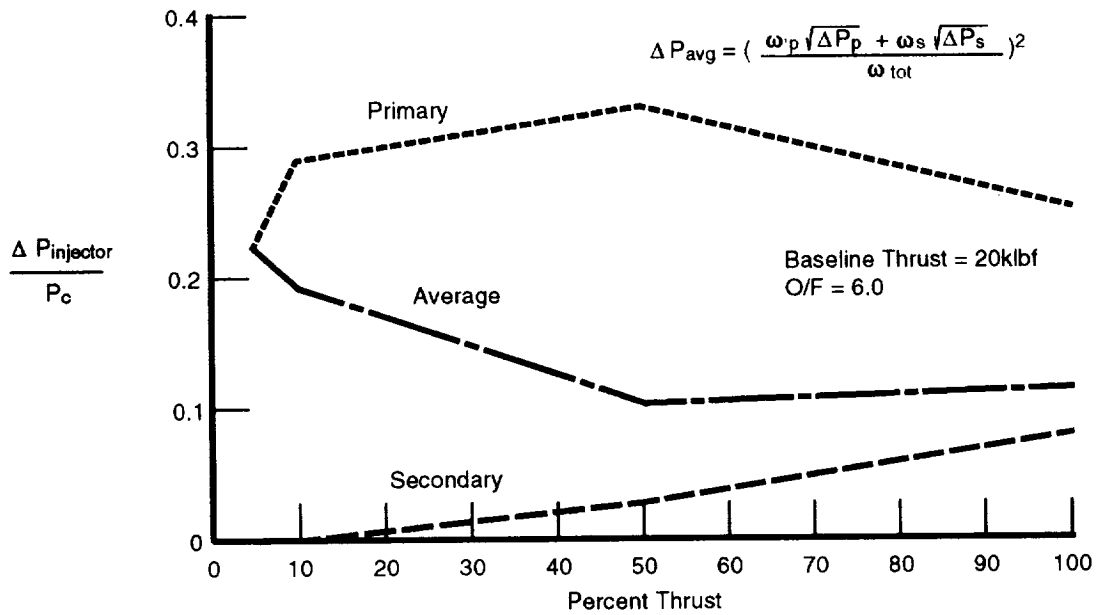

Figure 53. Full Expander With Regenerator, Ratio of ΔP Across Injector to P_c Versus Percent Thrust

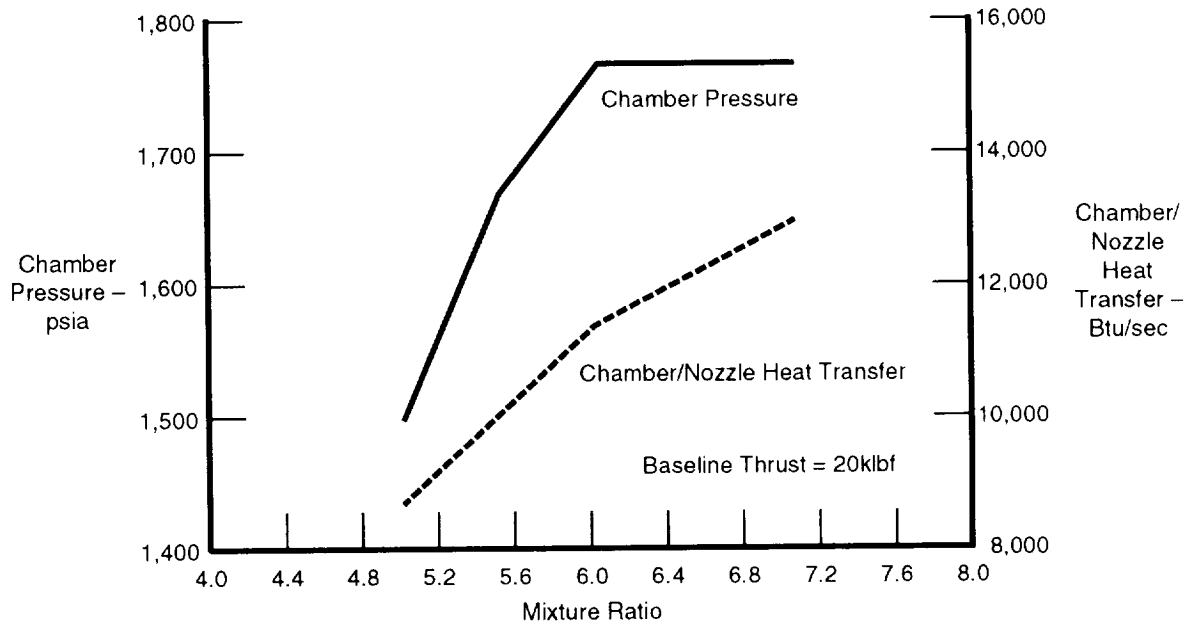

Figure 54. Full-Expander Cycle With Regenerator, Chamber Pressure and Chamber/Nozzle Heat Transfer Versus Mixture Ratio

SECTION IV RECOMMENDATIONS

Based upon the results of this study and related ongoing space engine studies at Pratt & Whitney, the following recommendations are offered:

1. Steps should be taken to investigate the key technology issues associated with design and fabrication of copper tubular thrust chambers. These issues include: (a) determination of the heat transfer enhancement associated with tubular chambers compared to smooth wall chambers, (b) determination of cyclic structural life increases associated with copper tubes over milled channel construction, and (c) investigation of copper tube chamber fabrication techniques to take full advantage of the total heat transfer and life advantages of copper tubular chambers.
2. The study should be expanded to investigate optimum cycles and design approaches for expander cycle engines in the 50 to 200klbf thrust range.
3. Interface definition should be expanded in conjunction with system requirement definitions from vehicle contractors.
4. Performance and envelope data should be updated as performance and technology levels become better defined from such sources as the NASA-LeRC high area ratio performance investigations and focused technology programs.

**APPENDIX A
PARAMETRIC DATA**

Parametric data are presented in Figures 55 through 107.

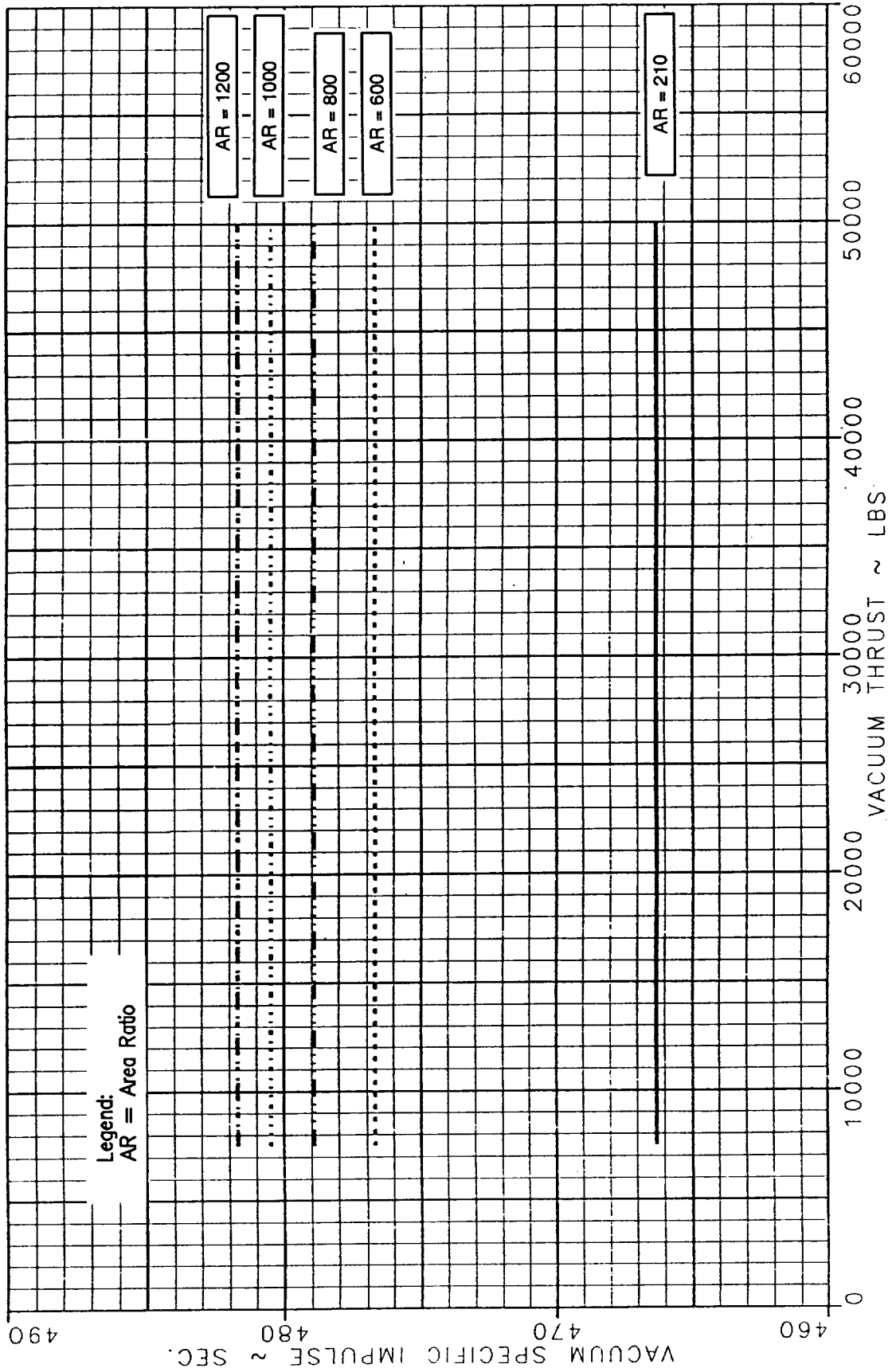

Figure 55. I_{vac} Versus Vacuum Thrust for Chamber Pressure = 1000 psia

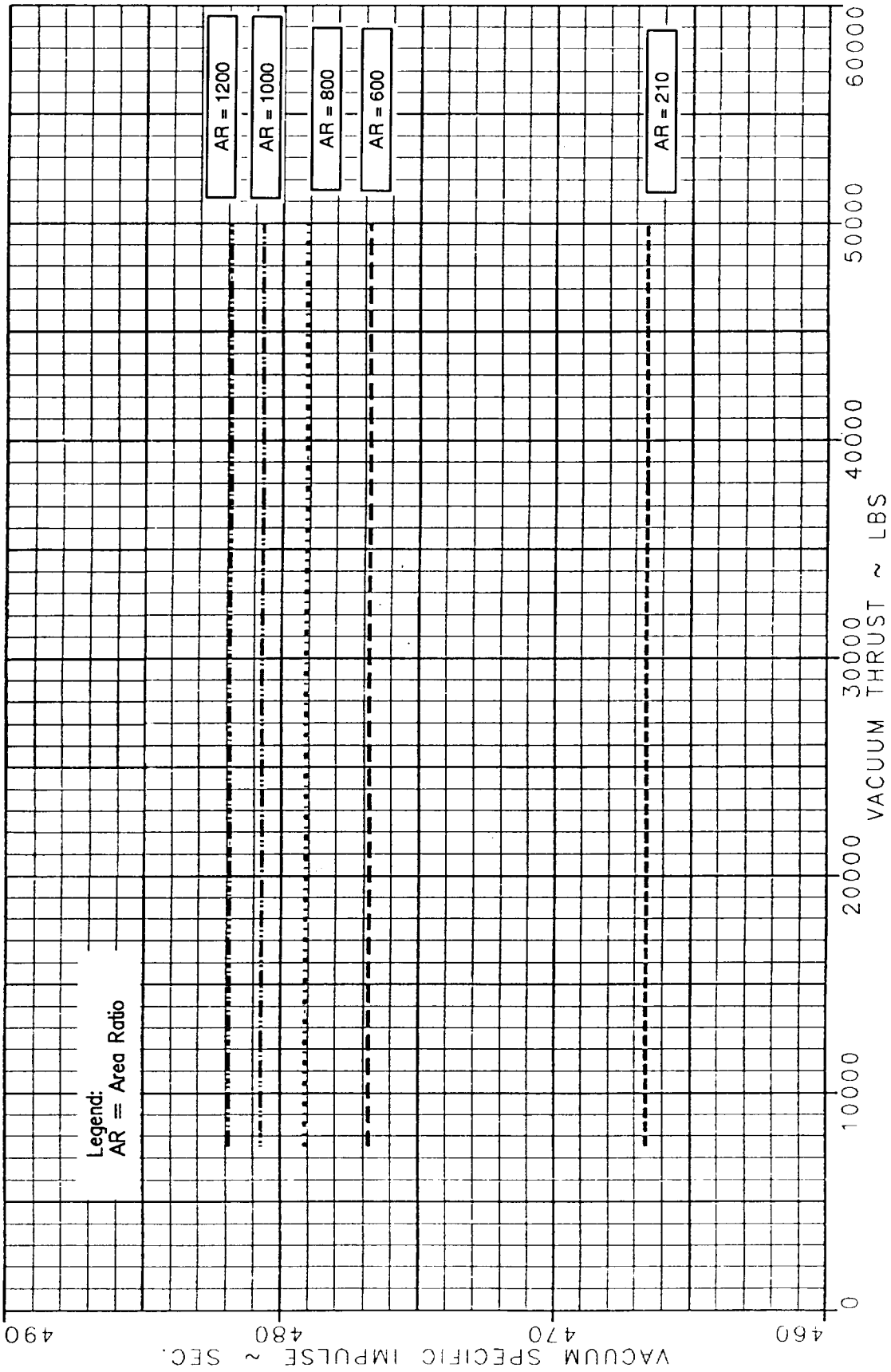

Figure 56. I_{vac} Versus Vacuum Thrust for Chamber Pressure = 1500 psia

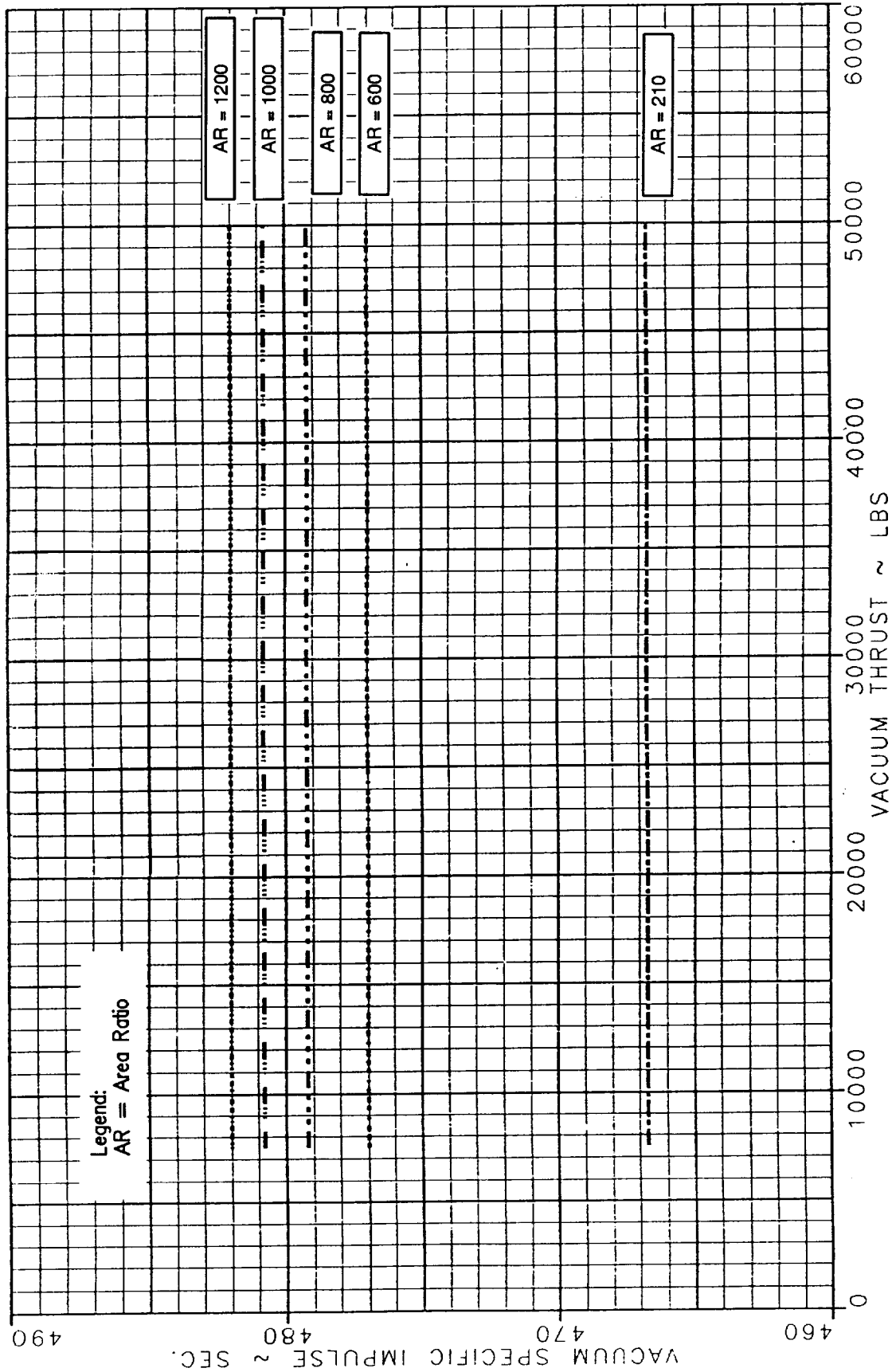

Figure 57. I_{vac} Versus Vacuum Thrust for Chamber Pressure = 2000 psia

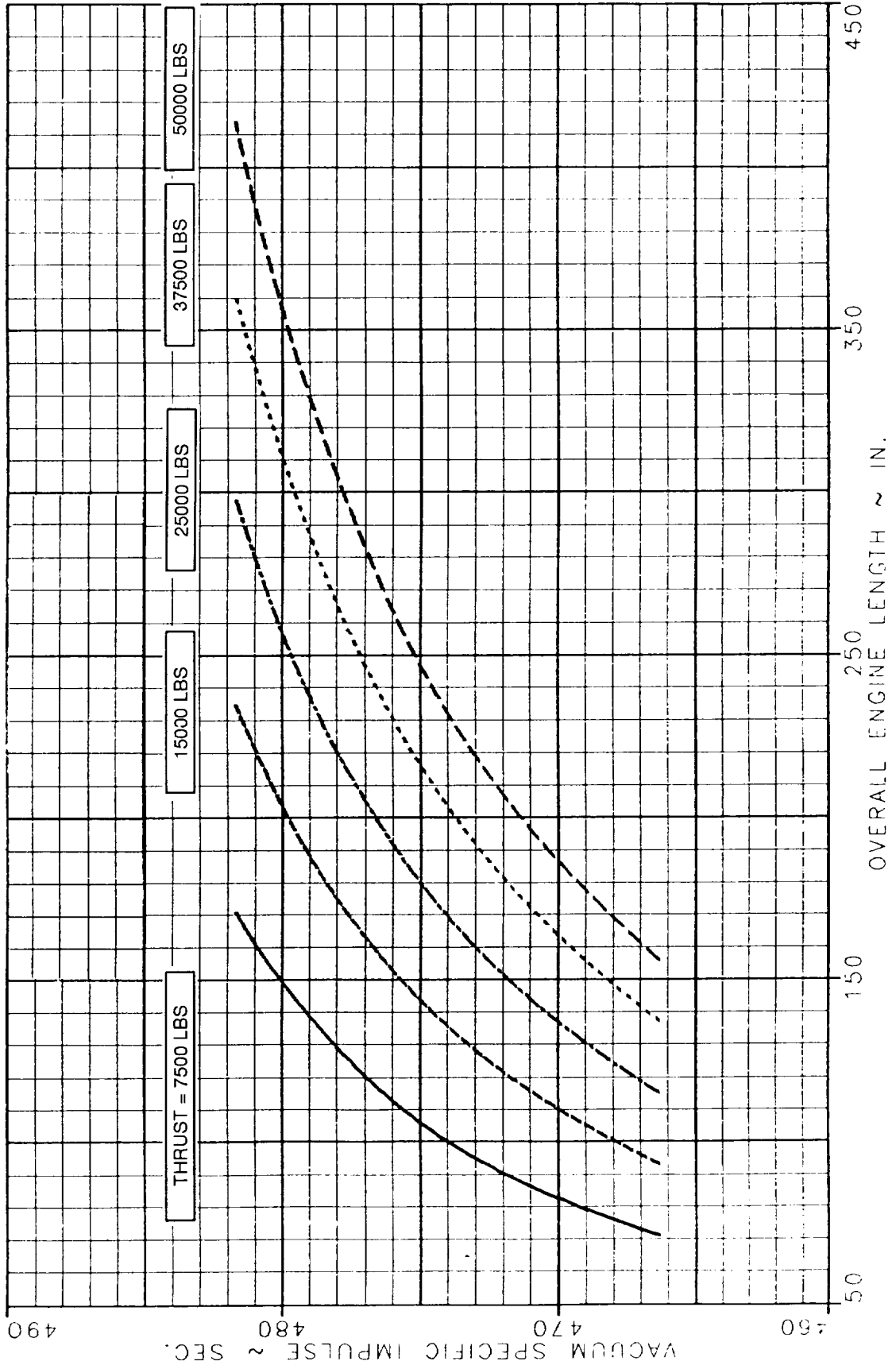

Figure 58. Vacuum Specific Impulse Versus Length for Chamber Pressure = 1000 psia

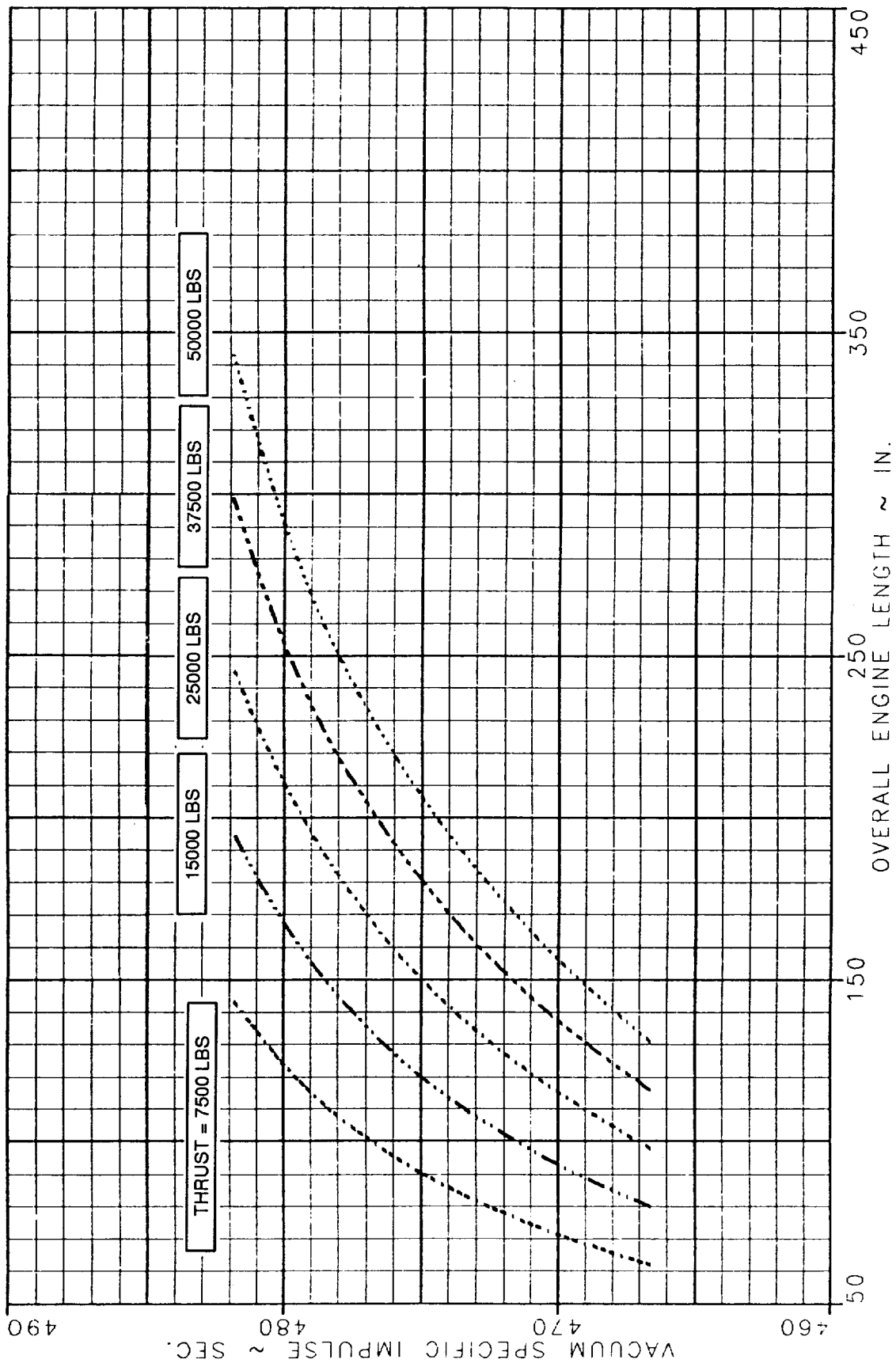

Figure 59. Vacuum Specific Impulse Versus Length for Chamber Pressure = 1500 psia

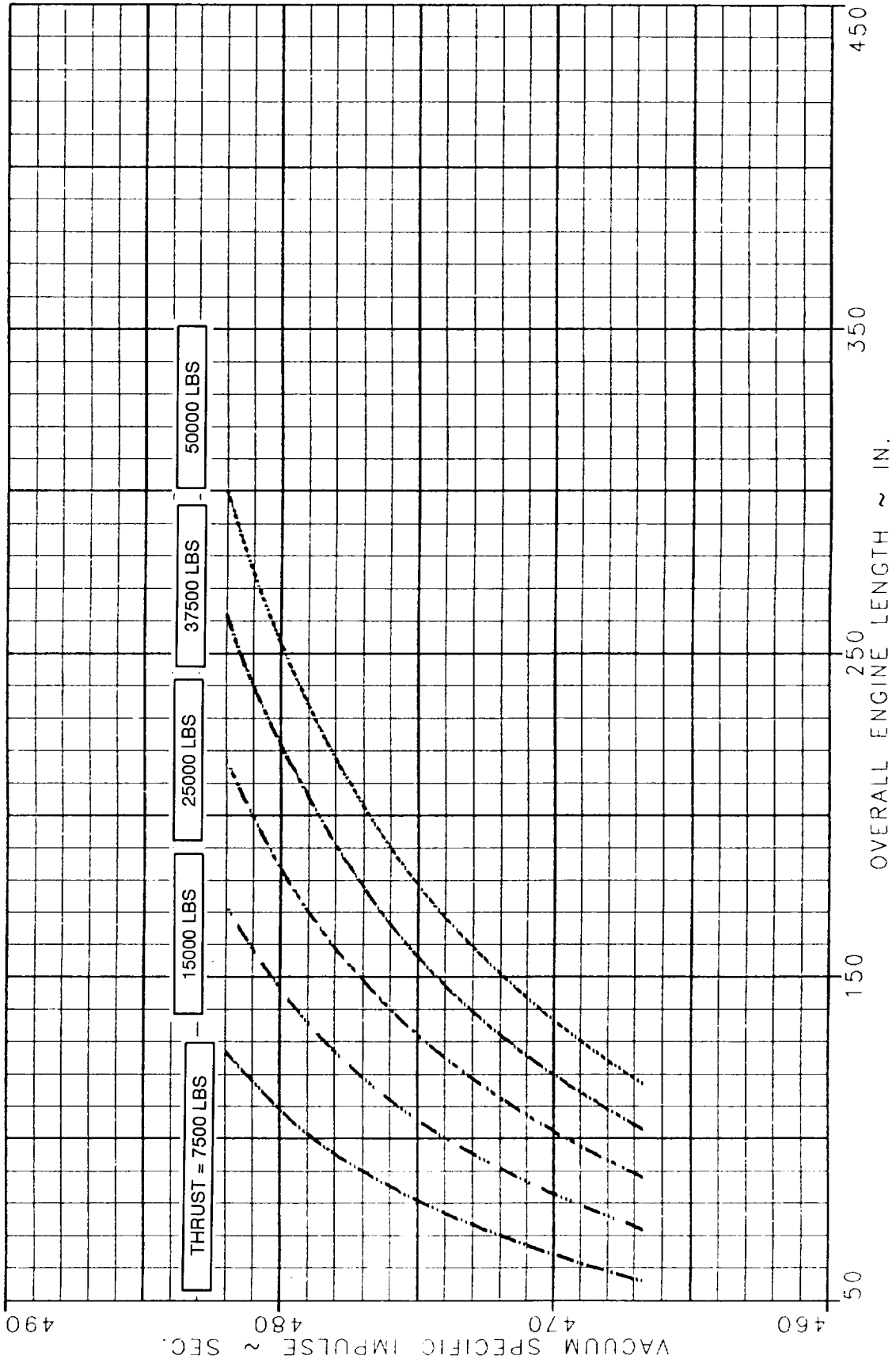

Figure 60. Vacuum Specific Impulse Versus Length for Chamber Pressure = 2000 psia

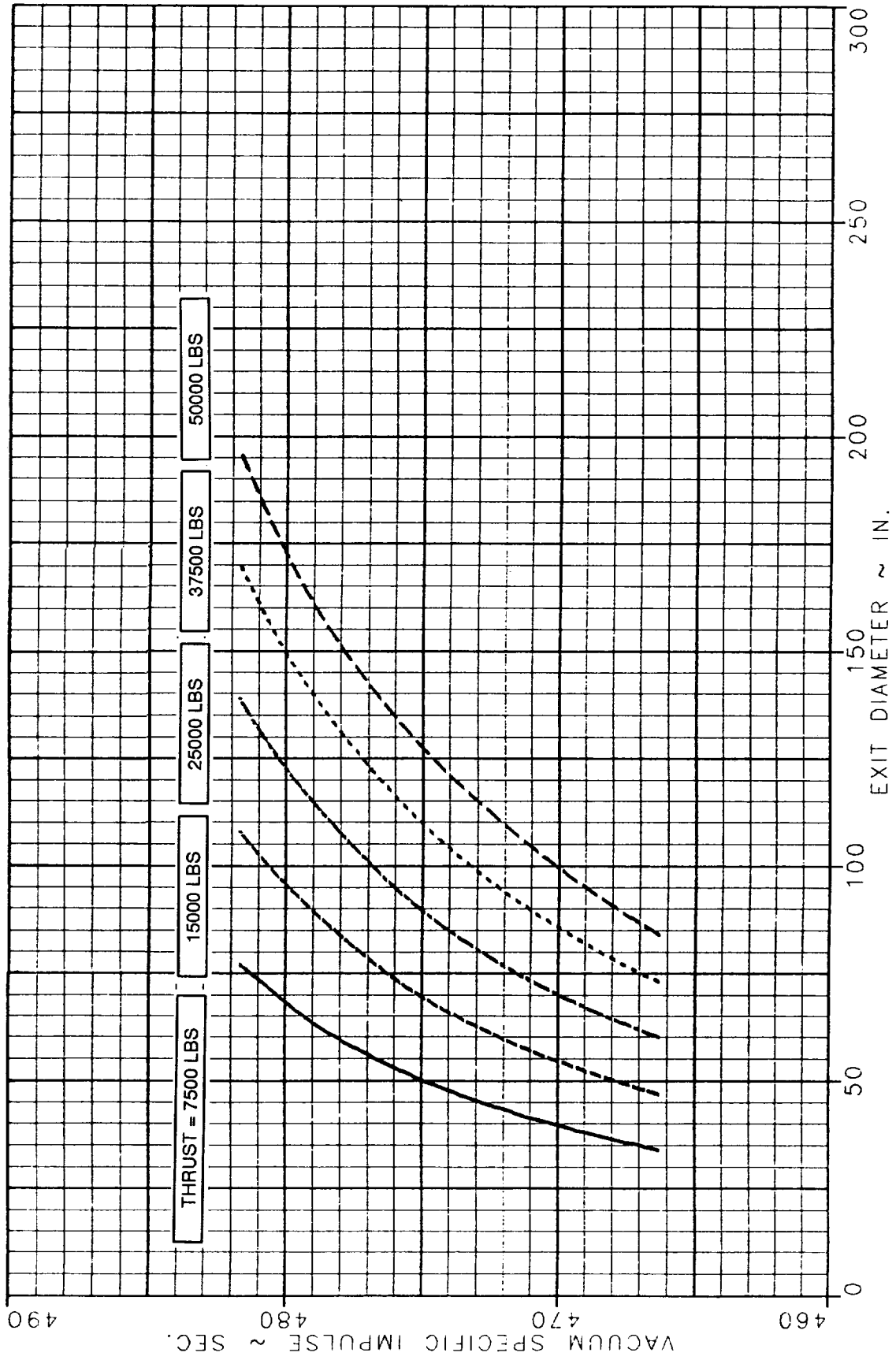

Figure 61. Vacuum Specific Impulse Versus Diameter for Chamber Pressure = 1000 psia

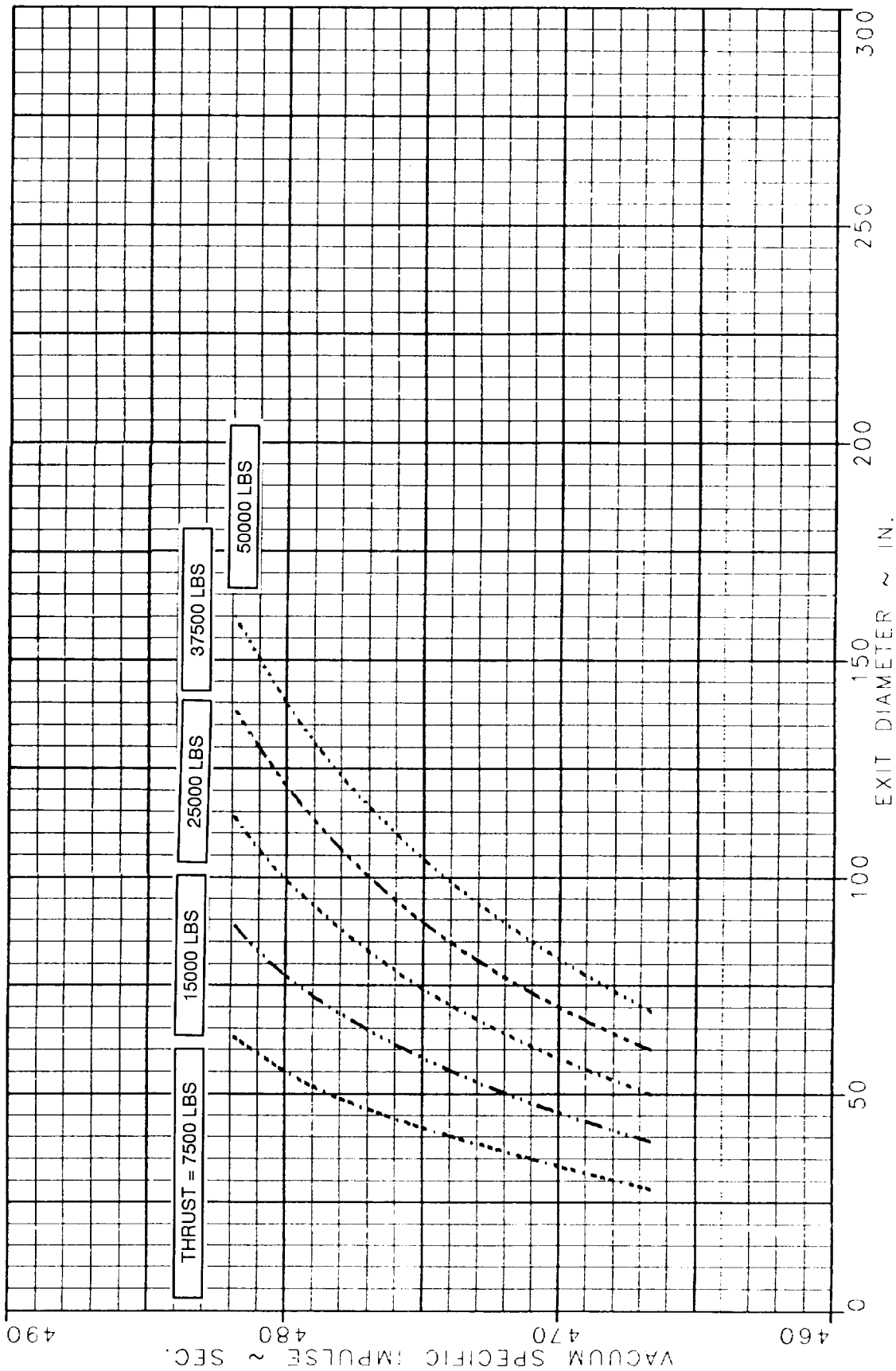

Figure 62. Vacuum Specific Impulse Versus Exhaust Nozzle Exit Diameter for Chamber Pressure = 1500 psia

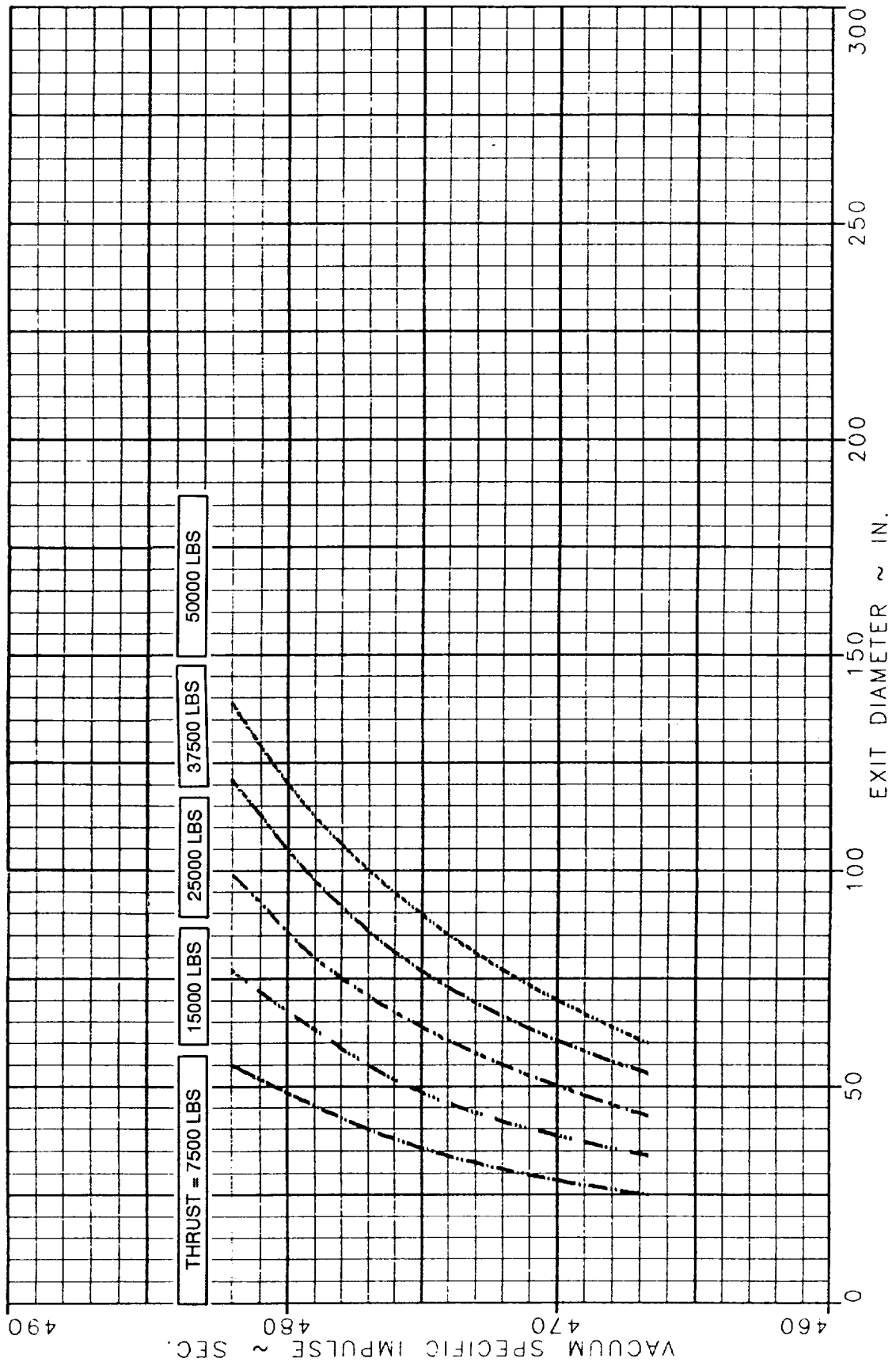

Figure 63. Vacuum Specific Impulse Versus Exhaust Nozzle Exit Diameter for Chamber Pressure = 2000 psia

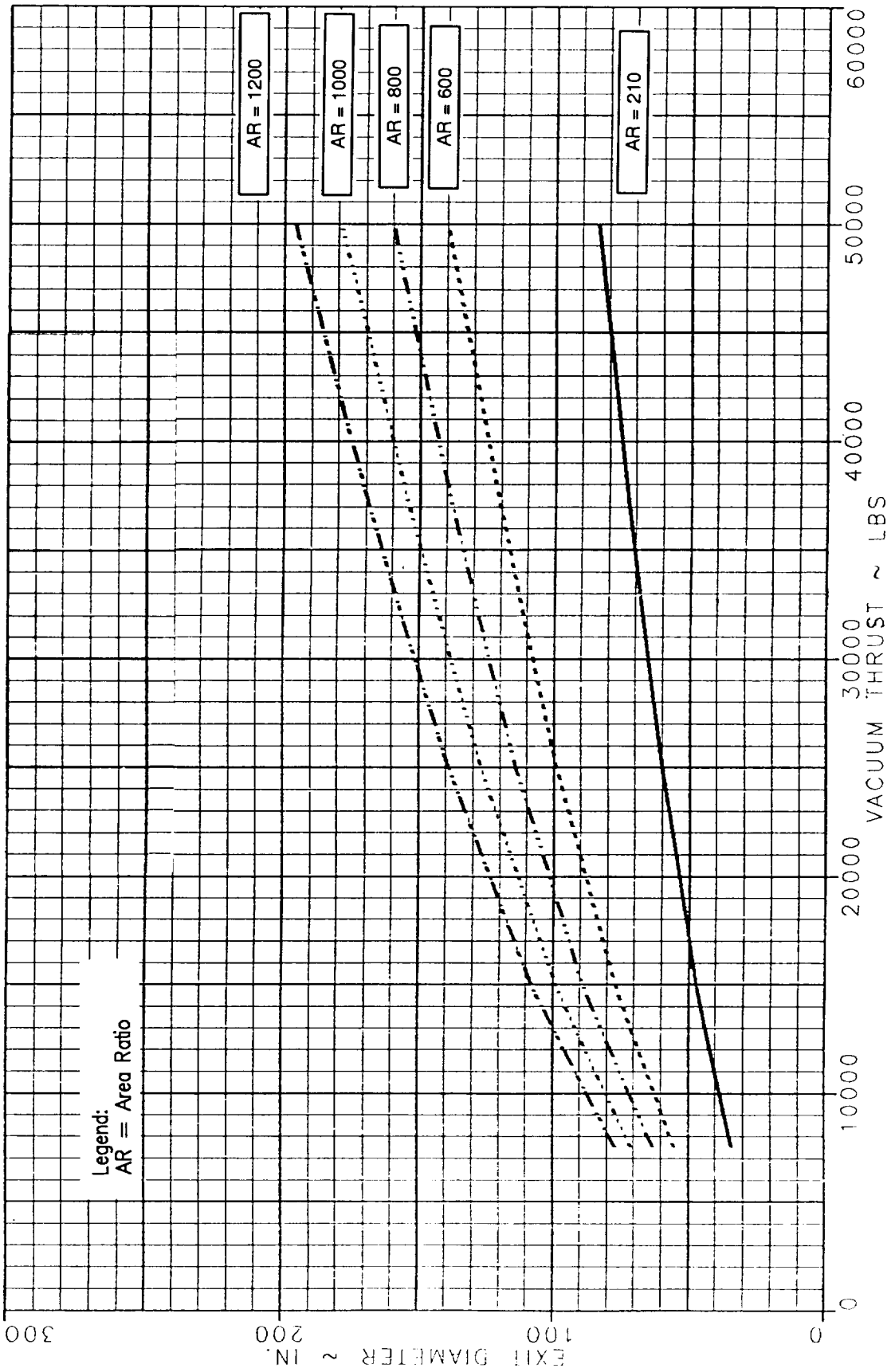

Figure 64. Exhaust Nozzle Exit Diameter Versus Thrust for Chamber Pressure = 1000 psia

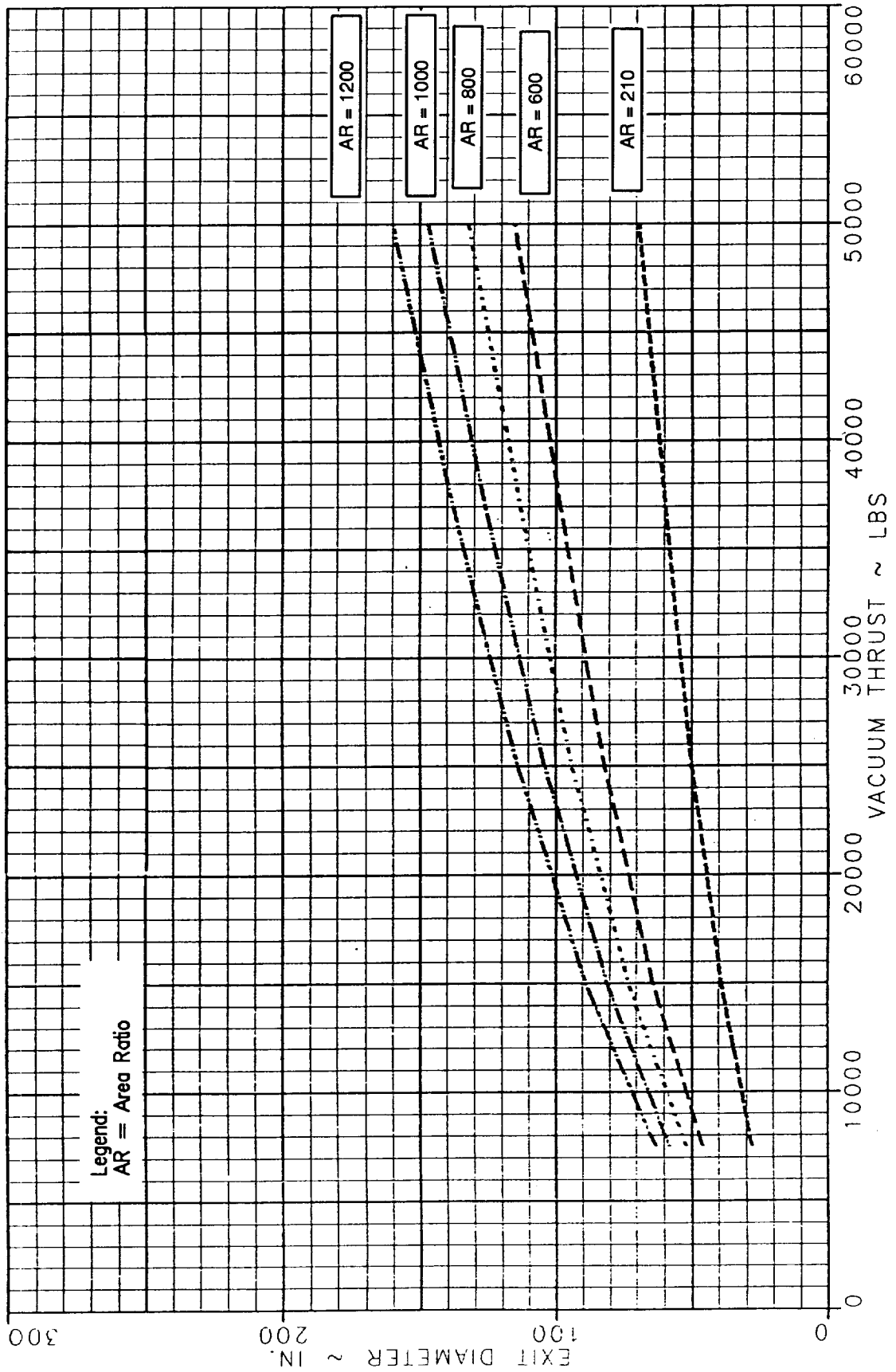

Figure 65. Exhaust Nozzle Exit Diameter Versus Thrust for Chamber Pressure = 1500 psia

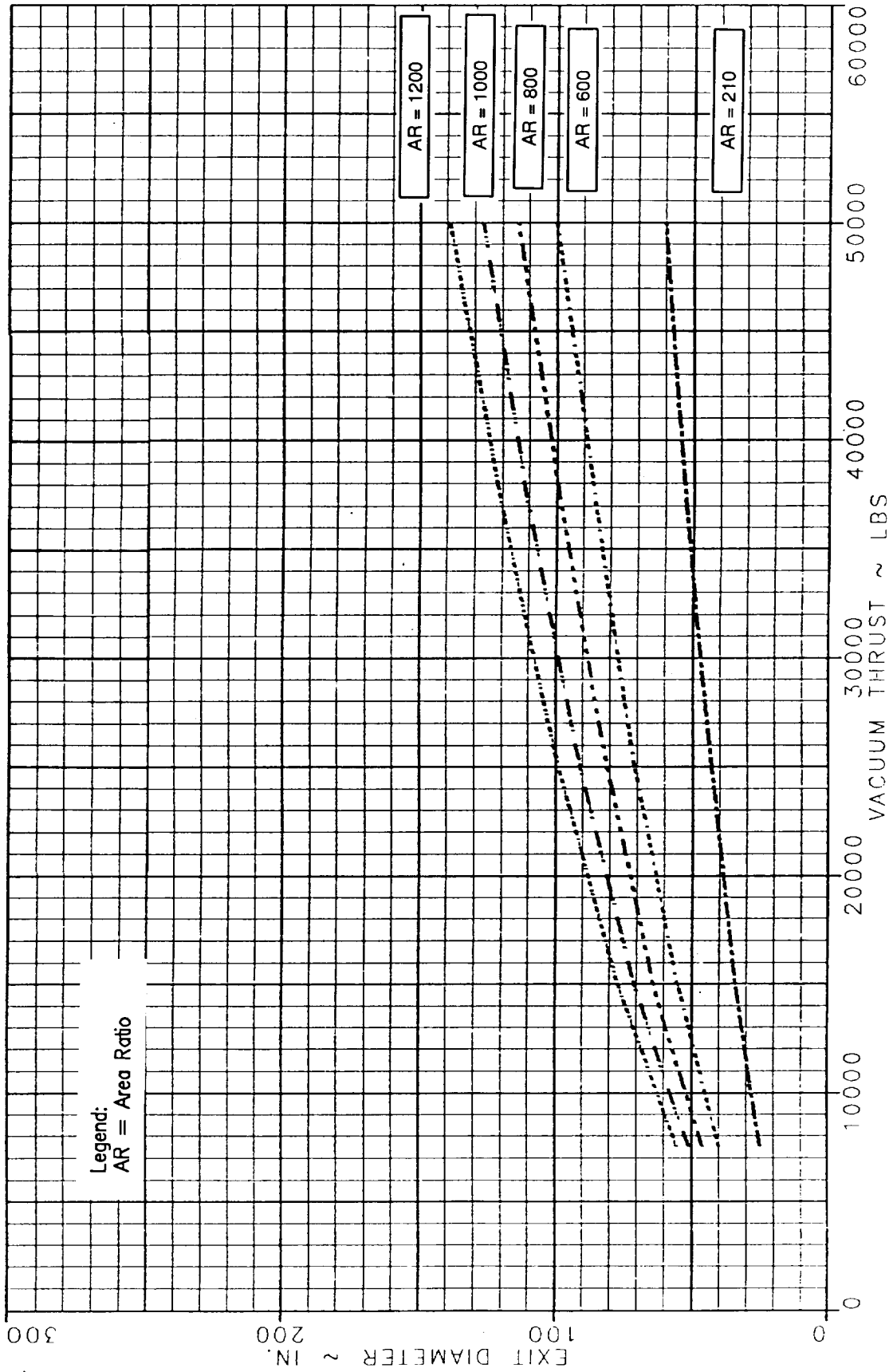

Figure 66. Exhaust Nozzle Exit Diameter Versus Thrust for Chamber Pressure = 2000 psia

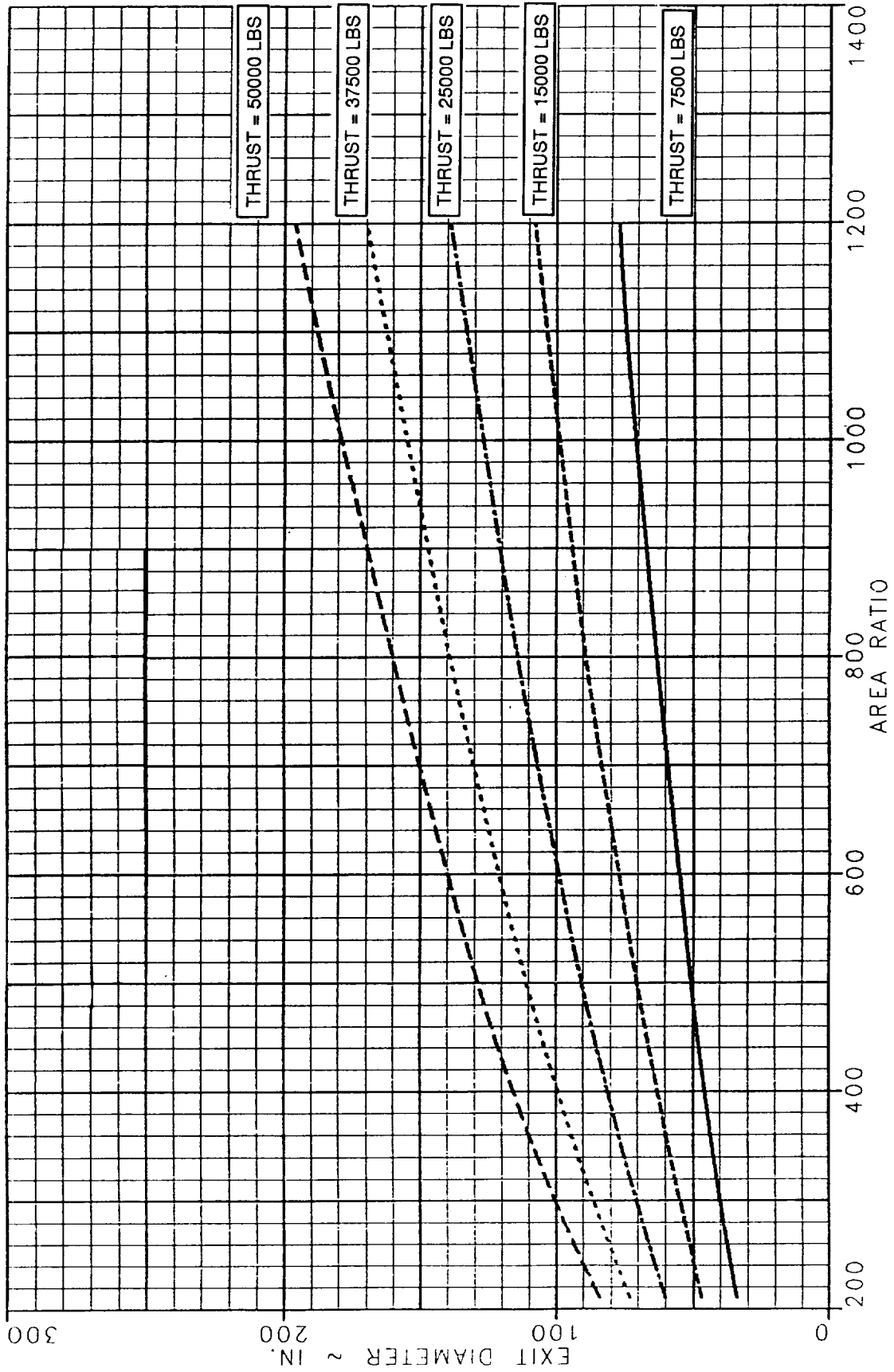

Figure 67. Exhaust Nozzle Exit Diameter Versus Area Ratio for Chamber Pressure = 1000 psia

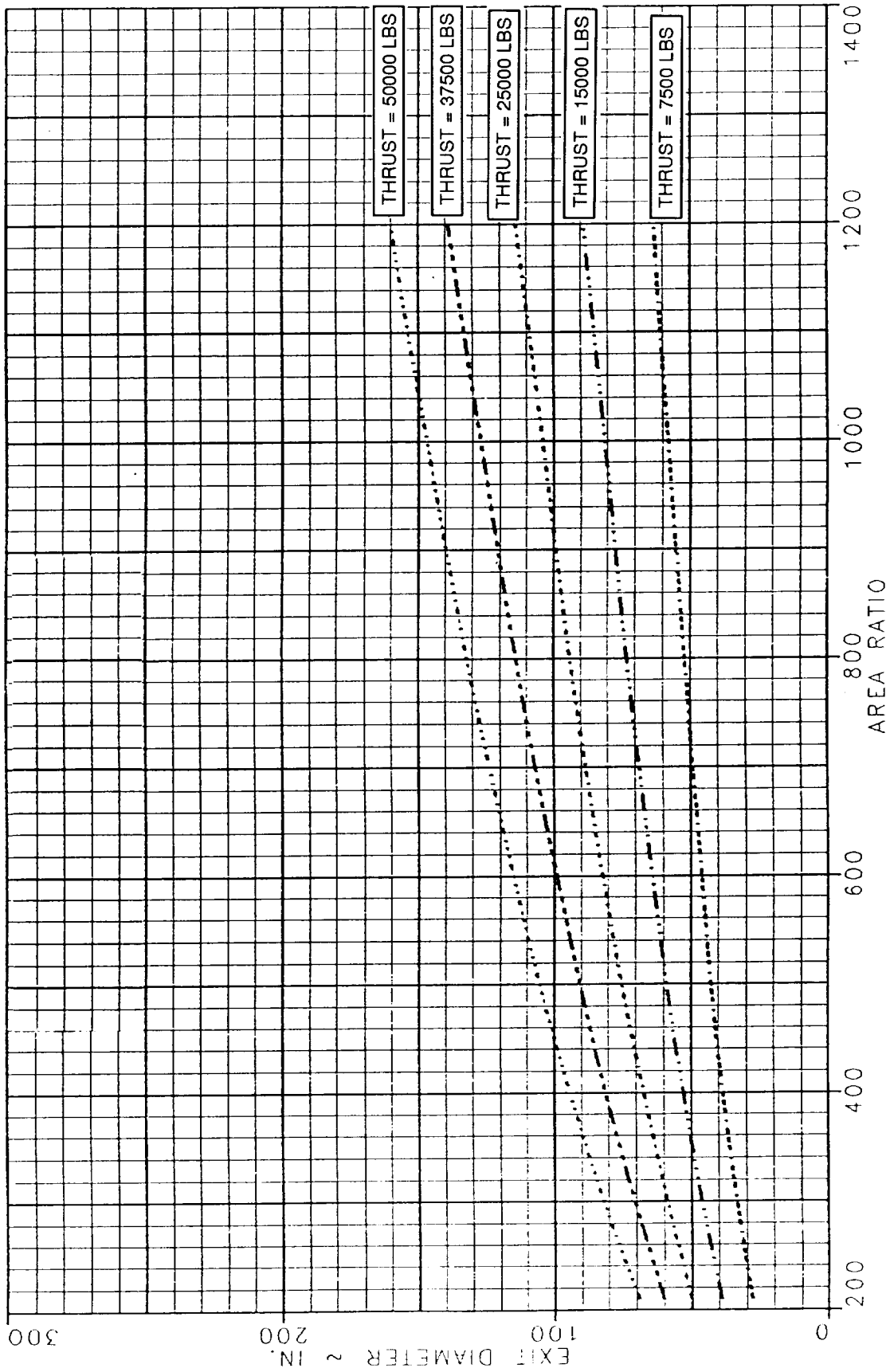

Figure 68. Exhaust Nozzle Exit Diameter Versus Area Ratio for Chamber Pressure = 1500 psia

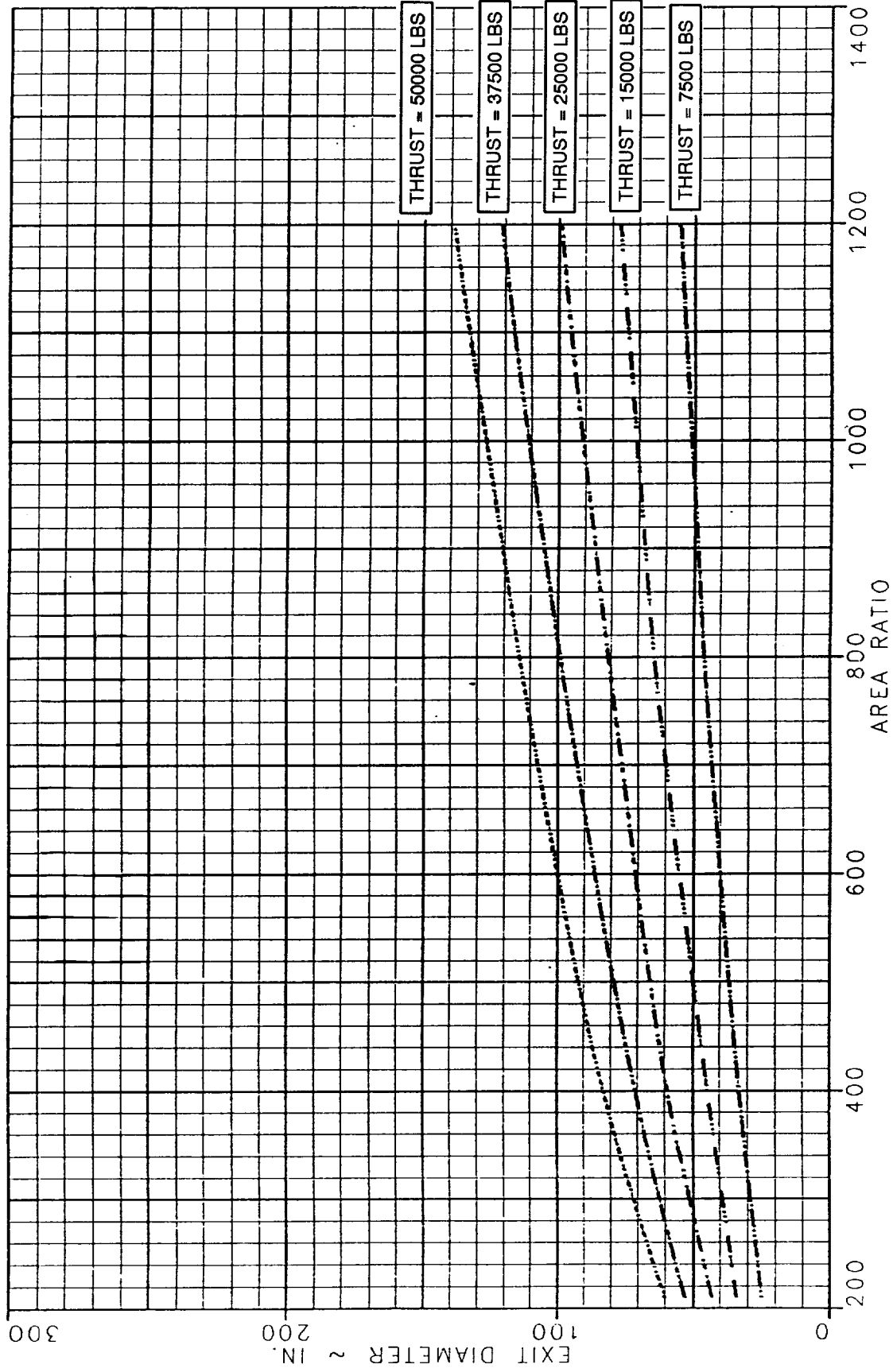

Figure 69. Exhaust Nozzle Exit Diameter Versus Area Ratio for Chamber Pressure = 2000 psia

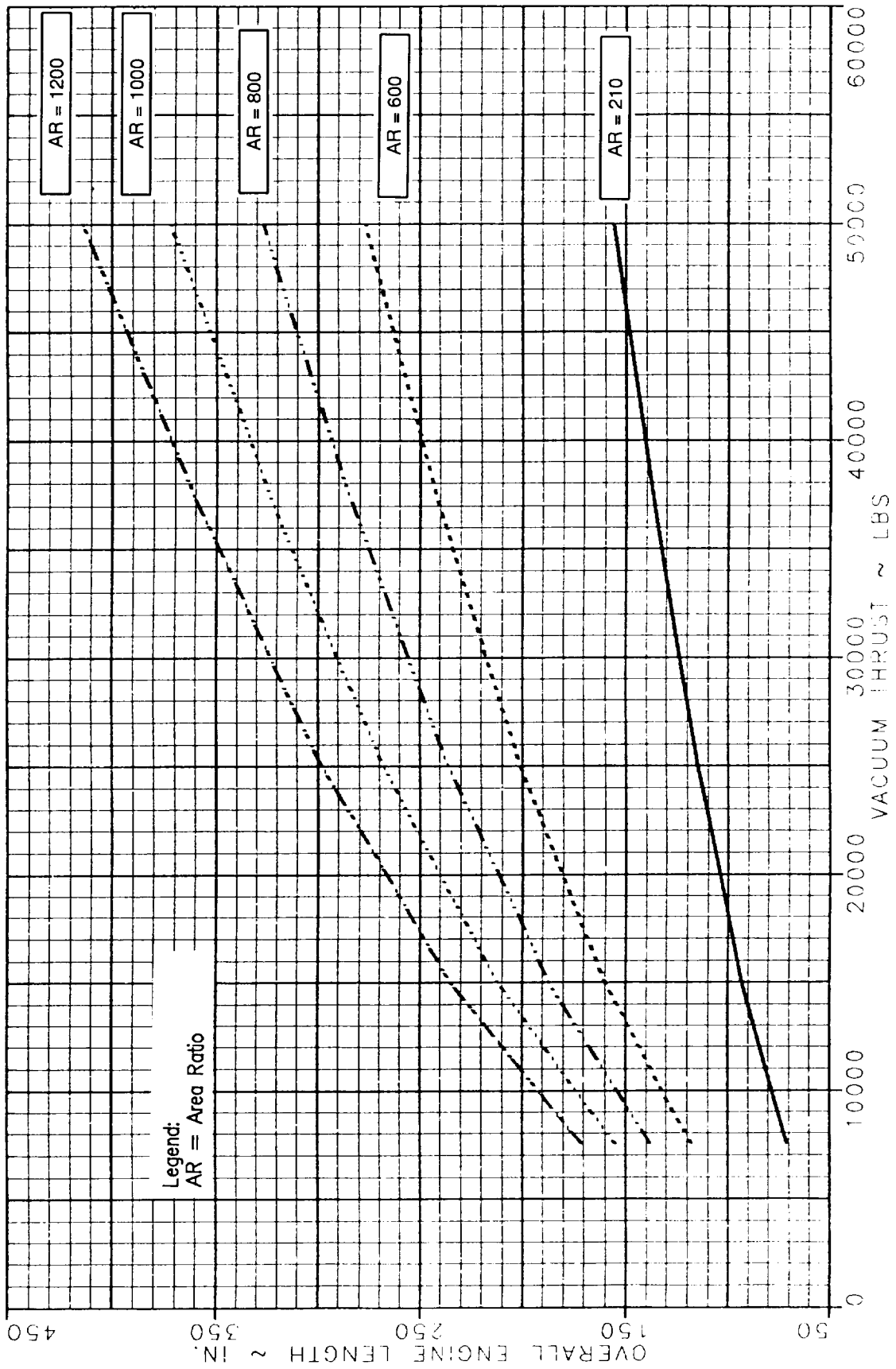

Figure 70. Engine Length Versus Thrust for Chamber Pressure = 1000 psia

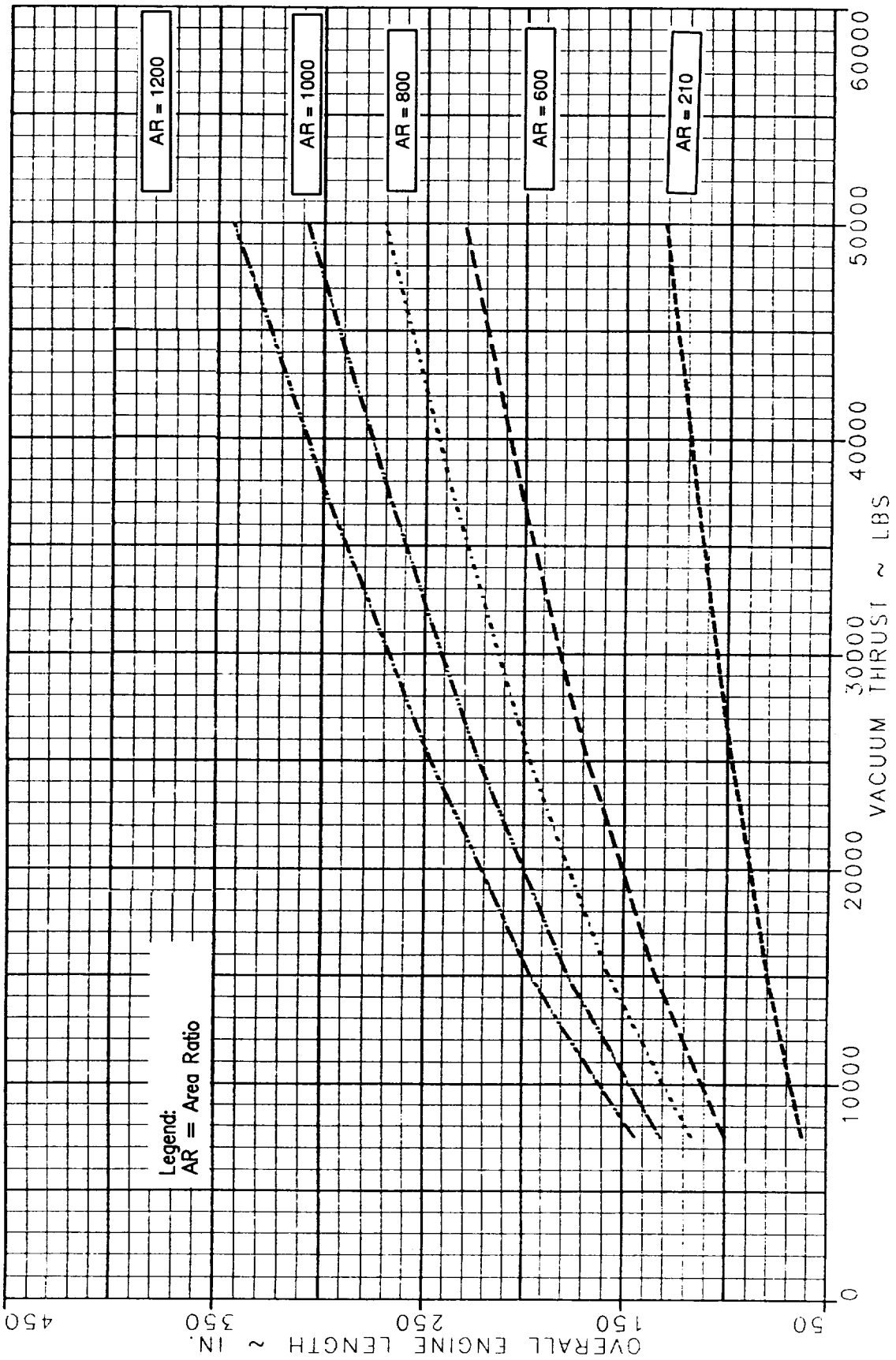

Figure 71. Engine Length Versus Thrust for Chamber Pressure = 1500 psia

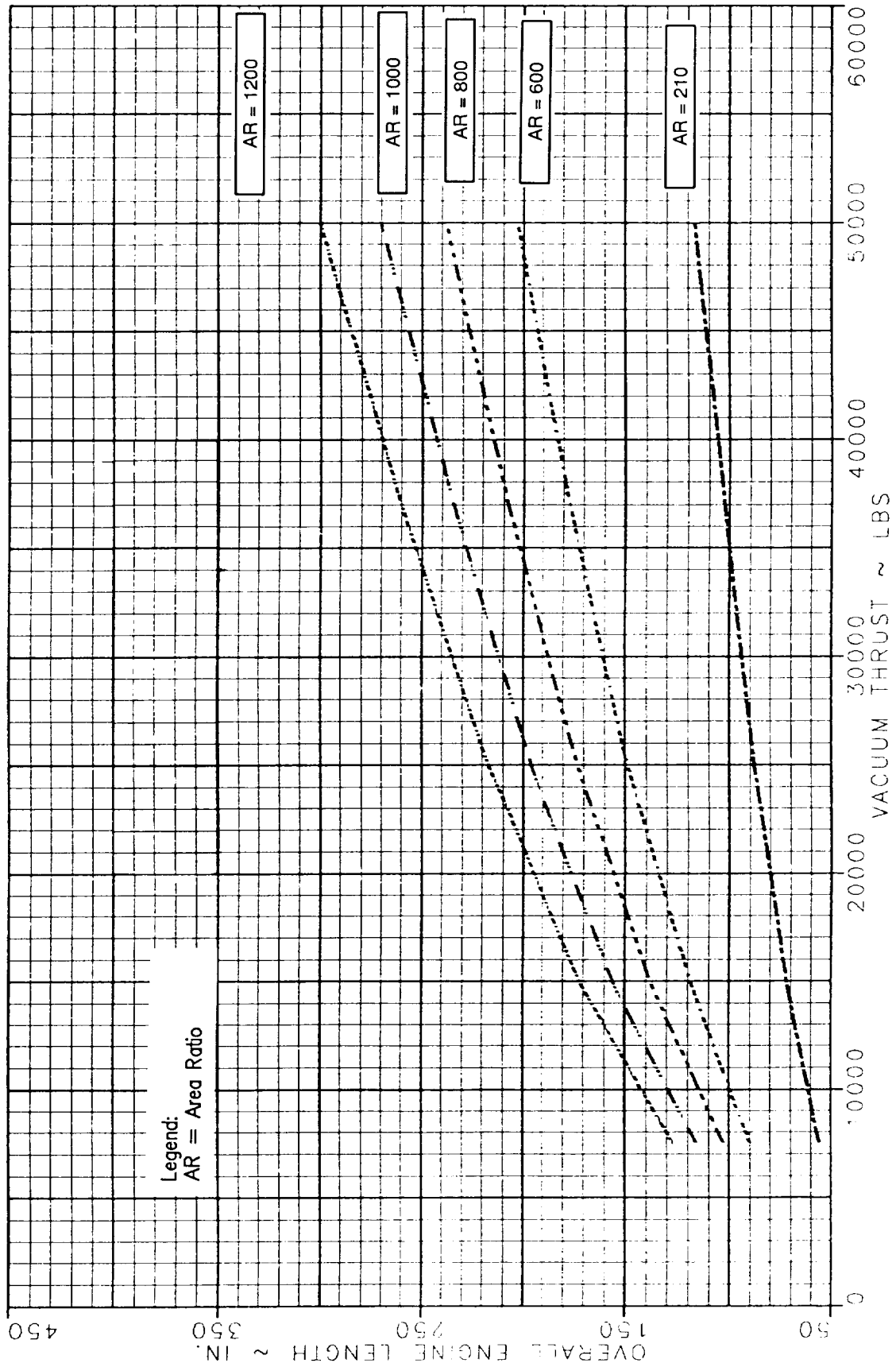

Figure 72. Engine Length Versus Thrust for Chamber Pressure = 2000 psia

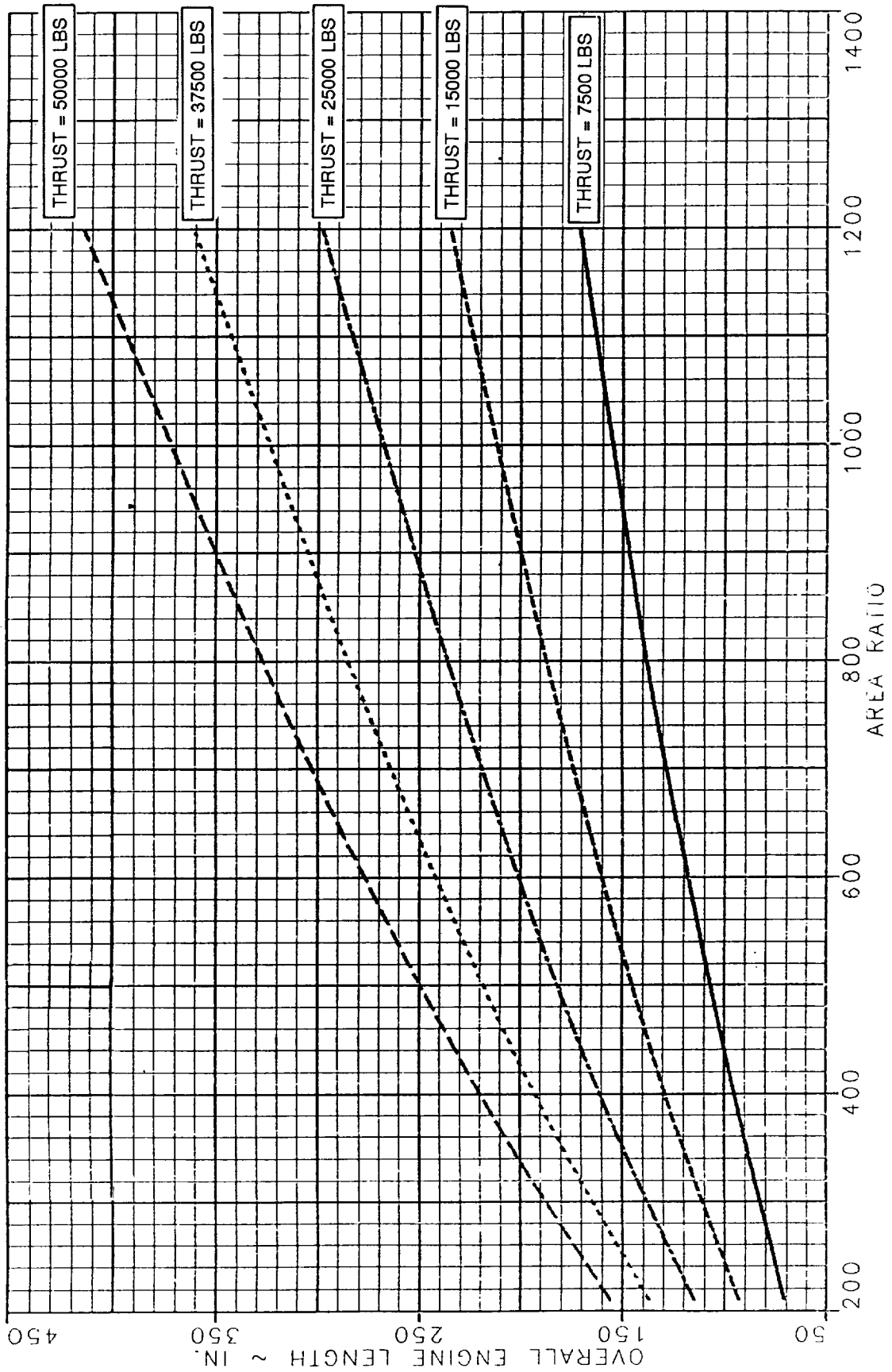

Figure 73. Engine Length Versus Area Ratio for Chamber Pressure = 1000 psia

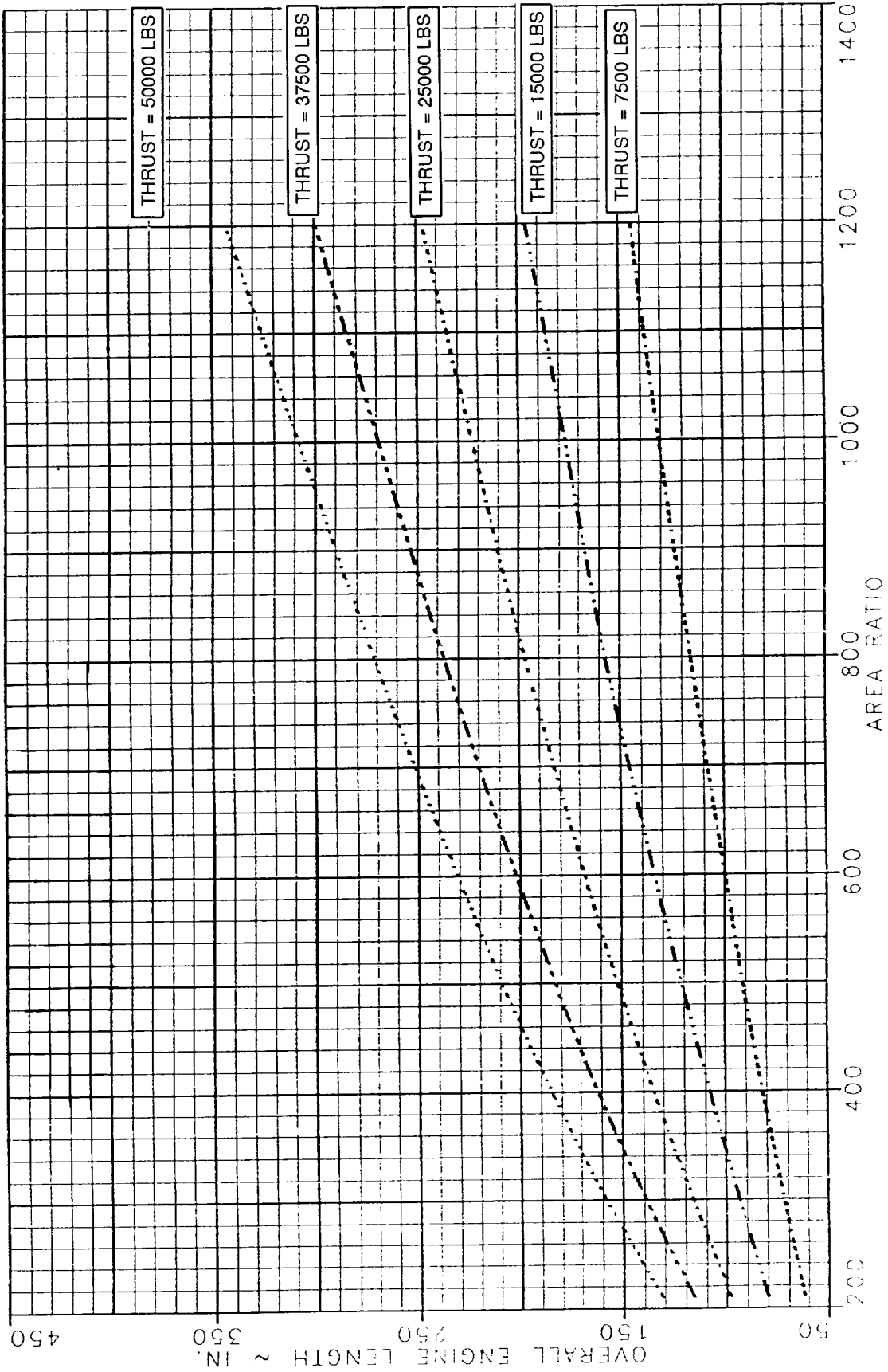

Figure 74. Engine Length Versus Area Ratio for Chamber Pressure = 1500 psia

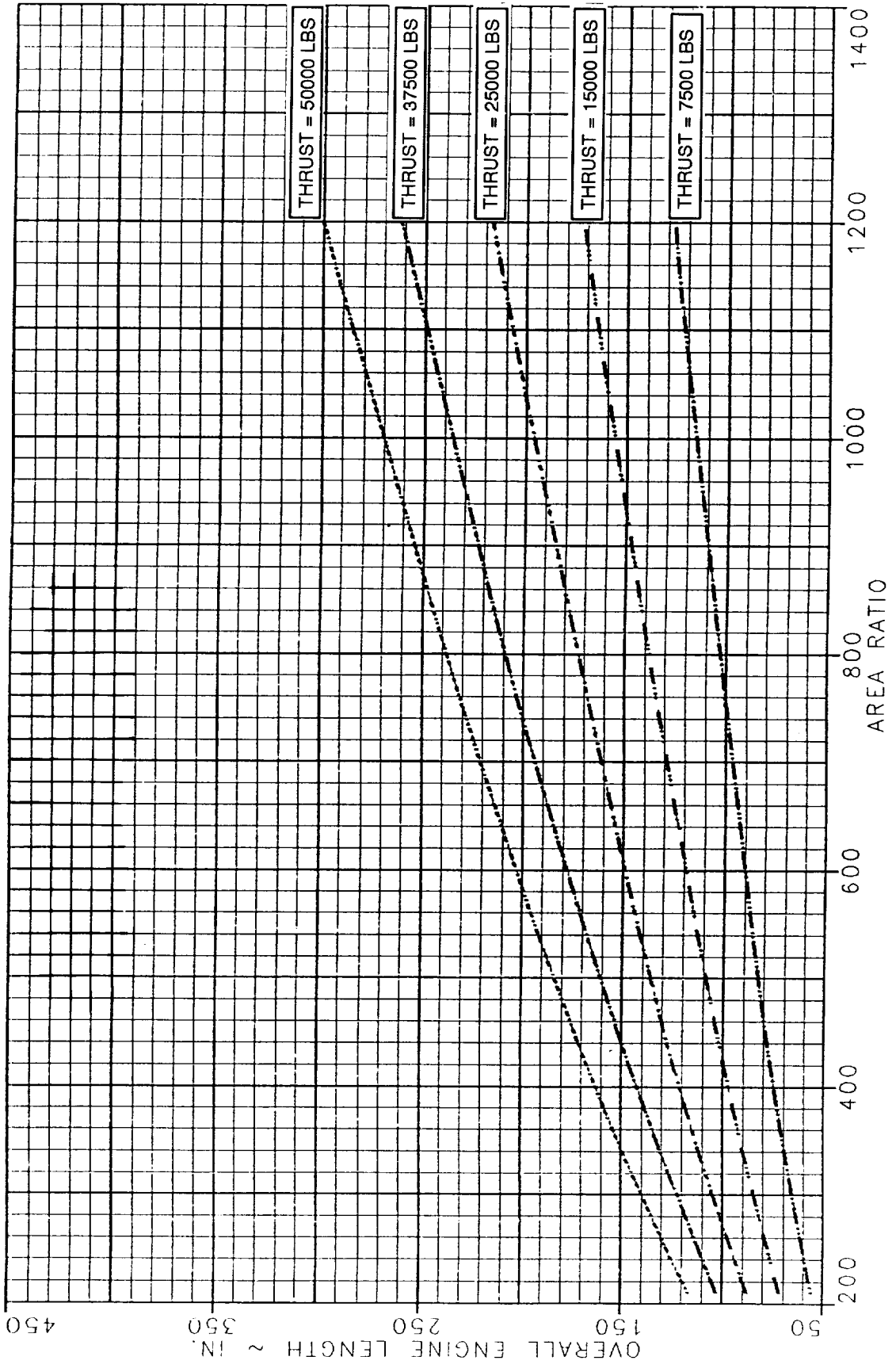

Figure 75. Engine Length Versus Area Ratio for Chamber Pressure = 2000 psia

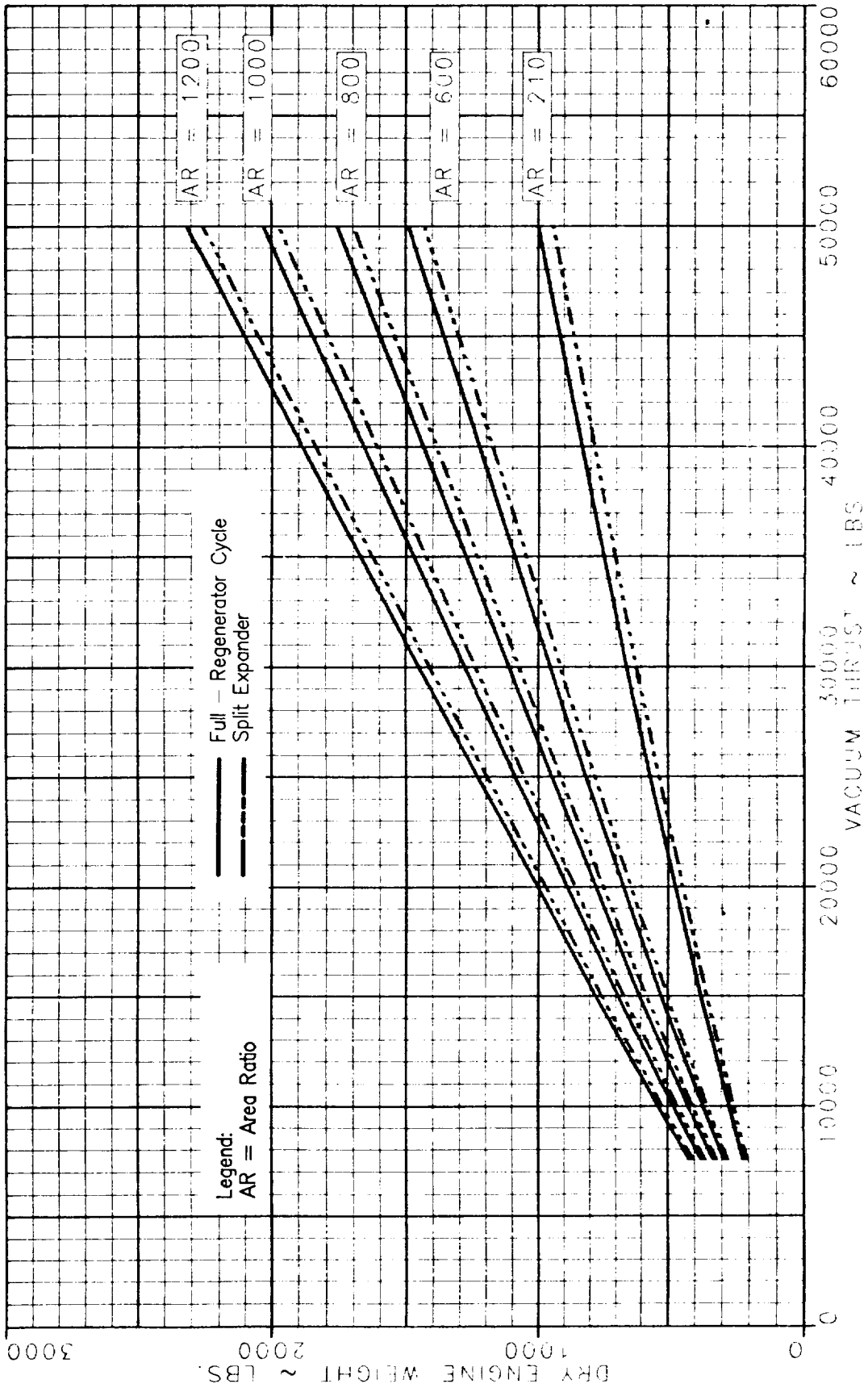

Figure 76. Parametric Engine Dry Weight Data for Chamber Pressure = 1000 psia

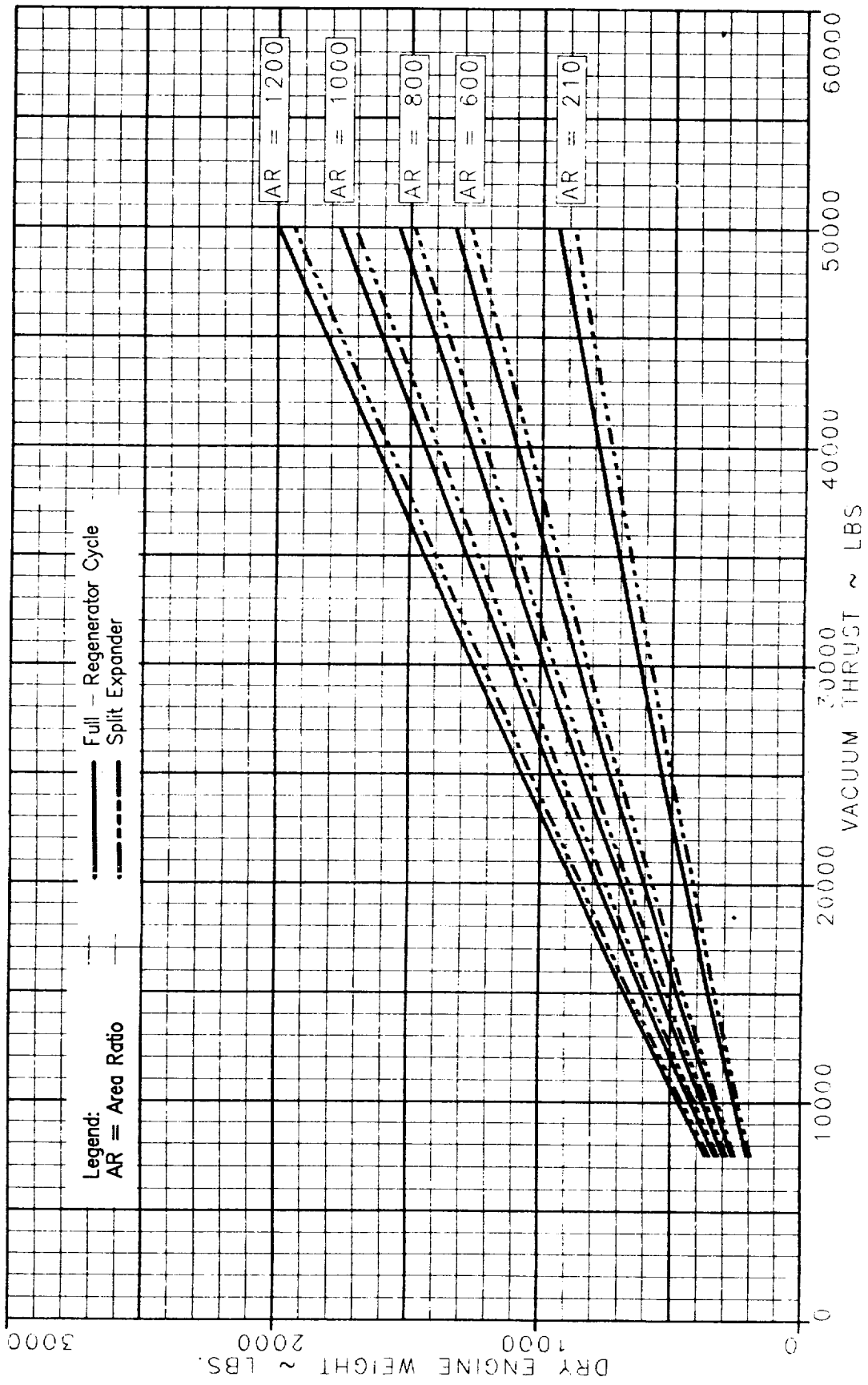

Figure 77. Parametric Engine Dry Weight Data for Chamber Pressure = 1250 psia

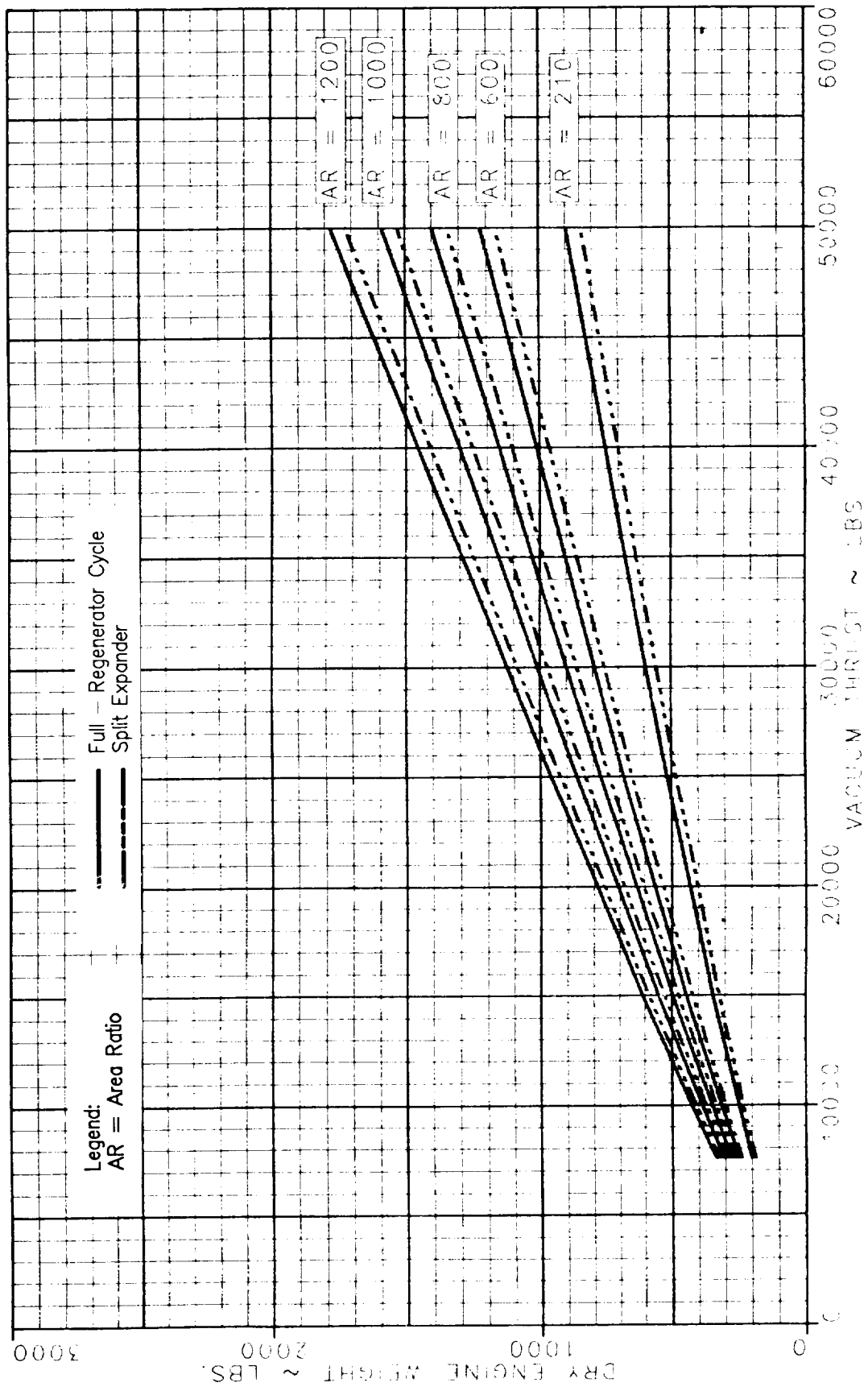

Figure 78. Parametric Engine Dry Weight Data for Chamber Pressure = 1500 psia

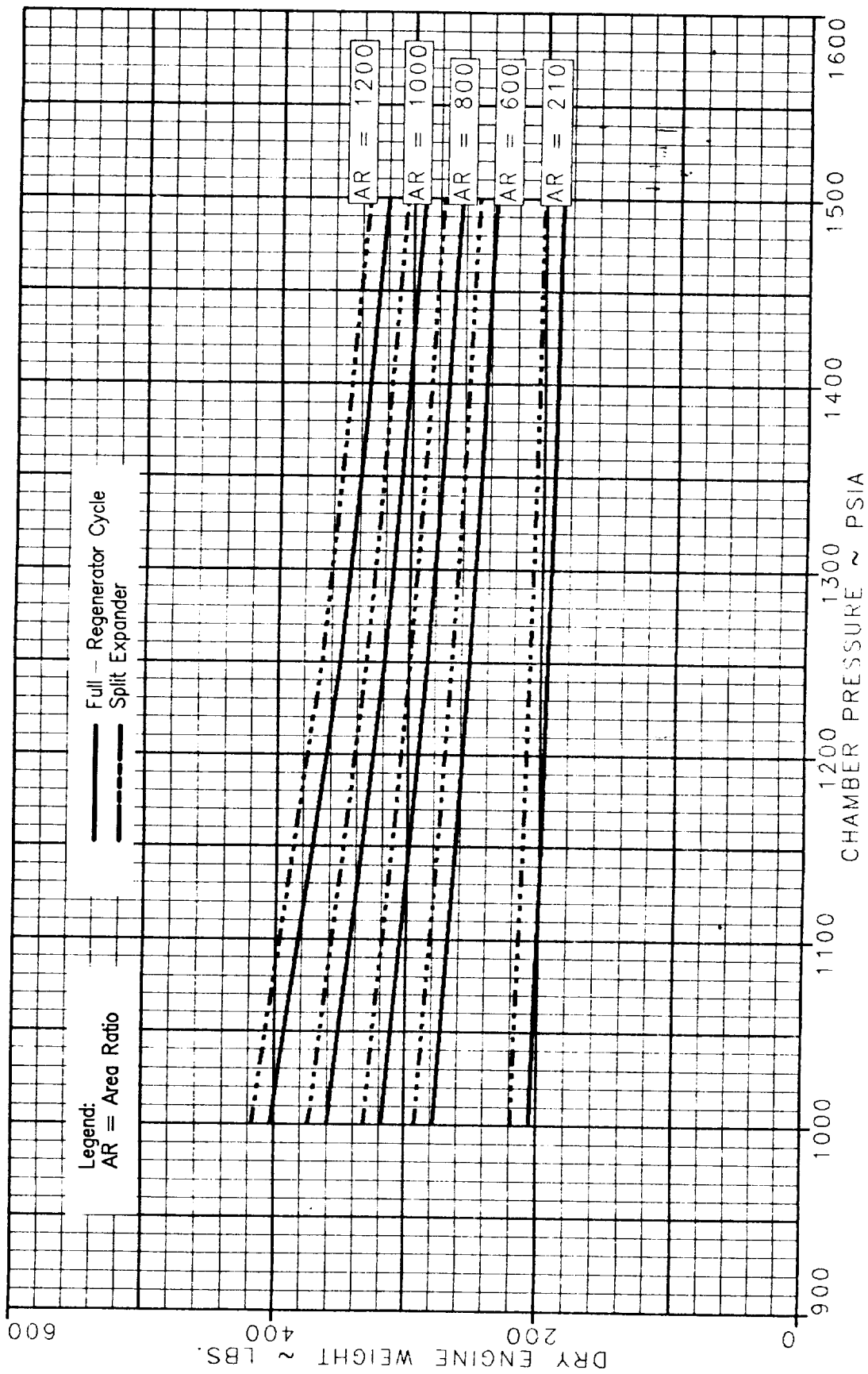

Figure 79. Parametric Engine Dry Weight Data for Vacuum Thrust = 7500 pounds

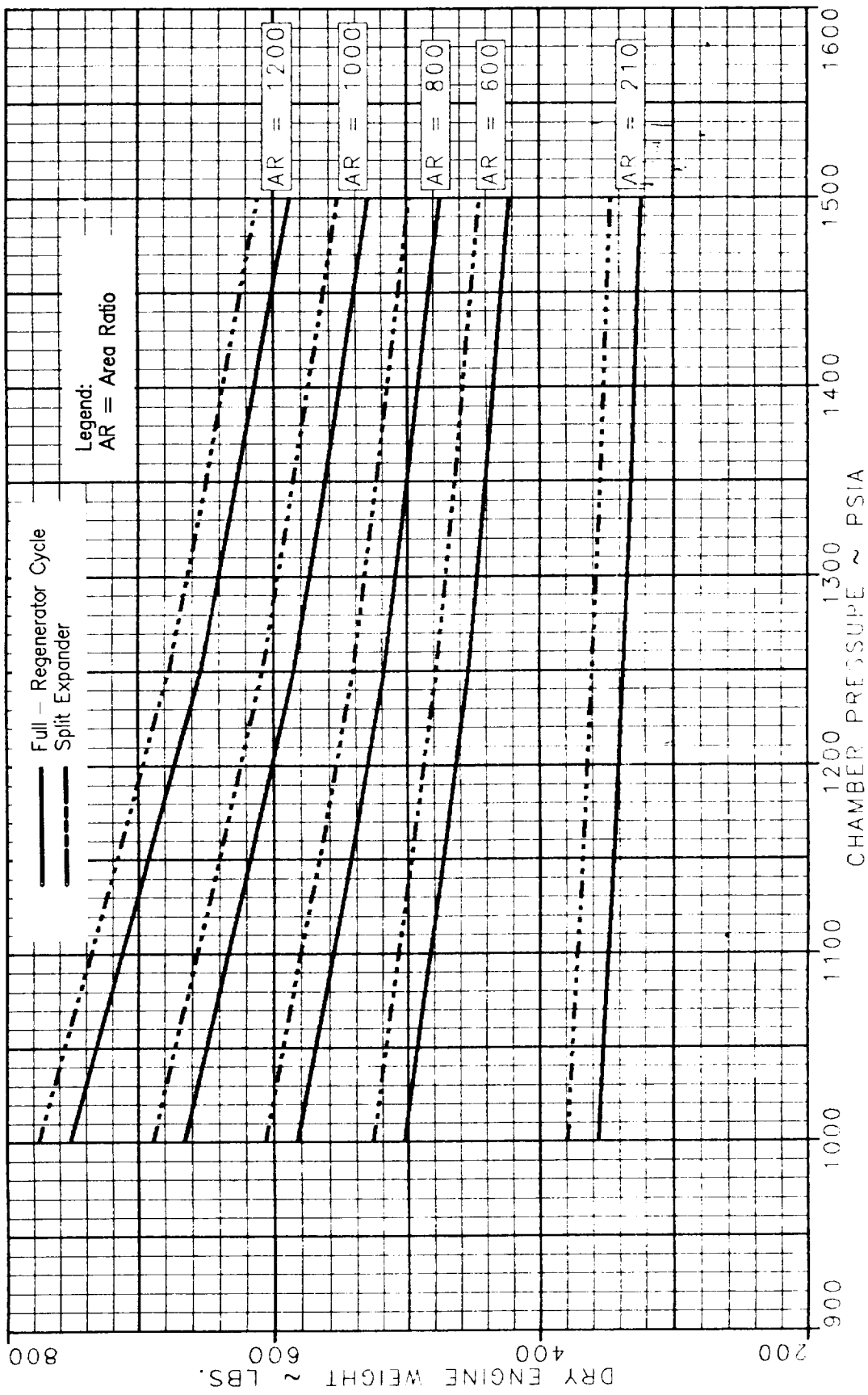

Figure 80. Parametric Engine Dry Weight Data for Vacuum Thrust = 15,000 pounds

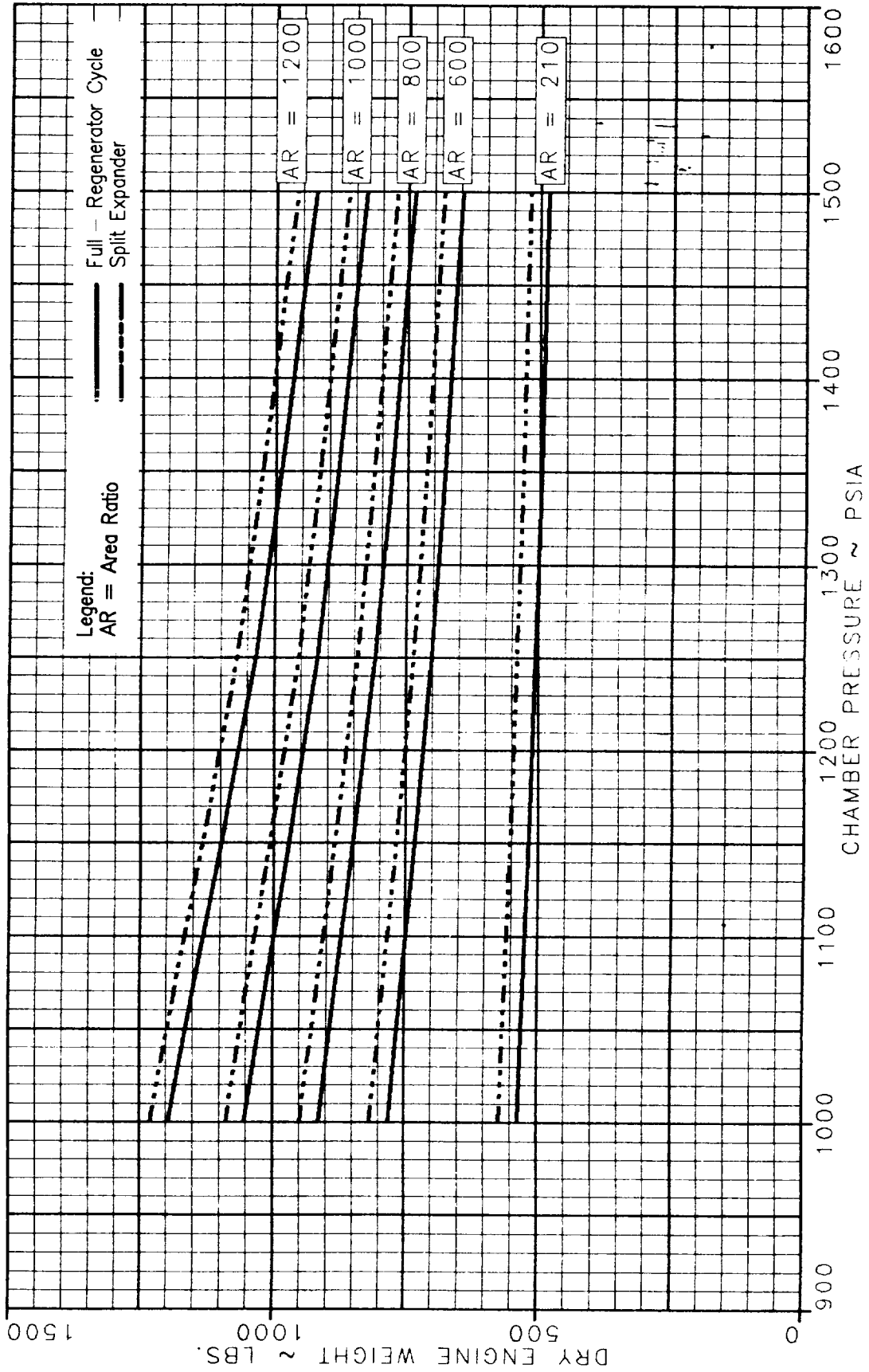

Figure 81. Parametric Engine Dry Weight Data for Vacuum Thrust = 25,000 pounds

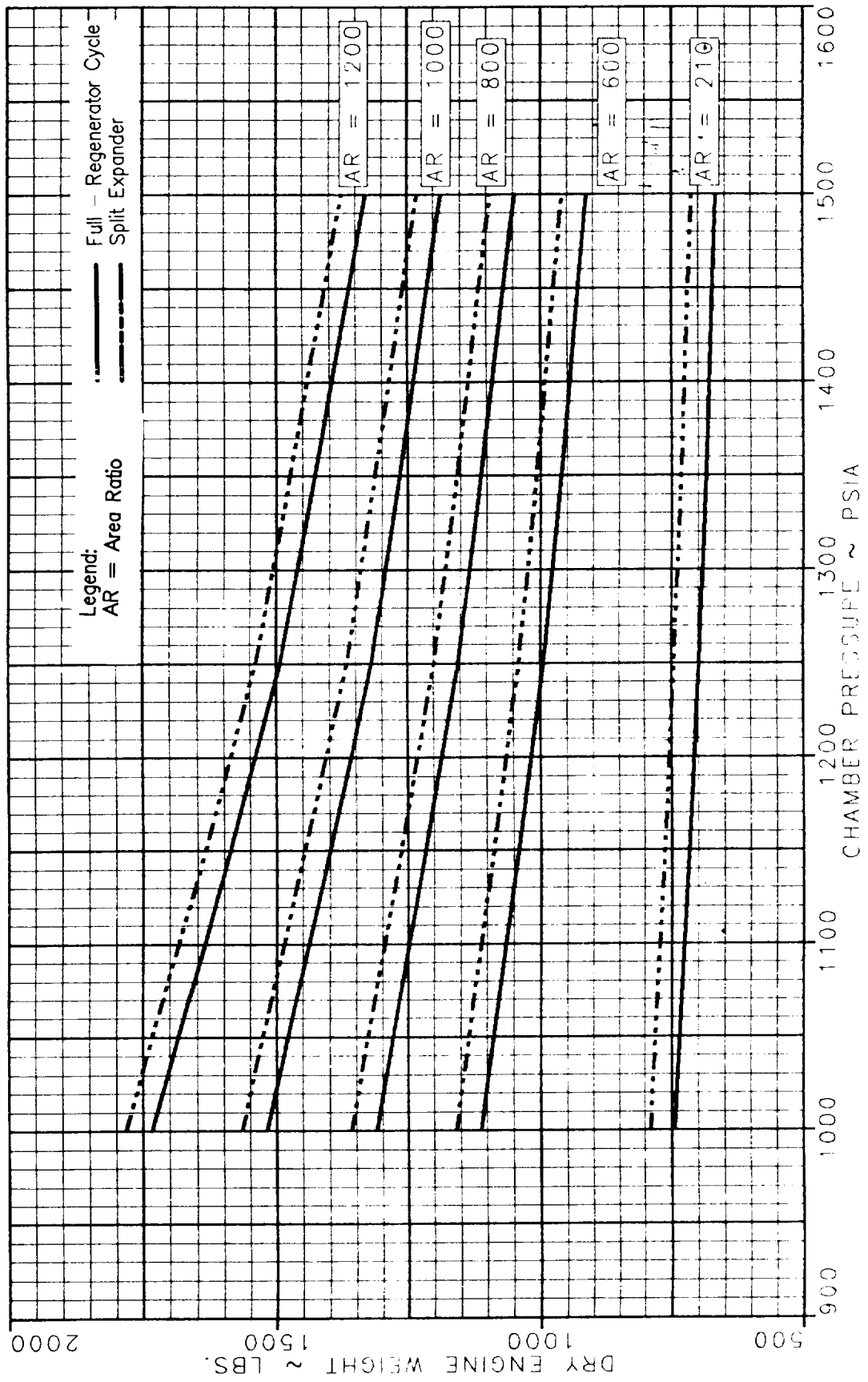

Figure 82. Parametric Engine Dry Weight Data for Vacuum Thrust = 37,500 pounds

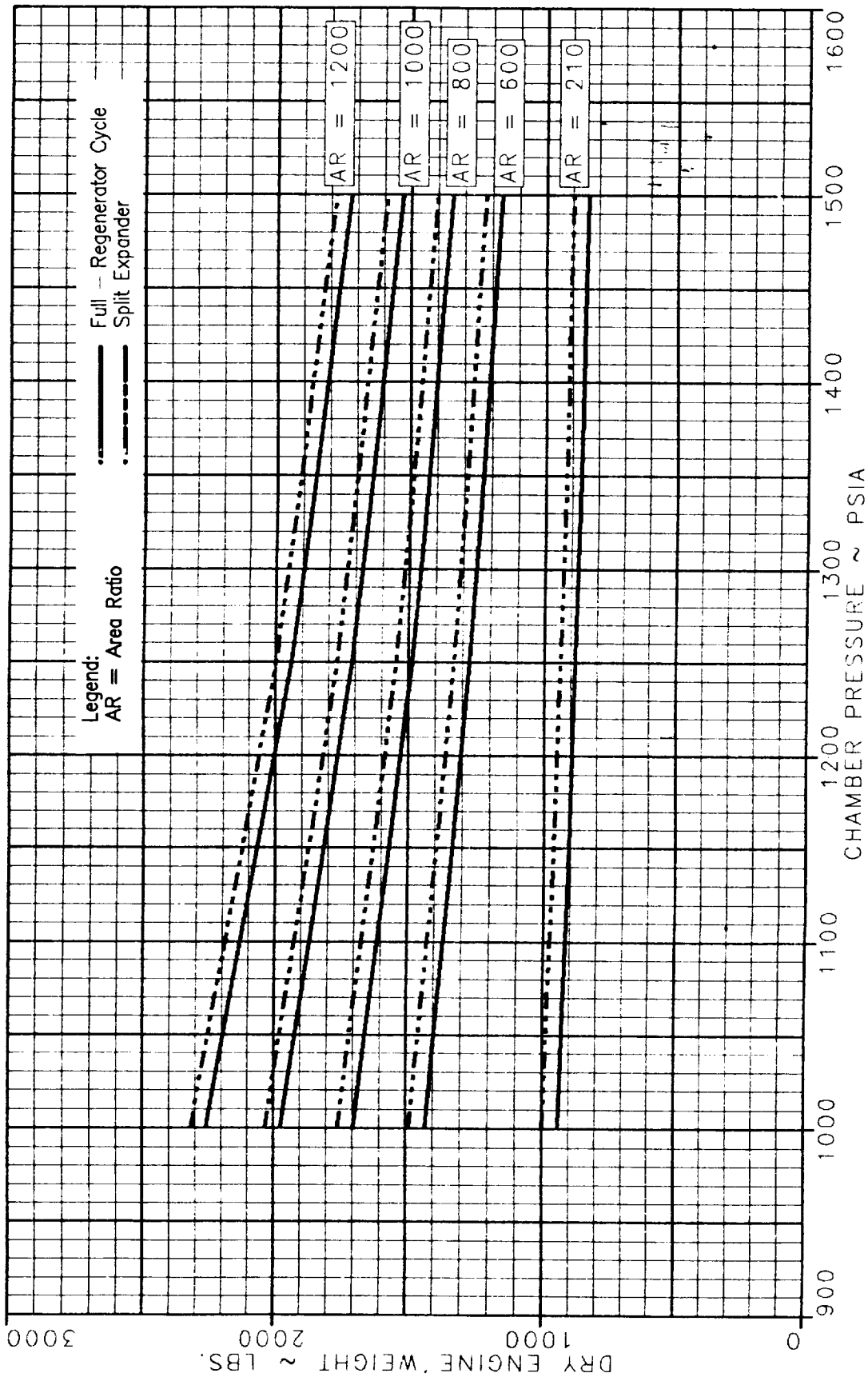

Figure 83. Parametric Engine Dry Weight Data for Vacuum Thrust = 50,000 pounds

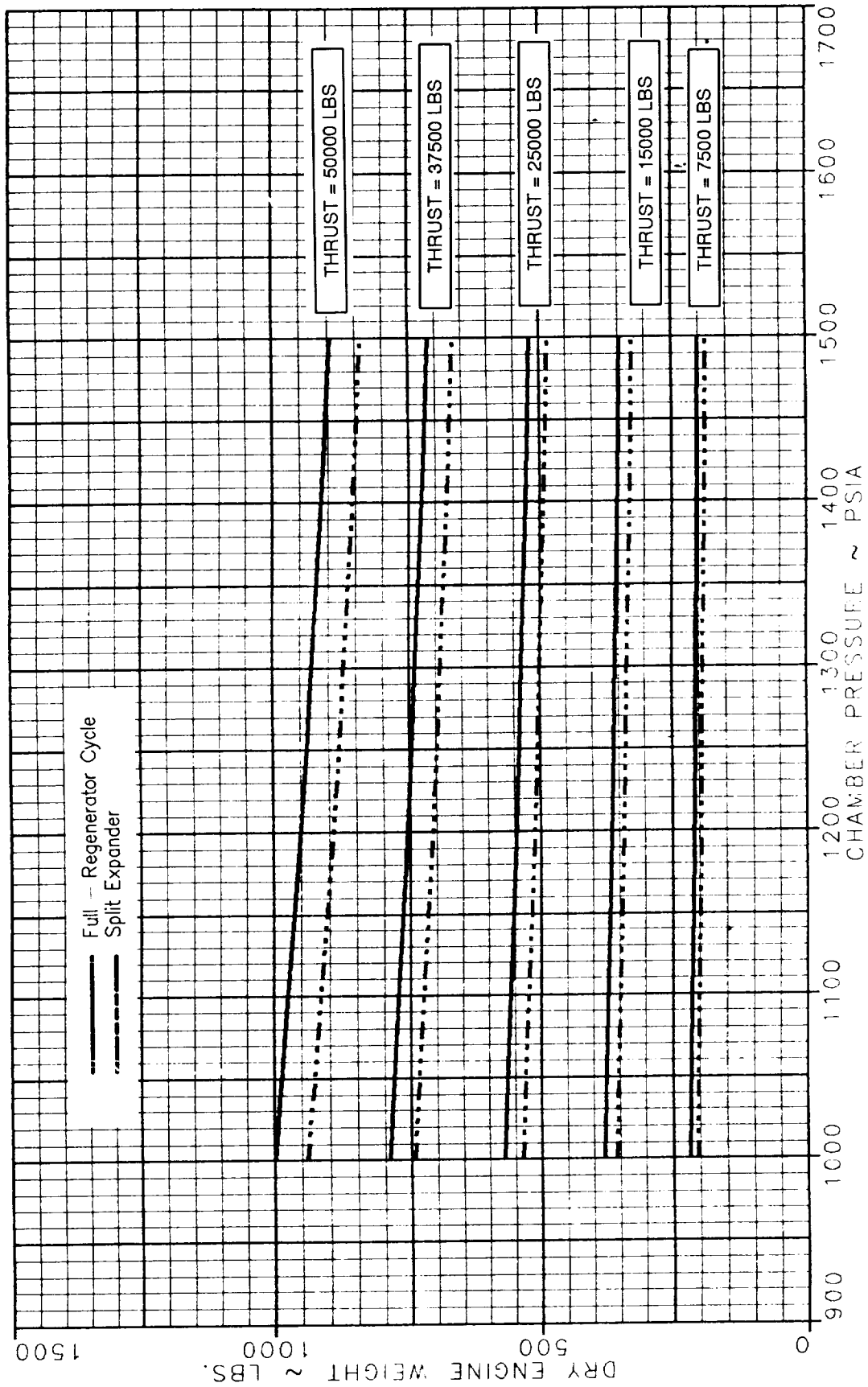

Figure 84. Parametric Engine Dry Weight Data for Area Ratio = 210

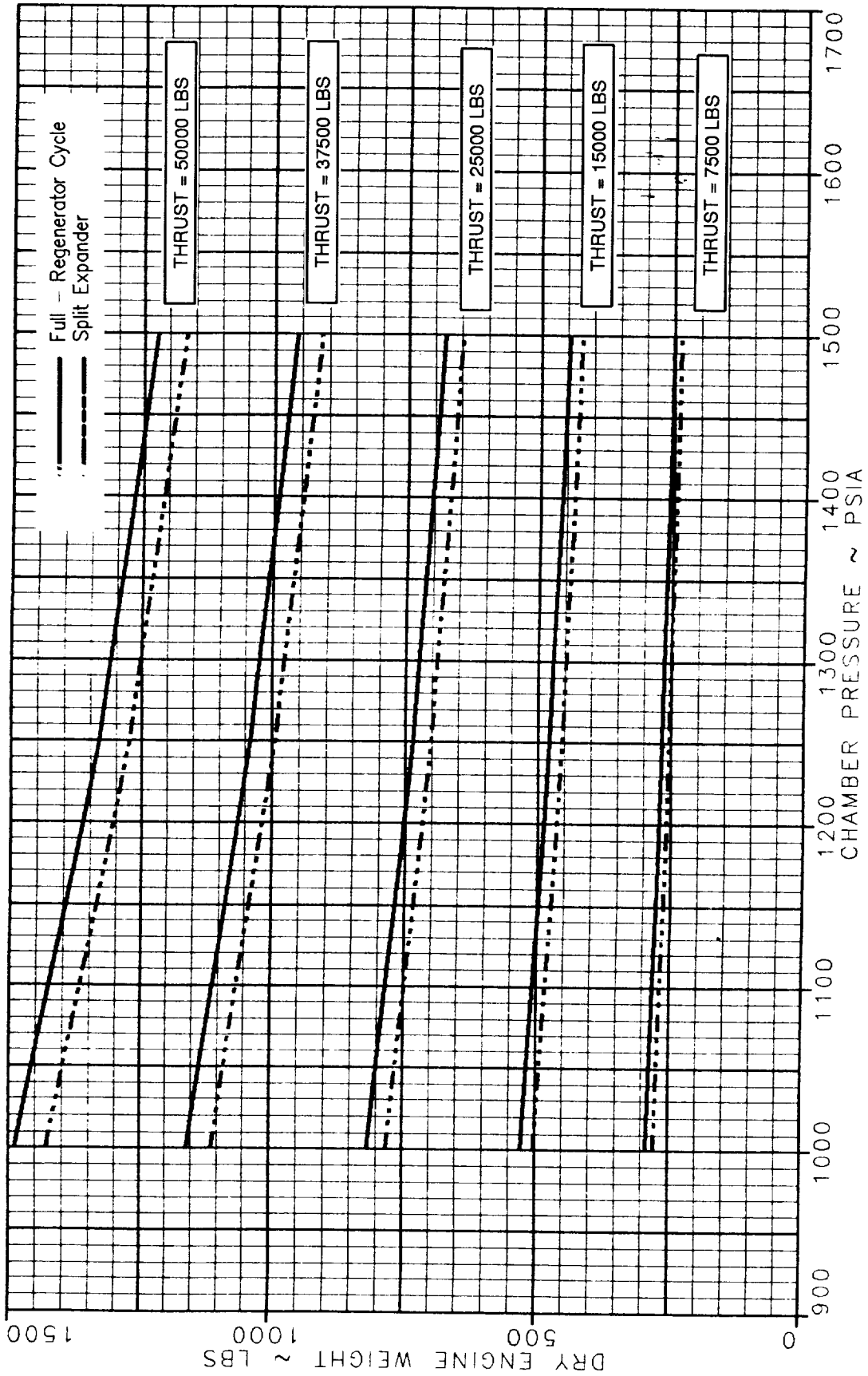

Figure 85. Parametric Engine Dry Weight Data for Area Ratio = 600

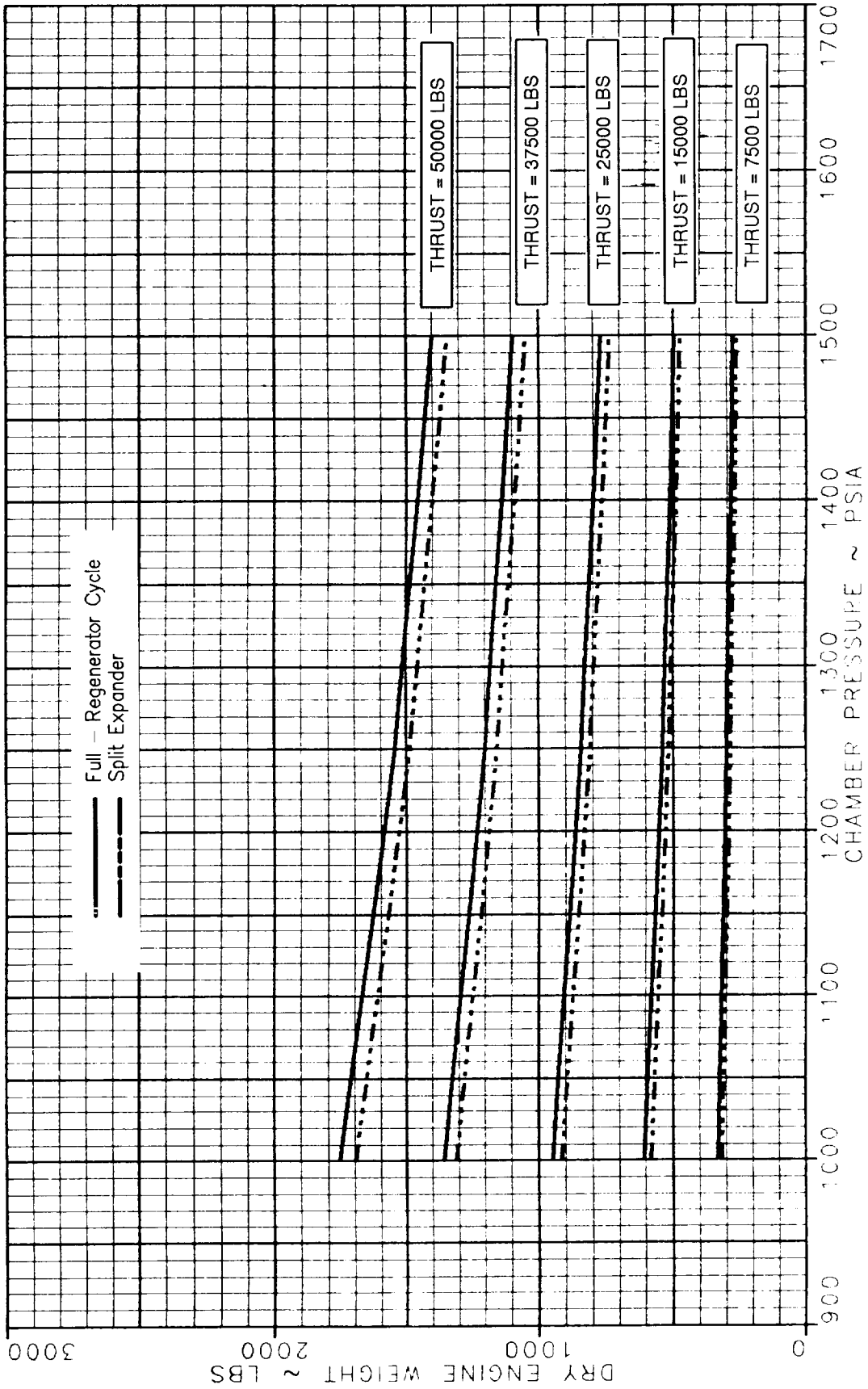

Figure 86. Parametric Engine Dry Weight Data for Area Ratio = 800

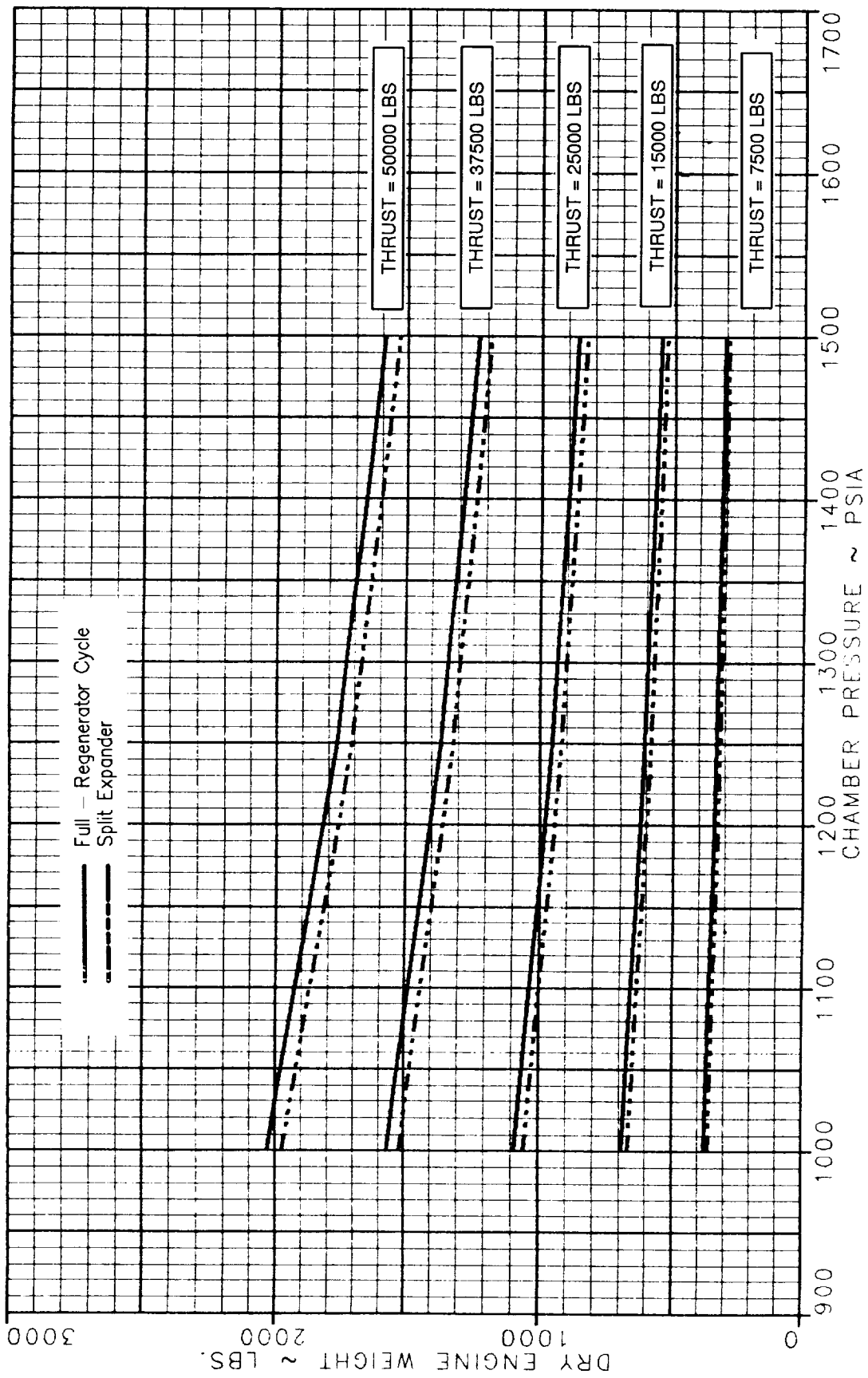

Figure 87. Parametric Engine Dry Weight Data for Area Ratio = 1000

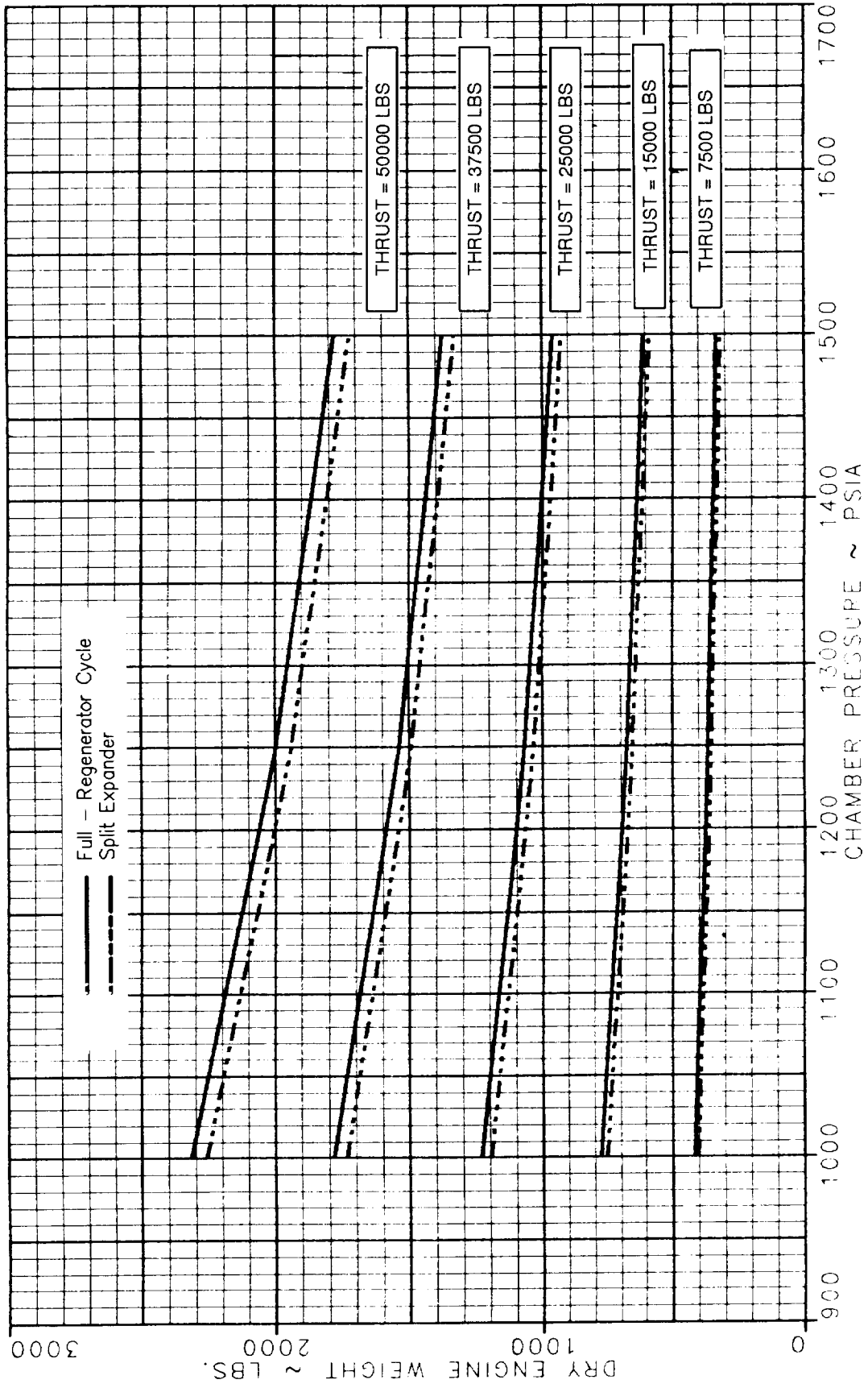

Figure 88. Parametric Engine Dry Weight Data for Area Ratio = 1200

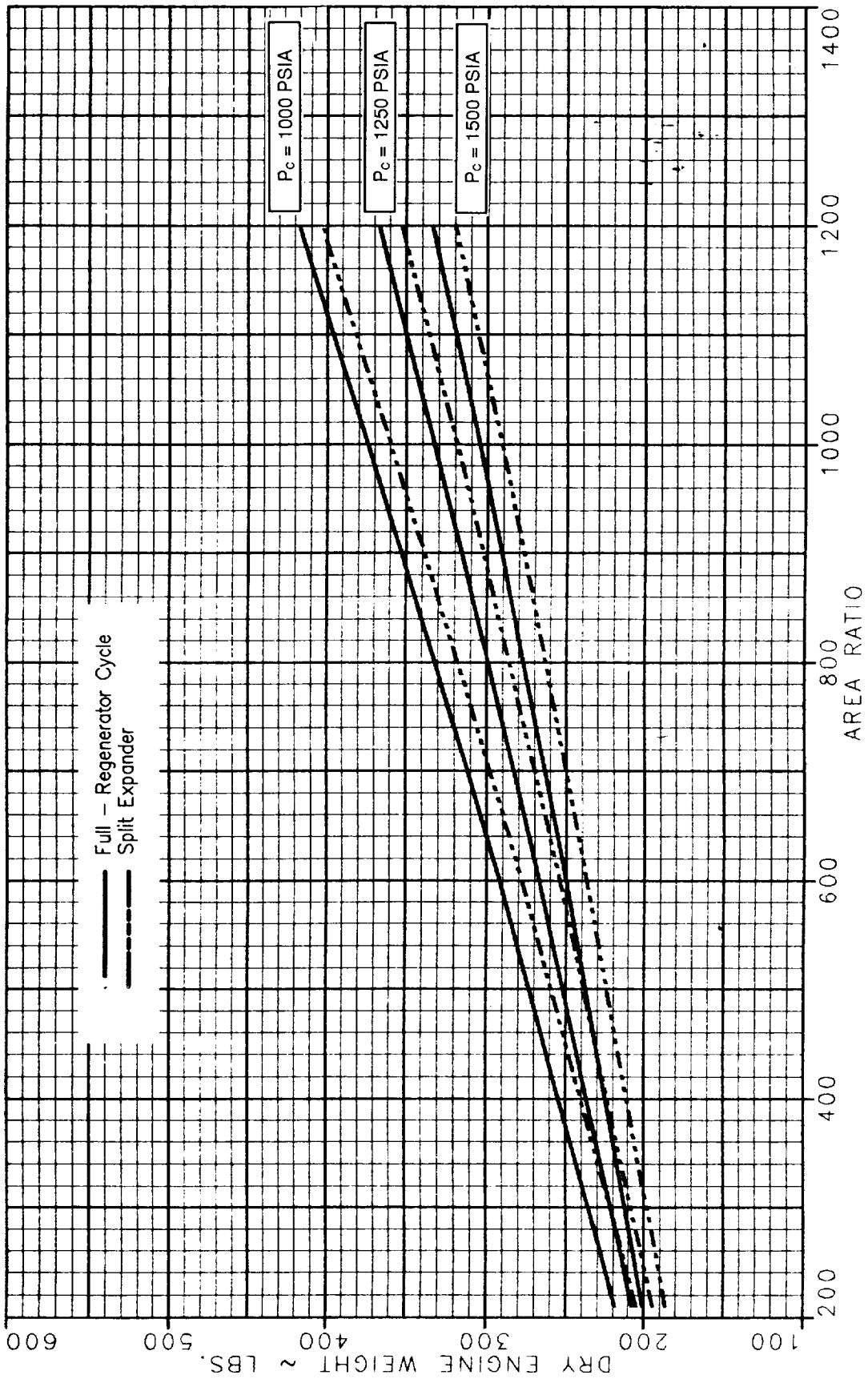

Figure 89. Parametric Engine Dry Weight Data for Thrust = 7500 lb



Figure 90. Parametric Engine Dry Weight Data for Thrust = 15,000 lb

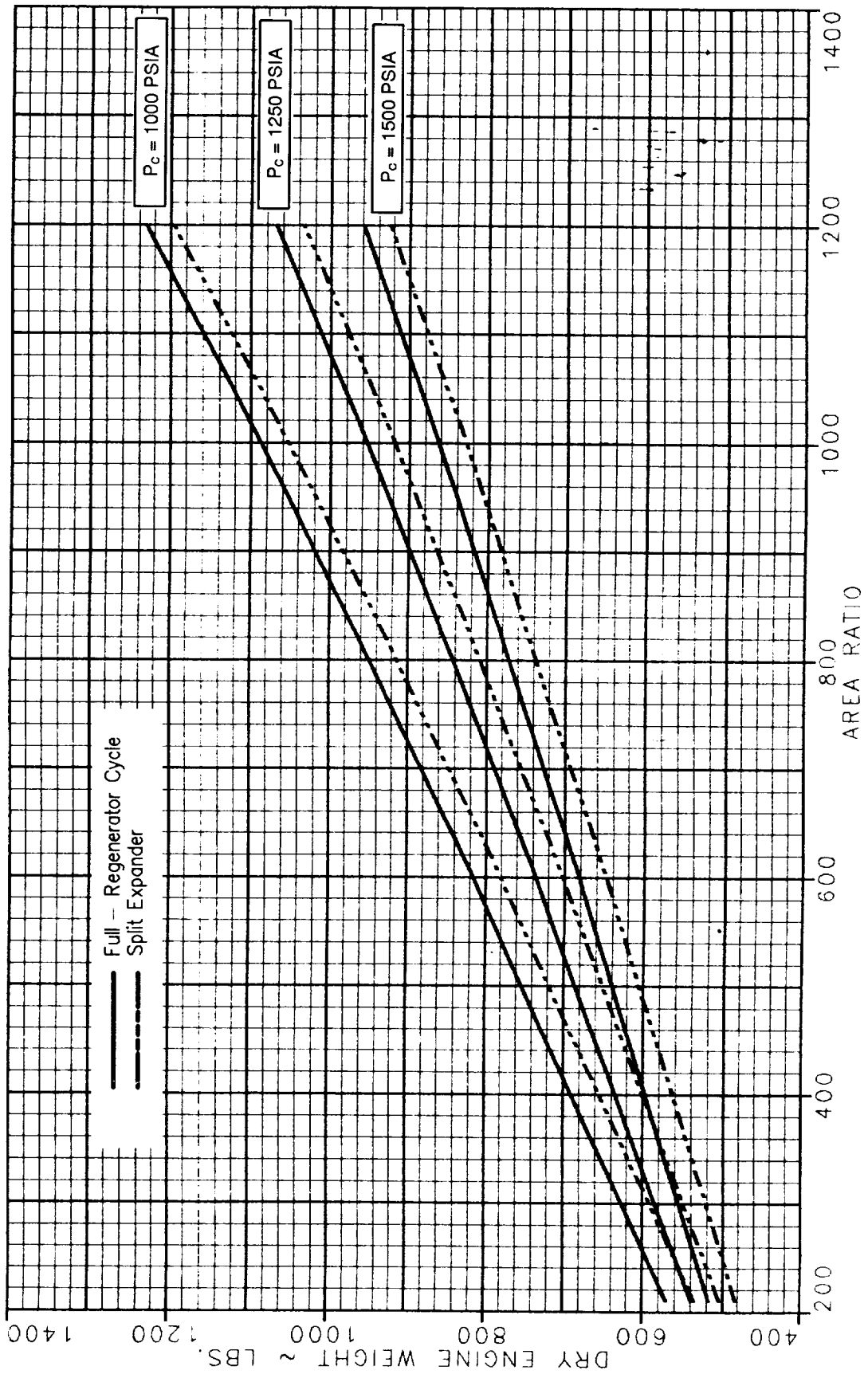

Figure 91. Parametric Engine Dry Weight Data for Thrust = 25,000 lb

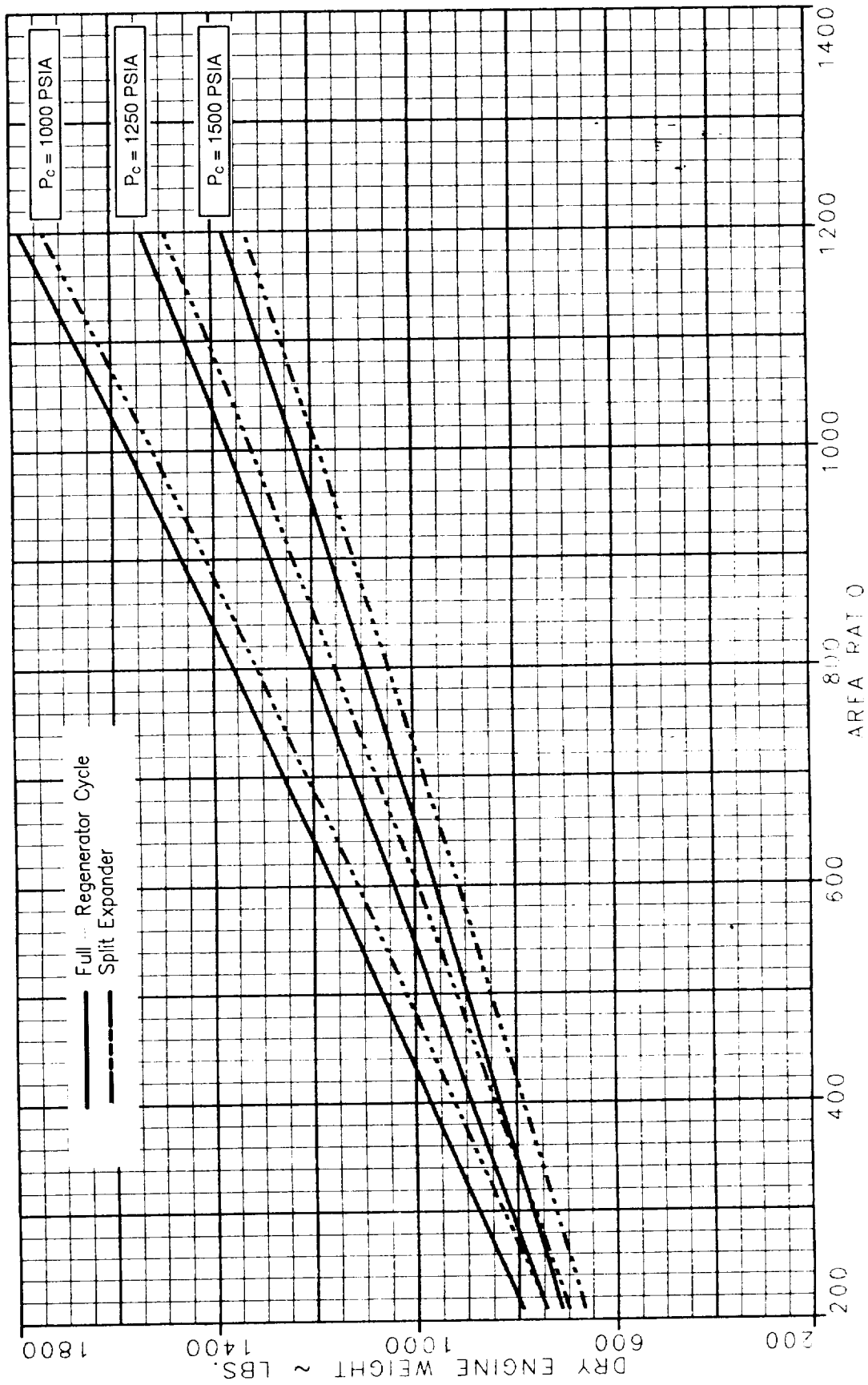

Figure 92. Parametric Engine Dry Weight Data for Thrust = 37,500 lb

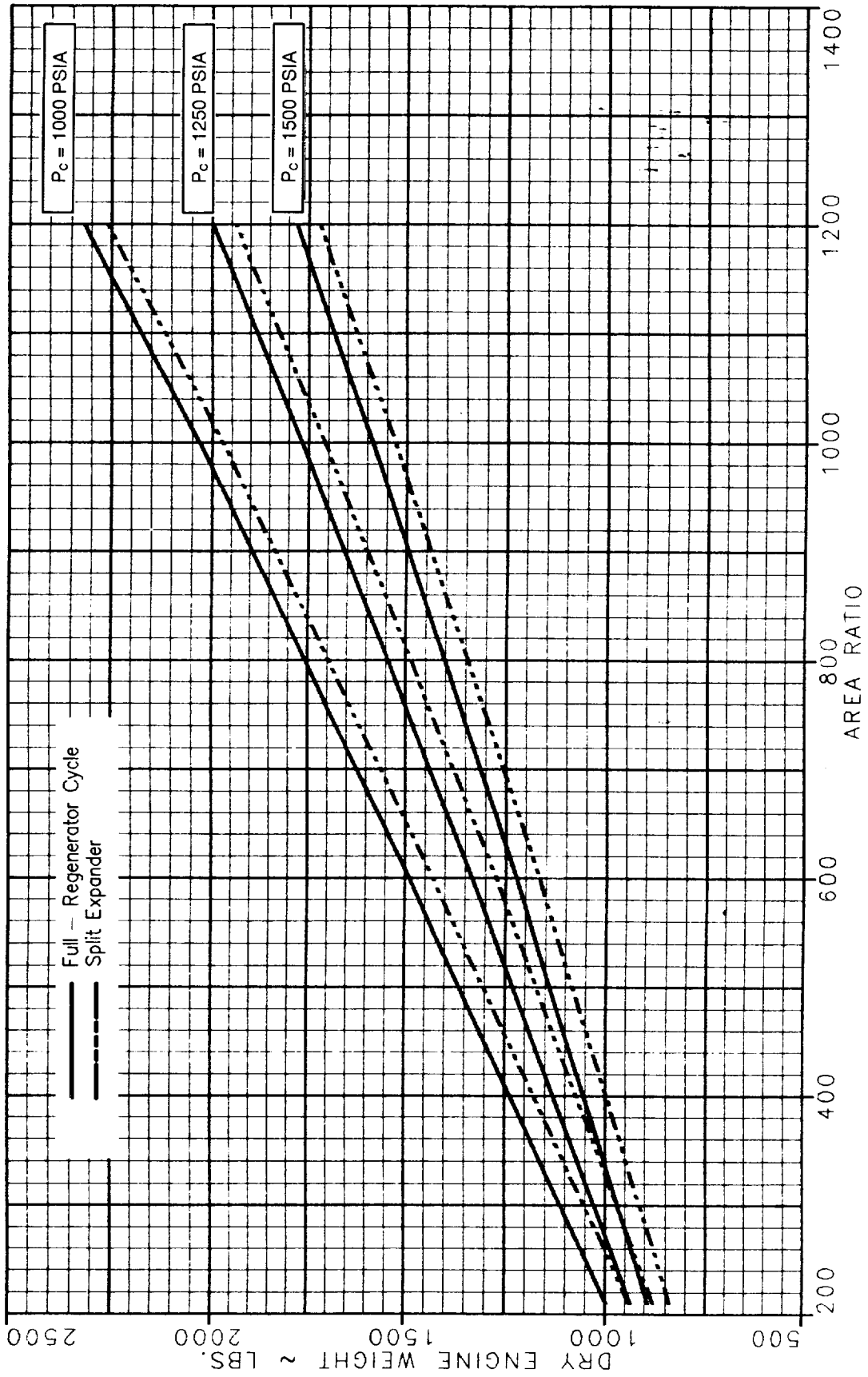

Figure 93. Parametric Engine Dry Weight Data for Thrust = 50,000 lb

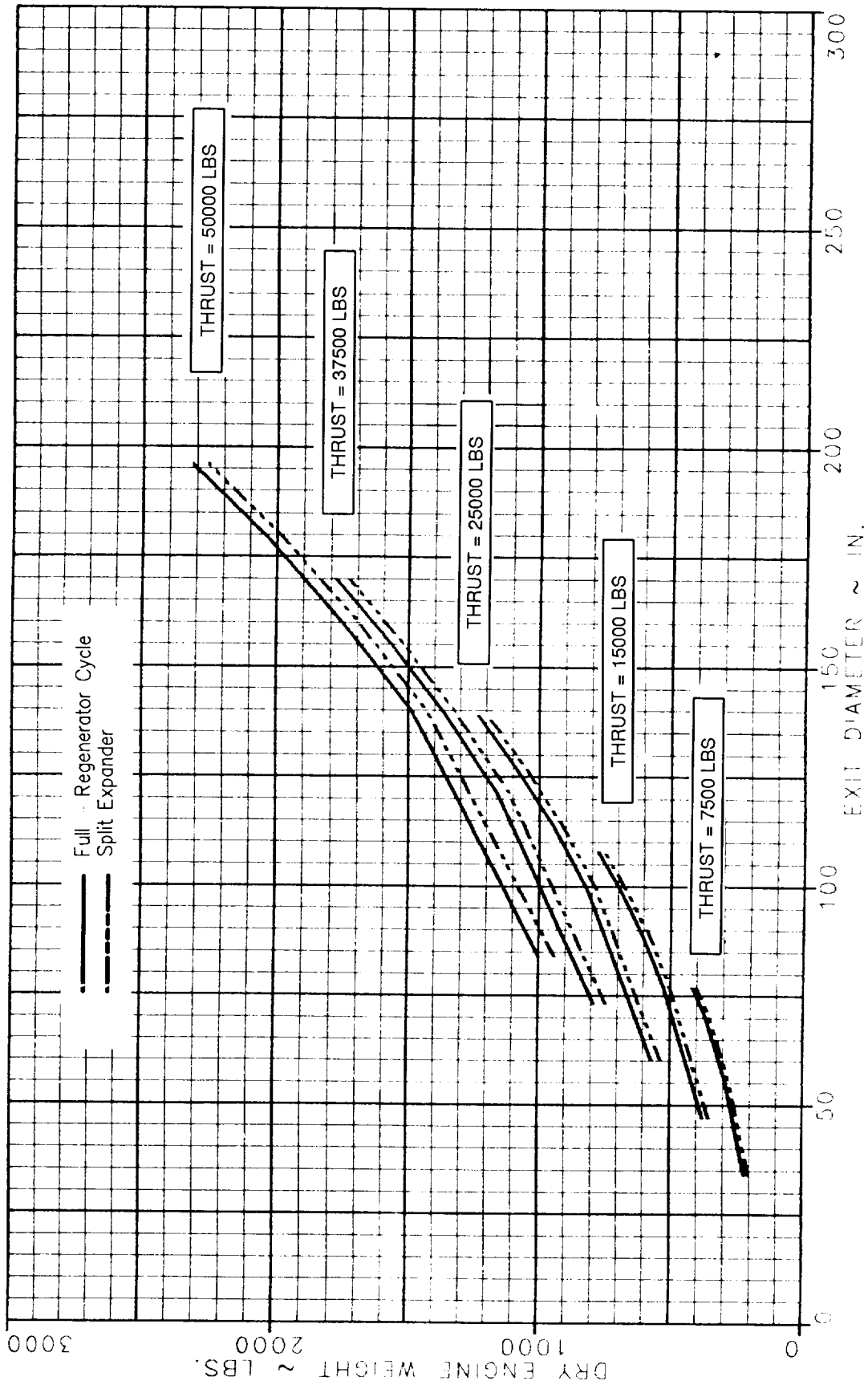

Figure 94. Parametric Engine Dry Weight Data for Chamber Pressure = 1000 psia

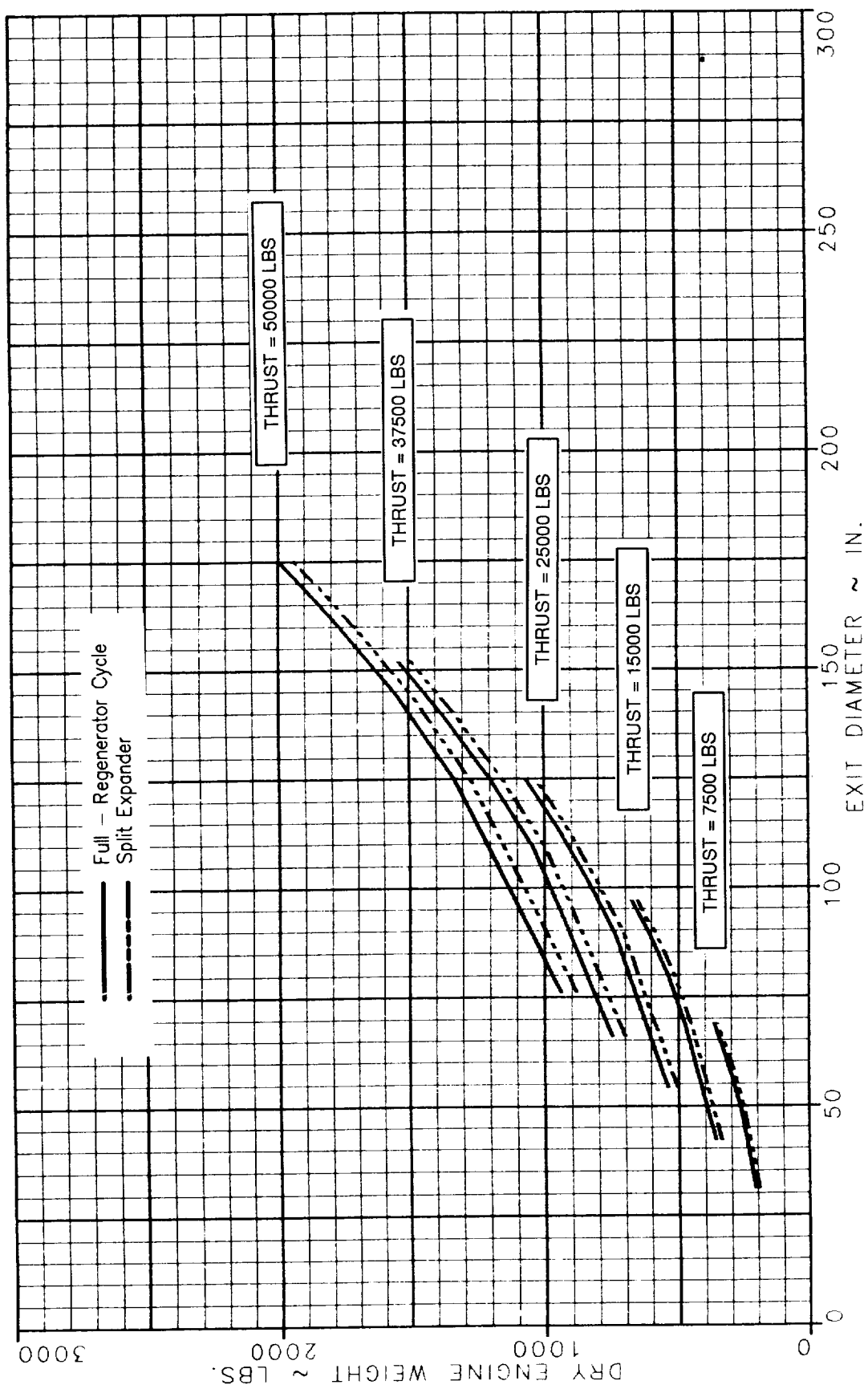

Figure 95. Parametric Engine Dry Weight Data for Chamber Pressure = 1250 psia

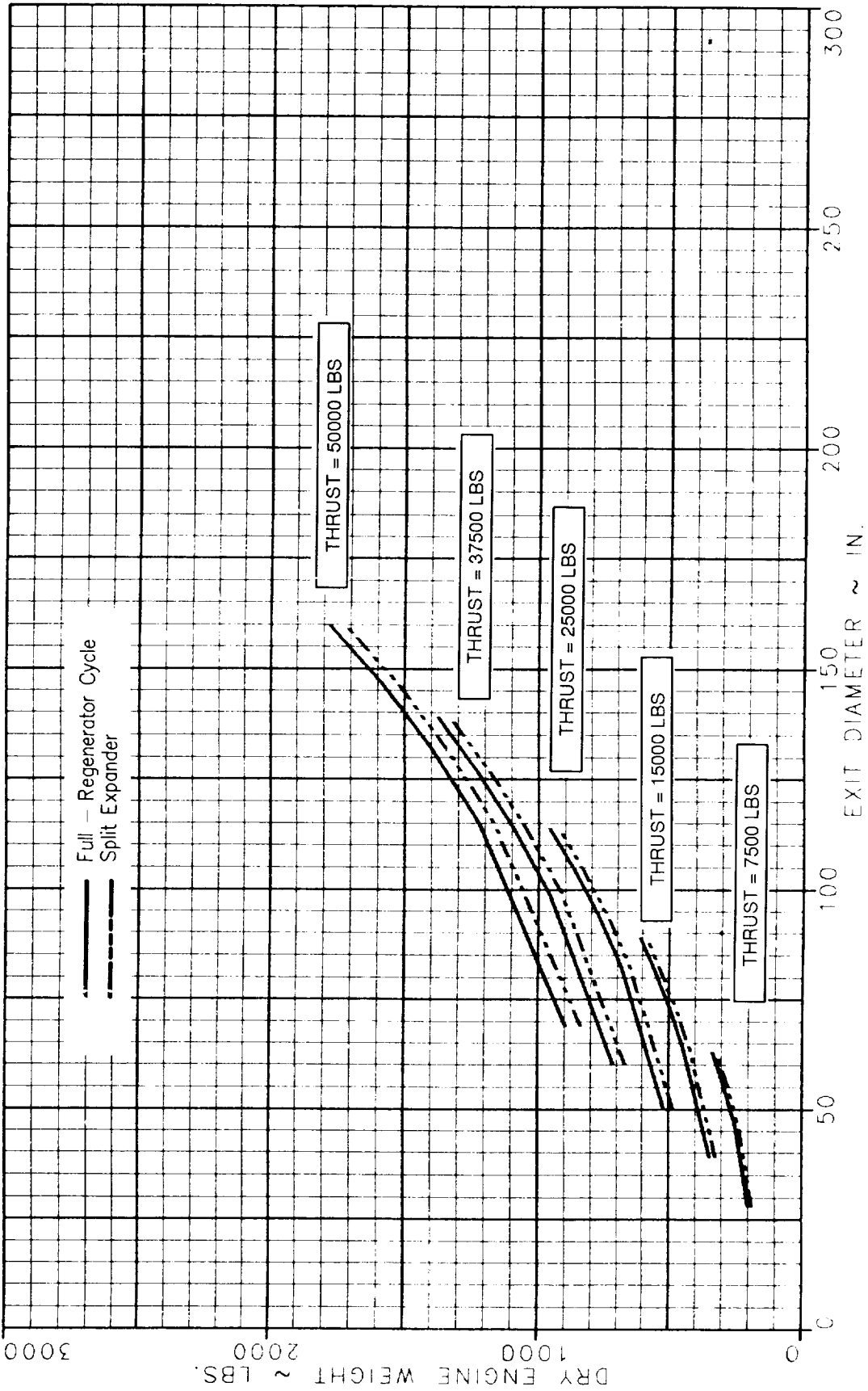

Figure 96. Parametric Engine Dry Weight Data for Chamber Pressure = 1500 psia

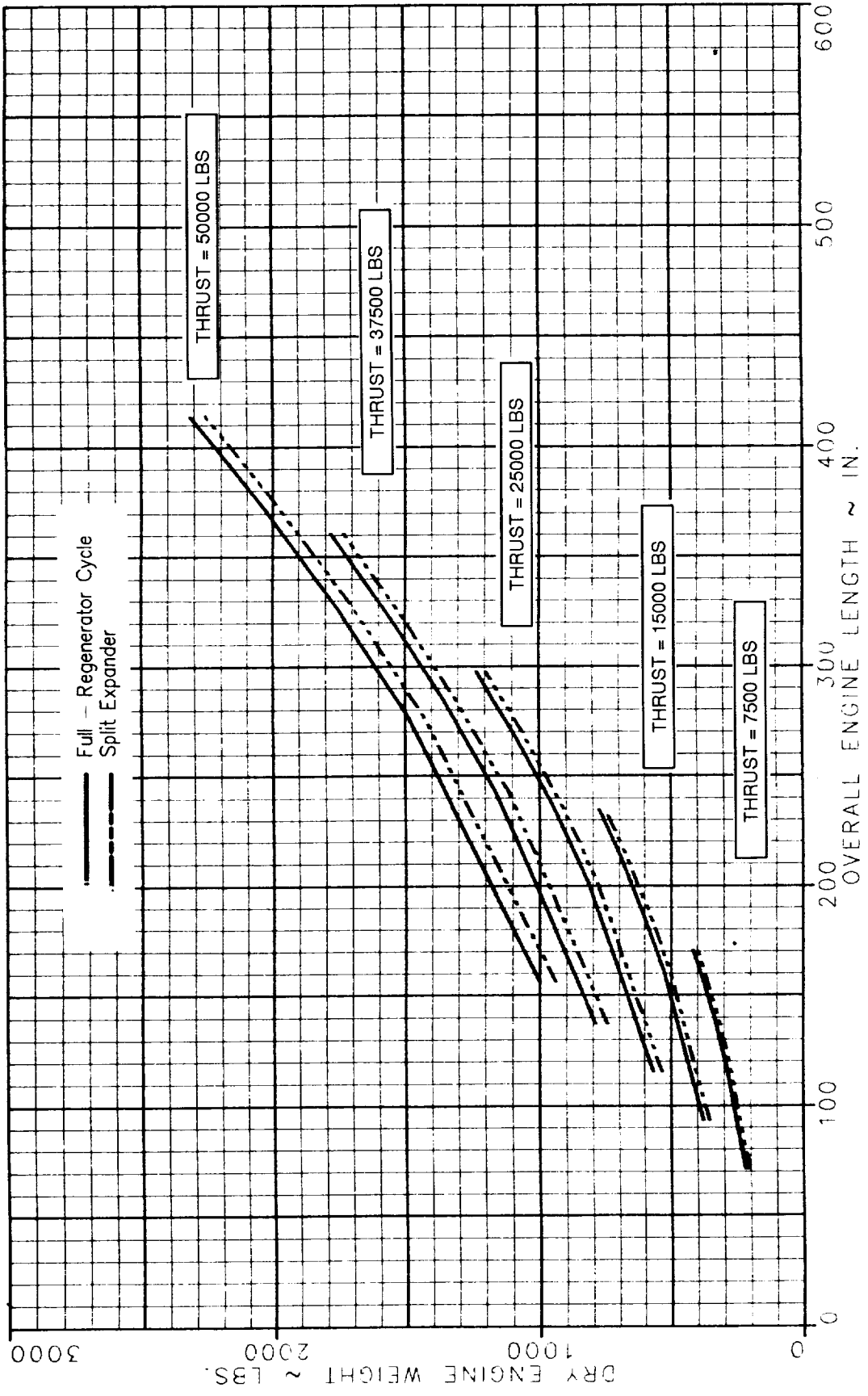

Figure 97. Parametric Engine Dry Weight Data for Chamber Pressure = 1000 psia

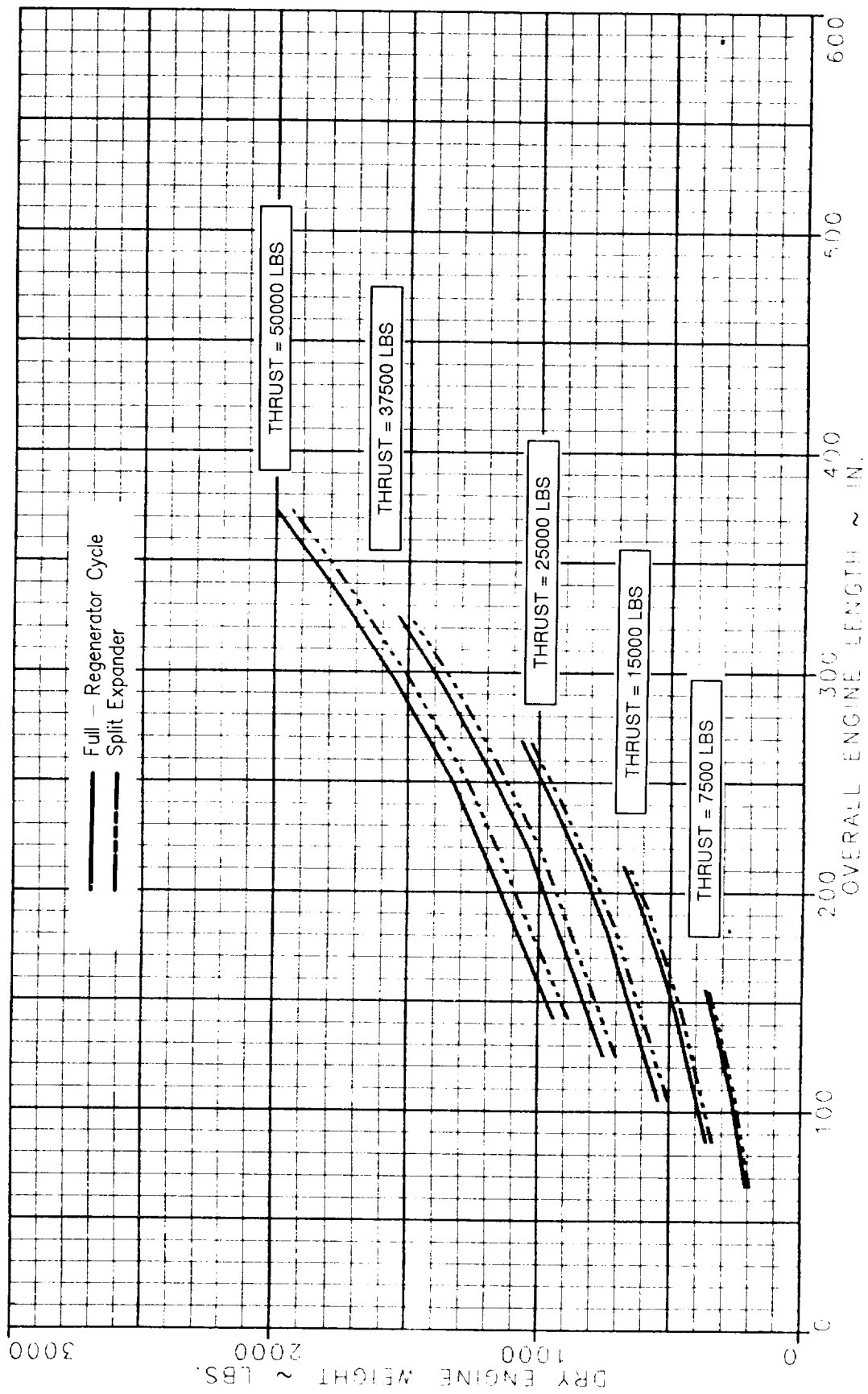

Figure 98. Parametric Engine Dry Weight Data for Chamber Pressure = 1250 psia

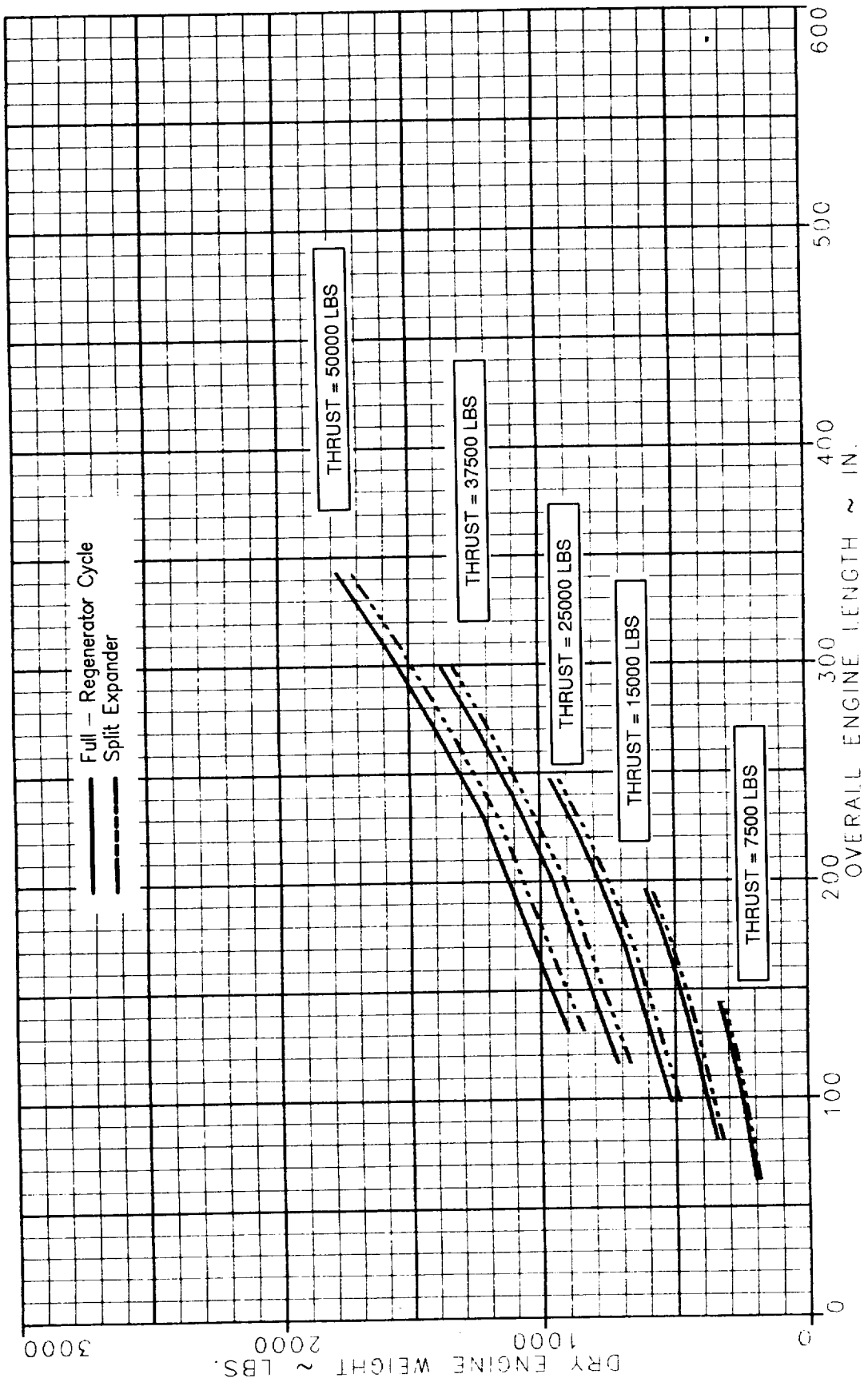

Figure 99. Parametric Engine Dry Weight Data for Chamber Pressure = 1500 psia

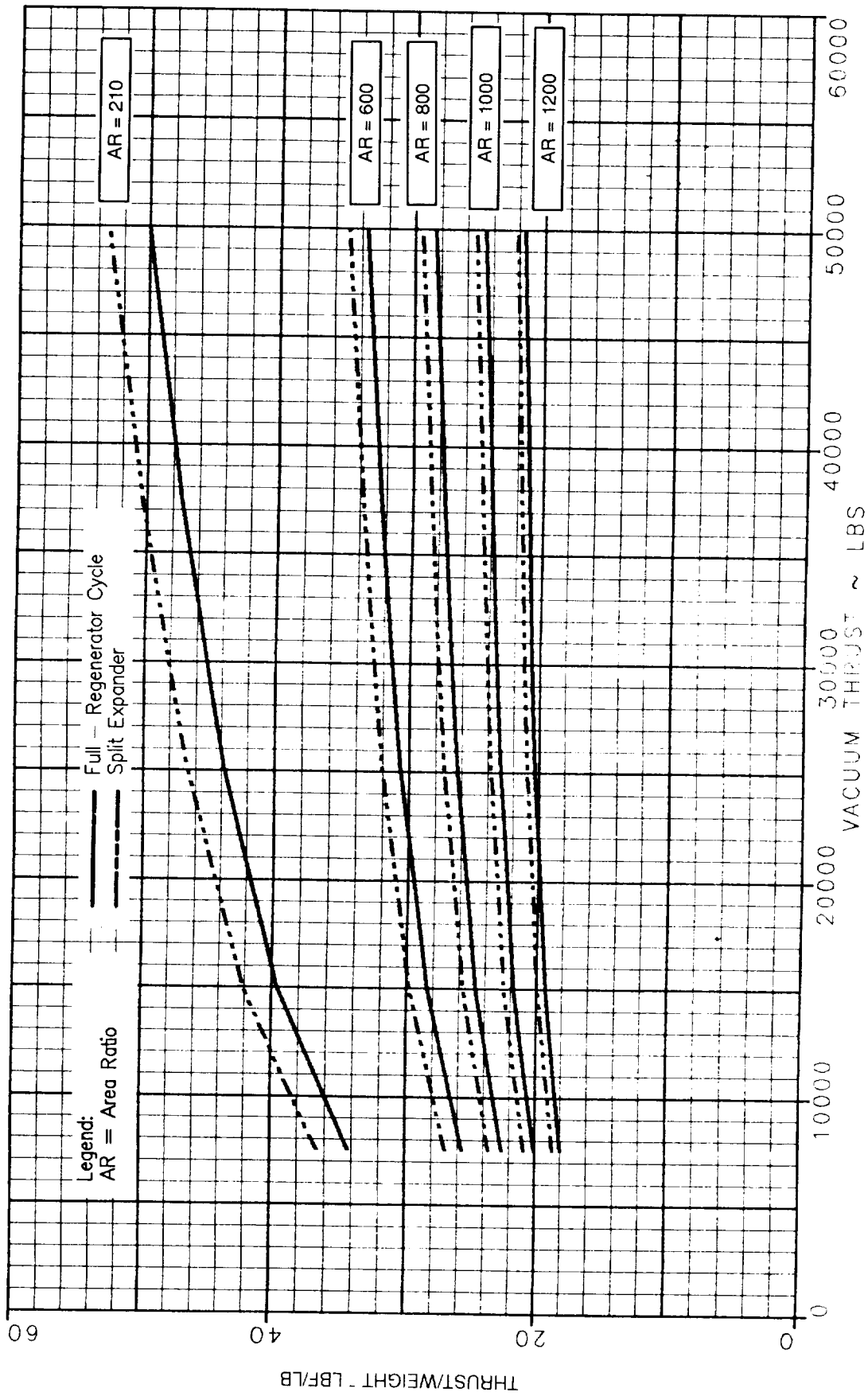

Figure 100. Parametric Engine Dry Weight Data for Chamber Pressure = 1000 psia

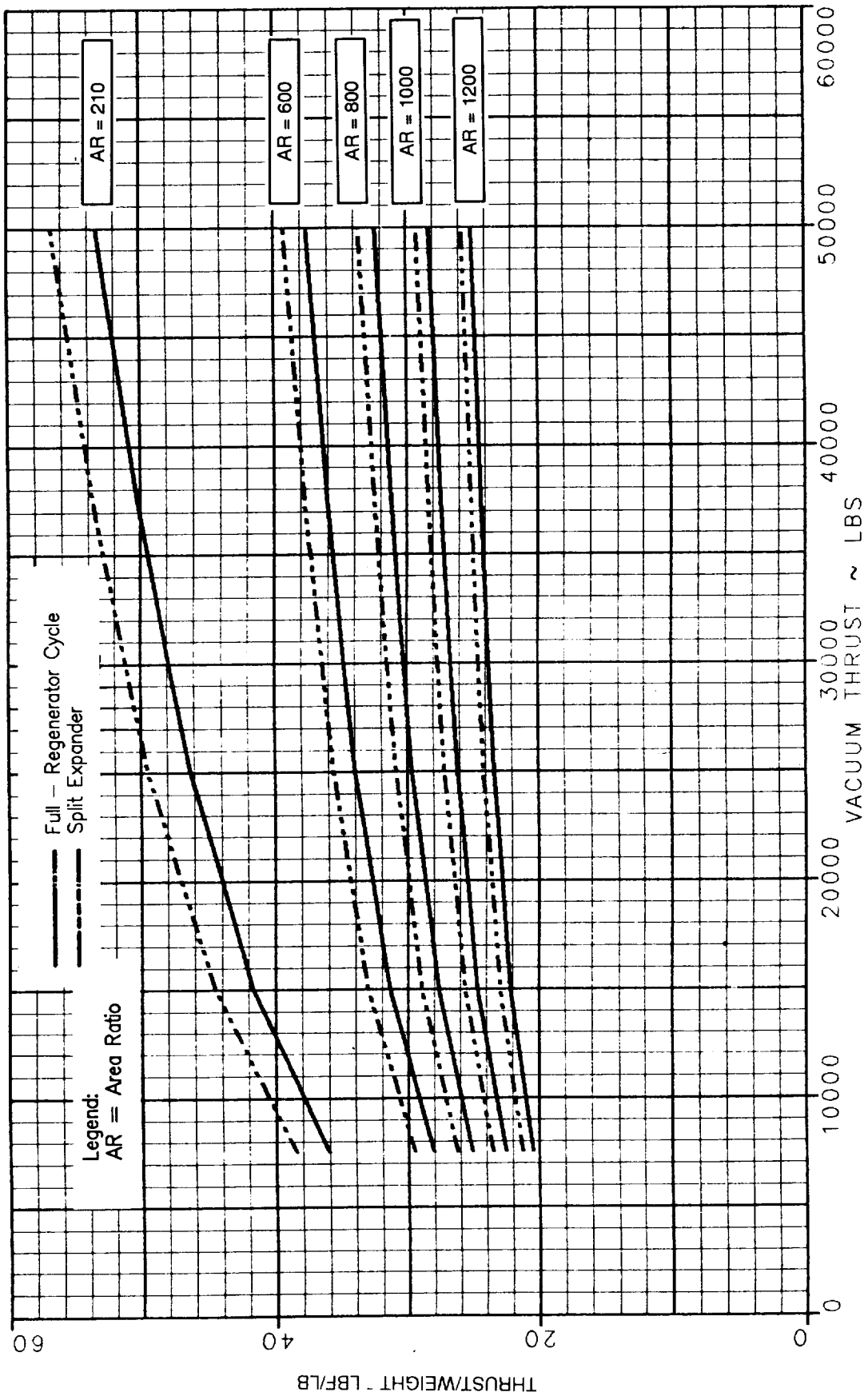

Figure 101. Parametric Engine Dry Weight Data for Chamber Pressure = 1250 psia

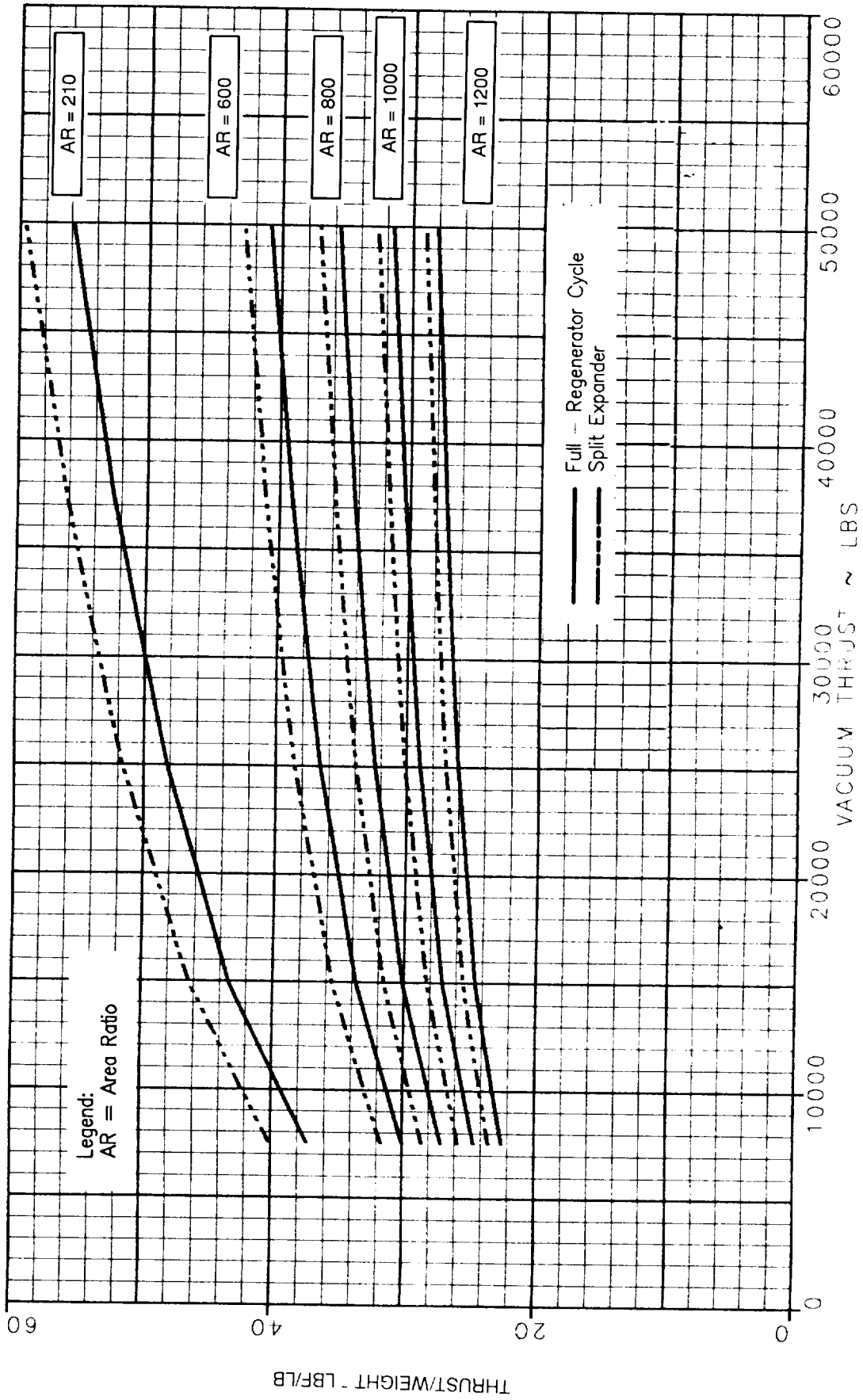

Figure 102. Parametric Engine Dry Weight Data for Chamber Pressure = 1500 psia

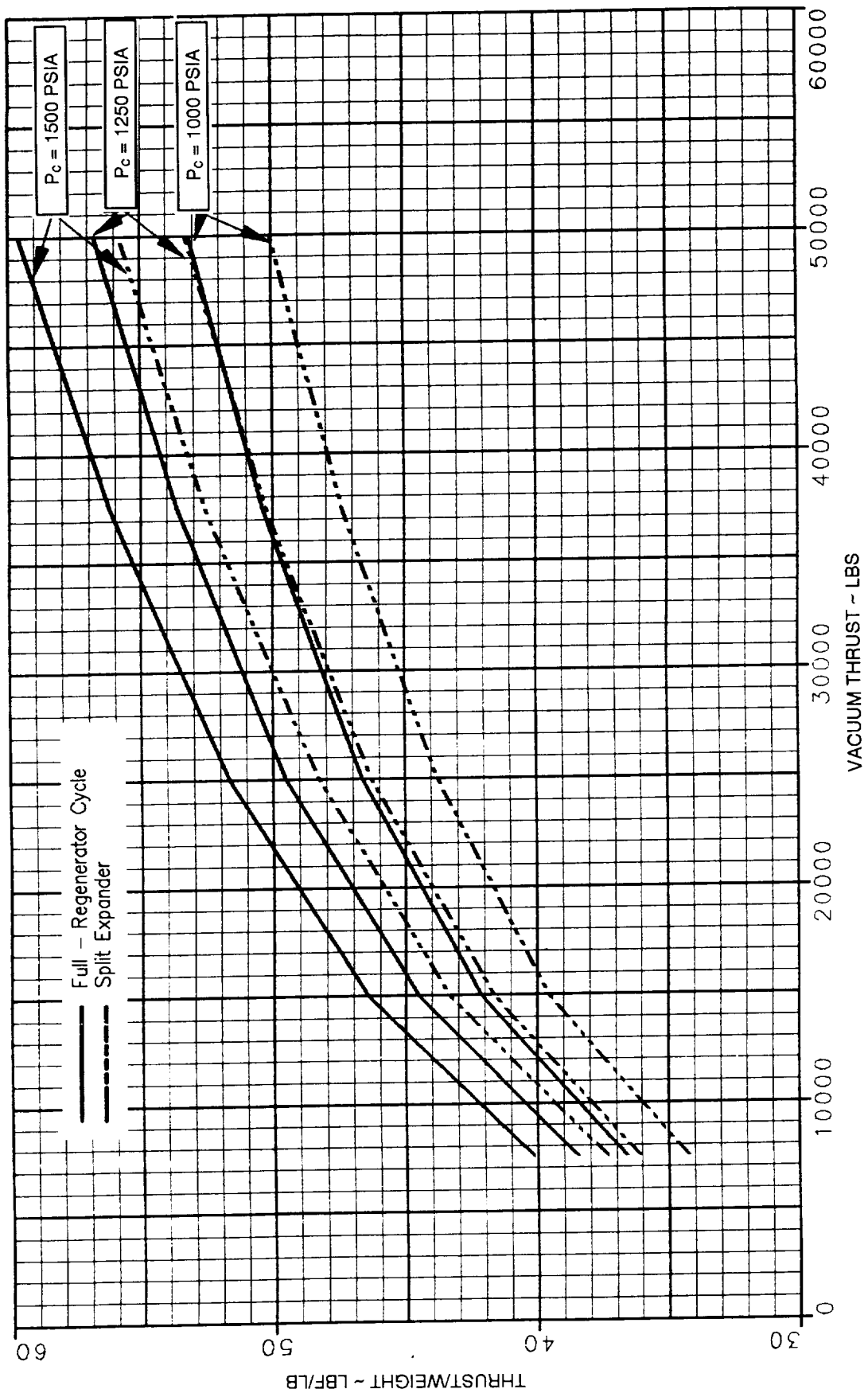

Figure 103. Parametric Engine Dry Weight Data for Area Ratio = 210

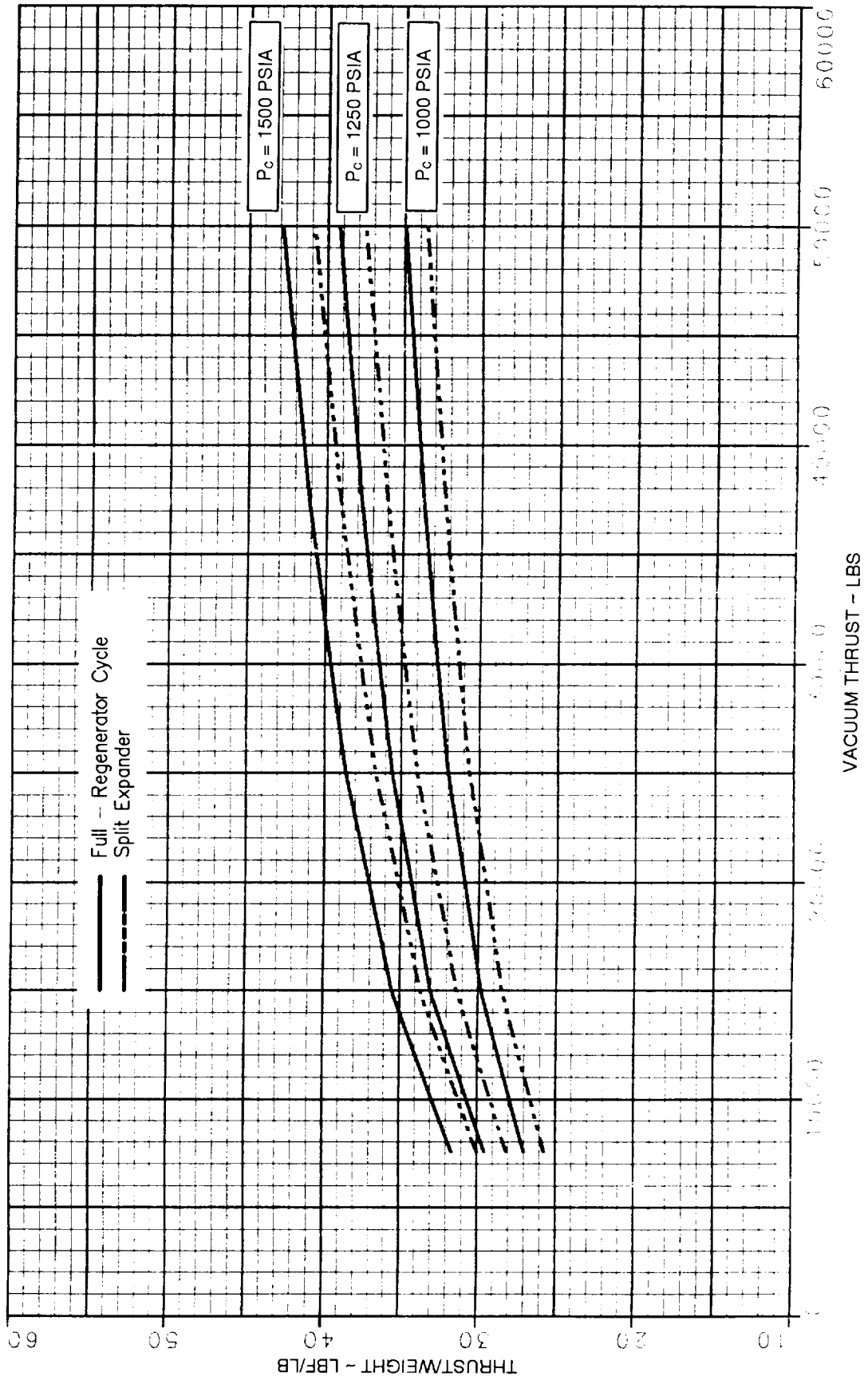

Figure 104. Parametric Engine Dry Weight Data for Area Ratio = 600

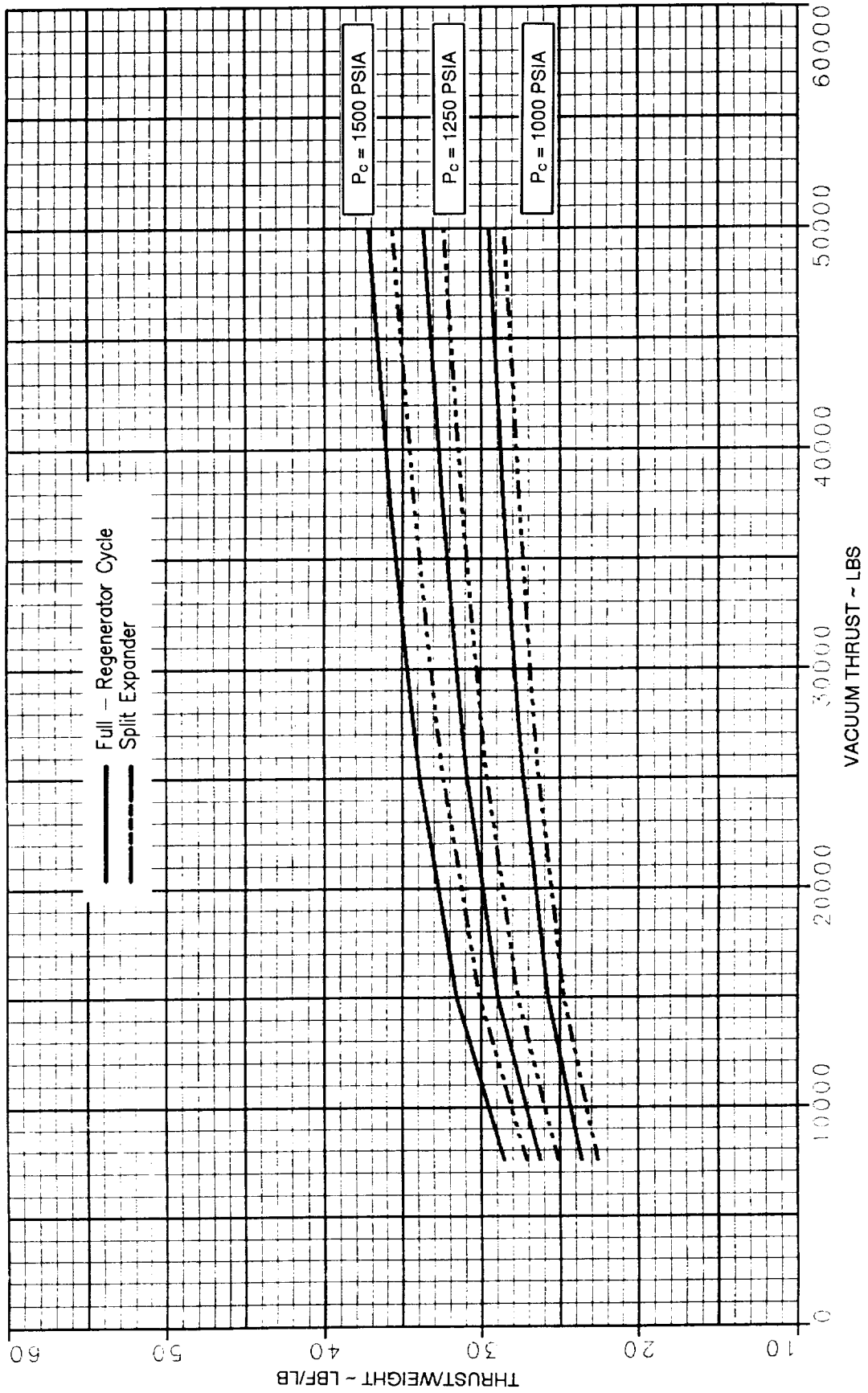

Figure 105. Parametric Engine Dry Weight Data for Area Ratio = 800

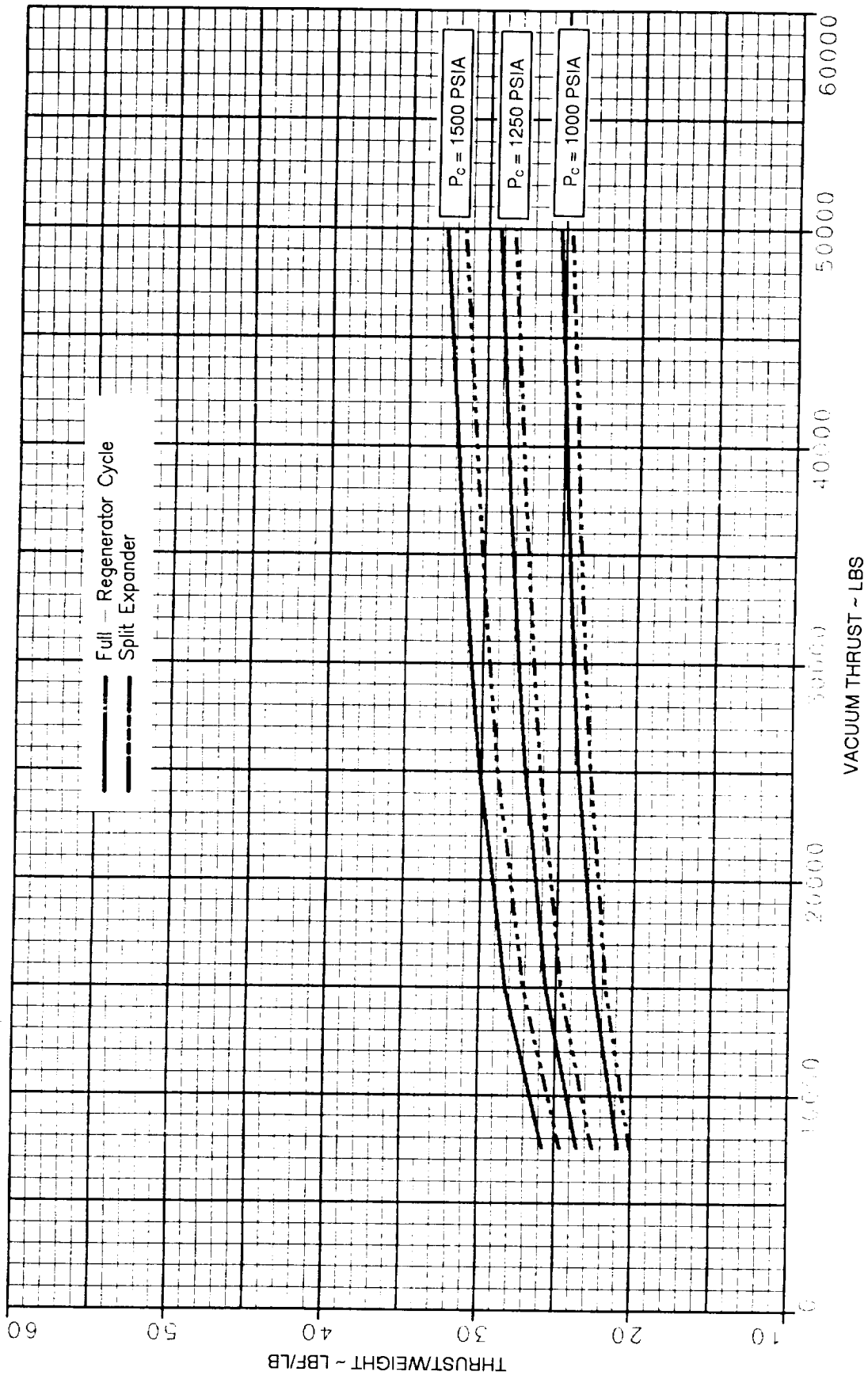

Figure 106. Parametric Engine Dry Weight Data for Area Ratio = 1000

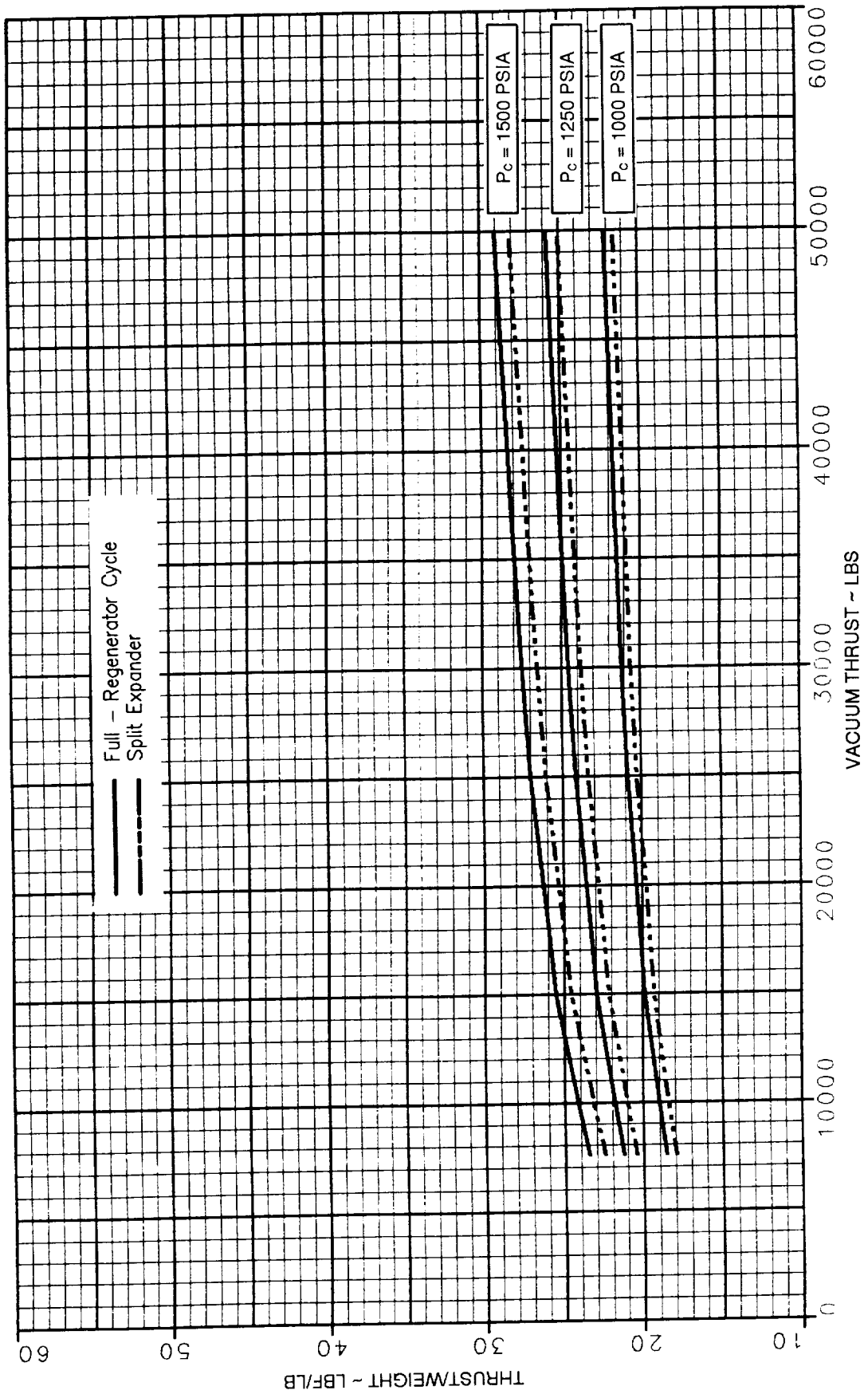

Figure 107. Parametric Engine Dry Weight Data for Area Ratio = 1200

**APPENDIX B
FULL-THRUST CYCLES**

Full-thrust cycle data are presented in Tables 9 through 48.

TABLE 9. — FULL-EXPANDER ENGINE — 7500 LBF THRUST (COPPER TUBE CHAMBER)

ENGINE PERFORMANCE PARAMETERS					
CHAMBER PRESSURE					1862.5
VAC ENGINE THRUST					7500.
TOTAL ENGINE FLOW RATE					15.62
DEL. VAC. ISP					480.1
THROAT AREA					1.97
NOZZLE AREA RATIO					1000.0
NOZZLE EXIT DIAMETER					50.10
ENGINE MIXTURE RATIO					6.00
ETA C*					0.993
CHAMBER COOLANT DP					791.
CHAMBER COOLANT DT					785.
NOZZLE/CHAMBER D					6571.

ENGINE STATION CONDITIONS					

# FUEL SYSTEM CONDITIONS #					
STATION	PRESS	TEMP	FLOW	ENTHALPY	DENSITY
B.P. INLET	18.6	37.4	2.23	-107.5	4.37
B.P. EXIT	100.4	38.5	2.23	-103.0	4.39
PUMP INLET	100.4	38.5	2.23	-103.0	4.39
1ST STAGE EXIT	1896.8	69.3	2.23	24.6	4.27
2ND STAGE EXIT	3618.5	97.8	2.23	146.9	4.25
PUMP EXIT	5287.6	124.3	2.23	264.1	4.28
COOLANT INLET	5234.8	124.7	2.23	264.1	4.26
COOLANT EXIT	4443.6	99.5	2.23	3205.3	0.82
TBV INLET	4399.1	909.8	0.11	3205.3	0.81
TBV EXIT	2084.4	925.6	0.11	3205.3	0.40
O2 TRB INLET	4399.1	909.8	2.12	3205.3	0.81
O2 TRB EXIT	4003.3	893.6	2.12	3138.4	0.76
H2 TRB INLET	4003.3	893.6	2.12	3138.4	0.76
H2 TRB EXIT	2209.2	796.1	2.12	2751.9	0.49
H2 TRB DIFFUSER	2182.0	796.3	2.12	2751.9	0.48
H2 BST TRB IN	2160.2	796.3	2.12	2751.9	0.48
H2 BST TRB OUT	2141.2	795.2	2.12	2747.1	0.48
H2 BST TRB DIFF	2126.1	795.3	2.12	2747.1	0.47
O2 BST TRB IN	2104.9	795.4	2.12	2747.1	0.47
O2 BST TRB OUT	2096.3	794.8	2.12	2744.6	0.47
O2 BST TRB DIFF	2094.8	794.8	2.12	2744.6	0.47
O2 TANK PRESS	18.6	814.2	0.0022	2767.6	0.0043
GOX HEAT EXCH IN	2084.4	801.4	2.23	2767.6	0.46
GOX HEAT EXCH OUT	2073.9	801.0	2.23	2766.2	0.46
FSDV INLET	2073.9	801.0	2.23	2766.2	0.46
FSDV EXIT	2022.1	801.4	2.23	2766.2	0.45
CHAMBER INJ	2001.8	801.5	2.23	2766.2	0.46
CHAMBER	1862.5				

# OXYGEN SYSTEM CONDITIONS #					
STATION	PRESS	TEMP	FLOW	ENTHALPY	DENSITY
B.P. INLET	16.0	162.7	13.4	61.1	71.17
B.P. EXIT	135.6	163.2	13.4	61.5	71.20
PUMP INLET	135.6	163.2	13.4	61.5	71.20
PUMP EXIT	3016.3	178.2	13.4	72.1	71.52
O2 TANK PRESS	16.0	600.0	0.023	204.7	0.12
OCV INLET	2986.2	178.3	13.4	72.1	71.47
OCV EXIT	2090.3	181.8	13.4	72.1	70.08
CHAMBER INJ	2048.7	182.0	13.4	72.1	70.02
CHAMBER	1862.5				

# VALVE DATA #				
VALVE	DELTA P	AREA	FLOW	% BYPASS
TBV	2315.	0.01	0.11	5.00
FSDV	52.	0.67	2.23	
OCV	896.	0.08	13.39	

# INJECTOR DATA #				
INJECTOR	DELTA P	AREA	FLOW	VELOCITY
FUEL	139.	0.47	2.23	1569.64
LOX	207.	0.18	13.39	156.98

TABLE 9. — FULL-EXPANDER ENGINE — 7500 LBF THRUST (COPPER TUBE CHAMBER) (CONTINUED)

*****		*****	
= H2 BOOST TURBINE =		= H2 BOOST PUMP =	
*****		*****	
EFFICIENCY (T/T)	0.687	EFFICIENCY	0.764
EFFICIENCY (T/S)	0.333	HORSEPOWER	14.
SPEED (RPM)	75325.	SPEED (RPM)	75325.
MEAN DIA (IN)	0.82	S SPEED	3049.
EFF AREA (IN ²)	1.03	HEAD (FT)	2688.
U/C (ACTUAL)	0.553	DIA. (IN)	1.33
MAX TIP SPEED	398.	TIP SPEED	438.
STAGES	1	VOL. FLOW	228.
GAMMA	1.38	HEAD COEF	0.450
PRESS RATIO (T/T)	1.01	FLOW COEF	0.201
PRESS RATIO (T/S)	1.02		
HORSEPOWER	14.		
EXIT MACH NUMBER	0.10		
SPECIFIC SPEED	143.05		
SPECIFIC DIAMETER	0.50		
*****		*****	
= H2 TURBINE =		= H2 PUMP =	
*****		*****	
		STAGE ONE	STAGE TWO STAGE THREE
EFFICIENCY (T/T)	0.801	EFFICIENCY	0.605 0.612 0.617
EFFICIENCY (T/S)	0.781	HORSEPOWER	404. 386. 371.
SPEED (RPM)	107500.	SPEED (RPM)	107500. 107500. 107500.
HORSEPOWER	1161.	SS SPEED	9332.
MEAN DIA. (IN)	1.62	S SPEED	749. 748. 785.
EFF AREA (IN ²)	0.11	HEAD (FT)	60127. 58236. 56326.
U/C (ACTUAL)	0.521	DIA. (IN)	2.35 2.35 2.35
MAX TIP SPEED	1436.	TIP SPEED	1925. 1924. 1925.
STAGES	3	VOL. FLOW	235. 236. 234.
GAMMA	1.38	HEAD COEF	0.522 0.506 0.489
PRESS RATIO (T/T)	1.81	FLOW COEF	0.093
PRESS RATIO (T/S)	1.84	DIAMETER RATIO	0.313
EXIT MACH NUMBER	0.14	BEARING DN	3.00E+06
SPECIFIC SPEED	53.11	SHAFT DIAMETER	16.00
SPECIFIC DIAMETER	1.39		
*****		*****	
= O2 BOOST TURBINE =		= O2 BOOST PUMP =	
*****		*****	
EFFICIENCY (T/T)	0.804	EFFICIENCY	0.764
EFFICIENCY (T/S)	0.655	HORSEPOWER	8.
SPEED (RPM)	20184.	SPEED (RPM)	20184.
MEAN DIA (IN)	2.25	S SPEED	3024.
EFF AREA (IN ²)	1.54	HEAD (FT)	242.
U/C (ACTUAL)	0.553	DIA. (IN)	1.49
MAX TIP SPEED	238.	TIP SPEED	132.
STAGES	1	VOL. FLOW	85.
GAMMA	1.38	HEAD COEF	0.450
PRESS RATIO (T/T)	1.00	FLOW COEF	0.200
PRESS RATIO (T/S)	1.01		
HORSEPOWER	8.		
EXIT MACH NUMBER	0.83		
SPECIFIC SPEED	101.67		
SPECIFIC DIAMETER	0.81		
*****		*****	
= O2 TURBINE =		= O2 PUMP =	
*****		*****	
EFFICIENCY (T/T)	0.803	EFFICIENCY	0.703
EFFICIENCY (T/S)	0.753	HORSEPOWER	201.
SPEED (RPM)	130652.	SPEED (RPM)	130652.
HORSEPOWER	201.	SS SPEED	23481.
MEAN DIA (IN)	1.62	S SPEED	1804.
EFF AREA (IN ²)	0.18	HEAD (FT)	5799.
U/C (ACTUAL)	0.503	DIA. (IN)	1.18
MAX TIP SPEED	994.	TIP SPEED	675.
STAGES	1	VOL. FLOW	84.
GAMMA	1.38	HEAD COEF	0.410
PRESS RATIO (T/T)	1.10	FLOW COEF	0.154
PRESS RATIO (T/S)	1.11	DIAMETER RATIO	0.679
EXIT MACH NUMBER	0.09	BEARING DN	1.57E+06
SPECIFIC SPEED	48.65	SHAFT DIAMETER	12.00
SPECIFIC DIAMETER	1.48		

TABLE 10. — FULL-EXPANDER ENGINE — 15,000 LBF THRUST (COPPER TUBE CHAMBER)

ENGINE PERFORMANCE PARAMETERS

CHAMBER PRESSURE	1696.5
VAC ENGINE THRUST	15000.
TOTAL ENGINE FLOW RATE	31.25
DEL. VAC. ISP	480.0
THROAT AREA	4.32
NOZZLE AREA RATIO	1000.0
NOZZLE EXIT DIAMETER	74.21
ENGINE MIXTURE RATIO	6.00
ETA C*	0.993
CHAMBER COOLANT DP	579.
CHAMBER COOLANT DT	599.
NOZZLE/CHAMBER Q	10185.

ENGINE STATION CONDITIONS

* FUEL SYSTEM CONDITIONS *					
STATION	PRESS	TEMP	FLOW	ENTHALPY	DENSITY
B.P. INLET	18.6	37.4	4.47	-107.5	4.37
B.P. EXIT	100.6	38.5	4.47	-103.0	4.39
PUMP INLET	100.6	38.5	4.47	-103.0	4.39
1ST STAGE EXIT	1843.1	64.7	4.47	10.4	4.38
2ND STAGE EXIT	3556.9	89.5	4.47	121.3	4.40
PUMP EXIT	5250.8	113.0	4.47	229.5	4.46
COOLANT INLET	5198.3	113.5	4.47	229.5	4.44
COOLANT EXIT	4619.0	712.1	4.47	2508.0	1.06
TBV INLET	4572.8	712.4	0.22	2508.0	1.05
TBV EXIT	1898.6	729.1	0.22	2508.0	0.46
O2 TRB INLET	4572.8	712.4	4.25	2508.0	1.05
O2 TRB EXIT	4123.2	698.9	4.25	2449.6	0.98
H2 TRB INLET	4123.2	698.9	4.25	2449.6	0.98
H2 TRB EXIT	2026.9	613.0	4.25	2099.5	0.58
H2 TRB DIFFUSER	1993.6	613.2	4.25	2099.5	0.57
H2 BST TRB IN	1973.7	613.2	4.25	2099.5	0.57
H2 BST TRB OUT	1952.9	612.1	4.25	2094.8	0.56
H2 BST TRB DIFF	1938.9	612.2	4.25	2094.8	0.56
O2 BST TRB IN	1919.5	612.3	4.25	2094.8	0.55
O2 BST TRB OUT	1909.6	611.6	4.25	2092.2	0.55
O2 BST TRB DIFF	1908.1	611.6	4.25	2092.2	0.55
H2 TANK PRESS	18.6		0.0058	2113.0	0.0057
GOX HEAT EXCH IN	1898.6	617.5	4.46	2113.0	0.54
GOX HEAT EXCH OUT	1889.1	617.1	4.46	2111.6	0.54
FSDV INLET	1889.1	617.1	4.46	2111.6	0.54
FSDV EXIT	1841.8	617.4	4.46	2111.6	0.53
CHAMBER INJ	1823.3	617.5	4.46	2111.6	0.52
CHAMBER	1696.5				

* OXYGEN SYSTEM CONDITIONS *					
STATION	PRESS	TEMP	FLOW	ENTHALPY	DENSITY
B.P. INLET	16.0	162.7	26.8	61.1	71.17
B.P. EXIT	135.6	163.2	26.8	61.5	71.20
PUMP INLET	135.6	163.2	26.8	61.5	71.20
PUMP EXIT	2747.5	175.9	26.8	70.7	71.63
O2 TANK PRESS	16.0	400.0	0.045	204.7	0.12
OCV INLET	2720.0	176.0	26.8	70.7	71.59
OCV EXIT	1904.0	179.1	26.8	70.7	70.32
CHAMBER INJ	1866.1	179.3	26.8	70.7	70.26
CHAMBER	1696.5				

* VALVE DATA *				
VALVE	DELTA P	AREA	FLOW	% BYPASS
TBV	2674.	0.01	0.22	5.00
FSDV	47.	1.30	4.46	
OCV	816.	0.17	26.78	

* INJECTOR DATA *				
INJECTOR	DELTA P	AREA	FLOW	VELOCITY
FUEL	127.	0.90	4.46	1388.26
LOX	188.	0.37	26.78	149.56

TABLE 10. — FULL-EXPANDER ENGINE — 15,000 LBF THRUST (COPPER TUBE CHAMBER) (CONTINUED)

 * TURBOMACHINERY PERFORMANCE DATA *

 * H2 BOOST TURBINE *

 EFFICIENCY (T/T) 0.746
 EFFICIENCY (T/S) 0.391
 SPEED (RPM) 53300.
 MEAN DIA (IN) 1.16
 EFF AREA (IN2) 1.00
 U/C (ACTUAL) 0.550
 MAX TIP SPEED 390.
 STAGES 1
 GAMMA 1.45
 PRESS RATIO (T/T) 1.01
 PRESS RATIO (T/S) 1.02
 HORSEPOWER 29.
 EXIT MACH NUMBER 0.10
 SPECIFIC SPEED 148.19
 SPECIFIC DIAMETER 0.52

 * H2 BOOST PUMP *

 EFFICIENCY 0.764
 HORSEPOWER 29.
 SPEED (RPM) 53300.
 S SPEED 1040.
 HEAD (FT) 2693.
 DIA. (IN) 1.09
 TIP SPEED 439.
 VOL. FLOW 457.
 HEAD COEF 0.450
 FLOW COEF 0.201

 * H2 TURBINE *

 EFFICIENCY (T/T) 0.790
 EFFICIENCY (T/S) 0.776
 SPEED (RPM) 136363.
 HORSEPOWER 2103.
 MEAN DIA. (IN) 2.33
 EFF AREA (IN2) 0.19
 U/C (ACTUAL) 0.469
 MAX TIP SPEED 1481.
 STAGES 2
 GAMMA 1.45
 PRESS RATIO (T/T) 2.03
 PRESS RATIO (T/S) 2.00
 EXIT MACH NUMBER 0.15
 SPECIFIC SPEED 39.56
 SPECIFIC DIAMETER 1.66

 * H2 PUMP *

 STAGE ONE STAGE TWO STAGE THREE

 EFFICIENCY 0.649 0.651 0.653
 HORSEPOWER 717. 701. 605.
 SPEED (RPM) 136363. 136363. 136363.
 SS SPEED 9507.
 S SPEED 709. 797. 805.
 HEAD (FT) 57270. 56200. 55023.
 DIA. (IN) 3.12 3.12 3.12
 TIP SPEED 1059. 1059. 1059.
 VOL. FLOW 450. 456. 450.
 HEAD COEF 0.533 0.523 0.512
 FLOW COEF 0.096
 DIAMETER RATIO 0.331
 BEARING DN 3.00E+06
 SHAFT DIAMETER 22.00

 * O2 BOOST TURBINE *

 EFFICIENCY (T/T) 0.826
 EFFICIENCY (T/S) 0.607
 SPEED (RPM) 14272.
 MEAN DIA (IN) 3.10
 EFF AREA (IN2) 2.44
 U/C (ACTUAL) 0.553
 MAX TIP SPEED 235.
 STAGES 1
 GAMMA 1.45
 PRESS RATIO (T/T) 1.01
 PRESS RATIO (T/S) 1.01
 HORSEPOWER 15.
 EXIT MACH NUMBER 0.03
 SPECIFIC SPEED 96.92
 SPECIFIC DIAMETER 0.86

 * O2 BOOST PUMP *

 EFFICIENCY 0.764
 HORSEPOWER 15.
 SPEED (RPM) 14272.
 S SPEED 3026.
 HEAD (FT) 242.
 DIA. (IN) 2.11
 TIP SPEED 132.
 VOL. FLOW 169.
 HEAD COEF 0.450
 FLOW COEF 0.200

 * O2 TURBINE *

 EFFICIENCY (T/T) 0.817
 EFFICIENCY (T/S) 0.771
 SPEED (RPM) 87749.
 HORSEPOWER 351.
 MEAN DIA (IN) 2.33
 EFF AREA (IN2) 0.29
 U/C (ACTUAL) 0.523
 MAX TIP SPEED 952.
 STAGES 1
 GAMMA 1.45
 PRESS RATIO (T/T) 1.11
 PRESS RATIO (T/S) 1.12
 EXIT MACH NUMBER 0.08
 SPECIFIC SPEED 45.33
 SPECIFIC DIAMETER 1.65

 * O2 PUMP *

 EFFICIENCY 0.730
 HORSEPOWER 351.
 SPEED (RPM) 87749.
 SS SPEED 22303.
 S SPEED 1045.
 HEAD (FT) 5249.
 DIA. (IN) 1.66
 TIP SPEED 634.
 VOL. FLOW 160.
 HEAD COEF 0.420
 FLOW COEF 0.155
 DIAMETER RATIO 0.402
 BEARING DN 1.40E+06
 SHAFT DIAMETER 16.00

TABLE 11. — FULL-EXPANDER ENGINE — 25,000 LBF THRUST (COPPER TUBE CHAMBER)

ENGINE PERFORMANCE PARAMETERS

CHAMBER PRESSURE	1603.4
VAC ENGINE THRUST	25000.
TOTAL ENGINE FLOW RATE	52.08
DEL. VAC. ISP	480.0
THROAT AREA	7.62
NOZZLE AREA RATIO	1000.0
NOZZLE EXIT DIAMETER	98.52
ENGINE MIXTURE RATIO	6.00
ETA C*	0.993
CHAMBER COOLANT DP	495.
CHAMBER COOLANT DT	505.
NOZZLE/CHAMBER Q	14356.

ENGINE STATION CONDITIONS

FUEL SYSTEM CONDITIONS

STATION	PRESS	TEMP	FLOW	ENTHALPY	DENSITY
B.P. INLET	18.6	37.4	7.45	-107.5	4.37
B.P. EXIT	100.9	38.5	7.45	-103.0	4.39
PUMP INLET	100.9	38.5	7.45	-103.0	4.39
1ST STAGE EXIT	1458.6	54.9	7.45	-25.5	4.50
2ND STAGE EXIT	2831.9	70.7	7.45	51.8	4.58
PUMP EXIT	4222.8	86.2	7.45	120.6	4.67
COOLANT INLET	4180.6	86.6	7.45	120.6	4.65
COOLANT EXIT	3685.4	591.9	7.45	2055.1	1.02
TBV INLET	3648.5	592.1	0.37	2055.1	1.01
TBV EXIT	1795.5	601.9	0.37	2055.1	0.53
O2 TRB INLET	3648.5	592.1	7.08	2055.1	1.01
O2 TRB EXIT	3266.7	579.5	7.08	2001.5	0.96
H2 TRB INLET	3266.7	579.5	7.08	2001.5	0.96
H2 TRB EXIT	1925.6	519.5	7.08	1757.7	0.64
H2 TRB DIFFUSER	1888.2	519.6	7.08	1757.7	0.63
H2 BST TRB IN	1869.3	519.6	7.08	1757.7	0.63
H2 BST TRB OUT	1848.2	518.5	7.08	1753.0	0.62
H2 BST TRB DIFF	1834.8	518.6	7.08	1753.0	0.62
O2 BST TRB IN	1816.4	518.6	7.08	1753.0	0.61
O2 BST TRB OUT	1806.0	518.0	7.08	1750.4	0.61
O2 BST TRB DIFF	1804.5	518.0	7.08	1750.4	0.61
H2 TANK PRESS	18.6	529.4	0.0113	1765.6	0.0066
GOX HEAT EXCH IN	1795.5	522.2	7.44	1765.6	0.60
GOX HEAT EXCH OUT	1786.5	521.9	7.44	1764.3	0.60
FSOV INLET	1786.5	521.9	7.44	1764.3	0.60
FSOV EXIT	1741.9	522.1	7.44	1764.3	0.58
CHAMBER INJ	1724.3	522.2	7.44	1764.3	0.58
CHAMBER	1603.4				

OXYGEN SYSTEM CONDITIONS

STATION	PRESS	TEMP	FLOW	ENTHALPY	DENSITY
B.P. INLET	16.0	162.7	44.7	61.1	71.17
B.P. EXIT	135.6	163.2	44.7	61.5	71.20
PUMP INLET	135.6	163.2	44.7	61.5	71.20
PUMP EXIT	2596.8	174.6	44.7	70.0	71.69
O2 TANK PRESS	16.0	400.0	0.076	204.7	0.12
OCV INLET	2570.9	174.7	44.6	70.0	71.65
OCV EXIT	1799.6	177.6	44.6	70.0	70.45
CHAMBER INJ	1763.8	177.8	44.6	70.0	70.39
CHAMBER	1603.4				

VALVE DATA

VALVE	DELTA P	AREA	FLOW	% BYPASS
TBV	1853.	0.02	0.37	5.00
FSOV	45.	2.10	7.44	
OCV	771.	0.28	44.64	

INJECTOR DATA

INJECTOR	DELTA P	AREA	FLOW	VELOCITY
FUEL	121.	1.45	7.44	1291.05
LOX	178.	0.63	44.64	145.27

TABLE 11. — FULL-EXPANDER ENGINE — 25,000 LBF THRUST (COPPER TUBE CHAMBER) (CONTINUED)

 • TURBOMACHINERY PERFORMANCE DATA •

 • H2 BOOST TURBINE •

EFFICIENCY (T/T) 0.823
 EFFICIENCY (T/S) 0.444
 SPEED (RPM) 41350.
 MEAN DIA (IN) 1.46
 EFF AREA (IN²) 2.82
 U/C (ACTUAL) 0.538
 MAX TIP SPEED 378.
 STAGES 1
 GAMMA 1.34
 PRESS RATIO (T/T) 1.01
 PRESS RATIO (T/S) 1.82
 HORSEPOWER 48.
 EXIT MACH NUMBER 0.11
 SPECIFIC SPEED 150.00
 SPECIFIC DIAMETER 0.52

 • H2 BOOST PUMP •

EFFICIENCY 0.765
 HORSEPOWER 48.
 SPEED (RPM) 41350.
 S SPEED 3045.
 HEAD (FT) 2703.
 DIA. (IN) 2.43
 TIP SPEED 440.
 VOL. FLOW 762.
 HEAD COEF 0.450
 FLOW COEF 0.201

 • H2 TURBINE •

EFFICIENCY (T/T) 0.863
 EFFICIENCY (T/S) 0.825
 SPEED (RPM) 125000.
 HORSEPOWER 2441.
 MEAN DIA. (IN) 2.36
 EFF AREA (IN²) 0.38
 U/C (ACTUAL) 0.521
 MAX TIP SPEED 1416.
 STAGES 2
 GAMMA 1.34
 PRESS RATIO (T/T) 1.70
 PRESS RATIO (T/S) 1.74
 EXIT MACH NUMBER 0.18
 SPECIFIC SPEED 61.45
 SPECIFIC DIAMETER 1.26

 • H2 PUMP •

	STAGE ONE	STAGE TWO	STAGE THREE
EFFICIENCY	0.726	0.725	0.724
HORSEPOWER	817.	813.	810.
SPEED (RPM)	125000.	125000.	125000.
SS SPEED	11310.		
S SPEED	1126.	1121.	1115.
HEAD (FT)	43769.	43508.	43284.
DIA. (IN)	3.06	3.06	3.06
TIP SPEED	1671.	1670.	1671.
VOL. FLOW	743.	730.	717.
HEAD COEF	0.504	0.502	0.499
FLOW COEF	0.118		
DIAMETER RATIO	0.412		
BEARING DN	3.00E+06		
SHAFT DIAMETER	24.00		

 • O2 BOOST TURBINE •

EFFICIENCY (T/T) 0.877
 EFFICIENCY (T/S) 0.736
 SPEED (RPM) 11055.
 MEAN DIA (IN) 4.11
 EFF AREA (IN²) 4.06
 U/C (ACTUAL) 0.553
 MAX TIP SPEED 233.
 STAGES 1
 GAMMA 1.34
 PRESS RATIO (T/T) 1.01
 PRESS RATIO (T/S) 1.01
 HORSEPOWER 26.
 EXIT MACH NUMBER 0.04
 SPECIFIC SPEED 96.61
 SPECIFIC DIAMETER 0.88

 • O2 BOOST PUMP •

EFFICIENCY 0.764
 HORSEPOWER 26.
 SPEED (RPM) 11055.
 S SPEED 3026.
 HEAD (FT) 242.
 DIA. (IN) 2.72
 TIP SPEED 152.
 VOL. FLOW 282.
 HEAD COEF 0.450
 FLOW COEF 0.200

 • O2 TURBINE •

EFFICIENCY (T/T) 0.845
 EFFICIENCY (T/S) 0.764
 SPEED (RPM) 65861.
 HORSEPOWER 538.
 MEAN DIA (IN) 2.36
 EFF AREA (IN²) 0.54
 U/C (ACTUAL) 0.414
 MAX TIP SPEED 746.
 STAGES 1
 GAMMA 1.34
 PRESS RATIO (T/T) 1.12
 PRESS RATIO (T/S) 1.13
 EXIT MACH NUMBER 0.12
 SPECIFIC SPEED 47.79
 SPECIFIC DIAMETER 1.27

 • O2 PUMP •

EFFICIENCY 0.747
 HORSEPOWER 538.
 SPEED (RPM) 65861.
 SS SPEED 21611.
 S SPEED 1870.
 HEAD (FT) 4942.
 DIA. (IN) 2.12
 TIP SPEED 611.
 VOL. FLOW 280.
 HEAD COEF 0.426
 FLOW COEF 0.156
 DIAMETER RATIO 0.683
 BEARING DN 1.45E+06
 SHAFT DIAMETER 22.00

TABLE 12. — FULL-EXPANDER ENGINE — 37,500 LBF THRUST (COPPER TUBE CHAMBER)

ENGINE PERFORMANCE PARAMETERS

CHAMBER PRESSURE	1502.9
VAC ENGINE THRUST	37500.
TOTAL ENGINE FLOW RATE	78.13
DEL. VAC. ISP	480.0
THROAT AREA	12.19
NOZZLE AREA RATIO	1000.0
NOZZLE EXIT DIAMETER	124.61
ENGINE MIXTURE RATIO	6.00
ETA C*	0.993
CHAMBER COOLANT DP	447.
CHAMBER COOLANT DT	420.
NOZZLE/CHAMBER Q	18018.

ENGINE STATION CONDITIONS

* FUEL SYSTEM CONDITIONS *					
STATION	PRESS	TEMP	FLOW	ENTHALPY	DENSITY
B.P. INLET	18.6	37.4	11.18	-107.5	4.37
B.P. EXIT	100.3	38.5	11.18	-103.0	4.39
PUMP INLET	100.3	38.5	11.18	-103.0	4.39
1ST STAGE EXIT	1523.0	55.0	11.18	-23.6	4.52
2ND STAGE EXIT	2971.8	70.9	11.18	55.8	4.63
PUMP EXIT	4445.4	86.4	11.18	135.0	4.72
COOLANT INLET	4400.9	86.8	11.18	135.0	4.70
COOLANT EXIT	3953.5	507.0	11.18	1746.4	1.25
TBV INLET	3914.0	507.2	0.56	1746.4	1.24
TBV EXIT	1682.1	517.4	0.56	1746.4	0.57
O2 TRB INLET	3914.0	507.2	10.62	1746.4	1.24
O2 TRB EXIT	3491.1	495.9	10.62	1697.1	1.14
H2 TRB INLET	3491.1	495.9	10.62	1697.1	1.14
H2 TRB EXIT	1818.3	435.6	10.62	1446.6	0.72
H2 TRB DIFFUSER	1774.3	435.7	10.62	1446.6	0.71
H2 BST TRB IN	1756.6	435.7	10.62	1446.6	0.71
H2 BST TRB OUT	1733.8	434.6	10.62	1441.9	0.69
H2 BST TRB DIFF	1720.7	434.6	10.62	1441.9	0.69
O2 BST TRB IN	1703.5	434.7	10.62	1441.9	0.68
O2 BST TRB OUT	1692.0	434.0	10.62	1439.3	0.68
O2 BST TRB DIFF	1690.5	434.0	10.62	1439.3	0.68
H2 TANK PRESS	18.6	442.8	0.0203	1454.7	0.0079
GOX HEAT EXCH IN	1682.1	438.2	11.16	1454.7	0.67
GOX HEAT EXCH OUT	1673.7	437.8	11.16	1453.3	0.67
FSOV INLET	1673.7	437.8	11.16	1453.3	0.67
FSOV EXIT	1631.8	438.0	11.16	1453.3	0.65
CHAMBER INJ	1615.5	438.0	11.16	1453.3	0.66
CHAMBER	1502.9				

* OXYGEN SYSTEM CONDITIONS *					
STATION	PRESS	TEMP	FLOW	ENTHALPY	DENSITY
B.P. INLET	16.0	162.7	67.1	61.1	71.17
B.P. EXIT	135.6	163.2	67.1	61.5	71.20
PUMP INLET	135.6	163.2	67.1	61.5	71.20
PUMP EXIT	2433.9	173.5	67.1	69.3	71.71
O2 TANK PRESS	16.0	400.0	0.115	204.7	0.12
OCV INLET	2409.6	173.6	67.0	69.3	71.67
OCV EXIT	1686.7	176.4	67.0	69.3	70.55
CHAMBER INJ	1653.1	176.5	67.0	69.3	70.50
CHAMBER	1502.9				

* VALVE DATA *				
VALVE	DELTA P	AREA	FLOW	% BYPASS
TBV	2232.	0.02	0.56	5.00
FSOV	42.	3.09	11.16	
OCV	723.	0.44	66.97	

* INJECTOR DATA *				
INJECTOR	DELTA P	AREA	FLOW	VELOCITY
FUEL	113.	2.13	11.16	1181.21
LOX	167.	0.97	66.97	140.53

TABLE 12. — FULL-EXPANDER ENGINE — 37,500 LBF THRUST (COPPER TUBE CHAMBER) (CONTINUED)

 * TURBOMACHINERY PERFORMANCE DATA *

 * H2 BOOST TURBINE *

 EFFICIENCY (T/T) 0.848
 EFFICIENCY (T/S) 0.479
 SPEED (RPM) 33637.
 MEAN DIA (IN) 1.78
 EFF AREA (IN2) 3.85
 U/C (ACTUAL) 0.537
 MAX TIP SPEED 370.
 STAGES 1
 GAMMA 1.42
 PRESS RATIO (T/T) 1.01
 PRESS RATIO (T/S) 1.02
 HORSEPOWER 71.
 EXIT MACH NUMBER 0.11
 SPECIFIC SPEED 150.00
 SPECIFIC DIAMETER 0.54

 * H2 BOOST PUMP *

 EFFICIENCY 0.766
 HORSEPOWER 71.
 SPEED (RPM) 33637.
 S SPEED 3051.
 HEAD (FT) 2683.
 DIA. (IN) 2.98
 TIP SPEED 438.
 VOL. FLOW 1143.
 HEAD COEF 0.450
 FLOW COEF 0.201

 * H2 TURBINE *

 EFFICIENCY (T/T) 0.865
 EFFICIENCY (T/S) 0.827
 SPEED (RPM) 187143.
 HORSEPOWER 3764.
 MEAN DIA (IN) 2.61
 EFF AREA (IN2) 0.48
 U/C (ACTUAL) 0.488
 MAX TIP SPEED 1347.
 STAGES 2
 GAMMA 1.42
 PRESS RATIO (T/T) 1.92
 PRESS RATIO (T/S) 1.98
 EXIT MACH NUMBER 0.20
 SPECIFIC SPEED 58.88
 SPECIFIC DIAMETER 1.23

 * H2 PUMP *

 STAGE ONE STAGE TWO STAGE THREE

 EFFICIENCY 0.759 0.730 0.737
 HORSEPOWER 1256. 1255. 1253.
 SPEED (RPM) 187143. 187143. 187143.
 SS SPEED 11947.
 S SPEED 1142. 1132. 1124.
 HEAD (FT) 45690. 45553. 45391.
 DIA. (IN) 3.64 3.64 3.64
 TIP SPEED 1702. 1702. 1702.
 VOL. FLOW 1110. 1085. 1064.
 HEAD COEF 0.507 0.506 0.506
 FLOW COEF 0.119
 DIAMETER RATIO 0.417
 BEARING DN 3.00E+04
 SHAFT DIAMETER 28.00

 * O2 BOOST TURBINE *

 EFFICIENCY (T/T) 0.887
 EFFICIENCY (T/S) 0.754
 SPEED (RPM) 9026.
 MEAN DIA (IN) 5.03
 EFF AREA (IN2) 5.48
 U/C (ACTUAL) 0.553
 MAX TIP SPEED 231.
 STAGES 1
 GAMMA 1.42
 PRESS RATIO (T/T) 1.01
 PRESS RATIO (T/S) 1.01
 HORSEPOWER 39.
 EXIT MACH NUMBER 0.04
 SPECIFIC SPEED 93.06
 SPECIFIC DIAMETER 0.92

 * O2 BOOST PUMP *

 EFFICIENCY 0.764
 HORSEPOWER 39.
 SPEED (RPM) 9026.
 S SPEED 3026.
 HEAD (FT) 242.
 DIA. (IN) 3.34
 TIP SPEED 132.
 VOL. FLOW 423.
 HEAD COEF 0.450
 FLOW COEF 0.200

 * O2 TURBINE *

 EFFICIENCY (T/T) 0.877
 EFFICIENCY (T/S) 0.826
 SPEED (RPM) 52014.
 HORSEPOWER 740.
 MEAN DIA (IN) 2.61
 EFF AREA (IN2) 0.68
 U/C (ACTUAL) 0.534
 MAX TIP SPEED 667.
 STAGES 2
 GAMMA 1.42
 PRESS RATIO (T/T) 1.12
 PRESS RATIO (T/S) 1.13
 EXIT MACH NUMBER 0.09
 SPECIFIC SPEED 74.54
 SPECIFIC DIAMETER 1.08

 * O2 PUMP *

 EFFICIENCY 0.768
 HORSEPOWER 740.
 SPEED (RPM) 52014.
 SS SPEED 20904.
 S SPEED 1904.
 HEAD (FT) 4613.
 DIA. (IN) 2.58
 TIP SPEED 587.
 VOL. FLOW 420.
 HEAD COEF 0.431
 FLOW COEF 0.158
 DIAMETER RATIO 0.684
 BEARING DN 1.46E+06
 SHAFT DIAMETER 28.00

TABLE 13. — FULL-EXPANDER ENGINE — 50,000 LBF THRUST (COPPER TUBE CHAMBER)

ENGINE PERFORMANCE PARAMETERS

CHAMBER PRESSURE	1402.6
VAC ENGINE THRUST	50000.
TOTAL ENGINE FLOW RATE	104.18
DEL. VAC. ISP	480.0
THROAT AREA	17.41
NOZZLE AREA RATIO	1000.0
NOZZLE EXIT DIAMETER	148.90
ENGINE MIXTURE RATIO	6.00
ETA C*	0.993
CHAMBER COOLANT DP	355.
CHAMBER COOLANT DT	383.
NOZZLE/CHAMBER D	21899.

ENGINE STATION CONDITIONS

* FUEL SYSTEM CONDITIONS *					
STATION	PRESS	TEMP	FLOW	ENTHALPY	DENSITY
B.P. INLET	18.6	37.4	14.91	-107.5	4.37
B.P. EXIT	100.2	38.5	14.91	-103.0	4.39
PUMP INLET	100.2	38.5	14.91	-103.0	4.39
1ST STAGE EXIT	1308.4	51.6	14.91	-37.9	4.53
2ND STAGE EXIT	2547.4	64.4	14.91	27.5	4.65
PUMP EXIT	3813.5	76.7	14.91	93.1	4.73
COOLANT INLET	3775.4	77.1	14.91	93.1	4.71
COOLANT EXIT	3420.6	459.9	14.91	1561.6	1.20
TBV INLET	3386.4	460.0	0.75	1561.6	1.19
TBV EXIT	1570.3	467.3	0.75	1561.6	0.59
O2 TRB INLET	3386.4	460.0	14.17	1561.6	1.19
O2 TRB EXIT	3016.7	449.7	14.17	1516.4	1.10
H2 TRB INLET	3016.7	449.7	14.17	1516.4	1.10
H2 TRB EXIT	1706.6	400.3	14.17	1309.9	0.74
H2 TRB DIFFUSER	1659.7	400.4	14.17	1309.9	0.72
H2 BST TRB IN	1643.1	400.4	14.17	1309.9	0.72
H2 BST TRB OUT	1620.3	399.3	14.17	1305.2	0.71
H2 BST TRB DIFF	1607.4	399.3	14.17	1305.2	0.70
O2 BST TRB IN	1591.3	399.4	14.17	1305.2	0.69
O2 BST TRB OUT	1579.8	398.7	14.17	1302.6	0.69
O2 BST TRB DIFF	1578.2	398.7	14.17	1302.6	0.69
H2 TANK PRESS	18.6	405.3	0.0296	1315.5	0.0087
GOX HEAT EXCH IN	1570.3	402.1	14.88	1315.5	0.68
GOX HEAT EXCH OUT	1562.5	401.8	14.88	1314.2	0.68
FSOV INLET	1562.5	401.8	14.88	1314.2	0.68
FSOV EXIT	1523.4	401.9	14.88	1314.2	0.66
CHAMBER INJ	1508.2	401.9	14.88	1314.2	0.66
CHAMBER	1402.6				

* OXYGEN SYSTEM CONDITIONS *					
STATION	PRESS	TEMP	FLOW	ENTHALPY	DENSITY
B.P. INLET	16.0	162.7	89.4	61.1	71.17
B.P. EXIT	135.6	163.2	89.4	61.5	71.20
PUMP INLET	135.6	163.2	89.4	61.5	71.20
PUMP EXIT	2271.6	172.6	89.4	68.6	71.71
O2 TANK PRESS	16.0	400.0	0.151	204.7	0.12
OCV INLET	2248.8	172.7	89.3	68.6	71.67
OCV EXIT	1574.2	175.3	89.3	68.6	70.62
CHAMBER INJ	1558.4	175.3	89.3	68.6	70.60
CHAMBER	1402.6				

* VALVE DATA *

VALVE	DELTA P	AREA	FLOW	% BYPASS
TBV	1816.	0.03	0.75	5.00
FSOV	39.	4.22	14.88	
OCV	675.	0.61	89.29	

* INJECTOR DATA *

INJECTOR	DELTA P	AREA	FLOW	VELOCITY
FUEL	106.	2.68	14.88	1131.21
LOX	156.	1.27	89.29	135.69

TABLE 13. — FULL-EXPANDER ENGINE — 50,000 LBF THRUST (COPPER TUBE CHAMBER) (CONTINUED)

***** # TURBOMACHINERY PERFORMANCE DATA # *****	
***** # H2 BOOST TURBINE # *****	***** # H2 BOOST PUMP # *****
EFFICIENCY (T/T) 0.861	EFFICIENCY 0.766
EFFICIENCY (T/S) 0.489	HORSEPOWER 95.
SPEED (RPM) 29123.	SPEED (RPM) 29123.
MEAN DIA (IN) 2.06	S SPEED 3051.
EFF AREA (IN2) 5.09	HEAD (FT) 2682.
U/C (ACTUAL) 0.533	DIA. (IN) 3.44
MAX TIP SPEED 367.	TIP SPEED 438.
STAGES 1	VOL. FLOW 1525.
GAMMA 1.41	HEAD COEF 0.450
PRESS RATIO (T/T) 1.01	FLOW COEF 0.201
PRESS RATIO (T/S) 1.02	
HORSEPOWER 95.	
EXIT MACH NUMBER 0.11	
SPECIFIC SPEED 150.00	
SPECIFIC DIAMETER 0.54	
***** # H2 TURBINE # *****	***** # H2 PUMP # *****
EFFICIENCY (T/T) 0.889	STAGE ONE STAGE TWO STAGE THREE
EFFICIENCY (T/S) 0.838	*****
SPEED (RPM) 100000.	EFFICIENCY 0.764 0.763 0.762
HORSEPOWER 4139.	HORSEPOWER 1375. 1380. 1384.
MEAN DIA. (IN) 2.83	SPEED (RPM) 100000. 100000. 100000.
EFF AREA (IN2) 0.71	SS SPEED 12880.
U/C (ACTUAL) 0.544	S SPEED 1391.
MAX TIP SPEED 1383.	HEAD (FT) 38744. 38828. 38875.
STAGES 2	DIA. (IN) 3.68 3.68 3.69
GAMMA 1.41	TIP SPEED 1609. 1609. 1609.
PRESS RATIO (T/T) 1.77	VOL. FLOW 1476. 1441. 1415.
PRESS RATIO (T/S) 1.83	HEAD COEF 0.481 0.483 0.483
EXIT MACH NUMBER 0.21	FLOW COEF 0.133
SPECIFIC SPEED 73.38	DIAMETER RATIO 0.472
SPECIFIC DIAMETER 1.12	BEARING DN 3.00E+06
	SHAFT DIAMETER 30.00
***** # O2 BOOST TURBINE # *****	***** # O2 BOOST PUMP # *****
EFFICIENCY (T/T) 0.896	EFFICIENCY 0.764
EFFICIENCY (T/S) 0.762	HORSEPOWER 51.
SPEED (RPM) 7817.	SPEED (RPM) 7817.
MEAN DIA (IN) 5.81	S SPEED 3026.
EFF AREA (IN2) 7.23	HEAD (FT) 242.
U/C (ACTUAL) 0.553	DIA. (IN) 3.85
MAX TIP SPEED 230.	TIP SPEED 132.
STAGES 1	VOL. FLOW 564.
GAMMA 1.41	HEAD COEF 0.450
PRESS RATIO (T/T) 1.01	FLOW COEF 0.200
PRESS RATIO (T/S) 1.01	
HORSEPOWER 51.	
EXIT MACH NUMBER 0.04	
SPECIFIC SPEED 93.04	
SPECIFIC DIAMETER 0.92	
***** # O2 TURBINE # *****	***** # O2 PUMP # *****
EFFICIENCY (T/T) 0.879	EFFICIENCY 0.769
EFFICIENCY (T/S) 0.822	HORSEPOWER 907.
SPEED (RPM) 43561.	SPEED (RPM) 43561.
HORSEPOWER 907.	SS SPEED 20215.
MEAN DIA (IN) 2.83	S SPEED 1945.
EFF AREA (IN2) 1.00	HEAD (FT) 4287.
U/C (ACTUAL) 0.506	DIA. (IN) 2.96
MAX TIP SPEED 617.	TIP SPEED 564.
STAGES 2	VOL. FLOW 560.
GAMMA 1.41	HEAD COEF 0.434
PRESS RATIO (T/T) 1.12	FLOW COEF 0.160
PRESS RATIO (T/S) 1.13	DIAMETER RATIO 0.686
EXIT MACH NUMBER 0.10	BEARING DN 1.31E+06
SPECIFIC SPEED 77.88	SHAFT DIAMETER 30.00
SPECIFIC DIAMETER 0.99	

TABLE 14. — SPLIT-EXPANDER ENGINE — 7500 LBF THRUST (COPPER TUBE CHAMBER)

ENGINE PERFORMANCE PARAMETERS

CHAMBER PRESSURE	1329.9
VAC ENGINE THRUST	7500.
TOTAL ENGINE FLOW RATE	15.63
DEL. VAC. ISP	479.9
THROAT AREA	2.75
NOZZLE AREA RATIO	1000.0
NOZZLE EXIT DIAMETER	59.21
ENGINE MIXTURE RATIO	6.00
ETA C*	0.993
CHAMBER COOLANT DP	1300.
CHAMBER COOLANT DT	1071.
NOZZLE/CHAMBER Q	4397.

ENGINE STATION CONDITIONS

* FUEL SYSTEM CONDITIONS *						
STATION	PRESS	TEMP	FLOW	ENTHALPY	DENSITY	
B.P. INLET	18.6	37.4	2.23	-107.5	4.37	
B.P. EXIT	100.3	38.5	2.23	-103.0	4.39	
PUMP INLET	100.3	38.5	2.23	-103.0	4.39	
1ST STAGE EXIT	1787.3	66.4	2.23	13.7	4.30	
JBV INLET	1740.5	66.6	1.12	13.9	4.28	
JBV EXIT	1496.4	68.6	1.12	13.9	4.09	
2ND STAGE EXIT	3473.0	104.6	1.12	164.0	4.05	
PUMP EXIT	4981.0	137.3	1.12	298.4	3.98	
COOLANT INLET	4931.2	137.7	1.12	298.4	3.96	
COOLANT EXIT	3631.6	1208.7	1.12	4234.7	0.53	
TBV INLET	3595.2	1209.0	0.06	4234.7	0.52	
TBV EXIT	1567.0	1223.8	0.06	4234.7	0.23	
O2 TRB INLET	3595.2	1209.0	1.06	4234.7	0.52	
O2 TRB EXIT	3240.7	1184.9	1.06	4140.6	0.48	
H2 TRB INLET	3240.7	1184.9	1.06	4140.6	0.48	
H2 TRB EXIT	1657.5	1040.3	1.06	3595.0	0.29	
H2 TRB DIFFUSER	1641.7	1040.4	1.06	3595.0	0.28	
H2 BST TRB IN	1625.3	1040.4	1.06	3585.5	0.28	
H2 BST TRB OUT	1606.3	1038.0	1.06	3585.5	0.28	
H2 BST TRB DIFF	1601.4	1038.0	1.06	3585.5	0.28	
O2 BST TRB IN	1585.4	1038.1	1.06	3580.4	0.27	
O2 BST TRB OUT	1575.6	1036.7	1.06	3580.4	0.27	
O2 BST TRB DIFF	1574.8	1036.7	1.06	3580.4	0.27	
H2 TANK PRESS	18.6	1057.3	0.0017	3613.1	0.0033	
GOX HEAT EXCH IN	1567.0	1046.1	1.12	3613.1	0.27	
GOX HEAT EXCH OUT	1559.1	1045.4	1.12	3610.3	0.27	
MIXER HOT IN	1559.1	1045.4	1.12	3610.3	0.27	
MIXER COLD IN	1496.4	68.6	1.12	13.9	4.09	
MIXER OUT	1481.2	535.9	2.23	1810.7	0.49	
FSOV INLET	1481.2	535.9	2.23	1810.7	0.49	
FSOV EXIT	1464.1	536.1	2.23	1810.7	0.48	
CHAMBER INJ	1429.7	536.2	2.23	1810.7	0.47	
CHAMBER	1329.9					

* OXYGEN SYSTEM CONDITIONS *						
STATION	PRESS	TEMP	FLOW	ENTHALPY	DENSITY	
B.P. INLET	16.0	162.7	13.4	61.1	71.17	
B.P. EXIT	135.6	163.2	13.4	61.5	71.20	
PUMP INLET	135.6	163.2	13.4	61.5	71.20	
PUMP EXIT	2153.8	173.7	13.4	68.9	71.42	
O2 TANK PRESS	16.0	400.0	0.023	204.7	0.12	
OCV INLET	2132.3	173.8	13.4	68.9	71.39	
OCV EXIT	1492.6	176.2	13.4	68.9	70.38	
CHAMBER INJ	1462.9	176.3	13.4	68.9	70.34	
CHAMBER	1329.9					

* VALVE DATA *				
VALVE	DELTA P	AREA	FLOW	% BYPASS
JBV	264.	0.05	1.12	50.00
TBV	2028.	0.00	0.06	5.00
FSOV	37.	0.77	2.23	
OCV	640.	0.09	13.39	

* INJECTOR DATA *				
INJECTOR	DELTA P	AREA	FLOW	VELOCITY
FUEL	100.	0.53	2.23	1288.81
LOX	148.	0.21	13.39	132.35

TABLE 14. — SPLIT-EXPANDER ENGINE — 7500 LBF THRUST (COPPER TUBE CHAMBER) (CONTINUED)

***** * TURBOMACHINERY PERFORMANCE DATA * *****					
***** * H2 BOOST TURBINE * *****				***** * H2 BOOST PUMP * *****	
EFFICIENCY (T/T)	0.789	EFFICIENCY		0.766	
EFFICIENCY (T/S)	0.584	HORSEPOWER		14.	
SPEED (RPM)	75254.	SPEED (RPM)		75254.	
MEAN DIA (IN)	1.16	S SPEED		3051.	
EFF AREA (IN ²)	0.68	HEAD (FT)		2483.	
U/C (ACTUAL)	0.553	DIA. (IN)		1.33	
MAX TIP SPEED	484.	TIP SPEED		438.	
STAGES	1	VOL. FLOW		228.	
GAMMA	1.38	HEAD COEF		0.450	
PRESS RATIO (T/T)	1.01	FLOW COEF		0.201	
PRESS RATIO (T/S)	1.02				
HORSEPOWER	14.				
EXIT MACH NUMBER	0.07				
SPECIFIC SPEED	128.86				
SPECIFIC DIAMETER	0.60				
***** * H2 TURBINE * *****				***** * H2 PUMP * *****	
EFFICIENCY (T/T)	0.763	EFFICIENCY		0.617	
EFFICIENCY (T/S)	0.758	HORSEPOWER		349.	
SPEED (RPM)	187500.	SPEED (RPM)		187500.	
HORSEPOWER	819.	SS SPEED		9345.	
MEAN DIA (IN)	2.36	S SPEED		785.	
EFF AREA (IN ²)	0.88	HEAD (FT)		56132.	
U/C (ACTUAL)	0.523	DIA. (IN)		2.28	
MAX TIP SPEED	2000.	TIP SPEED		1864.	
STAGES	2	VOL. FLOW		233.	
GAMMA	1.38	HEAD COEF		0.520	
PRESS RATIO (T/T)	1.96	FLOW COEF		0.096	
PRESS RATIO (T/S)	1.98	DIAMETER RATIO		0.324	
EXIT MACH NUMBER	0.12	BEARING DN		3.00E+06	
SPECIFIC SPEED	28.21	SHAFT DIAMETER		16.00	
SPECIFIC DIAMETER	2.51				
***** * O2 BOOST TURBINE * *****				***** * O2 BOOST PUMP * *****	
EFFICIENCY (T/T)	0.811	EFFICIENCY		0.764	
EFFICIENCY (T/S)	0.739	HORSEPOWER		8.	
SPEED (RPM)	20182.	SPEED (RPM)		20182.	
MEAN DIA (IN)	3.19	S SPEED		3026.	
EFF AREA (IN ²)	0.95	HEAD (FT)		242.	
U/C (ACTUAL)	0.553	DIA. (IN)		1.49	
MAX TIP SPEED	307.	TIP SPEED		132.	
STAGES	1	VOL. FLOW		85.	
GAMMA	1.38	HEAD COEF		0.450	
PRESS RATIO (T/T)	1.01	FLOW COEF		0.200	
PRESS RATIO (T/S)	1.01				
HORSEPOWER	8.				
EXIT MACH NUMBER	0.03				
SPECIFIC SPEED	61.66				
SPECIFIC DIAMETER	1.29				
***** * O2 TURBINE * *****				***** * O2 PUMP * *****	
EFFICIENCY (T/T)	0.772	EFFICIENCY		0.703	
EFFICIENCY (T/S)	0.743	HORSEPOWER		141.	
SPEED (RPM)	112415.	SPEED (RPM)		112415.	
HORSEPOWER	141.	SS SPEED		20241.	
MEAN DIA (IN)	2.36	S SPEED		2030.	
EFF AREA (IN ²)	0.12	HEAD (FT)		4068.	
U/C (ACTUAL)	0.535	DIA. (IN)		1.15	
MAX TIP SPEED	1201.	TIP SPEED		565.	
STAGES	1	VOL. FLOW		84.	
GAMMA	1.38	HEAD COEF		0.410	
PRESS RATIO (T/T)	1.11	FLOW COEF		0.163	
PRESS RATIO (T/S)	1.11	DIAMETER RATIO		0.686	
EXIT MACH NUMBER	0.07	BEARING DN		1.58E+06	
SPECIFIC SPEED	29.14	SHAFT DIAMETER		14.00	
SPECIFIC DIAMETER	2.51				

TABLE 15. — SPLIT-EXPANDER ENGINE — 15,000 LBF THRUST (COPPER TUBE CHAMBER)

ENGINE PERFORMANCE PARAMETERS					
CHAMBER PRESSURE					1610.6
VAC ENGINE THRUST					15000.
TOTAL ENGINE FLOW RATE					31.25
DEL. VAC. ISP					480.0
THROAT AREA					4.55
NOZZLE AREA RATIO					1000.0
NOZZLE EXIT DIAMETER					76.15
ENGINE MIXTURE RATIO					6.00
ETA C*					0.995
CHAMBER COOLANT DP					602.
CHAMBER COOLANT DT					1121.
NOZZLE/CHAMBER Q					9205.

ENGINE STATION CONDITIONS					
* FUEL SYSTEM CONDITIONS *					
STATION	PRESS	TEMP	FLOW	ENTHALPY	DENSITY
B.P. INLET	18.6	37.4	4.47	-107.5	4.37
B.P. EXIT	100.3	38.5	4.47	-103.0	4.39
PUMP INLET	100.3	38.5	4.47	-103.0	4.39
1ST STAGE EXIT	2164.6	72.6	4.47	40.2	4.29
JBV INLET	2132.2	72.9	2.23	40.2	4.27
JBV EXIT	1812.3	75.2	2.23	40.2	4.05
2ND STAGE EXIT	3476.6	95.3	2.23	136.0	4.25
PUMP EXIT	4736.6	116.4	2.23	227.4	4.26
COOLANT INLET	4689.2	116.7	2.23	227.4	4.24
COOLANT EXIT	4087.5	1237.4	2.23	4367.3	0.57
TBV INLET	4046.6	1237.7	0.11	4367.3	0.57
TBV EXIT	1898.0	1253.4	0.11	4367.3	0.27
O2 TRB INLET	4046.6	1237.7	2.12	4367.3	0.57
O2 TRB EXIT	3594.2	1209.6	2.12	4236.6	0.52
H2 TRB INLET	3594.2	1209.6	2.12	4236.6	0.52
H2 TRB EXIT	2004.5	1078.8	2.12	3737.9	0.33
H2 TRB DIFFUSER	1985.2	1078.9	2.12	3737.9	0.33
H2 BST TRB IN	1965.4	1078.9	2.12	3728.4	0.32
H2 BST TRB OUT	1943.9	1076.5	2.12	3728.4	0.32
H2 BST TRB DIFF	1938.9	1076.5	2.12	3728.4	0.32
O2 BST TRB IN	1919.5	1076.7	2.12	3723.2	0.32
O2 BST TRB OUT	1908.3	1075.3	2.12	3723.2	0.32
O2 BST TRB DIFF	1907.6	1075.3	2.12	3723.2	0.32
H2 TANK PRESS	18.6	1097.9	0.0033	3754.4	0.0032
GOX HEAT EXCH IN	1898.0	1084.3	2.23	3754.4	0.32
GOX HEAT EXCH OUT	1888.5	1083.6	2.23	3751.7	0.31
MIXER HOT IN	1888.5	1083.6	2.23	3751.7	0.31
MIXER COLD IN	1812.3	75.2	2.23	40.2	4.05
MIXER OUT	1794.1	557.6	4.46	1894.6	0.56
FSOV INLET	1794.1	557.6	4.46	1894.6	0.56
FSOV EXIT	1749.3	557.8	4.46	1894.6	0.55
CHAMBER INJ	1731.6	558.0	4.46	1894.6	0.55
CHAMBER	1610.6				

* OXYGEN SYSTEM CONDITIONS *					
STATION	PRESS	TEMP	FLOW	ENTHALPY	DENSITY
B.P. INLET	16.0	162.7	26.8	61.1	71.17
B.P. EXIT	135.6	163.2	26.8	61.5	71.20
PUMP INLET	135.6	163.2	26.8	61.5	71.20
PUMP EXIT	2608.5	175.2	26.8	70.2	71.61
O2 TANK PRESS	16.0	400.0	0.045	204.7	0.12
OCV INLET	2582.4	175.3	26.8	70.2	71.57
OCV EXIT	1807.7	178.2	26.8	70.2	70.36
CHAMBER INJ	1771.7	178.4	26.8	70.2	70.30
CHAMBER	1610.6				

* VALVE DATA *				
VALVE	DELTA P	AREA	FLOW	% BYPASS
JBV	320.	0.09	2.23	50.00
TBV	2149.	0.01	0.11	5.00
FSOV	45.	1.30	4.46	
OCV	775.	0.17	26.79	

* INJECTOR DATA *				
INJECTOR	DELTA P	AREA	FLOW	VELOCITY
FUEL	121.	0.90	4.46	1327.74
LOX	179.	0.38	26.79	145.68

TABLE 15. — SPLIT-EXPANDER ENGINE — 15,000 LBF THRUST (COPPER TUBE CHAMBER) (CONTINUED)

 * TURBOMACHINERY PERFORMANCE DATA *

 * H2 BOOST TURBINE *

EFFICIENCY (T/T) 0.815
 EFFICIENCY (T/S) 0.622
 SPEED (RPM) 53258.
 MEAN DIA (IN) 1.64
 EFF AREA (IN2) 1.18
 U/C (ACTUAL) 0.553
 MAX TIP SPEED 476.
 STAGES 1
 GAMMA 1.40
 PRESS RATIO (T/T) 1.01
 PRESS RATIO (T/S) 1.01
 HORSEPOWER 28.
 EXIT MACH NUMBER 0.06
 SPECIFIC SPEED 117.16
 SPECIFIC DIAMETER 0.71

 * H2 BOOST PUMP *

EFFICIENCY 0.766
 HORSEPOWER 28.
 SPEED (RPM) 53258.
 S SPEED 3050.
 HEAD (FT) 2485.
 DIA. (IN) 1.00
 TIP SPEED 438.
 VOL. FLOW 457.
 HEAD COEF 0.450
 FLOW COEF 0.201

 * H2 TURBINE *

EFFICIENCY (T/T) 0.779
 EFFICIENCY (T/S) 0.763
 SPEED (RPM) 136363.
 HORSEPOWER 1497.
 MEAN DIA. (IN) 3.26
 EFF AREA (IN2) 0.15
 U/C (ACTUAL) 0.540
 MAX TIP SPEED 2000.
 STAGES 2
 GAMMA 1.40
 PRESS RATIO (T/T) 1.79
 PRESS RATIO (T/S) 1.82
 EXIT MACH NUMBER 0.12
 SPECIFIC SPEED 29.04
 SPECIFIC DIAMETER 2.57

 * H2 PUMP *

	STAGE ONE	STAGE TWO	STAGE THREE
EFFICIENCY	0.617	0.592	0.600
HORSEPOWER	905.	303.	289.
SPEED (RPM)	136363.	136363.	136363.
SS SPEED	9605.		
S SPEED	694.	686.	705.
HEAD (FT)	48810.	44229.	42620.
DIA. (IN)	3.39	2.82	2.82
TIP SPEED	2020.	1677.	1677.
VOL. FLOW	467.	236.	235.
HEAD COEF	0.542	0.506	0.480
FLOW COEF	0.089		
DIAMETER RATIO	0.304		
BEARING DN	3.00E+06		
SHAFT DIAMETER	22.00		

 * O2 BOOST TURBINE *

EFFICIENCY (T/T) 0.827
 EFFICIENCY (T/S) 0.759
 SPEED (RPM) 14271.
 MEAN DIA (IN) 4.50
 EFF AREA (IN2) 1.64
 U/C (ACTUAL) 0.553
 MAX TIP SPEED 305.
 STAGES 1
 GAMMA 1.40
 PRESS RATIO (T/T) 1.01
 PRESS RATIO (T/S) 1.01
 HORSEPOWER 15.
 EXIT MACH NUMBER 0.02
 SPECIFIC SPEED 58.29
 SPECIFIC DIAMETER 1.38

 * O2 BOOST PUMP *

EFFICIENCY 0.764
 HORSEPOWER 15.
 SPEED (RPM) 14271.
 S SPEED 3026.
 HEAD (FT) 242.
 DIA. (IN) 2.11
 TIP SPEED 132.
 VOL. FLOW 169.
 HEAD COEF 0.450
 FLOW COEF 0.200

 * O2 TURBINE *

EFFICIENCY (T/T) 0.779
 EFFICIENCY (T/S) 0.755
 SPEED (RPM) 85773.
 HORSEPOWER 332.
 MEAN DIA (IN) 3.26
 EFF AREA (IN2) 0.20
 U/C (ACTUAL) 0.518
 MAX TIP SPEED 1257.
 STAGES 1
 GAMMA 1.40
 PRESS RATIO (T/T) 1.13
 PRESS RATIO (T/S) 1.13
 EXIT MACH NUMBER 0.07
 SPECIFIC SPEED 26.93
 SPECIFIC DIAMETER 2.64

 * O2 PUMP *

EFFICIENCY 0.730
 HORSEPOWER 332.
 SPEED (RPM) 85773.
 SS SPEED 21801.
 S SPEED 1879.
 HEAD (FT) 4971.
 DIA. (IN) 1.65
 TIP SPEED 617.
 VOL. FLOW 168.
 HEAD COEF 0.420
 FLOW COEF 0.157
 DIAMETER RATIO 0.683
 BEARING DN 1.37E+06
 SHAFT DIAMETER 16.00

TABLE 16. — SPLIT-EXPANDER ENGINE — 25,000 LBF THRUST (COPPER TUBE CHAMBER)

ENGINE PERFORMANCE PARAMETERS

CHAMBER PRESSURE	1712.8
VAC ENGINE THRUST	25000.
TOTAL ENGINE FLOW RATE	52.08
DEL. VAC. ISP	480.0
THROAT AREA	7.14
NOZZLE AREA RATIO	1000.0
NOZZLE EXIT DIAMETER	95.35
ENGINE MIXTURE RATIO	6.00
ETA C*	0.993
CHAMBER COOLANT DP	616.
CHAMBER COOLANT DT	1010.
NOZZLE/CHAMBER Q	13870.

ENGINE STATION CONDITIONS

* FUEL SYSTEM CONDITIONS *					
STATION	PRESS	TEMP	FLOW	ENTHALPY	DENSITY
B.P. INLET	18.6	37.4	7.45	-107.5	4.37
B.P. EXIT	101.2	38.5	7.45	-103.0	4.39
PUMP INLET	101.2	38.5	7.45	-103.0	4.39
1ST STAGE EXIT	2301.9	70.0	7.45	36.1	4.42
JBV INLET	2267.4	70.3	3.72	36.1	4.40
JBV EXIT	1927.3	73.0	3.72	36.1	4.17
2ND STAGE EXIT	3708.6	90.5	3.72	127.7	4.43
PUMP EXIT	5091.3	110.0	3.72	216.8	4.47
COOLANT INLET	5040.4	110.4	3.72	216.8	4.45
COOLANT EXIT	4424.2	1119.9	3.72	3942.2	0.67
TBV INLET	4379.9	1120.2	0.19	3942.2	0.67
TBV EXIT	2019.2	1137.1	0.19	3942.2	0.32
O2 TRB INLET	4379.9	1120.2	3.54	3942.2	0.67
O2 TRB EXIT	3864.7	1091.1	3.54	3827.0	0.61
H2 TRB INLET	3864.7	1091.1	3.54	3827.0	0.61
H2 TRB EXIT	2134.2	965.0	3.54	3343.9	0.39
H2 TRB DIFFUSER	2113.7	965.1	3.54	3343.9	0.39
H2 BST TRB IN	2092.6	965.1	3.54	3334.3	0.38
H2 BST TRB OUT	2068.5	962.7	3.54	3334.3	0.38
H2 BST TRB DIFF	2063.5	962.7	3.54	3334.3	0.38
O2 BST TRB IN	2042.9	962.9	3.54	3329.2	0.38
O2 BST TRB OUT	2030.2	961.5	3.54	3329.2	0.38
O2 BST TRB DIFF	2029.4	961.5	3.54	3329.2	0.38
H2 TANK PRESS	18.6	984.3	0.0061	3359.8	0.0036
GOX HEAT EXCH IN	2019.2	970.3	3.72	3359.8	0.37
GOX HEAT EXCH OUT	2009.2	969.6	3.72	3357.1	0.37
MIXER HOT IN	2009.2	969.6	3.72	3357.1	0.37
MIXER COLD IN	1927.3	73.0	3.72	36.1	4.17
MIXER OUT	1908.7	502.4	7.44	1695.3	0.66
FSDV INLET	1908.7	502.4	7.44	1695.3	0.66
FSDV EXIT	1861.0	502.6	7.44	1695.3	0.65
CHAMBER INJ	1842.6	502.7	7.44	1695.3	0.64
CHAMBER	1712.8				

* OXYGEN SYSTEM CONDITIONS *					
STATION	PRESS	TEMP	FLOW	ENTHALPY	DENSITY
B.P. INLET	16.0	162.7	44.7	61.1	71.17
B.P. EXIT	135.6	163.2	44.7	61.5	71.20
PUMP INLET	135.6	163.2	44.7	61.5	71.20
PUMP EXIT	2773.9	175.4	44.7	70.6	71.73
O2 TANK PRESS	16.0	400.0	0.076	204.7	0.12
OCV INLET	2746.2	175.5	44.6	70.6	71.68
OCV EXIT	1922.3	178.7	44.6	70.6	70.40
CHAMBER INJ	1884.1	178.8	44.6	70.6	70.34
CHAMBER	1712.8				

* VALVE DATA *				
VALVE	DELTA P	AREA	FLOW	% BYPASS
JBV	340.	0.14	3.72	50.00
TBV	2361.	0.01	0.19	5.00
FSDV	48.	1.93	7.44	
OCV	824.	0.27	44.64	

* INJECTOR DATA *				
INJECTOR	DELTA P	AREA	FLOW	VELOCITY
FUEL	130.	1.33	7.44	1274.82
LOX	190.	0.61	44.64	150.19

TABLE 16. — SPLIT-EXPANDER ENGINE — 25,000 LBF THRUST (COPPER TUBE CHAMBER) (CONTINUED)

 * TURBOMACHINERY PERFORMANCE DATA *

 * H2 BOOST TURBINE *

 EFFICIENCY (T/T) 0.073
 EFFICIENCY (T/S) 0.684
 SPEED (RPM) 41431.
 MEAN DIA (IN) 2.12
 EFF AREA (IN2) 1.70
 U/C (ACTUAL) 0.553
 MAX TIP SPEED 471.
 STAGES 1
 GAMMA 1.44
 PRESS RATIO (T/T) 1.01
 PRESS RATIO (T/S) 1.01
 HORSEPOWER 48.
 EXIT MACH NUMBER 0.06
 SPECIFIC SPEED 114.95
 SPECIFIC DIAMETER 0.75

 * H2 BOOST PUMP *

 EFFICIENCY 0.765
 HORSEPOWER 48.
 SPEED (RPM) 41431.
 S SPEED 3042.
 HEAD (FT) 2712.
 DIA. (IN) 2.43
 TIP SPEED 440.
 VOL. FLOW 761.
 HEAD COEF 0.450
 FLOW COEF 0.200

 * H2 TURBINE *

 EFFICIENCY (T/T) 0.028
 EFFICIENCY (T/S) 0.812
 SPEED (RPM) 125000.
 HORSEPOWER 2410.
 MEAN DIA. (IN) 3.16
 EFF AREA (IN2) 0.21
 U/C (ACTUAL) 0.495
 MAX TIP SPEED 1000.
 STAGES 2
 GAMMA 1.44
 PRESS RATIO (T/T) 1.01
 PRESS RATIO (T/S) 1.03
 EXIT MACH NUMBER 0.12
 SPECIFIC SPEED 33.40
 SPECIFIC DIAMETER 2.10

 * H2 PUMP *

 STAGE ONE STAGE TWO STAGE THREE

 EFFICIENCY 0.664 0.642 0.645
 HORSEPOWER 1465. 483. 470.
 SPEED (RPM) 125000. 125000. 125000.
 SS SPEED 11207.
 S SPEED 703. 776. 706.
 HEAD (FT) 71037. 45767. 44733.
 DIA. (IN) 3.79 3.09 3.09
 TIP SPEED 2066. 1680. 1680.
 VOL. FLOW 756. 377. 374.
 HEAD COEF 0.541 0.517 0.505
 FLOW COEF 0.096
 DIAMETER RATIO 0.333
 BEARING DN 3.00E+06
 SHAFT DIAMETER 24.00

 * O2 BOOST TURBINE *

 EFFICIENCY (T/T) 0.069
 EFFICIENCY (T/S) 0.802
 SPEED (RPM) 11055.
 MEAN DIA (IN) 5.02
 EFF AREA (IN2) 2.36
 U/C (ACTUAL) 0.553
 MAX TIP SPEED 302.
 STAGES 1
 GAMMA 1.44
 PRESS RATIO (T/T) 1.01
 PRESS RATIO (T/S) 1.01
 HORSEPOWER 26.
 EXIT MACH NUMBER 0.02
 SPECIFIC SPEED 55.64
 SPECIFIC DIAMETER 1.47

 * O2 BOOST PUMP *

 EFFICIENCY 0.764
 HORSEPOWER 26.
 SPEED (RPM) 11055.
 S SPEED 3026.
 HEAD (FT) 242.
 DIA. (IN) 2.72
 TIP SPEED 132.
 VOL. FLOW 282.
 HEAD COEF 0.450
 FLOW COEF 0.200

 * O2 TURBINE *

 EFFICIENCY (T/T) 0.050
 EFFICIENCY (T/S) 0.825
 SPEED (RPM) 67789.
 HORSEPOWER 576.
 MEAN DIA (IN) 3.16
 EFF AREA (IN2) 0.29
 U/C (ACTUAL) 0.550
 MAX TIP SPEED 904.
 STAGES 2
 GAMMA 1.44
 PRESS RATIO (T/T) 1.13
 PRESS RATIO (T/S) 1.14
 EXIT MACH NUMBER 0.07
 SPECIFIC SPEED 42.69
 SPECIFIC DIAMETER 1.85

 * O2 PUMP *

 EFFICIENCY 0.747
 HORSEPOWER 576.
 SPEED (RPM) 67789.
 SS SPEED 22244.
 S SPEED 1027.
 HEAD (FT) 5295.
 DIA. (IN) 2.14
 TIP SPEED 632.
 VOL. FLOW 280.
 HEAD COEF 0.426
 FLOW COEF 0.155
 DIAMETER RATIO 0.602
 BEARING DN 1.49E+06
 SHAFT DIAMETER 22.00

TABLE 17. — SPLIT-EXPANDER ENGINE — 37,500 LBF THRUST (COPPER TUBE CHAMBER)

ENGINE PERFORMANCE PARAMETERS

CHAMBER PRESSURE	1608.0
VAC ENGINE THRUST	37500.
TOTAL ENGINE FLOW RATE	78.12
DEL. VAC. ISP	480.0
THROAT AREA	11.40
NOZZLE AREA RATIO	1000.0
NOZZLE EXIT DIAMETER	120.49
ENGINE MIXTURE RATIO	6.00
ETA C*	0.993
CHAMBER COOLANT DP	547.
CHAMBER COOLANT DT	879.
NOZZLE/CHAMBER Q	18214.

ENGINE STATION CONDITIONS

STATION	* FUEL SYSTEM CONDITIONS *			ENTHALPY	DENSITY
	PRESS	TEMP	FLOW		
B.P. INLET	18.6	37.4	11.17	-107.5	4.37
B.P. EXIT	100.9	38.5	11.17	-103.0	4.39
PUMP INLET	100.9	38.5	11.17	-103.0	4.39
1ST STAGE EXIT	2161.1	65.1	11.17	19.4	4.49
JBV INLET	2128.7	65.4	5.59	19.5	4.47
JBV EXIT	1809.4	68.2	5.59	19.5	4.26
2ND STAGE EXIT	3418.3	81.1	5.59	94.6	4.54
PUMP EXIT	4672.0	96.6	5.59	168.6	4.59
COOLANT INLET	4625.3	97.0	5.59	168.6	4.57
COOLANT EXIT	4078.0	976.2	5.59	3429.6	0.71
TBV INLET	4037.2	976.4	0.28	3429.6	0.71
TBV EXIT	1895.0	991.2	0.28	3429.6	0.34
O2 TRB INLET	4037.2	976.4	5.31	3429.6	0.71
O2 TRB EXIT	3542.2	949.6	5.31	3323.8	0.64
H2 TRB INLET	3542.2	949.6	5.31	3323.8	0.64
H2 TRB EXIT	2012.1	841.7	5.31	2908.9	0.43
H2 TRB DIFFUSER	1988.7	841.8	5.31	2908.9	0.42
H2 BST TRB IN	1968.8	841.8	5.31	2908.9	0.42
H2 BST TRB OUT	1943.3	839.4	5.31	2899.3	0.41
H2 BST TRB DIFF	1938.3	839.5	5.31	2899.3	0.41
O2 BST TRB IN	1918.9	839.6	5.31	2899.3	0.41
O2 BST TRB OUT	1905.3	838.2	5.31	2894.2	0.41
O2 BST TRB DIFF	1904.5	838.2	5.31	2894.2	0.41
H2 TANK PRESS	18.6	857.9	0.0105	2921.0	0.0041
GOX HEAT EXCH IN	1895.0	845.8	5.58	2921.0	0.40
GOX HEAT EXCH OUT	1885.5	845.1	5.58	2918.2	0.40
MIXER HOT IN	1885.5	845.1	5.58	2918.2	0.40
MIXER COLD IN	1809.4	68.2	5.59	19.5	4.26
MIXER OUT	1791.2	441.3	11.16	1467.5	0.70
FSOV INLET	1791.2	441.3	11.16	1467.5	0.70
FSOV EXIT	1746.5	441.4	11.16	1467.5	0.69
CHAMBER INJ	1728.8	441.5	11.16	1467.5	0.68
CHAMBER	1608.0				

STATION	* OXYGEN SYSTEM CONDITIONS *			ENTHALPY	DENSITY
	PRESS	TEMP	FLOW		
B.P. INLET	16.0	162.7	67.1	61.1	71.17
B.P. EXIT	125.6	163.2	67.1	61.5	71.20
PUMP INLET	125.6	163.2	67.1	61.5	71.20
PUMP EXIT	2604.2	174.3	67.1	69.8	71.75
O2 TANK PRESS	16.0	400.0	0.113	204.7	0.12
OCV INLET	2578.2	174.4	67.0	69.8	71.71
OCV EXIT	1804.7	177.3	67.0	69.8	70.51
CHAMBER INJ	1768.8	177.4	67.0	69.8	70.45
CHAMBER	1608.0				

VALVE	* VALVE DATA *			% BYPASS
	DELTA P	AREA	FLOW	
JBV	319.	0.22	5.59	50.00
TBV	2142.	0.02	0.28	5.00
FSOV	45.	2.90	11.16	
OCV	773.	0.43	66.96	

INJECTOR	* INJECTOR DATA *			VELOCITY
	DELTA P	AREA	FLOW	
FUEL	121.	2.00	11.16	1193.76
LOX	179.	0.94	66.96	145.41

TABLE 17. — SPLIT-EXPANDER ENGINE — 37,500 LBF THRUST (COPPER TUBE CHAMBER) (CONTINUED)

 * TURBOMACHINERY PERFORMANCE DATA *

 * H2 BOOST TURBINE *

EFFICIENCY (T/T) 0.884
 EFFICIENCY (T/S) 0.701
 SPEED (RPM) 33776.
 MEAN DIA (IN) 2.60
 EFF AREA (IN2) 2.39
 U/C (ACTUAL) 0.553
 MAX TIP SPEED 467.
 STAGES 1
 GAMMA 1.41
 PRESS RATIO (T/T) 1.01
 PRESS RATIO (T/S) 1.02
 HORSEPOWER 72.
 EXIT MACH NUMBER 0.07
 SPECIFIC SPEED 112.96
 SPECIFIC DIAMETER 0.77

 * H2 BOOST PUMP *

EFFICIENCY 0.765
 HORSEPOWER 72.
 SPEED (RPM) 33776.
 S SPEED 3044.
 HEAD (FT) 2704.
 DIA. (IN) 2.90
 TIP SPEED 440.
 VOL. FLOW 1142.
 HEAD COEF 0.450
 FLOW COEF 0.201

 * H2 TURBINE *

EFFICIENCY (T/T) 0.851
 EFFICIENCY (T/S) 0.829
 SPEED (RPM) 107143.
 HORSEPOWER 3115.
 MEAN DIA. (IN) 3.70
 EFF AREA (IN2) 0.33
 U/C (ACTUAL) 0.536
 MAX TIP SPEED 1812.
 STAGES 2
 GAMMA 1.41
 PRESS RATIO (T/T) 1.76
 PRESS RATIO (T/S) 1.79
 EXIT MACH NUMBER 0.14
 SPECIFIC SPEED 38.64
 SPECIFIC DIAMETER 1.99

 * H2 PUMP *

	STAGE ONE	STAGE TWO	STAGE THREE
EFFICIENCY	0.697	0.686	0.686
HORSEPOWER	1936.	594.	585.
SPEED (RPM)	107143.	107143.	107143.
SS SPEED	11876.		
S SPEED	865.	889.	893.
HEAD (FT)	66458.	40081.	39546.
DIA. (IN)	4.26	3.37	3.37
TIP SPEED	1992.	1577.	1578.
VOL. FLOW	1116.	553.	546.
HEAD COEF	0.539	0.518	0.511
FLOW COEF	0.102		
DIAMETER RATIO	0.357		
BEARING DN	3.00E+06		
SHAFT DIAMETER	28.00		

 * O2 BOOST TURBINE *

EFFICIENCY (T/T) 0.877
 EFFICIENCY (T/S) 0.812
 SPEED (RPM) 9026.
 MEAN DIA (IN) 7.12
 EFF AREA (IN2) 3.30
 U/C (ACTUAL) 0.553
 MAX TIP SPEED 301.
 STAGES 1
 GAMMA 1.41
 PRESS RATIO (T/T) 1.01
 PRESS RATIO (T/S) 1.01
 HORSEPOWER 39.
 EXIT MACH NUMBER 0.03
 SPECIFIC SPEED 54.11
 SPECIFIC DIAMETER 1.51

 * O2 BOOST PUMP *

EFFICIENCY 0.764
 HORSEPOWER 39.
 SPEED (RPM) 9026.
 S SPEED 3026.
 HEAD (FT) 242.
 DIA. (IN) 3.34
 TIP SPEED 132.
 VOL. FLOW 423.
 HEAD COEF 0.450
 FLOW COEF 0.200

 * O2 TURBINE *

EFFICIENCY (T/T) 0.857
 EFFICIENCY (T/S) 0.833
 SPEED (RPM) 53578.
 HORSEPOWER 795.
 MEAN DIA (IN) 3.70
 EFF AREA (IN2) 0.43
 U/C (ACTUAL) 0.531
 MAX TIP SPEED 914.
 STAGES 2
 GAMMA 1.41
 PRESS RATIO (T/T) 1.14
 PRESS RATIO (T/S) 1.14
 EXIT MACH NUMBER 0.07
 SPECIFIC SPEED 43.23
 SPECIFIC DIAMETER 1.78

 * O2 PUMP *

EFFICIENCY 0.760
 HORSEPOWER 795.
 SPEED (RPM) 53578.
 SS SPEED 21532.
 S SPEED 1859.
 HEAD (FT) 4952.
 DIA. (IN) 2.60
 TIP SPEED 608.
 VOL. FLOW 420.
 HEAD COEF 0.431
 FLOW COEF 0.156
 DIAMETER RATIO 0.683
 BEARING DN 1.39E+04
 SHAFT DIAMETER 24.00

TABLE 18. — SPLIT-EXPANDER ENGINE — 50,000 LBF THRUST (COPPER TUBE CHAMBER)

ENGINE PERFORMANCE PARAMETERS

CHAMBER PRESSURE	1510.7
VAC ENGINE THRUST	50000.
TOTAL ENGINE FLOW RATE	104.17
DEL. VAC. ISP	480.0
THROAT AREA	16.18
NOZZLE AREA RATIO	1000.0
NOZZLE EXIT DIAMETER	143.52
ENGINE MIXTURE RATIO	6.00
ETA C*	0.993
CHAMBER COOLANT DP	487.
CHAMBER COOLANT DT	800.
NOZZLE/CHAMBER Q	22180.

ENGINE STATION CONDITIONS

* FUEL SYSTEM CONDITIONS *					
STATION	PRESS	TEMP	FLOW	ENTHALPY	DENSITY
B.P. INLET	18.6	37.4	14.90	-107.5	4.37
B.P. EXIT	101.0	38.5	14.90	-103.0	4.39
PUMP INLET	101.0	38.5	14.90	-103.0	4.39
1ST STAGE EXIT	2030.3	61.4	14.90	6.4	4.54
JBV INLET	1999.8	61.7	7.45	6.4	4.52
JBV EXIT	1699.9	64.5	7.45	6.4	4.32
2ND STAGE EXIT	3125.1	73.9	7.45	67.6	4.60
PUMP EXIT	4227.8	86.1	7.45	128.5	4.67
COOLANT INLET	4185.5	86.5	7.45	128.5	4.65
COOLANT EXIT	3698.9	886.6	7.45	3106.4	0.71
TBV INLET	3662.0	886.9	0.37	3106.4	0.70
TBV EXIT	1780.3	899.3	0.37	3106.4	0.35
O2 TRB INLET	3662.0	886.9	7.08	3106.4	0.70
O2 TRB EXIT	3201.7	862.1	7.08	3008.4	0.64
H2 TRB INLET	3201.7	862.1	7.08	3008.4	0.64
H2 TRB EXIT	1896.7	769.2	7.08	2649.7	0.44
H2 TRB DIFFUSER	1871.9	769.4	7.08	2649.7	0.43
H2 BST TRB IN	1853.2	769.4	7.08	2649.7	0.43
H2 BST TRB OUT	1827.1	766.9	7.08	2640.1	0.42
H2 BST TRB DIFF	1822.1	767.0	7.08	2640.1	0.42
O2 BST TRB IN	1803.9	767.1	7.08	2640.1	0.42
O2 BST TRB OUT	1790.1	765.7	7.08	2635.0	0.42
O2 BST TRB DIFF	1789.3	765.7	7.08	2635.0	0.42
H2 TANK PRESS	18.6	783.2	0.0153	2658.6	0.0045
GOX HEAT EXCH IN	1780.3	772.4	7.43	2658.6	0.41
GOX HEAT EXCH OUT	1771.4	771.7	7.43	2655.8	0.41
MIXER HOT IN	1771.4	771.7	7.43	2655.8	0.41
MIXER COLD IN	1699.9	64.5	7.45	6.4	4.32
MIXER OUT	1682.8	405.4	14.88	1329.7	0.72
FSOV INLET	1682.8	405.4	14.88	1329.7	0.72
FSOV EXIT	1640.8	405.6	14.88	1329.7	0.70
CHAMBER INJ	1624.3	405.6	14.88	1329.7	0.70
CHAMBER	1510.7				

* OXYGEN SYSTEM CONDITIONS *					
STATION	PRESS	TEMP	FLOW	ENTHALPY	DENSITY
B.P. INLET	16.0	162.7	89.4	61.1	71.17
B.P. EXIT	135.6	163.2	89.4	61.5	71.20
PUMP INLET	135.6	163.2	89.4	61.5	71.20
PUMP EXIT	2446.6	173.3	89.4	69.2	71.75
O2 TANK PRESS	16.0	400.0	0.151	204.7	0.12
OCV INLET	2422.1	173.4	89.3	69.2	71.71
OCV EXIT	1695.5	176.2	89.3	69.2	70.58
CHAMBER INJ	1661.7	176.3	89.3	69.2	70.53
CHAMBER	1510.7				

* VALVE DATA *				
VALVE	DELTA P	AREA	FLOW	% BYPASS
JBV	300.	0.30	7.45	50.00
TBV	1882.	0.02	0.37	5.00
FSOV	42.	3.94	14.88	
OCV	727.	0.59	89.29	

* INJECTOR DATA *				
INJECTOR	DELTA P	AREA	FLOW	VELOCITY
FUEL	114.	2.71	14.88	1142.70
LOX	168.	1.29	89.29	140.86

TABLE 18. — SPLIT-EXPANDER ENGINE — 50,000 LBF THRUST (COPPER TUBE CHAMBER) (CONTINUED)

 * TURBOMACHINERY PERFORMANCE DATA *

 * H₂ BOOST TURBINE *

 EFFICIENCY (T/T) 0.893
 EFFICIENCY (T/S) 0.711
 SPEED (RPM) 29259.
 MEAN DIA (IN) 3.00
 EFF AREA (IN²) 3.11
 U/C (ACTUAL) 0.553
 MAX TIP SPEED 466.
 STAGES 1
 GAMMA 1.40
 PRESS RATIO (T/T) 1.01
 PRESS RATIO (T/S) 1.02
 HORSEPOWER 96.
 EXIT MACH NUMBER 0.07
 SPECIFIC SPEED 112.51
 SPECIFIC DIAMETER 0.77

 * H₂ BOOST PUMP *

 EFFICIENCY 0.765
 HORSEPOWER 96.
 SPEED (RPM) 29259.
 S SPEED 3044.
 HEAD (FT) 2704.
 DIA. (IN) 3.44
 TIP SPEED 460.
 VOL. FLOW 1523.
 HEAD COEF 0.450
 FLOW COEF 0.201

 * H₂ TURBINE *

 EFFICIENCY (T/T) 0.869
 EFFICIENCY (T/S) 0.843
 SPEED (RPM) 100000.
 HORSEPOWER 3591.
 MEAN DIA. (IN) 3.47
 EFF AREA (IN²) 0.47
 U/C (ACTUAL) 0.534
 MAX TIP SPEED 1700.
 STAGES 2
 GAMMA 1.40
 PRESS RATIO (T/T) 1.49
 PRESS RATIO (T/S) 1.72
 EXIT MACH NUMBER 0.15
 SPECIFIC SPEED 46.16
 SPECIFIC DIAMETER 1.49

 * H₂ PUMP *

 STAGE ONE STAGE TWO STAGE THREE

 EFFICIENCY 0.726 0.723 0.722
 HORSEPOWER 2304. 645. 642.
 SPEED (RPM) 100000. 100000. 100000.
 SS SPEED 12793.
 S SPEED 980. 1065. 1063.
 HEAD (FT) 61750. 34459. 34230.
 DIA. (IN) 4.44 3.39 3.39
 TIP SPEED 1959. 1479. 1479.
 VOL. FLOW 1472. 726. 716.
 HEAD COEF 0.529 0.507 0.503
 FLOW COEF 0.109
 DIAMETER RATIO 0.391
 BEARING DN 3.00E+06
 SHAFT DIAMETER 30.00

 * O₂ BOOST TURBINE *

 EFFICIENCY (T/T) 0.883
 EFFICIENCY (T/S) 0.819
 SPEED (RPM) 7017.
 MEAN DIA (IN) 0.22
 EFF AREA (IN²) 4.30
 U/C (ACTUAL) 0.553
 MAX TIP SPEED 301.
 STAGES 1
 GAMMA 1.40
 PRESS RATIO (T/T) 1.01
 PRESS RATIO (T/S) 1.01
 HORSEPOWER 51.
 EXIT MACH NUMBER 0.03
 SPECIFIC SPEED 53.70
 SPECIFIC DIAMETER 1.53

 * O₂ BOOST PUMP *

 EFFICIENCY 0.764
 HORSEPOWER 51.
 SPEED (RPM) 7017.
 S SPEED 3026.
 HEAD (FT) 242.
 DIA. (IN) 3.05
 TIP SPEED 132.
 VOL. FLOW 564.
 HEAD COEF 0.450
 FLOW COEF 0.200

 * O₂ TURBINE *

 EFFICIENCY (T/T) 0.851
 EFFICIENCY (T/S) 0.824
 SPEED (RPM) 45004.
 HORSEPOWER 981.
 MEAN DIA (IN) 3.67
 EFF AREA (IN²) 0.60
 U/C (ACTUAL) 0.460
 MAX TIP SPEED 774.
 STAGES 2
 GAMMA 1.40
 PRESS RATIO (T/T) 1.14
 PRESS RATIO (T/S) 1.15
 EXIT MACH NUMBER 0.07
 SPECIFIC SPEED 43.75
 SPECIFIC DIAMETER 1.53

 * O₂ PUMP *

 EFFICIENCY 0.769
 HORSEPOWER 981.
 SPEED (RPM) 45004.
 SS SPEED 20885.
 S SPEED 1095.
 HEAD (FT) 4636.
 DIA. (IN) 2.90
 TIP SPEED 586.
 VOL. FLOW 560.
 HEAD COEF 0.434
 FLOW COEF 0.150
 DIAMETER RATIO 0.605
 BEARING DN 1.35E+06
 SHAFT DIAMETER 30.00

TABLE 19. — DUAL-EXPANDER ENGINE — 7500 LBF THRUST (COPPER TUBE CHAMBER)

ENGINE PERFORMANCE PARAMETERS	
CHAMBER PRESSURE	1371.2
VAC ENGINE THRUST	7500.
TOTAL ENGINE FLOW RATE	15.63
DEL. VAC. ISP	479.9
THROAT AREA	2.67
NOZZLE AREA RATIO	1000.0
NOZZLE EXIT DIAMETER	58.32
ENGINE MIXTURE RATIO	6.00
ETA C*	0.993
CHAMBER COOLANT DP	429.
CHAMBER COOLANT DT	490.
NOZZLE COOLANT DP	186.
NOZZLE COOLANT DT	564.
CHAMBER Q (HYDROGEN COOLED)	4196.
NOZZLE Q (OXYGEN COOLED)	2574.

ENGINE STATION CONDITIONS					
# FUEL SYSTEM CONDITIONS #					
STATION	PRESS	TEMP	FLOW	ENTHALPY	DENSITY
B.P. INLET	18.6	37.4	2.24	-107.5	4.37
B.P. EXIT	100.8	38.5	2.24	-103.0	4.39
PUMP INLET	100.8	38.5	2.24	-103.0	4.39
1ST STAGE EXIT	1703.5	64.3	2.24	5.9	4.33
PUMP EXIT	3256.5	88.4	2.24	111.2	4.32
COOLANT INLET	3223.9	88.7	2.24	111.2	4.31
COOLANT EXIT	2794.6	578.3	2.24	1988.1	0.82
TBV INLET	2766.7	578.5	0.11	1988.1	0.81
TBV EXIT	1527.4	584.5	0.11	1988.1	0.46
H2 TRB INLET	2766.7	578.5	2.12	1988.1	0.81
H2 TRB EXIT	1607.8	522.2	2.12	1762.7	0.54
H2 TRB DIFFUSER	1578.5	522.3	2.12	1762.7	0.53
H2 BST TRB IN	1562.8	522.3	2.12	1762.7	0.53
H2 BST TRB OUT	1542.2	521.2	2.12	1757.9	0.52
H2 BST TRB DIFF	1527.4	521.2	2.12	1757.9	0.52
H2 TANK PRESS	18.6	530.5	0.0034	1769.4	0.0066
FSOV INLET	1527.4	524.4	2.23	1769.4	0.51
FSOV EXIT	1489.2	524.5	2.23	1769.4	0.50
CHAMBER INJ	1474.3	524.6	2.23	1769.4	0.50
CHAMBER	1371.2				
# OXYGEN SYSTEM CONDITIONS #					
STATION	PRESS	TEMP	FLOW	ENTHALPY	DENSITY
B.P. INLET	16.0	162.7	13.4	61.1	71.17
B.P. EXIT	135.6	163.2	13.4	61.5	71.20
PUMP INLET	135.6	163.2	13.4	61.5	71.20
PUMP EXIT	4864.9	188.4	13.4	79.1	71.57
COOLANT INLET	4816.2	188.6	13.4	79.1	71.50
COOLANT EXIT	4630.0	752.7	13.4	271.0	16.91
OTBV INLET	4630.0	752.7	0.6	271.0	16.91
OTBV EXIT	2313.4	735.0	0.6	271.0	9.19
O2 TRB INLET	4630.0	752.7	11.5	271.0	16.91
O2 TRB EXIT	2516.1	656.8	11.5	250.4	11.38
O2 TRB DIFFUSER	2313.4	653.9	11.5	250.4	10.54
O2 BST TRB IN	4630.0	752.7	1.3	271.0	16.91
O2 BST TRB OUT	4598.2	737.4	1.3	267.0	17.22
O2 BST TRB DIFF	4596.8	737.4	1.3	267.0	17.21
OBTV INLET	4596.8	737.4	1.3	267.0	17.21
OBTV EXIT	2313.4	718.8	1.3	267.0	9.43
MIXER	2313.4	663.9	13.4	253.0	10.36
O2 TANK PRESS	16.0	619.8	0.015	253.0	0.08
OCV INLET	2197.7	662.3	13.4	253.0	9.88
OCV EXIT	1538.4	652.0	13.4	253.0	7.09
CHAMBER INJ	1523.0	651.7	13.4	253.0	7.02
CHAMBER	1371.2				
# VALVE DATA #					
VALVE	DELTA P	AREA	FLOW	% BYPASS	
OTBV	2317.	0.01	0.60	5.00	
TBV	1239.	0.01	0.11	5.00	
FSOV	38.	0.74	2.23		
OBTV	2283.	0.01	1.34		
OCV	659.	0.25	13.39		
# INJECTOR DATA #					
INJECTOR	DELTA P	AREA	FLOW	VELOCITY	
FUEL	103.	0.47	2.23	1278.14	
LOX	152.	0.41	13.39	426.51	

TABLE 19. — DUAL-EXPANDER ENGINE — 7500 LBF THRUST (COPPER TUBE CHAMBER) (CONTINUED)

***** * TURBOMACHINERY PERFORMANCE DATA * *****			
***** * H2 BOOST TURBINE * *****		***** * H2 BOOST PUMP * *****	
EFFICIENCY (T/T)	0.702	EFFICIENCY	0.765
EFFICIENCY (T/S)	0.356	HORSEPOWER	14.
SPEED (RPM)	75466.	SPEED (RPM)	75466.
MEAN DIA (IN)	0.82	S SPEED	3045.
EFF AREA (IN2)	0.94	HEAD (FT)	2701.
U/C (ACTUAL)	0.553	DIA. (IN)	1.33
MAX TIP SPEED	394.	TIP SPEED	439.
STAGES	1	VOL. FLOW	229.
GAMMA	1.39	HEAD COEF	0.450
PRESS RATIO (T/T)	1.01	FLOW COEF	0.201
PRESS RATIO (T/S)	1.03		
HORSEPOWER	14.		
EXIT MACH NUMBER	0.11		
SPECIFIC SPEED	143.67		
SPECIFIC DIAMETER	0.51		
***** * H2 TURBINE * *****		***** * H2 PUMP * *****	
EFFICIENCY (T/T)	0.786	EFFICIENCY	0.627
EFFICIENCY (T/S)	0.754	HORSEPOWER	345.
SPEED (RPM)	187500.	SPEED (RPM)	187500.
HORSEPOWER	677.	SS SPEED	9304.
MEAN DIA. (IN)	2.11	S SPEED	816.
EFF AREA (IN2)	0.13	HEAD (FT)	53103.
U/C (ACTUAL)	0.513	DIA. (IN)	2.22
MAX TIP SPEED	1800.	TIP SPEED	1818.
STAGES	1	VOL. FLOW	232.
GAMMA	1.39	HEAD COEF	0.517
PRESS RATIO (T/T)	1.72	FLOW COEF	0.098
PRESS RATIO (T/S)	1.76	DIAMETER RATIO	0.332
EXIT MACH NUMBER	0.16	BEARING DN	3.00E+06
SPECIFIC SPEED	34.00	SHAFT DIAMETER	16.00
SPECIFIC DIAMETER	2.10		
***** * O2 BOOST TURBINE * *****		***** * O2 BOOST PUMP * *****	
EFFICIENCY (T/T)	0.798	EFFICIENCY	0.764
EFFICIENCY (T/S)	0.752	HORSEPOWER	8.
SPEED (RPM)	20189.	SPEED (RPM)	20189.
MEAN DIA (IN)	2.83	S SPEED	3026.
EFF AREA (IN2)	0.08	HEAD (FT)	242.
U/C (ACTUAL)	0.553	DIA. (IN)	1.49
MAX TIP SPEED	263.	TIP SPEED	132.
STAGES	1	VOL. FLOW	85.
GAMMA	1.60	HEAD COEF	0.450
PRESS RATIO (T/T)	1.01	FLOW COEF	0.200
PRESS RATIO (T/S)	1.01		
HORSEPOWER	8.		
EXIT MACH NUMBER	0.02		
SPECIFIC SPEED	41.74		
SPECIFIC DIAMETER	1.85		
***** * O2 TURBINE * *****		***** * O2 PUMP * *****	
EFFICIENCY (T/T)	0.811	EFFICIENCY	0.693
EFFICIENCY (T/S)	0.697	HORSEPOWER	335.
SPEED (RPM)	156345.	SPEED (RPM)	156345.
HORSEPOWER	335.	SS SPEED	28091.
MEAN DIA (IN)	0.82	S SPEED	1488.
EFF AREA (IN2)	0.12	HEAD (FT)	9514.
U/C (ACTUAL)	0.553	DIA. (IN)	1.22
MAX TIP SPEED	648.	TIP SPEED	835.
STAGES	1	VOL. FLOW	84.
GAMMA	1.60	HEAD COEF	0.439
PRESS RATIO (T/T)	1.84	FLOW COEF	0.138
PRESS RATIO (T/S)	2.06	DIAMETER RATIO	0.669
EXIT MACH NUMBER	0.33	BEARING DN	1.56E+06
SPECIFIC SPEED	85.30	SHAFT DIAMETER	10.00
SPECIFIC DIAMETER	0.96		

TABLE 20. — DUAL-EXPANDER ENGINE — 15,000 LBF THRUST (COPPER TUBE CHAMBER)

ENGINE PERFORMANCE PARAMETERS					
CHAMBER PRESSURE					1218.5
VAC ENGINE THRUST					15000.
TOTAL ENGINE FLOW RATE					31.26
DEL. VAC. ISP					479.9
THROAT AREA					6.01
NOZZLE AREA RATIO					1000.0
NOZZLE EXIT DIAMETER					87.46
ENGINE MIXTURE RATIO					6.00
ETA C*					0.993
CHAMBER COOLANT DP					399.
CHAMBER COOLANT DT					394.
NOZZLE COOLANT DP					212.
NOZZLE COOLANT DT					439.
CHAMBER Q (HYDROGEN COOLED)					6797.
NOZZLE Q (OXYGEN COOLED)					4210.

ENGINE STATION CONDITIONS					
# FUEL SYSTEM CONDITIONS #					
STATION	PRESS	TEMP	FLOW	ENTHALPY	DENSITY
B.P. INLET	18.6	37.4	4.47	-107.5	4.37
B.P. EXIT	100.8	38.5	4.47	-103.0	4.39
PUMP INLET	100.8	38.5	4.47	-103.0	4.39
1ST STAGE EXIT	1459.8	56.9	4.47	-20.2	4.44
PUMP EXIT	2814.1	74.6	4.47	61.5	4.49
COOLANT INLET	2786.0	74.8	4.47	61.5	4.47
COOLANT EXIT	2386.6	469.3	4.47	1580.9	0.84
TBV INLET	2362.7	469.4	0.22	1580.9	0.85
TBV EXIT	1357.6	473.2	0.22	1580.9	0.51
H2 TRB INLET	2362.7	469.4	4.25	1580.9	0.85
H2 TRB EXIT	1440.9	426.3	4.25	1407.8	0.59
H2 TRB DIFFUSER	1407.1	426.4	4.25	1407.8	0.58
H2 BST TRB IN	1393.0	426.4	4.25	1407.8	0.58
H2 BST TRB OUT	1371.8	425.2	4.25	1403.0	0.57
H2 BST TRB DIFF	1357.6	425.2	4.25	1403.0	0.56
H2 TANK PRESS	18.6	431.1	0.0083	1411.9	0.0081
FSOV INLET	1357.6	427.6	4.47	1411.9	0.56
FSOV EXIT	1323.7	427.7	4.47	1411.9	0.55
CHAMBER INJ	1310.5	427.8	4.47	1411.9	0.54
CHAMBER	1218.5				
# OXYGEN SYSTEM CONDITIONS #					
STATION	PRESS	TEMP	FLOW	ENTHALPY	DENSITY
B.P. INLET	16.0	162.7	26.8	61.1	71.17
B.P. EXIT	135.6	163.2	26.8	61.5	71.20
PUMP INLET	135.6	163.2	26.8	61.5	71.20
PUMP EXIT	5031.7	187.5	26.8	79.0	71.84
COOLANT INLET	4981.3	187.7	26.8	79.0	71.76
COOLANT EXIT	4769.4	626.4	26.8	235.9	21.59
OTBV INLET	4769.4	626.4	1.2	235.9	21.59
OTBV EXIT	2056.5	594.0	1.2	235.9	10.60
O2 TRB INLET	4769.4	626.4	22.9	235.9	21.59
O2 TRB EXIT	2268.6	525.0	22.9	215.4	13.93
O2 TRB DIFFUSER	2056.5	518.3	22.9	215.4	12.77
O2 BST TRB IN	4769.4	626.4	2.7	235.9	21.59
O2 BST TRB OUT	4730.5	611.8	2.7	231.9	22.07
O2 BST TRB DIFF	4728.9	611.8	2.7	231.9	22.07
OBTV INLET	4728.9	611.8	2.7	231.9	22.07
OBTV EXIT	2056.5	578.5	2.7	231.9	10.96
MIXER	2056.5	527.4	26.8	218.0	12.45
O2 TANK PRESS	16.0	460.5	0.039	218.0	0.10
OCV INLET	1953.6	525.1	26.8	218.0	11.89
OCV EXIT	1367.5	510.0	26.8	218.0	8.55
CHAMBER INJ	1353.9	509.6	26.8	218.0	8.47
CHAMBER	1218.5				
# VALVE DATA #					
VALVE	DELTA P	AREA	FLOW	% BYPASS	
OTBV	2713.	0.01	1.21	5.00	
TBV	1005.	0.01	0.22	5.00	
FSOV	34.	1.51	4.47		
OBTV	2672.	0.02	2.68		
OCV	586.	0.48	26.79		
# INJECTOR DATA #					
INJECTOR	DELTA P	AREA	FLOW	VELOCITY	
FUEL	92.	0.96	4.47	1159.15	
LOX	135.	1.18	26.79	366.80	

TABLE 20. — DUAL-EXPANDER ENGINE — 15,000 LBF THRUST (COPPER TUBE CHAMBER) (CONTINUED)

***** * TURBOMACHINERY PERFORMANCE DATA * *****			
***** * H2 BOOST TURBINE * *****		***** * H2 BOOST PUMP * *****	
EFFICIENCY (T/T)	0.740	EFFICIENCY	0.765
EFFICIENCY (T/S)	0.391	HORSEPOWER	29.
SPEED (RPM)	53342.	SPEED (RPM)	53342.
MEAN DIA (IN)	1.16	S SPEED	3045.
EFF AREA (IN ²)	1.77	HEAD (FT)	2700.
U/C (ACTUAL)	0.551	DIA. (IN)	1.89
MAX TIP SPEED	390.	TIP SPEED	439.
STAGES	1	VOL. FLOW	457.
GAMMA	1.40	HEAD COEF	0.450
PRESS RATIO (T/T)	1.02	FLOW COEF	0.201
PRESS RATIO (T/S)	1.03		
HORSEPOWER	29.		
EXIT MACH NUMBER	0.12		
SPECIFIC SPEED	147.46		
SPECIFIC DIAMETER	0.52		

***** * H2 TURBINE * *****		***** * H2 PUMP * *****	
EFFICIENCY (T/T)	0.812	EFFICIENCY	0.486
EFFICIENCY (T/S)	0.767	HORSEPOWER	524.
SPEED (RPM)	136363.	SPEED (RPM)	136363.
HORSEPOWER	1041.	SS SPEED	9574.
MEAN DIA. (IN)	2.74	S SPEED	951.
EFF AREA (IN ²)	0.28	HEAD (FT)	44223.
U/C (ACTUAL)	0.553	DIA. (IN)	2.79
MAX TIP SPEED	1713.	TIP SPEED	1659.
STAGES	1	VOL. FLOW	452.
GAMMA	1.40	HEAD COEF	0.517
PRESS RATIO (T/T)	1.64	FLOW COEF	0.107
PRESS RATIO (T/S)	1.69	DIAMETER RATIO	0.371
EXIT MACH NUMBER	0.19	BEARING DN	3.00E+06
SPECIFIC SPEED	41.25	SHAFT DIAMETER	22.00
SPECIFIC DIAMETER	1.89		

***** * O2 BOOST TURBINE * *****		***** * O2 BOOST PUMP * *****	
EFFICIENCY (T/T)	0.807	EFFICIENCY	0.764
EFFICIENCY (T/S)	0.765	HORSEPOWER	15.
SPEED (RPM)	14272.	SPEED (RPM)	14272.
MEAN DIA (IN)	4.01	S SPEED	3026.
EFF AREA (IN ²)	0.14	HEAD (FT)	242.
U/C (ACTUAL)	0.553	DIA. (IN)	2.11
MAX TIP SPEED	261.	TIP SPEED	132.
STAGES	1	VOL. FLOW	169.
GAMMA	1.73	HEAD COEF	0.450
PRESS RATIO (T/T)	1.01	FLOW COEF	0.200
PRESS RATIO (T/S)	1.01		
HORSEPOWER	15.		
EXIT MACH NUMBER	0.02		
SPECIFIC SPEED	38.01		
SPECIFIC DIAMETER	2.04		

***** * O2 TURBINE * *****		***** * O2 PUMP * *****	
EFFICIENCY (T/T)	0.830	EFFICIENCY	0.717
EFFICIENCY (T/S)	0.722	HORSEPOWER	667.
SPEED (RPM)	110421.	SPEED (RPM)	110421.
HORSEPOWER	667.	SS SPEED	28065.
MEAN DIA (IN)	1.16	S SPEED	1450.
EFF AREA (IN ²)	0.20	HEAD (FT)	9811.
U/C (ACTUAL)	0.553	DIA. (IN)	1.73
MAX TIP SPEED	640.	TIP SPEED	834.
STAGES	1	VOL. FLOW	168.
GAMMA	1.73	HEAD COEF	0.454
PRESS RATIO (T/T)	2.10	FLOW COEF	0.136
PRESS RATIO (T/S)	2.40	DIAMETER RATIO	0.669
EXIT MACH NUMBER	0.35	BEARING DN	1.55E+06
SPECIFIC SPEED	81.68	SHAFT DIAMETER	14.00
SPECIFIC DIAMETER	1.01		

TABLE 21. — DUAL-EXPANDER ENGINE — 25,000 LBF THRUST (COPPER TUBE CHAMBER)

ENGINE PERFORMANCE PARAMETERS					
CHAMBER PRESSURE					1158.7
VAC ENGINE THRUST					25000.
TOTAL ENGINE FLOW RATE					52.10
DEL. VAC. ISP					479.9
THROAT AREA					10.52
NOZZLE AREA RATIO					1000.0
NOZZLE EXIT DIAMETER					115.76
ENGINE MIXTURE RATIO					6.00
ETA C*					0.993
CHAMBER COOLANT DP					335.
CHAMBER COOLANT DT					347.
NOZZLE COOLANT DP					233.
NOZZLE COOLANT DT					373.
CHAMBER Q (HYDROGEN COOLED)					9968.
NOZZLE Q (OXYGEN COOLED)					6216.

ENGINE STATION CONDITIONS					
* FUEL SYSTEM CONDITIONS *					
STATION	PRESS	TEMP	FLOW	ENTHALPY	DENSITY
B.P. INLET	18.6	37.4	7.46	-107.5	4.37
B.P. EXIT	100.5	38.5	7.46	-103.0	4.39
PUMP INLET	100.5	38.5	7.46	-103.0	4.39
1ST STAGE EXIT	1276.3	52.3	7.46	-37.0	4.50
PUMP EXIT	2470.4	65.7	7.46	29.0	4.59
COOLANT INLET	2445.7	66.0	7.46	29.0	4.57
COOLANT EXIT	2110.5	413.4	7.46	1365.6	0.87
TBV INLET	2089.4	413.5	0.37	1365.6	0.86
TBV EXIT	1291.4	415.7	0.37	1365.6	0.55
H2 TRB INLET	2089.4	413.5	7.09	1365.6	0.86
H2 TRB EXIT	1377.3	379.6	7.09	1226.6	0.64
H2 TRB DIFFUSER	1338.5	379.7	7.09	1226.6	0.62
H2 BST TRB IN	1325.1	379.7	7.09	1226.6	0.62
H2 BST TRB OUT	1304.8	378.5	7.09	1221.8	0.61
H2 BST TRB DIFF	1291.4	378.5	7.09	1221.8	0.60
H2 TANK PRESS	18.6	382.2	0.0157	1229.0	0.0092
FSOV INLET	1291.4	380.4	7.44	1229.0	0.60
FSOV EXIT	1259.1	380.4	7.44	1229.0	0.59
CHAMBER INJ	1244.5	380.5	7.44	1229.0	0.58
CHAMBER	1158.7				
* OXYGEN SYSTEM CONDITIONS *					
STATION	PRESS	TEMP	FLOW	ENTHALPY	DENSITY
B.P. INLET	16.0	162.7	44.7	61.1	71.17
B.P. EXIT	135.6	163.2	44.7	61.5	71.20
PUMP INLET	135.6	163.2	44.7	61.5	71.20
PUMP EXIT	4749.6	184.9	44.7	77.5	71.98
COOLANT INLET	4782.1	185.1	44.7	77.5	71.91
COOLANT EXIT	4469.5	558.1	44.7	216.5	23.78
OTBV INLET	4469.5	558.1	2.0	216.5	23.78
OTBV EXIT	1955.0	519.9	2.0	216.5	12.07
O2 TRB INLET	4469.5	558.1	38.2	216.5	23.78
O2 TRB EXIT	2156.0	460.9	38.2	197.7	16.13
O2 TRB DIFFUSER	1955.0	455.3	38.2	197.7	14.84
O2 BST TRB IN	4469.5	558.1	4.5	216.5	23.78
O2 BST TRB OUT	4430.6	544.5	4.5	212.4	24.41
O2 BST TRB DIFF	4429.0	544.5	4.5	212.4	24.41
OBTV INLET	4429.0	544.5	4.5	212.4	24.41
OBTV EXIT	1955.0	505.5	4.5	212.4	12.57
MIXER	1955.0	462.5	44.7	200.0	14.46
O2 TANK PRESS	16.0	378.4	0.080	200.0	0.13
OCV INLET	1857.3	459.7	44.7	200.0	13.82
OCV EXIT	1300.1	441.4	44.7	200.0	10.00
CHAMBER INJ	1287.1	440.9	44.7	200.0	9.91
CHAMBER	1158.7				
* VALVE DATA *					
VALVE	DELTA P	AREA	FLOW	% BYPASS	
OTBV	2514.	0.02	2.01	5.00	
TBV	798.	0.03	0.37	5.00	
FSOV	32.	2.49	7.44		
OBTV	2474.	0.04	4.47		
OCV	557.	0.76	44.65		
* INJECTOR DATA *					
INJECTOR	DELTA P	AREA	FLOW	VELOCITY	
FUEL	88.	1.58	7.44	1093.33	
LOX	128.	1.87	44.65	330.17	

TABLE 21. — DUAL-EXPANDER ENGINE — 25,000 LBF THRUST (COPPER TUBE CHAMBER) (CONTINUED)

*****		*****	
# H2 BOOST TURBINE #		# H2 BOOST PUMP #	
*****		*****	
EFFICIENCY (T/T)	0.824	EFFICIENCY	0.766
EFFICIENCY (T/S)	0.436	HORSEPOWER	48.
SPEED (RPM)	41240.	SPEED (RPM)	41240.
MEAN DIA (IN)	1.45	S SPEED	3049.
EFF AREA (IN ²)	2.93	HEAD (FT)	2690.
U/C (ACTUAL)	0.534	DIA. (IN)	2.44
MAX TIP SPEED	376.	TIP SPEED	439.
STAGES	1	VOL. FLOW	763.
GAMMA	1.41	HEAD COEF	0.450
PRESS RATIO (T/T)	1.02	FLOW COEF	0.201
PRESS RATIO (T/S)	1.03		
HORSEPOWER	48.		
EXIT MACH NUMBER	0.13		
SPECIFIC SPEED	150.00		
SPECIFIC DIAMETER	0.52		
*****		*****	
# H2 TURBINE #		# H2 PUMP #	
*****		*****	
		STAGE ONE	STAGE TWO
		*****	*****
EFFICIENCY (T/T)	0.870	EFFICIENCY	0.738
EFFICIENCY (T/S)	0.801	HORSEPOWER	697.
SPEED (RPM)	125000.	SPEED (RPM)	125000.
HORSEPOWER	1393.	SS SPEED	11361.
MEAN DIA. (IN)	2.67	S SPEED	1255.
EFF AREA (IN ²)	0.51	HEAD (FT)	37909.
U/C (ACTUAL)	0.553	DIA. (IN)	2.89
MAX TIP SPEED	1577.	TIP SPEED	1578.
STAGES	1	VOL. FLOW	744.
GAMMA	1.41	HEAD COEF	0.490
PRESS RATIO (T/T)	1.52	FLOW COEF	0.126
PRESS RATIO (T/S)	1.58	DIAMETER RATIO	0.436
EXIT MACH NUMBER	0.22	BEARING DN	3.00E+06
SPECIFIC SPEED	57.47	SHAFT DIAMETER	24.00
SPECIFIC DIAMETER	1.42		
*****		*****	
# O2 BOOST TURBINE #		# O2 BOOST PUMP #	
*****		*****	
EFFICIENCY (T/T)	0.847	EFFICIENCY	0.764
EFFICIENCY (T/S)	0.803	HORSEPOWER	26.
SPEED (RPM)	11053.	SPEED (RPM)	11053.
MEAN DIA (IN)	5.17	S SPEED	3026.
EFF AREA (IN ²)	0.22	HEAD (FT)	242.
U/C (ACTUAL)	0.553	DIA. (IN)	2.72
MAX TIP SPEED	261.	TIP SPEED	132.
STAGES	1	VOL. FLOW	282.
GAMMA	1.85	HEAD COEF	0.450
PRESS RATIO (T/T)	1.01	FLOW COEF	0.200
PRESS RATIO (T/S)	1.01		
HORSEPOWER	26.		
EXIT MACH NUMBER	0.02		
SPECIFIC SPEED	38.43		
SPECIFIC DIAMETER	2.06		
*****		*****	
# O2 TURBINE #		# O2 PUMP #	
*****		*****	
EFFICIENCY (T/T)	0.877	EFFICIENCY	0.737
EFFICIENCY (T/S)	0.764	HORSEPOWER	1018.
SPEED (RPM)	82933.	SPEED (RPM)	82933.
HORSEPOWER	1018.	SS SPEED	27218.
MEAN DIA (IN)	1.48	S SPEED	1471.
EFF AREA (IN ²)	0.33	HEAD (FT)	9227.
U/C (ACTUAL)	0.553	DIA. (IN)	2.22
MAX TIP SPEED	612.	TIP SPEED	804.
STAGES	1	VOL. FLOW	279.
GAMMA	1.85	HEAD COEF	0.459
PRESS RATIO (T/T)	2.07	FLOW COEF	0.137
PRESS RATIO (T/S)	2.37	DIAMETER RATIO	0.671
EXIT MACH NUMBER	0.35	BEARING DN	1.49E+06
SPECIFIC SPEED	83.68	SHAFT DIAMETER	18.00
SPECIFIC DIAMETER	1.01		

TABLE 22. — DUAL-EXPANDER ENGINE — 37,500 LBF THRUST (COPPER TUBE CHAMBER)

ENGINE PERFORMANCE PARAMETERS

CHAMBER PRESSURE	1075.9
VAC ENGINE THRUST	37500.
TOTAL ENGINE FLOW RATE	78.15
DEL. VAC. ISP	479.9
THROAT AREA	16.99
NOZZLE AREA RATIO	1000.0
NOZZLE EXIT DIAMETER	147.09
ENGINE MIXTURE RATIO	6.00
ETA C*	0.993
CHAMBER COOLANT DP	279.
CHAMBER COOLANT DT	317.
NOZZLE COOLANT DP	240.
NOZZLE COOLANT DT	326.
CHAMBER Q (HYDROGEN COOLED)	13588.
NOZZLE Q (OXYGEN COOLED)	8378.

ENGINE STATION CONDITIONS

• FUEL SYSTEM CONDITIONS •

STATION	PRESS	TEMP	FLOW	ENTHALPY	DENSITY
B.P. INLET	18.6	37.4	11.19	-107.5	4.37
B.P. EXIT	100.3	38.5	11.19	-103.0	4.39
PUMP INLET	100.3	38.5	11.19	-103.0	4.39
1ST STAGE EXIT	1139.0	50.0	11.19	-46.5	4.51
PUMP EXIT	2200.4	61.2	11.19	10.2	4.61
COOLANT INLET	2178.4	61.4	11.19	10.2	4.59
COOLANT EXIT	1899.3	378.0	11.19	1224.6	0.86
TBV INLET	1880.3	378.0	0.56	1224.6	0.85
TBV EXIT	1197.8	379.4	0.56	1224.6	0.56
H2 TRB INLET	1880.3	378.0	10.63	1224.6	0.85
H2 TRB EXIT	1284.1	349.2	10.63	1105.4	0.65
H2 TRB DIFFUSER	1243.7	349.2	10.63	1105.4	0.63
H2 BST TRB IN	1231.3	349.2	10.63	1105.4	0.63
H2 BST TRB OUT	1211.1	348.1	10.63	1100.6	0.62
H2 BST TRB DIFF	1197.8	348.1	10.63	1100.6	0.61
H2 TANK PRESS	18.6	350.3	0.0257	1106.8	0.0100
FSOV INLET	1197.8	349.7	11.16	1106.8	0.61
FSOV EXIT	1167.9	349.7	11.16	1106.8	0.59
CHAMBER INJ	1156.2	349.7	11.16	1106.8	0.59
CHAMBER	1075.9				

• OXYGEN SYSTEM CONDITIONS •

STATION	PRESS	TEMP	FLOW	ENTHALPY	DENSITY
B.P. INLET	16.0	162.7	67.1	61.1	71.17
B.P. EXIT	135.6	163.2	67.1	61.5	71.20
PUMP INLET	135.6	163.2	67.1	61.5	71.20
PUMP EXIT	4640.2	183.6	67.1	76.9	72.08
COOLANT INLET	4593.8	183.8	67.1	76.9	72.01
COOLANT EXIT	4353.9	509.5	67.1	201.7	26.47
OTBV INLET	4353.9	509.5	3.0	201.7	26.47
OTBV EXIT	1815.9	464.2	3.0	201.7	13.30
O2 TRB INLET	4353.9	509.5	57.4	201.7	26.47
O2 TRB EXIT	2016.1	416.3	57.4	183.6	18.20
O2 TRB DIFFUSER	1815.9	409.8	57.4	183.6	16.70
O2 BST TRB IN	4353.9	509.5	6.7	201.7	26.47
O2 BST TRB OUT	4312.6	496.8	6.7	197.6	27.23
O2 BST TRB DIFF	4310.9	496.8	6.7	197.6	27.22
OBTV INLET	4310.9	496.8	6.7	197.6	27.22
OBTV EXIT	1815.9	450.9	6.7	197.6	13.93
MIXER	1815.9	415.8	67.0	185.9	16.19
O2 TANK PRESS	16.0	313.7	0.144	185.9	0.15
OCV INLET	1725.1	412.6	67.0	185.9	15.49
OCV EXIT	1207.6	391.5	67.0	185.9	11.27
CHAMBER INJ	1195.5	390.9	67.0	185.9	11.17
CHAMBER	1075.9				

• VALVE DATA •

VALVE	DELTA P	AREA	FLOW	% BYPASS
OTBV	2538.	0.03	3.02	5.00
TBV	683.	0.04	0.56	5.00
FSOV	30.	3.86	11.16	
OBTV	2495.	0.06	6.71	
OCV	518.	1.12	66.98	

• INJECTOR DATA •

INJECTOR	DELTA P	AREA	FLOW	VELOCITY
FUEL	80.	2.46	11.16	1034.90
LOX	120.	2.74	66.98	300.13

TABLE 22. — DUAL-EXPANDER ENGINE — 37,500 LBF THRUST (COPPER TUBE CHAMBER) (CONTINUED)

*****		*****	
# H2 BOOST TURBINE #		# H2 BOOST PUMP #	
*****		*****	
EFFICIENCY (T/T)	0.836	EFFICIENCY	0.766
EFFICIENCY (T/S)	0.443	HORSEPOWER	71.
SPEED (RPM)	33632.	SPEED (RPM)	33632.
MEAN DIA (IN)	1.76	S SPEED	3051.
EFF AREA (IN2)	4.39	HEAD (FT)	2684.
U/C (ACTUAL)	0.530	DIA. (IN)	2.98
MAX TIP SPEED	373.	TIP SPEED	438.
STAGES	1	VOL. FLOW	1144.
GAMMA	1.37	HEAD COEF	0.450
PRESS RATIO (T/T)	1.02	FLOW COEF	0.201
PRESS RATIO (T/S)	1.03		
HORSEPOWER	71.		
EXIT MACH NUMBER	0.13		
SPECIFIC SPEED	150.00		
SPECIFIC DIAMETER	0.52		
*****		*****	
# H2 TURBINE #		# H2 PUMP #	
*****		*****	
		STAGE ONE	STAGE TWO
		*****	*****
EFFICIENCY (T/T)	0.884	EFFICIENCY	0.760
EFFICIENCY (T/S)	0.799	HORSEPOWER	895.
SPEED (RPM)	107143.	SPEED (RPM)	107143.
HORSEPOWER	1793.	SS SPEED	11948.
MEAN DIA. (IN)	2.89	S SPEED	1466.
EFF AREA (IN2)	0.83	HEAD (FT)	33431.
U/C (ACTUAL)	0.553	DIA. (IN)	3.22
MAX TIP SPEED	1488.	TIP SPEED	1508.
STAGES	1	VOL. FLOW	1113.
GAMMA	1.37	HEAD COEF	0.473
PRESS RATIO (T/T)	1.46	FLOW COEF	0.136
PRESS RATIO (T/S)	1.53	DIAMETER RATIO	0.471
EXIT MACH NUMBER	0.23	BEARING DN	3.00E+06
SPECIFIC SPEED	67.54	SHAFT DIAMETER	28.00
SPECIFIC DIAMETER	1.23		
*****		*****	
# O2 BOOST TURBINE #		# O2 BOOST PUMP #	
*****		*****	
EFFICIENCY (T/T)	0.853	EFFICIENCY	0.764
EFFICIENCY (T/S)	0.810	HORSEPOWER	39.
SPEED (RPM)	9023.	SPEED (RPM)	9023.
MEAN DIA (IN)	6.34	S SPEED	3026.
EFF AREA (IN2)	0.31	HEAD (FT)	242.
U/C (ACTUAL)	0.553	DIA. (IN)	3.34
MAX TIP SPEED	260.	TIP SPEED	132.
STAGES	1	VOL. FLOW	423.
GAMMA	1.95	HEAD COEF	0.450
PRESS RATIO (T/T)	1.01	FLOW COEF	0.200
PRESS RATIO (T/S)	1.01		
HORSEPOWER	39.		
EXIT MACH NUMBER	0.02		
SPECIFIC SPEED	37.44		
SPECIFIC DIAMETER	2.12		
*****		*****	
# O2 TURBINE #		# O2 PUMP #	
*****		*****	
EFFICIENCY (T/T)	0.887	EFFICIENCY	0.751
EFFICIENCY (T/S)	0.774	HORSEPOWER	1463.
SPEED (RPM)	66685.	SPEED (RPM)	66685.
HORSEPOWER	1463.	SS SPEED	26810.
MEAN DIA (IN)	1.80	S SPEED	1476.
EFF AREA (IN2)	0.48	HEAD (FT)	8996.
U/C (ACTUAL)	0.553	DIA. (IN)	2.71
MAX TIP SPEED	598.	TIP SPEED	790.
STAGES	1	VOL. FLOW	418.
GAMMA	1.95	HEAD COEF	0.466
PRESS RATIO (T/T)	2.16	FLOW COEF	0.138
PRESS RATIO (T/S)	2.49	DIAMETER RATIO	0.672
EXIT MACH NUMBER	0.36	BEARING DN	1.47E+06
SPECIFIC SPEED	83.50	SHAFT DIAMETER	22.00
SPECIFIC DIAMETER	1.02		

TABLE 23. — DUAL-EXPANDER ENGINE — 50,000 LBF THRUST (COPPER TUBE CHAMBER)

ENGINE PERFORMANCE PARAMETERS	
CHAMBER PRESSURE	1042.6
VAC ENGINE THRUST	50000.
TOTAL ENGINE FLOW RATE	104.20
DEL. VAC. ISP	479.8
THROAT AREA	23.37
NOZZLE AREA RATIO	1000.0
NOZZLE EXIT DIAMETER	172.52
ENGINE MIXTURE RATIO	6.00
ETA C*	0.993
CHAMBER COOLANT DP	243.
CHAMBER COOLANT DT	296.
NOZZLE COOLANT DP	243.
NOZZLE COOLANT DT	306.
CHAMBER Q (HYDROGEN COOLED)	16868.
NOZZLE Q (OXYGEN COOLED)	10504.

ENGINE STATION CONDITIONS	

* FUEL SYSTEM CONDITIONS *	
STATION	PRESS TEMP FLOW ENTHALPY DENSITY
B.P. INLET	18.6 37.4 14.92 -107.5 4.37
B.P. EXIT	100.8 38.5 14.92 -103.0 4.39
PUMP INLET	100.8 38.5 14.92 -103.0 4.39
PUMP EXIT	1093.9 49.2 14.92 -49.8 4.52
1ST STAGE EXIT	2113.5 59.6 14.92 3.8 4.62
PUMP EXIT	2113.5 59.6 14.92 3.8 4.61
COOLANT INLET	2092.4 59.8 14.92 1134.2 0.89
COOLANT EXIT	1849.0 355.5 14.92 1134.2 0.88
TBV INLET	1830.5 355.5 0.75 1134.2 0.58
TBV EXIT	1162.0 356.6 0.75 1134.2 0.88
H2 TRB INLET	1830.5 355.5 14.18 1134.2 0.67
H2 TRB EXIT	1252.7 328.3 14.18 1021.8 0.65
H2 TRB DIFFUSER	1207.8 328.3 14.18 1021.8 0.65
H2 BST TRB IN	1195.7 328.3 14.18 1017.0 0.64
H2 BST TRB OUT	1175.1 327.2 14.18 1017.0 0.63
H2 BST TRB DIFF	1162.0 327.2 14.18 1022.9 0.0107
H2 TANK PRESS	18.6 328.6 0.0364 1022.9 0.63
FSOV INLET	1162.0 328.6 14.89 1022.9 0.61
FSOV EXIT	1133.0 328.7 14.89 1022.9 0.61
CHAMBER INJ	1121.6 328.7 14.89 1022.9 0.61
CHAMBER	1042.6
* OXYGEN SYSTEM CONDITIONS *	
STATION	PRESS TEMP FLOW ENTHALPY DENSITY
B.P. INLET	16.0 162.7 89.5 61.1 71.17
B.P. EXIT	135.6 163.2 89.5 61.5 71.20
PUMP INLET	135.6 163.2 89.5 61.5 71.20
PUMP EXIT	4813.6 183.9 89.5 77.3 72.17
COOLANT INLET	4765.5 184.2 89.5 77.3 72.10
COOLANT EXIT	4502.3 489.7 89.5 196.6 28.70
OTBV INLET	4502.3 489.7 4.0 196.6 28.70
OTBV EXIT	1759.3 439.8 4.0 196.6 14.02
O2 TRB INLET	4502.3 489.7 76.5 196.6 28.70
O2 TRB EXIT	1964.3 396.8 76.5 176.1 19.87
O2 TRB DIFFUSER	1759.3 387.8 76.5 176.1 18.21
O2 BST TRB IN	4502.3 489.7 9.0 196.6 28.70
O2 BST TRB OUT	4458.1 477.3 9.0 190.5 29.58
O2 BST TRB DIFF	4456.4 477.3 9.0 190.5 29.57
OBTV INLET	4456.4 477.3 9.0 190.5 29.57
OBTV EXIT	1759.3 427.3 9.0 190.5 14.78
MIXER	1759.3 393.8 89.3 178.4 17.59
O2 TANK PRESS	16.0 279.6 0.217 178.4 0.17
OCV INLET	1671.4 390.5 89.3 178.4 16.85
OCV EXIT	1169.9 368.2 89.3 178.4 12.33
CHAMBER INJ	1158.2 367.6 89.3 178.4 12.22
CHAMBER	1042.6
* VALVE DATA *	
VALVE	DELTA P AREA FLOW % BYPASS
OTBV	2743. 0.03 4.03 5.00
TBV	668. 0.06 0.75 5.00
FSOV	29. 5.14 14.89
OBTV	2697. 0.07 8.95
OCV	501. 1.45 89.31
* INJECTOR DATA *	
INJECTOR	DELTA P AREA FLOW VELOCITY
FUEL	79. 3.26 14.89 1012.37
LOX	116. 3.56 89.31 282.09

TABLE 23. — DUAL-EXPANDER ENGINE — 50,000 LBF THRUST (COPPER TUBE CHAMBER) (CONTINUED)

***** * TURBOMACHINERY PERFORMANCE DATA * *****			
***** * H2 BOOST TURBINE * *****		***** * H2 BOOST PUMP * *****	
EFFICIENCY (T/T)	0.849	EFFICIENCY	0.765
EFFICIENCY (T/S)	0.458	HORSEPOWER	96.
SPEED (RPM)	29203.	SPEED (RPM)	29203.
MEAN DIA (IN)	2.02	S SPEED	3046.
EFF AREA (IN ²)	5.69	HEAD (FT)	2700.
U/C (ACTUAL)	0.526	DIA. (IN)	3.45
MAX TIP SPEED	370.	TIP SPEED	439.
STAGES	1	VOL. FLOW	1526.
GAMMA	1.40	HEAD COEF	0.450
PRESS RATIO (T/T)	1.02	FLOW COEF	0.201
PRESS RATIO (T/S)	1.03		
HORSEPOWER	96.		
EXIT MACH NUMBER	0.13		
SPECIFIC SPEED	150.00		
SPECIFIC DIAMETER	0.52		
***** * H2 TURBINE * *****		***** * H2 PUMP * *****	
EFFICIENCY (T/T)	0.893	EFFICIENCY	0.771
EFFICIENCY (T/S)	0.796	HORSEPOWER	1123.
SPEED (RPM)	100000.	SPEED (RPM)	100000.
HORSEPOWER	2254.	SS SPEED	12825.
MEAN DIA. (IN)	3.00	S SPEED	1612.
EFF AREA (IN ²)	1.10	HEAD (FT)	31936.
U/C (ACTUAL)	0.553	DIA. (IN)	3.44
MAX TIP SPEED	1464.	TIP SPEED	1501.
STAGES	1	VOL. FLOW	1483.
GAMMA	1.40	HEAD COEF	0.456
PRESS RATIO (T/T)	1.46	FLOW COEF	0.144
PRESS RATIO (T/S)	1.53	DIAMETER RATIO	0.505
EXIT MACH NUMBER	0.25	BEARING DN	3.00E+06
SPECIFIC SPEED	74.45	SHAFT DIAMETER	30.00
SPECIFIC DIAMETER	1.13		
***** * O2 BOOST TURBINE * *****		***** * O2 BOOST PUMP * *****	
EFFICIENCY (T/T)	0.857	EFFICIENCY	0.764
EFFICIENCY (T/S)	0.815	HORSEPOWER	52.
SPEED (RPM)	7813.	SPEED (RPM)	7813.
MEAN DIA (IN)	7.32	S SPEED	3026.
EFF AREA (IN ²)	0.39	HEAD (FT)	242.
U/C (ACTUAL)	0.553	DIA. (IN)	3.85
MAX TIP SPEED	260.	TIP SPEED	132.
STAGES	1	VOL. FLOW	564.
GAMMA	1.98	HEAD COEF	0.450
PRESS RATIO (T/T)	1.01	FLOW COEF	0.200
PRESS RATIO (T/S)	1.01		
HORSEPOWER	52.		
EXIT MACH NUMBER	0.02		
SPECIFIC SPEED	36.25		
SPECIFIC DIAMETER	2.19		
***** * O2 TURBINE * *****		***** * O2 PUMP * *****	
EFFICIENCY (T/T)	0.895	EFFICIENCY	0.758
EFFICIENCY (T/S)	0.784	HORSEPOWER	2003.
SPEED (RPM)	58298.	SPEED (RPM)	58298.
HORSEPOWER	2003.	SS SPEED	27047.
MEAN DIA (IN)	2.09	S SPEED	1449.
EFF AREA (IN ²)	0.60	HEAD (FT)	9330.
U/C (ACTUAL)	0.553	DIA. (IN)	3.14
MAX TIP SPEED	603.	TIP SPEED	799.
STAGES	1	VOL. FLOW	557.
GAMMA	1.98	HEAD COEF	0.470
PRESS RATIO (T/T)	2.29	FLOW COEF	0.136
PRESS RATIO (T/S)	2.66	DIAMETER RATIO	0.671
EXIT MACH NUMBER	0.36	BEARING DN	1.40E+06
SPECIFIC SPEED	81.67	SHAFT DIAMETER	24.00
SPECIFIC DIAMETER	1.04		

TABLE 24. — FULL-EXPANDER ENGINE WITH HYDROGEN REGENERATOR
— 7500 LBF THRUST (COPPER TUBE CHAMBER)

ENGINE PERFORMANCE PARAMETERS

CHAMBER PRESSURE	1941.3
VAC ENGINE THRUST	7500.
TOTAL ENGINE FLOW RATE	15.62
DEL. VAC. ISP	480.1
THROAT AREA	1.89
NOZZLE AREA RATIO	1000.0
NOZZLE EXIT DIAMETER	49.07
ENGINE MIXTURE RATIO	6.00
ETA C*	0.993
CHAMBER COOLANT DP	1386.
CHAMBER COOLANT DT	796.
NOZZLE/CHAMBER Q	6383.

ENGINE STATION CONDITIONS

* FUEL SYSTEM CONDITIONS *

STATION	PRESS	TEMP	FLOW	ENTHALPY	DENSITY
B.P. INLET	18.6	37.4	2.23	-107.5	4.37
B.P. EXIT	100.6	38.5	2.23	-103.0	4.39
PUMP INLET	100.6	38.5	2.23	-103.0	4.39
1ST STAGE EXIT	2202.9	78.4	2.23	58.1	4.15
2ND STAGE EXIT	4183.0	114.8	2.23	210.1	4.11
PUMP EXIT	6085.6	147.1	2.23	354.6	4.15
COLD REGEN IN	6024.8	147.6	2.23	354.6	4.13
COLD REGEN EX	5964.5	369.0	2.23	1247.9	2.24
COOLANT INLET	5964.5	369.0	2.23	1247.9	2.24
COOLANT EXIT	4578.7	1165.3	2.23	4105.7	0.67
TBV INLET	4532.9	1165.6	0.11	4105.7	0.67
TBV EXIT	2241.0	1182.1	0.11	4105.7	0.34
O2 TRB INLET	4532.9	1165.6	2.12	4105.7	0.67
O2 TRB EXIT	4200.2	1148.1	2.12	4035.8	0.63
H2 TRB INLET	4200.2	1148.1	2.12	4035.8	0.63
H2 TRB EXIT	2341.2	1023.4	2.12	3553.8	0.41
H2 TRB DIFFUSER	2335.7	1023.8	2.12	3553.8	0.41
H2 BST TRB IN	2312.4	1023.8	2.12	3553.8	0.41
H2 BST TRB OUT	2298.6	1022.7	2.12	3549.0	0.40
H2 BST TRB DIFF	2283.7	1022.8	2.12	3549.0	0.40
O2 BST TRB IN	2240.8	1023.0	2.12	3549.0	0.39
O2 BST TRB OUT	2253.4	1022.3	2.12	3546.5	0.39
O2 BST TRB DIFF	2252.2	1022.3	2.12	3546.5	0.39
H2 TANK PRESS	18.6	1044.2	0.0017	3574.4	0.0033
GOK HEAT EXCH IN	2241.0	1030.4	2.23	3574.4	0.39
GOK HEAT EXCH OUT	2229.8	1030.1	2.23	3573.1	0.39
HOT REGEN IN	2229.8	1030.1	2.23	3573.1	0.39
HOT REGEN EX	2162.9	775.9	2.23	2679.1	0.49
FSOV INLET	2162.9	775.9	2.23	2679.1	0.49
FSOV EXIT	2108.8	776.2	2.23	2679.1	0.48
CHAMBER INJ	2086.8	776.4	2.23	2679.1	0.47
CHAMBER	1941.3				

* OXYGEN SYSTEM CONDITIONS *

STATION	PRESS	TEMP	FLOW	ENTHALPY	DENSITY
B.P. INLET	16.0	162.7	13.4	61.1	71.17
B.P. EXIT	135.6	163.2	13.4	61.5	71.20
PUMP INLET	135.6	163.2	13.4	61.5	71.20
PUMP EXIT	3143.9	178.8	13.4	72.5	71.53
O2 TANK PRESS	16.0	400.0	0.023	204.7	0.12
OCV INLET	3112.5	179.0	13.4	72.5	71.48
OCV EXIT	2178.7	182.4	13.4	72.5	70.04
CHAMBER INJ	2135.4	182.8	13.4	72.5	69.97
CHAMBER	1941.3				

* VALVE DATA *

VALVE	DELTA P	AREA	FLOW	% BYPASS
TBV	2292.	0.01	0.11	5.00
FSOV	54.	0.64	2.23	
OCV	934.	0.08	13.39	

* INJECTOR DATA *

INJECTOR	DELTA P	AREA	FLOW	VELOCITY
FUEL	146.	0.44	2.23	1558.24
LOX	216.	0.17	13.39	160.32

TABLE 24. — FULL-EXPANDER ENGINE WITH HYDROGEN REGENERATOR
— 7500 LBF THRUST (COPPER TUBE CHAMBER) (CONTINUED)

* TURBOMACHINERY PERFORMANCE DATA *

* H2 BOOST TURBINE *

EFFICIENCY (T/T) 0.789
EFFICIENCY (T/S) 0.322
SPEED (RPM) 75394.
MEAN DIA (IN) 0.81
EFF AREA (IN2) 1.32
W/C (ACTUAL) 0.543
MAX TIP SPEED 404.
STAGES 1
GAMMA 1.35
PRESS RATIO (T/T) 1.01
PRESS RATIO (T/S) 1.01
HORSEPOWER 14.
EXIT MACH NUMBER 0.10
SPECIFIC SPEED 150.00
SPECIFIC DIAMETER 0.48

* H2 BOOST PUMP *

EFFICIENCY 0.766
HORSEPOWER 14.
SPEED (RPM) 75394.
S SPEED 3040.
HEAD (FT) 2493.
DIA. (IN) 1.33
TIP SPEED 439.
VOL. FLOW 228.
HEAD COEF 0.450
FLOW COEF 0.201

* H2 TURBINE *

EFFICIENCY (T/T) 0.797
EFFICIENCY (T/S) 0.779
SPEED (RPM) 187500.
HORSEPOWER 1447.
MEAN DIA. (IN) 1.77
EFF AREA (IN2) 0.12
W/C (ACTUAL) 0.511
MAX TIP SPEED 1545.
STAGES 3
GAMMA 1.35
PRESS RATIO (T/T) 1.70
PRESS RATIO (T/S) 1.00
EXIT MACH NUMBER 0.13
SPECIFIC SPEED 49.66
SPECIFIC DIAMETER 1.46

* H2 PUMP *

STAGE ONE STAGE TWO STAGE THREE

EFFICIENCY 0.573 0.503 0.589
HORSEPOWER 509. 481. 457.
SPEED (RPM) 187500. 187500. 187500.
SS SPEED 9319.
S SPEED 664. 687. 705.
HEAD (FT) 71821. 69071. 66271.
DIA. (IN) 2.55 2.55 2.55
TIP SPEED 2091. 2092. 2092.
VOL. FLOW 242. 244. 241.
HEAD COEF 0.528 0.508 0.487
FLOW COEF 0.007
DIAMETER RATIO 0.200
BEARING DN 3.00E+06
SHAFT DIAMETER 16.00

* O2 BOOST TURBINE *

EFFICIENCY (T/T) 0.800
EFFICIENCY (T/S) 0.433
SPEED (RPM) 20184.
MEAN DIA (IN) 2.25
EFF AREA (IN2) 1.04
W/C (ACTUAL) 0.553
MAX TIP SPEED 243.
STAGES 1
GAMMA 1.35
PRESS RATIO (T/T) 1.00
PRESS RATIO (T/S) 1.00
HORSEPOWER 0.
EXIT MACH NUMBER 0.03
SPECIFIC SPEED 100.41
SPECIFIC DIAMETER 0.76

* O2 BOOST PUMP *

EFFICIENCY 0.764
HORSEPOWER 0.
SPEED (RPM) 20184.
S SPEED 3826.
HEAD (FT) 242.
DIA. (IN) 1.49
TIP SPEED 132.
VOL. FLOW 95.
HEAD COEF 0.450
FLOW COEF 0.200

* O2 TURBINE *

EFFICIENCY (T/T) 0.808
EFFICIENCY (T/S) 0.749
SPEED (RPM) 132977.
HORSEPOWER 210.
MEAN DIA (IN) 1.77
EFF AREA (IN2) 0.21
W/C (ACTUAL) 0.549
MAX TIP SPEED 3107.
STAGES 1
GAMMA 1.35
PRESS RATIO (T/T) 1.00
PRESS RATIO (T/S) 1.09
EXIT MACH NUMBER 0.09
SPECIFIC SPEED 52.85
SPECIFIC DIAMETER 1.48

* O2 PUMP *

EFFICIENCY 0.703
HORSEPOWER 210.
SPEED (RPM) 132977.
SS SPEED 23899.
S SPEED 1777.
HEAD (FT) 6055.
DIA. (IN) 1.19
TIP SPEED 689.
VOL. FLOW 84.
HEAD COEF 0.411
FLOW COEF 0.152
DIAMETER RATIO 0.679
BEARING DN 1.60E+06
SHAFT DIAMETER 12.00

REGENERATOR DATA

COLD SIDE HOT SIDE
DELT 60.25 66.89
DELT 221.44 -254.15
AREA 0.16 0.65
FLOW 2.23 2.23
EFFECTIVENESS 0.29
NTU 0.41
CRATIO 0.87
CHIN 7.85
REGEN Q 1995.14

TABLE 25. — FULL-EXPANDER ENGINE WITH HYDROGEN REGENERATOR
 — 15,000 LBF THRUST (COPPER TUBE CHAMBER)

ENGINE PERFORMANCE PARAMETERS

CHAMBER PRESSURE	1844.7
VAC ENGINE THRUST	15000.
TOTAL ENGINE FLOW RATE	31.25
DEL. VAC. ISP	480.1
THROAT AREA	3.98
NOZZLE AREA RATIO	1000.0
NOZZLE EXIT DIAMETER	71.18
ENGINE MIXTURE RATIO	6.00
ETA C*	0.993
CHAMBER COOLANT DP	901.
CHAMBER COOLANT DT	599.
NOZZLE/CHAMBER Q	9975.

ENGINE STATION CONDITIONS

* FUEL SYSTEM CONDITIONS *					
STATION	PRESS	TEMP	FLOW	ENTHALPY	DENSITY
B.P. INLET	18.6	37.4	4.47	-107.5	4.37
B.P. EXIT	100.8	38.5	4.47	-103.0	4.39
PUMP INLET	100.8	38.5	4.47	-103.0	4.39
1ST STAGE EXIT	2021.3	68.9	4.47	26.5	4.33
2ND STAGE EXIT	3897.6	97.5	4.47	152.4	4.35
PUMP EXIT	5744.8	124.4	4.47	274.9	4.40
COLD REGEN IN	5687.3	124.8	4.47	274.9	4.38
COLD REGEN EX	5630.4	288.0	4.47	902.1	2.60
COOLANT INLET	5630.4	288.0	4.47	902.1	2.60
COOLANT EXIT	4729.4	887.5	4.47	3134.4	0.89
TBV INLET	4682.1	887.8	0.22	3134.4	0.88
TBV EXIT	2128.1	905.0	0.22	3134.4	0.42
O2 TRB INLET	4682.1	887.8	4.24	3134.4	0.88
O2 TRB EXIT	4278.6	872.5	4.24	3070.6	0.82
H2 TRB INLET	4278.6	872.5	4.24	3070.6	0.82
H2 TRB EXIT	2258.7	773.5	4.24	2672.8	0.51
H2 TRB DIFFUSER	2226.4	773.7	4.24	2672.8	0.51
H2 BST TRB IN	2204.1	773.7	4.24	2672.8	0.51
H2 BST TRB OUT	2185.4	772.6	4.24	2668.0	0.50
H2 BST TRB DIFF	2170.8	772.7	4.24	2668.0	0.50
O2 BST TRB IN	2149.1	772.8	4.24	2668.0	0.49
O2 BST TRB OUT	2140.3	772.2	4.24	2665.4	0.49
O2 BST TRB DIFF	2138.8	772.2	4.24	2665.4	0.49
H2 TANK PRESS	18.6	791.8	0.0045	2688.9	0.0044
GOX HEAT EXCH IN	2128.1	778.9	4.46	2688.9	0.48
GOX HEAT EXCH OUT	2117.5	778.6	4.46	2687.5	0.48
HOT REGEN IN	2117.5	778.6	4.46	2687.5	0.48
HOT REGEN EX	2054.0	601.9	4.46	2059.7	0.60
FSOV INLET	2054.0	601.9	4.46	2059.7	0.60
FSOV EXIT	2002.6	602.1	4.46	2059.7	0.58
CHAMBER INJ	1982.7	602.2	4.46	2059.7	0.58
CHAMBER	1844.7				

* OXYGEN SYSTEM CONDITIONS *					
STATION	PRESS	TEMP	FLOW	ENTHALPY	DENSITY
B.P. INLET	16.0	162.7	26.8	61.1	71.17
B.P. EXIT	135.6	163.2	26.8	61.5	71.20
PUMP INLET	135.6	163.2	26.8	61.5	71.20
PUMP EXIT	2987.5	177.0	26.8	71.6	71.67
O2 TANK PRESS	16.0	400.0	0.045	204.7	0.12
OCV INLET	2957.7	177.2	26.8	71.6	71.62
OCV EXIT	2070.4	180.6	26.8	71.6	70.25
CHAMBER INJ	2029.2	180.8	26.8	71.6	70.18
CHAMBER	1844.7				

* VALVE DATA *				
VALVE	DELTA P	AREA	FLOW	% BYPASS
TBV	2554.	0.01	0.22	5.00
FSOV	51.	1.18	4.46	
OCV	887.	0.16	26.78	

* INJECTOR DATA *				
INJECTOR	DELTA P	AREA	FLOW	VELOCITY
FUEL	138.	0.82	4.46	1379.91
LOX	205.	0.35	26.78	156.04

TABLE 25. — FULL-EXPANDER ENGINE WITH HYDROGEN REGENERATOR
— 15,000 LBF THRUST (COPPER TUBE CHAMBER) (CONTINUED)

***** * TURBOMACHINERY PERFORMANCE DATA * *****	
***** * H2 BOOST TURBINE * *****	***** * H2 BOOST PUMP * *****
EFFICIENCY (T/T) 0.736	EFFICIENCY 0.765
EFFICIENCY (T/S) 0.359	HORSEPOWER 29.
SPEED (RPM) 53374.	SPEED (RPM) 53374.
MEAN DIA (IN) 1.16	S SPEED 3045.
EFF AREA (IN2) 2.02	HEAD (FT) 2700.
U/C (ACTUAL) 0.553	DIA. (IN) 1.09
MAX TIP SPEED 397.	TIP SPEED 439.
STAGES 1	VOL. FLOW 457.
GAMMA 1.41	HEAD COEF 0.450
PRESS RATIO (T/T) 1.01	FLOW COEF 0.201
PRESS RATIO (T/S) 1.02	
HORSEPOWER 29.	
EXIT MACH NUMBER 0.10	
SPECIFIC SPEED 147.50	
SPECIFIC DIAMETER 0.51	
***** * H2 TURBINE * *****	***** * H2 PUMP * *****
EFFICIENCY (T/T) 0.794	STAGE ONE STAGE TWO STAGE THREE
EFFICIENCY (T/S) 0.773	EFFICIENCY 0.631 0.635 0.637
SPEED (RPM) 136363.	HORSEPOWER 810. 797. 774.
HORSEPOWER 2389.	SPEED (RPM) 136363. 136363. 136363.
MEAN DIA. (IN) 2.46	SS SPEED 9560.
EFF AREA (IN2) 0.23	S SPEED 733.
U/C (ACTUAL) 0.464	HEAD (FT) 63502.
MAX TIP SPEED 1560.	DIA. (IN) 3.27 3.27 3.27
STAGES 2	TIP SPEED 1949. 1949. 1949.
GAMMA 1.43	VOL. FLOW 463. 461. 455.
PRESS RATIO (T/T) 1.09	HEAD COEF 0.539 0.527 0.515
PRESS RATIO (T/S) 1.93	FLOW COEF 0.092
EXIT MACH NUMBER 0.14	DIAMETER RATIO 0.315
SPECIFIC SPEED 30.41	BEARING DN 1.00E+06
SPECIFIC DIAMETER 1.69	SHAFT DIAMETER 22.00
***** * O2 BOOST TURBINE * *****	***** * O2 BOOST PUMP * *****
EFFICIENCY (T/T) 0.824	EFFICIENCY 0.764
EFFICIENCY (T/S) 0.674	HORSEPOWER 15.
SPEED (RPM) 14272.	SPEED (RPM) 14272.
MEAN DIA (IN) 3.10	S SPEED 5026.
EFF AREA (IN2) 2.97	HEAD (FT) 242.
U/C (ACTUAL) 0.553	DIA. (IN) 2.11
MAX TIP SPEED 257.	TIP SPEED 182.
STAGES 1	VOL. FLOW 169.
GAMMA 1.41	HEAD COEF 0.450
PRESS RATIO (T/T) 1.00	FLOW COEF 0.200
PRESS RATIO (T/S) 1.01	
HORSEPOWER 15.	
EXIT MACH NUMBER 0.03	
SPECIFIC SPEED 101.42	
SPECIFIC DIAMETER 0.82	
***** * O2 TURBINE * *****	***** * O2 PUMP * *****
EFFICIENCY (T/T) 0.820	EFFICIENCY 0.729
EFFICIENCY (T/S) 0.767	HORSEPOWER 303.
SPEED (RPM) 91028.	SPEED (RPM) 91028.
HORSEPOWER 303.	SS SPEED 23136.
MEAN DIA (IN) 2.46	S SPEED 1792.
EFF AREA (IN2) 0.33	HEAD (FT) 5729.
U/C (ACTUAL) 0.547	DIA. (IN) 1.67
MAX TIP SPEED 1043.	TIP SPEED 663.
STAGES 1	VOL. FLOW 168.
GAMMA 1.41	HEAD COEF 0.420
PRESS RATIO (T/T) 1.09	FLOW COEF 0.153
PRESS RATIO (T/S) 1.10	DIAMETER RATIO 0.600
EXIT MACH NUMBER 0.09	BEARING DN 1.46E+06
SPECIFIC SPEED 48.17	SHAFT DIAMETER 16.00
SPECIFIC DIAMETER 1.63	
***** REGENERATOR DATA *****	
	COLD SIDE HOT SIDE
DELTA	56.00 63.52
DELTA	163.16 -176.69
AREA	0.30 1.19
FLOW	4.47 4.46
EFFECTIVENESS	0.27
MTU	0.38
CRATIO	0.92
CHIN	15.06
REGEN Q	2802.44

TABLE 26. — FULL-EXPANDER ENGINE WITH HYDROGEN REGENERATOR
 — 25,000 LBF THRUST (COPPER TUBE CHAMBER)

ENGINE PERFORMANCE PARAMETERS

CHAMBER PRESSURE	1786.4
VAC ENGINE THRUST	25000.
TOTAL ENGINE FLOW RATE	52.08
DEL. VAC. ISP	480.0
THROAT AREA	6.85
NOZZLE AREA RATIO	1000.0
NOZZLE EXIT DIAMETER	93.38
ENGINE MIXTURE RATIO	6.00
ETA C*	0.993
CHAMBER COOLANT DP	831.
CHAMBER COOLANT DT	480.
NOZZLE/CHAMBER Q	13641.

ENGINE STATION CONDITIONS

STATION	* FUEL SYSTEM CONDITIONS *				ENTHALPY	DENSITY
	PRESS	TEMP	FLOW			
B.P. INLET	18.6	37.4	7.45		-107.5	4.37
B.P. EXIT	101.2	38.5	7.45		-103.0	4.39
PUMP INLET	101.2	38.5	7.45		-103.0	4.39
1ST STAGE EXIT	1817.1	60.7	7.45		-1.1	4.48
2ND STAGE EXIT	3543.3	81.9	7.45		100.0	4.56
PUMP EXIT	5281.9	102.4	7.45		200.0	4.64
COLD REGEN IN	5229.1	102.9	7.45		200.0	4.62
COLD REGEN EX	5176.8	253.0	7.45		745.0	2.71
COOLANT INLET	5176.8	253.0	7.45		745.0	2.71
COOLANT EXIT	4366.0	733.1	7.45		2576.3	0.98
TBV INLET	4302.6	733.4	0.37		2576.3	0.97
TBV EXIT	2062.2	747.5	0.37		2576.3	0.97
O2 TRB INLET	4302.6	733.4	7.08		2576.3	0.97
O2 TRB EXIT	3897.1	719.1	7.08		2516.2	0.91
H2 TRB INLET	3897.1	719.1	7.08		2516.2	0.91
H2 TRB EXIT	2196.4	639.3	7.08		2197.4	0.60
H2 TRB DIFFUSER	2159.5	639.5	7.08		2197.4	0.59
H2 BST TRB IN	2137.9	639.5	7.08		2197.4	0.59
H2 BST TRB OUT	2118.2	638.4	7.08		2192.6	0.58
H2 BST TRB DIFF	2104.8	638.4	7.08		2192.6	0.57
O2 BST TRB IN	2083.8	638.6	7.08		2192.6	0.57
O2 BST TRB OUT	2074.1	637.9	7.08		2190.0	0.57
O2 BST TRB DIFF	2072.6	637.9	7.08		2190.0	0.57
H2 TANK PRESS	18.6	654.5	0.0091		2209.4	0.0053
GOX HEAT EXCH IN	2062.2	643.4	7.44		2209.4	0.56
GOX HEAT EXCH OUT	2051.9	643.1	7.44		2208.0	0.56
HOT REGEN IN	2051.9	643.1	7.44		2208.0	0.56
HOT REGEN EX	1990.4	493.1	7.44		1662.4	0.70
FSOV INLET	1990.4	493.1	7.44		1662.4	0.70
FSOV EXIT	1940.6	493.3	7.44		1662.4	0.68
CHAMBER INJ	1921.0	493.3	7.44		1662.4	0.68
CHAMBER	1786.4					

STATION	* OXYGEN SYSTEM CONDITIONS *				ENTHALPY	DENSITY
	PRESS	TEMP	FLOW			
B.P. INLET	16.0	162.7	44.7		61.1	71.17
B.P. EXIT	135.6	163.2	44.7		61.5	71.20
PUMP INLET	135.6	163.2	44.7		61.5	71.20
PUMP EXIT	2895.0	176.0	44.7		71.0	71.75
O2 TANK PRESS	16.0	400.0	0.076		204.7	0.12
OCV INLET	2864.1	176.1	44.6		71.0	71.70
OCV EXIT	2004.9	179.4	44.6		71.0	70.37
CHAMBER INJ	1965.0	179.6	44.6		71.0	70.31
CHAMBER	1786.4					

VALVE	* VALVE DATA *			
	DELTA P	AREA	FLOW	% BYPASS
TBV	2240.	0.02	0.37	5.00
FSOV	50.	1.84	7.44	
OCV	859.	0.27	44.64	

INJECTOR	* INJECTOR DATA *			
	DELTA P	AREA	FLOW	VELOCITY
FUEL	135.	1.26	7.44	1266.91
LOX	198.	0.60	44.64	153.42

TABLE 26. — FULL-EXPANDER ENGINE WITH HYDROGEN REGENERATOR
 — 25,000 LBF THRUST (COPPER TUBE CHAMBER) (CONTINUED)

 * TURBOMACHINERY PERFORMANCE DATA *

 * H2 BOOST TURBINE *

EFFICIENCY (T/T) 0.823
 EFFICIENCY (T/S) 0.431
 SPEED (RPM) 41420.
 MEAN DIA (IN) 1.44
 EFF AREA (IN²) 3.02
 W/C (ACTUAL) 0.538
 MAX TIP SPEED 377.
 STAGES 1
 GAMMA 1.44
 PRESS RATIO (T/T) 1.01
 PRESS RATIO (T/S) 1.02
 HORSEPOWER 48.
 EXIT MACH NUMBER 0.10
 SPECIFIC SPEED 150.00
 SPECIFIC DIAMETER 0.52

 * H2 BOOST PUMP *

EFFICIENCY 0.765
 HORSEPOWER 48.
 SPEED (RPM) 41420.
 S SPEED 3041.
 HEAD (FT) 2713.
 DIA. (IN) 2.43
 TIP SPEED 440.
 VOL. FLOW 762.
 HEAD COEF 0.450
 FLOW COEF 0.200

 * H2 TURBINE *

EFFICIENCY (T/T) 0.854
 EFFICIENCY (T/S) 0.826
 SPEED (RPM) 125000.
 HORSEPOWER 3191.
 MEAN DIA. (IN) 2.61
 EFF AREA (IN²) 0.35
 W/C (ACTUAL) 0.505
 MAX TIP SPEED 1543.
 STAGES 2
 GAMMA 1.44
 PRESS RATIO (T/T) 1.77
 PRESS RATIO (T/S) 1.81
 EXIT MACH NUMBER 0.16
 SPECIFIC SPEED 51.88
 SPECIFIC DIAMETER 1.43

 * H2 PUMP *

	STAGE ONE	STAGE TWO	STAGE THREE
EFFICIENCY	0.700	0.699	0.699
HORSEPOWER	1073.	1064.	1054.
SPEED (RPM)	125000.	125000.	125000.
SS SPEED	11287.		
S SPEED	945.	943.	942.
HEAD (FT)	55475.	54951.	54386.
DIA. (IN)	3.38	3.38	3.38
TIP SPEED	1845.	1845.	1844.
VOL. FLOW	746.	733.	720.
HEAD COEF	0.524	0.519	0.514
FLOW COEF	0.107		
DIAMETER RATIO	0.373		
BEARING DN	3.00E+06		
SHAFT DIAMETER	24.00		

 * O2 BOOST TURBINE *

EFFICIENCY (T/T) 0.877
 EFFICIENCY (T/S) 0.729
 SPEED (RPM) 11055.
 MEAN DIA (IN) 4.11
 EFF AREA (IN²) 4.35
 W/C (ACTUAL) 0.553
 MAX TIP SPEED 234.
 STAGES 1
 GAMMA 1.44
 PRESS RATIO (T/T) 1.00
 PRESS RATIO (T/S) 1.01
 HORSEPOWER 26.
 EXIT MACH NUMBER 0.03
 SPECIFIC SPEED 99.31
 SPECIFIC DIAMETER 0.86

 * O2 BOOST PUMP *

EFFICIENCY 0.764
 HORSEPOWER 26.
 SPEED (RPM) 11055.
 S SPEED 3026.
 HEAD (FT) 242.
 DIA. (IN) 2.72
 TIP SPEED 132.
 VOL. FLOW 282.
 HEAD COEF 0.450
 FLOW COEF 0.200

 * O2 TURBINE *

EFFICIENCY (T/T) 0.854
 EFFICIENCY (T/S) 0.794
 SPEED (RPM) 69046.
 HORSEPOWER 602.
 MEAN DIA (IN) 2.61
 EFF AREA (IN²) 0.53
 W/C (ACTUAL) 0.454
 MAX TIP SPEED 855.
 STAGES 1
 GAMMA 1.44
 PRESS RATIO (T/T) 1.10
 PRESS RATIO (T/S) 1.11
 EXIT MACH NUMBER 0.09
 SPECIFIC SPEED 48.09
 SPECIFIC DIAMETER 1.40

 * O2 PUMP *

EFFICIENCY 0.747
 HORSEPOWER 602.
 SPEED (RPM) 69046.
 SS SPEED 22456.
 S SPEED 1800.
 HEAD (FT) 5532.
 DIA. (IN) 2.14
 TIP SPEED 646.
 VOL. FLOW 280.
 HEAD COEF 0.426
 FLOW COEF 0.153
 DIAMETER RATIO 0.681
 BEARING DN 1.30E+06
 SHAFT DIAMETER 20.00

 REGENERATOR DATA

	COLD SIDE	HOT SIDE
DEL P	52.29	61.56
DEL T	150.12	-150.00
AREA	0.50	1.86
FLOW	7.45	7.44
EFFECTIVENESS		0.28
MTU		0.40
CRATIO		1.00
CHIN		27.04
REGEN Q		4059.52

TABLE 27. — FULL-EXPANDER ENGINE WITH HYDROGEN REGENERATOR
— 37,500 LBF THRUST (COPPER TUBE CHAMBER)

ENGINE PERFORMANCE PARAMETERS

CHAMBER PRESSURE	1673.2
VAC ENGINE THRUST	37500.
TOTAL ENGINE FLOW RATE	78.12
DEL. VAC. ISP	480.0
THROAT AREA	10.96
NOZZLE AREA RATIO	1000.0
NOZZLE EXIT DIAMETER	118.14
ENGINE MIXTURE RATIO	6.00
ETA C*	0.993
CHAMBER COOLANT DP	752.
CHAMBER COOLANT DT	403.
NOZZLE/CHAMBER Q	17580.

ENGINE STATION CONDITIONS

* FUEL SYSTEM CONDITIONS *					
STATION	PRESS	TEMP	FLOW	ENTHALPY	DENSITY
B.P. INLET	18.6	37.4	11.18	-107.5	4.37
B.P. EXIT	100.8	38.5	11.18	-103.0	4.39
PUMP INLET	100.8	38.5	11.18	-103.0	4.39
1ST STAGE EXIT	1768.9	58.6	11.18	-7.9	4.52
2ND STAGE EXIT	3463.0	77.9	11.18	87.1	4.62
PUMP EXIT	5182.8	96.7	11.18	181.6	4.72
COLD REGEN IN	5130.9	97.2	11.18	181.6	4.70
COLD REGEN EX	5079.6	228.0	11.18	638.8	2.90
COOLANT INLET	5079.6	228.0	11.18	638.8	2.90
COOLANT EXIT	4327.2	630.5	11.18	2211.8	1.11
TBV INLET	4283.9	630.8	0.56	2211.8	1.10
TBV EXIT	1930.3	644.8	0.56	2211.8	0.53
O2 TRB INLET	4283.9	630.8	10.62	2211.8	1.10
O2 TRB EXIT	3867.8	618.4	10.62	2156.7	1.03
H2 TRB INLET	3867.8	618.4	10.62	2156.7	1.03
H2 TRB EXIT	2072.2	546.1	10.62	1857.1	0.66
H2 TRB DIFFUSER	2026.3	546.3	10.62	1857.1	0.64
H2 BST TRB IN	2006.0	546.3	10.62	1857.1	0.64
H2 BST TRB OUT	1984.9	545.1	10.62	1852.3	0.63
H2 BST TRB DIFF	1971.7	545.2	10.62	1852.3	0.63
O2 BST TRB IN	1952.0	545.3	10.62	1852.3	0.62
O2 BST TRB OUT	1941.5	544.6	10.62	1849.7	0.62
O2 BST TRB DIFF	1940.0	544.6	10.62	1849.7	0.62
H2 TANK PRESS	18.6	558.1	0.0161	1867.8	0.0063
GOX HEAT EXCH IN	1930.3	549.7	11.16	1867.8	0.61
GOX HEAT EXCH OUT	1920.6	549.3	11.16	1866.5	0.61
HOT REGEN IN	1920.6	549.3	11.16	1866.5	0.61
HOT REGEN EX	1863.0	425.3	11.16	1408.6	0.75
FSOV INLET	1863.0	425.3	11.16	1408.6	0.75
FSOV EXIT	1816.4	425.4	11.16	1408.6	0.74
CHAMBER INJ	1798.4	425.5	11.16	1408.6	0.73
CHAMBER	1673.2				

* OXYGEN SYSTEM CONDITIONS *					
STATION	PRESS	TEMP	FLOW	ENTHALPY	DENSITY
B.P. INLET	16.0	162.7	67.1	61.1	71.17
B.P. EXIT	135.6	163.2	67.1	61.5	71.20
PUMP INLET	135.6	163.2	67.1	61.5	71.20
PUMP EXIT	2709.7	174.8	67.1	70.2	71.77
O2 TANK PRESS	16.0	400.0	0.113	204.7	0.12
OCV INLET	2682.6	174.9	67.0	70.2	71.73
OCV EXIT	1877.8	177.9	67.0	70.2	70.48
CHAMBER INJ	1840.5	178.0	67.0	70.2	70.42
CHAMBER	1673.2				

* VALVE DATA *				
VALVE	DELTA P	AREA	FLOW	% BYPASS
TBV	2354.	0.02	0.56	5.00
FSOV	47.	2.73	11.16	
OCV	805.	0.42	66.96	

* INJECTOR DATA *				
INJECTOR	DELTA P	AREA	FLOW	VELOCITY
FUEL	125.	1.89	11.16	1177.20
LOX	186.	0.92	66.96	148.36

TABLE 27. — FULL-EXPANDER ENGINE WITH HYDROGEN REGENERATOR
— 37,500 LBF THRUST (COPPER TUBE CHAMBER) (CONTINUED)

* TURBOMACHINERY PERFORMANCE DATA *

* H2 BOOST TURBINE *

EFFICIENCY (T/T) 0.839
EFFICIENCY (T/S) 0.456
SPEED (RPM) 33742.
MEAN DIA (IN) 1.77
EFF AREA (IN²) 4.19
U/C (ACTUAL) 0.533
MAX TIP SPEED 373.
STAGES 1
GAMMA 1.36
PRESS RATIO (T/T) 1.01
PRESS RATIO (T/S) 1.02
HORSEPOWER 72.
EXIT MACH NUMBER 0.10
SPECIFIC SPEED 150.00
SPECIFIC DIAMETER 0.53

* H2 BOOST PUMP *

EFFICIENCY 0.765
HORSEPOWER 72.
SPEED (RPM) 33742.
S SPEED 3046.
HEAD (FT) 2699.
DIA. (IN) 2.90
TIP SPEED 439.
VOL. FLOW 1143.
HEAD COEF 0.450
FLOW COEF 0.201

* H2 TURBINE *

EFFICIENCY (T/T) 0.855
EFFICIENCY (T/S) 0.819
SPEED (RPM) 107143.
HORSEPOWER 4501.
MEAN DIA. (IN) 2.72
EFF AREA (IN²) 0.49
U/C (ACTUAL) 0.464
MAX TIP SPEED 1597.
STAGES 2
GAMMA 1.36
PRESS RATIO (T/T) 1.07
PRESS RATIO (T/S) 1.92
EXIT MACH NUMBER 0.19
SPECIFIC SPEED 54.06
SPECIFIC DIAMETER 1.27

* H2 PUMP *

	STAGE ONE	STAGE TWO	STAGE THREE
EFFICIENCY	0.724	0.722	0.721
HORSEPOWER	1505.	1501.	1495.
SPEED (RPM)	107143.	107143.	107143.
SS SPEED	11092.		
S SPEED	1015.	1006.	1000.
HEAD (FT)	53404.	53336.	53021.
DIA. (IN)	3.09	3.09	3.09
TIP SPEED	1010.	1010.	1010.
VOL. FLOW	1110.	1004.	1043.
HEAD COEF	0.522	0.519	0.516
FLOW COEF	0.111		
DIAMETER RATIO	0.391		
BEARING DN	1.00E+06		
SHAFT DIAMETER	20.00		

* O2 BOOST TURBINE *

EFFICIENCY (T/T) 0.807
EFFICIENCY (T/S) 0.746
SPEED (RPM) 9026.
MEAN DIA (IN) 5.04
EFF AREA (IN²) 5.99
U/C (ACTUAL) 0.553
MAX TIP SPEED 232.
STAGES 1
GAMMA 1.36
PRESS RATIO (T/T) 1.01
PRESS RATIO (T/S) 1.01
HORSEPOWER 39.
EXIT MACH NUMBER 0.04
SPECIFIC SPEED 96.51
SPECIFIC DIAMETER 0.89

* O2 BOOST PUMP *

EFFICIENCY 0.764
HORSEPOWER 39.
SPEED (RPM) 9026.
S SPEED 3026.
HEAD (FT) 242.
DIA. (IN) 3.36
TIP SPEED 132.
VOL. FLOW 423.
HEAD COEF 0.450
FLOW COEF 0.200

* O2 TURBINE *

EFFICIENCY (T/T) 0.800
EFFICIENCY (T/S) 0.827
SPEED (RPM) 54516.
HORSEPOWER 020.
MEAN DIA (IN) 2.72
EFF AREA (IN²) 0.73
U/C (ACTUAL) 0.550
MAX TIP SPEED 726.
STAGES 2
GAMMA 1.36
PRESS RATIO (T/T) 1.11
PRESS RATIO (T/S) 1.12
EXIT MACH NUMBER 0.09
SPECIFIC SPEED 76.33
SPECIFIC DIAMETER 1.09

* O2 PUMP *

EFFICIENCY 0.760
HORSEPOWER 020.
SPEED (RPM) 54516.
SS SPEED 21910.
S SPEED 1033.
HEAD (FT) 5162.
DIA. (IN) 2.61
TIP SPEED 621.
VOL. FLOW 419.
HEAD COEF 0.431
FLOW COEF 0.155
DIAMETER RATIO 0.603
BEARING DN 1.42E+06
SHAFT DIAMETER 26.00

REGENERATOR DATA

	COLD SIDE	HOT SIDE
DELTA P	53.31	57.42
DELTA T	130.03	-124.06
AREA	0.74	2.76
FLOW	11.10	11.16
EFFECTIVENESS	0.29	
NTU	0.42	
CRATIO	0.95	
CHX	39.06	
REGEN Q	5109.96	

TABLE 28. — FULL-EXPANDER ENGINE WITH HYDROGEN REGENERATOR
— 50,000 LBF THRUST (COPPER TUBE CHAMBER)

ENGINE PERFORMANCE PARAMETERS	
CHAMBER PRESSURE	1557.9
VAC ENGINE THRUST	50000.
TOTAL ENGINE FLOW RATE	104.17
DEL. VAC. ISP	480.0
THROAT AREA	15.69
NOZZLE AREA RATIO	1000.0
NOZZLE EXIT DIAMETER	141.34
ENGINE MIXTURE RATIO	6.00
ETA C*	0.993
CHAMBER COOLANT DP	672.
CHAMBER COOLANT DT	358.
NOZZLE/CHAMBER Q	21099.

ENGINE STATION CONDITIONS	

# FUEL SYSTEM CONDITIONS #	
STATION	PRESS TEMP FLOW ENTHALPY DENSITY
B.P. INLET	18.6 37.4 14.91 -107.5 4.37
B.P. EXIT	100.9 38.5 14.91 -103.0 4.39
PUMP INLET	100.9 38.5 14.91 -103.0 4.39
1ST STAGE EXIT	1612.6 55.5 14.91 -20.1 4.55
2ND STAGE EXIT	3160.0 71.8 14.91 63.0 4.66
PUMP EXIT	4741.5 87.7 14.91 146.2 4.77
COLD REGEN IN	4694.1 88.2 14.91 146.2 4.75
COLD REGEN EX	4647.1 204.0 14.91 534.3 2.98
COOLANT INLET	4647.1 204.0 14.91 534.3 2.98
COOLANT EXIT	3975.6 561.9 14.91 1949.9 1.14
TBV INLET	3935.8 562.1 0.75 1949.9 1.13
TBV EXIT	1797.6 572.8 0.75 1949.9 0.55
O2 TRB INLET	3935.8 562.1 14.16 1949.9 1.13
O2 TRB EXIT	3542.5 550.4 14.16 1899.3 1.06
H2 TRB INLET	3542.5 550.4 14.16 1899.3 1.06
H2 TRB EXIT	1937.7 486.3 14.16 1637.1 0.69
H2 TRB DIFFUSER	1891.0 486.5 14.16 1637.1 0.67
H2 BST TRB IN	1872.0 486.5 14.16 1637.1 0.67
H2 BST TRB OUT	1850.4 485.4 14.16 1632.3 0.66
H2 BST TRB DIFF	1837.4 485.4 14.16 1632.3 0.66
O2 BST TRB IN	1819.1 485.5 14.16 1632.3 0.65
O2 BST TRB OUT	1808.2 484.8 14.16 1629.8 0.65
O2 BST TRB DIFF	1806.7 484.8 14.16 1629.8 0.65
H2 TANK PRESS	18.6 495.7 0.0242 1645.8 0.0071
GOX HEAT EXCH IN	1797.6 489.3 14.88 1645.8 0.64
GOX HEAT EXCH OUT	1788.7 488.9 14.88 1644.4 0.64
HOT REGEN IN	1788.7 488.9 14.88 1644.4 0.64
HOT REGEN EX	1735.0 386.3 14.88 1255.6 0.78
FSOV INLET	1735.0 386.3 14.88 1255.6 0.78
FSOV EXIT	1691.6 386.4 14.88 1255.6 0.76
CHAMBER INJ	1675.1 386.4 14.88 1255.6 0.75
CHAMBER	1557.9

# OXYGEN SYSTEM CONDITIONS #	
STATION	PRESS TEMP FLOW ENTHALPY DENSITY
B.P. INLET	16.0 162.7 89.4 61.1 71.17
B.P. EXIT	135.6 163.2 89.4 61.5 71.20
PUMP INLET	135.6 163.2 89.4 61.5 71.20
PUMP EXIT	2523.0 173.7 89.4 69.5 71.77
O2 TANK PRESS	16.0 400.0 0.151 204.7 0.12
OCV INLET	2497.8 173.8 89.3 69.5 71.73
OCV EXIT	1748.4 176.6 89.3 69.5 70.56
CHAMBER INJ	1713.6 176.8 89.3 69.5 70.51
CHAMBER	1557.9

# VALVE DATA #	
VALVE	DELTA P AREA FLOW % BYPASS
TBV	2138. 0.03 0.75 5.00
FSOV	43. 3.73 14.88
OCV	749. 0.58 89.29

# INJECTOR DATA #	
INJECTOR	DELTA P AREA FLOW VELOCITY
FUEL	117. 2.58 14.88 1117.41
LOX	173. 1.27 89.29 143.07

TABLE 28. — FULL-EXPANDER ENGINE WITH HYDROGEN REGENERATOR
 — 50,000 LBF THRUST (COPPER TUBE CHAMBER) (CONTINUED)

***** * TURBOMACHINERY PERFORMANCE DATA * *****	
***** * H2 BOOST TURBINE * *****	***** * H2 BOOST PUMP * *****
EFFICIENCY (T/T) 0.859	EFFICIENCY 0.765
EFFICIENCY (T/S) 0.476	HORSEPOWER 96.
SPEED (RPM) 29231.	SPEED (RPM) 29231.
MEAN DIA (IN) 2.83	S SPEED 3045.
EFF AREA (IN2) 5.39	HEAD (FT) 2782.
U/C (ACTUAL) 0.529	DIA. (IN) 3.44
MAX TIP SPEED 369.	TIP SPEED 648.
STAGES 1	VOL. FLOW 1524.
GAMMA 1.42	HEAD COEF 0.450
PRESS RATIO (T/T) 1.81	FLOW COEF 0.201
PRESS RATIO (T/S) 1.82	
HORSEPOWER 96.	
EXIT MACH NUMBER 0.11	
SPECIFIC SPEED 156.00	
SPECIFIC DIAMETER 0.53	
***** * H2 TURBINE * *****	***** * H2 PUMP * *****
EFFICIENCY (T/T) 0.876	EFFICIENCY 0.750 0.740 0.746
EFFICIENCY (T/S) 0.835	HORSEPOWER 1749. 1752. 1753.
SPEED (RPM) 100000.	SPEED (RPM) 100000. 100000. 100000.
HORSEPOWER 5254.	SS SPEED 12810.
MEAN DIA. (IN) 2.92	S SPEED 1176. 1162. 1150.
EFF AREA (IN2) 0.67	HEAD (FT) 48371. 48337. 48277.
U/C (ACTUAL) 0.497	DIA. (IN) 4.02 4.02 4.02
MAX TIP SPEED 1413.	TIP SPEED 1753. 1753. 1753.
STAGES 2	VOL. FLOW 1472. 1435. 1404.
GAMMA 1.42	HEAD COEF 0.506 0.506 0.505
PRESS RATIO (T/T) 1.83	FLOW COEF 0.121
PRESS RATIO (T/S) 1.89	DIAMETER RATIO 0.432
EXIT MACH NUMBER 0.20	BEARING DN 3.80E+06
SPECIFIC SPEED 43.23	SHAFT DIAMETER 38.00
SPECIFIC DIAMETER 1.18	
***** * O2 BOOST TURBINE * *****	***** * O2 BOOST PUMP * *****
EFFICIENCY (T/T) 0.896	EFFICIENCY 0.764
EFFICIENCY (T/S) 0.754	HORSEPOWER 51.
SPEED (RPM) 7817.	SPEED (RPM) 7817.
MEAN DIA (IN) 5.81	S SPEED 3026.
EFF AREA (IN2) 7.68	HEAD (FT) 242.
U/C (ACTUAL) 0.553	DIA. (IN) 3.85
MAX TIP SPEED 232.	TIP SPEED 132.
STAGES 1	VOL. FLOW 564.
GAMMA 1.42	HEAD COEF 0.450
PRESS RATIO (T/T) 1.81	FLOW COEF 0.200
PRESS RATIO (T/S) 1.83	
HORSEPOWER 51.	
EXIT MACH NUMBER 0.04	
SPECIFIC SPEED 95.36	
SPECIFIC DIAMETER 0.90	
***** * O2 TURBINE * *****	***** * O2 PUMP * *****
EFFICIENCY (T/T) 0.881	EFFICIENCY 0.769
EFFICIENCY (T/S) 0.826	HORSEPOWER 1813.
SPEED (RPM) 45615.	SPEED (RPM) 45615.
HORSEPOWER 1913.	SS SPEED 21168.
MEAN DIA (IN) 2.92	S SPEED 1874.
EFF AREA (IN2) 0.98	HEAD (FT) 4788.
U/C (ACTUAL) 0.516	DIA. (IN) 2.99
MAX TIP SPEED 641.	TIP SPEED 596.
STAGES 2	VOL. FLOW 559.
GAMMA 1.42	HEAD COEF 0.434
PRESS RATIO (T/T) 1.11	FLOW COEF 0.157
PRESS RATIO (T/S) 1.12	DIAMETER RATIO 0.684
EXIT MACH NUMBER 0.09	BEARING DN 1.37E+06
SPECIFIC SPEED 77.18	SHAFT DIAMETER 36.00
SPECIFIC DIAMETER 1.82	
***** REGENERATOR DATA *****	
	COLD SIDE HOT SIDE
DELTA	46.96 53.64
DELTA	115.00 -102.64
AREA	1.03 3.72
FLOW	14.91 14.88
EFFECTIVENESS	0.29
NTU	0.42
CRATIO	0.89
CHIN	49.96
REGEN Q	5795.64

TABLE 29. — FULL-EXPANDER ENGINE — 7500 LBF THRUST (COPPER GROOVED CHAMBER)

ENGINE PERFORMANCE PARAMETERS

CHAMBER PRESSURE	1750.2
VAC ENGINE THRUST	7500.
TOTAL ENGINE FLOW RATE	15.62
DEL. VAC. ISP	480.0
THROAT AREA	7.10
NOZZLE AREA RATIO	1000.0
NOZZLE EXIT DIAMETER	51.67
ENGINE MIXTURE RATIO	6.00
ETA C*	0.993
CHAMBER COOLANT DP	731.
CHAMBER COOLANT DT	710.
NOZZLE/CHAMBER Q	5975.

ENGINE STATION CONDITIONS

* FUEL SYSTEM CONDITIONS *					
STATION	PRESS	TEMP	FLOW	ENTHALPY	DENSITY
B.P. INLET	18.6	37.4	2.23	-107.5	4.37
B.P. EXIT	100.3	38.5	2.23	-103.0	4.39
PUMP INLET	100.3	38.5	2.23	-103.0	4.39
1ST STAGE EXIT	1804.9	66.9	2.23	15.5	4.30
2ND STAGE EXIT	3447.1	93.2	2.23	129.3	4.29
PUMP EXIT	5043.4	117.8	2.23	239.0	4.32
COOLANT INLET	4993.0	118.2	2.23	239.0	4.30
COOLANT EXIT	4262.4	828.3	2.23	2913.2	0.86
TBV INLET	4219.8	828.6	0.11	2913.2	0.85
TBV EXIT	1959.7	843.2	0.11	2913.2	0.41
O2 TRB INLET	4219.8	828.6	2.12	2913.2	0.85
O2 TRB EXIT	3829.5	813.4	2.12	2850.5	0.80
H2 TRB INLET	3829.5	813.4	2.12	2850.5	0.80
H2 TRB EXIT	2082.2	723.0	2.12	2490.3	0.51
H2 TRB DIFFUSER	2053.7	723.1	2.12	2490.3	0.50
H2 BST TRB IN	2033.1	723.1	2.12	2490.3	0.50
H2 BST TRB OUT	2015.3	722.0	2.12	2485.6	0.49
H2 BST TRB DIFF	1999.9	722.1	2.12	2485.6	0.49
O2 BST TRB IN	1979.9	722.2	2.12	2485.6	0.49
O2 BST TRB OUT	1971.0	721.5	2.12	2483.0	0.48
O2 BST TRB DIFF	1969.5	721.6	2.12	2483.0	0.48
H2 TANK PRESS	18.6	739.1	0.0024	2504.5	0.0047
GOX HEAT EXCH IN	1959.7	727.7	2.23	2504.5	0.48
GOX HEAT EXCH OUT	1949.9	727.4	2.23	2503.2	0.48
FSOV INLET	1949.9	727.4	2.23	2503.2	0.48
FSOV EXIT	1901.1	727.7	2.23	2503.2	0.46
CHAMBER INJ	1862.3	727.9	2.23	2503.2	0.45
CHAMBER	1750.2				

* OXYGEN SYSTEM CONDITIONS *					
STATION	PRESS	TEMP	FLOW	ENTHALPY	DENSITY
B.P. INLET	16.0	162.7	13.4	61.1	71.17
B.P. EXIT	135.6	163.2	13.4	61.5	71.20
PUMP INLET	135.6	163.2	13.4	61.5	71.20
PUMP EXIT	2834.5	177.2	13.4	71.4	71.50
O2 TANK PRESS	16.0	400.0	0.023	204.7	0.12
OCV INLET	2806.2	177.3	13.4	71.4	71.46
OCV EXIT	1964.3	180.6	13.4	71.4	70.15
CHAMBER INJ	1925.2	180.7	13.4	71.4	70.09
CHAMBER	1750.2				

* VALVE DATA *

VALVE	DELTA P	AREA	FLOW	% BYPASS
TBV	2240.	0.01	0.11	5.00
FSOV	49.	0.68	2.23	
OCV	842.	0.08	13.39	

* INJECTOR DATA *

INJECTOR	DELTA P	AREA	FLOW	VELOCITY
FUEL	132.	0.47	2.23	1504.14
LOX	194.	0.18	13.39	152.10

TABLE 29. — FULL-EXPANDER ENGINE — 7500 LBF THRUST (COPPER GROOVED CHAMBER) (CONTINUED)

***** # TURBOMACHINERY PERFORMANCE DATA # *****	
***** # H2 BOOST TURBINE # *****	***** # H2 BOOST PUMP # *****
EFFICIENCY (T/T) 0.758	EFFICIENCY 0.766
EFFICIENCY (T/S) 0.350	HORSEPOWER 14.
SPEED (RPM) 75279.	SPEED (RPM) 75279.
MEAN DIA (IN) 0.83	S SPEED 3050.
EFF AREA (IN2) 1.04	HEAD (FT) 2685.
U/C (ACTUAL) 0.562	DIA. (IN) 1.33
MAX TIP SPEED 400.	TIP SPEED 438.
STAGES 1	VOL. FLOW 228.
GAMMA 1.44	HEAD COEF 0.450
PRESS RATIO (T/T) 1.01	FLOW COEF 0.201
PRESS RATIO (T/S) 1.02	
HORSEPOWER 14.	
EXIT MACH NUMBER 0.10	
SPECIFIC SPEED 146.08	
SPECIFIC DIAMETER 0.51	
***** # H2 TURBINE # *****	***** # H2 PUMP # *****
EFFICIENCY (T/T) 0.808	STAGE ONE 0.615
EFFICIENCY (T/S) 0.787	STAGE TWO 0.621
SPEED (RPM) 187500.	STAGE THREE 0.626
HORSEPOWER 1082.	*****
MEAN DIA. (IN) 1.45	EFFICIENCY 0.615
EFF AREA (IN2) 0.11	HORSEPOWER 375.
U/C (ACTUAL) 0.549	SPEED (RPM) 187500.
MAX TIP SPEED 1456.	SS SPEED 9340.
STAGES 3	S SPEED 779.
GAMMA 1.44	HEAD (FT) 56759.
PRESS RATIO (T/T) 1.84	DIA. (IN) 2.29
PRESS RATIO (T/S) 1.87	TIP SPEED 1874.
EXIT MACH NUMBER 0.14	VOL. FLOW 233.
SPECIFIC SPEED 54.79	HEAD COEF 0.520
SPECIFIC DIAMETER 1.42	FLOW COEF 0.095
	DIAMETER RATIO 0.322
	BEARING DN 3.00E+06
	SHAFT DIAMETER 16.00
***** # O2 BOOST TURBINE # *****	***** # O2 BOOST PUMP # *****
EFFICIENCY (T/T) 0.805	EFFICIENCY 0.764
EFFICIENCY (T/S) 0.658	HORSEPOWER 8.
SPEED (RPM) 20183.	SPEED (RPM) 20183.
MEAN DIA (IN) 2.25	S SPEED 3026.
EFF AREA (IN2) 1.49	HEAD (FT) 242.
U/C (ACTUAL) 0.553	DIA. (IN) 1.49
MAX TIP SPEED 237.	TIP SPEED 132.
STAGES 1	VOL. FLOW 85.
GAMMA 1.44	HEAD COEF 0.450
PRESS RATIO (T/T) 1.00	FLOW COEF 0.200
PRESS RATIO (T/S) 1.01	
HORSEPOWER 8.	
EXIT MACH NUMBER 0.03	
SPECIFIC SPEED 100.36	
SPECIFIC DIAMETER 0.82	
***** # O2 TURBINE # *****	***** # O2 PUMP # *****
EFFICIENCY (T/T) 0.804	EFFICIENCY 0.703
EFFICIENCY (T/S) 0.754	HORSEPOWER 188.
SPEED (RPM) 127128.	SPEED (RPM) 127128.
HORSEPOWER 188.	SS SPEED 22848.
MEAN DIA (IN) 1.65	S SPEED 1843.
EFF AREA (IN2) 0.17	HEAD (FT) 5434.
U/C (ACTUAL) 0.515	DIA. (IN) 1.18
MAX TIP SPEED 981.	TIP SPEED 653.
STAGES 1	VOL. FLOW 84.
GAMMA 1.44	HEAD COEF 0.410
PRESS RATIO (T/T) 1.10	FLOW COEF 0.155
PRESS RATIO (T/S) 1.11	DIAMETER RATIO 0.681
EXIT MACH NUMBER 0.09	BEARING DN 1.53E+06
SPECIFIC SPEED 48.50	SHAFT DIAMETER 12.00
SPECIFIC DIAMETER 1.52	

TABLE 30. — FULL-EXPANDER ENGINE — 15,000 LBF THRUST (COPPER GROOVED CHAMBER)

ENGINE PERFORMANCE PARAMETERS					

CHAMBER PRESSURE					1556.2
VAC ENGINE THRUST					15000.
TOTAL ENGINE FLOW RATE					31.25
DEL. VAC. ISP					480.0
THROAT AREA					4.71
NOZZLE AREA RATIO					1000.0
NOZZLE EXIT DIAMETER					77.46
ENGINE MIXTURE RATIO					6.00
ETA C*					0.993
CHAMBER COOLANT DP					523.
CHAMBER COOLANT DT					535.
NOZZLE/CHAMBER Q					9138.

ENGINE STATION CONDITIONS					

# FUEL SYSTEM CONDITIONS #					
STATION	PRESS	TEMP	FLOW	ENTHALPY	DENSITY
B.P. INLET	18.6	37.4	4.47	-107.5	4.37
B.P. EXIT	100.5	38.5	4.47	-103.0	4.39
PUMP INLET	100.5	38.5	4.47	-103.0	4.39
1ST STAGE EXIT	1526.5	58.2	4.47	-15.2	4.43
2ND STAGE EXIT	2944.9	77.0	4.47	71.3	4.48
PUMP EXIT	4356.9	95.0	4.47	156.4	4.53
COOLANT INLET	4313.3	95.4	4.47	156.4	4.51
COOLANT EXIT	3789.8	630.7	4.47	2200.2	0.99
TBV INLET	3751.9	630.9	0.22	2200.2	0.98
TBV EXIT	1742.3	642.6	0.22	2200.2	0.48
O2 TRB INLET	3751.9	630.9	4.25	2200.2	0.98
O2 TRB EXIT	3374.2	618.6	4.25	2146.9	0.91
H2 TRB INLET	3374.2	618.6	4.25	2146.9	0.91
H2 TRB EXIT	1866.0	551.6	4.25	1873.8	0.59
H2 TRB DIFFUSER	1834.4	551.7	4.25	1873.8	0.58
H2 BST TRB IN	1816.1	551.7	4.25	1873.8	0.58
H2 BST TRB OUT	1794.8	550.6	4.25	1869.1	0.57
H2 BST TRB DIFF	1780.4	550.7	4.25	1869.1	0.57
O2 BST TRB IN	1762.6	550.7	4.25	1869.1	0.56
O2 BST TRB OUT	1752.6	550.1	4.25	1866.5	0.56
O2 BST TRB DIFF	1751.1	550.1	4.25	1866.5	0.56
H2 TANK PRESS	18.6	562.4	0.0064	1883.2	0.0062
GOX HEAT EXCH IN	1742.3	554.7	4.46	1883.2	0.55
GOX HEAT EXCH OUT	1733.6	554.4	4.46	1881.8	0.55
FSDV INLET	1733.6	554.4	4.46	1881.8	0.55
FSDV EXIT	1690.2	554.6	4.46	1881.8	0.54
CHAMBER INJ	1655.8	554.7	4.46	1881.8	0.53
CHAMBER	1556.2				

# OXYGEN SYSTEM CONDITIONS #					
STATION	PRESS	TEMP	FLOW	ENTHALPY	DENSITY
B.P. INLET	16.0	162.7	26.8	61.1	71.17
B.P. EXIT	135.6	163.2	26.8	61.5	71.20
PUMP INLET	135.6	163.2	26.8	61.5	71.20
PUMP EXIT	2520.3	174.8	26.8	69.9	71.59
O2 TANK PRESS	16.0	400.0	0.045	204.7	0.12
OCV INLET	2495.1	174.9	26.8	69.9	71.55
OCV EXIT	1746.6	177.7	26.8	69.9	70.38
CHAMBER INJ	1711.8	177.8	26.8	69.9	70.33
CHAMBER	1556.2				

# VALVE DATA #				
VALVE	DELTA P	AREA	FLOW	% BYPASS
TBV	2010.	0.01	0.22	5.00
FSDV	43.	1.34	4.46	
OCV	749.	0.17	26.79	

# INJECTOR DATA #				
INJECTOR	DELTA P	AREA	FLOW	VELOCITY
FUEL	117.	0.92	4.46	1321.67
LOX	173.	0.38	26.79	143.17

TABLE 30. — FULL-EXPANDER ENGINE — 15,000 LBF THRUST (COPPER GROOVED CHAMBER) (CONTINUED)

*****		*****	
* TURBOMACHINERY PERFORMANCE DATA *		*****	
*****		*****	
* H2 BOOST TURBINE *		* H2 BOOST PUMP *	
*****		*****	
EFFICIENCY (T/T)	0.742	EFFICIENCY	0.766
EFFICIENCY (T/S)	0.390	HORSEPOWER	29.
SPEED (RPM)	53252.	SPEED (RPM)	53252.
MEAN DIA (IN)	1.16	S SPEED	3049.
EFF AREA (IN ²)	1.76	HEAD (FT)	2489.
U/C (ACTUAL)	0.553	DIA. (IN)	1.89
MAX TIP SPEED	389.	TIP SPEED	438.
STAGES	1	VOL. FLOW	457.
GAMMA	1.37	HEAD COEF	0.450
PRESS RATIO (T/T)	1.01	FLOW COEF	0.201
PRESS RATIO (T/S)	1.02		
HORSEPOWER	29.		
EXIT MACH NUMBER	0.11		
SPECIFIC SPEED	146.55		
SPECIFIC DIAMETER	0.52		
*****		*****	
* H2 TURBINE *		* H2 PUMP *	
*****		*****	
		STAGE ONE	STAGE TWO STAGE THREE
		*****	*****
EFFICIENCY (T/T)	0.818	EFFICIENCY	0.680 0.681 0.681
EFFICIENCY (T/S)	0.790	HORSEPOWER	556. 547. 538.
SPEED (RPM)	136363.	SPEED (RPM)	136363. 136363. 136363.
HORSEPOWER	1641.	SS SPEED	9599.
MEAN DIA. (IN)	2.42	S SPEED	917. 922. 927.
EFF AREA (IN ²)	0.23	HEAD (FT)	46464. 45825. 45101.
U/C (ACTUAL)	0.550	DIA. (IN)	2.85 2.85 2.85
MAX TIP SPEED	1536.	TIP SPEED	1694. 1695. 1694.
STAGES	2	VOL. FLOW	453. 448. 443.
GAMMA	1.37	HEAD COEF	0.521 0.513 0.505
PRESS RATIO (T/T)	1.81	FLOW COEF	0.105
PRESS RATIO (T/S)	1.85	DIAMETER RATIO	0.363
EXIT MACH NUMBER	0.17	BEARING DN	3.00E+06
SPECIFIC SPEED	48.65	SHAFT DIAMETER	22.00
SPECIFIC DIAMETER	1.61		
*****		*****	
* O2 BOOST TURBINE *		* O2 BOOST PUMP *	
*****		*****	
EFFICIENCY (T/T)	0.826	EFFICIENCY	0.764
EFFICIENCY (T/S)	0.689	HORSEPOWER	15.
SPEED (RPM)	14271.	SPEED (RPM)	14271.
MEAN DIA (IN)	3.18	S SPEED	3026.
EFF AREA (IN ²)	2.59	HEAD (FT)	242.
U/C (ACTUAL)	0.553	DIA. (IN)	2.11
MAX TIP SPEED	234.	TIP SPEED	132.
STAGES	1	VOL. FLOW	169.
GAMMA	1.37	HEAD COEF	0.450
PRESS RATIO (T/T)	1.01	FLOW COEF	0.200
PRESS RATIO (T/S)	1.01		
HORSEPOWER	15.		
EXIT MACH NUMBER	0.04		
SPECIFIC SPEED	96.18		
SPECIFIC DIAMETER	0.86		
*****		*****	
* O2 TURBINE *		* O2 PUMP *	
*****		*****	
EFFICIENCY (T/T)	0.821	EFFICIENCY	0.730
EFFICIENCY (T/S)	0.767	HORSEPOWER	321.
SPEED (RPM)	84487.	SPEED (RPM)	84487.
HORSEPOWER	321.	SS SPEED	21475.
MEAN DIA (IN)	2.42	S SPEED	1902.
EFF AREA (IN ²)	0.33	HEAD (FT)	4795.
U/C (ACTUAL)	0.545	DIA. (IN)	1.64
MAX TIP SPEED	952.	TIP SPEED	606.
STAGES	1	VOL. FLOW	168.
GAMMA	1.37	HEAD COEF	0.420
PRESS RATIO (T/T)	1.11	FLOW COEF	0.158
PRESS RATIO (T/S)	1.12	DIAMETER RATIO	0.683
EXIT MACH NUMBER	0.10	BEARING DN	1.52E+06
SPECIFIC SPEED	48.53	SHAFT DIAMETER	18.00
SPECIFIC DIAMETER	1.61		

TABLE 31. — FULL-EXPANDER ENGINE — 25,000 LBF THRUST (COPPER GROOVED CHAMBER)

ENGINE PERFORMANCE PARAMETERS

CHAMBER PRESSURE	1491.7
VAC ENGINE THRUST	25000.
TOTAL ENGINE FLOW RATE	52.09
DEL. VAC. ISP	480.0
THROAT AREA	8.19
NOZZLE AREA RATIO	1000.0
NOZZLE EXIT DIAMETER	102.12
ENGINE MIXTURE RATIO	6.00
ETA C*	0.993
CHAMBER COOLANT DP	473.
CHAMBER COOLANT DT	468.
NOZZLE/CHAMBER Q	12774.

ENGINE STATION CONDITIONS

STATION	# FUEL SYSTEM CONDITIONS #			ENTHALPY	DENSITY
	PRESS	TEMP	FLOW		
B.P. INLET	18.6	37.4	7.45	-107.5	4.37
B.P. EXIT	100.6	38.5	7.45	-103.0	4.39
PUMP INLET	100.6	38.5	7.45	-103.0	4.39
1ST STAGE EXIT	1433.1	54.5	7.45	-27.1	4.50
2ND STAGE EXIT	2782.0	70.0	7.45	48.6	4.58
PUMP EXIT	4147.2	85.1	7.45	123.9	4.67
COOLANT INLET	4105.7	85.5	7.45	123.9	4.65
COOLANT EXIT	3632.5	533.3	7.45	1837.8	1.11
TBV INLET	3596.2	533.5	0.37	1837.8	1.10
TBV EXIT	1670.3	542.6	0.37	1837.8	0.54
O2 TRB INLET	3596.2	533.5	7.08	1837.8	1.10
O2 TRB EXIT	3211.3	521.9	7.08	1788.0	1.02
H2 TRB INLET	3211.3	521.9	7.08	1788.0	1.02
H2 TRB EXIT	1799.8	463.1	7.08	1549.3	0.68
H2 TRB DIFFUSER	1760.7	463.3	7.08	1549.3	0.66
H2 BST TRB IN	1743.1	463.3	7.08	1549.3	0.66
H2 BST TRB OUT	1721.4	462.1	7.08	1544.5	0.65
H2 BST TRB DIFF	1708.1	462.2	7.08	1544.5	0.64
O2 BST TRB IN	1691.0	462.3	7.08	1544.5	0.64
O2 BST TRB OUT	1680.2	461.6	7.08	1542.0	0.64
O2 BST TRB DIFF	1678.7	461.6	7.08	1542.0	0.64
H2 TANK PRESS	18.6	471.0	0.0127	1556.8	0.0074
GOX HEAT EXCH IN	1670.3	465.6	7.44	1556.8	0.63
GOX HEAT EXCH OUT	1661.9	465.3	7.44	1555.4	0.62
FSOV INLET	1661.9	465.3	7.44	1555.4	0.62
FSOV EXIT	1620.4	465.4	7.44	1555.4	0.61
CHAMBER INJ	1587.3	465.5	7.44	1555.4	0.60
CHAMBER	1491.7				

STATION	# OXYGEN SYSTEM CONDITIONS #			ENTHALPY	DENSITY
	PRESS	TEMP	FLOW		
B.P. INLET	16.0	162.7	44.7	61.1	71.17
B.P. EXIT	135.6	163.2	44.7	61.5	71.20
PUMP INLET	135.6	163.2	44.7	61.5	71.20
PUMP EXIT	2415.8	173.8	44.7	69.3	71.65
O2 TANK PRESS	16.0	400.0	0.076	204.7	0.12
OCV INLET	2391.7	173.9	44.6	69.3	71.61
OCV EXIT	1674.2	176.6	44.6	69.3	70.50
CHAMBER INJ	1640.9	176.7	44.6	69.3	70.44
CHAMBER	1491.7				

VALVE DATA

VALVE	DELTA P	AREA	FLOW	% BYPASS
TBV	1926.	0.02	0.37	5.00
FSOV	42.	2.14	7.44	
OCV	718.	0.29	44.64	

INJECTOR DATA

INJECTOR	DELTA P	AREA	FLOW	VELOCITY
FUEL	112.	1.47	7.44	1218.70
LOX	166.	0.65	44.64	140.06

TABLE 31. — FULL-EXPANDER ENGINE — 25,000 LBF THRUST (COPPER GROOVED CHAMBER) (CONTINUED)

*****		*****	
# TURBOMACHINERY PERFORMANCE DATA #		*****	
*****		*****	
# H2 BOOST TURBINE #		# H2 BOOST PUMP #	
*****		*****	
EFFICIENCY (T/T)	0.834	EFFICIENCY	0.764
EFFICIENCY (T/S)	0.458	HORSEPOWER	48.
SPEED (RPM)	41277.	SPEED (RPM)	41277.
MEAN DIA (IN)	1.45	S SPEED	3048.
EFF AREA (IN2)	2.72	HEAD (FT)	2694.
U/C (ACTUAL)	0.536	DIA. (IN)	2.43
MAX TIP SPEED	374.	TIP SPEED	439.
STAGES	1	VOL. FLOW	762.
GAMMA	1.39	HEAD COEF	0.450
PRESS RATIO (T/T)	1.01	FLOW COEF	0.201
PRESS RATIO (T/S)	1.02		
HORSEPOWER	48.		
EXIT MACH NUMBER	0.11		
SPECIFIC SPEED	150.00		
SPECIFIC DIAMETER	0.53		
*****		*****	
# H2 TURBINE #		# H2 PUMP #	
*****		*****	
EFFICIENCY (T/T)	0.849	EFFICIENCY	0.727
EFFICIENCY (T/S)	0.830	HORSEPOWER	800.
SPEED (RPM)	125000.	SPEED (RPM)	125000.
HORSEPOWER	2391.	SS SPEED	11347.
MEAN DIA. (IN)	2.46	S SPEED	1142.
EFF AREA (IN2)	0.36	HEAD (FT)	42954.
U/C (ACTUAL)	0.550	DIA. (IN)	3.04
MAX TIP SPEED	1465.	TIP SPEED	1658.
STAGES	2	VOL. FLOW	744.
GAMMA	1.39	HEAD COEF	0.503
PRESS RATIO (T/T)	1.78	FLOW COEF	0.119
PRESS RATIO (T/S)	1.84	DIAMETER RATIO	0.415
EXIT MACH NUMBER	0.19	BEARING DN	3.00E+06
SPECIFIC SPEED	61.19	SHAFT DIAMETER	24.00
SPECIFIC DIAMETER	1.33		
*****		*****	
# O2 BOOST TURBINE #		# O2 BOOST PUMP #	
*****		*****	
EFFICIENCY (T/T)	0.877	EFFICIENCY	0.764
EFFICIENCY (T/S)	0.740	HORSEPOWER	26.
SPEED (RPM)	11054.	SPEED (RPM)	11054.
MEAN DIA (IN)	4.11	S SPEED	3026.
EFF AREA (IN2)	3.89	HEAD (FT)	242.
U/C (ACTUAL)	0.553	DIA. (IN)	2.72
MAX TIP SPEED	232.	TIP SPEED	132.
STAGES	1	VOL. FLOW	282.
GAMMA	1.39	HEAD COEF	0.450
PRESS RATIO (T/T)	1.01	FLOW COEF	0.200
PRESS RATIO (T/S)	1.01		
HORSEPOWER	26.		
EXIT MACH NUMBER	0.04		
SPECIFIC SPEED	94.95		
SPECIFIC DIAMETER	0.90		
*****		*****	
# O2 TURBINE #		# O2 PUMP #	
*****		*****	
EFFICIENCY (T/T)	0.850	EFFICIENCY	0.747
EFFICIENCY (T/S)	0.782	HORSEPOWER	498.
SPEED (RPM)	63806.	SPEED (RPM)	63806.
HORSEPOWER	498.	SS SPEED	20937.
MEAN DIA (IN)	2.46	S SPEED	1918.
EFF AREA (IN2)	0.51	HEAD (FT)	4581.
U/C (ACTUAL)	0.435	DIA. (IN)	2.11
MAX TIP SPEED	749.	TIP SPEED	588.
STAGES	1	VOL. FLOW	280.
GAMMA	1.39	HEAD COEF	0.426
PRESS RATIO (T/T)	1.12	FLOW COEF	0.159
PRESS RATIO (T/S)	1.13	DIAMETER RATIO	0.484
EXIT MACH NUMBER	0.11	BEARING DN	1.40E+06
SPECIFIC SPEED	47.64	SHAFT DIAMETER	22.00
SPECIFIC DIAMETER	1.35		

TABLE 32. — FULL-EXPANDER ENGINE — 37,500 LBF THRUST (COPPER GROOVED CHAMBER)

ENGINE PERFORMANCE PARAMETERS	
CHAMBER PRESSURE	1334.9
VAC ENGINE THRUST	37500.
TOTAL ENGINE FLOW RATE	78.14
DEL. VAC. ISP	479.9
THROAT AREA	13.72
NOZZLE AREA RATIO	1000.0
NOZZLE EXIT DIAMETER	132.14
ENGINE MIXTURE RATIO	6.00
ETA C*	0.993
CHAMBER COOLANT DP	386.
CHAMBER COOLANT DT	376.
NOZZLE/CHAMBER Q	16125.

ENGINE STATION CONDITIONS						

# FUEL SYSTEM CONDITIONS #						
STATION	PRESS	TEMP	FLOW	ENTHALPY	DENSITY	
B.P. INLET	18.6	37.4	11.18	-107.5	4.37	
B.P. EXIT	100.7	38.5	11.18	-103.0	4.39	
PUMP INLET	100.7	38.5	11.18	-103.0	4.39	
1ST STAGE EXIT	1267.6	51.6	11.18	-39.0	4.52	
2ND STAGE EXIT	2460.2	64.3	11.18	25.0	4.62	
PUMP EXIT	3673.3	76.6	11.18	89.2	4.69	
COOLANT INLET	3636.6	77.0	11.18	89.2	4.68	
COOLANT EXIT	3250.7	452.5	11.18	1530.9	1.17	
TBV INLET	3218.2	452.7	0.56	1530.9	1.16	
TBV EXIT	1494.5	459.3	0.56	1530.9	0.57	
O2 TRB INLET	3218.2	452.7	10.63	1530.9	1.16	
O2 TRB EXIT	2875.6	442.7	10.63	1487.4	1.07	
H2 TRB INLET	2875.6	442.7	10.63	1487.4	1.07	
H2 TRB EXIT	1623.9	394.1	10.63	1285.1	0.72	
H2 TRB DIFFUSER	1581.6	394.2	10.63	1285.1	0.70	
H2 BST TRB IN	1565.8	394.2	10.63	1285.1	0.70	
H2 BST TRB OUT	1543.3	393.1	10.63	1280.3	0.69	
H2 BST TRB DIFF	1530.1	393.1	10.63	1280.3	0.68	
O2 BST TRB IN	1514.8	393.2	10.63	1280.3	0.67	
O2 BST TRB OUT	1503.5	392.5	10.63	1277.8	0.67	
O2 BST TRB DIFF	1502.0	392.5	10.63	1277.8	0.67	
H2 TANK PRESS	18.6	398.6	0.0225	1290.4	0.0088	
GOX HEAT EXCH IN	1494.5	395.8	11.16	1290.4	0.66	
GOX HEAT EXCH OUT	1487.0	395.5	11.16	1289.0	0.66	
FSOV INLET	1487.0	395.5	11.16	1289.0	0.66	
FSOV EXIT	1469.9	395.6	11.16	1289.0	0.64	
CHAMBER INJ	1420.3	395.6	11.16	1289.0	0.63	
CHAMBER	1334.9					

# OXYGEN SYSTEM CONDITIONS #						
STATION	PRESS	TEMP	FLOW	ENTHALPY	DENSITY	
B.P. INLET	16.0	162.7	67.1	61.1	71.17	
B.P. EXIT	135.6	163.2	67.1	61.5	71.20	
PUMP INLET	135.6	163.2	67.1	61.5	71.20	
PUMP EXIT	2162.0	172.3	67.1	68.3	71.65	
O2 TANK PRESS	16.0	400.0	0.114	204.7	0.12	
OCV INLET	2140.4	172.4	67.0	68.3	71.62	
OCV EXIT	1498.3	174.9	67.0	68.3	70.61	
CHAMBER INJ	1468.4	175.0	67.0	68.3	70.57	
CHAMBER	1334.9					

# VALVE DATA #				
VALVE	DELTA P	AREA	FLOW	% BYPASS
TBV	1724.	0.03	0.56	5.00
FSOV	37.	3.30	11.16	
OCV	442.	0.47	66.97	

# INJECTOR DATA #				
INJECTOR	DELTA P	AREA	FLOW	VELOCITY
FUEL	100.	2.28	11.16	1117.82
LOX	148.	1.03	66.97	132.38

TABLE 32. — FULL-EXPANDER ENGINE — 37,500 LBF THRUST (COPPER GROOVED CHAMBER) (CONTINUED)

***** # TURBOMACHINERY PERFORMANCE DATA # *****		***** # H2 BOOST TURBINE # *****				***** # H2 BOOST PUMP # *****			
EFFICIENCY (T/T)	0.847	EFFICIENCY (T/T)	0.765						
EFFICIENCY (T/S)	0.475	HORSEPOWER	72.						
SPEED (RPM)	33715.	SPEED (RPM)	33715.						
MEAN DIA (IN)	1.78	S SPEED	3047.						
EFF AREA (IN2)	3.90	HEAD (FT)	2697.						
U/C (ACTUAL)	0.536	DIA. (IN)	2.98						
MAX TIP SPEED	372.	TIP SPEED	439.						
STAGES	1	VOL. FLOW	1144.						
GAMMA	1.41	HEAD COEF	0.450						
PRESS RATIO (T/T)	1.01	FLOW COEF	0.201						
PRESS RATIO (T/S)	1.03								
HORSEPOWER	72.								
EXIT MACH NUMBER	0.12								
SPECIFIC SPEED	150.00								
SPECIFIC DIAMETER	0.54								
***** # H2 TURBINE # *****		***** # H2 PUMP # *****				***** STAGE ONE STAGE TWO STAGE THREE *****			
EFFICIENCY (T/T)	0.881	EFFICIENCY	0.754	0.752	0.752				
EFFICIENCY (T/S)	0.834	HORSEPOWER	1012.	1015.	1015.				
SPEED (RPM)	107143.	SPEED (RPM)	107143.	107143.	107143.				
HORSEPOWER	3042.	SS SPEED	11905.						
MEAN DIA. (IN)	2.45	S SPEED	1325.	1310.	1300.				
EFF AREA (IN2)	0.55	HEAD (FT)	37518.	37553.	37495.				
U/C (ACTUAL)	0.550	DIA. (IN)	3.37	3.37	3.37				
MAX TIP SPEED	1373.	TIP SPEED	1575.	1575.	1575.				
STAGES	2	VOL. FLOW	1111.	1007.	1069.				
GAMMA	1.41	HEAD COEF	0.487	0.487	0.486				
PRESS RATIO (T/T)	1.77	FLOW COEF	0.130						
PRESS RATIO (T/S)	1.83	DIAMETER RATIO	0.451						
EXIT MACH NUMBER	0.21	BEARING DN	3.00E+06						
SPECIFIC SPEED	70.25	SHAFT DIAMETER	28.00						
SPECIFIC DIAMETER	1.18								
***** # O2 BOOST TURBINE # *****		***** # O2 BOOST PUMP # *****				***** # O2 TURBINE # *****			
EFFICIENCY (T/T)	0.887	EFFICIENCY	0.764						
EFFICIENCY (T/S)	0.752	HORSEPOWER	39.						
SPEED (RPM)	9026.	SPEED (RPM)	9026.						
MEAN DIA (IN)	5.03	S SPEED	3026.						
EFF AREA (IN2)	5.58	HEAD (FT)	242.						
U/C (ACTUAL)	0.553	DIA. (IN)	3.34						
MAX TIP SPEED	231.	TIP SPEED	132.						
STAGES	1	VOL. FLOW	423.						
GAMMA	1.41	HEAD COEF	0.450						
PRESS RATIO (T/T)	1.01	FLOW COEF	0.200						
PRESS RATIO (T/S)	1.01								
HORSEPOWER	39.								
EXIT MACH NUMBER	0.04								
SPECIFIC SPEED	93.77								
SPECIFIC DIAMETER	0.91								
***** # O2 TURBINE # *****		***** # O2 PUMP # *****				***** # O2 TURBINE # *****			
EFFICIENCY (T/T)	0.880	EFFICIENCY	0.760						
EFFICIENCY (T/S)	0.823	HORSEPOWER	653.						
SPEED (RPM)	49369.	SPEED (RPM)	49369.						
HORSEPOWER	653.	SS SPEED	19842.						
MEAN DIA (IN)	2.65	S SPEED	1986.						
EFF AREA (IN2)	0.79	HEAD (FT)	4071.						
U/C (ACTUAL)	0.546	DIA. (IN)	2.56						
MAX TIP SPEED	647.	TIP SPEED	552.						
STAGES	2	VOL. FLOW	420.						
GAMMA	1.41	HEAD COEF	0.431						
PRESS RATIO (T/T)	1.12	FLOW COEF	0.162						
PRESS RATIO (T/S)	1.13	DIAMETER RATIO	0.686						
EXIT MACH NUMBER	0.10	BEARING DN	1.38E+06						
SPECIFIC SPEED	80.41	SHAFT DIAMETER	28.00						
SPECIFIC DIAMETER	1.03								

TABLE 33. — FULL-EXPANDER ENGINE — 50,000 LBF THRUST (COPPER GROOVED CHAMBER)

ENGINE PERFORMANCE PARAMETERS					

CHAMBER PRESSURE					1342.3
VAC ENGINE THRUST					50000.
TOTAL ENGINE FLOW RATE					104.18
DEL. VAC. ISP					479.9
THROAT AREA					18.19
NOZZLE AREA RATIO					1000.0
NOZZLE EXIT DIAMETER					152.19
ENGINE MIXTURE RATIO					6.00
ETA C*					0.993
CHAMBER COOLANT DP					361.
CHAMBER COOLANT DT					365.
NOZZLE/CHAMBER Q					20902.
ENGINE STATION CONDITIONS					

# FUEL SYSTEM CONDITIONS #					
STATION	PRESS	TEMP	FLOW	ENTHALPY	DENSITY
B.P. INLET	18.6	37.4	14.91	-107.5	4.37
B.P. EXIT	100.7	38.5	14.91	-103.0	4.39
PUMP INLET	100.7	38.5	14.91	-103.0	4.39
1ST STAGE EXIT	1240.0	51.0	14.91	-40.6	4.53
2ND STAGE EXIT	2449.2	63.2	14.91	22.0	4.64
PUMP EXIT	3466.8	75.1	14.91	84.8	4.74
COOLANT INLET	3630.1	75.4	14.91	84.8	4.72
COOLANT EXIT	3248.8	440.8	14.91	1486.4	1.20
TBV INLET	3236.1	440.9	0.75	1486.4	1.19
TBV EXIT	1502.6	447.3	0.75	1486.4	0.59
O2 TRB INLET	3236.1	440.9	14.17	1486.4	1.19
O2 TRB EXIT	2884.1	431.0	14.17	1443.2	1.10
H2 TRB INLET	2884.1	431.0	14.17	1443.2	1.10
H2 TRB EXIT	1437.4	383.9	14.17	1245.3	0.74
H2 TRB DIFFUSER	1590.4	384.0	14.17	1245.3	0.72
H2 BST TRB IN	1574.5	384.0	14.17	1245.3	0.71
H2 BST TRB OUT	1551.5	382.8	14.17	1240.6	0.70
H2 BST TRB DIFF	1538.6	382.9	14.17	1240.6	0.69
O2 BST TRB IN	1523.2	382.9	14.17	1240.6	0.69
O2 BST TRB OUT	1511.7	382.3	14.17	1238.0	0.69
O2 BST TRB DIFF	1510.1	382.3	14.17	1238.0	0.69
H2 TANK PRESS	18.6	387.9	0.0309	1250.4	0.0090
GOX HEAT EXCH IN	1502.6	385.5	14.88	1250.4	0.68
GOX HEAT EXCH OUT	1495.1	385.1	14.88	1249.0	0.68
FSOV INLET	1495.1	385.1	14.88	1249.0	0.68
FSOV EXIT	1457.7	385.2	14.88	1249.0	0.66
CHAMBER INJ	1428.0	385.3	14.88	1249.0	0.65
CHAMBER	1342.3				
# OXYGEN SYSTEM CONDITIONS #					
STATION	PRESS	TEMP	FLOW	ENTHALPY	DENSITY
B.P. INLET	16.0	142.7	89.4	61.1	71.17
B.P. EXIT	135.6	163.2	89.4	61.5	71.20
PUMP INLET	135.6	163.2	89.4	61.5	71.20
PUMP EXIT	2173.9	172.2	89.4	68.3	71.69
O2 TANK PRESS	16.0	400.0	0.151	204.7	0.12
OCV INLET	2152.2	172.3	89.3	68.3	71.65
OCV EXIT	1506.5	174.7	89.3	68.3	70.64
CHAMBER INJ	1476.5	174.8	89.3	68.3	70.60
CHAMBER	1342.3				
# VALVE DATA #					
VALVE	DELTA P	AREA	FLOW	% BYPASS	
TBV	1733.	0.03	0.75	5.00	
FSOV	37.	4.32	14.88		
OCV	646.	0.62	89.30		
# INJECTOR DATA #					
INJECTOR	DELTA P	AREA	FLOW	VELOCITY	
FUEL	101.	2.98	14.88	1104.05	
LOX	149.	1.37	89.30	132.72	

TABLE 33. — FULL-EXPANDER ENGINE — 50,000 LBF THRUST (COPPER GROOVED CHAMBER) (CONTINUED)

*****		*****	
# TURBOMACHINERY PERFORMANCE DATA #		*****	
*****		*****	
# H2 BOOST TURBINE #		# H2 BOOST PUMP #	
*****		*****	
EFFICIENCY (T/T)	0.861	EFFICIENCY	0.765
EFFICIENCY (T/S)	0.489	HORSEPOWER	96.
SPEED (RPM)	29193.	SPEED (RPM)	29193.
MEAN DIA (IN)	2.04	S SPEED	3047.
EFF AREA (IN2)	5.08	HEAD (FT)	2696.
U/C (ACTUAL)	0.533	DIA. (IN)	3.44
MAX TIP SPEED	368.	TIP SPEED	439.
STAGES	1	VOL. FLOW	1525.
GAMMA	1.39	HEAD COEF	0.450
PRESS RATIO (T/T)	1.01	FLOW COEF	0.201
PRESS RATIO (T/S)	1.03		
HORSEPOWER	96.		
EXIT MACH NUMBER	0.12		
SPECIFIC SPEED	150.00		
SPECIFIC DIAMETER	0.54		
*****		*****	
# H2 TURBINE #		# H2 PUMP #	
*****		*****	
		STAGE ONE	STAGE TWO STAGE THREE
		*****	*****
EFFICIENCY (T/T)	0.890	EFFICIENCY	0.766 0.765 0.764
EFFICIENCY (T/S)	0.837	HORSEPOWER	1317. 1323. 1326.
SPEED (RPM)	100000.	SPEED (RPM)	100000. 100000. 100000.
HORSEPOWER	3966.	SS SPEED	12833.
MEAN DIA. (IN)	2.81	S SPEED	1435. 1415. 1399.
EFF AREA (IN2)	0.73	HEAD (FT)	37200. 37299. 37355.
U/C (ACTUAL)	0.550	DIA. (IN)	3.63 3.63 3.63
MAX TIP SPEED	1373.	TIP SPEED	1585. 1585. 1585.
STAGES	2	VOL. FLOW	1478. 1443. 1412.
GAMMA	1.39	HEAD COEF	0.474 0.478 0.479
PRESS RATIO (T/T)	1.76	FLOW COEF	0.134
PRESS RATIO (T/S)	1.83	DIAMETER RATIO	0.479
EXIT MACH NUMBER	0.22	BEARING DN	3.00E+06
SPECIFIC SPEED	75.88	SHAFT DIAMETER	30.00
SPECIFIC DIAMETER	1.10		
*****		*****	
# O2 BOOST TURBINE #		# O2 BOOST PUMP #	
*****		*****	
EFFICIENCY (T/T)	0.896	EFFICIENCY	0.764
EFFICIENCY (T/S)	0.761	HORSEPOWER	51.
SPEED (RPM)	7816.	SPEED (RPM)	7816.
MEAN DIA (IN)	5.81	S SPEED	3026.
EFF AREA (IN2)	7.24	HEAD (FT)	242.
U/C (ACTUAL)	0.553	DIA. (IN)	3.85
MAX TIP SPEED	230.	TIP SPEED	132.
STAGES	1	VOL. FLOW	564.
GAMMA	1.39	HEAD COEF	0.450
PRESS RATIO (T/T)	1.01	FLOW COEF	0.200
PRESS RATIO (T/S)	1.01		
HORSEPOWER	51.		
EXIT MACH NUMBER	0.04		
SPECIFIC SPEED	93.13		
SPECIFIC DIAMETER	0.92		
*****		*****	
# O2 TURBINE #		# O2 PUMP #	
*****		*****	
EFFICIENCY (T/T)	0.878	EFFICIENCY	0.769
EFFICIENCY (T/S)	0.819	HORSEPOWER	866.
SPEED (RPM)	42723.	SPEED (RPM)	42723.
HORSEPOWER	866.	SS SPEED	19827.
MEAN DIA (IN)	2.81	S SPEED	1976.
EFF AREA (IN2)	1.02	HEAD (FT)	4093.
U/C (ACTUAL)	0.503	DIA. (IN)	2.95
MAX TIP SPEED	601.	TIP SPEED	551.
STAGES	2	VOL. FLOW	560.
GAMMA	1.39	HEAD COEF	0.434
PRESS RATIO (T/T)	1.12	FLOW COEF	0.161
PRESS RATIO (T/S)	1.13	DIAMETER RATIO	0.686
EXIT MACH NUMBER	0.10	BEARING DN	1.28E+06
SPECIFIC SPEED	78.94	SHAFT DIAMETER	30.00
SPECIFIC DIAMETER	0.98		

TABLE 34. — SPLIT-EXPANDER ENGINE — 7500 LBF THRUST (COPPER GROOVED CHAMBER)

ENGINE PERFORMANCE PARAMETERS

CHAMBER PRESSURE	1247.9
VAC ENGINE THRUST	7500.
TOTAL ENGINE FLOW RATE	15.63
DEL. VAC. ISP	479.9
THROAT AREA	2.93
NOZZLE AREA RATIO	1000.0
NOZZLE EXIT DIAMETER	61.12
ENGINE MIXTURE RATIO	6.00
ETA C*	0.993
CHAMBER COOLANT DP	1112.
CHAMBER COOLANT DT	993.
NOZZLE/CHAMBER Q	4087.

ENGINE STATION CONDITIONS

STATION	* FUEL SYSTEM CONDITIONS *				ENTHALPY	DENSITY
	PRESS	TEMP	FLOW			
B.P. INLET	18.6	37.4	2.23		-107.5	4.37
B.P. EXIT	100.7	38.5	2.23		-103.0	4.39
PUMP INLET	100.7	38.5	2.23		-103.0	4.39
1ST STAGE EXIT	1756.6	65.6	2.23		10.7	4.31
JBV INLET	1721.5	65.9	1.12		10.9	4.29
JBV EXIT	1463.2	67.8	1.12		10.9	4.09
2ND STAGE EXIT	3105.7	92.3	1.12		119.1	4.18
PUMP EXIT	4354.6	116.4	1.12		218.8	4.14
COOLANT INLET	4311.0	116.7	1.12		218.8	4.12
COOLANT EXIT	3198.8	1110.0	1.12		3876.7	0.50
TBV INLET	3166.8	1110.2	0.06		3876.7	0.50
TBV EXIT	1470.1	1122.3	0.06		3876.7	0.24
O2 TRB INLET	3166.8	1110.2	1.06		3876.7	0.50
O2 TRB EXIT	2851.0	1087.4	1.06		3788.8	0.46
H2 TRB INLET	2851.0	1087.4	1.06		3788.8	0.46
H2 TRB EXIT	1560.2	964.9	1.06		3329.9	0.29
H2 TRB DIFFUSER	1542.9	965.0	1.06		3329.9	0.29
H2 BST TRB IN	1527.5	965.0	1.06		3329.9	0.29
H2 BST TRB OUT	1508.2	962.5	1.06		3320.4	0.28
H2 BST TRB DIFF	1503.2	962.5	1.06		3320.4	0.28
O2 BST TRB IN	1488.1	962.6	1.06		3320.4	0.28
O2 BST TRB OUT	1478.2	961.2	1.06		3315.2	0.28
O2 BST TRB DIFF	1477.5	961.2	1.06		3315.2	0.28
H2 TANK PRESS	18.6	979.5	0.0018		3343.3	0.0036
GOX HEAT EXCH IN	1470.1	969.3	1.12		3343.3	0.27
GOX HEAT EXCH OUT	1462.8	968.6	1.12		3340.5	0.27
MIXER HOT IN	1462.8	968.6	1.12		3340.5	0.27
MIXER COLD IN	1463.2	67.8	1.12		10.9	4.09
MIXER OUT	1389.6	498.7	2.23		1674.4	0.49
FSOV INLET	1389.6	498.7	2.23		1674.4	0.49
FSOV EXIT	1354.9	498.9	2.23		1674.4	0.48
CHAMBER INJ	1341.3	498.9	2.23		1674.4	0.48
CHAMBER	1247.9					

STATION	* OXYGEN SYSTEM CONDITIONS *				ENTHALPY	DENSITY
	PRESS	TEMP	FLOW			
B.P. INLET	16.0	162.7	13.4		61.1	71.17
B.P. EXIT	135.6	163.2	13.4		61.5	71.20
PUMP INLET	135.6	163.2	13.4		61.5	71.20
PUMP EXIT	2020.9	173.0	13.4		68.4	71.41
O2 TANK PRESS	16.0	400.0	0.023		204.7	0.12
OCV INLET	2000.7	173.1	13.4		68.4	71.38
OCV EXIT	1400.5	175.4	13.4		68.4	70.43
CHAMBER INJ	1386.5	175.4	13.4		68.4	70.41
CHAMBER	1247.9					

* VALVE DATA *

VALVE	DELTA P	AREA	FLOW	% BYPASS
JBV	258.	0.05	1.12	50.00
TBV	1697.	0.00	0.06	5.00
FSOV	35.	0.79	2.23	
OCV	600.	0.10	13.40	

* INJECTOR DATA *

INJECTOR	DELTA P	AREA	FLOW	VELOCITY
FUEL	93.	0.51	2.23	1238.05
LOX	139.	0.20	13.40	128.16

TABLE 34. — SPLIT-EXPANDER ENGINE — 7500 LBF THRUST (COPPER GROOVED CHAMBER) (CONTINUED)

***** * TURBOMACHINERY PERFORMANCE DATA * *****	
***** * H2 BOOST TURBINE * *****	***** * H2 BOOST PUMP * *****
EFFICIENCY (T/T) 0.789	EFFICIENCY 0.765
EFFICIENCY (T/S) 0.587	HORSEPOWER 14.
SPEED (RPM) 75439.	SPEED (RPM) 75439.
MEAN DIA (IN) 1.16	S SPEED 3046.
EFF AREA (IN2) 0.67	HEAD (FT) 2697.
U/C (ACTUAL) 0.553	DIA. (IN) 1.33
MAX TIP SPEED 484.	TIP SPEED 439.
STAGES 1	VOL. FLOW 228.
GAMMA 1.42	HEAD COEF 0.450
PRESS RATIO (T/T) 1.01	FLOW COEF 0.201
PRESS RATIO (T/S) 1.02	
HORSEPOWER 14.	
EXIT MACH NUMBER 0.07	
SPECIFIC SPEED 120.28	
SPECIFIC DIAMETER 0.68	
***** * H2 TURBINE * *****	***** * H2 PUMP * *****
EFFICIENCY (T/T) 0.776	STAGE ONE STAGE TWO STAGE THREE
EFFICIENCY (T/S) 0.759	*****
SPEED (RPM) 187500.	EFFICIENCY 0.621 0.543 0.557
HORSEPOWER 689.	HORSEPOWER 360. 171. 158.
MEAN DIA. (IN) 2.28	SPEED (RPM) 187500. 187500. 187500.
EFF AREA (IN2) 0.09	SS SPEED 9310.
U/C (ACTUAL) 0.550	S SPEED 796. 656. 688.
MAX TIP SPEED 1933.	HEAD (FT) 55008. 45817. 43238.
STAGES 2	DIA. (IN) 2.26 2.13 2.13
GAMMA 1.42	TIP SPEED 1843. 1743. 1743.
PRESS RATIO (T/T) 1.83	VOL. FLOW 233. 120. 121.
PRESS RATIO (T/S) 1.85	HEAD COEF 0.519 0.485 0.458
EXIT MACH NUMBER 0.13	FLOW COEF 0.097
SPECIFIC SPEED 31.97	DIAMETER RATIO 0.327
SPECIFIC DIAMETER 2.34	BEARING DN 3.00E+06
	SHAFT DIAMETER 16.00
***** * O2 BOOST TURBINE * *****	***** * O2 BOOST PUMP * *****
EFFICIENCY (T/T) 0.811	EFFICIENCY 0.764
EFFICIENCY (T/S) 0.739	HORSEPOWER 8.
SPEED (RPM) 20181.	SPEED (RPM) 20181.
MEAN DIA (IN) 3.19	S SPEED 3026.
EFF AREA (IN2) 0.94	HEAD (FT) 242.
U/C (ACTUAL) 0.553	DIA. (IN) 1.49
MAX TIP SPEED 307.	TIP SPEED 132.
STAGES 1	VOL. FLOW 85.
GAMMA 1.42	HEAD COEF 0.450
PRESS RATIO (T/T) 1.01	FLOW COEF 0.200
PRESS RATIO (T/S) 1.01	
HORSEPOWER 8.	
EXIT MACH NUMBER 0.03	
SPECIFIC SPEED 61.32	
SPECIFIC DIAMETER 1.30	
***** * O2 TURBINE * *****	***** * O2 PUMP * *****
EFFICIENCY (T/T) 0.778	EFFICIENCY 0.702
EFFICIENCY (T/S) 0.750	HORSEPOWER 132.
SPEED (RPM) 109465.	SPEED (RPM) 109465.
HORSEPOWER 132.	SS SPEED 19676.
MEAN DIA (IN) 2.28	S SPEED 2077.
EFF AREA (IN2) 0.13	HEAD (FT) 3801.
U/C (ACTUAL) 0.519	DIA. (IN) 1.14
MAX TIP SPEED 1130.	TIP SPEED 546.
STAGES 1	VOL. FLOW 84.
GAMMA 1.42	HEAD COEF 0.410
PRESS RATIO (T/T) 1.11	FLOW COEF 0.165
PRESS RATIO (T/S) 1.12	DIAMETER RATIO 0.687
EXIT MACH NUMBER 0.07	BEARING DN 1.31E+06
SPECIFIC SPEED 30.59	SHAFT DIAMETER 12.00
SPECIFIC DIAMETER 2.33	

TABLE 35. — SPLIT-EXPANDER ENGINE — 15,000 LBF THRUST (COPPER GROOVED CHAMBER)

ENGINE PERFORMANCE PARAMETERS

CHAMBER PRESSURE	1494.3
VAC ENGINE THRUST	15000.
TOTAL ENGINE FLOW RATE	31.25
DEL. VAC. ISP	480.0
THROAT AREA	4.91
NOZZLE AREA RATIO	1000.0
NOZZLE EXIT DIAMETER	79.03
ENGINE MIXTURE RATIO	6.00
ETA C*	0.993
CHAMBER COOLANT DP	534.
CHAMBER COOLANT DT	1014.
NOZZLE/CHAMBER Q	8357.

ENGINE STATION CONDITIONS

* FUEL SYSTEM CONDITIONS *					
STATION	PRESS	TEMP	FLOW	ENTHALPY	DENSITY
B.P. INLET	18.6	37.4	4.47	-107.5	4.37
B.P. EXIT	100.3	38.5	4.47	-103.0	4.39
PUMP INLET	100.3	38.5	4.47	-103.0	4.39
1ST STAGE EXIT	2103.5	71.0	4.47	34.3	4.31
JBV INLET	2061.5	71.4	2.23	34.3	4.28
JBV EXIT	1752.3	73.6	2.23	34.3	4.07
2ND STAGE EXIT	3274.3	90.0	2.23	116.1	4.30
PUMP EXIT	4408.2	107.9	2.23	194.6	4.31
COOLANT INLET	4364.1	108.2	2.23	194.6	4.29
COOLANT EXIT	3830.6	1122.2	2.23	3935.2	0.59
TBV INLET	3792.3	1122.5	0.11	3935.2	0.58
TBV EXIT	1761.4	1137.0	0.11	3935.2	0.28
O2 TRB INLET	3792.3	1122.5	2.12	3935.2	0.58
O2 TRB EXIT	3361.7	1096.3	2.12	3832.9	0.54
H2 TRB INLET	3361.7	1096.3	2.12	3832.9	0.54
H2 TRB EXIT	1864.0	975.8	2.12	3375.0	0.34
H2 TRB DIFFUSER	1864.0	975.9	2.12	3375.0	0.34
H2 BST TRB IN	1827.6	975.9	2.12	3375.0	0.34
H2 BST TRB OUT	1805.6	973.4	2.12	3365.5	0.33
H2 BST TRB DIFF	1800.6	973.5	2.12	3365.5	0.33
O2 BST TRB IN	1782.6	973.6	2.12	3365.5	0.33
O2 BST TRB OUT	1771.0	972.2	2.12	3360.4	0.33
O2 BST TRB DIFF	1770.3	972.2	2.12	3360.4	0.33
H2 TANK PRESS	18.6	992.7	0.0036	3389.1	0.0035
GOX HEAT EXCH IN	1761.4	980.5	2.23	3389.1	0.32
GOX HEAT EXCH OUT	1752.6	979.8	2.23	3386.4	0.32
MIXER HOT IN	1752.6	979.8	2.23	3386.4	0.32
MIXER COLD IN	1752.3	73.6	2.23	34.3	4.07
MIXER OUT	1665.0	507.2	4.46	1709.0	0.58
FSOV INLET	1665.0	507.2	4.46	1709.0	0.58
FSOV EXIT	1623.3	507.4	4.46	1709.0	0.56
CHAMBER INJ	1607.1	507.4	4.46	1709.0	0.56
CHAMBER	1494.3				

* OXYGEN SYSTEM CONDITIONS *					
STATION	PRESS	TEMP	FLOW	ENTHALPY	DENSITY
B.P. INLET	16.0	162.7	26.8	61.1	71.17
B.P. EXIT	135.6	163.2	26.8	61.5	71.20
PUMP INLET	135.6	163.2	26.8	61.5	71.20
PUMP EXIT	2420.1	174.3	26.8	69.5	71.58
O2 TANK PRESS	16.0	400.0	0.045	204.7	0.12
OCV INLET	2395.9	174.4	26.8	69.5	71.54
OCV EXIT	1677.1	177.1	26.8	69.5	70.42
CHAMBER INJ	1660.3	177.2	26.8	69.5	70.39
CHAMBER	1494.3				

* VALVE DATA *

VALVE	DELTA P	AREA	FLOW	% BYPASS
JBV	309.	0.09	2.23	50.00
TBV	2031.	0.01	0.11	5.00
FSOV	42.	1.34	4.46	
OCV	719.	0.18	26.79	

* INJECTOR DATA *

INJECTOR	DELTA P	AREA	FLOW	VELOCITY
FUEL	113.	0.85	4.46	1266.55
LOX	166.	0.37	26.79	140.26

TABLE 35. — SPLIT-EXPANDER ENGINE — 15,000 LBF THRUST (COPPER GROOVED CHAMBER) (CONTINUED)

*****		*****	
* H2 BOOST TURBINE *		* H2 BOOST PUMP *	
*****		*****	
EFFICIENCY (T/T)	0.815	EFFICIENCY	0.766
EFFICIENCY (T/S)	0.626	HORSEPOWER	28.
SPEED (RPM)	53228.	SPEED (RPM)	53228.
MEAN DIA (IN)	1.64	S SPEED	3051.
EFF AREA (IN ²)	1.15	HEAD (FT)	2684.
U/C (ACTUAL)	0.553	DIA. (IN)	1.88
MAX TIP SPEED	475.	TIP SPEED	438.
STAGES	1	VOL. FLOW	457.
GAMMA	1.44	HEAD COEF	0.450
PRESS RATIO (T/T)	1.01	FLOW COEF	0.201
PRESS RATIO (T/S)	1.02		
HORSEPOWER	28.		
EXIT MACH NUMBER	0.06		
SPECIFIC SPEED	116.15		
SPECIFIC DIAMETER	0.72		
*****		*****	
* H2 TURBINE *		* H2 PUMP *	
*****		*****	
		STAGE ONE	STAGE TWO STAGE THREE
		*****	*****
EFFICIENCY (T/T)	0.786	EFFICIENCY	0.623 0.615 0.621
EFFICIENCY (T/S)	0.770	HORSEPOWER	868. 259. 248.
SPEED (RPM)	136363.	SPEED (RPM)	136363. 136363. 136363.
HORSEPOWER	1375.	SS SPEED	9607.
MEAN DIA. (IN)	3.06	S SPEED	710. 748. 765.
EFF AREA (IN ²)	0.15	HEAD (FT)	66570. 39185. 37954.
U/C (ACTUAL)	0.537	DIA. (IN)	3.34 2.66 2.66
MAX TIP SPEED	1884.	TIP SPEED	1990. 1582. 1583.
STAGES	2	VOL. FLOW	465. 233. 233.
GAMMA	1.44	HEAD COEF	0.541 0.503 0.488
PRESS RATIO (T/T)	1.80	FLOW COEF	0.090
PRESS RATIO (T/S)	1.83	DIAMETER RATIO	0.309
EXIT MACH NUMBER	0.12	BEARING DN	3.00E+06
SPECIFIC SPEED	30.55	SHAFT DIAMETER	22.00
SPECIFIC DIAMETER	2.41		
*****		*****	
* O2 BOOST TURBINE *		* O2 BOOST PUMP *	
*****		*****	
EFFICIENCY (T/T)	0.827	EFFICIENCY	0.764
EFFICIENCY (T/S)	0.760	HORSEPOWER	15.
SPEED (RPM)	14271.	SPEED (RPM)	14271.
MEAN DIA (IN)	4.50	S SPEED	3026.
EFF AREA (IN ²)	1.60	HEAD (FT)	242.
U/C (ACTUAL)	0.553	DIA. (IN)	2.11
MAX TIP SPEED	304.	TIP SPEED	132.
STAGES	1	VOL. FLOW	169.
GAMMA	1.44	HEAD COEF	0.450
PRESS RATIO (T/T)	1.01	FLOW COEF	0.200
PRESS RATIO (T/S)	1.01		
HORSEPOWER	15.		
EXIT MACH NUMBER	0.03		
SPECIFIC SPEED	57.49		
SPECIFIC DIAMETER	1.39		
*****		*****	
* O2 TURBINE *		* O2 PUMP *	
*****		*****	
EFFICIENCY (T/T)	0.782	EFFICIENCY	0.730
EFFICIENCY (T/S)	0.758	HORSEPOWER	307.
SPEED (RPM)	82994.	SPEED (RPM)	82994.
HORSEPOWER	307.	SS SPEED	21095.
MEAN DIA (IN)	3.06	S SPEED	1929.
EFF AREA (IN ²)	0.20	HEAD (FT)	4595.
U/C (ACTUAL)	0.489	DIA. (IN)	1.64
MAX TIP SPEED	1146.	TIP SPEED	593.
STAGES	1	VOL. FLOW	168.
GAMMA	1.44	HEAD COEF	0.420
PRESS RATIO (T/T)	1.13	FLOW COEF	0.159
PRESS RATIO (T/S)	1.13	DIAMETER RATIO	0.684
EXIT MACH NUMBER	0.06	BEARING DN	1.49E+06
SPECIFIC SPEED	27.29	SHAFT DIAMETER	18.00
SPECIFIC DIAMETER	2.47		

TABLE 36. — SPLIT-EXPANDER ENGINE — 25,000 LBF THRUST (COPPER GROOVED CHAMBER)

ENGINE PERFORMANCE PARAMETERS					

CHAMBER PRESSURE					1559.9
VAC ENGINE THRUST					25000.
TOTAL ENGINE FLOW RATE					52.08
DEL. VAC. ISP					480.0
THROAT AREA					7.83
NOZZLE AREA RATIO					1000.0
NOZZLE EXIT DIAMETER					99.88
ENGINE MIXTURE RATIO					6.00
ETA C*					0.993
CHAMBER COOLANT DP					539.
CHAMBER COOLANT DT					905.
NOZZLE/CHAMBER Q					12485.
ENGINE STATION CONDITIONS					

# FUEL SYSTEM CONDITIONS #					
STATION	PRESS	TEMP	FLOW	ENTHALPY	DENSITY
B.P. INLET	18.6	37.4	7.45	-107.5	4.37
B.P. EXIT	100.8	38.5	7.45	-103.0	4.39
PUMP INLET	100.8	38.5	7.45	-103.0	4.39
1ST STAGE EXIT	2195.6	67.8	7.45	27.4	4.44
JBV INLET	2151.7	68.2	3.72	27.5	4.41
JBV EXIT	1828.9	70.8	3.72	27.5	4.19
2ND STAGE EXIT	3396.2	84.1	3.72	102.2	4.47
PUMP EXIT	4583.6	99.8	3.72	175.3	4.51
COOLANT INLET	4537.7	100.2	3.72	175.3	4.49
COOLANT EXIT	3998.5	1004.9	3.72	3528.3	0.68
TBV INLET	3958.5	1005.2	0.19	3528.3	0.67
TBV EXIT	1838.3	1019.9	0.19	3528.3	0.32
O2 TRB INLET	3958.5	1005.2	3.54	3528.3	0.67
O2 TRB EXIT	3489.3	978.6	3.54	3423.9	0.62
H2 TRB INLET	3489.3	978.6	3.54	3423.9	0.62
H2 TRB EXIT	1949.5	866.0	3.54	2993.7	0.40
H2 TRB DIFFUSER	1928.6	866.1	3.54	2993.7	0.40
H2 BST TRB IN	1909.4	866.1	3.54	2993.7	0.40
H2 BST TRB OUT	1885.0	863.7	3.54	2984.1	0.39
H2 BST TRB DIFF	1880.0	863.8	3.54	2984.1	0.39
O2 BST TRB IN	1861.2	863.9	3.54	2984.1	0.38
O2 BST TRB OUT	1848.3	862.5	3.54	2979.0	0.38
O2 BST TRB DIFF	1847.5	862.5	3.54	2979.0	0.38
H2 TANK PRESS	18.6	882.3	0.0068	3006.4	0.0040
GOX HEAT EXCH IN	1838.3	870.4	3.72	3006.4	0.38
GOX HEAT EXCH OUT	1829.1	869.6	3.72	3003.7	0.38
MIXER HOT IN	1829.1	869.6	3.72	3003.7	0.38
MIXER COLD IN	1828.9	70.8	3.72	27.5	4.19
MIXER OUT	1737.6	454.0	7.44	1514.2	0.67
FSOV INLET	1737.6	454.0	7.44	1514.2	0.67
FSOV EXIT	1694.2	454.1	7.44	1514.2	0.65
CHAMBER INJ	1659.6	454.2	7.44	1514.2	0.64
CHAMBER	1559.9				
# OXYGEN SYSTEM CONDITIONS #					
STATION	PRESS	TEMP	FLOW	ENTHALPY	DENSITY
B.P. INLET	16.0	162.7	44.7	61.1	71.17
B.P. EXIT	135.6	163.2	44.7	61.5	71.20
PUMP INLET	135.6	163.2	44.7	61.5	71.20
PUMP EXIT	2526.3	174.3	44.7	69.7	71.68
O2 TANK PRESS	16.0	400.0	0.076	204.7	0.12
OCV INLET	2501.1	174.4	44.6	69.7	71.64
OCV EXIT	1750.8	177.2	44.6	69.7	70.47
CHAMBER INJ	1715.9	177.4	44.6	69.7	70.41
CHAMBER	1559.9				
# VALVE DATA #					
VALVE	DELTA P	AREA	FLOW	% BYPASS	
JBV	323.	0.15	3.72	50.00	
TBV	2120.	0.01	0.19	5.00	
FSOV	43.	2.02	7.44		
OCV	750.	0.29	44.64		
# INJECTOR DATA #					
INJECTOR	DELTA P	AREA	FLOW	VELOCITY	
FUEL	117.	1.39	7.44	1206.29	
LOX	173.	0.64	44.64	143.26	

TABLE 36. — SPLIT-EXPANDER ENGINE — 25,000 LBF THRUST (COPPER GROOVED CHAMBER) (CONTINUED)

***** * TURBOMACHINERY PERFORMANCE DATA * *****					
***** * H2 BOOST TURBINE * *****		***** * H2 BOOST PUMP * *****			
EFFICIENCY (T/T)	0.873	EFFICIENCY	0.765		
EFFICIENCY (T/S)	0.685	HORSEPOWER	48.		
SPEED (RPM)	41343.	SPEED (RPM)	41343.		
MEAN DIA. (IN)	2.12	S SPEED	3045.		
EFF AREA (IN ²)	1.68	HEAD (FT)	2700.		
U/C (ACTUAL)	0.553	DIA. (IN)	2.43		
MAX TIP SPEED	469.	TIP SPEED	439.		
STAGES	1	VOL. FLOW	761.		
GAMMA	1.44	HEAD COEF	0.450		
PRESS RATIO (T/T)	1.01	FLOW COEF	0.201		
PRESS RATIO (T/S)	1.02				
HORSEPOWER	48.				
EXIT MACH NUMBER	0.07				
SPECIFIC SPEED	114.44				
SPECIFIC DIAMETER	0.75				
***** * H2 TURBINE * *****		***** * H2 PUMP * *****			
EFFICIENCY (T/T)	0.837	EFFICIENCY	0.672	0.668	0.670
EFFICIENCY (T/S)	0.819	HORSEPOWER	1375.	394.	385.
SPEED (RPM)	125000.	SPEED (RPM)	125000.	125000.	125000.
HORSEPOWER	2153.	SS SPEED	11322.		
MEAN DIA. (IN)	3.13	S SPEED	813.	874.	883.
EFF AREA (IN ²)	0.22	HEAD (FT)	68187.	38830.	38091.
U/C (ACTUAL)	0.520	DIA. (IN)	3.70	2.87	2.87
MAX TIP SPEED	1787.	TIP SPEED	2019.	1566.	1565.
STAGES	2	VOL. FLOW	754.	374.	371.
GAMMA	1.44	HEAD COEF	0.538	0.510	0.500
PRESS RATIO (T/T)	1.79	FLOW COEF	0.098		
PRESS RATIO (T/S)	1.82	DIAMETER RATIO	0.341		
EXIT MACH NUMBER	0.13	BEARING DN	3.00E+06		
SPECIFIC SPEED	36.39	SHAFT DIAMETER	24.00		
SPECIFIC DIAMETER	2.04				
***** * O2 BOOST TURBINE * *****		***** * O2 BOOST PUMP * *****			
EFFICIENCY (T/T)	0.869	EFFICIENCY	0.764		
EFFICIENCY (T/S)	0.803	HORSEPOWER	26.		
SPEED (RPM)	11055.	SPEED (RPM)	11055.		
MEAN DIA. (IN)	5.82	S SPEED	3026.		
EFF AREA (IN ²)	2.32	HEAD (FT)	242.		
U/C (ACTUAL)	0.553	DIA. (IN)	2.72		
MAX TIP SPEED	302.	TIP SPEED	132.		
STAGES	1	VOL. FLOW	282.		
GAMMA	1.44	HEAD COEF	0.450		
PRESS RATIO (T/T)	1.01	FLOW COEF	0.200		
PRESS RATIO (T/S)	1.01				
HORSEPOWER	26.				
EXIT MACH NUMBER	0.03				
SPECIFIC SPEED	55.25				
SPECIFIC DIAMETER	1.48				
***** * O2 TURBINE * *****		***** * O2 PUMP * *****			
EFFICIENCY (T/T)	0.852	EFFICIENCY	0.747		
EFFICIENCY (T/S)	0.826	HORSEPOWER	522.		
SPEED (RPM)	65070.	SPEED (RPM)	65070.		
HORSEPOWER	522.	SS SPEED	21352.		
MEAN DIA. (IN)	3.13	S SPEED	1888.		
EFF AREA (IN ²)	0.30	HEAD (FT)	4881.		
U/C (ACTUAL)	0.550	DIA. (IN)	2.12		
MAX TIP SPEED	939.	TIP SPEED	602.		
STAGES	2	VOL. FLOW	280.		
GAMMA	1.44	HEAD COEF	0.426		
PRESS RATIO (T/T)	1.13	FLOW COEF	0.157		
PRESS RATIO (T/S)	1.14	DIAMETER RATIO	0.684		
EXIT MACH NUMBER	0.07	BEARING DN	1.43E+06		
SPECIFIC SPEED	43.98	SHAFT DIAMETER	22.00		
SPECIFIC DIAMETER	1.80				

TABLE 37. — SPLIT-EXPANDER ENGINE — 37,500 LBF THRUST (COPPER GROOVED CHAMBER)

ENGINE PERFORMANCE PARAMETERS					

CHAMBER PRESSURE					1465.3
VAC ENGINE THRUST					37500.
TOTAL ENGINE FLOW RATE					78.13
DEL. VAC. ISP					480.0
THROAT AREA					12.51
NOZZLE AREA RATIO					1000.0
NOZZLE EXIT DIAMETER					126.19
ENGINE MIXTURE RATIO					6.00
ETA C*					0.993
CHAMBER COOLANT DP					484.
CHAMBER COOLANT DT					784.
NOZZLE/CHAMBER Q					16332.
ENGINE STATION CONDITIONS					

# FUEL SYSTEM CONDITIONS #					
STATION	PRESS	TEMP	FLOW	ENTHALPY	DENSITY
B.P. INLET	18.6	37.4	11.17	-107.5	4.37
B.P. EXIT	100.8	38.5	11.17	-103.0	4.39
PUMP INLET	100.8	38.5	11.17	-103.0	4.39
1ST STAGE EXIT	2062.7	63.4	11.17	12.4	4.50
JBV INLET	2021.5	63.8	5.59	12.4	4.47
JBV EXIT	1718.2	66.5	5.59	12.4	4.27
2ND STAGE EXIT	3172.9	76.9	5.59	77.0	4.56
PUMP EXIT	4283.4	90.1	5.59	140.8	4.61
COOLANT INLET	4240.4	90.5	5.59	140.8	4.59
COOLANT EXIT	3756.2	874.3	5.59	3064.3	0.73
TBV INLET	3718.6	874.5	0.28	3064.3	0.72
TBV EXIT	1726.8	887.6	0.28	3064.3	0.35
O2 TRB INLET	3718.6	874.5	5.31	3064.3	0.72
O2 TRB EXIT	3257.5	850.4	5.31	2968.4	0.66
H2 TRB INLET	3257.5	850.4	5.31	2968.4	0.66
H2 TRB EXIT	1841.2	752.7	5.31	2590.3	0.43
H2 TRB DIFFUSER	1817.0	752.9	5.31	2590.3	0.43
H2 BST TRB IN	1798.8	752.9	5.31	2590.3	0.43
H2 BST TRB OUT	1772.8	750.4	5.31	2580.7	0.42
H2 BST TRB DIFF	1767.8	750.5	5.31	2580.7	0.42
O2 BST TRB IN	1750.1	750.6	5.31	2580.7	0.42
O2 BST TRB OUT	1734.2	749.2	5.31	2575.6	0.41
O2 BST TRB DIFF	1735.4	749.2	5.31	2575.6	0.41
H2 TANK PRESS	18.6	766.5	0.0117	2600.0	0.0046
GOX HEAT EXCH IN	1726.8	756.2	5.57	2600.0	0.41
GOX HEAT EXCH OUT	1718.1	755.5	5.57	2597.2	0.41
MIXER HOT IN	1718.1	755.5	5.57	2597.2	0.41
MIXER COLD IN	1718.2	66.5	5.59	12.4	4.27
MIXER OUT	1632.2	398.8	11.16	1303.5	0.71
FSOV INLET	1632.2	398.8	11.16	1303.5	0.71
FSOV EXIT	1591.4	398.9	11.16	1303.5	0.70
CHAMBER INJ	1559.0	399.0	11.16	1303.5	0.68
CHAMBER	1465.3				
# OXYGEN SYSTEM CONDITIONS #					
STATION	PRESS	TEMP	FLOW	ENTHALPY	DENSITY
B.P. INLET	16.0	162.7	67.1	61.1	71.17
B.P. EXIT	135.6	163.2	67.1	61.5	71.20
PUMP INLET	135.6	163.2	67.1	61.5	71.20
PUMP EXIT	2373.1	173.2	67.1	69.0	71.70
O2 TANK PRESS	16.0	400.0	0.113	204.7	0.12
OCV INLET	2349.3	173.3	67.0	69.0	71.66
OCV EXIT	1644.5	176.0	67.0	69.0	70.56
CHAMBER INJ	1611.8	176.1	67.0	69.0	70.51
CHAMBER	1465.3				
# VALVE DATA #					
VALVE	DELTA P	AREA	FLOW	% BYPASS	
JBV	303.	0.23	5.59	50.00	
TBV	1992.	0.02	0.28	5.00	
FSOV	41.	5.02	11.16		
OCV	705.	0.45	66.97		
# INJECTOR DATA #					
INJECTOR	DELTA P	AREA	FLOW	VELOCITY	
FUEL	110.	2.08	11.16	1150.27	
LCK	163.	0.99	66.97	138.75	

TABLE 37. — SPLIT-EXPANDER ENGINE — 37,500 LBF THRUST (COPPER GROOVED CHAMBER) (CONTINUED)

***** * TURBOMACHINERY PERFORMANCE DATA * *****			
***** * H2 BOOST TURBINE * *****		***** * H2 BOOST PUMP * *****	
EFFICIENCY (T/T)	0.885	EFFICIENCY	0.765
EFFICIENCY (T/S)	0.703	HORSEPOWER	72.
SPEED (RPM)	33752.	SPEED (RPM)	33752.
MEAN DIA (IN)	2.60	S SPEED	3046.
EFF AREA (IN ²)	2.34	HEAD (FT)	2700.
U/C (ACTUAL)	0.553	DIA. (IN)	2.98
MAX TIP SPEED	465.	TIP SPEED	439.
STAGES	1	VOL. FLOW	1142.
GAMMA	1.39	HEAD COEF	0.450
PRESS RATIO (T/T)	1.01	FLOW COEF	0.201
PRESS RATIO (T/S)	1.02		
HORSEPOWER	72.		
EXIT MACH NUMBER	0.07		
SPECIFIC SPEED	112.18		
SPECIFIC DIAMETER	0.77		
***** * H2 TURBINE * *****		***** * H2 PUMP * *****	
EFFICIENCY (T/T)	0.856	EFFICIENCY	0.704
EFFICIENCY (T/S)	0.832	HORSEPOWER	1824.
SPEED (RPM)	107143.	SPEED (RPM)	107143.
HORSEPOWER	2839.	SS SPEED	11888.
MEAN DIA. (IN)	3.61	S SPEED	897.
EFF AREA (IN ²)	0.34	HEAD (FT)	63208.
U/C (ACTUAL)	0.548	DIA. (IN)	4.17
MAX TIP SPEED	1771.	TIP SPEED	1950.
STAGES	2	VOL. FLOW	1114.
GAMMA	1.39	HEAD COEF	0.535
PRESS RATIO (T/T)	1.77	FLOW COEF	0.104
PRESS RATIO (T/S)	1.80	DIAMETER RATIO	0.364
EXIT MACH NUMBER	0.15	BEARING DN	3.00E+06
SPECIFIC SPEED	41.14	SHAFT DIAMETER	28.00
SPECIFIC DIAMETER	1.92		
***** * O2 BOOST TURBINE * *****		***** * O2 BOOST PUMP * *****	
EFFICIENCY (T/T)	0.876	EFFICIENCY	0.764
EFFICIENCY (T/S)	0.812	HORSEPOWER	39.
SPEED (RPM)	9026.	SPEED (RPM)	9026.
MEAN DIA (IN)	7.12	S SPEED	3026.
EFF AREA (IN ²)	3.24	HEAD (FT)	242.
U/C (ACTUAL)	0.553	DIA. (IN)	3.34
MAX TIP SPEED	301.	TIP SPEED	132.
STAGES	1	VOL. FLOW	423.
GAMMA	1.39	HEAD COEF	0.450
PRESS RATIO (T/T)	1.01	FLOW COEF	0.200
PRESS RATIO (T/S)	1.01		
HORSEPOWER	39.		
EXIT MACH NUMBER	0.03		
SPECIFIC SPEED	53.61		
SPECIFIC DIAMETER	1.53		
***** * O2 TURBINE * *****		***** * O2 PUMP * *****	
EFFICIENCY (T/T)	0.857	EFFICIENCY	0.760
EFFICIENCY (T/S)	0.833	HORSEPOWER	721.
SPEED (RPM)	51439.	SPEED (RPM)	51439.
HORSEPOWER	721.	SS SPEED	20673.
MEAN DIA (IN)	3.61	S SPEED	1921.
EFF AREA (IN ²)	0.44	HEAD (FT)	4492.
U/C (ACTUAL)	0.522	DIA. (IN)	2.58
MAX TIP SPEED	858.	TIP SPEED	579.
STAGES	2	VOL. FLOW	420.
GAMMA	1.39	HEAD COEF	0.431
PRESS RATIO (T/T)	1.14	FLOW COEF	0.159
PRESS RATIO (T/S)	1.15	DIAMETER RATIO	0.685
EXIT MACH NUMBER	0.07	BEARING DN	1.44E+06
SPECIFIC SPEED	44.05	SHAFT DIAMETER	28.00
SPECIFIC DIAMETER	1.72		

TABLE 38. — SPLIT-EXPANDER ENGINE — 50,000 LBF THRUST (COPPER GROOVED CHAMBER)

ENGINE PERFORMANCE PARAMETERS					

CHAMBER PRESSURE					1406.6
VAC ENGINE THRUST					50000.
TOTAL ENGINE FLOW RATE					104.18
DEL. VAC. ISP					480.0
THROAT AREA					17.36
NOZZLE AREA RATIO					1000.0
NOZZLE EXIT DIAMETER					148.69
ENGINE MIXTURE RATIO					6.00
ETA C*					0.993
CHAMBER COOLANT DP					448.
CHAMBER COOLANT DT					716.
NOZZLE/CHAMBER Q					19957.
ENGINE STATION CONDITIONS					

# FUEL SYSTEM CONDITIONS #					
STATION	PRESS	TEMP	FLOW	ENTHALPY	DENSITY
B.P. INLET	18.6	37.4	14.90	-107.5	4.37
B.P. EXIT	101.0	38.5	14.90	-103.0	4.39
PUMP INLET	101.0	38.5	14.90	-103.0	4.39
1ST STAGE EXIT	1980.1	60.7	14.90	3.1	4.54
JBV INLET	1940.5	61.1	7.45	3.0	4.52
JBV EXIT	1649.4	63.7	7.45	3.0	4.32
2ND STAGE EXIT	3033.6	72.5	7.45	61.7	4.61
PUMP EXIT	4094.4	84.2	7.45	119.9	4.67
COOLANT INLET	4053.4	84.6	7.45	119.9	4.65
COOLANT EXIT	3605.8	800.5	7.45	2798.8	0.77
TBV INLET	3569.7	800.7	0.37	2798.8	0.76
TBV EXIT	1658.4	812.8	0.37	2798.8	0.37
O2 TRB INLET	3569.7	800.7	7.08	2798.8	0.76
O2 TRB EXIT	3110.4	778.1	7.08	2708.0	0.69
H2 TRB INLET	3110.4	778.1	7.08	2708.0	0.69
H2 TRB EXIT	1775.1	688.3	7.08	2361.8	0.46
H2 TRB DIFFUSER	1748.7	688.4	7.08	2361.8	0.45
H2 BST TRB IN	1731.2	688.4	7.08	2361.8	0.45
H2 BST TRB OUT	1704.0	685.9	7.08	2352.2	0.44
H2 BST TRB DIFF	1699.0	686.0	7.08	2352.2	0.44
O2 BST TRB IN	1682.0	686.1	7.08	2352.2	0.44
O2 BST TRB OUT	1667.6	684.7	7.08	2347.1	0.44
O2 BST TRB DIFF	1666.7	684.7	7.08	2347.1	0.43
H2 TANK PRESS	18.6	700.4	0.0171	2369.7	0.0050
GOX HEAT EXCH IN	1658.4	691.2	7.43	2369.7	0.43
GOX HEAT EXCH OUT	1650.1	690.4	7.43	2366.9	0.43
MIXER HOT IN	1650.1	690.4	7.43	2366.9	0.43
MIXER COLD IN	1649.4	63.7	7.45	3.0	4.32
MIXER OUT	1567.6	368.3	14.88	1183.6	0.74
FSOV INLET	1567.6	368.3	14.88	1183.6	0.74
FSOV EXIT	1528.4	368.3	14.88	1183.6	0.72
CHAMBER INJ	1497.2	368.4	14.88	1183.6	0.71
CHAMBER	1406.6				
# OXYGEN SYSTEM CONDITIONS #					
STATION	PRESS	TEMP	FLOW	ENTHALPY	DENSITY
B.P. INLET	16.0	162.7	89.4	61.1	71.17
B.P. EXIT	135.6	163.2	89.4	61.5	71.20
PUMP INLET	135.6	163.2	89.4	61.5	71.20
PUMP EXIT	2278.1	172.6	89.4	68.6	71.71
O2 TANK PRESS	16.0	400.0	0.151	204.7	0.12
OCV INLET	2255.3	172.7	89.3	68.6	71.67
OCV EXIT	1578.7	175.3	89.3	68.6	70.62
CHAMBER INJ	1547.3	175.4	89.3	68.6	70.57
CHAMBER	1406.6				
# VALVE DATA #					
VALVE	DELTA P	AREA	FLOW	% BYPASS	
JBV	291.	0.31	7.45	50.00	
TBV	1911.	0.02	0.37	5.00	
FSOV	39.	4.03	14.88		
OCV	677.	0.61	89.29		
# INJECTOR DATA #					
INJECTOR	DELTA P	AREA	FLOW	VELOCITY	
FUEL	106.	2.77	14.88	1092.16	
LOX	156.	1.34	89.29	135.89	

TABLE 38. — SPLIT-EXPANDER ENGINE — 50,000 LBF THRUST (COPPER GROOVED CHAMBER) (CONTINUED)

*****		*****	
# H2 BOOST TURBINE #		# H2 BOOST PUMP #	
*****		*****	
EFFICIENCY (T/T)	0.894	EFFICIENCY	0.765
EFFICIENCY (T/S)	0.716	HORSEPOWER	96.
SPEED (RPM)	29253.	SPEED (RPM)	29253.
MEAN DIA (IN)	3.00	S SPEED	3044.
EFF AREA (IN2)	2.98	HEAD (FT)	2705.
U/C (ACTUAL)	0.553	DIA. (IN)	3.44
MAX TIP SPEED	464.	TIP SPEED	440.
STAGES	1	VOL. FLOW	1523.
GAMMA	1.39	HEAD COEF	0.450
PRESS RATIO (T/T)	1.02	FLOW COEF	0.201
PRESS RATIO (T/S)	1.02		
HORSEPOWER	96.		
EXIT MACH NUMBER	0.07		
SPECIFIC SPEED	110.80		
SPECIFIC DIAMETER	0.78		
*****		*****	
# H2 TURBINE #		# H2 PUMP #	
*****		*****	
		STAGE ONE	STAGE TWO STAGE THREE
EFFICIENCY (T/T)	0.871	EFFICIENCY	0.729 0.727 0.726
EFFICIENCY (T/S)	0.843	HORSEPOWER	2235. 618. 614.
SPEED (RPM)	100000.	SPEED (RPM)	100000. 100000. 100000.
HORSEPOWER	3466.	SS SPEED	12796.
MEAN DIA. (IN)	3.71	S SPEED	999. 1097. 1095.
EFF AREA (IN2)	0.45	HEAD (FT)	60136. 53143. 32916.
U/C (ACTUAL)	0.550	DIA. (IN)	4.39 3.33 3.33
MAX TIP SPEED	1715.	TIP SPEED	1917. 1455. 1455.
STAGES	2	VOL. FLOW	1472. 726. 716.
GAMMA	1.39	HEAD COEF	0.527 0.504 0.501
PRESS RATIO (T/T)	1.75	FLOW COEF	0.110
PRESS RATIO (T/S)	1.79	DIAMETER RATIO	0.395
EXIT MACH NUMBER	0.16	BEARING DN	3.00E+06
SPECIFIC SPEED	46.46	SHAFT DIAMETER	30.00
SPECIFIC DIAMETER	1.73		
*****		*****	
# O2 BOOST TURBINE #		# O2 BOOST PUMP #	
*****		*****	
EFFICIENCY (T/T)	0.882	EFFICIENCY	0.764
EFFICIENCY (T/S)	0.819	HORSEPOWER	51.
SPEED (RPM)	7816.	SPEED (RPM)	7816.
MEAN DIA (IN)	8.22	S SPEED	3026.
EFF AREA (IN2)	4.12	HEAD (FT)	242.
U/C (ACTUAL)	0.553	DIA. (IN)	3.85
MAX TIP SPEED	300.	TIP SPEED	132.
STAGES	1	VOL. FLOW	564.
GAMMA	1.39	HEAD COEF	0.450
PRESS RATIO (T/T)	1.01	FLOW COEF	0.200
PRESS RATIO (T/S)	1.01		
HORSEPOWER	51.		
EXIT MACH NUMBER	0.03		
SPECIFIC SPEED	52.65		
SPECIFIC DIAMETER	1.56		
*****		*****	
# O2 TURBINE #		# O2 PUMP #	
*****		*****	
EFFICIENCY (T/T)	0.853	EFFICIENCY	0.769
EFFICIENCY (T/S)	0.827	HORSEPOWER	910.
SPEED (RPM)	43615.	SPEED (RPM)	43615.
HORSEPOWER	910.	SS SPEED	20241.
MEAN DIA (IN)	3.71	S SPEED	1943.
EFF AREA (IN2)	0.58	HEAD (FT)	4300.
U/C (ACTUAL)	0.468	DIA. (IN)	2.97
MAX TIP SPEED	756.	TIP SPEED	565.
STAGES	2	VOL. FLOW	560.
GAMMA	1.39	HEAD COEF	0.434
PRESS RATIO (T/T)	1.15	FLOW COEF	0.160
PRESS RATIO (T/S)	1.15	DIAMETER RATIO	0.686
EXIT MACH NUMBER	0.07	BEARING DN	1.31E+06
SPECIFIC SPEED	43.45	SHAFT DIAMETER	30.00
SPECIFIC DIAMETER	1.57		

TABLE 39. — DUAL-EXPANDER ENGINE — 7500 LBF THRUST (COPPER GROOVED CHAMBER)

ENGINE PERFORMANCE PARAMETERS	
CHAMBER PRESSURE	1300.3
VAC ENGINE THRUST	7500.
TOTAL ENGINE FLOW RATE	15.63
DEL. VAC. ISP	479.9
THROAT AREA	2.82
NOZZLE AREA RATIO	1000.0
NOZZLE EXIT DIAMETER	59.88
ENGINE MIXTURE RATIO	6.00
ETA C*	0.993
CHAMBER COOLANT DP	407.
CHAMBER COOLANT DT	439.
NOZZLE COOLANT DP	184.
NOZZLE COOLANT DT	524.
CHAMBER Q (HYDROGEN COOLED)	3787.
NOZZLE Q (OXYGEN COOLED)	2435.

ENGINE STATION CONDITIONS					
# FUEL SYSTEM CONDITIONS #					
STATION	PRESS	TEMP	FLOW	ENTHALPY	DENSITY
B.P. INLET	18.6	37.4	2.24	-107.5	4.37
B.P. EXIT	101.1	38.5	2.24	-103.0	4.39
PUMP INLET	101.1	38.5	2.24	-103.0	4.39
1ST STAGE EXIT	1732.7	65.0	2.24	8.6	4.32
PUMP EXIT	3311.8	89.8	2.24	116.4	4.31
COOLANT INLET	3278.7	90.0	2.24	116.4	4.30
COOLANT EXIT	2871.6	529.5	2.24	1809.9	0.91
TBV INLET	2842.9	529.6	0.11	1809.9	0.90
TBV EXIT	1448.4	535.9	0.11	1809.9	0.48
H2 TRB INLET	2842.9	529.6	2.12	1809.9	0.90
H2 TRB EXIT	1532.4	472.1	2.12	1579.0	0.57
H2 TRB DIFFUSER	1499.6	472.2	2.12	1579.0	0.56
H2 BST TRB IN	1484.6	472.2	2.12	1579.0	0.56
H2 BST TRB OUT	1463.1	471.0	2.12	1574.2	0.55
H2 BST TRB DIFF	1448.4	471.1	2.12	1574.2	0.54
H2 TANK PRESS	18.6	479.0	0.0037	1586.0	0.0073
FSOV INLET	1448.4	474.2	2.23	1586.0	0.54
FSOV EXIT	1412.2	474.4	2.23	1586.0	0.53
CHAMBER INJ	1383.4	474.5	2.23	1586.0	0.52
CHAMBER	1300.3				

# OXYGEN SYSTEM CONDITIONS #					
STATION	PRESS	TEMP	FLOW	ENTHALPY	DENSITY
B.P. INLET	16.0	162.7	13.4	61.1	71.17
B.P. EXIT	135.6	163.2	13.4	61.5	71.20
PUMP INLET	135.6	163.2	13.4	61.5	71.20
PUMP EXIT	4749.6	187.8	13.4	78.7	71.57
COOLANT INLET	4702.1	188.0	13.4	78.7	71.50
COOLANT EXIT	4518.5	711.9	13.4	260.2	17.66
OTBV INLET	4518.5	711.9	0.6	260.2	17.66
OTBV EXIT	2194.9	690.5	0.6	260.2	9.39
O2 TRB INLET	4518.5	711.9	11.5	260.2	17.66
O2 TRB EXIT	2397.7	615.6	11.5	240.1	11.77
O2 TRB DIFFUSER	2194.9	612.3	11.5	240.1	10.87
O2 BST TRB IN	4518.5	711.9	1.3	260.2	17.66
O2 BST TRB OUT	4485.7	697.0	1.3	256.1	18.01
O2 BST TRB DIFF	4484.3	697.0	1.3	256.1	18.00
OBTV INLET	4484.3	697.0	1.3	256.1	18.00
OBTV EXIT	2194.9	674.5	1.3	256.1	9.66
MIXER	2194.9	622.0	13.4	242.6	10.66
O2 TANK PRESS	16.0	572.9	0.016	242.6	0.08
OCV INLET	2085.2	620.2	13.4	242.6	10.18
OCV EXIT	1459.6	608.7	13.4	242.6	7.29
CHAMBER INJ	1430.6	608.1	13.4	242.6	7.16
CHAMBER	1300.3				

# VALVE DATA #				
VALVE	DELTA P	AREA	FLOW	% BYPASS
OTBV	2324.	0.01	0.60	5.00
TBV	1394.	0.01	0.11	5.00
FSOV	36.	0.74	2.23	
OBTV	2289.	0.01	1.34	
OCV	624.	0.25	13.39	

# INJECTOR DATA #				
INJECTOR	DELTA P	AREA	FLOW	VELOCITY
FUEL	98.	0.51	2.23	1217.82
LOX	145.	0.66	13.39	410.59

TABLE 39. — DUAL-EXPANDER ENGINE — 7500 LBF THRUST (COPPER GROOVED CHAMBER) (CONTINUED)

*****		*****	
* TURBOMACHINERY PERFORMANCE DATA *			
*****		*****	
* H2 BOOST TURBINE *		* H2 BOOST PUMP *	
*****		*****	
EFFICIENCY (T/T)	0.708	EFFICIENCY	0.765
EFFICIENCY (T/S)	0.368	HORSEPOWER	14.
SPEED (RPM)	75548.	SPEED (RPM)	75548.
MEAN DIA (IN)	0.82	S SPEED	3043.
EFF AREA (IN2)	0.90	HEAD (FT)	2708.
U/C (ACTUAL)	0.553	DIA. (IN)	1.33
MAX TIP SPEED	392.	TIP SPEED	440.
STAGES	1	VOL. FLOW	229.
GAMMA	1.40	HEAD COEF	0.450
PRESS RATIO (T/T)	1.01	FLOW COEF	0.201
PRESS RATIO (T/S)	1.03		
HORSEPOWER	14.		
EXIT MACH NUMBER	0.12		
SPECIFIC SPEED	143.69		
SPECIFIC DIAMETER	0.52		
*****		*****	
* H2 TURBINE *		* H2 PUMP *	
*****		*****	
		STAGE ONE	STAGE TWO
		*****	*****
EFFICIENCY (T/T)	0.781	EFFICIENCY	0.623
EFFICIENCY (T/S)	0.749	HORSEPOWER	353.
SPEED (RPM)	187500.	SPEED (RPM)	187500.
HORSEPOWER	694.	SS SPEED	9288.
MEAN DIA. (IN)	2.22	S SPEED	805.
EFF AREA (IN2)	0.12	HEAD (FT)	54135.
U/C (ACTUAL)	0.535	DIA. (IN)	2.24
MAX TIP SPEED	1890.	TIP SPEED	1834.
STAGES	1	VOL. FLOW	232.
GAMMA	1.40	HEAD COEF	0.518
PRESS RATIO (T/T)	1.86	FLOW COEF	0.097
PRESS RATIO (T/S)	1.91	DIAMETER RATIO	0.329
EXIT MACH NUMBER	0.18	BEARING DN	1.00E+06
SPECIFIC SPEED	32.34	SHAFT DIAMETER	16.00
SPECIFIC DIAMETER	2.28		
*****		*****	
* O2 BOOST TURBINE *		* O2 BOOST PUMP *	
*****		*****	
EFFICIENCY (T/T)	0.797	EFFICIENCY	0.764
EFFICIENCY (T/S)	0.752	HORSEPOWER	8.
SPEED (RPM)	20187.	SPEED (RPM)	20187.
MEAN DIA (IN)	2.83	S SPEED	3026.
EFF AREA (IN2)	0.08	HEAD (FT)	242.
U/C (ACTUAL)	0.553	DIA. (IN)	1.49
MAX TIP SPEED	263.	TIP SPEED	132.
STAGES	1	VOL. FLOW	85.
GAMMA	1.63	HEAD COEF	0.450
PRESS RATIO (T/T)	1.01	FLOW COEF	0.200
PRESS RATIO (T/S)	1.01		
HORSEPOWER	8.		
EXIT MACH NUMBER	0.02		
SPECIFIC SPEED	41.09		
SPECIFIC DIAMETER	1.88		
*****		*****	
* O2 TURBINE *		* O2 PUMP *	
*****		*****	
EFFICIENCY (T/T)	0.811	EFFICIENCY	0.693
EFFICIENCY (T/S)	0.697	HORSEPOWER	326.
SPEED (RPM)	154919.	SPEED (RPM)	154919.
HORSEPOWER	326.	SS SPEED	27838.
MEAN DIA (IN)	0.82	S SPEED	1502.
EFF AREA (IN2)	0.12	HEAD (FT)	9282.
U/C (ACTUAL)	0.553	DIA. (IN)	1.22
MAX TIP SPEED	640.	TIP SPEED	826.
STAGES	1	VOL. FLOW	84.
GAMMA	1.63	HEAD COEF	0.438
PRESS RATIO (T/T)	1.88	FLOW COEF	0.139
PRESS RATIO (T/S)	2.12	DIAMETER RATIO	0.669
EXIT MACH NUMBER	0.34	BEARING DN	1.55E+06
SPECIFIC SPEED	85.40	SHAFT DIAMETER	10.00
SPECIFIC DIAMETER	0.95		

TABLE 40. — DUAL-EXPANDER ENGINE — 15,000 LBF THRUST (COPPER GROOVED CHAMBER)

ENGINE PERFORMANCE PARAMETERS					

CHAMBER PRESSURE					1140.6
VAC ENGINE THRUST					15000.
TOTAL ENGINE FLOW RATE					31.24
DEL. VAC. ISP					479.9
THROAT AREA					6.41
NOZZLE AREA RATIO					1000.0
NOZZLE EXIT DIAMETER					90.37
ENGINE MIXTURE RATIO					6.00
ETA C*					0.993
CHAMBER COOLANT DP					368.
CHAMBER COOLANT DT					356.
NOZZLE COOLANT DP					203.
NOZZLE COOLANT DT					404.
CHAMBER Q (HYDROGEN COOLED)					6150.
NOZZLE Q (OXYGEN COOLED)					3986.

ENGINE STATION CONDITIONS					

# FUEL SYSTEM CONDITIONS #					
STATION	PRESS	TEMP	FLOW	ENTHALPY	DENSITY
B.P. INLET	18.6	57.4	4.47	-107.5	4.37
B.P. EXIT	100.8	38.5	4.47	-103.0	4.39
PUMP INLET	100.8	38.5	4.47	-103.0	4.39
1ST STAGE EXIT	1374.1	55.4	4.47	-26.5	4.45
PUMP EXIT	2646.2	71.6	4.47	49.2	4.50
COOLANT INLET	2619.7	71.9	4.47	49.2	4.49
COOLANT EXIT	2252.2	428.0	4.47	1423.6	0.89
TBV INLET	2229.7	428.1	0.22	1423.6	0.88
TBV EXIT	1270.6	431.0	0.22	1423.6	0.52
H2 TRB INLET	2229.7	428.1	4.25	1423.6	0.88
H2 TRB EXIT	1353.4	389.1	4.25	1263.4	0.61
H2 TRB DIFFUSER	1319.9	389.2	4.25	1263.4	0.60
H2 BST TRB IN	1306.7	389.2	4.25	1263.4	0.60
H2 BST TRB OUT	1284.9	388.1	4.25	1258.6	0.59
H2 BST TRB DIFF	1270.6	388.1	4.25	1258.6	0.58
H2 TANK PRESS	18.6	392.3	0.0092	1266.9	0.0089
FSOV INLET	1270.6	390.2	4.47	1266.9	0.58
FSOV EXIT	1238.8	390.3	4.47	1266.9	0.56
CHAMBER INJ	1213.6	390.3	4.47	1266.9	0.55
CHAMBER	1140.6				

# OXYGEN SYSTEM CONDITIONS #					
STATION	PRESS	TEMP	FLOW	ENTHALPY	DENSITY
B.P. INLET	16.0	162.7	26.8	61.1	71.17
B.P. EXIT	135.6	163.2	26.8	61.5	71.20
PUMP INLET	135.6	163.2	26.8	61.5	71.20
PUMP EXIT	4682.5	185.7	26.8	77.7	71.82
COOLANT INLET	4635.7	185.9	26.8	77.7	71.75
COOLANT EXIT	4433.1	590.2	26.8	226.3	21.91
OTBV INLET	4433.1	590.2	1.2	226.3	21.91
OTBV EXIT	1925.5	554.6	1.2	226.3	10.85
O2 TRB INLET	4433.1	590.2	22.9	226.3	21.91
O2 TRB EXIT	2131.5	491.8	22.9	207.3	14.35
O2 TRB DIFFUSER	1925.5	486.6	22.9	207.3	13.12
O2 BST TRB IN	4433.1	590.2	2.7	226.3	21.91
O2 BST TRB OUT	4394.8	576.2	2.7	222.2	22.45
O2 BST TRB DIFF	4393.2	576.2	2.7	222.2	22.44
OBTV INLET	4393.2	576.2	2.7	222.2	22.44
OBTV EXIT	1925.5	539.7	2.7	222.2	11.26
MIXER	1925.5	494.9	26.8	209.6	12.76
O2 TANK PRESS	16.0	422.3	0.043	209.6	0.11
OCV INLET	1829.3	492.3	26.8	209.6	12.19
OCV EXIT	1280.5	476.2	26.8	209.6	8.77
CHAMBER INJ	1255.0	475.3	26.8	209.6	8.60
CHAMBER	1140.6				

# VALVE DATA #				
VALVE	DELTA P	AREA	FLOW	% BYPASS
OTBV	2508.	0.01	1.21	5.00
TBV	959.	0.01	0.22	5.00
FSOV	32.	1.54	4.47	
OBTV	2468.	0.02	2.68	
OCV	549.	0.49	26.79	

# INJECTOR DATA #				
INJECTOR	DELTA P	AREA	FLOW	VELOCITY
FUEL	86.	1.06	4.47	1100.17
LOX	127.	1.28	26.79	350.97

TABLE 40. — DUAL-EXPANDER ENGINE — 15,000 LBF THRUST (COPPER GROOVED CHAMBER) (CONTINUED)

***** * TURBOMACHINERY PERFORMANCE DATA * *****		
***** * H2 BOOST TURBINE * *****	***** * H2 BOOST PUMP * *****	
EFFICIENCY (T/T) 0.742	EFFICIENCY 0.765	
EFFICIENCY (T/S) 0.394	HORSEPOWER 29.	
SPEED (RPM) 53348.	SPEED (RPM) 53348.	
MEAN DIA (IN) 1.16	S SPEED 3045.	
EFF AREA (IN2) 1.73	HEAD (FT) 2702.	
U/C (ACTUAL) 0.553	DIA. (IN) 1.89	
MAX TIP SPEED 389.	TIP SPEED 439.	
STAGES 1	VOL. FLOW 458.	
GAMMA 1.38	HEAD COEF 0.450	
PRESS RATIO (T/T) 1.02	FLOW COEF 0.201	
PRESS RATIO (T/S) 1.03		
HORSEPOWER 29.		
EXIT MACH NUMBER 0.13		
SPECIFIC SPEED 146.46		
SPECIFIC DIAMETER 0.52		
***** * H2 TURBINE * *****	***** * H2 PUMP * *****	
EFFICIENCY (T/T) 0.815	STAGE ONE 0.695	STAGE TWO 0.695
EFFICIENCY (T/S) 0.767	HORSEPOWER 485.	479.
SPEED (RPM) 136363.	SPEED (RPM) 136363.	136363.
HORSEPOWER 964.	SS SPEED 9571.	
MEAN DIA. (IN) 2.63	S SPEED 999.	1001.
EFF AREA (IN2) 0.29	HEAD (FT) 41375.	40897.
U/C (ACTUAL) 0.553	DIA. (IN) 2.71	2.71
MAX TIP SPEED 1653.	TIP SPEED 1612.	1612.
STAGES 1	VOL. FLOW 452.	446.
GAMMA 1.38	HEAD COEF 0.512	0.506
PRESS RATIO (T/T) 1.65	FLOW COEF 0.110	
PRESS RATIO (T/S) 1.70	DIAMETER RATIO 0.381	
EXIT MACH NUMBER 0.20	BEARING DN 3.00E+06	
SPECIFIC SPEED 43.19	SHAFT DIAMETER 22.00	
SPECIFIC DIAMETER 1.81		
***** * O2 BOOST TURBINE * *****	***** * O2 BOOST PUMP * *****	
EFFICIENCY (T/T) 0.808	EFFICIENCY 0.764	
EFFICIENCY (T/S) 0.765	HORSEPOWER 15.	
SPEED (RPM) 14271.	SPEED (RPM) 14271.	
MEAN DIA (IN) 4.01	S SPEED 3026.	
EFF AREA (IN2) 0.14	HEAD (FT) 242.	
U/C (ACTUAL) 0.553	DIA. (IN) 2.11	
MAX TIP SPEED 261.	TIP SPEED 132.	
STAGES 1	VOL. FLOW 169.	
GAMMA 1.78	HEAD COEF 0.450	
PRESS RATIO (T/T) 1.01	FLOW COEF 0.200	
PRESS RATIO (T/S) 1.01		
HORSEPOWER 15.		
EXIT MACH NUMBER 0.02		
SPECIFIC SPEED 38.28		
SPECIFIC DIAMETER 2.02		
***** * O2 TURBINE * *****	***** * O2 PUMP * *****	
EFFICIENCY (T/T) 0.829	EFFICIENCY 0.720	
EFFICIENCY (T/S) 0.718	HORSEPOWER 618.	
SPEED (RPM) 107453.	SPEED (RPM) 107453.	
HORSEPOWER 618.	SS SPEED 27313.	
MEAN DIA (IN) 1.15	S SPEED 1492.	
EFF AREA (IN2) 0.21	HEAD (FT) 9114.	
U/C (ACTUAL) 0.553	DIA. (IN) 1.72	
MAX TIP SPEED 619.	TIP SPEED 807.	
STAGES 1	VOL. FLOW 168.	
GAMMA 1.78	HEAD COEF 0.450	
PRESS RATIO (T/T) 2.08	FLOW COEF 0.138	
PRESS RATIO (T/S) 2.39	DIAMETER RATIO 0.671	
EXIT MACH NUMBER 0.35	BEARING DN 1.50E+06	
SPECIFIC SPEED 83.84	SHAFT DIAMETER 14.00	
SPECIFIC DIAMETER 0.98		

TABLE 41. — DUAL-EXPANDER ENGINE — 25,000 LBF THRUST (COPPER GROOVED CHAMBER)

ENGINE PERFORMANCE PARAMETERS					

CHAMBER PRESSURE					1108.7
VAC ENGINE THRUST					25000.
TOTAL ENGINE FLOW RATE					52.10
DEL. VAC. ISP					479.9
THROAT AREA					11.00
NOZZLE AREA RATIO					1000.0
NOZZLE EXIT DIAMETER					118.33
ENGINE MIXTURE RATIO					6.00
ETA C*					0.993
CHAMBER COOLANT DP					308.
CHAMBER COOLANT DT					317.
NOZZLE COOLANT DP					222.
NOZZLE COOLANT DT					351.
CHAMBER Q (HYDROGEN COOLED)					9095.
NOZZLE Q (OXYGEN COOLED)					5893.
ENGINE STATION CONDITIONS					

# FUEL SYSTEM CONDITIONS #					
STATION	PRESS	TEMP	FLOW	ENTHALPY	DENSITY
B.P. INLET	18.6	37.4	7.46	-107.5	4.37
B.P. EXIT	100.5	38.5	7.46	-103.0	4.39
PUMP INLET	100.5	38.5	7.46	-103.0	4.39
1ST STAGE EXIT	1234.6	51.8	7.46	-39.5	4.50
PUMP EXIT	2386.6	64.6	7.46	23.9	4.59
COOLANT INLET	2362.7	64.8	7.46	23.9	4.57
COOLANT EXIT	2055.1	382.3	7.46	1243.2	0.91
TBV INLET	2034.6	382.4	0.37	1243.2	0.91
TBV EXIT	1235.1	384.2	0.37	1243.2	0.57
H2 TRB INLET	2034.6	382.4	7.09	1243.2	0.91
H2 TRB EXIT	1321.6	350.2	7.09	1109.6	0.67
H2 TRB DIFFUSER	1282.5	350.2	7.09	1109.6	0.65
H2 BST TRB IN	1269.4	350.2	7.09	1109.6	0.65
H2 BST TRB OUT	1248.5	349.1	7.09	1104.8	0.63
H2 BST TRB DIFF	1235.1	349.1	7.09	1104.8	0.63
H2 TANK PRESS	18.6	351.6	0.0171	1111.7	0.0100
FSOV INLET	1235.1	350.8	7.44	1111.7	0.62
FSOV EXIT	1204.2	350.9	7.44	1111.7	0.61
CHAMBER INJ	1179.7	350.9	7.44	1111.7	0.60
CHAMBER	1108.7				
# OXYGEN SYSTEM CONDITIONS #					
STATION	PRESS	TEMP	FLOW	ENTHALPY	DENSITY
B.P. INLET	16.0	162.7	44.7	61.1	71.17
B.P. EXIT	135.6	163.2	44.7	61.5	71.20
PUMP INLET	135.6	163.2	44.7	61.5	71.20
PUMP EXIT	4859.1	185.5	44.7	77.9	71.99
COOLANT INLET	4810.5	185.7	44.7	77.9	71.92
COOLANT EXIT	4589.0	537.0	44.7	209.7	25.58
OTBV INLET	4589.0	537.0	2.0	209.7	25.58
OTBV EXIT	1871.0	495.6	2.0	209.7	12.43
O2 TRB INLET	4589.0	537.0	38.3	209.7	25.58
O2 TRB EXIT	2078.1	436.8	38.3	190.4	17.06
O2 TRB DIFFUSER	1871.0	430.5	38.3	190.4	15.62
O2 BST TRB IN	4589.0	537.0	4.5	209.7	25.58
O2 BST TRB OUT	4547.3	523.7	4.5	205.6	26.34
O2 BST TRB DIFF	4545.7	523.7	4.5	205.6	26.33
OBTV INLET	4545.7	523.7	4.5	205.6	26.33
OBTV EXIT	1871.0	479.4	4.5	205.6	13.05
MIXER	1871.0	437.7	44.7	192.8	15.15
O2 TANK PRESS	16.0	345.2	0.087	192.8	0.14
OCV INLET	1777.5	434.7	44.7	192.8	14.49
OCV EXIT	1244.2	415.1	44.7	192.8	10.50
CHAMBER INJ	1219.5	414.0	44.7	192.8	10.31
CHAMBER	1108.7				
# VALVE DATA #					
VALVE	DELTA P	AREA	FLOW	% BYPASS	
OTBV	2718.	0.02	2.01	5.00	
TBV	799.	0.03	0.37	5.00	
FSOV	31.	2.50	7.44		
OBTV	2675.	0.04	4.47		
OCV	533.	0.76	44.66		
# INJECTOR DATA #					
INJECTOR	DELTA P	AREA	FLOW	VELOCITY	
FUEL	84.	1.72	7.44	1043.94	
LOX	123.	1.98	44.66	315.55	

TABLE 41. — DUAL-EXPANDER ENGINE — 25,000 LBF THRUST (COPPER GROOVED CHAMBER) (CONTINUED)

***** # TURBOMACHINERY PERFORMANCE DATA # *****			
***** # H2 BOOST TURBINE # *****		***** # H2 BOOST PUMP # *****	
EFFICIENCY (T/T)	0.821	EFFICIENCY	0.766
EFFICIENCY (T/S)	0.443	HORSEPOWER	48.
SPEED (RPM)	41232.	SPEED (RPM)	41232.
MEAN DIA (IN)	1.46	S SPEED	3049.
EFF AREA (IN2)	2.82	HEAD (FT)	2690.
U/C (ACTUAL)	0.537	DIA. (IN)	2.44
MAX TIP SPEED	376.	TIP SPEED	439.
STAGES	1	VOL. FLOW	763.
GAMMA	1.36	HEAD COEF	0.450
PRESS RATIO (T/T)	1.02	FLOW COEF	0.201
PRESS RATIO (T/S)	1.03		
HORSEPOWER	48.		
EXIT MACH NUMBER	0.13		
SPECIFIC SPEED	150.00		
SPECIFIC DIAMETER	0.52		

***** # H2 TURBINE # *****		***** # H2 PUMP # *****	
EFFICIENCY (T/T)	0.870	EFFICIENCY	0.740
EFFICIENCY (T/S)	0.800	HORSEPOWER	670.
SPEED (RPM)	125000.	SPEED (RPM)	125000.
HORSEPOWER	1340.	SS SPEED	11364.
MEAN DIA. (IN)	2.62	S SPEED	1290.
EFF AREA (IN2)	0.51	HEAD (FT)	36570.
U/C (ACTUAL)	0.553	DIA. (IN)	2.85
MAX TIP SPEED	1549.	TIP SPEED	1556.
STAGES	1	VOL. FLOW	744.
GAMMA	1.36	HEAD COEF	0.486
PRESS RATIO (T/T)	1.54	FLOW COEF	0.128
PRESS RATIO (T/S)	1.60	DIAMETER RATIO	0.442
EXIT MACH NUMBER	0.23	BEARING DN	3.00E+06
SPECIFIC SPEED	58.33	SHAFT DIAMETER	24.00
SPECIFIC DIAMETER	1.41		

***** # O2 BOOST TURBINE # *****		***** # O2 BOOST PUMP # *****	
EFFICIENCY (T/T)	0.844	EFFICIENCY	0.764
EFFICIENCY (T/S)	0.802	HORSEPOWER	26.
SPEED (RPM)	11052.	SPEED (RPM)	11052.
MEAN DIA (IN)	5.17	S SPEED	3026.
EFF AREA (IN2)	0.21	HEAD (FT)	242.
U/C (ACTUAL)	0.553	DIA. (IN)	2.72
MAX TIP SPEED	240.	TIP SPEED	132.
STAGES	1	VOL. FLOW	282.
GAMMA	1.91	HEAD COEF	0.450
PRESS RATIO (T/T)	1.01	FLOW COEF	0.200
PRESS RATIO (T/S)	1.01		
HORSEPOWER	26.		
EXIT MACH NUMBER	0.02		
SPECIFIC SPEED	37.16		
SPECIFIC DIAMETER	2.13		

***** # O2 TURBINE # *****		***** # O2 PUMP # *****	
EFFICIENCY (T/T)	0.877	EFFICIENCY	0.736
EFFICIENCY (T/S)	0.767	HORSEPOWER	1044.
SPEED (RPM)	83640.	SPEED (RPM)	83640.
HORSEPOWER	1044.	SS SPEED	27451.
MEAN DIA (IN)	1.49	S SPEED	1458.
EFF AREA (IN2)	0.31	HEAD (FT)	9445.
U/C (ACTUAL)	0.553	DIA. (IN)	2.22
MAX TIP SPEED	417.	TIP SPEED	812.
STAGES	1	VOL. FLOW	279.
GAMMA	1.91	HEAD COEF	0.461
PRESS RATIO (T/T)	2.21	FLOW COEF	0.137
PRESS RATIO (T/S)	2.55	DIAMETER RATIO	0.670
EXIT MACH NUMBER	0.36	BEARING DN	1.51E+06
SPECIFIC SPEED	81.81	SHAFT DIAMETER	18.00
SPECIFIC DIAMETER	1.03		

TABLE 42. — DUAL-EXPANDER ENGINE — 37,500 LBF THRUST (COPPER GROOVED CHAMBER)

ENGINE PERFORMANCE PARAMETERS

CHAMBER PRESSURE	1049.9
VAC ENGINE THRUST	37500.
TOTAL ENGINE FLOW RATE	78.15
DEL. VAC. ISP	479.8
THROAT AREA	17.41
NOZZLE AREA RATIO	1000.0
NOZZLE EXIT DIAMETER	148.89
ENGINE MIXTURE RATIO	6.00
ETA C*	0.993
CHAMBER COOLANT DP	263.
CHAMBER COOLANT DT	294.
NOZZLE COOLANT DP	233.
NOZZLE COOLANT DT	315.
CHAMBER Q (HYDROGEN COOLED)	12400.
NOZZLE Q (OXYGEN COOLED)	8113.

ENGINE STATION CONDITIONS

* FUEL SYSTEM CONDITIONS *					
STATION	PRESS	TEMP	FLOW	ENTHALPY	DENSITY
B.P. INLET	18.6	37.4	11.19	-107.5	4.37
B.P. EXIT	100.4	38.5	11.19	-103.0	4.39
PUMP INLET	100.4	38.5	11.19	-103.0	4.39
1ST STAGE EXIT	1134.6	49.9	11.19	-46.7	4.51
PUMP EXIT	2192.1	61.1	11.19	9.8	4.61
COOLANT INLET	2170.2	61.3	11.19	9.8	4.59
COOLANT EXIT	1907.1	355.7	11.19	1135.6	0.92
TBV INLET	1888.1	355.7	0.56	1135.6	0.91
TBV EXIT	1169.7	356.9	0.56	1135.6	0.58
H2 TRB INLET	1888.1	355.7	10.63	1135.6	0.91
H2 TRB EXIT	1257.3	327.1	10.63	1016.9	0.68
H2 TRB DIFFUSER	1216.1	327.1	10.63	1016.9	0.66
H2 BST TRB IN	1204.0	327.1	10.63	1016.9	0.66
H2 BST TRB OUT	1182.9	325.9	10.63	1012.1	0.64
H2 BST TRB DIFF	1169.7	325.9	10.63	1012.1	0.63
H2 TANK PRESS	18.6	327.4	0.0274	1018.3	0.0107
FSOV INLET	1169.7	327.5	11.16	1018.3	0.63
FSOV EXIT	1140.5	327.5	11.16	1018.3	0.62
CHAMBER INJ	1117.2	327.5	11.16	1018.3	0.61
CHAMBER	1049.9				

* OXYGEN SYSTEM CONDITIONS *					
STATION	PRESS	TEMP	FLOW	ENTHALPY	DENSITY
B.P. INLET	16.0	162.7	67.1	61.1	71.17
B.P. EXIT	135.6	163.2	67.1	61.5	71.20
PUMP INLET	135.6	163.2	67.1	61.5	71.20
PUMP EXIT	4716.1	184.0	67.1	77.1	72.09
COOLANT INLET	4668.9	184.2	67.1	77.1	72.02
COOLANT EXIT	4436.3	499.1	67.1	198.0	27.64
OTBV INLET	4436.3	499.1	3.0	198.0	27.64
OTBV EXIT	1772.4	450.8	3.0	198.0	13.58
O2 TRB INLET	4436.3	499.1	57.4	198.0	27.64
O2 TRB EXIT	1976.3	404.5	57.4	179.6	18.94
O2 TRB DIFFUSER	1772.4	397.6	57.4	179.6	17.35
O2 BST TRB IN	4436.3	499.1	6.7	198.0	27.64
O2 BST TRB OUT	4393.3	486.7	6.7	193.9	28.43
O2 BST TRB DIFF	4391.6	486.7	6.7	193.9	28.43
OBTV INLET	4391.6	486.7	6.7	193.9	28.43
OBTV EXIT	1772.4	438.1	6.7	193.9	14.24
MIXER	1772.4	403.6	67.0	181.9	16.79
O2 TANK PRESS	16.0	295.6	0.153	181.9	0.16
OCV INLET	1483.8	400.4	67.0	181.9	16.08
OCV EXIT	1178.7	378.7	67.0	181.9	11.72
CHAMBER INJ	1155.2	377.5	67.0	181.9	11.51
CHAMBER	1049.9				

* VALVE DATA *

VALVE	DELTA P	AREA	FLOW	% BYPASS
OTBV	2664.	0.02	3.02	5.00
TBV	718.	0.04	0.56	5.00
FSOV	29.	3.82	11.16	
OBTV	2619.	0.05	6.71	
OCV	505.	1.11	66.99	

* INJECTOR DATA *

INJECTOR	DELTA P	AREA	FLOW	VELOCITY
FUEL	79.	2.63	11.16	1009.01
LOX	117.	2.88	66.99	291.12

TABLE 42. — DUAL-EXPANDER ENGINE — 37,500 LBF THRUST (COPPER GROOVED CHAMBER) (CONTINUED)

***** * TURBOMACHINERY PERFORMANCE DATA * *****			
***** * H2 BOOST TURBINE * *****		***** * H2 BOOST PUMP * *****	
EFFICIENCY (T/T)	0.837	EFFICIENCY	0.766
EFFICIENCY (T/S)	0.454	HORSEPOWER	71.
SPEED (RPM)	33653.	SPEED (RPM)	33653.
MEAN DIA (IN)	1.76	S SPEED	3049.
EFF AREA (IN ²)	4.21	HEAD (FT)	2688.
U/C (ACTUAL)	0.531	DIA. (IN)	2.98
MAX TIP SPEED	372.	TIP SPEED	438.
STAGES	1	VOL. FLOW	1144.
GAMMA	1.40	HEAD COEF	0.450
PRESS RATIO (T/T)	1.02	FLOW COEF	0.201
PRESS RATIO (T/S)	1.03		
HORSEPOWER	71.		
EXIT MACH NUMBER	0.13		
SPECIFIC SPEED	150.00		
SPECIFIC DIAMETER	0.52		
***** * H2 TURBINE * *****		***** * H2 PUMP * *****	
EFFICIENCY (T/T)	0.883	EFFICIENCY	0.760
EFFICIENCY (T/S)	0.801	HORSEPOWER	891.
SPEED (RPM)	107143.	SPEED (RPM)	107143.
HORSEPOWER	1786.	SS SPEED	11935.
MEAN DIA. (IN)	2.88	S SPEED	1451.
EFF AREA (IN ²)	0.79	HEAD (FT)	33288.
U/C (ACTUAL)	0.553	DIA. (IN)	3.22
MAX TIP SPEED	1481.	TIP SPEED	1506.
STAGES	1	VOL. FLOW	1114.
GAMMA	1.40	HEAD COEF	0.472
PRESS RATIO (T/T)	1.50	FLOW COEF	0.136
PRESS RATIO (T/S)	1.57	DIAMETER RATIO	0.472
EXIT MACH NUMBER	0.24	BEARING DN	3.00E+06
SPECIFIC SPEED	66.16	SHAFT DIAMETER	28.00
SPECIFIC DIAMETER	1.26		
***** * O2 BOOST TURBINE * *****		***** * O2 BOOST PUMP * *****	
EFFICIENCY (T/T)	0.851	EFFICIENCY	0.764
EFFICIENCY (T/S)	0.809	HORSEPOWER	39.
SPEED (RPM)	9022.	SPEED (RPM)	9022.
MEAN DIA (IN)	6.34	S SPEED	3026.
EFF AREA (IN ²)	0.30	HEAD (FT)	242.
U/C (ACTUAL)	0.553	DIA. (IN)	3.34
MAX TIP SPEED	260.	TIP SPEED	132.
STAGES	1	VOL. FLOW	423.
GAMMA	1.97	HEAD COEF	0.450
PRESS RATIO (T/T)	1.01	FLOW COEF	0.200
PRESS RATIO (T/S)	1.01		
HORSEPOWER	39.		
EXIT MACH NUMBER	0.02		
SPECIFIC SPEED	36.68		
SPECIFIC DIAMETER	2.16		
***** * O2 TURBINE * *****		***** * O2 PUMP * *****	
EFFICIENCY (T/T)	0.887	EFFICIENCY	0.750
EFFICIENCY (T/S)	0.776	HORSEPOWER	1488.
SPEED (RPM)	67087.	SPEED (RPM)	67087.
HORSEPOWER	1488.	SS SPEED	26973.
MEAN DIA (IN)	1.81	S SPEED	1467.
EFF AREA (IN ²)	0.46	HEAD (FT)	9146.
U/C (ACTUAL)	0.553	DIA. (IN)	2.72
MAX TIP SPEED	602.	TIP SPEED	796.
STAGES	1	VOL. FLOW	418.
GAMMA	1.97	HEAD COEF	0.465
PRESS RATIO (T/T)	2.24	FLOW COEF	0.137
PRESS RATIO (T/S)	2.60	DIAMETER RATIO	0.672
EXIT MACH NUMBER	0.36	BEARING DN	1.48E+06
SPECIFIC SPEED	82.37	SHAFT DIAMETER	22.00
SPECIFIC DIAMETER	1.03		

TABLE 43. — DUAL-EXPANDER ENGINE — 50,000 LBF THRUST (COPPER GROOVED CHAMBER)

ENGINE PERFORMANCE PARAMETERS					
CHAMBER PRESSURE					1022.1
VAC ENGINE THRUST					50000.
TOTAL ENGINE FLOW RATE					104.20
DEL. VAC. ISP					479.8
THROAT AREA					23.84
NOZZLE AREA RATIO					1000.0
NOZZLE EXIT DIAMETER					174.23
ENGINE MIXTURE RATIO					6.00
ETA C*					0.993
CHAMBER COOLANT DP					226.
CHAMBER COOLANT DT					278.
NOZZLE COOLANT DP					235.
NOZZLE COOLANT DT					295.
CHAMBER Q (HYDROGEN COOLED)					15803.
NOZZLE Q (OXYGEN COOLED)					10262.

ENGINE STATION CONDITIONS					
* FUEL SYSTEM CONDITIONS *					
STATION	PRESS	TEMP	FLOW	ENTHALPY	DENSITY
B.P. INLET	18.4	37.4	14.92	-107.5	4.37
B.P. EXIT	100.8	38.5	14.92	-103.0	4.39
PUMP INLET	100.8	38.5	14.92	-103.0	4.39
1ST STAGE EXIT	1081.4	49.0	14.92	-50.4	4.52
PUMP EXIT	2088.7	59.3	14.92	2.5	4.62
COOLANT INLET	2067.8	59.5	14.92	2.5	4.60
COOLANT EXIT	1842.0	337.4	14.92	1061.3	0.93
TBV INLET	1823.4	337.5	0.75	1061.3	0.93
TBV EXIT	1138.4	338.3	0.75	1061.3	0.60
H2 TRB INLET	1823.4	337.5	14.18	1061.3	0.93
H2 TRB EXIT	1230.1	310.7	14.18	950.3	0.78
H2 TRB DIFFUSER	1184.7	310.7	14.18	950.3	0.67
H2 BST TRB IN	1172.9	310.7	14.18	950.3	0.67
H2 BST TRB OUT	1151.7	309.6	14.18	945.5	0.66
H2 BST TRB DIFF	1138.4	309.6	14.18	945.5	0.65
H2 TANK PRESS	18.4	310.2	0.0386	951.3	0.0113
FSOV INLET	1138.4	311.0	14.89	951.3	0.65
FSOV EXIT	1110.1	311.0	14.89	951.3	0.63
CHAMBER INJ	1087.5	311.0	14.89	951.3	0.62
CHAMBER	1022.1				
* OXYGEN SYSTEM CONDITIONS *					
STATION	PRESS	TEMP	FLOW	ENTHALPY	DENSITY
B.P. INLET	14.0	162.7	89.5	61.1	71.17
B.P. EXIT	135.4	163.2	89.5	61.5	71.20
PUMP INLET	135.4	163.2	89.5	61.5	71.20
PUMP EXIT	4632.1	183.1	89.5	76.6	72.15
COOLANT INLET	4585.8	183.3	89.5	76.6	72.00
COOLANT EXIT	4351.1	478.5	89.5	191.2	28.95
OTBV INLET	4351.1	478.5	4.0	191.2	28.95
OTBV EXIT	1725.0	428.3	4.0	191.2	14.40
O2 TRB INLET	4351.1	478.5	76.6	191.2	28.95
O2 TRB EXIT	1926.5	387.5	76.6	173.5	20.57
O2 TRB DIFFUSER	1725.0	380.4	76.6	173.5	18.60
O2 BST TRB IN	4351.1	478.5	9.0	191.2	28.95
O2 BST TRB OUT	4307.4	466.2	9.0	187.2	29.87
O2 BST TRB DIFF	4305.7	466.2	9.0	187.2	29.86
O2 TV INLET	4305.7	466.2	9.0	187.2	29.86
O2 TV EXIT	1725.0	416.2	9.0	187.2	15.21
MIXER	1725.0	385.3	89.3	175.7	18.64
O2 TANK PRESS	14.0	267.1	0.227	175.7	0.18
OCV INLET	1638.7	382.1	89.3	175.7	17.53
OCV EXIT	1147.1	359.2	89.3	175.7	12.69
CHAMBER INJ	1124.3	358.0	89.3	175.7	12.46
CHAMBER	1022.1				
* VALVE DATA *					
VALVE	DELTA P	AREA	FLOW	% BYPASS	
OTBV	2426.	0.03	4.03		5.00
TBV	685.	0.06	0.75		5.00
FSOV	28.	5.10	14.89		
O2 TV	2581.	0.07	8.95		
OCV	492.	1.45	89.32		
* INJECTOR DATA *					
INJECTOR	DELTA P	AREA	FLOW	VELOCITY	
FUEL	77.	3.51	14.89	982.19	
LOX	114.	3.75	89.32	275.70	

TABLE 43. — DUAL-EXPANDER ENGINE — 50,000 LBF THRUST (COPPER GROOVED CHAMBER) (CONTINUED)

***** * TURBOMACHINERY PERFORMANCE DATA * *****			

* H2 BOOST TURBINE *		* H2 BOOST PUMP *	

EFFICIENCY (T/T)	0.856	EFFICIENCY	0.765
EFFICIENCY (T/S)	0.468	HORSEPOWER	96.
SPEED (RPM)	29210.	SPEED (RPM)	29210.
MEAN DIA (IN)	2.02	S SPEED	3045.
EFF AREA (IN ²)	5.52	HEAD (FT)	2701.
U/C (ACTUAL)	0.527	DIA. (IN)	3.45
MAX TIP SPEED	369.	TIP SPEED	439.
STAGES	1	VOL. FLOW	1526.
GAMMA	1.36	HEAD COEF	0.450
PRESS RATIO (T/T)	1.02	FLOW COEF	0.201
PRESS RATIO (T/S)	1.03		
HORSEPOWER	96.		
EXIT MACH NUMBER	0.14		
SPECIFIC SPEED	150.00		
SPECIFIC DIAMETER	0.53		

* H2 TURBINE *		* H2 PUMP *	

		STAGE ONE	STAGE TWO
		*****	*****
EFFICIENCY (T/T)	0.893	EFFICIENCY	0.772
EFFICIENCY (T/S)	0.797	HORSEPOWER	1110.
SPEED (RPM)	100000.	SPEED (RPM)	100000.
HORSEPOWER	2226.	SS SPEED	12819.
MEAN DIA. (IN)	2.99	S SPEED	1627.
EFF AREA (IN ²)	1.08	HEAD (FT)	31545.
U/C (ACTUAL)	0.553	DIA. (IN)	3.42
MAX TIP SPEED	1454.	TIP SPEED	1495.
STAGES	1	VOL. FLOW	1483.
GAMMA	1.36	HEAD COEF	0.454
PRESS RATIO (T/T)	1.48	FLOW COEF	0.145
PRESS RATIO (T/S)	1.56	DIAMETER RATIO	0.507
EXIT MACH NUMBER	0.24	BEARING DN	3.00E+06
SPECIFIC SPEED	74.15	SHAFT DIAMETER	30.00
SPECIFIC DIAMETER	1.14		

* O2 BOOST TURBINE *		* O2 BOOST PUMP *	

EFFICIENCY (T/T)	0.857	EFFICIENCY	0.764
EFFICIENCY (T/S)	0.815	HORSEPOWER	52.
SPEED (RPM)	7812.	SPEED (RPM)	7812.
MEAN DIA (IN)	7.32	S SPEED	3026.
EFF AREA (IN ²)	0.39	HEAD (FT)	242.
U/C (ACTUAL)	0.553	DIA. (IN)	3.05
MAX TIP SPEED	260.	TIP SPEED	132.
STAGES	1	VOL. FLOW	564.
GAMMA	2.01	HEAD COEF	0.450
PRESS RATIO (T/T)	1.01	FLOW COEF	0.200
PRESS RATIO (T/S)	1.01		
HORSEPOWER	52.		
EXIT MACH NUMBER	0.02		
SPECIFIC SPEED	36.46		
SPECIFIC DIAMETER	2.18		

* O2 TURBINE *		* O2 PUMP *	

EFFICIENCY (T/T)	0.895	EFFICIENCY	0.759
EFFICIENCY (T/S)	0.783	HORSEPOWER	1923.
SPEED (RPM)	57463.	SPEED (RPM)	57463.
HORSEPOWER	1923.	SS SPEED	26681.
MEAN DIA (IN)	2.08	S SPEED	1471.
EFF AREA (IN ²)	0.61	HEAD (FT)	8971.
U/C (ACTUAL)	0.553	DIA. (IN)	3.13
MAX TIP SPEED	592.	TIP SPEED	785.
STAGES	1	VOL. FLOW	557.
GAMMA	2.01	HEAD COEF	0.468
PRESS RATIO (T/T)	2.26	FLOW COEF	0.137
PRESS RATIO (T/S)	2.62	DIAMETER RATIO	0.672
EXIT MACH NUMBER	0.36	BEARING DN	1.49E+06
SPECIFIC SPEED	82.68	SHAFT DIAMETER	26.00
SPECIFIC DIAMETER	1.03		

TABLE 44. — FULL-EXPANDER ENGINE WITH HYDROGEN REGENERATOR
 — 7500 LBF THRUST (COPPER GROOVED CHAMBER)

ENGINE PERFORMANCE PARAMETERS

CHAMBER PRESSURE	1906.0
VAC ENGINE THRUST	7500.
TOTAL ENGINE FLOW RATE	15.62
DEL. VAC. ISP	480.1
THROAT AREA	1.93
NOZZLE AREA RATIO	1000.0
NOZZLE EXIT DIAMETER	49.52
ENGINE MIXTURE RATIO	6.00
ETA C*	0.993
CHAMBER COOLANT DP	1302.
CHAMBER COOLANT DT	747.
NOZZLE/CHAMBER Q	5996.

ENGINE STATION CONDITIONS

* FUEL SYSTEM CONDITIONS *					
STATION	PRESS	TEMP	FLOW	ENTHALPY	DENSITY
B.P. INLET	18.6	37.4	2.23	-107.5	4.37
B.P. EXIT	100.4	38.5	2.23	-103.0	4.39
PUMP INLET	100.4	38.5	2.23	-103.0	4.39
1ST STAGE EXIT	2168.6	77.3	2.23	54.2	4.16
2ND STAGE EXIT	4119.0	112.8	2.23	202.8	4.13
PUMP EXIT	5994.5	144.5	2.23	344.0	4.17
COLD REGEN IN	5934.5	145.0	2.23	344.0	4.15
COLD REGEN EX	5875.2	374.0	2.23	1266.3	2.19
COOLANT INLET	5875.2	374.0	2.23	1266.3	2.19
COOLANT EXIT	4573.3	1121.3	2.23	3950.8	0.69
TBV INLET	4527.6	1121.6	0.11	3950.8	0.69
TBV EXIT	2199.7	1138.3	0.11	3950.8	0.35
O2 TRB INLET	4527.6	1121.6	2.12	3950.8	0.69
O2 TRB EXIT	4186.7	1104.4	2.12	3881.8	0.65
H2 TRB INLET	4186.7	1104.4	2.12	3881.8	0.65
H2 TRB EXIT	2316.5	983.0	2.12	3411.2	0.42
H2 TRB DIFFUSER	2290.7	983.2	2.12	3411.2	0.41
H2 BST TRB IN	2267.8	983.2	2.12	3411.2	0.41
H2 BST TRB OUT	2252.9	982.1	2.12	3406.4	0.41
H2 BST TRB DIFF	2244.4	982.2	2.12	3406.4	0.41
O2 BST TRB IN	2222.0	982.3	2.12	3406.4	0.40
O2 BST TRB OUT	2214.1	981.6	2.12	3403.8	0.40
O2 BST TRB DIFF	2210.7	981.7	2.12	3403.8	0.40
H2 TANK PRESS	18.6	1004.8	0.0018	3431.2	0.0035
GOX HEAT EXCH IN	2199.7	989.6	2.23	3431.2	0.40
GOX HEAT EXCH OUT	2188.7	989.3	2.23	3429.8	0.39
HOT REGEN IN	2188.7	989.3	2.23	3429.8	0.39
HOT REGEN EX	2123.0	727.4	2.23	2506.8	0.51
FSOV INLET	2123.0	727.4	2.23	2506.8	0.51
FSOV EXIT	2070.0	727.7	2.23	2506.8	0.50
CHAMBER INJ	2049.3	727.8	2.23	2506.8	0.50
CHAMBER	1906.0				

* OXYGEN SYSTEM CONDITIONS *					
STATION	PRESS	TEMP	FLOW	ENTHALPY	DENSITY
B.P. INLET	16.0	162.7	13.4	61.9	70.99
B.P. EXIT	135.2	165.3	13.4	62.3	70.84
PUMP INLET	135.2	165.3	13.4	62.3	70.84
PUMP EXIT	3086.8	180.8	13.4	73.2	71.17
O2 TANK PRESS	16.0	400.0	0.023	204.7	0.12
OSOV INLET	3056.0	181.0	2.0	73.2	71.12
OSOV EXIT	2139.2	184.6	2.0	73.2	69.70
OCV INLET	3056.0	181.0	11.4	73.2	71.12
OCV EXIT	2139.2	184.6	11.4	73.2	69.70
CHAMBER INJ	2117.8	184.7	13.4	73.2	69.66
CHAMBER	1906.0				

* VALVE DATA *

VALVE	DELTA P	AREA	FLOW	% BYPASS
TBV	2328.	0.01	0.11	5.00
FSOV	53.	0.63	2.23	
OCV	917.	0.07	13.39	

* INJECTOR DATA *

INJECTOR	DELTA P	AREA	FLOW
FUEL	143.	0.40	2.23
LOX	212.	0.16	13.39

TABLE 44. — FULL-EXPANDER ENGINE WITH HYDROGEN REGENERATOR
— 7500 LBF THRUST (COPPER GROOVED CHAMBER) (CONTINUED)

***** * TURBOMACHINERY PERFORMANCE DATA * *****	
***** * H2 BOOST TURBINE * *****	***** * H2 BOOST PUMP * *****
EFFICIENCY (T/T) 0.745	EFFICIENCY 0.766
EFFICIENCY (T/S) 0.422	HORSEPOWER 14.
SPEED (RPM) 75301.	SPEED (RPM) 75301.
MEAN DIA (IN) 1.44	S SPEED 3050.
EFF AREA (IN2) 1.25	HEAD (FT) 2486.
U/C (ACTUAL) 0.971	DIA. (IN) 1.33
MAX TIP SPEED 572.	TIP SPEED 438.
STAGES 1	VOL. FLOW 228.
GAMMA 1.44	HEAD COEF 0.450
PRESS RATIO (T/T) 1.01	FLOW COEF 0.201
PRESS RATIO (T/S) 1.01	
HORSEPOWER 14.	
EXIT MACH NUMBER 0.07	
SPECIFIC SPEED 150.00	
SPECIFIC DIAMETER 0.78	
***** * H2 TURBINE * *****	***** * H2 PUMP * *****
EFFICIENCY (T/T) 0.799	STAGE ONE 0.576
EFFICIENCY (T/S) 0.781	STAGE TWO 0.506
SPEED (RPM) 187500.	STAGE THREE 0.593
HORSEPOWER 1413.	*****
MEAN DIA. (IN) 1.77	EFFICIENCY 0.497
EFF AREA (IN2) 0.12	HORSEPOWER 470.
U/C (ACTUAL) 0.517	SPEED (RPM) 187500.
MAX TIP SPEED 1563.	SS SPEED 187500.
STAGES 3	S SPEED 937.
GAMMA 1.44	S SPEED 673.
PRESS RATIO (T/T) 1.81	HEAD (FT) 70485.
PRESS RATIO (T/S) 1.85	DIA. (IN) 67813.
EXIT MACH NUMBER 0.13	TIP SPEED 2.53
SPECIFIC SPEED 49.52	VOL. FLOW 2073.
SPECIFIC DIAMETER 1.48	HEAD COEF 241.
	FLOW COEF 0.528
	DIAMETER RATIO 0.088
	BEARING DN 3.00E+06
	SHAFT DIAMETER 14.00
***** * O2 BOOST TURBINE * *****	***** * O2 BOOST PUMP * *****
EFFICIENCY (T/T) 0.750	EFFICIENCY 0.764
EFFICIENCY (T/S) 0.478	HORSEPOWER 8.
SPEED (RPM) 20162.	SPEED (RPM) 20162.
MEAN DIA (IN) 4.11	S SPEED 3026.
EFF AREA (IN2) 1.74	HEAD (FT) 242.
U/C (ACTUAL) 1.007	DIA. (IN) 1.50
MAX TIP SPEED 392.	TIP SPEED 132.
STAGES 1	VOL. FLOW 85.
GAMMA 1.44	HEAD COEF 0.450
PRESS RATIO (T/T) 1.00	FLOW COEF 0.200
PRESS RATIO (T/S) 1.01	
HORSEPOWER 8.	
EXIT MACH NUMBER 0.05	
SPECIFIC SPEED 86.62	
SPECIFIC DIAMETER 1.33	
***** * O2 TURBINE * *****	***** * O2 PUMP * *****
EFFICIENCY (T/T) 0.807	EFFICIENCY 0.703
EFFICIENCY (T/S) 0.750	HORSEPOWER 207.
SPEED (RPM) 131256.	SPEED (RPM) 131256.
HORSEPOWER 207.	SS SPEED 23891.
MEAN DIA (IN) 1.77	S SPEED 1777.
EFF AREA (IN2) 0.21	HEAD (FT) 5971.
U/C (ACTUAL) 0.546	DIA. (IN) 1.19
MAX TIP SPEED 1091.	TIP SPEED 484.
STAGES 1	VOL. FLOW 85.
GAMMA 1.44	HEAD COEF 0.411
PRESS RATIO (T/T) 1.00	FLOW COEF 0.152
PRESS RATIO (T/S) 1.09	DIAMETER RATIO 0.679
EXIT MACH NUMBER 0.00	BEARING DN 1.57E+06
SPECIFIC SPEED 51.70	SHAFT DIAMETER 12.00
SPECIFIC DIAMETER 1.50	
***** REGENERATOR DATA *****	
	COLD SIDE HOT SIDE
DEL P	59.35 65.46
DEL T	220.99 -261.89
AREA	0.14 0.65
FLOW	2.23 2.23
EFFECTIVENESS	0.31
NTU	0.45
CRATIO	0.87
CMIN	7.87
REGEN Q	2060.03

TABLE 45. — FULL-EXPANDER ENGINE WITH HYDROGEN REGENERATOR
 — 15,000 LBF THRUST (COPPER GROOVED CHAMBER)

ENGINE PERFORMANCE PARAMETERS

CHAMBER PRESSURE	1824.0
VAC ENGINE THRUST	15000.
TOTAL ENGINE FLOW RATE	31.24
DEL. VAC. ISP	480.1
THROAT AREA	4.02
NOZZLE AREA RATIO	1000.0
NOZZLE EXIT DIAMETER	71.58
ENGINE MIXTURE RATIO	6.00
ETA C*	0.993
CHAMBER COOLANT DP	854.
CHAMBER COOLANT DT	567.
NOZZLE/CHAMBER Q	9408.

ENGINE STATION CONDITIONS

* FUEL SYSTEM CONDITIONS *					
STATION	PRESS	TEMP	FLOW	ENTHALPY	DENSITY
B.P. INLET	18.6	37.4	4.47	-107.5	4.37
B.P. EXIT	100.8	38.5	4.47	-103.0	4.39
PUMP INLET	100.8	38.5	4.47	-103.0	4.39
1ST STAGE EXIT	1839.2	64.6	4.47	10.1	4.38
2ND STAGE EXIT	3548.9	89.3	4.47	120.6	4.40
PUMP EXIT	5238.7	112.8	4.47	228.5	4.46
COLD REGEN IN	5186.4	113.2	4.47	228.5	4.44
COLD REGEN EX	5134.5	302.9	4.47	957.5	2.35
COOLANT INLET	5134.5	302.9	4.47	957.5	2.35
COOLANT EXIT	4280.1	870.4	4.47	3063.1	0.82
TBV INLET	4237.3	870.7	0.22	3063.1	0.82
TBV EXIT	2105.1	884.8	0.22	3063.1	0.42
O2 TRB INLET	4237.3	870.7	4.24	3063.1	0.82
O2 TRB EXIT	3868.6	855.2	4.24	2999.7	0.77
H2 TRB INLET	3868.6	855.2	4.24	2999.7	0.77
H2 TRB EXIT	2222.3	767.5	4.24	2650.7	0.51
H2 TRB DIFFUSER	2193.7	767.7	4.24	2650.7	0.50
H2 BST TRB IN	2171.8	767.7	4.24	2650.7	0.50
H2 BST TRB OUT	2154.6	766.6	4.24	2646.0	0.50
H2 BST TRB DIFF	2147.8	766.6	4.24	2646.0	0.49
O2 BST TRB IN	2126.3	766.8	4.24	2646.0	0.49
O2 BST TRB OUT	2117.5	766.1	4.24	2643.4	0.49
O2 BST TRB DIFF	2115.7	766.1	4.24	2643.4	0.49
H2 TANK PRESS	18.6	784.8	0.0046	2664.4	0.0045
GOX HEAT EXCH IN	2105.1	772.1	4.46	2664.4	0.48
GOX HEAT EXCH OUT	2094.6	771.8	4.46	2663.0	0.48
HOT REGEN IN	2094.6	771.8	4.46	2663.0	0.48
HOT REGEN EX	2031.8	567.1	4.46	1933.3	0.62
FSOV INLET	2031.8	567.1	4.46	1933.3	0.62
FSOV EXIT	1981.0	567.4	4.46	1933.3	0.61
CHAMBER INJ	1961.2	567.4	4.46	1933.3	0.60
CHAMBER	1824.0				

* OXYGEN SYSTEM CONDITIONS *					
STATION	PRESS	TEMP	FLOW	ENTHALPY	DENSITY
B.P. INLET	16.0	162.7	26.8	61.9	70.99
B.P. EXIT	135.2	165.3	26.8	62.3	70.84
PUMP INLET	135.2	165.3	26.8	62.3	70.84
PUMP EXIT	2954.0	179.2	26.8	72.4	71.31
O2 TANK PRESS	16.0	400.0	0.046	204.7	0.12
OSOV INLET	2924.5	179.3	4.0	72.4	71.26
OSOV EXIT	2047.1	182.7	4.0	72.4	69.90
OCV INLET	2924.5	179.3	22.8	72.4	71.26
OCV EXIT	2047.1	182.7	22.8	72.4	69.90
CHAMBER INJ	2026.7	182.8	26.8	72.4	69.87
CHAMBER	1824.0				

* VALVE DATA *

VALVE	DELTA P	AREA	FLOW	% BYPASS
TBV	2132.	0.01	0.22	5.00
FSOV	51.	1.16	4.46	
OCV	877.	0.14	26.78	

* INJECTOR DATA *

INJECTOR	DELTA P	AREA	FLOW
FUEL	137.	0.74	4.46
LOX	203.	0.34	26.78

TABLE 45. — FULL-EXPANDER ENGINE WITH HYDROGEN REGENERATOR
— 15,000 LBF THRUST (COPPER GROOVED CHAMBER) (CONTINUED)

***** * TURBOMACHINERY PERFORMANCE DATA * *****	

* H2 BOOST TURBINE *	* H2 BOOST PUMP *
*****	*****
EFFICIENCY (T/T) 0.796	EFFICIENCY 0.765
EFFICIENCY (T/S) 0.519	HORSEPOWER 29.
SPEED (RPM) 53383.	SPEED (RPM) 53383.
MEAN DIA (IN) 1.44	S SPEED 3045.
EFF AREA (IN2) 2.11	HEAD (FT) 2701.
U/C (ACTUAL) 0.686	DIA. (IN) 1.89
MAX TIP SPEED 433.	TIP SPEED 459.
STAGES 1	VOL. FLOW 457.
GAMMA 1.39	HEAD COEF 0.450
PRESS RATIO (T/T) 1.01	FLOW COEF 0.201
PRESS RATIO (T/S) 1.01	
HORSEPOWER 29.	
EXIT MACH NUMBER 0.07	
SPECIFIC SPEED 150.00	
SPECIFIC DIAMETER 0.65	
*****	*****
* H2 TURBINE *	* H2 PUMP *
*****	*****
EFFICIENCY (T/T) 0.807	EFFICIENCY 0.649
EFFICIENCY (T/S) 0.784	HORSEPOWER 715.
SPEED (RPM) 136363.	SPEED (RPM) 136363.
HORSEPOWER 2096.	SS SPEED 9565.
MEAN DIA. (IN) 2.48	S SPEED 790.
EFF AREA (IN2) 0.23	HEAD (FT) 57137.
U/C (ACTUAL) 0.499	DIA. (IN) 3.12
MAX TIP SPEED 1575.	TIP SPEED 1857.
STAGES 2	VOL. FLOW 458.
GAMMA 1.39	HEAD COEF 0.533
PRESS RATIO (T/T) 1.74	FLOW COEF 0.096
PRESS RATIO (T/S) 1.77	DIAMETER RATIO 0.331
EXIT MACH NUMBER 0.16	BEARING DN 5.00E-06
SPECIFIC SPEED 43.34	SHAFT DIAMETER 22.00
SPECIFIC DIAMETER 1.63	
*****	*****
* O2 BOOST TURBINE *	* O2 BOOST PUMP *
*****	*****
EFFICIENCY (T/T) 0.824	EFFICIENCY 0.764
EFFICIENCY (T/S) 0.648	HORSEPOWER 15.
SPEED (RPM) 14257.	SPEED (RPM) 14257.
MEAN DIA (IN) 4.11	S SPEED 3026.
EFF AREA (IN2) 2.97	HEAD (FT) 262.
U/C (ACTUAL) 0.712	DIA. (IN) 2.11
MAX TIP SPEED 290.	TIP SPEED 132.
STAGES 1	VOL. FLOW 170.
GAMMA 1.39	HEAD COEF 0.450
PRESS RATIO (T/T) 1.00	FLOW COEF 0.200
PRESS RATIO (T/S) 1.01	
HORSEPOWER 15.	
EXIT MACH NUMBER 0.06	
SPECIFIC SPEED 90.31	
SPECIFIC DIAMETER 1.01	
*****	*****
* O2 TURBINE *	* O2 PUMP *
*****	*****
EFFICIENCY (T/T) 0.822	EFFICIENCY 0.730
EFFICIENCY (T/S) 0.766	HORSEPOWER 380.
SPEED (RPM) 90118.	SPEED (RPM) 90118.
HORSEPOWER 380.	SS SPEED 23201.
MEAN DIA (IN) 2.48	S SPEED 1787.
EFF AREA (IN2) 0.36	HEAD (FT) 5691.
U/C (ACTUAL) 0.548	DIA. (IN) 1.68
MAX TIP SPEED 1064.	TIP SPEED 660.
STAGES 1	VOL. FLOW 169.
GAMMA 1.39	HEAD COEF 0.420
PRESS RATIO (T/T) 1.10	FLOW COEF 0.153
PRESS RATIO (T/S) 1.10	DIAMETER RATIO 0.680
EXIT MACH NUMBER 0.09	BEARING DN 1.44E-06
SPECIFIC SPEED 69.91	SHAFT DIAMETER 16.00
SPECIFIC DIAMETER 1.57	
*****	*****
REGENERATOR DATA	

COLD SIDE	HOT SIDE
DEL P 51.87	42.84
DEL T 189.70	-204.66
AREA 0.32	1.20
FLOW 4.47	4.46
EFFECTIVENESS 0.31	
NTU 0.46	
CRATIO 0.93	
CMIN 15.92	
REGEN Q 3257.29	

TABLE 46. — FULL-EXPANDER ENGINE WITH HYDROGEN REGENERATOR
 — 25,000 LBF THRUST (COPPER GROOVED CHAMBER)

ENGINE PERFORMANCE PARAMETERS

CHAMBER PRESSURE	1718.0
VAC ENGINE THRUST	25000.
TOTAL ENGINE FLOW RATE	52.08
DEL. VAC. ISP	480.1
THROAT AREA	7.12
NOZZLE AREA RATIO	1000.0
NOZZLE EXIT DIAMETER	95.20
ENGINE MIXTURE RATIO	6.00
ETA C*	0.993
CHAMBER COOLANT DP	778.
CHAMBER COOLANT DT	443.
NOZZLE/CHAMBER Q	12628.

ENGINE STATION CONDITIONS

* FUEL SYSTEM CONDITIONS *					
STATION	PRESS	TEMP	FLOW	ENTHALPY	DENSITY
B.P. INLET	18.6	37.4	7.45	-107.5	4.37
B.P. EXIT	100.6	38.5	7.45	-103.0	4.39
PUMP INLET	100.6	38.5	7.45	-103.0	4.39
1ST STAGE EXIT	1709.0	58.8	7.45	-8.8	4.49
2ND STAGE EXIT	3331.9	78.3	7.45	85.0	4.57
PUMP EXIT	4968.4	97.3	7.45	177.8	4.66
COLD REGEN IN	4918.8	97.7	7.45	177.8	4.63
COLD REGEN EX	4869.6	258.6	7.45	763.8	2.56
COOLANT INLET	4869.6	258.6	7.45	763.8	2.56
COOLANT EXIT	4091.5	701.7	7.45	2459.0	0.97
TBV INLET	4050.6	702.0	0.37	2459.0	0.96
TBV EXIT	1982.9	714.7	0.37	2459.0	0.49
O2 TRB INLET	4050.6	702.0	7.08	2459.0	0.96
O2 TRB EXIT	3666.1	688.1	7.08	2401.0	0.90
H2 TRB INLET	3666.1	688.1	7.08	2401.0	0.90
H2 TRB EXIT	2116.3	614.2	7.08	2105.4	0.60
H2 TRB DIFFUSER	2079.7	614.4	7.08	2105.4	0.59
H2 BST TRB IN	2058.9	614.4	7.08	2105.4	0.59
H2 BST TRB OUT	2039.0	613.3	7.08	2100.6	0.58
H2 BST TRB DIFF	2024.3	613.4	7.08	2100.6	0.58
O2 BST TRB IN	2004.1	613.5	7.08	2100.6	0.57
O2 BST TRB OUT	1994.3	612.8	7.08	2098.1	0.57
O2 BST TRB DIFF	1992.9	612.8	7.08	2098.1	0.57
H2 TANK PRESS	18.6	628.0	0.0097	2116.1	0.0057
GOX HEAT EXCH IN	1982.9	617.9	7.44	2116.1	0.56
GOX HEAT EXCH OUT	1973.0	617.6	7.44	2114.8	0.56
HOT REGEN IN	1973.0	617.6	7.44	2114.8	0.56
HOT REGEN EX	1913.8	457.0	7.44	1528.0	0.72
FSOV INLET	1913.8	457.0	7.44	1528.0	0.72
FSOV EXIT	1865.9	457.2	7.44	1528.0	0.71
CHAMBER INJ	1847.3	457.3	7.44	1528.0	0.70
CHAMBER	1718.0				

* OXYGEN SYSTEM CONDITIONS *					
STATION	PRESS	TEMP	FLOW	ENTHALPY	DENSITY
B.P. INLET	16.0	162.7	44.7	61.9	70.99
B.P. EXIT	135.2	165.3	44.7	62.3	70.84
PUMP INLET	135.2	165.3	44.7	62.3	70.84
PUMP EXIT	2782.4	177.7	44.7	71.5	71.37
O2 TANK PRESS	16.0	400.0	0.076	204.7	0.12
OSOV INLET	2754.5	177.9	6.7	71.5	71.33
OSOV EXIT	1928.2	181.1	6.7	71.5	70.04
OCV INLET	2754.5	177.9	37.9	71.5	71.33
OCV EXIT	1928.2	181.1	37.9	71.5	70.04
CHAMBER INJ	1908.9	181.1	44.6	71.5	70.01
CHAMBER	1718.0				

* VALVE DATA *

VALVE	DELTA P	AREA	FLOW	% BYPASS
TBV	2068.	0.02	0.37	5.00
FSOV	48.	1.84	7.44	
OCV	826.	0.23	44.64	

* INJECTOR DATA *

INJECTOR	DELTA P	AREA	FLOW
FUEL	129.	1.17	7.44
LOX	191.	0.58	44.64

ORIGINAL PAGE IS
 OF POOR QUALITY

TABLE 46. — FULL-EXPANDER ENGINE WITH HYDROGEN REGENERATOR
— 25,000 LBF THRUST (COPPER GROOVED CHAMBER) (CONTINUED)

***** * TURBOMACHINERY PERFORMANCE DATA * *****			
***** * H ₂ BOOST TURBINE * *****		***** * H ₂ BOOST PUMP * *****	
EFFICIENCY (T/T)	0.814	EFFICIENCY	0.766
EFFICIENCY (T/S)	0.407	HORSEPOWER	48.
SPEED (RPM)	41283.	SPEED (RPM)	41283.
MEAN DIA (IN)	1.44	S SPEED	3048.
EFF AREA (IN ²)	3.01	HEAD (FT)	2693.
U/C (ACTUAL)	0.531	DIA. (IN)	2.43
MAX TIP SPEED	380.	TIP SPEED	439.
STAGES	1	VOL. FLOW	762.
GAMMA	1.43	HEAD COEF	0.450
PRESS RATIO (T/T)	1.01	FLOW COEF	0.201
PRESS RATIO (T/S)	1.02		
HORSEPOWER	48.		
EXIT MACH NUMBER	0.11		
SPECIFIC SPEED	149.74		
SPECIFIC DIAMETER	0.51		
***** * H ₂ TURBINE * *****		***** * H ₂ PUMP * *****	
EFFICIENCY (T/T)	0.861	EFFICIENCY	0.708
EFFICIENCY (T/S)	0.828	HORSEPOWER	994.
SPEED (RPM)	125000.	SPEED (RPM)	125000.
HORSEPOWER	2959.	SS SPEED	11347.
MEAN DIA. (IN)	2.40	S SPEED	992.
EFF AREA (IN ²)	0.36	HEAD (FT)	51938.
U/C (ACTUAL)	0.521	DIA. (IN)	3.29
MAX TIP SPEED	1539.	TIP SPEED	1794.
STAGES	2	VOL. FLOW	745.
GAMMA	1.43	HEAD COEF	0.519
PRESS RATIO (T/T)	1.73	FLOW COEF	0.110
PRESS RATIO (T/S)	1.77	DIAMETER RATIO	0.383
EXIT MACH NUMBER	0.17	BEARING DN	3.00E+06
SPECIFIC SPEED	55.08	SHAFT DIAMETER	24.00
SPECIFIC DIAMETER	1.39		
***** * O ₂ BOOST TURBINE * *****		***** * O ₂ BOOST PUMP * *****	
EFFICIENCY (T/T)	0.874	EFFICIENCY	0.744
EFFICIENCY (T/S)	0.730	HORSEPOWER	24.
SPEED (RPM)	11043.	SPEED (RPM)	11043.
MEAN DIA (IN)	4.11	S SPEED	3026.
EFF AREA (IN ²)	4.34	HEAD (FT)	242.
U/C (ACTUAL)	0.552	DIA. (IN)	2.73
MAX TIP SPEED	234.	TIP SPEED	132.
STAGES	1	VOL. FLOW	283.
GAMMA	1.43	HEAD COEF	0.450
PRESS RATIO (T/T)	1.00	FLOW COEF	0.200
PRESS RATIO (T/S)	1.01		
HORSEPOWER	24.		
EXIT MACH NUMBER	0.04		
SPECIFIC SPEED	99.07		
SPECIFIC DIAMETER	0.86		
***** * O ₂ TURBINE * *****		***** * O ₂ PUMP * *****	
EFFICIENCY (T/T)	0.854	EFFICIENCY	0.747
EFFICIENCY (T/S)	0.791	HORSEPOWER	581.
SPEED (RPM)	67533.	SPEED (RPM)	67533.
HORSEPOWER	581.	SS SPEED	22446.
MEAN DIA (IN)	2.40	S SPEED	1813.
EFF AREA (IN ²)	0.55	HEAD (FT)	5339.
U/C (ACTUAL)	0.450	DIA. (IN)	2.15
MAX TIP SPEED	834.	TIP SPEED	635.
STAGES	1	VOL. FLOW	281.
GAMMA	1.43	HEAD COEF	0.426
PRESS RATIO (T/T)	1.10	FLOW COEF	0.154
PRESS RATIO (T/S)	1.11	DIAMETER RATIO	0.682
EXIT MACH NUMBER	0.10	BEARING DN	1.49E+06
SPECIFIC SPEED	48.64	SHAFT DIAMETER	22.00
SPECIFIC DIAMETER	1.37		

REGENERATOR DATA *****		
	COLD SIDE	HOT SIDE
DELP	49.19	59.19
DELT	140.89	-140.52
AREA	0.52	1.90
FLOW	7.45	7.44
EFFECTIVENESS	0.31	
NTU	0.47	
CRATIO	1.00	
CHIN	27.13	
REGEN Q	4365.10	

TABLE 47. — FULL-EXPANDER ENGINE WITH HYDROGEN REGENERATOR
— 37,500 LBF THRUST (COPPER GROOVED CHAMBER)

ENGINE PERFORMANCE PARAMETERS					

CHAMBER PRESSURE					1612.0
VAC ENGINE THRUST					37500.
TOTAL ENGINE FLOW RATE					78.12
DEL. VAC. ISP					480.0
THROAT AREA					11.37
NOZZLE AREA RATIO					1000.0
NOZZLE EXIT DIAMETER					120.34
ENGINE MIXTURE RATIO					6.00
ETA C*					0.993
CHAMBER COOLANT DP					694.
CHAMBER COOLANT DT					375.
NOZZLE/CHAMBER Q					16426.
ENGINE STATION CONDITIONS					

* FUEL SYSTEM CONDITIONS *					
STATION	PRESS	TEMP	FLOW	ENTHALPY	DENSITY
B.P. INLET	18.6	37.4	11.18	-107.5	4.37
B.P. EXIT	100.9	38.5	11.18	-103.0	4.39
PUMP INLET	100.9	38.5	11.18	-103.0	4.39
1ST STAGE EXIT	1675.9	57.2	11.18	-13.9	4.52
2ND STAGE EXIT	3279.3	75.2	11.18	75.0	4.63
PUMP EXIT	4908.3	92.7	11.18	163.7	4.72
COLD REGEN IM	4859.2	93.1	11.18	163.7	4.70
COLD REGEN EX	4810.6	226.8	11.18	629.7	2.81
COOLANT INLET	4810.6	226.8	11.18	629.7	2.81
COOLANT EXIT	4116.6	601.4	11.18	2099.3	1.11
TBV INLET	4075.4	601.7	0.56	2099.3	1.10
TBV EXIT	1860.5	613.9	0.56	2099.3	0.53
O2 TRB INLET	4075.4	601.7	10.62	2099.3	1.10
O2 TRB EXIT	3662.2	589.5	10.62	2046.1	1.02
H2 TRB INLET	3662.2	589.5	10.62	2046.1	1.02
H2 TRB EXIT	2006.9	521.2	10.62	1765.3	0.67
H2 TRB DIFFUSER	1966.7	521.4	10.62	1765.3	0.65
H2 BST TRB IM	1947.0	521.4	10.62	1765.3	0.65
H2 BST TRB OUT	1924.3	520.3	10.62	1760.5	0.64
H2 BST TRB BIFF	1901.6	520.4	10.62	1760.5	0.64
O2 BST TRB IM	1882.6	520.4	10.62	1760.5	0.63
O2 BST TRB OUT	1871.8	519.8	10.62	1758.0	0.63
O2 BST TRB BIFF	1869.9	519.8	10.62	1758.0	0.63
H2 TANK PRESS	18.6	532.0	0.0169	1775.0	0.0066
GOX HEAT EXCH IN	1860.5	524.5	11.16	1775.0	0.62
GOX HEAT EXCH OUT	1851.2	524.2	11.16	1773.7	0.62
HOT REGEN IM	1851.2	524.2	11.16	1773.7	0.62
HOT REGEN EX	1795.7	399.3	11.16	1307.0	0.78
FSOV INLET	1795.7	399.3	11.16	1307.0	0.78
FSOV EXIT	1750.8	399.4	11.16	1307.0	0.76
CHAMBER INJ	1733.3	399.5	11.16	1307.0	0.75
CHAMBER	1612.0				
* OXYGEN SYSTEM CONDITIONS *					
STATION	PRESS	TEMP	FLOW	ENTHALPY	DENSITY
B.P. INLET	16.0	162.7	67.1	61.9	70.99
B.P. EXIT	135.2	165.3	67.1	62.3	70.84
PUMP INLET	135.2	165.3	67.1	62.3	70.84
PUMP EXIT	2610.7	176.6	67.1	70.8	71.40
O2 TANK PRESS	16.0	400.0	0.114	204.7	0.12
OSOV INLET	2584.6	176.7	10.0	70.8	71.36
OSOV EXIT	1809.2	179.6	10.0	70.8	70.14
OCV INLET	2584.6	176.7	56.9	70.8	71.36
OCV EXIT	1809.2	179.6	56.9	70.8	70.14
CHAMBER INJ	1791.1	179.7	67.0	70.8	70.12
CHAMBER	1612.0				
* VALVE DATA *					
VALVE	DELTA P	AREA	FLOW	% BYPASS	
TBV	2215.	0.02	0.56	5.00	
FSOV	45.	2.75	11.16		
OCV	775.	0.36	66.96		
* INJECTOR DATA *					
INJECTOR	DELTA P	AREA	FLOW		
FUEL	121.	1.75	11.16		
LOX	179.	0.89	66.96		

TABLE 47. — FULL-EXPANDER ENGINE WITH HYDROGEN REGENERATOR
 — 37,500 LBF THRUST (COPPER GROOVED CHAMBER) (CONTINUED)

***** * TURBOMACHINERY PERFORMANCE DATA * *****	
***** * H ₂ BOOST TURBINE * *****	***** * H ₂ BOOST PUMP * *****
EFFICIENCY (T/T) 0.795	EFFICIENCY 0.765
EFFICIENCY (T/S) 0.338	HORSEPOWER 72.
SPEED (RPM) 33756.	SPEED (RPM) 33756.
MEAN DIA (IN) 1.44	S SPEED 3045.
EFF AREA (IN ²) 4.01	HEAD (FT) 2702.
U/C (ACTUAL) 0.434	DIA. (IN) 2.98
MAX TIP SPEED 324.	TIP SPEED 440.
STAGES 1	VOL. FLOW 1161.
GAMMA 1.36	HEAD COEF 0.450
PRESS RATIO (T/T) 1.01	FLOW COEF 0.201
PRESS RATIO (T/S) 1.03	
HORSEPOWER 72.	
EXIT MACH NUMBER 0.14	
SPECIFIC SPEED 123.78	
SPECIFIC DIAMETER 0.48	
***** * H ₂ TURBINE * *****	***** * H ₂ PUMP * *****
EFFICIENCY (T/T) 0.870	EFFICIENCY 0.730 0.728 0.727
EFFICIENCY (T/S) 0.835	HORSEPOWER 1409. 1407. 1402.
SPEED (RPM) 107143.	SPEED (RPM) 107143. 107143. 107143.
HORSEPOWER 4218.	SS SPEED 11885.
MEAN DIA. (IN) 2.93	S SPEED 1058. 1049. 1042.
EFF AREA (IN ²) 0.51	HEAD (FT) 50591. 50407. 50141.
U/C (ACTUAL) 0.516	DIA. (IN) 3.79 3.79 3.79
MAX TIP SPEED 1493.	TIP SPEED 1775. 1775. 1775.
STAGES 2	VOL. FLOW 1110. 1084. 1042.
GAMMA 1.36	HEAD COEF 0.517 0.515 0.512
PRESS RATIO (T/T) 1.82	FLOW COEF 0.114
PRESS RATIO (T/S) 1.87	DIAMETER RATIO 0.400
EXIT MACH NUMBER 0.18	BEARING DN 3.00E-06
SPECIFIC SPEED 57.56	SHAFT DIAMETER 28.00
SPECIFIC DIAMETER 1.33	
***** * O ₂ BOOST TURBINE * *****	***** * O ₂ BOOST PUMP * *****
EFFICIENCY (T/T) 0.873	EFFICIENCY 0.764
EFFICIENCY (T/S) 0.705	HORSEPOWER 39.
SPEED (RPM) 9016.	SPEED (RPM) 9016.
MEAN DIA (IN) 4.11	S SPEED 3024.
EFF AREA (IN ²) 5.88	HEAD (FT) 242.
U/C (ACTUAL) 0.450	DIA. (IN) 3.34
MAX TIP SPEED 197.	TIP SPEED 132.
STAGES 1	VOL. FLOW 425.
GAMMA 1.36	HEAD COEF 0.450
PRESS RATIO (T/T) 1.01	FLOW COEF 0.200
PRESS RATIO (T/S) 1.01	
HORSEPOWER 39.	
EXIT MACH NUMBER 0.04	
SPECIFIC SPEED 91.86	
SPECIFIC DIAMETER 0.77	
***** * O ₂ TURBINE * *****	***** * O ₂ PUMP * *****
EFFICIENCY (T/T) 0.853	EFFICIENCY 0.760
EFFICIENCY (T/S) 0.778	HORSEPOWER 800.
SPEED (RPM) 53362.	SPEED (RPM) 53362.
HORSEPOWER 800.	SS SPEED 21723.
MEAN DIA (IN) 2.93	S SPEED 1845.
EFF AREA (IN ²) 0.73	HEAD (FT) 4991.
U/C (ACTUAL) 0.417	DIA. (IN) 2.62
MAX TIP SPEED 745.	TIP SPEED 610.
STAGES 1	VOL. FLOW 422.
GAMMA 1.36	HEAD COEF 0.431
PRESS RATIO (T/T) 1.11	FLOW COEF 0.155
PRESS RATIO (T/S) 1.12	DIAMETER RATIO 0.683
EXIT MACH NUMBER 0.11	BEARING DN 1.39E-06
SPECIFIC SPEED 45.99	SHAFT DIAMETER 26.00
SPECIFIC DIAMETER 1.34	
***** REGENERATOR DATA *****	
	COLD SIDE HOT SIDE
DEL P	48.59 55.54
DEL T	133.71 -124.85
AREA	8.77 2.80
FLOW	11.18 11.14
EFFECTIVENESS	0.31
NTU	0.46
CRATIO	0.93
CMIN	38.95
REGEN Q	5207.88

ORIGINAL PAGE IS
 OF POOR QUALITY

TABLE 48. — FULL-EXPANDER ENGINE WITH HYDROGEN REGENERATOR
 — 50,000 LBF THRUST (COPPER GROOVED CHAMBER)

ENGINE PERFORMANCE PARAMETERS					
CHAMBER PRESSURE					1506.0
VAC ENGINE THRUST					50000.
TOTAL ENGINE FLOW RATE					104.16
DEL. VAC. ISP					480.0
THROAT AREA					16.23
NOZZLE AREA RATIO					1000.0
NOZZLE EXIT DIAMETER					143.74
ENGINE MIXTURE RATIO					6.00
ETA C*					0.993
CHAMBER COOLANT DP					601.
CHAMBER COOLANT DT					335.
NOZZLE/CHAMBER Q					19840.

ENGINE STATION CONDITIONS					
* FUEL SYSTEM CONDITIONS *					
STATION	PRESS	TEMP	FLOW	ENTHALPY	DENSITY
B.P. INLET	18.6	37.4	14.91	-107.5	4.37
B.P. EXIT	100.8	38.5	14.91	-103.0	4.39
PUMP INLET	100.8	38.5	14.91	-103.0	4.39
1ST STAGE EXIT	1536.4	54.5	14.91	-24.6	4.54
2ND STAGE EXIT	3006.6	69.8	14.91	54.0	4.66
PUMP EXIT	4508.4	84.9	14.91	132.6	4.76
COLD REGEN IN	4463.4	85.3	14.91	132.6	4.74
COLD REGEN EX	4418.7	205.3	14.91	536.0	2.88
COOLANT INLET	4418.7	205.3	14.91	536.0	2.88
COOLANT EXIT	3817.7	540.3	14.91	1867.0	1.14
TBV INLET	3779.5	540.5	0.75	1867.0	1.13
TBV EXIT	1738.1	550.3	0.75	1867.0	0.55
O2 TRB INLET	3779.5	540.5	14.16	1867.0	1.13
O2 TRB EXIT	3401.6	529.1	14.16	1818.0	1.05
H2 TRB INLET	3401.6	529.1	14.16	1818.0	1.05
H2 TRB EXIT	1900.6	468.3	14.16	1570.1	0.70
H2 TRB DIFFUSER	1855.0	468.5	14.16	1570.1	0.69
H2 BST TRB IN	1836.4	468.5	14.16	1570.1	0.69
H2 BST TRB OUT	1811.9	467.4	14.16	1565.3	0.67
H2 BST TRB DIFF	1778.7	467.5	14.16	1565.3	0.66
O2 BST TRB IN	1760.9	467.6	14.16	1565.3	0.66
O2 BST TRB OUT	1749.6	466.9	14.16	1562.7	0.65
O2 BST TRB DIFF	1746.8	466.9	14.16	1562.7	0.65
H2 TANK PRESS	18.6	476.8	0.0250	1578.0	0.0074
GOX HEAT EXCH IN	1738.1	471.0	14.88	1578.0	0.64
GOX HEAT EXCH OUT	1729.4	470.7	14.88	1576.6	0.64
HOT REGEN IN	1729.4	470.7	14.88	1576.6	0.64
HOT REGEN EX	1677.5	365.3	14.88	1172.5	0.79
F50V INLET	1677.5	365.3	14.88	1172.5	0.79
F50V EXIT	1635.6	365.4	14.88	1172.5	0.78
CHAMBER INJ	1619.2	365.4	14.88	1172.5	0.77
CHAMBER	1506.0				

* OXYGEN SYSTEM CONDITIONS *					
STATION	PRESS	TEMP	FLOW	ENTHALPY	DENSITY
B.P. INLET	16.0	162.7	89.4	61.9	70.99
B.P. EXIT	135.2	165.3	89.4	62.3	70.84
PUMP INLET	135.2	165.3	89.4	62.3	70.84
PUMP EXIT	2439.0	175.5	89.4	70.1	71.39
O2 TANK PRESS	16.0	400.0	0.152	204.7	0.12
OSOV INLET	2414.6	175.6	13.4	70.1	71.36
OSOV EXIT	1690.2	178.4	13.4	70.1	70.22
OCV INLET	2414.6	175.6	75.9	70.1	71.36
OCV EXIT	1690.2	178.4	75.9	70.1	70.22
CHAMBER INJ	1673.3	178.4	89.3	70.1	70.19
CHAMBER	1506.0				

* VALVE DATA *				
VALVE	DELTA P	AREA	FLOW	% BYPASS
TBV	2041.	0.03	0.75	5.00
F50V	42.	3.75	14.88	
OCV	724.	0.50	89.28	

* INJECTOR DATA *				
INJECTOR	DELTA P	AREA	FLOW	
FUEL	113.	2.58	14.88	
LOX	167.	1.23	89.28	

TABLE 48. — FULL-EXPANDER ENGINE WITH HYDROGEN REGENERATOR
 — 50,000 LBF THRUST (COPPER GROOVED CHAMBER) (CONTINUED)

***** TURBOMACHINERY PERFORMANCE DATA *****			
***** H2 BOOST TURBINE *****		***** H2 BOOST PUMP *****	
EFFICIENCY (T/T)	0.770	EFFICIENCY	0.765
EFFICIENCY (T/S)	0.272	HORSEPOWER	96.
SPEED (RPM)	29226.	SPEED (RPM)	29226.
MEAN DIA (IN)	1.44	S SPEED	1045.
EFF AREA (IN ²)	5.02	HEAD (FT)	2701.
U/C (ACTUAL)	0.376	DIA. (IN)	3.44
MAX TIP SPEED	290.	TIP SPEED	459.
STAGES	1	VOL. FLOW	1526.
GAMMA	1.38	HEAD COEF	0.450
PRESS RATIO (T/T)	1.01	FLOW COEF	0.201
PRESS RATIO (T/S)	1.04		
HORSEPOWER	96.		
EXIT MACH NUMBER	0.17		
SPECIFIC SPEED	103.11		
SPECIFIC DIAMETER	0.46		
***** H2 TURBINE *****		***** H2 PUMP *****	
		STAGE ONE	STAGE TWO STAGE THREE
EFFICIENCY (T/T)	0.885	EFFICIENCY	0.754 0.752 0.750
EFFICIENCY (T/S)	0.842	HORSEPOWER	1653. 1656. 1658.
SPEED (RPM)	100000.	SPEED (RPM)	100000. 100000. 100000.
HORSEPOWER	4967.	SS SPEED	12813.
MEAN DIA. (IN)	3.08	S SPEED	1223.
EFF AREA (IN ²)	0.69	HEAD (FT)	45957.
U/C (ACTUAL)	0.540	DIA. (IN)	3.93 3.93 3.93
MAX TIP SPEED	1484.	TIP SPEED	1718. 1718. 1718.
STAGES	2	VOL. FLOW	1472. 1436. 1405.
GAMMA	1.38	HEAD COEF	0.501 0.501 0.500
PRESS RATIO (T/T)	1.79	FLOW COEF	0.124
PRESS RATIO (T/S)	1.85	DIAMETER RATIO	0.441
EXIT MACH NUMBER	0.20	BEARING DN	3.00E+06
SPECIFIC SPEED	44.39	SHAFT DIAMETER	30.00
SPECIFIC DIAMETER	1.22		
***** O2 BOOST TURBINE *****		***** O2 BOOST PUMP *****	
EFFICIENCY (T/T)	0.865	EFFICIENCY	0.764
EFFICIENCY (T/S)	0.452	HORSEPOWER	52.
SPEED (RPM)	7808.	SPEED (RPM)	7808.
MEAN DIA (IN)	4.11	S SPEED	5026.
EFF AREA (IN ²)	7.50	HEAD (FT)	242.
U/C (ACTUAL)	0.390	DIA. (IN)	5.86
MAX TIP SPEED	176.	TIP SPEED	132.
STAGES	1	VOL. FLOW	567.
GAMMA	1.38	HEAD COEF	0.450
PRESS RATIO (T/T)	1.01	FLOW COEF	0.200
PRESS RATIO (T/S)	1.01		
HORSEPOWER	52.		
EXIT MACH NUMBER	0.05		
SPECIFIC SPEED	84.96		
SPECIFIC DIAMETER	0.71		
***** O2 TURBINE *****		***** O2 PUMP *****	
EFFICIENCY (T/T)	0.887	EFFICIENCY	0.769
EFFICIENCY (T/S)	0.832	HORSEPOWER	982.
SPEED (RPM)	44714.	SPEED (RPM)	44714.
HORSEPOWER	982.	SS SPEED	21019.
MEAN DIA (IN)	3.08	S SPEED	1885.
EFF AREA (IN ²)	1.01	HEAD (FT)	4445.
U/C (ACTUAL)	0.543	DIA. (IN)	5.01
MAX TIP SPEED	679.	TIP SPEED	587.
STAGES	2	VOL. FLOW	562.
GAMMA	1.38	HEAD COEF	0.454
PRESS RATIO (T/T)	1.11	FLOW COEF	0.157
PRESS RATIO (T/S)	1.12	DIAMETER RATIO	0.684
EXIT MACH NUMBER	0.09	BEARING DN	1.34E+06
SPECIFIC SPEED	78.07	SHAFT DIAMETER	30.00
SPECIFIC DIAMETER	1.04		
***** REGENERATOR DATA *****			
	COLD SIDE	HOT SIDE	
DELTA P	44.64	51.88	
DELTA T	119.92	-105.39	
AREA	1.87	3.78	
FLOW	14.91	14.88	
EFFECTIVENESS	0.51		
NTU	0.46		
CRATIO	0.88		
CMIM	50.14		
REGEN Q	6012.47		

**APPENDIX C
THROTTLED CYCLES**

Throttled cycle data are presented in Tables 49 through 56.

TABLE 49. — ADVANCED ENGINE PARAMETRIC STUDY SPLIT-EXPANDER ENGINE 100% OF DESIGN THRUST LEVEL

ENGINE PERFORMANCE PARAMETERS					

CHAMBER PRESSURE	1612.0				
VAC ENGINE THRUST	20000.				
DEL. VAC. ISP	480.0				
TOTAL ENGINE FLOW RATE	41.7				
THROAT AREA	6.066				
NOZZLE AREA RATIO	1000.0				
ENGINE MIXTURE RATIO	6.00				
CHAMBER/NOZZLE COOLANT DP	583.				
CHAMBER/NOZZLE COOLANT DT	1018.				
ETA C*	0.993				
CHAMBER/NOZZLE Q	11190.				

ENGINE STATION CONDITIONS					

* FUEL SYSTEM CONDITIONS *					
STATION	PRESS	TEMP	FLOW	ENTHALPY	DENSITY
B.P. INLET	18.6	37.4	5.96	-107.5	4.37
B.P. EXIT	100.9	38.5	5.96	-103.0	4.39
PUMP INLET	100.9	38.5	5.96	-103.0	4.39
1ST STAGE EXIT	2177.3	70.3	5.96	34.1	4.36
JBV INLET	2133.8	70.7	2.98	34.1	4.33
JBV EXIT	1813.9	73.1	2.98	34.1	4.11
2ND STAGE EXIT	3487.5	90.9	2.98	123.8	4.35
PUMP EXIT	4762.3	110.4	2.98	210.3	4.37
COOLANT INLET	4714.6	110.8	2.98	210.3	4.35
COOLANT EXIT	4131.6	1128.8	2.98	3965.9	0.63
TBV INLET	4090.3	1129.1	0.15	3965.9	0.62
TBV EXIT	1899.9	1144.8	0.15	3965.9	0.30
LOX TRB INLET	4090.3	1129.1	2.03	3965.9	0.62
LOX TRB EXIT	3612.5	1101.3	2.03	3856.6	0.57
H2 TRB INLET	3612.5	1101.3	2.03	3856.6	0.57
H2 TRB EXIT	2011.4	976.9	2.03	3382.6	0.37
H2 TRB DIFF	1990.1	977.1	2.03	3382.6	0.36
H2 BST TRB IN	1970.2	977.2	2.03	3382.6	0.36
H2 BST TRB EXIT	1947.4	974.6	2.03	3373.1	0.36
H2 BST TRB DIFF	1942.5	974.7	2.03	3373.1	0.36
O2 BST TRB IN	1923.1	974.8	2.03	3373.1	0.35
O2 BST TRB EXIT	1911.2	973.4	2.03	3367.9	0.35
O2 BST TRB DIFF	1910.4	973.4	2.03	3367.9	0.35
H2 TANK PRESS	18.6	995.3	0.0048	3390.0	0.0035
GOX HEAT EXCH IN	1899.9	982.1	2.97	3390.0	0.55
GOX HEAT EXCH OUT	1890.4	981.4	2.97	3395.2	0.55
MIXER HOT IN	1890.4	981.4	2.97	3395.2	0.55
MIXER COLD IN	1813.9	73.1	2.98	34.1	4.11
MIXER OUT	1795.8	508.0	5.95	1713.8	0.62
FSV INLET	1795.8	508.0	5.95	1713.8	0.62
FSV EXIT	1750.9	508.2	5.95	1713.8	0.60
CHAMBER INJ	1733.4	508.2	5.95	1713.8	0.60
CHAMBER	1612.0				

* OXYGEN SYSTEM CONDITIONS *					
STATION	PRESS	TEMP	FLOW	ENTHALPY	DENSITY
B.P. INLET	16.0	162.7	35.77	61.1	71.17
B.P. EXIT	135.2	163.3	35.77	61.5	71.20
PUMP INLET	135.2	163.3	35.77	61.5	71.20
PUMP EXIT	2612.1	174.9	35.77	70.1	71.65
O2 TANK PRESS	16.0	400.0	0.86	204.8	0.12
POSV INLET	2586.0	175.0	5.17	70.1	71.61
POSV EXIT	1795.6	178.0	5.17	70.1	70.38
OCV INLET	2586.0	175.0	30.55	70.1	71.61
OCV EXIT	1811.7	178.0	30.55	70.1	70.41
PRIMARY INJ	1762.1	178.2	5.17	70.1	70.33
SECONDARY INJ	1775.2	178.1	30.55	70.1	70.35
CHAMBER	1612.0				

VALVE DATA				

VALVE	DELTA P	AREA	FLOW	% BYPASS
JBV	358.	0.120	2.98	49.98
TBV	2140.	0.009	0.15	5.02
FSV	45.	1.653	5.95	
POSV	790.	0.032	5.17	
OCV	774.	0.194	30.55	

INJECTOR DATA				

* FUEL *		* OXID *		
		PRIMARY	SECOND	
DEL P MAN	18.20	20.68	18.14	
DEL P INJ	103.18	80.07	163.21	
AREA	1.14	0.08	0.43	
FLOW	5.95	5.17	30.55	

TABLE 49. — ADVANCED ENGINE PARAMETRIC STUDY SPLIT-EXPANDER ENGINE 100% OF DESIGN THRUST LEVEL (CONTINUED)

***** * TURBOMACHINERY PERFORMANCE DATA * *****					
***** * H2 BOOST TURBINE * *****			***** * H2 BOOST PUMP * *****		
EFFICIENCY	0.857		EFFICIENCY	0.765	
HORSEPOWER	38.		HORSEPOWER	38.	
SPEED (RPM)	46158.		SPEED (RPM)	46158.	
MEAN DIA (IN)	1.90		S SPEED	3839.	
EFF AREA (IN2)	1.45		HEAD (FT)	2703.	
U/C (IDEAL)	0.512		DIA. (IN)	2.18	
MAX TIP SPEED	382.		TIP SPEED	439.	
STAGES	1.		VOL. FLOW	609.	
DELTA H (ACT)	9.56		HEAD COEF	0.452	
GAMMA	1.43		FLOW COEF	0.201	
PRESS RATIO (T/T)	1.01				

***** * H2 TURBINE * *****			***** * H2 PUMP * *****		
	STAGE 1	STAGE 2	STAGE ONE	STAGE TWO	STAGE THREE
EFFICIENCY	0.805	0.808	EFFICIENCY	0.642	0.621
HORSEPOWER	950.	948.	HORSEPOWER	1155.	378.
SPEED (RPM)	124983.	124983.	SPEED (RPM)	124983.	124983.
MEAN DIA (IN)	3.47	3.47	S SPEED	731.	744.
EFF AREA (IN2)	0.21	0.26	HEAD (FT)	68442.	43325.
U/C (IDEAL)	0.493	0.494	DIA. (IN)	3.69	3.02
MAX TIP SPEED	1895.	1895.	TIP SPEED	2012.	1647.
DELTA H (ACT)	237.	237.	VOL. FLOW	613.	307.
GAMMA (ACT)	1.43	1.43	HEAD COEF	0.544	0.514
PRESS RATIO(T/T)	1.33	1.35	FLOW COEF	0.092	0.092
					0.093

***** * O2 BOOST TURBINE * *****			***** * O2 BOOST PUMP * *****		
EFFICIENCY	0.859		EFFICIENCY	0.764	
HORSEPOWER	21.		HORSEPOWER	21.	
SPEED (RPM)	12324.		SPEED (RPM)	12324.	
MEAN DIA (IN)	5.20		S SPEED	3024.	
EFF AREA (IN2)	2.02		HEAD (FT)	241.	
U/C (IDEAL)	0.512		DIA. (IN)	2.44	
MAX TIP SPEED	280.		TIP SPEED	131.	
STAGES	1.		VOL. FLOW	226.	
DELTA H (ACT)	5.13		HEAD COEF	0.451	
GAMMA	1.43		FLOW COEF	0.200	
PRESS RATIO (T/T)	1.01				

***** * O2 TURBINE * *****			***** * O2 PUMP * *****		
EFFICIENCY	0.806		EFFICIENCY	0.740	
HORSEPOWER	438.		HORSEPOWER	438.	
SPEED (RPM)	74008.		SPEED (RPM)	74008.	
MEAN DIA (IN)	3.47		S SPEED	1870.	
EFF AREA (IN2)	0.25		HEAD (FT)	4976.	
U/C (IDEAL)	0.430		DIA. (IN)	1.90	
MAX TIP SPEED	1122.		TIP SPEED	615.	
STAGES	1.		VOL. FLOW	224.	
DELTA H (ACT)	109.27		HEAD COEF	0.423	
GAMMA	1.43		FLOW COEF	0.157	
PRESS RATIO (T/T)	1.13				

TABLE 50. — ADVANCED ENGINE PARAMETRIC STUDY SPLIT-EXPANDER
ENGINE 50% OF DESIGN THRUST LEVEL

ENGINE PERFORMANCE PARAMETERS					

CHAMBER PRESSURE					801.9
VAC ENGINE THRUST					10000.
DEL. VAC. ISP					479.7
TOTAL ENGINE FLOW RATE					20.8
THROAT AREA					6.066
NOZZLE AREA RATIO					1000.0
ENGINE MIXTURE RATIO					6.00
CHAMBER/NOZZLE COOLANT DP					547.
CHAMBER/NOZZLE COOLANT DT					730.
ETA C*					0.993
CHAMBER/NOZZLE Q					6340.
ENGINE STATION CONDITIONS					

* FUEL SYSTEM CONDITIONS *					
STATION	PRESS	TEMP	FLOW	ENTHALPY	DENSITY
B.P. INLET	18.6	37.4	2.98	-107.5	4.37
B.P. EXIT	66.0	38.2	2.98	-104.5	4.38
PUMP INLET	66.0	38.2	2.98	-104.5	4.38
1ST STAGE EXIT	1345.6	60.5	2.98	-13.0	4.27
JBV INLET	1343.4	60.6	0.66	-13.0	4.27
JBV EXIT	908.0	63.3	0.66	-13.0	3.89
2ND STAGE EXIT	1998.7	71.4	2.33	33.1	4.25
PUMP EXIT	2627.5	81.8	2.33	77.3	4.24
COOLANT INLET	2597.6	82.0	2.33	77.3	4.22
COOLANT EXIT	2050.2	811.8	2.33	2803.9	0.45
TBV INLET	2014.9	812.0	0.71	2803.9	0.44
TBV EXIT	997.3	818.4	0.71	2803.9	0.22
LOX TRB INLET	2014.9	812.0	1.61	2803.9	0.44
LOX TRB EXIT	1788.8	792.9	1.61	2731.2	0.40
H2 TRB INLET	1788.8	792.9	1.61	2731.2	0.40
H2 TRB EXIT	1051.3	712.3	1.61	2431.9	0.27
H2 TRB DIFF	1041.7	712.4	1.61	2431.9	0.27
H2 BST TRB IN	1032.9	712.4	1.61	2431.9	0.26
H2 BST TRB EXIT	1022.6	710.9	1.61	2426.4	0.26
H2 BST TRB DIFF	1020.4	710.9	1.61	2426.4	0.26
O2 BST TRB IN	1011.8	711.0	1.61	2426.4	0.26
O2 BST TRB EXIT	1006.4	710.2	1.61	2423.4	0.26
O2 BST TRB DIFF	1006.1	710.2	1.61	2423.4	0.26
H2 TANK PRESS	18.6	749.3	0.0032	2540.0	0.0047
GOX HEAT EXCH IN	997.3	743.4	2.32	2540.0	0.24
GOX HEAT EXCH OUT	989.1	743.0	2.32	2538.2	0.24
MIXER HOT IN	989.1	743.0	2.32	2538.2	0.24
MIXER COLD IN	908.0	63.3	0.66	-13.0	3.89
MIXER OUT	907.1	584.2	2.98	1976.3	0.28
FSV INLET	907.1	584.2	2.98	1976.3	0.28
FSV EXIT	881.4	584.3	2.98	1976.3	0.27
CHAMBER INJ	871.8	584.3	2.98	1976.3	0.27
CHAMBER	801.9				
* OXYGEN SYSTEM CONDITIONS *					
STATION	PRESS	TEMP	FLOW	ENTHALPY	DENSITY
B.P. INLET	16.0	162.7	17.90	61.1	71.17
B.P. EXIT	84.3	163.1	17.90	61.3	71.17
PUMP INLET	84.3	163.1	17.90	61.3	71.17
PUMP EXIT	1800.0	172.6	17.90	67.9	71.28
O2 TANK PRESS	16.0	400.0	0.03	204.8	0.12
POSV INLET	1793.4	172.6	5.20	67.9	71.27
POSV EXIT	989.0	175.6	5.20	67.9	69.97
OCV INLET	1793.4	172.6	12.67	67.9	71.27
OCV EXIT	836.5	176.2	12.67	67.9	69.72
PRIMARY INJ	954.8	175.7	5.20	67.9	69.91
SECONDARY INJ	830.2	176.2	12.67	67.9	69.71
CHAMBER	801.9				
VALVE DATA					

VALVE	DELTA P	AREA	FLOW	% BYPASS	
JBV	426.	0.023	0.66	22.00	
TBV	1018.	0.072	0.71	30.63	
FSV	26.	1.653	2.98		
POSV	804.	0.032	5.20		
OCV	957.	0.073	12.67		
INJECTOR DATA					

* FUEL *		* OXID *			
		PRIMARY	SECOND		
DEL P MAN	10.05	16.99	3.15		
DEL P INJ	59.81	152.91	28.32		
AREA	1.14	0.08	0.43		
FLOW	2.98	5.20	12.67		

TABLE 50. — ADVANCED ENGINE PARAMETRIC STUDY SPLIT-EXPANDER
ENGINE 50% OF DESIGN THRUST LEVEL (CONTINUED)

***** * TURBOMACHINERY PERFORMANCE DATA * *****					
***** * H2 BOOST TURBINE * *****			***** * H2 BOOST PUMP * *****		
EFFICIENCY	0.784		EFFICIENCY	0.675	
HORSEPOWER	13.		HORSEPOWER	13.	
SPEED (RPM)	30494.		SPEED (RPM)	30494.	
MEAN DIA (IN)	1.90		S SPEED	2148.	
EFF AREA (IN2)	1.45		HEAD (FT)	1560.	
U/C (IDEAL)	0.512		DIA. (IN)	2.18	
MAX TIP SPEED	252.		TIP SPEED	290.	
STAGES	1.		VOL. FLOW	306.	
DELTA H (ACT)	5.49		HEAD COEF	0.597	
GAMMA	1.39		FLOW COEF	0.153	
PRESS RATIO (T/T)	1.01				
***** * H2 TURBINE * *****			***** * H2 PUMP * *****		
	STAGE 1	STAGE 2		STAGE ONE	STAGE TWO
	*****	*****		*****	*****
EFFICIENCY	0.766	0.775	EFFICIENCY	0.602	0.615
HORSEPOWER	347.	336.	HORSEPOWER	386.	152.
SPEED (RPM)	92001.	92001.	SPEED (RPM)	92001.	92001.
MEAN DIA (IN)	3.47	3.47	S SPEED	547.	796.
EFF AREA (IN2)	0.21	0.26	HEAD (FT)	42849.	22073.
U/C (IDEAL)	0.442	0.452	DIA. (IN)	3.69	3.02
MAX TIP SPEED	1395.	1395.	TIP SPEED	1481.	1212.
DELTA H	152.	147.	VOL. FLOW	313.	245.
GAMMA (ACT)	1.39	1.39	HEAD COEF	0.629	0.483
PRESS RATIO(T/T)	1.33	1.35	FLOW COEF	0.064	0.100
					0.102
***** * O2 BOOST TURBINE * *****			***** * O2 BOOST PUMP * *****		
EFFICIENCY	0.784		EFFICIENCY	0.674	
HORSEPOWER	7.		HORSEPOWER	7.	
SPEED (RPM)	8074.		SPEED (RPM)	8074.	
MEAN DIA (IN)	5.20		S SPEED	2129.	
EFF AREA (IN2)	2.02		HEAD (FT)	138.	
U/C (IDEAL)	0.512		DIA. (IN)	2.44	
MAX TIP SPEED	183.		TIP SPEED	86.	
STAGES	1.		VOL. FLOW	113.	
DELTA H (ACT)	2.92		HEAD COEF	0.602	
GAMMA	1.39		FLOW COEF	0.153	
PRESS RATIO (T/T)	1.01				
***** * O2 TURBINE * *****			***** * O2 PUMP * *****		
EFFICIENCY	0.777		EFFICIENCY	0.679	
HORSEPOWER	166.		HORSEPOWER	166.	
SPEED (RPM)	56756.		SPEED (RPM)	56756.	
MEAN DIA (IN)	3.47		S SPEED	1334.	
EFF AREA (IN2)	0.25		HEAD (FT)	3466.	
U/C (IDEAL)	0.397		DIA. (IN)	1.90	
MAX TIP SPEED	860.		TIP SPEED	472.	
STAGES	1.		VOL. FLOW	113.	
DELTA H (ACT)	72.74		HEAD COEF	0.502	
GAMMA	1.39		FLOW COEF	0.103	
PRESS RATIO (T/T)	1.13				

TABLE 51. — ADVANCED ENGINE PARAMETRIC STUDY SPLIT-EXPANDER ENGINE 10% OF DESIGN THRUST LEVEL

ENGINE PERFORMANCE PARAMETERS

CHAMBER PRESSURE	158.2
VAC ENGINE THRUST	2009.
DEL. VAC. ISP	478.9
TOTAL ENGINE FLOW RATE	4.2
THROAT AREA	6.066
NOZZLE AREA RATIO	1000.0
ENGINE MIXTURE RATIO	6.00
CHAMBER/NOZZLE COOLANT DP	214.
CHAMBER/NOZZLE COOLANT DT	786.
ETA C*	0.993
CHAMBER/NOZZLE Q	1740.

ENGINE STATION CONDITIONS

* FUEL SYSTEM CONDITIONS *						
STATION	PRESS	TEMP	FLOW	ENTHALPY	DENSITY	
B.P. INLET	18.6	37.4	0.60	-187.5	4.37	
B.P. EXIT	25.6	37.6	0.60	-186.9	4.36	
PUMP INLET	25.6	37.6	0.60	-186.9	4.36	
1ST STAGE EXIT	272.9	45.2	0.60	-80.9	4.21	
JBV INLET	272.9	45.2	0.00	-80.9	4.21	
JBV EXIT	187.6	45.9	0.00	-80.9	4.11	
2ND STAGE EXIT	420.5	48.1	0.60	-69.5	4.19	
PUMP EXIT	563.0	50.8	0.60	-58.6	4.17	
COOLANT INLET	561.0	50.8	0.60	-58.6	4.17	
COOLANT EXIT	347.0	837.0	0.60	2855.1	0.08	
TBV INLET	333.5	837.1	0.36	2855.1	0.07	
TBV EXIT	217.1	837.9	0.36	2855.1	0.05	
LOX TRB INLET	333.5	837.1	0.23	2855.1	0.07	
LOX TRB EXIT	305.3	826.7	0.23	2818.0	0.07	
H2 TRB INLET	305.3	826.7	0.23	2818.0	0.07	
H2 TRB EXIT	224.8	792.0	0.23	2693.9	0.05	
H2 TRB DIFF	223.7	792.0	0.23	2693.9	0.05	
H2 BST TRB IN	222.8	792.0	0.23	2693.9	0.05	
H2 BST TRB EXIT	221.7	791.5	0.23	2692.2	0.05	
H2 BST TRB DIFF	221.5	791.5	0.23	2692.2	0.05	
O2 BST TRB IN	220.6	791.5	0.23	2692.2	0.05	
O2 BST TRB EXIT	220.0	791.3	0.23	2691.4	0.05	
O2 BST TRB DIFF	220.0	791.3	0.23	2691.4	0.05	
H2 TANK PRESS	18.6	821.0	0.0006	2791.4	0.0043	
GDX HEAT EXCH IN	217.1	819.7	0.60	2791.4	0.05	
GDX HEAT EXCH OUT	214.4	819.3	0.60	2790.0	0.05	
MIXER HOT IN	214.4	819.3	0.60	2790.0	0.05	
MIXER COLD IN	187.6	45.9	0.00	-80.9	4.11	
MIXER OUT	187.6	819.5	0.60	2790.0	0.04	
FSV INLET	187.6	819.5	0.60	2790.0	0.04	
FSV EXIT	180.5	819.6	0.60	2790.0	0.04	
CHAMBER INJ	178.0	819.6	0.60	2790.0	0.04	
CHAMBER	158.2					

* OXYGEN SYSTEM CONDITIONS *

STATION	PRESS	TEMP	FLOW	ENTHALPY	DENSITY
B.P. INLET	16.0	162.7	3.59	61.1	71.17
B.P. EXIT	25.5	162.8	3.59	61.1	71.16
PUMP INLET	25.5	162.8	3.59	61.1	71.16
PUMP EXIT	423.5	167.1	3.59	63.5	70.82
O2 TANK PRESS	16.0	400.0	0.01	206.8	0.12
POSV INLET	423.2	167.1	2.68	63.5	70.82
POSV EXIT	207.6	167.9	2.68	63.5	70.46
OCV INLET	423.2	167.1	0.90	63.5	70.82
OCV EXIT	158.3	168.0	0.90	63.5	70.38
PRIMARY INJ	198.6	167.9	2.68	63.5	70.45
SECONDARY INJ	158.2	168.0	0.90	63.5	70.38
CHAMBER	158.2				

VALVE DATA

VALVE	DELTA P	AREA	FLOW	% BYPASS
JBV	85.	0.000	0.00	0.00
TBV	116.	0.222	0.36	61.09
FSV	7.	1.653	0.60	
POSV	216.	0.002	2.68	
OCV	265.	0.010	0.90	

INJECTOR DATA

* FUEL *		* OXID *	
	PRIMARY	SECOND	
DEL P MAN	2.68	4.49	0.02
DEL P INJ	17.10	0.41	0.14
AREA	1.14	0.08	0.43
FLOW	0.60	2.68	0.90

TABLE 51. — ADVANCED ENGINE PARAMETRIC STUDY SPLIT-EXPANDER ENGINE 10% OF DESIGN THRUST LEVEL (CONTINUED)

***** * TURBOMACHINERY PERFORMANCE DATA * *****						
***** * H2 BOOST TURBINE * *****			***** * H2 BOOST PUMP * *****			
EFFICIENCY	0.443		EFFICIENCY	0.444		
HORSEPOWER	1.		HORSEPOWER	1.		
SPEED (RPM)	10195.		SPEED (RPM)	10195.		
MEAN DIA (IN)	1.90		S SPEED	1362.		
EFF AREA (IN2)	1.45		HEAD (FT)	228.		
U/C (IDEAL)	0.512		DIA. (IN)	2.18		
MAX TIP SPEED	84.		TIP SPEED	97.		
STAGES	1.		VOL. FLOW	61.		
DELTA H (ACT)	1.69		HEAD COEF	0.781		
GAMMA	1.41		FLOW COEF	0.092		
PRESS RATIO (T/T)	1.01					

***** * H2 TURBINE * *****			***** * H2 PUMP * *****			
	STAGE 1	STAGE 2		STAGE ONE	STAGE TWO	STAGE THREE
EFFICIENCY	0.495	0.538	EFFICIENCY	0.415	0.571	0.577
HORSEPOWER	22.	19.	HORSEPOWER	22.	10.	9.
SPEED (RPM)	39541.	39541.	SPEED (RPM)	39541.	39541.	39541.
MEAN DIA (IN)	3.47	3.47	S SPEED	361.	527.	540.
EFF AREA (IN2)	0.21	0.26	HEAD (FT)	8363.	5061.	4910.
U/C (IDEAL)	0.231	0.258	DIA. (IN)	3.69	3.02	3.02
MAX TIP SPEED	599.	599.	TIP SPEED	636.	521.	521.
DELTA H	66.	58.	VOL. FLOW	64.	64.	64.
GAMMA (ACT)	1.41	1.41	HEAD COEF	0.664	0.600	0.582
PRESS RATIO(T/T)	1.33	1.35	FLOW COEF	0.030	0.060	0.062

***** * O2 BOOST TURBINE * *****			***** * O2 BOOST PUMP * *****			
EFFICIENCY	0.435		EFFICIENCY	0.437		
HORSEPOWER	0.		HORSEPOWER	0.		
SPEED (RPM)	2633.		SPEED (RPM)	2633.		
MEAN DIA (IN)	5.20		S SPEED	1361.		
EFF AREA (IN2)	2.02		HEAD (FT)	19.		
U/C (IDEAL)	0.512		DIA. (IN)	2.44		
MAX TIP SPEED	60.		TIP SPEED	28.		
STAGES	1.		VOL. FLOW	23.		
DELTA H (ACT)	0.87		HEAD COEF	0.740		
GAMMA	1.41		FLOW COEF	0.094		
PRESS RATIO (T/T)	1.01					

***** * O2 TURBINE * *****			***** * O2 PUMP * *****			
EFFICIENCY	0.516		EFFICIENCY	0.432		
HORSEPOWER	12.		HORSEPOWER	12.		
SPEED (RPM)	26519.		SPEED (RPM)	26519.		
MEAN DIA (IN)	3.47		S SPEED	833.		
EFF AREA (IN2)	0.25		HEAD (FT)	909.		
U/C (IDEAL)	0.212		DIA. (IN)	1.90		
MAX TIP SPEED	402.		TIP SPEED	220.		
STAGES	1.		VOL. FLOW	23.		
DELTA H (ACT)	37.16		HEAD COEF	0.537		
GAMMA	1.41		FLOW COEF	0.064		
PRESS RATIO (T/T)	1.09					

TABLE 52. — ADVANCED ENGINE PARAMETRIC STUDY SPLIT-EXPANDER ENGINE 5% OF DESIGN THRUST LEVEL

ENGINE PERFORMANCE PARAMETERS

CHAMBER PRESSURE	78.6
VAC ENGINE THRUST	1000.
DEL. VAC. ISP	478.5
TOTAL ENGINE FLOW RATE	2.1
THROAT AREA	6.066
NOZZLE AREA RATIO	1000.0
ENGINE MIXTURE RATIO	6.00
CHAMBER/NOZZLE COOLANT DP	96.
CHAMBER/NOZZLE COOLANT DT	891.
ETA C*	0.993
CHAMBER/NOZZLE Q	980.

ENGINE STATION CONDITIONS

* FUEL SYSTEM CONDITIONS *					
STATION	PRESS	TEMP	FLOW	ENTHALPY	DENSITY
B.P. INLET	18.6	37.4	0.30	-107.5	4.37
B.P. EXIT	21.3	37.5	0.30	-107.2	4.36
PUMP INLET	21.3	37.5	0.30	-107.2	4.36
1ST STAGE EXIT	128.5	41.9	0.30	-93.7	4.26
JBV INLET	128.5	41.9	0.00	-93.7	4.26
JBV EXIT	95.2	42.1	0.00	-93.7	4.22
2ND STAGE EXIT	195.0	43.4	0.30	-88.0	4.24
PUMP EXIT	259.3	44.8	0.30	-82.5	4.22
COOLANT INLET	258.8	44.8	0.30	-82.5	4.22
COOLANT EXIT	162.8	936.2	0.30	3197.0	0.03
TBV INLET	154.8	936.3	0.21	3197.0	0.03
TBV EXIT	111.5	936.6	0.21	3197.0	0.02
LOX TRB INLET	154.8	936.3	0.09	3197.0	0.03
LOX TRB EXIT	144.0	929.1	0.09	3171.8	0.03
H2 TRB INLET	144.0	929.1	0.09	3171.8	0.03
H2 TRB EXIT	114.8	906.5	0.09	3092.6	0.02
H2 TRB DIFF	114.4	906.5	0.09	3092.6	0.02
H2 BST TRB IN	114.1	906.5	0.09	3091.6	0.02
H2 BST TRB EXIT	113.7	906.2	0.09	3091.6	0.02
H2 BST TRB DIFF	113.6	906.2	0.09	3091.6	0.02
O2 BST TRB IN	113.3	906.2	0.09	3091.6	0.02
O2 BST TRB EXIT	113.1	906.1	0.09	3091.1	0.02
O2 BST TRB DIFF	113.1	906.1	0.09	3091.1	0.02
H2 TANK PRESS	18.6	927.7	0.0003	3163.9	0.0038
GOX HEAT EXCH IN	111.5	927.1	0.30	3163.9	0.02
LOX HEAT EXCH OUT	110.0	926.7	0.30	3162.5	0.02
MIXER HOT IN	110.0	926.7	0.30	3162.5	0.02
MIXER COLD IN	95.2	42.1	0.00	-93.7	4.22
MIXER OUT	95.2	926.8	0.30	3162.5	0.02
FSV INLET	95.2	926.8	0.30	3162.5	0.02
FSV EXIT	91.2	926.8	0.30	3162.5	0.02
CHAMBER INJ	89.8	926.8	0.30	3162.5	0.02
CHAMBER	78.6				

* OXYGEN SYSTEM CONDITIONS *					
STATION	PRESS	TEMP	FLOW	ENTHALPY	DENSITY
S.P. INLET	16.0	162.7	1.79	61.1	71.17
S.P. EXIT	19.6	162.7	1.79	61.1	71.16
PUMP INLET	19.6	162.7	1.79	61.1	71.16
PUMP EXIT	196.1	165.2	1.79	62.4	70.91
O2 TANK PRESS	16.0	-00.0	0.30	204.8	0.12
POSV INLET	196.0	165.2	1.79	62.4	70.91
POSV EXIT	100.4	165.6	1.79	62.4	70.75
CCV INLET	196.0	165.2	0.00	62.4	70.91
CCV EXIT	78.6	165.6	0.00	62.4	70.72
PRIMARY INJ	96.4	165.6	1.79	62.4	70.75
SECONDARY INJ	78.6	165.6	0.00	62.4	70.72
CHAMBER	78.6				

VALVE DATA

VALVE	DELTA P	AREA	FLOW	% BYPASS
JBV	32.1	1.000	0.00	0.00
TBV	43.1	1.215	0.21	68.78
FSV	4.0	1.653	0.30	
POSV	19.2	1.032	1.79	
CCV	117.4	1.000	0.00	

DIFFUSER DATA

* FUEL *			* OXID *	
	PRIMARY	SECOND		
DELP MAN	1.51	1.79	0.00	
DELP INJ	9.73	2.95	0.00	
AREA	1.14	0.98	0.43	
FLOW	0.30	1.79	0.00	

ORIGINAL PHOTO
OF POOR QUALITY

TABLE 52. — ADVANCED ENGINE PARAMETRIC STUDY SPLIT-EXPANDER ENGINE 5% OF DESIGN THRUST LEVEL (CONTINUED)

***** * TURBOMACHINERY PERFORMANCE DATA * *****									
***** * H2 BOOST TURBINE * *****					***** * H2 BOOST PUMP * *****				
EFFICIENCY	0.314				EFFICIENCY	0.376			
HORSEPOWER	0.				HORSEPOWER	0.			
SPEED (RPM)	6152.				SPEED (RPM)	6152.			
MEAN DIA (IN)	1.90				S SPEED	1187.			
EFF AREA (IN ²)	1.45				HEAD (FT)	88.			
U/C (IDEAL)	0.512				DIA. (IN)	2.18			
MAX TIP SPEED	51.				TIP SPEED	58.			
STAGES	1.				VOL. FLOW	31.			
DELTA H (ACT)	0.97				HEAD COEF	0.828			
GAMMA	1.43				FLOW COEF	0.076			
PRESS RATIO (T/T)	1.01								
***** * H2 TURBINE * *****					***** * H2 PUMP * *****				
	STAGE 1	STAGE 2				STAGE ONE	STAGE TWO	STAGE THREE	
EFFICIENCY	0.370	0.417			EFFICIENCY	0.340	0.508	0.515	
HORSEPOWER	6.	5.			HORSEPOWER	6.	2.	2.	
SPEED (RPM)	25943.	25943.			SPEED (RPM)	25943.	25943.	25943.	
MEAN DIA (IN)	3.47	3.47			S SPEED	314.	446.	457.	
EFF AREA (IN ²)	0.21	0.26			HEAD (FT)	3590.	2254.	2190.	
U/C (IDEAL)	0.163	0.188			DIA. (IN)	3.69	3.02	3.02	
MAX TIP SPEED	393.	393.			TIP SPEED	418.	342.	342.	
DELTA H (ACT)	43.	36.			VOL. FLOW	31.	32.	32.	
GAMMA (ACT)	1.43	1.43			HEAD COEF	0.662	0.621	0.603	
PRESS RATIO(T/T)	1.33	1.35			FLOW COEF	0.023	0.046	0.046	
***** * O2 BOOST TURBINE * *****					***** * O2 BOOST PUMP * *****				
EFFICIENCY	0.307				EFFICIENCY	0.369			
HORSEPOWER	0.				HORSEPOWER	0.			
SPEED (RPM)	1579.				SPEED (RPM)	1579.			
MEAN DIA (IN)	5.20				S SPEED	1188.			
EFF AREA (IN ²)	2.02				HEAD (FT)	7.			
U/C (IDEAL)	0.512				DIA. (IN)	2.44			
MAX TIP SPEED	36.				TIP SPEED	17.			
STAGES	1.				VOL. FLOW	11.			
DELTA H (ACT)	0.49				HEAD COEF	0.839			
GAMMA	1.43				FLOW COEF	0.078			
PRESS RATIO (T/T)	1.01								
***** * O2 TURBINE * *****					***** * O2 PUMP * *****				
EFFICIENCY	0.383				EFFICIENCY	0.352			
HORSEPOWER	3.				HORSEPOWER	3.			
SPEED (RPM)	17635.				SPEED (RPM)	17635.			
MEAN DIA (IN)	3.47				S SPEED	721.			
EFF AREA (IN ²)	0.25				HEAD (FT)	258.			
U/C (IDEAL)	0.147				DIA. (IN)	1.90			
MAX TIP SPEED	267.				TIP SPEED	147.			
STAGES	1.				VOL. FLOW	11.			
DELTA H (ACT)	25.18				HEAD COEF	0.537			
GAMMA	1.43				FLOW COEF	0.033			
PRESS RATIO (T/T)	1.07								

ORIGINAL FROM
OF BUREAU OF AERONAUTICS

TABLE 53. — ADVANCED ENGINE PARAMETRIC STUDY FULL-EXPANDER ENGINE WITH A HYDROGEN REGENERATOR 100% OF DESIGN THRUST LEVEL

ENGINE PERFORMANCE PARAMETERS						
CHAMBER PRESSURE	1763.9					
VAC ENGINE THRUST	20000.					
DEL. VAC. ISP	480.8					
TOTAL ENGINE FLOW RATE	41.7					
THROAT AREA	5.547					
NOZZLE AREA RATIO	1000.0					
ENGINE MIXTURE RATIO	6.00					
CHAMBER/NOZZLE COOLANT DP	874.					
CHAMBER/NOZZLE COOLANT DT	503.					
ETA C*	0.993					
CHAMBER/NOZZLE Q	11390.					
ENGINE STATION CONDITIONS						

* FUEL SYSTEM CONDITIONS *						
STATION	PRESS	TEMP	FLOW	ENTHALPY	DENSITY	
B.P. INLET	18.6	37.4	5.96	-107.5	4.37	
B.P. EXIT	100.2	38.5	5.96	-103.0	4.39	
PUMP INLET	100.2	38.5	5.96	-103.0	4.39	
1ST STAGE EXIT	1877.6	63.7	5.96	8.5	4.42	
2ND STAGE EXIT	3643.0	87.7	5.96	118.3	4.47	
PUMP EXIT	5403.2	110.6	5.96	226.1	4.54	
COLD REGEN IN	5349.1	111.1	5.96	226.1	4.52	
COLD REGEN EX	5295.6	255.4	5.96	757.5	2.73	
COOLANT INLET	5295.6	255.4	5.96	757.5	2.73	
COOLANT EXIT	4421.6	758.6	5.96	2668.9	0.96	
TBV INLET	4377.3	758.9	0.31	2668.9	0.95	
TBV EXIT	2035.2	773.8	0.31	2668.9	0.47	
LOX TRB INLET	4377.3	758.9	5.65	2668.9	0.95	
LOX TRB EXIT	3978.6	744.7	5.65	2608.9	0.89	
H2 TRB INLET	3978.6	744.7	5.65	2608.9	0.89	
H2 TRB EXIT	2162.4	657.7	5.65	2261.7	0.58	
H2 TRB DIFF	2131.1	657.8	5.65	2261.7	0.57	
H2 BST TRB IN	2109.8	658.0	5.65	2261.7	0.56	
H2 BST TRB EXIT	2090.5	656.7	5.65	2257.0	0.56	
H2 BST TRB DIFF	2077.0	656.8	5.65	2257.0	0.56	
O2 BST TRB IN	2056.3	656.9	5.65	2257.0	0.55	
O2 BST TRB EXIT	2046.9	656.2	5.65	2254.4	0.55	
O2 BST TRB DIFF	2045.4	656.3	5.65	2254.4	0.55	
H2 TANK PRESS	18.6	673.5	0.0071	2275.8	0.0052	
GOX HEAT EXCH IN	2035.2	662.4	5.65	2275.8	0.54	
GOX HEAT EXCH OUT	2026.0	662.0	5.65	2274.4	0.54	
HOT REGEN IN	2026.0	662.0	5.65	2274.4	0.54	
HOT REGEN EX	1965.4	507.3	5.65	1714.0	0.67	
FSV INLET	1965.4	520.9	5.95	1763.4	0.66	
FSV EXIT	1916.2	521.1	5.95	1763.4	0.66	
CHAMBER INJ	1897.1	521.2	5.95	1763.4	0.63	
CHAMBER	1763.5					
* OXYGEN SYSTEM CONDITIONS *						
STATION	PRESS	TEMP	FLOW	ENTHALPY	DENSITY	
B.P. INLET	16.0	162.7	35.77	61.1	71.17	
B.P. EXIT	134.9	163.3	35.77	61.5	71.20	
PUMP INLET	134.9	163.3	35.77	61.5	71.20	
PUMP EXIT	2852.9	176.1	35.77	70.9	71.70	
O2 TANK PRESS	16.0	400.0	0.06	206.8	0.12	
POSV INLET	2824.3	176.2	8.55	70.9	71.65	
POSV EXIT	2309.8	178.2	8.55	70.9	70.86	
OCV INLET	2824.3	176.2	27.16	70.9	71.65	
OCV EXIT	1936.8	179.6	27.16	70.9	70.27	
PRIMARY INJ	2210.2	178.5	8.55	70.9	70.70	
SECONDARY INJ	1905.3	179.7	27.16	70.9	70.22	
CHAMBER	1763.8					
VALVE DATA						

VALVE	DELTA P	AREA	FLOW	% BYPASS		
TBV	2042.	0.014	0.31	5.17		
FSV	49.	1.528	5.95			
POSV	515.	0.067	8.55			
OCV	987.	0.161	27.16			
INJECTOR DATA						

* FUEL *	* OXID *					
		PRIMARY	SECOND			
HELP MAN	19.93	49.57	15.71			
HELP INJ	113.20	446.33	141.36			
AREA	1.05	0.07	0.41			
FLOW	5.95	8.55	27.16			

TABLE 53. — ADVANCED ENGINE PARAMETRIC STUDY FULL-EXPANDER ENGINE WITH A HYDROGEN REGENERATOR 100% OF DESIGN THRUST LEVEL (CONTINUED)

***** * TURBOMACHINERY PERFORMANCE DATA * *****						
***** * H2 BOOST TURBINE * *****			***** * H2 BOOST PUMP * *****			
EFFICIENCY	0.797		EFFICIENCY	0.766		
HORSEPOWER	38.		HORSEPOWER	38.		
SPEED (RPM)	45998.		SPEED (RPM)	45998.		
MEAN DIA (IN)	1.30		S SPEED	3047.		
EFF AREA (IN2)	2.49		HEAD (FT)	2682.		
U/C (IDEAL)	0.478		DIA. (IN)	2.18		
MAX TIP SPEED	260.		TIP SPEED	437.		
STAGES	1.		VOL. FLOW	609.		
DELTA H (ACT)	4.75		HEAD COEF	0.451		
GAMMA	1.35		FLOW COEF	0.201		
PRESS RATIO (T/T)	1.01					
***** * H2 TURBINE * *****			***** * H2 PUMP * *****			
	STAGE 1	STAGE 2		STAGE ONE	STAGE TWO	STAGE THREE
EFFICIENCY	0.841	0.828	EFFICIENCY	0.668	0.669	0.670
HORSEPOWER	1388.	1387.	HORSEPOWER	941.	925.	909.
SPEED (RPM)	124911.	124911.	SPEED (RPM)	124911.	124911.	124911.
MEAN DIA (IN)	2.78	2.78	S SPEED	822.	826.	831.
EFF AREA (IN2)	0.31	0.40	HEAD (FT)	58028.	57176.	56217.
U/C (IDEAL)	0.471	0.467	DIA. (IN)	3.43	3.43	3.43
MAX TIP SPEED	1515.	1515.	TIP SPEED	1869.	1869.	1868.
DELTA H (ACT)	174.	173.	VOL. FLOW	605.	599.	589.
GAMMA (ACT)	1.35	1.35	HEAD COEF	0.535	0.527	0.518
PRESS RATIO(T/T)	1.34	1.37	FLOW COEF	0.099	0.099	0.099
***** * O2 BOOST TURBINE * *****			***** * O2 BOOST PUMP * *****			
EFFICIENCY	0.863		EFFICIENCY	0.764		
HORSEPOWER	20.		HORSEPOWER	20.		
SPEED (RPM)	12315.		SPEED (RPM)	12315.		
MEAN DIA (IN)	3.68		S SPEED	3028.		
EFF AREA (IN2)	3.60		HEAD (FT)	241.		
U/C (IDEAL)	0.514		DIA. (IN)	2.44		
MAX TIP SPEED	198.		TIP SPEED	131.		
STAGES	1.		VOL. FLOW	226.		
DELTA H (ACT)	2.56		HEAD COEF	0.450		
GAMMA	1.35		FLOW COEF	0.201		
PRESS RATIO (T/T)	1.00					
***** * O2 TURBINE * *****			***** * O2 PUMP * *****			
EFFICIENCY	0.852		EFFICIENCY	0.739		
HORSEPOWER	480.		HORSEPOWER	480.		
SPEED (RPM)	76933.		SPEED (RPM)	76933.		
MEAN DIA (IN)	2.78		S SPEED	1813.		
EFF AREA (IN2)	0.43		HEAD (FT)	5457.		
U/C (IDEAL)	0.496		DIA. (IN)	1.92		
MAX TIP SPEED	933.		TIP SPEED	644.		
STAGES	1.		VOL. FLOW	224.		
DELTA H (ACT)	60.04		HEAD COEF	0.423		
GAMMA	1.35		FLOW COEF	0.154		
PRESS RATIO (T/T)	1.10					
***** REGENERATOR DATA *****						
	COLD SIDE	HOT SIDE				
DELP	53.52	60.61				
DELT	144.34	-154.70				
AREA	0.41	1.46				
FLOW	5.96	5.65				
EFFECTIVENESS		0.28				
NTU		0.40				
CRATIO		0.93				
CMIN		20.47				
REGEN Q		3166.75				

TABLE 54. — ADVANCED ENGINE PARAMETRIC STUDY FULL-EXPANDER ENGINE WITH A HYDROGEN REGENERATOR 50% OF DESIGN THRUST LEVEL

ENGINE PERFORMANCE PARAMETERS						
CHAMBER PRESSURE	877.5					
VAC ENGINE THRUST	10000.					
DEL. VAC. ISP	479.0					
TOTAL ENGINE FLOW RATE	20.8					
THROAT AREA	5.547					
NOZZLE AREA RATIO	1000.0					
ENGINE MIXTURE RATIO	6.00					
CHAMBER/NOZZLE COOLANT DP	703.					
CHAMBER/NOZZLE COOLANT DT	590.					
ETA C*	0.993					
CHAMBER/NOZZLE Q	6520.					

ENGINE STATION CONDITIONS						

* FUEL SYSTEM CONDITIONS *						
STATION	PRESS	TEMP	FLOW	ENTHALPY	DENSITY	
B.P. INLET	18.6	37.4	2.98	-107.5	4.27	
B.P. EXIT	52.5	37.9	2.98	-105.6	4.28	
PUMP INLET	52.5	37.9	2.98	-105.6	4.28	
1ST STAGE EXIT	896.4	51.0	2.98	-50.2	4.36	
2ND STAGE EXIT	1724.1	63.4	2.98	3.9	4.36	
PUMP EXIT	2535.4	75.3	2.98	56.7	4.37	
COLD REGEN IN	2521.4	75.4	2.98	56.7	4.36	
COLD REGEN EX	2502.1	262.1	2.98	751.9	1.55	
COOLANT INLET	2502.1	262.1	2.98	751.9	1.55	
COOLANT EXIT	1799.1	851.6	2.98	2939.4	0.38	
TBV INLET	1770.9	851.8	0.94	2939.4	0.37	
TBV EXIT	1018.3	856.6	0.94	2939.4	0.22	
LOX TRB INLET	1770.9	851.8	2.04	2939.4	0.37	
LOX TRB EXIT	1628.9	839.0	2.04	2898.7	0.35	
H2 TRB INLET	1628.9	839.0	2.04	2898.7	0.35	
H2 TRB EXIT	1057.4	775.5	2.04	2656.1	0.25	
H2 TRB DIFF	1047.6	775.6	2.04	2656.1	0.25	
H2 BST TRB IN	1041.1	775.6	2.04	2656.1	0.24	
H2 BST TRB EXIT	1035.1	774.8	2.04	2651.2	0.24	
H2 BST TRB DIFF	1030.9	774.9	2.04	2651.2	0.24	
O2 BST TRB IN	1024.7	774.9	2.04	2651.2	0.24	
O2 BST TRB EXIT	1021.8	774.5	2.04	2649.7	0.24	
O2 BST TRB DIFF	1021.4	774.5	2.04	2649.7	0.24	
H2 TANK PRESS	18.6	806.6	0.0030	2740.7	0.0844	
GOX HEAT EXCH IN	1018.3	800.3	2.04	2740.7	0.23	
GOX HEAT EXCH OUT	1015.5	799.8	2.04	2738.7	0.23	
HOT REGEN IN	1015.5	799.8	2.04	2738.7	0.23	
HOT REGEN EX	996.7	514.2	2.04	1724.9	0.25	
FSV INLET	996.7	620.3	2.98	2106.5	0.29	
FSV EXIT	967.6	620.4	2.98	2106.5	0.28	
CHAMBER INJ	956.8	620.5	2.98	2106.5	0.28	
CHAMBER	877.4					

* OXYGEN SYSTEM CONDITIONS *						
STATION	PRESS	TEMP	FLOW	ENTHALPY	DENSITY	
B.P. INLET	16.0	162.7	17.90	61.1	71.17	
B.P. EXIT	64.7	163.0	17.90	61.2	71.18	
PUMP INLET	64.7	163.0	17.90	61.2	71.18	
PUMP EXIT	1571.5	170.8	17.90	66.8	71.25	
O2 TANK PRESS	16.0	400.0	0.03	204.8	0.12	
POSV INLET	1564.3	170.9	6.87	66.8	71.24	
POSV EXIT	1220.4	172.1	6.87	66.8	70.80	
OCV INLET	1564.3	170.9	11.00	66.8	71.54	
OCV EXIT	905.8	173.3	11.00	66.8	70.27	
PRIMARY INJ	1166.0	172.3	6.87	66.8	70.70	
SECONDARY INJ	900.7	173.3	11.00	66.8	70.26	
CHAMBER	877.6					

VALVE DATA				

VALVE	DELTA P	AREA	FLOW	% BYPASS
TBV	752.	0.009	0.94	31.42
FSV	29.	0.528	2.98	
POSV	334.	0.007	6.87	
OCV	659.	0.076	11.00	

INJECTOR DATA				

* FUEL *				
* O2 OXID *				
		PRIMARY	SECOND	
DELP MAN	11.25	22.04	2.57	
DELP INJ	68.07	178.44	23.15	
AREA	1.05	3.07	0.41	
FLOW	2.98	6.87	11.00	

TABLE 54. — ADVANCED ENGINE PARAMETRIC STUDY FULL-EXPANDER ENGINE WITH A HYDROGEN REGENERATOR 50% OF DESIGN THRUST LEVEL (CONTINUED)

```

*****
* TURBOMACHINERY PERFORMANCE DATA *
*****

*****
* H2 BOOST TURBINE *
*****
EFFICIENCY      0.648
HORSEPOWER      8.
SPEED (RPM)     27083.
MEAN DIA (IN)   1.30
EFF AREA (IN2)  2.49
U/C (IDEAL)     0.478
MAX TIP SPEED   153.
STAGES          1.
DELTA H (ACT)   2.87
GAMMA           1.45
PRESS RATIO (T/T) 1.01

*****
* H2 BOOST PUMP *
*****
EFFICIENCY      0.729
HORSEPOWER      8.
SPEED (RPM)     27083.
S SPEED         2454.
HEAD (FT)       1115.
DIA. (IN)       2.18
TIP SPEED       257.
VOL. FLOW       306.
HEAD COEF       0.541
FLOW COEF       0.172

*****
* H2 TURBINE *
*****
          STAGE 1  STAGE 2
EFFICIENCY  0.690  0.713
HORSEPOWER  363.   321.
SPEED (RPM) 81622. 81622.
MEAN DIA (IN)  2.78  2.78
EFF AREA (IN2) 0.31  0.40
U/C (IDEAL)  0.328 0.354
MAX TIP SPEED 990.   990.
DELTA H      125.  111.
GAMMA (ACT)  1.45  1.45
PRESS RATIO(T/T) 1.34 1.37

*****
* H2 PUMP *
*****
          STAGE ONE  STAGE TWO  STAGE THREE
EFFICIENCY  0.646  0.649  0.652
HORSEPOWER  233.   228.   222.
SPEED (RPM) 81622. 81622. 81622.
S SPEED     663.   673.   683.
HEAD (FT)   27819. 27316. 26753.
DIA. (IN)   3.43   3.43   3.43
TIP SPEED   1221.  1221.  1221.
VOL. FLOW   307.   307.   306.
HEAD COEF   0.600  0.589  0.578
FLOW COEF   0.076  0.078  0.079

*****
* O2 BOOST TURBINE *
*****
EFFICIENCY      0.701
HORSEPOWER      4.
SPEED (RPM)     7188.
MEAN DIA (IN)   3.68
EFF AREA (IN2)  3.60
U/C (IDEAL)     0.514
MAX TIP SPEED   115.
STAGES          1.
DELTA H (ACT)   1.52
GAMMA           1.45
PRESS RATIO (T/T) 1.00

*****
* O2 BOOST PUMP *
*****
EFFICIENCY      0.729
HORSEPOWER      4.
SPEED (RPM)     7188.
S SPEED         1402.
HEAD (FT)       99.
DIA. (IN)       2.44
TIP SPEED       77.
VOL. FLOW       113.
HEAD COEF       0.542
FLOW COEF       0.172

*****
* O2 TURBINE *
*****
EFFICIENCY      0.704
HORSEPOWER      141.
SPEED (RPM)     53400.
MEAN DIA (IN)   2.78
EFF AREA (IN2)  0.43
U/C (IDEAL)     0.348
MAX TIP SPEED   648.
STAGES          1.
DELTA H (ACT)   48.72
GAMMA           1.45
PRESS RATIO (T/T) 1.09

*****
* O2 PUMP *
*****
EFFICIENCY      0.702
HORSEPOWER      141.
SPEED (RPM)     53400.
S SPEED         1384.
HEAD (FT)       3041.
DIA. (IN)       1.92
TIP SPEED       447.
VOL. FLOW       113.
HEAD COEF       0.490
FLOW COEF       0.112

*****
REGENERATOR DATA
*****
          COLD SIDE  HOT SIDE
DELP      19.24    18.84
DELT      186.70   -285.59
AREA       0.41    1.46
FLOW       2.98    2.04
EFFECTIVENESS 0.39
NTU        0.62
RATIO      0.65
OMIN       7.26
REGEN Q    2072.05

```

TABLE 55. — ADVANCED ENGINE PARAMETRIC STUDY FULL-EXPANDER ENGINE WITH A HYDROGEN REGENERATOR 10% OF DESIGN THRUST LEVEL

ENGINE PERFORMANCE PARAMETERS					
CHAMBER PRESSURE					173.1
VAC ENGINE THRUST					2000.
DEL. VAC. ISP					479.0
TOTAL ENGINE FLOW RATE					4.2
THROAT AREA					5.547
NOZZLE AREA RATIO					1000.0
ENGINE MIXTURE RATIO					6.00
CHAMBER/MOZZLE COOLANT DP					142.
CHAMBER/MOZZLE COOLANT DT					841.
ETA C*					0.993
CHAMBER/MOZZLE Q					1808.

ENGINE STATION CONDITIONS					

* FUEL SYSTEM CONDITIONS *					
STATION	PRESS	TEMP	FLOW	ENTHALPY	DENSITY
B.P. INLET	18.6	37.4	0.60	-107.5	4.37
B.P. EXIT	22.7	37.4	0.60	-107.2	4.37
PUMP INLET	22.7	37.4	0.60	-107.2	4.37
1ST STAGE EXIT	162.8	41.1	0.60	-95.0	4.32
2ND STAGE EXIT	299.4	44.2	0.60	-83.1	4.27
PUMP EXIT	432.3	47.3	0.60	-71.6	4.23
COLD REGEN IN	431.7	47.3	0.60	-71.6	4.23
COLD REGEN EX	428.9	276.7	0.60	816.4	0.29
COOLANT INLET	428.9	276.7	0.60	816.4	0.29
COOLANT EXIT	286.9	1118.1	0.60	3831.7	0.05
TBV INLET	277.9	1118.2	0.37	3831.7	0.05
TBV EXIT	207.8	1118.7	0.37	3831.7	0.03
LOX TRB INLET	277.9	1118.2	0.23	3831.7	0.05
LOX TRB EXIT	263.3	1112.0	0.23	3809.7	0.04
H2 TRB INLET	263.3	1112.0	0.23	3809.7	0.04
H2 TRB EXIT	211.2	1085.8	0.23	3717.4	0.04
H2 TRB DIFF	210.3	1085.8	0.23	3717.4	0.04
H2 BST TRB IN	209.7	1085.8	0.23	3717.4	0.04
H2 BST TRB EXIT	209.2	1085.6	0.23	3716.5	0.04
H2 BST TRB DIFF	208.8	1085.6	0.23	3716.5	0.04
O2 BST TRB IN	208.3	1085.6	0.23	3716.5	0.04
O2 BST TRB EXIT	208.1	1085.5	0.23	3716.1	0.04
O2 BST TRB DIFF	208.0	1085.5	0.23	3716.1	0.04
H2 TANK PRESS	18.6	1107.3	0.0004	3787.1	0.0032
GOX HEAT EXCH IN	207.8	1105.9	0.23	3787.1	0.04
GOX HEAT EXCH OUT	207.5	1104.8	0.23	3783.3	0.04
HOT REGEN IN	207.5	1104.8	0.23	3783.3	0.04
HOT REGEN EX	205.9	449.8	0.23	1482.7	0.09
FSV INLET	205.9	857.8	0.60	2925.1	0.04
FSV EXIT	198.1	857.9	0.60	2925.1	0.04
CHAMBER INJ	195.2	857.9	0.60	2925.1	0.04
CHAMBER	173.1				

* OXYGEN SYSTEM CONDITIONS *					
STATION	PRESS	TEMP	FLOW	ENTHALPY	DENSITY
B.P. INLET	16.0	162.7	3.59	61.1	71.17
B.P. EXIT	21.6	162.7	3.59	61.1	71.17
PUMP INLET	21.6	162.7	3.59	61.1	71.17
PUMP EXIT	293.6	165.1	3.59	62.5	71.03
O2 TANK PRESS	16.0	400.0	0.01	204.8	0.12
POSV INLET	293.3	165.1	2.87	62.5	71.03
POSV EXIT	234.6	165.4	2.87	62.5	70.93
OCV INLET	293.3	165.1	0.70	62.5	71.03
OCV EXIT	173.2	165.6	0.70	62.5	70.83
PRIMARY INJ	223.4	165.4	2.87	62.5	70.92
SECONDARY INJ	173.2	165.6	0.70	62.5	70.83
CHAMBER	173.1				

VALVE DATA				

VALVE	DELTA P	AREA	FLOW	% BYPASS
TBV	170.	1.264	0.37	61.41
FSV	100.	1.528	0.60	
POSV	120.	1.267	0.37	
OCV	120.	1.011	0.70	

INJECTOR DATA			

* FUEL *	* OXID *		
	PRIMARY	SECOND	
DELP MAN	2.98	5.59	0.01
DELP INJ	19.12	50.22	0.09
AREA	1.05	0.97	0.41
FLOW	0.60	2.87	0.70

TABLE 55. — ADVANCED ENGINE PARAMETRIC STUDY FULL-EXPANDER ENGINE WITH A HYDROGEN REGENERATOR 10% OF DESIGN THRUST LEVEL (CONTINUED)

***** # TURBOMACHINERY PERFORMANCE DATA # *****						
***** # H2 BOOST TURBINE # *****			***** # H2 BOOST PUMP # *****			
EFFICIENCY	0.381		EFFICIENCY	0.543		
HORSEPOWER	0.		HORSEPOWER	0.		
SPEED (RPM)	8140.		SPEED (RPM)	8140.		
MEAN DIA (IN)	1.30		S SPEED	1632.		
EFF AREA (IN2)	2.49		HEAD (FT)	133.		
U/C (IDEAL)	0.478		DIA. (IN)	2.18		
MAX TIP SPEED	46.		TIP SPEED	77.		
STAGES	1.		VOL. FLOW	61.		
DELTA H (ACT)	0.81		HEAD COEF	0.712		
GAMMA	1.40		FLOW COEF	0.115		
PRESS RATIO (T/T)	1.01					
***** # H2 TURBINE # *****			***** # H2 PUMP # *****			
	STAGE 1	STAGE 2		STAGE ONE	STAGE TWO	STAGE THREE
EFFICIENCY	0.371	0.417	EFFICIENCY	0.489	0.495	0.502
HORSEPOWER	16.	14.	HORSEPOWER	10.	10.	10.
SPEED (RPM)	32027.	32027.	SPEED (RPM)	32027.	32027.	32027.
MEAN DIA (IN)	2.78	2.78	S SPEED	448.	455.	464.
EFF AREA (IN2)	0.31	0.40	HEAD (FT)	4653.	4580.	4498.
U/C (IDEAL)	0.149	0.173	DIA. (IN)	3.43	3.43	3.43
MAX TIP SPEED	388.	388.	TIP SPEED	479.	479.	479.
DELTA H	50.	42.	VOL. FLOW	62.	63.	63.
GAMMA (ACT)	1.40	1.40	HEAD COEF	0.652	0.642	0.631
PRESS RATIO(T/T)	1.34	1.37	FLOW COEF	0.039	0.040	0.042
***** # O2 BOOST TURBINE # *****			***** # O2 BOOST PUMP # *****			
EFFICIENCY	0.322		EFFICIENCY	0.536		
HORSEPOWER	0.		HORSEPOWER	0.		
SPEED (RPM)	2117.		SPEED (RPM)	2117.		
MEAN DIA (IN)	3.68		S SPEED	1633.		
EFF AREA (IN2)	3.60		HEAD (FT)	11.		
U/C (IDEAL)	0.514		DIA. (IN)	2.44		
MAX TIP SPEED	34.		TIP SPEED	23.		
STAGES	1.		VOL. FLOW	23.		
DELTA H (ACT)	0.42		HEAD COEF	0.717		
GAMMA	1.40		FLOW COEF	0.117		
PRESS RATIO (T/T)	1.00					
***** # O2 TURBINE # *****			***** # O2 PUMP # *****			
EFFICIENCY	0.371		EFFICIENCY	0.502		
HORSEPOWER	7.		HORSEPOWER	7.		
SPEED (RPM)	21785.		SPEED (RPM)	21785.		
MEAN DIA (IN)	2.78		S SPEED	911.		
EFF AREA (IN2)	0.43		HEAD (FT)	552.		
U/C (IDEAL)	0.153		DIA. (IN)	1.92		
MAX TIP SPEED	264.		TIP SPEED	182.		
STAGES	1.		VOL. FLOW	23.		
DELTA H (ACT)	21.98		HEAD COEF	0.534		
GAMMA	1.40		FLOW COEF	0.055		
PRESS RATIO (T/T)	1.06					
***** # REGENERATOR DATA # *****						
	COLD SIDE	HOT SIDE				
DEL P	2.82	1.60				
DEL T	229.44	-654.98				
AREA	0.41	1.46				
FLOW	0.60	0.23				
EFFECTIVENESS		0.62				
NTU		1.18				
CRATIO		0.35				
CMIN		0.81				
REGEN Q		530.04				

TABLE 56. — ADVANCED ENGINE PARAMETRIC STUDY FULL-EXPANDER ENGINE WITH A HYDROGEN REGENERATOR 5% OF DESIGN THRUST LEVEL

ENGINE PERFORMANCE PARAMETERS					
CHAMBER PRESSURE	86.0				
VAC ENGINE THRUST	1000.				
DEL. VAC. ISP	478.5				
TOTAL ENGINE FLOW RATE	2.1				
THROAT AREA	5.567				
NOZZLE AREA RATIO	1008.0				
ENGINE MIXTURE RATIO	6.00				
CHAMBER/NOZZLE COOLANT DP	53.				
CHAMBER/NOZZLE COOLANT DT	929.				
ETA C*	0.995				
CHAMBER/NOZZLE Q	990.				

ENGINE STATION CONDITIONS					
* FUEL SYSTEM CONDITIONS *					
STATION	PRESS	TEMP	FLOW	ENTHALPY	DENSITY
B.P. INLET	18.6	37.4	0.30	-107.5	4.37
B.P. EXIT	20.1	37.4	0.30	-107.4	4.37
PUMP INLET	20.1	37.4	0.30	-107.4	4.37
1ST STAGE EXIT	78.0	39.4	0.30	-101.5	4.34
2ND STAGE EXIT	134.6	41.0	0.30	-95.8	4.30
PUMP EXIT	189.8	42.6	0.30	-90.2	4.27
COLD REGEN IN	189.6	42.6	0.30	-90.2	4.27
COLD REGEN EX	188.2	276.7	0.30	818.8	0.13
COOLANT INLET	188.2	276.7	0.30	818.8	0.13
COOLANT EXIT	135.2	1205.5	0.30	4132.8	0.02
TBV INLET	130.1	1205.6	0.21	4132.8	0.02
TBV EXIT	104.7	1205.8	0.21	4132.8	0.02
LOX TRB INLET	130.1	1205.6	0.09	4132.8	0.02
LOX TRB EXIT	124.6	1201.7	0.09	4119.1	0.02
H2 TRB INLET	124.6	1201.7	0.09	4119.1	0.02
H2 TRB EXIT	106.0	1186.1	0.09	4064.1	0.02
H2 TRB DIFF	105.7	1186.1	0.09	4064.1	0.02
H2 BST TRB IN	105.5	1186.1	0.09	4064.1	0.02
H2 BST TRB EXIT	105.3	1186.0	0.09	4063.6	0.02
H2 BST TRB DIFF	105.1	1186.0	0.09	4063.6	0.02
O2 BST TRB IN	104.9	1186.0	0.10	4063.6	0.02
O2 BST TRB EXIT	104.8	1185.9	0.10	4063.4	0.02
O2 BST TRB DIFF	104.8	1185.9	0.10	4063.4	0.02
H2 TANK PRESS	18.6	1200.2	0.0002	4111.2	0.0029
GOX HEAT EXCH IN	104.7	1199.6	0.09	4111.2	0.02
GOX HEAT EXCH OUT	104.7	1198.3	0.09	4106.5	0.02
HOT REGEN IN	104.7	1198.3	0.09	4106.5	0.02
HOT REGEN EX	104.1	371.8	0.09	1190.0	0.05
FSV INLET	104.1	942.0	0.30	3215.6	0.02
FSV EXIT	99.8	942.0	0.30	3215.6	0.02
CHAMBER INJ	98.2	942.0	0.30	3215.6	0.02
CHAMBER	86.0				

* OXYGEN SYSTEM CONDITIONS *					
STATION	PRESS	TEMP	FLOW	ENTHALPY	DENSITY
B.P. INLET	16.0	162.7	1.79	61.1	71.17
B.P. EXIT	17.0	162.7	1.79	61.1	71.17
PUMP INLET	17.0	162.7	1.79	61.1	71.17
PUMP EXIT	132.4	164.0	1.79	61.8	71.07
O2 TANK PRESS	16.0	400.0	0.00	204.8	0.12
POSV INLET	132.3	164.0	1.78	61.8	71.07
POSV EXIT	109.8	164.1	1.78	61.8	71.03
OCV INLET	132.3	164.0	0.01	61.8	71.07
OCV EXIT	86.0	164.2	0.01	61.8	70.99
PRIMARY INJ	105.5	164.1	1.78	61.8	71.02
SECONDARY INJ	86.0	164.2	0.01	61.8	70.99
CHAMBER	86.2				

VALVE DATA				
VALVE	DELTA P	AREA	FLOW	% BYPASS
TBV	25.	0.484	0.21	68.83
FSV	4.	1.528	0.30	
POSV	23.	0.067	1.78	
OCV	46.	0.000	0.01	

INJECTOR DATA				
* FUEL *		* OXID *		
	PRIMARY	SECOND		
DEL P MAN	1.63	2.15		0.00
DEL P INJ	10.62	19.31		0.00
AREA	1.05	3.37		0.41
FLOW	0.30	1.78		0.01

TABLE 56. — ADVANCED ENGINE PARAMETRIC STUDY FULL-EXPANDER ENGINE WITH A HYDROGEN REGENERATOR 5% OF DESIGN THRUST LEVEL (CONTINUED)

***** # TURBOMACHINERY PERFORMANCE DATA # *****						
# H2 BOOST TURBINE #			# H2 BOOST PUMP #			
*****			*****			
EFFICIENCY	0.209		EFFICIENCY	0.468		
HORSEPOWER	0.		HORSEPOWER	0.		
SPEED (RPM)	4798.		SPEED (RPM)	4798.		
MEAN DIA (IN)	1.30		S SPEED	1426.		
EFF AREA (IN2)	2.49		HEAD (FT)	49.		
U/C (IDEAL)	0.470		DIA. (IN)	2.18		
MAX TIP SPEED	27.		TIP SPEED	46.		
STAGES	1.		VOL. FLOW	31.		
DELTA H (ACT)	0.44		HEAD COEF	0.765		
GAMMA	1.37		FLOW COEF	0.097		
PRESS RATIO (T/T)	1.01					
*****			*****			
# H2 TURBINE #			# H2 PUMP #			
*****			*****			
	STAGE 1	STAGE 2	STAGE ONE	STAGE TWO	STAGE THREE	
	*****	*****	*****	*****	*****	
EFFICIENCY	0.273	0.315	EFFICIENCY	0.418	0.423	0.430
HORSEPOWER	4.	3.	HORSEPOWER	2.	2.	2.
SPEED (RPM)	20529.	20529.	SPEED (RPM)	20529.	20529.	20529.
MEAN DIA (IN)	2.70	2.70	S SPEED	394.	400.	407.
EFF AREA (IN2)	0.31	0.40	HEAD (FT)	1915.	1886.	1855.
U/C (IDEAL)	0.106	0.125	DIA. (IN)	3.43	3.43	3.43
MAX TIP SPEED	249.	249.	TIP SPEED	307.	307.	307.
DELTA H	30.	25.	VOL. FLOW	31.	31.	31.
GAMMA (ACT)	1.37	1.37	HEAD COEF	0.653	0.644	0.633
PRESS RATIO(T/T)	1.34	1.37	FLOW COEF	0.031	0.031	0.032
*****			*****			
# O2 BOOST TURBINE #			# O2 BOOST PUMP #			
*****			*****			
EFFICIENCY	0.150		EFFICIENCY	0.601		
HORSEPOWER	0.		HORSEPOWER	0.		
SPEED (RPM)	934.		SPEED (RPM)	934.		
MEAN DIA (IN)	3.68		S SPEED	1836.		
EFF AREA (IN2)	3.60		HEAD (FT)	2.		
U/C (IDEAL)	0.514		DIA. (IN)	2.44		
MAX TIP SPEED	15.		TIP SPEED	10.		
STAGES	1.		VOL. FLOW	11.		
DELTA H (ACT)	0.19		HEAD COEF	0.667		
GAMMA	1.37		FLOW COEF	0.133		
PRESS RATIO (T/T)	1.00					
*****			*****			
# O2 TURBINE #			# O2 PUMP #			
*****			*****			
EFFICIENCY	0.271		EFFICIENCY	0.423		
HORSEPOWER	2.		HORSEPOWER	2.		
SPEED (RPM)	14146.		SPEED (RPM)	14146.		
MEAN DIA (IN)	2.78		S SPEED	796.		
EFF AREA (IN2)	0.43		HEAD (FT)	234.		
U/C (IDEAL)	0.100		DIA. (IN)	1.92		
MAX TIP SPEED	172.		TIP SPEED	118.		
STAGES	1.		VOL. FLOW	11.		
DELTA H (ACT)	13.69		HEAD COEF	0.537		
GAMMA	1.37		FLOW COEF	0.042		
PRESS RATIO (T/T)	1.04					

REGENERATOR DATA						

	COLD SIDE	HOT SIDE				
DELP	1.45	0.56				
DELT	234.08	-826.44				
AREA	0.41	1.46				
FLOW	0.30	0.09				
EFFECTIVENESS	0.72					
NTU	1.54					
CRATIO	0.28					
CMIN	0.33					
REGEN Q	271.56					



**APPENDIX D
OFF-DESIGN MIXTURE RATIO CYCLES**

Off-design mixture ratio cycle data are presented in Tables 57 through 68.

PRECEDING PAGE BLANK NOT FILMED

TABLE 57. — SPLIT-EXPANDER CYCLE — O/F = 5.0

ENGINE PERFORMANCE PARAMETERS					

CHAMBER PRESSURE	1370.7				
VAC ENGINE THRUST	14476.				
DEL. VAC. ISP	477.1				
TOTAL ENGINE FLOW RATE	34.5				
THROAT AREA	6.071				
NOZZLE AREA RATIO	1000.0				
ENGINE MIXTURE RATIO	5.00				
CHAMBER/NOZZLE COOLANT DP	467.				
CHAMBER/NOZZLE COOLANT DT	790.				
ETA C*	0.993				
CHAMBER/NOZZLE Q	8509.				
ENGINE STATION CONDITIONS					

* FUEL SYSTEM CONDITIONS *					
STATION	PRESS	TEMP	FLOW	ENTHALPY	DENSITY
B.P. INLET	18.6	37.4	5.76	-107.5	4.37
B.P. EXIT	93.0	38.4	5.76	-103.4	4.39
PUMP INLET	93.0	38.4	5.76	-103.4	4.39
1ST STAGE EXIT	1919.6	66.6	5.76	17.5	4.36
JBV INLET	1878.8	66.9	2.88	17.5	4.33
JBV EXIT	1547.9	69.4	2.88	17.5	4.09
2ND STAGE EXIT	3070.1	84.9	2.88	96.6	4.34
PUMP EXIT	4185.3	102.2	2.88	172.8	4.35
COOLANT INLET	4140.5	102.6	2.88	172.8	4.33
COOLANT EXIT	3673.7	892.5	2.88	3126.5	0.70
TBV INLET	3639.2	892.7	0.03	3126.5	0.70
TBV EXIT	1618.4	906.1	0.03	3126.5	0.32
LOX TRB INLET	3639.2	892.7	2.85	3126.5	0.70
LOX TRB EXIT	3204.7	869.9	2.85	3036.0	0.63
H2 TRB INLET	3204.7	869.9	2.85	3036.0	0.63
H2 TRB EXIT	1721.6	766.1	2.85	2634.8	0.40
H2 TRB DIFF	1701.8	766.2	2.85	2634.8	0.40
H2 BST TRB IN	1683.2	766.3	2.85	2634.8	0.39
H2 BST TRB EXIT	1662.0	764.1	2.85	2626.5	0.39
H2 BST TRB DIFF	1657.4	764.1	2.85	2626.5	0.39
O2 BST TRB IN	1639.2	764.2	2.85	2626.5	0.38
O2 BST TRB EXIT	1628.0	763.0	2.85	2622.1	0.38
O2 BST TRB DIFF	1627.3	763.0	2.85	2622.1	0.38
H2 TANK PRESS	18.6	774.2	0.0060	2627.1	0.0045
GOX HEAT EXCH IN	1618.4	764.5	2.85	2627.1	0.38
GOX HEAT EXCH OUT	1610.4	763.9	2.85	2624.8	0.38
MIXER HOT IN	1610.4	763.9	2.85	2624.8	0.38
MIXER COLD IN	1547.9	69.4	2.88	17.5	4.09
MIXER OUT	1530.8	402.0	5.76	1314.6	0.67
FSV INLET	1530.8	402.0	5.76	1314.6	0.67
FSV EXIT	1491.9	402.1	5.76	1314.6	0.65
CHAMBER INJ	1476.7	402.1	5.76	1314.6	0.64
CHAMBER	1371.1				
* OXYGEN SYSTEM CONDITIONS *					
STATION	PRESS	TEMP	FLOW	ENTHALPY	DENSITY
B.P. INLET	16.0	162.7	28.83	61.9	70.99
B.P. EXIT	138.7	165.4	28.83	62.4	70.83
PUMP INLET	138.7	165.4	28.83	62.4	70.83
PUMP EXIT	2647.8	177.8	28.83	71.3	71.24
O2 TANK PRESS	16.0	400.0	0.05	204.7	0.12
POSV INLET	2630.8	177.8	6.09	71.3	71.22
POSV EXIT	1627.3	181.7	6.09	71.3	69.63
OCV INLET	2630.8	177.8	22.68	71.3	71.22
OCV EXIT	1481.8	182.3	22.68	71.3	69.40
PRIMARY INJ	1580.4	181.9	6.09	71.3	69.56
SECONDARY INJ	1461.5	182.4	22.68	71.3	69.36
CHAMBER	1370.6				
VALVE DATA					

VALVE	DELTA P	AREA	FLOW	% BYPASS	
JBV	348.	0.114	2.88	50.00	
TBV	2021.	0.002	0.03	1.00	
FSV	39.	1.654	5.76		
POSV	1004.	0.034	6.09		
OCV	1149.	0.119	22.68		
INJECTOR DATA					

* FUEL *		* OXID *			
		PRIMARY	SECOND		
DELP MAN	15.76	23.31	10.09		
DELP INJ	90.19	209.80	90.77		
AREA	1.14	0.08	0.43		
FLOW	5.76	6.09	22.68		

TABLE 57. — SPLIT-EXPANDER CYCLE — O/F = 5.0 (CONTINUED)

* TURBOMACHINERY PERFORMANCE DATA *						

*****			*****			
* H2 BOOST TURBINE *			* H2 BOOST PUMP *			
*****			*****			
EFFICIENCY	0.867		EFFICIENCY	0.765		
HORSEPOWER	33.		HORSEPOWER	33.		
SPEED (RPM)	44201.		SPEED (RPM)	44201.		
MEAN DIA (IN)	1.90		S SPEED	3088.		
EFF AREA (IN2)	1.45		HEAD (FT)	2443.		
U/C (IDEAL)	0.512		DIA. (IN)	2.18		
MAX TIP SPEED	366.		TIP SPEED	420.		
STAGES	1.		VOL. FLOW	589.		
DELTA H (ACT)	8.29		HEAD COEF	0.445		
GAMMA	1.41		FLOW COEF	0.203		
PRESS RATIO (T/T)	1.01					
*****			*****			
* H2 TURBINE *			* H2 PUMP *			
*****			*****			
	STAGE 1	STAGE 2	STAGE ONE	STAGE TWO	STAGE THREE	
	*****	*****	*****	*****	*****	
EFFICIENCY	0.818	0.816	EFFICIENCY	0.640	0.619	0.624
HORSEPOWER	1619.	1619.	HORSEPOWER	986.	323.	310.
SPEED (RPM)	118310.	118310.	SPEED (RPM)	118310.	118310.	118310.
MEAN DIA (IN)	3.47	3.47	S SPEED	750.	749.	765.
EFF AREA (IN2)	0.21	0.27	HEAD (FT)	60268.	38125.	36980.
U/C (IDEAL)	0.515	0.506	DIA. (IN)	3.68	3.02	3.02
MAX TIP SPEED	1792.	1792.	TIP SPEED	1904.	1558.	1558.
DELTA H	197.	204.	VOL. FLOW	594.	298.	297.
GAMMA (ACT)	1.41	1.41	HEAD COEF	0.535	0.505	0.490
PRESS RATIO(T/T)	1.33	1.35	FLOW COEF	0.094	0.094	0.095
*****			*****			
* O2 BOOST TURBINE *			* O2 BOOST PUMP *			
*****			*****			
EFFICIENCY	0.860		EFFICIENCY	0.732		
HORSEPOWER	18.		HORSEPOWER	18.		
SPEED (RPM)	11472.		SPEED (RPM)	11472.		
MEAN DIA (IN)	5.21		S SPEED	2470.		
EFF AREA (IN2)	2.02		HEAD (FT)	250.		
U/C (IDEAL)	0.512		DIA. (IN)	2.44		
MAX TIP SPEED	261.		TIP SPEED	122.		
STAGES	1.		VOL. FLOW	183.		
DELTA H (ACT)	4.43		HEAD COEF	0.537		
GAMMA	1.41		FLOW COEF	0.173		
PRESS RATIO (T/T)	1.01					
*****			*****			
* O2 TURBINE *			* O2 PUMP *			
*****			*****			
EFFICIENCY	0.824		EFFICIENCY	0.728		
HORSEPOWER	365.		HORSEPOWER	365.		
SPEED (RPM)	70756.		SPEED (RPM)	70756.		
MEAN DIA (IN)	3.47		S SPEED	1587.		
EFF AREA (IN2)	0.25		HEAD (FT)	5070.		
U/C (IDEAL)	0.457		DIA. (IN)	1.92		
MAX TIP SPEED	1072.		TIP SPEED	592.		
STAGES	1.		VOL. FLOW	182.		
DELTA H (ACT)	90.48		HEAD COEF	0.465		
GAMMA	1.41		FLOW COEF	0.131		
PRESS RATIO (T/T)	1.14					

TABLE 58. — SPLIT-EXPANDER CYCLE — O/F = 5.5

ENGINE PERFORMANCE PARAMETERS					
CHAMBER PRESSURE					1522.7
VAC ENGINE THRUST					18600.
DEL. VAC. ISP					479.0
TOTAL ENGINE FLOW RATE					38.8
THROAT AREA					6.071
NOZZLE AREA RATIO					1000.0
ENGINE MIXTURE RATIO					5.50
CHAMBER/NOZZLE COOLANT DP					525.
CHAMBER/NOZZLE COOLANT DT					886.
ETA C*					0.993
CHAMBER/NOZZLE Q					9849.
ENGINE STATION CONDITIONS					

* FUEL SYSTEM CONDITIONS *					
STATION	PRESS	TEMP	FLOW	ENTHALPY	DENSITY
B.P. INLET	18.6	37.4	5.98	-107.5	4.37
B.P. EXIT	100.2	38.5	5.98	-103.0	4.39
PUMP INLET	100.2	38.5	5.98	-103.0	4.39
1ST STAGE EXIT	2104.4	69.3	5.98	29.5	4.36
JBV INLET	2060.5	69.7	2.99	29.5	4.33
JBV EXIT	1712.9	72.3	2.99	29.5	4.09
2ND STAGE EXIT	3368.4	89.3	2.99	116.3	4.34
PUMP EXIT	4596.1	108.2	2.99	199.9	4.36
COOLANT INLET	4548.1	108.6	2.99	199.9	4.34
COOLANT EXIT	4023.2	995.0	2.99	3494.2	0.69
TBV INLET	3985.3	995.3	0.03	3494.2	0.69
TBV EXIT	1789.7	1010.5	0.03	3494.2	0.32
LOX TRB INLET	3985.3	995.3	2.96	3494.2	0.69
LOX TRB EXIT	3510.0	970.0	2.96	3394.2	0.63
H2 TRB INLET	3510.0	970.0	2.96	3394.2	0.63
H2 TRB EXIT	1902.0	855.2	2.96	2954.4	0.40
H2 TRB DIFF	1880.4	855.4	2.96	2954.4	0.39
H2 BST TRB IN	1860.2	855.5	2.96	2954.4	0.39
H2 BST TRB EXIT	1837.1	853.1	2.96	2945.3	0.38
H2 BST TRB DIFF	1832.1	853.1	2.96	2945.3	0.38
O2 BST TRB IN	1812.4	853.2	2.96	2945.3	0.38
O2 BST TRB EXIT	1800.2	851.9	2.96	2940.4	0.38
O2 BST TRB DIFF	1799.4	851.9	2.96	2940.4	0.38
H2 TANK PRESS	18.6	865.0	0.0056	2946.0	0.0041
GOX HEAT EXCH IN	1789.7	853.6	2.96	2946.0	0.38
GOX HEAT EXCH OUT	1781.0	852.9	2.96	2943.5	0.37
MIXER HOT IN	1781.0	852.9	2.96	2943.5	0.37
MIXER COLD IN	1712.9	72.3	2.99	29.5	4.09
MIXER OUT	1694.5	444.7	5.97	1479.2	0.66
FSV INLET	1694.5	444.7	5.97	1479.2	0.66
FSV EXIT	1652.6	444.8	5.97	1479.2	0.65
CHAMBER INJ	1636.2	444.9	5.97	1479.2	0.64
CHAMBER	1522.7				
* OXYGEN SYSTEM CONDITIONS *					
STATION	PRESS	TEMP	FLOW	ENTHALPY	DENSITY
B.P. INLET	16.0	162.7	32.91	61.9	70.99
B.P. EXIT	143.0	165.3	32.91	62.4	70.84
PUMP INLET	143.0	165.3	32.91	62.4	70.84
PUMP EXIT	2698.8	177.7	32.91	71.4	71.31
O2 TANK PRESS	16.0	400.0	0.06	204.7	0.12
POSV INLET	2676.7	177.8	5.84	71.4	71.27
POSV EXIT	1757.3	181.3	5.84	71.4	69.83
OCV INLET	2676.7	177.8	27.02	71.4	71.27
OCV EXIT	1679.6	181.6	27.02	71.4	69.70
PRIMARY INJ	1714.5	181.5	5.84	71.4	69.76
SECONDARY INJ	1651.0	181.7	27.02	71.4	69.66
CHAMBER	1522.7				
VALVE DATA					

VALVE	DELTA P	AREA	FLOW	% BYPASS	
JBV	366.	0.115	2.99	50.00	
TBV	2196.	0.002	0.03	1.00	
FSV	42.	1.654	5.97		
POSV	919.	0.034	5.84		
OCV	997.	0.152	27.02		
INJECTOR DATA					

* FUEL *	* OXID *				
	PRIMARY	SECOND			
DEL P MAN	17.03	21.31	14.25		
DEL P INJ	96.49	191.80	128.26		
AREA	1.14	0.08	0.43		
FLOW	5.97	5.84	27.02		

TABLE 58. — SPLIT-EXPANDER CYCLE — O/F = 5.5 (CONTINUED)

***** * TURBOMACHINERY PERFORMANCE DATA * *****						
***** * H2 BOOST TURBINE * *****			***** * H2 BOOST PUMP * *****			
EFFICIENCY	0.865		EFFICIENCY	0.765		
HORSEPOWER	38.		HORSEPOWER	38.		
SPEED (RPM)	46114.		SPEED (RPM)	46114.		
MEAN DIA (IN)	1.90		S SPEED	3062.		
EFF AREA (IN2)	1.45		HEAD (FT)	2679.		
U/C (IDEAL)	0.512		DIA. (IN)	2.18		
MAX TIP SPEED	382.		TIP SPEED	438.		
STAGES	1.		VOL. FLOW	611.		
DELTA H (ACT)	9.09		HEAD COEF	0.449		
GAMMA	1.43		FLOW COEF	0.202		
PRESS RATIO (T/T)	1.01					
***** * H2 TURBINE * *****			***** * H2 PUMP * *****			
	STAGE 1	STAGE 2	STAGE ONE	STAGE TWO	STAGE THREE	
EFFICIENCY	0.816	0.816	EFFICIENCY	0.641	0.620	0.625
HORSEPOWER	1842.	1842.	HORSEPOWER	1121.	367.	354.
SPEED (RPM)	123580.	123580.	SPEED (RPM)	123580.	123580.	123580.
MEAN DIA (IN)	3.47	3.47	S SPEED	744.	742.	758.
EFF AREA (IN2)	0.21	0.27	HEAD (FT)	66095.	41839.	40624.
U/C (IDEAL)	0.512	0.507	DIA. (IN)	3.68	3.02	3.02
MAX TIP SPEED	1872.	1872.	TIP SPEED	1988.	1628.	1628.
DELTA H (ACT)	218.	222.	VOL. FLOW	616.	309.	308.
GAMMA (ACT)	1.43	1.43	HEAD COEF	0.538	0.508	0.493
PRESS RATIO(T/T)	1.33	1.35	FLOW COEF	0.094	0.093	0.095
***** * O2 BOOST TURBINE * *****			***** * O2 BOOST PUMP * *****			
EFFICIENCY	0.863		EFFICIENCY	0.756		
HORSEPOWER	20.		HORSEPOWER	20.		
SPEED (RPM)	12162.		SPEED (RPM)	12162.		
MEAN DIA (IN)	5.21		S SPEED	2726.		
EFF AREA (IN2)	2.02		HEAD (FT)	258.		
U/C (IDEAL)	0.512		DIA. (IN)	2.44		
MAX TIP SPEED	277.		TIP SPEED	130.		
STAGES	1.		VOL. FLOW	209.		
DELTA H (ACT)	4.88		HEAD COEF	0.494		
GAMMA	1.43		FLOW COEF	0.187		
PRESS RATIO (T/T)	1.01					
***** * O2 TURBINE * *****			***** * O2 PUMP * *****			
EFFICIENCY	0.818		EFFICIENCY	0.738		
HORSEPOWER	419.		HORSEPOWER	419.		
SPEED (RPM)	73101.		SPEED (RPM)	73101.		
MEAN DIA (IN)	3.47		S SPEED	1728.		
EFF AREA (IN2)	0.25		HEAD (FT)	5159.		
U/C (IDEAL)	0.447		DIA. (IN)	1.92		
MAX TIP SPEED	1107.		TIP SPEED	612.		
STAGES	1.		VOL. FLOW	207.		
DELTA H (ACT)	99.96		HEAD COEF	0.444		
GAMMA	1.43		FLOW COEF	0.145		
PRESS RATIO (T/T)	1.14					

TABLE 59. — SPLIT-EXPANDER CYCLE — O/F = 6.0

ENGINE PERFORMANCE PARAMETERS

CHAMBER PRESSURE	1610.7
VAC ENGINE THRUST	20000.
DEL. VAC. ISP	480.0
TOTAL ENGINE FLOW RATE	41.7
THROAT AREA	6.071
NOZZLE AREA RATIO	1000.0
ENGINE MIXTURE RATIO	6.00
CHAMBER/NOZZLE COOLANT DP	583.
CHAMBER/NOZZLE COOLANT DT	1018.
ETA C*	0.993
CHAMBER/NOZZLE Q	11190.

ENGINE STATION CONDITIONS

* FUEL SYSTEM CONDITIONS *

STATION	PRESS	TEMP	FLOW	ENTHALPY	DENSITY
B.P. INLET	18.6	37.4	5.96	-107.5	4.37
B.P. EXIT	100.6	38.5	5.96	-103.0	4.39
PUMP INLET	100.6	38.5	5.96	-103.0	4.39
1ST STAGE EXIT	2163.5	70.1	5.96	33.2	4.36
JBV INLET	2120.0	70.5	2.98	33.2	4.33
JBV EXIT	1808.4	72.9	2.98	33.2	4.12
2ND STAGE EXIT	3465.7	90.6	2.98	122.3	4.35
PUMP EXIT	4732.3	110.0	2.98	208.3	4.37
COOLANT INLET	4684.7	110.4	2.98	208.3	4.35
COOLANT EXIT	4101.7	1128.8	2.98	3965.4	0.62
TBV INLET	4060.2	1129.1	0.17	3965.4	0.62
TBV EXIT	1884.0	1144.7	0.17	3965.4	0.30
LOX TRB INLET	4060.2	1129.1	2.81	3965.4	0.62
LOX TRB EXIT	3583.4	1101.3	2.81	3855.8	0.57
H2 TRB INLET	3583.4	1101.3	2.81	3855.8	0.57
H2 TRB EXIT	1994.0	976.8	2.81	3381.8	0.37
H2 TRB DIFF	1972.8	977.0	2.81	3381.8	0.36
H2 BST TRB IN	1953.0	977.1	2.81	3381.8	0.36
H2 BST TRB EXIT	1930.3	974.5	2.81	3372.2	0.36
H2 BST TRB DIFF	1925.4	974.5	2.81	3372.2	0.35
O2 BST TRB IN	1906.1	974.7	2.81	3372.2	0.35
O2 BST TRB EXIT	1894.2	973.3	2.81	3367.1	0.35
O2 BST TRB DIFF	1893.5	973.3	2.81	3367.1	0.35
H2 TANK PRESS	18.6	996.0	0.0048	3400.5	0.0035
GOX HEAT EXCH IN	1884.0	982.9	2.81	3400.5	0.34
GOX HEAT EXCH OUT	1875.4	982.2	2.81	3397.7	0.34
MIXER HOT IN	1875.4	982.2	2.81	3397.7	0.34
MIXER COLD IN	1808.4	72.9	2.98	33.2	4.12
MIXER OUT	1790.3	495.2	5.95	1667.0	0.63
FSV INLET	1790.3	495.2	5.95	1667.0	0.63
FSV EXIT	1746.5	495.3	5.95	1667.0	0.62
CHAMBER INJ	1729.4	495.4	5.95	1667.0	0.61
CHAMBER	1610.8				

* OXYGEN SYSTEM CONDITIONS *

STATION	PRESS	TEMP	FLOW	ENTHALPY	DENSITY
B.P. INLET	16.0	162.7	35.77	61.9	70.99
B.P. EXIT	134.5	165.3	35.77	62.3	70.84
PUMP INLET	134.5	165.3	35.77	62.3	70.84
PUMP EXIT	2592.0	177.1	35.77	70.9	71.30
O2 TANK PRESS	16.0	400.0	0.06	204.7	0.12
POSV INLET	2565.9	177.2	5.31	70.9	71.26
POSV EXIT	1804.4	180.1	5.31	70.9	70.07
OCV INLET	2565.9	177.2	30.40	70.9	71.26
OCV EXIT	1808.3	180.1	30.40	70.9	70.07
PRIMARY INJ	1769.0	180.2	5.31	70.9	70.01
SECONDARY INJ	1772.2	180.2	30.40	70.9	70.01
CHAMBER	1610.7				

VALVE DATA

VALVE	DELTA P	AREA	FLOW	% BYPASS
JBV	330.	0.121	2.98	50.00
TBV	2176.	0.010	0.17	5.59
FSV	44.	1.654	5.95	
POSV	762.	0.034	5.31	
OCV	758.	0.196	30.40	

INJECTOR DATA

	* FUEL *	* OXID *	
		PRIMARY	SECOND
DELP MAN	17.78	17.59	17.95
DELP INJ	100.88	158.28	161.51
AREA	1.14	0.08	0.43
FLOW	5.95	5.31	30.40

TABLE 59. — SPLIT-EXPANDER CYCLE — O/F = 6.0 (CONTINUED)

***** * TURBOMACHINERY PERFORMANCE DATA * *****									
***** * H2 BOOST TURBINE * *****					***** * H2 BOOST PUMP * *****				
EFFICIENCY	0.855				EFFICIENCY	0.765			
HORSEPOWER	38.				HORSEPOWER	38.			
SPEED (RPM)	46119.				SPEED (RPM)	46119.			
MEAN DIA (IN)	1.90				S SPEED	3044.			
EFF AREA (IN2)	1.45				HEAD (FT)	2694.			
U/C (IDEAL)	0.512				DIA. (IN)	2.18			
MAX TIP SPEED	382.				TIP SPEED	438.			
STAGES	1.				VOL. FLOW	609.			
DELTA H (ACT)	9.58				HEAD COEF	0.451			
GAMMA	1.43				FLOW COEF	0.201			
PRESS RATIO (T/T)	1.01								
***** * H2 TURBINE * *****					***** * H2 PUMP * *****				
	STAGE 1	STAGE 2			STAGE ONE	STAGE TWO	STAGE THREE		
EFFICIENCY	0.804	0.807			EFFICIENCY	0.642	0.620	0.625	
HORSEPOWER	1885.	1885.			HORSEPOWER	1147.	376.	362.	
SPEED (RPM)	124731.	124731.			SPEED (RPM)	124731.	124731.	124731.	
MEAN DIA (IN)	3.47	3.47			S SPEED	733.	732.	746.	
EFF AREA (IN2)	0.21	0.27			HEAD (FT)	67999.	43062.	41841.	
U/C (IDEAL)	0.492	0.493			DIA. (IN)	3.68	3.02	3.02	
MAX TIP SPEED	1890.	1890.			TIP SPEED	2007.	1643.	1643.	
DELTA H	237.	237.			VOL. FLOW	613.	307.	306.	
GAMMA (ACT)	1.43	1.43			HEAD COEF	0.563	0.513	0.499	
PRESS RATIO(T/T)	1.33	1.35			FLOW COEF	0.092	0.092	0.093	
***** * O2 BOOST TURBINE * *****					***** * O2 BOOST PUMP * *****				
EFFICIENCY	0.857				EFFICIENCY	0.764			
HORSEPOWER	21.				HORSEPOWER	21.			
SPEED (RPM)	12307.				SPEED (RPM)	12307.			
MEAN DIA (IN)	5.21				S SPEED	3030.			
EFF AREA (IN2)	2.02				HEAD (FT)	241.			
U/C (IDEAL)	0.512				DIA. (IN)	2.44			
MAX TIP SPEED	280.				TIP SPEED	131.			
STAGES	1.				VOL. FLOW	227.			
DELTA H (ACT)	5.16				HEAD COEF	0.450			
GAMMA	1.43				FLOW COEF	0.201			
PRESS RATIO (T/T)	1.01								
***** * O2 TURBINE * *****					***** * O2 PUMP * *****				
EFFICIENCY	0.804				EFFICIENCY	0.740			
HORSEPOWER	436.				HORSEPOWER	436.			
SPEED (RPM)	73440.				SPEED (RPM)	73440.			
MEAN DIA (IN)	3.47				S SPEED	1864.			
EFF AREA (IN2)	0.25				HEAD (FT)	4962.			
U/C (IDEAL)	0.425				DIA. (IN)	1.92			
MAX TIP SPEED	1113.				TIP SPEED	614.			
STAGES	1.				VOL. FLOW	225.			
DELTA H (ACT)	109.63				HEAD COEF	0.423			
GAMMA	1.43				FLOW COEF	0.156			
PRESS RATIO (T/T)	1.13								

TABLE 60. — SPLIT-EXPANDER CYCLE — O/F = 6.5

ENGINE PERFORMANCE PARAMETERS					

CHAMBER PRESSURE					1610.8
VAC ENGINE THRUST					20338.
DEL. VAC. ISP					480.3
TOTAL ENGINE FLOW RATE					42.3
THROAT AREA					6.071
NOZZLE AREA RATIO					1000.0
ENGINE MIXTURE RATIO					4.50
CHAMBER/NOZZLE COOLANT DP					428.
CHAMBER/NOZZLE COOLANT DT					1118.
ETA C*					0.993
CHAMBER/NOZZLE Q					11597.
ENGINE STATION CONDITIONS					

* FUEL SYSTEM CONDITIONS *					
STATION	PRESS	TEMP	FLOW	ENTHALPY	DENSITY
B.P. INLET	18.6	37.4	5.65	-107.5	4.37
B.P. EXIT	96.0	38.4	5.65	-103.2	4.39
PUMP INLET	96.0	38.4	5.65	-103.2	4.39
1ST STAGE EXIT	2104.8	69.3	5.65	29.6	4.36
JBV INLET	2065.6	69.7	2.83	29.6	4.33
JBV EXIT	1799.7	71.7	2.83	29.6	4.15
2ND STAGE EXIT	3371.8	89.4	2.83	116.6	4.34
PUMP EXIT	4602.9	108.3	2.83	200.4	4.36
COOLANT INLET	4559.9	108.6	2.83	200.4	4.34
COOLANT EXIT	3922.0	1226.8	2.83	4305.6	0.56
TBV INLET	3880.1	1227.1	0.28	4305.6	0.55
TBV EXIT	1868.7	1241.7	0.28	4305.6	0.27
LOX TRB INLET	3880.1	1227.1	2.55	4305.6	0.55
LOX TRB EXIT	3435.1	1198.1	2.55	4192.2	0.50
H2 TRB INLET	3435.1	1198.1	2.55	4192.2	0.50
H2 TRB EXIT	1968.6	1070.6	2.55	3708.2	0.33
H2 TRB DIFF	1949.3	1070.7	2.55	3708.2	0.33
H2 BST TRB IN	1931.4	1070.8	2.55	3708.2	0.32
H2 BST TRB EXIT	1910.8	1068.3	2.55	3698.8	0.32
H2 BST TRB DIFF	1906.3	1068.3	2.55	3698.8	0.32
O2 BST TRB IN	1888.8	1068.4	2.55	3698.8	0.32
O2 BST TRB EXIT	1878.0	1067.0	2.55	3693.7	0.32
O2 BST TRB DIFF	1877.3	1067.0	2.55	3693.7	0.32
H2 TANK PRESS	18.6	1097.7	0.0041	3753.8	0.0032
GOX HEAT EXCH IN	1868.7	1084.3	2.55	3753.8	0.31
GOX HEAT EXCH OUT	1861.0	1083.4	2.55	3750.5	0.31
MIXER HOT IN	1861.0	1083.4	2.55	3750.5	0.31
MIXER COLD IN	1799.7	71.7	2.83	29.6	4.15
MIXER OUT	1783.6	530.0	5.65	1793.9	0.59
FSV INLET	1783.6	530.0	5.65	1793.9	0.59
FSV EXIT	1741.2	530.2	5.65	1793.9	0.58
CHAMBER INJ	1724.7	530.3	5.65	1793.9	0.57
CHAMBER	1610.7				
* OXYGEN SYSTEM CONDITIONS *					
STATION	PRESS	TEMP	FLOW	ENTHALPY	DENSITY
B.P. INLET	16.0	162.7	36.76	61.9	70.99
B.P. EXIT	117.8	165.2	36.76	62.3	70.83
PUMP INLET	117.8	165.2	36.76	62.3	70.83
PUMP EXIT	2342.2	176.0	36.76	70.1	71.23
O2 TANK PRESS	16.0	400.0	0.06	204.7	0.12
POSV INLET	2314.6	176.1	4.56	70.1	71.18
POSV EXIT	1752.8	178.2	4.56	70.1	70.30
OCV INLET	2314.6	176.1	32.14	70.1	71.18
OCV EXIT	1830.4	177.9	32.14	70.1	70.43
PRIMARY INJ	1726.9	178.3	4.56	70.1	70.26
SECONDARY INJ	1790.3	178.1	32.14	70.1	70.36
CHAMBER	1610.7				
VALVE DATA					

VALVE	DELTA P	AREA	FLOW	% BYPASS	
JBV	282.	0.125	2.83	50.00	
TBV	2011.	0.018	0.28	9.82	
FSV	42.	1.654	5.65		
POSV	562.	0.034	4.56		
OCV	484.	0.259	32.14		
INJECTOR DATA					

* FUEL *	* OXID *				
	PRIMARY	SECOND			
DEL P MAN	17.15	12.91	19.96		
DEL P INJ	96.84	116.21	179.62		
AREA	1.14	0.08	0.43		
FLOW	5.65	4.56	32.14		

TABLE 60. — SPLIT-EXPANDER CYCLE — O/F = 6.5 (CONTINUED)

***** * TURBOMACHINERY PERFORMANCE DATA * *****						
***** * H2 BOOST TURBINE * *****			***** * H2 BOOST PUMP * *****			
EFFICIENCY	0.839		EFFICIENCY	0.765		
HORSEPOWER	34.		HORSEPOWER	34.		
SPEED (RPM)	44378.		SPEED (RPM)	44378.		
MEAN DIA (IN)	1.90		S SPEED	2980.		
EFF AREA (IN2)	1.45		HEAD (FT)	2542.		
U/C (IDEAL)	0.512		DIA. (IN)	2.18		
MAX TIP SPEED	367.		TIP SPEED	422.		
STAGES	1.		VOL. FLOW	578.		
DELTA H (ACT)	9.47		HEAD COEF	0.459		
GAMMA	1.39		FLOW COEF	0.198		
PRESS RATIO (T/T)	1.01					
***** * H2 TURBINE * *****			***** * H2 PUMP * *****			
	STAGE 1	STAGE 2	STAGE ONE	STAGE TWO	STAGE THREE	
EFFICIENCY	0.787	0.793	EFFICIENCY	0.641	0.620	0.625
HORSEPOWER	1744.	1744.	HORSEPOWER	1062.	348.	335.
SPEED (RPM)	122010.	122010.	SPEED (RPM)	122010.	122010.	122010.
MEAN DIA (IN)	3.47	3.47	S SPEED	713.	711.	726.
EFF AREA (IN2)	0.21	0.27	HEAD (FT)	66256.	41945.	40737.
U/C (IDEAL)	0.469	0.474	DIA. (IN)	3.68	3.02	3.02
MAX TIP SPEED	1848.	1848.	TIP SPEED	1963.	1607.	1607.
DELTA H	244.	240.	VOL. FLOW	582.	292.	291.
GAMMA (ACT)	1.39	1.39	HEAD COEF	0.553	0.523	0.507
PRESS RATIO(T/T)	1.33	1.35	FLOW COEF	0.090	0.089	0.091
***** * O2 BOOST TURBINE * *****			***** * O2 BOOST PUMP * *****			
EFFICIENCY	0.844		EFFICIENCY	0.753		
HORSEPOWER	18.		HORSEPOWER	18.		
SPEED (RPM)	11932.		SPEED (RPM)	11932.		
MEAN DIA (IN)	5.21		S SPEED	3336.		
EFF AREA (IN2)	2.02		HEAD (FT)	207.		
U/C (IDEAL)	0.512		DIA. (IN)	2.44		
MAX TIP SPEED	272.		TIP SPEED	127.		
STAGES	1.		VOL. FLOW	233.		
DELTA H (ACT)	5.10		HEAD COEF	0.412		
GAMMA	1.39		FLOW COEF	0.213		
PRESS RATIO (T/T)	1.01					
***** * O2 TURBINE * *****			***** * O2 PUMP * *****			
EFFICIENCY	0.783		EFFICIENCY	0.736		
HORSEPOWER	409.		HORSEPOWER	409.		
SPEED (RPM)	71441.		SPEED (RPM)	71441.		
MEAN DIA (IN)	3.47		S SPEED	1981.		
EFF AREA (IN2)	0.25		HEAD (FT)	4496.		
U/C (IDEAL)	0.402		DIA. (IN)	1.92		
MAX TIP SPEED	1082.		TIP SPEED	598.		
STAGES	1.		VOL. FLOW	232.		
DELTA H (ACT)	113.34		HEAD COEF	0.405		
GAMMA	1.39		FLOW COEF	0.165		
PRESS RATIO (T/T)	1.13					

TABLE 61. — SPLIT-EXPANDER CYCLE — O/F = 7.0

ENGINE PERFORMANCE PARAMETERS					

CHAMBER PRESSURE					1610.8
VAC ENGINE THRUST					20675.
DEL. VAC. ISP					477.4
TOTAL ENGINE FLOW RATE					43.3
THROAT AREA					6.071
NOZZLE AREA RATIO					1000.0
ENGINE MIXTURE RATIO					7.00
CHAMBER/NOZZLE COOLANT DP					693.
CHAMBER/NOZZLE COOLANT DT					1211.
ETA C*					0.988
CHAMBER/NOZZLE Q					12005.
ENGINE STATION CONDITIONS					

* FUEL SYSTEM CONDITIONS *					
STATION	PRESS	TEMP	FLOW	ENTHALPY	DENSITY
B.P. INLET	18.6	37.4	5.42	-107.5	4.37
B.P. EXIT	93.3	38.4	5.42	-103.4	4.39
PUMP INLET	93.3	38.4	5.42	-103.4	4.39
1ST STAGE EXIT	2071.6	68.9	5.42	27.7	4.35
JBV INLET	2035.6	69.2	2.71	27.7	4.33
JBV EXIT	1794.4	71.1	2.71	27.7	4.16
2ND STAGE EXIT	3318.8	88.7	2.71	113.5	4.34
PUMP EXIT	4529.9	107.5	2.71	196.2	4.35
COOLANT INLET	4490.4	107.8	2.71	196.2	4.34
COOLANT EXIT	3797.5	1319.3	2.71	4628.2	0.50
TBV INLET	3754.8	1319.6	0.35	4628.2	0.50
TBV EXIT	1859.1	1333.6	0.35	4628.2	0.25
LOX TRB INLET	3754.8	1319.6	2.36	4628.2	0.50
LOX TRB EXIT	3331.6	1289.4	2.36	4510.9	0.46
H2 TRB INLET	3331.6	1289.4	2.36	4510.9	0.46
H2 TRB EXIT	1952.4	1158.8	2.36	4016.3	0.30
H2 TRB DIFF	1934.3	1158.9	2.36	4016.3	0.30
H2 BST TRB IN	1917.6	1159.0	2.36	4016.3	0.30
H2 BST TRB EXIT	1898.3	1156.4	2.36	4006.8	0.30
H2 BST TRB DIFF	1894.2	1156.5	2.36	4006.8	0.29
O2 BST TRB IN	1877.9	1156.6	2.36	4006.8	0.29
O2 BST TRB EXIT	1867.8	1155.2	2.36	4001.7	0.29
O2 BST TRB DIFF	1867.1	1155.2	2.36	4001.7	0.29
H2 TANK PRESS	18.6	1192.1	0.0036	4082.7	0.0029
GOX HEAT EXCH IN	1859.1	1178.3	2.36	4082.7	0.28
GOX HEAT EXCH OUT	1851.9	1177.3	2.36	4079.0	0.28
MIXER HOT IN	1851.9	1177.3	2.36	4079.0	0.28
MIXER COLD IN	1794.4	71.1	2.71	27.7	4.16
MIXER OUT	1779.6	562.8	5.41	1913.3	0.56
FSV INLET	1779.6	562.8	5.41	1913.3	0.56
FSV EXIT	1738.2	563.0	5.41	1913.3	0.54
CHAMBER INJ	1722.1	563.1	5.41	1913.3	0.54
CHAMBER	1610.8				
* OXYGEN SYSTEM CONDITIONS *					
STATION	PRESS	TEMP	FLOW	ENTHALPY	DENSITY
B.P. INLET	16.0	162.7	37.96	61.9	70.99
B.P. EXIT	104.1	165.2	37.96	62.2	70.82
PUMP INLET	104.1	165.2	37.96	62.2	70.82
PUMP EXIT	2149.2	175.3	37.96	69.5	71.16
O2 TANK PRESS	16.0	400.0	0.06	204.7	0.12
POSV INLET	2119.8	175.4	3.88	69.5	71.12
POSV EXIT	1712.8	176.9	3.88	69.5	70.48
OCV INLET	2119.8	175.4	34.02	69.5	71.12
OCV EXIT	1855.9	176.4	34.02	69.5	70.71
PRIMARY INJ	1694.0	177.0	3.88	69.5	70.45
SECONDARY INJ	1811.1	176.5	34.02	69.5	70.64
CHAMBER	1610.1				
VALVE DATA					

VALVE	DELTA P	AREA	FLOW	% BYPASS	
JBV	256.	0.125	2.71		50.00
TBV	1896.	0.024	0.35		12.93
FSV	41.	1.654	5.41		
POSV	407.	0.034	3.88		
OCV	264.	0.371	34.02		
INJECTOR DATA					

* FUEL *		* OXID *			
		PRIMARY	SECOND		
DEL P MAN	16.70	9.32	22.27		
DEL P INJ	94.69	83.90	200.43		
AREA	1.14	0.08	0.43		
FLOW	5.41	3.88	34.02		

TABLE 61. — SPLIT-EXPANDER CYCLE — O/F = 7.0 (CONTINUED)

* TURBOMACHINERY PERFORMANCE DATA *						

*****			*****			
* H2 BOOST TURBINE *			* H2 BOOST PUMP *			
*****			*****			
EFFICIENCY	0.826		EFFICIENCY	0.764		
HORSEPOWER	32.		HORSEPOWER	32.		
SPEED (RPM)	43200.		SPEED (RPM)	43200.		
MEAN DIA (IN)	1.90		S SPEED	2915.		
EFF AREA (IN ²)	1.45		HEAD (FT)	2455.		
U/C (IDEAL)	0.512		DIA. (IN)	2.18		
MAX TIP SPEED	358.		TIP SPEED	411.		
STAGES	1.		VOL. FLOW	554.		
DELTA H (ACT)	9.49		HEAD COEF	0.468		
GAMMA	1.38		FLOW COEF	0.195		
PRESS RATIO (T/T)	1.01					
*****			*****			
* H2 TURBINE *			* H2 PUMP *			
*****			*****			
	STAGE 1	STAGE 2	STAGE ONE	STAGE TWO	STAGE THREE	
	*****	*****	*****	*****	*****	
EFFICIENCY	0.773	0.782	EFFICIENCY	0.640	0.619	0.624
HORSEPOWER	1650.	1650.	HORSEPOWER	1005.	329.	317.
SPEED (RPM)	120203.	120203.	SPEED (RPM)	120203.	120203.	120203.
MEAN DIA (IN)	3.47	3.47	S SPEED	696.	694.	709.
EFF AREA (IN ²)	0.21	0.27	HEAD (FT)	65287.	41325.	40126.
U/C (IDEAL)	0.452	0.460	DIA. (IN)	3.68	3.02	3.02
MAX TIP SPEED	1821.	1821.	TIP SPEED	1934.	1583.	1583.
DELTA H	251.	244.	VOL. FLOW	558.	280.	279.
GAMMA (ACT)	1.38	1.38	HEAD COEF	0.562	0.530	0.515
PRESS RATIO(T/T)	1.33	1.35	FLOW COEF	0.087	0.087	0.088
*****			*****			
* O2 BOOST TURBINE *			* O2 BOOST PUMP *			
*****			*****			
EFFICIENCY	0.833		EFFICIENCY	0.726		
HORSEPOWER	17.		HORSEPOWER	17.		
SPEED (RPM)	11659.		SPEED (RPM)	11659.		
MEAN DIA (IN)	5.21		S SPEED	3691.		
EFF AREA (IN ²)	2.02		HEAD (FT)	179.		
U/C (IDEAL)	0.512		DIA. (IN)	2.44		
MAX TIP SPEED	265.		TIP SPEED	124.		
STAGES	1.		VOL. FLOW	241.		
DELTA H (ACT)	5.11		HEAD COEF	0.373		
GAMMA	1.38		FLOW COEF	0.225		
PRESS RATIO (T/T)	1.01					
*****			*****			
* O2 TURBINE *			* O2 PUMP *			
*****			*****			
EFFICIENCY	0.767		EFFICIENCY	0.729		
HORSEPOWER	391.		HORSEPOWER	391.		
SPEED (RPM)	70123.		SPEED (RPM)	70123.		
MEAN DIA (IN)	3.47		S SPEED	2103.		
EFF AREA (IN ²)	0.25		HEAD (FT)	4137.		
U/C (IDEAL)	0.384		DIA. (IN)	1.92		
MAX TIP SPEED	1062.		TIP SPEED	587.		
STAGES	1.		VOL. FLOW	239.		
DELTA H (ACT)	117.33		HEAD COEF	0.387		
GAMMA	1.38		FLOW COEF	0.174		
PRESS RATIO (T/T)	1.13					

TABLE 62. — SPLIT-EXPANDER CYCLE — O/F = 12.0

ENGINE PERFORMANCE PARAMETERS

CHAMBER PRESSURE	1250.0
VAC ENGINE THRUST	15884.
DEL. VAC. ISP	396.3
TOTAL ENGINE FLOW RATE	40.1
THROAT AREA	6.071
NOZZLE AREA RATIO	1000.0
ENGINE MIXTURE RATIO	12.00
CHAMBER/NOZZLE COOLANT DP	455.
CHAMBER/NOZZLE COOLANT DT	726.
ETA C*	0.980
CHAMBER/NOZZLE Q	8431.

ENGINE STATION CONDITIONS

* FUEL SYSTEM CONDITIONS *

STATION	PRESS	TEMP	FLOW	ENTHALPY	DENSITY
B.P. INLET	18.6	37.4	3.09	-107.5	4.37
B.P. EXIT	93.6	38.9	3.09	-102.3	4.37
PUMP INLET	93.6	38.9	3.09	-102.3	4.37
1ST STAGE EXIT	2053.3	76.4	3.09	48.7	4.14
JBV INLET	2053.3	76.4	0.00	48.7	4.14
JBV EXIT	1497.9	79.3	0.00	48.7	3.71
2ND STAGE EXIT	2924.6	92.0	3.09	114.3	4.12
PUMP EXIT	3762.9	106.9	3.09	177.3	4.11
COOLANT INLET	3708.6	107.3	3.09	177.3	4.09
COOLANT EXIT	3253.7	833.8	3.09	2909.1	0.67
TBV INLET	3212.2	834.1	0.52	2909.1	0.66
TBV EXIT	1568.7	844.6	0.52	2909.1	0.33
LOX TRB INLET	3212.2	834.1	2.56	2909.1	0.66
LOX TRB EXIT	2844.1	814.2	2.56	2830.0	0.61
H2 TRB INLET	2844.1	814.2	2.56	2830.0	0.61
H2 TRB EXIT	1650.5	726.3	2.56	2493.2	0.41
H2 TRB DIFF	1634.7	726.4	2.56	2493.2	0.40
H2 BST TRB IN	1620.0	726.5	2.56	2493.2	0.40
H2 BST TRB EXIT	1603.1	724.8	2.56	2486.9	0.40
H2 BST TRB DIFF	1599.5	724.8	2.56	2486.9	0.40
O2 BST TRB IN	1585.1	724.9	2.56	2486.9	0.39
O2 BST TRB EXIT	1576.3	724.0	2.56	2483.4	0.39
O2 BST TRB DIFF	1575.7	724.0	2.56	2483.4	0.39
H2 TANK PRESS	18.6	753.8	0.0033	2555.7	0.0046
GOX HEAT EXCH IN	1568.7	744.5	2.56	2555.7	0.38
GOX HEAT EXCH OUT	1562.2	743.6	2.56	2552.3	0.38
MIXER HOT IN	1562.2	743.6	2.56	2552.3	0.38
MIXER COLD IN	1497.9	79.3	0.00	48.7	3.71
MIXER OUT	1497.9	744.0	3.08	2552.3	0.36
FSV INLET	1497.9	744.0	3.08	2552.3	0.36
FSV EXIT	1220.1	745.1	3.08	2552.3	0.32
CHAMBER INJ	1311.3	745.1	3.08	2552.3	0.32
CHAMBER	1249.9				

* OXYGEN SYSTEM CONDITIONS *

STATION	PRESS	TEMP	FLOW	ENTHALPY	DENSITY
B.P. INLET	16.0	162.7	37.06	61.9	70.99
B.P. EXIT	82.2	165.1	37.06	62.2	70.82
PUMP INLET	82.2	165.1	37.06	62.2	70.82
PUMP EXIT	1569.4	172.9	37.06	67.6	71.01
O2 TANK PRESS	16.0	400.0	0.06	204.7	0.12
POSV INLET	1541.3	173.0	2.93	67.6	70.97
POSV EXIT	1308.1	173.9	2.93	67.6	70.59
OCV INLET	1541.3	173.0	34.06	67.6	70.97
OCV EXIT	1495.2	173.2	34.06	67.6	70.89
PRIMARY INJ	1297.4	173.9	2.93	67.6	70.57
SECONDARY INJ	1450.4	173.3	34.06	67.6	70.82
CHAMBER	1249.6				

VALVE DATA

VALVE	DELTA P	AREA	FLOW	% BYPASS
JBV	555.	0.000	0.00	0.00
TBV	1643.	0.033	0.52	16.98
FSV	178.	0.600	3.08	
POSV	233.	0.034	2.93	
OCV	46.	0.193	34.06	

INJECTOR DATA

	* FUEL *	* OXID *	
		PRIMARY	SECOND
DELP MAN	9.17	5.02	22.27
DELP INJ	52.07	47.87	200.45
AREA	1.14	0.08	0.43
FLOW	3.08	2.93	34.06

TABLE 62. — SPLIT-EXPANDER CYCLE — O/F = 12.0 (CONTINUED)

```

*****
* TURBOMACHINERY PERFORMANCE DATA *
*****

# H2 BOOST TURBINE #
*****
EFFICIENCY          0.844
HORSEPOWER          23.
SPEED (RPM)        36541.
MEAN DIA (IN)      1.90
EFF AREA (IN2)     1.45
U/C (IDEAL)        0.512
MAX TIP SPEED      302.
STAGES              1.
DELTA H (ACT)      6.30
GAMMA              1.44
PRESS RATIO (T/T)  1.01

# H2 BOOST PUMP #
*****
EFFICIENCY          0.608
HORSEPOWER          23.
SPEED (RPM)        36541.
S SPEED            1856.
HEAD (FT)          2472.
DIA. (IN)          2.18
TIP SPEED          347.
VOL. FLOW          317.
HEAD COEF          0.659
FLOW COEF          0.132

# H2 TURBINE #
*****
          STAGE 1  STAGE 2
*****
EFFICIENCY          0.827  0.836
HORSEPOWER          1221.  1221.
SPEED (RPM)        113796.  113796.
MEAN DIA (IN)      3.47  3.47
EFF AREA (IN2)     0.21  0.27
U/C (IDEAL)        0.534  0.548
MAX TIP SPEED      1724.  1724.
DELTA H            172.  165.
GAMMA (ACT)        1.44  1.44
PRESS RATIO(T/T)   1.33  1.35

# H2 PUMP #
*****
          STAGE ONE  STAGE TWO  STAGE THREE
*****
EFFICIENCY          0.572  0.596  0.598
HORSEPOWER          659.  286.  275.
SPEED (RPM)        113796.  113796.  113796.
S SPEED            499.  907.  932.
HEAD (FT)          67185.  30401.  29329.
DIA. (IN)          3.68  3.02  3.02
TIP SPEED          1831.  1499.  1499.
VOL. FLOW          335.  336.  337.
HEAD COEF          0.645  0.435  0.420
FLOW COEF          0.055  0.110  0.112

# O2 BOOST TURBINE #
*****
EFFICIENCY          0.878
HORSEPOWER          13.
SPEED (RPM)        10741.
MEAN DIA (IN)      5.21
EFF AREA (IN2)     2.62
U/C (IDEAL)        0.512
MAX TIP SPEED      244.
STAGES              1.
DELTA H (ACT)      3.50
GAMMA              1.44
PRESS RATIO (T/T)  1.01

# O2 BOOST PUMP #
*****
EFFICIENCY          0.715
HORSEPOWER          13.
SPEED (RPM)        10741.
S SPEED            4163.
HEAD (FT)          135.
DIA. (IN)          2.44
TIP SPEED          115.
VOL. FLOW          235.
HEAD COEF          0.330
FLOW COEF          0.238

# O2 TURBINE #
*****
EFFICIENCY          0.807
HORSEPOWER          287.
SPEED (RPM)        62881.
MEAN DIA (IN)      3.47
EFF AREA (IN2)     0.25
U/C (IDEAL)        0.429
MAX TIP SPEED      953.
STAGES              1.
DELTA H (ACT)      79.16
GAMMA              1.44
PRESS RATIO (T/T)  1.13

# O2 PUMP #
*****
EFFICIENCY          0.708
HORSEPOWER          287.
SPEED (RPM)        62881.
S SPEED            2365.
HEAD (FT)          3015.
DIA. (IN)          1.92
TIP SPEED          526.
VOL. FLOW          234.
HEAD COEF          0.350
FLOW COEF          0.190

```

TABLE 63. — FULL-EXPANDER CYCLE WITH REGENERATION — O/F = 5.0

ENGINE PERFORMANCE PARAMETERS					

CHAMBER PRESSURE					1497.1
VAC ENGINE THRUST					16436.
DEL. VAC. ISP					477.1
TOTAL ENGINE FLOW RATE					34.4
THROAT AREA					5.547
NOZZLE AREA RATIO					1000.0
ENGINE MIXTURE RATIO					5.00
CHAMBER/NOZZLE COOLANT DP					772.
CHAMBER/NOZZLE COOLANT DT					385.
ETA C*					0.993
CHAMBER/NOZZLE Q					8653.
ENGINE STATION CONDITIONS					

* FUEL SYSTEM CONDITIONS *					
STATION	PRESS	TEMP	FLOW	ENTHALPY	DENSITY
B.P. INLET	18.6	37.4	5.75	-107.5	4.37
B.P. EXIT	95.1	38.4	5.75	-103.3	4.39
PUMP INLET	95.1	38.4	5.75	-103.3	4.39
1ST STAGE EXIT	1696.7	61.4	5.75	-2.2	4.41
2ND STAGE EXIT	3281.1	83.3	5.75	97.1	4.45
PUMP EXIT	4852.5	104.2	5.75	194.6	4.50
COLD REGEN IN	4801.2	104.7	5.75	194.6	4.48
COLD REGEN EX	4748.3	227.5	5.75	631.7	2.79
COOLANT INLET	4748.3	227.5	5.75	631.7	2.78
COOLANT EXIT	3976.7	612.3	5.75	2136.6	1.06
TBV INLET	3938.9	612.5	0.06	2136.6	1.05
TBV EXIT	1736.3	624.9	0.06	2136.6	0.49
LOX TRB INLET	3938.9	612.5	5.69	2136.6	1.05
LOX TRB EXIT	3570.4	600.8	5.69	2085.7	0.98
H2 TRB INLET	3570.4	600.8	5.69	2085.7	0.98
H2 TRB EXIT	1859.4	527.2	5.69	1784.8	0.61
H2 TRB DIFF	1829.2	527.3	5.69	1784.8	0.61
H2 BST TRB IN	1808.7	527.4	5.69	1784.8	0.60
H2 BST TRB EXIT	1789.7	526.3	5.69	1780.5	0.59
H2 BST TRB DIFF	1776.4	526.4	5.69	1780.5	0.59
O2 BST TRB IN	1756.4	526.5	5.69	1780.5	0.58
O2 BST TRB EXIT	1747.5	525.9	5.69	1778.3	0.58
O2 BST TRB DIFF	1746.1	525.9	5.69	1778.3	0.58
H2 TANK PRESS	18.6	533.9	0.0086	1781.8	0.0066
GOK HEAT EXCH IN	1736.3	526.9	5.69	1781.8	0.58
GOK HEAT EXCH OUT	1727.4	526.6	5.69	1780.7	0.57
HOT REGEN IN	1727.4	526.6	5.69	1780.7	0.57
HOT REGEN EX	1675.0	407.9	5.69	1339.2	0.71
FSV INLET	1675.0	407.9	5.74	1339.1	0.71
FSV EXIT	1631.5	408.0	5.74	1339.1	0.70
CHAMBER INJ	1614.5	408.1	5.74	1339.1	0.69
CHAMBER	1496.5				
* OXYGEN SYSTEM CONDITIONS *					
STATION	PRESS	TEMP	FLOW	ENTHALPY	DENSITY
B.P. INLET	16.0	162.7	28.76	61.9	70.99
B.P. EXIT	141.8	165.4	28.76	62.4	70.83
PUMP INLET	141.8	165.4	28.76	62.4	70.83
PUMP EXIT	2965.7	179.4	28.76	72.5	71.28
O2 TANK PRESS	16.0	400.0	0.05	204.7	0.12
POSV INLET	2947.0	179.5	6.21	72.5	71.26
POSV EXIT	1792.8	184.0	6.21	72.5	69.45
OCV INLET	2947.0	179.5	22.50	72.5	71.26
OCV EXIT	1618.5	184.7	22.50	72.5	69.16
PRIMARY INJ	1738.8	184.2	6.21	72.5	69.36
SECONDARY INJ	1596.3	184.8	22.50	72.5	69.12
CHAMBER	1497.1				
VALVE DATA					

VALVE	DELTA P	AREA	FLOW	% BYPASS	
TBV	2202.	0.003	0.06	1.00	
FCV	44.	1.502	5.74		
POSV	1154.	0.032	6.21		
OCV	1329.	0.109	22.50		
INJECTOR DATA					

* FUEL *	* OXID *				
	PRIMARY	SECOND			
DELP MAN	17.63	26.85	11.03		
DELP INJ	99.78	241.70	99.21		
AREA	1.03	0.07	0.41		
FLOW	5.74	6.21	22.50		

TABLE 63. — FULL-EXPANDER CYCLE WITH REGENERATION — O/F = 5.0
(CONTINUED)

***** * TURBOMACHINERY PERFORMANCE DATA * *****									
***** * H2 BOOST TURBINE * *****					***** * H2 BOOST PUMP * *****				
EFFICIENCY	0.779				EFFICIENCY	0.765			
HORSEPOWER	34.				HORSEPOWER	34.			
SPEED (RPM)	44528.				SPEED (RPM)	44528.			
MEAN DIA (IN)	1.34				S SPEED	3041.			
EFF AREA (IN ²)	2.45				HEAD (FT)	2514.			
U/C (IDEAL)	0.485				DIA. (IN)	2.18			
MAX TIP SPEED	260.				TIP SPEED	423.			
STAGES	1.				VOL. FLOW	588.			
DELTA H (ACT)	4.26				HEAD COEF	0.451			
GAMMA	1.38				FLOW COEF	0.201			
PRESS RATIO (T/T)	1.01								
***** * H2 TURBINE * *****					***** * H2 PUMP * *****				
	STAGE 1	STAGE 2			STAGE ONE	STAGE TWO	STAGE THREE		
EFFICIENCY	0.853	0.838			EFFICIENCY	0.666	0.666	0.667	
HORSEPOWER	2423.	2423.			HORSEPOWER	823.	808.	793.	
SPEED (RPM)	118750.	118750.			SPEED (RPM)	118750.	118750.	118750.	
MEAN DIA (IN)	2.86	2.86			S SPEED	830.	837.	843.	
EFF AREA (IN ²)	0.31	0.40			HEAD (FT)	52380.	51514.	50562.	
U/C (IDEAL)	0.503	0.491			DIA. (IN)	3.44	3.44	3.44	
MAX TIP SPEED	1484.	1484.			TIP SPEED	1785.	1785.	1785.	
DELTA H	148.	153.			VOL. FLOW	585.	581.	573.	
GAMMA (ACT)	1.38	1.38			HEAD COEF	0.529	0.520	0.510	
PRESS RATIO(T/T)	1.34	1.37			FLOW COEF	0.100	0.100	0.101	
***** * O2 BOOST TURBINE * *****					***** * O2 BOOST PUMP * *****				
EFFICIENCY	0.861				EFFICIENCY	0.728			
HORSEPOWER	18.				HORSEPOWER	18.			
SPEED (RPM)	11559.				SPEED (RPM)	11559.			
MEAN DIA (IN)	3.69				S SPEED	2439.			
EFF AREA (IN ²)	3.60				HEAD (FT)	256.			
U/C (IDEAL)	0.514				DIA. (IN)	2.44			
MAX TIP SPEED	186.				TIP SPEED	123.			
STAGES	1.				VOL. FLOW	182.			
DELTA H (ACT)	2.28				HEAD COEF	0.542			
GAMMA	1.38				FLOW COEF	0.172			
PRESS RATIO (T/T)	1.00								
***** * O2 TURBINE * *****					***** * O2 PUMP * *****				
EFFICIENCY	0.871				EFFICIENCY	0.727			
HORSEPOWER	410.				HORSEPOWER	410.			
SPEED (RPM)	74295.				SPEED (RPM)	74295.			
MEAN DIA (IN)	2.86				S SPEED	1523.			
EFF AREA (IN ²)	0.43				HEAD (FT)	5703.			
U/C (IDEAL)	0.542				DIA. (IN)	1.93			
MAX TIP SPEED	928.				TIP SPEED	627.			
STAGES	1.				VOL. FLOW	181.			
DELTA H (ACT)	50.94				HEAD COEF	0.467			
GAMMA	1.38				FLOW COEF	0.128			
PRESS RATIO (T/T)	1.10								
***** REGENERATOR DATA *****									
	COLD SIDE	HOT SIDE							
DELP	52.92	52.38							
DELT	122.82	-118.75							
AREA	0.40	1.52							
FLOW	5.75	5.69							
EFFECTIVENESS		0.29							
NTU		0.43							
CRATIO		0.97							
CHIN		20.47							
REGEN Q		2513.80							

TABLE 64. — FULL-EXPANDER CYCLE WITH REGENERATION — O/F = 5.5

ENGINE PERFORMANCE PARAMETERS					
CHAMBER PRESSURE	1665.9				
VAC ENGINE THRUST	18583.				
DEL. VAC. ISP	479.0				
TOTAL ENGINE FLOW RATE	38.8				
THROAT AREA	5.547				
NOZZLE AREA RATIO	1000.0				
ENGINE MIXTURE RATIO	5.50				
CHAMBER/NOZZLE COOLANT DP	818.				
CHAMBER/NOZZLE COOLANT DT	437.				
ETA C*	0.993				
CHAMBER/NOZZLE Q	10064.				

ENGINE STATION CONDITIONS					
* FUEL SYSTEM CONDITIONS *					
STATION	PRESS	TEMP	FLOW	ENTHALPY	DENSITY
B.P. INLET	18.6	37.4	5.98	-107.5	4.37
B.P. EXIT	101.5	38.5	5.98	-102.9	4.39
PUMP INLET	101.5	38.5	5.98	-102.9	4.39
1ST STAGE EXIT	1839.4	63.4	5.98	6.7	4.41
2ND STAGE EXIT	3563.3	87.0	5.98	114.5	4.46
PUMP EXIT	5278.7	109.7	5.98	220.4	4.52
COLD REGEN IN	5223.6	110.1	5.98	220.4	4.50
COLD REGEN EX	5168.4	241.7	5.98	697.7	2.80
COOLANT INLET	5168.4	241.7	5.98	697.7	2.80
COOLANT EXIT	4350.1	678.2	5.98	2381.6	1.05
TBV INLET	4308.9	678.5	0.06	2381.6	1.04
TBV EXIT	1925.1	693.0	0.06	2381.6	0.49
LOX TRB INLET	4308.9	678.5	5.92	2381.6	1.04
LOX TRB EXIT	3906.3	665.3	5.92	2325.7	0.98
H2 TRB INLET	3906.3	665.3	5.92	2325.7	0.98
H2 TRB EXIT	2058.5	585.0	5.92	1999.0	0.61
H2 TRB DIFF	2025.8	585.2	5.92	1999.0	0.60
H2 BST TRB IN	2003.6	585.3	5.92	1999.0	0.60
H2 BST TRB EXIT	1983.0	584.1	5.92	1994.4	0.59
H2 BST TRB DIFF	1968.6	584.2	5.92	1994.4	0.59
O2 BST TRB IN	1946.9	584.3	5.92	1994.4	0.58
O2 BST TRB EXIT	1937.3	583.6	5.92	1991.9	0.58
O2 BST TRB DIFF	1935.8	583.6	5.92	1991.9	0.58
H2 TANK PRESS	18.6	594.0	0.0081	1495.8	0.0059
GOX HEAT EXCH IN	1925.1	584.8	5.92	1495.8	0.57
GOX HEAT EXCH OUT	1915.5	584.5	5.92	1494.6	0.57
HOT REGEN IN	1915.5	584.5	5.92	1494.6	0.57
HOT REGEN EX	1858.9	453.1	5.92	1512.5	0.71
FSV INLET	1858.9	453.1	5.97	1512.5	0.71
FSV EXIT	1811.8	453.2	5.97	1512.5	0.69
CHAMBER INJ	1793.4	453.3	5.97	1512.5	0.69
CHAMBER	1666.0				

* OXYGEN SYSTEM CONDITIONS *					
STATION	PRESS	TEMP	FLOW	ENTHALPY	DENSITY
B.P. INLET	16.0	162.7	32.88	61.9	70.99
B.P. EXIT	145.0	165.4	32.88	62.4	70.84
PUMP INLET	145.0	165.4	32.88	62.4	70.84
PUMP EXIT	3006.5	179.2	32.88	72.4	71.36
O2 TANK PRESS	16.0	400.0	0.06	204.7	0.12
POSV INLET	2982.1	179.2	5.92	72.4	71.32
POSV EXIT	1933.7	183.4	5.92	72.4	69.69
OCV INLET	2982.1	179.2	26.91	72.4	71.32
OCV EXIT	1838.6	183.7	26.91	72.4	69.53
PRIMARY INJ	1884.8	183.6	5.92	72.4	69.61
SECONDARY INJ	1807.1	183.9	26.91	72.4	69.48
CHAMBER	1665.9				

VALVE DATA				
VALVE	DELTA P	AREA	FLOW	% BYPASS
TBV	2384.	0.003	0.06	1.00
FSV	47.	1.502	5.97	
POSV	1048.	0.032	5.92	
OCV	1144.	0.141	26.91	

INJECTOR DATA				
* FUEL *		* OXID *		
		PRIMARY	SECOND	
DELP MAN	19.12	24.22	15.33	
DELP INJ	108.44	218.93	141.15	
AREA	1.03	0.07	0.41	
FLOW	5.97	5.92	26.91	

ORIGINAL PAGE IS
OF POOR QUALITY

TABLE 64. — FULL-EXPANDER CYCLE WITH REGENERATION — O/F = 5.5
(CONTINUED)

***** * TURBOMACHINERY PERFORMANCE DATA * *****						
* H2 BOOST TURBINE *			* H2 BOOST PUMP *			

EFFICIENCY	0.778		EFFICIENCY	0.765		
HORSEPOWER	39.		HORSEPOWER	39.		
SPEED (RPM)	46313.		SPEED (RPM)	46313.		
MEAN DIA (IN)	1.34		S SPEED	3037.		
EFF AREA (IN ²)	2.45		HEAD (FT)	2723.		
U/C (IDEAL)	0.485		DIA. (IN)	2.18		
MAX TIP SPEED	271.		TIP SPEED	440.		
STAGES	1.		VOL. FLOW	611.		
DELTA H (ACT)	4.62		HEAD COEF	0.452		
GAMMA	1.39		FLOW COEF	0.201		
PRESS RATIO (T/T)	1.01					

* H2 TURBINE *			* H2 PUMP *			

	STAGE 1	STAGE 2	STAGE ONE	STAGE TWO	STAGE THREE	
	*****	*****	*****	*****	*****	
EFFICIENCY	0.851	0.839	EFFICIENCY	0.666	0.667	0.667
HORSEPOWER	2734.	2734.	HORSEPOWER	927.	912.	895.
SPEED (RPM)	123568.	123568.	SPEED (RPM)	123568.	123568.	123568.
MEAN DIA (IN)	2.86	2.86	S SPEED	828.	833.	838.
EFF AREA (IN ²)	0.31	0.40	HEAD (FT)	56800.	55940.	54985.
U/C (IDEAL)	0.500	0.492	DIA. (IN)	3.44	3.44	3.44
MAX TIP SPEED	1544.	1544.	TIP SPEED	1857.	1858.	1858.
DELTA H	162.	165.	VOL. FLOW	608.	602.	593.
GAMMA (ACT)	1.39	1.39	HEAD COEF	0.530	0.522	0.513
PRESS RATIO(T/T)	1.34	1.37	FLOW COEF	0.100	0.100	0.100

* O2 BOOST TURBINE *			* O2 BOOST PUMP *			

EFFICIENCY	0.866		EFFICIENCY	0.755		
HORSEPOWER	21.		HORSEPOWER	21.		
SPEED (RPM)	12219.		SPEED (RPM)	12219.		
MEAN DIA (IN)	3.69		S SPEED	2705.		
EFF AREA (IN ²)	3.60		HEAD (FT)	262.		
U/C (IDEAL)	0.514		DIA. (IN)	2.44		
MAX TIP SPEED	197.		TIP SPEED	130.		
STAGES	1.		VOL. FLOW	208.		
DELTA H (ACT)	2.48		HEAD COEF	0.497		
GAMMA	1.39		FLOW COEF	0.186		
PRESS RATIO (T/T)	1.00					

* O2 TURBINE *			* O2 PUMP *			

EFFICIENCY	0.865		EFFICIENCY	0.737		
HORSEPOWER	468.		HORSEPOWER	468.		
SPEED (RPM)	76597.		SPEED (RPM)	76597.		
MEAN DIA (IN)	2.86		S SPEED	1663.		
EFF AREA (IN ²)	0.43		HEAD (FT)	5773.		
U/C (IDEAL)	0.522		DIA. (IN)	1.93		
MAX TIP SPEED	957.		TIP SPEED	647.		
STAGES	1.		VOL. FLOW	207.		
DELTA H (ACT)	55.93		HEAD COEF	0.444		
GAMMA	1.39		FLOW COEF	0.141		
PRESS RATIO (T/T)	1.10					

REGENERATOR DATA *****		
	COLD SIDE	HOT SIDE
DELP	55.26	56.56
DELT	131.59	-131.40
AREA	0.40	1.52
FLOW	5.98	5.92
EFFECTIVENESS		0.28
NTU		0.40
CRATIO		1.00
CMIN		21.68
REGEN Q		2852.87

ORIGINAL PAGE IS
OF POOR QUALITY

TABLE 65. — FULL-EXPANDER CYCLE WITH REGENERATION — O/F = 6.0

ENGINE PERFORMANCE PARAMETERS					

CHAMBER PRESSURE					1764.0
VAC ENGINE THRUST					20000.
DEL. VAC. ISP					489.1
TOTAL ENGINE FLOW RATE					41.7
THROAT AREA					5.547
NOZZLE AREA RATIO					1000.0
ENGINE MIXTURE RATIO					6.00
CHAMBER/NOZZLE COOLANT DP					874.
CHAMBER/NOZZLE COOLANT DT					585.
ETA C*					0.993
CHAMBER/NOZZLE Q					11370.
ENGINE STATION CONDITIONS					

* FUEL SYSTEM CONDITIONS *					
STATION	PRESS	TEMP	FLOW	ENTHALPY	DENSITY
B.P. INLET	18.6	37.4	5.96	-107.5	4.37
B.P. EXIT	100.3	38.5	5.96	-103.0	4.39
PUMP INLET	100.3	38.5	5.96	-103.0	4.39
1ST STAGE EXIT	1882.3	63.9	5.96	9.2	4.41
2ND STAGE EXIT	3651.4	88.1	5.96	119.6	4.46
PUMP EXIT	5414.2	111.2	5.96	220.1	4.53
COLD REGEN IN	5359.5	111.7	5.96	220.1	4.51
COLD REGEN EX	5305.2	263.0	5.96	790.2	2.67
COOLANT INLET	5305.2	263.0	5.96	790.2	2.67
COOLANT EXIT	4431.2	767.8	5.96	2701.8	0.96
TBV INLET	4386.0	768.1	0.36	2701.8	0.95
TBV EXIT	2030.5	783.1	0.36	2701.8	0.46
LOX TRB INLET	4386.0	768.1	5.60	2701.8	0.95
LOX TRB EXIT	3984.6	753.6	5.60	2640.8	0.88
H2 TRB INLET	3984.6	753.6	5.60	2640.8	0.88
H2 TRB EXIT	2159.4	665.3	5.60	2288.6	0.57
H2 TRB DIFF	2127.6	665.5	5.60	2288.6	0.56
H2 BST TRB IN	2106.2	665.6	5.60	2288.6	0.56
H2 BST TRB EXIT	2086.3	664.4	5.60	2283.8	0.55
H2 BST TRB DIFF	2072.4	664.5	5.60	2283.8	0.55
O2 BST TRB IN	2051.5	664.6	5.60	2281.3	0.54
O2 BST TRB EXIT	2042.2	663.9	5.60	2281.3	0.54
O2 BST TRB DIFF	2040.7	663.9	5.60	2281.3	0.54
H2 TANK PRESS	18.6	682.3	0.0070	2306.4	0.0051
GOX HEAT EXCH IN	2030.5	671.1	5.60	2306.4	0.53
GOX HEAT EXCH OUT	2021.2	670.7	5.60	2304.9	0.53
HOT REGEN IN	2021.2	670.7	5.60	2304.9	0.53
HOT REGEN EX	1966.2	505.4	5.60	1707.1	0.67
FSV INLET	1966.2	505.4	5.95	1707.1	0.67
FSV EXIT	1916.8	505.6	5.95	1707.1	0.66
CHAMBER INJ	1897.5	505.7	5.95	1707.1	0.65
CHAMBER	1764.0				
* OXYGEN SYSTEM CONDITIONS *					
STATION	PRESS	TEMP	FLOW	ENTHALPY	DENSITY
B.P. INLET	16.0	162.7	35.77	61.9	70.99
B.P. EXIT	134.0	165.3	35.77	62.3	70.84
PUMP INLET	134.0	165.3	35.77	62.3	70.84
PUMP EXIT	2854.8	178.4	35.77	71.9	71.34
O2 TANK PRESS	16.0	400.0	0.06	204.7	0.12
POSV INLET	2825.9	178.5	5.32	71.9	71.30
POSV EXIT	1979.3	181.8	5.32	71.9	69.98
OCV INLET	2825.9	178.5	30.39	71.9	71.30
OCV EXIT	1982.9	181.7	30.39	71.9	69.99
PRIMARY INJ	1940.0	181.9	5.32	71.9	69.92
SECONDARY INJ	1943.0	181.9	30.39	71.9	69.92
CHAMBER	1764.0				
VALVE DATA					

VALVE	DELTA P	AREA	FLOW	% BYPASS	
TBV	2356.	0.016	0.36	5.97	
FSV	49.	1.902	5.95		
POSV	847.	0.032	5.32		
OCV	843.	0.185	30.39		
INJECTOR DATA					

	* FUEL *		* OXID *		
		PRIMARY	SECOND		
DELP MAN	20.01	19.55	19.88		
DELP INJ	113.49	175.97	178.93		
AREA	1.03	0.07	0.41		
FLOW	5.95	5.32	30.39		

TABLE 65. — FULL-EXPANDER CYCLE WITH REGENERATION — O/F = 6.0
(CONTINUED)

***** * TURBOMACHINERY PERFORMANCE DATA * *****						
***** * H2 BOOST TURBINE * *****			***** * H2 BOOST PUMP * *****			
EFFICIENCY	0.770		EFFICIENCY	0.765		
HORSEPOWER	38.		HORSEPOWER	38.		
SPEED (RPM)	46052.		SPEED (RPM)	46052.		
MEAN DIA (IN)	1.34		S SPEED	3049.		
EFF AREA (IN ²)	2.45		HEAD (FT)	2683.		
U/C (IDEAL)	0.485		DIA. (IN)	2.18		
MAX TIP SPEED	269.		TIP SPEED	438.		
STAGES	1.		VOL. FLOW	609.		
DELTA H (ACT)	4.79		HEAD COEF	0.450		
GAMMA	1.36		FLOW COEF	0.202		
PRESS RATIO (T/T)	1.01					
***** * H2 TURBINE * *****			***** * H2 PUMP * *****			
	STAGE 1	STAGE 2		STAGE ONE	STAGE TWO	STAGE THREE
EFFICIENCY	0.839	0.828	EFFICIENCY	0.667	0.668	0.668
HORSEPOWER	2792.	2792.	HORSEPOWER	946.	931.	915.
SPEED (RPM)	124577.	124577.	SPEED (RPM)	124577.	124577.	124577.
MEAN DIA (IN)	2.86	2.86	S SPEED	818.	823.	827.
EFF AREA (IN ²)	0.31	0.40	HEAD (FT)	58219.	57358.	56415.
U/C (IDEAL)	0.480	0.476	DIA. (IN)	3.44	3.44	3.44
MAX TIP SPEED	1557.	1557.	TIP SPEED	1872.	1873.	1873.
DELTA H	176.	176.	VOL. FLOW	606.	599.	590.
GAMMA (ACT)	1.36	1.36	HEAD COEF	0.534	0.526	0.517
PRESS RATIO(T/T)	1.34	1.37	FLOW COEF	0.098	0.099	0.099
***** * O2 BOOST TURBINE * *****			***** * O2 BOOST PUMP * *****			
EFFICIENCY	0.861		EFFICIENCY	0.764		
HORSEPOWER	20.		HORSEPOWER	20.		
SPEED (RPM)	12293.		SPEED (RPM)	12293.		
MEAN DIA (IN)	3.69		S SPEED	3036.		
EFF AREA (IN ²)	3.60		HEAD (FT)	240.		
U/C (IDEAL)	0.514		DIA. (IN)	2.44		
MAX TIP SPEED	198.		TIP SPEED	131.		
STAGES	1.		VOL. FLOW	227.		
DELTA H (ACT)	2.58		HEAD COEF	0.449		
GAMMA	1.36		FLOW COEF	0.201		
PRESS RATIO (T/T)	1.00					
***** * O2 TURBINE * *****			***** * O2 PUMP * *****			
EFFICIENCY	0.850		EFFICIENCY	0.739		
HORSEPOWER	483.		HORSEPOWER	483.		
SPEED (RPM)	76647.		SPEED (RPM)	76647.		
MEAN DIA (IN)	2.86		S SPEED	1803.		
EFF AREA (IN ²)	0.43		HEAD (FT)	5490.		
U/C (IDEAL)	0.505		DIA. (IN)	1.93		
MAX TIP SPEED	958.		TIP SPEED	647.		
STAGES	1.		VOL. FLOW	225.		
DELTA H (ACT)	60.92		HEAD COEF	0.422		
GAMMA	1.36		FLOW COEF	0.154		
PRESS RATIO (T/T)	1.10					
***** REGENERATOR DATA *****						
	COLD SIDE	HOT SIDE				
DELTA P	54.26	55.05				
DELTA T	151.37	-165.29				
AREA	0.40	1.52				
FLOW	5.96	5.60				
EFFECTIVENESS		0.30				
NTU		0.43				
CRATIO		0.92				
CMIN		20.26				
REGEN Q		3349.23				

TABLE 66. — FULL-EXPANDER CYCLE WITH REGENERATION — O/F = 6.5

ENGINE PERFORMANCE PARAMETERS					
CHAMBER PRESSURE	1764.0				
VAC ENGINE THRUST	20336.				
DEL. VAC. ISP	480.3				
TOTAL ENGINE FLOW RATE	42.3				
THROAT AREA	5.547				
NOZZLE AREA RATIO	1000.0				
ENGINE MIXTURE RATIO	6.50				
CHAMBER/NOZZLE COOLANT DP	884.				
CHAMBER/NOZZLE COOLANT DT	578.				
ETA C*	0.993				
CHAMBER/NOZZLE Q	12145.				

ENGINE STATION CONDITIONS					

* FUEL SYSTEM CONDITIONS *					
STATION	PRESS	TEMP	FLOW	ENTHALPY	DENSITY
B.P. INLET	18.6	37.4	5.65	-107.5	4.37
B.P. EXIT	95.5	38.4	5.65	-103.3	4.39
PUMP INLET	95.5	38.4	5.65	-103.3	4.39
1ST STAGE EXIT	1804.2	62.9	5.65	4.5	4.41
2ND STAGE EXIT	3498.9	86.1	5.65	110.5	4.46
PUMP EXIT	5184.6	108.4	5.65	214.5	4.52
COLD REGEN IN	5135.3	108.8	5.65	214.5	4.50
COLD REGEN EX	5085.7	292.4	5.65	911.6	2.40
COOLANT INLET	5085.7	292.4	5.65	911.6	2.40
COOLANT EXIT	4201.5	870.3	5.65	3060.9	0.81
TBV INLET	4153.7	870.6	0.71	3060.9	0.80
TBV EXIT	2021.1	884.8	0.71	3060.9	0.41
LOX TRB INLET	4153.7	870.6	4.94	3060.9	0.80
LOX TRB EXIT	3780.9	854.6	4.94	2995.6	0.75
H2 TRB INLET	3780.9	854.6	4.94	2995.6	0.75
H2 TRB EXIT	2136.8	762.9	4.94	2632.4	0.49
H2 TRB DIFF	2108.2	763.0	4.94	2632.4	0.49
H2 BST TRB IN	2089.0	763.2	4.94	2632.4	0.48
H2 BST TRB EXIT	2071.1	761.9	4.94	2627.6	0.48
H2 BST TRB DIFF	2058.6	762.0	4.94	2627.6	0.48
O2 BST TRB IN	2039.9	762.1	4.94	2627.6	0.47
O2 BST TRB EXIT	2031.5	761.4	4.94	2624.9	0.47
O2 BST TRB DIFF	2030.2	761.4	4.94	2624.9	0.47
H2 TANK PRESS	18.6	789.1	0.0058	2679.4	0.0045
GOX HEAT EXCH IN	2021.1	776.9	4.94	2679.4	0.46
GOX HEAT EXCH OUT	2012.7	776.4	4.94	2677.7	0.46
HOT REGEN IN	2012.7	776.4	4.94	2677.7	0.46
HOT REGEN EX	1963.1	553.1	4.94	1881.1	0.62
FSV INLET	1963.1	553.1	5.64	1881.1	0.62
FSV EXIT	1914.4	553.4	5.64	1881.1	0.60
CHAMBER INJ	1895.5	553.4	5.64	1881.1	0.60
CHAMBER	1764.1				

* OXYGEN SYSTEM CONDITIONS *					
STATION	PRESS	TEMP	FLOW	ENTHALPY	DENSITY
B.P. INLET	16.0	162.7	36.75	61.9	70.99
B.P. EXIT	117.1	165.2	36.75	62.3	70.83
PUMP INLET	117.1	165.2	36.75	62.3	70.83
PUMP EXIT	2607.6	177.3	36.75	71.1	71.28
O2 TANK PRESS	16.0	400.0	0.06	204.7	0.12
POSV INLET	2577.0	177.4	4.65	71.1	71.23
POSV EXIT	1928.2	179.9	4.65	71.1	70.22
OCV INLET	2577.0	177.4	32.04	71.1	71.23
OCV EXIT	2006.1	179.6	32.04	71.1	70.34
PRIMARY INJ	1898.3	180.0	4.65	71.1	70.17
SECONDARY INJ	1961.9	179.8	32.04	71.1	70.27
CHAMBER	1764.0				

VALVE DATA				

VALVE	DELTA P	AREA	FLOW	% BYPASS
TBV	2133.	0.036	0.71	12.50
FSV	49.	1.502	5.64	
POSV	649.	0.032	4.65	
OCV	571.	0.238	32.04	

INJECTOR DATA			

	* FUEL *	* OXID *	
		PRIMARY	SECOND
DELP MAN	19.65	14.92	21.99
DELP INJ	111.83	124.23	197.88
AREA	1.03	0.07	0.41
FLOW	5.64	4.65	32.04

TABLE 66. — FULL-EXPANDER CYCLE WITH REGENERATION — O/F = 6.5
(CONTINUED)

***** * TURBOMACHINERY PERFORMANCE DATA * *****						
***** * H2 BOOST TURBINE * *****			***** * H2 BOOST PUMP * *****			
EFFICIENCY	0.750		EFFICIENCY	0.765		
HORSEPOWER	34.		HORSEPOWER	34.		
SPEED (RPM)	44288.		SPEED (RPM)	44288.		
MEAN DIA (IN)	1.34		S SPEED	2987.		
EFF AREA (IN ²)	2.45		HEAD (FT)	2527.		
U/C (IDEAL)	0.485		DIA. (IN)	2.18		
MAX TIP SPEED	259.		TIP SPEED	421.		
STAGES	1.		VOL. FLOW	578.		
DELTA H (ACT)	4.85		HEAD COEF	0.459		
GAMMA	1.38		FLOW COEF	0.199		
PRESS RATIO (T/T)	1.01					
***** * H2 TURBINE * *****			***** * H2 PUMP * *****			
	STAGE 1	STAGE 2		STAGE ONE	STAGE TWO	STAGE THREE
	*****	*****		*****	*****	*****
EFFICIENCY	0.813	0.810	EFFICIENCY	0.666	0.667	0.668
HORSEPOWER	2541.	2541.	HORSEPOWER	862.	847.	832.
SPEED (RPM)	121121.	121121.	SPEED (RPM)	121121.	121121.	121121.
MEAN DIA (IN)	2.86	2.86	S SPEED	799.	804.	809.
EFF AREA (IN ²)	0.31	0.40	HEAD (FT)	55857.	55010.	54067.
U/C (IDEAL)	0.448	0.455	DIA. (IN)	3.44	3.44	3.44
MAX TIP SPEED	1513.	1513.	TIP SPEED	1821.	1821.	1821.
DELTA H	185.	179.	VOL. FLOW	575.	569.	561.
GAMMA (ACT)	1.38	1.38	HEAD COEF	0.542	0.534	0.525
PRESS RATIO(T/T)	1.34	1.37	FLOW COEF	0.096	0.096	0.097
***** * O2 BOOST TURBINE * *****			***** * O2 BOOST PUMP * *****			
EFFICIENCY	0.842		EFFICIENCY	0.753		
HORSEPOWER	18.		HORSEPOWER	18.		
SPEED (RPM)	11907.		SPEED (RPM)	11907.		
MEAN DIA (IN)	3.69		S SPEED	3347.		
EFF AREA (IN ²)	3.60		HEAD (FT)	206.		
U/C (IDEAL)	0.514		DIA. (IN)	2.44		
MAX TIP SPEED	192.		TIP SPEED	127.		
STAGES	1.		VOL. FLOW	233.		
DELTA H (ACT)	2.61		HEAD COEF	0.410		
GAMMA	1.38		FLOW COEF	0.213		
PRESS RATIO (T/T)	1.00					
***** * O2 TURBINE * *****			***** * O2 PUMP * *****			
EFFICIENCY	0.821		EFFICIENCY	0.735		
HORSEPOWER	457.		HORSEPOWER	457.		
SPEED (RPM)	74858.		SPEED (RPM)	74858.		
MEAN DIA (IN)	2.86		S SPEED	1907.		
EFF AREA (IN ²)	0.43		HEAD (FT)	5030.		
U/C (IDEAL)	0.468		DIA. (IN)	1.93		
MAX TIP SPEED	935.		TIP SPEED	632.		
STAGES	1.		VOL. FLOW	231.		
DELTA H (ACT)	65.35		HEAD COEF	0.405		
GAMMA	1.38		FLOW COEF	0.162		
PRESS RATIO (T/T)	1.10					
***** REGENERATOR DATA *****						
	COLD SIDE	HOT SIDE				
DEL P	49.62	49.67				
DEL T	183.57	-223.29				
AREA	0.40	1.52				
FLOW	5.65	6.94				
EFFECTIVENESS	0.33					
NTU	0.50					
CRATIO	0.82					
CMIN	17.64					
REGEN Q	3938.60					

TABLE 67. — FULL-EXPANDER CYCLE WITH REGENERATION — O/F = 7.0

ENGINE PERFORMANCE PARAMETERS					

CHAMBER PRESSURE					1763.9
VAC ENGINE THRUST					20672.
DEL. VAC. ISP					477.5
TOTAL ENGINE FLOW RATE					43.3
THROAT AREA					5.547
NOZZLE AREA RATIO					1000.0
ENGINE MIXTURE RATIO					7.00
CHAMBER/NOZZLE COOLANT DP					890.
CHAMBER/NOZZLE COOLANT DT					650.
ETA C*					0.988
CHAMBER/NOZZLE Q					12914.
ENGINE STATION CONDITIONS					

* FUEL SYSTEM CONDITIONS *					
STATION	PRESS	TEMP	FLOW	ENTHALPY	DENSITY
B.P. INLET	18.6	37.4	5.42	-107.5	4.37
B.P. EXIT	91.8	38.4	5.42	-103.5	4.39
PUMP INLET	91.8	38.4	5.42	-103.5	4.39
1ST STAGE EXIT	1748.8	62.2	5.42	1.2	4.41
2ND STAGE EXIT	3390.2	84.8	5.42	104.1	4.45
PUMP EXIT	5020.7	106.5	5.42	205.1	4.51
COLD REGEN IN	4975.3	106.9	5.42	205.1	4.49
COLD REGEN EX	4929.1	316.9	5.42	1013.2	2.20
COOLANT INLET	4929.1	316.9	5.42	1013.2	2.20
COOLANT EXIT	4038.9	967.2	5.42	3397.2	0.71
TBV INLET	3988.8	967.5	0.95	3397.2	0.70
TBV EXIT	2015.4	981.1	0.95	3397.2	0.37
LOX TRB INLET	3988.8	967.5	4.47	3397.2	0.70
LOX TRB EXIT	3637.6	950.2	4.47	3328.2	0.66
H2 TRB INLET	3637.6	950.2	4.47	3328.2	0.66
H2 TRB EXIT	2121.5	853.8	4.47	2954.2	0.44
H2 TRB DIFF	2095.2	853.9	4.47	2954.2	0.44
H2 BST TRB IN	2077.7	854.0	4.47	2954.2	0.43
H2 BST TRB EXIT	2061.2	852.8	4.47	2949.3	0.43
H2 BST TRB DIFF	2049.7	852.8	4.47	2949.3	0.43
O2 BST TRB IN	2032.7	852.9	4.47	2949.3	0.42
O2 BST TRB EXIT	2025.0	852.3	4.47	2946.6	0.42
O2 BST TRB DIFF	2023.8	852.3	4.47	2946.6	0.42
H2 TANK PRESS	18.6	887.8	0.0049	3025.5	0.0039
GOK HEAT EXCH IN	2015.4	874.7	4.47	3025.5	0.41
GOK HEAT EXCH OUT	2007.8	874.2	4.47	3023.6	0.41
HOT REGEN IN	2007.8	874.2	4.47	3023.6	0.41
HOT REGEN EX	1962.1	597.9	4.47	2043.9	0.57
FSV INLET	1962.1	597.9	5.41	2043.9	0.57
FSV EXIT	1913.6	598.2	5.41	2043.9	0.56
CHAMBER INJ	1894.9	598.3	5.41	2043.9	0.56
CHAMBER	1764.2				
* OXYGEN SYSTEM CONDITIONS *					
STATION	PRESS	TEMP	FLOW	ENTHALPY	DENSITY
B.P. INLET	16.0	162.7	37.95	61.9	70.99
B.P. EXIT	101.6	165.2	37.95	62.2	70.82
PUMP INLET	101.6	165.2	37.95	62.2	70.82
PUMP EXIT	2379.8	176.4	37.95	70.4	71.20
O2 TANK PRESS	16.0	400.0	0.06	204.7	0.12
POSV INLET	2347.2	176.5	3.94	70.4	71.15
POSV EXIT	1880.9	178.3	3.94	70.4	70.42
OCV INLET	2347.2	176.5	33.94	70.4	71.15
OCV EXIT	2034.5	177.7	33.94	70.4	70.66
PRIMARY INJ	1859.4	178.4	3.94	70.4	70.39
SECONDARY INJ	1985.1	177.9	33.94	70.4	70.58
CHAMBER	1763.4				
VALVE DATA					

VALVE	DELTA P	AREA	FLOW	% BYPASS	
TBV	1973.	0.053	0.95	17.51	
FSV	48.	1.502	5.41		
POSV	466.	0.032	3.94		
OCV	513.	0.340	33.94		
INJECTOR DATA					

* FUEL *		* OXID *			
		PRIMARY	SECOND		
DELP MAN	19.45	10.98	24.56		
DELP INJ	111.54	96.08	221.10		
AREA	1.03	0.07	0.41		
FLOW	5.41	0.94	33.94		

TABLE 67. — FULL-EXPANDER CYCLE WITH REGENERATION — O/F = 7.0
(CONTINUED)

***** * TURBOMACHINERY PERFORMANCE DATA * *****					
***** * H2 BOOST TURBINE * *****			***** * H2 BOOST PUMP * *****		
EFFICIENCY	0.734		EFFICIENCY	0.765	
HORSEPOWER	31.		HORSEPOWER	31.	
SPEED (RPM)	42920.		SPEED (RPM)	42920.	
MEAN DIA (IN)	1.34		S SPEED	2940.	
EFF AREA (IN2)	2.45		HEAD (FT)	2406.	
U/C (IDEAL)	0.485		DIA. (IN)	2.18	
MAX TIP SPEED	251.		TIP SPEED	408.	
STAGES	1.		VOL. FLOW	554.	
DELTA H (ACT)	4.90		HEAD COEF	0.465	
GAMMA	1.40		FLOW COEF	0.197	
PRESS RATIO (T/T)	1.01				
***** * H2 TURBINE * *****			***** * H2 PUMP * *****		
	STAGE 1	STAGE 2	STAGE ONE	STAGE TWO	STAGE THREE
EFFICIENCY	0.792	0.795	EFFICIENCY	0.665	0.666
HORSEPOWER	2345.	2365.	HORSEPOWER	802.	789.
SPEED (RPM)	118602.	118602.	SPEED (RPM)	118602.	118602.
MEAN DIA (IN)	2.86	2.86	S SPEED	784.	790.
EFF AREA (IN2)	0.31	0.40	HEAD (FT)	54197.	53348.
U/C (IDEAL)	0.425	0.438	DIA. (IN)	3.44	3.44
MAX TIP SPEED	1482.	1482.	TIP SPEED	1783.	1783.
DELTA H (ACT)	192.	182.	VOL. FLOW	552.	547.
GAMMA (ACT)	1.40	1.40	HEAD COEF	0.549	0.540
PRESS RATIO(T/T)	1.34	1.37	FLOW COEF	0.094	0.095
***** * O2 BOOST TURBINE * *****			***** * O2 BOOST PUMP * *****		
EFFICIENCY	0.826		EFFICIENCY	0.721	
HORSEPOWER	17.		HORSEPOWER	17.	
SPEED (RPM)	11574.		SPEED (RPM)	11574.	
MEAN DIA (IN)	3.69		S SPEED	3743.	
EFF AREA (IN2)	3.60		HEAD (FT)	174.	
U/C (IDEAL)	0.514		DIA. (IN)	2.44	
MAX TIP SPEED	186.		TIP SPEED	123.	
STAGES	1.		VOL. FLOW	241.	
DELTA H (ACT)	2.64		HEAD COEF	0.368	
GAMMA	1.40		FLOW COEF	0.226	
PRESS RATIO (T/T)	1.00				
***** * O2 TURBINE * *****			***** * O2 PUMP * *****		
EFFICIENCY	0.796		EFFICIENCY	0.729	
HORSEPOWER	436.		HORSEPOWER	436.	
SPEED (RPM)	73352.		SPEED (RPM)	73352.	
MEAN DIA (IN)	2.86		S SPEED	2029.	
EFF AREA (IN2)	0.43		HEAD (FT)	4607.	
U/C (IDEAL)	0.440		DIA. (IN)	1.93	
MAX TIP SPEED	917.		TIP SPEED	619.	
STAGES	1.		VOL. FLOW	239.	
DELTA H (ACT)	68.96		HEAD COEF	0.387	
GAMMA	1.40		FLOW COEF	0.171	
PRESS RATIO (T/T)	1.10				
***** REGENERATOR DATA *****					
	COLD SIDE	HOT SIDE			
DELTA P	46.20	45.68			
DELTA T	210.01	-276.25			
AREA	0.40	1.53			
FLOW	5.42	4.47			
EFFECTIVENESS	0.36				
NTU	0.55				
CRATIO	0.76				
CMIN	15.85				
REGEN Q	4377.96				

TABLE 68. — FULL-EXPANDER CYCLE WITH REGENERATION — O/F = 12.0

ENGINE PERFORMANCE PARAMETERS					

CHAMBER PRESSURE					1160.0
VAC ENGINE THRUST					13474.
DEL. VAC. ISP					396.3
TOTAL ENGINE FLOW RATE					34.0
THROAT AREA					5.547
NOZZLE AREA RATIO					1000.0
ENGINE MIXTURE RATIO					12.00
CHAMBER/NOZZLE COOLANT DP					417.
CHAMBER/NOZZLE COOLANT DT					795.
ETA C*					0.980
CHAMBER/NOZZLE Q					7296.
ENGINE STATION CONDITIONS					

# FUEL SYSTEM CONDITIONS #					
STATION	PRESS	TEMP	FLOW	ENTHALPY	DENSITY
B.P. INLET	18.6	37.4	2.62	-107.5	4.37
B.P. EXIT	61.5	38.1	2.62	-104.7	4.37
PUMP INLET	61.5	38.1	2.62	-104.7	4.37
1ST STAGE EXIT	1352.4	61.9	2.62	-9.1	4.23
2ND STAGE EXIT	2599.2	84.1	2.62	83.6	4.17
PUMP EXIT	3813.5	105.4	2.62	173.9	4.16
COLD REGEN IN	3802.0	105.5	2.62	173.9	4.16
COLD REGEN EX	3788.2	642.8	2.62	2243.4	0.98
COOLANT INLET	3788.2	642.8	2.62	2243.4	0.98
COOLANT EXIT	3371.4	1436.2	2.62	5031.2	0.41
TBV INLET	3351.4	1436.4	0.01	5031.2	0.41
TBV EXIT	2350.0	1443.9	0.01	5031.2	0.29
LOX TRB INLET	3351.4	1436.4	2.60	5031.2	0.41
LOX TRB EXIT	3146.7	1420.6	2.60	4969.8	0.39
H2 TRB INLET	3146.7	1420.6	2.60	4969.8	0.39
H2 TRB EXIT	2399.2	1347.0	2.60	4689.7	0.32
H2 TRB DIFF	2386.8	1347.1	2.60	4689.7	0.32
H2 BST TRB IN	2378.7	1347.2	2.60	4689.7	0.32
H2 BST TRB EXIT	2371.0	1346.4	2.60	4686.9	0.32
H2 BST TRB DIFF	2365.7	1346.5	2.60	4686.9	0.32
O2 BST TRB IN	2357.9	1346.5	2.60	4686.9	0.31
O2 BST TRB EXIT	2354.3	1346.1	2.60	4685.3	0.31
O2 BST TRB DIFF	2353.8	1346.1	2.60	4685.3	0.31
H2 TANK PRESS	18.6	1346.6	0.0015	4687.1	0.0026
GOX HEAT EXCH IN	2350.0	1346.6	2.60	4687.1	0.31
GOX HEAT EXCH OUT	2346.6	1345.8	2.60	4684.3	0.31
HOT REGEN IN	2346.6	1345.8	2.60	4684.3	0.31
HOT REGEN EX	2326.5	753.7	2.60	2604.1	0.54
FSV INLET	2326.5	753.7	2.62	2604.1	0.54
FSV EXIT	1227.1	760.4	2.62	2604.1	0.29
CHAMBER INJ	1218.7	760.4	2.62	2604.1	0.29
CHAMBER	1160.0				
# OXYGEN SYSTEM CONDITIONS #					
STATION	PRESS	TEMP	FLOW	ENTHALPY	DENSITY
B.P. INLET	16.0	162.7	31.44	61.9	70.99
B.P. EXIT	52.1	164.9	31.44	62.1	70.81
PUMP INLET	52.1	164.9	31.44	62.1	70.81
PUMP EXIT	1460.1	172.1	31.44	67.1	71.04
O2 TANK PRESS	16.0	400.0	0.05	204.7	0.12
POSV INLET	1437.7	172.2	2.72	67.1	71.00
POSV EXIT	1215.5	173.0	2.72	67.1	70.64
OCV INLET	1437.7	172.2	28.67	67.1	71.00
OCV EXIT	1352.4	172.5	28.67	67.1	70.86
PRIMARY INJ	1205.4	173.0	2.72	67.1	70.62
SECONDARY INJ	1317.2	172.6	28.67	67.1	70.81
CHAMBER	1159.8				
VALVE DATA					

VALVE	DELTA P	AREA	FLOW	% BYPASS	
TBV	1001.	0.001	0.01	0.51	
FSV	1099.	0.100	2.62		
POSV	222.	0.032	2.72		
OCV	85.	0.184	28.67		
INJECTOR DATA					

# FUEL #		# OXID #			
		PRIMARY	SECOND		
DEL P MAN	8.71	5.06	17.47		
DEL P INJ	50.05	45.52	157.23		
AREA	1.03	0.07	0.41		
FLOW	2.62	2.72	28.67		

TABLE 68. — FULL-EXPANDER CYCLE WITH REGENERATION — O/F = 12.0
(CONTINUED)

***** * TURBOMACHINERY PERFORMANCE DATA * *****						
***** * H2 BOOST TURBINE * *****			***** * H2 BOOST PUMP * *****			
EFFICIENCY	0.659		EFFICIENCY	0.647		
HORSEPOWER	10.		HORSEPOWER	10.		
SPEED (RPM)	28390.		SPEED (RPM)	28390.		
MEAN DIA (IN)	1.34		S SPEED	2020.		
EFF AREA (IN ²)	2.45		HEAD (FT)	1412.		
U/C (IDEAL)	0.485		DIA. (IN)	2.18		
MAX TIP SPEED	166.		TIP SPEED	270.		
STAGES	1.		VOL. FLOW	269.		
DELTA H (ACT)	2.82		HEAD COEF	0.623		
GAMMA	1.36		FLOW COEF	0.144		
PRESS RATIO (T/T)	1.01					
***** * H2 TURBINE * *****			***** * H2 PUMP * *****			
	STAGE 1	STAGE 2	STAGE ONE	STAGE TWO	STAGE THREE	
EFFICIENCY	0.740	0.789	EFFICIENCY	0.585	0.593	0.597
HORSEPOWER	1032.	1032.	HORSEPOWER	354.	343.	334.
SPEED (RPM)	98658.	98658.	SPEED (RPM)	98658.	98658.	98658.
MEAN DIA (IN)	2.86	2.86	S SPEED	545.	557.	565.
EFF AREA (IN ²)	0.31	0.40	HEAD (FT)	43535.	42777.	41976.
U/C (IDEAL)	0.380	0.438	DIA. (IN)	3.44	3.44	3.44
MAX TIP SPEED	1233.	1233.	TIP SPEED	1483.	1483.	1483.
DELTA H	155.	125.	VOL. FLOW	278.	282.	282.
GAMMA (ACT)	1.36	1.36	HEAD COEF	0.637	0.626	0.614
PRESS RATIO(T/T)	1.34	1.37	FLOW COEF	0.057	0.059	0.060
***** * O2 BOOST TURBINE * *****			***** * O2 BOOST PUMP * *****			
EFFICIENCY	0.798		EFFICIENCY	0.715		
HORSEPOWER	6.		HORSEPOWER	6.		
SPEED (RPM)	8579.		SPEED (RPM)	8579.		
MEAN DIA (IN)	3.69		S SPEED	4819.		
EFF AREA (IN ²)	3.60		HEAD (FT)	74.		
U/C (IDEAL)	0.514		DIA. (IN)	2.44		
MAX TIP SPEED	138.		TIP SPEED	91.		
STAGES	1.		VOL. FLOW	199.		
DELTA H (ACT)	1.60		HEAD COEF	0.283		
GAMMA	1.36		FLOW COEF	0.253		
PRESS RATIO (T/T)	1.00					
***** * O2 TURBINE * *****			***** * O2 PUMP * *****			
EFFICIENCY	0.694		EFFICIENCY	0.721		
HORSEPOWER	226.		HORSEPOWER	226.		
SPEED (RPM)	58806.		SPEED (RPM)	58806.		
MEAN DIA (IN)	2.86		S SPEED	2123.		
EFF AREA (IN ²)	0.43		HEAD (FT)	2854.		
U/C (IDEAL)	0.349		DIA. (IN)	1.93		
MAX TIP SPEED	735.		TIP SPEED	496.		
STAGES	1.		VOL. FLOW	199.		
DELTA H (ACT)	61.39		HEAD COEF	0.373		
GAMMA	1.36		FLOW COEF	0.177		
PRESS RATIO (T/T)	1.07					
***** REGENERATOR DATA *****						
	COLD SIDE	HOT SIDE				
DELP	13.85	20.11				
DELT	537.32	-592.10				
AREA	0.40	1.52				
FLOW	2.62	2.60				
EFFECTIVENESS		0.48				
NTU		0.96				
CRATIO		0.91				
CMIN		9.15				
REGEN Q		5415.54				

REPORT DOCUMENTATION PAGE

Form Approved
OMB No. 0704-0188

Public reporting burden for this collection of information is estimated to average 1 hour per response, including the time for reviewing instructions, searching existing data sources, gathering and maintaining the data needed, and completing and reviewing the collection of information. Send comments regarding this burden estimate or any other aspect of this collection of information, including suggestions for reducing this burden, to Washington Headquarters Services, Directorate for Information Operations and Reports, 1215 Jefferson Davis Highway, Suite 1204, Arlington, VA 22202-4302, and to the Office of Management and Budget, Paperwork Reduction Project (0704-0188), Washington, DC 20503.

1. AGENCY USE ONLY (Leave blank)	2. REPORT DATE June 1993	3. REPORT TYPE AND DATES COVERED Final Contractor Report	
4. TITLE AND SUBTITLE Advanced Engine Study Program		5. FUNDING NUMBERS WU-593-12-11 C-NAS3-23858	
6. AUTHOR(S) A.I. Masters, D.E. Galler, T.F. Denman, R.A. Shied, J.R. Black, A.R. Fierstein, G.L. Clark, and B.R. Branstrom			
7. PERFORMING ORGANIZATION NAME(S) AND ADDRESS(ES) Pratt & Whitney Government Engines & Space Propulsion P.O. Box 109600 West Palm Beach, Florida 33410-9600		8. PERFORMING ORGANIZATION REPORT NUMBER E-7909	
9. SPONSORING/MONITORING AGENCY NAME(S) AND ADDRESS(ES) National Aeronautics and Space Administration Lewis Research Center Cleveland, Ohio 44135-3191		10. SPONSORING/MONITORING AGENCY REPORT NUMBER NASA CR-187217	
11. SUPPLEMENTARY NOTES Project Manager, G. Paul Richter, Space Propulsion Technology Division, (216) 977-7537.			
12a. DISTRIBUTION/AVAILABILITY STATEMENT Unclassified - Unlimited Subject Category 20		12b. DISTRIBUTION CODE	
13. ABSTRACT (Maximum 200 words) A design and analysis study was conducted to provide advanced engine descriptions and parametric data for space transfer vehicles. The study was based on an advanced oxygen/hydrogen engine in the 7,500 to 50,000 lbf thrust range. Emphasis was placed on defining requirements for high-performance engines capable of achieving reliable and versatile operation in a space environment. Four variations on the expander cycle were compared, and the advantages and disadvantages of each were assessed. Parametric weight, envelope, and performance data were generated over a range of 7,500 to 50,000 lb thrust and a wide range of chamber pressure and nozzle expansion ratio.			
14. SUBJECT TERMS Rocket performance; Parametric rocket data; Expander cycle engines; Oxygen/hydrogen engines; Space propulsion; Liquid propellant rockets		15. NUMBER OF PAGES 236	
		16. PRICE CODE All	
17. SECURITY CLASSIFICATION OF REPORT Unclassified	18. SECURITY CLASSIFICATION OF THIS PAGE Unclassified	19. SECURITY CLASSIFICATION OF ABSTRACT Unclassified	20. LIMITATION OF ABSTRACT

National Aeronautics and
Space Administration

FOURTH CLASS MAIL

Lewis Research Center
Cleveland, Ohio 44135

ADDRESS CORRECTION REQUESTED

P. Richter
Official Business
Penalty for Private Use \$300

SPDL-2

NASA

