

11/10/93  
171918  
R. 1079

SSD93D0354

STRATEGIC AVIONICS TECHNOLOGY DEFINITION STUDIES  
SUBTASK 3-1A, ELECTRICAL ACTUATION (ELA) SYSTEMS

INTERIM REPORT

JUNE 30, 1993

CONTRACT NAS9-18880

SOW TASKS A1 - A2



NASA-CR-193237

(NASA-CR-193237) STRATEGIC  
AVIONICS TECHNOLOGY DEFINITION  
STUDIES. SUBTASK 3-1A: ELECTRICAL  
ACTUATION (ELA) SYSTEMS (Rockwell  
International Corp.) 154 p

N93-29215

Unclas

G3/16 0171918



SSD93D0354

**STRATEGIC AVIONICS TECHNOLOGY DEFINITION STUDIES  
SUBTASK 3-1A, ELECTRICAL ACTUATION (ELA) SYSTEMS**

**INTERIM REPORT**

**JUNE 30, 1993**

**CONTRACT NAS9-18880**

**SOW TASKS A1 - A2**



**Rockwell International  
Space Systems Division**



**STRATEGIC AVIONICS TECHNOLOGY DEFINITION STUDIES  
SUBTASK 3-1A, ELECTRICAL ACTUATION (ELA) SYSTEMS**

---

**INTERIM REPORT, JUNE 30, 1993**

**PREPARED BY:**

*C. L. Pond*

**C. L. POND**

**FLIGHT CONTROL SYSTEMS**

*W.A. McDermott*

**W. A. McDERMOTT**

**FLIGHT CONTROL SYSTEMS**

*B. T. F. Lum*

**B. T. F. LUM**

**FLIGHT CONTROL SYSTEMS**

**APPROVED BY:**

*J. Ogburn*

**J. OGBURN, FUNCTIONAL MANAGER**

**FLIGHT CONTROL SYSTEMS**



**PURPOSE OF REPORT**

---

**THIS INTERIM REPORT PRESENTS THE PRELIMINARY RESULTS OF AN ELECTRICAL ACTUATION (ELA) SYSTEM STUDY (SUBTASK TA3-1A) TO SUPPORT THE NASA STRATEGIC AVIONICS TECHNOLOGY DEFINITION STUDIES. THE FINAL REPORT OF THIS ELA STUDY IS SCHEDULED FOR SEPTEMBER 30, 1993. (NOTE: THE INTERIM REPORT DOES NOT CONTAIN ALL THE FINAL STUDY RESULTS.)**





## **CONTENTS**

---

- 1.0 INTRODUCTION**
- 2.0 ELA TECHNOLOGY DEMONSTRATION TESTING**
- 3.0 ELA SYSTEM BASELINE**
- 4.0 POWER AND ENERGY REQUIREMENTS FOR SHUTTLE EFFECTOR SYSTEMS**
- 5.0 POWER EFFICIENCY AND LOSSES OF ELA EFFECTOR SYSTEMS**
- 6.0 POWER AND ENERGY REQUIREMENTS FOR ELA POWER SOURCES**
- 7.0 CONCLUSIONS AND RECOMMENDATIONS**



---

## 1.0 INTRODUCTION



## **INTRODUCTION**

---

- **ROCKWELL ELA TASKS**
- **OBJECTIVES**
- **RESPONSIBILITY**
- **STATUS AND ACCOMPLISHMENTS**
- **SUMMARY OF RESULTS**



**ROCKWELL 1993 ELA TASKS  
(NASA STATEMENT OF WORK)**

---

**TA3-1. ELECTRICAL ACTUATION (ELA) SYSTEMS**

**TA3-1A. ELA SYSTEM TRADES AND BASELINE SELECTION. PERFORM THE FOLLOWING TRADE STUDIES AND BASELINE SELECTION TASKS:**

**A1. ELA TECHNOLOGY DEMONSTRATION TESTING**

**CONTINUE TO SUPPORT THE ELECTRICAL ACTUATION (ELA) DEMONSTRATION TESTING AT NASA - SELECTED FACILITIES. THE CONTRACTOR WILL: (A) DEVELOP AND COORDINATE TEST PLAN, (B) PERFORM INDEPENDENT REVIEW AND ASSESSMENT OF TEST DATA, AND (C) DOCUMENT AND COORDINATE THE TEST RESULTS WITH THE PARTICIPATING NASA ORGANIZATIONS SUCH AS MSFC AND LERC.**

**A2. ELA SYSTEM POWER EFFICIENCY AND REQUIREMENTS**

**PERFORM SYSTEMS ENGINEERING DEFINITION OF ELA POWER SOURCE LOSSES AND REQUIREMENTS FOR SHUTTLE/ORBITER AND SHUTTLE-DERIVED VEHICLES. THE CONTRACTOR WILL: (A) DEFINE AN ELA BASELINE USING THE SPACE SHUTTLE AS AN EXAMPLE VEHICLE, (B) DETERMINE POWER AND ENERGY REQUIREMENTS FOR THE SHUTTLE EFFECTOR SYSTEMS, (C) DETERMINE POWER EFFICIENCY AND LOSSES OF THE ELA SYSTEM EQUIPMENT (POWER SOURCE, ACTUATORS AND CONTROLLERS), AND (D) DOCUMENT THE STUDY RESULTS.**

## OBJECTIVES

---

- **TASK A1. ELA TECHNOLOGY DEMONSTRATION TESTING**
  - **CONFIRM ADEQUATE STABILITY AND PERFORMANCE OF ELA SYSTEM FOR AEROSPACE APPLICATIONS.**
  - **OBTAIN TEST DATA TO UPDATE ELA MATH MODELS FOR FAILURE-DETECTION-ISOLATION (FDI) AND REDUNDANCY - MANAGEMENT (RM) ANALYSES.**
- **TASK A2. ELA SYSTEM POWER EFFICIENCY AND REQUIREMENTS**
  - **DEFINE AN EXAMPLE BASELINE FOR AEROSPACE ELA SYSTEMS.**
  - **ESTABLISH METHODS FOR DETERMINATION OF ELA SYSTEM POWER EFFICIENCY, LOSSES AND REQUIREMENTS.**
  - **DETERMINE EXAMPLE POWER REQUIREMENTS, EFFICIENCY AND LOSSES FOR ELA SYSTEMS IN AEROSPACE VEHICLES.**



**RESPONSIBILITY**

---

**TASK A1. ELA TECHNOLOGY DEMONSTRATION TESTING**

**RESPONSIBLE ENGINEER: W. A. McDERMOTT**

**TASK A2. ELA SYSTEM POWER EFFICIENCY AND REQUIREMENTS**

**RESPONSIBLE ENGINEERS: B. T. F. LUM AND C. L. POND**

## STATUS AND ACCOMPLISHMENTS

---

- **TASK A1 ELA TECHNOLOGY DEMONSTRATION TESTING**
  - **NO TEST SUPPORT WAS REQUIRED DURING THE REPORT PERIOD.**
  
- **TASK A2. ELA POWER EFFICIENCY AND REQUIREMENTS**
  - **REVIEWED THE REQUIREMENTS FOR SPACE SHUTTLE EFFECTOR SYSTEMS.**
  - **PERFORMED PRELIMINARY ELA TRADES AND SELECTION**
  - **DEFINED A PRELIMINARY ELA SYSTEM BASELINE.**
  - **COMPILED, REVIEWED AND ANALYZED INPUT DATA FOR DETERMINATION OF POWER AND ENERGY REQUIREMENTS FOR ELA EFFECTOR SYSTEMS.**
  - **THE FINAL RESULTS ON ELA SYSTEM BASELINE AND THE DETERMINATION OF POWER EFFICIENCY, LOSSES AND REQUIREMENTS ARE TO BE PRESENTED IN THE FINAL REPORT (9/30/93)**

## **SUMMARY OF RESULTS**

---

- **SECTION 2 PRESENTS THE STATUS AND RESULTS OF A CONTINUING SUPPORT TO NASA ELA TECHNOLOGY DEMONSTRATION TESTING.**
- **SECTION 3 PRESENTS THE ELA SYSTEM CONCEPTS, COMPONENT TRADES AND BASELINE SELECTION, USING THE SPACE SHUTTLE AS AN EXAMPLE VEHICLE.**
- **SECTION 4 PRESENTS THE METHODS, DATA AND RESULTS FROM THE DETERMINATION OF POWER AND ENERGY REQUIREMENTS FOR THE SHUTTLE EFFECTOR SYSTEMS.**
- **SECTION 5 PRESENTS THE METHODS, DATA AND RESULTS FROM THE DETERMINATION OF POWER EFFICIENCY AND LOSSES OF ELA SYSTEM EQUIPMENT (POWER SOURCES, ACTUATORS, CONTROLLERS AND EFFECTORS).**
- **SECTION 6 PRESENTS THE METHODS, DATA AND RESULTS FROM THE DETERMINATION OF POWER AND ENERGY REQUIREMENTS OF ELA POWER SOURCES.**
- **SECTION 7 PRESENTS THE STUDY CONCLUSIONS AND RECOMMENDATIONS.**



---

## 2.0 ELA TECHNOLOGY DEMONSTRATION TESTING



**STATUS AND RESULTS OF ELA TECHNOLOGY DEMONSTRATION TESTING**

---

- NO TEST SUPPORT WAS REQUIRED DURING THE REPORT PERIOD.
- DEMONSTRATION TESTING AT NASA MSFC IS PLANNED BUT YET UNSCHEDULED.
- THE RESULTS OF TEST SUPPORT ARE TO BE PRESENTED IN THE FINAL REPORT (9/30/93).





---

### 3.0 ELA SYSTEM BASELINE



## **ELA BASELINE FOR SHUTTLE EFFECTOR SYSTEMS**

---

- **EFFECTOR SYSTEM DESCRIPTION**
- **ELA SYSTEM CONCEPTS**
- **ELA TRADES AND SELECTION**
- **EXAMPLE ELA BASELINE**

---

• THE FLIGHT-CONTROL EFFECTORS IN THE SPACE SHUTTLE ARE DEPICTED IN CHART 16. THESE EFFECTORS ARE:

- GIMBALLED SOLID ROCKET MOTORS (SRM'S), SPACE SHUTTLE MAIN ENGINES (SSME'S) AND ORBITAL MANEUVERING SYSTEM (OMS) ENGINES FOR THRUST VECTOR CONTROL (TVC),
- AEROSURFACES (ELEVONS, RUDDER, SPEEDBRAKE AND BODYFLAP) FOR ATMOSPHERIC FLIGHT CONTROL, AND
- AUXILIARY CONTROLS WHICH INCLUDE SSME PROPELLANT VALVES, EXTERNAL-TANK (ET) UMBILICAL RETRACTS, BRAKES, NOSEWHEEL STEERING, AND NOSE AND MAIN LANDING GEAR UPLOCKS AND STRUTS.

THE SRM-TVC EFFECTORS ARE IN THE SOLID ROCKET BOOSTERS (SRB'S). THE OTHER EFFECTORS ARE IN THE ORBITER.

- EXCEPT FOR THE OMS-TVC, THE SHUTTLE EFFECTORS ARE PRESENTLY DRIVEN BY HYDRAULICS. THE OMS-TVC IS DRIVEN BY ELA. THE PROPOSED CHANGE IS TO REPLACE ALL THE SHUTTLE HYDRAULIC EFFECTOR SYSTEMS WITH ELA. STUDIES AT NASA AND ROCKWELL TO-DATE INDICATE THAT REPLACEMENT OF AUXILIARY POWER UNITS (APU'S) AND HYDRAULICS IN THE SHUTTLE ORBITER WITH ELA WOULD IMPROVE SAFETY, RELIABILITY, WEIGHT, OPERATIONAL COST, TURNAROUND TIME AND VEHICLE HEALTH MONITORING.
- A TYPICAL EFFECTOR SYSTEM IS ILLUSTRATED IN CHARTS 17 (PICTORIAL) AND 18 (BLOCK DIAGRAM). IN GENERAL, THE SYSTEM CONSISTS OF AN EFFECTOR, ACTUATOR ASSEMBLY, ELECTRONIC CONTROLLERS AND THE LOCAL MOUNTING STRUCTURES. THE ELA EFFECTOR SYSTEM IS DRIVEN BY AN ELECTRICAL POWER SOURCE.

## EFFECTOR SYSTEM DESCRIPTION

---

Page 2

- THE FUNCTIONS OF THE EFFECTOR SYSTEMS ARE:
  - PERFORM POSITIONING CONTROL OF THE SHUTTLE EFFECTORS
  - PROVIDE FAILURE DETECTION AND ISOLATION (FDI). THIS INCLUDES FAILURES OCCURRING WITHIN THE EFFECTOR SYSTEM, AND FAILURES OCCURRING IN INTERFACING SYSTEMS (DATA PROCESSING, ELECTRICAL POWER, ETC.)
- THE TOP-LEVEL REQUIREMENTS FOR THE DESIGN OF THE SHUTTLE EFFECTOR SYSTEMS ARE DESCRIBED IN CHART 19. THESE REQUIREMENTS INCLUDE THE TOTAL NUMBER OF EFFECTORS (OR ACTUATORS) REQUIRED, THE NUMBER OF REDUNDANT CONTROL CHANNELS PER ACTUATOR, AND THE MISSION PHASES WHEN THE EFFECTORS ARE UTILIZED. THE PERFORMANCE REQUIREMENTS (RATES, LOADS, POWER, ETC.) ARE DISCUSSED IN SECTIONS 4 THROUGH 6.

15

# SPACE SHUTTLE EFFECTORS

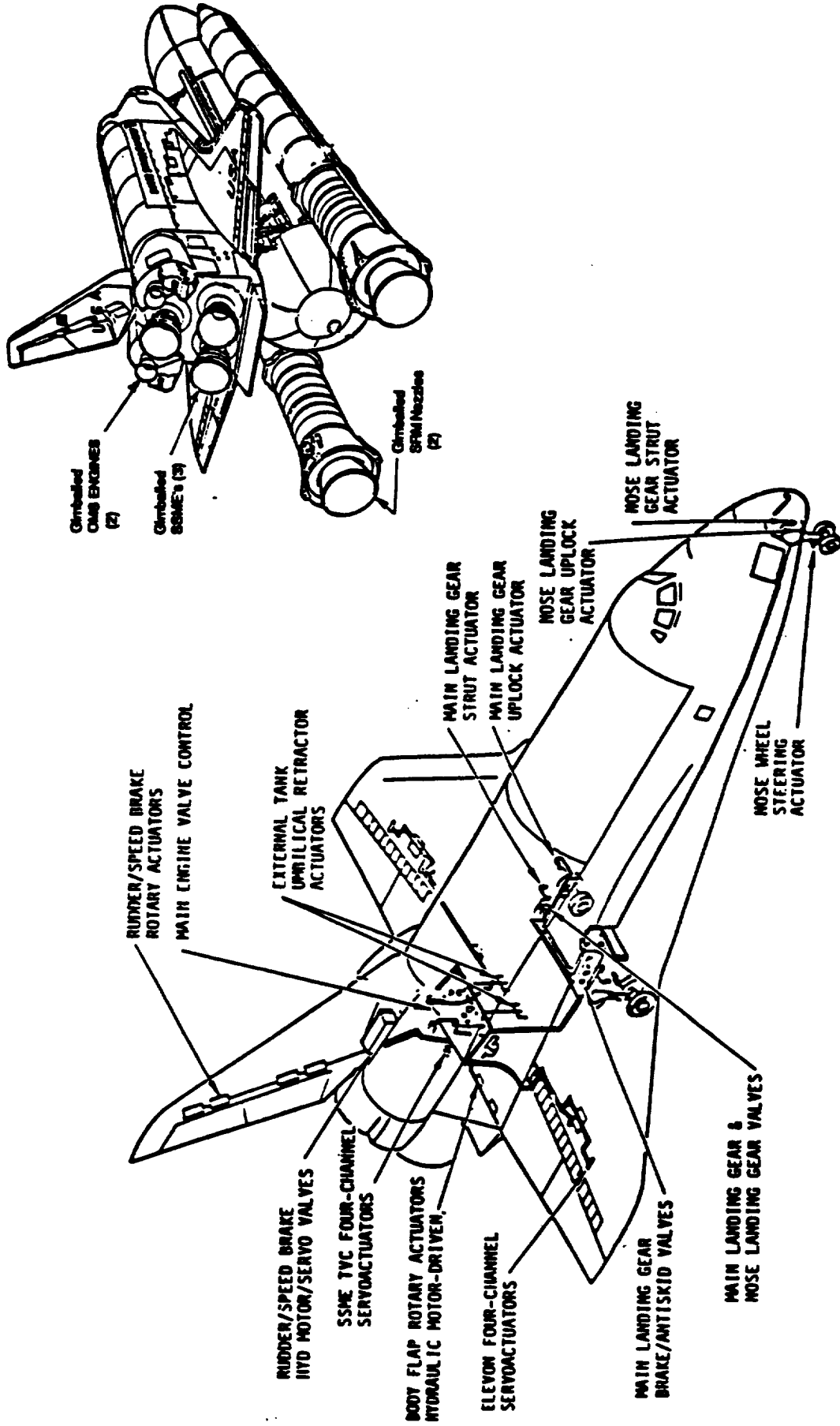

# ILLUSTRATION OF ELA AND HYDRAULIC EFFECTOR SYSTEMS

HYDRAULIC (PRESENT)

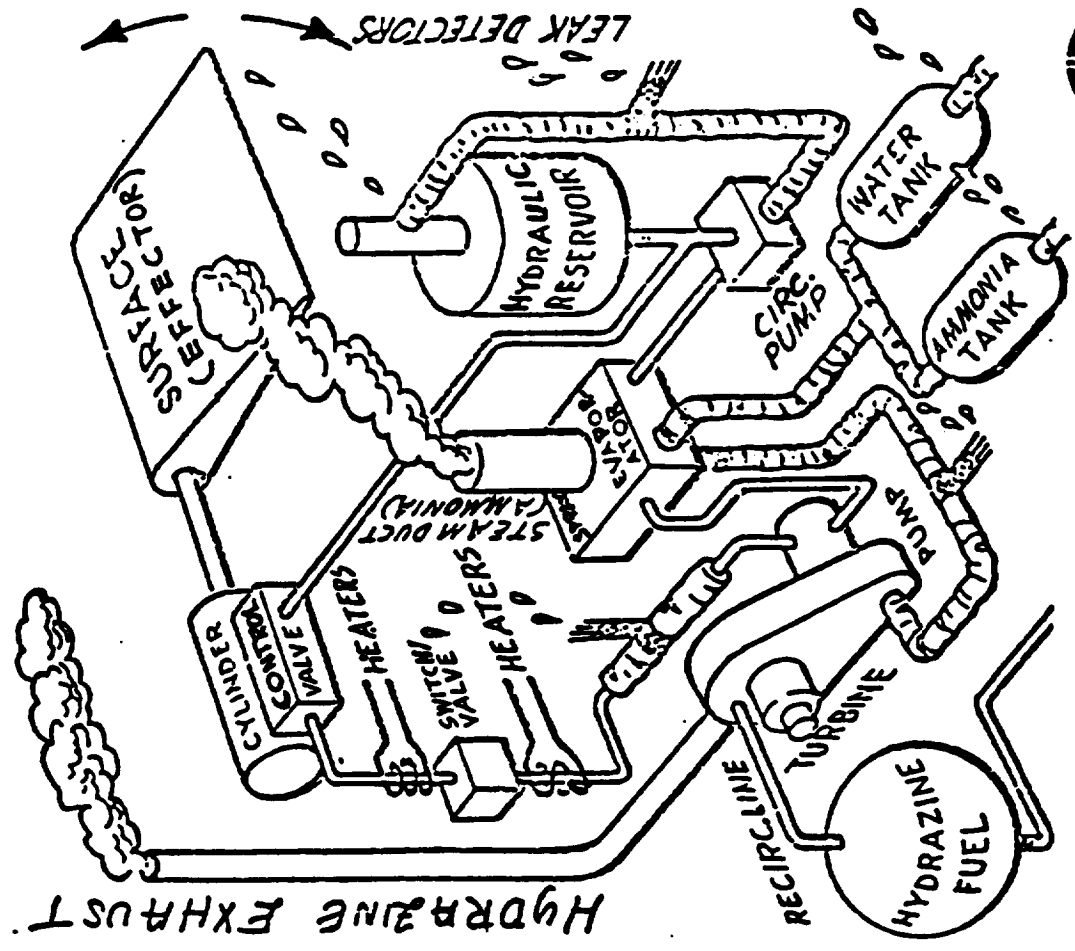

ELA (PROPOSED)

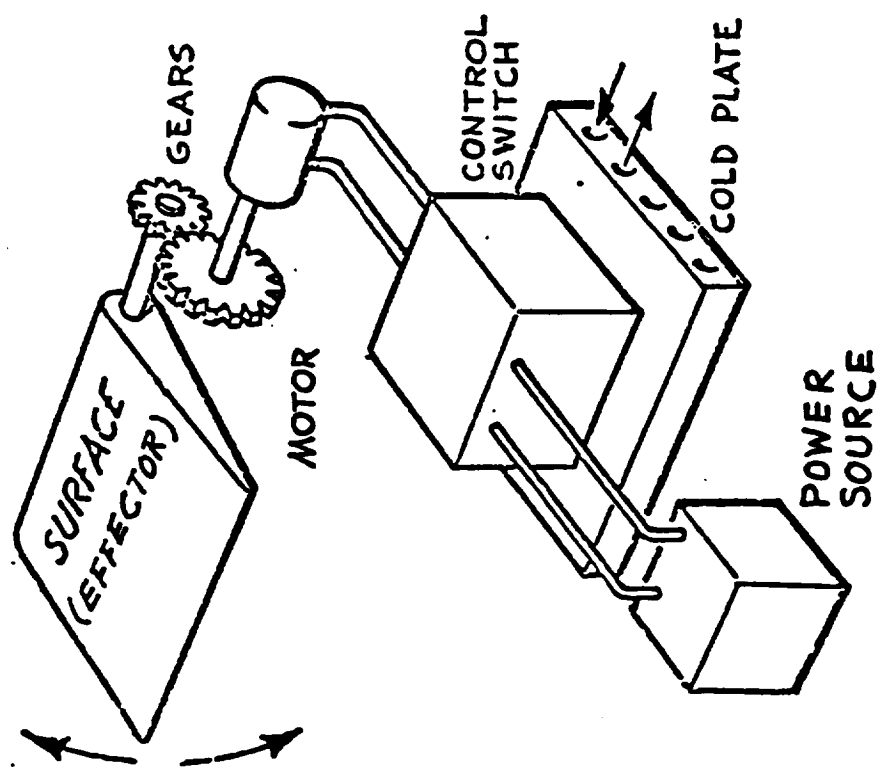

# BLOCK DIAGRAM OF A SHUTTLE EFFECTOR SYSTEM

## HYDRAULIC (PRESENT)

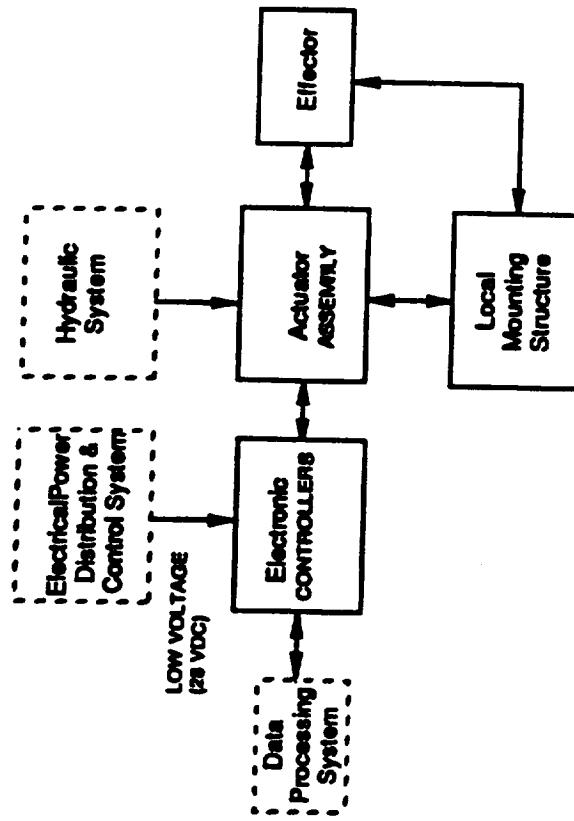

## ELA (PROPOSED)

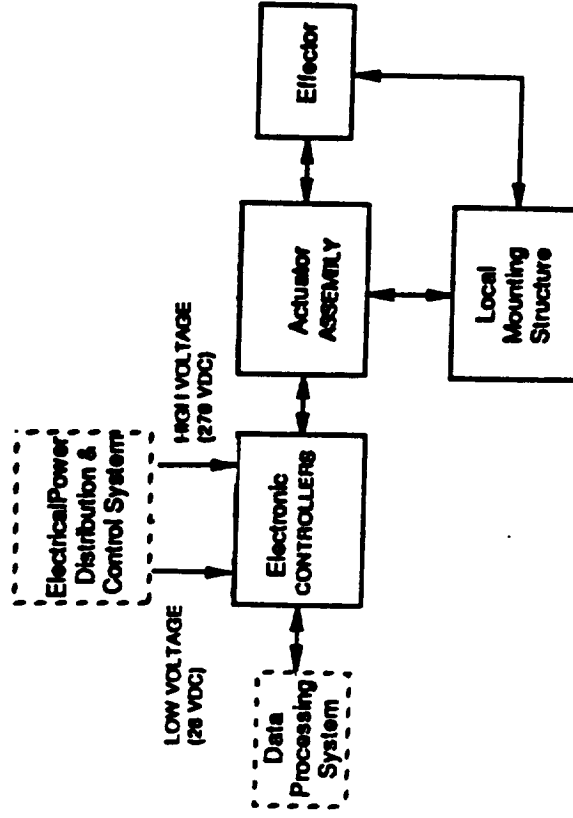

— EFFECTOR SYSTEM



# TOP-LEVEL REQUIREMENTS FOR SPACE SHUTTLE EFFECTOR SYSTEMS

SHUTTLE ELEMENT	EFFECTOR SYSTEM	NUMBER OF ACTUATORS	NO. OF CHANNELS	FAULT TOLERANCE	REDUNDANCY REQUIREMENTS		MISSION PHASE*	
					RATIONALE			
SRB'S	SRM TVC (2 SRB'S, 2 AXES EACH)	4		FO/FO	<ul style="list-style-type: none"> <li>LOSS OF EFFECTOR SYSTEM CONTROL RESULTS IN POSSIBLE LOSS OF VEHICLE</li> </ul>		A	
	ELEVONS (2 INBOARD, & 2 OUTBOARD)	4					A, D	
	RUDDER/SPEEDBRAKE	2					D	
	BODYFLAP	1	4				D	
	BRAKES	4					D	
	ET UMBILICAL RETRACTS	6					A	
ORBITER	SSME TVC (3 ENGINES, 2 AXES EACH)	6		FO/FS	<ul style="list-style-type: none"> <li>LOSS OF EFFECTOR SYSTEM CONTROL MAY PRECLUDE MISSION SUCCESS</li> <li>ONE-ENGINE-OUT ABORT CAPABILITY PROVIDES VEHICLE SAFETY</li> <li>DIFFERENTIAL BRAKING PROVIDES BACKUP FOR LOSS OF STEERING</li> <li>PYRO BACKUP MAY BE USED FOR FAILED UPLOCK</li> <li>SINGLE ENGINE OPERATION (OTHER ENGINE) OR +X JETS MAY BE USED IN CASE ACTUATOR FAILURE</li> <li>PNEUMATIC BACKUP AND ONE-ENGINE-OUT ABORT CAPABILITY PROVIDE VEHICLE FOFS CAPABILITY</li> <li>GROUND OPERATION ONLY</li> </ul>		A	
	NOSEWHEEL STEERING	1		FO			D	
	NOSE AND MAIN GEAR UPLOCKS	3					D	
	OMS TVC (2 ENGINES, 2 AXES EACH)	4	2	FS			O	
	SSME Propellant Valves (2 ENGINES, 5 VALVES EACH)	15		FS			A	
	Nose & Main Gear Struts	3		FS			D	

FO = FAIL OPERATIONAL; FS = FAIL SAFE

\* APPLICABLE MISSION PHASE:  
A = ASCENT; O = ON-ORBIT; D = DESCENT

## **ELA SYSTEM CONCEPTS FOR SHUTTLE EFFECTORS**

---

- **OVERALL ARCHITECTURE**
- **SYSTEM CONFIGURATIONS**
- **SYSTEM INTERFACES**
- **COMPONENTS REQUIRED**
- **EQUIPMENT LOCATIONS**

## **ELA ARCHITECTURE FOR SHUTTLE EFFECTORS**

---

- **THE OVERALL ELA ARCHITECTURE FOR THE SHUTTLE EFFECTORS IS DEPICTED IN CHART 22.**
- **THE ELA ARCHITECTURE DESIGN IS GENERALLY BASED ON THE PROVEN CONCEPTS OF THE PRESENT SHUTTLE EFFECTOR SYSTEMS.**
- **THE EXISTING FUEL CELLS IN THE ORBITER PROVIDE THE LOW-VOLTAGE POWER FOR THE EXISTING AVIONICS AND THE ELA CONTROLLERS.**
- **THE ADDED POWER SOURCES IN THE ORBITER AND EACH OF THE SRB'S PROVIDE THE HIGH-VOLTAGE (TYPICALLY 270 VDC) POWER FOR THE ELA MOTORS**
- **THE SERVO AND FDI CONTROLLERS (SC) INTERFACE WITH THE GENERAL PURPOSE COMPUTERS (GPC'S) AND THE POWER CONTROLLERS (PC) FOR COMMAND AND FEEDBACK SIGNALS THROUGH DATA BUSES; NO MULTIPLEXER-DEMULTIPLEXER (MDM) IS REQUIRED.**
- **THE POWER CONTROLLERS CONTROL THE ELECTRICAL CURRENT FROM THE POWER SOURCE THROUGH THE MOTOR WINDINGS IN THE ACTUATOR ASSEMBLY (AA).**
- **THE MOTORS AND THE GEARING IN THE ACTUATOR ASSEMBLY DRIVE THE EFFECTOR FOR POSITIONING CONTROL.**

# ARCHITECTURE OF ELA EFFECTOR SYSTEMS

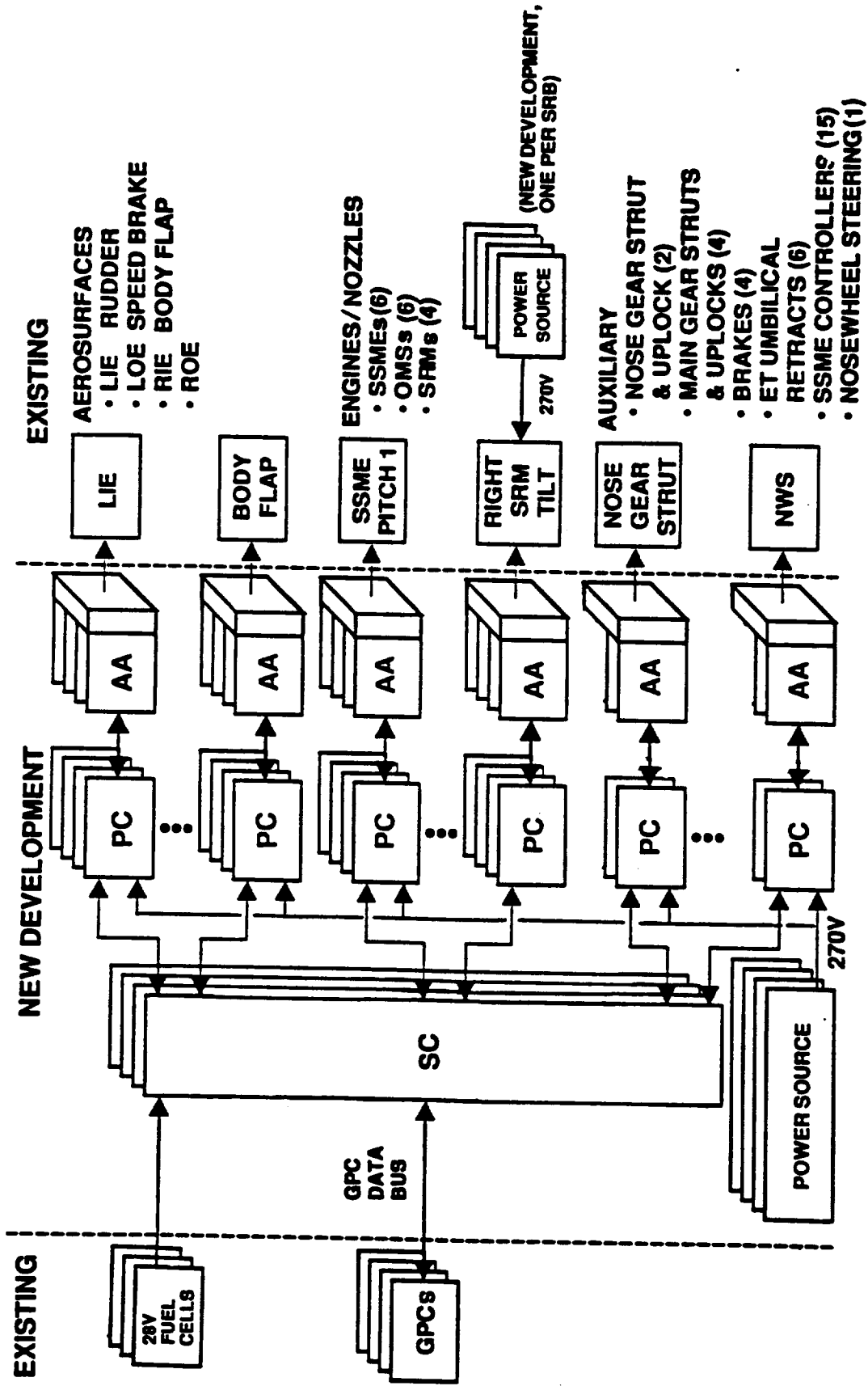

SC = SERVO AND FDI CONTROLLER  
 PC = POWER CONTROLLER  
 AA = ACTUATOR ASSEMBLY

## ELA SYSTEM CONFIGURATIONS

---

- THE REQUIRED ELA SYSTEM CONFIGURATIONS FOR THE SHUTTLE EFFECTORS ARE DESCRIBED IN CHARTS 24 THROUGH 28. THESE SYSTEM CONFIGURATIONS ARE:
  - FOUR REDUNDANT CONTROL CHANNELS WITH FAILURE DETECTION AND ISOLATION (FDI), AND
  - TWO REDUNDANT CONTROL CHANNELS IN AN ACTIVE-STANDBY ARRANGEMENT.
- DETAILED DESCRIPTIONS OF THE COMPONENTS AND SIGNAL FLOWS OF EACH ELA SYSTEM CHANNEL ARE PRESENTED IN CHARTS 29 THROUGH 53.
- THE ELA SYSTEM CONFIGURATIONS WERE DESIGNED BASED ON THE REDUNDANCY REQUIREMENTS SPECIFIED IN CHART 19.
- THE ELA CONCEPT IS GENERALLY SIMILAR TO THE PRESENT HYDRAULIC ACTUATION WITH ONE DISTINCT DIFFERENCE. THE ELA SYSTEM USES ELECTRICAL CURRENT SIGNALS WHICH MAY BE NOMINALLY NON-ZERO FOR DETERMINATION OF FAILURE; THE HYDRAULIC ACTUATION USES SECONDARY DIFFERENTIAL PRESSURES WHICH ARE NOMINALLY ZERO.

## FOUR CHANNEL ELA SYSTEM

---

- THE CONCEPT OF A FOUR-CHANNEL ELA SYSTEM IS ILLUSTRATED IN CHART 25. THE SYSTEM USES FOUR REDUNDANT CONTROL CHANNELS TO DRIVE THE ACTUATOR AND HENCE THE EFFECTOR. THE FOUR CHANNEL SYSTEM PROVIDES TWO-FAULT-TOLERANT RELIABILITY (FAIL OPERATIONAL/FAIL SAFE).
- FOR POSITIONING CONTROL, THE POSITION COMMAND, ACTUATOR POSITION AND MOTOR RATE ARE SUMMED AND COMPENSATED IN THE SERVO PROCESSOR TO FORM A CURRENT COMMAND TO DRIVE THE MOTOR VIA THE POWER CONTROLLER. THE GEAR TRAIN SUMS THE MOTOR TORQUE OUTPUTS FROM THE CHANNELS TO DRIVE THE ACTUATOR. EQUALIZATION FEEDBACK MAY BE ADDED IF REQUIRED TO COMPENSATE FOR THE REDUNDANT SYSTEM TOLERANCES.
- FOR FAILURE DETECTION AND ISOLATION, THE FDI PROCESSOR IN EACH CHANNEL USES THE DIFFERENCES IN MOTOR CURRENT COMMANDS RETURNED FROM THE POWER CONTROLLER TO DETERMINE FAILURE. THE FAULT ISOLATION COMMAND LOGIC IS TURNED ON (FAILURE INDICATION) WHEN THE CURRENT FAULT MOTOR DETECTS A FAILED CONDITION. THE ISOLATION COMMAND ISOLATES THE CHANNEL FROM DRIVING THE ACTUATOR BY ZEROING THE COMMAND IN THE POWER CONTROLLER AND REMOVING POWER TO THE MOTOR.
- THE SERVO AND FDI CONTROLLER ALSO PROVIDES ACTUATOR POSITION, MOTOR CURRENT AND OPERATING STATUS OF THE CHANNEL TO THE FLIGHT COMPUTER.
- THE INTERFACES BETWEEN CHANNELS AND BETWEEN THE SERVO & FDI CONTROLLERS AND POWER CONTROLLERS ARE ILLUSTRATED IN CHART 26.

# BLOCK DIAGRAM OF FOUR-CHANNEL ELA SYSTEM

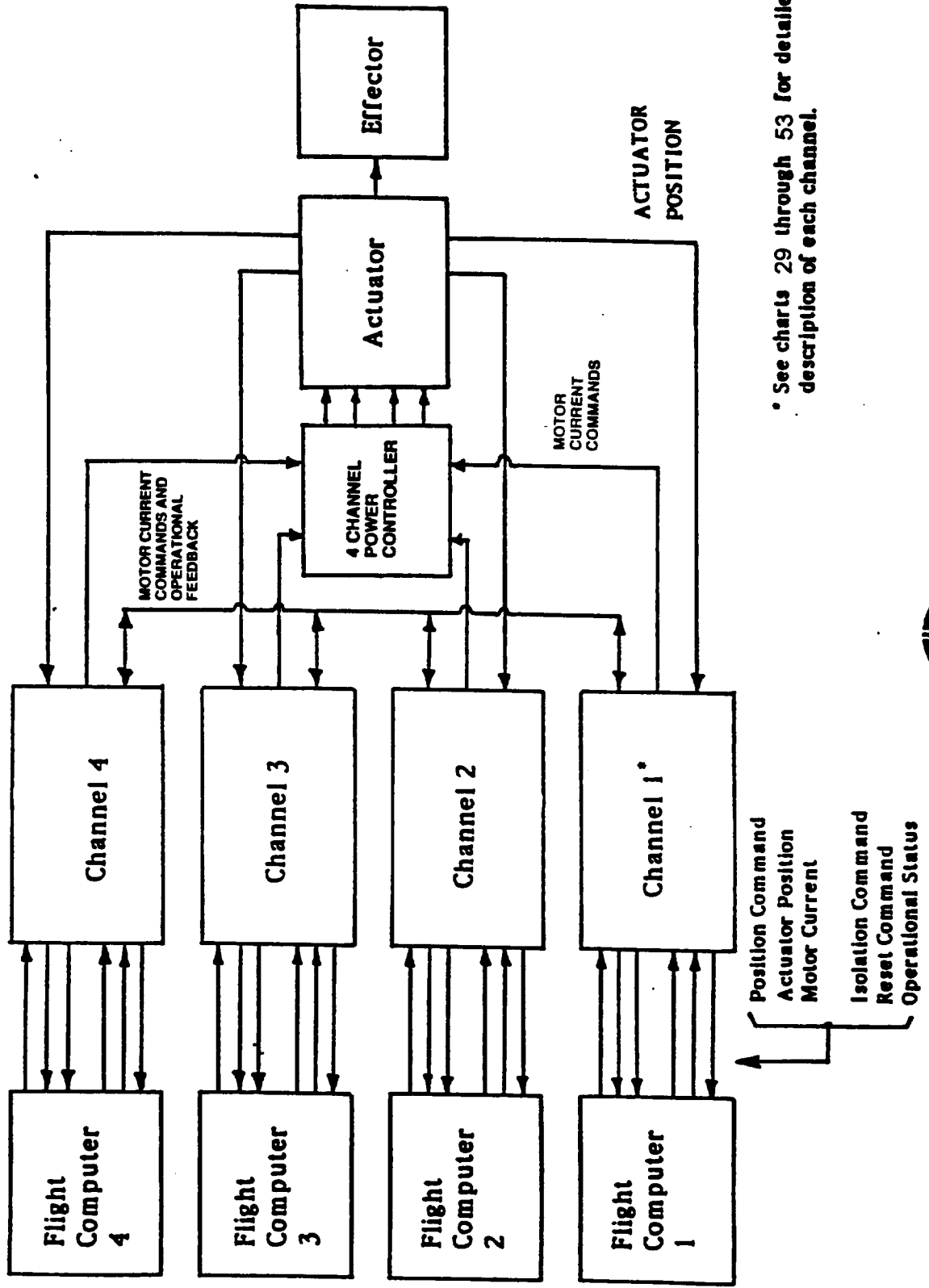

\* See charts 29 through 53 for detailed description of each channel.

# SCHEMATIC DIAGRAM OF FOUR-CHANNEL ELA SYSTEM

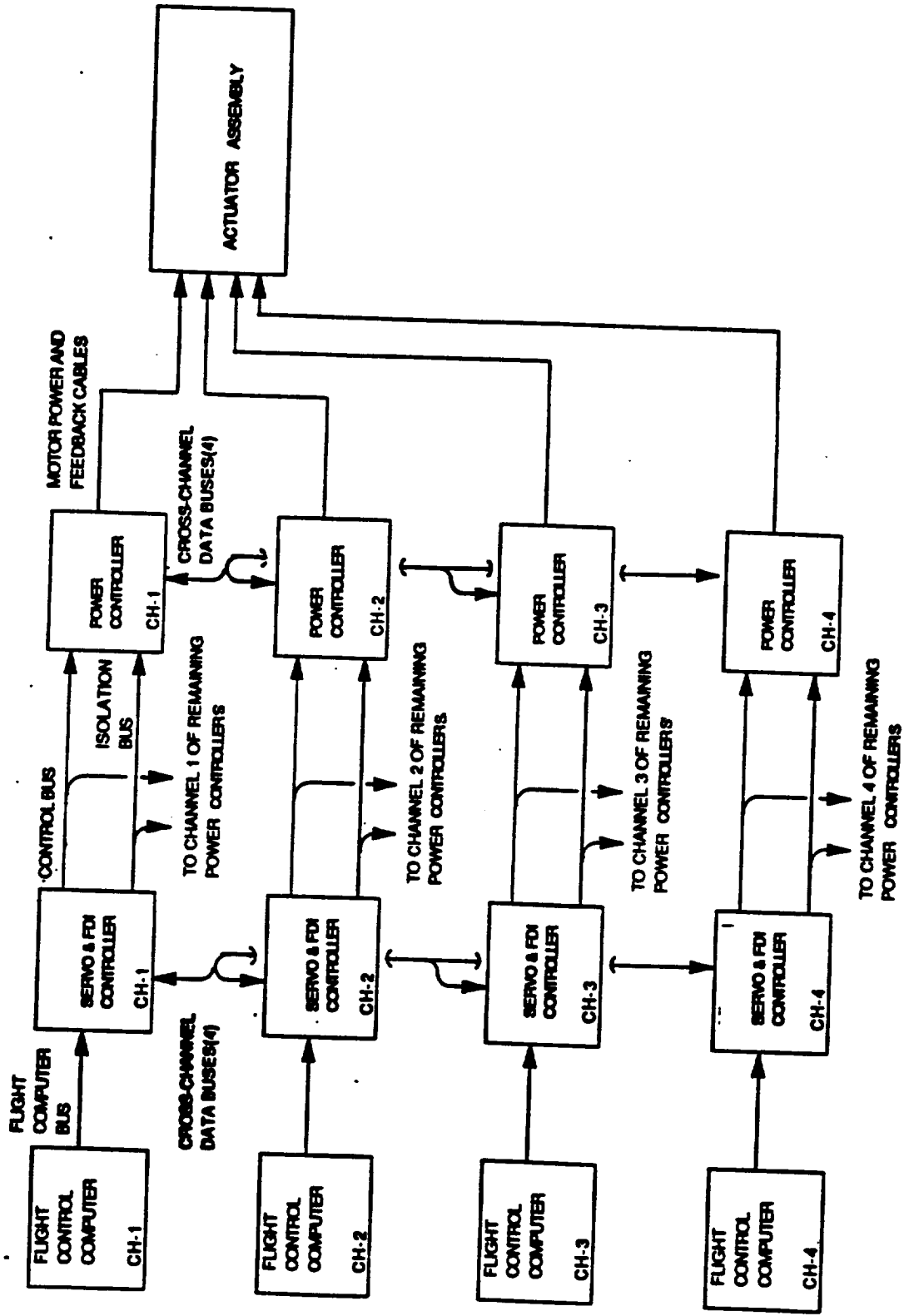



## TWO CHANNEL ELA SYSTEM

---

- THE CONCEPT OF A TWO-CHANNEL (ACTIVE-STANDBY) ELA SYSTEM IS ILLUSTRATED IN CHART 28. EACH CHANNEL OF THE ACTIVE-STANDBY SYSTEM IS ESSENTIALLY THE SAME AS A CHANNEL OF THE FOUR CHANNEL SYSTEM EXCEPT THAT ACTUATOR POSITION IS USED FOR FDI INSTEAD OF MOTOR CURRENT.
- THE ACTUATOR AND EFFECTOR ARE DRIVEN BY ONE CHANNEL AT A TIME, NORMALLY THE PRIMARY CHANNEL. IF THE PRIMARY CHANNEL FAILS, IT IS SHUT DOWN AND A SIGNAL IS TRANSMITTED TO THE STANDBY CHANNEL TURNING IT ON. IF THE PRIMARY CHANNEL IS RESTORED, THE SIGNAL IS REMOVED FROM THE STANDBY WHICH TURNS IT OFF.
- FOR FAILURE DETECTION AND ISOLATION, THE FDI PROCESSOR IN THE ACTIVE CHANNEL COMPARES THE POSITION WITH THE COMMAND TO DETERMINE FAILURE AND GENERATE A POSITION FAULT SIGNAL. THE POSITION FAULT SIGNAL IS USED THE SAME WAY AS THE CURRENT FAULT SIGNAL IS USED IN THE MULTI-CHANNEL SYSTEM TO ISOLATE THE FAILED CHANNEL.
- THE ACTIVE-STANDBY SYSTEM PROVIDES FAIL-OPERATE CAPABILITY. HOWEVER, THE TRANSIENT RESPONSE IN RESPONSE TO THE FAILURE AND SUBSEQUENT FDI ACTION MAY BE GREATER.

# BLOCK DIAGRAM OF TWO-CHANNEL (ACTIVE-STANDBY) ELA SYSTEM

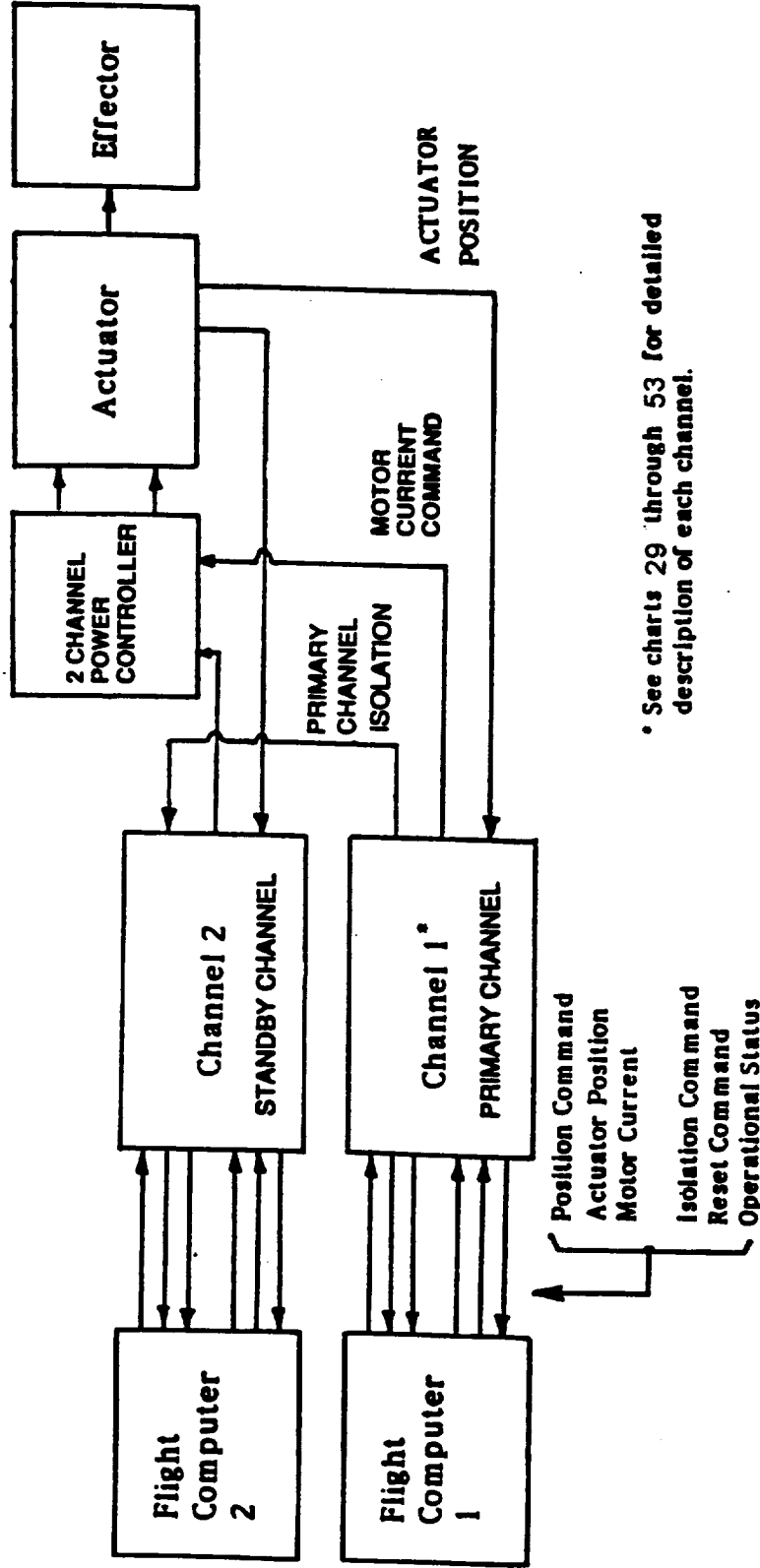

• See charts 29 through 53 for detailed description of each channel.

# ELA SYSTEM AND COMPONENTS (EACH CHANNEL)

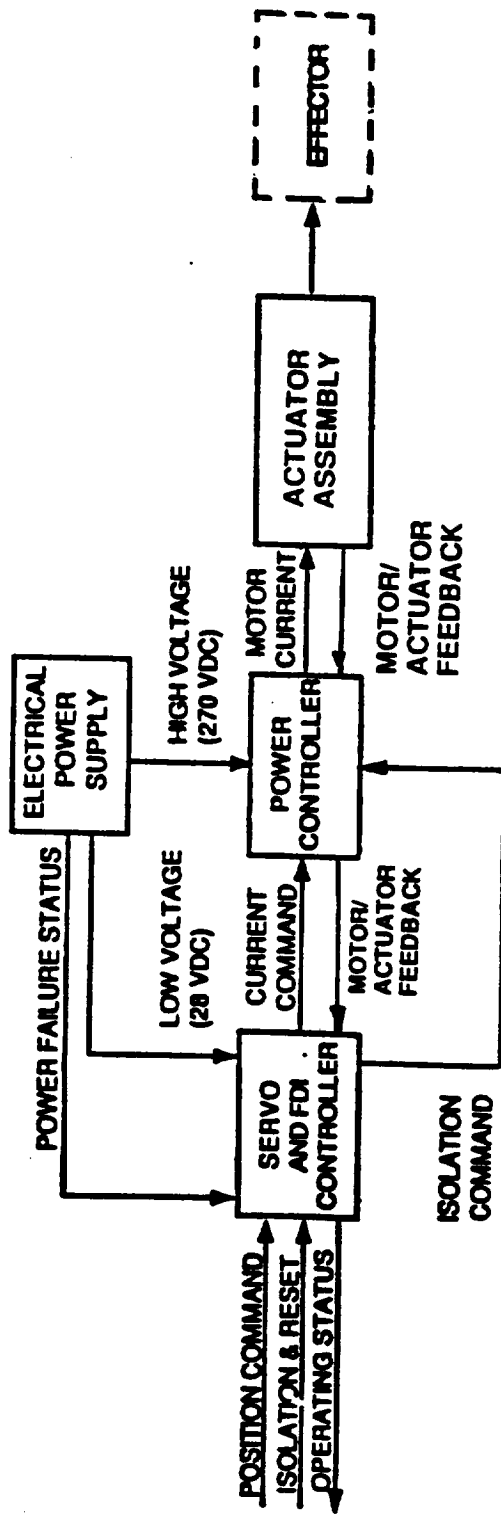

## • ELA COMPONENTS

- SERVO AND FDI CONTROLLER
- POWER CONTROLLER
- ACTUATOR ASSEMBLY (MOTORS, GEAR TRAIN AND ACTUATOR)
- POWER SOURCE (OR SUPPLY)

## **SERVO AND FDI CONTROLLER**

---

**THE SERVO AND FDI CONTROLLER (ILLUSTRATED IN CHART 31) PROVIDES THE FOLLOWING ELECTRONICS:**

- **DIGITAL SERVO PROCESSOR TO PROCESS POSITION ERROR AND MOTOR CURRENT FEEDBACK TO GENERATE MOTOR CURRENT COMMAND TO POWER CONTROLLER. THE SERVO PROCESSOR IS DESCRIBED IN CHARTS 32 THROUGH 34.**
- **DIGITAL FDI PROCESSOR TO PROCESS POSITION ERROR, MOTOR CURRENT FEEDBACKS, ELA FAULT STATUS AND FDI COMMANDS TO GENERATE ISOLATIONS COMMANDS TO POWER PROCESSOR. THE FDI PROCESSOR IS DESCRIBED IN CHARTS 35 THROUGH 40.**
- **DIGITAL INTERFACE UNITS TO REFORMAT DATA FOR TRANSFER BETWEEN THE CONTROLLER AND OTHER UNITS VIA DATA BUSES.**
  - **FLIGHT CONTROL INTERFACE UNIT.**
  - **POWER CONTROLLER INTERFACE UNIT.**
  - **ISOLATION INTERFACE UNIT.**
  - **CROSS-CHANNEL INTERFACE CONTROL UNIT.**
- **POWER SUPPLY TO PROVIDE POWER IN APPROPRIATE FORM TO CONTROLLER ELECTRONICS.**
- **CIRCUITRY TO DETECT POWER SUPPLY FAULTS AND COMBINE STATUS WITH FAULT STATUS FROM FDI PROCESSOR.**

# SERVO AND FDI CONTROLLER (CHANNEL 1, TYPICAL)

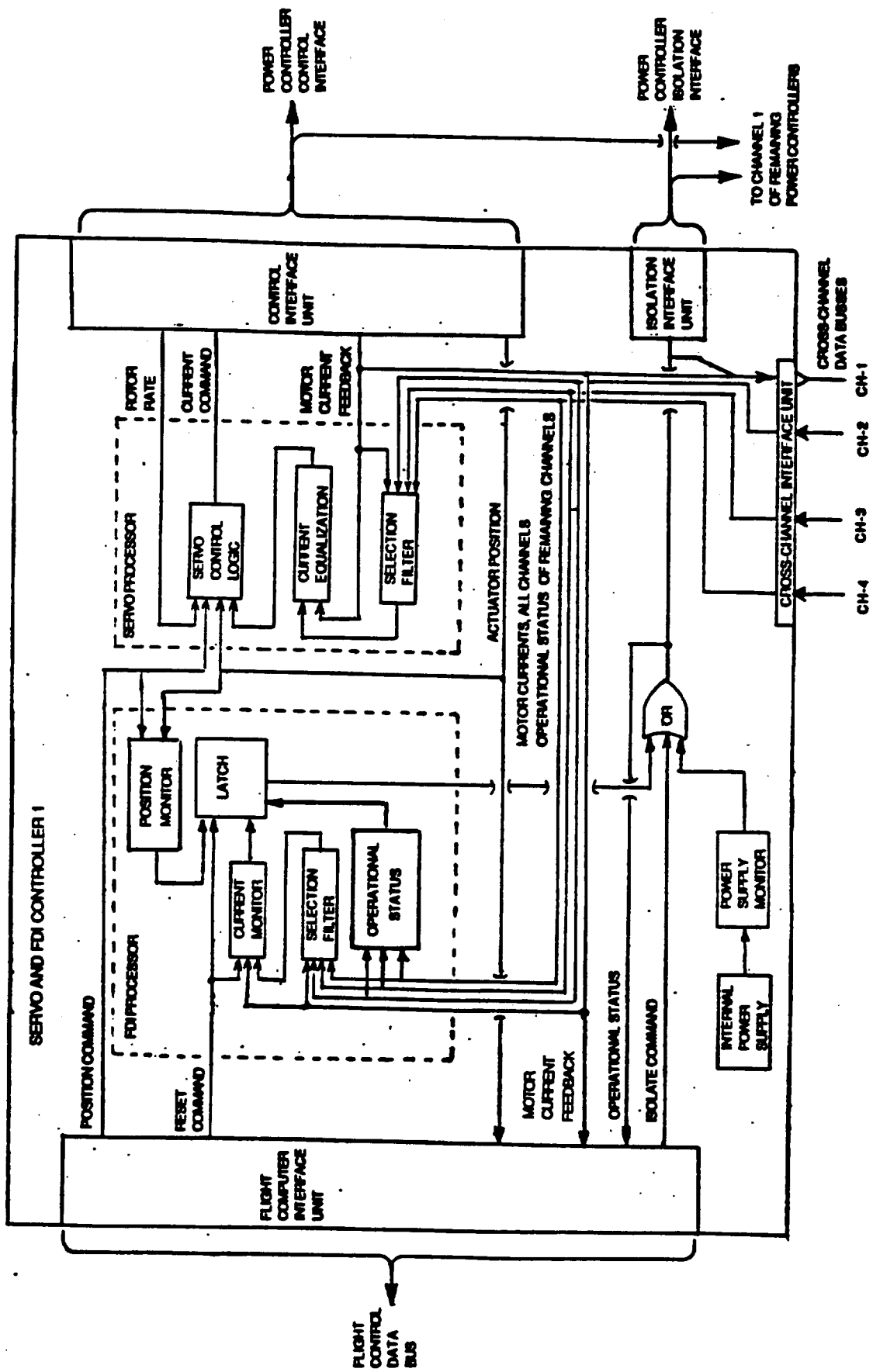

## SERVO PROCESSOR

---

- IN THE SERVO PROCESSOR (ILLUSTRATED IN CHART 33), THE POSITION COMMAND, ACTUATOR POSITION AND ROTOR RATE ARE COMPENSATED (BY FILTERS, LIMITERS, ETC.) AND COMBINED TO FORM A PRELIMINARY MOTOR CURRENT COMMAND.
- MOTOR-CURRENT SELECTION AND EQUALIZATION (SEE CHART 34) ARE ADDED TO EACH CHANNEL FOR COMPENSATION OF REDUNDANT-SYSTEM TOLERANCES AFFECTING THE CHANNEL. EQUALIZATION APPLIES ONLY TO MULTIPLE PARALLEL CHANNELS AND DOES NOT APPLY TO ACTIVE-STANDBY SYSTEMS. IT IS NOT NEEDED WITH PRECISION ENCODERS.
- MOTOR CURRENT FEEDBACK SIGNALS (FOR TORQUE SUMMING) ARE CROSS-STRAPPED BETWEEN CHANNELS, AND A SELECTION FILTER SELECTS SECOND LARGEST MAGNITUDE.
- THE SELECTED SIGNAL IS SUBTRACTED FROM THE IN-CHANNEL SIGNAL AND THE DIFFERENCE IS PROCESSED THROUGH A DEADBAND, A FILTER AND A LIMITER TO FORM AN EQUALIZATION FEEDBACK.
- THE EQUALIZATION FEEDBACK IS SUBTRACTED FROM THE PRELIMINARY CURRENT COMMAND TO FORM THE FINAL MOTOR CURRENT COMMAND.
- THE FINAL MOTOR CURRENT COMMAND IS SENT TO THE POWER CONTROLLER.

# POSITIONING (SERVO) CONTROL IN EACH ELA SYSTEM CHANNEL

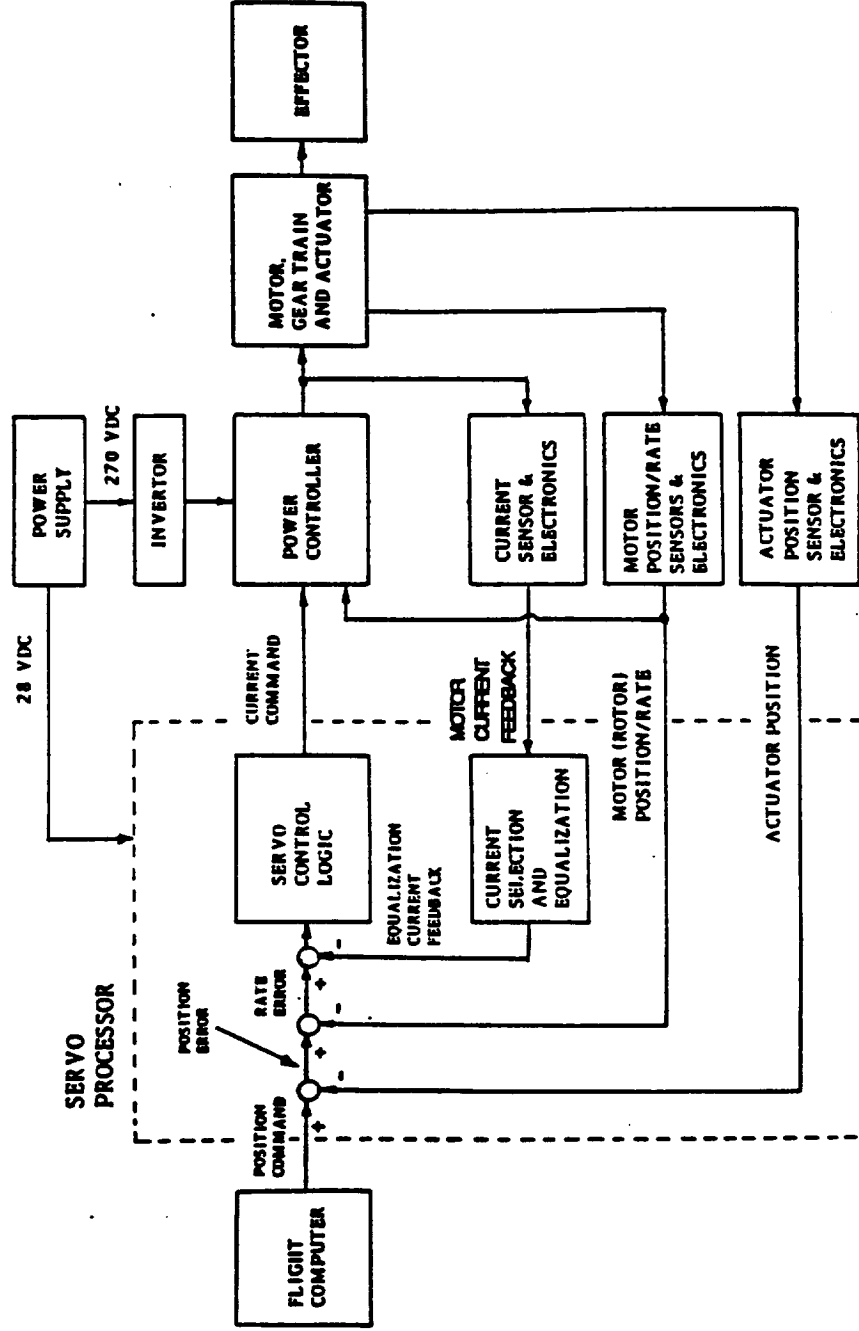

# MOTOR-CURRENT SELECTION AND EQUALIZATION FOR SERVO PROCESSOR (CHANNEL 1, TYPICAL)

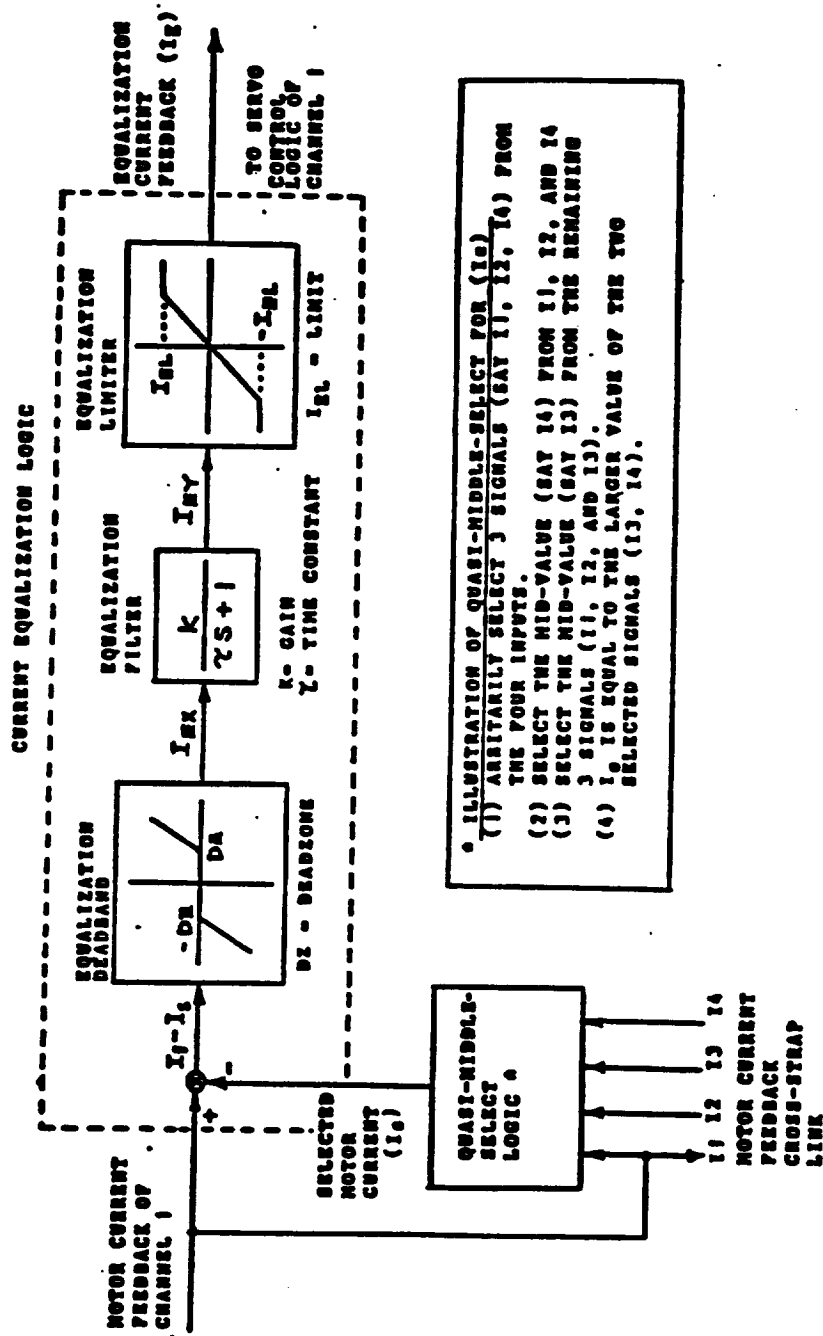



## FDI PROCESSOR

---

- IN THE FDI PROCESSOR (ILLUSTRATED IN CHART 36), THE SIGNAL D FROM THE FAULT ISOLATION COMMAND LOGIC IS TURNED ON (FAILURE INDICATION) WHEN THE POSITION-FAULT SIGNAL A (SEE CHARTS 36 AND 38) IS TURNED ON OR WHEN THE CURRENT-FAULT SIGNAL B (SEE CHARTS 36 AND 40) IS TURNED ON. FOR THE TWO CHANNEL ELA, D FOR BACKUP IS ON ALSO WHEN THE PRIMARY CHANNEL ISOLATION COMMAND IS OFF (PRIMARY CHANNEL GOOD).
- D REMAINS ON UNTIL THE RESET COMMAND IS TURNED ON. THE RESET TURNS D OFF AND RESETS THE CURRENT FAULT MONITOR. FOR THE TWO CHANNEL ELA, D FOR BACKUP IS TURNED OFF WHEN THE PRIMARY CHANNEL ISOLATION COMMAND IS TURNED ON.
- THE OUTPUT ISOLATION COMMAND (G) IS ON IF THE SIGNAL D IS ON, THE ISOLATION COMMAND FROM THE FLIGHT COMPUTER IS ON OR IF THE POWER SUPPLY FAULT MONITOR SIGNAL (F) IS ON. OTHERWISE THE OUTPUT ISOLATION COMMAND IS OFF.
- THE SERVO AND FDI CONTROLLER ALSO PROVIDES AN OPERATIONAL STATUS OF THE CHANNEL TO THE FLIGHT COMPUTER.

# FDI PROCESSOR (CHANNEL 1, TYPICAL)

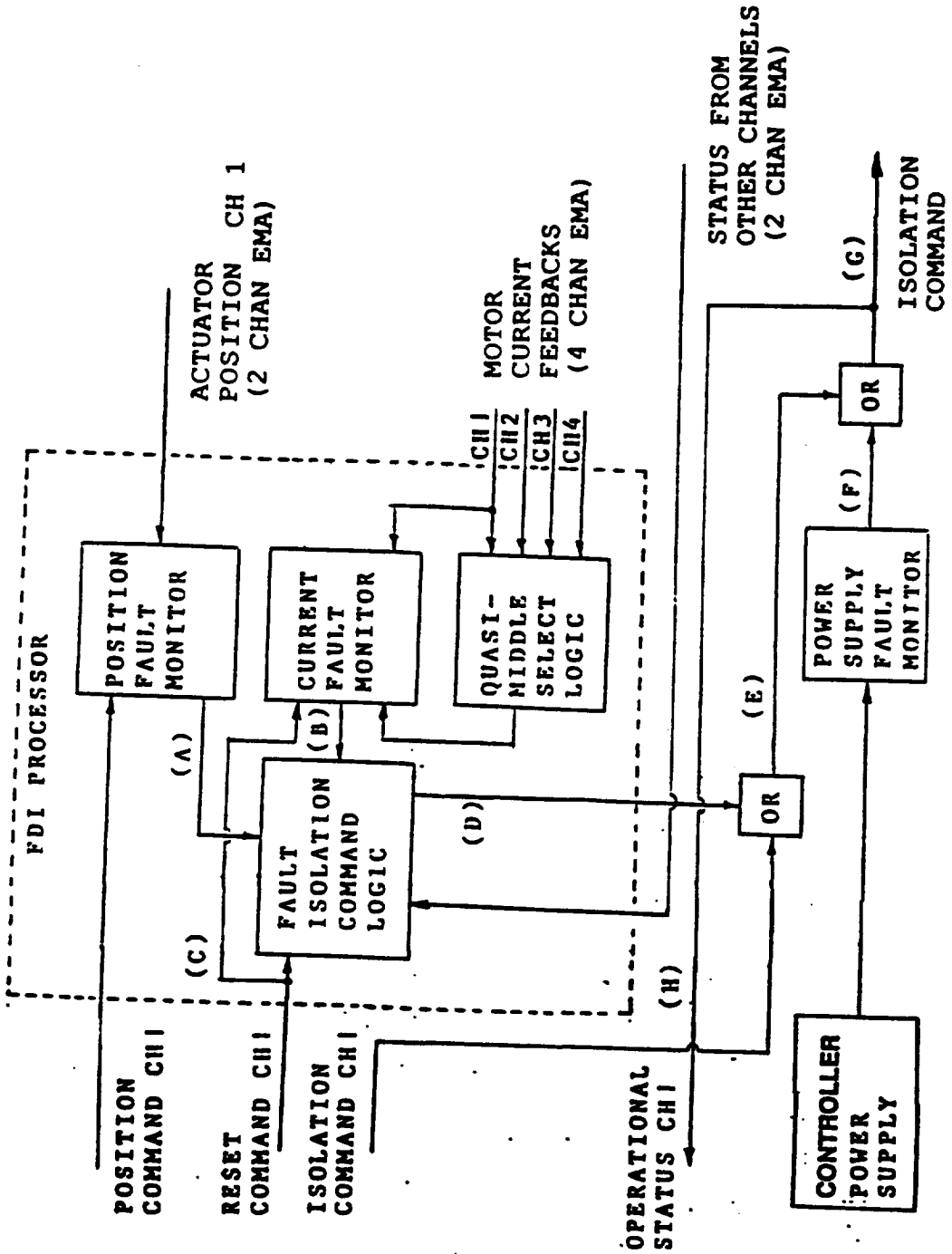

**POSITION FAULT MONITOR FOR FDI PROCESSOR  
(SEE CHART 38 FOR ILLUSTRATION)**

---

- **THE POSITION FAULT IS USED ONLY WITH TWO-CHANNEL SYSTEMS.**
- **IF POSITION FEEDBACK AGREES WITH COMMAND WITHIN THRESHOLD LEVEL  $S_L$ , THE COUNTERS AND FAULT FLAG (A) ARE RESET.**
- **IF POSITION ERROR EXISTS AND RATE IS OPPOSITE OF COMMAND FOR SPECIFIED TIME  $L_D$ , THE FAULT FLAG (A) IS SET.**
- **IF POSITION ERROR EXISTS AND RATE IS IN RIGHT DIRECTION BUT IS TOO LOW FOR SPECIFIED TIME  $L_R$ , THE FAULT FLAG IS SET.**
- **PARAMETER VALUES OF POSITION FAULT MONITOR ARE DETERMINED FROM THE FOLLOWING CRITERIA:**
  - **POSITION THRESHOLD  $S_L$  GREATER THAN VARIATIONS DUE TO NORMAL OPERATION AND TOLERANCES AND LESS THAN MAXIMUM ALLOWABLE POSITION ERROR MINUS TOLERANCES**
  - **RATE THRESHOLD  $R_L$  GREATER THAN VARIATIONS DUE TO NORMAL OPERATION AND LESS THAN AVAILABLE RATE MINUS TOLERANCES**
  - **COUNTER INCREMENTS AND COUNT LIMITS LARGE ENOUGH TO PREVENT REACTION TO SPURIOUS NOISE AND SMALL ENOUGH TO PREVENT EXCESSIVE POSITION TRANSIENT**

# POSITION FAULT MONITOR FOR FDI PROCESSOR (EACH CHANNEL)

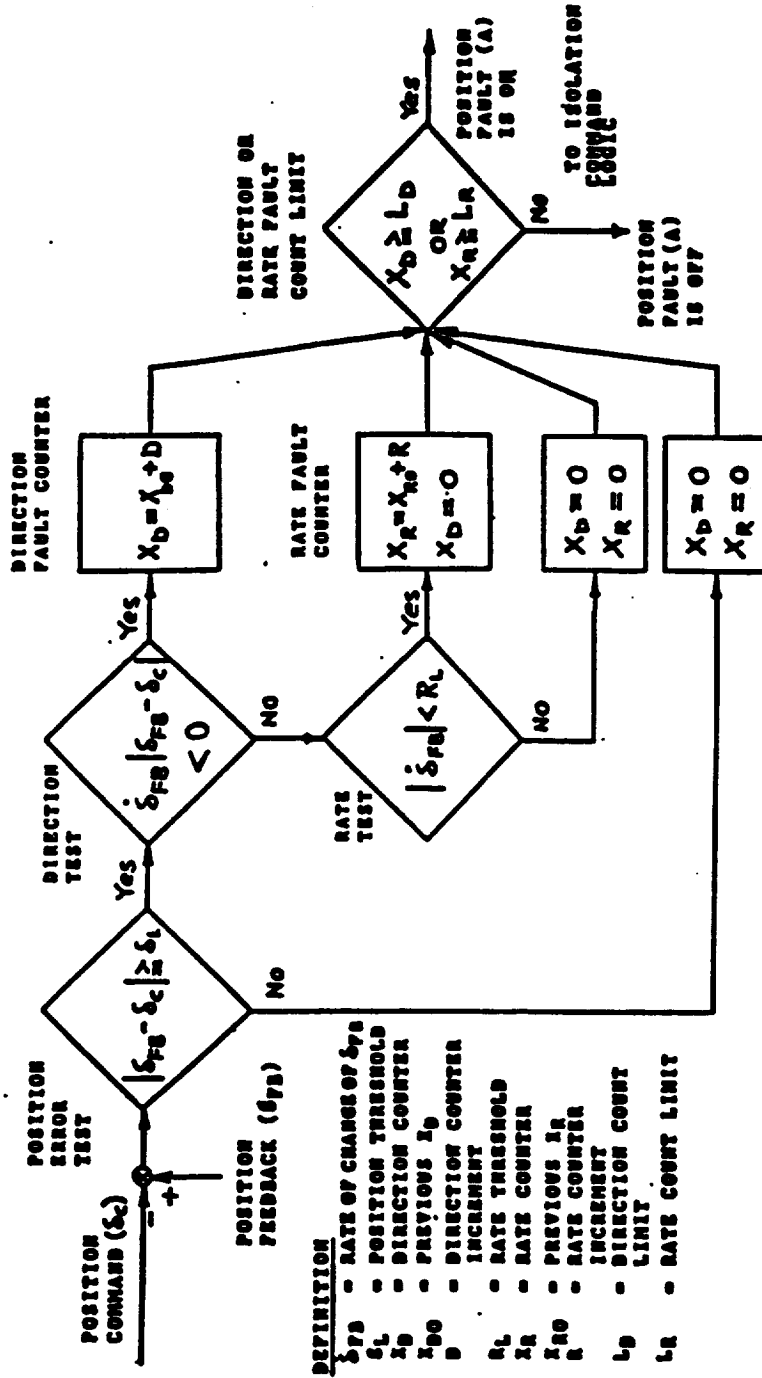

NOTE: THE POSITION FAULT MONITOR IS FOR TWO-CHANNEL ELA SYSTEM ONLY.

**MOTOR-CURRENT FAULT MONITOR FOR FDI PROCESSOR  
(SEE CHART 40 FOR ILLUSTRATION)**

---

- THE MOTOR-CURRENT FAULT MONITOR IS USED ONLY WITH FOUR-CHANNEL SYSTEMS.
- MOTOR CURRENT FEEDBACK IN CHANNEL 1 OF TORQUE-SUMMED EMA USED AS ILLUSTRATION.
- WHEN CURRENT FEEDBACK DISAGREES WITH SELECTED CURRENT FEEDBACK BY MORE THAN FAULT THRESHOLD  $I_T$ , INTEGRATOR COUNTS UP AT RATE OF  $N_U$ .
- WHEN CURRENT FEEDBACK AGREES WITH SELECTED CURRENT WITHIN THRESHOLD  $I_T$ , INTEGRATOR COUNTS DOWN AT RATE OF  $N_D$ .
- WHEN INTEGRATOR COUNTS UP TO FAULT LIMIT  $N_L$ , FAULT FLAG B IS SET.
- RESET COMMAND RESETS INTEGRATOR TO ZERO.
- THE PARAMETER VALUES OF MOTOR-CURRENT FAULT MONITOR ARE DETERMINED FROM THE FOLLOWING CRITERIA:
  - FAULT THRESHOLD  $I_T$  GREATER THAN VARIATIONS DUE TO NORMAL OPERATION AND TOLERANCES AND LESS THAN AVAILABLE CURRENT MINUS TOLERANCES
  - COUNT UP INCREMENT  $N_U$  AND CURRENT FAULT LIMIT  $N_L$  LARGE ENOUGH TO PREVENT REACTION TO SPURIOUS NOISE AND SMALL ENOUGH TO PREVENT EXCESSIVE POSITION TRANSIENT
  - COUNT DOWN INCREMENT  $N_D$  ADJUSTED TO DETECT OSCILLATIONS BUT NOT NOISE
  - QUASI-MIDDLE SELECT LOGIC SELECTS SECOND HIGH MAGNITUDE

# MOTOR-CURRENT FAULT MONITOR FOR FDI PROCESSOR (CHANNEL 1, TYPICAL)

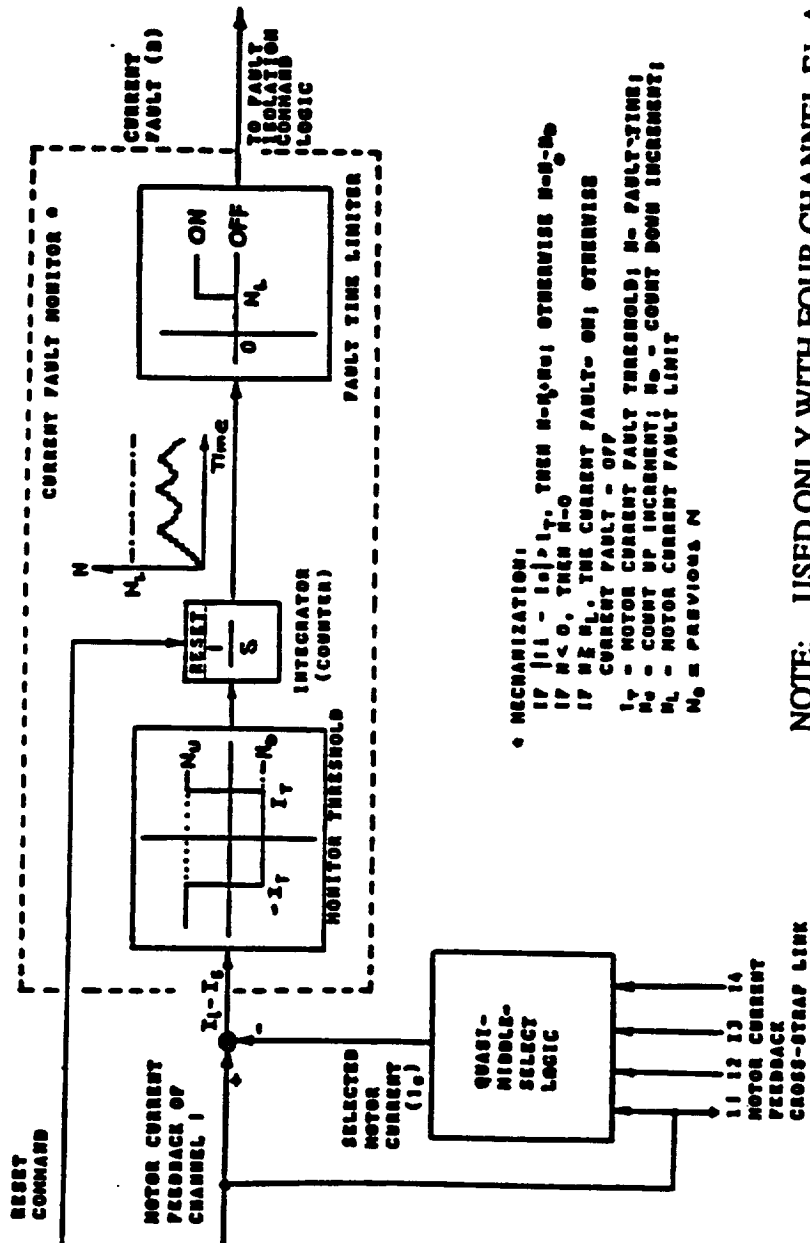

NOTE: USED ONLY WITH FOUR CHANNEL ELA SYSTEMS.

## POWER CONTROLLER

---

THE POWER CONTROLLER (ILLUSTRATED IN CHART 42) USES THE CURRENT COMMAND FROM THE SERVO CONTROLLER TO CONTROL THE CURRENT FLOWING FROM THE POWER SUPPLY THROUGH THE MOTOR WINDINGS. IN GENERAL, THERE ARE TWO TYPES OF POWER CONTROLLER:

- DIRECT-CURRENT (DC) SWITCH-MODE POWER CONTROLLER
- HIGH-FREQUENCY ALTERNATING-CURRENT (AC) POWER CONTROLLER

THESE CONTROLLERS ARE DESCRIBED IN CHARTS 43 THROUGH 46. IT SHOULD BE NOTED THAT EITHER THE DC CONTROLLER OR THE AC CONTROLLER AS DESCRIBED CAN DRIVE SYNCHRONOUS MOTORS (PERMANENT MAGNET OR RELUCTANCE). EITHER CONTROLLER CAN ALSO DRIVE AN INDUCTION MOTOR WHICH IS NONSYNCHRONOUS. IN THIS CASE, THE SEQUENCING OF POWER FROM PHASE TO PHASE IS NOT REFERRED TO AS COMMUTATION. MOTOR RATE MAY BE USED INSTEAD OF ROTOR POSITION.

# POWER CONTROLLER WITH CURRENT SELECTION FILTER

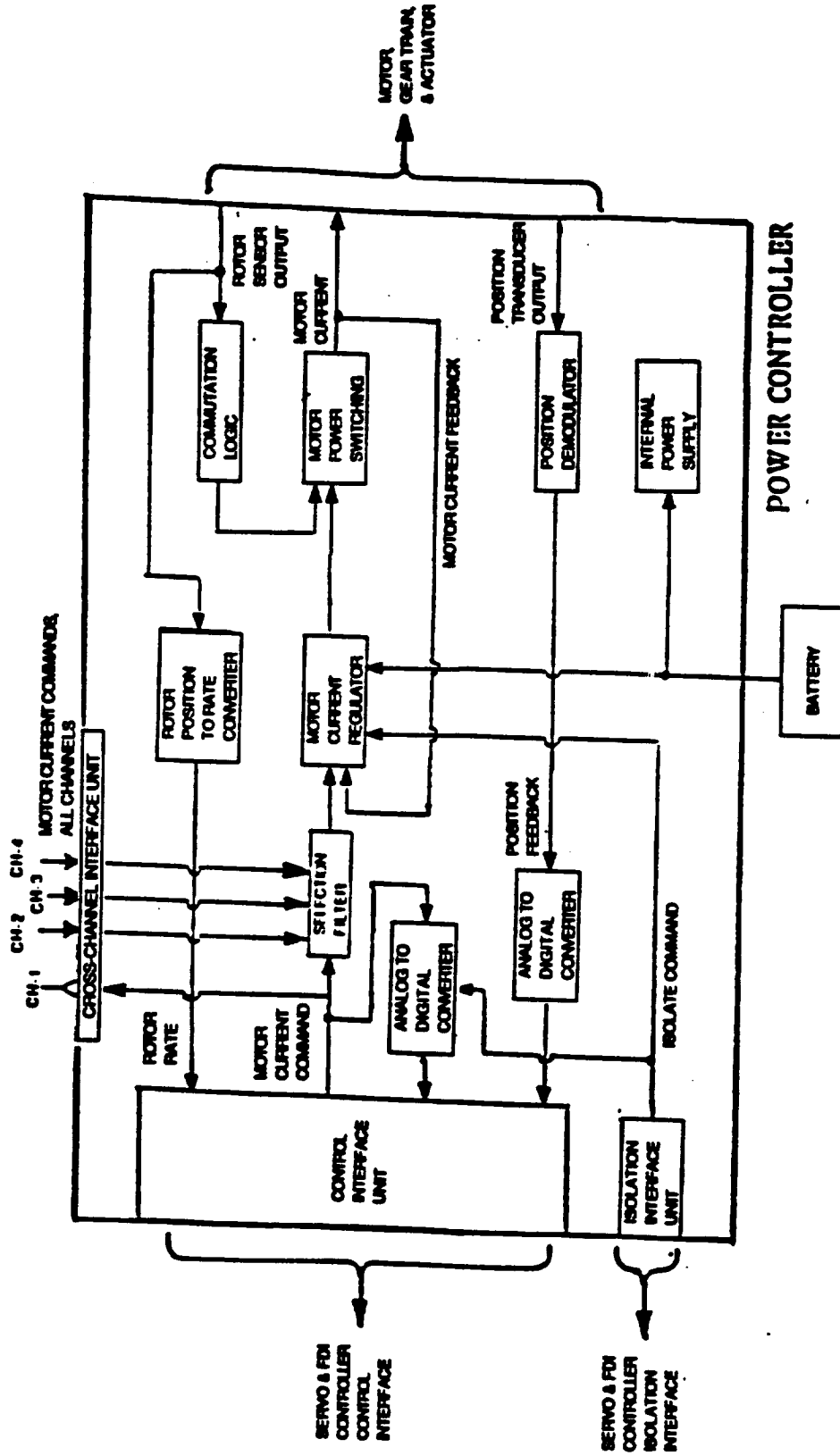



## **DC SWITCH-MODE POWER CONTROLLER (SEE CHART 44 FOR ILLUSTRATION.)**

---

- **THE ERROR SIGNAL (DIFFERENCE BETWEEN COMMANDED CURRENT AND MOTOR CURRENT) CAUSES THE PULSE WIDTH MODULATOR INCLUDING LOOP STABILIZATION COMPENSATION AND MOTOR-CONTROL SCHEME SUCH AS FIELD ORIENTED CONTROL TO PRODUCE:**
  - **A SERIES OF ON-OFF PULSES WHOSE ON-WIDTHS ARE PROPORTIONAL TO THE MAGNITUDE OF THE ERROR SIGNAL.**
  - **A DIRECTION COMMAND TO CONTROL DIRECTION OF ACTUATOR SLEW.**
- **THE ON-OFF PULSES CONTROL A SWITCH FOR VARYING THE CURRENT FLOWING FROM THE DC POWER SUPPLY (270 VDC FOR EXAMPLE) THROUGH THE MOTOR WINDINGS.**
- **THE COMMUTATION LOGIC USES THE DIRECTION COMMAND AND THE ROTOR POSITION FEEDBACK TO DETERMINE THE ON-OFF SEQUENCE OF THE POWER SWITCHES.**
- **THE SEQUENCED POWER SWITCHES CONVERT THE CURRENT SUPPLY TO THE APPROPRIATE THREE-PHASE POWER TO DRIVE THE MOTOR.**

# DC SWITCH-MODE POWER CONTROLLER (EACH CHANNEL)

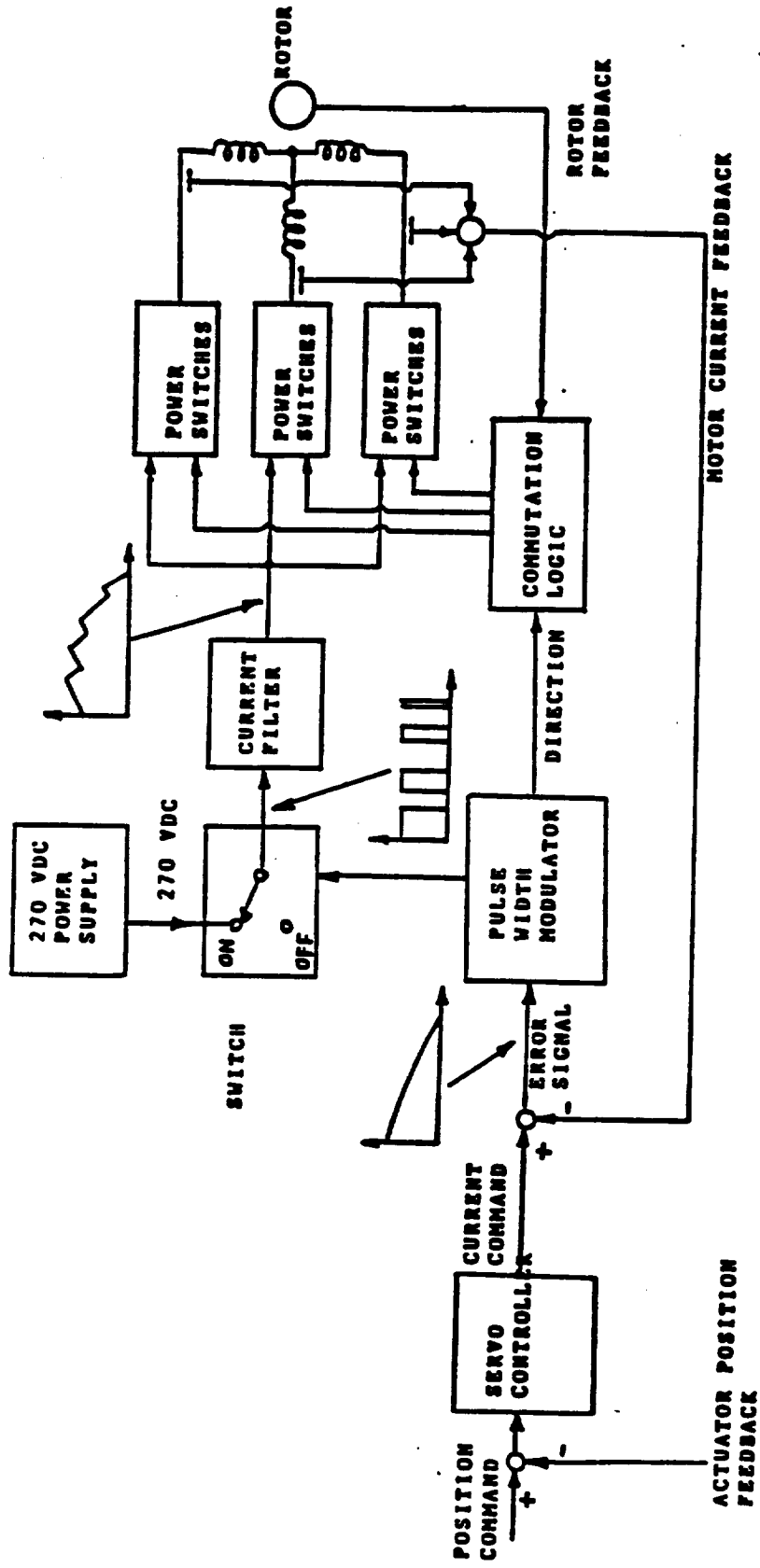

## **HIGH-FREQUENCY AC POWER CONTROLLER (SEE CHART 46 FOR ILLUSTRATION.)**

---

- **THE DC VOLTAGE FROM THE POWER SUPPLY IS CONVERTED INTO A HIGH-FREQUENCY (SUCH AS 20 KHZ) AC VOLTAGE (380 VAC FOR EXAMPLE)**
- **THE ERROR SIGNAL (DIFFERENCE BETWEEN COMMANDED CURRENT AND MOTOR CURRENT) CAUSES THE POPULATION DENSITY MODULATOR (PDM) INCLUDING LOOP STABILIZATION COMPENSATION AND MOTOR CONTROL SCHEME SUCH AS FIELD ORIENTED CONTROL TO PRODUCE:**
  - **A SERIES OF ON-OFF PULSES WHICH DRIVE A SWITCH FOR CONTROLLING THE AC CURRENT FLOWING THROUGH THE MOTOR WINDINGS.**
  - **A DIRECTION COMMAND TO CONTROL THE DIRECTION OF ACTUATOR SLEW.**
- **THE ZERO-CROSSING DETECTOR INSURES THAT POWER SWITCHING OCCURS ONLY AT ZERO CURRENT TO MINIMIZE STRESS ON THE SWITCH.**
- **THE COMBINED FUNCTION OF THE PDM, ZERO-CROSSING DETECTOR, SWITCH, AND RECTIFIER RESULTS IN A SERIES OF HALF-CYCLE CURRENT PULSES WITH DENSITY (NUMBER OF PULSES PER SECOND) PROPORTIONAL TO THE ERROR SIGNAL.**
- **THE COMMUTATION LOGIC USES THE DIRECTION COMMAND AND THE ROTOR POSITION TO DETERMINE THE ON-OFF SEQUENCE OF THE POWER SWITCHES.**
- **THE SEQUENCED POWER SWITCHES CONVERT THE CURRENT SUPPLY TO THE APPROPRIATE THREE-PHASE POWER TO DRIVE THE MOTOR.**

# HIGH-FREQUENCY AC POWER CONTROLLER (EACH CHANNEL)

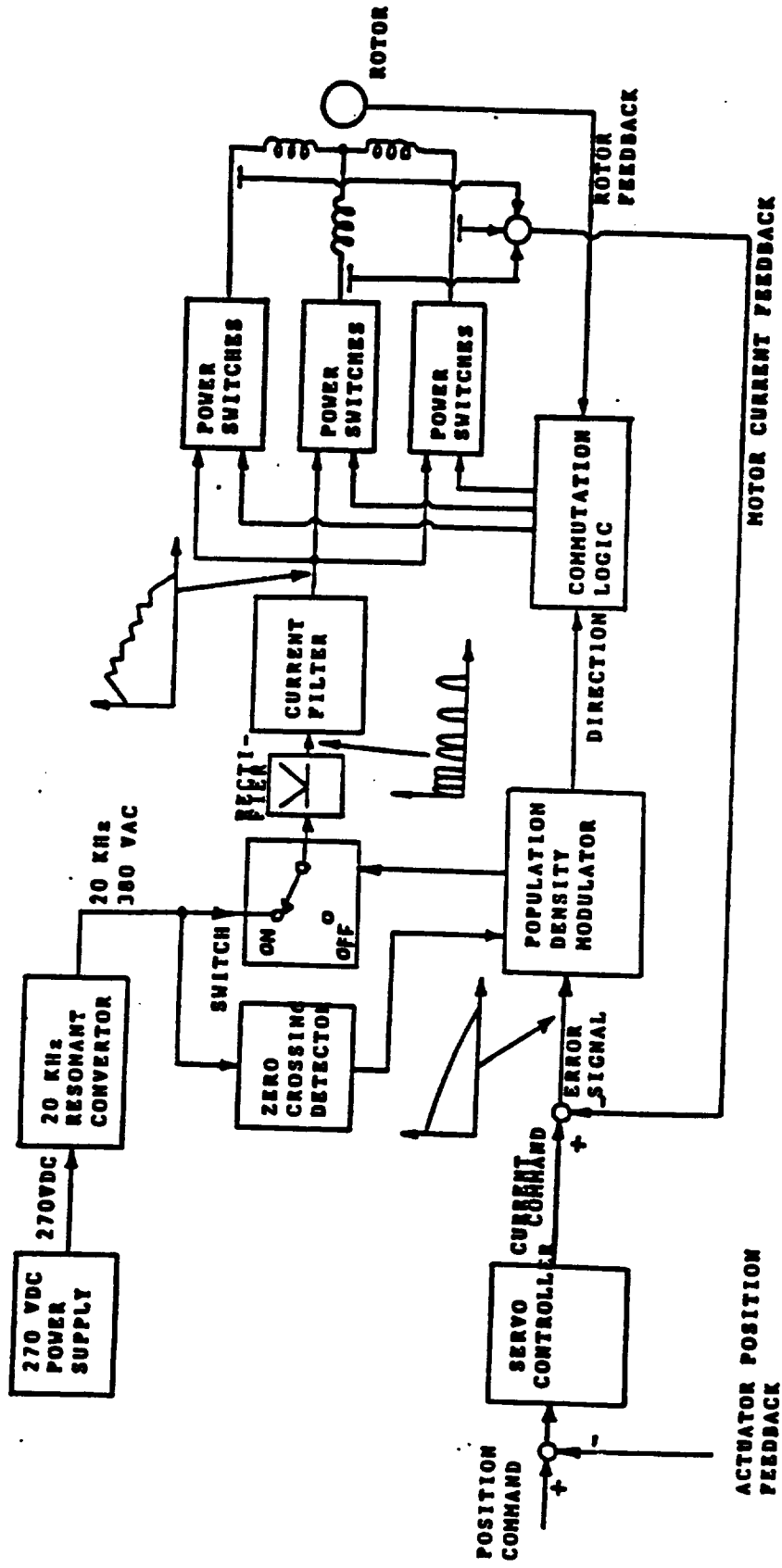

# ACTUATOR ASSEMBLY: MOTORS, GEAR TRAIN AND ACTUATOR

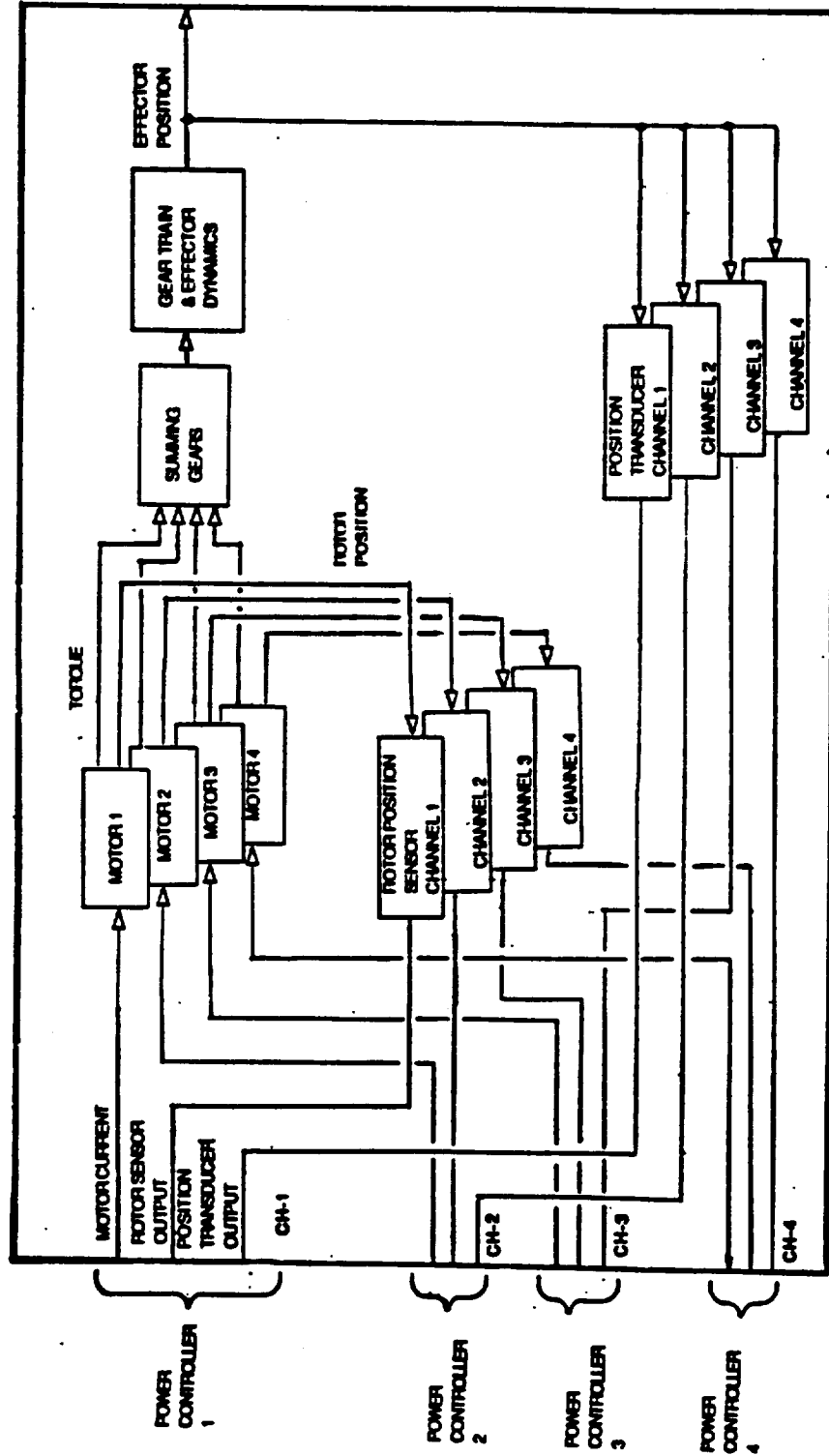

## MOTOR

(PAGE 1 OF 2)

**THE MOTORS IN THE ACTUATOR ASSEMBLY CONVERT ELECTRICAL POWER (CURRENT FROM THE POWER SUPPLY) INTO MECHANICAL MOTION (TORQUE) TO DRIVE THE ACTUATOR. IN GENERAL, THERE ARE THREE TYPES OF MOTORS THAT ARE APPLICABLE TO ELA SYSTEMS (SEE CHART 50 FOR ILLUSTRATION): PERMANENT MAGNET (OR BRUSHLESS DC) MOTOR, INDUCTION MOTOR AND VARIABLE (SWITCHED) RELUCTANCE MOTOR. THESE ELA MOTORS ARE DESCRIBED BELOW.**

- PERMANENT MAGNET (PM) MOTOR
  - THE ROTOR CONTAINS PERMANENT MAGNET (SUCH AS SAMARIUM COBALT) AND THE STATOR CONSISTS OF THREE PHASES OF WINDINGS.
  - THE ROTOR POSITION IS MEASURED AND FED BACK TO THE POWER CONTROLLER FOR COMMUTATION LOGIC WHICH SWITCHES THE MOTOR POWER TO THE NEXT PHASE IN SEQUENCE.
  - THE POWER CONTROLLER ADJUSTS THE POWER FOR THE REQUIRED MOTOR CURRENT.
  - THE CURRENT IN THE STATOR WINDINGS REACTS WITH THE MAGNETIC FIELD OF THE ROTOR TO CREATE TORQUE THAT CAUSES THE ROTOR TO ROTATE.
- INDUCTION MOTOR
  - A SQUIRREL CAGE ROTOR IS USED WHICH HAS LONGITUDINAL CONDUCTORS SHORTED TOGETHER AT THE ENDS OF THE ROTOR.
  - THE STATOR CONSISTS OF THREE PHASES OF WINDINGS.

## MOTOR

(PAGE 2 OF 2)

- 
- THE ROTOR RATE OR POSITION IS MEASURED AND FED BACK TO THE POWER CONTROLLER FOR THE LOGIC WHICH SWITCHES THE MOTOR POWER SEQUENTIALLY FROM PHASE TO PHASE AT THE COMMANDED RATE.
  - THE STATOR-INDUCED CURRENT IN THE ROTOR CONDUCTORS CREATES A MAGNETIC FIELD WHICH REACTS WITH THE CURRENT FLOW IN THE STATOR WINDINGS TO FORM TORQUE.
  - VARIABLE (SWITCHED) RELUCTANCE MOTOR
  - THE ROTOR HAS NO WINDINGS OR PERMANENT MAGNET; THE STATOR HAS THREE PHASES OF WINDINGS.
  - THE ROTOR AND STATOR HAVE UNEQUAL NUMBERS OF SALIENT (OR EXPLICIT) POLES.
  - THE ROTOR POSITION IS MEASURED AND FED BACK TO THE POWER CONTROLLER FOR COMMUTATION LOGIC WHICH SWITCHES THE MOTOR POWER TO THE NEXT PHASE IN SEQUENCE.
  - THE POWER CONTROLLER ADJUSTS THE POWER FOR THE REQUIRED MOTOR CURRENT
  - THE CURRENT FLOW IN THE STATOR WINDINGS CREATES A MAGNETIC FIELD WHICH ALIGNS THE ROTOR POLES WITH THE MAGNETIZED STATOR POLES RESULTING IN TORQUE AND ROTOR ROTATION.

# ELA MOTOR CONCEPTS

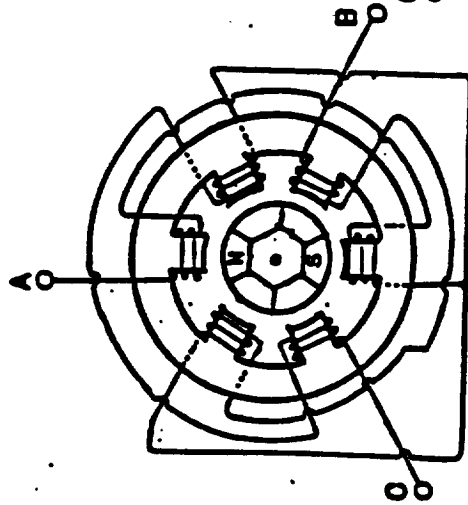

PERMANENT MAGNET

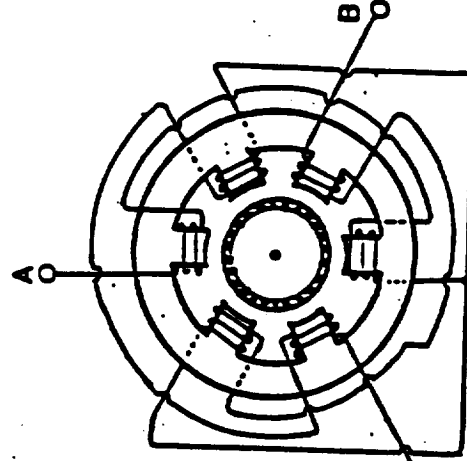

INDUCTION

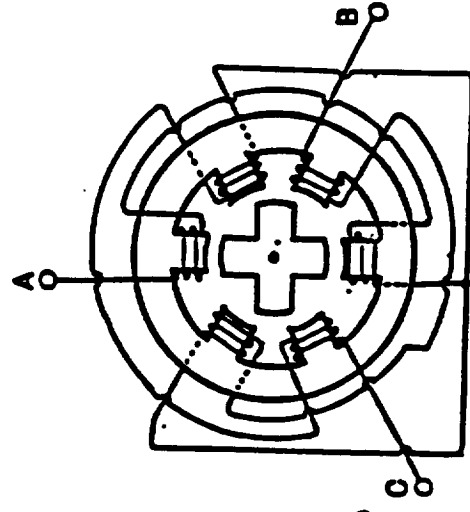

VARIABLE RELUCTANCE  
(SWITCHED RELUCTANCE)



## **GEAR TRAIN AND ACTUATOR (SEE CHARTS 47 AND 52 FOR ILLUSTRATION)**

---

**THE GEAR TRAIN SUMS THE PARALLEL CHANNELS TOGETHER INTO ONE OUTPUT, AND CONVERTS MOTOR TORQUE AND ROTATION INTO ACTUATOR FORCE AND DISPLACEMENT. THERE ARE FOUR TYPES OF CHANNEL-SUMMING ARRANGEMENT: LINEAR TORQUE SUMMED, ROTARY TORQUE SUMMED, LINEAR VELOCITY SUMMED AND ROTARY VELOCITY SUMMED. THESE SUMMING ARRANGEMENTS ARE DESCRIBED BELOW.**

- **TORQUE SUMMING**
  - **ALL MOTORS GEARED DIRECTLY TO SINGLE SUMMING GEAR**
  - **OUTPUT TORQUE IS SUM OF INPUT TORQUES - ALL MOTORS RUN AT SAME RATE**
  - **SEPARATE MOTORS FOR MECHANICAL SUMMING - EACH MOTOR MAY HAVE CLUTCH**
  - **MULTIPLE SETS OF WINDINGS IN ONE MOTOR FOR MAGNETIC SUMMING, NO CLUTCHES**
  - **FAILED MOTOR (OR WINDING) ISOLATED BY REMOVING POWER AND DISENGAGING CLUTCH, IF ANY**
- **VELOCITY SUMMING**
  - **COMBINES MOTOR RATES THROUGH DIFFERENTIALS**
  - **OUTPUT VELOCITY IS SUM OF MOTOR RATES, ALL MOTORS PROVIDE SAME TORQUE**
  - **EACH MOTOR REQUIRES BRAKE TO PREVENT BACKDRIVING**
  - **FAILED MOTOR ISOLATED BY REMOVING POWER AND APPLYING BRAKE**

**THE ACTUATOR PROVIDES NUT AND SCREW MECHANISM WITH ROLLERS OR BALLS FOR LINEAR ACTUATORS, AND ROTARY GEARING TO DRIVE HINGE-LINE FOR ROTARY ACTUATORS.**

# TORQUE AND VELOCITY SUMMING MECHANIZATION

---

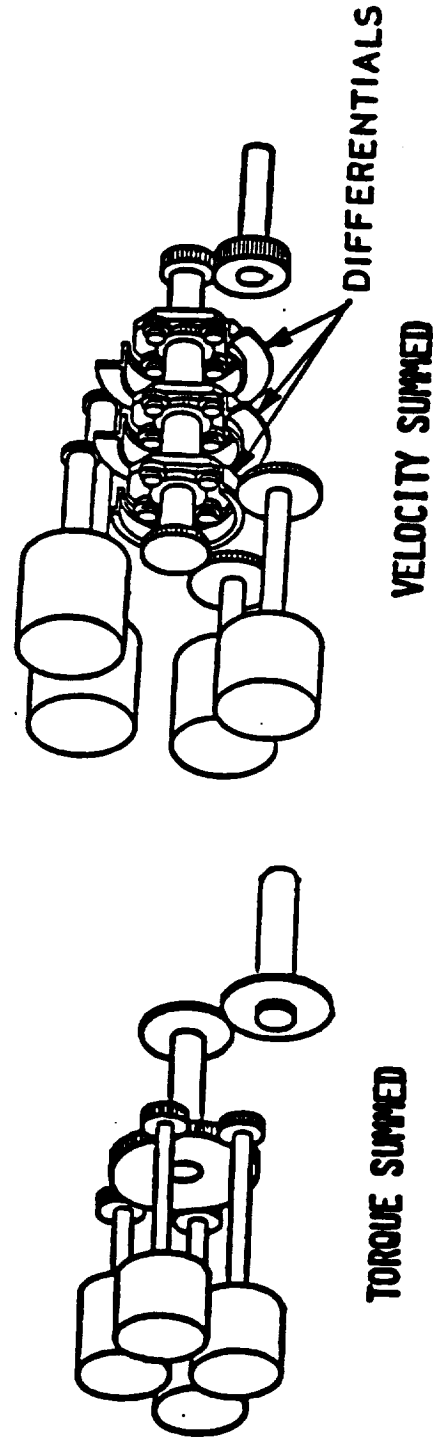

## **POWER SOURCE**

---

**THE POWER SOURCE PROVIDES HIGH ELECTRICAL POWER (SUCH AS 270 VDC) FOR ELA SYSTEMS, AND LOW ELECTRICAL POWER (SUCH AS 28 VDC) FOR THE SERVO AND FDI CONTROLLERS AND OTHER AVIONICS IN THE VEHICLE. THE APPLICABLE POWER SOURCE FOR ELA SYSTEMS ARE: PRIMARY (NON-CHARGEABLE) AND SECONDARY (RE-CHARGEABLE) BATTERIES, FUEL CELLS AND AUXILIARY POWER UNIT (APU) AND OTHER POWER GENERATORS.**

## ELA SYSTEM INTERFACES

---

- THE ELA SYSTEMS INTERFACE WITH THE FOLLOWING SHUTTLE VEHICLE SYSTEMS: DATA PROCESSING, ELECTRICAL POWER DISTRIBUTION AND CONTROL, THERMAL CONTROL, STRUCTURE, DISPLAY AND CONTROL, AND EFFECTORS. THE INTERFACE REQUIREMENTS ARE DESCRIBED BELOW.
- DATA PROCESSING SYSTEM
  - INTERFACES WITH COMPUTER THROUGH DIGITAL DATA BUSES; MDM'S ARE NOT REQUIRED
  - SOFTWARE IN COMPUTER FOR ELA CONTROL AND DISPLAY
- ELECTRICAL POWER DISTRIBUTION AND CONTROL SYSTEM (ORBITER AND EACH SRB)
  - CABLES, SWITCHING CONTROL AND INSTRUMENTATION FOR ELA EQUIPMENT
  - 270 VDC POWER SOURCE FOR MOTOR POWER AND 28 VDC FUEL CELLS FOR LOGIC POWER
- THERMAL CONTROL SYSTEM (ORBITER AND EACH SRB)
  - COLD PLATES FOR ELA CONTROLLERS
  - PASSIVE COOLING FOR ELA ACTUATOR ASSEMBLIES AND POWER SOURCE STRUCTURES (ORBITER AND EACH SRB)
  - MOUNTING FIXTURES FOR ELA COMPONENTS AND CABLING
- DISPLAY AND CONTROL SYSTEM
  - SAME AS FOR EXISTING HYDRAULIC SYSTEMS
- EFFECTORS
  - SAME AS FOR EXISTING HYDRAULIC SYSTEMS

**ELA COMPONENTS REQUIRED FOR SHUTTLE EFFECTOR SYSTEMS**

---

	<u>EACH OF THE 2 SRB'S</u>	<u>ORBITER</u>
• SERVO AND FDI CONTROLLER	0*	4
• POWER CONTROLLER	2	45
• ACTUATOR ASSEMBLY	2	45
• POWER SOURCE	4	4

• SHARED WITH ORBITER EFFECTOR SYSTEMS

## ELA EQUIPMENT LOCATIONS

---

- **CRITERIA FOR DETERMINATION OF ELA LOCATIONS**
  - **ACCEPTABLE RANGE OF VEHICLE CENTER-OF-GRAVITY (CG) FOR FLIGHT CONTROL**
  - **AVAILABLE SPACE**
  - **ACCESSIBLE FOR SERVICE AND MAINTENANCE**
  - **MINIMUM REQUIREMENTS FOR ELA THERMAL CONTROL**
  - **MINIMUM EFFECT DUE TO ANY ELECTROMAGNETIC INTERFERENCE (EMI)**
  - **MINIMUM CABLING**
- **POTENTIAL ELA LOCATIONS IN ORBITER**
  - **SERVO AND FDI CONTROLLERS: SIMILAR LOCATIONS FOR THE PRESENT AEROSURFACE SERVO AMPLIFIERS (ASA'S) AND ASCENT TVC (ATVC) DRIVERS (SEE CHART 57)**
  - **ACTUATOR ASSEMBLIES: SIMILAR LOCATIONS FOR THE PRESENT HYDRAULIC ACTUATORS**
  - **POWER SOURCE: SEE CHARTS 57 AND 58.**
  - **POWER CONTROLLERS: SEE CHARTS 57 AND 59.**
  - **ELA CABLING: SEE CHART 60.**
- **POTENTIAL ELA LOCATIONS IN EACH SRB (TBD)**



# POTENTIAL ELA LOCATIONS IN ORBITER: VIEW 1, BATTERIES AND CONTROLLERS

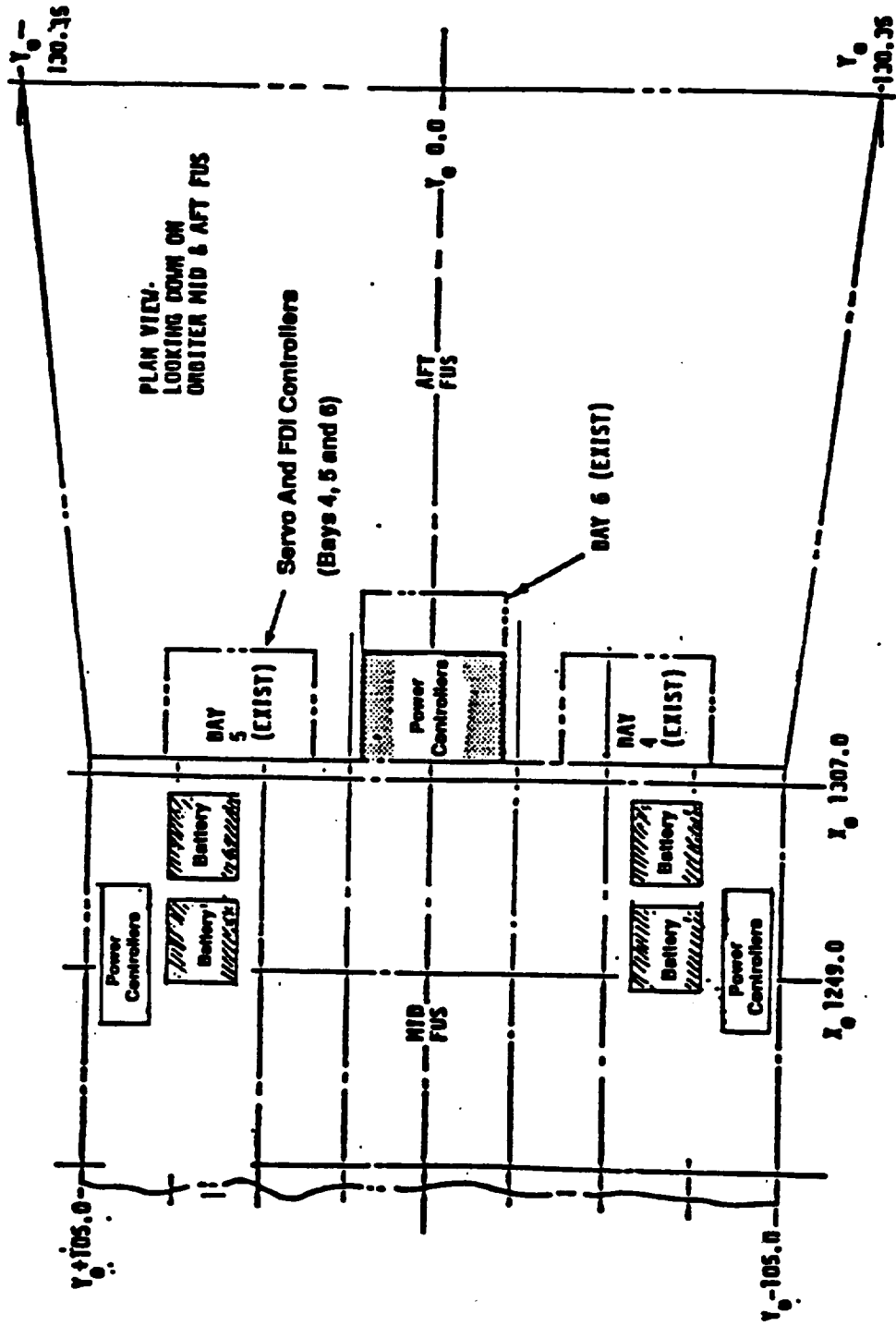

**POTENTIAL ELA LOCATIONS IN ORBITER: VIEW 2, BATTERIES**

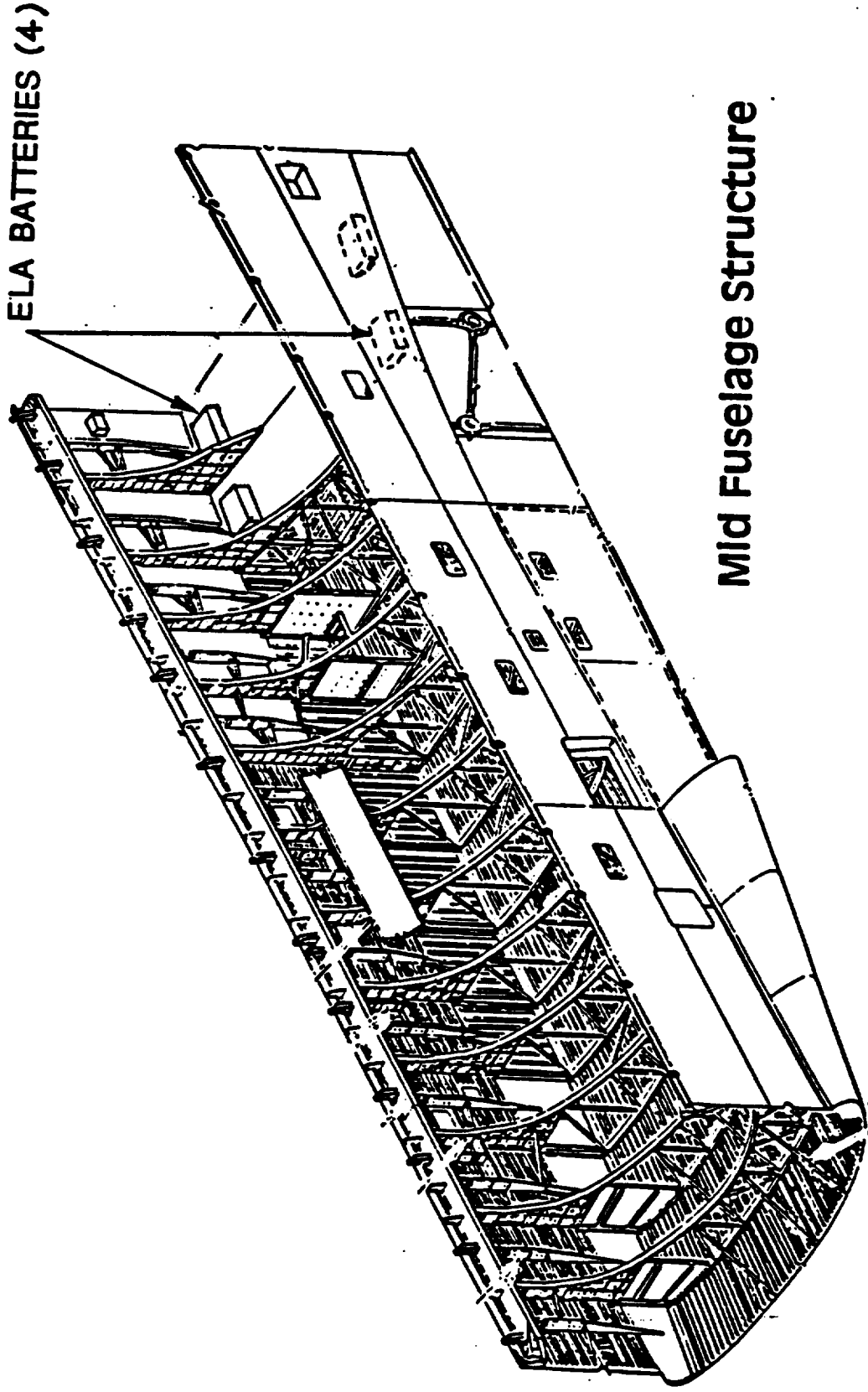



**POTENTIAL ELA LOCATIONS IN ORBITER: VIEW 3, POWER CONTROLLER (PC)**

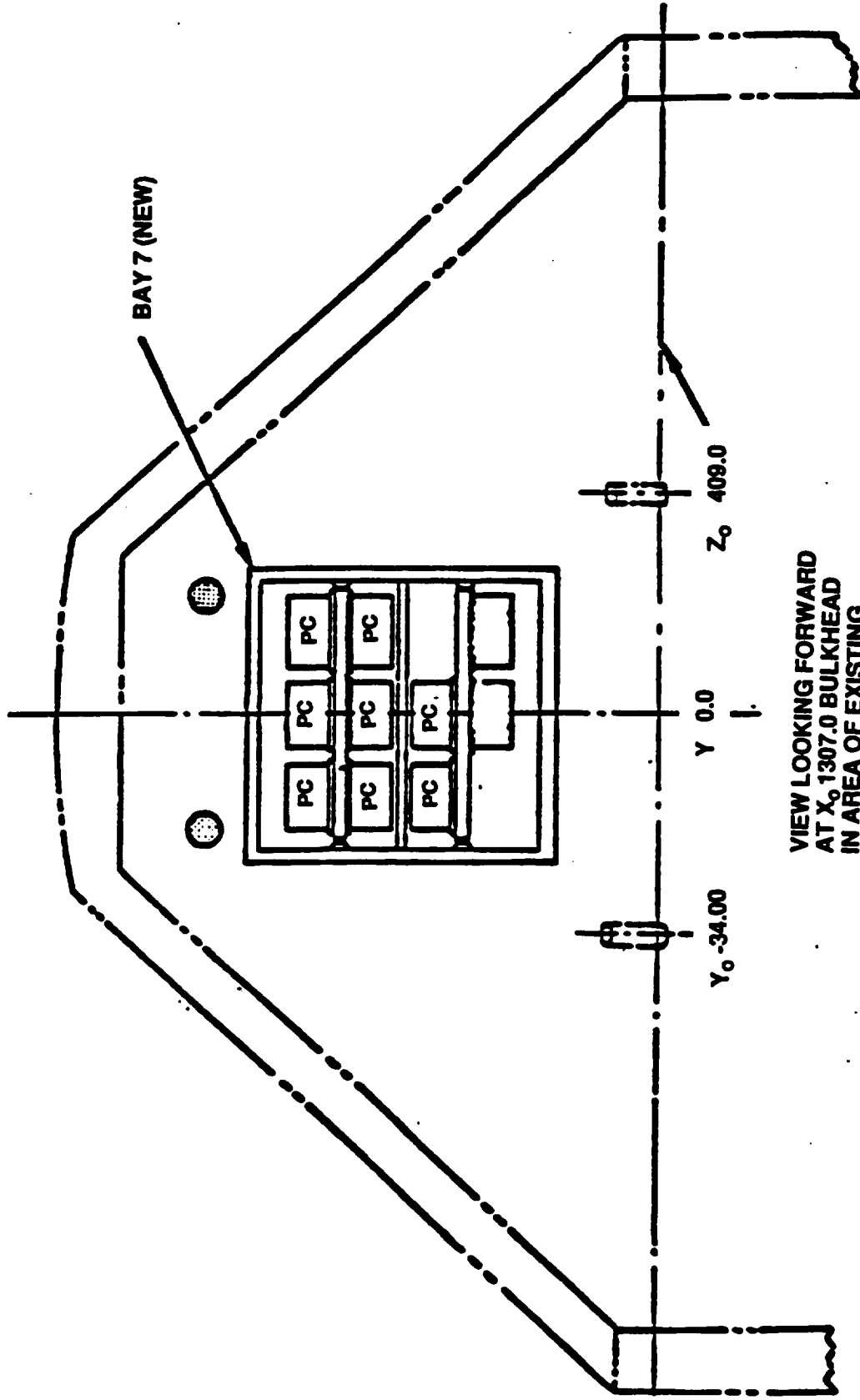

**VIEW LOOKING FORWARD  
AT X<sub>0</sub> 1307.0 BULKHEAD  
IN AREA OF EXISTING  
APU EQUIPMENT**

# POTENTIAL ELA LOCATIONS IN ORBITER: VIEW 4, CABLING

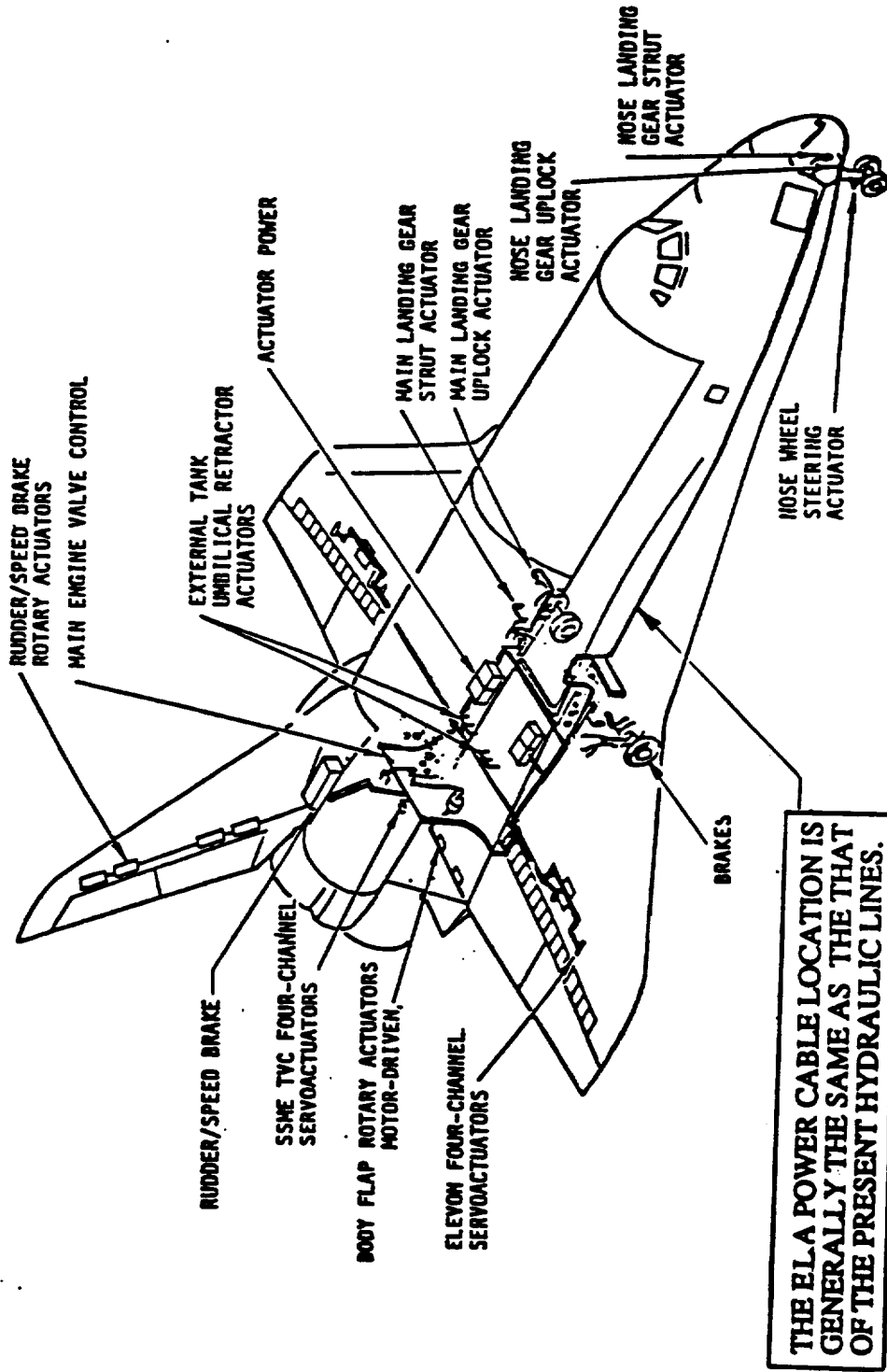

## **ELA COMPONENT TRADES AND SELECTION**

---

- **POWER SOURCE**
- **POWER CONTROLLER**
- **ACTUATOR ASSEMBLY**
- **SERVO-FDI CONTROLLER**

## POWER SOURCE TRADES

---

- **PRIMARY (NON-RECHARGEABLE) SILVER-ZINC (AG/ZN) BATTERIES**
  - HIGH POWER DENSITY (ESTIMATED POWER AND ENERGY DENSITIES: 1100 W/KG & 150WH/KG)
  - REQUIRES BATTERY REPLACEMENT EACH FLIGHT
- **PRIMARY LITHIUM THIONYL CHLORIDE (LI/SOC1<sub>2</sub>) BATTERIES**
  - HIGH ENERGY DENSITY (ESTIMATED POWER AND ENERGY DENSITIES: 450 W/KG & 400 WH/KG)
  - SAFETY CONCERN DUE TO LOW MELTING POINT OF LITHIUM
  - REQUIRES BATTERY REPLACEMENT BUT MAY HAVE ENOUGH ENERGY FOR MORE THAN ONE FLIGHT
- **SECONDARY (RECHARGEABLE) SILVER ZINC BATTERIES**
  - HIGH POWER DENSITY (ESTIMATED POWER AND ENERGY DENSITIES: 900 W/KG & 100 WH/KG)
  - BATTERIES RECHARGED RATHER THAN REPLACED FOR FLIGHT
- **SECONDARY BIPOLAR LEAD ACID BATTERIES**
  - HIGH POWER DENSITY (ESTIMATED POWER AND ENERGY DENSITIES: 1500 W/KG & 57 WH/KG)
  - LOW ENERGY DENSITY
  - HIGH DEVELOPMENT RISK
- **ADVANCED FUEL CELLS**
  - LOW WEIGHT IF USED TO POWER EMA'S AND AVIONICS (ELIMINATING PRESENT FUEL CELLS)
  - MORE GROUND SERVICING REQUIRED THAN FOR BATTERIES
- **AUXILIARY POWER UNITS**
  - SAFETY CONCERN DUE TO TOXIC PROPELLANTS
  - HIGH GROUND SERVICING REQUIRED
- **BASELINE SELECTION: SECONDARY SILVER ZINC BATTERIES**



**Rockwell International**  
Space Systems Division

## **POWER CONTROLLER TRADES**

---

- **DIRECT CURRENT (DC) SWITCH-MODE POWER CONTROLLER**
  - **POWER SWITCHING AT HIGH CURRENT INCREASING STRESS ON TRANSISTORS**
  - **LOWER EFFICIENCY AND GREATER COOLING REQUIREMENTS DUE TO SWITCHING LOSS AT HIGH CURRENT**
- **HIGH FREQUENCY ALTERNATING CURRENT (AC) POWER CONTROLLER**
  - **POWER SWITCHING AT ZERO CURRENT REDUCING STRESS ON TRANSISTORS**
  - **THEORETICALLY REDUCED LOSSES AND THERMAL REQUIREMENTS ON TRANSISTORS**
  - **THEORETICALLY PROVIDES IMPROVED PERFORMANCE DUE TO LESS STRINGENT REQUIREMENTS ON SWITCHING TRANSISTORS**
  - **REQUIRES DC TO AC POWER CONVERTOR**
- **BASELINE SELECTION: HIGH FREQUENCY AC POWER CONTROLLER**

## ACTUATOR ASSEMBLY TRADES - EMA VERSUS EHA

---

- **ELECTROMECHANICAL ACTUATOR (EMA)**
  - **MOTORS DRIVE GEAR MECHANISM WHICH DRIVES EFFECTOR**
  - **NATURAL SUMMING METHOD IS TORQUE SUMMING. VELOCITY SUMMING REQUIRES ADDITIONAL GEARING MECHANISM**
- **ELECTROHYDROSTATIC ACTUATOR (EHA)**
  - **MOTORS DRIVE REVERSIBLE HYDRAULIC PUMPS TO DRIVE HYDRAULIC PISTON CONNECTED TO EFFECTOR**
  - **ELECTROHYDROSTATIC MECHANISM READILY PERMITS DISENGAGING CHANNEL AND DAMPING SUBSEQUENT MOTION**
  - **PRESENCE OF HYDRAULIC OIL IN ACTUATOR RAISES CONCERN OF POSSIBLE HYDRAULIC LEAKS**
  - **NATURAL SUMMING METHOD IS VELOCITY SUMMING. TORQUE OR FORCE SUMMING REQUIRES ADDITIONAL HYDRAULIC MECHANISM.**
- **BASELINE SELECTION: EMA FOR ALL EXCEPT NOSE WHEEL STEERING.  
EHA FOR NOSE WHEEL STEERING TO OBTAIN DAMPING MODE**

## ACTUATOR ASSEMBLY TRADES - MOTOR TYPE

---

- PERMANENT MAGNET (BRUSHLESS DC) MOTOR
  - SERVO CONTROL TECHNOLOGY USING PERMANENT MAGNET MOTOR HAS BEEN DEVELOPED AND DEMONSTRATED
  - SHORTED TURN MAY CAUSE SEVERE HEATING AND LOAD ON MOTOR DUE TO BACK EMF GENERATED BY ROTOR MAGNET
- INDUCTION MOTOR
  - COMMERCIAL PRODUCTION WELL DEVELOPED
  - SENSITIVITY TO HIGH TEMPERATURE DUE TO HEATING IN ROTOR
- VARIABLE RELUCTANCE MOTOR
  - NO SHORTED-TURN PROBLEM ONCE MOTOR POWER IS REMOVED SINCE ROTOR HAS NO MAGNETS
  - RUGGED ROTOR CONSTRUCTION (NO MAGNETS OR WINDINGS ON ROTOR)
- BASELINE SELECTION: VARIABLE RELUCTANCE MOTOR

## ACTUATOR ASSEMBLY TRADES - CHANNEL SUMMING

---

- **MECHANICAL TORQUE SUMMING (4 SEPARATE MOTORS)**
  - **LOW MECHANICAL COMPLEXITY**
  - **ALLOWS USE OF CLUTCH TO ISOLATE FAILED MOTOR**
  - **POTENTIAL STRUCTURAL LOADING TWICE NOMINAL WITH FAIL OPERATE/FAIL SAFE EFFECTOR SYSTEM**
- **MAGNETIC TORQUE SUMMING (4-IN-1 MOTOR)**
  - **SHORTED-TURN PROBLEM IS NOT CORRECTABLE**
  - **POTENTIAL STRUCTURAL LOAD TWICE NOMINAL WITH FAIL OPERATE/FAIL SAFE EFFECTOR SYSTEM**
  - **CLUTCHES OR BRAKES CANNOT BE USED**
  - **SIMPLE SUMMING MECHANISM**
- **VELOCITY SUMMING**
  - **TOLERANT OF SHORTED TURNS (DEVIATION OF MOTOR VELOCITY ENGAGES BRAKE)**
  - **COMPLEX SUMMING MECHANISM DUE TO DIFFERENTIAL AND BRAKES**
  - **REQUIRES BRAKES TO ISOLATE FAILED MOTORS**
- **BASELINE SELECTION: MECHANICAL TORQUE SUMMING**



## **SERVO & FDI CONTROLLER TRADES - DIGITAL VERSUS ANALOG**

---

- **DIGITAL CONTROL PROCESSING**
  - **DIRECT CONNECTION TO GENERAL PURPOSE COMPUTER (GPC) DATA BUS. MDM'S NOT REQUIRED.**
  - **MORE PROCESSING CAPABILITIES AND EASIER TO CHANGE**
  - **MORE SENSITIVE TO ELECTROMAGNET INTERFERENCE (EMI)**
  - **REQUIRES ANALOG-DIGITAL (A/D AND D/A) CONVERSIONS**
- **ANALOG CONTROL PROCESSING**
  - **LESS SENSITIVE TO EMI**
  - **NO A/D OR D/A CONVERSIONS REQUIRED EXCEPT FOR GPC INTERFACES**
  - **REQUIRES MDM'S TO INTERFACE WITH GPC'S**
  - **LIMITED PROCESSING CAPABILITY AND INCONVENIENT TO CHANGE**
  - **REQUIRES SEPARATE CIRCUIT FOR EACH ACTUATOR**
- **BASELINE SELECTION: DIGITAL PROCESSING**

## **SERVO AND FDI CONTROLLER TRADES - FDI LOCATION**

---

- **LOCAL FDI (FDI IN SERVO AND FDI CONTROLLER)**
  - **MINIMIZES EFFECTOR SYSTEM FAILURE TRANSIENTS**
  - **MINIMIZES GPC SOFTWARE REQUIREMENTS**
  - **ADDS HARDWARE REQUIREMENTS TO SERVO AND FDI CONTROLLER**
- **REMOTE FDI (FDI IN GENERAL PURPOSE COMPUTERS)**
  - **REDUCES HARDWARE REQUIREMENTS ON SERVO AND FDI CONTROLLER**
  - **INCREASES EFFECTOR SYSTEM FAILURE TRANSIENTS**
  - **INCREASES SOFTWARE PROCESSING REQUIREMENTS ON GPC'S**
- **BASELINE SELECTION: LOCAL FDI**

# ELA BASELINE FOR SPACE SHUTTLE EFFECTOR SYSTEMS (PRELIMINARY)

---

- ELA EFFECTOR SYSTEMS
  - REDUNDANCY LEVEL
  - SERVO AND FDI CONTROLLER
  - POWER CONTROLLER
  - ACTUATOR ASSEMBLY
  - ELA POWER SOURCE
  - ELA POWER DISTRIBUTION
  
- ELA INTERFACE SYSTEMS
  - DATA PROCESSING
  - DISPLAY AND CONTROL (PANELS)
  - STRUCTURE
  - THERMAL CONTROL

**BASELINE FOR ELA EFFECTOR SYSTEM: REDUNDANCY LEVEL  
(PRELIMINARY)**

---

**• FOUR PARALLEL CHANNELS FOR:**

- 4 SRB TVC, 6 SSME TVC, 4 ELEVONS,  
RUDDER, SPEEDBRAKE, BODYFLAP,  
4 BRAKES AND 6 ET (FUEL AND OXIDIZER)  
UMBILICAL RETRACTS**

- FO/FS PLUS MINIMIZING EFFECTOR  
FAILURE TRANSIENTS (EFFECTOR  
POSITION EXCURSION DUE TO FAILURE  
AND THE SUBSEQUENT FDI ACTION)**

**• TWO CHANNELS (PRIMARY/STANDBY) FOR:**

- 4 OMS TVC**
- NOSEWHEEL STEERING**
- 15 SSME PROPELLANT VALVES**
- 3 NOSE- AND MAIN-GEAR UPLOCKS**
- 3 NOSE- AND MAIN-GEAR STRUTS  
(RETRACTS)**

- FS (SINGLE OMS ENGINE OPERATION  
ACCEPTABLE)**
- FS PLUS DIFFERENTIAL BRAKING  
BACKUP**
- FS PLUS PNEUMATIC BACKUP**
- FS PLUS PYRO BACKUP**
- FS (GROUND OPERATION ONLY)**



**BASELINE FOR ELA EFFECTOR SYSTEMS: SERVO AND FDI CONTROLLER  
(PRELIMINARY)**

---

**ELA BASELINE**

- **DIGITAL SERVO CONTROLLER CONNECTED TO GPC DATA BUS**
- **CROSS-CHANNEL DATA TRANSFER**
- **ACTUATOR FEEDBACK PROCESSING**
- **GENERATION OF POSITION ERROR**
- **FAILURE DETECTION AND ISOLATION (FDI) PROCESSING RESIDES IN SERVO AND FDI CONTROLLER (LOCAL FDI)**
- **BUILT-IN SELF TEST**
- **FOUR CONTROLLERS, ONE FOR EACH CHANNEL. EACH CONTROLLER PROCESSES THAT CHANNEL FOR ALL ORBITER AND SRB ACTUATORS**
- **CONTROLLERS POWERED BY EXISTING ORBITER POWER SYSTEM**

**RATIONALE/REMARKS**

- **ELIMINATE THE NEED FOR MULTI-PLEXER - DEMULTIPLEXER (MDM); MORE PROCESSING CAPABILITIES AND MORE READILY CHANGED**
- **NEEDED FOR FDI PROCESSING**
- **NEEDED FOR SERVO AND FDI PROCESSING**
- **NEEDED FOR MOTOR CONTROL**
- **MINIMIZE FAILURE TRANSIENTS PLUS ELIMINATE REQUIREMENTS FOR FDI SOFTWARE IN THE GENERAL PURPOSE COMPUTERS (GPC'S) AND DATA BUS**
- **FAULT DETECTION OF SERVO AND FDI CONTROLLER**
- **SAVE WEIGHT, SPACE AND CABLES**
- **EXISTING ORBITER MATCHES VOLTAGE REQUIREMENTS AND IS READILY AVAILABLE**



**BASELINE FOR ELA EFFECTOR SYSTEMS: POWER CONTROLLER  
(PRELIMINARY)**

---

**ELA BASELINE**

- ONE CONTROLLER ASSEMBLY FOR EACH ACTUATOR ASSEMBLY WITH ALL CONTROL CHANNELS FOR THAT ACTUATOR
- HIGH FREQUENCY (20 KHZ) AC POWER INPUT
- USES CURRENT COMMAND FROM SERVO AND FDI CONTROLLERS TO CONTROL CURRENT FLOW FROM POWER SOURCE THROUGH MOTOR WINDINGS
- RECEIVES FDI COMMANDS FROM SERVO AND FDI CONTROLLERS TO ISOLATE FAILED CHANNELS
- INTERFACES WITH ELA TRANSDUCERS TO OBTAIN MOTOR AND ACTUATOR FEEDBACK FOR SERVO AND FDI CONTROLLER
- CROSS-CHANNEL CURRENT DATA TRANSFER

**RATIONALE/REMARKS**

- SAVE WEIGHT, SPACE AND CABLES
- ALLOW ZERO POWER SWITCHING TO REDUCE LOSSES AND TRANSISTOR STRESS
- DRIVE ACTUATOR MOTORS AS REQUIRED FOR SERVO CONTROL
- REMOVE EFFECTS OF SYSTEM FAILURES
- REQUIRED FOR SERVO CONTROL
- MINIMIZE IMPACT OF WASTED POWER DUE TO FAILED CHANNEL



**BASELINE FOR ELA EFFECTOR SYSTEMS: ACTUATOR ASSEMBLY  
(PRELIMINARY)**

---

**ELA BASELINE**

- VARIABLE RELUCTANCE MOTOR
- MOTOR POSITION TRANSDUCERS
- ACTUATOR POSITION DIGITAL ENCODERS

**RATIONALE/REMARKS**

- SIMPLE ROTOR, NO SHORTED TURN PROBLEM WITH POWER REMOVED
- PROVIDE COMMUTATION SIGNALS TO POWER CONTROLLER FOR CONTROLLING SWITCHING TRANSISTORS
- PROVIDE ACCURATE POSITION FEEDBACK FOR SERVO CONTROL AND ELIMINATE NEED FOR EQUALIZATION IN SERVO AND FDI CONTROLLER

**ALL EXCEPT NOSEWHEEL STEERING:**

- MECHANICAL GEAR TRAIN WITH MECHANICAL TORQUE SUMMING

- LOW COMPLEXITY AND WEIGHT, NO CONCERN OF HYDRAULIC LEAKS

**NOSEWHEEL STEERING ELA:**

- ELECTROHYDROSTATIC ACTUATOR MECHANISM WITH FORCE SUMMING AND DAMPER MODE

- PROVIDE DAMPER MODE FOR FAIL SAFE OPERATION



# BASELINE FOR ELA EFFECTOR SYSTEMS: POWER SOURCE (PRELIMINARY)

---

## ELA BASELINE

- QUAD REDUNDANT BATTERIES (FOUR FOR ORBITER AND FOUR FOR EACH SRB)
- RE-CHARGABLE SILVER ZINC BATTERIES
- 270 VOLTS DIRECT CURRENT (VDC)
- PEAK POWER PER BATTERY: 82 KW FOR ORBITER; 67 KW FOR SRB
- ENERGY PER BATTERY: 5.4 KWH FOR ORBITER; 0.8 KWH FOR SRB

## RATIONALE/REMARKS

- FAIL OPERATIONAL/FAIL SAFE (FO/FS)
- HIGH POWER DENSITY (STUDIES TO DATE SHOW THAT BATTERY SIZING FOR SHUTTLE IS DRIVEN PRIMARILY BY POWER DENSITY RATHER THAN ENERGY DENSITY).
- COMMON VOLTAGE FOR ELA'S (ORIGINALLY BASED ON RECTIFIED THREE PHASE 115 VAC)
- PRELIMINARY POWER REQUIREMENTS (TO BE UPDATED IN FINAL REPORT)
- PRELIMINARY ENERGY REQUIREMENTS (TO BE UPDATED IN FINAL REPORT)



# BASELINE FOR ELA EFFECTOR SYSTEMS: POWER DISTRIBUTION SYSTEM (PRELIMINARY)

---

## ELA BASELINE

- FOUR POWER BUSES FOR ORBITER EFFECTORS AND FOUR POWER BUSES IN EACH SRB
- DC TO 20 KHZ ALTERNATING CURRENT (AC) POWER CONVERSION
- SWITCHING CONTROLS AND CIRCUIT INTERRUPTERS
- PROVIDE VOLTAGE AND CURRENT MEASUREMENTS AND STATUS SIGNALS TO DPS AND DISPLAYS
- POWER CABLES IN ORBITER LOCATED GENERALLY THE SPACE AS EXISTING HYDRAULIC LINES
- POWER CABLES IN SRB'S TO BE DETERMINED

## RATIONALE/REMARKS

- FO/FS FOR 4-CHANNEL EFFECTOR SYSTEMS AND FAILSAFE (FS) FOR 2-CHANNEL SYSTEMS
- PROVIDE AC TO POWER CONTROLLER FOR REDUCED LOSSES AND THERMAL IMPACTS
- ALLOW DISCONNECTING BATTERIES FOR REPLACEMENT OR RECHARGING OR ISOLATION OF SHORTS AND OTHER FAULTS
- PROVIDE POWR STATUS AND FEEDBACK FOR FLIGHT CONTROL
- AVAILABLE ROUTING SPACE

# BASELINE FOR ELA INTERFACE SYSTEMS: DATA PROCESSING SYSTEM (PRELIMINARY)

---

## ELA BASELINE

## RATIONALE/REMARKS

- CONTROLLER INTERFACE WITH GPC DATA BUS
    - EFFECTOR COMMANDS
    - ELA FEEDBACK DATA
  - UPDATED CRT DISPLAYS
  - DISPLAY ELA POSITIONS, CURRENTS, VOLTAGES, STATUS, ETC.
  - GENERATE ISOLATE OR RESET COMMANDS
  - OTHERS (TO BE DETERMINED)
- ELIMINATE NEED FOR MDM
  - PROVIDE ELA DATA TO CREW AND FOR DOWNLIST
  - PROVIDE CREW FDI OVERRIDE CAPABILITY

**BASELINE FOR ELA INTERFACE SYSTEMS: DISPLAYS AND CONTROL  
(PRELIMINARY)**

---

**ELA BASELINE**

- PANEL METERS FOR POWER SYSTEM VOLTAGES AND EFFECTOR POSITIONS
- SWITCHING CONTROLS AND CIRCUIT INTERRUPTERS
- OTHERS (TO BE DETERMINED)

**RATIONALE/REMARKS**

- PROVIDE CREW VISIBILITY OF ELA OPERATION
- PROVIDE CAPABILITY TO ISOLATE FAULTED CIRCUITS AND DISCONNECT BATTERIES FOR RECHARGING

# BASELINE FOR ELA INTERFACE SYSTEMS: STRUCTURE (PRELIMINARY)

---

## ELA BASELINE

- NEW ELECTRONICS BAY 7 MOUNTED ON 1307 BULKHEAD
- EXISTING ATTACH POINTS FOR PRESENT HYDRAULIC ACTUATORS
- ADDITIONAL MOUNTING PROVISIONS TO BE DETERMINED
- LOCATION OF ELA EQUIPMENT:

SEE CHARTS 56 THROUGH 60 FOR EXAMPLE

## RATIONALE/REMARKS

- PROVIDE MOUNTING SPACE AND COLD PLATE FOR POWER CONTROLLERS
- ELA SYSTEM ACTUATOR ASSEMBLIES TO BE DESIGNED TO FIT SAME SPACE AND ATTACH POINTS AS PRESENT HYDRAULIC ACTUATORS



**BASELINE FOR ELA INTERFACE SYSTEMS: THERMAL CONTROL  
(PRELIMINARY)**

---

**ELA BASELINE**

- ACTIVE COOLING (COLD PLATE) FOR POWER CONTROLLERS AND SERVO AND FDI CONTROLLERS
- PASSIVE COOLING (AIR OR HEAT SINK) FOR BATTERIES AND ACTUATOR ASSEMBLIES
- OTHERS (TO BE DETERMINED)

**RATIONALE/REMARKS**

- REQUIRED BY RELATIVELY HIGH HEAT LOSS, ELECTRONICS SENSITIVE TO HEAT
- LOW HEAT LOSS AND HEAT SINK TO FRAME CAPABILITY



---

## 4.0 POWER AND ENERGY REQUIREMENTS FOR SHUTTLE EFFECTOR SYSTEMS





## **POWER AND ENERGY REQUIREMENTS FOR SHUTTLE EFFECTOR SYSTEMS**

---

- **THE MECHANICAL (OR OUTPUT) POWER AND ENERGY REQUIREMENTS FOR EACH INDIVIDUAL SHUTTLE EFFECTOR SYSTEM ARE NEEDED IN ORDER TO DETERMINE:  
(1) POWER AND ENERGY REQUIREMENTS FOR ELA POWER SOURCES (SEE SECTION 6.0), AND  
(2) THE ELA ACTUATOR SIZING (PEAK POWER CAPABILITIES) FOR THE EFFECTORS.**
- **THE REQUIREMENTS INCLUDE: (1) PEAK POWER AND THE DURATION OF THE PEAK, (2) AVERAGE POWER AND THE OPERATING DURATION, AND (3) POWER AND ENERGY DEMANDS AS FUNCTIONS OF MISSION TIME (DUTY CYCLES).**
- **THE METHODS, DATA AND RESULTS FROM THE CALCULATION OF THE SUBJECT REQUIREMENTS ARE PRESENTED IN THIS SECTION AS FOLLOWS.**
  - **METHODS: SEE CHART 82.**
  - **DATA: SEE CHARTS 83 THROUGH 127.**
  - **RESULTS: SEE CHART 128 THROUGH 136.**

**THE DATA USED FOR THE CALCULATION WERE OBTAINED FROM FLIGHTS, TESTS, SIMULATIONS AND ANALYSES. THE DATA WERE SELECTED BECAUSE THEY ARE REPRESENTATIVE OF THE SHUTTLE EFFECTOR SYSTEMS UNDER NOMINAL AND OFF-NOMINAL CONDITIONS. THE RESULTS WILL BE PRESENTED IN THE FINAL REPORT.**

## METHODS FOR CALCULATION OF EFFECTOR SYSTEM POWER AND ENERGY REQUIREMENTS

---

THE MECHANICAL OR OUTPUT POWER (P) AND ENERGY (E) REQUIREMENTS FOR EACH EFFECTOR SYSTEM OVER AN OPERATIONAL TIME PERIOD T (SECONDS) IN THE SPACE SHUTTLE MISSION CAN BE CALCULATED BY THE FOLLOWING EQUATIONS:

$$P(t) = 2.64 \quad k \quad L(t) \quad R(t) \quad \text{HORSEPOWER (HP)}$$

$$E(t) = \int_0^T P(t) dt \quad \text{HP - SECONDS (HPS)}$$

WHERE L(t) AND R(t) ARE THE EFFECTOR LOAD (MILLION IN-LBS), AND RATE (DEGREES/SECOND) AS FUNCTIONS OF TIME t (SECONDS). THE PEAK POWER REQUIREMENT OCCURS WHEN THE PRODUCT OF L AND R IS MAXIMUM. THE AVERAGE POWER IS DEFINED AS E/T. THE FACTOR k ( $k \geq 1$ ) IS ADDED TO ACCOUNT FOR VARIATIONS IN LOADS AND RATES AS THE RESULTS OF MISSION MANEUVER VARIATIONS, FLIGHT ENVIRONMENT EXTREMES AND OFF-NOMINAL CONDITIONS. (k MAY BE STATISTICAL AND TIME DEPENDENT.)



# DATA FOR CALCULATION OF EFFECTOR SYSTEM POWER AND ENERGY REQUIREMENTS

<u>EFFECTORS</u>	<u>CONDITIONS</u>	<u>DATA (LOADS &amp; RATES)</u>	<u>TYPES</u>	<u>SOURCES</u>
SRM - TVC	NOMIINAL	84-87	S, A, T	1, 3
	OFF-NOMINAL (TRAJECTORY VARIATIONS)	88-91	S, A	3
SSME - TVC	NOMINAL	93-106	S, A, T, F	3
	OFF-NOMINAL (3 DISPERSION & ENGINE OUT)	107-112	S, A	3
OMS - TVC	NOMINAL AND OFF-NOMINAL	127	A	3
ELEVONS	NOMINAL AND OFF-NOMINAL	113 - 120	S, A	3
RUDDER	NOMINAL AND OFF-NOMINAL	121 - 122	S, A	3
	OFF-NOMINAL ENTRY WITH 2 RCS JETS FAILURE			
SPEEDBRAKE	NOMINAL AND OFF-NOMINAL	123 - 124	S, A	3
BODYFLAP	NOMINAL AND OFF-NOMINAL	125 - 126	S, A	3
AUXILIARY	NOMINAL AND OFF-NOMINAL	127	A	2, 3

NOTES: LOADS AND RATES DATA: SEE CHARTS WITH NUMBERS INDICATED.  
 DATA TYPES: T = TEST; A = ANALYSIS; S= SIMULATION; F= FLIGHT DATA  
 DATA SOURCES: 1 = NASA MSFC; 2 = NASA JSC; 3 = ROCKWELL

# SRM NOZZLE LOAD ON ROCK OR TILT ACTUATOR VERSUS MISSION TIME AND GIMBAL ANGLE

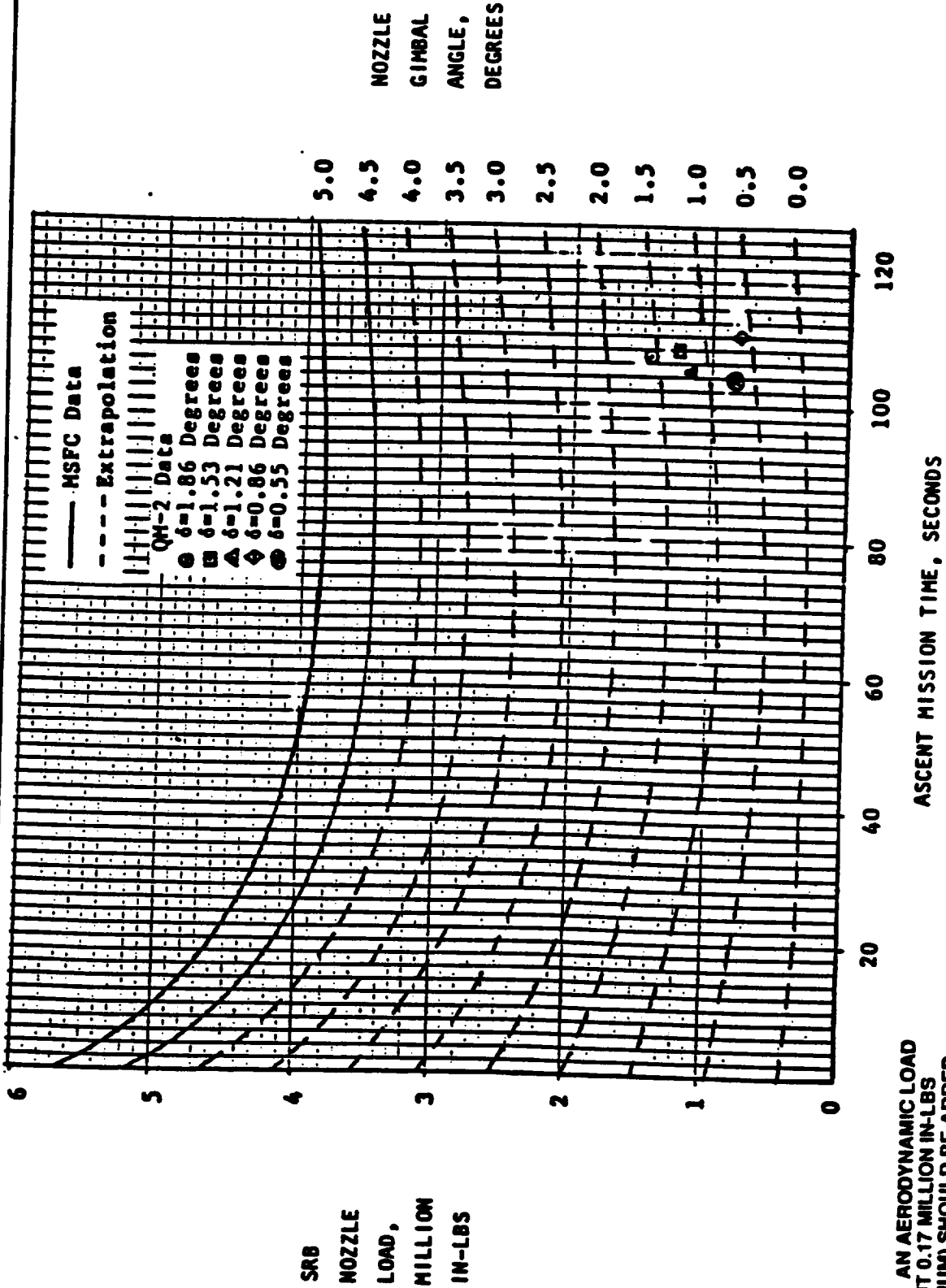

NOTE: AN AERODYNAMIC LOAD (ABOUT 0.17 MILLION IN-LBS MAXIMUM) SHOULD BE ADDED TO THE NOZZLE LOAD IN ORDER TO OBTAIN THE TOTAL LOAD ON THE ACTUATOR.



**ESTIMATED SRM SIDELOADS AT IGNITION AND SHUTDOWN**

---

**(TO BE PRESENTED IN FINAL REPORT)**

# POSITION AND RATES OF RIGHT SRM - TVC ACTUATORS DURING NOMINAL ASCENT

STS-56 FIRST STAGE ASCENT SIMULATION, NOMINAL MISSION

RIGHT SRB TILT

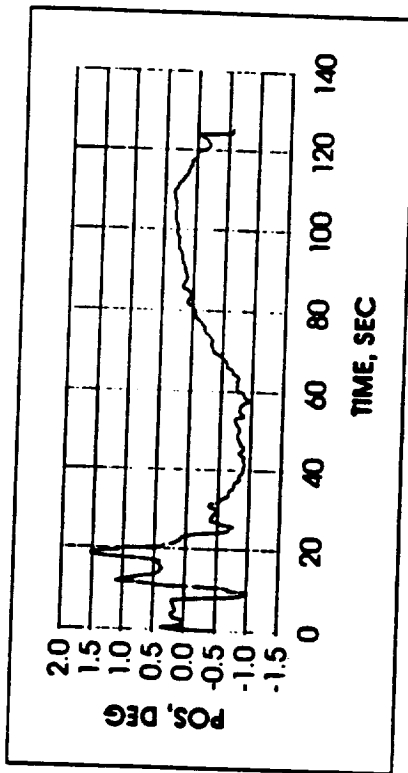

RIGHT SRB ROCK

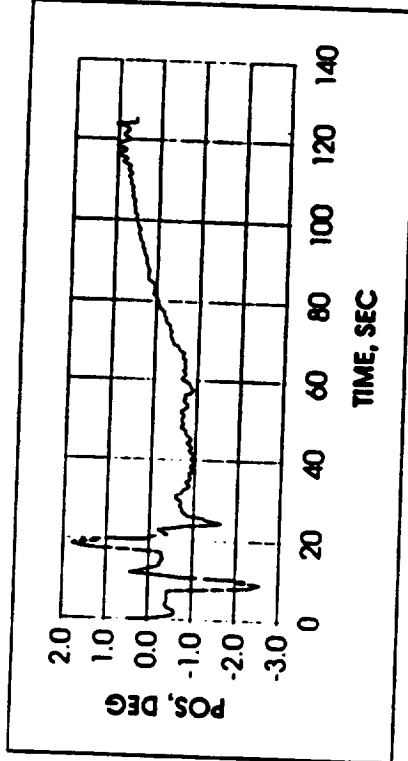

RIGHT SRB TILT

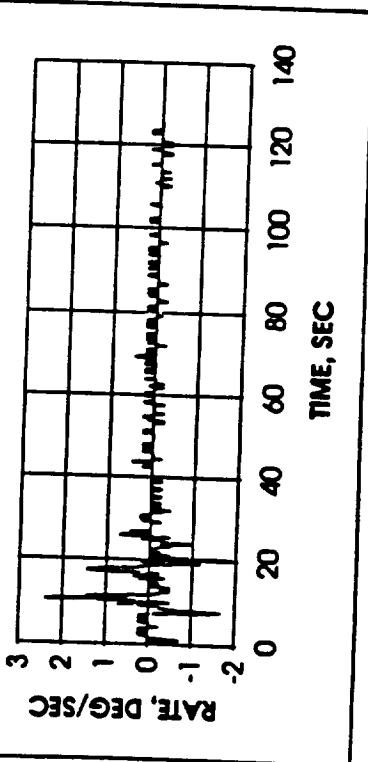

RIGHT SRB ROCK

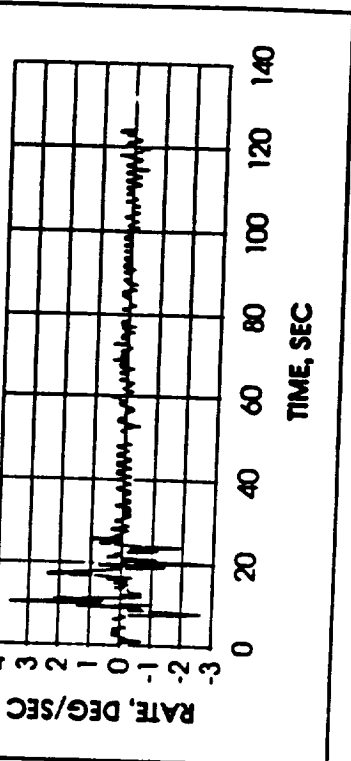

**Rockwell International**  
Space Systems Division

# POSITIONS AND RATES OF LEFT SRM - TVC ACTUATORS DURING NOMINAL ASCENT

STS-56 FIRST STAGE ASCENT SIMULATION, NOMINAL MISSION

LEFT SR8 TILT

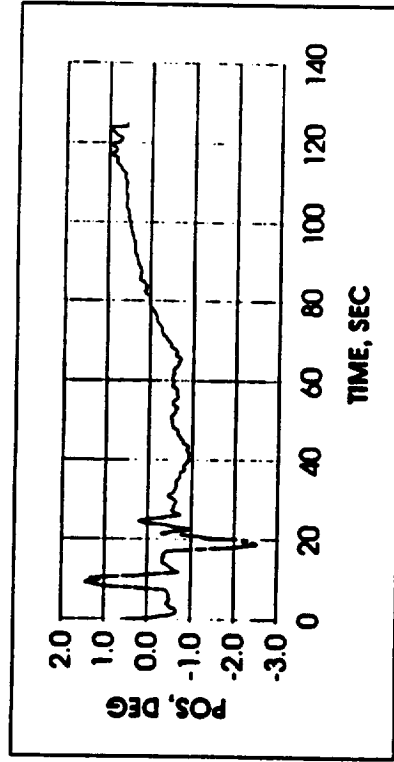

LEFT SR8 ROCK

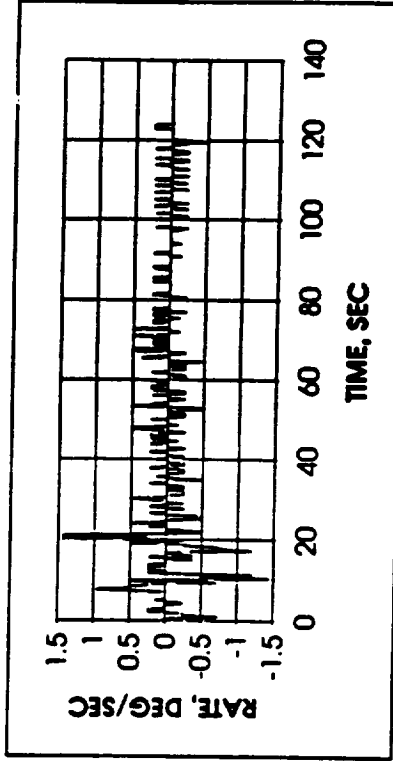
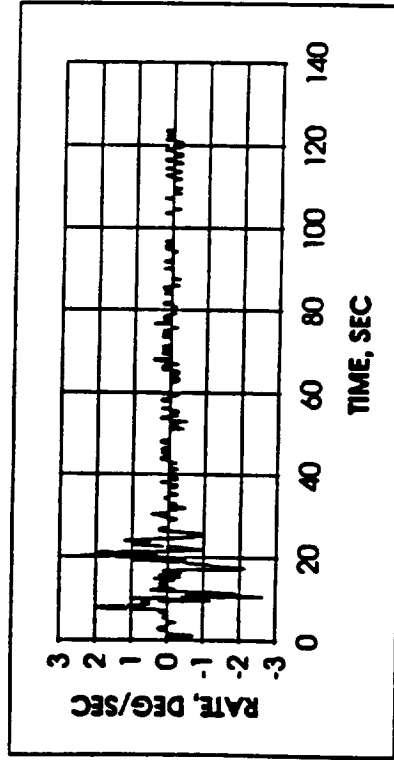
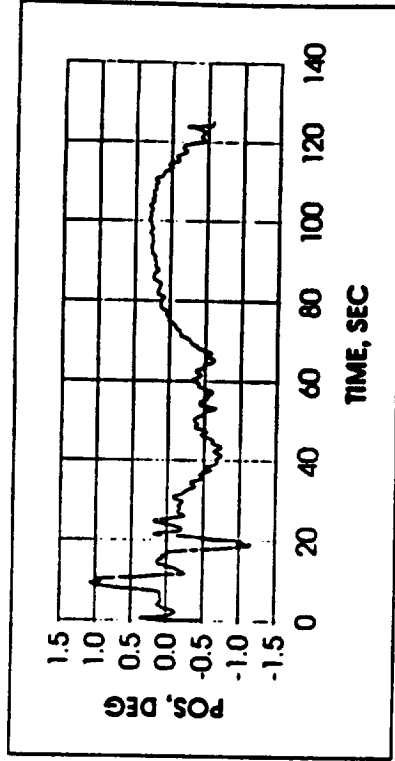

**SRM NOZZLE ANGLES VERSUS MISSION TIME FOR RIGHT-SRB TVC ACTUATORS WITH NO FAILURES (150 SIMULATED STS-1 MISSIONS)**

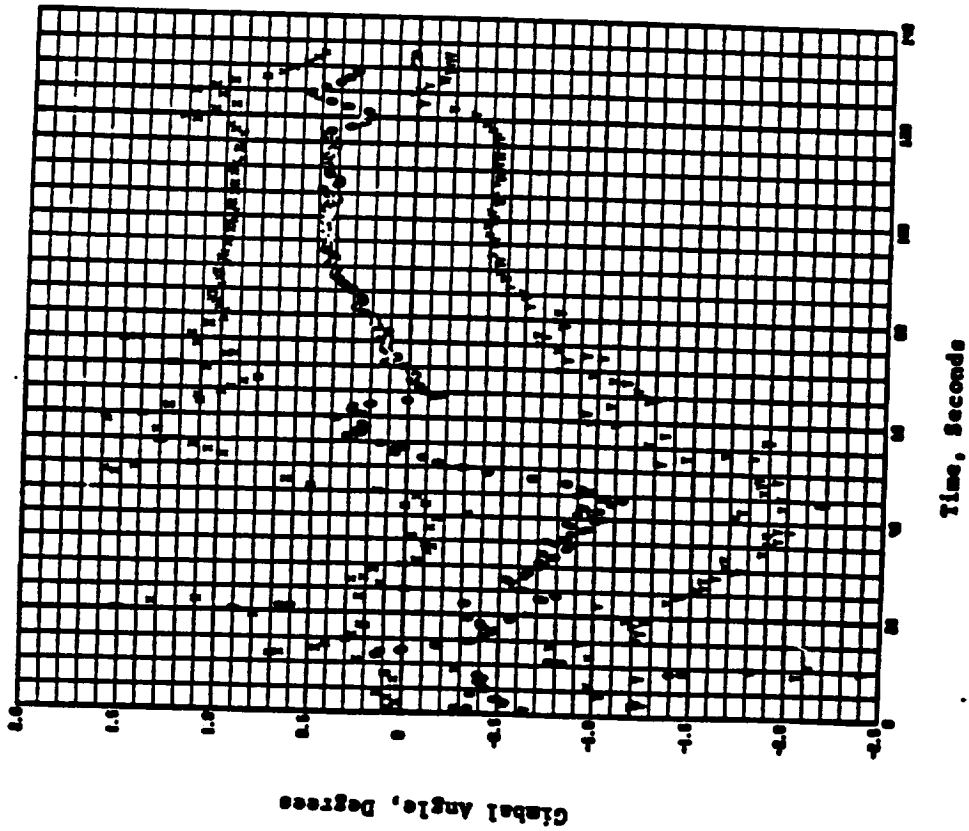

**ROCK ACTUATOR**

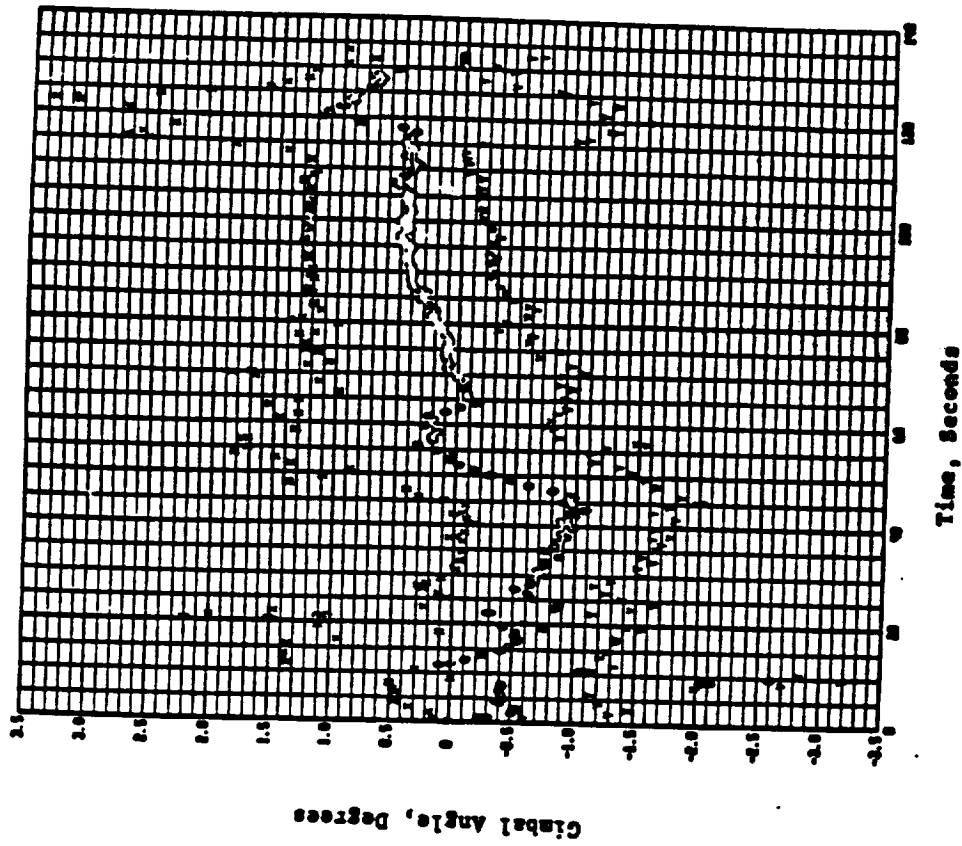

**TILT ACTUATOR**



**SRM NOZZLE ANGLES VERSUS MISSION TIME FOR LEFT-SRB TVC ACTUATORS WITH NO FAILURES (150 SIMULATED STS-1 MISSIONS)**

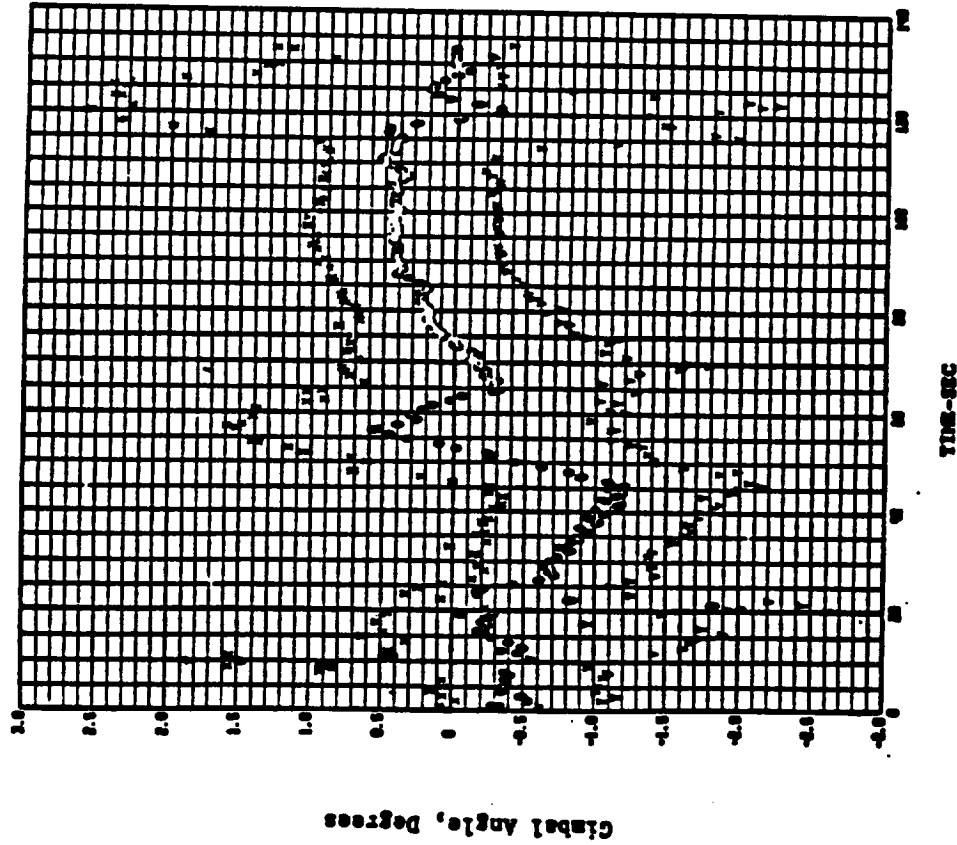

**TIME-SEC**  
**ROCK ACTUATOR**

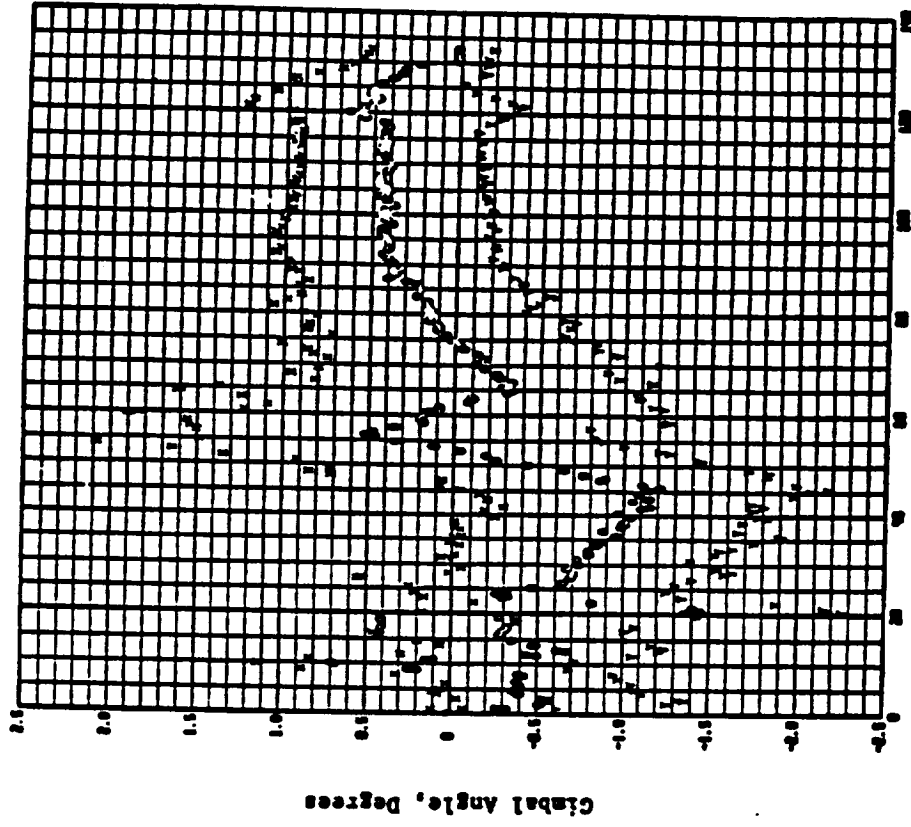

**Time, Seconds**  
**TILT ACTUATOR**

**SRM NOZZLE GIMBAL RATES VERSUS MISSION TIME FOR RIGHT -SRB TVC ACTUATORS WITH NO FAILURES (150 SIMULATED STS-1 MISSIONS)**

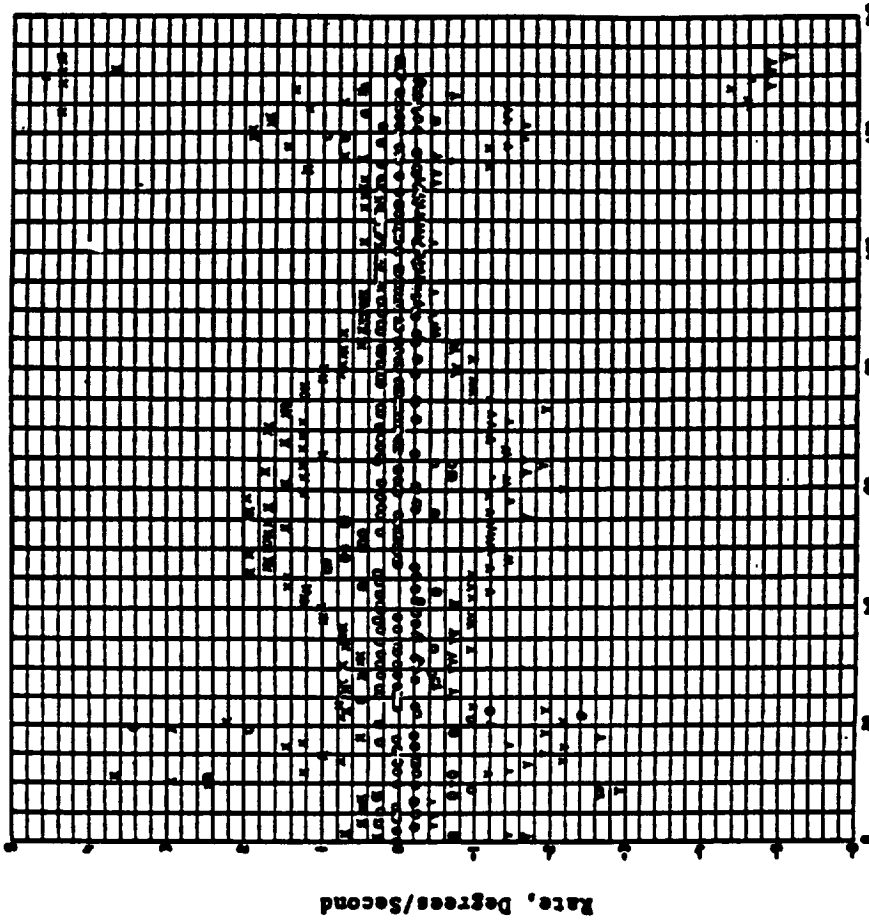
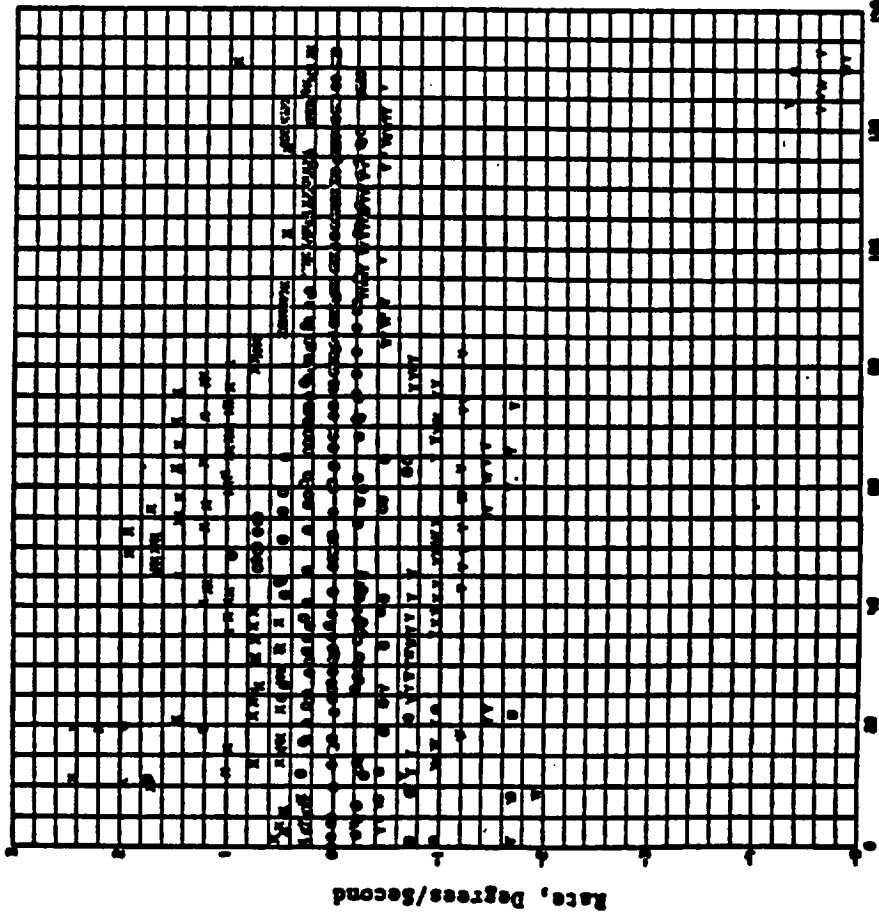

Time, Seconds

ROCK ACTUATOR

Time, Seconds

TILT ACTUATOR

# SRM NOZZLE GIMBAL RATES VERSUS MISSION TIME FOR LEFT-SRB TVC ACTUATORS WITH NO FAILURES (150 SIMULATED STS-1 MISSIONS)

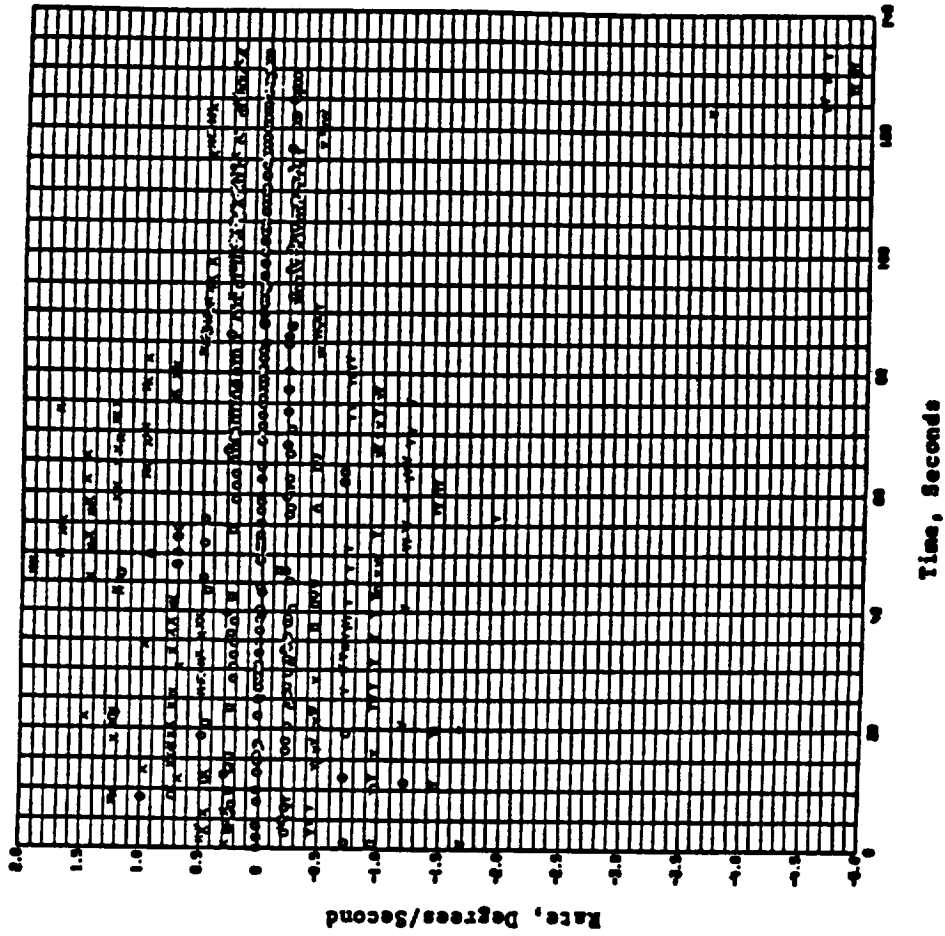
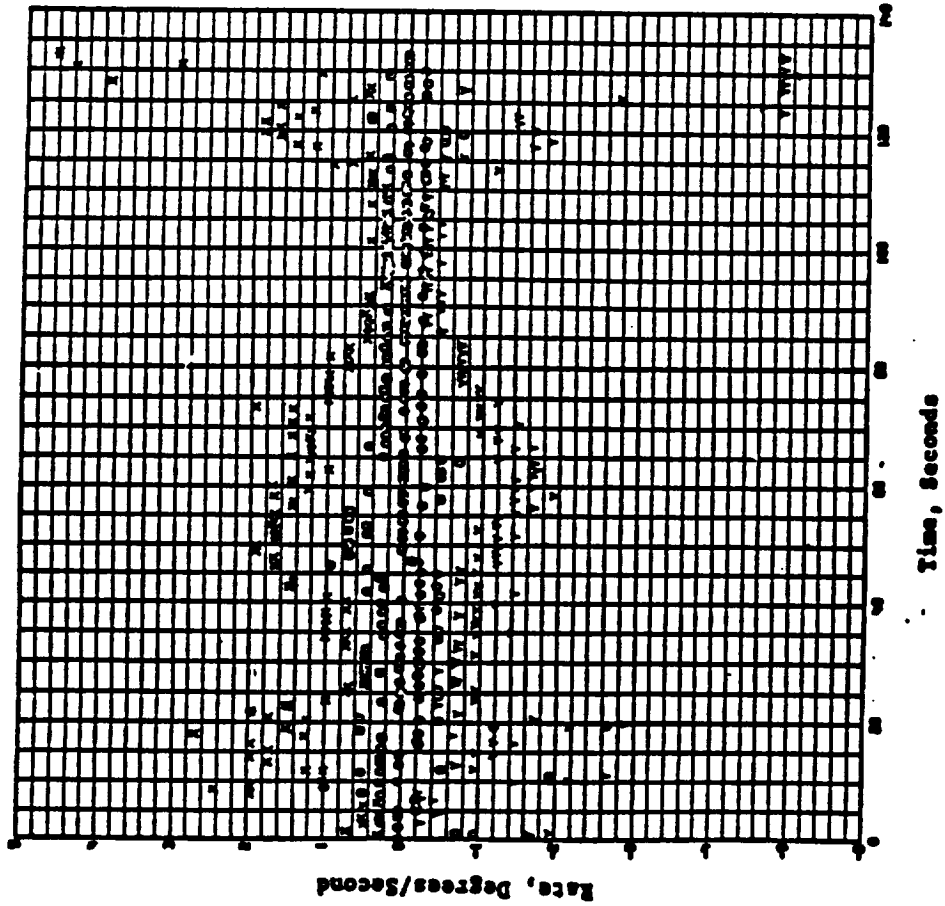

## LOADS ON SSME - TVC EFFECTORS

---

THE LOADS (L) ON THE SSME - TVC EFFECTORS (OR ACTUATORS) ARE CALCULATED BY THE FOLLOWING EQUATION:

$$L = \Delta P \quad A \quad L \quad \text{IN - LBS}$$

WHERE  $\Delta P$  IS THE ACTUATOR PRIMARY PRESSURE ( POUNDS PER SQUARE INCH OR PSID);  
A IS THE ACTUATOR PISTON AREA (SQUARE INCHES); L IS THE ACTUATOR MOMENT ARM  
(INCHES). THE DATA USED FOR THE CALCULATION ARE AS FOLLOWS:  $\Delta P$ 'S ARE THE MEASURED  
PRIMARY PRESSURES OBTAINED FROM THE SHUTTLE STS-1 THROUGH STS-5 FLIGHTS  
(SEE CHARTS 93 THROUGH 97); A IS EQUAL TO 24.83 FOR SSME 1 (UPPER ENGINE)  
PITCH AND 20.03 FOR OTHER SSME-TVC ACTUATORS; L IS EQUAL TO 29.74 FOR EACH  
ACTUATOR.

# MEASURED PRIMARY PRESSURES OF SSME-TVC ACTUATORS DURING STS-1 ASCENT

## PRIMARY PRESSURE (PSID)

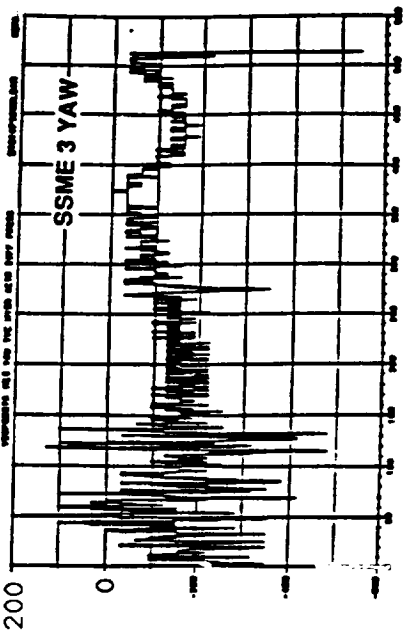
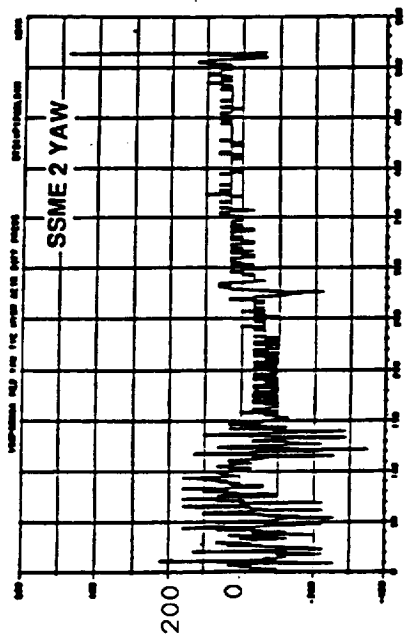
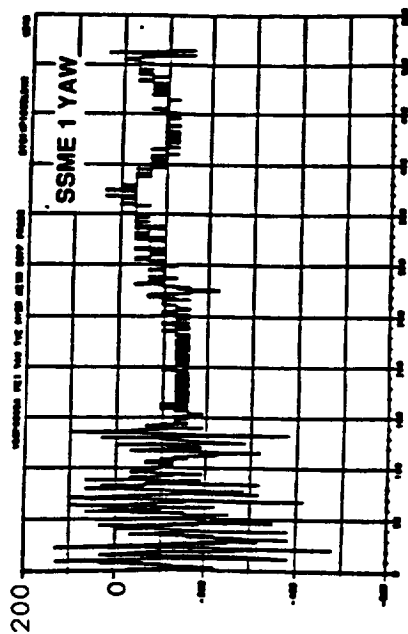
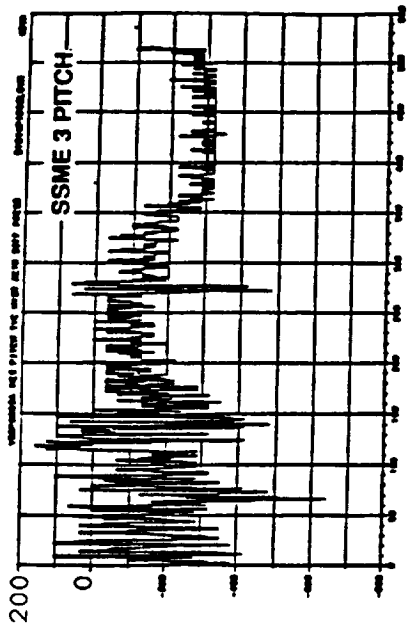
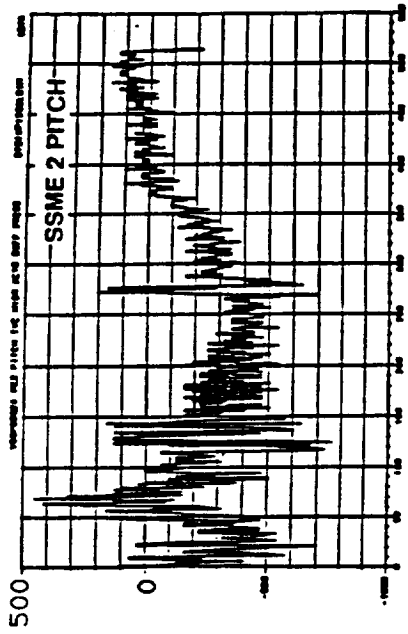
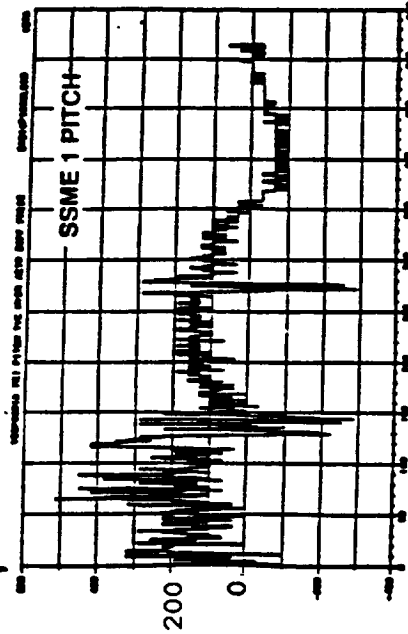

## ASCENT MISSION TIME (SECONDS)

# MEASURED PRIMARY PRESSURES OF SSME-TVC ACTUATORS DURING STS-2 ASCENT

## PRIMARY PRESSURE (PSID)

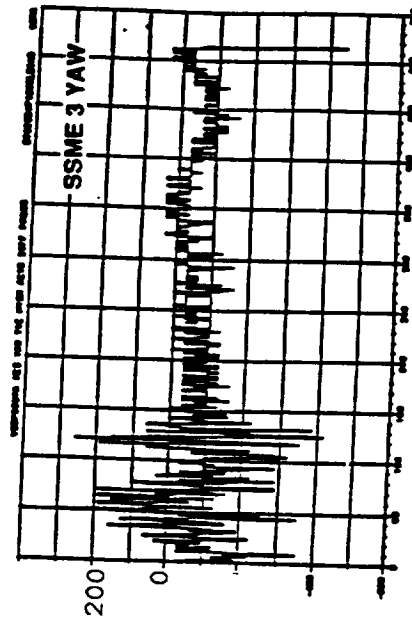
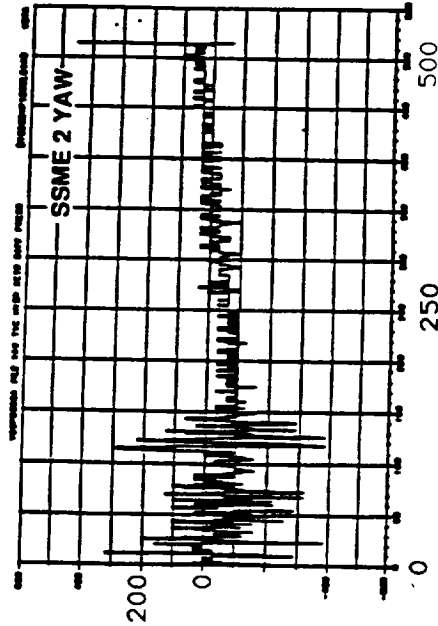
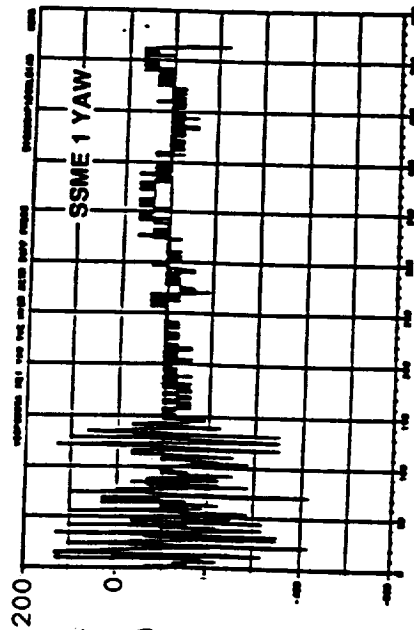
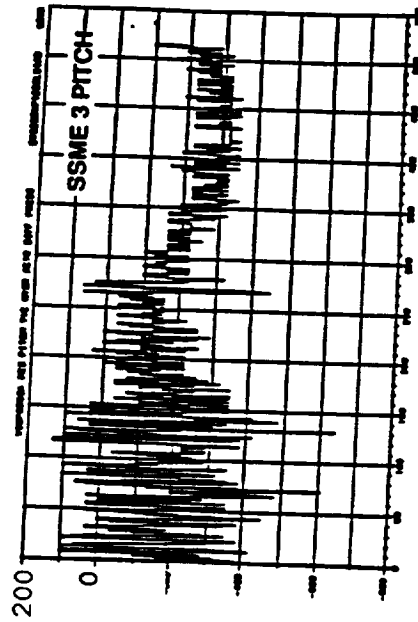
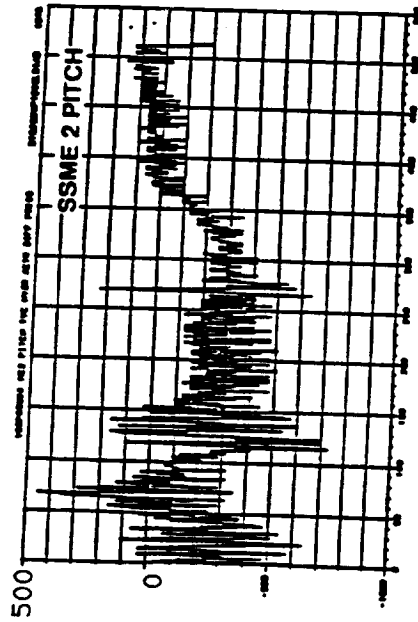
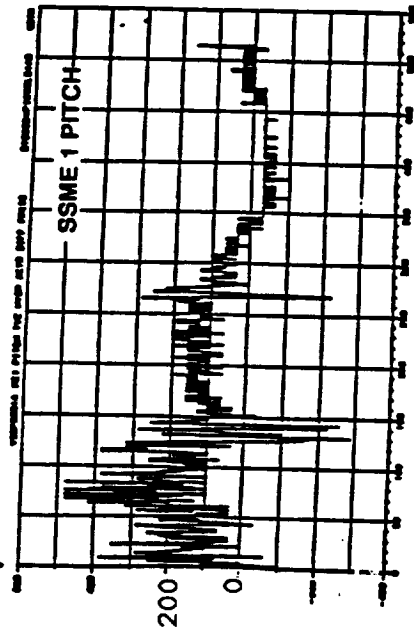

ASCENT MISSION TIME (SECONDS)

ORIGINAL PAGE IS  
OF POOR QUALITY

ORIGINAL PAGE IS  
OF POOR QUALITY

# MEASURED PRIMARY PRESSURES OF SSME-TVC ACTUATORS DURING STS-3 ASCENT

PRIMARY PRESSURE (PSID)

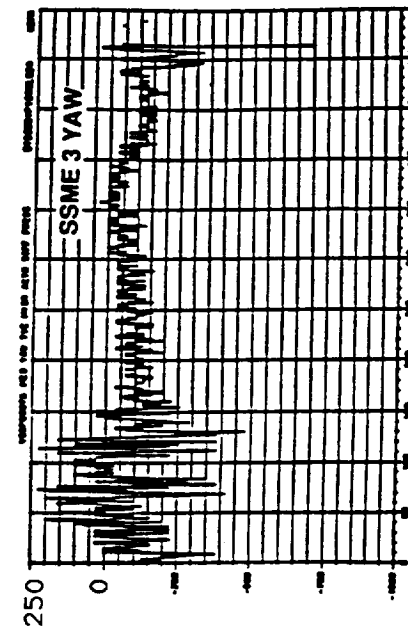
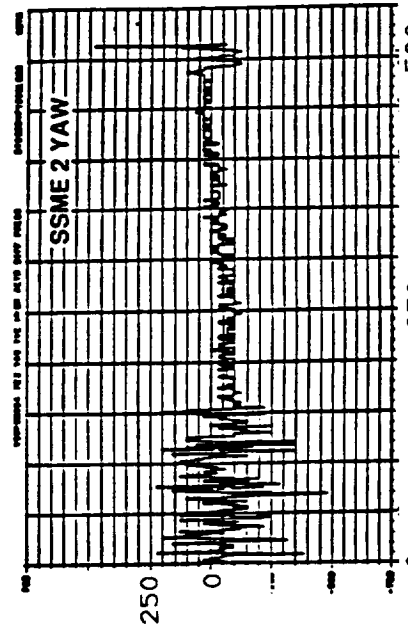
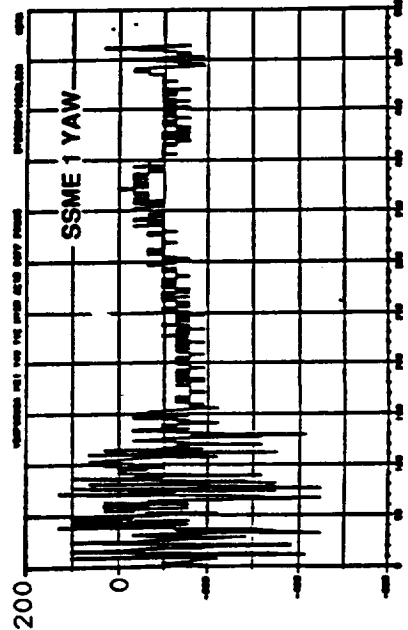
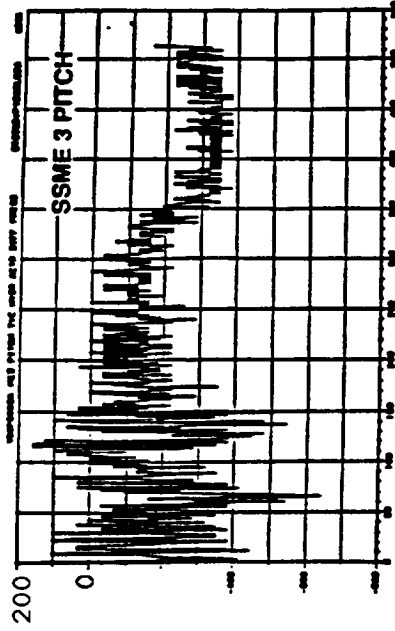
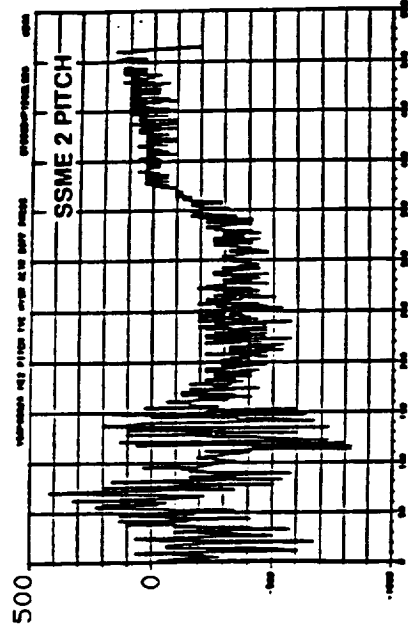
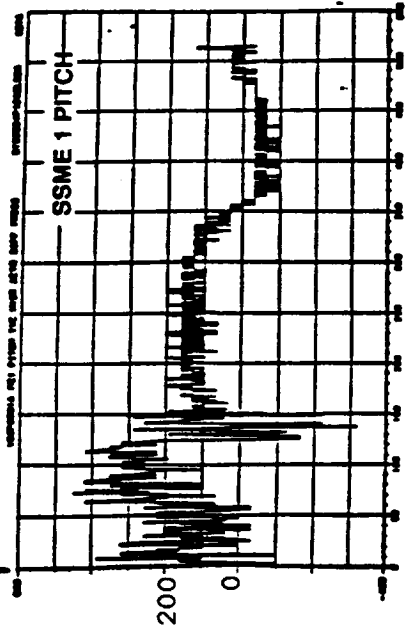

ASCENT MISSION TIME (SECONDS)

# MEASURED PRIMARY PRESSURES OF SSME-TVC ACTUATORS DURING STS-4 ASCENT

PRIMARY PRESSURE (PSID)

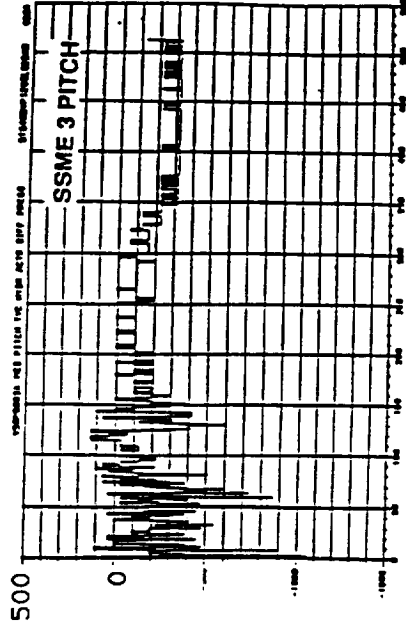
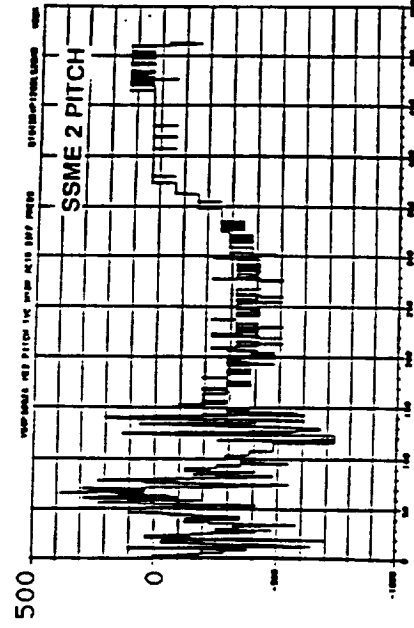
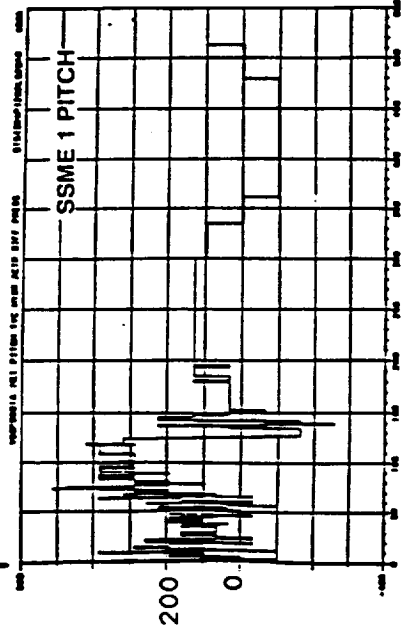

SSME 1 YAW

NO DATA AVAILABLE

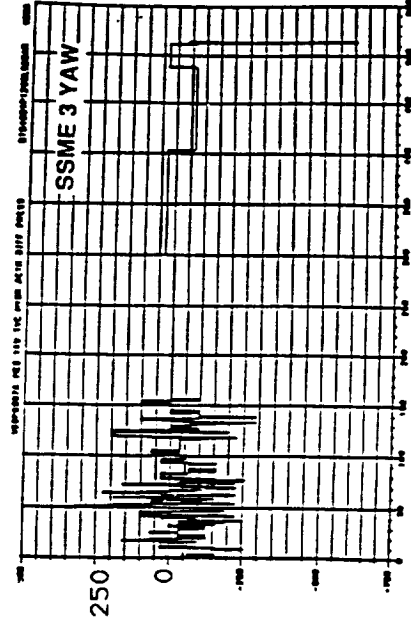
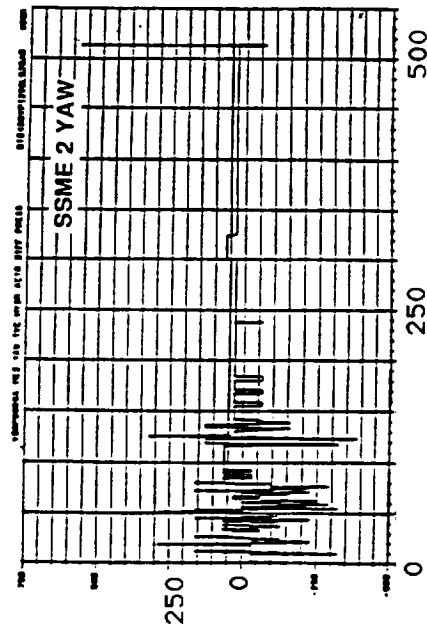

ASCENT MISSION TIME (SECONDS)



# MEASURED PRIMARY PRESSURES OF SSME-TVC ACTUATORS DURING STS-5 ASCENT

## PRIMARY PRESSURE (PSID)

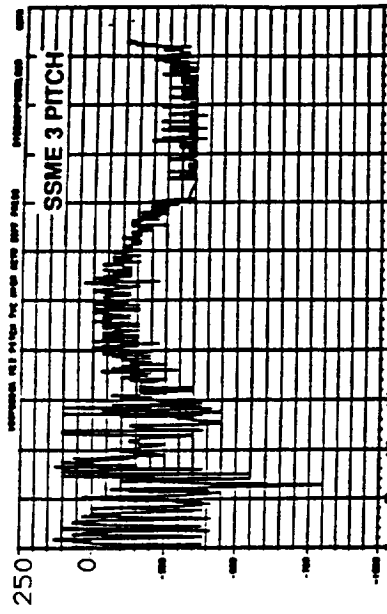
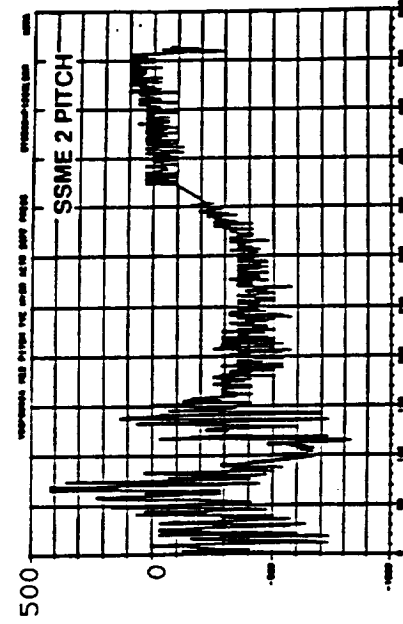
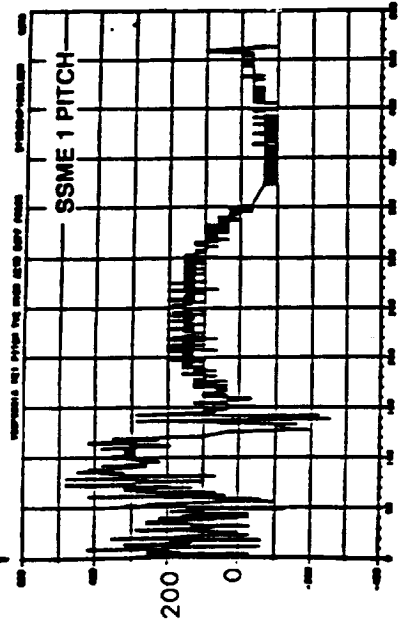

## SSME 1 YAW

NO DATA AVAILABLE

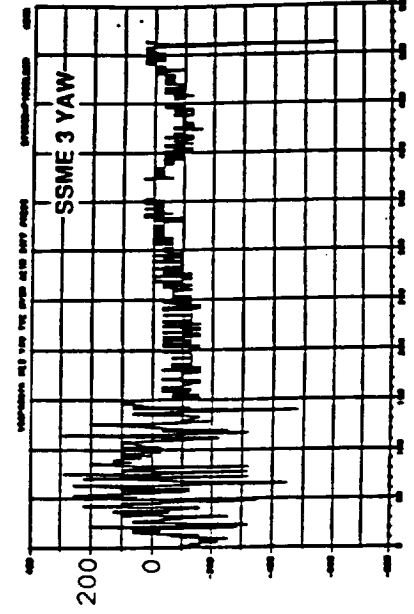
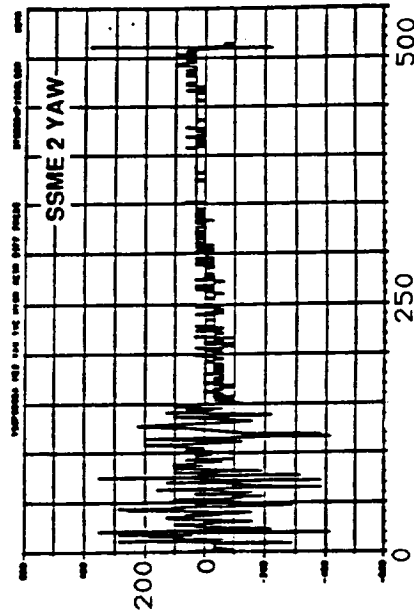

## ASCENT MISSION TIME (SECONDS)

**ESTIMATED SSME SIDELOADS AT IGNITION AND SHUTDOWN**

---

**(TO BE PRESENTED IN FINAL REPORT)**

# MEASURED POSITIONS OF SSME-TVC ACTUATORS DURING STS-1 ASCENT

ACTUATOR POSITION (DEGREES)

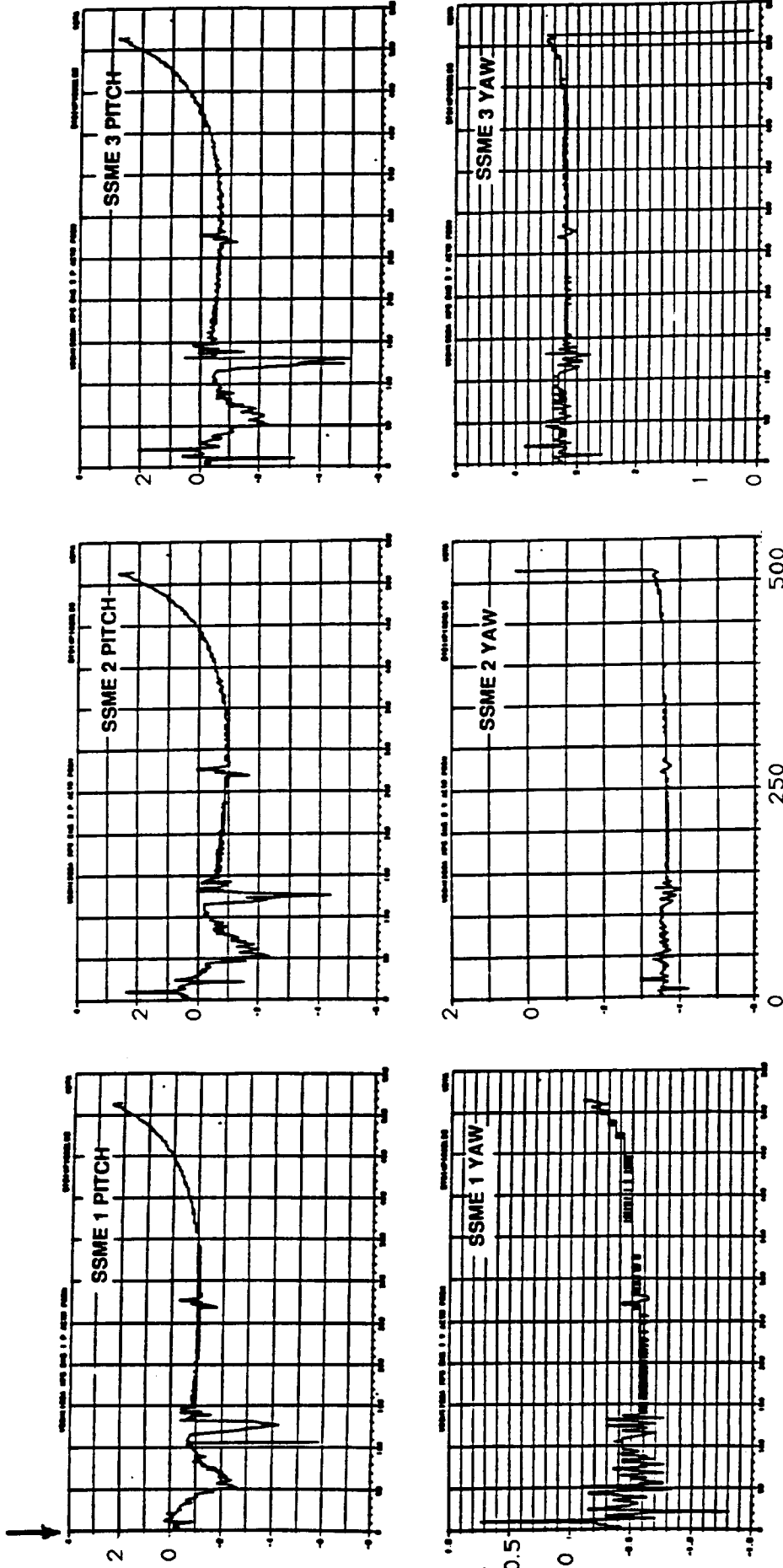

ASCENT MISSION TIME (SECONDS)

# MEASURED POSITIONS OF SSME-TVC ACTUATORS DURING STS-2 ASCENT

ACTUATOR POSITION (DEGREES)

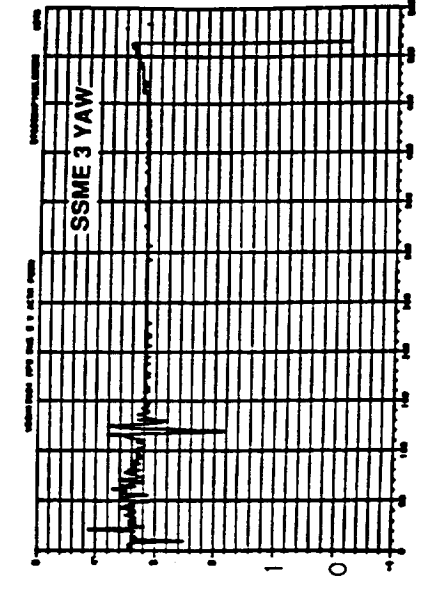
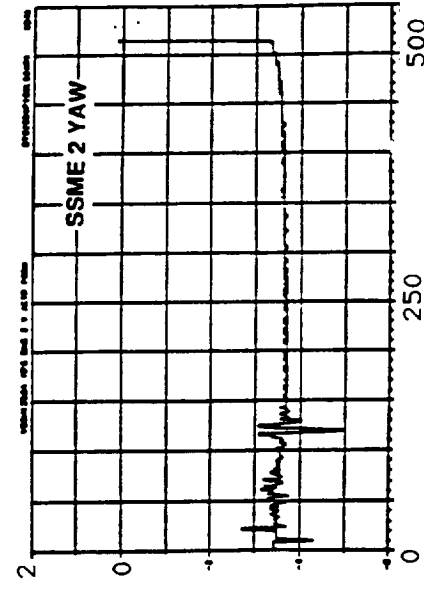
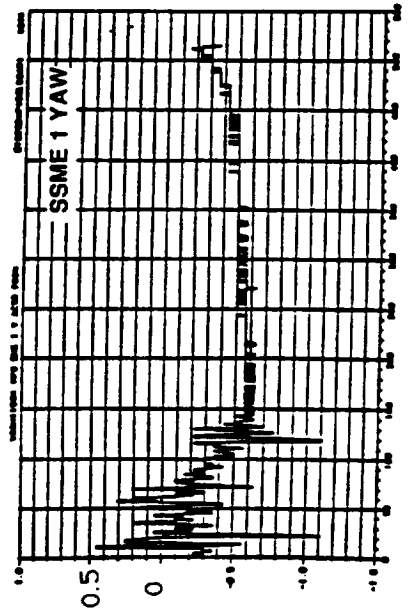
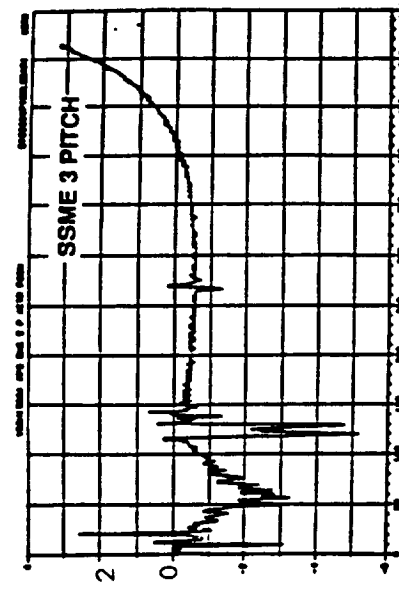
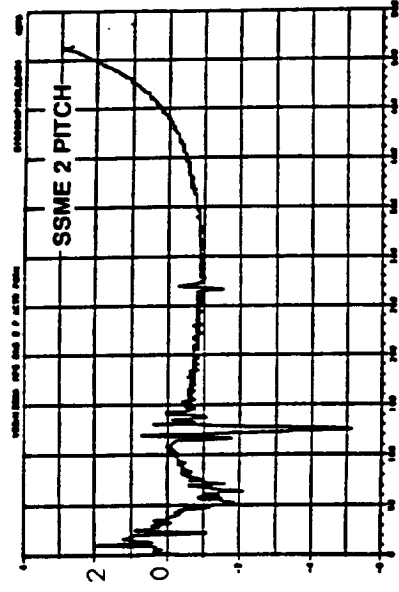
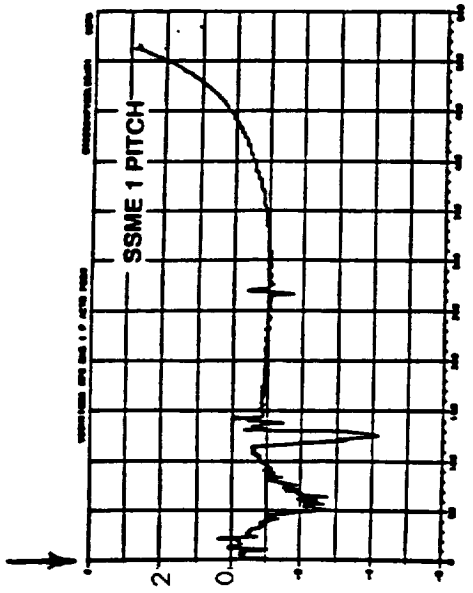

ASCENT MISSION TIME (SECONDS)

# MEASURED POSITIONS OF SSME-TVC ACTUATORS DURING STS-3 ASCENT

ACTUATOR POSITION (DEGREES)

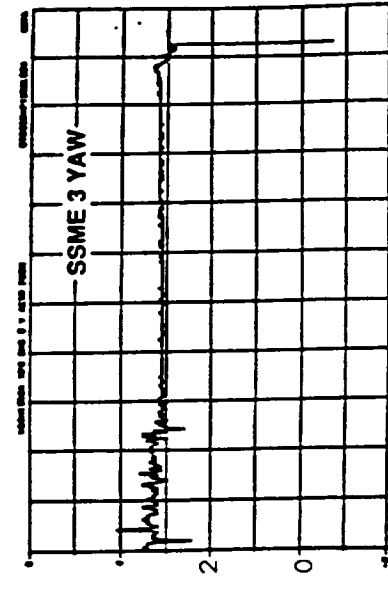
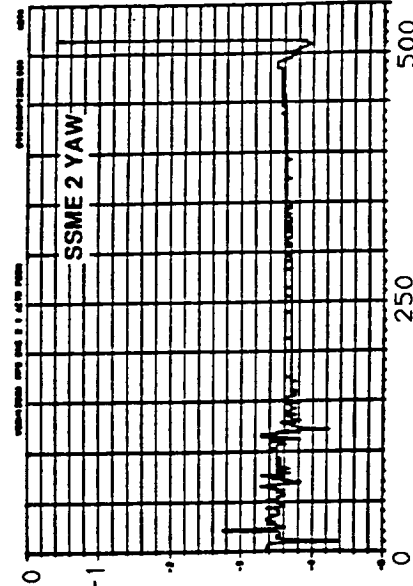
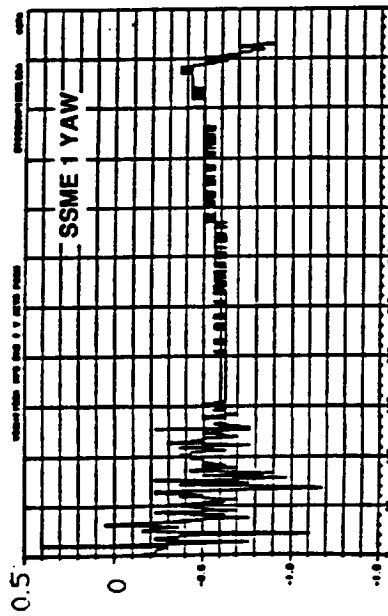
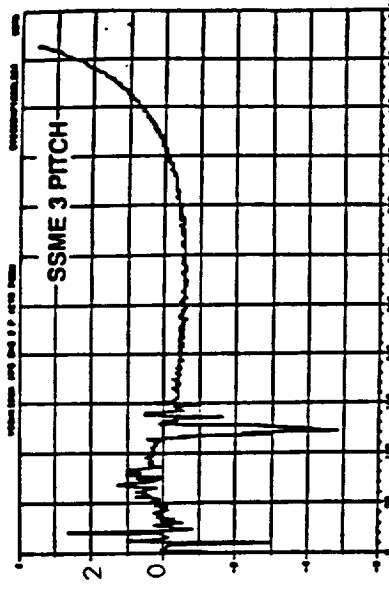
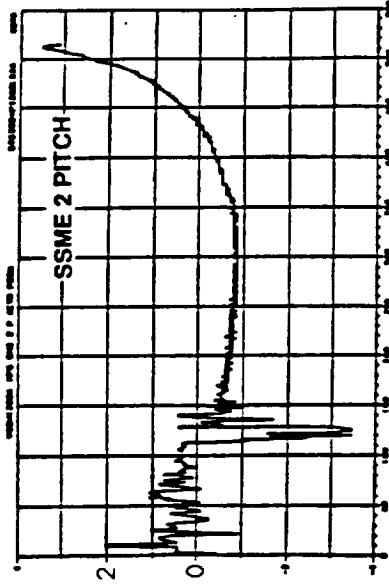
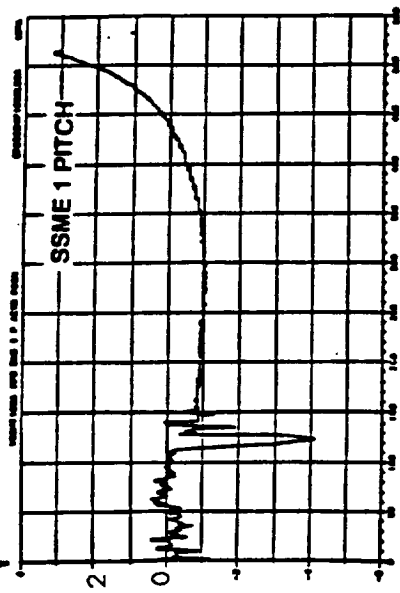

ASCENT MISSION TIME (SECONDS)

# MEASURED POSITIONS OF SSME-TVC ACTUATORS DURING STS-4 ASCENT

## ACTUATOR POSITION (DEGREES)

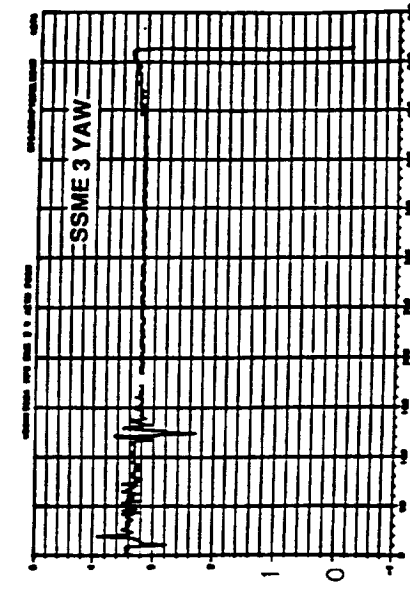
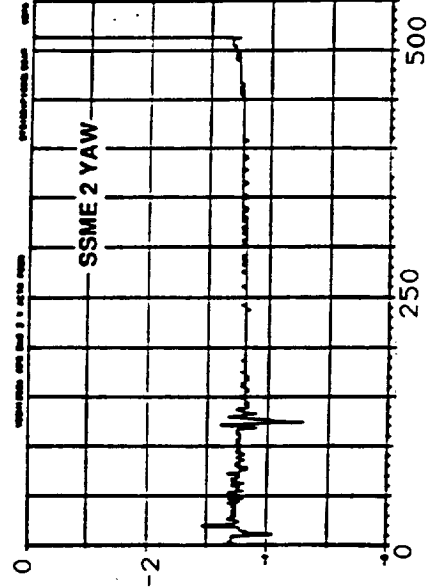
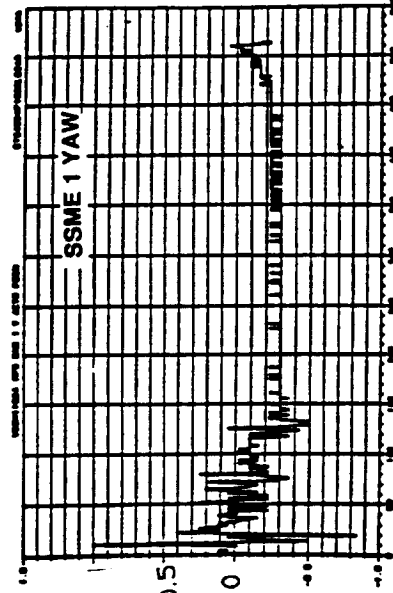
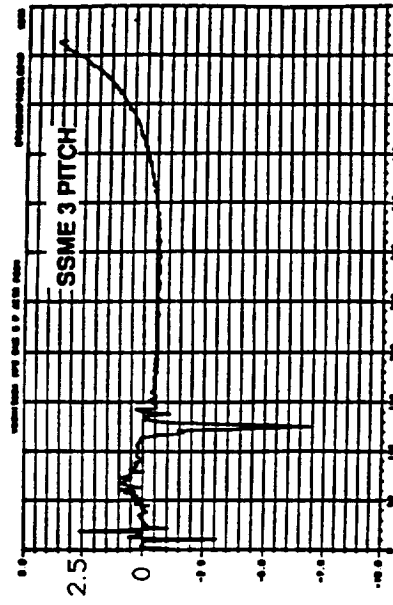
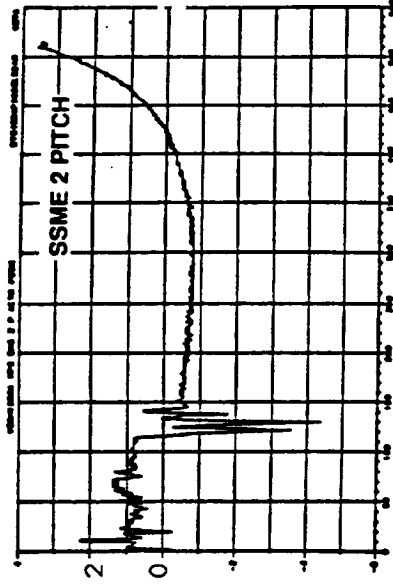
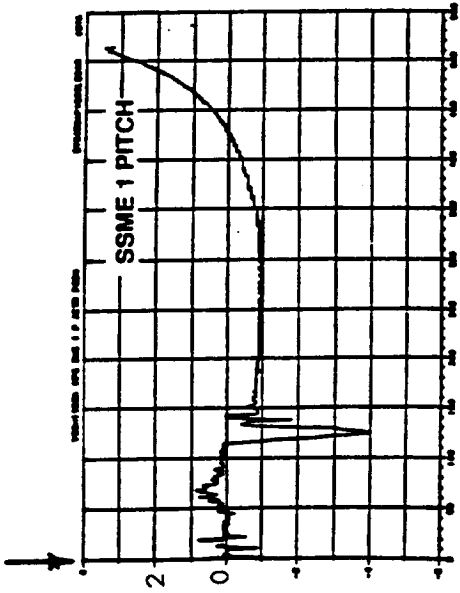

## ASCENT MISSION TIME (SECONDS)

# MEASURED POSITIONS OF SSME-TVC ACTUATORS DURING STS-5 ASCENT

ACTUATOR POSITION (DEGREES)

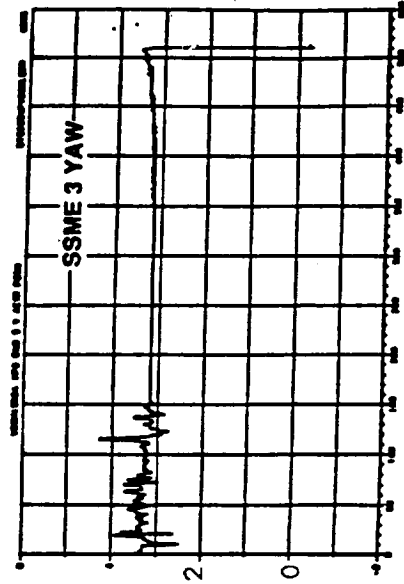
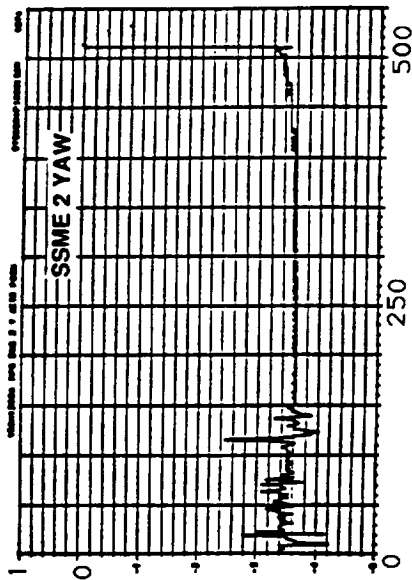
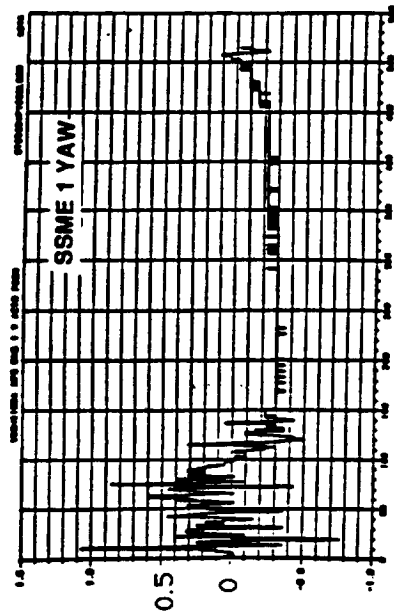
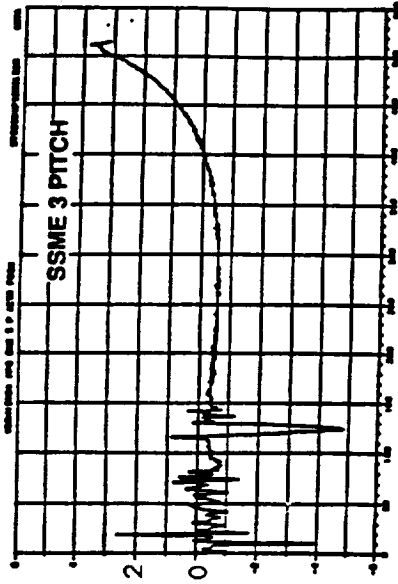
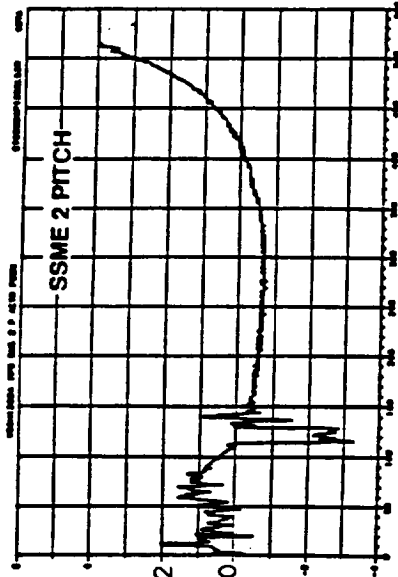
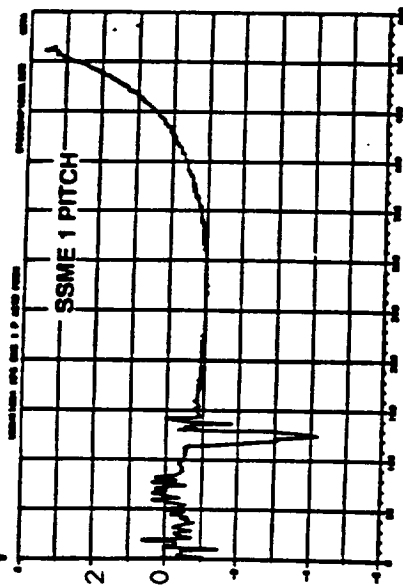

ASCENT MISSION TIME (SECONDS)

# POSITIONS AND RATES OF SSME-TVC ACTUATORS DURING NOMINAL ASCENT: SSME 1 (UPPER ENGINE)

STS-56 FIRST STAGE SIMULATION, NOMINAL ASCENT

SSME UPPER PITCH

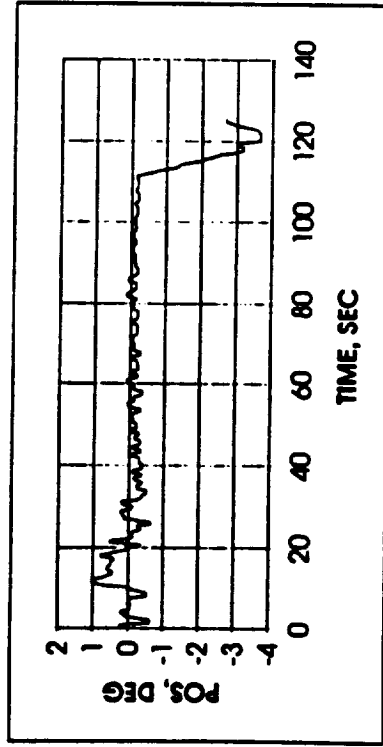

SSME UPPER YAW

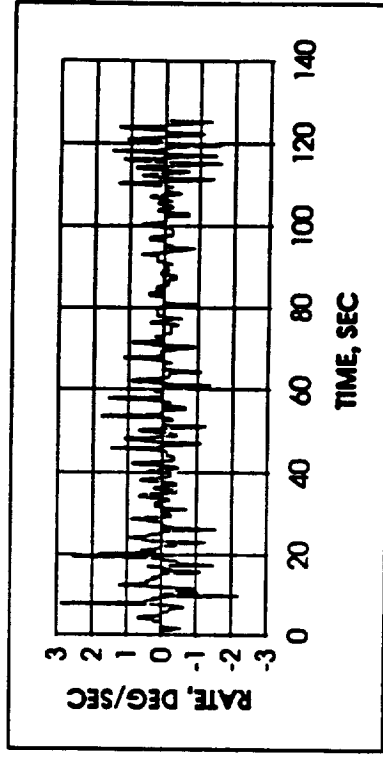
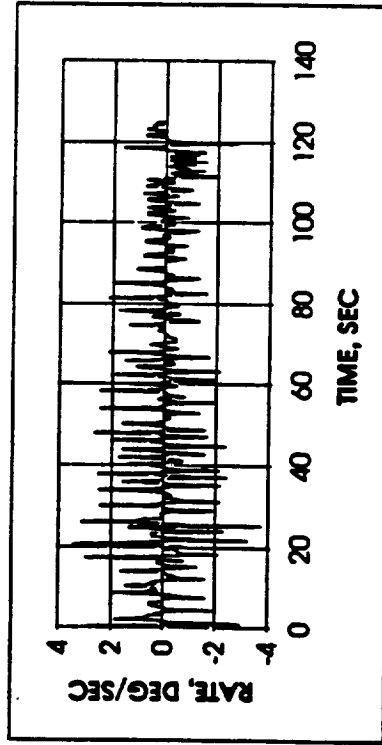
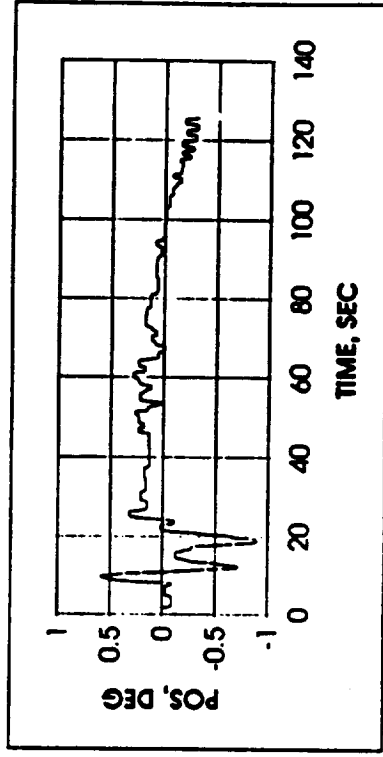



# POSITIONS AND RATES OF SSME-TVAC ACTUATORS DURING NOMINAL ASCENT: SSME 2

STS-56 FIRST STAGE ASCENT SIMULATION, NOMINAL ASCENT

SSME #2 PITCH

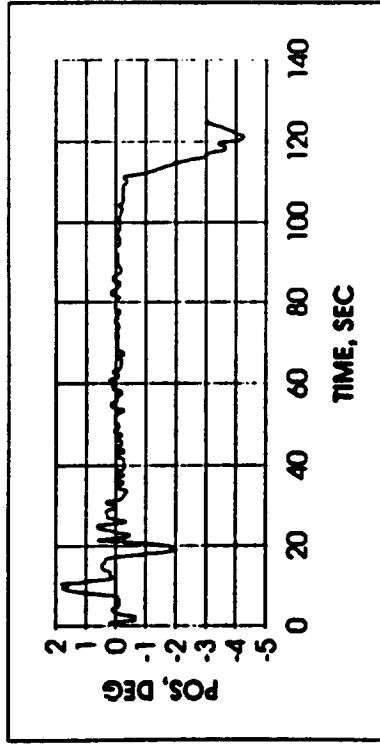

SSME #2 YAW

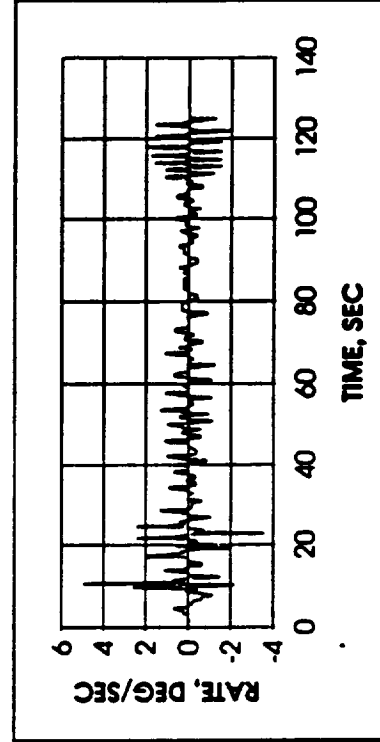
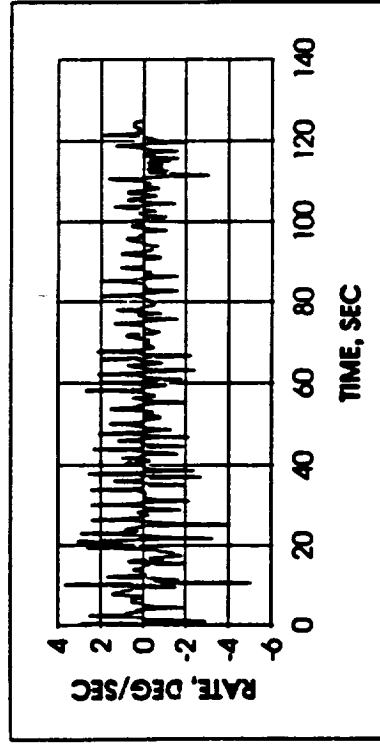
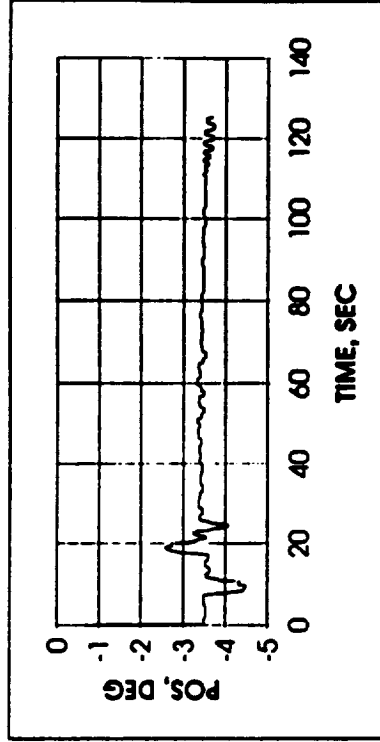

# POSITIONS AND RATES OF SSME-TVC ACTUATORS DURING NOMINAL ASCENT: SSME 3

STS-56 FIRST STAGE ASCENT SIMULATION, NOMINAL ASCENT

SSME #3 PITCH

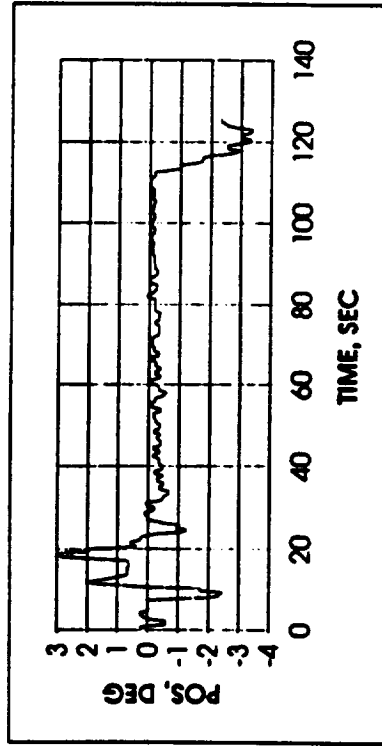

SSME #3 YAW

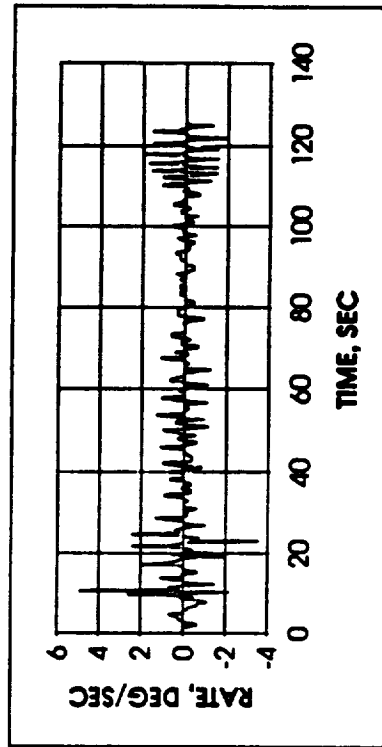
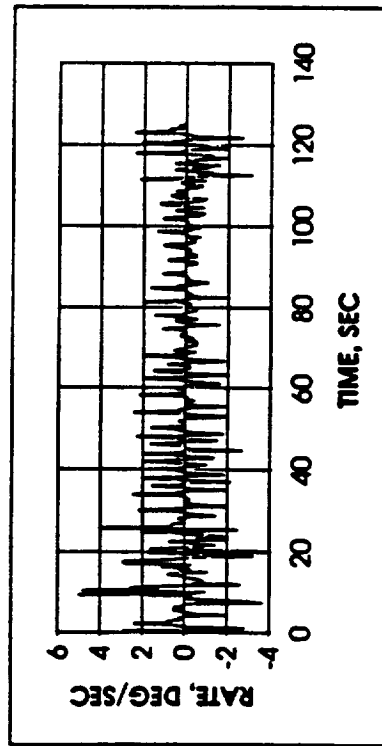
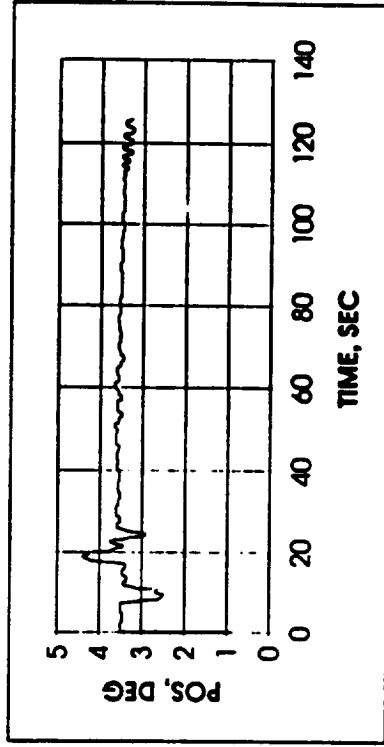

# POSITIONS AND RATES OF SSME-TVC ACTUATORS DURING ASCENT WITH 3-SIGMA DISPERSION: SSME 1 (UPPER ENGINE)

STS-56 FIRST STAGE SIMULATION, 3 SIGMA DISPERSION

SSME UPPER PITCH

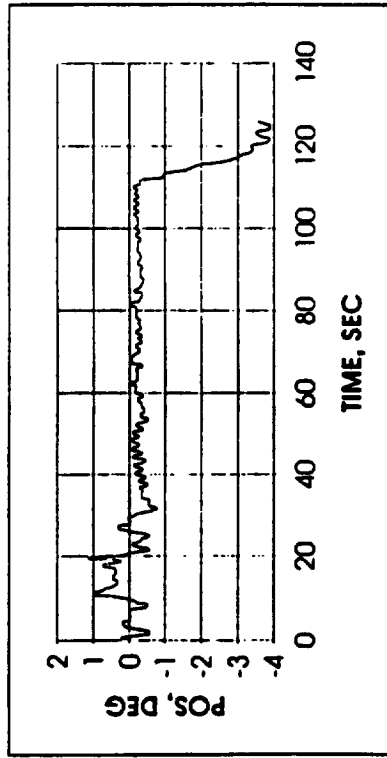

SSME UPPER YAW

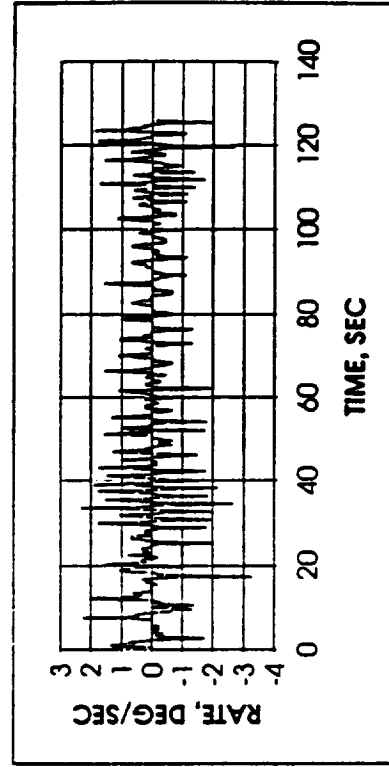
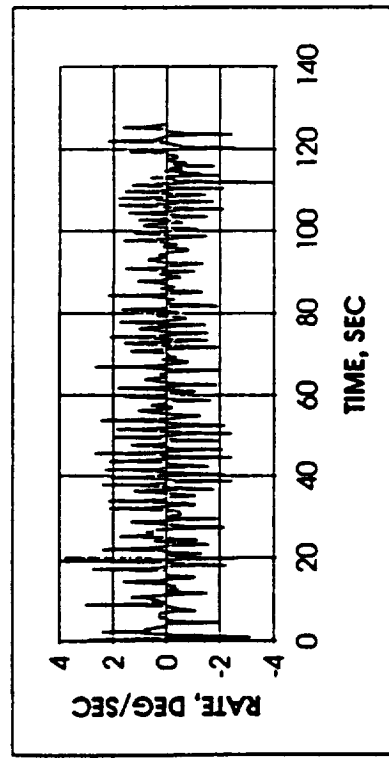
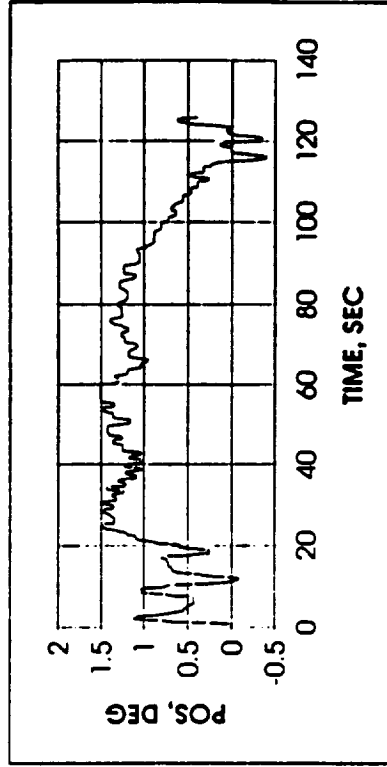

# POSITIONS AND RATES OF SSME-TVC ACTUATORS DURING ASCENT WITH 3-SIGMA DISPERSION: SSME 2

STS-56 FIRST STAGE ASCENT SIMULATION, 3 SIGMA DISPERSION

SSME #2 PITCH

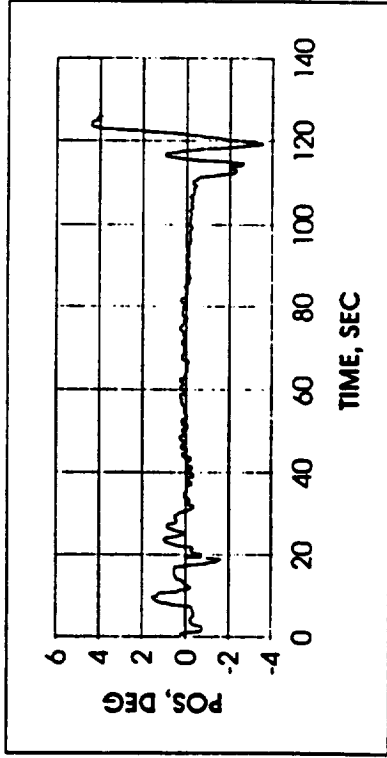

SSME #2 YAW

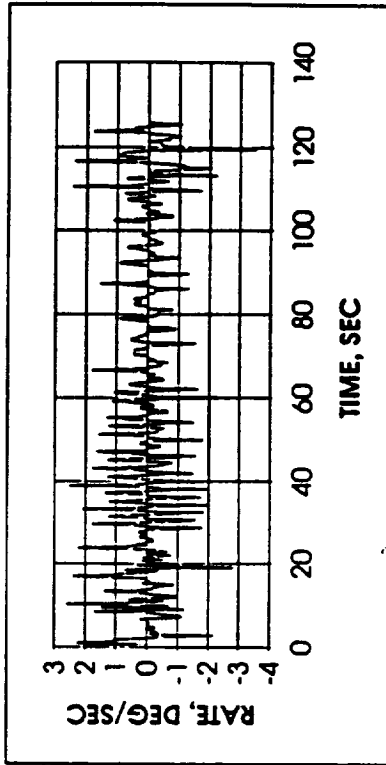
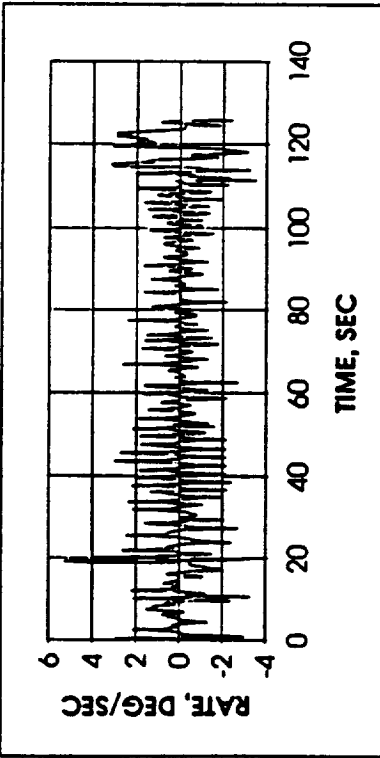
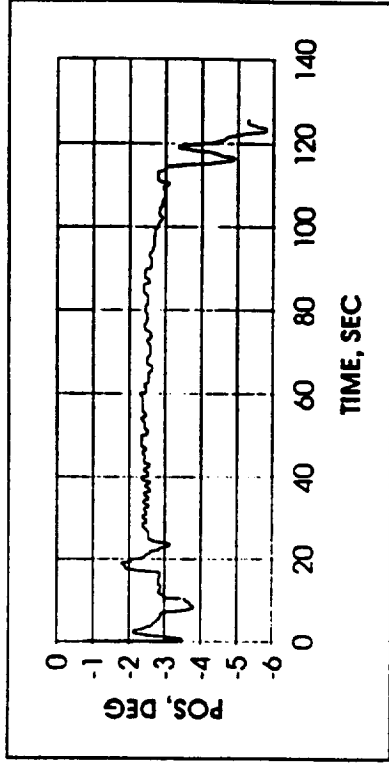

# POSITIONS AND RATES OF SSME-TVC ACTUATORS DURING ASCENT WITH 3-SIGMA DISPERSION: SSME 3

STS-56 FIRST STAGE ASCENT SIMULATION, 3 SIGMA DISPERSION

SSME #3 PITCH

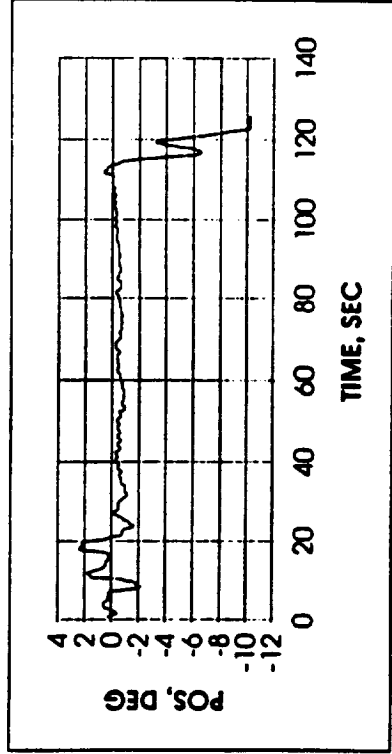

SSME #3 YAW

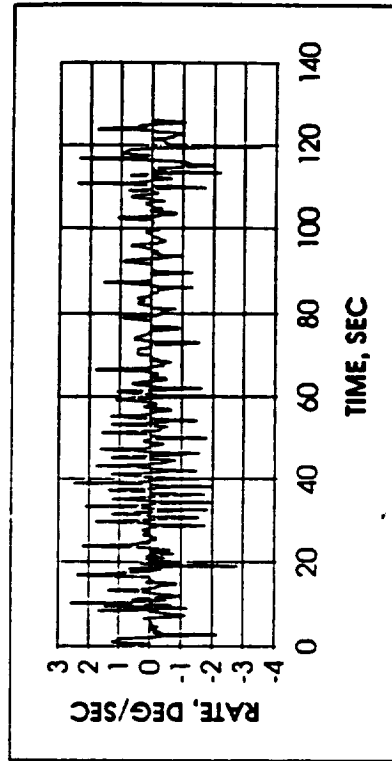
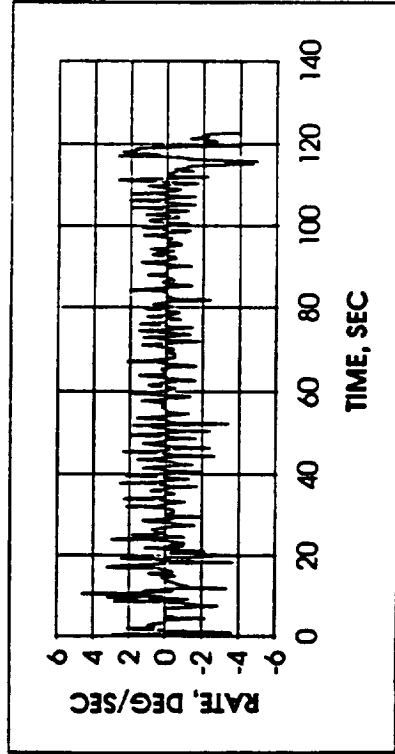
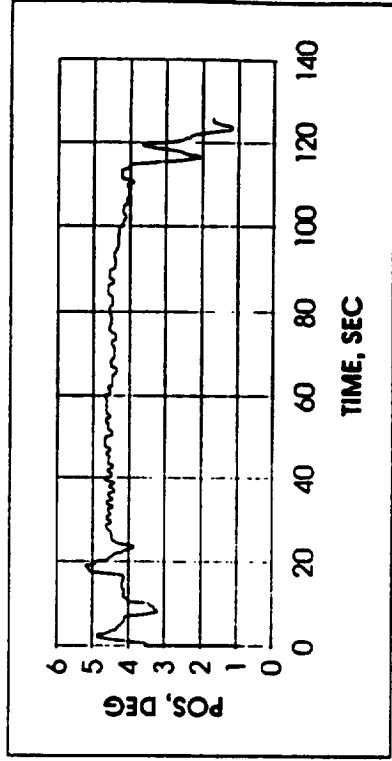

# POSITIONS AND RATES OF SSME-TVC ACTUATORS DURING ASCENT WITH ONE ENGINE OUT: SSME 1 (UPPER ENGINE)

STS-56 FIRST STAGE SIMULATION, SSME #2 FAILED AT LIFTOFF

SSME UPPER PITCH

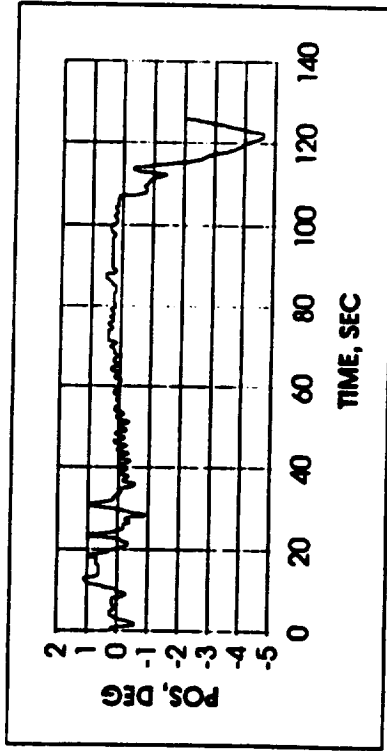

SSME UPPER YAW

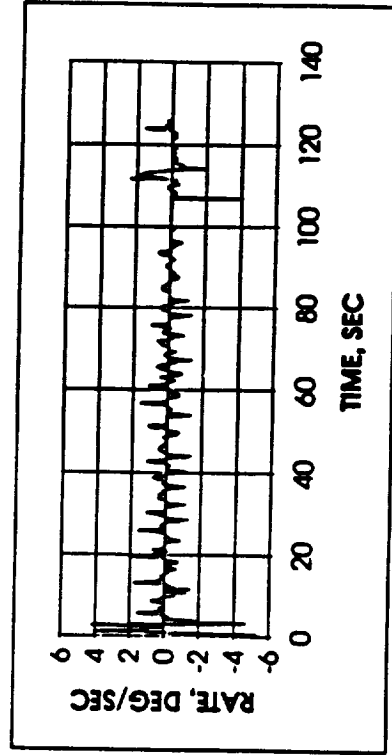
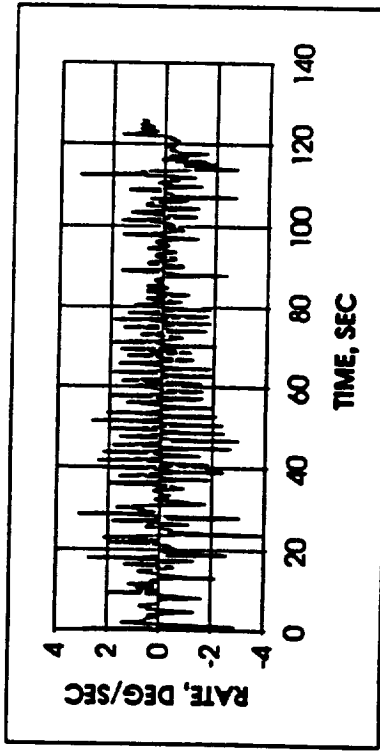
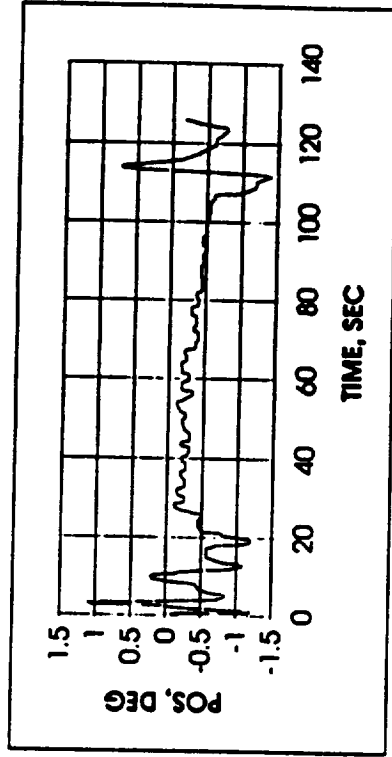

# POSITIONS AND RATES OF SSME-TVC ACTUATORS DURING ASCENT WITH ONE ENGINE OUT: SSME 2

STS-56 FIRST STAGE ASCENT SIMULATION, SSME #2 FAILED AT LIFTOFF

SSME #2 PITCH

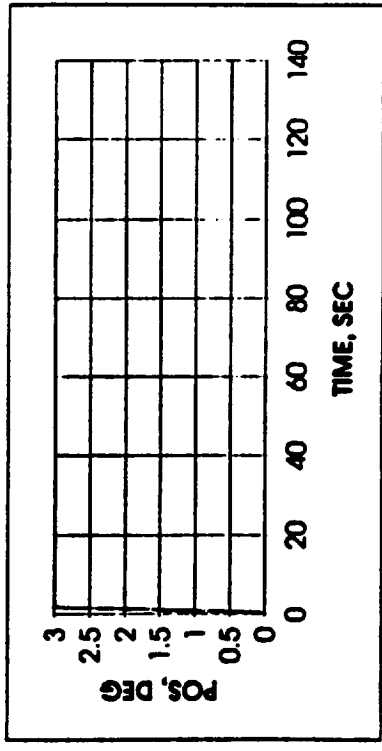

SSME #2 YAW

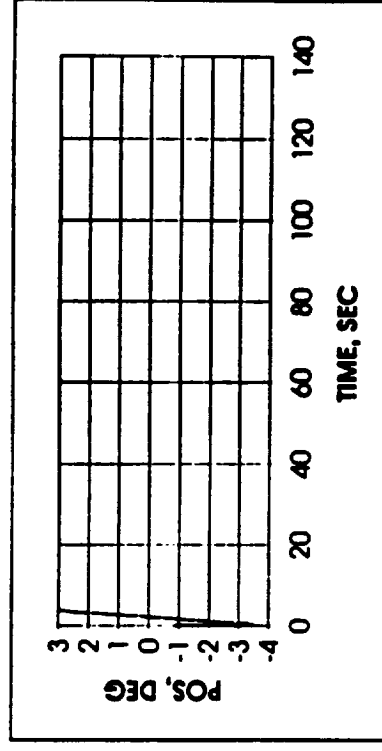

SSME #2 Pitch Rate

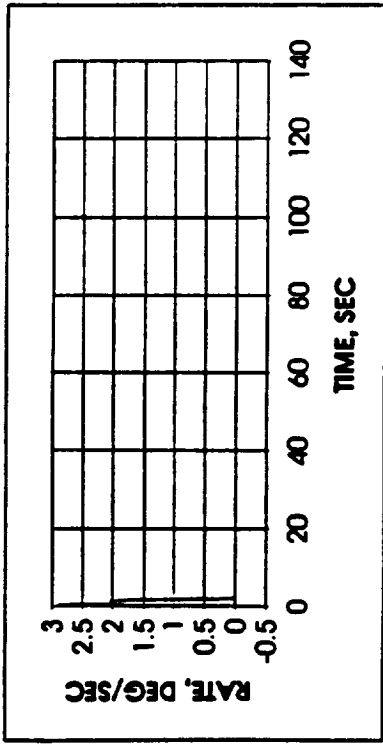

SSME #2 Yaw Rate

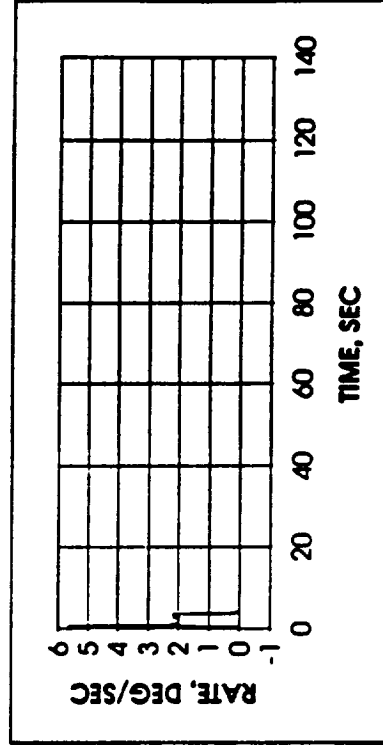

# POSITIONS AND RATES OF SSME-TVC ACTUATORS DURING ASCENT WITH ONE ENGINE OUT: SSME 3

STS-56 FIRST STAGE ASCENT SIMULATION, SSME #2 FAILED AT LIFTOFF

SSME #3 PITCH

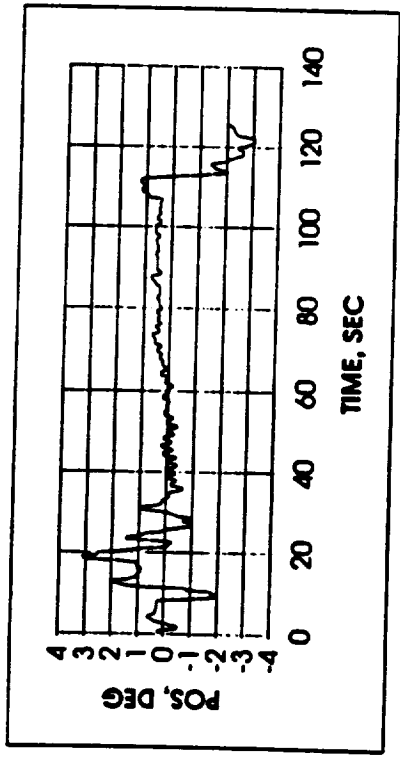

SSME #3 YAW

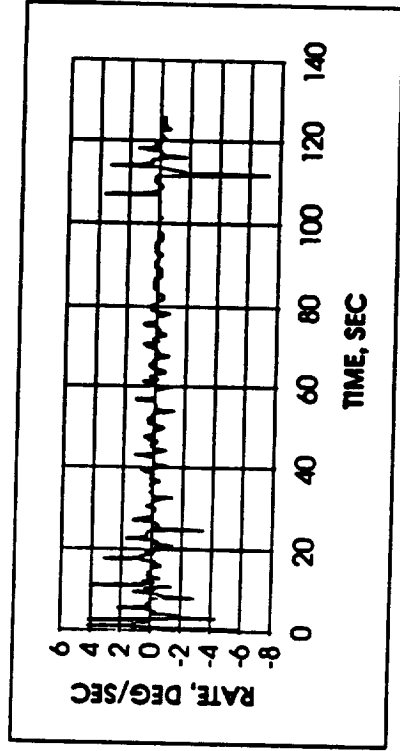
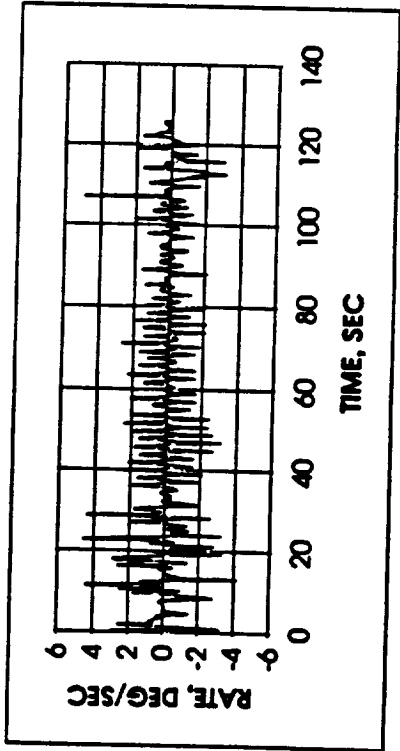
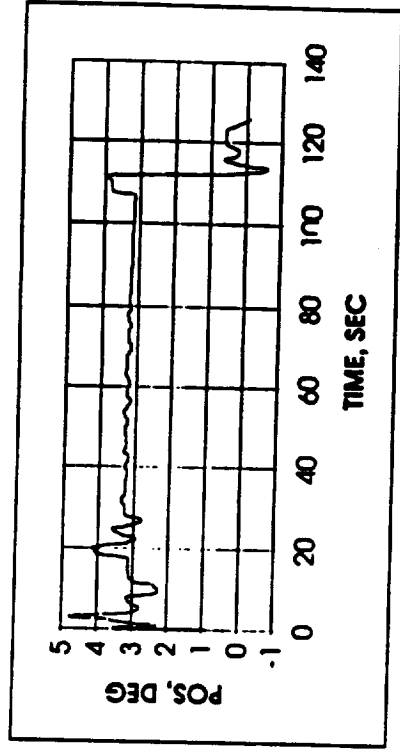



# DYNAMICS OF RIGHT INBOARD ELEVON DURING NOMINAL ENTRY

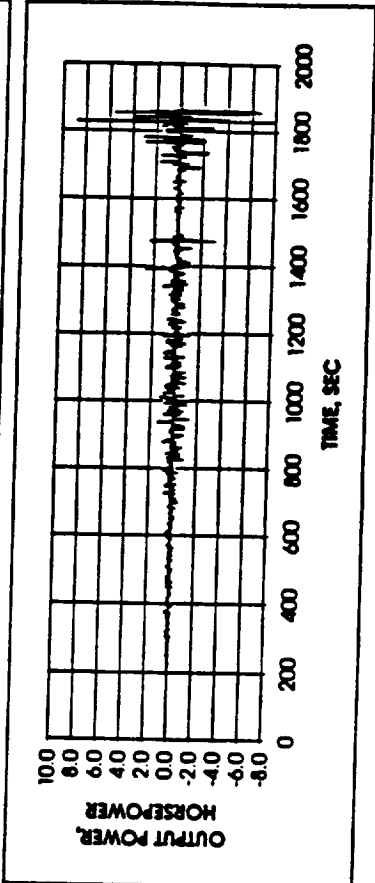
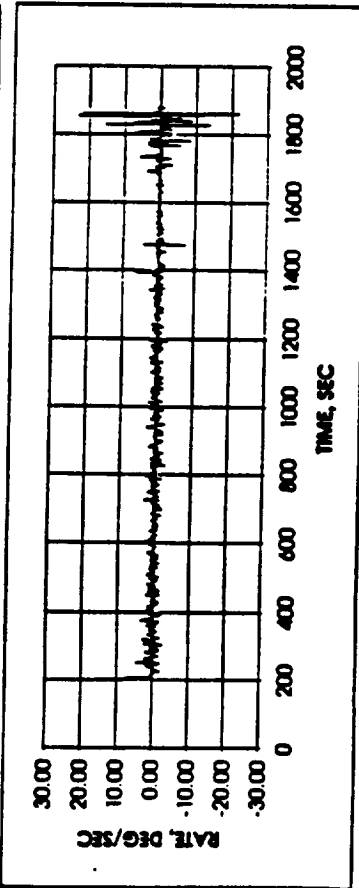
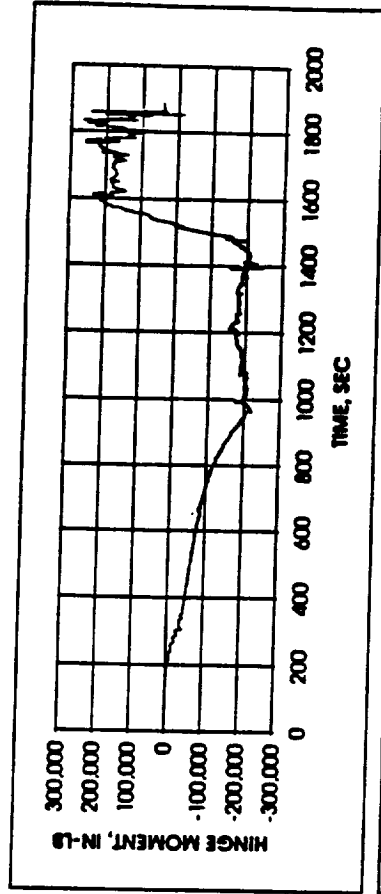
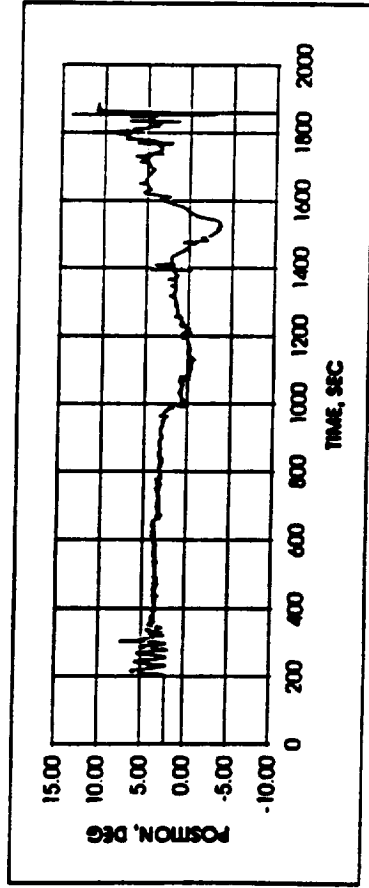

From Entry Interface to End of Rollout

# DYNAMICS OF RIGHT OUTBOARD ELEVON DURING NOMINAL ENTRY

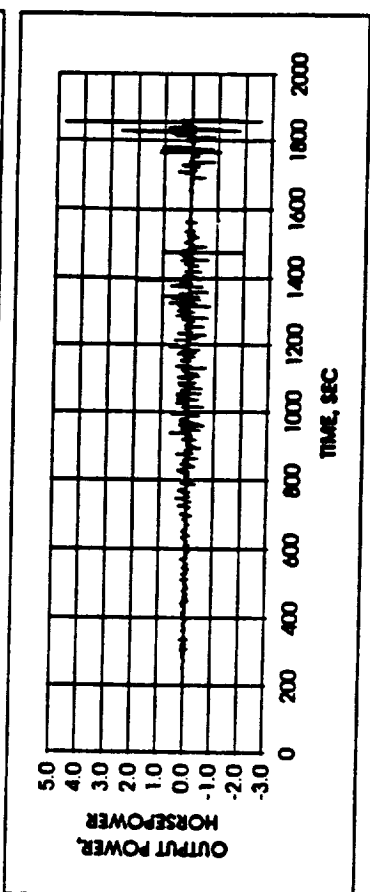
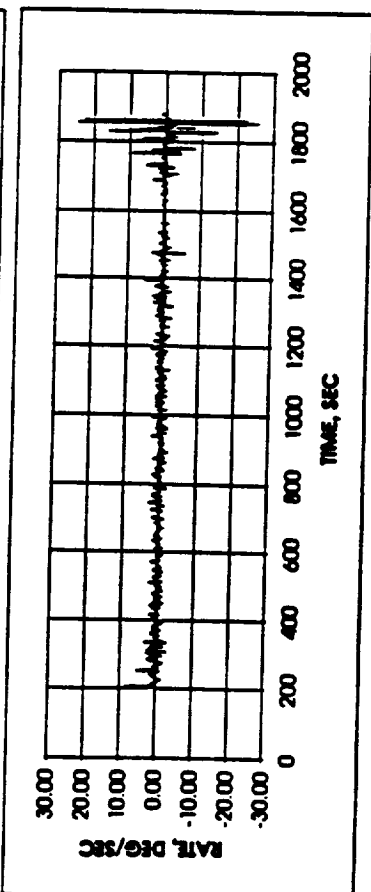
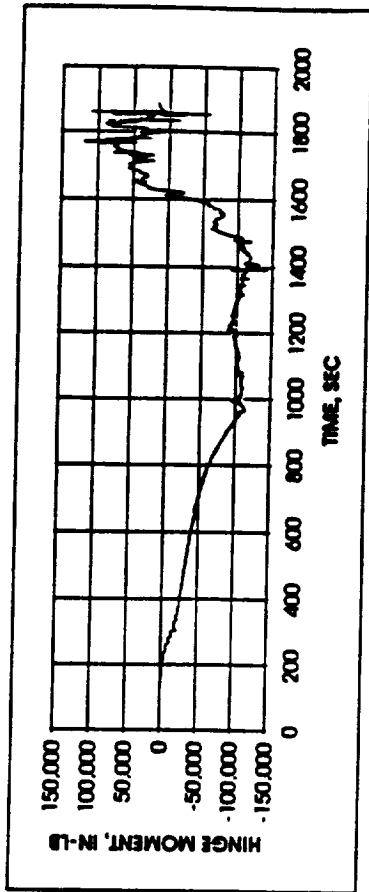
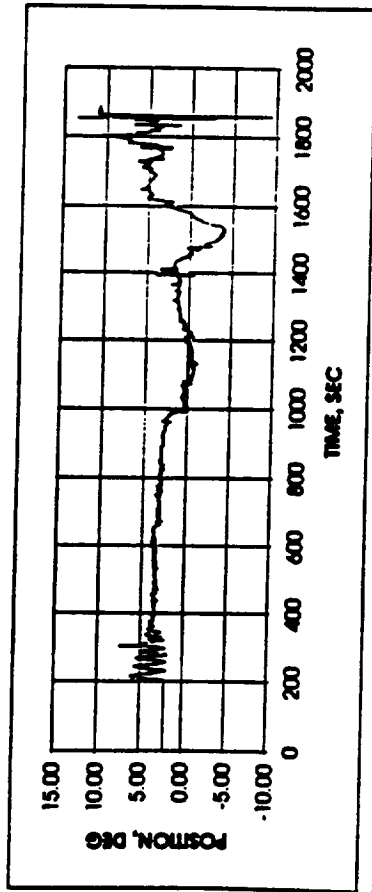

From Entry Interface to End of Rollout

## OI20 SAIL TEST DATA



# DYNAMICS OF LEFT INBOARD ELEVEN DURING NOMINAL ENTRY

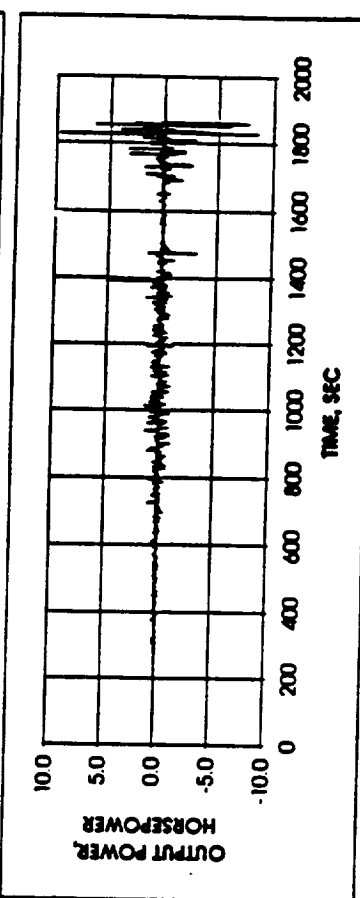
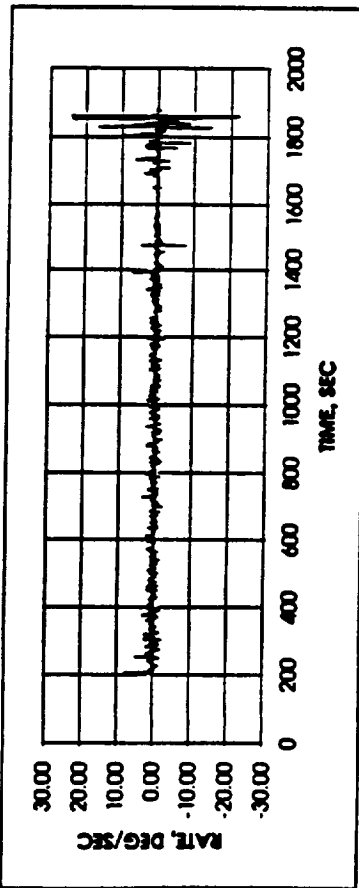
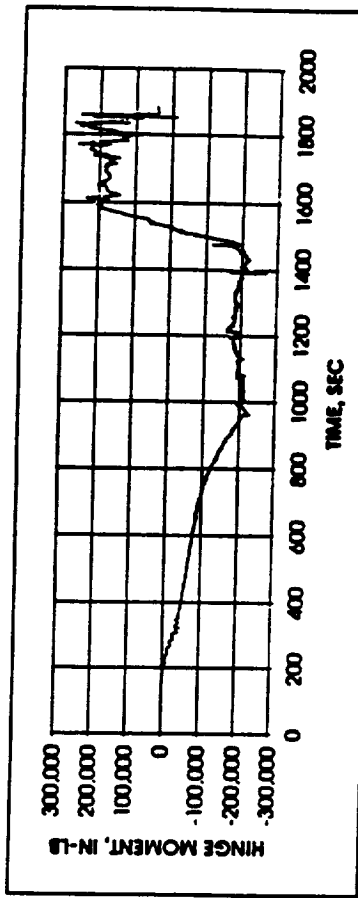
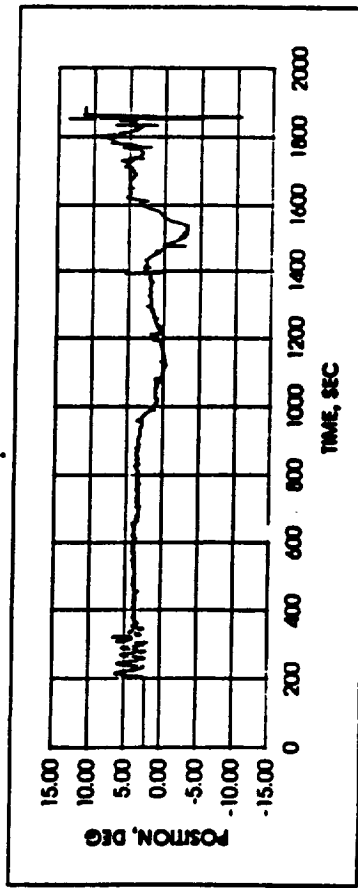

From Entry Interface to End of Rollout

# DYNAMICS OF LEFT OUTBOARD ELEVON DURING NOMINAL ENTRY

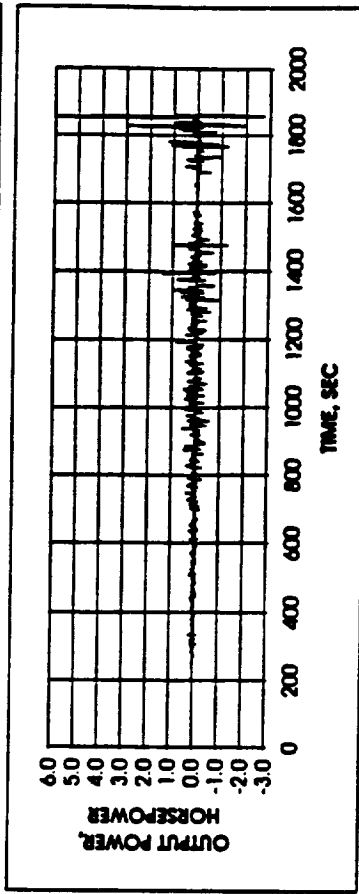
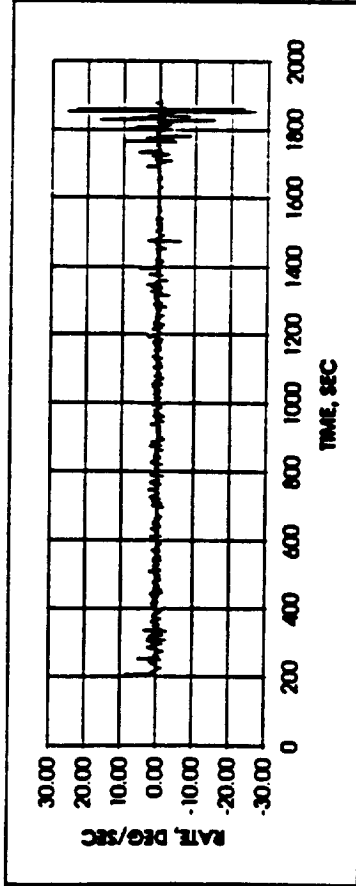
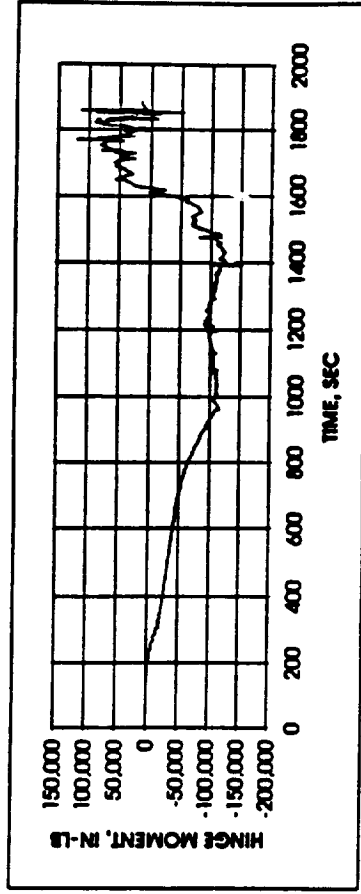
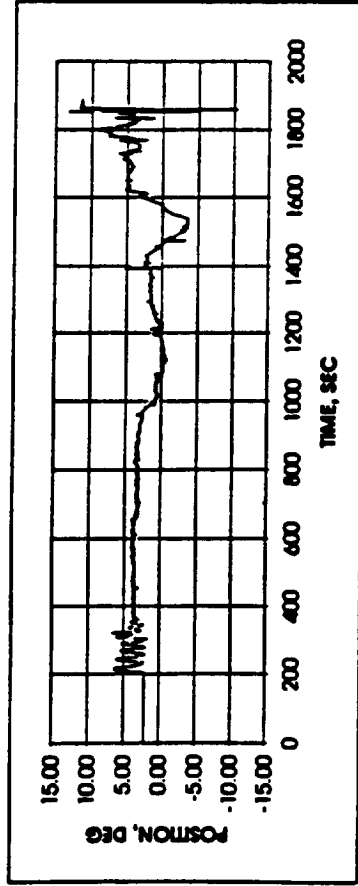

From Entry Interface to End of Rollout

# DYNAMICS OF RIGHT INBOARD ELEVEN DURING OFF-NOMINAL ENTRY

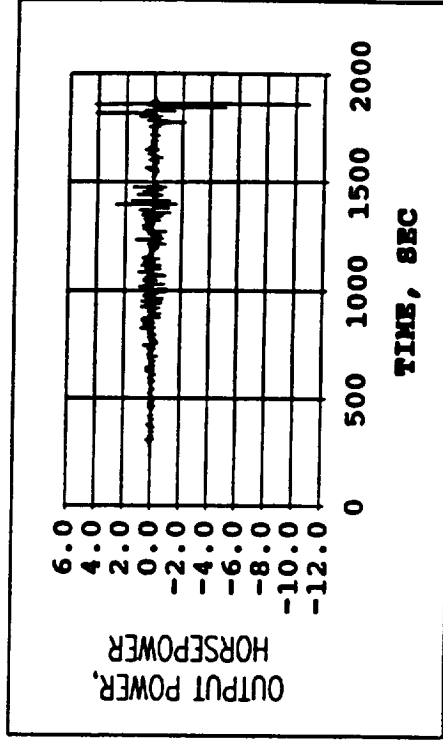
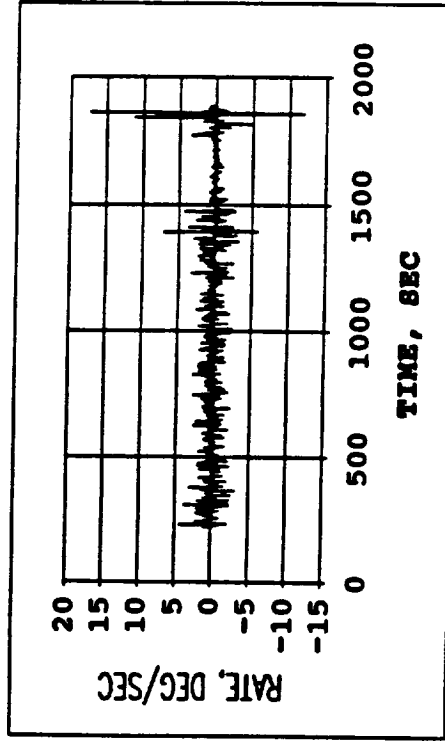
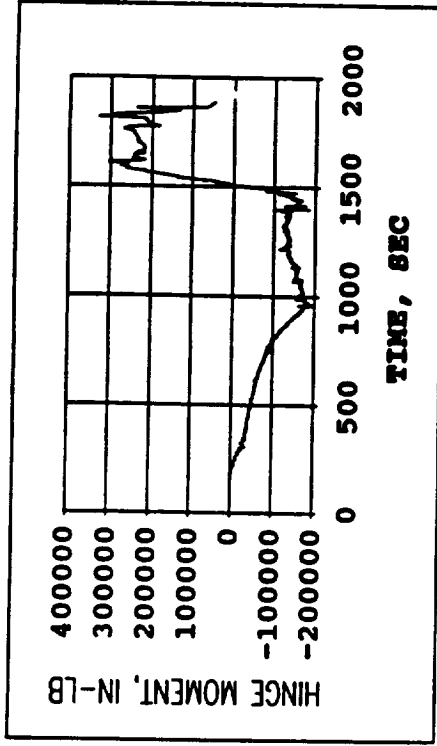
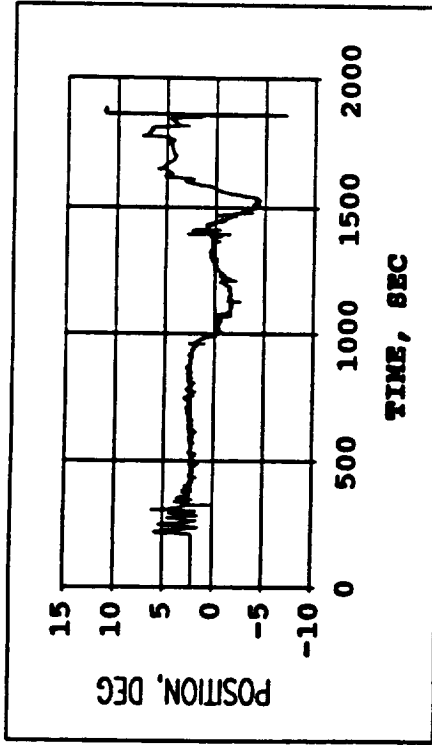

From Entry Interface to End of Rollout

# DYNAMICS OF RIGHT OUTBOARD ELEVON DURING OFF-NOMINAL ENTRY

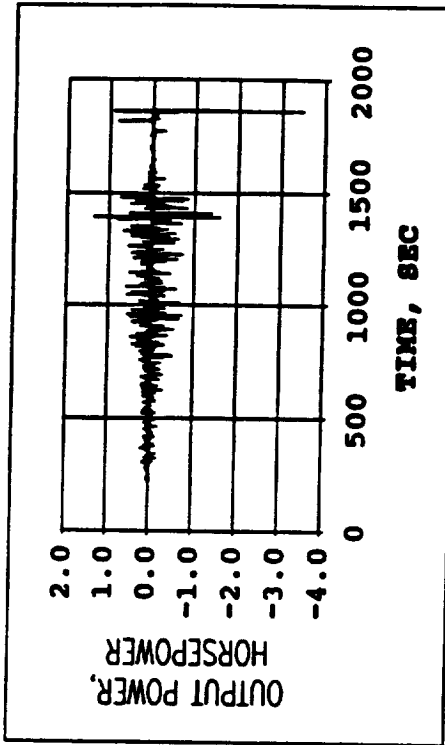
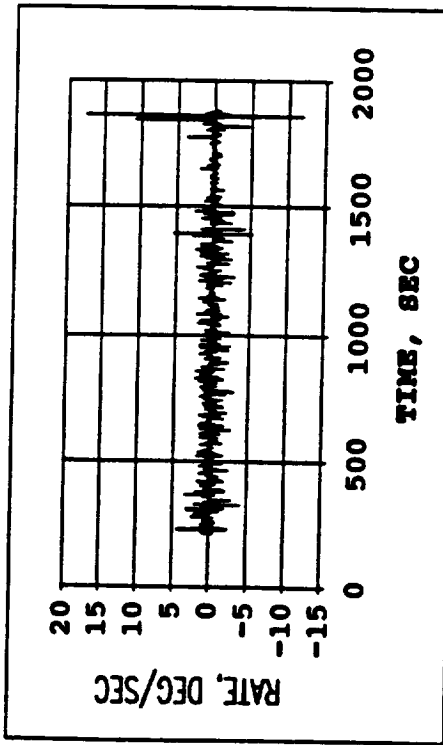
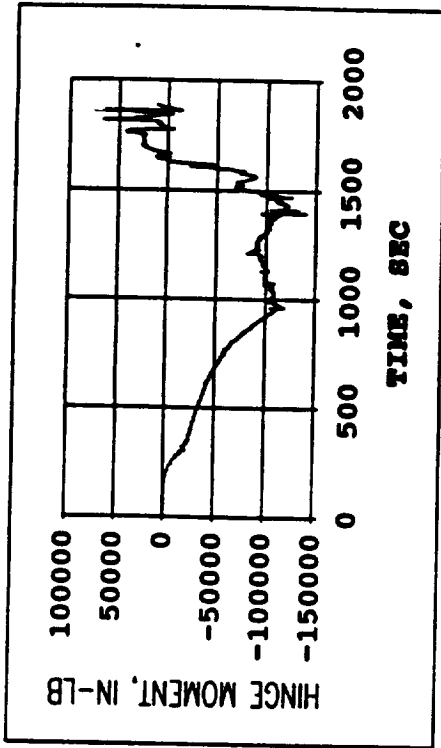
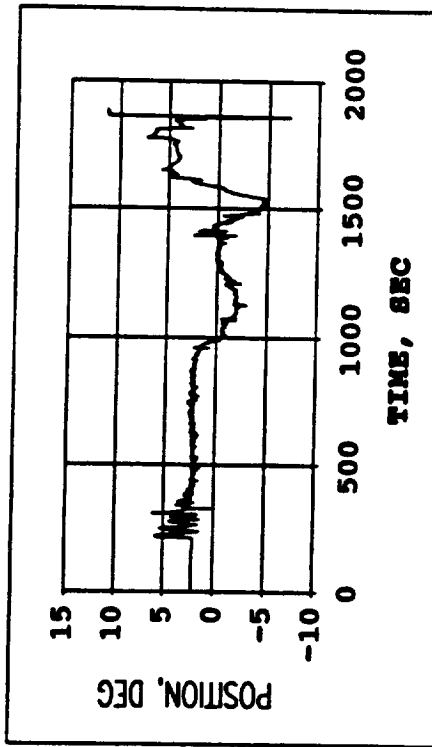

From Entry Interface to End of Rollout

# DYNAMICS OF LEFT INBOARD ELEVON DURING OFF-NOMINAL ENTRY

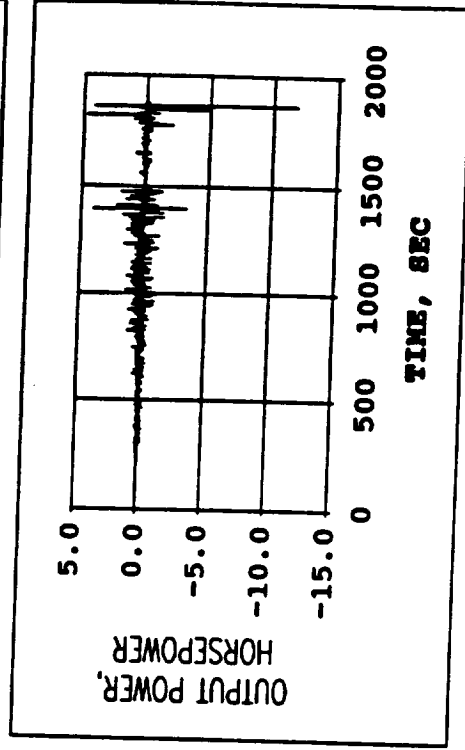
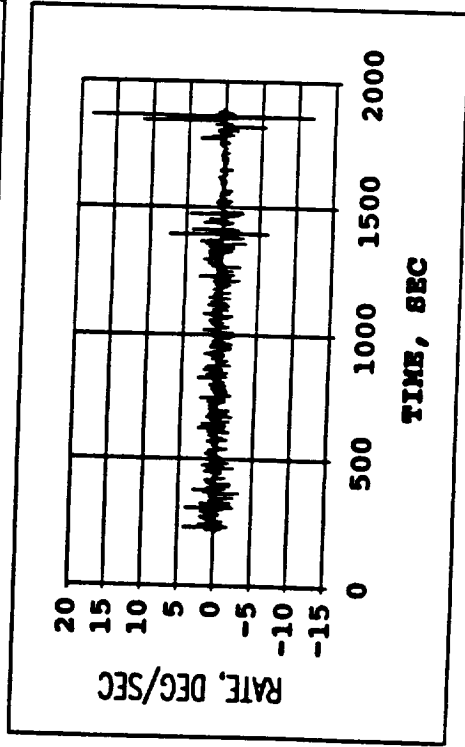
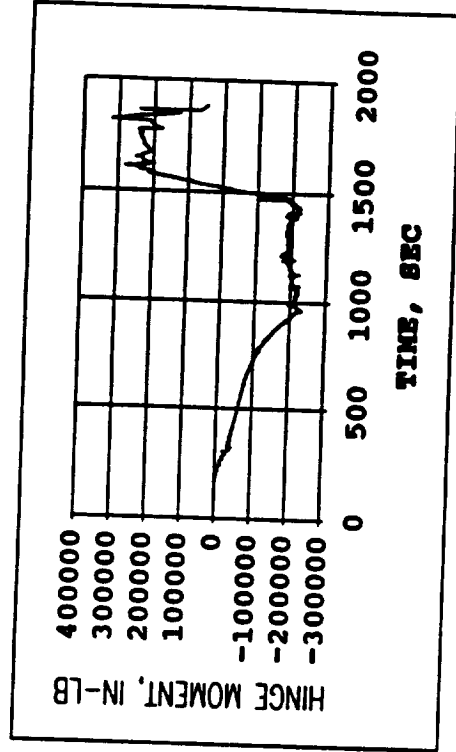
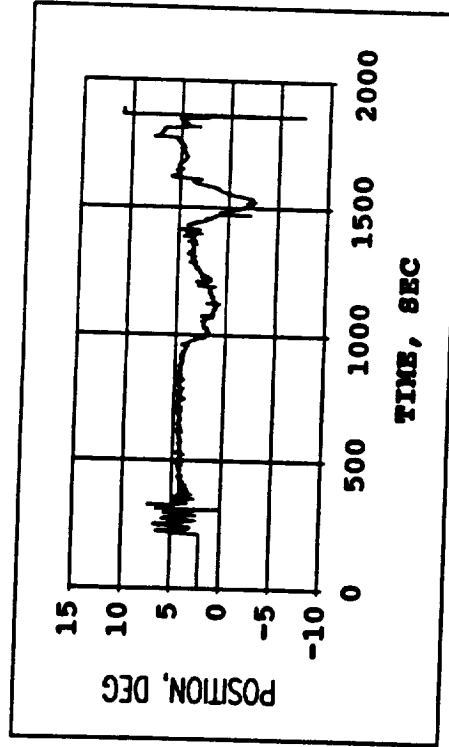

From Entry Interface to End of Rollout



# DYNAMICS OF LEFT OUTBOARD ELEVON DURING OFF-NOMINAL ENTRY

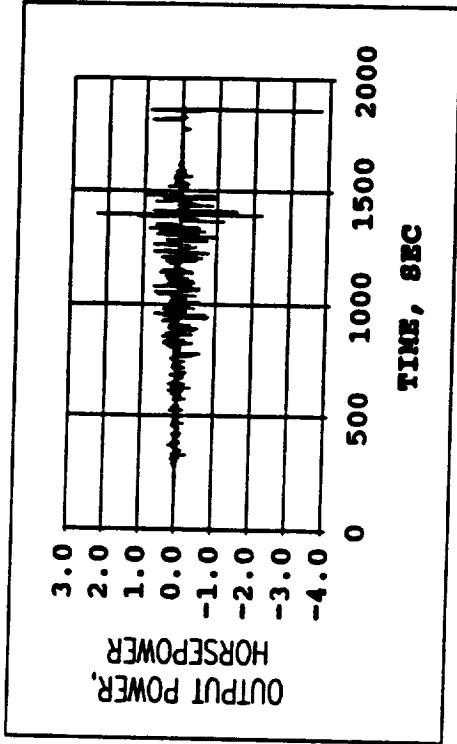
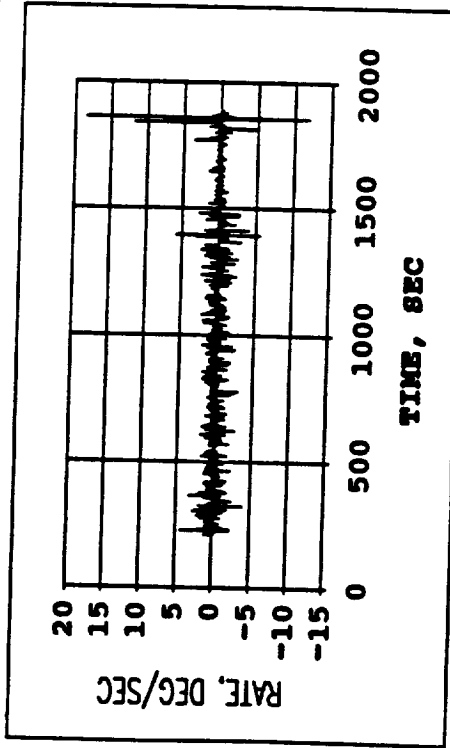
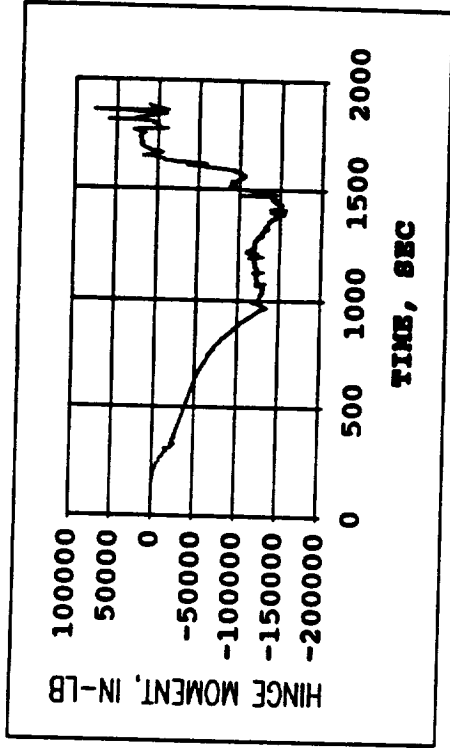
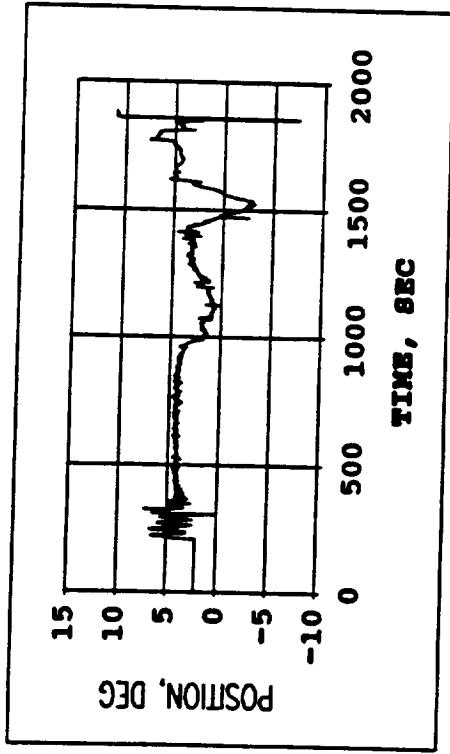

From Entry Interface to End of Rollout

O120 SAIL TEST DATA

120





# DYNAMICS OF RUDDER DURING NOMINAL ENTRY

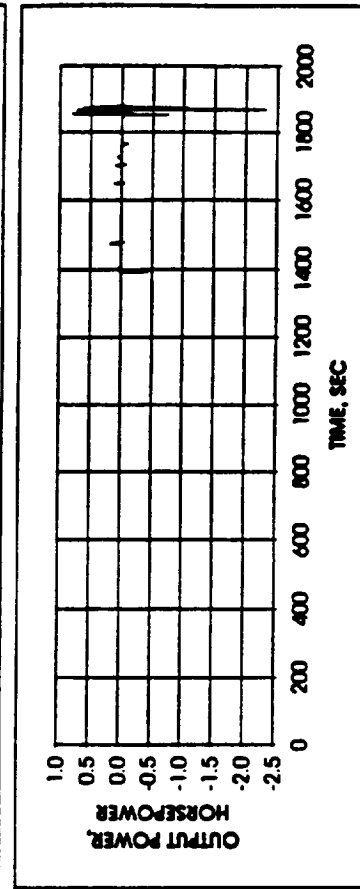
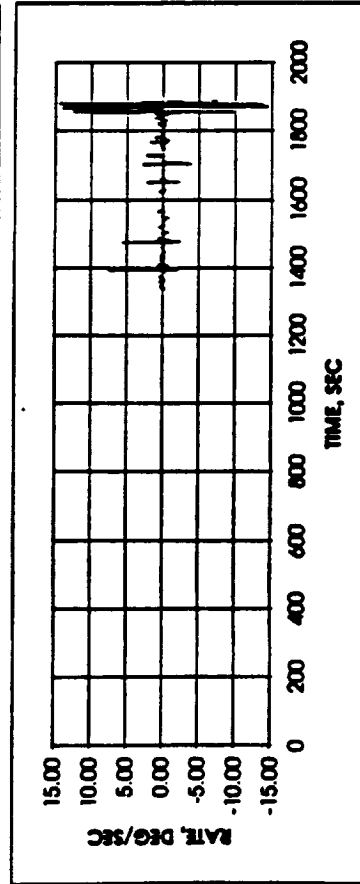
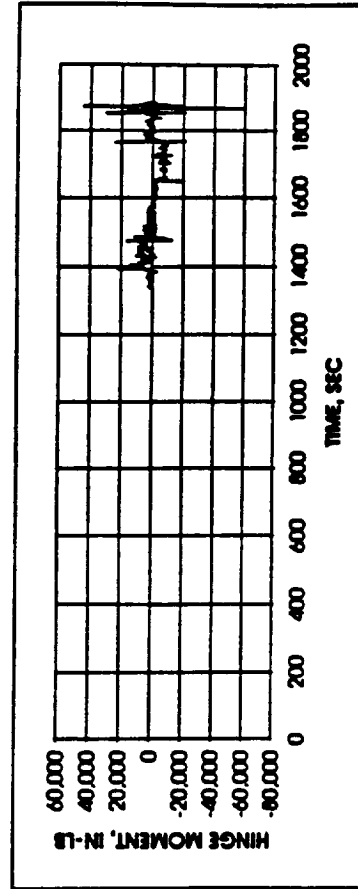
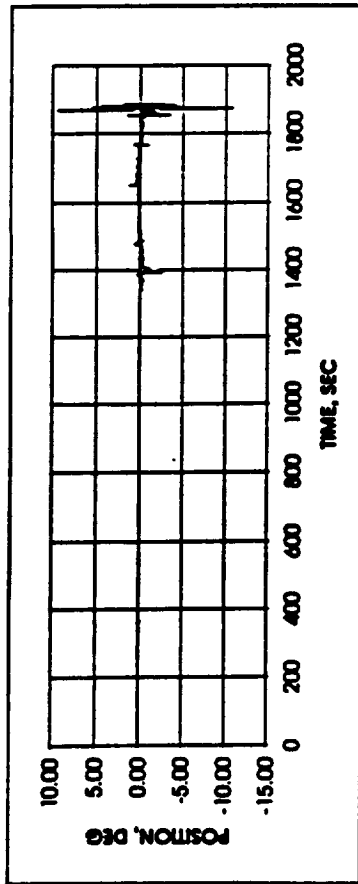

From Entry Interface to End of Rollout

# DYNAMICS OF RUDDER DURING OFF-NOMINAL ENTRY

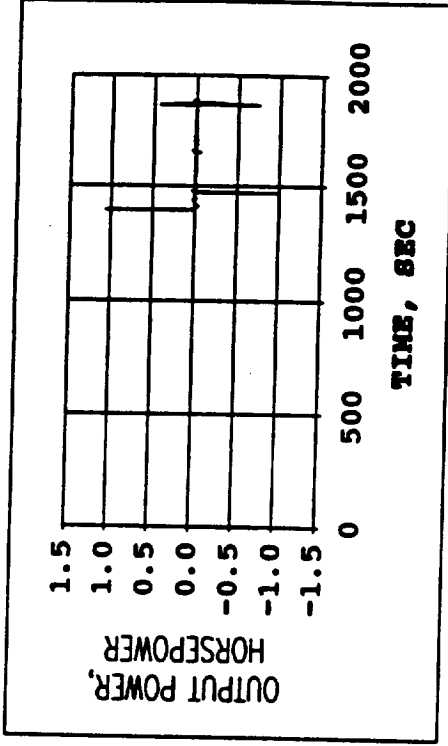
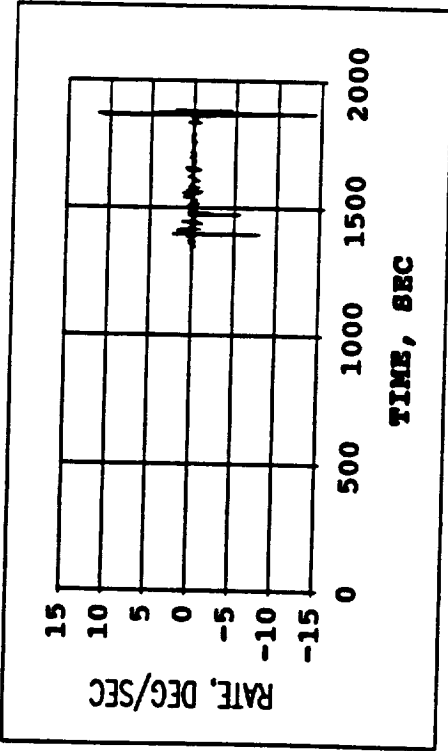
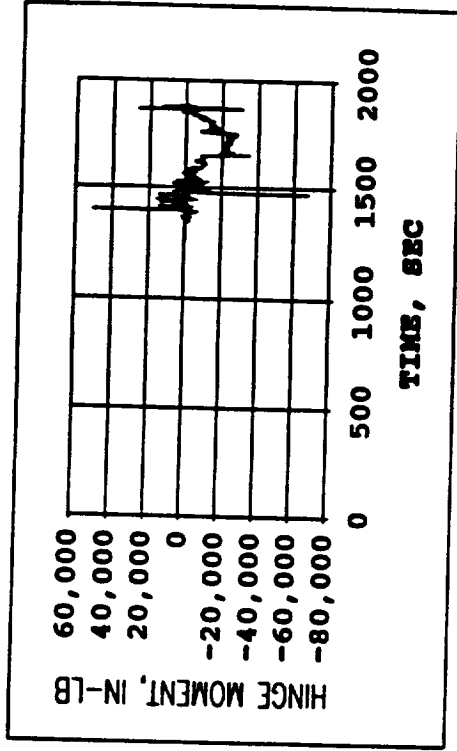
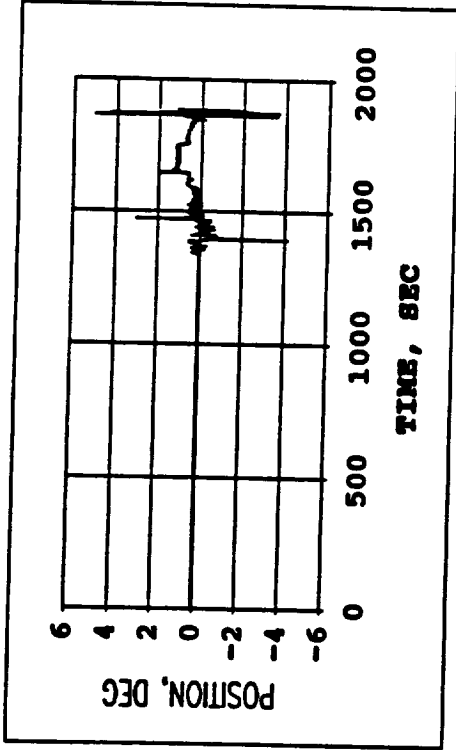

From Entry Interface to End of Rollout

OI20 SAIL TEST DATA



# DYNAMICS OF SPEEDBRAKE DURING NOMINAL ENTRY

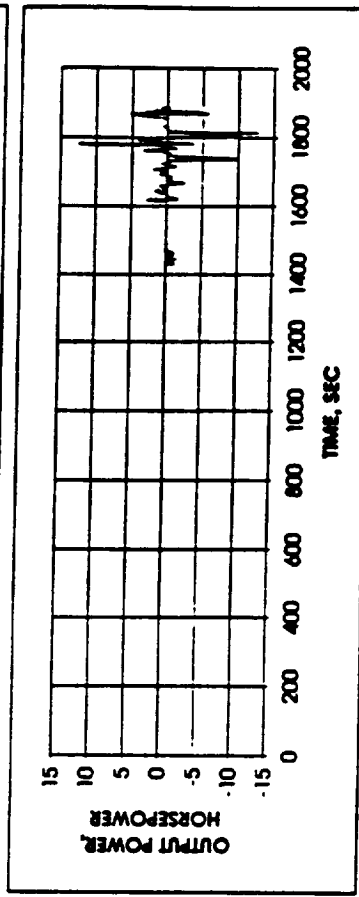
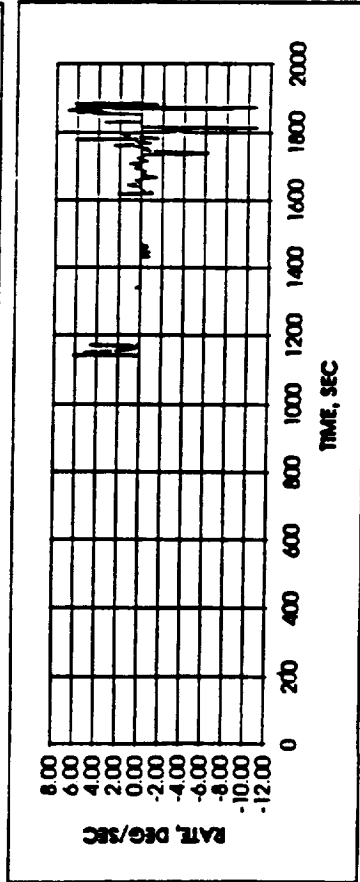
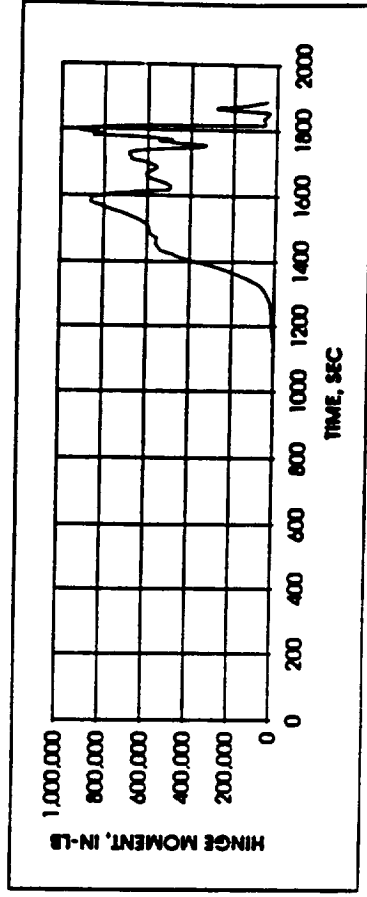
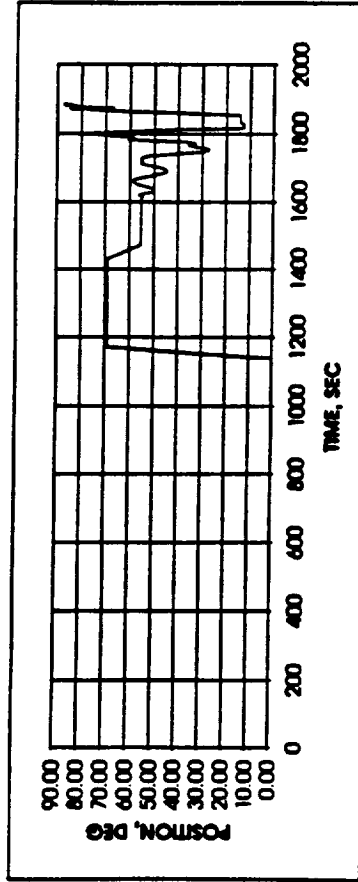

From Entry Interface to End of Rollout

# DYNAMICS OF SPEEDBRAKE DURING OFF-NOMINAL ENTRY

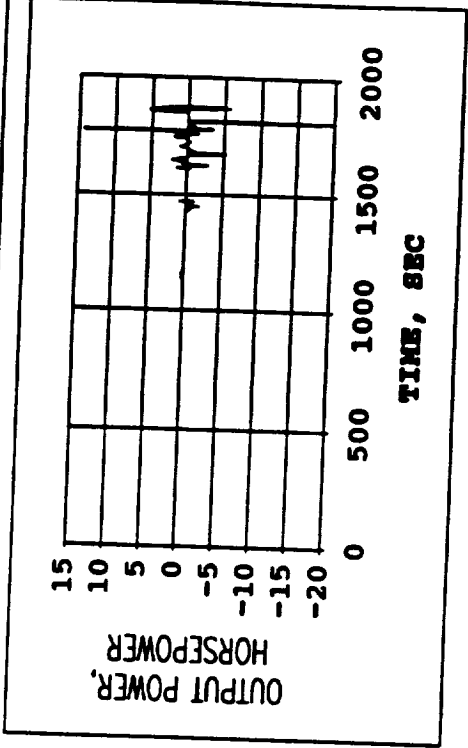
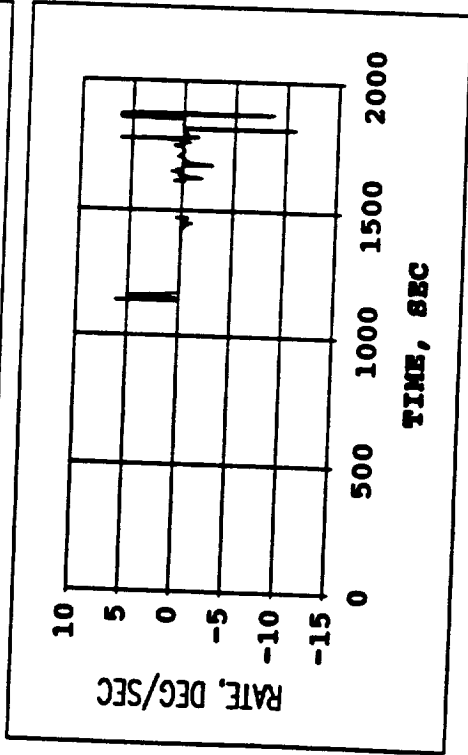
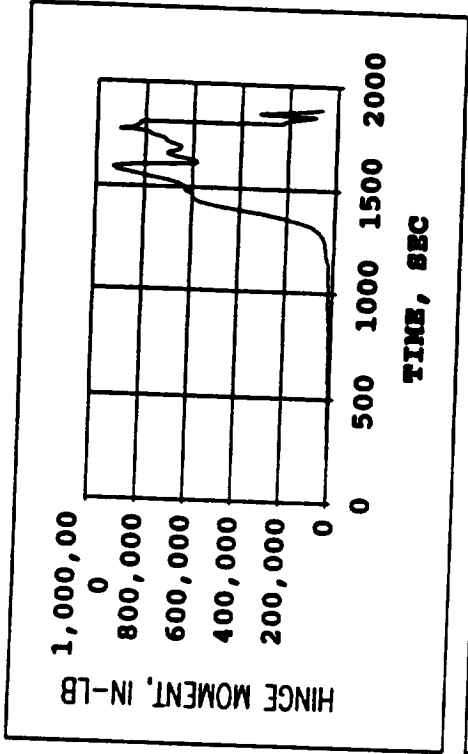
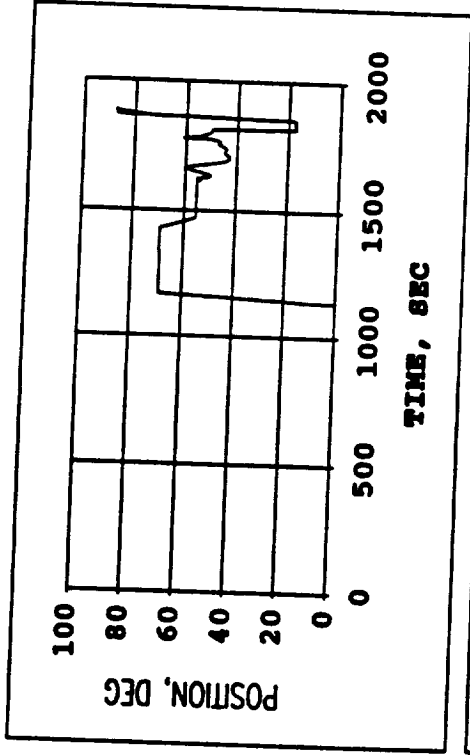

From Entry Interface to End of Rollout

O120 SAIL TEST DATA



# DYNAMICS OF BODYFLAP DURING NOMINAL ENTRY

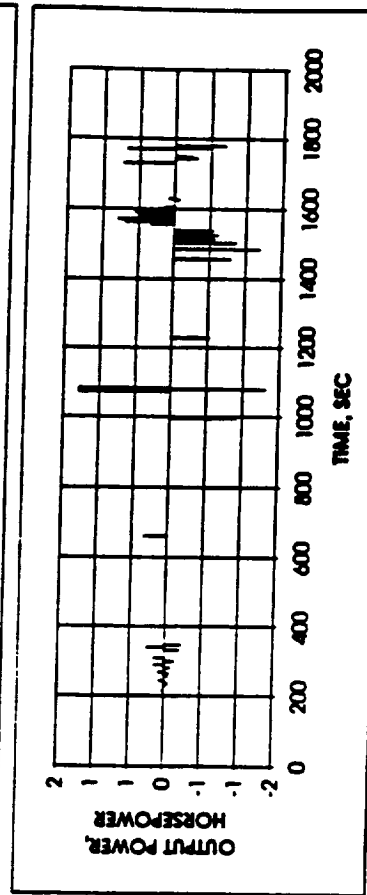
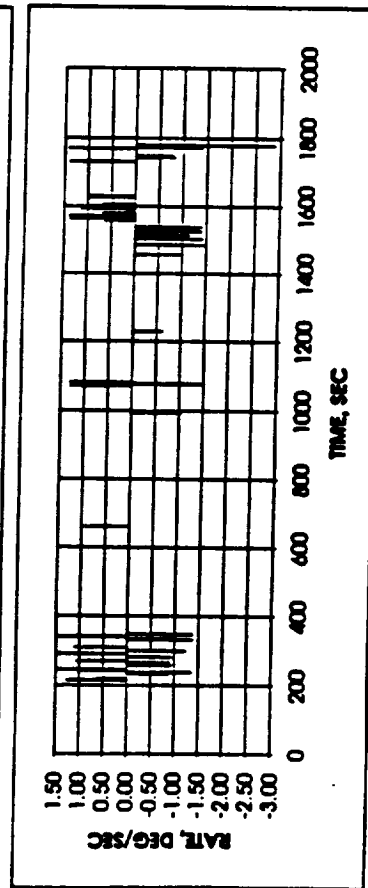
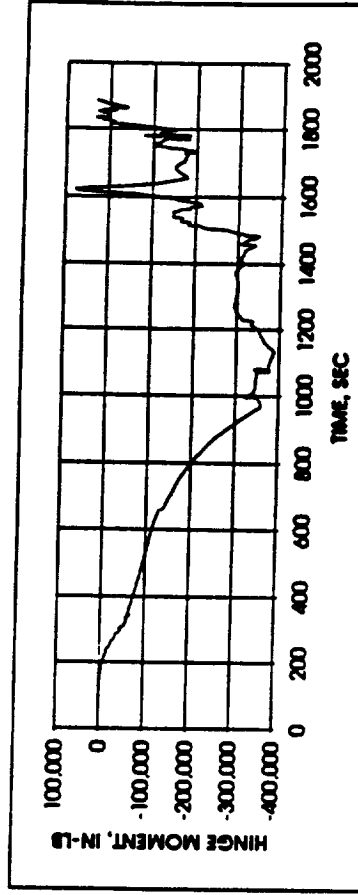
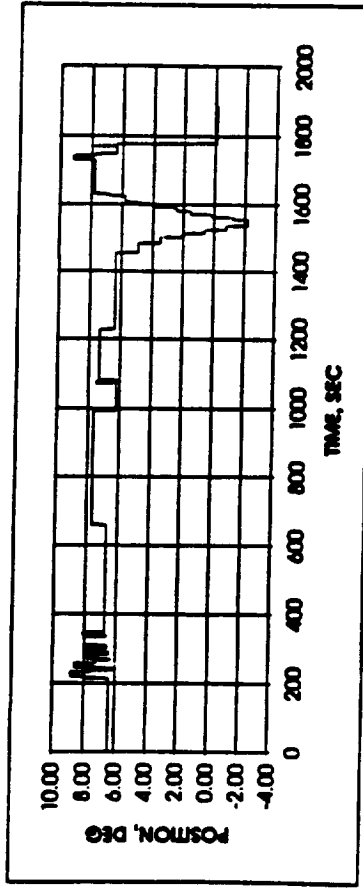

From Entry Interface to End of Rollout

# DYNAMICS OF BODYFLAP DURING OFF-NOMINAL ENTRY

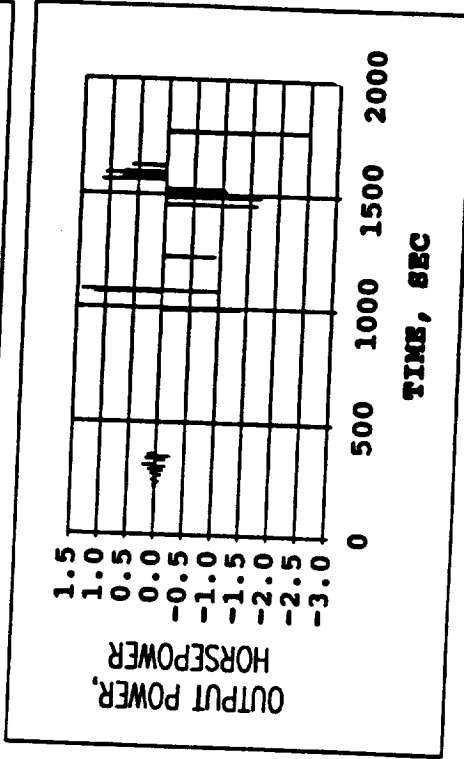
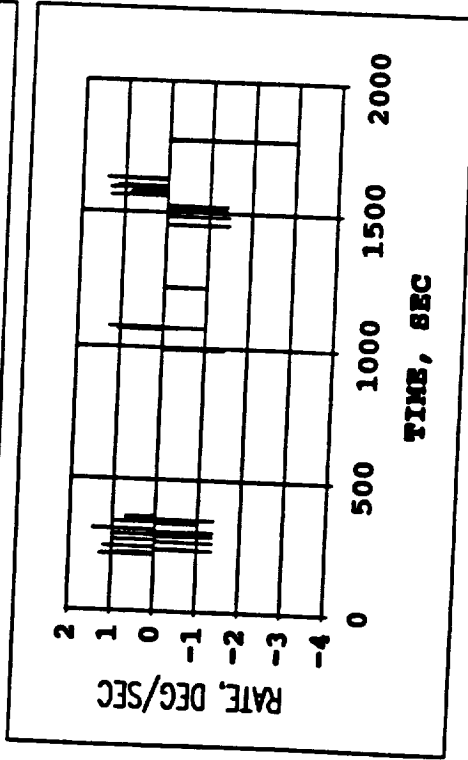
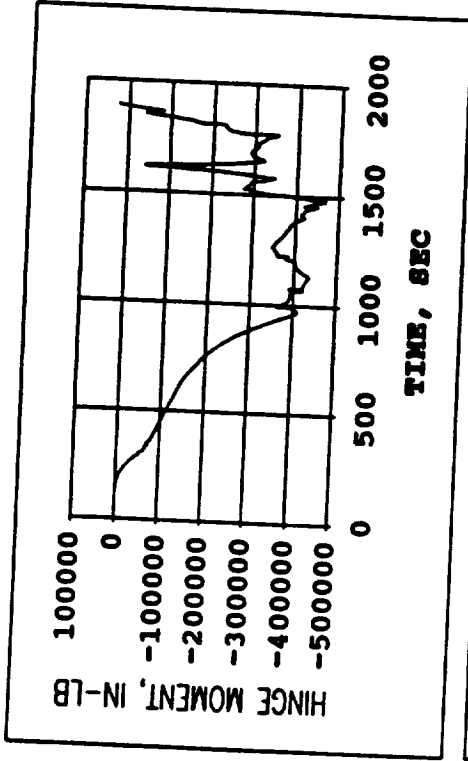
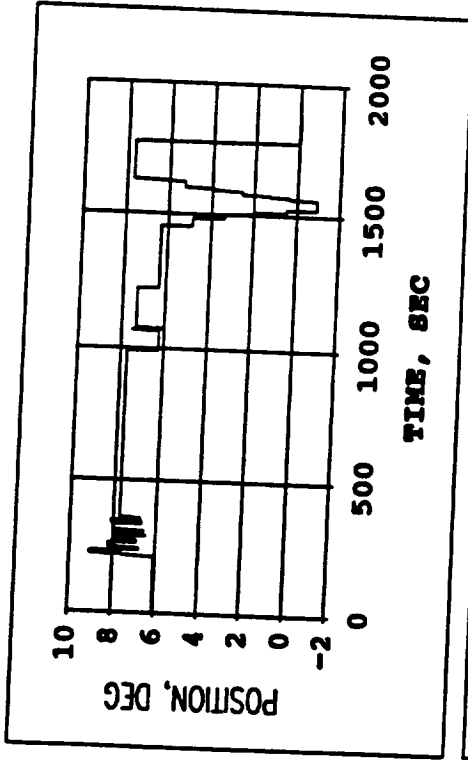

From Entry Interface to End of Rollout

OI20 SAIL TEST DATA

**POWER AND ENERGY DATA FOR OTHER EFFECTORS**

---

<u>EFFECTOR (TOTAL NUMBER)</u>	<u>RATES, LOADS AND/OR OUTPUT POWER REQUIRED</u>	<u>MISSION ON TIME AND/OR OUTPUT ENERGY REQUIRED</u>	<u>DATA SOURCE</u>
OMS - TVC'S (6)			
SSME VALVES (15)			
ET UMBILICALS (6)			
MAIN GEAR UPLOCKS (2)			
NOSE GEAR UPLOCK (1)			
MAIN GEAR STRUTS (2)			
NOSE GEAR STRUT (1)			
NOSEWHEEL STEERING (1)			
BRAKES (4)			

(TO BE PRESENTED IN FINAL REPORT)

# CALCULATION RESULTS: POWER AND ENERGY REQUIREMENTS FOR SHUTTLE EFFECTORS

---

EFFECTOR	PEAK POWER PER ACTUATOR, KW (DURATION, SECONDS)	AVG. POWER PER ACTUATOR, KW (DURATION, MINUTES)	POWER & ENERGY VS TIME (SEE CHART)
----------	--	--	---------------------------------------

- SRM - TVC
- SSME - TVC
- UPPER PITCH
- LOWER PITCH
- YAW
- OMS-TVC
- ELEVONS
- INBOARD
- OUTBOARD
- RUDDER
- SPEEDBRAKE
- BODYFLAP
- MAIN GEAR
- UPLOCKS
- STRUTS
- NOSE GEAR
- UPLOCK
- STRUT
- NW STEERING
- BRAKES

(TO BE PRESENTED IN FINAL REPORT)



**POWER REQUIREMENTS VERSUS MISSION TIME FOR SHUTTLE EFFECTORS: SRM - TVC**

**(TO BE PRESENTED IN FINAL REPORT)**

---

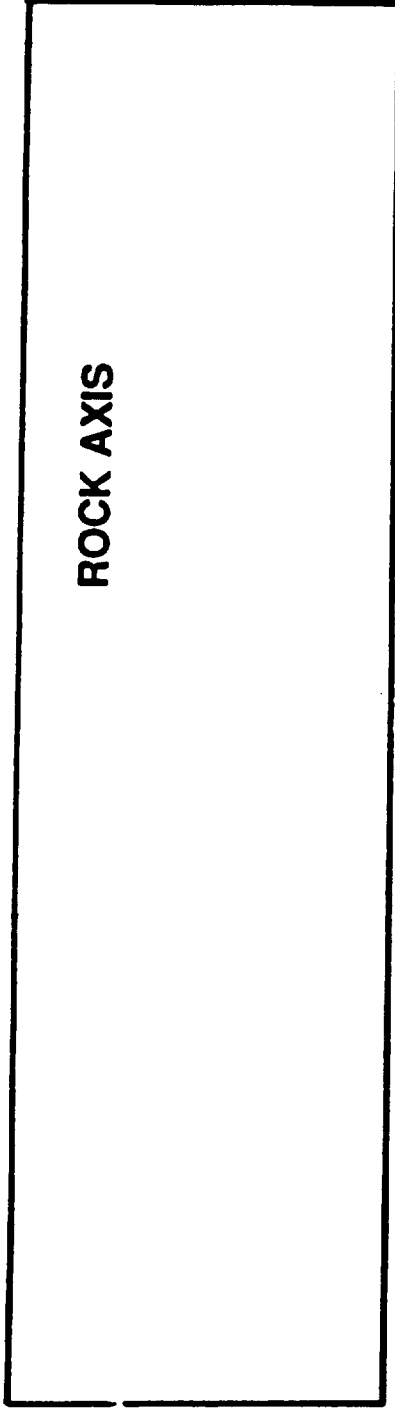

**POWER  
REQUIRED  
(HP)**

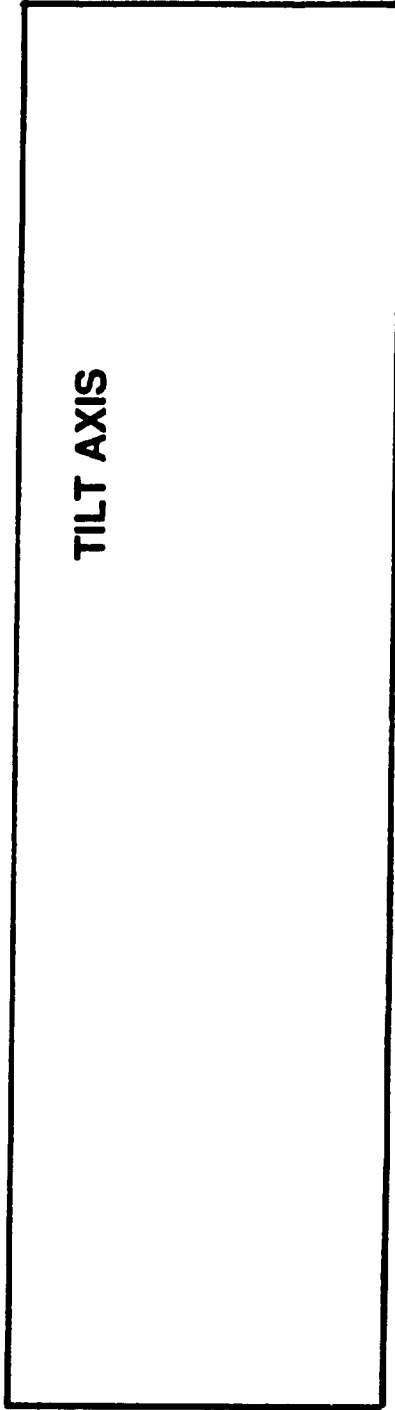

**MISSION TIME (SECONDS)**

**129-01 THROUGH 129-XX**

**ENERGY REQUIREMENTS VERSUS MISSION TIME  
FOR SHUTTLE EFFECTORS: SRM - TVC**

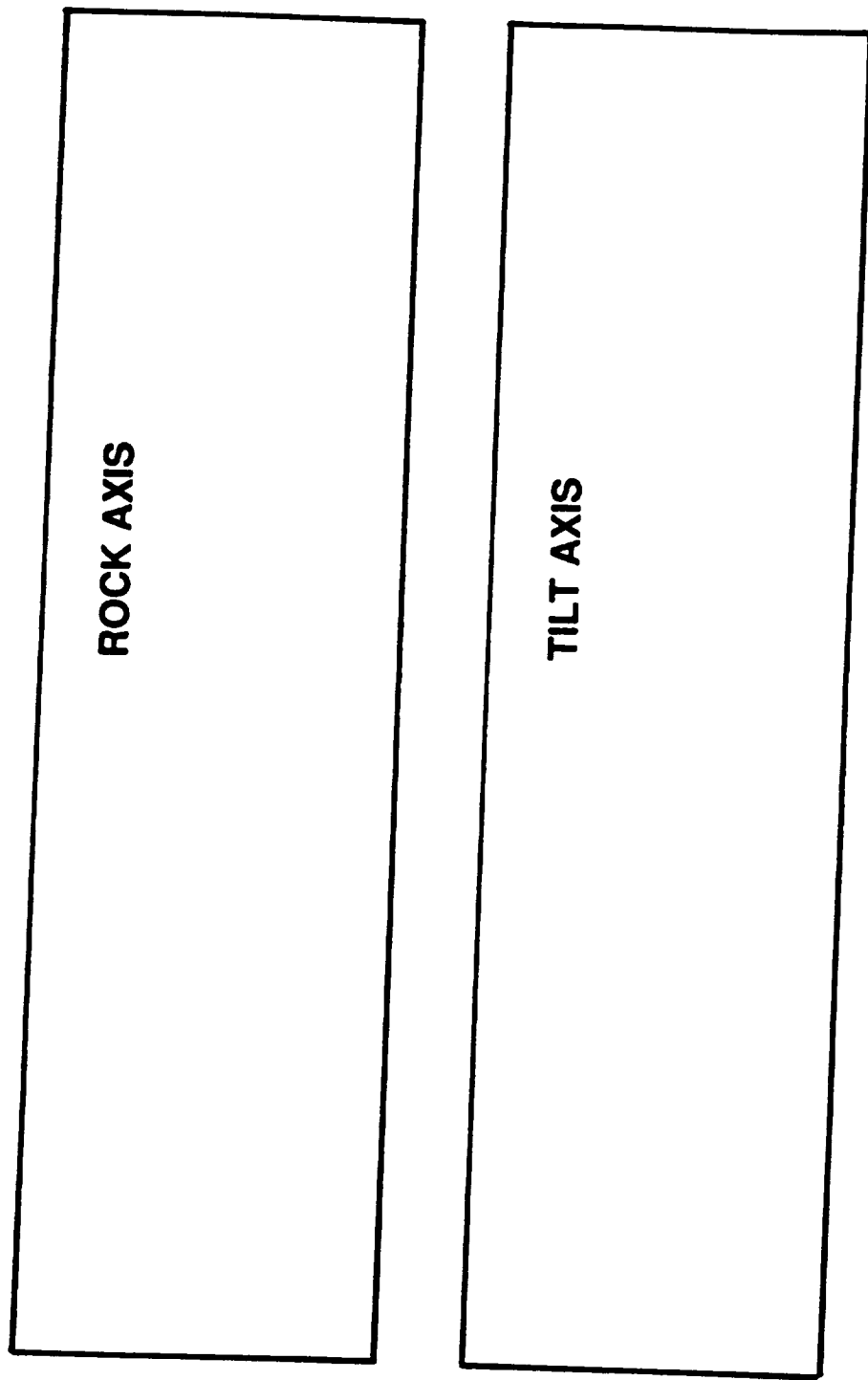

**ENERGY  
REQUIRED  
(HPS)**

**MISSION TIME (SECONDS)**

**130-01 THROUGH 130-XX**



**POWER REQUIREMENTS VERSUS MISSION TIME FOR  
SHUTTLE EFFECTORS: SSME - TVC**

---

**PITCH AXIS OF SSME 1 (UPPER SSME)**

**PITCH AXIS OF SSME 2 OR 3 (LOWER SSME'S)**

**YAW AXIS OF SSME 1, 2 OR 3**

**POWER  
REQUIRED  
(HP)**

**MISSION TIME (SECONDS)**

**131-01 THROUGH 131-XX**

**ENERGY REQUIREMENTS VERSUS MISSION TIME FOR SHUTTLE EFFECTORS: SSME-TVC**

---

PITCH AXIS OF SSME 1 (UPPER SSME)

PITCH AXIS OF SSME 2 OR 3 (LOWER SSME'S)

YAW AXIS OF SSME 1, 2 OR 3

**ENERGY  
REQUIRED  
(HPS)**

**MISSION TIME (SECONDS)**

**132-01 THROUGH 132-XX**



**POWER REQUIREMENTS VERSUS MISSION TIME FOR  
SHUTTLE EFFECTORS: ELEVONS**

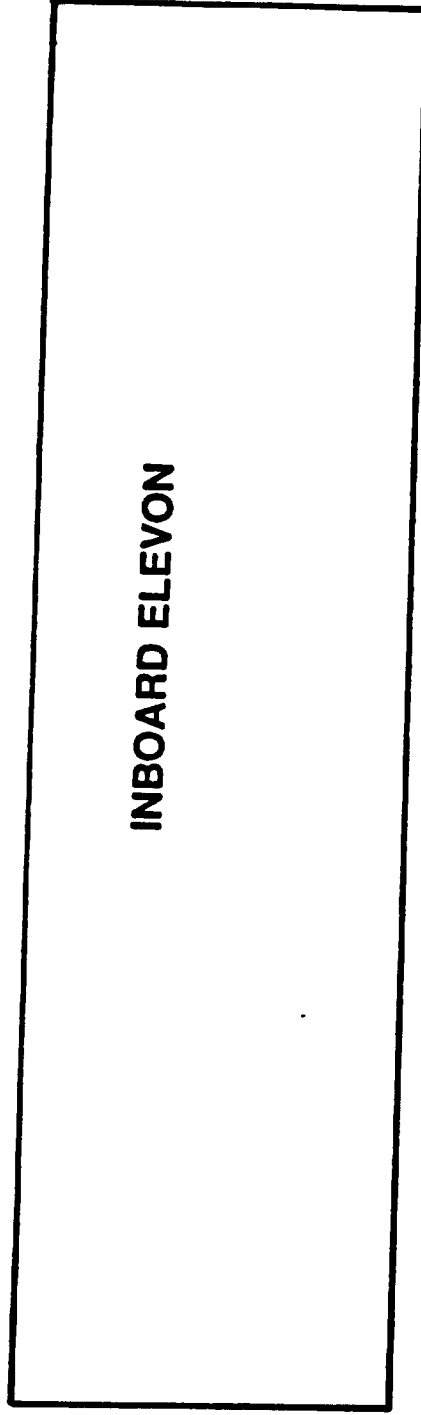

**INBOARD ELEVON**

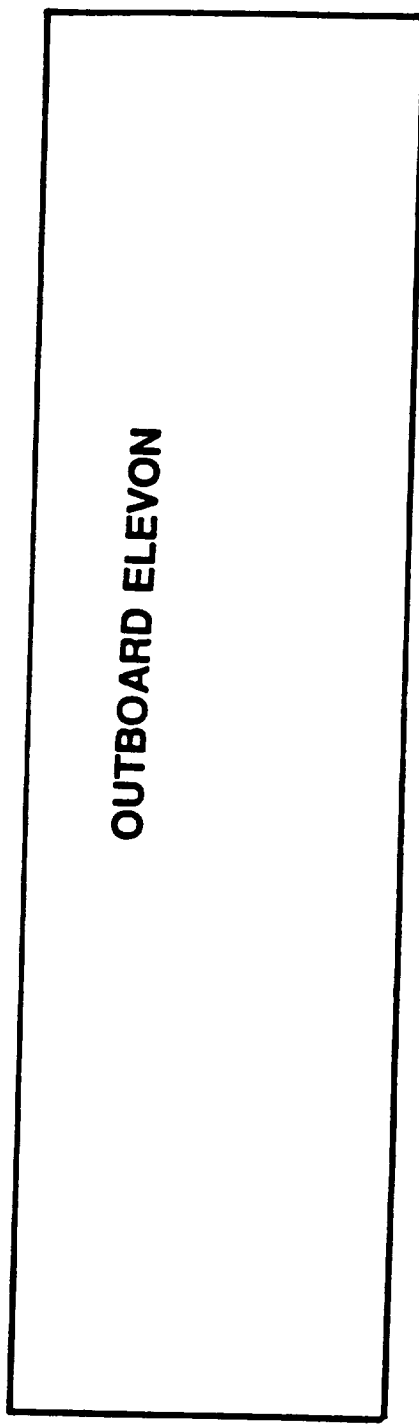

**OUTBOARD ELEVON**

**POWER  
REQUIRED  
(HP)**

**MISSION TIME (SECONDS)**

**133-01 THROUGH 133-XX**

**ENERGY REQUIREMENTS VERSUS MISSION TIME  
FOR SHUTTLE EFFECTORS: ELEVONS**

---

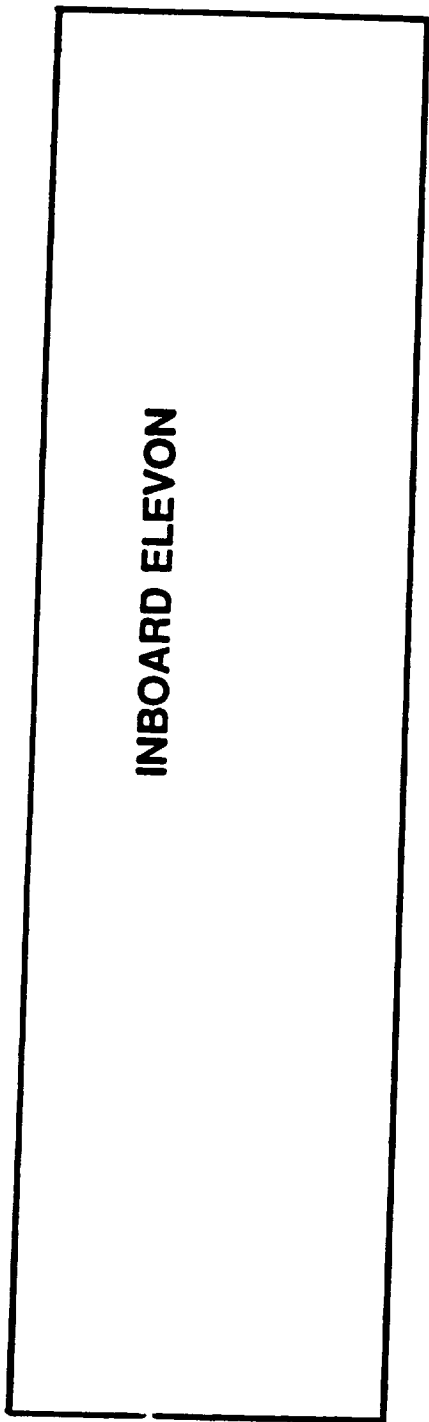

**INBOARD ELEVON**

**ENERGY  
REQUIRED  
(HPS)**

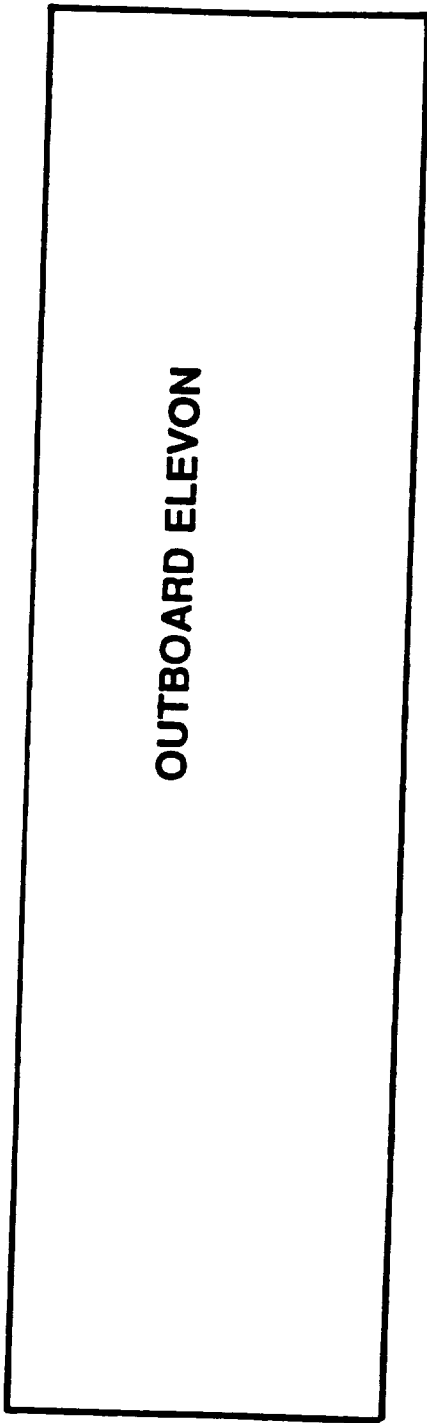

**OUTBOARD ELEVON**

**MISSION TIME (SECONDS)**

**134-01 THROUGH 134-XX**



**POWER REQUIREMENTS VERSUS MISSION TIME  
FOR SHUTTLE EFFECTORS: RUDDER, SPEEDBRAKE AND BODYFLAP**

---

**RUDDER**

**SPEEDBRAKE**

**BODYFLAP**

**POWER  
REQUIRED  
(HP)**

**MISSION TIME (SECONDS)**

**135-01 THROUGH 135-XX**



**ENERGY REQUIREMENTS VERSUS MISSION TIME FOR  
SHUTTLE EFFECTORS: RUDDER, SPEEDBRAKE AND BODYFLAP**

---

<b>ENERGY REQUIRED (HPS)</b>	<b>RUDDER</b>
<b>SPEEDBRAKE</b>	
<b>BODYFLAP</b>	

**MISSION TIME (SECONDS)**

**136-01 THROUGH 136-XX**





5.0 POWER EFFICIENCY AND LOSSES OF ELA EFFECTOR SYSTEMS



## **POWER EFFICIENCY AND LOSSES OF ELA EFFECTOR SYSTEMS**

---

- **THE CALCULATION OF POWER EFFICIENCY AND LOSSES OF THE EQUIPMENT (OR COMPONENTS) IN THE ELA EFFECTOR SYSTEMS IS NEEDED IN ORDER TO DETERMINE: (1) POWER AND ENERGY REQUIREMENTS FOR THE ELA POWER SOURCES (SEE SECTION 6.0), AND (2) THERMAL CONTROL REQUIREMENTS FOR THE ELA EQUIPMENT.**
- **THE COMPONENTS OF EACH ELA EFFECTOR SYSTEM INCLUDE: SERVO-FDI CONTROLLERS, POWER CONTROLLERS, ACTUATOR ASSEMBLY, EFFECTOR, POWER SOURCE AND CABLING.**
- **THE METHODS, DATA AND RESULTS FROM THE SUBJECT CALCULATION ARE PRESENTED IN THIS SECTION AS FOLLOWS.**
  - **METHOD: SEE CHART 139 .**
  - **DATA: SEE CHART 140 .**
  - **RESULTS: SEE CHART 141 .**

# **METHODS FOR CALCULATION OF POWER EFFICIENCY AND LOSSES**

---

**(TO BE PRESENTED IN FINAL REPORT)**

**139 - 01 THROUGH 139- XX**



**INPUT DATA FOR CALCULATION OF POWER EFFICIENCY AND LOSSES**

---

**(TO BE PRESENTED IN FINAL REPORT)**

**140-01 THROUGH 140-XX**



**CALCULATION RESULTS: POWER EFFICIENCY AND LOSSES OF EQUIPMENT IN SHUTTLE ELA EFFECTOR SYSTEMS**

EFFECTOR SYSTEM	POWER EFFICIENCY, PERCENT (OR POWER LOSS, KW)						
	SERVO-FDI CONTROLLERS	POWER CONTROLLERS	ACTUATOR ASSEMBLY	EFFECTOR	POWER SOURCE	CABLING	TOTAL SYSTEM
SRM - TVC SSME - TVC SSME PROPELLANT VALVE ET UMBILICAL RETRACT OMS - TVC ELEVON RUDDER SPEEDBRAKE BODYFLAP MAIN - GEAR UPLOCK MAIN - GEAR STRUT NOSE - GEAR UPLOCK NOSE - GEAR STRUT NOSE WHEEL STEERING BRAKE							
<b>(TO BE PRESENTED IN FINAL REPORT)</b>							

141-01 THROUGH 141-XX



---

## 6.0 POWER AND ENERGY REQUIREMENTS FOR ELA POWER SOURCES





## **POWER AND ENERGY REQUIREMENTS FOR ELA POWER SOURCES**

---

- **THE SUBJECT POWER AND ENERGY REQUIREMENTS ARE NEEDED IN ORDER TO DESIGN THE POWER SOURCES FOR THE ELA EFFECTOR SYSTEMS IN THE ORBITER AND EACH OF THE TWO SRB'S. A POWER SOURCE IS A SYSTEM WHICH MAY CONTAIN REDUNDANT ELEMENTS SUCH AS BATTERIES, FUEL CELLS, ETC. TO PROVIDE ELECTRICAL POWER FOR THE ELA EFFECTOR SYSTEMS.**
- **THE REQUIREMENTS INCLUDE: (1) PEAK POWER AND THE DURATION OF THE PEAK, (2) AVERAGE POWER AND THE OPERATING DURATION, (3) TOTAL ENERGY FOR THE MISSION, AND (4) POWER AND ENERGY DEMANDS AS FUNCTIONS OF MISSION TIME (DUTY CYCLES).**
- **THE METHODS, DATA AND RESULTS FROM THE CALCULATION OF THESE REQUIREMENTS ARE PRESENTED IN THIS SECTION AS FOLLOWS.**
  - **METHODS: SEE CHART 144 .**
  - **DATA: SEE CHART 145 .**
  - **RESULTS: SEE CHARTS 146 THROUGH 149 .**

## METHOD FOR CALCULATION OF POWER SOURCE REQUIREMENTS

THE POWER AND ENERGY REQUIREMENTS FOR ELA POWER SOURCE IN THE ORBITER (OR IN EACH ONE OF THE TWO SRB'S) ARE CALCULATED AS FOLLOWS.

- POWER REQUIREMENTS

$$\boxed{\text{POWER REQUIRED FOR ELA POWER SOURCE IN ORBITER (SRB)}} = \boxed{\text{SUM OF POWER REQUIREMENTS FOR EFFECTORS IN ORBITER (SRB)}} + \boxed{\text{SUM OF POWER LOSSES OF THE ELA EFFECTOR SYSTEMS IN ORBITER (SRB)}}$$

- ENERGY REQUIREMENTS

$$\boxed{\text{ENERGY REQUIRED FOR ELA POWER SOURCE IN ORBITER (SRB)}} = \boxed{\text{SUM OF ENERGY REQUIREMENTS FOR EFFECTORS IN ORBITER (SRB)}} + \boxed{\text{SUM OF ENERGY LOSSES OF THE ELA EFFECTOR SYSTEMS IN ORBITER (SRB)}}$$

THE ENERGY LOSS IN AN EFFECTOR SYSTEM IS THE INTEGRAL OF THE POWER LOSS IN THAT SYSTEM.

## **INPUT DATA FOR CALCULATION OF POWER SOURCE REQUIREMENTS**

---

**THE INPUT DATA USED FOR THE CALCULATION OF POWER AND ENERGY REQUIREMENTS FOR THE POWER SOURCES IN THE ORBITER AND IN EACH SRB ARE AS FOLLOWS.**

- **POWER AND ENERGY REQUIREMENTS FOR THE INDIVIDUAL SHUTTLE EFFECTOR SYSTEMS: SEE SECTION 4.0.**
- **POWER AND ENERGY LOSSES OF THE ELA EFFECTOR SYSTEM EQUIPMENT: SEE SECTION 5.0.**

**CALCULATION RESULTS: POWER AND ENERGY REQUIREMENTS FOR  
ELA POWER SOURCES**

ELA POWER SOURCE	POWER REQUIREMENTS			ENERGY REQUIREMENTS	
	PEAK POWER, KW (DURATION, SECONDS)	AVERAGE POWER, KW (DURATION, MINUTES)	POWER VERSUS MISSION TIME	TOTAL ENERGY REQUIRED FOR THE MISSION, KWH	ENERGY VERSUS MISSION TIME
ORBITER			SEE CHART 147		SEE CHART 148
EACH SRB			SEE CHART 149		SEE CHART 149

**(TO BE PRESENTED IN FINAL REPORT)**

- NOTES: (1) THE POWER AND ENERGY REQUIREMENTS FOR THE ELA EFFECTOR SYSTEMS DO NOT INCLUDE THOSE FOR THE EXISTING SHUTTLE AVIONICS. FOR EXAMPLE, THE EXISTING ORBITER AVIONICS REQUIRE AN AVERAGE POWER OF ABOUT 11.3 KILOWATTS (KW).**
- (2) THE ABOVE REQUIREMENTS ARE INDEPENDENT OF THE REDUNDANCY OF THE POWER SOURCE. FOR EXAMPLE, EACH BATTERY OF A QUAD-REDUNDANT (FAIL OPERATIONAL/FAIL SAFE) POWER SOURCE WITH FOUR BATTERIES SHALL MEET 50 PERCENT OF THE REQUIREMENTS. (100 PERCENT FOR REMAINING TWO BATTERIES)**

**POWER REQUIREMENTS VERSUS MISSION TIME FOR ORBITER ELA POWER SOURCE**

---

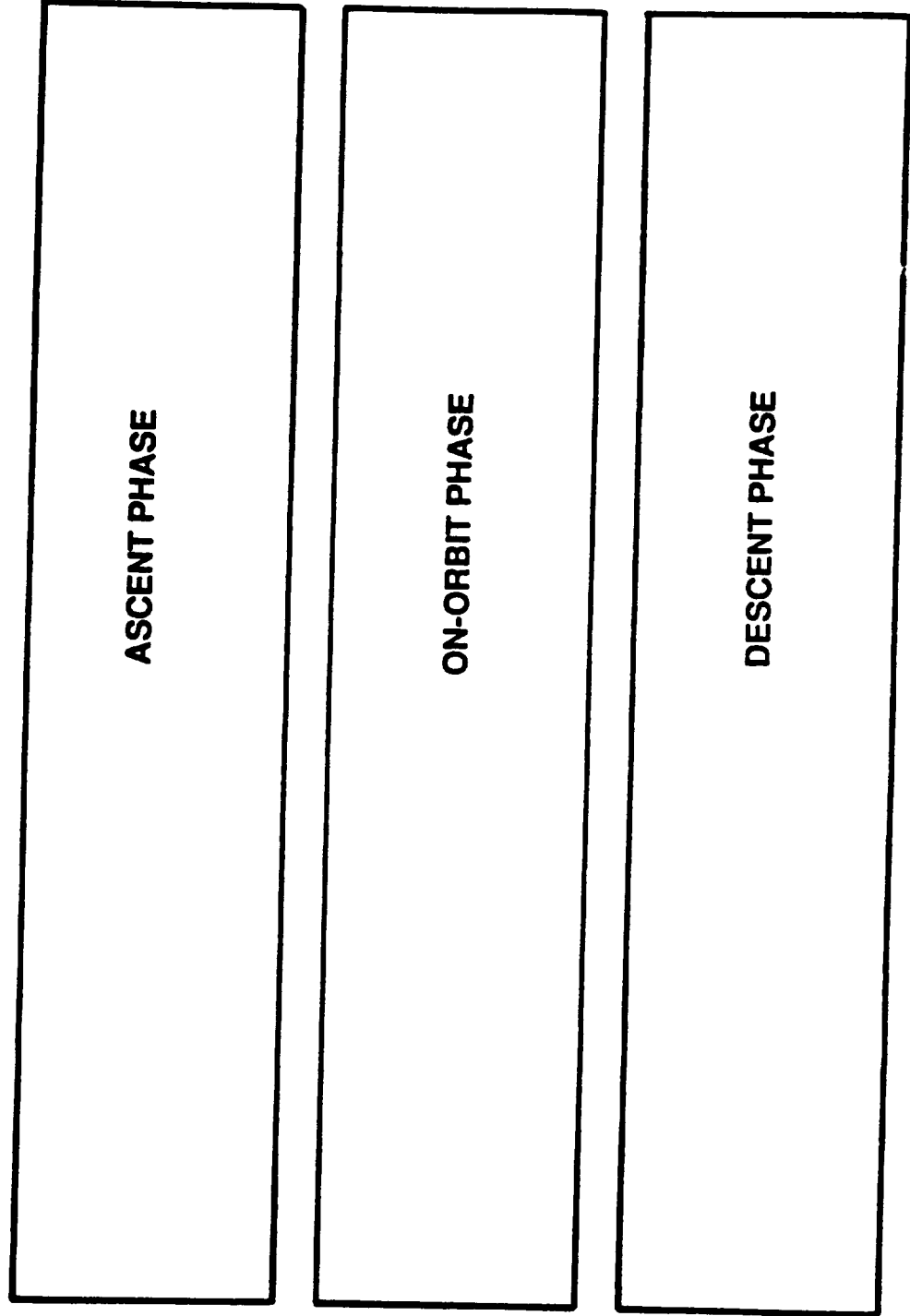

**MISSION TIME (SECONDS)**

**147-01 THROUGH 147-XX**

**ENERGY REQUIREMENTS VERSUS MISSION TIME FOR ORBITER ELA POWER SOURCE**

---

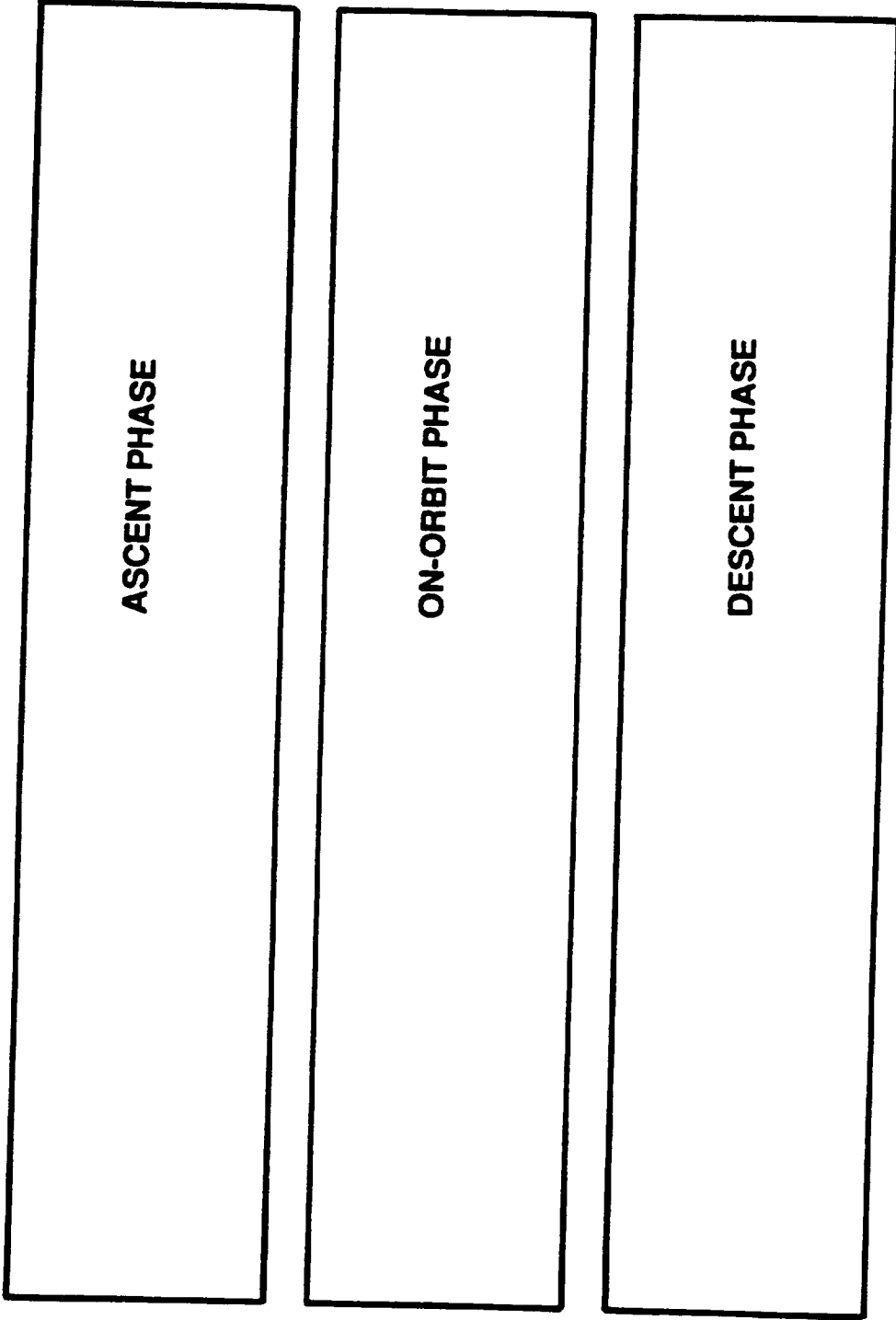

**ENERGY  
REQUIRED  
(KWH)**

**MISSION TIME (SECONDS)**

**148-01 THROUGH 148-XX**



**POWER AND ENERGY REQUIREMENTS VERSUS MISSION TIME FOR SRB ELA POWER SOURCE**

---

**POWER  
REQUIRED  
(KW)**

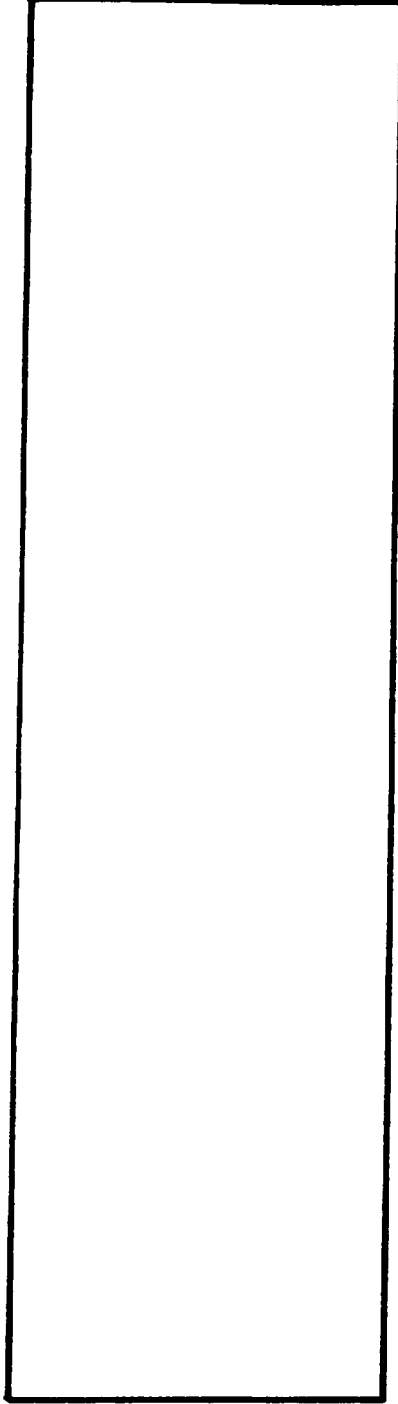

**ENERGY  
REQUIRED  
(KWH)**

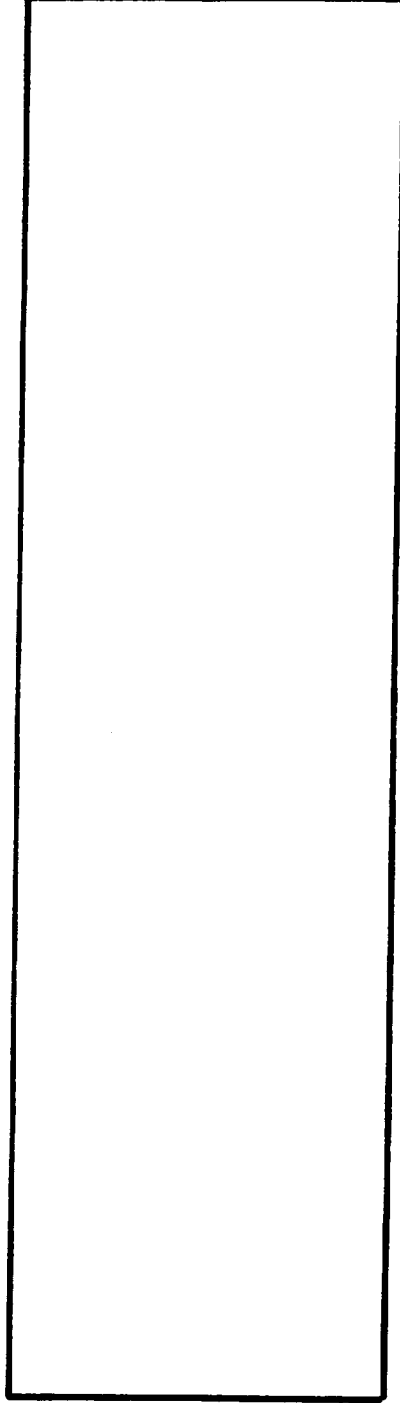

**MISSION TIME (SECONDS)**

**149-01 THROUGH 149-XX**





---

**7.0 CONCLUSIONS AND RECOMMENDATIONS**

**(TO BE PRESENTED IN FINAL REPORT, 9/30/93)**





# Report Documentation Page

1. Report No.		2. Government Accession No.		3. Recipient's Catalog No.	
4. Title and Subtitle <b>Strategic Avionics Technology Definition Studies Subtask 3 - 1A, Electrical Actuation (ELA) Systems Interim Report</b>				5. Report Date <b>June 30, 1993</b>	
				6. Performing Organization Code	
7. Author(s) <b>Ben T. F. Lum Charles Pond William McDermott</b>				8. Performing Organization Report No. <b>SSD93D0354</b>	
				10. Work Unit No.	
9. Performing Organization Name and Address <b>Rockwell International Space Systems Division 12214 Lakewood Blvd. Downey, Ca. 90241</b>				11. Contract or Grant No. <b>NAS9-18880</b>	
				13. Type of Report and Period Covered <b>Interim 1993</b>	
12. Sponsoring Agency Name and Address <b>National Aeronautics and Space Administration Johnson Space Center Houston, Texas 77058</b>				14. Sponsoring Agency Code	
15. Supplementary Notes					
16. Abstract <p>Electrical Actuator (ELA) power efficiency and requirements are examined for space system application. Requirements for Space Shuttle effector systems are presented, along with preliminary ELA trades and selection to form a preliminary ELA system baseline. Power and energy requirements for this baseline ELA system are applicable to the Space Shuttle and similar space vehicles.</p>					
17. Key Words (Suggested by Author(s)) <b>Electrical Actuation, ELA, Electro-Mechanical Actuators, EMA, Actuation, Space Shuttle, effector</b>				18. Distribution Statement <b>Unclassified - Unlimited</b>	
19. Security Classif. (of this report) <b>Unclassified</b>		20. Security Classif. (of this page) <b>Unclassified</b>		21. No. of pages <b>150</b>	22. Price

