

# **Space Transfer Concepts and Analyses for Exploration Missions**

**Contract NAS8-37857**

**Phase 3**

**Final Report**

**June 1993**

**Boeing Defense & Space Group  
Civil Space Product Development  
Huntsville, Alabama**

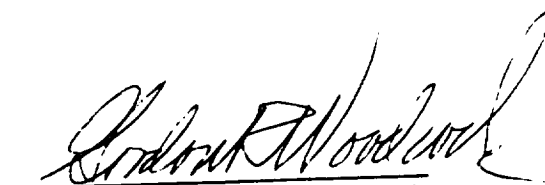

**Gordon R. Woodcock  
Study Manager**

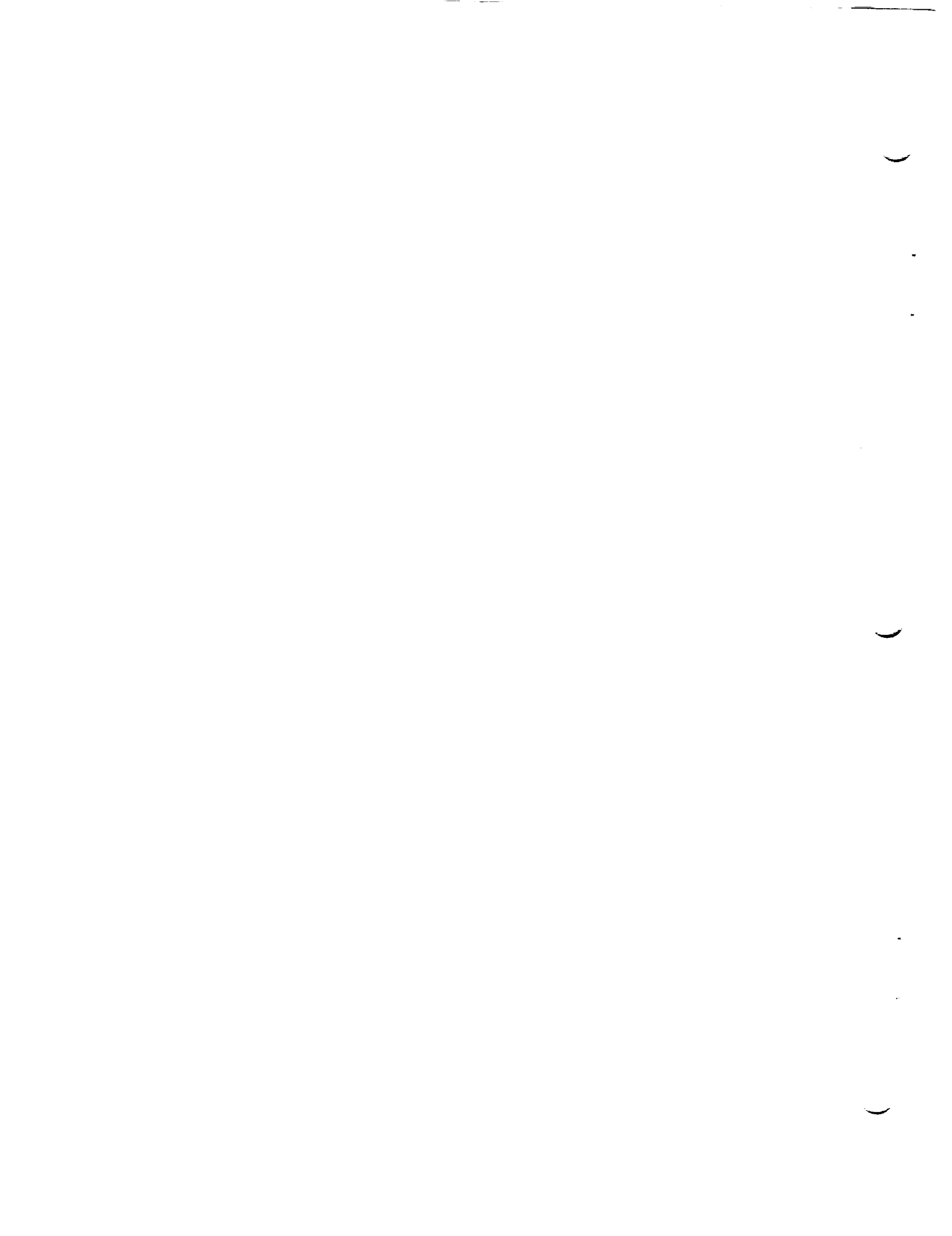

# BOEING

CAGE CODE 81205

THIS DOCUMENT IS:

CONTROLLED BY

ALL REVISIONS TO THIS DOCUMENT SHALL BE APPROVED BY THE ABOVE ORGANIZATION PRIOR TO RELEASE

PREPARED UNDER

- CONTRACT NO. NAS8-37857
- IR&D
- OTHER

PREPARED ON

FILED UNDER

DOCUMENT NO. D615-10062-2

MODEL

TITLE Space Transfer Concepts and Analyses for Exploration Mission, Phase 3, Final Report, June 1993

- THE INFORMATION CONTAINED HEREIN IS NOT PROPRIETARY.
- THE INFORMATION CONTAINED HEREIN IS PROPRIETARY TO THE BOEING COMPANY AND SHALL NOT BE REPRODUCED OR DISCLOSED IN WHOLE OR IN PART OR USED FOR ANY DESIGN OR MANUFACTURE EXCEPT WHEN SUCH USER POSSESSES DIRECT, WRITTEN AUTHORIZATION FROM THE BOEING COMPANY.

ORIGINAL RELEASE DATE 93-06-29, S. Daugette

ISSUE NO.	TO	DATE
-----------	----	------

ADDITIONAL LIMITATIONS IMPOSED ON THIS DOCUMENT WILL BE FOUND ON A SEPARATE LIMITATIONS PAGE.

PREPARED BY	STCAEM Team	2-1222	93-6-22
CHECKED BY	Irwin E. Vas <i>Irwin E. Vas</i>	2-1222	93-6-22
SUPERVISED BY	Gordon R. Woodcock <i>Gordon R. Woodcock</i>	2-1222	93-6-22
APPROVED BY	J. E. Kingsbury	2-1220	93-6-22

*J. E. Kingsbury*  
 SIGNATURE  
 J. E. Kingsbury

ORGN

6.22.93  
DATE





**FOREWORD**

The study entitled "Space Transfer Concepts and Analyses for Exploration Missions (STCAEM)" was performed by Boeing Defense and Space Group, Huntsville, Alabama, for the George C. Marshall Space Flight Center (MSFC). The activities reported herein were carried out under Technical Directives 10, 11, 13, 14, and 15 during the period October 1991 through December 1992. (TD-12, an investigation of laser-electric orbit transfer, was separately reported.) The Boeing program manager was Gordon Woodcock and the MSFC Contracting Officer's Technical Representative was Alan Adams. The task activities for the studies carried out under these Technical Directives were performed by M. Appleby, P. Buddington, J. Burruss, S. Capps, M. Cupples, S. Doll, B. Donahue, D. Eder, R. Fowler, D. Harrison, K. Imtiaz, S. LeDoux, J. McGhee, N. Rao, and T. Ruff.

## CONTENTS

	Page
1.0 INTRODUCTION .....	1
1.1 Study Scope .....	1
1.2 Report Scope .....	1
1.3 The Premise of the First Lunar Outpost .....	1
2.0 EXECUTIVE SUMMARY .....	3
2.1 The FLO Concept .....	3
2.1.1 FLO Baseline Development .....	6
2.1.2 FLO Trades and Analyses .....	8
2.2 Mars Transportation Carry-Over Tasks .....	14
2.2.1 Launch Vehicle Size Trade .....	14
2.2.2 Lunar Dress Rehearsal Analysis .....	15
2.2.3 MEV Options .....	15
3.0 FIRST LUNAR OUTPOST HABITATION SYSTEM	
INTEGRATED BASELINE .....	16
3.1 Introduction to FLO Habitation Study .....	16
3.2 Top Level Requirements .....	16
3.3 Design Approach .....	16
3.4 History of FLO Habitation System Integrated Baseline .....	18
3.5 Habitat Configuration .....	19
3.6 Preliminary Concepts for First Lunar Outpost .....	19
3.6.1 Delta One ( $\Delta 1$ ) Changes .....	23
3.6.2 Delta Two ( $\Delta 2$ ) Changes .....	23
3.6.3 Delta Three ( $\Delta 3$ ) Changes .....	24
3.6.4 Development of Integrated Baseline .....	24
3.6.5 Internal Systems Location For Integrated Baseline .....	25
3.7 External Configuration for Integrated Baseline .....	30
3.7.1 Integration of External Systems to Hab Module .....	30
3.7.2 External Systems Location .....	32
3.7.3 External Access .....	32
3.8 Integrated Baseline Mass Summary .....	34
3.9 Consumables Stowage Volume Assessment .....	34
3.10 Preliminary Structural Evaluation .....	36
3.10.1 Loads and Reactions .....	37
3.10.2 Weight Reduction Efforts .....	39
3.10.3 Hyperbaric vs. Nonhyperbaric - Structural Evaluation ..	41
3.10.4 FLO External Structure .....	43
3.11 Human Support .....	44
3.11.1 ECLS .....	44
3.11.2 Food Supply .....	48
3.11.3 Medical Support .....	48
3.11.4 Hyperbaric Treatment .....	49
3.11.5 Crew Systems .....	50
3.12 Communications and Data Management Systems .....	51
3.13 Power System Sizing/Analysis Summary .....	52
3.13.1 Introduction and Background .....	52
3.13.2 Power Requirements .....	53
3.13.3 Power and Heat Rejection System Sizing .....	58
3.13.4 Subsystem Level Trade Studies Support .....	66

## CONTENTS (Continued)

	Page
3.14 Airlock System .....	67
3.15 Consumables .....	68
3.16 Internal Science .....	69
4.0 SSF DEVIATION TRADE: ALTERNATE SUBSYSTEMS .....	71
4.1 Introduction .....	71
4.2 Alternate Subsystems Trade Summary .....	72
4.2.1 Open vs Closed Water Trade .....	72
4.2.2 Heat Pumped vs Non-Heat Pumped Heat Rejection System (HRS) Trade .....	75
4.2.3 Possible Uses of Crew Lander Fuel Cell Water Trade ..	77
4.2.4 Inflatable Hyperbaric Chamber Concept .....	80
4.2.5 Open vs Closed Power System Trade .....	80
4.2.6 Reduced Power Processing Levels .....	82
4.2.7 Fixed vs Articulating Arrays .....	82
4.2.8 Off-load Some First Visit Consumables to Crew Lander .....	85
4.2.9 Deferral of Full Power Capability Until Arrival of First Crew .....	86
4.3 SSF Deviation - FLO Habitation System Trades .....	87
4.3.1 Alternate Internal Pressures .....	87
4.3.2 Alternate Materials .....	90
4.4 Inflatable Structures .....	93
4.4.1 Advantages and Potential Applications .....	93
4.4.2 History of Inflatables for Aerospace Applications .....	94
4.4.3 Available Materials and Construction .....	94
4.4.4 Disadvantages and Concerns Regarding FLO Application .....	95
4.4.5 Simplified Comparison of Inflatable vs. Aluminum Structure .....	96
4.4.6 Conclusions and Recommendations .....	96
5.0 RADIATION ANALYSIS .....	97
5.1 Introduction .....	97
5.2 Models and Methods .....	97
5.2.1 Background and Description of Analyses .....	97
5.2.2 Natural Radiation Environment Models .....	98
5.2.3 The Boeing Radiation Exposure Model .....	99
5.3 Analysis Results .....	99
5.3.1 Boeing-Lunar Crew Return Vehicle .....	99
5.3.2 First Lunar Outpost (Habitat and Storm-Shelter Evaluations) .....	100
5.4 Conclusion .....	111
6.0 RESUPPLY AND LOGISTICS .....	112
6.1 Introduction .....	112
6.2 Small Package Logistics .....	112
6.3 Logistics Modules and Spares .....	116
6.4 Impacts to Outpost Design and Operations .....	120
6.5 Evolution and Operations Using Planned Cargo Flights .....	121

## CONTENTS (Continued)

	Page
7.0 FLO ALTERNATIVES .....	125
7.1 Introduction .....	125
7.2 FLO Alternative Configurations .....	125
7.3 Airlock alternative Configurations .....	132
8.0 AVIONICS COMMONALITY ASSESSMENT .....	138
8.1 Introduction .....	138
8.2 Avionics Functions .....	139
8.2.1 Avionics Sub-Functions .....	140
8.3 Specific Vehicle Avionics Functions .....	141
8.4 Avionics Commonality Analysis .....	142
8.4.1 Case-1: NLS and FLO .....	142
8.4.2 Case-2: SSF-Hab and FLO-Hab .....	142
8.4.3 Overall NLS, SSF, and FLO Commonality .....	148
8.5 Key Technologies and Their Priority .....	148
8.6 Summary and Conclusions .....	150
8.7 Data Sources .....	150
9.0 LAUNCH VEHICLE SIZE TRADE AND RELATED SUBJECTS .....	151
9.1 Assembly Options and Concepts .....	151
9.1.1 Shroud Packaging .....	157
9.1.2 Length Sizing by Pad-Wind Loading .....	159
9.2 Platform Concepts .....	164
9.2.1 I-Beam Platform .....	166
9.2.2 Saddle Platform .....	166
9.3 Meteoroid/Orbital Debris Program (MOD) .....	171
9.4 Delta-V and Descent Analysis .....	172
9.4.1 Introduction .....	172
9.4.2 Delta-V Sets .....	173
9.4.3 Mars Parking Orbit Descriptions .....	178
9.4.4 2016 TEI Reduction .....	179
9.4.5 Low-L/D MEV Landing Site Access .....	182
9.4.6 High-L/D MEV Landing Site Access .....	184
9.4.7 Nuclear Reactor Disposal .....	186
9.4.8 Summary .....	187
10.0 LUNAR DRESS REHEARSAL ANALYSIS .....	188
10.1 Introduction .....	188
10.1.1 Specific Areas of Investigation .....	188
10.2 Mission Profile .....	189
10.2.1 Earth-Moon-Earth Transfer .....	189
10.2.2 Reuse .....	189
10.2.3 Abort Modes .....	190
10.3 Validation of Mars Mission Unique Hardware .....	190
10.4 Space Transfer Vehicle Description .....	190
10.4.1 Transfer Vehicle Systems .....	191
10.4.2 Transfer Vehicle Performance and Mass .....	192
10.4.3 Transfer Vehicle Propulsion System .....	192
10.4.4 Transfer Vehicle Crew Systems .....	194
10.4.5 Radiation Sources .....	194

## CONTENTS (Concluded)

	Page
10.4.6 Transfer Vehicle Attitude Control Propulsion System ..	195
10.4.7 Transfer Vehicle Truss Strongback/Interconnect System (Structures) .....	195
10.4.8 Earth-to-Orbit Vehicle Flight Manifests .....	196
10.5 Validation of Mars Mission Unique Operations .....	196
10.5.1 On-Orbit Assembly/Assembly Platform .....	196
10.5.2 Outbound Flight/Lunar Arrival/Lunar Orbit .....	197
10.5.3 Surface Operations .....	198
10.5.4 Inbound Flight .....	198
10.5.5 Earth Return .....	198
10.6 Surface Manifest .....	199
10.7 Surface Habitat System Delivery .....	200
10.7.1 Lunar Lander Application .....	200
10.7.2 Lander Mass and Performance .....	200
10.8 Mars Ascent Stage Checkout Test at the Moon .....	201
10.8.1 Flight Plan for Propulsion and Flight Control Systems ..	201
10.8.2 Cryogenic Propellant Thermal Insulation Validation ..	202
10.8.3 Mars Descent Aerobrake Qualification Flight .....	203
10.9 Lunar Dress Rehearsal Mission Schedules .....	203
10.10 Follow on Lunar Missions .....	207
11.0 MARS EXCURSION VEHICLE OPTIONS .....	207
11.1 Symmetric Biconic Concepts .....	207
11.1.1 Parametric Study .....	210
11.1.2 Additional Studies .....	216
11.1.3 Biconic MEV Structural Analysis .....	220
11.1.4 MEV Biconic Lander .....	220
11.1.5 Biconic MEV Summary .....	221
11.2 Structural Analysis - Low L/D Aerobrake .....	221
11.2.1 Background .....	224
11.2.2 Finite Element Model .....	224
11.2.3 Loads .....	227
11.2.4 Analysis Results .....	228
11.2.5 Conclusions .....	233
12.0 CONCLUDING REMARKS .....	234
REFERENCES .....	234
APPENDIX A Boeing Mass Breakdown Details .....	A-1
APPENDIX B Boeing and MSFC System Mass and Rational .....	B-1
APPENDIX C Power Budget - Dormant Operation .....	C-1
APPENDIX D Power Budget Details - Crew Onboard Operations .....	D-1
APPENDIX E Surface Mission Timeline .....	E-1
APPENDIX F FLO Habitation System Critical Spares Assessment .....	F-1
APPENDIX G Proposed Evaluation Criteria .....	G-1

**FIGURES**

	<u>Page</u>
2.1 First Lunar Outpost Configuration .....	4
2-2. First Lunar Outpost Habitat, Plan View .....	5
2-3. Integrated Baseline Concept Description, Mass Properties Summary .....	6
2-4. Boeing STCAEM Lunar Outpost Habitat, Concept Mass History .....	8
2-5. Lunar Habitation Radiation Assessment Configuration - Concept M .....	11
2-6. FLO Hab Unloader Option 1 .....	12
2-7. FLO Ellipsoidal Habitat Option .....	13
3-1. Outpost Habitat Methodology .....	17
3-2. STCAEM TD 13 FLO Habitat Heritage .....	18
3-3. Lunar Hab Airlock Configuration Options .....	20
3-4. Lunar Outpost Configuration Airlock Alternatives and Assessment .....	21
3-5. First Lunar Outpost Habitat, Plan View .....	26
3-6. First Lunar Outpost Habitat, Section View .....	27
3-7. Outpost Hab External Interfaces .....	31
3-8. First Lunar Outpost Configuration .....	31
3-9. First Lunar Outpost Configuration .....	32
3-10. Resupply and Logistics .....	33
3-11. First Lunar Outpost Configuration .....	34
3-12. Integrated Baseline Concept Description, Mass Properties Summary .....	35
3-13. Boeing STCAEM Lunar Outpost Habitat, Concept Mass History ..	35
3-14. Study Results .....	37
3-15. SSF Hab Module - General Information .....	38
3-16. SSF Hab Module - Attachment Point Reactions .....	38
3-17. Lunar Hab Module - Launch Loading (MSFC) .....	39

## FIGURES (Continued)

	<u>Page</u>
3-18. Maximum Reactions and Dynamic Amplification Factors . . . . .	40
3-19. Lunar Hab Module Summary of Launch Reactant Loads . . . . .	40
3-20. SSF Hab Module - Rack Design Load Factors . . . . .	41
3-21. Lunar Hab Airlock Configuration Options . . . . .	42
3-22. Hyperbaric vs. Nonhyperbaric Structural Mass Comparison . . . . .	43
3-23. External Structure Mass Estimate . . . . .	44
3-24. Life Support System Open to Closed Loop Crossover . . . . .	46
3-25. FLO Habitation System, ECLSS - Subsystem Masses . . . . .	47
3-26. FLO Habitation System, Crew Systems Masses . . . . .	50
3-27. FLO Communication and Tracking . . . . .	51
3-28. Lunar Campsite Overall Power Budget Summary - $\Delta 1$ . . . . .	53
3-29. Lunar Campsite Overall Power Budget Summary - $\Delta 2$ . . . . .	54
3-30. Power Summary Changes . . . . .	55
3-31. FLO Reference Power Budget Summary . . . . .	55
3-32. Fan Power Requirement Deltas for Reference FLO . . . . .	56
3-33. Lunar Campsite Airlock/EVA Systems Power Budget Summary - A&G Nonhyperbaric . . . . .	57
3-34. Reference Top Level Power System Mass Summary . . . . .	61
3-35. Reference Heat Pumped System Functional Schematic . . . . .	63
3-36. Heat Pump Working Fluid Options . . . . .	65
3-37. External Heat Rejection System Mass Summary . . . . .	66
3-38. FLO Habitation System, Crewlock/EVAS Status . . . . .	68
3-39. FLO Habitation System, Consumables . . . . .	69
3-40. FLO Habitation System, Internal Science Support Mass . . . . .	70
4-1. Mass and Power Summary for Referenced Closed Water Loop System . . . . .	73
4-2. Mass and Power Summary for Open Water Loop System Option . . . . .	73

## FIGURES (Continued)

	<u>Page</u>
4-3. Radiator Area vs. Optical Surface Properties . . . . .	74
4-4. Radiator Mass and Area vs. Optical Surface Properties . . . . .	75
4-5. Operational Scenario for Inflatable Hyperbaric Chamber . . . . .	78
4-6. ILC Dover Collapsible Hyperbaric Chamber . . . . .	79
4-7. Inflatable Hyperbaric Chambers Issues to be Addressed . . . . .	79
4-8. Reference FLO Electrical Power System Functional Schematic . . . . .	81
4-9. Percent of Articulated Solar Array System Power Output vs. Array Elevation Angle . . . . .	83
4-10. Fixed Solar Array Surface Area vs. Array Elevation Angle . . . . .	83
4-11. Possible Fixed Array Configuration and Preliminary Mass Estimate . . . . .	84
4-12. Deployment Scheme for Fixed Array Structure . . . . .	84
4-13. Array Blanket Deployment Scheme for Fixed Concept . . . . .	85
4-14. Summary of Advantages and Disadvantages of Fixed Solar Array Concept . . . . .	85
4-15. Variation in Oxygen Concentration . . . . .	87
4-16. NASA Flammability Test Results . . . . .	89
4-17. SSF Structural Materials . . . . .	91
5-1. NASA Limits . . . . .	99
5-2. LCRV Dose Equivalent in Rem/Event . . . . .	100
5-3. Lunar Habitat Radiation Assessment Configuration . . . . .	101
5-4. Radiation Storm-Shelter Configuration . . . . .	101
5-5. Maximum and Minimum Calculated Blood-Forming Organ Dose Rate Points . . . . .	102
5-6. Maximum and Minimum Calculated Dose Rate Points to the Skin for the Habitat . . . . .	102
5-7. Maximum and Minimum Calculated Dose Rate Points to the Skin Within the Storm Shelter . . . . .	103



## FIGURES (Continued)

	<u>Page</u>
5-8. Lunar Habitat Radiation Assessment Configuration - Concept M .....	104
5-9. Lunar Habitat Radiation Assessment Configuration - Concept N .....	104
5-10. Blood-Forming Organ and Skin Dose Equivalent Comparison for Shelter Concepts M and N .....	105
5-11. Radiation Analysis Model Exterior .....	106
5-12. Rack and Sampling Locations .....	107
5-13. Lunar Habitat Radiation Storm-Shelter Configuration .....	107
5-14. Equivalent Aluminum Differential Shield Distribution .....	108
5-15. Differential Incident and Calculated Internal Spectra .....	109
5-16. Analysis Dose Equivalent Results .....	110
6-1. FLO Resupply Packaging .....	113
6-2. Critical Items for Early Transport .....	114
6-3. Initial Resupply Logistics Flow .....	114
6-4. Preliminary Estimate of EVA Task Time Single EVA .....	115
6-5. Preliminary Estimate of EVA Task Time Double EVA .....	115
6-6. Lunar Logistic Module from Mini-PLM .....	116
6-7. Lunar Logistic Module, "Stripped Down" Mini-PLM .....	116
6-8. Lunar Logistic Module Shortened "Stripped Down" Mini-PLM ...	117
6-9. Mini-PLM Mass Summaries .....	117
6-10. Total Material to Support 45 Day FLO .....	119
6-11. 45 Day Mission Support Packaging .....	119
6-12. Lightened Mini-PLM Logistics Modules .....	120
6-13. Preliminary Lunar Pressurized Logistics Module Mass .....	120
6-14. Preliminary LPLM and Airlock Side View .....	121
6-15. Preliminary LPLM and Airlock End View .....	122
6-16. Preliminary Transition Flow .....	123

## FIGURES (Continued)

	<u>Page</u>
9-18a. LEO Debris Shielding Model-1 .....	173
9-18b. LEO Debris Shielding Model-2 .....	173
9-18c. LEO Debris Shielding Model-3 .....	174
9-19. 2012 - 2020 Mission Delta-V Data .....	175
9-20. Reference Delta-V Set, Synthesis Report .....	177
9-21. 2014 Reserves, Losses, Midcourse, Reactor Cool Down .....	177
9-22. Mars Parking Orbits .....	178
9-23. Parking Orbit Delta-V .....	179
9-24. 2016 Opposition, Split Delta-V .....	180
9-25. Definition of Angle Psi .....	181
9-26. 2016 Split Delta-V .....	181
9-27. 2014 Landing Site Access .....	183
9-28. 2018 Landing Site Access .....	183
9-29. Polar Access with HMEV Lander .....	185
9-30. Polar Access With Biconic Lander .....	185
9-31. Reactor Disposal Delta-V .....	187
10-1. Nuclear Thermal Propulsion Lunar Dress Rehearsal .....	191
10-2. Vehicle Mass Variation with Surface Payload .....	192
10-3. Validation of Mars Mission Unique Operations at the Moon .....	197
10-4. Mars Surface Exploration Manifest - 2014, 90-day stay .....	199
10-5. Lunar Dress Rehearsal - Top-Level Development Schedule .....	204
10-6. Lunar Dress Rehearsal - NTP Engine Development .....	205
10-7. Lunar Dress Rehearsal - Vehicle Habitat .....	206
11-1. Types of Aerobrake Shapes Examined .....	208
11-2. Biconic Geometry Parameters .....	208
11-3. Biconic Lift And Drag Values .....	210

## FIGURES (Concluded)

	<u>Page</u>
11-4. Nose Cone Angle Effects . . . . .	211
11-5. Center of Pressure Locations . . . . .	211
11-6. Concept 408.7033 Aerodynamic Parameters . . . . .	212
11-7. Comparison of Biconic Shapes . . . . .	214
11-8. Biconic Lift and Drag Values . . . . .	215
11-9. Scaled Peak Heating Rates for BMEV Descent . . . . .	215
11-10. Aerodynamic Coefficients for BMEV and HMEV . . . . .	216
11-11. Lift-to-Drag Ratios for BMEV and HMEV . . . . .	217
11-12. Moment Coefficient for Concept 414.7516 . . . . .	217
11-13. Concept 408.733, Loading, Shear, and Moment Diagrams . . . . .	219
11-14. Biconic MEV Lander 6 Crew Habitat . . . . .	221
11-15. Biconic MEV/Habitat Internal Arrangement . . . . .	222
11-16. Biconic MEV Crew Vehicle . . . . .	223
11-17. Low L/D Aerobrake - Preliminary Configuration . . . . .	223
11-18. Low L/D Aerobrake - Finite Element Model . . . . .	225
11-19. Loads and Boundary Conditions . . . . .	226
11-20. Peak "g" Loading vs. Peak Heating . . . . .	226
11-21. Exaggerated Deformed Shape, Blue - Undeformed, Black - Deformed - Aero Loads . . . . .	228
11-22. Major Principal Stresses on the Outer Surface (PA) - Aero Loads . . . . .	229
11-23. Magnitude of Total Displacements (meters) - Aero Loads . . . . .	230
11-24. Maximum Deformations Due to Thermal Loads . . . . .	231
11-25. Exaggerated Deformation Plot - Thermal Loads . . . . .	231
11-26. Maximum Stresses Due to Thermal Loads . . . . .	232

## ABBREVIATIONS AND ACRONYMS

<b>A</b>	<b>Area</b>
<b>ACM</b>	<b>Atmosphere Composition Monitor</b>
<b>ACMA</b>	<b>Atmosphere Composition Monitoring Assembly</b>
<b>ACS</b>	<b>Atmosphere Control and Supply</b>
<b>ADPA</b>	<b>Airlock Depressurization Pump Assembly</b>
<b>A/L</b>	<b>Air Lock</b>
<b>ALARA</b>	<b>As low as reasonably achievable</b>
<b>ALSPE</b>	<b>Anomalous Large solar Proton Event</b>
<b>AR</b>	<b>Air Revitalization</b>
<b>ARS</b>	<b>Atmosphere Revitalization System</b>
<b>ASE</b>	<b>Airborne Support Equipment</b>
<b>BFO</b>	<b>Blood-Forming Organs</b>
<b>BMS</b>	<b>Bed Molecular Sieve</b>
<b>BMEV</b>	<b>Bionic MEV</b>
<b>BREM</b>	<b>Boeing Radiation Exposure Model</b>
<b>C&amp;T</b>	<b>Communications and Tracking</b>
<b>CA</b>	<b>Collision Avoidance, Commonality Assessment</b>
<b>CAD/CAM</b>	<b>Computer-Aided Design/Computer-Aided Manufacturing</b>
<b>CAM</b>	<b>Computer Anatomical Man</b>
<b>CF</b>	<b>Critical Fluids Control</b>
<b>c.g.</b>	<b>Center of Gravity</b>
<b>CHeCS</b>	<b>Crew Health Care System</b>
<b>CL, CD, CM</b>	<b>Coefficient of Lift, Drag, Moment</b>
<b>CM</b>	<b>Communications</b>
<b>CO<sub>2</sub></b>	<b>Carbon Dioxide</b>
<b>COP</b>	<b>Coefficient of Performance</b>
<b>CP</b>	<b>Center of Pressure</b>
<b>CRV</b>	<b>Crew Return Vehicle</b>
<b>CTV</b>	<b>Cargo Transfer Vehicle</b>
<b>D</b>	<b>Drag</b>
<b>D and C</b>	<b>Display and Control</b>
<b>DDCU</b>	<b>dc-to-dc Converter Unit</b>
<b>DDT&amp;E</b>	<b>Design, Development, Test, and Evaluation</b>
<b>DI</b>	<b>Design Integration</b>
<b>DM</b>	<b>Data Management</b>
<b>DMS</b>	<b>Data Management System</b>
<b>DSN</b>	<b>Deep Space Network</b>
<b>EC</b>	<b>Environmental Control</b>
<b>ECLSS</b>	<b>Environmental Control and Life Support System</b>
<b>ECWS</b>	<b>Element Control Workstation</b>
<b>ED</b>	<b>Emergency Detection</b>
<b>EOL</b>	<b>End of Life</b>
<b>EMU</b>	<b>Extra Vehicular Mobility Unit</b>
<b>EP</b>	<b>Electric Power and Distribution</b>
<b>EPDS</b>	<b>Electrical Power Distribution System</b>
<b>EPS</b>	<b>Electrical Power System</b>
<b>ETO</b>	<b>Earth-to-Orbit</b>
<b>EVA</b>	<b>Extravehicular Activity</b>

## ABBREVIATIONS AND ACRONYMS (CONTINUED)

EVAS	Extravehicular Activity System
ExPO	Exploration Program Office
FC	Flight Control
FCW	Fuel Cell Water
FDS	Fire Detection and Suppression
FLO	First Lunar Outpost
FR	Fault detection, Isolation and Recovery
FSD	Full Scale Development
FSE	Flight Support Equipment
FSS	Fixed Servicing System, Fluid System Servicer
g	Acceleration in Earth Gravities (acceleration 9.80665 m/s <sup>2</sup> )
GaAs/Ge	Gallium Arsenide/Germanium
GCA	Gas Conditioning Assembly
GEO	Geosynchronous Earth Orbit
HGA	High Gain Antenna
HI	Human Interface
HLLV	Heavy Lift Launch Vehicle
HMEV	High L/D Mars Excursion Vehicle
HRS	Heat Rejection System
IA/V	Internal Audio/Video
IMLEO	Initial Mass in low Earth Orbit
IMV	Intermodule Ventilation
IR&D	Internal Research and Development
ITCS	Internal TCS
IVA	Intravehicular Activity
JSC	Johnson Space Center
K	Temperature in Kelvin Units
kg	kilograms
km	kilometers
km/sec	kilometers/second
KSC	Kennedy Space Center
kts	knots
kW	kilowatts
kWe	Kilowatts electric
kWt	Kilowatts thermal
L	Lift
LaRC	Langley Research Center
LCRV	Lunar Crew Return Vehicle
LDR	Lunar Dress Rehearsal
LEO	Low Earth Orbit
LEV	Lunar Excursion Vehicle
LGA	Low Gain Antenna
LiOH	Lithium Hydroxide
LOR	Lunar Orbit Rendezvous
LPLM	Lunar Pressurized Logistics Module
LRU	Lunar Replaceable Unit

## ABBREVIATIONS AND ACRONYMS (CONTINUED)

MBSU	Main Bus Switching Unit
MCRV	Mars Crew Return Vehicle
MEV	Mars Excursion Vehicle
MLI	Multi-layer Insulation
MM	Mission Management
MO	Mechanisms and Ordnance Control
MOC	Mars Orbit Capture
MOD	Meteoroid/Orbital Debris
MSFC	Marshall Space Flight Center
MSU	Mass Storage Unit
mt	Metric Ton (1000kg)
MTC	Man-Tended Capability
MTS	Mars Transportation System
MU	Mission Unique
MWS	Maintenance Workstation
NASA	National Aeronautics and Space Administration
NCRP	National Council on Radiation Protection and Measurements
NHI	No Human Interface
NLS	National Launch System
NTP	Nuclear Thermal Propulsion
NTR	Nuclear Thermal Rocket
NV	Navigation
$N_x, N_y, N_z$	Axial Load factor (g's) in x-direction, y-direction, z-direction
O <sub>2</sub>	Oxygen
PA	Payload Accommodations
PC	Propulsion Control
PDOSE	Proton Dose Code
PEP	Personnel Emergency Provisions
PHS	Personnel Hygiene Systems
PLM	Pressurized Logistics Module
PLSS	Portable Life Support System
PMC	Permanently Manned Capability
PMPAC	Portable Multipurpose Application Console
PNP	Probability of No Penetration
Psi	Angle defined in Figure 9-25
psia	Pounds per square inch absolute
PV	Photovoltaic
q.	Dynamic Pressure
RCS	Reaction Control System
R&D	Research and Development
RFC	Regenerable Fuel Cell
R&MA	Restraints and Mobility Aids
RPC	Remote Power Controller
RPCM	Remote Power Controller Module
RPDA	Remote Power Distribution Assembly
RS	Range Safety
$R_x, R_y, R_z$	Angular Acceleration (rad/sec) in x, y, z direction

## ABBREVIATIONS AND ACRONYMS (CONCLUDED)

SDP	Standard Data Processor
SOTA	State of the Art
SPCU	Suit Processing and Check-out Unit
SPDA	Secondary Power Distribution Assembly
SPE	Solar Proton Event
SPI	Special Performance Instrumentation
SSF	Space Station Freedom
STCAEM	Space Transfer Concepts and Analyses for Exploration Missions
STS	Space Transportation System (Shuttle)
t	Metric tons (1000 kg), thickness
T&C	Telemetry and Command
TCCS	Trace Containment Control Subsystem
TCS	Thermal Control System
THC	Temperature and Humidity Control
TLI	TransLunar Injection
TMI	Trans Mars Injection
TPS	Thermal Protection System
VECTRACE	Vector Trace
VSB	Venus Swingby
WM	Waste Management
WMC	Waste Management Compartment
WR	Water Recovery
WRM	Water Recovery and Management
$\Delta 1$	Delta One (1)
$\Delta 2$	Delta Two (2)
$\Delta 3$	Delta Three (3)
$\rho$	density
E	Modulus of Elasticity (Pa)
G	Modulus of Rigidity (Pa)
$\mu$	Poisson's Ratio
$\sigma_y$	Allowable Tensile Yield Stress (Pa)
$\sigma_{ey}$	Allowable Compressive Yield Stress (Pa)
$\sigma_{sv}$	Allowable Shear Yield Stress (Pa)
$\epsilon$	emissivity
$\alpha$	solar absorptivity
$\theta$	cone half angle

**ABSTRACT**

This report covers the third phase of a broad-scoped and systematic study of space transfer concepts for human lunar and Mars missions. The study addressed issues that were raised during Phase 2, developed generic Mars missions profile analysis data, and conducted preliminary analysis of the Mars in-space transportation requirements and implementation from Stafford Committee Synthesis Report. The major effort of the study was the development of the First Lunar Outpost (FLO) baseline which evolved from the Space Station Freedom Hab Module. Modifications for the First Lunar Outpost were made to meet mission requirements and technology advancements.



## 1.0 INTRODUCTION

### 1.1 STUDY SCOPE

The Space Transfer Concepts and Analyses for Exploration Missions (STCAEM) study addresses in-space transportation systems for human exploration missions to the Moon and Mars. The subject matter includes orbit-to-orbit transfer vehicles, planetary landing/ascent vehicles, and the crew modules needed to form complete crew and cargo transportation systems. Also included are orbital assembly and operations facilities if these are needed for assembly, construction, recovery, storage in orbit, or processing in-space transportation systems for reuse. All propulsion and systems technologies that can be technically evaluated are open for consideration. Excluded from the study are Earth-to-orbit systems. Crew entry vehicles intended for direct Earth atmosphere entry from a lunar or planetary return trajectory are included. Capabilities of, and constraints on, Earth-to-orbit systems and their operations are parametrically considered as a boundary condition on in-space transportation systems.

### 1.2 REPORT SCOPE

This report represents Phase 3 of the STCAEM study. Phase 1 covered a wide range of lunar and Mars transportation options (ref. 1) and lunar rover concepts and technology needs. Phase 2 concentrated on Mars transportation using nuclear thermal propulsion (ref. 2). Phase 3 concluded certain trade studies on Mars transportation that were begun during Phase 2; most of Phase 3 was devoted to analysis of a lunar surface habitation system, the "First Lunar Outpost" (FLO). This report provides details of the FLO habitation system in Sections 3 through 8 and on the conclusion of the Mars transportation studies in Sections 9 to 11.

### 1.3 THE PREMISE OF THE FIRST LUNAR OUTPOST

The idea for the First Lunar Outpost arose during STCAEM Phase 1. Analyses of lunar transportation and lunar base buildup scenarios had highlighted a "chicken and egg" issue wherein astronauts are needed on the Moon to build a surface base but a surface base is needed to house the astronauts. Phase 1 analysis indicated a possible solution in the form of a turn-key habitation system that could be placed on the lunar surface in a single landing of about 30 t payload. This followed logically from earlier concepts, identified in several studies, for "construction shacks". The Phase 1 scope did not include surface base elements, so the idea was not pursued under the contract; instead it was picked up on Boeing IR&D. An IR&D concept was developed and briefed to NASA as a "lunar Campsite".

Later, a brief analysis was funded under the STCAEM contract to investigate minimum-mass options for a FLO-type habitat, with a target of 15 t. It was concluded that a lunar-day-only habitat could be designed at about 18 t but that the target was not reachable under the given assumptions (a) derive the habitat from a Space Station Freedom habitat module, and (b) accommodate a crew of 4.

In 1992, the target mass was increased to 25 to 30 t by NASA in view of the need to have that delivery capability for a crew mission. The concept was named First Lunar Outpost and designated as a target initial return-to-the-Moon mission for the Space Exploration Initiative. The STCAEM contract was modified by task order to fund Boeing to assist NASA MSFC in developing a FLO habitation conceptual design, supported by trade studies and analyses.

## 2.0 EXECUTIVE SUMMARY

### 2.1 THE FLO CONCEPT

The FLO concept general requirements are:

- a. To be deliverable to the Moon on a single landing and through remote and/or automated deployment and checkout, be ready to accommodate a crew with essentially no crew time devoted to preparing the FLO for habitation.
- b. To accommodate a crew of four, under somewhat austere conditions, e.g. no crew private quarters.
- c. To support a crew of four through one lunar day, one lunar night, and the next lunar day.
- d. To repeat this support mission an indefinite number of times, given suitable resupply of consumables and spares.
- e. To provide airlock access to the lunar surface.
- f. To have hyperbaric chamber capability within the airlock to support aeroembolism countermeasures.
- g. To provide other somewhat unspecified lunar surface mission support capabilities. Some specifics are known:
  1. Provide EVA EMU storage, refurbishment, and servicing capabilities,
  2. Provide electric power for recharge of a small unpressurized piloted rover,
  3. Include in the logistics provisions an allowance for science mission equipment delivery and resupply,
  4. Be stocked with enough consumables and other provisions for the first mission, in the as-delivered configuration,
- h. The FLO is targeted to have an all-up mass, as payload for a lunar lander, of 30 t or less.
- i. Redundancy provisions may be relaxed somewhat from the usual "fail-op, fail-op, fail-safe" manned system approach in view of the mission design. It provides constantly accessible return-to-Earth capability through presence of a fueled and ready crew return transportation system within walking distance during all of every FLO crew mission. However, safety and abort analyses were to be conducted to ensure crew safety and to ensure that nothing in the design or operations plan would preclude using the abort return to Earth capability.
- j. The FLO conceptual approach was to provide a self-contained habitation system that could be delivered as the payload of a lander. The system was to be derived as directly as possible from a Space Station Freedom (SSF) habitation module, to

minimize R&D cost and maximize maturity of life support and other mission hardware. Since a SSF habitation module relies on other elements of Space Station Freedom for support and services, these must be provided in the complete FLO design. Specifically, the following capabilities in addition to the SSF habitation module are required:

1. Airlock,
2. Electrical power supply, lunar day and night,
3. External thermal control system,
4. External communications system for EVA and Earth communications,
5. Resupply provisions suitable for lunar surface operations (It is deemed not feasible to remove and replace entire racks as accomplished for Space Station Freedom, in view of the 1/6 g environment of the lunar surface).

An external view of the FLO concept, on the lunar surface still mated to the lander as delivered, is shown in figure 2-1. The baseline concept is used as delivered; it is not offloaded from the lander. An internal arrangement, top view, is shown in figure 2-2. The high degree of heritage from the SSF habitation module is evident.

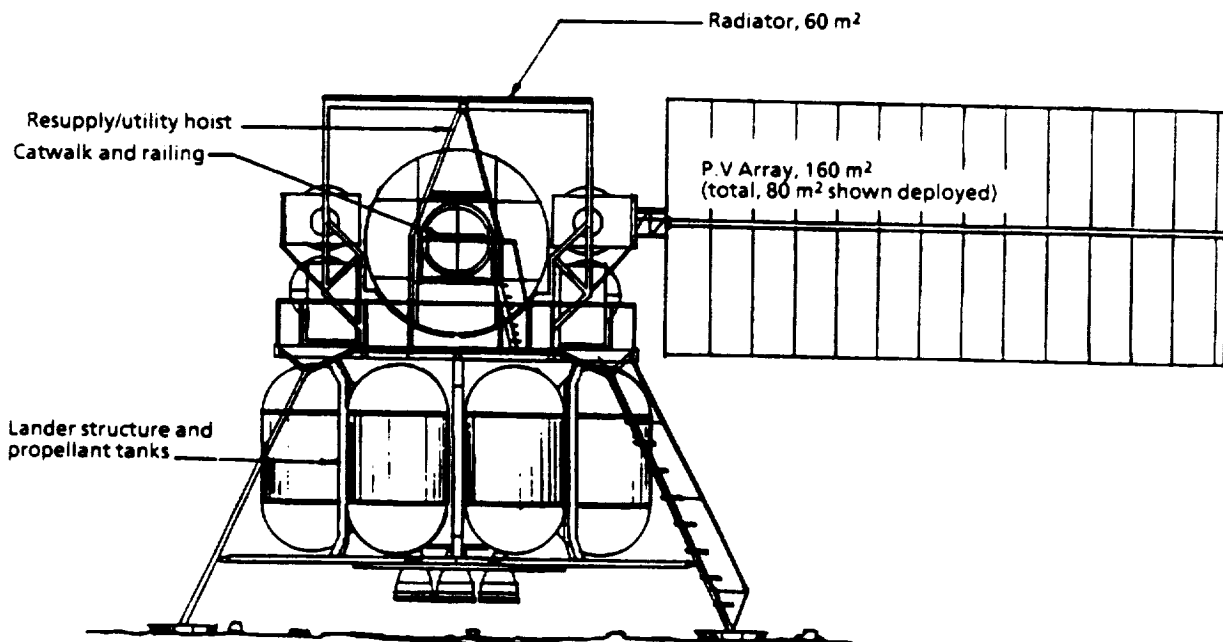

ACS016

Figure 2-1. First Lunar Outpost Configuration

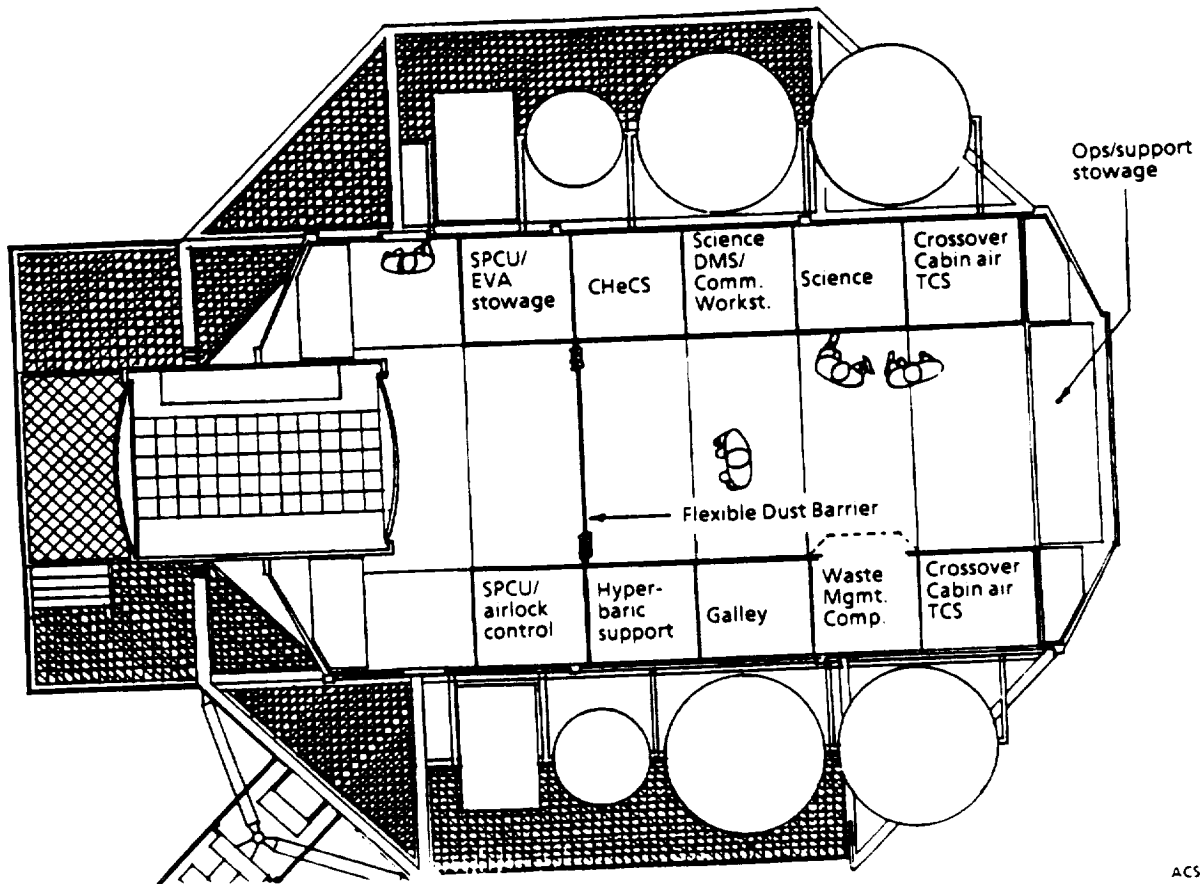

ACS014

Figure 2-2. First Lunar Outpost Habitat, Plan View

The FLO incorporates the "crewlock" portion of the SSF airlock and the support equipment needed to operate it. EMU servicing and storage are located in the FLO module. The electrical power system uses solar arrays and regenerable fuel cells to supply about 10 kWe continuous power. The large tanks on the outside of the habitat are fuel cell gas reactant storage. Smaller tanks store water and makeup atmosphere. A thermal control radiator is located on the top of the habitat. The external thermal control loop includes a heat pump to raise the radiator temperature and thus reduce the radiator size. A stairway and a motorized hoist/elevator facilitate crew and equipment transport between the airlock portal and the lunar surface. In the baseline, all internal resupply is brought in through the airlock as a task added to normal EVA operations. A logistics module was examined in one of several trade studies.

The mass target of 30 t was attained. Earlier in the study this target was set at 25 t. It became clear that the baseline crew mission system would have more than 30 t capability as a cargo system. To attain the 25-t target, it would be necessary to delete the hyperbaric airlock capability or make other mass reduction changes indicated as costly. A summary mass statement is presented in figure 2-3.

<b>Module Structure</b>	<b>6345 kg</b>
<b>Internal Systems</b>	
ECLSS	2990 kg
Medical Support	668 kg
Crew Systems	1402 kg
DMS	687 kg
IAV	97 kg
Internal EPS	711 kg
Internal TCS	1262 kg
Internal Science	767 kg
Internal EVAS	535 kg
<b>External Systems</b>	
Support Structure	2064 kg
C&T	72 kg
External EPS	5451 kg
External TCS	520 kg
Airlock System	2175 kg
EVA Suits	with crew
Gas Conditioning Assembly	258 kg
<b>Dedicated Radiation Protection</b>	<b>Not Required</b>
<b>Consumables</b>	<b>2505 kg</b>
<b>Contingency (15 - 28% of Ext Systems)</b>	<b>1477 kg</b>
<b>Total Landed Mass</b>	<b>29,986 kg</b>

Figure 2-3. Integrated Baseline Concept Description, Mass Properties Summary

If the crew mission system were changed to incorporate a higher-performance Earth return stage, its delivery capability would drop to the 25-t range. Promising mass reduction options for the FLO hab to attain a 25-t target include (1) deletion of hyperbaric requirement; (2) reduce structural mass by redesign and use of higher-performance materials; (3) reduce the initial consumables inventory by bringing some of this inventory on the first crew mission; and (4) scrubbing the power budget, especially to reduce average night time power.

### 2.1.1 FLO Baseline Development

Evolution of the baseline included several stages, summarized as follows:

- a. An initial baseline was created by modifying the Space Station Freedom Hab-A only as necessary to make it operable on the lunar surface. These changes included such things as adding an adapted shuttle Orbiter airlock and moving active equipment racks out of the floor tier, which is expected to accumulate lunar dust. External systems were initially represented parametrically, e.g. power as kg/kWe so that a preliminary overall mass estimate could be made. The initial baseline did not achieve the 25-t target.
- b. The Hab-A equipment list was reviewed in detail to determine what could be eliminated because it is not needed for the FLO mission. An example is the convective oven in the galley. It was judged that the "somewhat austere" ground rule for FLO permits eliminating the convective oven, retaining only a microwave oven. This version was denoted Δ1.

- c. The  $\Delta 1$  configuration was reviewed to ascertain what could be modified to further reduce mass. An example is reduction of cabin air circulating fan power since the 1/6 g lunar environment will provide some natural convection. At this time, the overall power budget, which had been adapted from the Hab-A, was critically reviewed with special attention to night time average power. Night time power must be delivered from the fuel cells at a mass penalty of several hundred kg per kWe. Significant reductions were made, including duty factor estimates for intermittently operating equipment. This version was designated  $\Delta 2$ . This baseline came close to the 25-t target.
- d. The  $\Delta 2$  configuration was reviewed in detail with respect to proper satisfaction of known requirements. A major revision occurred at this time due to recognition that the shuttle airlock was not suitable for 1/6 g operation with lunar EVA EMUs, and that hyperbaric capability was an important requirement for the FLO mission. At this time, the SSF "crewlock" was incorporated into the design. An alternate concept, creating an airlock volume by placing a bulkhead in the Hab-A module, was also investigated but this option became quite massive when the 2.8 atmosphere hyperbaric pressure requirement was met. The SSF "crewlock" was indicated as a lower mass and lower cost solution, but still drove the estimated mass well above 25 t and a new target of 30 t was adopted.
- e. At this point, major attention was directed to the external systems: power, thermal control, communications, and resupply/operational provisions. Analysis of the power system yielded some modest mass reductions in the gas storage systems. The external thermal control system was analyzed in detail with attention to realistic performance of thermal control coatings in the difficult daytime lunar environment. Desirability of a heat-pumped thermal control radiator was confirmed. The SSF Hab-A does not have an external communications system; that function is allocated to a node in the SSF system. A communications schematic and an equipment list were developed. An overall configuration design was developed, including placement of the external equipment and the resupply hoist/elevator. The mass statement was updated. Several trades around this updated baseline were in progress or initiated upon completion of the baseline. The baseline evolution history including mass trending is shown in figure 2-4.

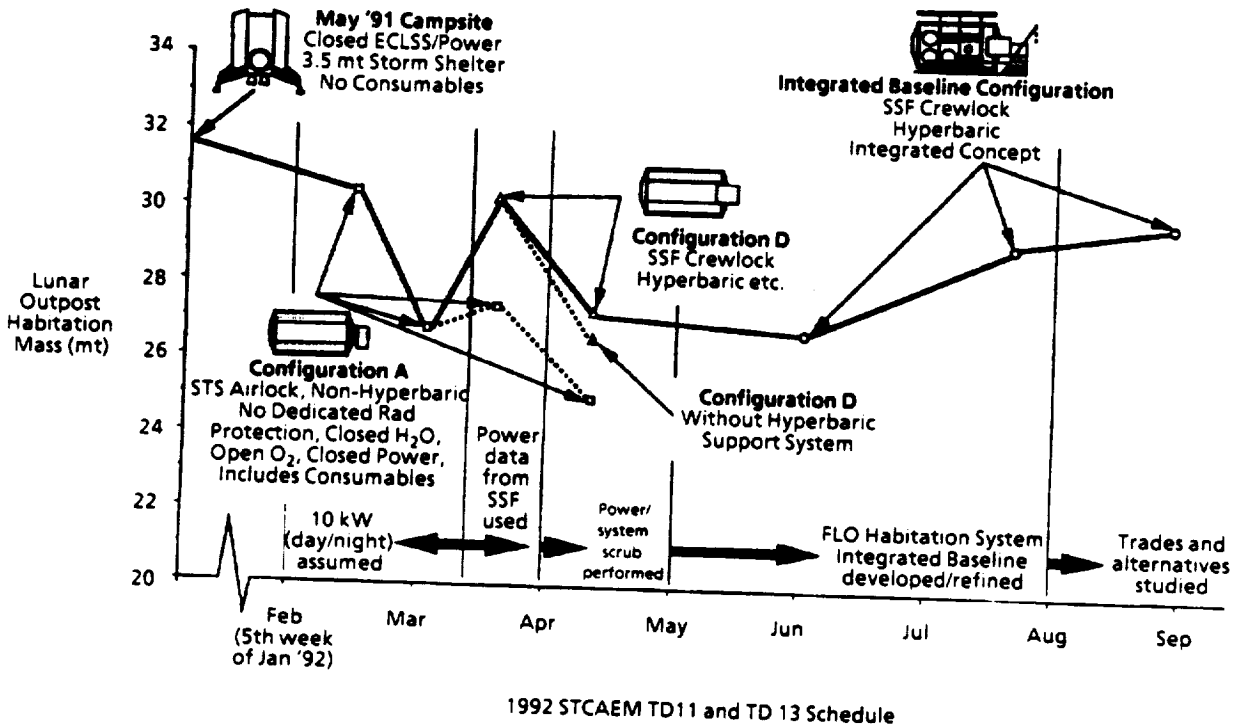

Figure 2-4. Boeing STCAEM Lunar Outpost Habitat, Concept Mass History

ACS078

All of the mass estimates use a 15% contingency allowance on new equipment and use the Space Station Freedom current allowance for SSF hardware. The SSF mass contingency allowance varies from one hardware item to another depending on the maturity of the mass estimate.

### 2.1.2 FLO Trades and Analyses

Trades and analyses are covered in detail in this report. Trades were divided into those not involving significant changes to the general baseline configuration and those that are major changes. High points of the more significant trades are covered here; some have already been addressed.

Analysis of available internal volume indicated that the FLO is indeed austere but probably acceptable given its premises. Storage volume was seen as adequate for food and crew supplies, but possibly inadequate for equipment spares.

No requirements were available for mission/science internal storage volume. A very modest amount is available in the one rack partially devoted to science equipment. The major open issue on science storage seems to be whether there is a significant internal requirement, for (a) science equipment, (b) science support equipment, or (c) samples held for return to Earth.



FLO EMUs present a significant issue. There is not space in the airlock for them. The habitat designers presumed that EMUs would be brought by the crew and used by them, e.g. for the transfer from the crew transport vehicle to the FLO at the beginning of the mission. The crew vehicle designers, seeing a problem with the bulky EMUs, presumed that they would be sent with the FLO and that the crew would use flight EMUs (less bulky, worn by the crew during flight, suitable only for short EVA and not during the heat of the lunar day) for the transfer.

The EMUs must be accommodated inside the FLO hab during the mission. Four EMUs are assumed. Since the EMUs are not designed, their size and storage requirements may only be estimated. It appears that the EMUs can be stored in the space between the airlock and the interior sides of the hab module (there are no racks in this location) but the space may not be sufficient. Additional space may be required by EMU spares. Depending on the mission operations plans, it is possible fewer than four lunar EMUs are needed, assuming the crew uses another "flight" EMU for the transfers from the crew lander to the FLO and back. It is also possible that more than four are needed. Also, space for storing the "flight" EMUs must be provided.

**Logistics and resupply** analyses addressed the issues of spares and consumables and their handling. The storage volume in the FLO, and the mass target, permit initial stocking with only critical spares (those for mission and safety critical subsystems). Spares for electrical power, thermal control, communications, and ECLS are given higher priority than those for mission functions and crew comfort.

The nominal resupply requirement was specified at 5 t. This is spartan, and includes relatively little mission payload mass. It includes no allowance for a logistics module and only a modest allowance for packaging. Of the 5 t, about 1.7 t must be brought into the module interior, through the airlock. The FLO baseline is that all internal resupply will be (a) packaged in suitcase-sized units with necessary environmental protection, (b) transported from the crew lander to the FLO by the unpressurized rover (it is sized to carry 500 kg per trip), (c) hoisted up to the airlock by the FLO hoist, and (d) manually transported through the airlock by the crew. External supplies and equipment will be suitably packaged for transport by rover and handling by the crew. Resupply fluids, for example, are packaged on a cart towed by the rover and plugged into FLO umbilicals at ground level.

Pressurized logistics modules were examined as an option. The smallest and lightest option considered was a stripped and shortened version of the Alenia SSF mini-PLM fabricated from lightweight composites. This design uses about 1.8 t of the nominal 5 t logistics cargo allowance; some of the more massive options used all of it.

It was concluded that (a) the baseline method is adequate for a spartan FLO mission operation but spares will tend to always be in short supply because of the delivery mass limits; (b) a logistics module creates a severe mass penalty for the crew mission; and (c) a dedicated logistics cargo flight, placed somewhere in the first five lunar crew/cargo trips, and using a large logistics module, is a logical first step in growth of FLO to a permanent base, and relieves the chronic resupply shortage that exists without it.

**Internal pressure** was a major trade. The Space Station Freedom system and equipment is designed for one atmosphere operation with the capability to operate at 10.2 psia which is the planned man-tended operational pressure. Crew systems engineers for FLO desire to operate at lower than one atmosphere pressure because (a) the pressure differential between the EVA EMU and the FLO habitat module must be limited to avoid long prebreathe periods and to minimize risk of aeroembolism (the "bends"); (b) EMUs and especially gloves are limited in mobility at higher pressures. Current EMUs operate at about 5 psia; it isn't likely that lunar EMU weight and mobility objectives at higher pressure can be achieved. If the EMU is to operate at 5 psia, the FLO must be at 8 psia to attain zero prebreathe. At 10.2 psia the prebreathe requirement is only a minor nuisance.

Reduced pressure requires higher oxygen concentration to maintain an oxygen partial pressure similar to that at sea level. The Skylab, for example, operated at 5 psia with 70% oxygen and 30% hydrogen. The shuttle operates at a slightly enriched oxygen level when pressure is reduced to 10.2 psia.

**Alternate materials of construction** were evaluated, from aluminum-lithium to metal-matrix composites. Structural mass savings estimates were about 10% for aluminum-lithium up to about 30% for the most advanced materials. It was concluded that aluminum-lithium is the most promising option since it can be applied with minimum impact to the existing FLO hab design and tooling. If a major structural configuration design change were contemplated (see next section) the use of more advanced materials should be revisited.

**Radiation analyses** were conducted to estimate crew radiation dose inside the FLO habitat. These used the Boeing CAD-based radiation exposure model to examine the baseline geometry and some rearrangements that provide a "storm shelter" space within the module. The FLO geometry provides reasonable shielding by the equipment rack locations except at the ends of the module, where no racks are located. Radiation analysis predicted that crew doses for the baseline configuration, in the event of a severe solar flare, would approach or exceed anticipated standards for the mission, and substantially exceed the working limit of 9 rem for preliminary design.

Storm shelter configurations can be created by moving racks. For these analyses it was assumed that the racks to be moved would be storage racks not requiring disconnection of electrical or other feeds in order to be moved. Figure 2-5 illustrates one storm shelter configuration. The storm shelter configurations reduced the predicted dose to the preliminary design working limit.

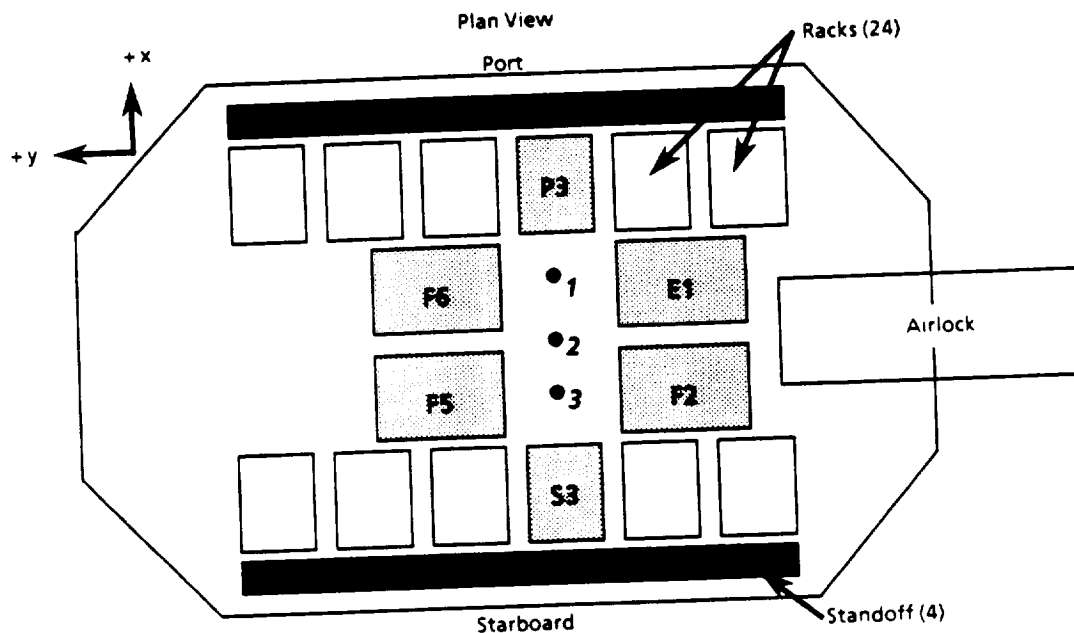
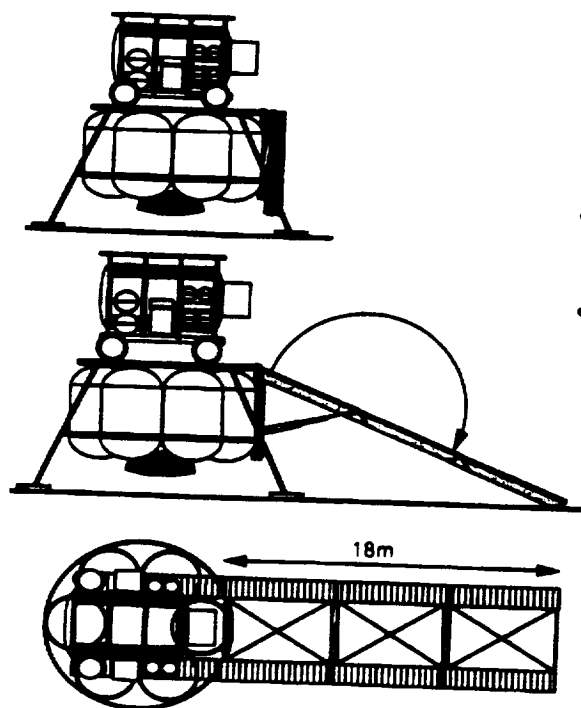

Figure 2-5. Lunar Habitat Radiation Assessment Configuration - Concept M

**FLO Alternatives.** Several major variations in the configuration were considered. A list of desirable improvement goals was prepared, with subjects such as "closer to the ground" or "more usable interior volume". Specific design approaches for meeting each of these goals were developed. Two of these studies were very significant:

**Offloading** the FLO module would eliminate most of the vertical height between the lunar surface and the airlock portal. A powered hoist might not be needed depending on resupply considerations, and only a few stairs would be climbed from the lunar surface to the airlock. Several offloading schemes have been proposed. In this study, a deployable ramp was considered with powered wheels on the FLO module. This concept is illustrated in figure 2-6. The ramp deploys after landing and the FLO module drives off at very low speed. The powered wheel scheme solves the problem of moving the FLO to a desired location after it gets down to the lunar surface. The powered wheels can be designed to be removed from the FLO module and used elsewhere after offloading. The mass of the wheels and the deployable ramp was estimated as about 2 t total. The structure and provisions that could be removed for an offloaded FLO represent about 1 t.



- Unloader ramp packages on the side of the lander descent stage
- Folded ramp sections self deploy on command from the ground
- Hab mobility system includes wheels, drive and suspension system for each wheel, and minimal guidance. Hab power supplies deployment and unloading systems
- Habitat unloads itself by driving down ramp, and "creeping" to a pre-specified location

Mass Estimate	
Ramp structure	600 kg
Deployment Mech	200 kg
Hab Mobility Sys.	1120 kg
Total	1920 kg

Figure 2-6. FLO Hab Unloader Option 1

ACS079

An alternate habitat configuration was the principal effort under alternatives trades. The objective of the alternative habitat configuration was to increase the usable interior volume without an increase in structural mass. The approach was to examine geometries that made more efficient use of internal volume and that are structurally more efficient. The prime candidate is an ellipsoidal configuration illustrated in figure 2-7. It was assumed that subsystems would be the same as for the cylindrical habitat design, i.e. no changes except those required because of installation differences.

The ellipsoid is the nearest practical approach to a sphere. With a diameter of 6.5 meters, it has the same internal volume as the SSF-derived cylindrical habitat. It gains useful internal volume since the airlock can be placed entirely external to the habitat volume and still remains within the 10 meter launch shroud. The useful floor area is 16.6 square meters compared to 14.2 square meters for the cylindrical unit. The useful working volume is 36.6 cubic meters compared to 34.0 cubic meters for the cylindrical unit, in terms of volume per crew member, 9.15 versus 8.5. The ellipsoidal habitat comes closer to satisfying a desirable working volume of 10 cubic meters per crew member.

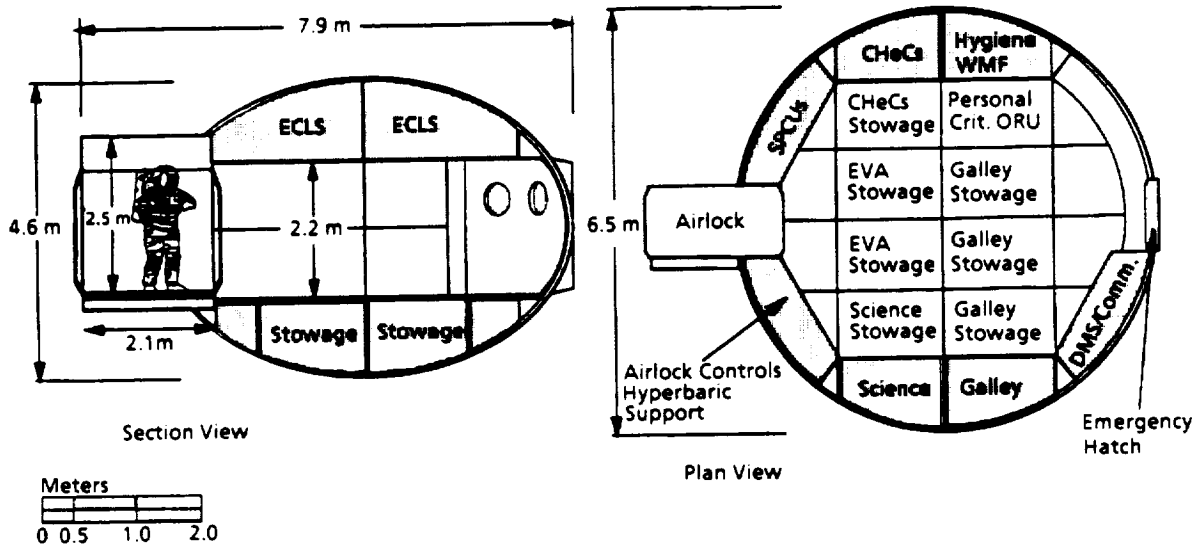

Figure 2-7. FLO Ellipsoidal Habitat Option

ACS081

The different internal arrangement and geometry means that the equipment/subsystem support racks must be redesigned. Unlike the cylindrical habitat, more than one rack design is needed for efficient use of the available volume. The ceiling and floor racks must fit into pie-shaped areas while the wall racks fit into a doubly curved area similar in shape to the cylinder walls (but the latter are not doubly curved). Also, the redesign of rack/subsystem interconnections is a more complete redesign than required for the cylindrical habitat.

No particular advantages were seen for this configuration in terms of packaging and installation of external subsystems, or in offloading from the lander should that be desired. It was estimated that the ellipsoidal habitat is 180 kg. less massive than the cylindrical habitat assuming that savings in shell structure mass are not offset by increases in secondary structure or rack mass.

The ellipsoidal habitat can readily be stretched to much greater useful interior volume by adding a 6.5-m diameter cylindrical section to the structural shell, creating a configuration with more than one floor or deck. The result is a habitat geometry similar to concepts identified earlier in the STCAEM study for Mars transfer and surface mission habitats. This gives the ellipsoidal design a somewhat more direct growth path to larger habitats for later missions.

The evaluation of the ellipsoidal habitat is that it offers modest improvements in interior volume and floor area; it offers a more direct growth path to larger habitats for later missions; but because of the substantial redesign compared to use of the Space Station Freedom habitat module structure, the cost of the first FLO habitat module will be about twice that for the SSF-derived module. In terms of the cost of the entire FLO habitat system including external subsystems and logistics/resupply provisions, the cost with the ellipsoidal habitat module is about 20% greater, assuming costs other than those for the habitat module do not change significantly. Evaluated in terms of the FLO mission itself, the ellipsoidal habitat advantages appear not worth the added cost. In terms of a long-term evolutionary program, the ellipsoidal design may be justifiable, but it is really a question of when the redesign costs are incurred; that is, the initial FLO could proceed with an SSF-derived module and the redesign costs incurred for a second or later habitat module.

**Avionics Commonality.** An analysis was undertaken to assess the commonality potential for avionics, considering lunar transfer vehicles, crew modules, the FLO habitat, potential future launch vehicles, and Space Station Freedom. It is apparent that high commonality potential exists between Space Station Freedom and the FLO habitat. It is almost as apparent that commonality potential exists between lunar transfer and launch systems. We found that significant broader commonality potential also exists, i.e. between crew modules, habitats and transportation systems. There are significant differences in the need for and implementation of redundancy because transportation vehicles and modules need instantaneous switchover to functional systems in the event of a failure during a critical operation, where habitation systems do not. There is also a potential issue of processing power and speed, depending on the particular needs of a transportation system. Important commonality potential in software also exists with use of object-oriented reusable code, but current space industry practices don't offer much encouragement in this area.

## **2.2 MARS TRANSPORTATION CARRY-OVER TASKS**

### **2.2.1 Launch Vehicle Size Trade**

Launch vehicle capabilities from about 125 t to over 200 t were investigated. Shroud diameter of 10 meters is adequate for the smaller size, and 14 m. is recommended for the larger size. We did not find significant differences in assembly complexity over this range of launch vehicle capability. The larger vehicles require fewer launches, mainly fewer tanks of propellant, and hence fewer berthing operations. The nature of the operations, however, does not change over this range of launcher capability; in all cases rendezvous and simple berthing is all that is required. These operations can be robotic; an assembly crew in orbit appears not necessary.

This section also includes material on assembly operations and delta-V budgets. An important conclusion from assembly operations is that if the vehicle is designed for assembly, a simple robotic assembly operation is adequate. A simple assembly fixture launched attached to the vehicle segment on the first launch is all that is needed; an assembly facility in the usual sense can be eliminated by proper design of the vehicle. The assembly operations are simpler than those planned for Space Station Freedom.

### **2.2.2 Lunar Dress Rehearsal Analysis**

This section reports on a study of a full dress rehearsal for a Mars mission at the Moon, including nuclear propulsion operations, long-duration orbital storage of a Mars transfer habitat, landing, a long-duration surface mission, ascent and return to Earth. The rehearsal could be implemented using Mars mission hardware and launch vehicles. The only unique element needed is a lunar lander, and the lunar lander used for the lunar program appears to suffice.

### **2.2.3 MEV Options**

This section reports on two MEV analyses, intended to complete a survey and analysis of MEV concepts, requirements, and operational factors. The STCAEM study had addressed a range of MEV options from L/D 0.2 to L/D nearly 2, and aerobrake designs from a rigid-section deployable symmetric sphere-cone to slender blended lifting bodies and bionics. This section reports on a parametric study of biconic shapes, aerodynamics and packaging and on a structural analysis of a blunt L/D 0.5 shape. The biconic analysis concluded that an acceptable biconic configuration is feasible, with L/D about 1.6 and base diameter small enough for integral launch as the "nose cone" of a heavy lift vehicle. This permits integral launch of an MEV designed for high L/D access to nearly anywhere on the surface of Mars.

The structural analysis concluded a study of structural concepts to simplify assembly and packaging of blunt shaped brakes. Earlier concepts had used structural ribs and spars for stiffening. These concepts did not divide up into easily packaged segments for launch. The structure investigated here was a monocoque shell with no discrete stiffeners; it could be divided into segments to optimize launch packaging. The structural analysis concluded that the monocoque structure could be very efficient; this provides a reasonable structural solution to the design of a shaped brake for efficient launch packaging and assembly on orbit.

### **3.0 FIRST LUNAR OUTPOST HABITATION SYSTEM INTEGRATED BASELINE**

#### **3.1 INTRODUCTION TO FLO HABITATION STUDY**

The current study has focused on defining and exploring issues and concepts for the First Lunar Outpost. Specifically, our involvement has been to apply data and experience gained from previous and on-going activities, such as the Lunar Campsite study (ref. 3) and Space Station Freedom (SSF) (refs. 4 to 7), to the development of Outpost Habitation and Airlock system configurations and resource descriptions. The Campsite approach is intended to provide the first significant manned lunar access and capability beyond Apollo-style sorties and to serve either in a remote stand-alone mode or as precursor to a more permanent base. FLO is also based on this philosophy but has afforded a more detailed examination of the concept and each of its systems. The methodology and current results of this initial activity will be discussed.

#### **3.2 TOP LEVEL REQUIREMENTS**

Basic ground rules for developing the FLO concept have included: (1) support of multiple, non-contiguous manned missions, each involving a one-and-a-half lunar day duration with 72 hours contingency time (for a total of 45 earth-days); (2) FLO should consist of existing or near-term systems to the extent practicable; (3) a total landed cargo mass of 25 mt is desirable (dependent upon matching payload capability with the crew vehicle); (4) FLO must support a crew of four; (5) launch of FLO elements will use a 220-mt Earth-to-Orbit (ETO) vehicle with a 10m x 30m payload shroud; (6) habitation system will arrive unmanned and deploy/activate automatically with crew arriving separately in a common lander (which includes ascent and return stage); and, (7) growth should not be precluded. More detailed ground rules have been included in the "First Lunar Outpost Requirements and Guidelines" document, reference 8. Requirements development effort has been on-going and is discussed later in this report.

#### **3.3 DESIGN APPROACH**

The First Lunar Outpost applies a "campsite" philosophy based on a direct mission mode for human return to the Moon. Mission capability and architecture employing this approach were first integrated in Phase I of this contract (ref. 1). Initial configurations and concepts for the Lunar Campsite habitat and landers were developed under Boeing IRAD in 1990. From these early feasibility studies, a dedicated Lunar Campsite effort was conducted during Phase 2 (ref. 2) which better defined the integrated vehicles necessary to conduct these types of missions. Early in 1992, the NASA Office of Exploration adopted this approach as a working baseline for return to the Moon as the First Lunar Outpost. Development of the FLO habitation system integrated baseline began under Technical Directive 11 (TD11) which examined a number of different



habitat/airlock configurations, studied deviations, modifications, and improvements necessary to utilize SSF elements and systems, and conducted more detailed trades and concepts for Electrical Power, Heat Rejection, and Environmental Control Life Support Systems, (ref. 9). The FLO Habitat heritage for TD11 is illustrated in figure 3-1. Modifications were necessary to provide FLO functions different from or beyond that of SSF Hab-A; improvements contained in the baseline as well as in the delta ( $\Delta$ ) options were made to better match the FLO concept to the lunar environment and/or to the campsite requirements. At the end of this portion of the study (TD11), Configuration "A" which used the STS airlock was recommended as a promising concept for meeting FLO objectives, including the 25 mt constraint.

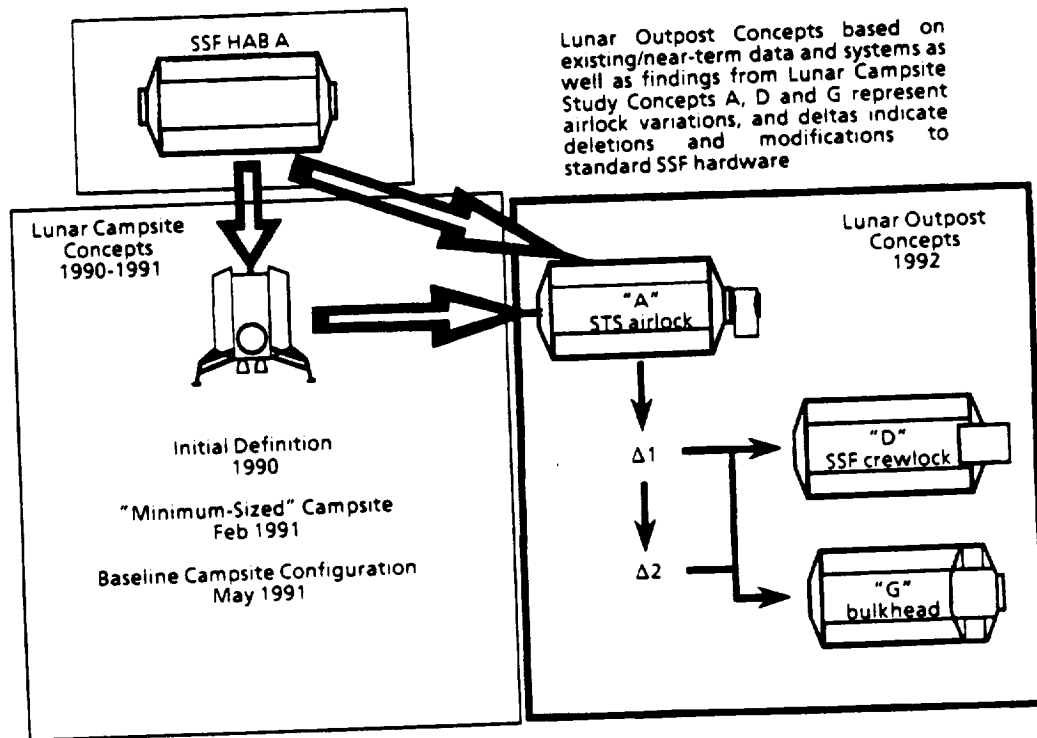

Figure 3-1. Outpost Habitat Methodology

The activities performed under the next portion of this study (TD13) were focused on developing an integrated baseline concept for the FLO habitation system, on conducting trades and analyses for numerous hardware/system/element alternatives, and on deriving requirements through more formal functional flow analyses. As shown in figure 3-2, the TD13 baseline sought an integrated configuration to accommodate the SSF module, SSF Crewlock, internal and external systems, as well as access and logistics operations. This current habitat/airlock combination was selected based upon mission requirements, including desire for hyperbarics capability and significant use of SSF

hardware and systems. Once the baseline had been well defined, trades and analyses were identified with the main objective of reducing weight, which has resulted in candidate alternatives even to module configuration and materials. The results of these efforts may now support the classical functional flows to identify a set of derived requirements to meet mission goals. Discussions expanding each of these three study areas are addressed in this report.

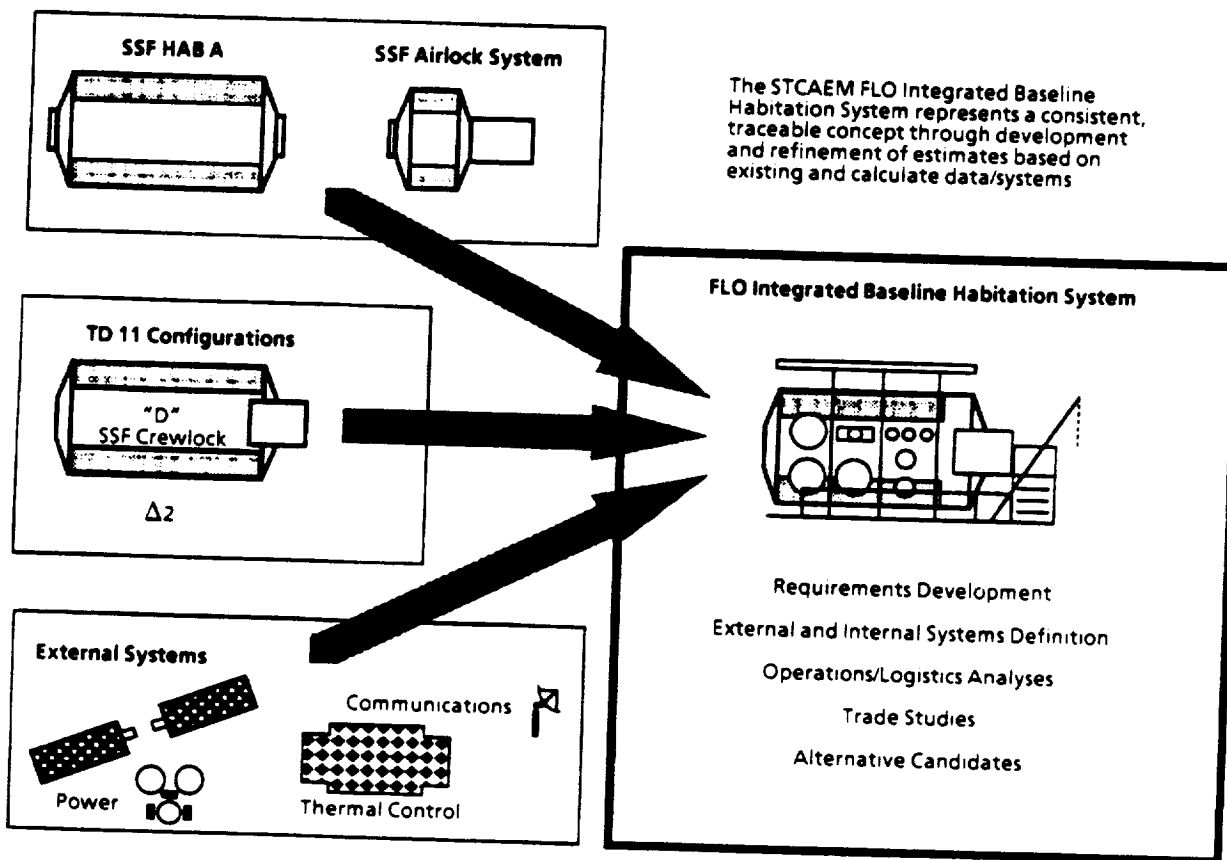

Figure 3-2. STCAEM TD 13 FLO Habitat Heritage

ACS036

### 3.4 HISTORY OF FLO HABITATION SYSTEM INTEGRATED BASELINE

The integrated baseline has been developed to provide a traceable, internally consistent concept for the First Lunar Outpost Habitation System which will provide preliminary resource estimates, a basis for alternative trades and analyses, a scenario for operations studies, and a framework of configurations, issues, and requirements for more detailed design. As discussed previously under Design Approach, the integrated baseline applies previous strategies to the selected module/airlock combination (SSF Hab-A with SSF Crewlock) while improving the definition of all internal and external systems. The current work has afforded continued and maturing habitation concept definition in support of the overall FLO activity.

### 3.5 HABITAT CONFIGURATION

The First Lunar Outpost Habitat has been closely based on SSF Hab-A architecture, SSF systems, and SSF mass and power data. However, the needs of FLO require three hab functions in addition to those provided by the standard SSF Hab-A: (1) support of airlock operations and EVA systems; (2) internal science capabilities; and, (3) crew health care and monitoring. Accommodation of these additional functions in conjunction with perceived redundancy and operations needs, requires changes to the topology and system selection for the FLO habitat module. The FLO habitation system concept represents a coordinated compilation of functions and configurations which are currently recognized as necessary to conduct a manned lunar mission; as a result, SSF and other existing/near-term hardware and technology have been applied to this concept in order to produce performance, operations, and resource profiles. This has been done assuming that these systems and elements will be available and sufficient for the FLO program to reduce schedule and DDT&E costs; however, more detailed studies are needed to ultimately determine the requirements and capability for the First Lunar Outpost

### 3.6 PRELIMINARY CONCEPTS FOR *FIRST LUNAR OUTPOST*

During the performance of this study, it became clear that the airlock is a major driver in the Outpost concept; moreover, airlock design appears to depend upon four basic requirements: (1) hyperbaric capabilities and associated needs, (2) size of Lunar Replaceable Unit (LRU) to be passed through the airlock, (3) number of crewmembers to be cycled through at one time, and (4) hatch and interior dimensions necessary to allow crewmembers to pass through the airlock. Hyperbaric treatment is preferred for decompression sickness and other disorders which may occur during EVA or other space activities. Although its need and appropriateness for the Outpost remains uncertain, hyperbaric operations have potential of greatly increasing size, mass, and complexity of both the airlock and the habitat (ref. 10). These impacts include: (1) airlock structure will, in part, depend upon internal pressure (recommended hyperbaric pressure is 2.8 atmospheres absolute or 2.8 times 14.7 psia irrespective of EVA suit or lunar module pressure and volume (SSF requirements state that the patient must be horizontal and attended by a crew medical officer who has access to three sides of the patient); (2) internal airlock systems must support extended shirt-sleeve operations (hyperbaric treatment may last as long as 72 hours); (3) additional make-up gases, monitoring and control equipment, etc., must be included to support hyperbarics; and (4) medical equipment must be included within the airlock to monitor, diagnose, and respond to the patient's condition. The other three basic airlock requirements mainly impact internal volume needs, which consequently lead to sizing make-up gas quantities, depress pump size and power, and operational procedures.

In response to these concerns, numerous options for the FLO habitat/airlock combination were initially examined. Several configuration options which utilize a Shuttle airlock (Schemes A, B and C), a SSF Crewlock (Schemes D and E), or an internal bulkhead which separates a portion of the habitat module to be used as an airlock (Schemes F and G) are shown in figure 3-3. Accompanying each of these airlock element options are the Extravehicular Activity (EVA) systems which facilitate both EVA and airlock operations. EVAS include suit processing and maintenance, depressurization pumps, controls and stowage which have been burdened upon the hab module for the concepts explored in this study. SSF system mass and power data have been used to estimate EVAS for all habitat/airlock configurations.

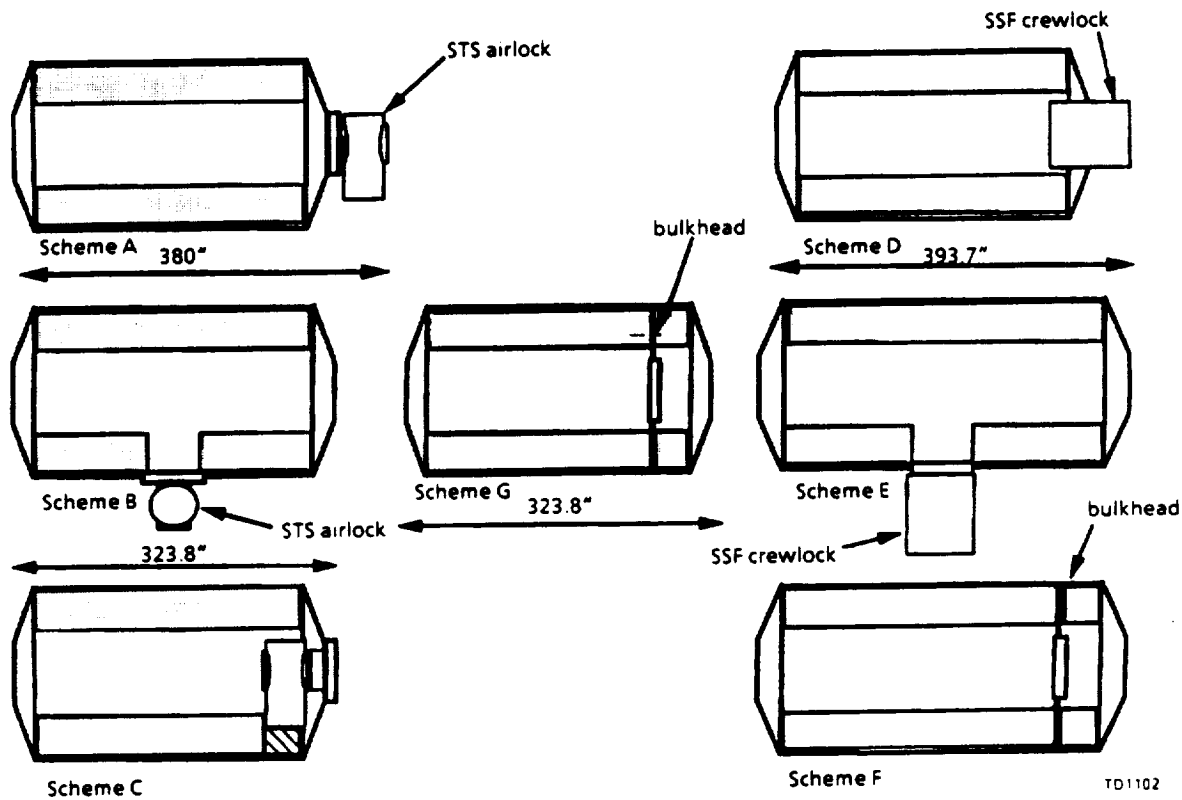

Figure 3-3. Lunar Hab Airlock Configuration Options

A qualitative study was performed to identify advantages and disadvantages associated with each of the above airlock options. These assessments identified the STS airlock, mounted externally to the endcone of the habitat module via a simple adaptor, as potentially the least impact solution and was thus chosen for further evaluation along with using either the SSF Crewlock or the integral bulkhead airlock. For this study, only options which seemed to require minimal changes to the preliminary best SSF module have been included; thus, Configurations A, D and G were chosen as the preliminary but

representative set of habitat/airlock combinations. Each airlock concept's effect on the habitat internal systems, internal volume, structure, power/thermal systems as well as crew egress/ingress capabilities were analyzed. Also, both hyperbaric and nonhyperbaric capabilities were assumed and examined for Configurations D and G. The qualitative comparison for these three configurations is given in figure 3-4. The goal at this stage of the study was to settle upon a reasonable baseline which could be studied in-depth; in parallel, alternatives to this set were also examined, some of which departed greatly from the reference.

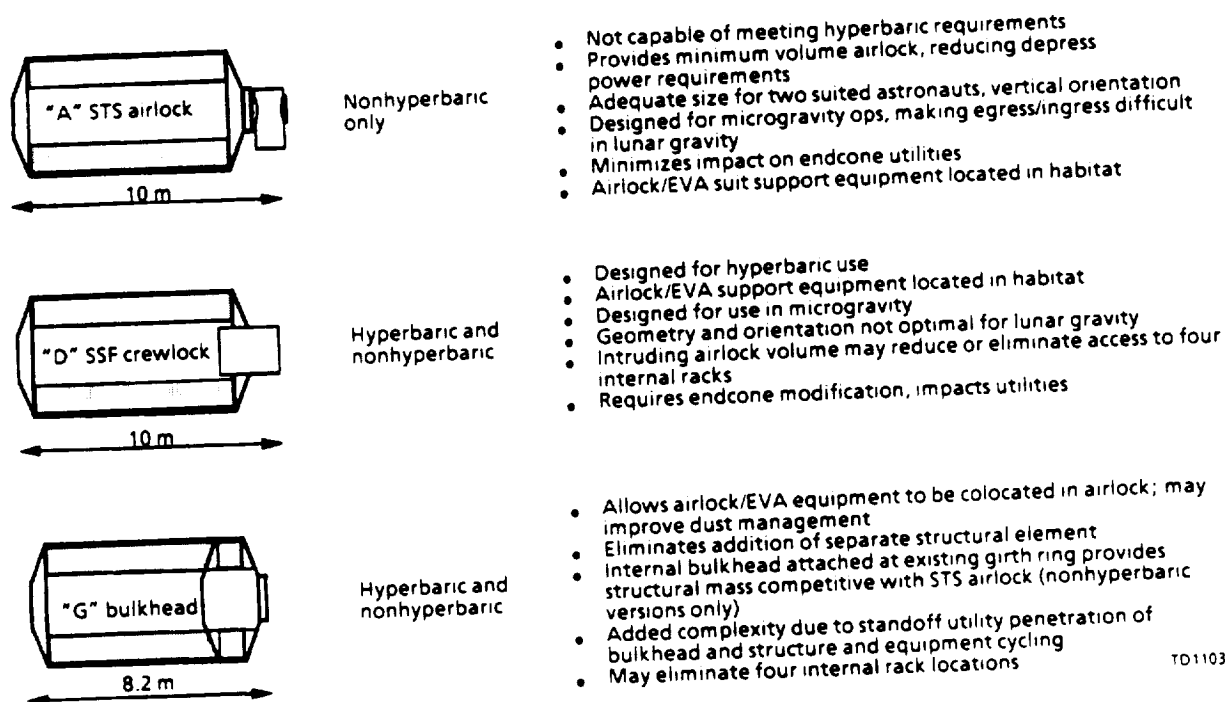

Figure 3-4. Lunar Outpost Configuration Airlock Alternatives and Assessment

Based upon Configuration A, an initial Outpost was developed using the module, architecture, and internal systems from SSF Hab-A, an airlock from the Space Shuttle Orbiter, and external utilities based on near-term technologies. Although each of the configurations proposed significant changes at the rack (and, as discussed later, at the subsystem) level, heritage has been maintained to SSF in the following ways: (1) the Outpost module structure is assumed identical to SSF Hab-A (see a more detailed discussion of structures in section 3.10); (2) relative arrangement of internal systems are preserved, especially with regard to ECLSS (see section 3.6.5); (3) overall architecture as well as technologies of the Outpost habitat are based on SSF Hab-A; and (4) most of the mass and power estimates are derived or taken directly from SSF data (thus, SSF internal systems have been assumed). Although this heritage allows concepts to be defined which

are traceable and as complete as possible, it must be recognized that future efforts will necessarily go to greater detail as a fully integrated and coherent concept is developed. For example, SSF Hab-A values for utilities in the standoffs and endcones have been assumed but will require changes as Outpost packaging needs are clarified; likewise, a unique and comprehensive redundancy scheme has yet to be applied to the FLO. However, it would be prudent to perform substantial requirement, mission analyses, design trades and alternative feasibility studies to define the context of the Outpost before one particular configuration concept is exhaustively detailed.

Configurations D and G substitute their respective airlock candidates but maintain the same basic habitat and external utilities as described for Configuration A. Significant differences between these options, include: (1) Configurations D and G potentially impact four internal rack locations and volumes. The SSF Crewlock of D must be embedded approximately 1.2 meters in the habitat module to fit within the 10-meter launch payload shroud envelope; thus, the bay of four racks (as well as standoff and endcone equipment) located at that end of the module may be blocked from access and made unuseable. Similarly, the placement of a bulkhead within the module might be accommodated also by displacing a bay of four racks; however, the required shape of the integral bulkhead has not been finalized. For this study, the bulkhead mass and size was assumed to be the same as a SSF endcone; but, if the "airlock" portion of the habitat module would be used as a "safe haven" (in case the remainder of the module had become depressurized for any reason) or if hyperbaric capabilities were necessary, then the bulkhead would need to contain pressure differentials from either side and the design could be quite different from that assumed. In fact, a flat bulkhead might be used which would reduce the impact to internal volume (but would be more massive); (2) the internal bulkhead of Configuration G will also impact standoff utility runs as well as subject equipment and hardware on the "airlock" side to pressure cycling not normally encountered on Space Station Freedom. The significance of these concerns has not yet been quantified; and (3) hyperbaric operations (for which SSF Crewlock is designed and to which Configuration G could be modified) will require at least one dedicated hyperbaric support rack within the habitat module (which must displace some existing rack); likewise, additional utilities and medical support will be required within the airlock itself. This study also examined the system changes required by hyperbarics for both Configurations D and G.

### 3.6.1 Delta One ( $\Delta 1$ ) Changes

As discussed above, SSF Hab-A was chosen as the reference for the FLO habitat module; however, changes were made to the topology and accommodations in accordance with the different and additional functions to be performed by the FLO hab. Changes within habitat subsystem (identified as "Deltas" in this study) were also defined and applied to all three configurations (A, D, and G), with the goal of improving the FLO concept through the addition, deletion, or modification of reference systems or equipment in accordance with the Outpost environment and mission. This current study has concentrated mainly upon the latter two of the three means of improvement in attempts to meet the original 25-mt mass "characteristic"; however, these changes have continued allegiance to the reference approach and have not yet proposed major deviations from SSF or near-term technologies.

Delta One ( $\Delta 1$ ) changes involved the removal or reduction of unnecessary and self-contained items from SSF Hab-A systems. Delta One suggests changes in six habitat/airlock areas: (1) Structures/Mechanisms. Proposed here is the removal of one of the module hatches as the airlock hatch should suffice at that end; also, because the habitat is located on the lunar surface (and on top of the lander in LEO), the lower half of the micro-meteoroid debris shielding has been removed; (2) Life Support. Obsolete or unneeded items include out-of-date information (contained in ref. 4) as well as SSF connections between modules; (3) Crew Systems. Due to the mission's relative shortness compared to the SSF tour of duty and the premium being put on habitat overall mass reduction, only the minimum required crew accommodations would be included; thus, the convection oven and Personal Hygiene Compartment (changing room and vanity) were deleted; (4) Power and Heat Rejection. These systems were changed in accordance with the new resource requirements resulting from other system changes; and (5) Airlock Systems. The SSF EVA toolbox is sized for requirements beyond that currently identified for the Lunar Outpost and was reduced to 15% of the tool mass.

### 3.6.2 Delta Two ( $\Delta 2$ ) Changes

Delta Two modifications were made to SSF hardware because of known lunar outpost requirements or due to the lunar environment. This second set of changes correspond to four habitat/airlock areas: (1) Structures. In accordance with the details given in section 3.10, rack structural mass was reduced by approximately 30% through the elimination of STS-specific launch "pseudo-forcing" functions; (2) Life Support. The lunar gravity environment may allow removal of system complexities added to SSF due to the weightlessness of Low Earth Orbit (LEO); replacement systems have not yet been

estimated; (3) Power. Further possible power system reductions were studied, including re-electrolyzing fuel cell reactants over the number of lunar days between manned visits (which adds complexity but does not seem to significantly reduce mass); and (4) Airlock Systems. Further reductions were proposed in EVA tool mass.

### 3.6.3 Delta Three ( $\Delta 3$ ) Changes

Delta Three changes were suggested as candidate major departures from SSF hardware, systems, operations, and/or current outpost scenarios. Some of these proposed modifications included optimizing the module structural design, examining 14-day and 30-day manned missions, studying alternatives to housing systems within racks (the purpose and utility of racks in the First Lunar Outpost should be examined), assessing new or exotic power generation options, modifying or developing new airlock designs, and incorporating solutions to address operational concerns such as loading/unloading, dust removal, system deployment and safing. Most of the Delta Three options were examined as part of the parallel alternative configuration task (see discussions later in this report).

One other investigation was conducted to determine what mass savings, if any, could be gained from substituting the standard SSF endcone structure, which is designed to withstand STS docking loads, with a specialized end "dome", that would also act as an airlock adaptor. This work was done under the assumption that the airlock is being supported by the lander structure, and is not cantilevered off the Hab. Results of this cursory study indicate a potential savings of a few hundred kilograms but have not been incorporated into any of the options offered by this study.

### 3.6.4 Development of Integrated Baseline

The initial work (TD11) performed on Configurations A, D, and G as well as the Delta modifications provided valuable data necessary to the development of an integrated concept. The strong desire for hyperbaric capability made the STS airlock unusable; thus, formal work under TD13 began with a short, focused trade study on the choice of hyperbaric airlock and its attachment to the habitat module. Under consideration were the SSF Crewlock or a new design, either of which would be located on the module cylinder or endcone. Due to maturity of the SSF Crewlock and the lesser impacts of mounting it onto the habitat endcone, this configuration (formerly called "D") was chosen as the baseline to be studied. Reservations which continue with this selection include: (1) the Crewlock is not designed for the lunar environment (less-than-optimal internal height, dust, thermal, and radiation concerns, etc.); (2) changes to the module endcone; and, (3) loss of four standard rack locations to accommodate the



Crewlock within a 10 meter ETO shroud. In answer to these concerns, first, all of the systems and elements proposed for FLO will require some design changes to survive the lunar environment; at some point, the ultimate extent of these changes could be traded against "all-new, lunar-optimized" designs. Second, initial estimates have shown that enlarging the opening in the flat portion of the module endcone should allow placement of the Crewlock without affecting the basic endcone shape and without significantly reducing external or internal endcone packaging volumes and schemes; however, access to these areas, "feed throughs" to and from the Crewlock, and load requirements must still be considered. Third, alternatives to losing four internal racks were examined (including, moving the entire complement of racks aft, enlarging the payload shroud, and assuming deeper "pockets" within the 10 meter shroud); however, the assumption of an unnegotiable 10 meter dimension along with the need for cylinder, endcone, and adjacent rack access as well as the possible requirement for external viewing dictated a removal of the forward bay of four racks.

The choice of which four racks to remove is eased somewhat by a change in the Avionics Air System; namely, this change redesigns Avionics Air from a centralized to a distributed system. In so doing, this change also deletes the need for both Avionics Air Crossover Racks (which is assumed to account for 2 of the 4 racks to be removed). In accordance with NASA's emphasis on external lunar science with minimal internal capabilities, the other two rack deletions were realized by reducing internal science from (the TD11 number of) three dedicated racks to just one. This remaining science rack has been based upon the SSF Lab-A Maintenance Workstation (MWS) which would allow characterization studies, suit maintenance, etc. but would not strictly be an experiment rack. Additional stowage or equipment volume could still be available in the "lost" ceiling and floor locations (in addition, loose storage or EVA suits could be placed in front of the windows) as shown in the internal volume assessment discussed later in this report. Other aspects of internal configuration and systems selection are included in the next section.

### **3.6.5 Internal Systems Location For Integrated Baseline**

Given the need to accommodate different functions within the module as discussed above, the internal configuration and system complement shown in figures 3-5 and 3-6 were developed specifically for the FLO integrated baseline with the goal to provide these capabilities and yet maintain substantial heritage to the SSF Hab-A architecture and design. The internal outfitting for a habitation module must observe numerous requirements in order to provide an operational and ergonomic vehicle. FLO will share

many of these constraints with SSF; for example, system layouts must obey adjacency requirements (both functional and physical), packaging limitations, access requirements, contingency needs and procedures, etc. The operating environment of FLO will also dictate additional constraints, including gravity, radiation, dust, and thermal concerns. Some of these considerations are discussed below and will ultimately be reflected in each of the internal systems which, due to both inter- and intradependencies, cascade into overall lunar habitation design.

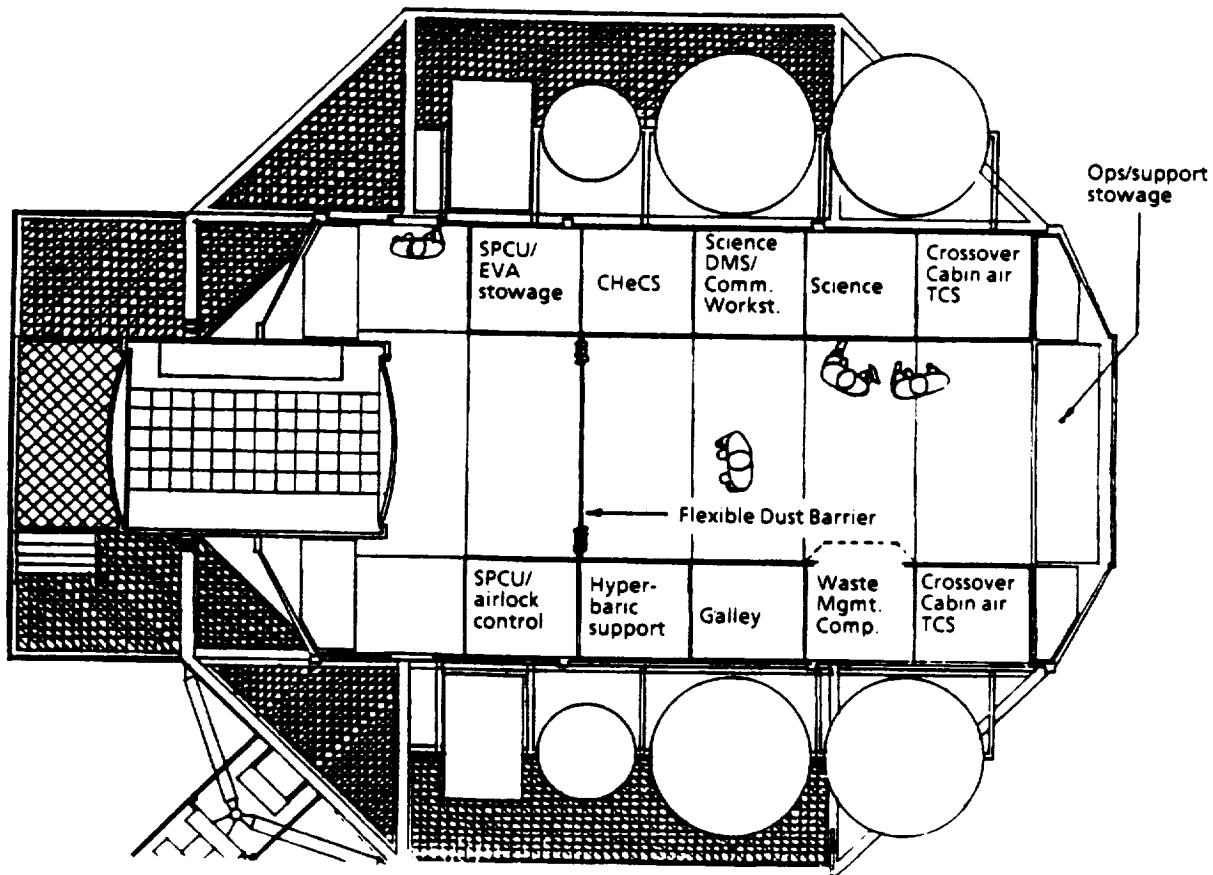
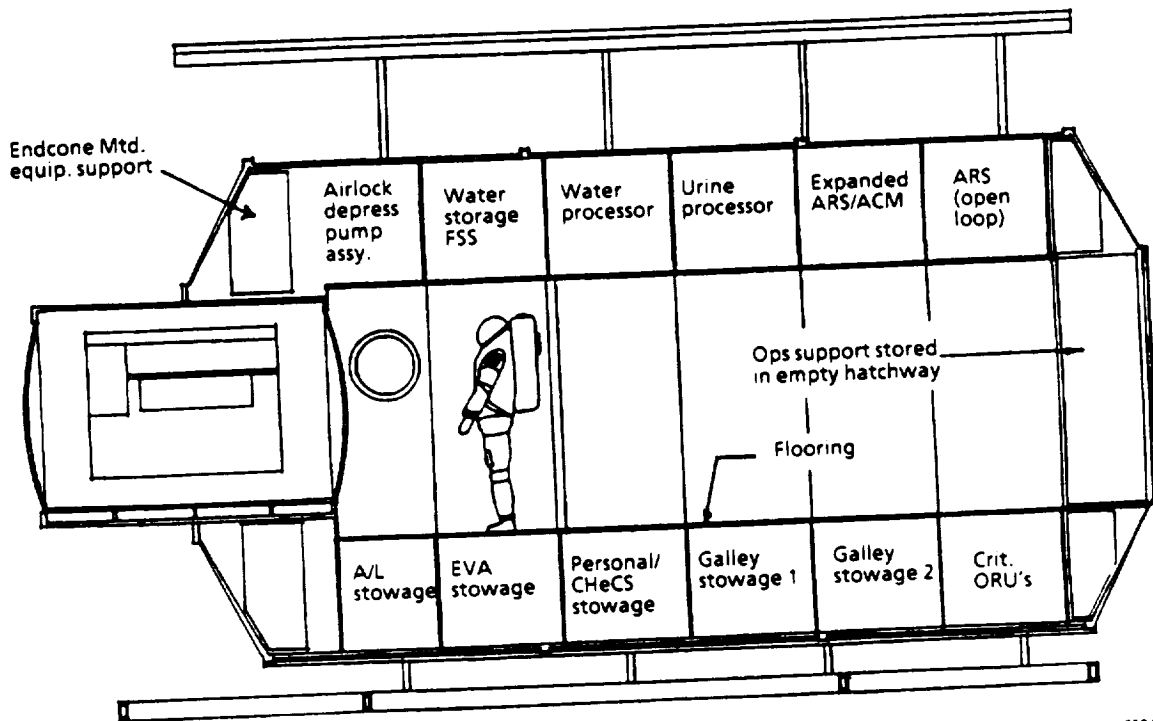

Figure 3-5. First Lunar Outpost Habitat, Plan View

ACS014

Although the Outpost configuration does arrange the ECLSS tier, Crossovers, and Waste Management Compartment in the same relative position as they exist for SSF Hab-A, a major change is made by locating ECLSS operating equipment in the ceiling instead of the "floor" (as in SSF). This modification is suggested for several reasons: (1) lunar dust is certain to enter the module irrespective of any dust-off scheme; thus, it is deemed reasonable to avoid placing operating equipment in the floor (therefore, only unpowered stowage is placed there); (2) solar and galactic radiation bombards the lunar surface with essentially no attenuation (except by the Moon itself); thus, placing massive



ACS015

Figure 3-6. First Lunar Outpost Habitat, Section View

equipment and especially water in the ceiling provides substantial benefit. However, in order to preserve the SSF ECLS system arrangement, water storage is no longer directly over the proposed storm shelter location (this and other changes will be discussed later in this section); (3) placement of non-ECLSS powered racks only on the walls is hoped to simplify standoff utility runs and services; and (4) maintaining SSF Hab-A relative positions for this equipment is hoped to reduce cost and design impacts (for example, the highly corrosive urine line from WMC to ECLSS processing is kept at its nominal length). However, this change also results in several potential impacts: (1) pumping of water and other fluids up to the ceiling is now required and may not be within the capabilities of currently designed SSF hardware; (2) simplifying utility services may require wall racks to interface with the standoffs at the top of the rack instead of at the bottom (which is potentially a substantial change to both internal rack packaging and rack pivoting design but may be advantageous with regard to dust mitigation, avoiding interference with the floor and crew activity, etc.); (3) ECLSS racks may need to interface both at the top and the bottom in order to feed and be fed from both adjacent standoffs (if this proves beneficial); and, (4) it is assumed but not known that the distributed Avionics Air Subsystem will not preclude packaging each functional rack as shown (better data on this subsystem are still forthcoming). Another change from the SSF Hab-A ECLS system is expansion of the second ARS rack to include redundant CO<sub>2</sub> Removal and Mass Constituent Analyzer assemblies (making these life critical functions one-failure

tolerant) which are assumed to fit in this rack in place of the SSF laundry facility. Also, as described in reference 9, ECLSS water storage is reduced by half to better reflect Outpost needs; thus, the Fluid System Servicer (FSS) is assumed to be able to share this rack. ECLSS also includes make-up and emergency gas tanks which require accommodation external to the module.

Several system racks have been located in an attempt to satisfy adjacency requirements. EVA and airlock support racks (SPCUs, EVA Stowage, Depress Pump) are placed nearest the airlock (which, in conjunction with some type of flexible dust barrier like a zippered plastic curtain, will hopefully also serve to minimize dust transport throughout the module). As mentioned earlier, windows are placed in the vacated forward positions to assist in visual inspection and monitoring (actual visual requirements and analyses have yet to be identified). Also, the Hyperbaric Support, Crew Health Care System (CHeCS), and CHeCS Stowage racks are located near the airlock (an alternative may be to switch the Science rack, envisioned to be like a SSF Maintenance Work Station (MWS), and CHeCS rack locations to assist in suit maintenance activities). The Science/DMS/Comm Workstation is a shared resource comprised of central computing and crew interface hardware; this rack is located between the CHeCS and Science racks to support both life science and selenology activities (a concern may be that the workstation also provides IVA monitoring of EVA activities and may desire a location nearer a window or away from other internal activities). As previously discussed, the WMC and both Crossover racks are positioned as they are in SSF Hab-A, which locates the Galley rack as shown. Placing this rack next to the WMC does not result in an ideal solution, but this concern is not overcome with the current module volume. Another less than optimal arrangement is the location of Galley Stowage in the floor (close to the galley for convenience). These two racks will house most of the food and meal preparation equipment which will be frequently accessed. Another use for this food would be as a radiation attenuator during large natural radiation events; however, due to the presence of the Moon itself, protection is mainly needed on the module sides and ceiling. Thus, in forming the in-situ storm shelter, this food must be relocated from the floor as discussed later. Critical ORUs, located at the aft end, consist of equipment spares and emergency provisions (critical spares philosophy and needs remain unidentified; however, estimates based on SSF are included elsewhere in this report while the baseline ORU mass and volume allowance is meant as a placeholder only). Since the second hatch is normally not used, Operations Support equipment (housekeeping supplies, cameras, etc.) are stored in this empty hatchway. Other storage space may be available in the vacated sub-floor and ceiling in front of the airlock; also, some loose storage (to accommodate EVA suits, for example) may be possible on the floor in this area.

As discussed above, the forward bay of four racks were removed mainly to prevent access violations. Several other access issues exist both internal and external to the FLO hab: (1) even in the lunar gravity environment, some type of device(s) will be required to assist in lowering, raising, and/or moving racks to perform maintenance, arrange storm shelters, gain access to the module shell, changeout equipment, etc. (2) full access to the embedded Crewlock shell may still not be possible; (3) airlock pass-through of crew and equipment requires further study to identify volume, hatch, operations, etc. concerns; (4) access to the external endcone opposite the airlock will be difficult but may be necessary for equipment located there due to redundancy and separation requirements, offloading from the forward endcone, functional constraints (such as short external water lines), etc.; (5) likewise, access to much of the external equipment, including power generation and thermal control systems, must be possible but remains a challenge; and, (6) access to the surface in addition to airlock egress/ingress, dust removal, and resupply operations may require powered hoists/lifts, large platforms, etc. which result from the Operations/Logistics study discussed elsewhere in this report. This aspect of the hab system design is discussed below as part of the external configuration and will ultimately be driven by the requirements yet to be identified for the First Lunar Outpost.

Another consideration of the FLO habitation system which will help dictate its configuration is radiation protection. Although normal solar activity and cosmic radiation is not currently expected to be a significant crew hazard for short duration stay-times, the possibility of anomalously large solar proton events (ALSPEs or "solar storms") is a very real concern for all lunar missions. Our approach to deal with these events is to "build" a "storm shelter" as needed using available Outpost mass for shielding. This available mass consists of racks which may be relocated, external equipment which may be strategically pre-placed or possibly even moved upon initial storm warnings, and/or, if necessary, use of dedicated mass to provide additional protection where needed. Due to high lunar transportation costs, it is desirable to minimize the amount of dedicated shielding required and current preliminary analyses have shown dosage to be below assumed limits using inherent habitat mass only (see section 5.0). The storm shelter must provide living volume capable of supporting 4 people for 3 days (during the most intense period of the ALSPE); for current study purposes, we have assumed this shelter will be formed around rack bays three and four by closing off the aisle with storage racks from the floor and aft hatchway. This volume provides approximately 8 cubic meters and is situated where the Galley, CHeCS, and control workstation are nominally located. Food and galley equipment would be used to

"close off" one half of one aisle; the other aisle would be closed using Critical ORUs and Ops Stowage. This arrangement would place the Waste Management Compartment outside of the shelter; however, this is a less massive rack which would not provide significant protection and personal hygiene may be accomplished for these three days by means similar to that used during Earth-to-Moon transport. One concern is raised in how much food will be used during this time and possibly reducing protection afforded by its presence (one mitigation scheme proposes to replenish this "wall" with wastes). An updated radiation analysis to assess the environment corresponding to this new layout is included later in this report and provides some insight when compared to previous analyses, reference 9 (for example, how much the missing forward bay of racks affects crew dose). External configuration will also balance radiation protection with other concerns; thus, the location of power fuel cell reactants, ECLSS gas tanks, and other equipment will be a trade off between access, launch constraints, thermal considerations, and other factors including their possible use as radiation shielding.

### **3.7 EXTERNAL CONFIGURATION FOR INTEGRATED BASELINE**

In addition to the module and its internal systems, the FLO integrated baseline includes the external equipment and accommodations necessary to support the habitat and its crew. These external systems include power generation, storage, and distribution, thermal control, communications, ECLSS gas storage and management, and EVA support. While many of these systems could share hardware and operational burdens with the FLO lander, study assumptions have sized this concept for habitat needs only. As discussed above and as illustrated in figure 3-7, external systems are very much related to the module and its systems as well as to each other; thus, configuration and selection of external systems must consider many of the same factors posed for internal systems.

#### **3.7.1 Integration of External Systems to Hab Module**

The habitat, its subsystems and supporting structure are treated as an integrated payload to be attached to the lander at several points. The habitat's external subsystems are integrated into a framework of vertical trusses and diagonal cross-bracing that extend from the base of the hab to the bottom of the radiator panel support structure, which support individual tanks, fuel cells, and other equipment, and transfer loads to the habitat support structure figure 3-8. This also has the benefit of minimizing any modifications to the lander, so that it can function as a common lander stage for crew delivery, or for future cargo missions in support of lunar base buildup.

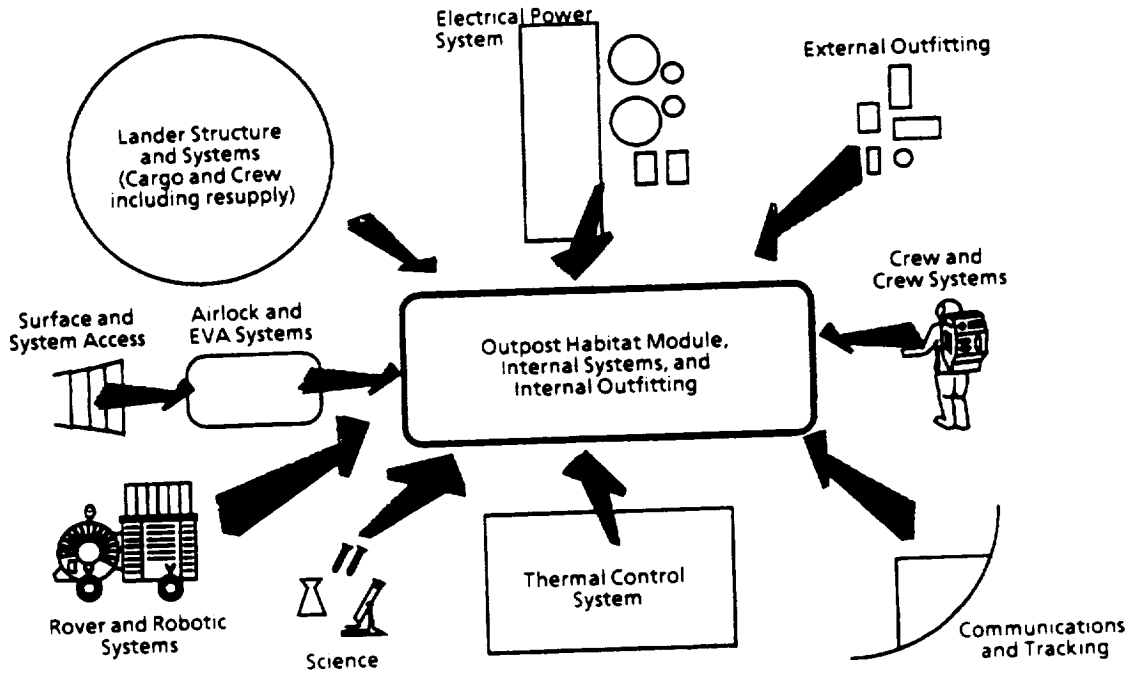
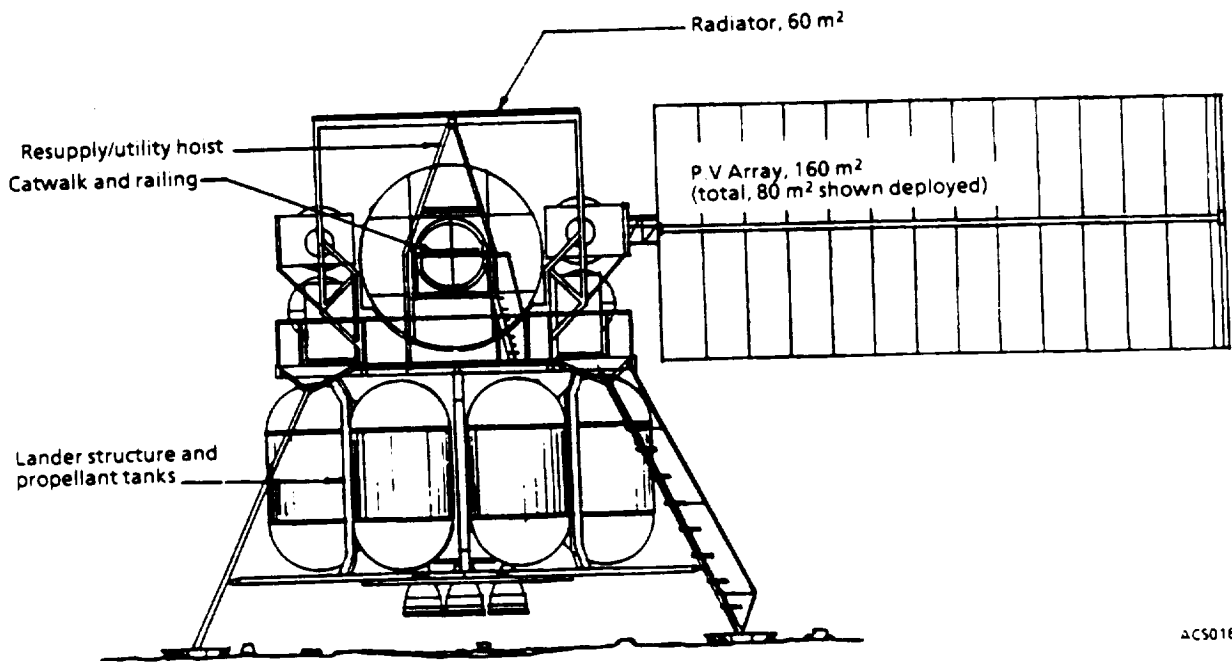

Figure 3-7. Outpost Hab External Interfaces

MR005



ACS016

Figure 3-8. First Lunar Outpost Configuration

### 3.7.2 External Systems Location

The location of power and life support systems on the exterior of the lunar habitat is effected primarily by the limitations imposed by the launch shroud diameter of 10 meters. Equipment and storage tanks have been located on either side of the habitat, mounted in vertical frames that allow partial EVA access around the sides of the habitat, and also provide partial coverage of the habitat structure for radiation protection. Power system fuel, liquid hydrogen and oxygen, is located in a series of spherical tanks, split evenly on each side of the habitat. Fuel cells, electrolyzers and solar array structures are also split into two separate units, and located on either side of the hab. ECLS supplies, repress gasses and EVA sublimator water, are also divided evenly, and located on either side of the hab structure, figure 3-9.

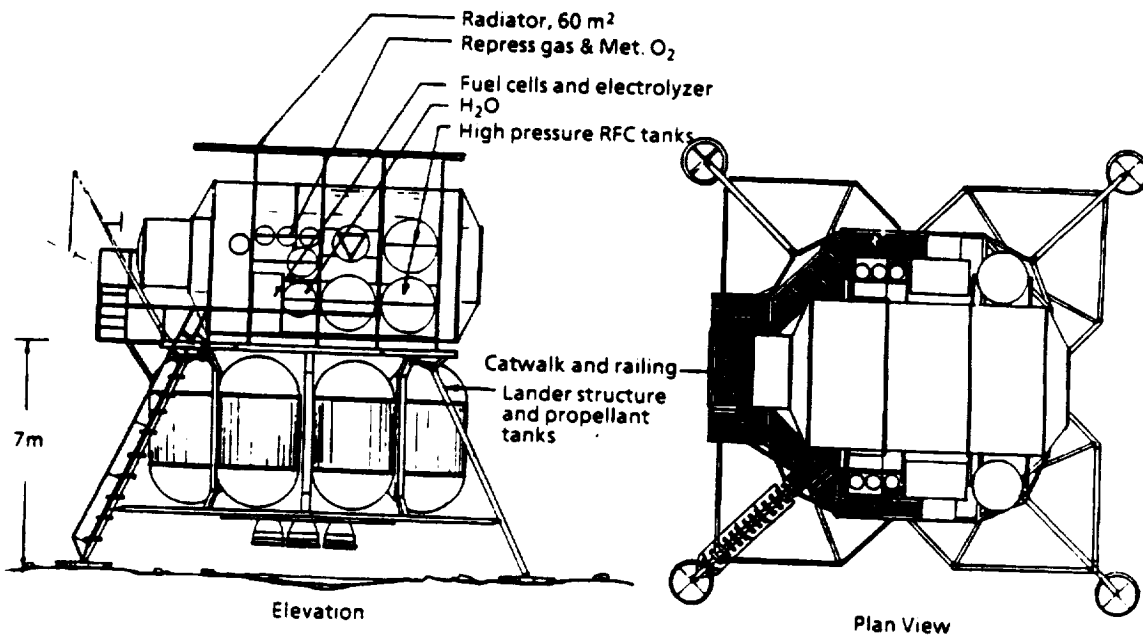

Figure 3-9. First Lunar Outpost Configuration

ACS017

### 3.7.3 External Access

During normal outpost operations, astronaut access to critical areas of the habitat for inspection, maintenance, and repair will be required. Access to fuel cells, electrolyzer, solar array deployment mechanisms and valving is achieved by placing a catwalk type of platform around the front and forward sides of the habitat. The catwalk, parts of which are deployed after the crew arrives, would be attached to the upper members of the lander structure, and would provide a safe working area for EVA personnel, figures 3-9 and 3-10.



**Design Requirements**

- 7 cubic meters of resupply weighing approximately 1700 kg must be brought into the habitat through the airlock
- Resupply packages must be lifted 8-9 meters from surface to airlock entrance
- The size of resupply packages may vary depending on the enclosed materials
- Externally stored resupply materials, such as repress gas, metabolic oxygen and EVA sublimator water, will not be required to be lifted to the habitat level of the lander for resupply operations

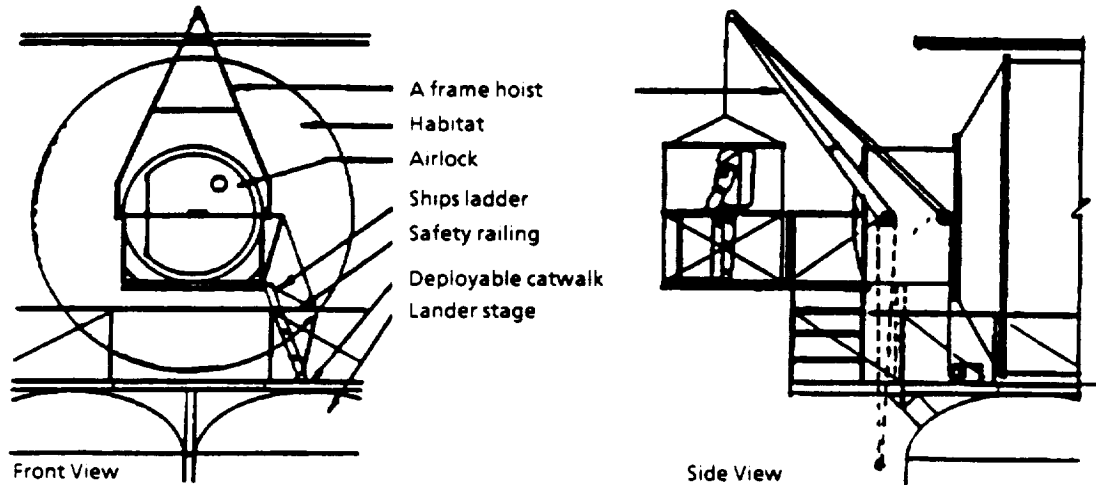
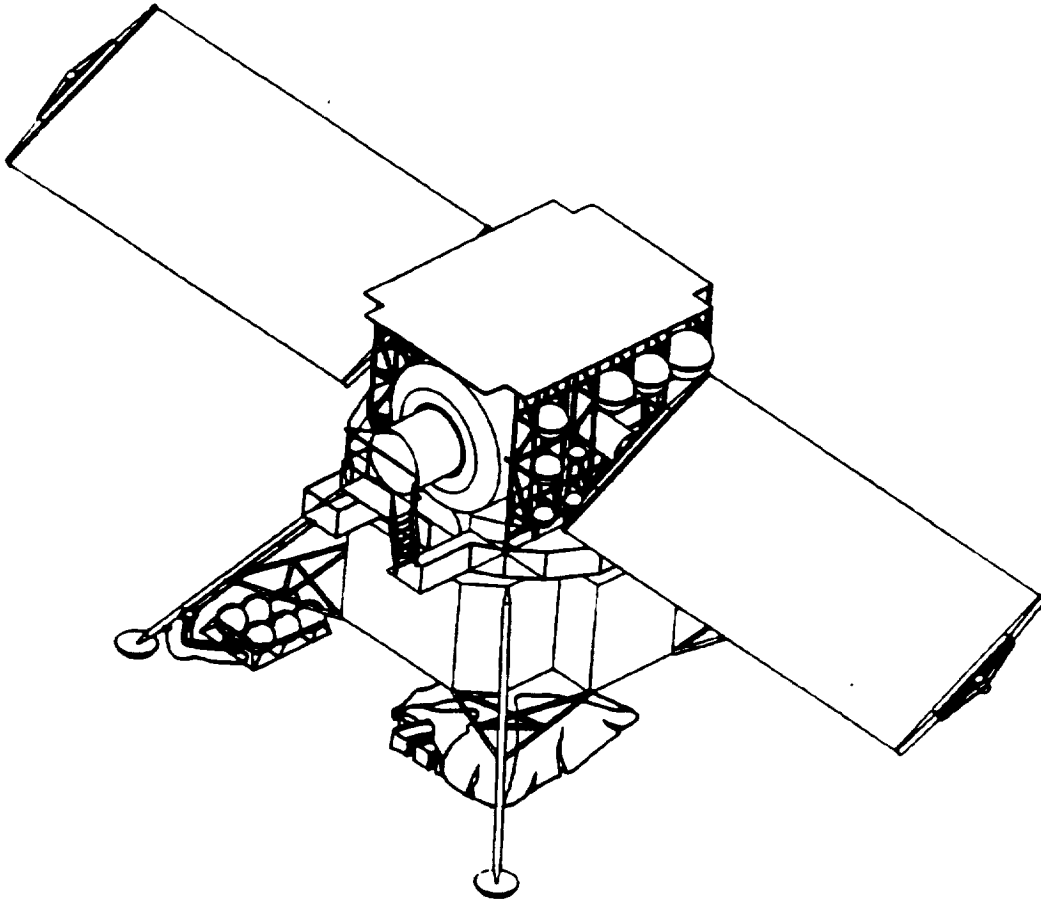

Figure 3-10. Resupply and Logistics

ACS018

Access to the catwalk from the surface is by way of a ladder located on one of the forward lander legs. The long axis of the habitat/payload is oriented on the lander at a 45 degree angle to the landing legs, which allows the ladder to terminate at an open space on the catwalk, instead of directly beneath the airlock. This will enhance the safety of EVA operations by eliminating the need for a vertical ladder section connecting the "leg-ladder" and the airlock. The airlock entrance is located approximately two meters above the level of the catwalk, and has a smaller, deployable "threshold" platform of it's own. A ships ladder connects the catwalk and this smaller platform. Both platforms are surrounded with handrails.

Roughly five tonnes of resupply cargo will be offloaded from the crew lander on the second mission, and delivered to the airlock entrance for transfer into the habitat. The airlock entrance is seven to eight meters above the surface, and it will be difficult for a suited astronaut to deliver the required resupply packages to the airlock platform by hand. Therefore, methods were developed to minimize the amount of material lifted to the level of the habitat. Life support resupply gases will be connected to the system through valving located at the base of the lander, after transfer from the crew lander on a trailer attached to a rover. Other noncritical resupply materials can be stored under a thermal protection blanket, under the habitat lander, and brought into the hab as needed. Those supplies that are required immediately would be hoisted directly to the airlock platform from the surface through the use of an "A" frame type hoist, figures 3-10 and 3-11. The hoist's capacity will allow 400 kilograms of cargo or personnel to be lifted directly to the airlock entrance.



ACS033

Figure 3-11. First Lunar Outpost Configuration

### 3.8 INTEGRATED BASELINE MASS SUMMARY

A mass summary for the Boeing FLO Integrated Baseline Habitation System is presented in figure 3-12. An illustrated history of FLO habitation system mass is provided in figure 3-13. Appendix A gives a detailed breakdown of Boeing masses along with hardware locations, data sources, and assumptions. Appendix B includes lower level values of Boeing and MSFC mass estimates and associated rationale for any differences. Descriptions for specific baseline systems are included in the following paragraphs of this section.

### 3.9 CONSUMABLES STOWAGE VOLUME ASSESSMENT

Internal volume is recognized as a valued commodity on SSF and may also be a significant constraint to FLO design. Earlier discussions have stated the assumption that systems currently contained within a SSF rack would continue to occupy this volume for FLO applications; thus, system volume estimates have been made mainly on a rack-to-rack comparison and the current internal configuration has been developed to

<b>Module Structure</b>	<b>6345 kg</b>
<b>Internal Systems</b>	
ECLSS	2990 kg
Medical Support	668 kg
Crew Systems	1402 kg
DMS	687 kg
IAV	97 kg
Internal EPS	711 kg
Internal TCS	1262 kg
Internal Science	767 kg
Internal EVAS	535 kg
<b>External Systems</b>	
Support Structure	2064 kg
C&T	72 kg
External EPS	5451 kg
External TCS	520 kg
Airlock System	2175 kg
EVA Suits	with crew
Gas Conditioning Assembly	258 kg
<b>Dedicated Radiation Protection</b>	<b>Not Required</b>
<b>Consumables</b>	<b>2505 kg</b>
<b>Contingency (15 - 28% of Ext Systems)</b>	<b>1477 kg</b>
<b>Total Landed Mass</b>	<b>29,986 kg</b>

Figure 3-12. Integrated Baseline Concept Description, Mass Properties Summary

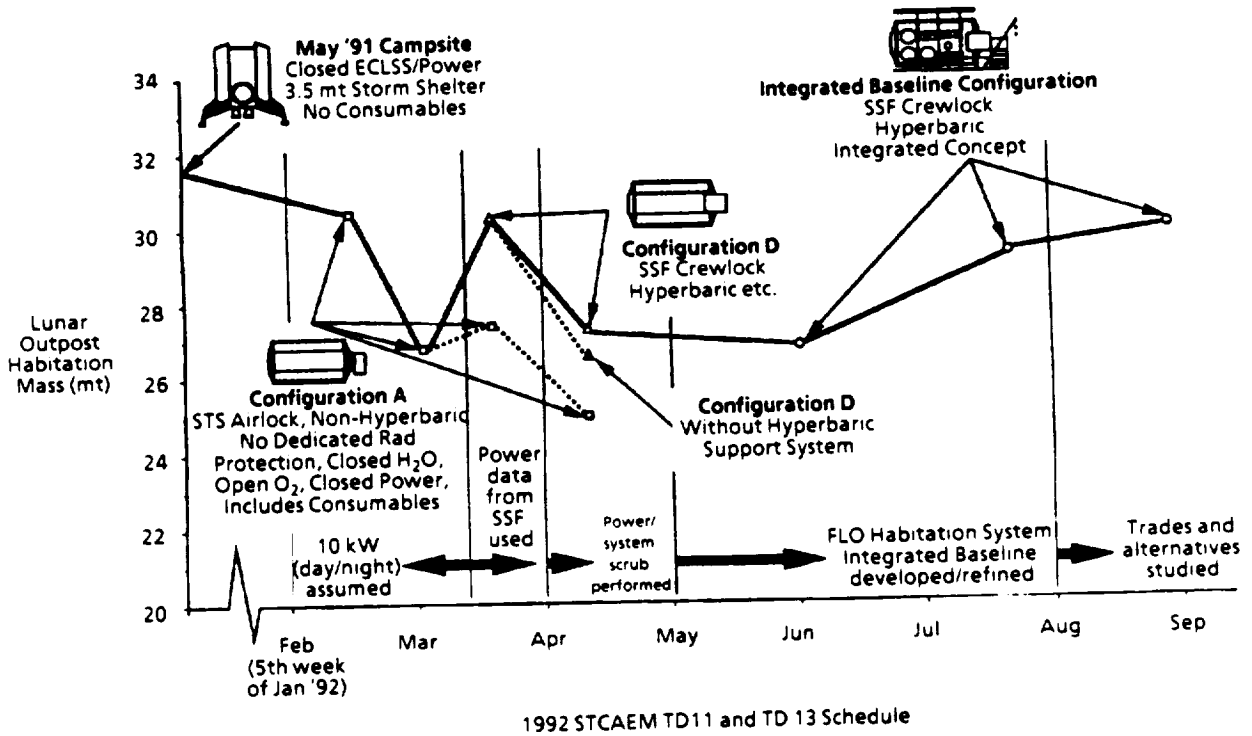

Figure 3-13. Boeing STCAEM Lunar Outpost Habitat, Concept Mass History

accommodate these necessary functions. The FLO habitation system also contains a large quantity of consumables, the majority of which must be stored internal to the module. To evaluate the internal volume needs versus availability, a preliminary assessment was made of the volume required for 45 days worth of consumables. The obvious purpose of this study was to identify potential problems and solutions associated with internal volume storage requirements in support of habitat definition, operations/logistics analyses, and consumables philosophy development.

The results of this evaluation and comparison of the volume available in the current module layout to the estimated volume needed for internal consumables is given in figure 3-14. These initial findings suggest the baseline layout offers a potential 12.4 cubic meters of stowage volume; however, 3 m<sup>3</sup> of this potential volume is located in front of the windows and may not be usable due to access needs and viewing operations but may be suitable for hanging EVA suits (and possibly allowing all four suits to be attached to the SPCUs simultaneously). Currently, 7.9 m<sup>3</sup> of internal consumables have been identified and may suggest changes to the present layout; for example, Personal/CH<sub>2</sub>CS Stowage will probably require more than one rack but Galley Supplies and Food take up only a third of its allocated space (although trash and waste storage is still unknown). Other unknowns include actual system spares and expendables needs, furniture stowage schemes, and science/sample stowage requirements. Assuming that the empty space in front of the windows is used for suits only, volume needed approaches 85% of volume available. Continuing definition of the quantity, size, and scheduling of consumables is necessary to verify packaging densities, to identify resupply operations and changeout needs, to help establish repair/replace and redundancy schemes, to define both dormancy and manned requirements, and to develop the optimal consumables manifest mix between that burdened on the initial habitat and that brought by the first visiting crew. A very real concern is the actual packaging available within racks, consumable packaging, and other containers which may further reduce the available volumes assumed in this study. FLO development should closely consider both SSF volume allocation history and ongoing refinement to ensure reasonable planning for its own internal volume.

### 3.10 PRELIMINARY STRUCTURAL EVALUATION

A preliminary structural evaluation of the Space Station Freedom Hab module was performed in order to utilize it as the First Lunar Outpost. The effects of SSF Hab-A mass change on trunnion loads and reactions were calculated, possible weight reductions issues were addressed, and a trade study on the selection of an airlock was conducted. A brief summary of the work is provided.

Stowage Volume Identifier	Racks or Rack Equivalents	Volume Available (m <sup>3</sup> )*	Consumables to be included	Volume Needed (m <sup>3</sup> )*
EVA Stowage Rack	1.0	1.5	<ul style="list-style-type: none"> <li>• EMU expendables</li> <li>• EMU Spares</li> <li>• Dust Control</li> </ul>	0.72 0.31 0.67 <span style="font-size: 2em; vertical-align: middle;">}</span> 1.70
Personnel/CHeCS Stowage Rack	1.0	1.5	<ul style="list-style-type: none"> <li>• Clothing</li> <li>• Personal Hygiene</li> <li>• Off Duty</li> <li>• CHeCS Supplies</li> </ul>	1.77 0.21 0.19 0.50 <span style="font-size: 2em; vertical-align: middle;">}</span> 2.67
Galley Stowage Racks	2.0	3.0	<ul style="list-style-type: none"> <li>• Food</li> <li>• Galley Supply</li> </ul>	0.58 0.34 <span style="font-size: 2em; vertical-align: middle;">}</span> 0.92
Critical ORUs Rack	1.0	1.5	<ul style="list-style-type: none"> <li>• Internal System Spares (placeholder)</li> </ul>	1.5 (assumed)
SPCU/EVA Stowage Rack	0.25 (assumed)	0.375	<ul style="list-style-type: none"> <li>• Stowed Suits (?)</li> </ul>	
Volume available in ADPA Rack	0.25 (assumed)	0.375	<ul style="list-style-type: none"> <li>• ECLSS Expendables</li> </ul>	0.40
Volume available under floor at end near Crewlock	0.25 (assumed)	0.375	<ul style="list-style-type: none"> <li>• Stowed Suits(?)</li> </ul>	
Open area in front of windows (must consider access)	2.0	3.0 (maybe?)	<ul style="list-style-type: none"> <li>• Standing Suits (?)</li> </ul>	
Volume available in back-up hatchway	0.5 (assumed)	0.75	<ul style="list-style-type: none"> <li>• Operations</li> <li>• Maintenance</li> <li>• Science</li> </ul>	0.43 0.14 0.16 <span style="font-size: 2em; vertical-align: middle;">}</span> 0.73
<b>Totals</b>	<b>8.25</b>	<b>12.375</b>		<b>7.92 +</b>

\* Usable volume in 80" rack approximately 1.5 cubic meters

Figure 3-14. Study Results

### 3.10.1 Loads and Reactions

The SSF Hab launch and abort-landing loads/reactions were evaluated. FLO Hab's launch configuration is 90 degrees to the SSF Hab's launch configuration (which is similar to the SSF Hab landing configuration). Basic geometry and the trunnion locations are shown in figures 3-15 and 3-16, respectively. In order to evaluate the magnitude of the loads, with respect to change in mass, the following assumptions were made:

- a. SSF Hab to be used without major structural modifications.
- b. SSF Hab Baseline mass ~17.5.
- c. FLO Hab to be launched aboard an NLS-type launch vehicle.
- d. FLO Hab to be supported at the same reaction points as the SSF Hab.
- e. Space Shuttle forcing functions will be used for dynamic loads calculations.

Calculations were based upon the FLO Hab launch "g" loading provided (fig. 3-17, ref. 11). Static loads and reactions were calculated for the FLO Hab for three mass configurations, 17.5-, 20.0- and 23.0-metric tons. Dynamic loads and trunnion reactions were generated for 17.5- and 23-metric ton mass configurations using the "g" loading and Space Shuttle forcing functions. Reactions for 20-metric ton Hab were interpolated

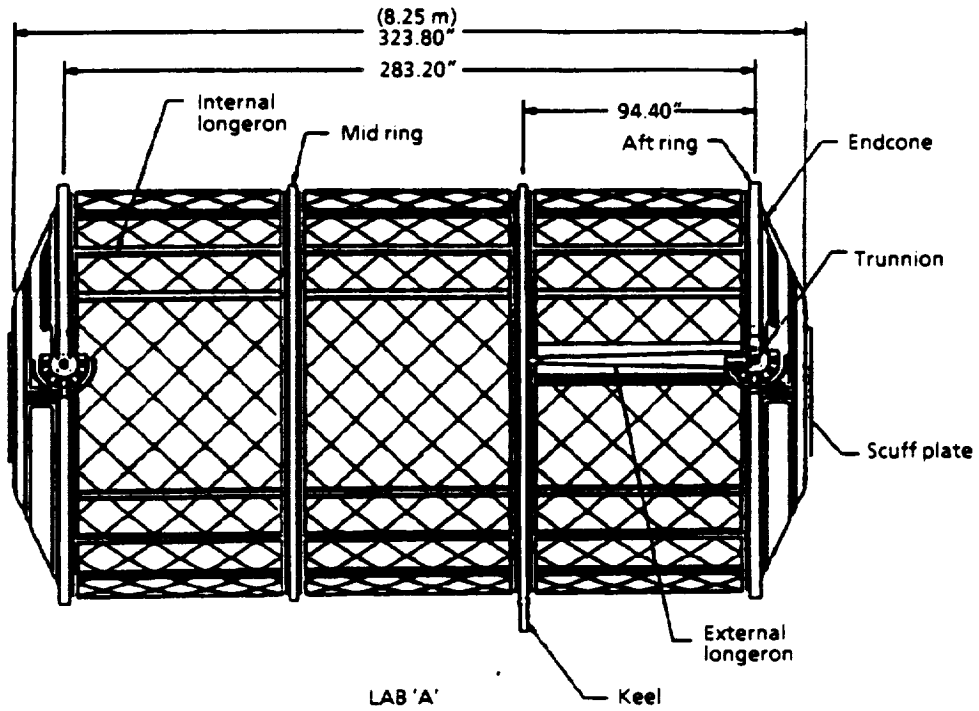

TD1107

Figure 3-15. SSF Hab Module - General Information

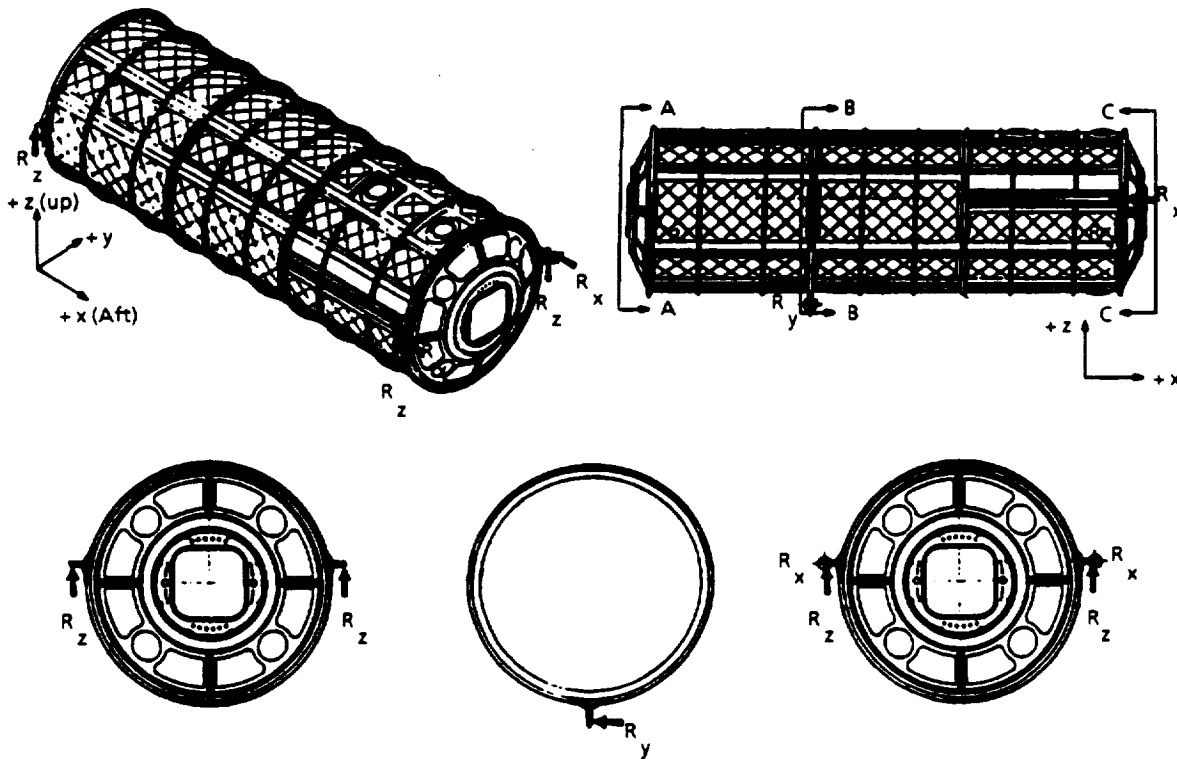

TD1108

Figure 3-16. SSF Hab Module - Attachment Point Reactions

from the 17.5-mt and 23-mt reactions. Once the static and dynamic loads and reactions were available, dynamic amplification factors were obtained for each of the three mass configurations by taking a ratio of dynamic-to-static reaction loads. Dynamic amplification factors provide a means of determining reaction load changes with changing mass. Reaction loads and the dynamic amplification factors are provided in figure 3-18, and are depicted by the graph in figure 3-19.

Lunar Habitation Study - Structures

Assessment of the effect of different launch loads on the SSF module

SSF Modules	Lunar Habitat
Vertical orientation Launched on Shuttle Launch loads Axial: 2 g's Lateral: 2.5 g's Modules mounted on trunnions Modules required to survive an abort landing Landing loads Axial: 1.7 g's Lateral: 3.6 g's	Horizontal orientation Launches on HLLV-derived vehicle Launch loads Axial: 4.0 g's Lateral: 2.7 g's

- Determine minimum modifications required to SSF modules to support the Lunar Habitat mission
- Determine modifications required to provide an optimized module for the Lunar Habitat mission

*Figure 3-17. Lunar Hab Module - Launch Loading (MSFC)*

The dynamic reaction loading on the Lunar Hab is nonlinear with respect to mass increase. Increasing the mass from 17.5 mt to 20 mt (which is a 14% increase) results in an increase in the reaction loads by almost 70%, and increasing the mass from 17.5 mt to 23 mt (a 30% increase) results in an increase in the reaction loads by almost 120%. It is concluded that the SSF Hab can be used without major modifications as long as the mass is kept at or below 18 mt. The severe loading increase observed when increasing the Lunar Hab mass will require major structural changes to the SSF Hab. A more detailed and realistic analysis must be performed as the launch vehicle and Lunar Hab launch configuration are better defined. Realistic forcing functions for the Lunar Hab launch vehicle are required in order to calculate accurate dynamic amplification factors.

### 3.10.2 Weight Reduction Efforts

An investigation was undertaken to reduce the structural mass of the SSF Hab. A detailed breakdown of the SSF Hab structural mass and payload was performed, and those areas were identified that showed a potential of weight reduction. A new bulkhead without a hatch was proposed for one of the two ends which could save as much as

Lunar Hab Launch Reaction Loads  
Static - Dynamic Loads Comparison  
17.5 mt/20 mt/23 mt

Configuration	Phase	Axis	Load factor (g)	Total static load (lbf)	No. of reaction points	Maximum static reaction (lbf)	Maximum dynamic reaction (lbf)	Dynamic amplification factor
SSF Configuration 38600 (lbs)	Launch (17.5 mt)	X	3.4	131240	2	65620	71000	1.08
		Y	1.0	38600	1	38600	42000	1.09
		Z	3.2	123520	4	30880	46000	1.49
	Abort landing	X	1.4	54040	2	27020	30000	1.11
		Y	1.0	38600	1	38600	42000	1.09
		Z	3.7	142820	4	35705	43000	12.0
Lunar Hab Configuration 51000	Launch (23 mt)	X	2.7	137700	2	68850	89100	1.29
		Y	1.0	51000	1	51000	51000	1.00
		Z	4.0	204000	4	51000	96100	1.88
Lunar Hab Configuration 44000	Launch (20 mt)	X	2.7	118800	2	59400	70570	1.19
		Y	1.0	44000	1	44000	45938	1.04
		Z	4.0	176000	4	44000	74227	1.69

\* Dynamic amplification factor for 20 mt is obtained by linear interpolation of 17.5-mt and 23-mt amplification factors

Figure 3-18. Maximum Reactions and Dynamic Amplification Factors

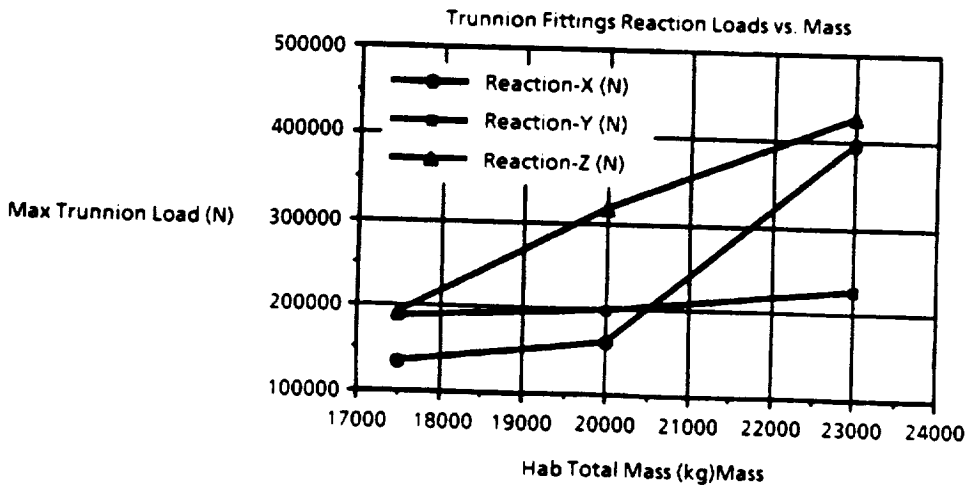
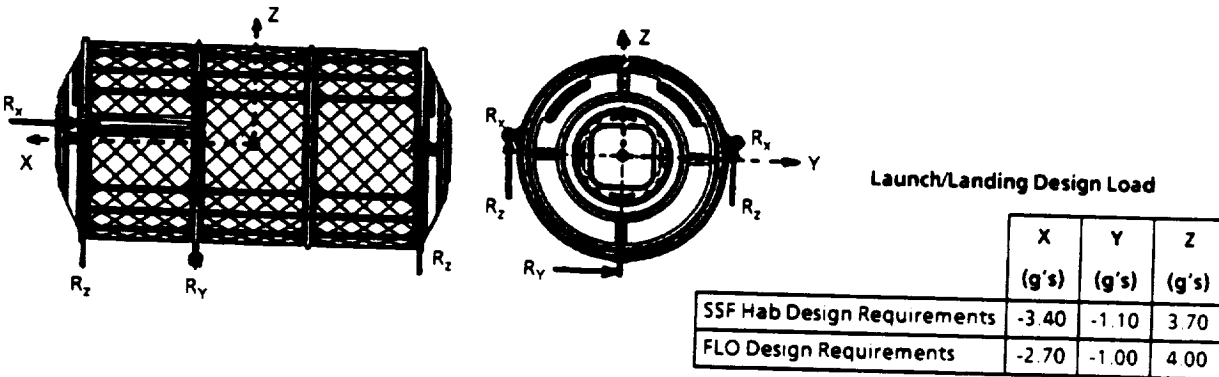

Figure 3-19 Lunar Hab Module Summary of Launch Reaction Loads



250 kg. Changing the pressure vessel material from 2219 Al to 2090 aluminum-lithium will also result in approximately 10% weight saving.

Storage racks seem to be another candidate for a potential weight savings as they are add-on structure and could be modified without redesign of SSF Hab primary structure. The present total structural weight of the racks is 2335 kg (74% as heavy as the basic SSF Hab structure). It was found that the driving factors for the rack design are the frequency requirements of 25 Hz, and the design loads resulting from two conservative "Pseudo Forcing Functions". The rack design loads are shown in figure 3-20. These pseudo forcing functions account for 40% to 60% increase in rack loads. It was proposed that the pseudo forcing functions which are very specific to Space Shuttle and Booster dynamics, not be considered when calculating dynamic loads for the Lunar Hab racks. Penalizing Lunar Hab racks by imposing Space Shuttle forcing functions is not appropriate in the conceptual design phase. Forcing functions other than pseudos shall be considered as usual. This results in a potential weight savings of about 20% to 30% (approximately 700 kg). The final design and sizing of the rack will be accomplished as the Lunar Hab launch vehicle is better defined.

	Design limit load factors					
	N <sub>X</sub>	N <sub>Y</sub>	N <sub>Z</sub>	R <sub>X</sub>	R <sub>Y</sub>	R <sub>Z</sub>
Hab	3.4	1.1	3.7	---	---	---
Racks	±9.0	±7.6	±8.0	±53.4	±42.0	±31.5

• Design ultimate load factors are 1.4\* limit load factors

Figure 3-20. SSF Hab Module - Rack Design Load Factors

### 3.10.3 Hyperbaric vs. Nonhyperbaric - Structural Evaluation

**Airlock.** A trade study was conducted to identify concerns and features of several FLO Habitat/Airlock configurations in order to arrive at an optimal baseline. Internal and external airlocks were evaluated for hyperbaric and non-hyperbaric operations. These configurations are shown in figure 3-21. External airlocks included the Orbiter airlock, SSF Crewlock mounted on the endcone or skin, and a new airlock mounted on the endcone and designed to fit within the 10m payload shroud. Internal airlocks included addition of an internal bulkhead creating a chamber providing hyperbaric or non-hyperbaric operations. Primary structural masses for configurations A, G and F were evaluated for nonhyperbaric operations. Structural weight penalties for operating configurations G(h) and F(h) in hyperbaric mode were calculated. Configurations G(h) and F(h) both required major modifications to the bulkhead and skin. Mass estimates for all configurations are provided in figure 3-22. Configuration A (nonhyperbaric), with a SSF airlock, was the baseline configuration. Configuration G (nonhyperbaric, with internal bulkhead) had the same structural mass as that of the baseline configuration.

Configuration F (Extended Hab, nonhyperbaric) and configuration D (hyperbaric with SSF Crewlock) were both about 12% higher than the baseline. Both configuration G(h) and F(h) seemed to be about 80% heavier than the baseline. Analysis showed that internal airlock is not an efficient design. Mass penalties of up to 80% of total hab structural weight will be realized with internal bulkhead designed for hyperbaric operations. Configuration 'D' with SSF Crew lock was evaluated to be the optimum choice with hyperbaric capabilities and about 12% higher mass than the baseline non-hyperbaric Orbiter airlock configuration 'A'.

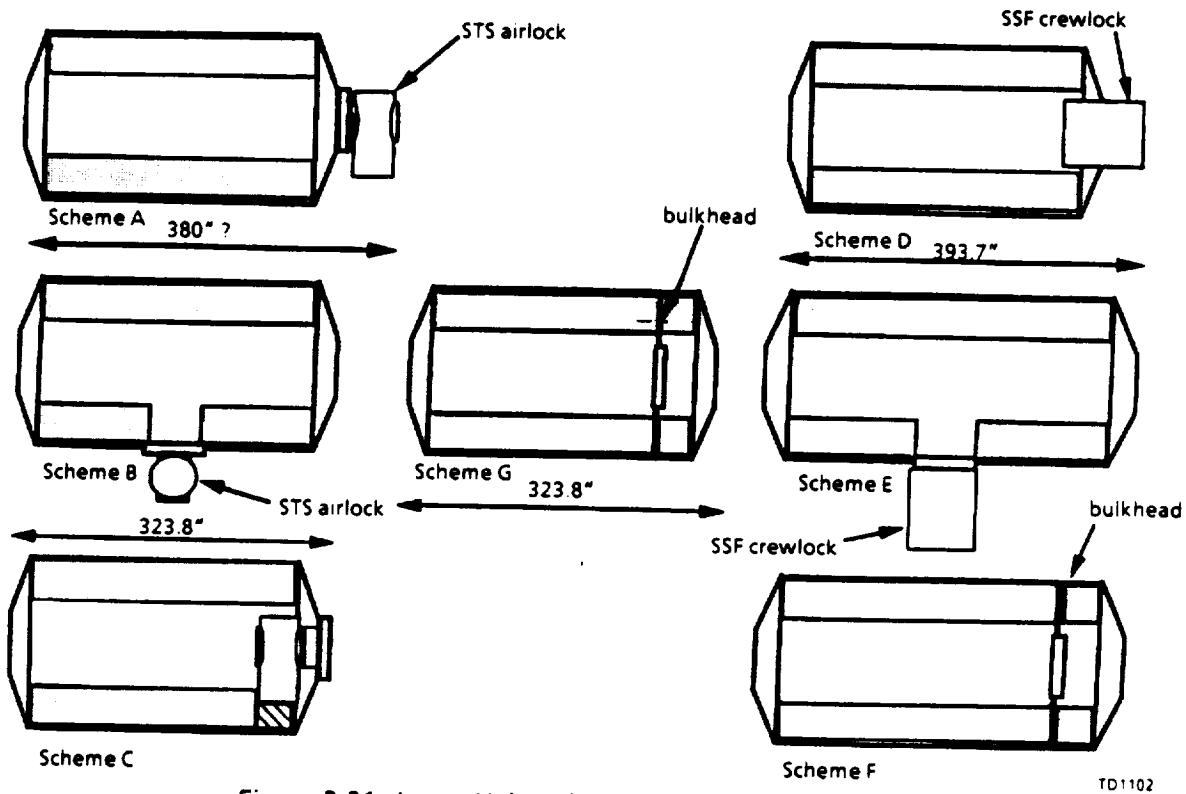

Figure 3-21. Lunar Hab Airlock Configuration Options

TD1102

Once the SSF Crewlock was selected, structural analysis was performed to evaluate the impact of adding it to the SSF hab module. Two configurations, bulkhead mounted airlock and skin mounted airlock were evaluated. Mass savings and mass penalties were calculated. Supporting the airlock entirely by the hab would require major structural changes to the hab. It was assumed that the weight of the Crewlock will be supported by some external structure such as lander platform, etc. The analysis reflected hab modifications due to cutouts and reinforcements.

For the bulkhead mounted Crewlock configuration, a new and more efficient semi-elliptic end cone was considered. Stress analysis for the end cone with a cutout for the Crewlock was performed. This configuration resulted in approximately 275 kg of

Primary Structure Weight Comparison  
Outpost Airlock Options

	Nonhyperbaric Mass (kg)			Hyperbaric Mass (kg)		
	Ref (A)	(G)nh	(F)nh	(D)nh or (D)h	(G)h	(F)h
Basic module structural weight	3175	3175	3175	3175	3175	3175
STS airlock weight	454					
SSF crewlock structural weight				726		
Airlock-to-module adapter	113			227		
New bulkhead structural weight		415	576		1728	1728
New cylinder skin			284			851
New bulkhead/skin installation		129	68		91	91
Existing bulkhead structural mod					1111	1111
Existing skin mod					850	
Trunnion modification			45	45	68	68
Total	3742	3719**	4148	4173	7023*	7024*
Percent Change from Ref. (A)	0%	-1%	11%	12%	88%	88%

\*\* Using existing mid ring      \* May be optimized for possible mass reduction

Figure 3-22. Hyperbaric vs. Nonhyperbaric Structural Mass Comparison

structural mass savings. A drawback to this configuration is that four racks could be lost. Skin mounted Crewlock required a 77in diameter cutout on the side of the hab. Stress analysis for this skin cutout was performed and doubler thickness and stiffener sizes were calculated. This configuration does not affect the end cones. Outcome of the analysis was a net mass gain of ~50 kg with the loss of two rack spaces.

A new hyperbaric airlock was also evaluated which would take advantage of the excess volume of the 10m payload shroud. The mass of new airlock was calculated to be ~1700kg. With this configuration no modifications to the hab were required and there was no impact to the existing racks. The new airlock is approximately 1000 kg heavier than the SSF crewlock but provides two to three cubic meter additional volume. Based on technical and programmatic criteria, the configuration utilizing a SSF crewlock embedded in the endcone of the hab was chosen.

### 3.10.4 FLO External Structure

A preliminary structural mass estimate for the FLO external structure was carried out. External structure is defined as all the structure which is outside the Hab and Airlock, and is not a part of the Lunar lander. This includes the support structure for tanks, arrays, crewlock, and other exterior equipment, hab to lander platform, catwalks, and hoist and lift structure.

Structural masses were calculated for those elements which had a defined configuration. These included hoist and lift structure, catwalks and beams, and radiator secondary support structure. Mass for the remaining structural elements was estimated. Support structure for solar array is included with external power system summary. A summary of external structure mass is shown in figure 3-23.

An update to the mass calculations and estimates will be performed as the configuration is further developed.

Hoist and lift structure	=	25 kg
Catwalks and Beams	=	500 kg
Radiator secondary support structure	=	49 kg
All other external structure	=	1490 kg
Total	=	2064 kg

Figure 3-23. External Structure Mass Estimate

### 3.11 HUMAN SUPPORT

#### 3.11.1 ECLS

U.S. space flight experience has been for short-duration missions (days), with Apollo and the Shuttle, and medium-duration missions (months) with Skylab. Space Station Freedom will provide experience in long-duration (months to years) presence in space. Life support systems for short missions are traditionally open loop. That is, life support resources such as water and oxygen are brought from Earth, and waste products are discarded. As mission duration increases so does the quantity of resources that must be carried. Longer duration missions employ closed-loop technologies which recover resources from waste materials, thus reducing the mass of supplies which must be brought from Earth. The lunar outpost mission (45 days) fills in the area between short- and medium-duration missions. Additional analysis is required to determine the optimal life support system for this application; and, whether it is appropriate to use open- or closed-loop systems. The two major life support subsystems that are candidates for closed-loop or regenerative technologies are Water Recovery and Management (WRM) and air revitalization (AR).

Functions provided by the water recovery subsystem include potable and hygiene water supply, water distribution and disposal of urine. Potable water is ingested by the crew and converted into waste products such as urine, perspiration and respiration vapor. Hygiene water is converted to "dirty" hygiene water after being used by the crewmembers for showers, handwash, laundry, etc. Potable and hygiene water can be provided by stored water (open loop) or by converting waste water products back into useful resources (closed loop). Dirty hygiene water and condensate can be processed to directly provide usable water. Urine can be collected and stored or dumped or it can be

processed to recover the water. There is still some debate over whether water recovered from urine should be used by the crew. Examples of other, non-crew related uses for water recovered from urine include electrolysis for production of oxygen or cooling water for EVA sublimators.

Primary air revitalization functions include oxygen supply, and removal of carbon dioxide, trace gases and particulates from the atmosphere. Crewmembers consume oxygen and produce carbon dioxide as a waste product. Oxygen can be provided from storage, high pressure or cryogenic (open loop), or can be generated from other sources. There are several processes that use CO<sub>2</sub> as the feed source and convert it to O<sub>2</sub> (closed loop). Conversion can be accomplished in a reactor which either converts CO<sub>2</sub> directly to O<sub>2</sub>, or produces water as an intermediate step which is then electrolyzed to produce oxygen. Either way, CO<sub>2</sub> conversion is closed-loop technology because it converts waste material into a useful product. If excess water from urine processing or fuel cells, for example, is available, it can be electrolyzed directly to produce oxygen. This is not a closed-loop system because the CO<sub>2</sub> waste, produced as crewmembers consume O<sub>2</sub>, would not be recovered. Carbon dioxide can be removed from the air by physical and/or chemical means. The two technologies which have been used in the past to remove CO<sub>2</sub> are lithium hydroxide (LiOH) absorption and molecular sieve extraction. The former is a chemical process which permanently binds the CO<sub>2</sub>, and the spent LiOH is discarded. In the latter, the CO<sub>2</sub> is preferentially absorbed onto a zeolite material which can be desorbed using vacuum or heat. If one of the regenerative technologies to recover O<sub>2</sub> from CO<sub>2</sub> is used, a compatible CO<sub>2</sub> removal system must also be employed.

An analysis was performed to determine which combination of life support technologies should be used for the lunar outpost. Power, mass and volume were calculated for four life support system options using different combinations of technologies. Systems were sized for a crew of four using SSF technologies for closed-loop systems. Mass penalties (kg/kW<sub>e</sub>, kg/kW<sub>t</sub>, kg/m<sup>3</sup>) were assigned for power, heat rejection and volume for each option based on the lunar outpost concept outlined earlier. System mass and mass penalties were summed to give system "equivalent" mass. A graphical representation which shows the increase in equivalent mass of the four life support system options as mission duration increases is shown in figure 3-24.

The four LSS options which were evaluated included the two open-loop systems, a partially-closed system and a fully-closed system listed below:

- a. Open loop - LiOH: open-loop water and oxygen, LiOH carbon dioxide removal.
- b. Open loop - 4BMS: open-loop water and O<sub>2</sub>, four bed molecular sieve (4BMS) CO<sub>2</sub> removal.
- c. Closed - water only: closed-loop water, open-loop oxygen, 4BMS carbon dioxide removal.

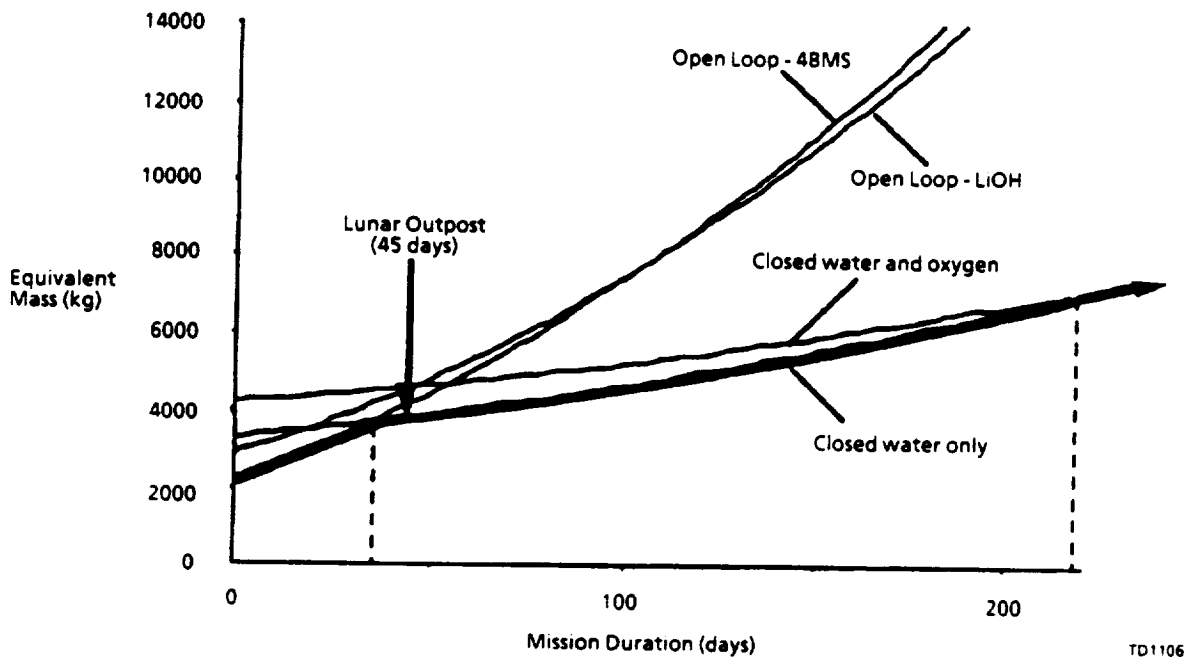

Figure 3-24. Life Support System Open to Closed Loop Crossover

- d. Closed - water and oxygen: closed-loop water, open-loop oxygen, 4BMS carbon dioxide removal.

These ECLSS parametric studies show that for the FLO mission duration of 45 days, an "open" oxygen, "closed" water system is the preferred technology. Based on Regenerable Fuel Cell (RFC) technology for the night-time power system, the water system mass crossover occurs at 40 days for the transition from "open" (that is, not recycled in the habitat but resupplied from Earth) to "closed" (recycled); in comparison, the oxygen crossover is at 220 days. While a single FLO mission satisfies the water crossover, the selection of a "closed" system is further justified by the requirement for multiple visits (however, five visits would be necessary to make the "closed" oxygen system mass competitive). Since the SSF Permanently Manned Capability (PMC) is also planning for "open" oxygen, "closed" water capability, the FLO system is based on SSF Hab-A architecture and hardware.

As discussed under Internal Configuration in this section, the relative positions of ECLSS equipment are identical to that of SSF Hab-A; however, the ECLSS tier has been located on the ceiling instead of the floor mainly for dust and radiation protection reasons. The module layout also assumes a distributed avionics air subsystem which is currently being evaluated by SSF WP01. FLO mass estimates currently use the previous centralized subsystem numbers as a reference until better definition of the new architecture is available from SSF. An ECLSS mass summary is provided in figure 3-25.

FLO ECLSS Subsystem	Boeing Mass (kg)
THC	811
ACS	263
ARS	650
FDS	120
WRM	1025
WM	121
<b>Total Internal ECLSS Mass</b>	<b>2990</b>

Figure 3-25. FLO Habitation System, ECLSS - Subsystem Masses

The viability and necessary modifications for each ECLS subsystem were considered in developing the FLO concept. While utility routings and locations will definitely change, ECLSS hardware and associated mass in the standoffs and endcones have been assumed identical to that of SSF Hab-A. FLO habitat racks which have been based directly on their SSF counterpart have also inherited the appropriate ECLSS supporting hardware; however, internal EVA system racks and the active CHeCS rack incorporated mass, power, and volume numbers for their primary function which were available from WP02 but had their rack housing and generic rack support systems (including ECLSS) based on the SSF Hab-A Urine Processor Rack. One Atmosphere Composition Monitoring Assembly (ACMA) and one Trace Contaminant Control Subsystem (TCCS) along with all of the original sampling lines are included in the FLO habitat as they exist in SSF Hab-A. Also, the FLO baseline maintains both Cabin Air assemblies in the same locations in SSF Hab-A. Each of the Water Storage and Water Processor Racks contain one water storage tank to allow use from one while filling the other (this total is sized for FLO needs, which are approximately half that of SSF due to removal of shower and laundry facilities). Fire Detection and Suppression (FDS) equipment is identical to that of SSF Hab-A and sized for the 17 powered racks in the FLO baseline layout. One additional carbon dioxide removal assembly and one additional major constituent analyzer assembly are provided to make these life-critical Subsystems one-failure tolerant. Intermodule ECLSS hardware has been removed except for that needed between the habitat and Crewlock. External ECLSS gas thermal and pressure control estimates have been based on the SSF Gas Conditioning Assembly (GCA) and use one O<sub>2</sub> and one N<sub>2</sub> conditioning strings.

The FLO habitat has baselined a 10.2 psia internal atmosphere, primarily in order to facilitate EVA operations by matching pre-breath time to EMU donning time and reducing risk of decompression sickness. SSF also intends to operate at 10.2 psia during Manned-Tended Capability (MTC) before increasing to 14.7 psia at PMC. However, some of the ECLSS equipment may not be optimally designed for the 10.2 psia condition and will be modified prior to its use on FLO. Other design and safety concerns associated with less than standard atmosphere operations are contained within the Alternative Internal Pressure Trade to be discussed later in this report.

### 3.11.2 Food Supply

Information on the ambient temperature storage of food is summarized to provide a rationale for baselining no refrigerated food (ref. 12). The requirements for military operations are remarkably similar to those for space exploration: "need to appeal to changing individual preferences under extreme physical and emotional stress; food may be the only break from unpleasantness, discomfort, or monotony; food must travel long distances and maintain properties which make them suitable and desirable for consumption; economical of labor in unloading, handling, and preparation; conservation of weight and space in transport and storage precludes reliance upon freezers." The military has been doing research for decades to develop technologies to prepare and package food that does not require refrigeration. Some of the technologies being looked at include freeze drying or binding water, dehydration, thermoprocessing, ionizing radiation, modified atmosphere packaging and various combinations of the above. Soldiers routinely eat army rations for long periods of time with no detrimental effects. The proposed 45-day mission to the Moon falls well within the extensive successful military experience (minimum requirements for ambient storage of food; 3 years at 80°F or 6 months at 100°F).

### 3.11.3 Medical Support

Crew health care system requirements for exploration missions fall into two major categories; (1) operational health care and (2) monitoring and countermeasure development equipment. The operational health care system includes the following: (1) medical equipment includes dental, fluid management, diagnostic equipment, monitoring equipment, etc.; (2) environmental monitor equipment includes monitoring respirable atmosphere, surfaces, water, radiation, microbial, light, acoustic, etc.; (3) health equipment includes stress test equipment, nutrition monitor/analysis, laboratory, etc.; (4) minimum countermeasures equipment includes exercise equipment, hazardous spill and cleanup supplies, etc.; and (5) supplies and stowage. Additional monitoring and countermeasure development equipment are required for ensuring crew health and for biomedical investigations. Initial mass estimates for each set of equipment were 648 and 517 kilograms, respectively. After further evaluation, it was determined that some of the equipment could be deferred until later missions. Potential reductions were up to 140 and 191 kilograms, respectively. This brought the combined mass of the two sets of crew health care equipment to 834 kilograms. Skylab experience exceeded the 45-day expected lunar mission duration and encountered more serious reduced-gravity effects than expected on the lunar surface. If this experience is applicable, then the countermeasure development equipment could be further reduced by another 166 kilograms, bringing the minimum health care system mass down to 668



kilograms (current baseline mass). There is some concern that eliminating this equipment would introduce unacceptable risk to the lunar outpost mission because our experience on the lunar surface was for mission durations significantly less than 45 days.

However, our philosophy has been to enable monitoring of crew health in order to learn about lunar environment effects but to limit response to those problems that seem reasonable for a 45-day, anytime-abort mission. As with most of the FLO concept, more detailed scenario development and risk analyses are needed to arrive at the appropriate CHeCS manifest.

#### 3.11.4 Hyperbaric Treatment

There are two reasons for having hyperbaric treatment capability on a lunar mission; one is routine, the other is contingency (ref. 13). The first is related to routine EVA operations. The pressure differential between the cabin and the EVA suit can potentially cause problems. If the ratio of the cabin nitrogen partial pressure and the suit pressure is small enough (i.e., cabin at 8 psia, suit at ~4-5 psia), the risk of decompression sickness can be eliminated. The second cause of decompression sickness is accidental crewmember exposure to vacuum. The decision about whether or not to have hyperbaric capability will determine what the program will permit as acceptable risk to the crew.

Hyperbaric requirements can have a significant impact on airlock structural design. Two issues identified were position of a crewmember during treatment and treatment pressure requirements. A fully reclining position for a crew member being treated could be the major driver for sizing the airlock. However, a horizontal position for the patient might not be necessary in lunar gravity and that the most important requirement for patient orientation is attendant access to the patient, especially the head. The 2.8-atmosphere requirement for hyperbaric treatment places specific structural demands on the airlock. A reduction in this requirement (based on a cabin pressure less than one atmosphere) would result in weight savings for the lunar outpost airlock. Current hyperbaric treatment requirements are based on the extensive experience that is available using this pressure. Medical experts felt that a different treatment pressure might be adequate for lunar missions where the pressurized volume is below 14.7 psia, but that extensive testing would be necessary to establish protocols for a new treatment regime. This type of testing is currently underway, but it will take a considerable amount of time to develop a revised treatment regime. In the meantime, the requirement for hyperbaric treatment will continue to be 2.8 atmospheres for the foreseeable future.

### 3.11.5 Crew Systems

Crew accommodations and crew-related equipment are spartan in keeping with the "campsite" philosophy but are closely related to the SSF Hab-A Man-Systems hardware and/or mass. A mass summary of the crew systems envisioned for the FLO integrated baseline habitation system is given in figure 3-26. The Endcone/Standoff Support includes the mass for restraints and mobility aids (R&MA) used on SSF which has been kept as an analog to the furniture and other accommodations necessary for the Moon's one-sixth gravity field; also, contained in this support equipment are rack and endcone closeout masses which have been increased by 50 kg over SSF Hab-A numbers to account for additional dust containment needs. Crew bunks are assumed to be constructible cots which would be stretched across the aisle and "plugged-in" to seat tracks on a rack face. Stowage drawers are assumed identical to those used on SSF. The Galley is based on its SSF Hab-A counterpart but includes the addition of a handwash (for a total of two in the FLO habitat) and deletion of the convection oven (microwave has been retained). A deployable table is added to the active Galley Rack to serve as a "wardroom" area in contrast to the more elaborate accommodations afforded by SSF. No refrigerator or freezer is included with the FLO baseline but several unpowered storage options may exist for providing fresh or frozen foods (see logistics discussion later in this report) if necessary. The SSF Hab-A waste management hardware mass is assumed to be analogous to a corresponding system for use on the Moon. Currently, no shower is included for FLO; however, through careful water management and design of a combination waste management/cleansing compartment, periodic showers (which seem to be highly desirable) may be possible. A mass representing Critical ORUs for internal systems has been included equaling approximately 5% of the active internal systems mass, but this serves as a placeholder only until more detailed analyses are performed (refer to "spares" discussions later in this report). Consumables stowage needs are addressed above under Internal Volume Assessment.

FLO Crew Systems	Boeing Mass (kg)
Endcone/Standoff Support	127
Rack Support/Stowage	471
Workstation Support	28
Galley/WR Functions	220
PHS Functions	126
Critical ORUs	429
<b>Total Internal Crew Systems Mass</b>	<b>1402</b>

Figure 3-26. FLO Habitation System, Crew Systems Masses

### 3.12 COMMUNICATIONS AND DATA MANAGEMENT SYSTEMS

Communications hardware consist of both internal and external systems which provide both audio and video capabilities within the module, between the module and crew or equipment on the lunar surface, and between FLO and Earth. A schematic of the FLO external Communications and Tracking (C&T) system along with interfaces to internal audio/video (IAV) and internal data management system (DMS) is given in figure 3-27. The S-Band Earth links may utilize the Deep Space Network (DSN) rather than requiring additional orbiting relay satellites or new ground stations. Requirements for voice and data rates are not yet finalized but will have substantial effect on final systems design. Internal audio and video have been modeled directly on the hardware and masses included for SSF Hab-A and specific rack needs with one external camera added to facilitate EVA viewing operations.

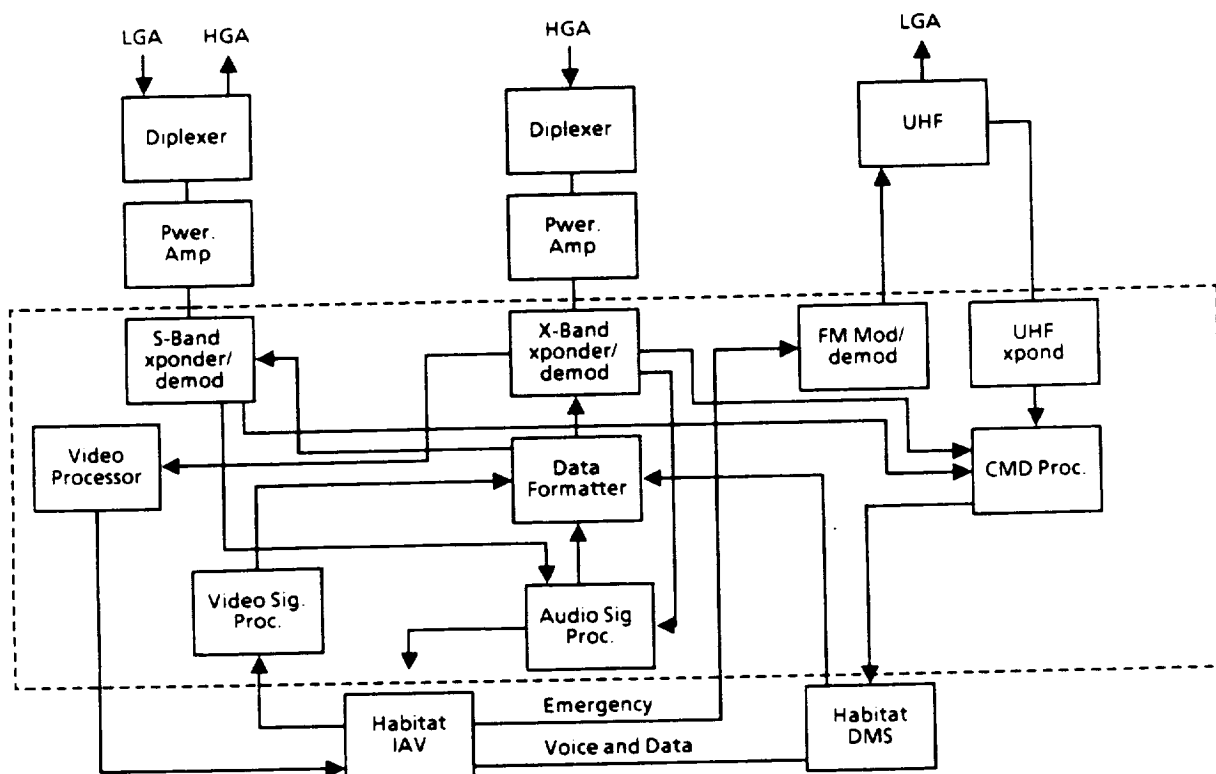

Figure 3-27. FLO Communication and Tracking

The Data Management System has also been based on SSF Hab-A and specific racks with the addition of Standard Data Processors (SDPs) and Mass Storage Units (MSUs) found from SSF Lab-A numbers. The Element Control Workstation (ECWS) from SSF Lab-A has also been included as the main command and control center and the primary computer interface for the crew. Portable Multipurpose Applications Consoles (PMPACs) which may plug into data ports throughout the habitat have also been provided

for additional capabilities. With the rapid advancement in computer technology, DMS hardware is a likely candidate for departure from standard SSF equipment; however, it is hoped that software and code developed by SSFP will remain usable to avoid the significant costs associated with these activities.

### **3.13 POWER SYSTEM SIZING/ANALYSIS SUMMARY**

#### **3.13.1 Introduction and Background**

The FLO habitat concept, operating in the harsh lunar surface environment, places significant requirements on both power and heat rejection systems. The power levels and mission durations required for the FLO system have never been approached by any other lunar system. Perhaps the closest application, Apollo, required much less power and heat rejection capacity (1-2 kW), over a much shorter period of time (~2 days). The FLO requirements (>20 kW peak capability over a several year operational lifetime) cannot be met with strictly Apollo derived systems. The power system will require regenerable fuel cell technology, including the application of large radiation and dust degradation resistant solar arrays in the 1/6 g lunar environment. Significant increases in heat rejection system efficiency will be required to handle the greater loads. Water boilers, as used on Apollo, would require prohibitive amounts of water to reject FLO level heat loads.

A reference power and heat rejection system concept has been developed for the FLO mission. A power budget was derived to support the system sizing and performance analysis for this concept. Separate power budgets were derived for manned lunar day and night operations (average and peak), as well as unmanned operations. The activities undertaken were divided into three main areas. They include power system requirements determination, power system and heat rejection system sizing, and subsystem level trade studies support. Peak and average power requirements were derived for the reference FLO concept for both manned and dormancy operations. The power requirements for each mission phase were utilized to size a solar/regenerable fuel cell (RFC) power system. A significant portion of this analysis was devoted to refining the power system components sizing procedure and/or power budget, and investigating options (both hardware and architectural) to reduce the EPS mass. Initially, several reference cases were investigated, (ref. Δ1 and Δ2) for 3 airlock options. A detailed account of these analyses is included in an earlier report, reference 9. Later work focused on a single reference case, described later in this section.

### 3.13.2 Power Requirements

After an initial 10-kW power system was sized to serve as a reference, a power budget was derived for a new reference system. The FLO power budgets were broken down to the element level, utilizing a SSF power summary (ref. 5) where possible.

The first power system requirements revision of the reference power summary reflected the following operational and hardware changes. The revised top-level power budget summary ( $\Delta 1$ ) is shown in figure 3-28. The major differences from the reference included the following:

Item	All Loads in Watts	
	Connected Load	Av. Load
EPDS/DMS/SPI/AV	1428	884
TCS/THC/ACS	1849	1535
Galley/Wardroom	1934	456
Science	1769	702
Water stor./Proc.	1125	292
Air Revit. System	1298.6	796
Crew Health	911	91
Fire Det./Suppression	838	40
RPC Modules	312	312
Waste Management	455	46
M/S Hygiene	821	133
Hab Growth	345	345
Gas Cond. Assembly	240	240
Heat Pump - Day	2840	2840
- Night	300	300
Totals: - Day	16166 W	8712 W
- Night	13626 W	6172 W

Figure 3-28. Lunar Campsite Overall Power Budget Summary -  $\Delta 1$

- a. Power requirements listed by subsystem; some components were removed/modified as follows:
  1. Airlock: removed growth power; 5/10% duty cycles (depending on component); removed ECLS and THC.
  2. TCS: removed IMV fan and resized ITCS pump and Avionics air for lower loads.
  3. Crew systems: replaced oven with 600-watt microwave unit.
  4. Crew health: duty cycle = 10%.
  5. ACM: duty cycle = 25/100% (day/night).
  6. PEP equipment: remove all PEP loads.
  7. Glovebox: power level set at 250 W and a 10% duty cycle.
  8. Workstation: removed blowers, H<sub>2</sub>O pumps, and second set of lights; task light fixture duty cycle set at 10%.
- b. SSF power growth numbers scaled and added to total.

This revision resulted in a reduction of ~2 to 2.5 kW in the average power requirements. The Δ1 case was further revised to reflect the removal of standoff fans and water/air separators (not required in gravity field). The final revision, Δ2, is summarized in figure 3-29. The Δ2\* case is simply the Δ2 case with multiple lunar day fuel cell recharge. The reduction in average power for the Δ2 configuration was roughly 300 - 500 W. Major differences from the Δ1 case included the following:

- a. Some components removed/modified as follows:
  - 1. TCS - removed standoff fans.
  - 2. Crew systems - removed all H<sub>2</sub>O/air separators.
- b. SSF power growth numbers scaled and added to total.

Item	All Loads in Watts	
	Connected Load	Av. Load
EPDS/DMS/SPI/AV	1428	884
TCS/THC/ACS	1552	1271
Galley/Wardroom	1629	443
Science	1769	702
Water stor./Proc.	1125	292
Air Revit. System	1298	796
Crew Health	911	91
Fire Det./Suppression	838	40
RPC Modules	312	312
Waste Management	205	27
M/S Hygiene	516	108
Hab Growth	328	328
Gas Cond. Assembly	240	240
Heat Pump - Day	2684	2684
- Night	300	300
Totals: - Day	14836 W	8219 W
- Night	12452 W	5835 W

Figure 3-29. Lunar Campsite Overall Power Budget Summary - Δ2

The new reference power budget described in reference 9 included all systems outlined in the SSF habitat module summary of the report, along with additional power requirements associated with the laboratory science racks LAS1 and LAS2 (the ECWS and science/workbench racks). The science/glovebox power was derived from an older SSF power summary, since it is no longer included in the baseline SSF design. SSF power growth derived numbers were also included in the total. This power budget was again modified as the FLO concept became better defined. The next change to the reference power budget was the addition of necessary DMS, airlock, and external equipment, which was not included in the earlier summary. A summary of these changes is shown in figure 3-30.

Addition	Power Level	Duty Cycle	# Units	Total Power
Standard Data Processor	138 W	100%	2	276 W
Mass Storage Unit	160 W	100%	2	320 W
Misc. Science Equip.	500 W	10%	1	50 W
Airlock Vacuum	500 W	10%	1	50 W
Airlock Lights	20 W	10%	1	2 W
External Cameras	88 W	100%	1	88 W
External Comm. Equip.	150 W	100%	1	150 W
Total delta	1556 W			936 W

Figure 3-30. Power Summary Changes

A reference power budget was produced for the unmanned dormancy period, in order to more accurately size the RFC system (drives fuel cell reactant, fuel cell, electrolyzer, radiator, and array requirements). All non-necessary equipment was deactivated, including the CO<sub>2</sub> removal unit, and other equipment (ARS, TCS, av. air, cabin air, heat pump, etc.) were scaled down for the lower unmanned loads. The dormancy budget was derived from the reference power budget and available knowledge of both FLO requirements and SSF derived subsystems. A summary of this power budget is shown in figure 3-31, and the complete breakdown is included in Appendix C. The reference power budget was modified to reflect the additional power required for redesigned fans to operate at 10.2 psi, since SSF fan power requirements are prohibitive for long term 10.2 psi operation (designed for nominal 14.7 psi). A brief summary of these changes is shown in figure 3-32.

All Loads in Watts		
	Connected Load	Av. Load
EPDS/DMS/SPI/IVA	2471	1927
TCS/THC/ACS	2257	1976
Galley/Wardroom	1629	443
Science	2019	727
Water stor./Proc.	1125	292
Air Revt. System	1298	796
Crew Health	911	91
Fire Det./Suppression	838	40
External Comm. Equip.	150	150
Waste Management	205	27
M/S Hygiene	516	108
Hab Growth	342	342
Gas Cond. Assy.	240	240
Heat Pump - Day	3787	3787
- Night	300	300
Airlock - Day	6674	2371
- Night	6674	1551
Grand Totals - Day	24463 W	13318 W
- Night	20976 W	9011 W

Figure 3-31. FLO Reference Power Budget Summary

Pressure (psi)	Avionics air fan	Cabin air fan	Crossover air fan	Total fan pwr	Delta power
14.7	520 W	360 W	220 W	1100 W	NA
10.2	749 W	519 W	317 W	1585 W	485 W

Figure 3-32. Fan Power Requirement Deltas for Reference FLO

The next step of the power budgeting process was to derive average- and peak-power requirements for the STS type airlock, and both the hyperbaric and nonhyperbaric SSF derived crewlock and internal bulkhead airlocks. The summaries, shown in figure 3-33, include internal equipment as well as additional heat-pump power requirements for the additional thermal loads they impose on the system. Airlock required pump power was determined assuming a 5-minute pumpdown for the STS and SSF derived airlocks, and a 10-minute pumpdown for the bulkhead airlock. The pumpdown time for the bulkhead option was extended, since the added volume allowed for more crew operations to be performed during the process, and pumpdown power requirements were significantly lower. Assumptions made for the calculations include initial/final pressures of 10.2/1.02 psi, and pump and electric motor efficiencies of 70% and 85%, respectively. The majority of the pumpdown power required is derived from electrolyzer power bleed, which should be kept below 50% total for short periods. A 10% duty cycle was assumed, since power system oversize for off-peak times can be utilized to replenish the electrolyzer, although a high number of A/L cycles may require an array oversize. Hyperbaric pressures were assumed to be obtained from stored gas (SSF method), and a portion of the gas vented after use (mission likely aborted). The nominal use airlock pumpdown gas was assumed routed into the Hab module. Five airlock options were derived from the three power summaries:

- a. Minimum A/L with two required pump powers for STS derived (option A - lower power), and bulkhead (option G - higher power) options; bulkhead option ECLS equipment power requirements are included in Hab mass/power.
- b. SSF derived A/L with adjusted pumping power primarily for configuration D (SSF crewlock).
- c. SSF derived A/L with hyperbaric capabilities for configurations D and G.

The airlock pumps were resized using a compressor power computer code developed under IR&D and along with the other power budget changes, new heat pump and hab growth power levels were determined. These changes resulted in a power system mass increase to approximately 5000 kg, and an array area increase from ~182 m<sup>2</sup> to ~195 m<sup>2</sup>. The reference system is sized to provide 9.912 kW average (including 10% fuel cell capacity margin) and 13.52 kW peak (1.5 x average power) nighttime power, and 13.32 kW average and 19.98 kW peak (1.5 x average pwr) daytime power manned, and 2.525 kW night-time dormancy power. The detailed power budget summary is included in Appendix D.



D615-10062-2

Item	All Loads in Watts		
	Connected Load	Duty Cycle (%)	Av. Load
<b>A&amp;G NONHYPERBARIC</b>			
Control/sel.	9.6	0.21	0.02
A/L ACS	11.6	100	11.6
Flame detector	14	100	14
Smoke sensors	14	100	14
A/L audio	84.6	10	8.5
A/L video	43.5	10	4.4
SPCU	1240	27	335
CMDM	106	50	53
RPCMs	45	100	45
Depress D&C Panels (2)	20	100	20
Pumps (config. A/G)	1684/3150	10	236/441
Heat Pump Delta: Total:	327/418 W (Avg) 3272/4738 W	491/627 W (Peak)	1069/1365 W
<b>D NONHYPERBARIC</b>			
Cabin air fan	292	100	292
Cab air - electrical I/F	25	100	25
Cab air - temp. ctrl.	34	1.7	0.57
Cab air - H <sub>2</sub> O sep.	43	100	43
Control/sel.	9.6	0.21	0.02
A/L ACS	11.6	100	11.6
Flame detector	14	100	14
Smoke sensors	14	100	14
A/L audio	84.6	10	8.5
A/L video	43.5	57	24.6
SPCU	1240	27	335
CMDM	106	50	53
RPCMs	45	100	45
O <sub>2</sub> -N <sub>2</sub> control/vent	11.1	100	11.1
Depress D&C Panels (2)	20	100	20
Pumps (config. D/G)	1684/3150	14	236/441
Heat Pump Delta: Total:	500/590 W (Avg) 3677/5143 W	750 W (Peak)	1633/1928 W
<b>D&amp;G HYPERBARIC</b>			
Cabin air fan	292	100	292
Cab air - electrical I/F	25	100	25
Cab air - temp. ctrl.	34	1.7	0.57
Cab air - H <sub>2</sub> O sep.	43	100	43
Control/sel.	9.6	0.21	0.02
A/L ACS	11.6	100	11.6
Flame detector	14	100	14
Smoke sensors	14	100	14
A/L audio	84.6	10	8.5
A/L video	43.5	57	24.6
SPCU	1240	27	335
CMDM	106	50	53
RPCMs	45	100	45
O <sub>2</sub> -N <sub>2</sub> control/vent	11.1	100	11.1
Depress D&C Panels (2)	20	100	20
Pumps (config. D/G)	1684/3150	14	236/441
Hyperbaric audio I/F unit	28.6	2	0.452
Hyperbaric gas and press ctrl. assembly	100	10	10
Hyperbaric environ. ctrl. assembly	1175	10	118
Hyperbaric lighting assembly	100	10	10
Heat Pump Delta: Total:	561/478.6* W (Avg) 5081/6547 W	841/718 W (Peak)	1833/1956 W

\* Derived from minimum A/L + hyperbaric equipment.

Figure 3-33. Lunar Campsite Airlock/EVA Systems Power Budget Summary - A&G Nonhyperbaric

Power system peak capabilities were determined as 1.5 x average power, which was determined as a reasonable assumption based on previous spacecraft systems. This assumption, although somewhat arbitrary, is reasonable for the prescribed application until more design and operational detail is available for the outpost internal and external systems. The array system was sized to provide peak power and nominal electrolyzer charging power simultaneously. Additional power, when needed, can be derived from the fuel cell reactant electrolyzer budget during the day and additional fuel cell capacity at night. Arrays are sized for 5 year End-of-Life (EOL) performance, as derived for each cell type. It should be noted that the overall system mass is not as sensitive to peak power as it is to average night-time power. The power required for the external heat pump system was scaled from total internal and airlock power, based on derived COP for given operating conditions (primarily condenser and evaporator temperatures and working fluid chosen).

The heat pump is not required at night, however, due to the much lower effective sink temperature that the radiator "sees" during the lunar night (~120 K vs. ~300 to 320 K during the lunar day). Its heat transport capabilities are replaced during the night with a single phase pumped system which requires only ~300 W. The radiator is sized to reject both internal and external loads, with the exception of electrolyzer inefficiencies. The electrolyzers were assumed to reject their own waste heat.

The reference power budget served as a baseline for all additional system level trade support activities.

### 3.13.3 Power and Heat Rejection System Sizing

After the reference manned and dormancy power budgets were finalized, the sizing of the reference power and external heat rejection systems was initiated.

The first set of power system masses, derived from previous lunar campsite material, were for a system sized to provide a continuous 10 kW over consecutive lunar day/night cycles (fuel cells recharged over one lunar day). This resulted in rather large tank masses, since the required storage temperature is high for the lunar day (~300 K), which results in low H<sub>2</sub> and O<sub>2</sub> densities at even the higher tank pressures. Solar array sizes were also large, in order to provide the high power levels needed by the water electrolyzer and outpost during the lunar day. The initial power-system mass was over 6000 kg, which made it a leading candidate for possible mass savings. An initial pass was made to validate the parametric sizing code (SURPWER). Several refinements were made to the analysis, which resulted in reduced system mass. The fuel cell duty cycle was adjusted from 375 to 354 hours to more closely model the average lunar night, which decreased the amount of reactants and storage capacity required. Power level remained at 10 kW. The effective yield strength of the filament-wound composite tanks was increased to a less conservative value of 125 ksi (although this is still a relatively low

value for advanced composite tanks). These adjustments resulted in a system mass of ~5100 kg, not including array support structure; a reduction of approximately 1200 kg compared to the original system mass.

As part of an investigation of possible methods to further reduce the mass of the power system, an analysis was conducted to make use of the lunar night for refrigeration of the electrolyzer during the lunar day. Once again, the power system was sized to provide 10 kW of electrical power for a lunar day/night/day cycle (manned), but was modified to provide a nominal power of ~2 kW for 5 lunar day/night cycles. The fuel cell reactants depleted during the first lunar night would be re-electrolyzed over 5 lunar days. This time period coincides with 180day mission centers. High-pressure tanks are utilized to hold enough reactants to provide 2 kW during the lunar night, and 20% of the next manned mission reactant supply. During the lunar night, the "hot" reactants are cooled and transferred to larger, insulated lower-pressure tanks. These tanks are sized to contain the highest pressures attained as a result of the parasitic heat leak during the day. This option resulted in a ~600 kg decrease in system mass. By refrigerating the larger tanks during the day, the system mass was decreased another 230 kg, at the expense of increased complexity. Heating rates (and refrigeration power required) were determined assuming a 300K surface temperature, and a 1-inch thickness of multi-layered insulation.

This option was not utilized in the reference however, due to added complexity and reduced system flexibility. A more detailed look at the trade of electrolyzing the reactants over 5 lunar days resulted in only a moderate mass savings (300 - 500 kg) for the revised power level systems (ref.  $\Delta 1$  and  $\Delta 2$ ), at the expense of system complexity (additional tanks, etc.). Greater savings may be possible for higher-power systems, and/or systems requiring less "housekeeping" power for unmanned lunar night operations (2 kW was assumed for the current trade analysis - much lower level of design required to determine actual requirements).

A final preliminary calibration activity undertaken in the power-system sizing task was to adjust and verify the SURPOWER sizing-code process for calculating tank residuals. The routine, which had originally been written to calculate residuals for lower-pressure storage systems, was modified to produce more accurate residual allowances for the high-pressure storage system. The residual pressure in the hydrogen and oxygen storage tanks was assumed to be ~80 psi (60psi fuel cell operating pressure, +20psi line pressure drop). This resulted in a significant reduction of reactants and required storage-system mass.

The revised power system was sized based on the following:

- a. Solar PV system utilizes GaAs/Ge (8 mil) arrays; nominal efficiency ~ 18%
- b. Night-time average power increased 10% to provide power/reactant margin; Peak power = 1.5 x average power + electrolyzer power (day)
- c. Fuel cell capacity "stretched" 1 day at 11 kW to provide mission abort window in case of solar PV system malfunction at beginning of lunar day
- d. ~14.9% temperature induced array degradation at lunar "noon"; 10% radiation degradation added (see degradation assessment information below)
- e. Electrolyzer and array sized to provide nominal charging rate at worst case array performance; Nominal rate = dormancy requirements + 1/5 average manned nighttime power (kW-hr)
- f. Filament wound composite tanks utilized for 3000 psi regenerable fuel cell reactant storage; reactant storage temperature assumed to be 300 K
- g. Heat pump power requirements are derived utilizing R-11 working fluid and compressor with ~60% isentropic efficiency; Pheat pump/Prej = 0.529.

The solar array temperature induced degradation value was determined from a survey of available performance data for GaAs and Si arrays. The average values are as follows (referenced to 27°C):

- a. GaAs:  $\Delta$  performance  $\approx 0.23\%/^{\circ}\text{C}$
- b. Si:  $\Delta$  performance  $\approx 0.422\%/^{\circ}\text{C}$

The surface properties of the reference GaAs/Ge cells were found to be:  $\epsilon$  (emissivity) = 0.85, and  $\alpha$  (solar absorptivity) = 0.60. From this, the maximum array surface temperature was found to be  $-92^{\circ}\text{C}$  with an insulated array backside ( $\sim 1/2$ " MLI). The total temperature induced degradation was found to be:

- a. GaAs:  $\Delta$  performance  $\approx 14.9\%$
- b. Si:  $\Delta$  performance  $\approx 27.4\%$

A brief technology survey resulted in average 5 yr degradation values in GEO to be:

- a. GaAs: 20% degradation
- b. Si: 27% degradation

The above radiation values were halved to account for the shielding effect of the lunar surface. After the degradation assessment was completed, the reference power budget was utilized to size the reference power system using the SURPWER parametric power system sizing code. A mass summary for the FLO reference is presented in figure 3-34.

Fuel Cells	135 kg	
Electrolyzer	88 kg	
Radiator	0 kg*	
Hydrogen Reactant	152 kg	
Hydrogen Residual	5 kg	
Oxygen Reactant	1218 kg	
Oxygen Residual	32 kg	
Hydrogen Tank(s)	1763 kg	
Oxygen Tank(s)	800 kg	
Water Tank	69 kg	
Solar Array	435 kg	
Support Equipment (cables, converters, etc.)	305 kg	
Solar array support structure	449 kg	
Total Mass:	5451 kg	* Included in HRS mass

Figure 3-34. Reference Top Level Power System Mass Summary

As stated earlier, the rejection of waste heat at the lunar surface is a significant problem due to the high surface temperatures experienced during the lunar day (~380 K at lunar "noon"). The relatively high level of required heat rejection capability of the FLO habitat (~20 kW peak daytime) places a great demand on the external heat rejection system. A method for increasing radiator efficiency (particularly during the lunar day), and therefore decreasing required radiator area, will become a potentially large leverage technology. An increase in radiator efficiency can be effected by either reducing sink temperatures from decreased exposure to the surface or sun (shielded, pointed away, etc.), by increasing the radiator operating temperature, or by constructing the radiator of materials with selective optical/thermal properties (low solar absorptivity, high emissivity). Any combination of these methods can be even more effective in increasing radiating efficiency. Increasing the rejection temperature of the radiator is an especially effective method for increasing radiator heat rejection efficiency (W/unit area). Additionally an increase in the emissivity of a radiating surface will have roughly a linear effect on heat rejection capability. For this study, a heat pumped augmented system was chosen, based on its flexibility to performance degradation, reduced radiator area requirements, and mass. The assumptions for the heat rejection system were:

- a. SSF derived internal heat acquisition/transport system design
- b. Radiator rejection load:  

$$Prej = 1.5 \times (Phab + PA/L) + Pelectrol \times (1 - helectrolysis) + Qmetabolic$$
- c. Horizontal radiator utilized; heat pump augmented rejection
- d. Heat pump motor/pump assembly rejects waste heat at condenser temperature (conservative assumption - probably 20° - 50°C higher)

- e. Compressor isentropic efficiency = 0.6 (terrestrial sys data);  $P_{comp}/P_{rej} = 0.529$  (R-11)
- f. Heat pump system mass  $\sim 31.83 \times Q$  (from terrestrial systems data)
- g. Heat pump power provided by main arrays
- h.  $\alpha_{rad} = 0.25$  (absorptivity)  $f_{in}$  efficiency = 0.85  
 $\epsilon_{rad} = 0.8$  (emissivity) radiator rejection temperature = 360K  
radiator specific mass  $\sim 5.2$  kg/m
- i. Single phase pump efficiency 0.30 (used to determine night-time pump power)
- j. Minimum fluid operating temp (nighttime) = 165 K (Triple Point = 162 K)
- k.  $Q_{metabolic} = 132$  W/person  $\times 4$  crew

During the sizing process for the heat rejection system, several issues were raised. These issues were considered in the derivation and sizing of the reference heat rejection system concept. The major issues derived and considered:

- a. Heat rejection system performance may be very sensitive to lunar dust coverage/surface degradation (increase in surface solar absorptivity)
- b. Heat pumped system could require significant additional power to account for higher effective sink temperatures; passive system would necessitate significantly decreasing power consumption, adding radiator area, etc.
- c. Heat pumped system less sensitive to radiator absorptivity due to its higher rejection temperatures ( $Q_{rej} \propto T^4 \propto \alpha \propto \epsilon$ )
  - 1. State of the Art (SOTA) selective optical property coatings may not be applicable to large radiators; dust degradation may be significant (coverage and abrasive)
  - 2. Non-silicon based radiator coatings with low  $\alpha/\epsilon$  (i.e., zinc orthotitanate, TW1300) can be very brittle, and may be difficult to adhere to some materials (metals and composites)
  - 3. Silicon based paints with potassium silicate binders not commercially available
  - 4. SSF utilizing SOTA coatings, which still have EOL absorptivities of 0.22 to 0.25
  - 5. Developing suitable coatings/radiator materials for passive heat rejection on lunar surface may require significant technology development, with some degree of risk.

Based on the above assumptions and concerns, a heat pump augmented heat rejection system was chosen for the reference system. A schematic of the reference heat rejection system is shown in figure 3-35. As shown in the schematic, the heat pumped system is utilized to reject only the habitat induced heat loads. The compressor and electrolyzer, which operate at much higher temperatures, should not require the

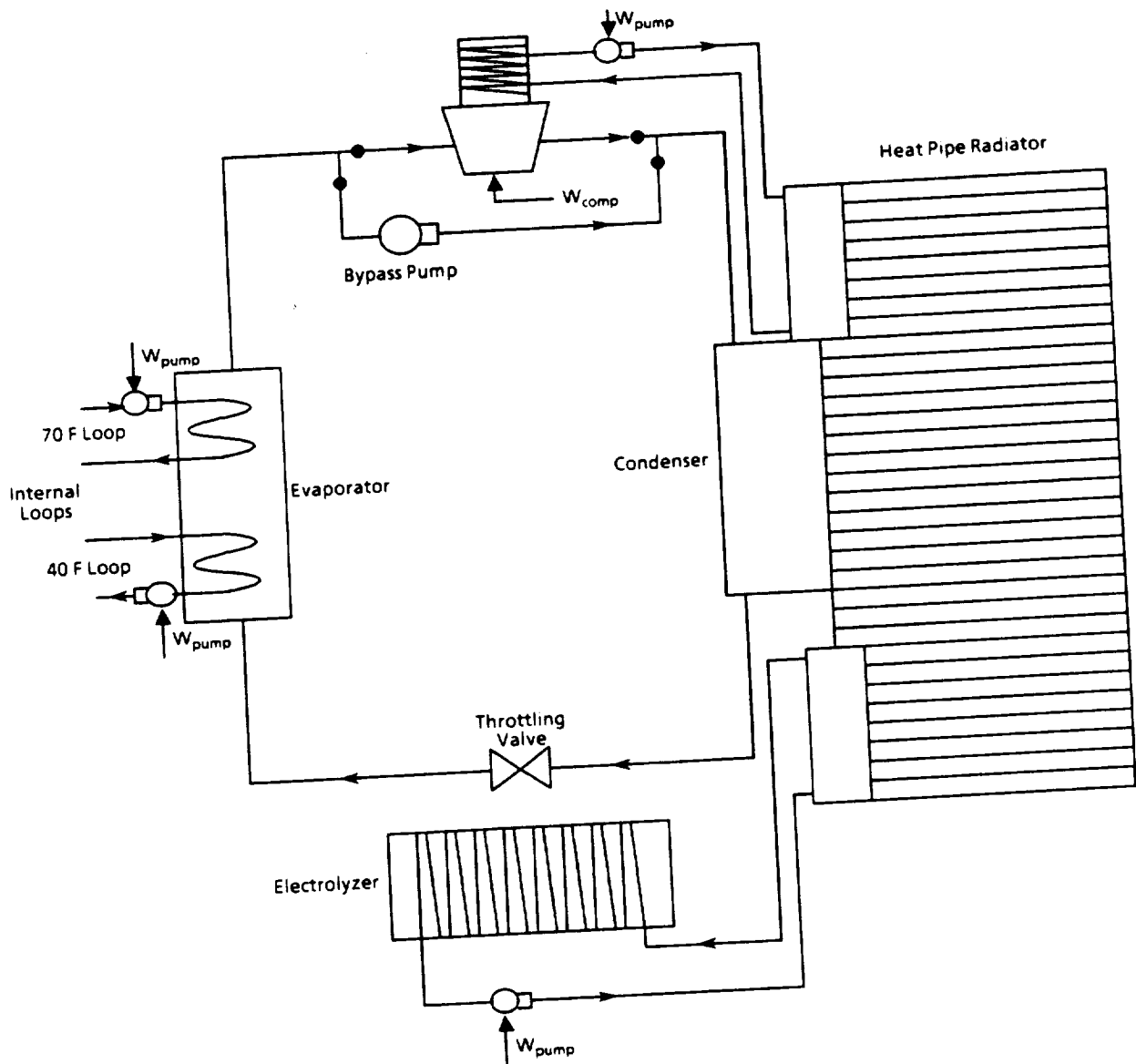

Figure 3-35. Reference Heat Pumped System Functional Schematic

heat pump to boost rejection temperature. For radiator sizing purposes, the electrolyzer and compressor were assumed to operate at 360 K (reasonably conservative). Pump power required to cool the electrolyzer and compressor was considered negligible (~ 100-200W). The bypass pump only operates during single phase operation (during lunar night).

Due to the sensitivity of the external heat rejection system to dust coverage, a brief study was undertaken to assess the possibility of accumulating dust on various components of the Lunar Outpost external equipment. Three areas of possible dust disturbance were investigated. Using simple particle dynamics, the first two areas, astronaut and rover movement, were determined as not being a source of dust coverage.

The height of the bottom of the hab (~7m) was determined to be above the maximum height of the dust thrown up by the rover wheel (~6 m for 10 mi/hr rover). Dust disturbed by the crew vehicle upon landing, however becomes a much larger dust coverage problem. Dust particles entrained in the exhaust plume of the lander can reach a significant percentage of the exhaust gas velocity (as high as 2-3 km/sec). Although the lander can be positioned far enough away to protect the Outpost from the initial lower velocity dust disturbed by the lander at higher altitude, no reasonable distance (<1-2 km) will completely spare the Outpost from the higher velocity particles (ejected just before touch-down). These particles will not only cover surfaces facing the Lander, but may "sand-blast" them as well. Operational considerations such as pointing or stowing the arrays, stowing the radiator (thermal energy storage required), or regular surface cleaning will be investigated as this study continues. Finally, the effects of scattered dust from the natural effects on the lunar surface (i.e., terminator line ionization/deionization, and micrometeoroid impact scattering) were investigated. Although the terminator line should not cause significant problems for equipment high on the lander, its effects could be significant for other lander hardware (e.g., storage tanks).

A portion of the habitat dormancy assessment mentioned earlier consisted of an assessment of habitat night-time operation issues (manned and dormant). Several refrigerants were determined suitable for the heat pumped system (depending on rejection and acquisition temperatures), including R11, 12, 21, 22, 113, 114, 142b, 152a, and ammonia for non-heat pumped cases (primarily at night). A summary of the working fluids investigated is shown in figure 3-36. Due to its relatively high specific heat as compared to the liquid states of the other refrigerants, ammonia results in the lowest overall night-time pumping requirements. The ability of a single working fluid to handle both night and day operations removes the necessity of changing fluids for night/day operation (heat pumped system), or carrying a parallel external transport loop for night use only. Although the heat pump can be operated at night, its power requirements are significantly higher than a single phase system. A single phase night operating concept using the heat pump working fluid is feasible (by varying fluid level and/or pumping rate), which would utilize the entire radiator area without freezing the working fluid, eliminating (or at least reducing) the need for thermally disconnecting portions of the radiator during the night. The heat pump only requires 10 to 35% of the radiator surface area for unmanned or manned night-time use. For manned night-time use, in order to reject waste heat at the lower radiator surface temperatures, a temperature drop across the radiator of less than or equal to 10 K is required. The radiator inlet temperature was assumed to be equal to the average temperature of the internal TCS fluid across the interface heat exchanger ( $T_{in} = 90^{\circ}\text{F}$ ,  $T_{out} = 35^{\circ}\text{F}$ ,  $T_{avg} = 62.5^{\circ}\text{F}$  [ $290^{\circ}\text{K}$ ]). The mass flow rate required to satisfy the above conditions was determined to be ~ 2300 lb/hr for a



typical refrigerant, and ~ 600 lb/hr for ammonia. Although the pumping power requirements for night-time operation would be somewhat higher for the chosen daytime refrigerant R-11, the added complexity of switching operating fluids verses only modest pumping power savings resulted in the selection of R-11 for both day and night-time use. It was determined that for the R-11 night-time flow rate requirements, that the allowed night-time pump power of 300 W was reasonable. Night-time heat pump operation, however, would require roughly the same power level as during the lunar day, although radiator size requirement would be significantly reduced.

Fluid	Triple Point (K)	Pressure (high/low - psi)	Liquid Sp. ht kJ/kg K	kWhp/kWrej
Ammonia	195.5	750/125	4.815	0.643
R11	162	110/12	0.88	0.529
R12	115	380/70	0.98	0.782
R21	138	Not Avail.	1.07	Not Avail.
R22	113	580/110	1.22	0.77
R113	238	45/5	0.925	0.61*
R114	179	175/25	0.996	0.85
R142b	<205	235/30	1.12	0.61
R152a	<<177	400/58	1.60	0.71

Figure 3-36. Heat Pump Working Fluid Options

An assessment of habitat heating during the lunar day and night was undertaken to identify any possible areas of concern to the HRS. The assessment considered habitat shell, penetration, and window heat leak. Heat leak through the window was determined assuming complete solar transmission between 0.2 - 0.8 mm wavelength and 1.2 - 3 mm wavelength (SSF windows "blind" between 0.8 and 1.2 in order to limit interference of IR controls). All other incident solar energy was assumed to be adsorbed and included in the thermal balance. The habitat TPS consisted of 18 layers of MLI ( $\epsilon_{surf} = 0.30$ ,  $\epsilon_{surf} = 0.40$  - M/D shield outer surf). The worst case heating was determined to be at lunar "noon", where  $Q_{leak} < 1$  kW (with 3 SSF sized windows). Worst case habitat heating during the day assumed complete lunar dust coverage of the hab shell. It was assumed that the windows would be kept relatively clean (shields, cleaning, etc.). Covering the windows when not in use will reduce the transmitted solar radiation (i.e., heat leak) by as much as 200 - 300 W. A portion of the waste heat produced during lunar night can be utilized to maintain the habitat heat balance, although it may require separate heat transport loop. Additional TPS can be added to the habitat shell if the 700 W to 1 kW heating rates are deemed too high. It should be noted that no shielding effects were included for any external equipment, and therefore the heat flux is relatively conservative. A mass, rejection load, and radiator area summary for the reference external heat rejection system is shown in figure 3-37.

Rejection load:	22.61 kW
Radiator Area:	63 m <sup>2</sup>
Radiator mass	327 kg
Heat pump mass	108.5 kg
Insulation mass	25 kg
Aux. pump mass	60 kg
Total HRS Mass:	520.5 kg

Figure 3-37. External Heat Rejection System Mass Summary

### 3.13.4 Subsystem Level Trade Studies Support

Several system level trades assessments were completed for power and thermal system impacts. The majority of these were in support of the FLO alternate subsystems task. In an early trade, the reference heat pumped heat rejection system was traded against a non heat pumped system. The savings in power system mass for the non heat pumped system was compared to the area and mass sensitivity of the heat rejection system to radiator surface properties. The results of this and all other trades are included in the appropriate trade sections of this document. The top level conclusion was that power system mass was reduced only slightly (~160 kg: heat pump only needed during day, where power penalty is relatively low), at the expense of significant radiator efficiency and flexibility. Another alternate subsystem trade was to utilize an open power system with reactants resupply for each manned flight. This trade resulted in significant additional initial FLO mass, as well as greatly increased resupply mass, since enough reactants must be carried with the outpost for the initial dormancy period and the first manned mission.

Next, as a portion of a reduced pressure habitat trade, power budget deltas were determined for habitat internal or external equipment influenced by the lower pressure levels. The only major area of concern initially identified which could have significant impact on the power budget was the avionics, cabin, and crossover air systems. It was determined that the fans and ducting would require redesign for any significant pressure level other than the SSF value of 14.7 psi, as the fan efficiency curve falls off rapidly at higher demand levels (SSF study identified ~3 kW to 1 kW ratio in required fan power for MTC 10.2 psi operation). SSF MTC operations allow off nominal performance for relatively brief MTC phase. The required power systems for redesigned fans were sized for 14.7, 10.2, 8, and 5 psi operation. The results (included in graphical and tabular form in the reduced pressure trade section) show a significant increase in required power (and therefore power and heat rejection system mass) between 8 and 5 psia. Other aspects of reduced power operation were also included in the trade, and are included in other sections of this report.

A trade was undertaken to compare the performance of fixed solar arrays to the reference articulating system, in support of the alternate subsystems trade. The first part of the task was to identify the optimum tilt angle for the FLO array. The plot, included in the "trades" section (Section 4.2.7), included a clear crossover point at  $-63^\circ$  tilt angle, which should be the point of maximum average performance. The arrays were sized to provide peak power at worst case solar angle (noon and dawn/dusk). The fixed array performance was found to be  $\sim 45\%$  of articulating system levels, and the required area was  $\sim 435 \text{ m}^2$ . The size and orientation of the array resulted in a significant mass penalty over the reference system.

### 3.14 AIRLOCK SYSTEM

The FLO Airlock System consists of the Crewlock and its internal outfitting, EVA systems burdened onto the habitat module, and external support hardware. As discussed earlier in this section, the SSF Crewlock was chosen because of its perceived maturity and hyperbaric capability but not necessarily for being the "optimal" lunar airlock. A discussion of hyperbaric treatment requirements is included in the reference 9. Mass and power estimates have been derived from current SSF WP02 data; however, a persistent difficulty has been the interpretation of these data. The SSF WP02 mass report provides an itemized breakdown of the SSF Airlock (which includes both an Equipment Lock and the Crewlock) but is not clear as to where each of these components belong (inside, outside, Equipment Lock, Crewlock, or elsewhere). This ambiguity has led to differing weight estimates for the Crewlock and EVA systems; unfortunately, without better definition from SSF WP02, the correct numbers will remain unknown. The Boeing airlock system mass summary given in figure 3-38 combines internal habitat EVA systems (535.1 kg) with airlock and extended EVA systems (2174.8 kg) for a total of 2710 kg.

The internal EVA systems burdened onto the hab (as shown in the baseline layout) include Suit Processing and Checkout Units (SPCUs), Airlock Depressurization Pump Assembly (ADPA), and Hyperbaric Support which have been based on a similar SSF Equipment Lock complement. The use of these systems assumes lunar suit operations to be similar to the STS EMU; however, JSC has proposed a new, regenerable suit which may require much different support. Updates to the baseline can be made once data and definition of this new suit are available. Dedicated EVA sublimator water has been included under Consumables but may be provided from Crew Vehicle or Lander Fuel Cell Water, Urine Processor product water, or become unneeded for a regenerable Portable Life Support System (PLSS). EVA suit spares necessary for 45 days are also included under Consumables; however, the primary EMUs are assumed to be brought with the crew. In keeping with the "Outpost" philosophy, tool and tool stowage have been reduced by nearly 90% from SSF numbers. EVA access needs and accommodations are discussed earlier in this report under External Configuration. Concept development will obviously continue for the airlock system, which is a major driver to FLO habitation design and mass.

FLO Crewlock/EVAS Component	Boeing Mass (kg)
• <b>Structures and Mechanisms</b>	<b>1532.7</b>
Crewlock cylinder section	152.9
Crewlock EVA bulkhead ring	264.0
Crewlock IVA bulkhead ring	326.6
Longerons and struts	40.6
Isogrid panel/support angles	93.0
MM/D shield	79.2
EVA/IVA hatches/mech	228.1
Non-rack/rack support struct	17.8
Crewlock rack	58.3
1/6 g internal/external struct	
Pass-thru lock	
IV yoke	
Keel trunnion ftg and pins	
Transportation pins (2 keels)	
1/2 Equip Lock end dome	
Hab/Crewlock interface (est)	272.2
• <b>Internal EVA Systems</b>	<b>656.3</b>
Crewlock hyperbaric supp	121.2
Hab EVAS (SPCU, H/B, pump)	535.1
• <b>Other Distributed Hardware</b>	
• <b>Crewlock EVA Hardware</b>	<b>428.9</b>
• <b>External EVA Equipment</b>	<b>92.0</b>
<b>Total Mass</b>	<b>2709.9</b>

Figure 3-38. FLO Habitation System, Crewlock/EVAS Status

### 3.15 CONSUMABLES

The Consumables listed in figure 3-39 include crew and system needs for the initial 45-day manned visit to the First Lunar Outpost. Most of these masses have been derived from SSF data or JSC FLO reports. Not included in this list are external science payloads and external equipment spares which are still being defined (see Logistics/Operations discussion later in this report). Also remaining is a firm understanding of habitat needs prior to and in-between crew visits; for example, leakage make-up gases, system expendables, system operations, and consumable lifetimes must still be evaluated to develop a viable concept. A stowage volume assessment is given earlier in this section. Another consideration is the fact that consumables for subsequent visits must be brought with the crew; thus, the Crew Lander must accommodate these items. A brief study was conducted to determine the most probable first-visit consumables which could be offloaded to the Crew Vehicle (included later in this report); however, while this reduces FLO habitation mass, the Crew Vehicle mass, which may already be the mission driver, increases by this same amount.

FLO Consumables Mass	Boeing Mass (kg)
• <b>Crew Accommodations</b>	<b>1134.0</b>
Crew Quarters	0.0
Clothing	245.0
Off Duty	84.2
Photography	} 182.8
Workstation	
Food & Galley Supply	463.0
Personal Hygiene	45.8
Housekeeping	113.2
• <b>Life Support</b>	<b>735.2</b>
Water (Closed Loop)	in hab
Oxygen	305.2
Nitrogen	259.0
ARS expendables	} 129.4
WRM expendables	
WM expendables	
THC expendables	
• <b>Health Maintenance</b>	<b>80.0</b>
• <b>Science</b>	<b>50.0</b>
• <b>EVA</b>	<b>505.7</b>
EMU expendables	166.3
EMU spares	74.8
Dust Control	97.0
EVA Sublimator Water	167.6
• <b>Spares</b>	<b>in hab</b>
<b>Total Consumables Mass</b>	<b>2504.9</b>

Figure 3-39. FLO Habitation System, Consumables

### 3.16 INTERNAL SCIENCE

The emphasis of the FLO concept has been to conduct external lunar science and exploration; therefore, minimal accommodations for internal science have been considered. Since the actual mission objectives and profiles for the First Lunar Outpost have not yet been completed, the integrated baseline seeks to provide some generic but useful internal science capabilities. As shown in figure 3-40, this consists of one dedicated rack (which has been modeled after the SSF Lab-A Maintenance Workstation) and some mass allocation for general science equipment (stowage location is currently undefined). These provisions are intended to enable limited sample examination and characterization, to accommodate some internal maintenance capability (on EVA suits, for example), and to support life science experiments. Also included in this list is a Fluid System Servicer (FSS) and leak detection equipment which are based on SSF numbers and bookkeeping (actual use and location of this equipment remains unknown). With a major feature of FLO being the support of human presence to conduct missions on the Moon, it is expected that internal science capabilities will be a significant consideration of habitation system design.

<b>FLO Internal Science Support</b>	<b>Boeing Mass (kg)</b>
Science Workbench	300
Science Equipment	365
Fluid System Servicer and leak Detection Equipment	102
Sample Prep. Instruments	
Imaging Instruments	
Spectrometers	
<b>Total Internal Science Mass</b>	<b>767</b>

*Figure 3-40. FLO Habitation System, Internal Science Support Mass*

## 4.0 SSF DEVIATION TRADE: ALTERNATE SUBSYSTEMS

### 4.1 INTRODUCTION

Subsystem trades were undertaken to examine design alternatives to the current FLO habitation system baseline. These were divided into two groups: (1) those that maintain a high degree of Space Station Freedom heritage in the habitat module, called SSF deviation trades, and (2) those that examined alternatives to the basic SSF design, called SSF alternative trades. This section of the report describes the first group of trades.

Subsystem alternatives were explored with the objectives of simplifying design, simplifying operations, and reducing cost and mass. Trades were carried out in nine main areas. (1) "Open" vs "Closed" ECLSS water: Use stored water instead of closed-loop processors; (2) Heat pumped vs non-heat pumped heat rejection system: Avoid development and power costs associated with heat pump; (3) Possible uses of crew lander fuel cell water (FCW): Use crew lander FCW for habitat oxygen and water needs; (4) Inflatable hyperbaric chamber for use inside habitat module: Reduce mass and volume impacts associated with SSF crewlock; (5) "Open" vs "Closed" power system: Resupply reactants for night-time power needs; (6) Reduced power processing levels: Simplify and consolidate power processing steps; (7) Fixed vs articulating solar arrays: Simplify deployment and tracking systems; (8) Off-load some first-visit consumables to crew lander: Unburden initial FLO mass by allocating a portion of its supplies to the crew lander; and (9) Deferral of full power capability until arrival of first crew: Examine manned vs dormancy requirements to off-load initial FLO mass by delivery of augmenting power system with crew lander.

Due to the diversity of the various trades, a rather short list of common groundrules was derived. The quantification of trade study results were based on the Boeing Integrated Baseline FLO Habitation System. Mass comparisons considered both initial and resupply FLO requirements. No complete cost comparisons are available at this time; in some cases, qualifying statements regarding cost are made (for example, existing designs and hardware should cost less for comparable systems). SSF data were used where available, and other parameters were calculated or derived. Alternatives which trade better than the baseline system may be explored in more detail for inclusion into concept in the future.

## **4.2 ALTERNATE SUBSYSTEMS TRADE SUMMARY**

### **4.2.1 Open vs Closed Water Trade**

A trade was performed to assess ECLSS water supply options for the FLO mission. An open system which requires resupply of all necessary ECLSS water was compared to a closed system utilizing SSF derived water processing equipment. Mass summaries developed for the current reference system (closed), and the open system option are shown in figures 4-1 and 4-2, respectively. The total mass of the reference system was found to be approximately 626 kg lower than the open system, with the total system masses diverging for each manned mission. The resupply requirements for either system would consist of expendables and any spares needed, but the open system would also require ~1 mt of water and tanks for each manned visit. The overall system mass for the closed system was found to be 1568.8 kg, while the system mass for the open system was 2194.7 kg. The increased thermal and power systems mass for the closed system water processor operation was estimated to be only ~146 kg, since the power system mass is much more sensitive to average power than peak power levels (increase in average power required for water processor less than peak power increase). The required resupply for expendables for either system may be assumed similar since a complete spares assessment cannot be completed until more is known about the respective systems, although expendable requirements may be higher for the closed system. The EMUs will also require water but the PLSS may be regenerable, so EMU water requirements were not included in the trade (an overall system level water balance may also leverage this trade for either option). Both the "Closed" and the "Open" Water Systems require 3 rack spaces inside the module, although plumbing and other utilities may require slightly less volume for the "open" version. The conclusion reached as a result of this trade was that the closed version is preferred over the 'simpler' open system for the following reasons:

- a. Closed water system should be proven by SSF.
- b. FLO is intended for multiple missions.
- c. Both initial and resupply masses are significantly lower for closed water option.

### **4.2.2 Heat Pumped vs Non-Heat Pumped Heat Rejection System (HRS) Trade**

A trade was performed to assess the sensitivity of the performance of the reference heat rejection system to the presence of a heat pump to augment the rejection temperature of the FLO radiator. Power system mass impacts of the heat pump power requirements were also assessed to quantify the mass impacts of the heat pump. The radiator area required to reject a representative FLO habitat waste heat (~16 kW) for a range of radiator absorptivities, and for surface emissivities of 0.6 and 0.8 is shown in figure 4-3. The two emissivity curves are shown to illustrate that the radiator area vs absorptivity trends are similar for different emissivity levels. The solar absorptivity of



Alternative	System Description	Mass (kg)	Power (W)
Current Baseline Concept (SSF "Closed Water" System)	• Water Storage Rack (with 1 tank)	159.7	} 70W Peak 14W Avg
	- basic utilities and rack	157.0	
	- water storage assembly	110.4	
	- water (1 tank)	15.3	
	• Water Processing Rack (with 1 tank)	171.0	} 700W Peak 200W Avg
	- basic utilities and rack	312.9	
	- water processor assembly	110.1	
	- water (1 tank)	30.8	
	- process cntrl wtr qual monitor	26.4	
	• Urine Processor Rack	187.9	} 355 W Peak 77.8 W Avg
	- basic utilities and rack	146.7	
- urine processor assembly	11.2		
• Expendables	129.4		
• Spares	?		
<b>Total System Mass and Power</b>		<b>1568.8</b>	<b>1125W/291.9W</b>

Figure 4-1. Mass and Power Summary for Referenced Closed Water Loop System

Alternative	System Description	Mass (kg)	Power (W)	
Specification Candidate ("Open or Stored Water" System)	• Crew Water Needs: <b>between</b> 4.65 kg/p-d x 4 people x 45 days = 837 kg (hydrated food, handwash, urinal) <b>and</b> 5.45 kg/p-d x 4 people x 45 days = 981 kg (add 1 shower/week)			
	• Water System Capabilities	2013.6	} (3x70) W Peak (3x14) W Avg	
	- 3 Water Storage Racks (w/3 tanks each) (with 5% tank fraction, will provide 945.9 kg of water total)	30.8		
	- PCWQM	20.9		
	- MDM	0.0		
	- Additional tankage for urine/condensate (assume use of emptied water tanks for storage of waste water - tanks switched out for resupply)			
	• Expendables (assumed)	129.4		
	• Spares	?		
	<b>Total System Mass and Power</b>		<b>2194.7</b>	<b>210W/42W</b>

Figure 4-2. Mass and Power Summary for Open Water Loop System Option

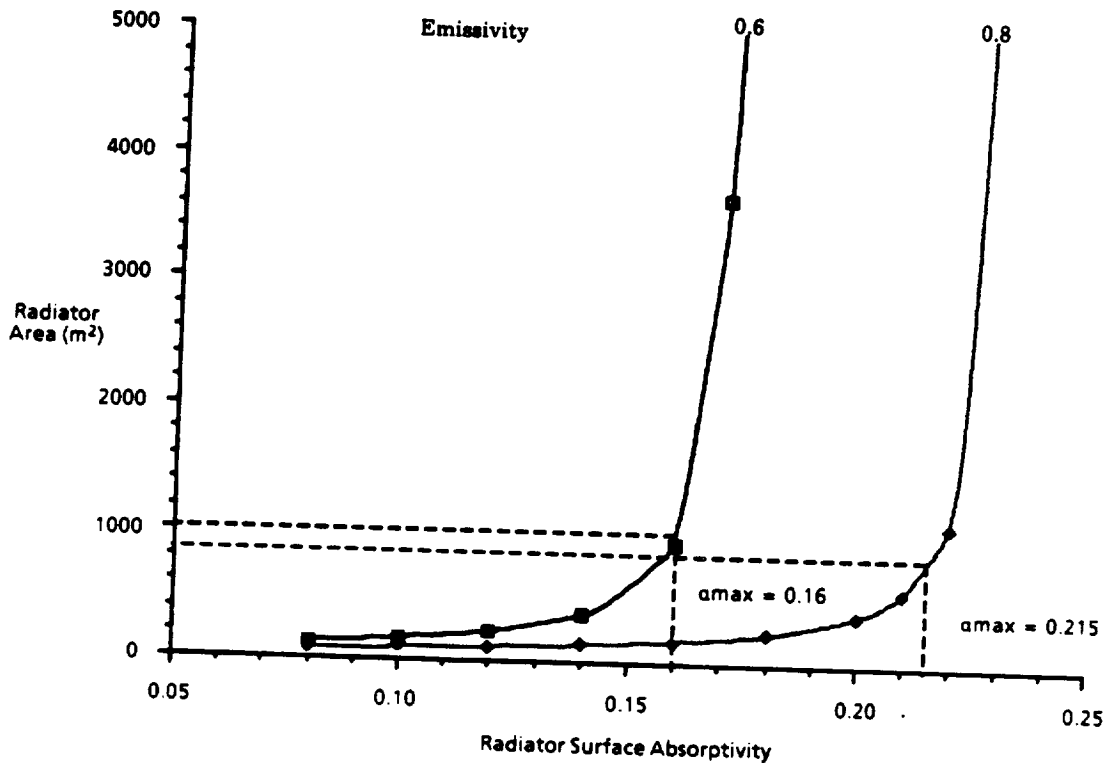

• Selected maximum  $\alpha$  corresponds to 5% offset from asymptotic value

Figure 4-3. Radiator Area vs. Optical Surface Properties

ACS023

the radiator will probably be the most effected by the lunar environment, since lunar dust (which is likely to become deposited on the radiator) has a rather high emissivity ( $>0.9$ ). As can be seen from the graph, the radiator is much more sensitive to the surface absorptivity than emissivity in the area of interest. The 5% offsets were shown for illustration only, to give a reasonable point where the surface area goes asymptotic to a given absorptivity. Even at these values, however, the required radiating areas are ~850 and 1000 m<sup>2</sup>, for emissivities of 0.8 and 0.6, respectively. The same area trend, along with the radiator mass vs surface absorptivity is illustrated in figure 4-4. Top level assumptions made for the trade are also shown on the figure. The radiator area and masses were derived for a horizontal orientation at worst case conditions (lunar "noon"). The radiator was assumed to be insulated on the back to limit lunar surface heating effects. As can be seen in the figures, the non-heat pumped thermal control system was very sensitive to radiator optical properties (absorptivity and emissivity).

Although the heat pumped system will likely be slightly more complex than a non-heat pumped option, and would require heat pump technology development, the non-heat pumped TCS will pose several challenges in the development phase. The absorptivity range (including expected degradation) should be kept away from the mass

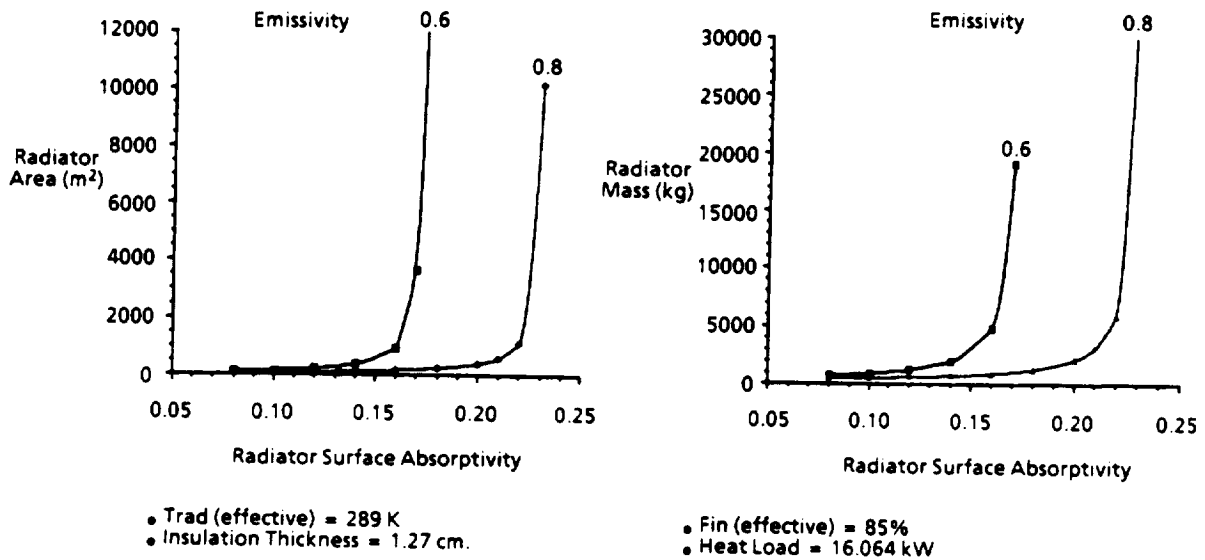

Figure 4-4. Radiator Mass and Area vs. Optical Surface Properties

ACS024

and area asymptotes in order to increase system reliability given the uncertainties in dust and erosion effects on performance. Current state-of-the-art radiator coatings have some difficulty to provide required  $\alpha/\epsilon$  values over the FLO operational life (frequent changeout may be necessary). If absorptivity approaches the asymptotic value, small increases in degraded optical values would make required radiator size and mass unworkable. SSF degraded  $\alpha$  and  $\epsilon$  values used to size the heat pumped radiator ( $\alpha = 0.25$  and  $\epsilon = 0.8$ ), would cause the radiator mass and area to become prohibitively large for the non-heat pumped system. Since the heat pump is only required during the day, the reference power system impact in mass for delivering heat pump power during the lunar daytime is only ~159 kg (mainly due to increased solar array area required). The heat pump mass is approximately 110 kg, which is more than offset by the additional radiator mass of the non-heat pumped system. Due to its lower area, the heat pumped radiator may be pre-integrated so as to require little or no deployment after landing. The heat pumped TCS should be inherently more flexible than the non-heat pumped TCS in that the power level input to the heat pump compressor can be altered to raise the evaporator (i.e., radiator) rejection temperature. The primary conclusion of this trade was that the heat pumped system was preferable due to its operational flexibility, greater rejection efficiency, and lower overall external HRS mass.

#### 4.2.3 Possible Uses of Crew Lander Fuel Cell Water Trade

A trade was performed to investigate the possibility of utilizing the crew lander fuel cell water for the FLO habitat system. The crew lander power level is estimated to be ~4 kW in active mode, and ~1 kW in standby. Fuel cell water (FCW) will be produced at

8.736 kg/kW-day at these power levels. Assuming 5 days active mode on lunar transfer, and 42 days on standby, the crew lander generates 541.6 kg of water by the end of FLO mission. The FLO lander may also produce fuel cell water during its active mode, depending on the lander power system architecture, and its relationship to the FLO power system.

The fuel cell water has two major uses in the Outpost Habitation System: (1) to meet crew water needs in an open water ECLS system, and (2) to meet crew oxygen needs via electrolysis (utilizing FLO external power generation equipment to split this water into O<sub>2</sub> and H<sub>2</sub>). Either of these uses require fuel cell water to be transported from the crew lander to the FLO habitat, so several small lander water tanks would probably be necessary. Removal and transport operations for the water to be integrated into the appropriate habitation system would take place very near the end of the mission, in order to capture the most water. The crew lander TCS is not yet defined, but it may require fuel cell water for sublimator cooling, potentially leaving no excess for FLO uses. If it is not used for onboard TCS, the crew lander fuel cell water may be used to meet crew water needs: the 541.6 kg of water generated by the crew lander would provide 50 - 60% of the necessary ECLSS water for a typical FLO mission. As shown earlier in this section, without the use of fuel cell water, the ECLSS water trade showed that the open water system mass is 480.3 kg greater than closed version, and that open resupply requirements may be ~1 mt higher. With the use of fuel cell water, the first FLO must still pay the 480.3 kg penalty (to accommodate the first manned visit needs) and the open resupply requirements would still be ~400 kg higher, so the use of crew lander fuel cell water does not overcome the mass benefits associated with a closed water system, although it may be very useful in meeting other needs, such as for EMU sublimators. Another area of use for crew lander water could be to meet crew oxygen needs, utilizing the electrical power system electrolyzer. At the end of the first mission, lander fuel cell water would be introduced to the product water storage of the FLO external power generation system, and electrolyzed into hydrogen and oxygen during the interim lunar daylight periods between manned missions. The excess 541.6 kg of water would produce 481.4 kg of oxygen, which would be more than adequate for oxygen resupply (42 day metabolic load and makeup/repress requires 225 kg). Resizing the FLO product water tanks to hold a full 541.6 kg of water, enlarging the oxygen reactant tanks to hold an additional 225 kg, and increasing the array and electrolyzer mass needed to split this water results in a ~164.5 kg impact to FLO power system. It is assumed that the remaining water is utilized by EMU, etc., but the hydrogen is lost, unless it becomes valuable for later ISRU or other uses.

There will likely be several negative impacts to the initial FLO habitat relating to the utilization of the lander fuel cell water. The complexity of the FLO system will likely be higher with delivery of oxygen from the reactant storage subsystem, introduction of crew lander water into the fuel cell product storage, etc. Fuel cell water utilization may result in a -165 kg mass penalty for the first FLO mission, above the requirement of supplying the first mission oxygen needs (later lessened resupply requirements may offset this initial impact). The main discriminator in this trade will be the amount of water available, if any, from the yet to be defined crew lander. A final set of recommendations cannot be made until the crew lander is better defined.

#### 4.2.4 Inflatable Hyperbaric Chamber Concept

All FLO concepts provide hyperbaric treatment capabilities that meet current understanding of the NASA Exploration Program Office (ExPO) requirements. The reference SSF crewlock concept is near-term hardware which combines airlock and hyperbaric chamber functions. The crewlock mass is high, however, (mass estimates for the crewlock system range from 2700 to 4200 kg), and the crewlock intrudes into the habitat volume in order to fit within the 10m launch vehicle shroud. An inflatable hyperbaric chamber in conjunction with a smaller dedicated airlock may significantly reduce airlock system mass and size. The airlock could be designed for optimal egress/ingress and equipment pass-thru only, potentially reducing its size and mass significantly. A hyperbaric chamber would stow and deploy inside the habitat module when required. ILC Dover has constructed, tested, and delivered a one-person collapsible hyperbaric chamber prototype to the United States Air Force, reference 14. In order to apply such a chamber to a FLO mission, requirements for the hyperbaric chamber will require further clarification (i.e., attendant medical officer, treatment profiles, internal subsystems and support, pass-thru supplies, medical needs, etc.). In order to determine if this inflatable concept is attractive or even feasible for FLO applications, further data and concept development will be required.

A possible operational scenario for an inflatable airlock is shown in figure 4-5, and the USAF model mentioned above, along with relevant physical and operational data is shown in figure 4-6. ILC, under contract to Wright-Patterson AFB, has designed, developed, fabricated, tested, and delivered one prototype collapsible hyperbaric enclosure to demonstrate the technology which may be used for treatment of decompression sickness on board STS, SSF, or remote sites. The ILC work was conducted in two phases: Phase I established design criteria entailing the research of materials and fabrication techniques, and an in-depth investigation of system design. As a result of

this study, it was recommended that a prototype enclosure operating at 41.2 psia (26.5 psid) should be fabricated. Phase II included the detailed design, fabrication, and testing (to 1.5 times the operating pressure to ensure safety) of a prototype hyperbaric enclosure. The unit was delivered to the USAF School of Aerospace Medicine at Brooks Air Force Base for evaluation. A preliminary list of issues to be addressed before the application of an inflatable airlock can be considered a viable option is given in figure 4-7. As stated earlier, many of these issues are requirements driven, and as such, cannot be addressed until more is known about the FLO mission operational requirements.

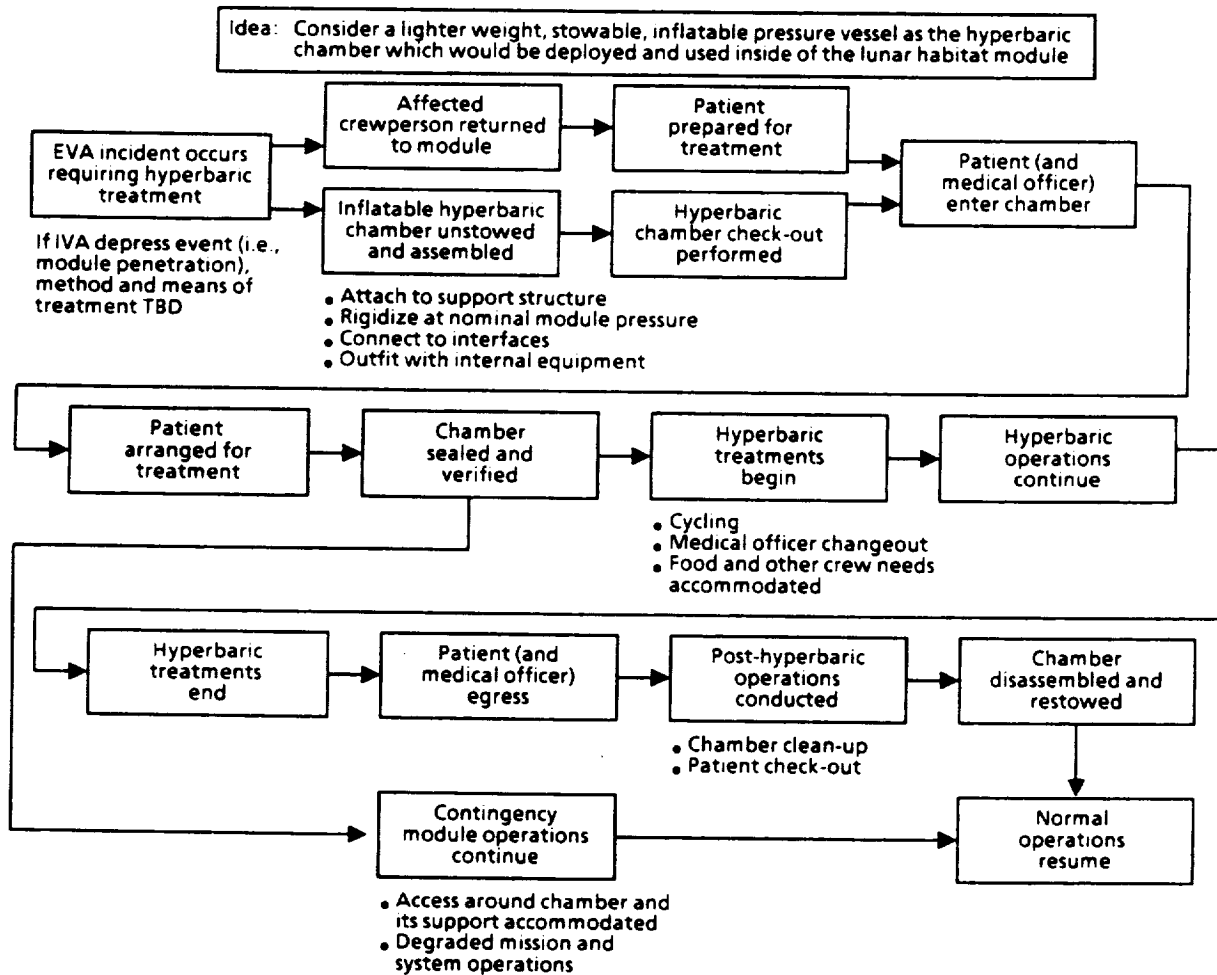
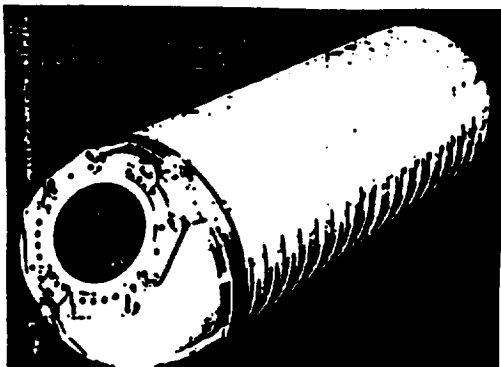

Figure 4-5. Operational Scenario for Inflatable Hyperbaric Chamber



- NORMAL OPERATING PRESSURE: 26.5 PSIG
- BURST PRESSURE: 60 PSIG
- 77" LONG X 24" LD.
- SOFTGOODS WEIGHT: 14.5 LBS.
- PACKAGING DIMENSIONS: 26" X 26" X 3 1/2"
- POLYESTER RESTRAINT/URETHANE COATED NYLON BLADDER



Figure 4-6. ILC Dover Collapsible Hyperbaric Chamber

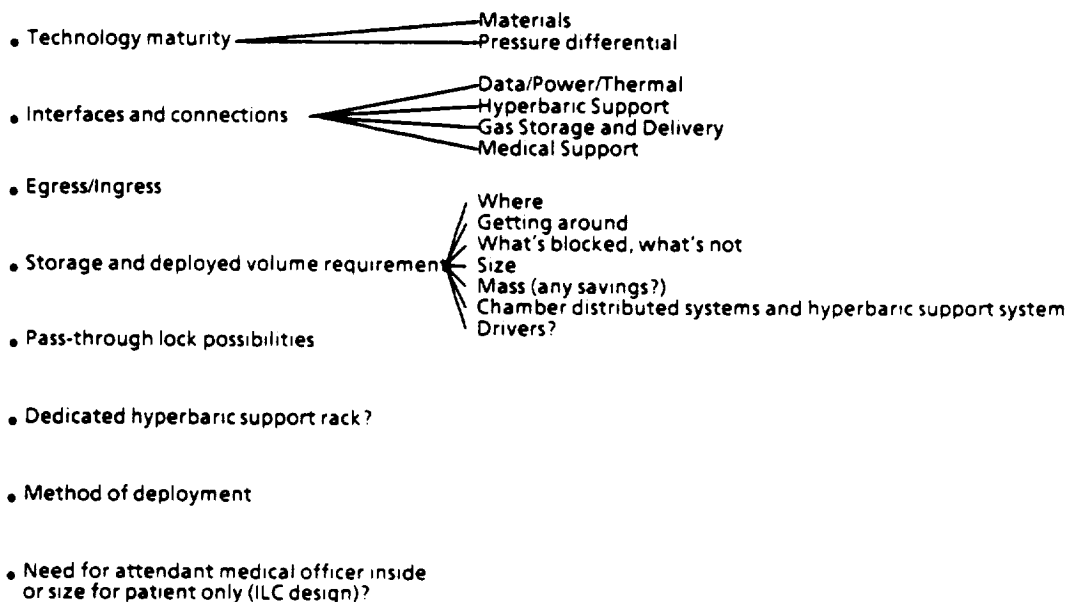

Figure 4-7. Inflatable Hyperbaric Chambers Issues to be Addressed

#### 4.2.5 Open vs Closed Power System Trade

A brief comparison was made of an open, or non regenerable fuel cell electrical power system, versus the reference regenerable fuel cell concept. For the reference system, lunar nighttime power is supplied by fuel cells using oxygen and hydrogen reactants. The electrolyzer is used to break down fuel cell product water into oxygen and hydrogen in order to eliminate need for resupply of fuel cell reactants. The solar array for the reference system is sized to accommodate daytime electrolyzer use, while supplying required daytime power to all habitat systems. High pressure storage of the fuel cell reactants is required to minimize tankage volume and mass, and therefore efficiency. An alternative to this baseline is to use an open fuel cell system, which employs no electrolyzer, since the reactants are for one-time use only. Low pressure, or low temperature supercritical storage of the reactants is possible since no refrigeration would be required to densify electrolyze reactants (required for regen systems, since reactants leaving electrolyzer are at  $-60^{\circ}\text{C}$  or higher). The initial reactant supply must satisfy a 6 month dormancy period, and the first crew mission (~3595 kg of reactants and ~723 kg of tankage). Each crew must bring the same amount of reactants for each 6 month dormancy period and 42 day mission. The fuel cell product water is available for other uses (open water system, EMU PLSS use, etc.), or must be disposed of to provide storage space for next mission. Using the above scenario, the mass for the open power system for the first FLO mission is about 637 kg higher than the baseline. In addition, the open system would require an additional 4317 kg of resupply every visit (including the first). Based on this brief assessment, the closed, or regenerable fuel cell electrical power system was the preferred option.

#### 4.2.6 Reduced Power Processing Levels

An effort to identify possible areas of simplification for the SSF derived power system architecture was completed on a qualitative basis. A schematic of the reference power system is shown in figure 4-8. The schematic is similar to the current SSF architecture, with the exception of the electrolyzer/fuel cell system (SSF utilizes batteries). The power coming from the solar arrays requires conditioning, since it is delivered from the array in a range between ~160 - 200 V, depending on array orientation, solar flux, surface temperature, etc. A sequential shunt unit, which "bleeds" off excess power from the array, is used for overload protection. A DC switching unit is used to control fuel cell discharge and electrolyzer recharge, and main bus switching units are utilized to control the flow of external and internal power to and from the habitat. A DC to DC conversion unit (DDCU) in the habitat converts power from the unregulated nominal 160 V, to a regulated 120 V. The secondary power distribution assembly units (SPDA) provide power at the module level, and are equivalent to a main "breaker box". The remote power distribution assembly units (RPDA) provide power at the rack level for user loads, and further regulation of 120 V (down to 28 or 15 V) power is executed at ORU level within individual racks.



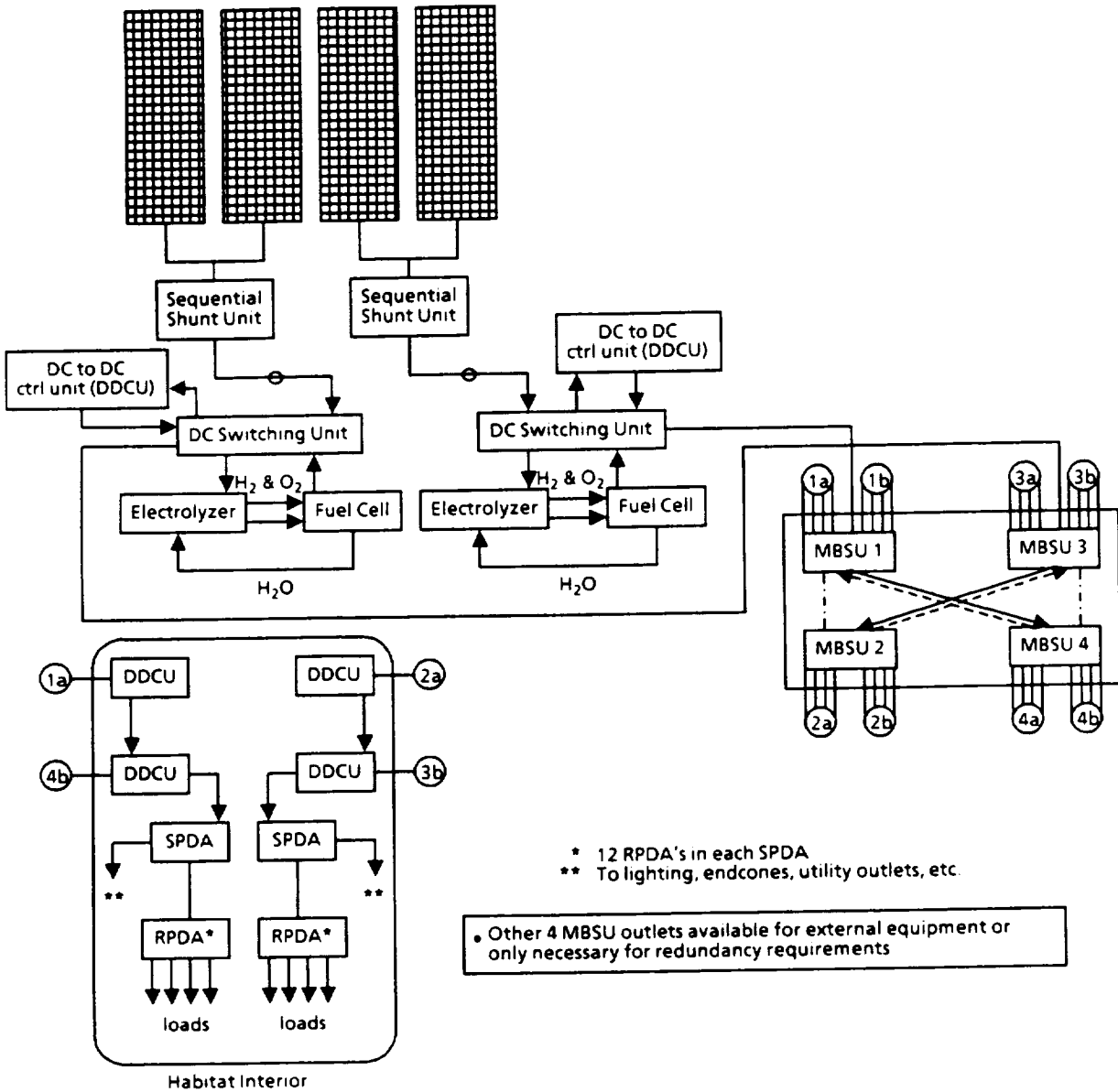

Figure 4-8. Reference FLO Electrical Power System Functional Schematic

Qualitative assessments were made regarding possible avenues of simplification to the FLO EPS architecture. The fuel cell output requires relatively small amount of conditioning as compared to the array output, so conditioning equipment can probably be bypassed during lunar night, increasing end-to-end power delivery efficiency. Reduced levels of power conditioning would result in increase in power system efficiency, although significant component level redesign would be required to standardize voltage level to 28 or 120 V, in order to accomplish this need. The required redesign of SSF derived components to standardize electrical power requirements could be a significant cost driver, however. If system standardization proves prohibitively complex or costly,

the amount of electronic equipment requiring off nominal power conditioning (currently 120 V after first DDCU) should be minimized to reduce power losses, complexity, and mass. Control and stability issues may be less severe for FLO solar array, due to its 14/14 day charge/discharge cycle compared to the 57/35 minute cycle for SSF. Utilizing single stage DDCU's with multiple voltage outputs at the rack level may decrease conversion losses and complexity, although system mass may increase slightly. Until more is known regarding the design and integration issues mentioned above, the reference FLO system (i.e., SSF EPS architecture) was preferred due to its compatibility with SSF derived hardware, and lack of design data on the associated costs of common power conditioning. A more detailed assessment of design environments and issues would also be required for a more accurate assessment of an optimal power conditioning system.

#### 4.2.7 Fixed vs Articulating Arrays

A trade was undertaken to compare the performance of fixed solar arrays to the reference FLO articulating array concept. The first part of the task was to identify the optimum tilt angle for a fixed FLO array. A plot of fixed array output as fraction of articulating system output was constructed for both dawn/dusk and lunar noon sun positions. The plot, shown in figure 4-9, included a clear crossover point at  $-63^\circ$  tilt angle, which should be the point of maximum average performance. As was the case for articulating arrays, the fixed arrays were sized to provide peak power at worst case:  $0^\circ$  and  $90^\circ$  solar angle (noon and dawn/dusk). As can be seen in the crossover graph, and in the array area versus array elevation graph (figure 4-10), the fixed array performance is  $\sim 45\%$  of articulating system levels, and the required area is  $\sim 435 \text{ m}^2$ . A possible configuration of the fixed array system, along with a summary mass statement, is shown in figure 4-11. As shown, the size and orientation of the array result in a significant mass penalty over the reference system. A preliminary deployment scheme for the fixed array concept is shown in figures 4-12 and 4-13. The frame would deploy in two parts. First, structural "runners" would deploy to the surface, to provide support for the deployment of main array support structure, which could unfold in "accordion" fashion. The array would roll or unfold along the support structure, and then expand to its full length of  $\sim 15$  meters (second "lengthwise" folds necessitated by 10 meter launch shroud allowance). The advantages and disadvantages of the fixed array concept as compared to the reference are summarized in figure 4-14. Although it will likely be more complex than the fixed array system, the articulating system was preferred for the reference FLO concept due to its significantly lower mass (885 kg vs 2575 kg) and area (190 square meters vs  $\sim 435$  square meters).

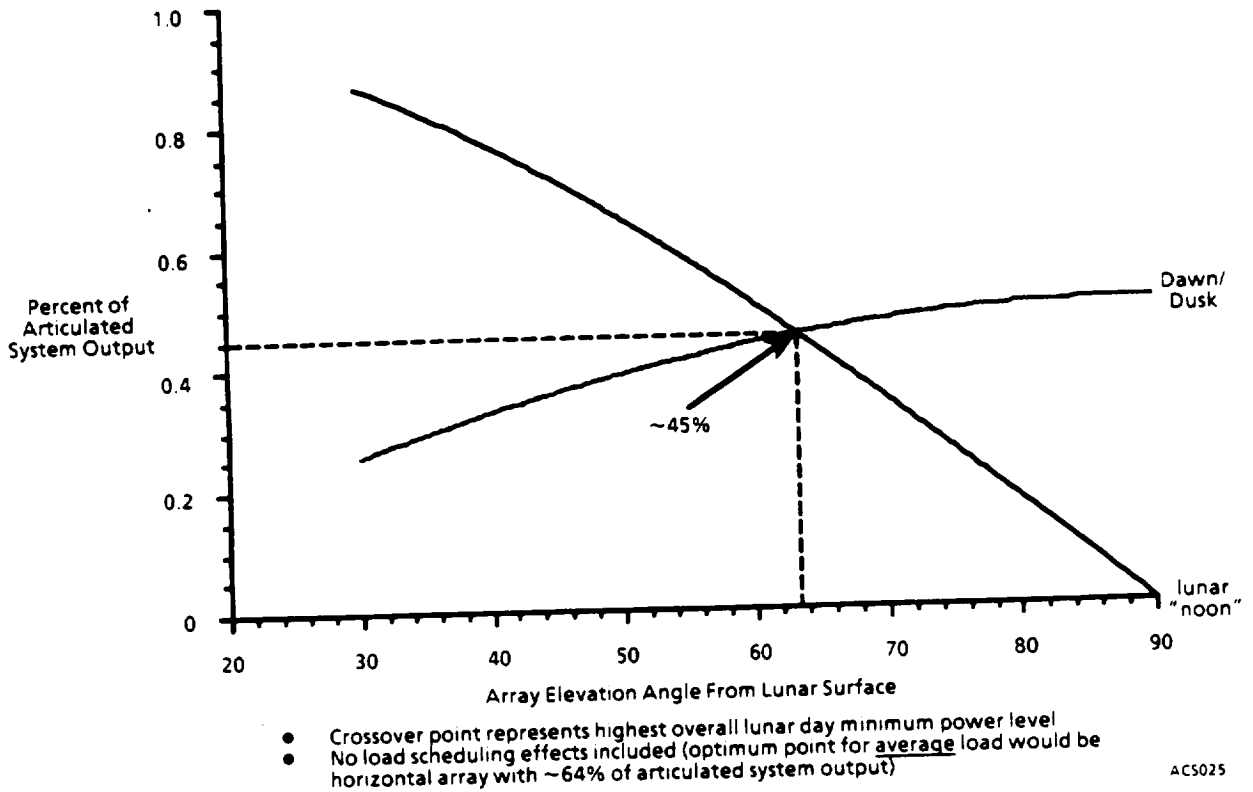

Figure 4-9. Percent of Articulated Solar Array System Power Output vs. Array Elevation Angle

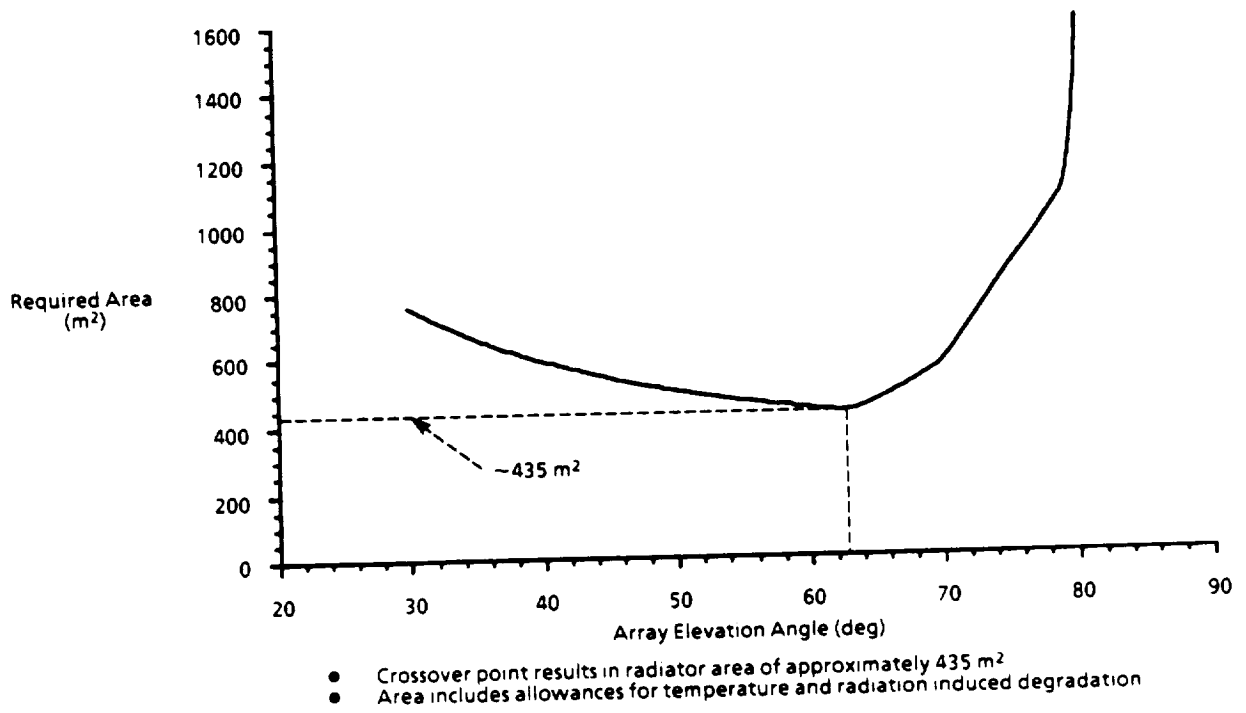
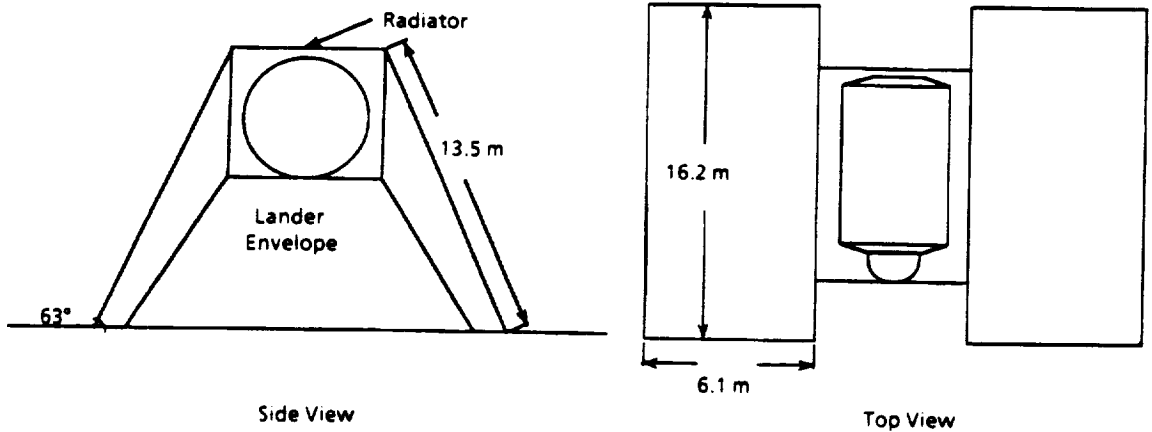

Figure 4-10. Fixed Solar Array Surface Area vs. Array Elevation Angle



Element	Material	Prelim. Mass
Solar Array Blanket	planar GaAs - 435 m <sup>2</sup>	969 kg
Main Support Structure	2219 Aluminum	1106 kg
Support columns	2219 Aluminum	400 kg
Misc. deployment equip.	na	100 kg
	Total:	*2575 kg

\* Reference system total mass = 885 kg

Figure 4-11. Possible Fixed Array Configuration and Preliminary Mass Estimate

ACS009

1. Deploy structural "runners" to surface  
supports fold out as runners deploy

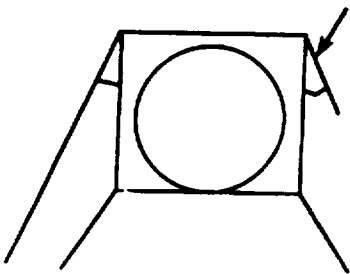

2. Deploy main support structure  
Structure deploys "accordian" style

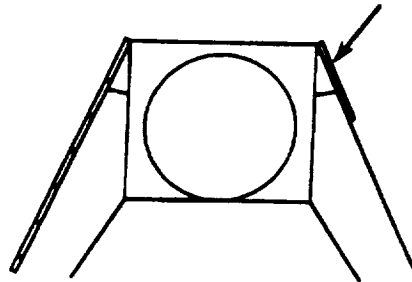

3. Deploy solar array  
Array deploys in "accordian" style, or unrolls and unfolds

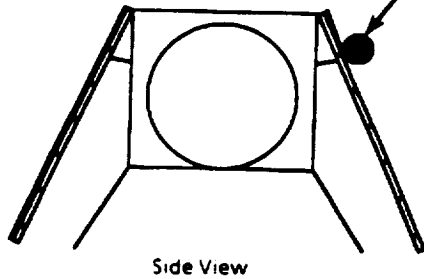

Figure 4-12. Deployment Scheme for Fixed Array Structure

ACS010

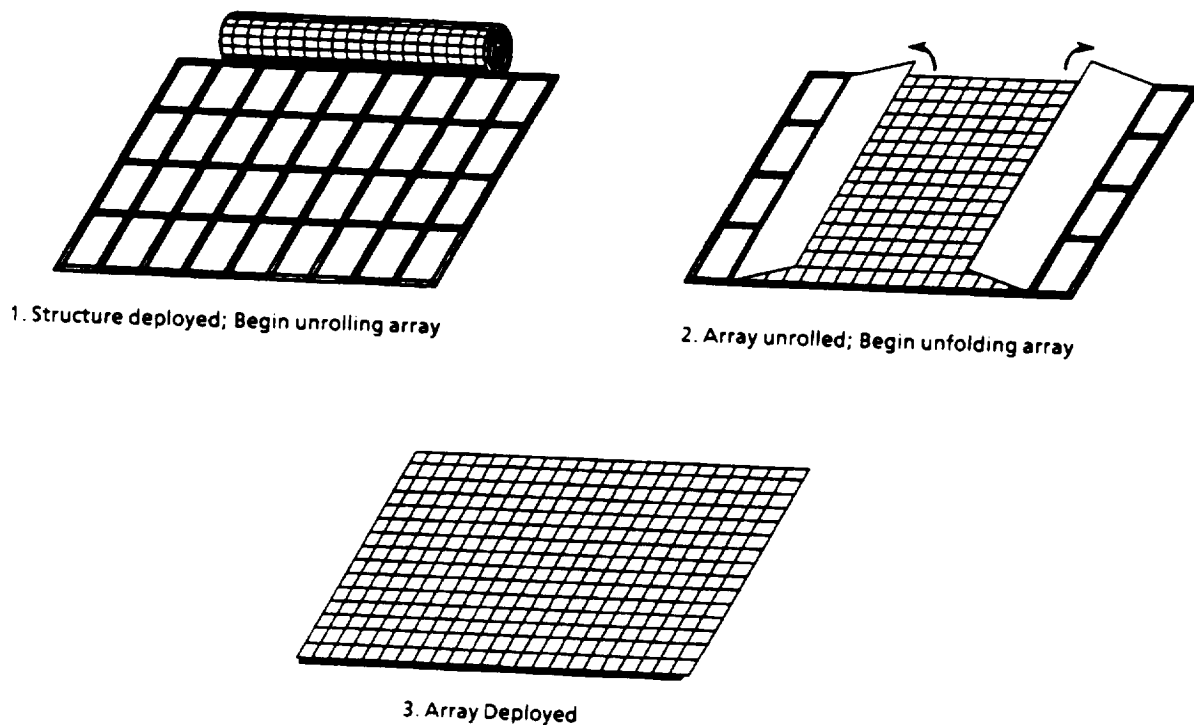

Figure 4-13. Array Blanket Deployment Scheme for Fixed Concept

ACS011

- | Advantage  | Disadvantage  |
|--|---|
| <ul style="list-style-type: none"> <li>• Can be fully deployed before manned landing; operational reliability high</li> <li>• Dust impingement on rotating mech. of greatly reduced concern</li> <li>• Nominal operation is routine and relatively simple</li> <li>• Not sensitive to sun inclination angle array alignment</li> </ul> | <ul style="list-style-type: none"> <li>• Articul. system can also be fully deployed before manned landing; lifetime operational reliability somewhat lower than fixed</li> <li>• Array dust buildup/shielding more difficult; cannot stow array during crew arrival/depart.</li> <li>• Autonomous deployment more difficult; system mass much higher</li> <li>• As sensitive to sun azimuth alignment with array; design limits flexibility of system to correct for off nominal landing</li> </ul> |

Figure 4-14. Summary of Advantages and Disadvantages of Fixed Solar Array Concept

#### 4.2.8 Off-load Some First Visit Consumables to Crew Lander

The option of off-loading some first visit consumables to the crew lander, rather than carrying them on the unmanned FLO, which currently burdens all consumables necessary for the first 45 day stay against the habitation system mass, was investigated. Since this mass must be brought by the second crew to sustain their visit, the crew lander and surface operations must be designed to accommodate these items. Depending upon manifest needs, the first crew could also bring a substantial amount of their initial supplies. In fact, most of the consumables are only needed by the crew (food, etc.), or can only be utilized by the crew (internal spares/expendables, etc.), with the exception of make-up gas, which has not yet been fully burdened for unmanned operations. If crew-specific items only, were off-loaded from the habitat, including food, clothing,

EMU expendables and spares, CHeCS supplies, personal hygiene articles, operations gear, and off-duty items, 1238.9 kg of consumables could be removed from the habitat system mass. A consumables Stowage Volume study contained elsewhere in this report, discusses current volume estimates, and the need for significant additional investigation into this potentially enhancing area of operations modifications.

#### 4.2.9 Deferral of Full Power Capability Until Arrival of First Crew

The reference FLO lander/habitat employs external systems which automatically deploy and activate after the habitat comes to rest on the lunar surface. Means of reducing the requirements on the various deployment systems have been examined. A heat pump augmented radiator system reduces radiator size, allowing it to be pre-integrated without deploying, or at least significantly decreasing the level of deployment required (see heat pumped vs non-heat pumped HRS trade). The fixed vs articulating solar array trade explores alternatives to the baseline deployment and tracking scheme, at the expense of the difficulties involved in deploying (either automatically or manually) a very large array. The self-activation of both internal and external systems require significant further study and development before activation methods and operations can be defined and selected. Options to the reference must consider system survival and verification both prior to each crew arrival, and after each crew departure. This trade examined the possibility of equipping the initial FLO habitat with power sufficient only for unmanned operations with the remainder of the reactants, tanks, and solar arrays brought and emplaced by the crew.

The baseline FLO dormancy average day/night power needs are 7.85 kW, and 2.525 kW, respectively, compared to the manned requirements of 13.32 kW/9.91 kW. This difference may allow some power system mass to be deferred by equipping the initial FLO for dormancy power generation only, with full power capability delivered by the first crew. Such a scheme would remove ~3100 kg (including reactants, tanks, and additional arrays) from the habitation system mass, and add it to the Crew Lander, which would also incur an additional ~100 kg impact, for added valves, lines, etc., due to the splitting of the reactants into smaller tanks for transport on the two vehicles. Crew-delivered power system augmentation supplies could be emplaced on the surface near the habitat lander, and "plugged into" the existing systems. As with the consumables off-loading trade, any mass off-loaded from the habitat and burdened onto the crew lander must consider the latter's own mass limitations, as well as the required surface operations to be conducted by the crew. Related studies have been conducted on this subject, and discussions are presented elsewhere in this document to aid in the selection of optimal payload splits for habitat and crew lander manifests.

**4.3 SSF DEVIATION - FLO HABITATION SYSTEM TRADES**

A SSF deviation study was carried out to investigate ways, independent of SSF design, to reduce current FLO baseline costs and weights by simplifying design, reducing operations, and/or proposing alternate and innovative approaches of achieving FLO mission goals. The SSF deviation study addressed alternate internal pressures, alternate materials, alternate structural configurations, alternate subsystems, and inflatable structures.

**4.3.1 Alternate Internal Pressures**

To arrive at an optimal pressure which satisfies FLO mission goals, the effects of operating the FLO Habitation module with internal pressure lower than the current baseline of 14.7 psia were investigated and advantages and disadvantages associated with lower internal pressures were assessed. The FLO Hab is based on SSF Hab-A which is designed and optimized for 14.7 psia and operates at the following internal pressures;

- a. 14.7 psia nominal pressure-Permanently Manned Capability (PMC)
- b. 10.2 psia operating pressure - Man Tended Capability (MTC).

Alternate internal pressures of 10.2, 8.0, and 5.0 psia are evaluated in this study. Typical advantages associated with lower internal pressures are;

- a. Improved EVA operations by decreasing or eliminating pre-breathe requirements, decreasing decompression risk, and accommodating lower pressure suit to increase mobility and reduce fatigue.
- b. Reduce leakage rate resulting in lower resupply air mass and smaller tank sizes.

Keeping O<sub>2</sub> partial pressure constant, a change in internal pressure results in a change in oxygen concentration as indicated, figure 4-15.

Internal Pressure (psia)	O <sub>2</sub> Partial Pressure (psi)	O <sub>2</sub> Concentration %
14.7	3.1	21
10.2	3.1	30
8.0	3.1	38
5.0	3.6	70

Figure 4-15. Variation in Oxygen Concentration

- Change in O<sub>2</sub> concentration and pressure impacts several areas as follows;
- a. Change in Oxygen Concentration affects
    - 1. Flammability
    - 2. EVA Operations
    - 3. Physiological factors
  - b. Change in total pressure affects
    - 1. Pressure Vessel Structure

2. Material Outgassing
3. Physiological Factors
4. EVA Requirements and Operations
5. ECLS Systems
6. Heat Rejection System (avionics cooling & cabin air systems)
7. Power Requirements
8. Leakage Rate (Resupply Air Mass & Tank Sizes).

Some of these issues are discussed in the following sections.

#### 4.3.1.1 Flammability

NASA manned program requirements state that all materials must pass NASA's Upward Propagation Flammability Test, reference 15. All space qualified ("A" rated) materials must pass the NASA Upward Flammability Test at or above 30% O<sub>2</sub> concentration. The following facts must be remembered when evaluating materials for flammability:

- a. Risk of Flammability is directly proportional to Oxygen concentration
- b. For a constant partial pressure of O<sub>2</sub>, flame propagation rate increases with decrease in total pressure. This is true even with normal O<sub>2</sub> partial pressure

Flammability tests on frequently used spacecraft engineering materials indicate that:

- a. ~ 76% of the materials tested pass at 14.7 psia / 21% O<sub>2</sub>
- b. ~ 52% of the materials tested pass at 10.2 psia / 30% O<sub>2</sub>
- c. ~ 28% of the materials tested pass at 5.2 psia / 70 % O<sub>2</sub>
- d. ~ 18% of the materials tested pass at 5.2 psia / 100 % O<sub>2</sub>

Materials used on SSF Hab-A are qualified to approx. 30% O<sub>2</sub> concentration. Several high usage materials have failed the flammability test at 33% O<sub>2</sub>, such as:

- a. Polyimide foam insulation
- b. Silicon rubber coating used as fire barrier
- c. Fabric used in Orbiter crew uniforms
- d. Outer fabric of EVA suits
- e. Woven composite material used in SSF racks
- f. Various paints

The results from NASA's flammability tests are shown in figure 4-16. It should be noted that flammability tests at 33% O<sub>2</sub> were conducted on 244 materials used in the Orbiter.



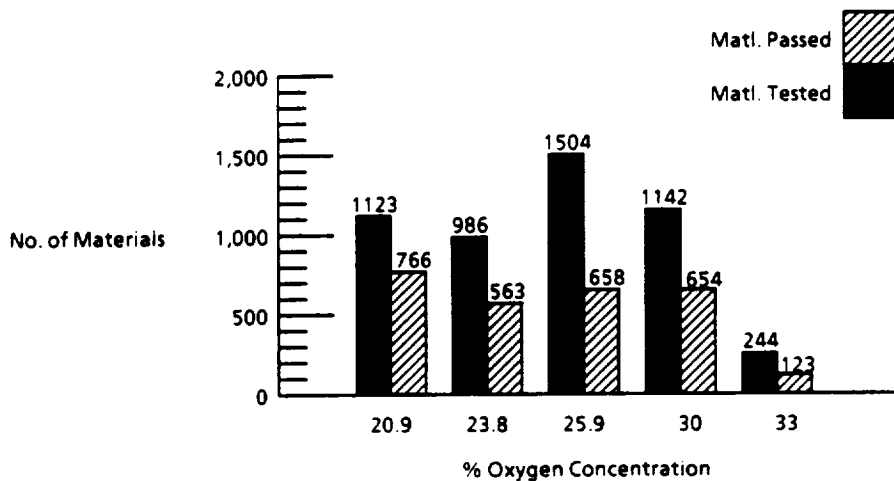

Figure 4-16. NASA Flammability Test Results

Test data indicates that a knee exists in the data at about 33% O<sub>2</sub> concentration. Less than 50% materials passed flammability test above 33% O<sub>2</sub> concentration. Materials that pass at 33% concentration usually pass at 100% as well. If an increase O<sub>2</sub> concentration above 33% is desirable, material re-qualification and/or extinguishing methods must be investigated.

#### 4.3.1.2 Toxic Outgassing Due To Lower Pressure

The SSF Materials and Processes Group was consulted on the issue of outgassing due to reduced pressures. It was pointed out that:

- Material outgassing is roughly the same at any internal pressure being considered (14.7, 10.2, 8, or 5.0 psia). Significant increase in outgassing does not occur until near-vacuum pressures are reached. Pressure as low as 0.5 psia will be sufficient to keep the outgassing problem under control (dictated by gas theory). Major outgassing will be produced only when there is complete vacuum (dictated by theory of molecular dynamics).
- At lower internal pressures, normal outgassed products form a larger percentage of atmosphere. Contamination control system may require redesign and/or increased maintenance to cope with higher concentration
- As internal pressure goes down, outgassed products become difficult to scrub.

Outgassing was not considered to be a major concern. A more thorough investigation of all of the materials involved must be carried out before a final conclusion on outgassing is arrived at. Materials must be selected such that outgassed products (especially at higher concentrations) do not increase flammability (volatiles) or

toxicity risks. SSF is presently examining the impact of new 180-day hard vacuum requirements (operations and survivability). Results of this study may affect design and material selection of SSF Hab.

#### 4.3.1.3 Structures

SSF hab structural sizing is not a function of internal pressure only. Skin sizes are primarily driven by Space Shuttle launch/landing loads and by LEO meteoroid/debris shielding requirements. Minimum required skin thickness for the SSF hab module is 0.125 in. Longerons and rings are designed to carry launch/landing loads as well as localized rack loads.

Lunar surface has no man made debris protection requirements. Meteoroid and secondary ejecta requirements are also different than those in LEO. Structural analysis may be performed to resize the skin with lunar launch loading, FLO pressures, and lunar particle/meteoroid shielding requirements. There is a potential of up to 200kg mass savings.

#### 4.3.1.4 Summary

As a result of reduced internal pressures, EVA operations and module leakage rates are improved; however, physiology, flammability, and power system concerns require additional work.

The conclusion of the trade was that 10.2 psia reduced pressure could be accommodated with minimal impact and that 8.0 psia would probably require significant materials changes or waivers. Little attention was given to 5 psia since crew systems analysts indicated little interest in going below 8 psia.

#### 4.3.2 Alternate Materials

In order to optimize weight, a preliminary investigation was carried out to find alternate materials for FLO hab module primary and secondary structures. State-of-the-art metallic, non-metallic composite, and hybrid metal-matrix composite materials were reviewed as a replacement for materials currently used on SSF Hab-A. included in this review were aluminum-lithium, titanium, graphite/epoxy, boron/epoxy, silicon-carbide/aluminum, silicon-carbide/titanium etc. Candidate materials selected for final evaluation were;

- a. Metals - aluminum-lithium
- b. Non-metals - graphite/epoxy composite
- c. Hybrid - silicon-carbide/aluminum metal-matrix composite.

The current FLO Hab structure is based on SSF Hab-A. Materials used on the SSF Hab-A primary and secondary structure are summarized to establish a baseline for investigation in figure 4-17.

Part	Material	Weight (kg)
Cylinder Skins	2219-T87 Al	1542
End Cones	2219-T87 Al	1113
Longerons	2219-T87 Al	347
Fittings	7075-T73 Al	217
Stand-Off	7075-T73 Al	1042
M/D Shield	6061-T6 Al	747
Racks	Gr/Epoxy Comp	2308

Figure 4-17. SSF Structural Materials

#### 4.3.2.1 Material Selection Criteria

Material selection for space applications is based on the following criteria:

- a. Higher specific strength
- b. Higher specific modulus
- c. Fatigue and damage tolerance characteristics
- d. Corrosion resistance properties
- e. Degradation due to temperature extremes and thermal cycling
- f. Fabrication and weldability
- g. Flammability characteristics in O<sub>2</sub> rich environment
- h. Toxicity and outgassing characteristics for livable areas
- i. Resistance to UV and other types of radiation
- j. Inspection and maintainability
- k. Design, Development, Test, and Evaluation (DDT&E) costs
- l. Miscellaneous environmental effects

#### 4.3.2.2 Metals - Aluminum-Lithium

- a. Advantages. Advantages of aluminum lithium (2090/8090, or Weldalite 049) are as follows;

1. Fully commercialized alloy, readily available (listed in MIL-HDBK 5F)
2. 8% to 10% lower density than other aluminum alloys
3. 10% higher modulus than other aluminum alloys
4. Higher corrosion resistance properties
5. Excellent weldability
6. Comparable fatigue and damage tolerance properties
7. Superior high temperature strength
8. Currently used in aerospace applications (A330/340, C17, Atlas, Titan)
9. Direct replacement for currently used aluminum alloys
10. Requires no new tooling development
11. Overall weight savings of more than 10% over Aluminum materials

b. Disadvantages. Disadvantages related to aluminum-lithium are:

1. Relatively newer material
2. More DDT&E required
3. Further material testing may be required for space applications

**4.3.2.3 Non-Metals - Graphite/Epoxy Composites**

a. Advantages

1. Space qualified materials available (e.g., Hercules IM6 and IM7)
2. Mature resin systems meet NASA outgassing and flammability requirements (e.g., Hercules 3501-7 and 8551-7, Fiberites 977 etc.)
3. Higher specific strength than aluminums (can be tailored to applications)
4. Higher specific modulus than aluminum alloys (up to 20% higher)
5. Low density (40-50% less than aluminum)
6. Reduced parts count with co-cured longitudinal and ring stiffeners
7. Mature manufacturing technology (filament winding, hand layup)
8. Good candidate for filament winding (process used on rocket motors)
9. Cylinder and end cones can be fabricated together eliminating shell joints
10. Mature inspection technology (ultra-sound, holography, etc)
11. Carbon composites provide 15-20% more radiation protection than aluminum
12. Overall weight savings of approximately 20% -30% over current materials

b. Disadvantages

1. Redesign of FLO hab structure required
2. Requalification of the structure required
3. New tooling to be developed (mandrel, handling tools, bonding and installation tools etc.)
4. Highly reactive to atomic oxygen (can be controlled with coatings e.g. teflon, metallic coats etc. Boeing developed a chromic anodized aluminum foil for NASP, .002-.003 in thick that can be co-cured or secondary bonded.)
5. Requalification for meteoroid/particle protection required
6. Trapped particle radiation tests required (to study total dose absorption and material ionization effects)
7. Inspection techniques and repair procedures on lunar surface to be addressed
8. Higher costs of DDT&E (up to 100% more than that of aluminum)

**4.3.2.4 Hybrid Materials - Silicon-Carbide/Al Metal Matrix Comp.**

a. Advantages

1. Space qualified material available (currently being used on NASP and ATF)
2. Higher specific strength than aluminums (almost 300% higher)
3. Higher specific modulus than aluminum alloys (up to 300% higher)
4. Density equivalent to aluminum (0.103 lb/cu. in.)
5. Strength and stiffness retained at elevated temperatures (up to 500 deg F)

6. Strength can be tailored to desired load paths by orienting the fibers
  7. Superior fatigue strength over aluminum alloys
  8. Welded joints are possible (but weld strength of that of baseline aluminum)
  9. Corrosion resistance properties comparable to baseline aluminum material
  10. No outgassing concerns
  11. Overall weight savings of over 30% over current materials
- b. Disadvantages
1. Relatively new technology - lacks a comprehensive data base for space applications
  2. Redesign of FLO hab structure required
  3. Requalification of the structure required
  4. New tooling to be developed
  5. Long term space application effects not understood as of today
  6. Thermal/mechanical cycling effects due to mismatch in thermal expansion coefficients between matrix and fiber need to be investigated
  7. Radiation, outgassing, and flammability qualification testing required
  8. Higher costs of Design, Development, Test, and Evaluation

#### 4.3.2.5 Conclusions

Of the three candidates, aluminum-lithium appears to be the most desirable alternate material for FLO structure for the following reasons;

- a. Commercially available
- b. A direct replacement for 2219 and 7075 aluminum
- c. Requires minimum DDT&E
- d. Current tooling applicable
- e. No impact to schedules
- f. Lowest cost alternative

#### 4.4 INFLATABLE STRUCTURES

An investigation was carried out to study the feasibility of using inflatable structures for space applications. The study included the history and past experiences, inflatable structure design concepts, materials used, and feasibility of inflatable structures in lunar environments.

##### 4.4.1 Advantages and Potential Applications

Typical advantages of using inflatable structures are that large volumes may be launched in smaller packages and a possible weight saving depending on application. Inflatable structures may be utilized for the following applications;

- a. Living and storage areas
- b. Airlocks
- c. Landing aids

- d. Connecting tunnels
- e. Surface enclosures for thermal and dust protection
- f. Antennas
- g. Insulation of cryogenic or other temperature critical materials
- h. Hyperbaric chambers
- i. Other structures (radiator or solar panel support, landing area, debris shields and emergency shelters etc.)

#### 4.4.2 History of Inflatables for Aerospace Applications

The concept of using inflatables for space applications has been around since mid sixties. An exhaustive literature search revealed the following aerospace related applications of inflatable structures. Most of these applications were never realized.

- a. Lunar shelter developed by Goodyear Aerospace Corp. (GAC) in 1965. To support a crew of two for 8-30 day periods with radiative thermal control and micrometeoroid protection. The shelter was 7 ft in diameter and 15 ft long and constructed of nylon/vinyl foam/nylon sandwich. Total weight of the shelter-148 kg.
- b. Apollo Lunar Stay-Time Extension Module - hab volume addition, 1965
- c. Airlock developed for U. S. Skylab by Goodyear Aero. Corp, 1967 5.2 ft diameter, 6.2 ft long airlock was developed through a joint NASA-DOD venture, constructed of composite bladder, steel wire structure, polyurethane foam micrometeoroid barrier, and fabric film laminate thermal coat. Total weight -85 kg.
- d. Space habitat developed by GAC in 1968. A prototype of a 110 ft habitat was developed. Prototype, dubbed "Moby Dick" was 12.8 ft in dia. and 37.5 ft long. It was made of Dacron bladder sealed with PVC foam. The entire structure was covered with polyurethane foam and covered with thermal controlled nylon film-fabric laminate. Total weight 737 kg.
- e. Shuttle/Spacelab connector tunnel fabricated in 1979 by GAC. 4 ft dia., 14.2 ft long flexible tunnel between Orbiter's crew cabin and the Spacelab module was constructed using Nomex fabric coated with Viton B-50 elastomer wrapped around steelbeads. Debris shield was constructed of Kevlar 29. Total weight 344 kg.
- f. GAC and LaRC research including Toroidal Space Station.
- g. Soviet developed airlock demonstrated in March 1985 on Vostok 2 spacecraft.

#### 4.4.3 Available Materials and Construction

Inflatable structure for space application are constructed in layers. A multi-layered base material (fabric) is the member carrying all the pressure loading. An elastomer coating or a layer of vinyl is applied to seal the base material. Steel wire or another form of expandable structure is provided to act as reinforcement. Thermal protection is provided by a thermal control coating or a layer of thermal controlled fabric. Micrometeoroid/debris protection is achieved by using an outer layer of foam or Kevlar.

The following materials have been used in the past or have a potential for use in the construction of an inflatable aerospace structure;

- a. Base Material
  - 1. Nomex fabric coated with an elastomer
  - 2. Nylon layered with vinyl foam
  - 3. Dacron fabric coated with PVC foam
  - 4. Kevlar 29 or Kevlar 49 coated with an elastomer
- b. Reinforcement
  - 1. Steel wire
  - 2. Composite framework
- c. Thermal protection:
  - 1. Thermal controlled film fabric
  - 2. Thermal controlled paint
- d. Meteoroid Protection:
  - 1. Kevlar
  - 2. Polyurethane/vinyl foam

#### 4.4.4 Disadvantages and Concerns Regarding FLO Application

Disadvantages and concerns regarding the use of inflatable structures for FLO specific applications are as follows:

- a. Subsystem integration must be performed after or during inflation process
- b. Internal support structure may have to be assembled on lunar surface
- c. Greater DDT&E required due to unique application (impacts cost/schedule)
- d. Inflation of structure may be complex operation. Difficulty in complying with campsite autonomous deployment and subsystem deployment and activation requirement, for example;
  - 1. Access to equipment
  - 2. Time required for deployment and system checkout
- e. Limited commonality with SSF and other existing hardware
- f. Integration of exterior systems with inflatable structures
- g. Flame resistant properties of inflatable structural materials
- h. Particle impact shield requirements (micrometeoroid and lunar surface ejecta)
- i. Life of structural materials in lunar environment
- j. Outgassing of toxic materials into habitable areas
- k. Checkout and test of subsystems prior to launch

#### 4.4.5 Simplified Comparison of Inflatable vs. Aluminum Structure

For evaluation purpose Kevlar 29 was chosen as the inflatable material and a direct mass comparison with aluminum was performed.

- a. Density - Kevlar(k) is 50% lighter than Aluminum(A)

$$\rho_{kevlar} = (0.50 * \rho_{Alum}) \text{ kg/m}^3$$

- b. Strength - Kevlar is 67% stronger than Aluminum

$$\sigma_{kevlar} = (1.67 * \sigma_{Alum}) \text{ Pascals}$$

- c. Thickness - Skin thickness(*t*) required based on purely internal pressure loading

$$t_{kevlar} = (0.60 * t_{Alum}) \text{ mm}$$

- d. Mass - For same pressure loading and internal volume, an inflatable structure mass (*m<sub>inflatable</sub>*) in terms of aluminum (*m<sub>Alum</sub>*) would be

$$m_{kevlar} = (0.30 * m_{Alum}) \text{ kg}$$

$$m_{inflatable} = m_{kevlar} + m_{misc.} = m_{kevlar} + 1.0 * m_{kevlar}$$

$$m_{inflatable} = (0.30 * m_{Alum}) + 1.0 * (0.30 * m_{Alum})$$

$$m_{inflatable} = 0.60 * m_{Alum} \text{ kg}$$

where,

*m<sub>misc.</sub>* is the sealant/coating and secondary support structure mass.

The above relationships show a 40% mass savings over aluminum structure. It must be noted that launch loads and packaging for inflatables have not been considered in this analysis. Actual mass savings may be less than 40%.

#### 4.4.6 Conclusions and Recommendations

In order to establish the usefulness and advantages of inflatable structures for FLO, further research is required. Since the early applications of 60's and 70's, materials technology as well as analysis methodology and computing power has greatly increased. Inflatable structures have potential for use in the lunar environments. More research, and testing is required to space qualify the newer materials. New requirements for FLO must be established that would reflect the use of inflatables. Following remarks are based on the technology used on previous applications;

- First Lunar Outpost requirements of self deployment and use of SSF derived hardware will make using an inflatable habitat difficult.
- Inflatable structure DDT&E costs may be higher than a metallic structure.
- Chemically rigidized structures offer advantages but could impose added mass and complexity. They will need further investigation.



## 5.0 RADIATION ANALYSIS

### 5.1 INTRODUCTION

For manned U.S. spaceflights, sufficient radiation protection has been provided to the crew by the spacecraft's structure and equipment, detailed mission planning, short mission durations, and relatively favorable radiation conditions. The First Lunar Outpost mission, however, involves much longer crew durations outside the Earth's protective magnetosphere than any prior mission. To insure crew safety for the First Lunar Outpost habitat and crew transfer vehicles, radiation shielding must be addressed early in order to minimize potential impacts to the program. Early development of innovative solutions effectively and efficiently limiting crew dose is critical. At best, vehicle designers will be able to reduce but not completely eliminate radiation exposure. The application of the Boeing Radiation Exposure Model (BREM) allows radiation analysis to be brought well forward into the preliminary design phase where major design changes will have the least effect on system complexity, mass, and ultimately, program cost.

Radiation analyses have been performed to determine astronaut exposure for Boeing and NASA Lunar Crew Return Vehicles (LCRV) and four FLO habitat storm-shelter configurations. In each case, the focus of the studies was to evaluate the impact to vehicle and habitat design due to accurate analysis of radiation exposure resulting from three reference solar proton events

### 5.2 MODELS AND METHODS

#### 5.2.1 Background and Description of Analyses

Evaluating the radiation environment within a spacecraft involves determining the incident radiation flux at the surface of the spacecraft and "transporting" the radiation through the vehicles structure to derive the attenuated internal radiation environment. To determine the exposure and resulting risk to the crew, the internal radiation environment is then transported through a simulated astronaut to determine the radiation fluence at specified critical organs.

#### 5.2.2 Natural Radiation Environment Models

When astronauts leave the relative protection of the geomagnetic field, they are exposed to unpredictable solar proton events. The level of solar activity and modulation of radiation sources is tied directly to the strength of the sun's pervasive magnetic field. During the course of the roughly eleven year solar cycle, several tens of solar flares will produce sufficient energy to release elevated charged particle fluxes, primarily protons. Typical events are classified as "ordinary" and would have little effect on crew or spacecraft. Historically, an average of two to four flares release tremendous energy and particle fluxes and are classified as Anomalously Large Solar Proton Events (ALSPE).

The cumulative fluence resulting from proton events during the solar cycle are dominated by the few occurrences of ALSPE. Large solar proton events can deliver debilitating or lethal doses to unprotected astronauts. Three such ALSPE were used to perform the analyses; the February 1956, August 8, 1972, and October 19, 1989 events. All three are considered reference events and each has unique spectral qualities. Radiation analyses of the FLO habitat incorporates the fact that the Moon has no natural radiation protection other than its own shadowing effect. Therefore the free space radiation environment proceeds unhindered to the lunar surface over the upper hemisphere. The free-space differential flux of the reference events have been reduced by a factor of 2 to account for the  $2\pi$  shielding provided by the mass of the Moon.

### 5.2.3 The Boeing Radiation Exposure Model

The Boeing Radiation Exposure Model has been employed to perform the Radiation Analysis task. BREM combines computer aided design (CAD) capabilities with established NASA transport codes permitting fast, accurate and consistent radiation analysis. BREM uses an Intergraph workstation to create the solid models of the vehicles. VECTRACE (VECTOR TRACE), a custom ray-tracing subroutine contained within BREM was used to establish the shield-distribution about the desired analysis points within LCRV and FLO habitats. VECTRACE divides the  $4\pi$  solid angle surrounding a "detector" into a number of equal solid angles as specified by the analyst. Vectors originating at the detector point and co-aligned with the centers of solid angles traverse the spacecraft shielding to determine the shield thickness and composition. Complete descriptions of the integrated BREM modules and their applications have been reported previously in a number of final reports and contributed papers references 2, 16 and 17.

A modified version of Hardy's PDOSE (Proton DOSE Code) (ref. 17), was used to determine crew exposure. PDOSE has adopted a continuous slowing down approximation to calculate the attenuation and propagation of particles in various shield materials. Secondary particles generated by nuclear interactions are not included in PDOSE. Results from PDOSE have been extensively compared against Shuttle measurements by NASA's Radiation Analysis Branch (Johnson Space Center) and has been found to be fairly accurate (ref. 18). Organ dose calculations, necessary for risk assessment, were performed using a detailed mathematical anthropomorphic phantom. The phantom model, known as the Computer Anatomical Man (CAM), represents the anatomical structure of a fifty percentile Air Force male. The CAM model provides a more realistic shield distribution for the blood forming organs (BFO), ocular lens and skin than simple water sphere geometries. In the assessment, the BFO and skin represent the average distribution of 33 points distributed throughout the BFO and skin organs.

### 5.3 ANALYSIS RESULTS

Crew dose and dose equivalent quantities have been determined as a result of simulated exposure to the previously noted reference solar proton events. The purpose of the study was to estimate exposure to astronauts for early lunar missions and make comparisons of these results with current NASA limits. The National Council on Radiation Protection and Measurements (NCRP) has recommended career, annual and monthly limits for NASA to use in planning manned missions. These limits are shown in figure 5-1. The limits presented have been established for missions taking place in Low-Earth-Orbit but have been adopted by NASA for planning early lunar missions. The 30-day and annual exposure limits are based on considerations of deterministic effects, whereas career limits are based on an increase in cancer mortality of three (3) percent. Re-evaluation of the LEO 30-day and annual limits has yielded no change, but the new career dose equivalent for both male and females has been reduced by as much as a factor of two. The higher limits given to astronauts are based in part on risk versus gain and a relative comparison to other potential mission risks such as vehicle system failure. The results of the analyses are presented in chronological order.

All values presented in cSv - (cSv = rem)			
Time Period	BFO*	Lens of Eye	Skin
30 day	25	100	150
Annual	50	200	300
Career	See table below	400	300

\* Blood forming organs. This term has been used to denote the dose at a depth of 5cm  
 Career whole body dose equivalent limits based on a lifetime excess risk of cancer mortality of 3%

Age (years)	Female	Male
25	100	150
35	175	250
45	200	320
55	300	400

\* Data from Guidance on Radiation Received in Space Activities, NCRP Report No. 98

Figure 5-1. NASA Limits

#### 5.3.1 Boeing-Lunar Crew Return Vehicle

Dosimeter locations were established at each of the six crew couch positions. It was assumed that crew members would stay positioned in their couches during the full transfer period. It was necessary to construct solid anatomical figures that would provide some degree of radiation protection. The anatomical figures are constructed of

water which simulates the bodies self shielding capabilities. Five of these figures were "turned-on" while the shield distribution for the sixth was being established. The Computerized Anatomical Man model provided the shield distribution analytically for the sixth crew member. A typical dosimeter location was established, located roughly at a mid chest position. Results of the analysis are provided in figure 5-2.

SPE	Position		1	2	3	4	5	6
	Organ							
'72	BFO		10.3	10.3	12.0	12.0	16.4	16.4
	Skin		63.4	63.4	95.5	96.8	102.0	102.0
'89	BFO		11.5	11.6	11.7	11.7	15.8	15.8
	Skin		40.2	40.2	57.0	57.0	59.4	59.5

Figure 5-2. LCRV Dose Equivalent in Rem/event

The dose equivalent results are below the current annual and monthly limits but would not be sufficient to meet the accepted principle of ALARA used by NASA. New concepts in shield materials or methods should be investigated for the LCRV. The amount of dedicated shielding needed can be reduced, however, by first shielding with the vehicles inherent mass. The Boeing Radiation Exposure Model allows vehicle designers to make such design changes and decisions early in the program where their impact is minimized.

### 5.3.2 First Lunar Outpost (Habitat and Storm-Shelter Evaluations)

The analysis was conducted in two phases: (1) assessment of the exposure received within the habitat module and (2) determination of exposure inside the storm shelter. For the habitat (without shield augmentation), the analysis was completed using a 21-point (3 x 7) grid plane centered between floor- and ceiling-rack faces (fig. 5-3). Analysis of the storm-shelter required use of a 9-point grid as shown in figure 5-4. Astronaut exposure has been determined for critical organs as described above. Values are given in dose equivalent rates per event (cSv/event). The maximum ionizing radiation dose determined for the blood-forming organs for the habitat was 16.5 cSv and for the storm shelter, 8.9 cSv (fig. 5-5). These doses were the result of exposure from the Aug. '72 and Feb. '56 solar proton events, respectively. The hard nature of the Feb. '56 spectrum allows its particles to penetrate through a greater amount of shielding. The maximum exposure to the skin was calculated to be 124 cSv in the habitat and 34 cSv in the storm shelter (figs. 5-6 and 5-7, respectively). The calculated dose in both cases was the result of exposure from the Aug. '72 event.

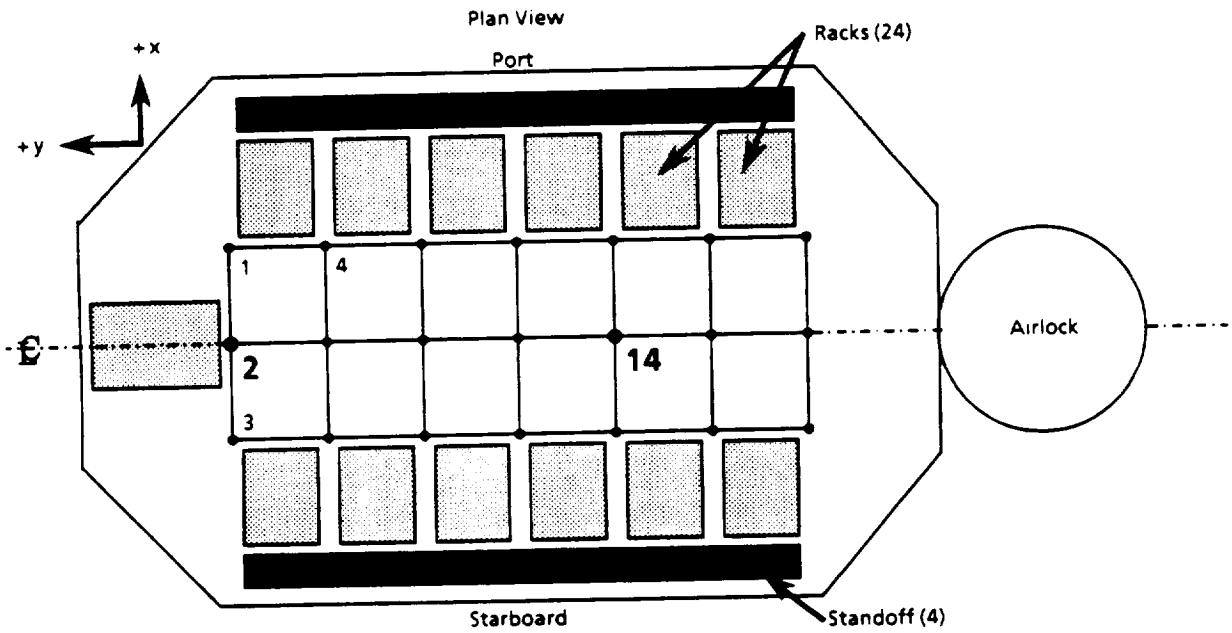

- Detector locations 2 and 14 represent positions of maximum and minimum dose rates respectively
- Shield distribution established for 21 points with 256 rays over  $2\pi$  steradians.

Figure 5-3. Lunar Habitat Radiation Assessment Configuration

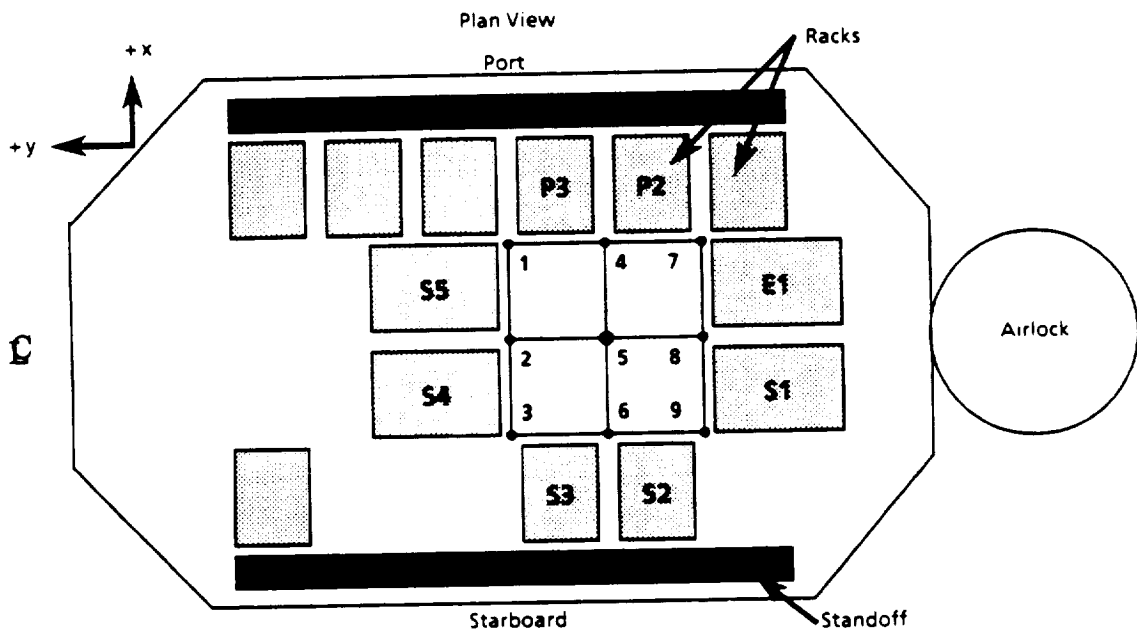

Figure 5-4. Radiation Storm-Shelter Configuration

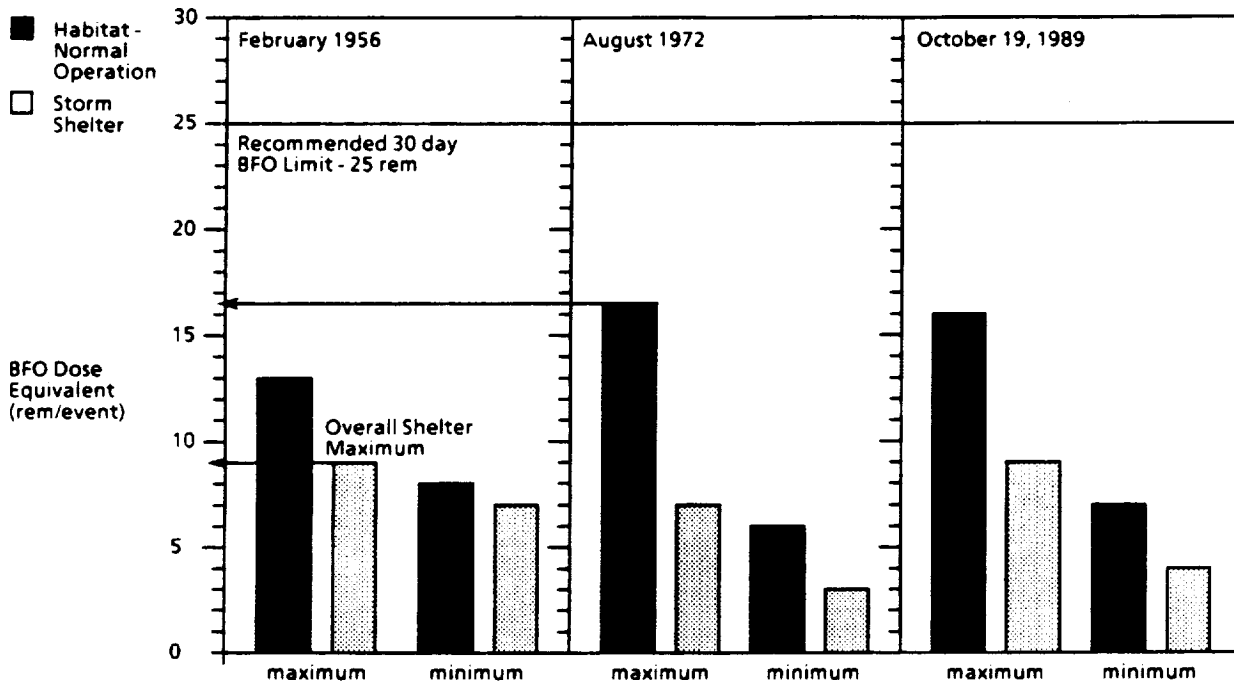

Figure 5-5. Maximum and Minimum Calculated Blood-Forming Organ Dose Rate Points

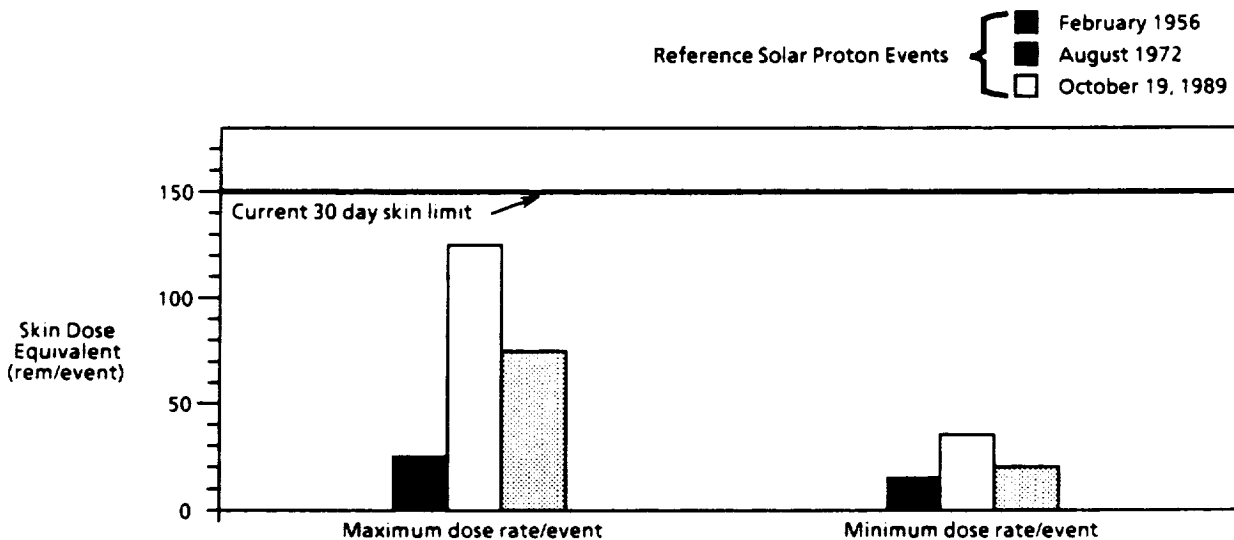

Figure 5-6. Maximum and Minimum Calculated Dose Rate Points to the Skin for the Habitat

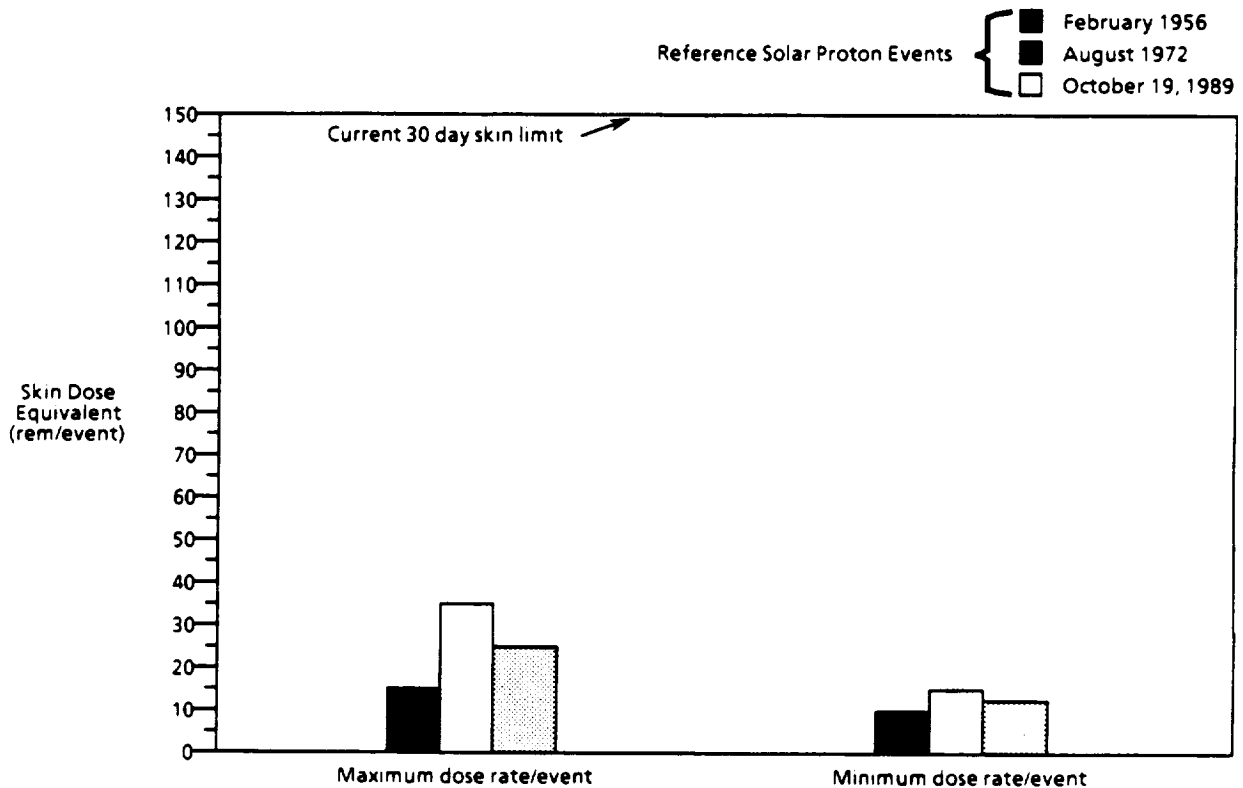

Figure 5-7. Maximum and Minimum Calculated Dose Rate Points to the Skin Within the Storm Shelter

### 5.3.2.1 NASA Storm-Shelter Concept Radiation Analyses

An analysis was performed for two NASA storm-shelter concepts. The concepts, described as 'M' and 'N', were analyzed using a single line of 3 points due to the reduced internal shelter volume. The points again were located midway between the ceiling and floor racks. Concept 'M' used a protection method that was similar to that employed in the initial phase of the study in which storage racks located in the floor and the single end-cone rack were moved to establish the shelter (fig. 5-8). Concept 'N', on the other hand, staggered port and starboard racks to augment the shielding (fig. 5-9). For shelter 'M', the maximum dose equivalent estimated for the blood-forming organs was 6.4 cSv (6.4 rem) and for the staggered concept ('N') was 7.0 cSv. These maximums were both the result of exposure to the February '56 solar proton event. Exposure to the skin from the August 1972 SPE resulted in the maximum doses for both shelter concepts.

The calculated maximum doses were 13.8 cSv and 20.6 cSv for concepts 'M' and 'N' respectively. The ranges of doses for each of the concepts and reference solar proton events are presented in figure 5-10.

In the final phase, the radiation analysis was performed taking into account external equipment and tanks. The external equipment modeled is shown in figure 5-11.

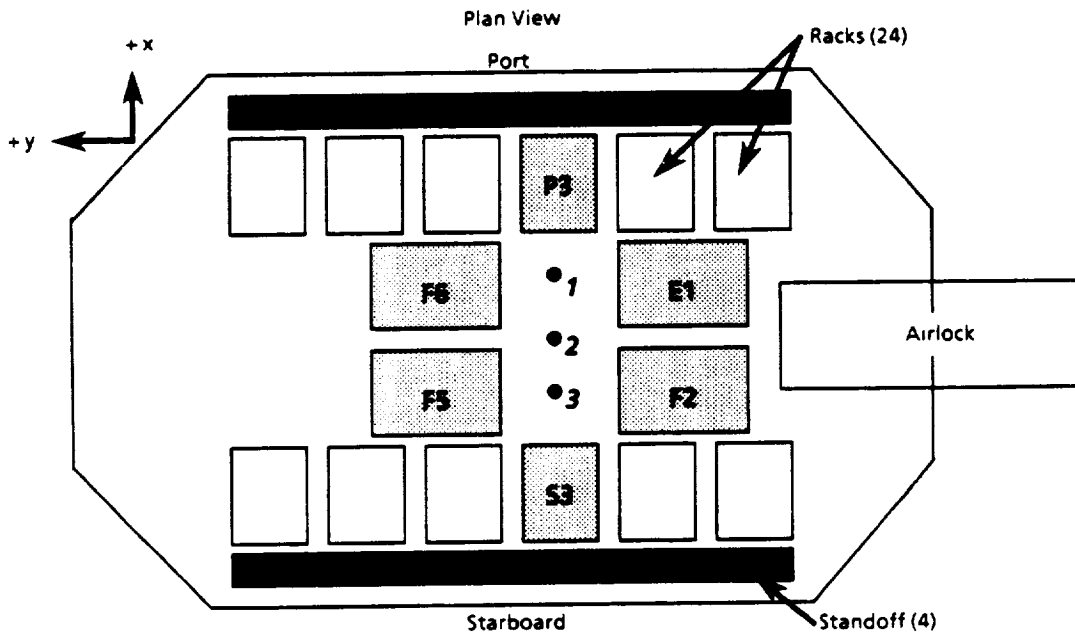

Figure 5-8. Lunar Habitat Radiation Assessment Configuration - Concept M

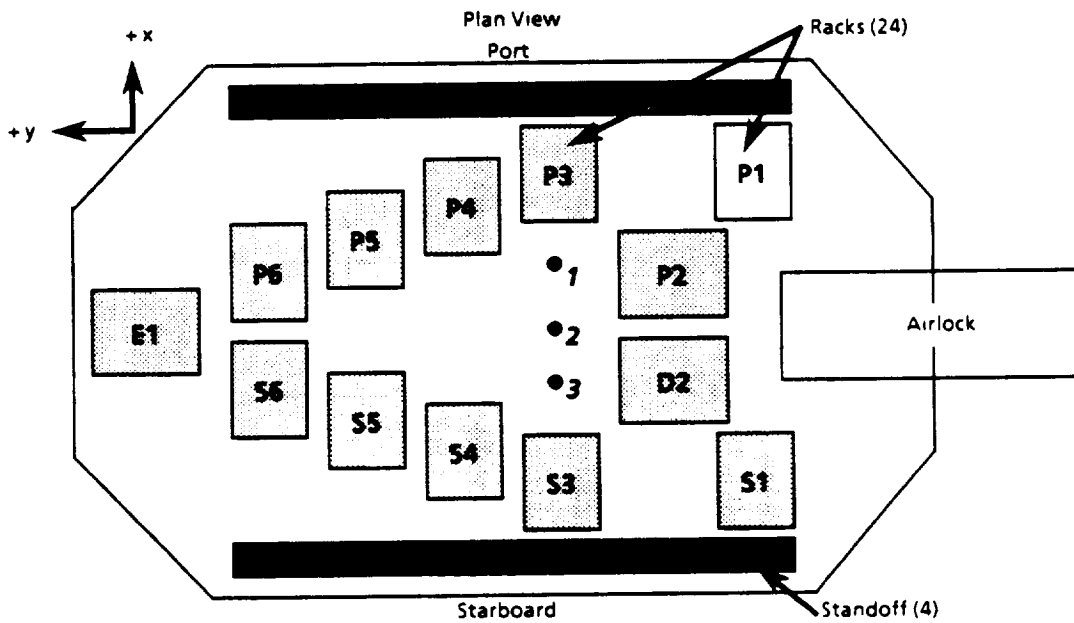

Figure 5-9. Lunar Habitat Radiation Assessment Configuration - Concept N



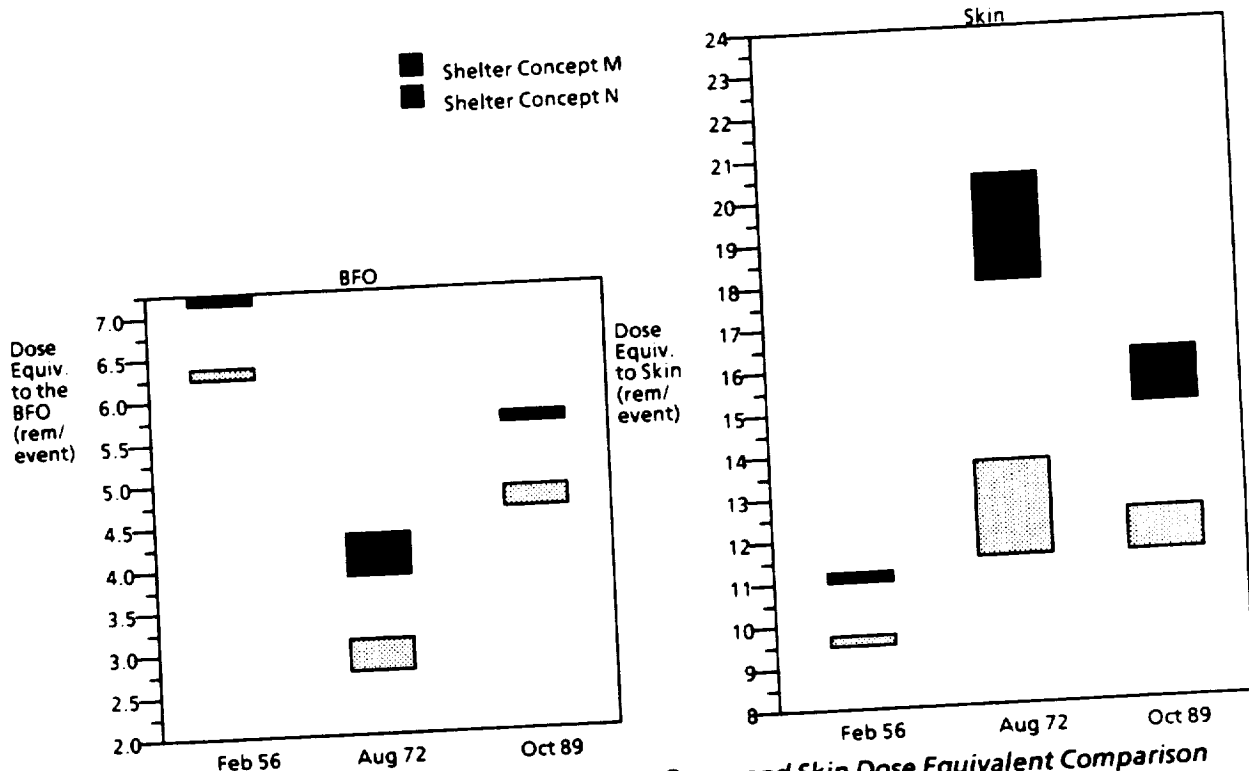

Figure 5-10. Blood-Forming Organ and Skin Dose Equivalent Comparison for Shelter Concepts M and N

Exposures were determined for fifteen locations in the habitat module and nine locations in the storm-shelter. The sample locations were confined to single planes mid-way between the faces of the floor and ceiling racks. The distribution of these points are shown in figures 5-12 and 5-13. A comparison has been provided in figure 5-14 of the differential shield distribution for a number of locations in the habitat and storm-shelter. The equivalent aluminum areal density ( $g/cm^2$ ) is plotted against the number of shield elements found in each of the defined bins. The comparison of the averages of these groups of locations (habitat and storm-shelter) shows the increase in shielding provided by the storm-shelter. Not only has the peak shielding region (approximately 12 to 14  $g/cm^2$ ) been shifted to the right, but the overall shield thickness average for the greater shielding bins has also increased for the shelter. The storm-shelter was configured by relocating three floor and the single endcone rack.

Transmission of the proton spectra through the spacecraft structure and human body and determination of the resulting absorbed dose and dose equivalent rates were made with PDOSE. In calculating the dose to the critical organs, the  $2\pi$  proton spectrum is first determined within the spacecraft at the point of interest by transporting the incident spectrum along a ray through the spacecraft structure. A comparison of the incident differential proton spectra and the transported internal spectra are shown in figure 5-15. Although the differential proton flux for all three events has been reduced for the full energy range, the primary attenuation takes place below approximately

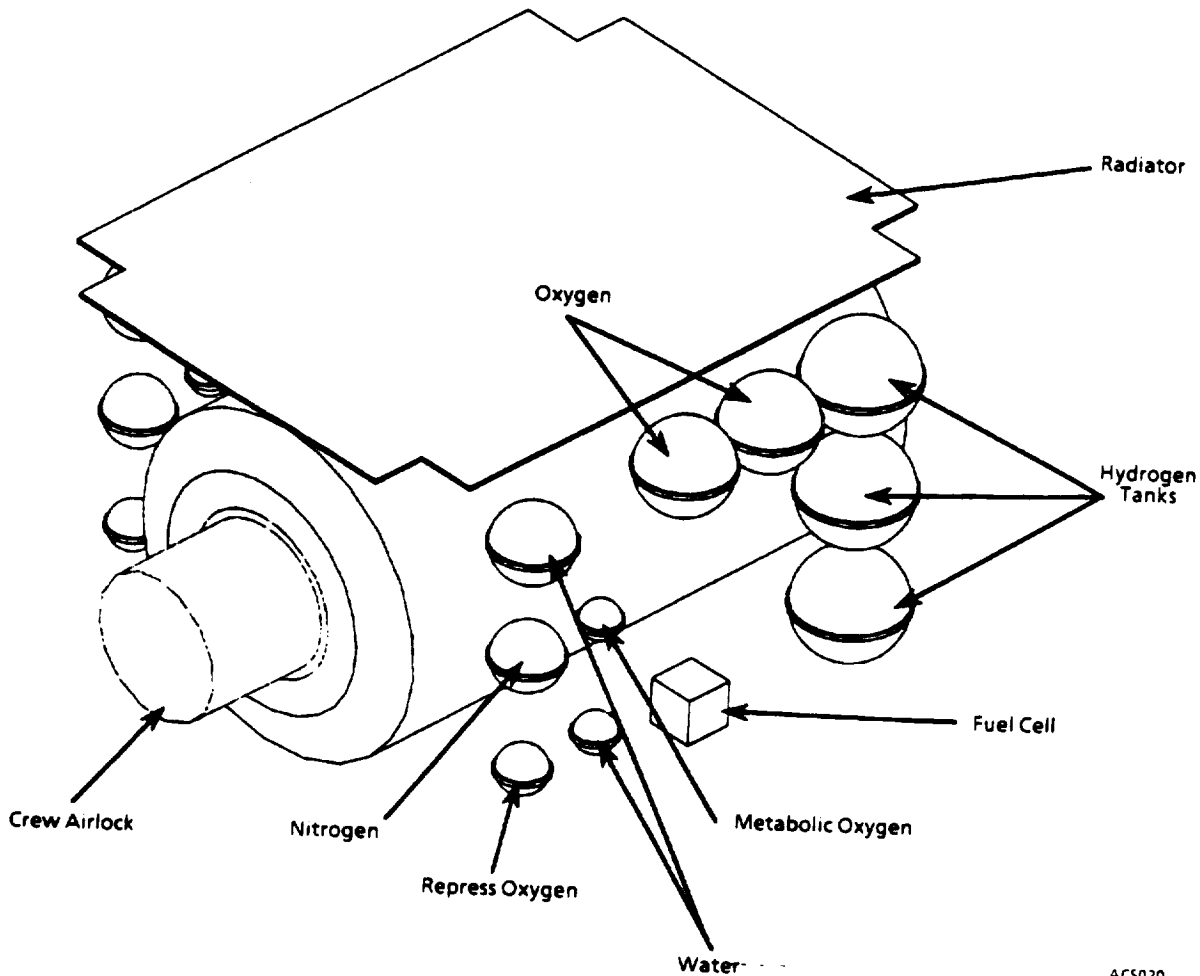

Figure 5-11. Radiation Analysis Model Exterior

ACS020

120 MeV. The second graph then compares the internal spectra calculated for sample location 8 in the habitat and position 5 in the storm-shelter. The interesting result to note here is that the further attenuation of the proton spectra within the storm-shelter is very small. The greatest reduction in the proton flux again occurs below roughly 120 MeV. The smallest reduction in the spectra occurs for the February 1956 SPE. As noted in the results all maximum doses recorded within the storm-shelter to the blood forming organs were the result of exposure to this event. However, the largest dose equivalent to the skin inside and outside the storm-shelter was the result to exposure from the August 1972 SPE. The higher energy nature of the February 1956 event allowed particles to penetrate deeper into body even with additional storm-shelter shielding. Integrating over the  $4\pi$  solid angle about the detector point, the cumulative transmitted spectrum at the dose point is produced. This flux is then assumed to be isotropic and is then transmitted through the organ distribution. Any orientational effects of the astronaut relative to the spacecraft shield distribution are removed.

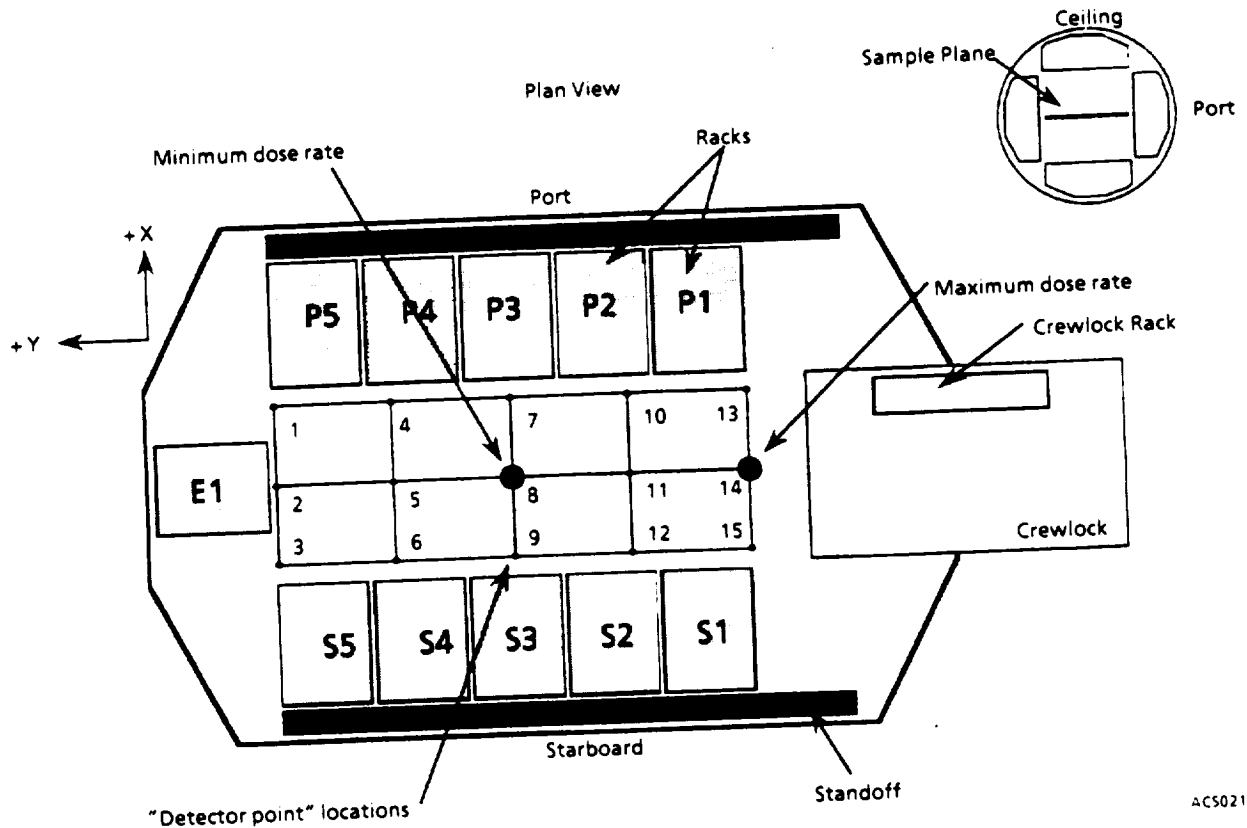

Figure 5-12. Rack and Sampling Locations

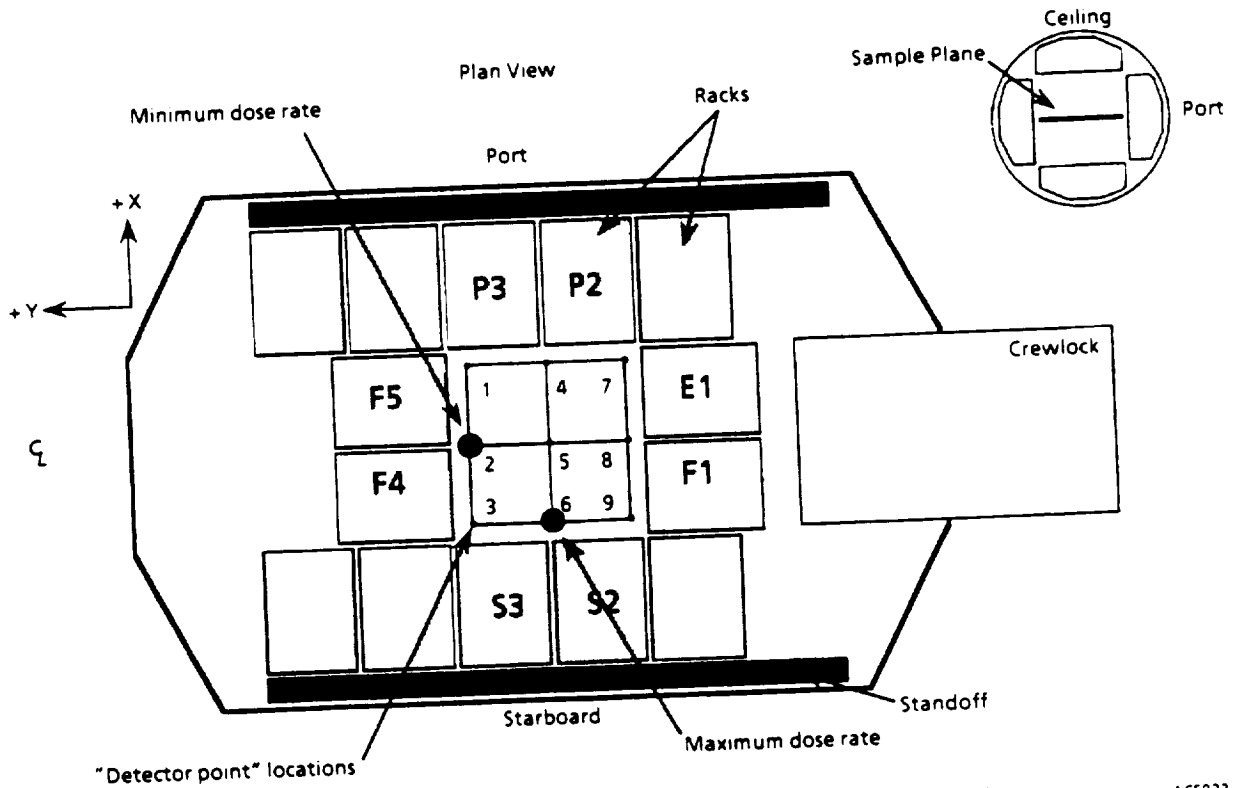
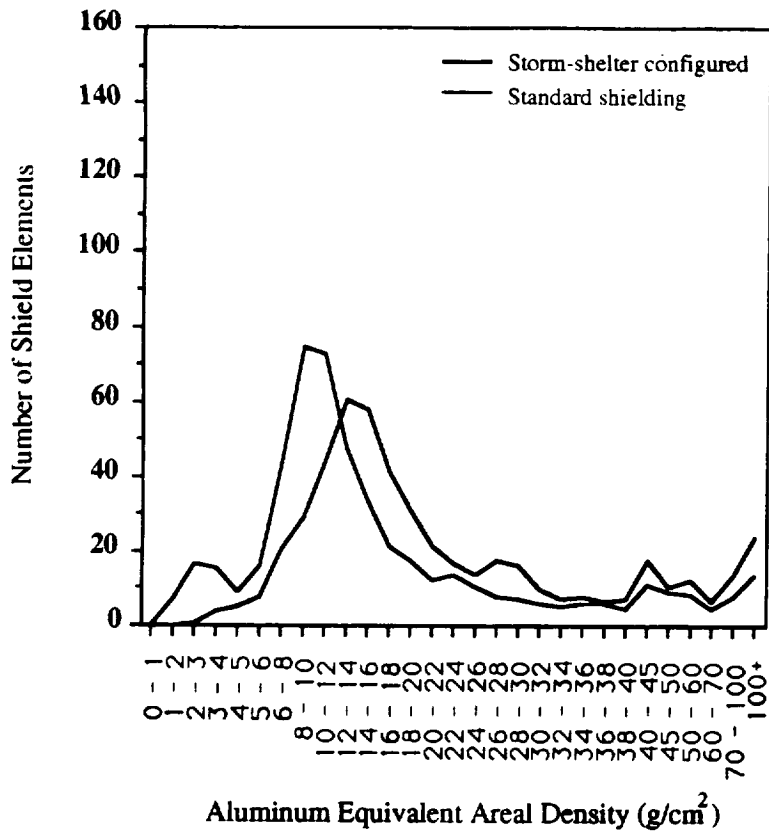
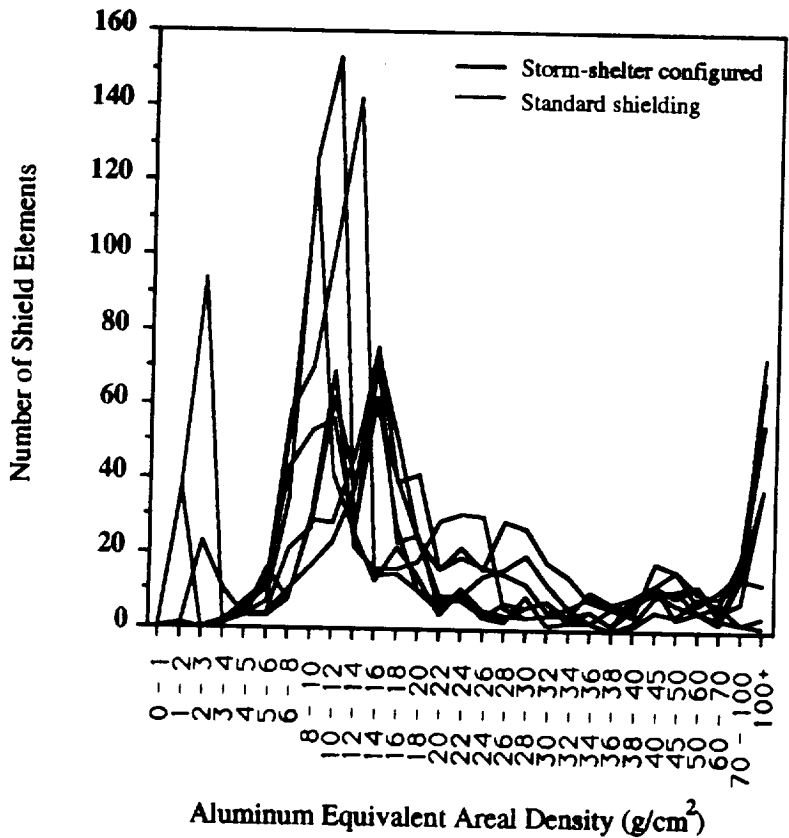

Figure 5-13. Lunar Habitat Radiation Storm-Shelter Configuration





Comparison of Average Shielding With and Without Storm-Shelter



Differential Shield Distribution for Longitudinal Sampling Locations

Figure 5-14. Equivalent Aluminum Differential Shield Distribution

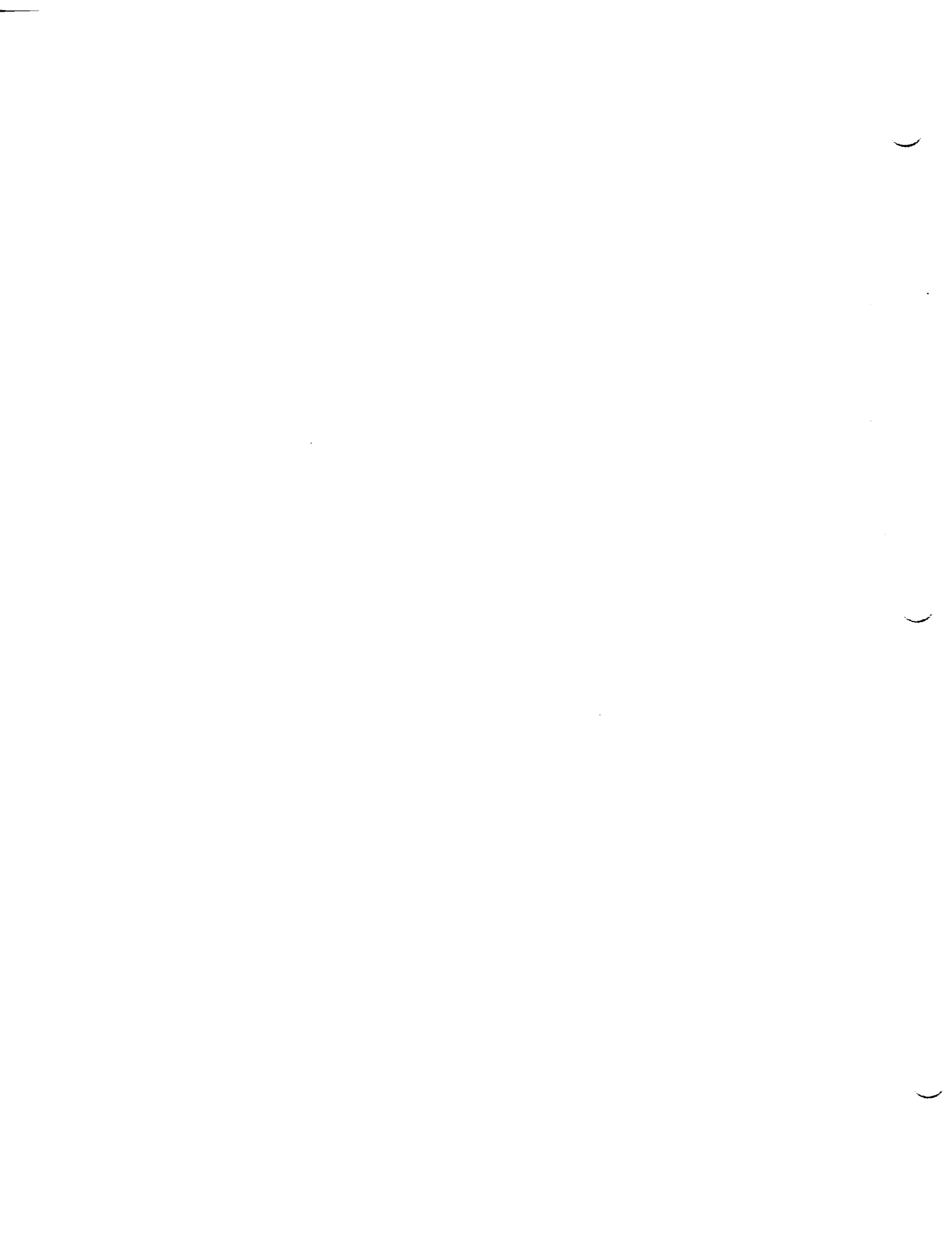

Comparison of Incident Spectra and Internal Spectra for Sample Point 8

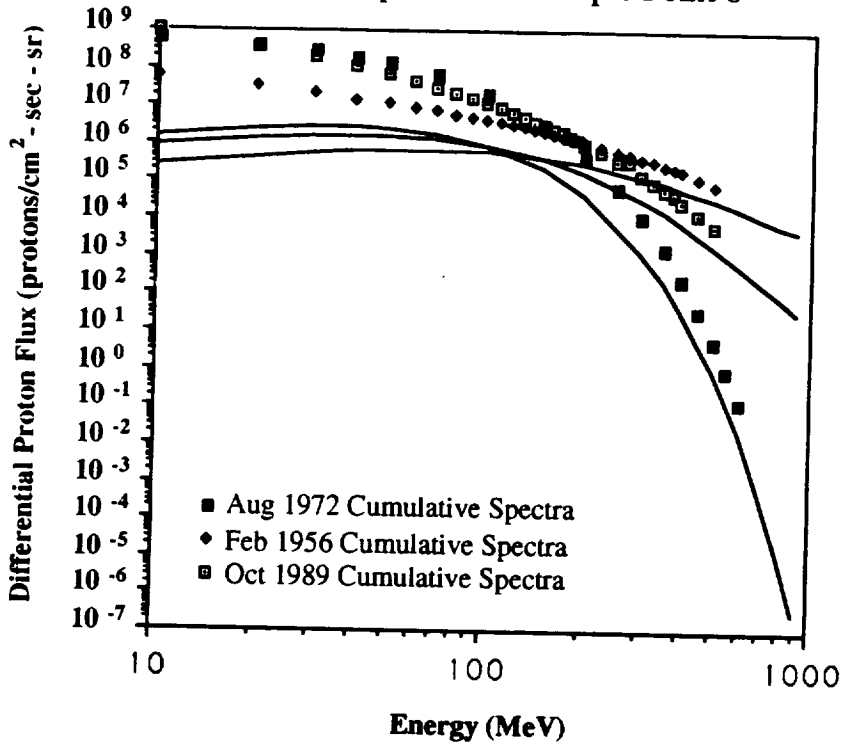

Comparison of Internal Spectra With and Without Storm-Shelter

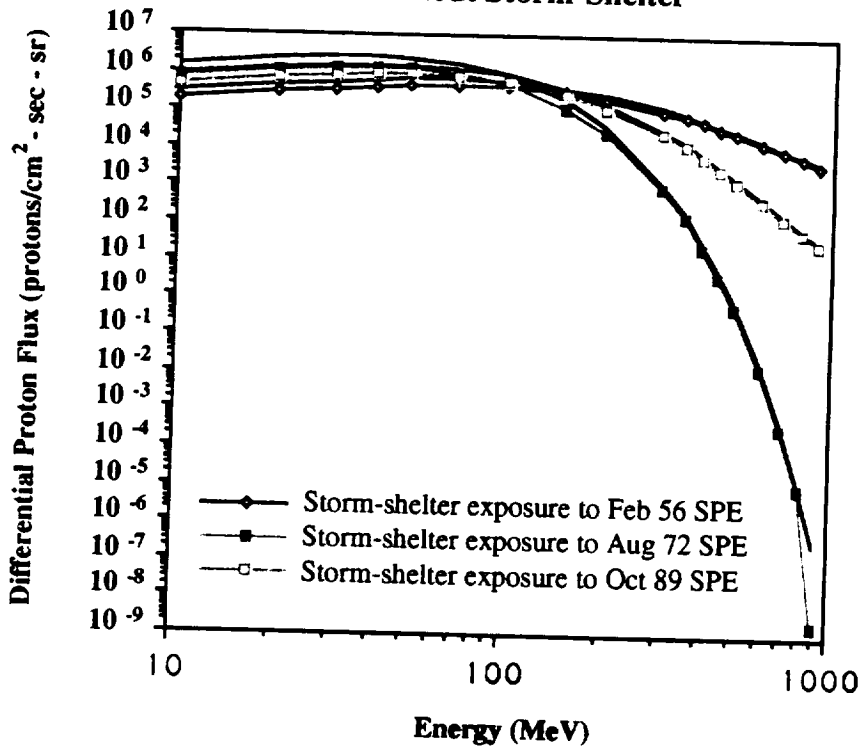
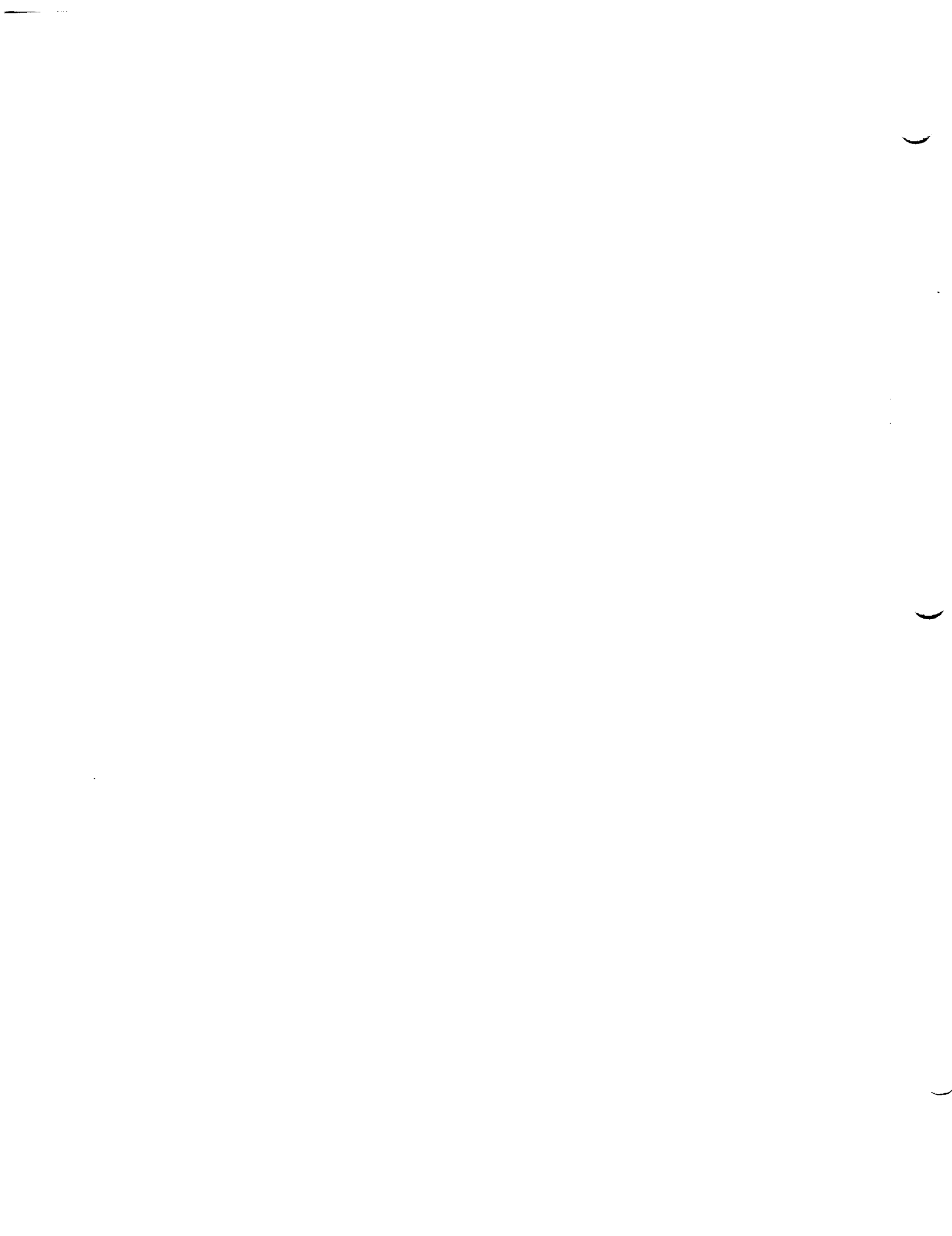

Figure 5-15. Differential Incident and Calculated Internal Spectra





(150 cSv) are indicated on each of the graphs. In addition, 9 cSv (described as a Proposed FLO SPE Limit) has also been identified. This number is at this point a recommendation for FLO design studies. As a first cut, this threshold value has been determined to establish a dose equivalent recommendation that would allow successful completion of a 45 day mission by maintaining both NASA's current 30-day limit to the blood forming organs and principle of ALARA (As Low As Reasonably Achievable). As can be seen all maximum exposures, with the exception of the August 1972 skin dose, are below both of these recommended limits.

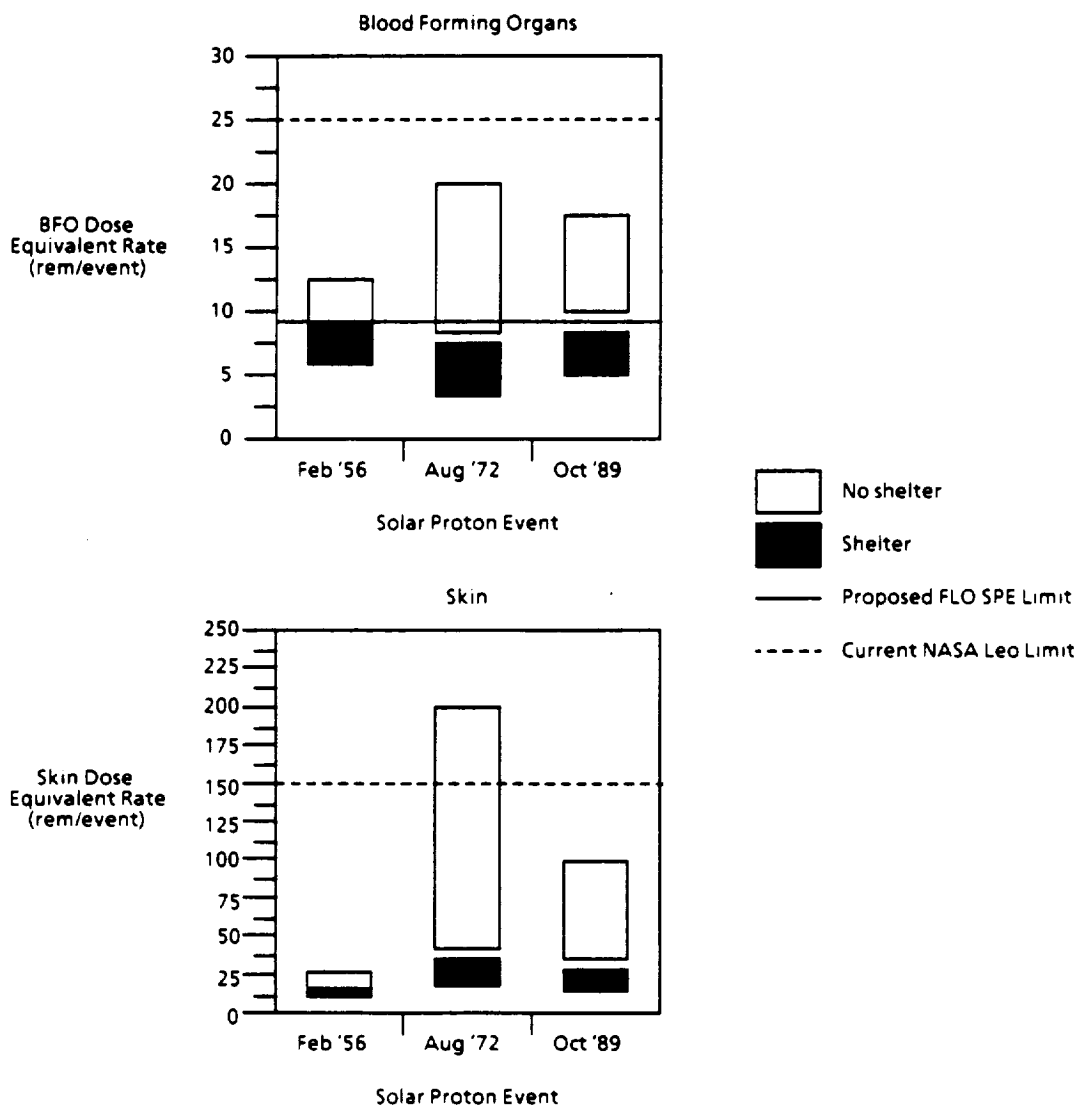
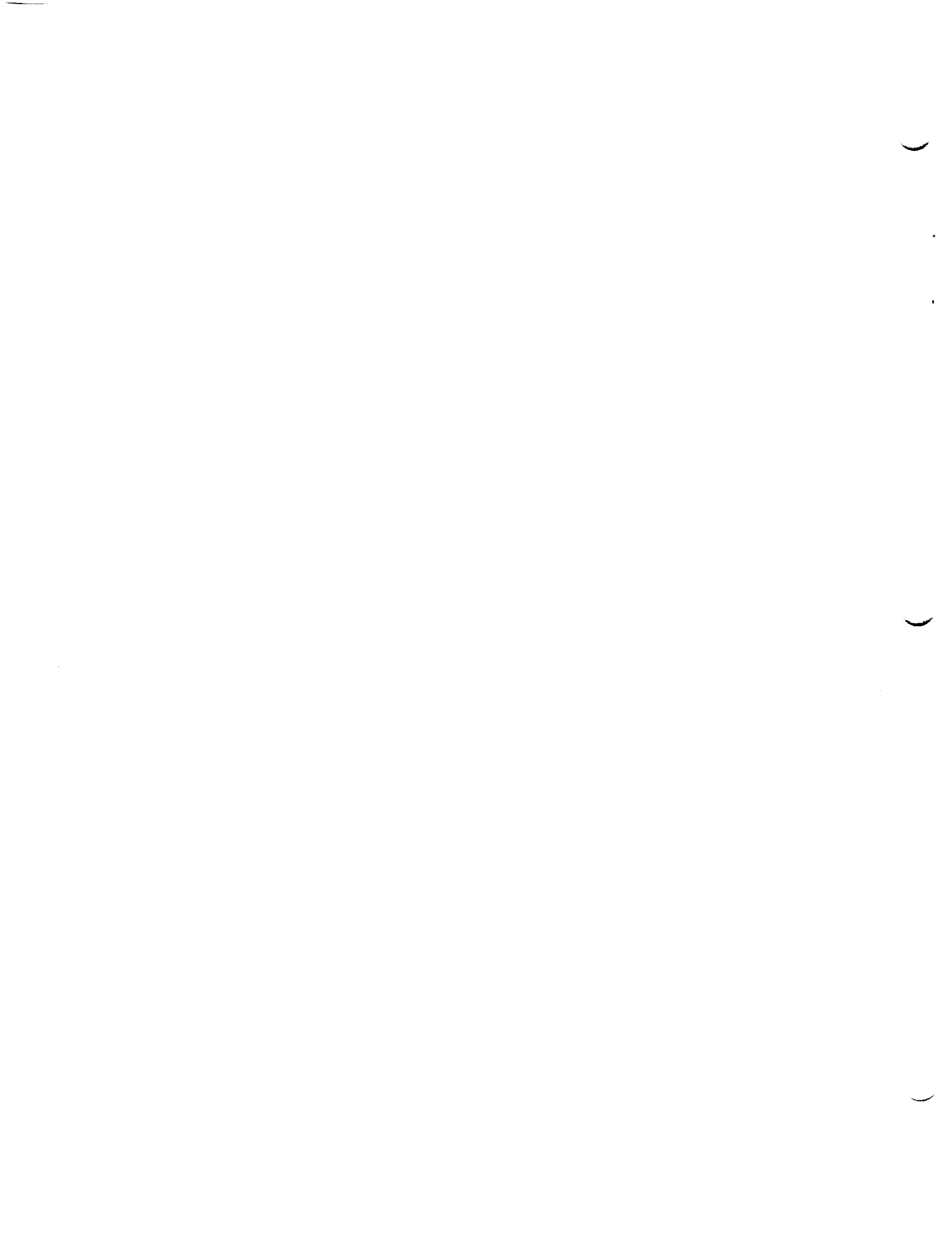

Figure 5-16. Analysis Dose Equivalent Results



cost to a program. The protection that has been devised uses inherent mass (equipment and structure) of the vehicle first. If, needed, these methods can be augmented by utilizing a dedicated mass or material. Food, water, and other "light" (low atomic weight) materials are very good attenuators of protons. Shield augmentation may include the use of local material such as the lunar regolith. At the very least, however, the protection method employed within the habitat should use as much on-board equipment and mass as possible.

Astronauts realize a great advantage in being on the surface of the Moon. Even though the radiation environment is the same as that found in free-space and proceeds unhindered to the lunar surface from the upper hemisphere, the isotropic flux of both galactic cosmic and solar proton event radiation can be reduced by a factor of two due to the shadowing effect of the Moon itself.

Although the results are less than the current recommended limits for the BFO and skin, they should not be misinterpreted. There still remains a large number of uncertainties regarding the determination of crew exposure. The fundamental causes of these uncertainties include, transport theory, nuclear cross-section determination, and environment modeling. As a result, exposure predictions can potentially be in error by as much as a factor of two (2). Additions to the exposure will come from trapped particles during lunar and Earth transfers, the occasional "ordinary" solar proton events, galactic cosmic radiation and its generated secondary particle effects, and man-made sources such as small reactors. Protection of the astronaut will vary during the course of the mission from the relative safety of the habitat to the protection provided only by a space suit during EVA.

Finally, the use of an on-board active SPE warning system is seen as a critical need. SPE warning and detection will be the result of solar X-ray telescope that continuously monitors the visible solar disk. In addition to SPE detection and warning, crew dosimeters will be used to warn of solar proton event exposure concerns. Two threshold dose rates are needed with such a detection and warning system. The first threshold warns of an enhanced proton flux that is tied to a detected solar flare and the second threshold dose rate warns of the criticality they face in seeking enhanced shielding. The first threshold has been established to remove the problem of false alarms, the second to provide maximum protection for crew. It is critical that work in determining solar proton event propagation and cumulative dose versus time continue.

## 6.0 RESUPPLY AND LOGISTICS

### 6.1 INTRODUCTION

At present the plan for surface operations begins with all the expendable items for the first 45 terrestrial day mission on board the Outpost lander. The first manned mission proceeds using these on-board expendables with a rover brought on the manned vehicle. The rovers, this one and one brought on the subsequent mission is an LOR unpressurized rover with improved drive train and tires. They are capable of carrying 4-crew or 2-crew and 500 kg packaged material in a towed cart. Their maximum speed is 8 km/hr average (4 km/hr against a target around obstacles to a specific point).

The second manned mission brings the next crew plus 5 t of resupply for a nominal 38 day surface mission staytime. Internal and external supplies are given in figure 6-1. The second mission lander is to land approximately one kilometer away from the FLO. All these expendables are to be transported to the FLO area for storage. The first set of transported items will be (a) those that are deemed critical and cannot take external storage, such as canned or moist food, CHeCS (medical), some personal hygiene and necessary clothes, EVA expendables and dust control (approximately 500 kg total), and (b) critical externally stored items such as repressurization gases (they come carted ready for transport). These critical stores are shown in figure 6-2. Other supplies will be brought to the Outpost and stored externally until needed. These supplies will be brought in as a regular part of the normal operations, reducing the need to expend additional airlock repressurizations specifically to get supplies. The amount of supplies were limited to the available volume for storage in the habitat, about 6.5 cubic meters. (This is less than the 9 cubic meters of supplies in an early NASA estimate.)

Currently it is estimated that each manned mission will land with no less than ten terrestrial days of sunlight before the lunar night (to ensure the correct angle of sunlight for landing and avoiding obstacles). The first manned transport done on each mission is currently scheduled to be with Shuttle IVA suits. The normal lunar EVA suit will be good for eight hours of external operations for each surface venture and needs to be refurbished before each excursion.

### 6.2 SMALL PACKAGE LOGISTICS

With this information the surface mission timelines is given in Appendix E for both a single EVA operation of two crew on the surface and two in the habitat and a double EVA operation of all four crew on the surface for eight hours of operations. It is during this time that all supplies are transported and stored or attached and all external science has been deployed on the surface. The logistics flow is illustrated in figure 6-3. The single EVA requires eleven days of operations to complete all resupply and deployment

	A	B	C	D	E	F
1	Outpost Resupply Packaging					6/9/92
2						
3			Mass (kg)	Volume (m <sup>3</sup> )	# Packages	Package Volume
4	Interior	Food	360.0	0.58	7.2	0.08
5		Clothing	245.0	1.77	4.9	0.36
6		Galley Supply	103.0	0.34	2.1	0.17
7	ECLSS	ARS	20.6	0.05	0.4	0.12
8		WRM	129.4	0.22	2.6	0.09
9		WM	11.0	0.10	0.2	0.46
10		THC	10.0	0.03	0.2	0.13
11	EMU	Expendables	166.3	0.72	3.3	0.22
12		Spares	74.8	0.31	1.5	0.21
13		Dust Control	97.0	0.67	1.9	0.35
14		CHeCS	80.0	0.50	1.6	0.31
15		Pers. Hygiene	45.8	0.21	0.9	0.23
16		Operations	182.8	0.43	3.7	0.12
17		Off Duty	84.2	0.19	1.7	0.11
18		Maintenance	113.2	0.14	2.3	0.06
19		Science	50.0	0.16	1.0	0.16
20	Exterior	N <sub>2</sub> make-up	259.0	0.67	5.2	0.13
21		O <sub>2</sub> make-up	119.8	0.26	2.4	0.11
22		Met O <sub>2</sub>	185.4	0.15	3.7	0.04
23		Eve sub. water	167.6	0.16	3.4	0.05
24		Science	2390.0	7.96	47.8	0.17
25		Spares	17.0	0.09	0.3	0.26
26						
27						
28						
29	# Packages					
30	Total resupply volume		83.6			
31	Total resupply mass		14.5			
32	Package Mass (ea.)		4911.9			Note: shaded area not included
33	Avg Package Volume, m <sup>3</sup>		50.0			in packaging estimates
34	# Interior packages		35.5			
35	Interior package volume		6.4			
36	Interior package mass		1773.13			
37	Exterior resupply volume		9.3			
38	Exterior resupply mass		3138.8			

Figure 6-1. FLO Resupply Packaging

tasks; the double EVA requires seven days. Pie charts were developed for the total (all suit usage) available EVA task time over the life of the mission using single EVAs, except as noted and double EVAs. For a single EVA of two crew per EVA, 21.4% of the available EVA time is devoted to storage, figure 6-4. These data can be compared to using a double EVA of all four crew outside at one time in which case 15.7% of the available EVA time is devoted to resupply, figure 6-5.

Note: All Sets use a 500kg capacity cart for transport

First Package Set:	Item	Mass	Volume	# of Packages
	Food*:	260.0 kg	0.42 m <sup>3</sup>	5.2
	CHeCS:	80.0 kg	0.50 m <sup>3</sup>	1.6
	(1/4) EMU resupply:	84.5 kg	0.43 m <sup>3</sup>	1.7
	Personal hygiene:	45.8 kg	0.21 m <sup>3</sup>	0.9
	(1/12) clothing:	29.7 kg	0.21 m <sup>3</sup>	0.6
	<b>Total:</b>	<b>500.0 kg</b>	<b>1.93 m<sup>3</sup></b>	<b>10.0</b>

\* food consists of moist, canned goods (temperature sensitive) or frozen food; dry goods come in the third set

Second Package Set: Make up Gases - Nitrogen 259 kg  
 Oxygen 120 kg  
 Total: 379 kg + connection hardware

Third Package Set: Metabolic Oxygen 185.4 kg  
 EVA Sublimator Water 167.6kg  
 Subtotal 353.4 kg + connection hardware  
 + 100 kg dry food  
 Total: 453.4 + connection hardware

Figure 6-2. Critical Items for Early Transport

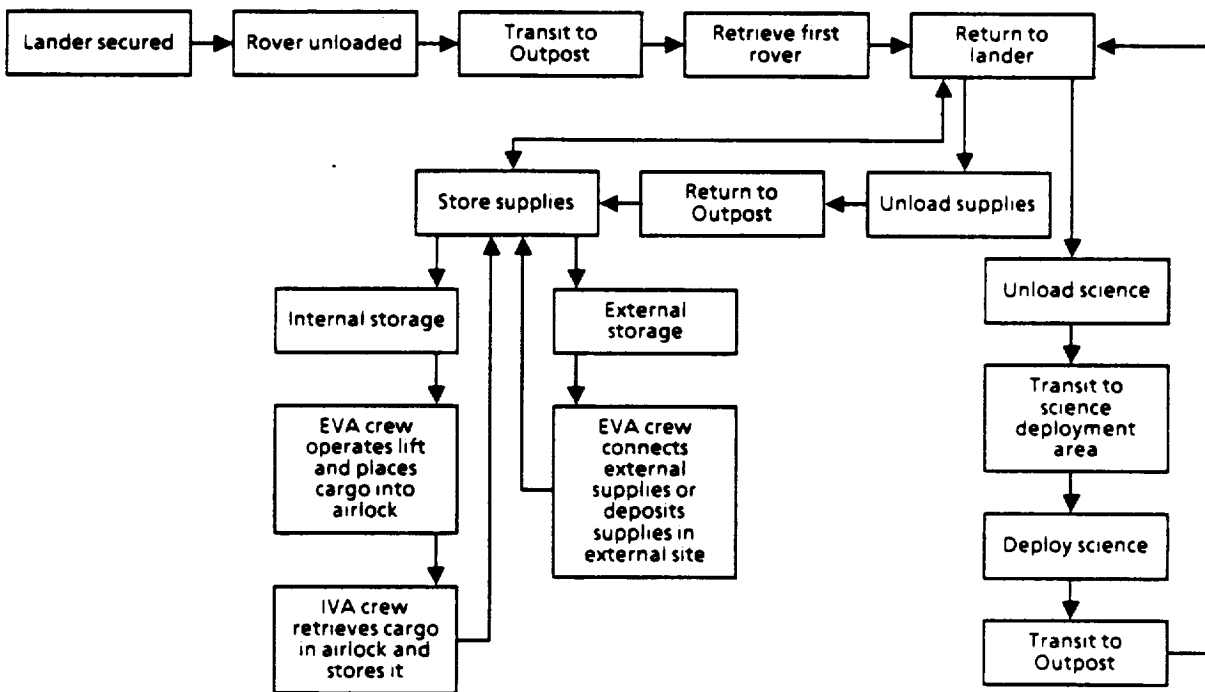
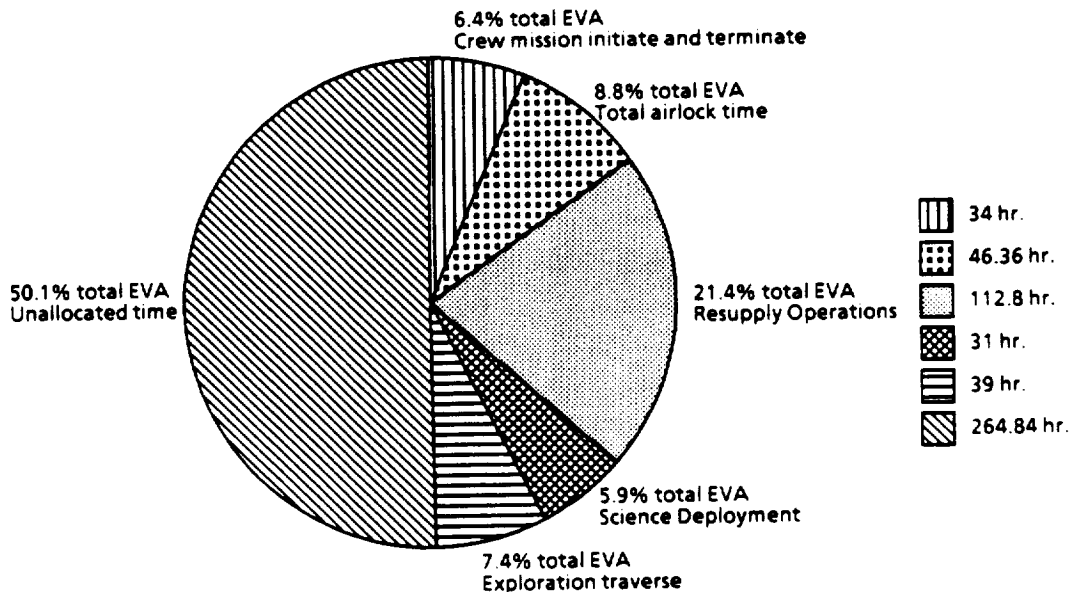
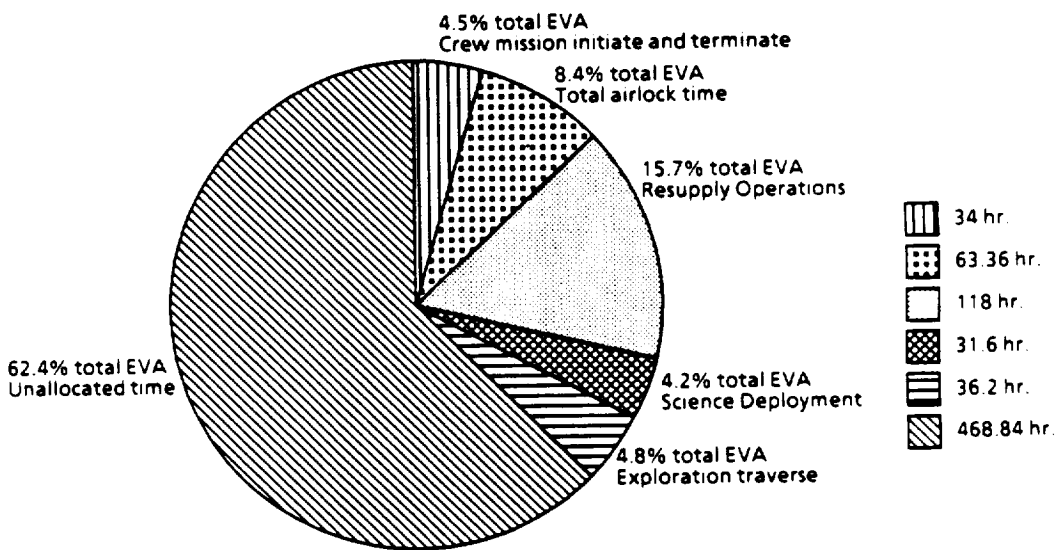

Figure 6-3. Initial Resupply Logistics Flow



31 days at 16 hr./day EVA + 2 days of double EVA (32 hr.) on landing and leaving = 528 hr. EVA

Figure 6-4. Preliminary Estimate of EVA Task Time Single EVA



16 days at 16 hr./day EVA + 15 days of double EVA (32 hr.) = 752 hr. EVA

Figure 6-5. Preliminary Estimate of EVA Task Time Double EVA

### 6.3 LOGISTICS MODULES AND SPARES

A preliminary examination was made of logistics modules and an assessment for maintenance and spares. Data from ALENIA SPAZIO S.P.A. on the Mini-Pressurized Logistics Module was acquired and this planned module and two reduced weight versions of it were examined for lunar resupply use, reference 19. The resultant weight reduction and implications are given in figures 6-6 to 6-9.

#### Basic "Requirements"

- Must contain 1800 kg of resupply - 3 to 4 racks
- Must be able to be transported
- Must contain a pressure

Using Mini-PLM as it is now designed

#### Provides

- Contains 8 racks - 7 for users (2 refrigerator/freezer, 5 stowage), 1 for utilities
- Has active pressure, thermal control, fluids, power, avionics, man systems
- Size is 4.3 m long by 4.4 m diameter
- Has standard SSF connections

#### Impacts

- Requires an additional SSF hatch
- Requires crane or ramp to offload and onload
- Requires a ground transport mechanism
- Requires an additional to the outpost lander platform and a bulkhead in the habitat

#### Disadvantages

- Will not use the full capacity of the Mini-PLM
  - Uses ~1800 kg of ~4000 kg capacity
- Basic structural weight with systems provided is 3765 kg
  - Combined with the internal stores the total mass is ~5.5t and completely uses the allotted resupply capacity on the manned lander (no additional rover, no external resupply or science, no ground transport vehicle)

*Figure 6-6. Lunar Logistic Module from Mini-PLM*

Using a "stripped down" Mini-PLM

#### Provides

- Contains 8 racks - all for users, no utilities
- Has passive pressure and thermal control, but no utilities, man systems, or avionics
- Size is 4.3 m long by 4.4 m diameter
- Has standard SSF connections

#### Impacts

- Requires an additional SSF hatch
- Requires crane or ramp to offload and onload
- Requires a ground transport mechanism
- Requires an additional to the outpost lander platform and a bulkhead in the habitat

#### Disadvantages

- Will not use the full capacity of the Mini-PLM
  - Uses ~1800 kg of ~4000 kg capacity
- Basic structural weight with rack supports provided is 2773.4 kg
  - Combined with the internal stores the total mass is ~4.5t and uses the most of allotted resupply capacity on the manned lander (rover mass not used in resupply, therefore it can be flown with this cargo, 453 kg external resupply or science, no ground transport vehicle)

*Figure 6-7. Lunar Logistic Module, "Stripped Down" Mini-PLM*



Using a shortened "stripped down" Mini-PLM

Provides

- Contains 4 racks - all for storage, no utilities
- Has passive pressure and thermal control, but no utilities, man systems, or avionics
- Size is 3.2 m long by 4.4 m diameter
- Has standard SSF connections

Impacts

- Requires an additional SSF hatch
- Requires crane or ramp to offload and onload
- Requires a ground transport mechanism
- Requires an additional to the outpost lander platform and a bulkhead in the habitat

Disadvantages

- Basic structural weight with rack supports provided is 2461.3 kg
  - Combined with the internal stores the total mass is ~4.24t and uses the most of allotted resupply capacity on the manned lander (rover mass not used in resupply, therefore it can be flown with this cargo, 764 kg external resupply or science, no ground transport vehicle)

**Figure 6-8. Lunar Logistic Module Shortened "Stripped Down" Mini-PLM**

Mini-PLM Subsystem	Mass (kg)		
	MPLM	Stripped	Shortened
Structure	3116.4	2773.4	2461.3
ECLS	266.2	—	—
ITCS	209.3	—	—
Avionics	124.1	—	—
Man Systems	18.0	—	—
Fluids	55.0	—	—
Total	3789	2773.4	2461.3

**Figure 6-9. Mini-PLM Mass Summaries**

A set of maintenance issues that are yet to be resolved were examined along with some parts failure rate information obtained previously, reference 20. Data on maintenance and spares was acquired, reference 21. The principal critical spares (class 1C and 1) for the SSF habitat was examined. This was an incomplete list but gave some indication of the magnitude of the "spares problem" to the lunar surface. A preliminary reduced list for FLO is included in Appendix F.

Major maintenance considerations that have to be addressed include:

- a. A minimum of 2% of all active items should be available for maintenance covering habitat internal and external systems, all active deployed science packages and all mobile equipment. (Items replaced by a module or larger unit, such as a rover wheel will drive the percentage higher). This is resupply not initial spares.
- b. Failure rates must be addressed over both the time the crew is present and in the "dormant" conditions between missions.

- c. Commonality of parts (not systems) must be addressed and a priority on cannibalization established.
- d. Spares and maintenance rates will have an impact on the amount of material to be transported.
- e. Maintenance performance tools required and the access to equipment must be determined.
- f. Review of "Lessons Learned" from previous space programs should be initiated.

An initial cursory review of these "Lessons Learned" revealed several methods that should be incorporated in the FLO logistics and design. Redundant systems should not necessarily be identical. The backup system could fail in the same manner as the primary, leaving the whole non operational. Systems should be designed for rapid detection and isolation of the malfunctions. Time is more critical the further away from home you are. Human engineering principles must be applied to reduce the time at the task and the potential errors in correcting a problem for safety considerations. Interdependent systems should be avoided to prevent cascading failures. It must be recognized that some repair functions will have to be done in a space suit, both IVA and EVA activities must be taken into account. Hardware should be standardized and traceable to avoid "reworking" the part during the mission or the possibility of a non fit. As many tasks as possible should be mechanized to reduce the crew time involved in the task with the resultant fatigue. Intense tasks will "key up" the crew and should not be done prior to a rest period Palatable excess consumables should be provided both as a reassurance and to provide selection for the crew.

Using spares list derived from the Space Station, found in Appendix F, as the known set of initial spares (no mission spares have been allocated), the estimated total mass and volume that must be accommodated in a spares resupply mission is shown in figure 6-10. Identifying what materials are the external stores and which are the internal stores, shown in figure 6-11, an idea can be gathered of the mass and volume that must be placed inside a pressurized volume, how much pressurized space is needed, and what material may be left outside such a space. When the impact of initial spares and resupply are considered together, the system appears to be driven to consider a separate cargo flight. In identifying the initial spares and evaluating the resupply that must be delivered at about the same time, we were driven to evaluate both the logistics module weight and the use of an individual resupply flight.

The data from ALENIA SPAZIO S.P.A. for a Mini-PLM and the stripped and shortened versions were reexamined. A silicon carbide/aluminum matrix was then substituted for aluminum alloy in all three versions of the Mini-PLM. The comparison of the original mass of the aluminum versions and the estimated mass of the matrix

		Mass (kg)	Volume (m <sup>3</sup> )
Initial Spares* (not resupply)	External	1,149	5.82
- brought once and replenish as required	Food	360	0.58
	Known internal CI and 1 categories	1,180	3.79
Resupply	External	3,139	9.3
- brought each time	Internal with food	1,773	6.4
With 15% growth for	Total	7,601	25.89
both mass & volume	New Total	8,741	29.77
	→ or ~	9t	and 30 m <sup>3</sup>

\* does not include lander spares and mobile systems

Figure 6-10. Total Material to Support 45 Day FLO

	Mass (kg)	Volume (m <sup>3</sup> )
External Supplies & Spares with growth (4288 kg without)	4,931	17.39
Known Internal Supplies & Spares with growth (3313 kg without)	3,810	12.83

- Mass and volume drives you to use a cargo mission
- Known internal supplies and spares might fit in a lightened Mini-Pressurized Logistics Module, if not volume limited
- A full Pressurized Logistics Module makes physical integration into the baseline FLO Outpost difficult, therefore:
  - Abandon integration at 10 meters above the surface
  - Add an airlock
  - Set it on the surface as an independent structure
  - Use it to "gear up" for 6 month capability and base establishment

Figure 6-11. 45 Day Mission Support Packaging

versions, that have all parts that can be replaced by the matrix, is shown in figure 6-12. From this it can be seen that even with this reduction in mass, and reduction in volume of a stripped and shortened version, that the Mini-PLM still takes nearly 40% of the available 5t transport mass on a manned mission in hardware alone. The volume considered in any of the Mini-PLMs will not support the transport of resupply and logistics spares together, and severely reduces the amount of science and exploration equipment brought if used on a manned mission. At this point, the using a full Pressurized Logistics Module (PLM) that is scheduled to be used on SSF, modified for lunar use as given in figure 6-13, on a separate cargo flight becomes a viable option.

Lightened Mini-PLM concepts use silicon carbide/Al matrix material in place of aluminum where applicable

Configuration	Nominal	Lightened
	Mass (kg)	Mass (kg)
MPLM	3116	2564
Stripped	2773	2183
Shortened	2461	1952

Figure 6-12. Lightened Mini-PLM Logistics Modules

Item	Mass (kg)	
DI	316	
FSE	34	
Structure, internal	2,547	modified for lunar
Structure, external	410	modified for lunar
Hatch (2)	211	modified for lunar
80 inch racks	1,234	modified for lunar
EPDS	117	
DMS	119	
IAV	59	modified for lunar
TCS	361	
ECLSS:		
THC	201	modified for lunar
ACS	180	
FDS	107	
M/S	1,442	modified for lunar
TSS	9	
<b>Total</b>	<b>7,347</b>	

Figure 6-13. Preliminary Lunar Pressurized Logistics Module Mass

#### 6.4 IMPACTS TO OUTPOST DESIGN AND OPERATIONS

Possible concept design and schedule recommendations may include the following:

- a. If the single EVA crew schedule is used, it is likely that the last supply transport mission will be done in the lunar night or that the remaining supplies will be left at the lander until lunar day returns. Recommend that the lighting at the lander, the path back to the Outpost, and the Outpost be revised for work in Earthshine or darkness.
- b. Active suit time is critical to the time to complete the resupply from the lander. It should be as long as possible without stressing the surface crew.

- c. With a set cargo limit, use of a lunar logistics module will either limit the amount of external resupply or science that can come with a manned mission or require a separate resupply flight. The alternative is to live with the EVA time consumed in using small transportable packages, or design a new lunar logistics module. Use of a logistics module for resupply must still be considered. It may not be feasible to start with a logistics module, but to go to it as the activity at the FLO becomes more regular and expands.

### 6.5 EVOLUTION AND OPERATIONS USING PLANNED CARGO FLIGHTS

In exploring the option given in section 6.4 item (c), that of using an independent cargo flight with a PLM, the logistics of establishing initial spares and resupply, lends itself to a solution that prepares the site for evolving to a lunar base with some flexibility.

The initial site will be done with a planned FLO habitat landing with the initial supplies. The second manned mission will proceed with the 5t of resupply and manually carting the provisions to the base of the FLO outpost from the lander. The third mission will be a cargo flight that carries a modified PLM with an attached airlock all on a mobile carriage that will descend to the ground. The powered Lunar PLM (LPLM) and airlock are illustrated in figures 6-14 and 6-15. This arrangement fits into a

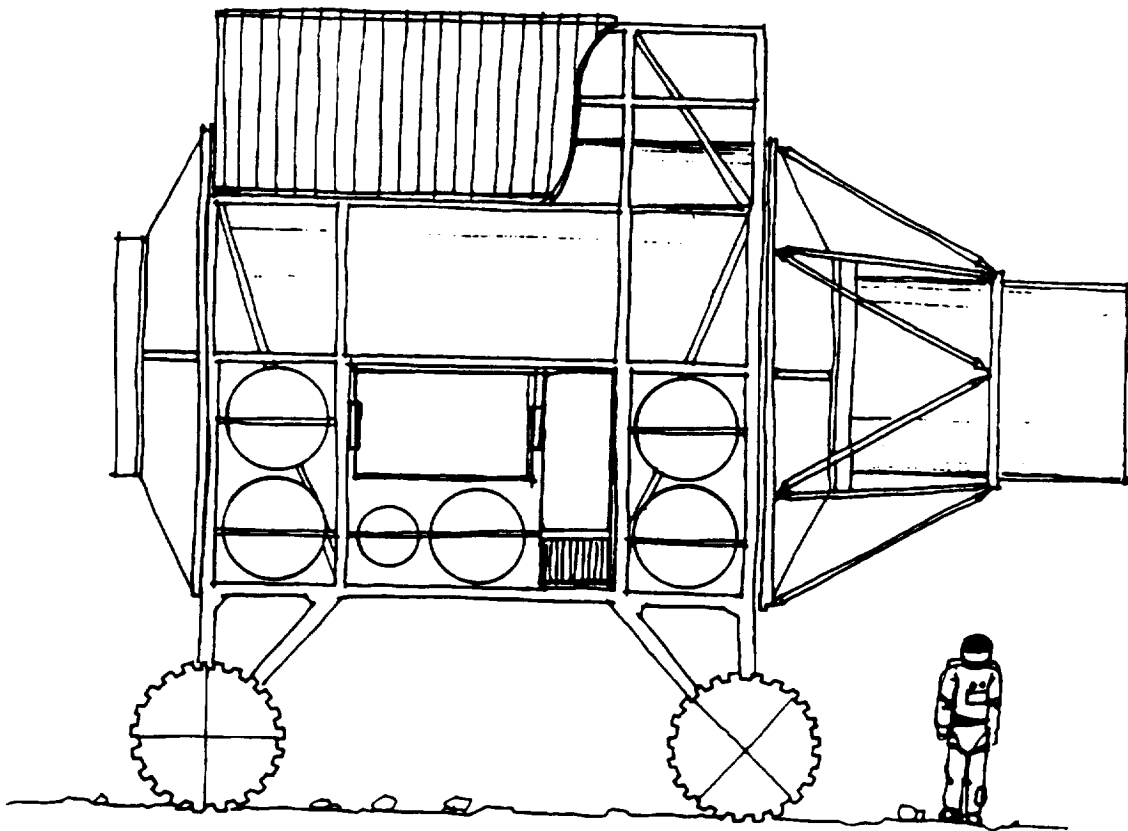

ACS076

Figure 6-14. Preliminary LPLM and Airlock Side View

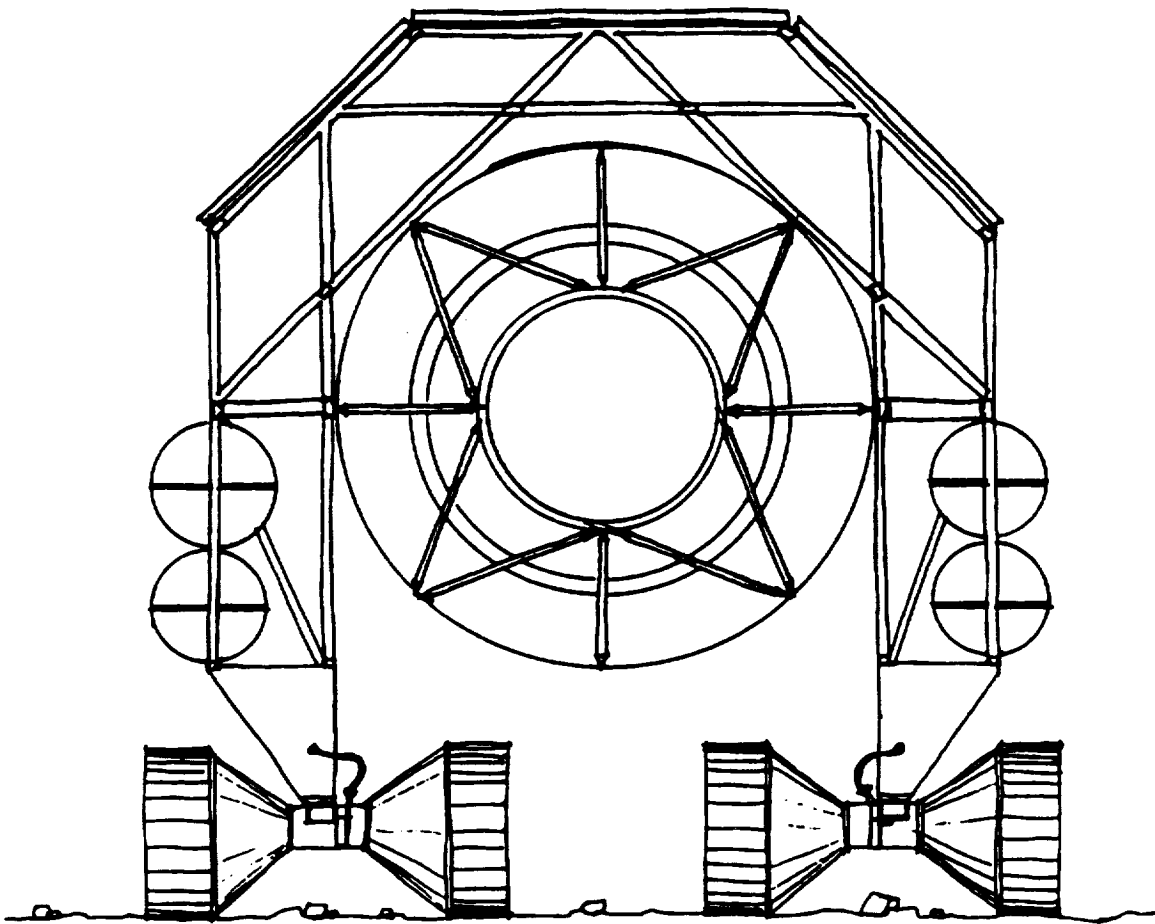

Figure 6-15. Preliminary LPLM and Airlock End View

ACS077

10 meter dia. shroud. The LPLM and airlock can be moved by telepresence slowly to the FLO site and set down. Since the LPLM/airlock is pressurized with active thermal controls and powered, this provides an on-surface access to spares and supplies with additional space and emergency (or normal) living space and shelter. The next manned mission proceeds, bring more supplies and additional science used on this mission and may live and work out of either or both the original FLO habitat and the logistics module. The next cargo flight brings a mobile habitat that offloads, transport to the FLO site and connects to the LPLM and airlock. The mobile habitat brings another full living space to be activated by the crew from the next mission. When the second LPLM arrives on the succeeding cargo mission, and is set up by the following crew, the base is established and may grow from this core or, since it is mobile, any section may be disengaged and sent to another area. The flow for this buildup is given in figure 6-16. The waterfall for establishing the base is given in figure 6-17. A top level accounting of the supplies and stores over the first nine missions (base establishment) is given in figure 6-18. In checking the size of the airlock-LPLM-habitat arrangement, the mass and subsystem distribution was given a preliminary check. These were based on conservative

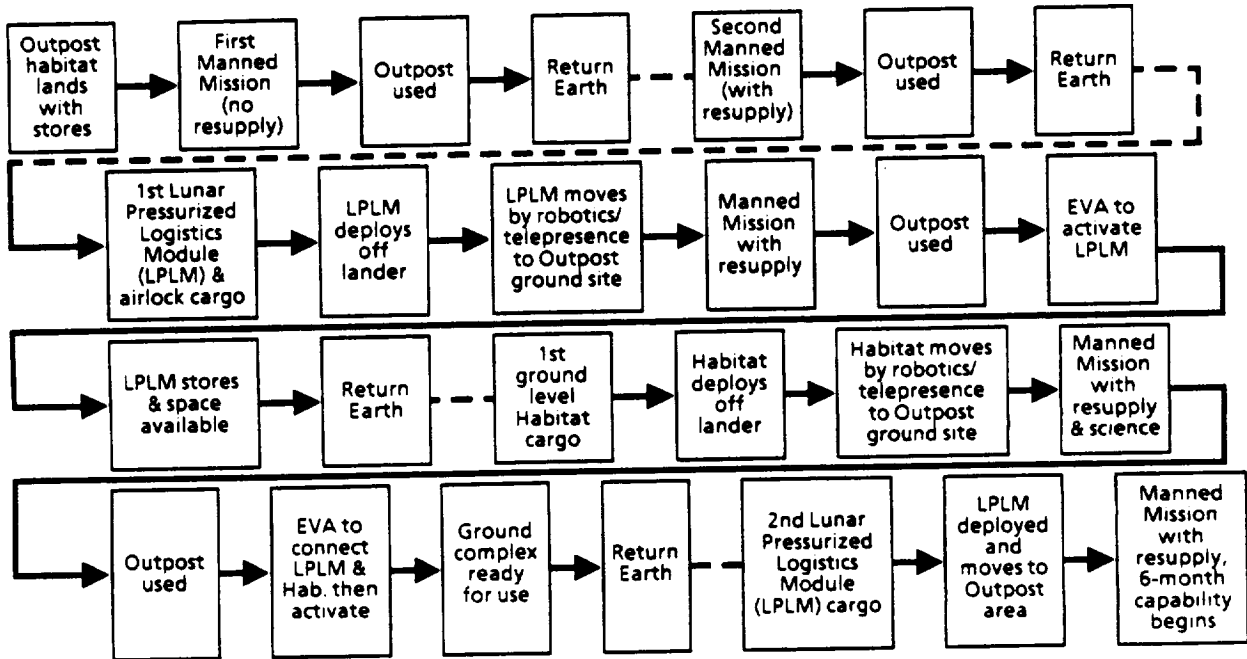
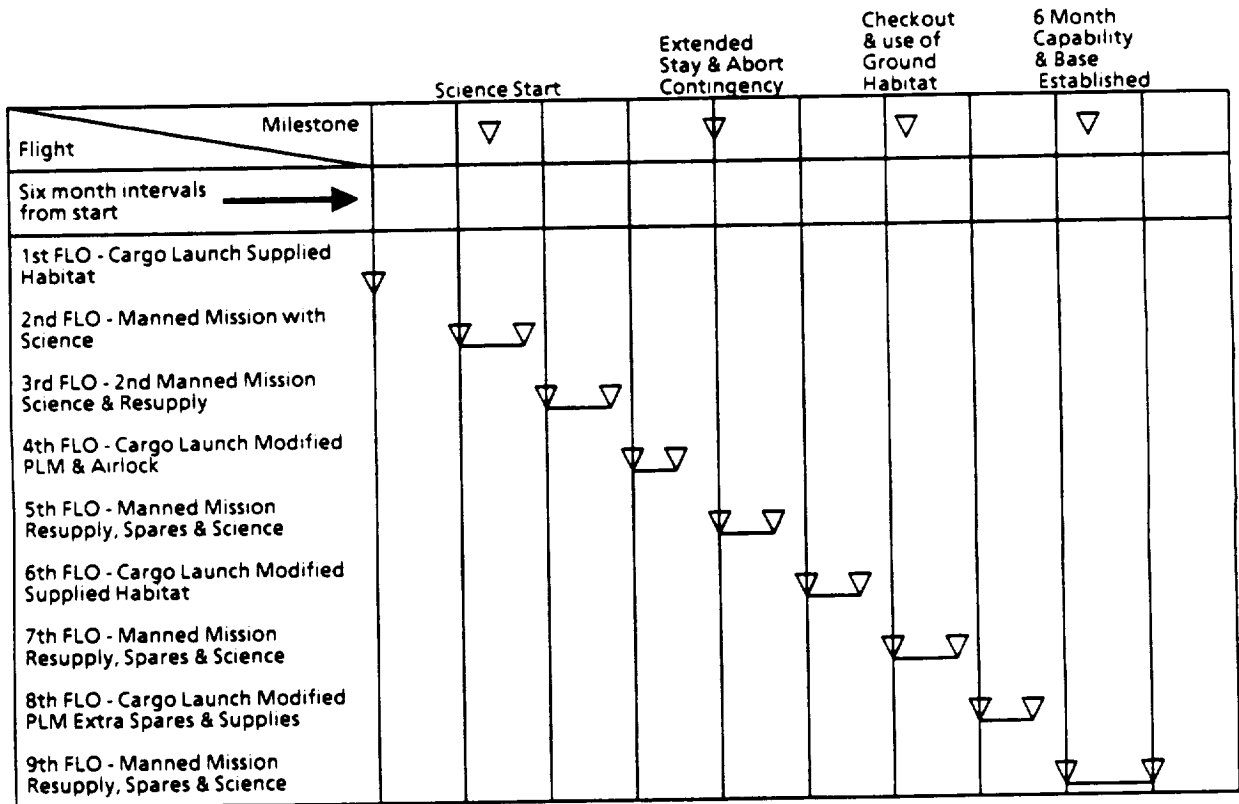

Figure 6-16. Preliminary Transition Flow



Assumes two flights per year dedicated to FLO

Figure 6-17. Preliminary Modified FLO Schedule

D615-10062-2

Flight No.	Mission Type	Hardware Brought	Material Brought	Supplies Brought	Supplies on Surface	Spares Brought	Spares on Surface	Supported Staytime
1	Cargo	Outpost	Habitat on lander	one 45 terrestrial day stay	One 45 terrestrial day stay	Contingency	Contingency	One 45 terrestrial day stay
2	Manned	Rover, Science	Rover	Spares/ supply allocation?	One 45 terrestrial day stay	Contingency	Contingency	One 45 terrestrial day stay
3	Manned	Rover, Science	Rover	One 45 terrestrial day stay	One 45 terrestrial day stay	Contingency	Contingency	One 45 terrestrial day stay
4	Cargo	LPLM with airlock	LPM with airlock	One 45 terrestrial day stay	One 45 terrestrial day stay	Critical initial	Critical initial	One 45 terrestrial day stay
5	Manned	Science	Spares/ supply allocation?	One 45 terrestrial day stay	@ mission start, two 45 day stays	Critical initial +	Critical initial +	One 45 day, extended stay or abort
6	Cargo	Surface Habitat, Science	Surface Habitat	One 45 terrestrial day stay	@ mission start, two 45 day stays	Full initial +	Full initial +	One 45 day, extended stay or abort
7	Manned	Science	Spares/ supply allocation?	One 45 terrestrial day stay	@ mission start, two 45 day stays	Full initial +	Full initial +	One 45 day, extended stay or abort
8	Cargo	#2 LPLM	#2 LPLM	Two 45 terrestrial day stay	@ mission end, three 45 day stays	Full initial +	Full initial +	One 90 day, extended stay or abort
9	Manned	Science	Spares/ supply allocation?	One 45 day, extended stay or abort	@ mission start, four 45 day stays	Full initial +	Full initial +	One 108 day, extended stay or abort

Figure 6-18. FLO Site Evolution

estimates of the systems and subsystems masses. This means that the total mass for the LPLM and ground habitat shown in figure 6-19 are more likely to decrease than increase. Even with these masses, both systems can fit in a 10 meter dia. shroud, with a 30t delivery capability.

1st LPLM		Ground Habitat	
Item	Mass (kg)	Item	Mass (kg)
External spares & supplies*	4,288	Outpost Habitat minus thermal, power & airlock	15,802
Internal spares & supplies*	3,313	1/3 power system	1,585
Logistic module	7,347	1/3 thermal system	594
Airlock**	2,710	3 sections regolith fill radiation shield	3,000
Cradle	3,000	Cradle	3,000
Power	4,755	Internal radiation shield	1,500
Thermal	1,782	Additional science & stores	2,500
<b>delivered mass</b>	<b>27,195</b>	<b>delivered mass</b>	<b>27,981</b>
Off loader	2,000	Off loader	2,000
<b>Total mass</b>	<b>29,195</b>	<b>Total mass</b>	<b>29,981</b>

\*growth brought on manned mission  
\*\*with Hyperbaric

Figure 6-19. Preliminary LPLM and Habitat Mission Mass statements



## 7.0 FLO ALTERNATIVES

### 7.1 INTRODUCTION

An effort was initiated to develop alternatives to the baseline FLO habitation system, in support of trade studies being conducted at MSFC and at JSC. The alternative configuration study was initiated by examining the baseline, and identifying its perceived drawbacks and limitations with regard to the FLO mission. Results of this examination yielded specific design goals that can be used to evaluate new concepts. Twelve alternative concepts were identified as potential solutions to one or more goals, and some of those were developed in greater detail in order to provide mass and cost estimates.

### 7.2 FLO ALTERNATIVE CONFIGURATIONS

The investigation of alternative configurations, conducted in order to resolve some of the issues and concerns that are identified with the baseline habitat, resulted in a list of goals that, when reached, would provide a FLO mission that fits within the context of "better, faster and cheaper". The goals that were identified included better access to the surface for EVA personnel, easier and less complicated growth towards a lunar base, more habitable volume, better radiation protection, and a reduction in the overall habitat system mass.

A trade study was performed to identify potential solutions to each goal, select solutions that tended to address more than one goal, and then determine the advantages and disadvantages that each solution might possess.

*Goal 1: Provide better access to the surface for EVA personnel, and simplify resupply operations.* This goal may be achieved in two basic ways. First, the habitat can be placed in closer proximity to the surface to minimize vertical movement, and secondly, the means of vertical movement can be improved. The current configuration utilizes an "A" frame type hoist to facilitate delivery of resupply packages to the airlock hatch. This system seems to adequately address the transfer problem, however, there is concern that the amount of time required to transfer the resupply packages from the surface into the airlock, and then into the habitat, may consume an unacceptable amount of the limited EVA time. Two concepts were identified that attempt to achieve the goal of improving vertical access.

The first concept involves relocating the airlock on the bottom of the hab cylinder, so that EVA personnel enter the airlock at the bottom of the descent stage, and transfer through the airlock cylinder in a vertical manner (fig. 7-1). This allows the airlock entrance to be closer to the surface, however, translating through a vertically oriented airlock may present some problems. Access by a ladder built into the airlock, and hatches (lower and upper) would be difficult to operate. A potential benefit would be the isolation of lunar dust at the bottom of the airlock, where it could be removed by opening the lower hatch.

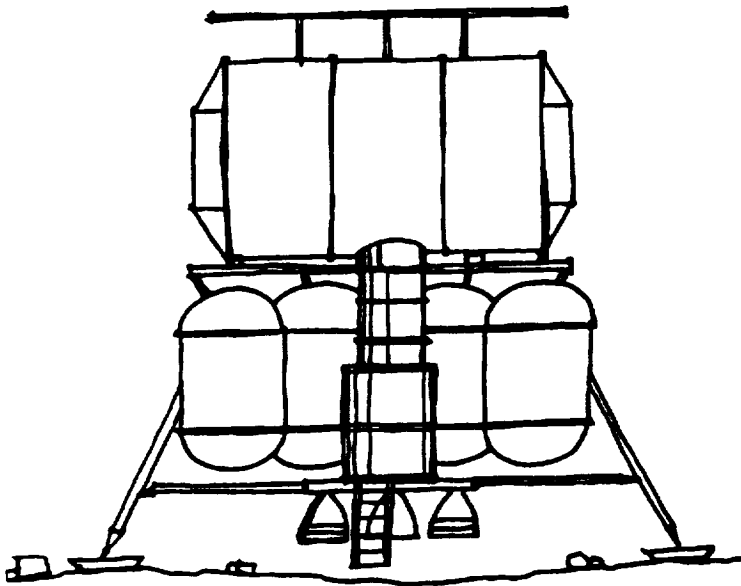

**Potential Advantages:**  
Improved surface access, dust control, proper orientation for use of the crewlock, and potential use of the tunnel and airlock as a radiation "storm shelter"

**Concerns:**  
access through base of lander

**Disadvantages:**  
added mass of tunnel

Figure 7-1. FLO Alternative Configuration - Lander Core Airlock

ACS038

The second concept involves reconfiguring the lander so that the habitat is located below the propellant tanks, but above the engines and thrust structure. This is the distinguishing characteristic of the Boeing "Campsite", figure 7-2. This configuration does not eliminate vertical translation by EVA personnel and cargo, but limits it to about 4 meters versus 8 meters for the baseline vehicle. Another concept involves landing the habitat with a two stage lander. The vehicle would brake and descent towards the surface with one engine/propellant tankset, and make the final landing maneuvers with a smaller system that includes split, throttling engine sets, and a structure that suspends the habitat between the engines, and allows it to be lowered directly to the surface, figure 7-3. The lander structure can also be outfitted with a mobility system, primarily wheels, drive train and minimal navigation, that would allow the lander to transport the habitat to a remote site.

**Goal 2: Easier growth towards a lunar base.** Basic design decisions to support this goal include provisions for removing the habitat from the lander, so that it can be connected to other future base elements, or providing for the connection of future elements to the integrated habitat/lander in it's original configuration and location. Four concepts were developed to remove the habitat from the lander. The first involves providing a ramp and mobility system for the hab, that would enable it to "drive" itself off the top to the lander (fig. 7-4). The ramp structure is automatically deployed from a package on the side of the lander, and a mobility system attached to the habitat subsystem support structure would slowly move the habitat, including all it's external support systems, off the lander and onto the surface. A similar concept that uses

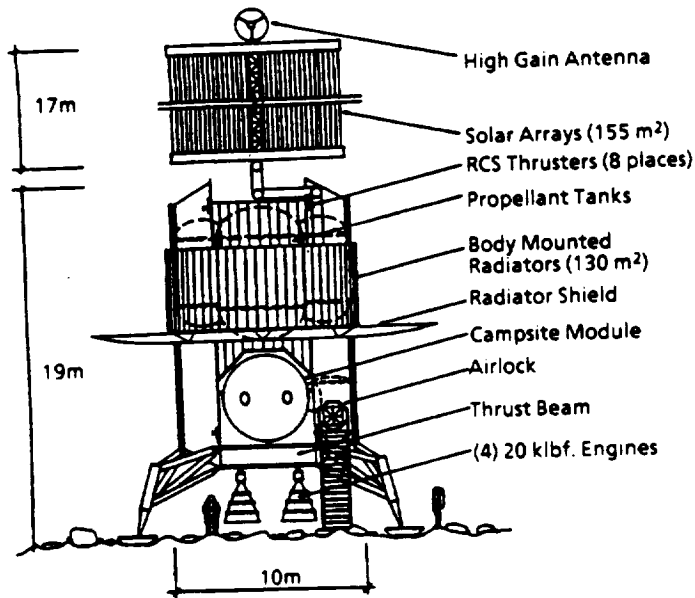

**Advantages:**  
 Better access to surface, better radiation protection, easier resupply operations and potentially simpler growth options

**Disadvantages:**  
 commonality with crew lander

Figure 7-2. FLO Alternative Configuration - "Boeing Campsite"

ACS035

**Potential Advantages:**  
 Better access to surface, facilitates growth to permanent base, mobile structure could be incorporated into framework for regolith support structure

**Disadvantages:**  
 Staging and descent control with split engines, commonality with crew lander

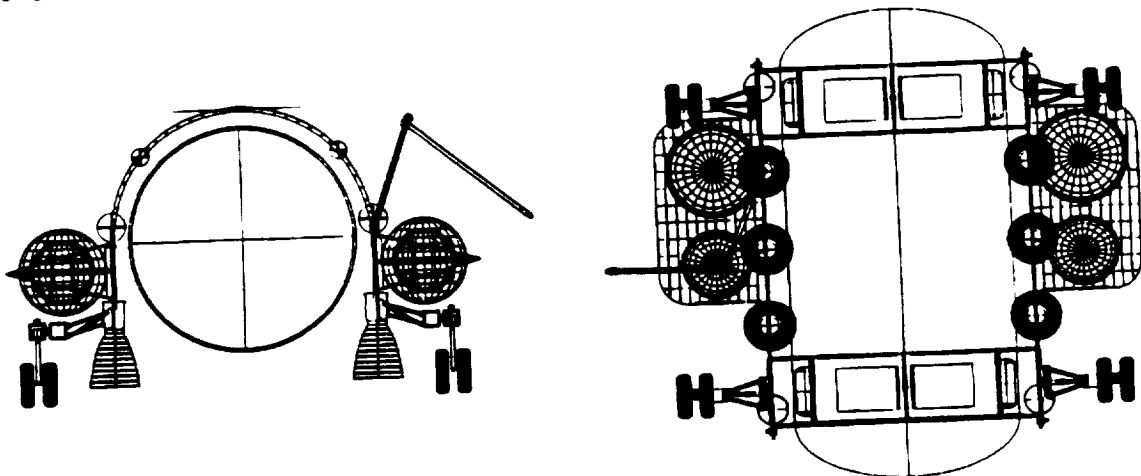

Figure 7-3. FLO Alternative Configuration - Mobile Two Stage Lander

ACS039

anchored cables to unload the hab is shown in figure 7-5. This concept used winches instead of motorized wheels to move the payload. Another concept would require the lander structure to perform the task of unloading it's cargo. This could be accomplished through the use of hoists located on the top of the lander, or by allowing the lander structure and cargo support structure to reconfigure, changing it's shape by hinging or pivoting mechanisms once it has landed it's payload. A fourth method of unloading the habitat could be through the use of a two stage lander and mobility system, as previously described under Goal 1.

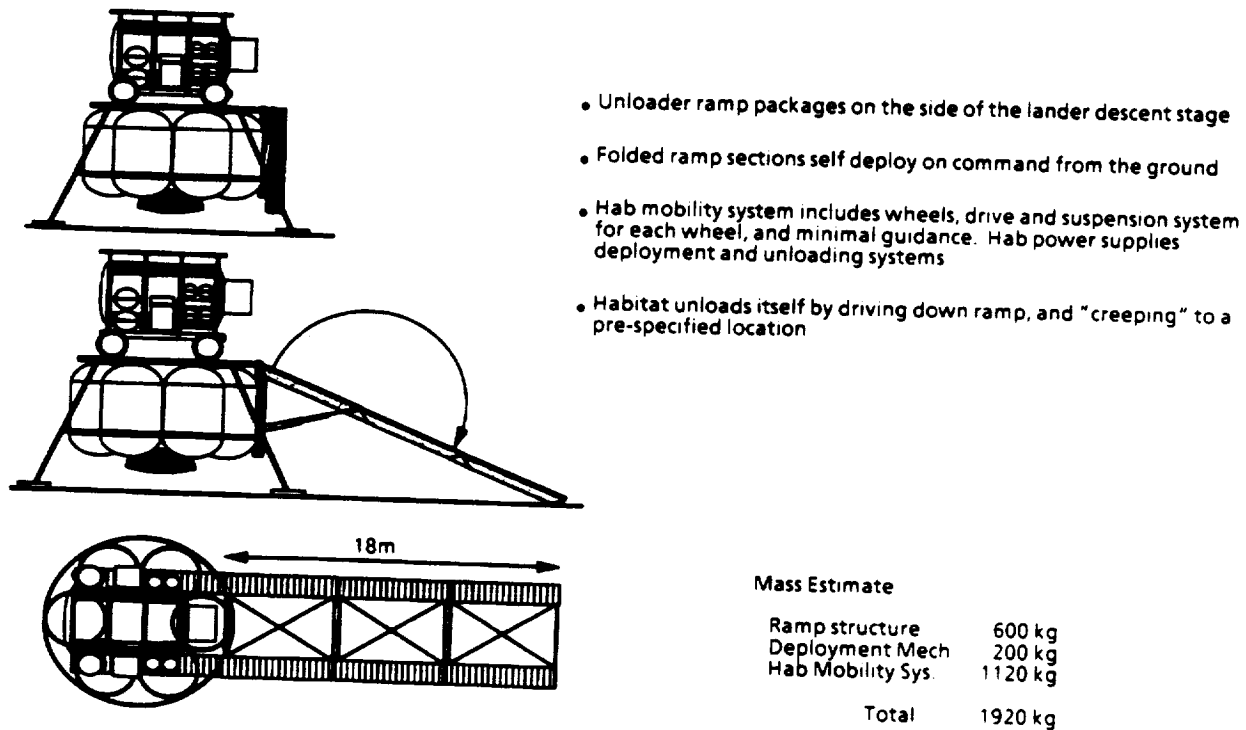
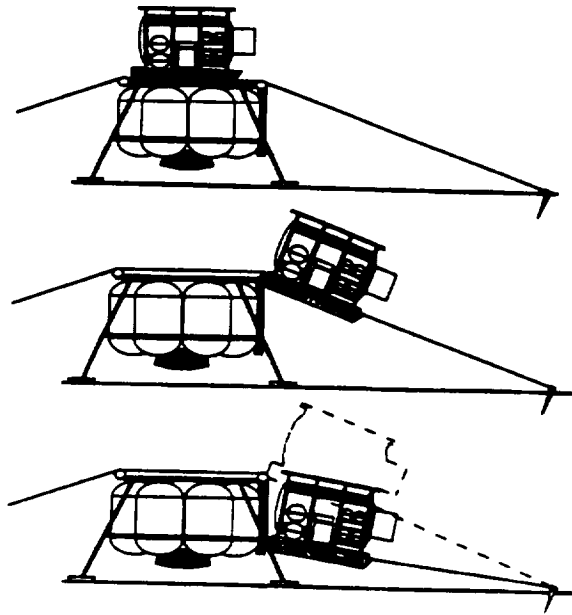

Figure 7-4. FLO Hab Unloader Option 1

ACS079

Growth by connecting modules together while still attached to the lander structure can be accomplished in three different ways. First, the lander itself could be mobile, which would allow habitats to be maneuvered together on the surface. The landers would be required to orient, align and level individual modules for proper "berthing", or connectors between each module would need to be flexible to some degree, to allow for topography. Another method of joining modules might be through the use of inflatable tunnels or bridges between landers. This solution might be fairly simple, but would probably incur a substantial mass penalty depending on the distance between modules. A third concept would cover the entire base with an inflatable pressurized structure. Even though much work has been done over the past 20 years on the use of inflatable structures for space applications, substantial progress in this field would have to be made in order to consider this as a serious option.



- Unloading cable is deployed by EVA personnel. Cable deploys from support beams attached to either side of the habitat subsystem support structure, and is anchored in the regolith on two sides of the lander.
- Winch drums located on each beam pull the hab off the lander structure until rollers located on the back edge of the beam enter guide channels attached to the front face of the lander descent stage.
- As the end of each beam slides down its guide channel, winches maintain continuous tension on the front set of cables, while lowering the back end of the beams toward the surface.

#### Mass Estimate

Support Beams, Guide Channel	500 kg
Deployment Mechanisms	200 kg
Cable, Anchors	270 kg

Total 1920 kg

ACS080

Figure 7-5. FLO Hab Unloader Option 2

**Goal 3: Provide more habitable volume.** Three methods for increasing habitable volume have been identified. The first is to provide for increasing the existing volume of the baseline through the addition of inflatables, logistics modules or removal of equipment from inside the baseline. One concept was developed that provides an inflatable logistics module that could be attached to the second hatchway on the baseline habitat. The module would be hoisted to the hatchway, attached and sealed, and then inflated to the habitat's internal pressure level (fig 7-6). The hatch could then be opened, and the resupply material removed as needed. Once the module is emptied of resupply materials, it could be used as a place to store trash and waste, it could be used as additional habitable volume, or as an emergency airlock. Should the habitat ever be offloaded from the lander, the log module could be used as a connector to future pressurized volumes. This concept also has the added benefit of becoming a testbed for the use of inflatable structures technology on the lunar surface.

Another method of providing more habitable volume would be to simply make the hab module larger. In order to do this without increasing the overall mass of the vehicle, other structures that are delivered to the surface with the FLO mission could be used to provide pressurized living space. For example, the descent propellant tanks, if properly outfitted, would provide significant added volume. Also, by providing a pressurized connector, and the ability to move the habitat and its lander, the crew delivery module could serve as added living or working space. A third method of providing more habitable volume involves changing the geometry of the baseline pressure vessel, and the packaging system used in integrating its internal subsystems.

**Advantages:** Increased habitable volume, improved resupply transfer and storage, use as a tunnel connector for future growth, use as an emergency airlock and as an inflatable structures "testbed"

**Concerns:** Added complexity and mass

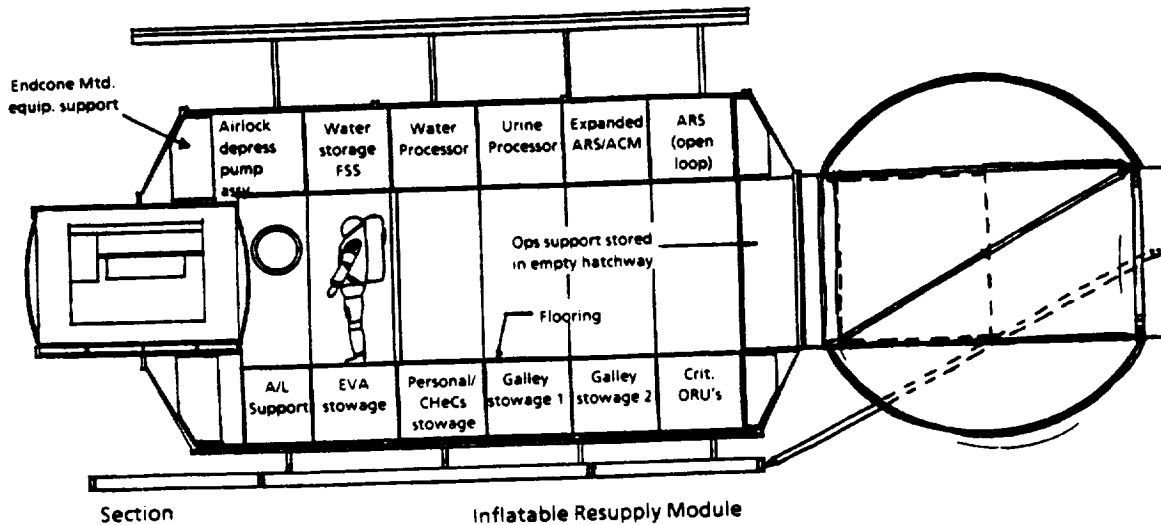

Figure 7-6. FLO Alternative Configurations

ACS041

Because of its efficiency as a pressure vessel, an ellipsoidal shape was selected as an alternative geometry for this study. The ellipsoid was initially sized to provide the same overall pressurized volume as the baseline SSF derived habitat. In this way, a comparison could be made between the two shapes to determine which was more efficient in terms of structural mass, usable volume, habitable volume, and floor area. A preliminary layout of this habitat, using the baseline subsystems packaged volume as a design requirement, was developed and is illustrated in figure 7-7. An analysis of packaged ellipsoid habitat revealed that its pressure vessel mass was slightly less than that of the baseline, if similar construction and materials were assumed for both. The packaging of internal systems was not limited to SSF type racks, and an analysis of habitable internal functions, stowage requirements and equipment types was done to identify which elements could be packaged together, what volumes were required, and what location within the module was most appropriate. The resulting layout shows an improvement in habitable volume of about 10 cubic meters, and an improvement in floor area of about 7 square meters, figure 7-8. The increases in habitable volume are a result of the elimination of "standoffs", the reduction of the size of the airlock intrusion into the habitable volume, and the use of fewer, larger, fixed packaging units (used instead of SSF "racks"). The ellipsoidal habitat seems to have distinct advantages over the baseline, however, until more detail is put into this concept, issues such as standoff volume requirements and access requirements will go unresolved.

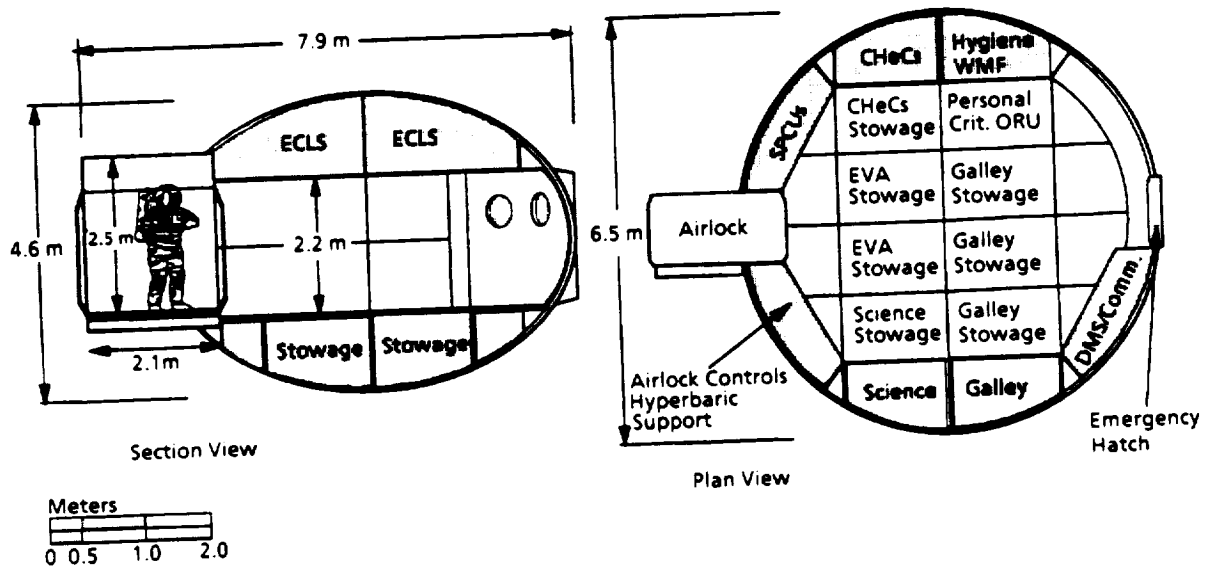

Figure 7-7. FLO Ellipsoidal Habitat Option

AC5081

	Volume Allocated in Baseline FLO Hab	Above Ceiling	Deck Level	Below Deck	Distributed Systems
Airlock Support	1.0	0.0	0.0	1.5	0.0
Depress Pump Assembly	1.0	1.0	0.0	0.0	1.0
SPCUs	2.0	0.0	2.2	0.0	0.0
EVA Stowage	3.0	0.0	0.0	2.0	0.0
AL Controls/Hyperbaric Support	3.0	0.0	2.2	0.0	0.0
CHECs/Stowage	3.0	0.0	2.8	0.0	0.0
Science	3.0	0.0	2.8	0.0	0.0
Science Stowage	0.0	0.0	0.0	1.2	0.0
DMS Comm.	1.0	0.0	2.2	0.0	0.0
Hygiene/WMF	2.0	0.0	2.0	0.0	0.0
Galley	2.0	0.0	2.8	0.0	0.0
Galley Stowage	4.0	0.0	0.8	4.0	0.0
Personal Stowage	1.0	0.0	0.0	2.2	0.0
Critical ORUs	2.0	0.0	0.0	2.4	0.0
OPS Stowage	1.8	0.0	0.0	2.4	0.0
ECLS	14.0	14.0	0.0	0.0	14.0
Utility "Standoff" Volume	13.0	0.0	0.0	0.0	7.9
Airlock Intrusion	5.3	0.2	1.5	0.2	0.2
Rack "Swing" Space	4.8	NA	NA	NA	NA
Endcone Dist. Systems	1.4	NA	NA	NA	NA
Usable Endcone Volume	1.6	NA	NA	NA	NA
Habitable Volume	31.7	0.0	42.5	0.0	0.0
<b>TOTALS</b>	<b>101.6</b>	<b>15.2</b>	<b>61.8</b>	<b>17.7</b>	<b>7.0</b>

= 101.7m<sup>3</sup>

Figure 7-8. Ellipsoidal FLO Hab Volume Analysis

*Goal 4: Better radiation protection.* Several well known concepts exist, all of which involve providing shielding material around or within the habitat. Several of the alternatives to the baseline that were developed have characteristics that would potentially enhance it's ability to protect the crew from solar flares. No schemes were developed in this study, however, that addressed the radiation problem specifically.

*Goal 5: Reduce habitat system mass.* Of all the design issues concerning the FLO hab, mass probably has the greatest impact on the goal of becoming "better, faster and cheaper". Several concepts were developed to address reduction in mass, including construction of the habitat primary and secondary structure by lighter weight materials such as aluminum-lithium or other composites, redesign of the endcone for internal pressure loading only, launch of the hab in a vertical orientation to reduce structural additions that would be required for the baseline horizontal launch configuration and installation of the internal systems in non-rack packaging, as illustrated by the ellipsoidal hab design shown in figure 7-7.

### 7.3 AIRLOCK ALTERNATIVE CONFIGURATIONS

During the course of the alternative concept studies, the suitability of using the SSF crewlock as an airlock for FLO was assessed. Alternatives to the baseline airlock were investigated. Also, recent work performed in conjunction with an in-house study, resulted in an airlock designed specifically for lunar EVA. In considering alternatives to the baseline, the designer is required to look at all of the activities supported by the airlock, and at the systems that are required to perform those activities. A trade tree illustrating airlock "options" is shown in figures 7-9 and 7-10. Options such as size, location, number of personnel and hatch type, are factors to be considered in developing an alternative configuration. Other factors such as hyperbaric operations impose limits on any design options. Three ground rules were established for this study, and they include accommodation of the MARK III EVA suit for sizing purposes, the consideration of hyperbaric operations, and the goal of reducing the mass and volume of the FLO airlock.

The airlock alternatives study yielded two related configurations. The first is an airlock concept resulting from the in-house study. The distinguishing features of this alternative are that it is non-cylindrical, and is shaped to provide standing headroom for suited EVA personnel. It's length is reduced from that of the baseline, but it still accommodates hyperbaric activities (fig. 7-11). Overall volume is reduced from that of the baseline, which should translate into saving in structural mass, volume of repress gas required, reduction of power required to depressurize the airlock, and an increase in habitable volume in the habitat. The second alternative focuses attention not only on airlock geometry, but on location. This concept would locate the new airlock in the



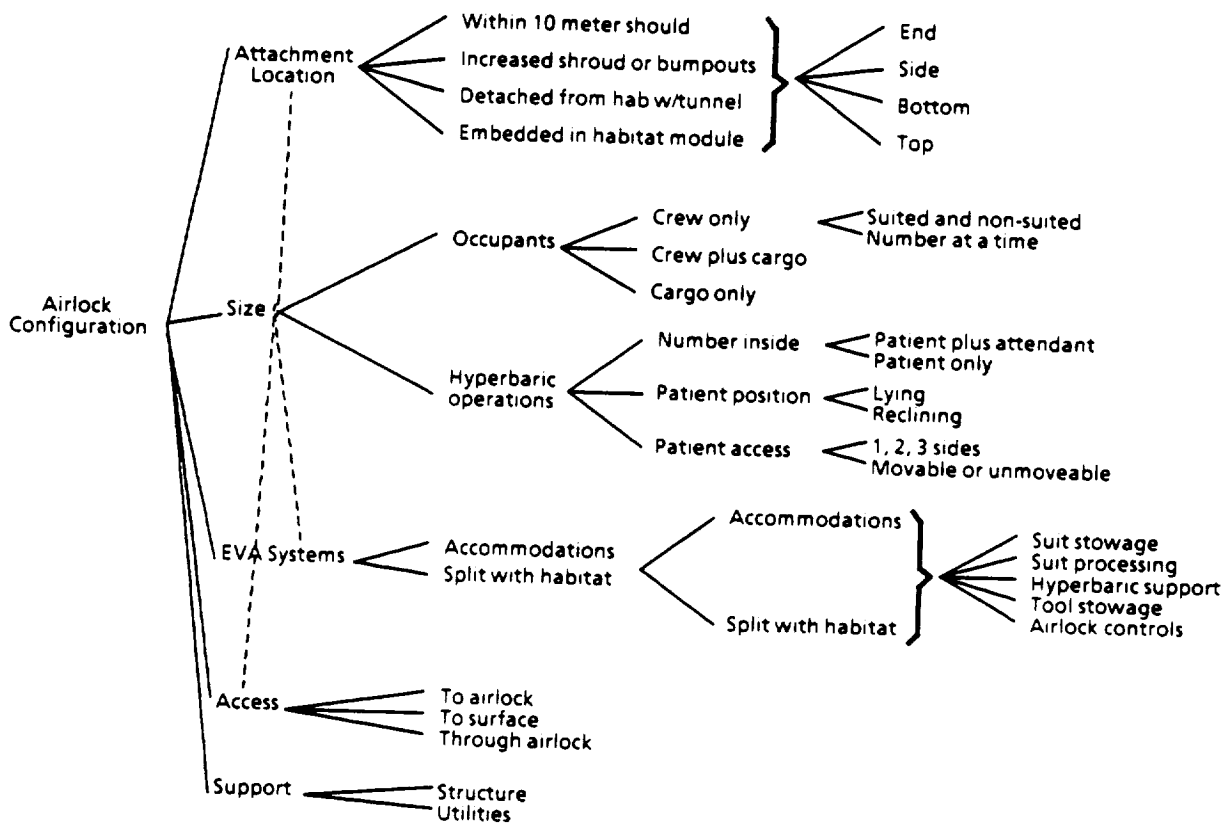

Figure 7-9. Habitat/Airlock Options

center of the baseline habitat cylinder instead of at the end dome. The advantages of this configuration are that it better utilizes the diameter of the launch vehicle shroud, avoids redesigning complex end dome distributed systems, and may reduce the number of racks eliminated by the insertion of the airlock into the habitat. Because the airlock is located at the center of the cylinder, external subsystems such as solar arrays, fuel cells and life support consumables storage, and the structure that supports them, will also have to be reconfigured.

A proposed external configuration that supports the new airlock location is shown in figure 7-12. The addition of a radial port, and the elimination of two racks within the habitat for access to the new airlock, will also change the internal arrangement of the hab, and two proposed layouts are illustrated in figures 7-13 and 7-14.

These new configurations possess advantages, but also raise some questions. Some of the advantages are the separation of the crew living area into "clean" and "dirty" areas, storage of EMUs out of the primary living space, location of the waste management facility away from the galley, and provision for a workstation/observation area in a modified "end dome". Issues associated with the layout of option 1 include relocation of the ADPA function, limitation of volume and area for EMU donning and

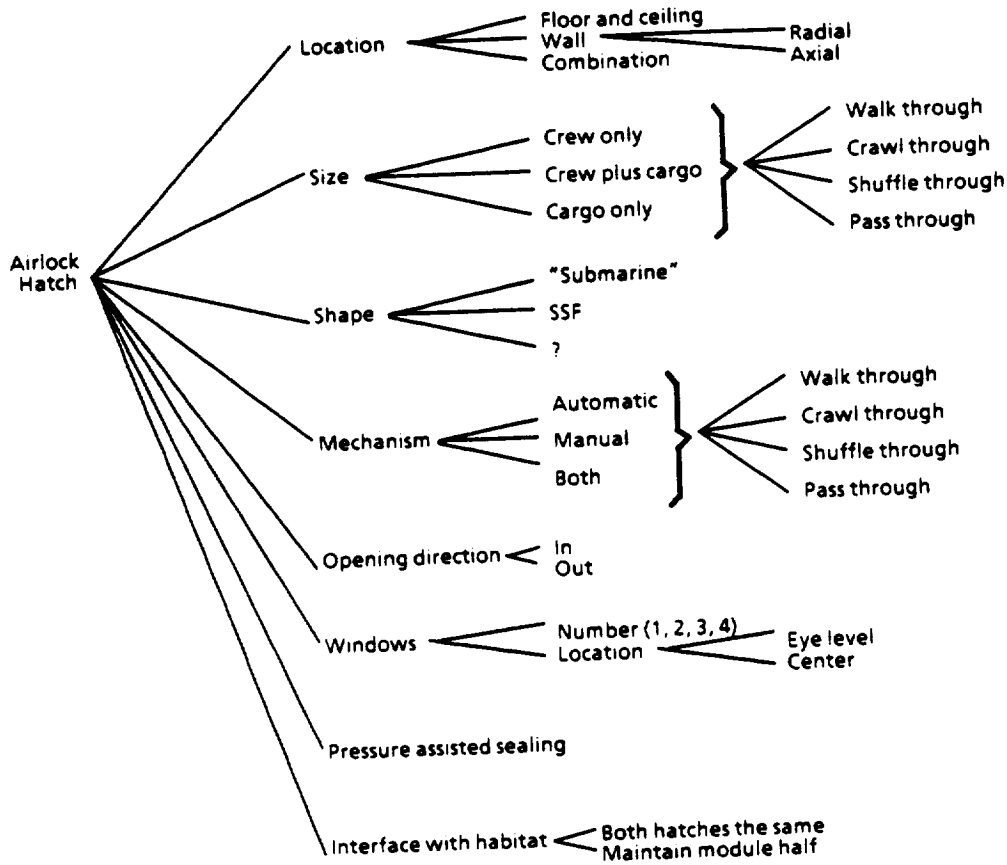
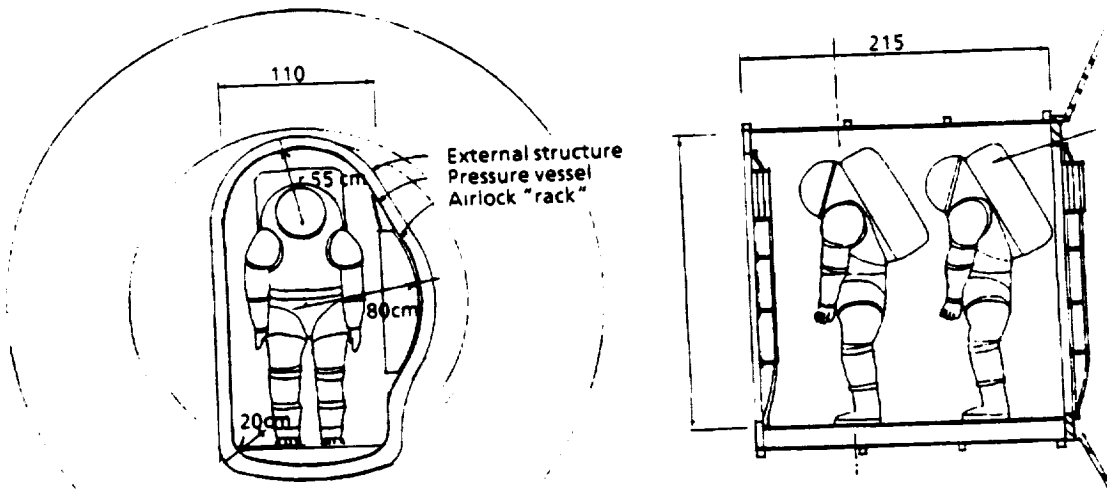

Figure 7-10. Habitat/Airlock Options (Continued)



- Accommodates 2 suited crewmembers (MK III suit shown)
- Accommodates hyperbaric treatment activities
- Minimum volume to conserve gas and power
- Accommodates resupply operations as well as SSF crewlock

ACS082

Figure 7-11. Alternative FLO Airlock

doffing, location of the hyperbaric support rack away from the airlock, and the distribution of module functions throughout the hab, without clearly defined "activity zones". Option 2 enhances the division of the module into "clean" and "dirty" areas while providing more volume for pre- and post-EVA operations, relocating crossover racks to free up prime wall space, and placing hyperbaric support adjacent to the airlock; however, these improvements are made at the expense of significantly affecting the existing ECLSS tier packaging. For both option 1 and option 2, the new "end dome" poses challenges in configuring the storm shelter and endcone equipment.

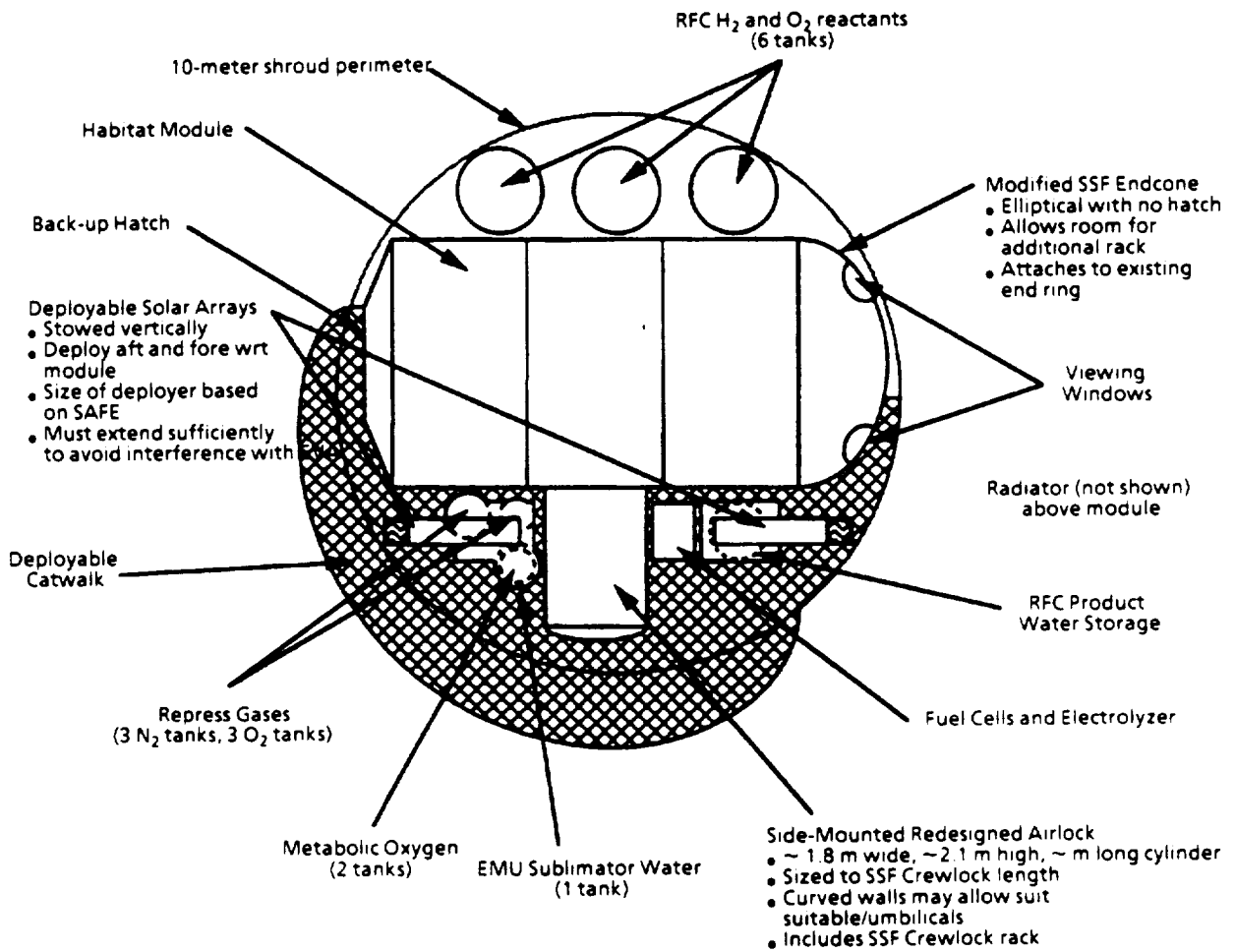

Figure 7-12. Side-Mounted Redesigned Airlock, External Configuration

ACS083

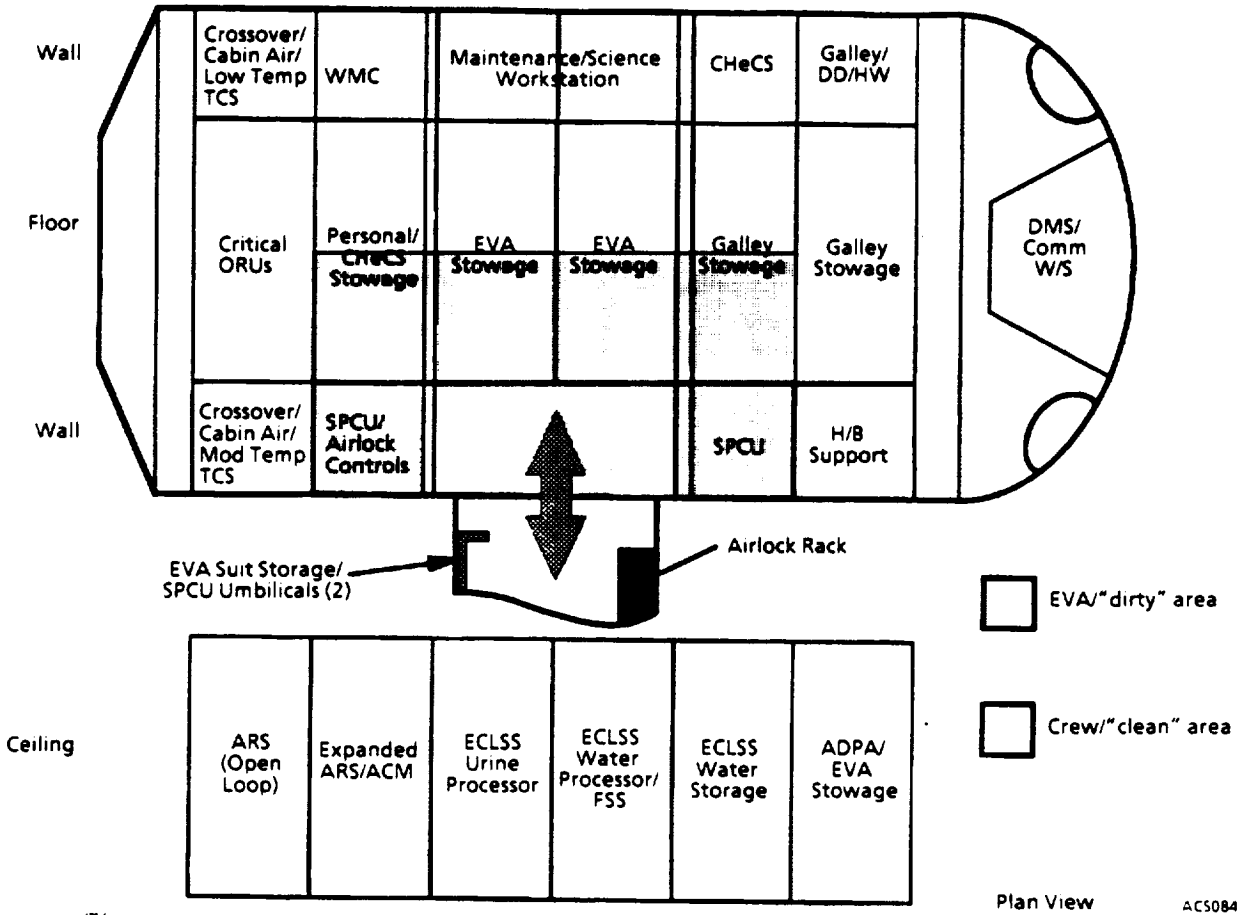

Figure 7-13. Side-Mounted Redesigned Airlock, Internal Configuration - Option 1 Layout

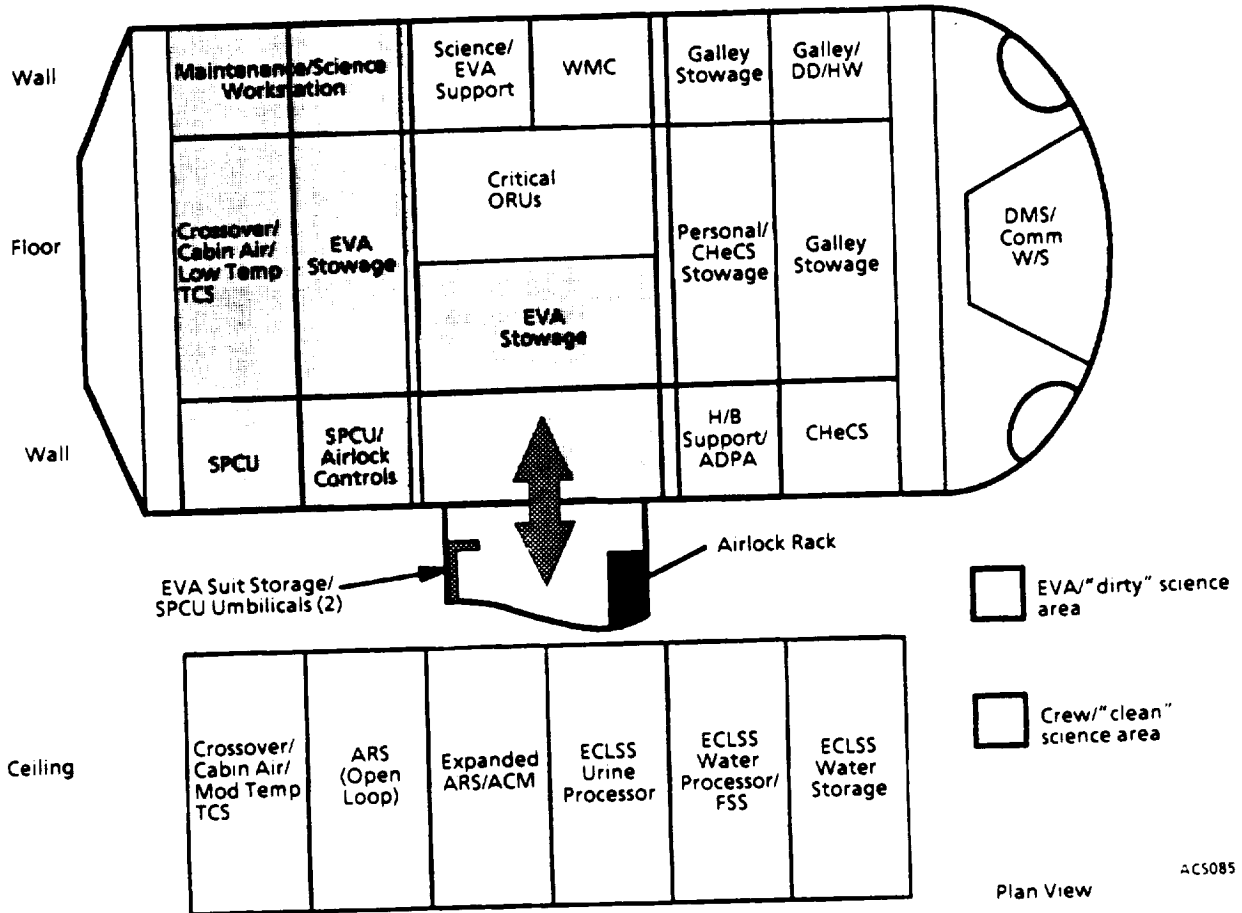

Figure 7-14. Side-Mounted Redesigned Airlock, Internal Configuration - Option 2 Layout

## 8.0 AVIONICS COMMONALITY ASSESSMENT

### 8.1 INTRODUCTION

An avionics commonality assessment was carried out between the First Lunar Outpost, the National Launch System (NLS) type vehicle, and Space Station Freedom. The manner in which this was accomplished is illustrated in figure 8-1.

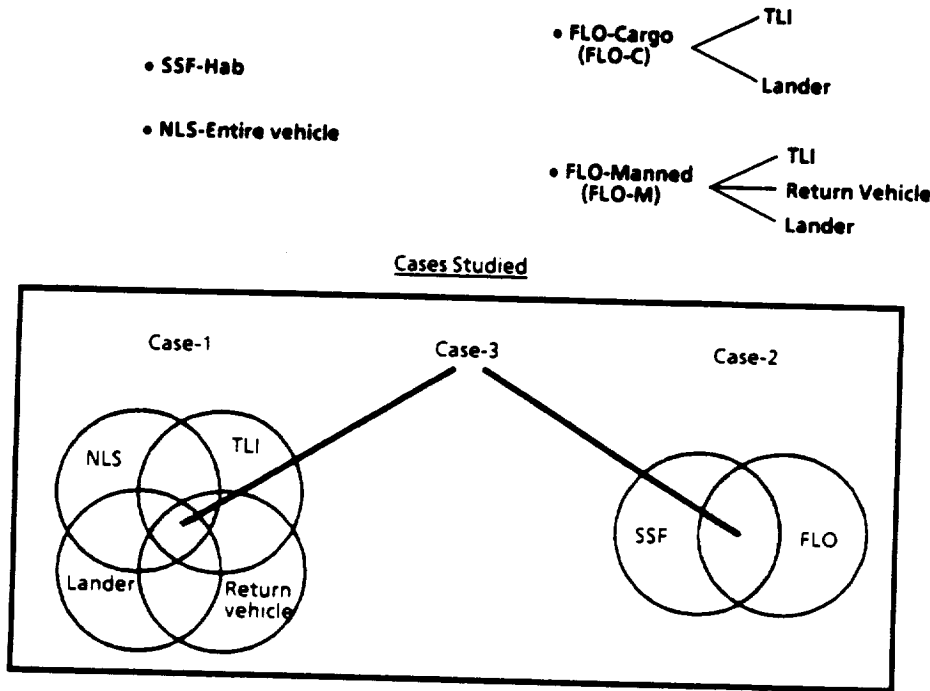

Figure 8-1. Avionics Commonality Assessment

ACS093

The FLO system is comprised of a cargo vehicle (FLO-C) which transports the FLO module to the lunar surface and a separate manned vehicle (FLO-M) that transports a crew to the lunar surface in the vicinity of FLO-C. FLO-C consists of a TLI stage and a Lander stage; it does not have a return stage. FLO-M consists of identical TLI and Lander stages (as FLO-C), in addition to a return stage for the trip back to Earth. These components of the FLO system are represented at the top portion of figure 8-1. This study attempted to identify and characterize beneficial avionics commonality and inheritance between the FLO system, NLS, and SSF. Two commonality assessment cases are illustrated at the bottom of figure 8-1. In Case-1, NLS avionics are compared with the FLO system (TLI, Lander, and Return Vehicle) avionics and in Case-2 the SSF-Hab module is compared with the FLO-Hab module, which is transported to the lunar surface on the FLO-C vehicle. A third case, not explicitly shown in figure 8-1, involves determining the avionics commonality between the shaded regions of Case-1 and Case-2. This last case will then identify the common avionics between NLS, SSF, and the entire FLO system, as illustrated in figure 8-2.

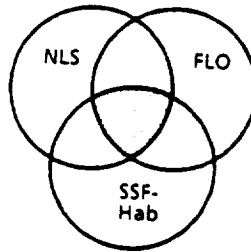

Figure 8-2. Overall Avionics Commonality Between NLS, SSF, and FLO

ACS094

## 8.2 AVIONICS FUNCTIONS

The FLO system is at a conceptual stage of development and much of the avionics hardware is at present undefined. However, this is not the same case with the NLS and SSF where work on these vehicles has progressed to the point where the avionics hardware and software have been defined. Hence, for consistency in this study, avionics are considered at a functional level rather than at the more detailed hardware and software component levels.

Since the term "avionics" can potentially include all flight qualified electronics for any particular vehicle, and this can be a very large number of functions and/or components, this study has bounded avionics to those functions listed in figure 8-3.

- Vehicle management (VM)
- Data management (DM)
- Telemetry and command (T&C)
- Navigation (NV)
- Guidance (Gd)
- Flight Control (FC)
- Communications (CM)
- Propulsion Control (PC)
- Mechanisms & ordnance control (MO)
- Electric power and distribution (EP)
- Environment control (EC)
- Critical fluids control (CF)
- Payload accommodations (PA)
- Emergency detection (ED)
- Collision avoidance (for prox. ops.) (CA)
- Range safety (RS)
- Mission management (MM)
- Mission Unique (MU)
- Fault detection, isolations & recovery (FR)

Figure 8-3. Avionics Functions

This does not imply that all of the vehicles being considered in this study incorporate all these functions. The list is simply provided for completeness.

### 8.2.1 Avionics Sub-Functions

Each of the avionics functions listed in figure 8-3, was further decomposed to lower level of sub-functions. These are listed in figure 8-4. These sub-functions are not exhaustive; only the principal ones associated with each of the functions are listed.

<p><b>VM:</b>                      Mode control test &amp; sequencing                      Command processing &amp; distribution                      Vehicle time keeping                      Vehicle health monitoring                      VM health monitoring</p> <p><b>DM:</b>                      Processing                      Data Storage                      Human interface                      Communication                      Data acquisition &amp; distribution                      DM health management</p> <p><b>T&amp;C:</b>                      Formatting telemetry                      Storage                      Receive                      Transmit                      Decode                      RF link control                      Instrumentation                      T&amp;C health management</p> <p><b>NV:</b>                      Inertial measurement                      Sensor compensation                      State vector computation/update                      Ops processing                      On-rad alignment &amp; sensor bias estimation                      Relative navigation                      Navigation health management</p> <p><b>Gd:</b>                      Guidance prediction &amp; analysis                      Engine cutoff timing                      Translocational thruster firing                      Steering-misalignment correction                      Guidance health monitoring</p>	<p><b>FC:</b>                      Gains computation                      Sensor data acq. &amp; filtering                      Compensation filtering                      Global angle cond. computation                      Wind load alleviation                      Engine actuator mixing                      RCS cmds computation                      FC health management</p> <p><b>PC:</b>                      Engine controller cmds.                      Fluids management                      Gases management                      Secondary PC                      Prop. health management</p> <p><b>MO:</b>                      Mechanism timing/control                      Separation timing/control                      MO health management</p> <p><b>EP:</b>                      Power distribution                      Source control                      Power changeover control                      Source                      EPS health management</p> <p><b>EC:</b>                      Avionics thermal control                      EC health management</p> <p><b>CF:</b>                      Flow control                      Fluids states monitoring                      Emergency detection                      CF health management</p> <p><b>PA:</b>                      Electrical power                      TM and data collection                      PC thermal management                      Mode control                      PA health management</p>	<p><b>ED:</b>                      Out-of-limit detection                      Escape system activation                      Vehicle safing                      ED health management</p> <p><b>CA:</b>                      CA process &amp; control                      Vehicle safing                      CA health management</p> <p><b>RS:</b>                      Tracking beacon                      Destruct cmd receiving                      RS safing                      RS health monitoring</p> <p><b>MM:</b>                      Task scheduling                      Events timing &amp; monitoring                      Overall control &amp; execution                      MM health monitoring</p> <p><b>MU:</b>                      Control &amp; monitoring                      Fault detection, isolation, &amp; recovery                      Emergency detection                      MU health management</p> <p><b>FR:</b>                      Fault detection, isolation, and recovery (FDIR)                      FR health monitoring</p> <p><b>CM:</b>                      Voice - Earth-LEO                      Voice - Earth-Moon                      Voice - Enroute                      Video - Vehicle - external                      Video - Vehicle - internal                      Video - Science                      Data - Biomed                      Data - Payload                      Data - Science</p>
---	--	---

Figure 8-4. Avionics Sub-Functions

Commonality was then addressed from this lower level of functionality. Hardware and software component commonality can be identified from this lower level but was not accomplished at this time.



**8.3 SPECIFIC VEHICLE AVIONICS FUNCTIONS**

For each of the vehicles considered in this study, figure 8-5 lists the required avionics functions from the superset of avionics functions listed in figure 8-3. The abbreviations are as defined in figure 8-3.

Avionics Functions *	National Launch System-Cargo	First Lunar Outpost - Manned Vehicle			Manned Habitats	
		First Lunar Outpost - Cargo Vehicle		FLO - Ret. Veh.	FLO-Hab	SSF-Hab
	NLS	FLO-TLI	FLO-Lander			
VM	X			X		
DM - HI				X	X	X
- NHI	X		X			X
T&C	X	X	X	X		
NV	X		X	X		
Gd	X		X	X		
FC	X		X	X		
PC	X	X	X	X		
MO	X	X	X	X	X (mechanisms)	X (mechanisms)
EP	X	X	X	X	X	X
EC	X	X	X	X	X	X
CF	X	X	X	X	X	X
PA	X		X			
ED	X			X	X	X
CA	X					
RS	X					
MM	X		X	X		
MU	X				X	X
FR	X	X				
CM	(data,video)	(data)	(data,video)	(voice, data, video)	(voice, data, video)	voice, data, video)

\* Abbreviations are defined in figure 8-3  
 HI - Human Interfaces  
 NHI - No Human Interfaces

*Figure 8-5. Required Avionics Functions For Each Vehicle*

The NLS vehicle, being an unmanned heavy lift cargo vehicle, excludes all the avionics that are required to support and interface with a crew during flight. For the FLO system, avionics are separated according to the FLO system elements, defined earlier in figure 8-1, i.e., the TLI, Lander, Return Vehicle stages, and the FLO-Hab module. With respect to SSF, only the SSF-Hab module avionics functions are of interest and are listed. It should be noted that the TLI and Lander stages of FLO-C and FLO-M are identical with the exception that in the FLO-M the crew will have control/monitoring facilities, which are not required on the FLO-C vehicle.

#### 8.4 AVIONICS COMMONALITY ANALYSIS

The total number of commonality assessments (CA), is given by the following combinatorial relationship:

$$CA = \sum_{k=2}^N \frac{N!}{k!(N-k)!};$$

$N$  = Total number of vehicles

$k$  = # vehicles combined;  $2 \leq k \leq N$

This equation simply says that the total number of commonality assessments is equal to the summation of the total number of assessments based on each combination of vehicles from 2 to  $N$ . This study requires a total of 13 commonality assessments from Case-1, Case-2, and the combination of Case-1/Case-2. This equation can be generalized to commonality assessments of other systems and vehicles as well.

##### 8.4.1 Case-1: NLS and FLO

Based on the relationship derived in the previous section, the total number of avionics commonality assessments for Case-1, shown in figure 8-1, is 11, since there are 4 vehicle elements all together. These are the NLS and FLO (TLI, Lander, and Return Vehicle).

For each of the specific vehicle combinations germane to Case-1, the avionics functions with their associated sub-functions are shown in figure 8-6. Those avionics functions, that are deemed to be common to the specific vehicle combination, are indicated by a darkened square symbol. Those functions that are partially common to all the vehicle combinations, are shown by a partially shaded square symbol and those vehicle combinations that do not share specific avionics functions are marked by an unshaded square symbols. A square with an X marked in it indicates that only the specific vehicle combination has only X-marked avionics sub-functions in common. Each of these symbols is defined in the legend in figure 8-6. From this commonality analysis, it appears that the avionics functions shared by all vehicle combinations (marked by the shaded square) for Case-1, are the following: VM, T&C, PC, MO, EP, EC, CF, and FR.

##### 8.4.2 Case-2: SSF-Hab and FLO-Hab

For Case-2, there is only a single assessment of avionics commonality that has to be performed. The common avionics functions between the SSF-Hab module and the FLO-Hab module, shown as Case-2 on the left axis of the figure is presented in figure 8-6. Common avionics functions between these elements are DM, T&C, EP, EC, CF, ED, and FR functions. Since the FLO-Hab is a Lunar habitation element, certain functions will be required that will not be required by the SSF-Hab (which is meant for LEO) and vice versa.

Commonality Assessment Combinations	VM 1. Mode control & sequencing 2. Command processing & distribution 3. Vehicle time keeping 4. Vehicle health monitoring 5. VM health monitoring					DM 1. Data processing 2. Data storage 3. Human interface 4. Communication 5. Data acquisition & distribution 6. DM health monitoring						T&C 1. Formatting telemetry 2. Storage 3. Receive 4. Transmit 5. Decode 6. RF link control 7. Instrumentation 8. T&C health monitoring							
	1	2	3	4	5	1	2	3	4	5	6	1	2	3	4	5	6	7	8
	VM	DM	DM	DM	DM	DM	DM	DM	DM	DM	DM	T&C	T&C	T&C	T&C	T&C	T&C	T&C	T&C
1. NLS-TLI-LN-RV	■					■	x		x		x								
2. NLS-TLI-LN							x		x		x								
3. NLS-TLI-RV																			
4. NLS-LN-RV																			
5. TLI-LN-RV																			
6. NLS-TLI																			
7. NLS-LN																			
8. NLS-RV																			
9. TLI-LN																			
10. TLI-RV																			
11. LN-RV																			
CASE-2 SF-FLO-HAB																			
CASE-1/ CASE-2 NLS-FLO-SSF							x		x		x								

= Common to all vehicles/all combinations  
 = X'd sub-functions common to all vehicles/all combinations (applicable sub-functions are X'd)  
 = Common only to specific vehicle combinations  
 = No commonality between any vehicle combinations except those marked by

Figure 8-6. NLS-FLO Commonality Analysis

Commonality Assessment Combinations	NV 1. Inertial measurement 2. Sensor compensation 3. State vector computation 4. GPS processing 5. On-pad alignment 6. Relative navigation 7. NV health monitoring							Gd 1. Guidance prediction & analysis 2. Engine cutoff timing 3. Translational thruster correction 4. Steering-misalignment 5. Gd health monitoring					FC 1. Gains computation 2. Sensor data acquisition/filtering 3. Compensation filtering 4. Gimbal angle command 5. Wind load alleviation 6. Engine actuator mixing 7. RCS command computation 8. FC health monitoring							
	1.	2.	3.	4.	5.	6.	7.	1.	2.	3.	4.	5.	1.	2.	3.	4.	5.	6.	7.	8.
1. NLS-TLI-LN-RV	<input type="checkbox"/>																			<input checked="" type="checkbox"/>
2. NLS-TLI-LN																				
3. NLS-TLI-RV																				
4. NLS-LN-RV	<input checked="" type="checkbox"/>	X	X	X	X	X	X		X	X	X	X		X	X	X	X	X	X	
5. TLI-LN-RV																				
6. NLS-TLI																				
7. NLS-LN	<input checked="" type="checkbox"/>	X	X	X	X	X	X		X	X	X	X		X	X	X	X	X	X	
8. NLS-RV	<input checked="" type="checkbox"/>	X	X	X	X	X	X		X	X	X	X		X	X	X	X	X	X	
9. TLI-LN																				
10. TLI-RV																				
11. LN-RV	<input checked="" type="checkbox"/>	X	X	X	X	X	X		X	X	X	X		X	X	X	X	X	X	
CASE-2																				
CASE-1/ CASE-2																				

= Common to all vehicles/all combinations  
 = X'd sub-functions common to all vehicles/all combinations (applicable sub-functions are X'd)  
 = Common only to specific vehicle combinations  
 = No commonality between any vehicle combinations except those marked by

Figure 8-6. NLS-FLO Commonality Analysis (Continued)

Commonality Assessment Combinations	PC 1. Engine control commands 2. Fluids management 3. Gases management 4. Secondary PC 5. PC health monitoring					MO 1. Mechanism timing & control 2. Separation timing & control 3. MO health monitoring			EP 1. Power distribution 2. Source control 3. Power changeover control 4. Source 5. EP health monitoring					EC 1. Avionics thermal control 2. EC health monitoring		CF 1. Flow control 2. Fluids state monitoring 3. Emergency detection 4. CF health monitoring			
	1.	2.	3.	4.	5.	1.	2.	3.	1.	2.	3.	4.	5.	1.	2.	1.	2.	3.	4.
1. NLS-TLI-LN-RV	■					■			■					■					
2. NLS-TLI-LN																			
3. NLS-TLI-RV																			
4. NLS-LN-RV																			
5. TLI-LN-RV																			
6. NLS-TLI																			
7. NLS-LN																			
8. NLS-RV																			
9. TLI-LN																			
10. TLI-RV																			
11. LN-RV																			
CASE-1																			
CASE-2						■					X								
CASE-1/ CASE-2						■					X								

= Common to all vehicles/all combinations  
 = X'd sub-functions common to all vehicles/all combinations (applicable sub-functions are X'd)  
 = Common only to specific vehicle combinations  
 = No commonality between any vehicle combinations except those marked by

Figure 8-6. NLS-FLO Commonality Analysis (Continued)

Commonality Assessment Combinations	PA 1. Electrical power 2. TM & data collection 3. PC thermal management 4. Mode control 5. PA health monitoring					ED 1. Out-of-limit detection 2. Escape system activation 3. Vehicle safing 4. ED health monitoring				CA 1. CA process & control 2. Vehicle safing 3. CA health monitoring				RS 1. Tracking beacon 2. Destruct command receiving 3. RS safing 4. RS health monitoring				MM 1. Task scheduling 2. Events timing & monitoring 3. Overall control/execution 4. MM health monitoring			
	PA 1	PA 2	PA 3	PA 4	PA 5	ED 1	ED 2	ED 3	ED 4	CA 1	CA 2	CA 3	RS 1	RS 2	RS 3	RS 4	MM 1	MM 2	MM 3	MM 4	
1. NLS-TLI-LN-RV	<input type="checkbox"/>					<input checked="" type="checkbox"/>	X	X	X	<input type="checkbox"/>											
2. NLS-TLI-LN																					
3. NLS-TLI-RV					X																
4. NLS-LN-RV	<input checked="" type="checkbox"/>	X	X	X																	
5. TLI-LN-RV																					
6. NLS-TLI																					
7. NLS-LN	<input checked="" type="checkbox"/>	X	X	X	X					<input checked="" type="checkbox"/>	X	X	X								
8. NLS-RV	<input checked="" type="checkbox"/>	X	X	X	X																
9. TLI-LN																					
10. TLI-RV																					
11. LN-RV	<input checked="" type="checkbox"/>	X	X	X	X																
CASE-1																					
12. SSF-HAB/FLO-HAB	<input type="checkbox"/>																				
CASE-2																					
13. NLS-FLO-SSF	<input type="checkbox"/>																				
CASE-1/ CASE-2																					

= Common to all vehicles/all combinations  
 = X'd sub-functions common to all vehicles/all combinations (applicable sub-functions are X'd)  
 = Common only to specific vehicle combinations  
 = No commonality between any vehicle combinations except those marked by

Figure 8-6. NLS-FLO Commonality Analysis (Continued)

Commonality Assessment Combinations	MU 1. Control & monitoring 2. FDIR 3. Emergency detection 4. MU health monitoring				FR 1. FDIR 2. FR health monitoring		CM 1. VC-E-LEO 2. VC-E-Moon 3. VC-Enroute 4. Vd-Vehicle, external 5. Vd-Vehicle, internal 6. Vd-Science 7. Dt-Biomed 8. Dt-Payload 9. Dt-Science											
	1	2	3	4	1	2	CA	1	2	3	4	5	6	7	8	9		
	MU	1	2	3	4	FR	1	2	CA	1	2	3	4	5	6	7	8	9
1 NLS-TLI-LN-RV	<input type="checkbox"/>					<input checked="" type="checkbox"/>			<input checked="" type="checkbox"/>			X						
2 NLS-TLI-LN																		
3 NLS-TLI-RV									<input checked="" type="checkbox"/>									
4 NLS-LN-RV									<input checked="" type="checkbox"/>									
5 TLI-LN-RV									<input checked="" type="checkbox"/>									
6 NLS-TLI									<input checked="" type="checkbox"/>									
7 NLS-LN	<input checked="" type="checkbox"/>								<input checked="" type="checkbox"/>									
8 NLS-RV									<input checked="" type="checkbox"/>									
9 TLI-LN																		
10 TLI-RV																		
11 LN-RV																		
CASE-2	<input type="checkbox"/>																	
CASE-1/ CASE-2	<input type="checkbox"/>																	

= Common to all vehicles/all combinations  
 = X'd sub-functions common to all vehicles/all combinations (applicable sub-functions are X'd)  
 = Common only to specific vehicle combinations  
 = No commonality between any vehicle combinations except those marked by

Figure 8-6. NLS-FLO Commonality Analysis (Concluded)

### 8.4.3 Overall NLS, SSF, and FLO Commonality

The final case is the determination of avionics commonality between the shaded portions of Case-1 and Case-2, shown earlier in figure 8-1. As shown in figure 8-6, the avionics functions that permeate through each of the vehicles considered in this study are the T&C, EP, EC, CF, and FR avionics functions and the partially common avionics are as indicated by the partially shaded square symbol in the figure.

### 8.5 KEY TECHNOLOGIES AND THEIR PRIORITY

Technologies, whose development and incorporation into the FLO system will improve its performance and reliability and perhaps aid in the reduction of overall avionics systems mass, are summarized in figure 8-7.

Driving Requirements		Reduce mission operation costs	Reduce Ground/SSF Operation Costs	Self-inspection/diagnostics	Increased number of transducers	Transducer data rate	Robust flight control	High performance processing	Module level fault detection	Minimize avionics implementation cost
		Avionics Technology Areas & Levels								
Device										
1	Application specific ICs			X				X	X	X
2	Fiber optic sensors			X					X	X
3	Neural networks			X	X			X		X
4	Navigation instruments						X			X
Network										
5	Digital data buses					X	X	X		
6	Sensor networks			X	X	X				X
7	Standard interfaces		X		X					X
Subsystems										
8	Autonomous nav subsys.	X	X				X			X
9	Autonomous guid subsys	X			X		X			
10	Vehicle health monitoring	X	X	X	X				X	
11	Expert systems	X	X	X					X	
12	Fault tolerant avionics	X	X	X					X	
13	Communication and Tracking	X	X							
14	Regenerable power source	X								X

Figure 8-7. Key Avionics Technologies

Each of the technology areas is further subdivided into specific technologies associated with each technology areas. An indication of the technology development priorities are shown in figure 8-8. Those technologies that should receive early attention are shown by the lower number in the priority column.



Specific Avionics Technologies	Priority	Rationale
1. Application specific integrated circuits • ASIC/VHSIC/SoS Microelectronics • Wafer Micro subsystems	9	
2. Fiber optic sensors • Optically powered sensors • Micro laser diode transceivers • Multifunction sensors • Protective/sensitive fiber coatings	10	
3. Neural networks • Neural network hardware • Parallel processing • Vector processing	12	Early development not essential for FLO
4. Navigation instruments • Fiber optic gyro • Quartz accelerometer technology	6	Solid state NV will reduce mass and increase reliability
5. Digital data buses • Fiber optic couplers/splitters • Micro laser diode transceivers • Optical quality fibers • Radiation hardened LAN	4	Necessary to handle large volumes of data between subsystems
6. Sensor networks • Multifunctions sensors • Integrated optics	13	
7. Standard interfaces • Free space interfaces • Standard digital interface for all flight elements • Standard interface across vehicles • Packaging	3	Essential for commonality to work especially if avionics are functionally similar but different in terms of part numbers.
8. Navigation subsystems • Navigation algorithm • Sensor fusion • Synthetic aperture radar (SAR) • Range/range rate radar • Embedded, phased array antennas • GPS/Stellar/IMU	8	
9. Guidance and control • Adaptive guidance algorithm • Sensor data fusion • Parallel processing	7	Automated systems will require advanced algorithms to guide vehicle unassisted throughout mission.
10. Vehicle health monitoring • Modular, subsystem automated testsets • Advanced system diagnostics • Smart sensors • Sensor data fusion • Fiber optic sensors • Optical disk drive system • Ferro electric memory • Development tools	2	Necessary as feedback to operators and astronauts
11. Expert Systems • Expert system selfcheck • Failure trend analysis • Failure forecasting • Planning • Repair	14	Of greater use on the ground for diagnosis, maintenance
12. Fault tolerant avionics and avioptics • Fault tolerant processor (self-repair) • Parallel processing • High total dose radiation tolerance • Fault tolerant architectures • Photonics	1	Increased mission success rate even with failures or degradation in redundant avionics systems
13. Communication and tracking • Image compression ICs • High power laser diodes • Laser communications	5	Necessary for the transfer of large volumes of data between Earth and Space
14. Regenerable power sources • Advanced fuel cells • Low mass/high energy rechargeable batteries	11	

Figure 8-8. Specific Avionics Technology Development Priority

## 8.6 SUMMARY AND CONCLUSIONS

This study has investigated the commonality in avionics functions for the FLO NLS, and SSF-Hab systems. The avionics functions were decomposed to specific avionics sub-functions and a commonality assessment was performed. The general conclusion drawn from this study is that although each of the system considered in this assessment, serve completely different missions, there are avionics functions that can be common to all. From the sub-functions level, common avionics hardware and software can also be derived.

Following the commonality assessment, specific technology areas were extracted from the list of avionics functions to determine the specific avionics technologies that should perhaps receive early attention during the development phase.

## 8.7 DATA SOURCES

Available data to perform this brief assignment may be found in a large number of sources. For the current effort, data was obtained from a few sources which are identified below.

- a. Boeing Space Station Program Office, "Architectural Control Document - Data Management System", Sept. 1991.
- b. Boeing Space Station Program Office, "Architectural Control Document - Communications and Tracking Systems", June 1991.
- c. Boeing Space Station Freedom Program Office, Element Description Handbook, Volume 2 - U.S. Lab Modules, Issue D, Oct. 1991.
- d. Boeing Space Station Freedom Program Office, Element Description Handbook, Volume 3 - Habitation Modules, Issue C, Oct. 1991.
- e. The Boeing Company, STV Contract Final Report, Doc. No. D180-32040-2, 1991.
- f. The Boeing Company, "First Lunar Outpost Study", Oct. 1992.
- g. Ron Kahl, NASA-ExPO, "Space Transportation/Lander Subteam Report to SEIAA", April 1992.
- h. "National Launch System Avionics - Product Development Team 'Cycle 0' Summary", Jan. 1992.
- i. NASA-MSFC, "First Lunar Outpost, Lunar Habitat Documentation", May 1992.

## 9.0 LAUNCH VEHICLE SIZE TRADE AND RELATED SUBJECTS

### 9.1 ASSEMBLY OPTIONS AND CONCEPTS

A review was made of tank sizing and assembly criteria and analysis, as well as, design and manifesting assessments. Both the I-Beam and Saddle platform designs were considered. The features of these designs are given in figure 9-1 and further defined under the individual headings listed below.

Two Concepts	
I-Beam Concept	<ul style="list-style-type: none"> <li>Designed to have the most of the service functions located on the platform</li> <li>Allows checkout of the vehicle systems with platform backup</li> <li>Vehicle systems are conserved for the Mars departure (management of MTBF on critical systems)</li> <li>Served as an "at hand" parts storage area</li> <li>It is its own resource node.</li> </ul>
"Saddle" Concept	<ul style="list-style-type: none"> <li>Designed to use the vehicle systems as much as possible</li> <li>Long-term vehicle systems checkout prior to Mars departure</li> <li>Small and more easily reconfigurable with SSF support</li> <li>Does not appear to require a separate launch.</li> </ul>

Figure 9-1. Assembly Options/Concepts

A launch vehicle size trade was supported with calculations of vehicle mass and tank size for manifesting considerations. A description of the conditions from which the data was generated is shown in figure 9-2, and the resultant vehicle parameters are shown in figures 9-3a through 9-3e. Additional orbital and flight mechanics work was done to answer specific questions on the capability of possible vehicle elements, landing site access and nuclear disposal questions. This information is given under its own separate heading in section 9.4.

	250 (mt) Payload Class ETO Vehicle:
Data Sheet	Shroud Sizes: 14 (m) dia by up to 30 (m) cyl length 257 (mt) payload actually delivered by Launch Veh
1	2014 Piloted NTR vehicle: <ul style="list-style-type: none"> <li>IMLEO = 815 (mt)</li> <li>Four ETO flights are necessary for delivery to LEO</li> <li>Veh core up in two flights</li> </ul>
2	2012 Cargo NTR vehicle: <ul style="list-style-type: none"> <li>IMLEO = 216 (mt)</li> <li>Only one ETO flight is necessary for delivery to LEO</li> </ul>
	150 (mt) Payload Class ETO Vehicle:
	Shroud Sizes: (1) 14 (m) dia by up to 30 (m) cyl length 115 (mt) p/l actually delivered by Launch Veh or (2) 10 (m) dia by up to 30 (m) cyl length 132 (mt) p/l actually delivered by Launch Veh
3	2014 Piloted NTR vehicle: <ul style="list-style-type: none"> <li>IMLEO = 815 (mt)</li> <li>Seven ETO flights are necessary for delivery to LEO</li> <li>Veh core up in two flights</li> </ul>
4	2012 Cargo NTR vehicle: <ul style="list-style-type: none"> <li>IMLEO = 216 (mt)</li> <li>Two ETO flights are necessary for delivery to LEO</li> </ul>
	Enhanced 150 (mt) Payload Class ETO Vehicle:
	Increase actual deliverable payload to 148 (mt) to LEO reduces required ETO flights by one, from seven to six.
5	2014 Piloted NTR vehicle: <ul style="list-style-type: none"> <li>IMLEO = 815 (mt)</li> <li>Six ETO flights are necessary for delivery to LEO</li> <li>Veh core up in two flights</li> </ul>

Figure 9-2. Trade Study NTP Vehicle Data Sheets - Summary

MARS SEI VEHICLE DATA SHEET

VEHICLE: NTP Piloted for 250 mt payload class ETO vehicle

LAST DATA UPDATE: 11/20/91 launch veh actually delivers 257 mt P/L max

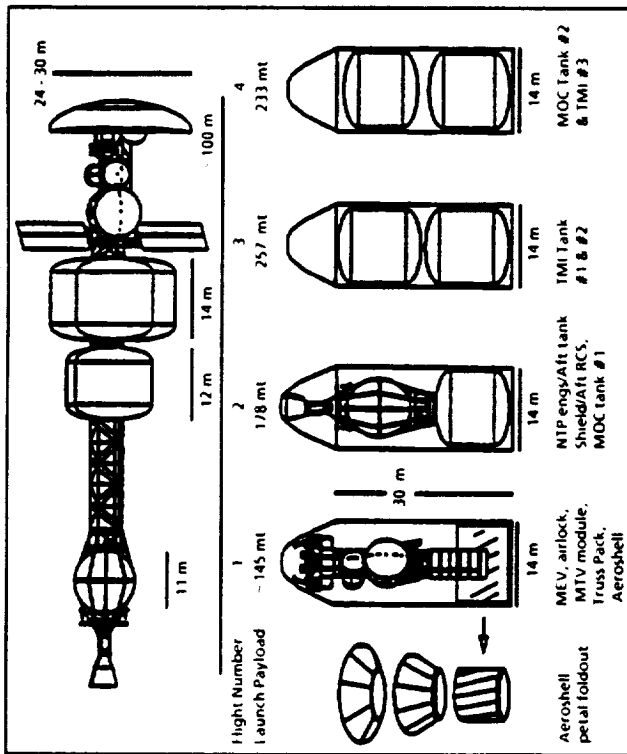

PROPELLANT TANKS

Num Trks	Tank Name	Fluid(s)	Tank Size	Dry Mass (ea)	Prop Mass (ea)	Total Mass (ea)
1	TEI	H2	11 m sphere	9918 kg	52067 kg	61985 kg
2	MOC	H2	14 m by 12.0 m	13070 kg	80286 kg	93356 kg
2	TMI 1&2	H2	14 m by 14.0 m	17990 kg	110510 kg	128500 kg
1	TMI 3	H2	14 m by 15.0 m	19675 kg	120861 kg	140536 kg
6	TOTALS			91713 kg	554520 kg	646233 kg

COMMENTS

Veh sketch serves as representation, not definitive of latest configuration. Level II dV set with losses, 440 d transfer, 90 d stay, elliptical orbits, CRV return to Earth, veh expended, crew of 6, shield weight equals engine weight. NTP engines operate at 2700K, nozzle area ratio of 400:1 - engine performance = 925 secs ISP.

SEI CASE NAME

AC5088

Figure 9-3a. Data Sheet 1

Surface Payload Mass: 5.7 mt payload to the surface  
 Departure Orbit: 407 km 407 km 28.3 deg

IMLEO: 814800 kg  
 ENGINE OUT: Single Engine Out  
 NUMBER OF CREW: 6  
 MTV: QTY: 1  
 INERT MASS: 260360 kg  
 USABLE PROP. MASS: 554520 kg  
 PROPELLANT TYPE: Hydrogen  
 ENG. TYPE/ISP/#: NTP - Carbide Fuel Element/925  
 VAC THRUST (EA): 75000 lbf  
 REACTOR MASS (EA): 3402 kg  
 ELECTRIC CONVERSION CYCLE: ---  
 NOM. PWR LEVEL/PWR SYS MASS: ---  
 LENGTH/WIDTH: ~100 by ~30 m  
 REUSABLE PARTS: Veh core, Eng, aft tank, truss, crew mod, airlock  
 OTHER: QTY: 1  
 INERT MASS: ---  
 USABLE PROP. MASS: ---  
 PROPELLANT TYPE: ---  
 ENG. TYPE/ISP/#: ---  
 VAC THRUST (EA): ---  
 LENGTH/WIDTH: ---  
 A/B SIZE/MASS: ---  
 REUSABLE PARTS: ---  
 MTV: 10/17/91, 0.2 L/D, storable, 5.7 ton down cargo w Asc Sig QTY: 1  
 INERT MASS: 78,522 kg  
 USABLE PROP. MASS: 15,427 kg  
 PROPELLANT TYPE (Descent/Ascent): N<sub>2</sub>O<sub>4</sub>/MMH N<sub>2</sub>O<sub>4</sub>/MMH  
 ENGINES (Descent/Ascent): 4/2  
 THRUST (EA) (Descent/Ascent): 30,000/30,000 lbf  
 ISP (Descent/Ascent): 340 sec  
 LENGTH/WIDTH: ---  
 A/B SIZE MASS: 24 - 30 by 24 - 30 m  
 REUSABLE PARTS: none  
 REFERENCES:

10/25/91 Performance/wt statement: Boeing STCAEM B. Donahue  
 09/10/91 Trajectory/dV set: Level II; g-loss/plane change dV Boeing STCAEM M. Cupples  
 10/15/91 MEV performance/wt statement: Boeing STCAEM B. Donahue  
 OTHER MASS includes masses NOT included in MTV, OTHER, MEV, Prop Tanks, or Payload.  
 Describe OTHER MASS Below

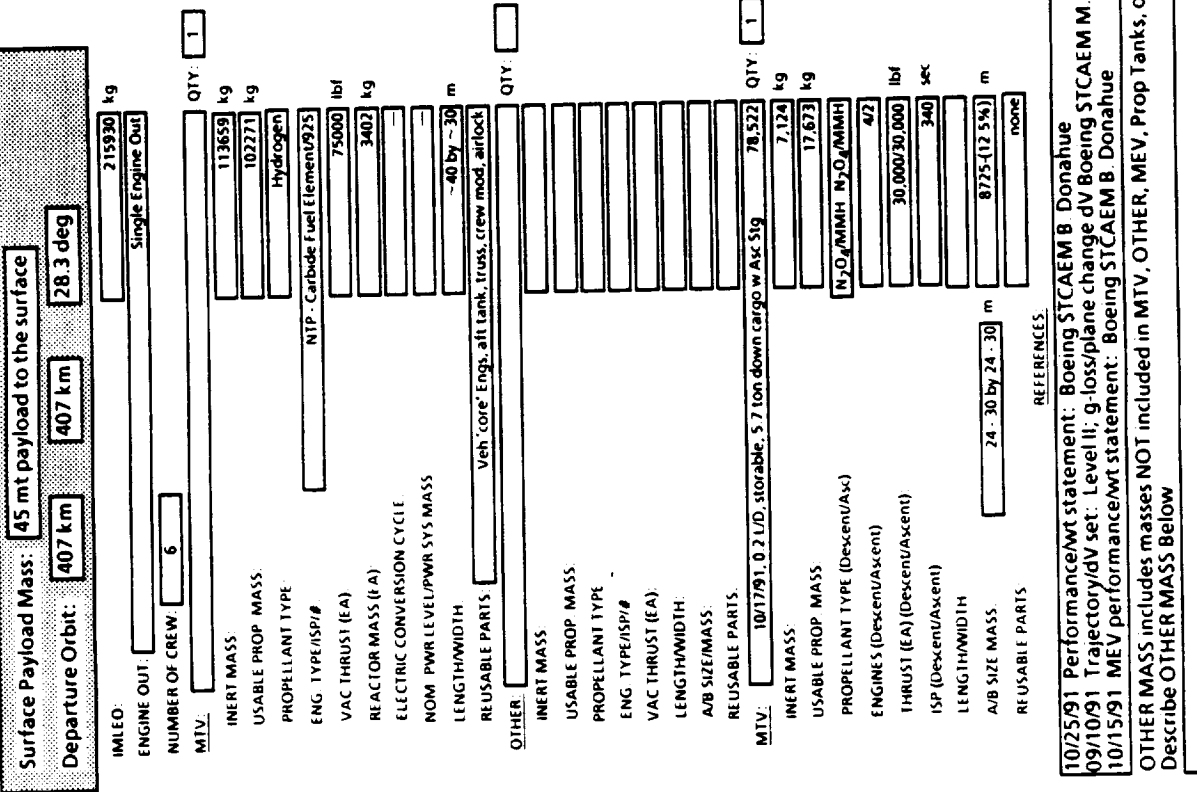
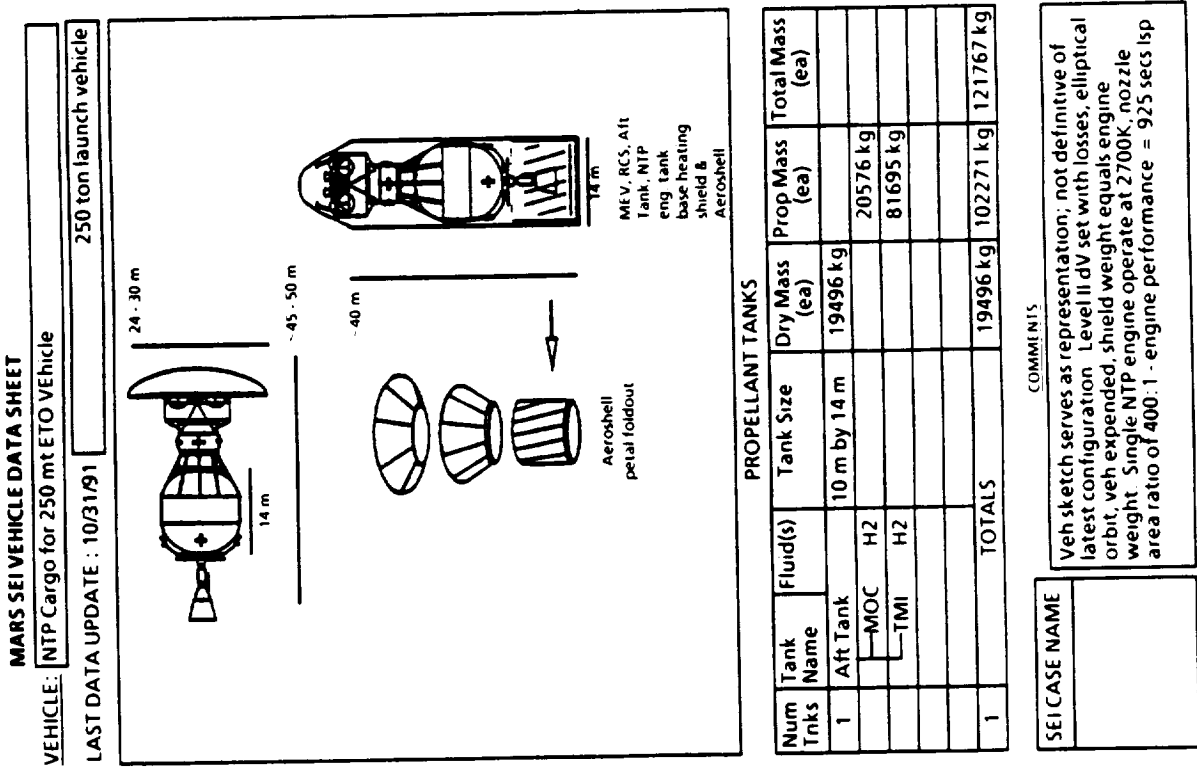
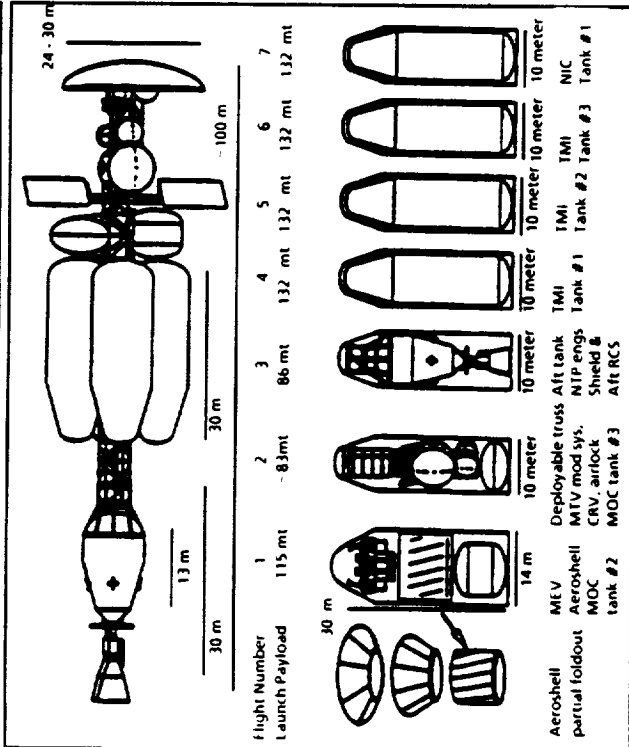

Figure 9-3b. Data Sheet 2

MARS SEI VEHICLE DATA SHEET

VEHICLE: NTP Piloted for 150 mt payload class ETO vehicle

LAST DATA UPDATE : 11/20/91 [launch veh actually delivers 132 mt P/L max



PROPELLANT TANKS

Num Tanks	Tank Name	Fluid(s)	Tank Size	Dry Mass (ea)	Prop Mass (ea)	Total Mass (ea)
1	TEI	H2	10m by 13.0 m	9918 kg	52067 kg	61985 kg
1	MOC #1	H2	10 m by 30.0 m	18500 kg	113500 kg	132000 kg
1	MOC #2	H2	10 m by 8.5 m	5138 kg	31562 kg	36700 kg
1	MOC #3	H2	10 m by 5.0 m	3000 kg	15302 kg	18302 kg
3	TMI	H2	10 m by 30.0 m	18500 kg	113500 kg	132000 kg
7	TOTALS			92056 kg	552931 kg	649987 kg

COMMENTS

Veh sketch serves as representation; not definitive of latest configuration. Level II dV set with losses, elliptical orbit, veh expended, shield weight equals engine weight. Single NTP engine operate at 2700K, nozzle area ratio of 400: 1 - engine performance = 925 secs Isp

AC5090

Figure 9-3c. Data Sheet 3

Surface Payload Mass: 5.7 mt payload to the surface  
 Departure Orbit: 407 km 407 km 28.3 deg

IMLEO: 814880 kg  
 ENGINE OUT: Single Engine Out  
 NUMBER OF CREW: 6  
 MTV: 1  
 INERT MASS: 261949 kg  
 USABLE PROP MASS: 552931 kg  
 PROPELLANT TYPE: Hydrogen  
 ENG TYPE/ISP/#: NTP - Carbide Fuel Element/925  
 VAC THRUST (EA): 75000 lbf  
 REACTOR MASS (EA): 3402 kg  
 ELECTRIC CONVERSION CYCLE: -  
 NOM PWR LEVEL/PWR SYS MASS: -  
 LENGTH/WIDTH: ~ 100 by ~ 30 m  
 REUSABLE PARTS: Veh 'core' Eng, aft tank, truss, crew mod, airlock  
 OTHER: -  
 INERT MASS: -  
 USABLE PROP MASS: -  
 PROPELLANT TYPE: -  
 ENG TYPE/ISP/#: -  
 VAC THRUST (EA): -  
 LENGTH/WIDTH: -  
 A/B SIZE/MASS: -  
 REUSABLE PARTS: -  
 MTV: 10/17/91, 0.2 L/D, storable, 5.7 ton down cargo w Asc Sig  
 INERT MASS: 78,522 kg  
 USABLE PROP MASS: 15,427 kg  
 PROPELLANT TYPE (Descen/Asc): N<sub>2</sub>O<sub>4</sub>/MMH N<sub>2</sub>O<sub>4</sub>/MMH  
 ENGINES (Descen/Asc): 4/2  
 THRUST (EA) (Descen/Asc): 30,000/30,000 lbf  
 ISP (Descen/Asc): 340 sec  
 LENGTH/WIDTH: 24 - 30 by 24 - 30 m  
 A/B SIZE MASS: 8725-(12.5%) m  
 REUSABLE PARTS: none

REFERENCES:

10/25/91 Performance/Wt statement: Boeing STCAEM B. Donahue  
 09/10/91 Trajectory/dV set: Level II; g-loss/plane change dV Boeing STCAEM M. Cupples  
 10/15/91 MEV performance/Wt statement: Boeing STCAEM B. Donahue  
 OTHER MASS includes masses NOT included in MTV, OTHER, MEV, Prop Tanks, or Payload.  
 Describe OTHER MASS Below

**MARS SEI VEHICLE DATA SHEET**  
 VEHICLE: NTP Cargo for 150 mt ETO Vehicle  
 LAST DATA UPDATE : 10/31/91 launch veh actually delivers 132 mts p/l max

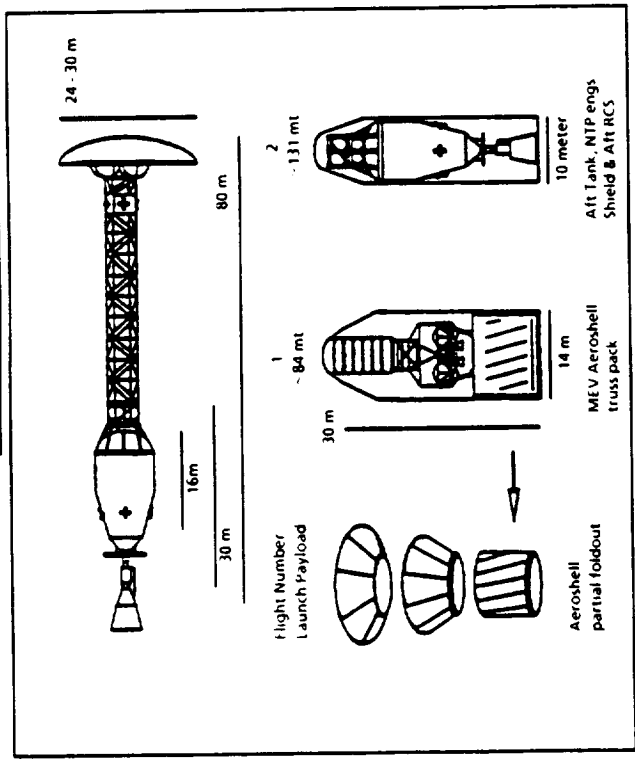

**PROPELLANT TANKS**

Num Trks	Tank Name	Fluid(s)	Tank Size	Dry Mass (ea)	Prop Mass (ea)	Total Mass (ea)
1	Aft Tank		10 m by 16 m	19496 kg	20576 kg	
	MOC	H2			81695 kg	
	TMI	H2				
1	TOTALS			19496 kg	102271 kg	121767 kg

**SEI CASE NAME**

**COMMENTS**  
 Preliminary data. Veh sketch serves as representation; not definitive of latest configuration. Level II dV set with losses, elliptical orbit, veh expended, shield weight equals engine weight. Single NTP engine operate at 2700K, nozzle area ratio of 400:1 - engine performance = 925 secs isp

Surface Payload Mass: 45 mt payload to the surface  
 Departure Orbit: 407 km 407 km 28.3 deg

IMLEO: 215930 kg  
 ENGINE OUT: Single Engine Out

NUMBER OF CREW: 6  
 MTV: 1.1

INERT MASS: 113659 kg  
 USABLE PROP. MASS: 102271 kg  
 PROPELLANT TYPE: Hydrogen  
 ENG. TYPE/ISP/#: NTP - Carbide Fuel Element/925  
 VAC THRUST (EA): 75000 lbf  
 REACTOR MASS (EA): 3400 kg  
 ELECTRIC CONVERSION CYCLE: -  
 NOM. PWR LEVEL/PWR SYS MASS: -  
 LENGTH/WIDTH: ~80 by ~30 m  
 REUSABLE PARTS: Veh. core' Eng's. aft tank, truss, crew mod, airlock  
 OTHER: QTY: 0

INERT MASS: -  
 USABLE PROP. MASS: -  
 PROPELLANT TYPE: -  
 ENG. TYPE/ISP/#: -  
 VAC THRUST (EA): -  
 LENGTH/WIDTH: -  
 A/B SIZE/MASS: -  
 REUSABLE PARTS: -

MTV: 10/17/91, 0.2 L/D, storable, 5.7 ton down cargo w Asc Stig QTY: 1  
 INERT MASS: 7,124 kg  
 USABLE PROP. MASS: 17,673 kg  
 PROPELLANT TYPE (Descent/Ascent): N<sub>2</sub>O<sub>4</sub>/MMH N<sub>2</sub>O<sub>4</sub>/MMH  
 ENGINES (Descent/Ascent): 4/2  
 THRUST (EA) (Descent/Ascent): 30,000/30,000 lbf  
 ISP (Descent/Ascent): 340 sec  
 LENGTH/WIDTH: 24 : 30 by 24 : 30 m  
 A/B SIZE MASS: 8725 (12.5%)  
 REUSABLE PARTS: none

**REFERENCES:**

10/25/91 Performance/Wt statement: Boeing STCAEM B Donahue  
 09/10/91 Trajectory/dV set: Level II; g loss/plane change dV Boeing STCAEM M. Cupples  
 10/15/91 MEV performance/wt statement: Boeing STCAEM B. Donahue  
 OTHER MASS includes masses NOT included in MTV, OTHER, MEV, Prop Tanks, or Payload.  
 Describe OTHER MASS Below

Figure 9-3d: Data Sheet 4

MARS SEI VEHICLE DATA SHEET

VEHICLE: NTP Piloted for 150 mt payload class ETO vehicle

LAST DATA UPDATE : 11/20/91 [launch veh actually delivers 148 mt P/L max

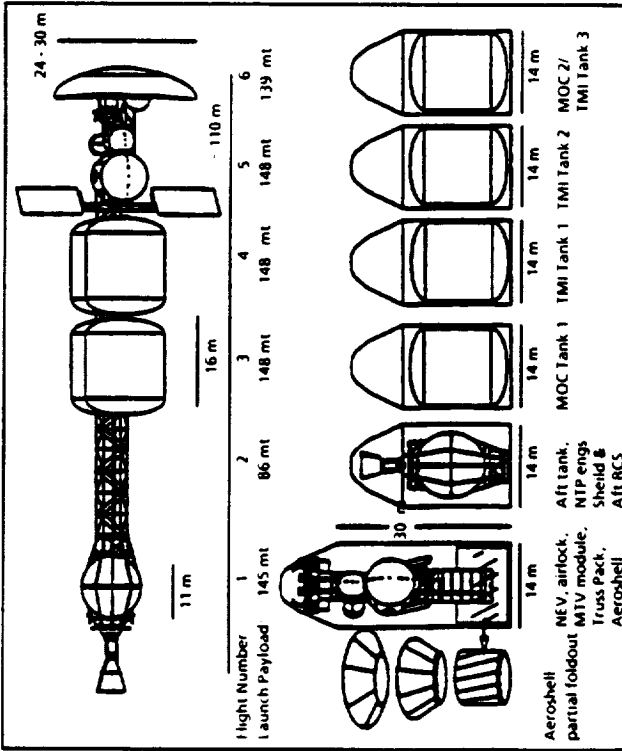

PROPELLANT TANKS

Num Tanks	Tank Name	Fluid(s)	Tank Size	Dry Mass (ea)	Prop Mass (ea)	Total Mass (ea)
1	TEI	H2	11 m sphere	9918 kg	52067 kg	61985 kg
1	MOC 1	H2	14 m by 16 m	20720 kg	127280 kg	148000 kg
2	TMI 1&2	H2	14 m by 16 m	20720 kg	127280 kg	148000 kg
1	MOC2/TMI 3	H2	14 m by 15.5 m	19978 kg	119024 kg	139002 kg
5	TOTALS			92056 kg	552931 kg	644987 kg

COMMENTS

Veh sketch serves as representation; not definitive of latest configuration. Level II dV set with losses, elliptical orbit, veh expended, shield weight equals engine weight. Single NTP engine operate at 2700K, nozzle area ratio of 400:1 - engine performance = 925 secs isp.

SEI CASE NAME

ACS092

Surface Payload Mass: 5.7 mt payload to the surface

Departure Orbit: 407 km

407 km

28.3 deg

IMLEO:		814800	kg
ENGINE OUT:		Single Engine Out	
NUMBER OF CREW:	6		
MTV:			QTY: 1
INERT MASS:		261949	kg
USABLE PROP. MASS:		552931	kg
PROPELLANT TYPE:		Hydrogen	
ENG. TYPE/SP/#:		NTP - Carbide Fuel Element/925	
VAC THRUST (EA):		75000	lbf
REACTOR MASS (EA):		3402	kg
ELECTRIC CONVERSION CYCLE:			
NOM. PWR LEVEL/PWR SYS MASS:			
LENGTH/WIDTH:		~ 100 by ~ 30	m
REUSABLE PARTS:		Veh. Core, Engg. aft tank, truss, crew mod, airlock	
OTHER:			QTY: 1
INERT MASS:			
USABLE PROP. MASS:			
PROPELLANT TYPE:			
ENG. TYPE/SP/#:			
VAC THRUST (EA):			
LENGTH/WIDTH:			
A/B SIZE/MASS:			
REUSABLE PARTS:			
MTV:	10/17/91, 0.2 LTD, storable, 5.7 ton down, cargo, w Asc. Sig	70,522	QTY: 1
INERT MASS:		15,427	kg
USABLE PROP. MASS:		48,670	kg
PROPELLANT TYPE (Descent/Ascent):		N <sub>2</sub> O <sub>4</sub> /MMH N <sub>2</sub> O <sub>4</sub> /MMH	
ENGINES (Descent/Ascent):		4/2	
THRUST (EA) (Descent/Ascent)		30,000/30,000	lbf
ISP (Descent/Ascent)		340	sec
LENGTH/WIDTH:			
A/B SIZE MASS		24.30 by 24.30	m
REUSABLE PARTS:		none	

REFERENCES:

10/25/91 Performance/Wt statement: Boeing STCAEM B. Donahue  
 09/10/91 Trajectory/dV set: Level II; g-loss/plane change dV Boeing STCAEM M. Cupples  
 10/15/91 MEV performance/wt statement: Boeing STCAEM B. Donahue  
 OTHER MASS includes masses NOT included in MTV, OTHER, MEV, Prop Tanks, or Payload.  
 Describe OTHER MASS Below

Figure 9-3e. Data Sheet 5



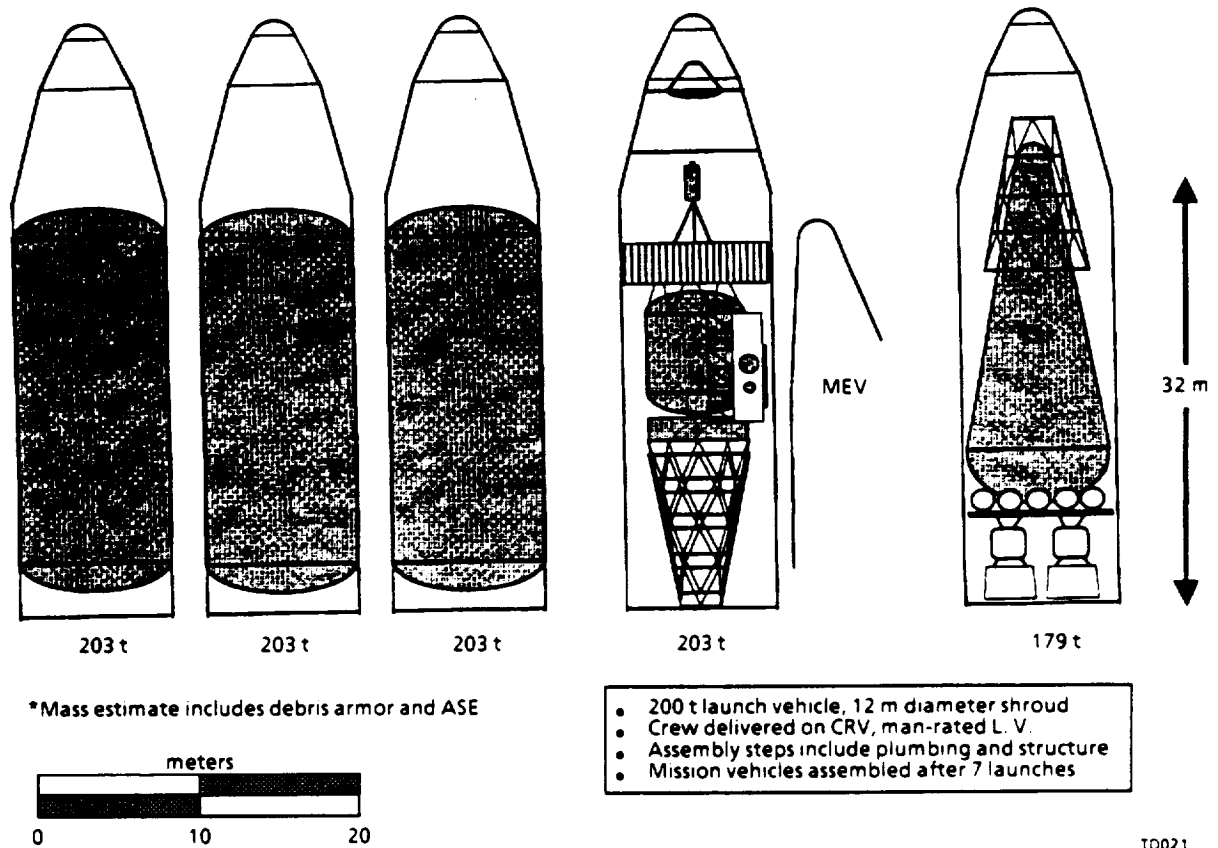

Figure 9-4. Baseline NTP Manifest 12 m Diameter Shroud

Additional work has been done in two areas: (a) the basic packaging of the new NTP vehicle in the 150 t and 250 t ETO, and (b) the shroud size optimization for the new NTP. The first area examined entails analysis of three options for manifest and launch. Two options involve the current NTP vehicle configuration with airborne support equipment (ASE) and debris shields (armor). The third option involves a launch optimized vehicle design that does not use the same criteria as was used in previous NTP configurations. The second part was to determine the optimum length for each of the vehicle shroud sizes based on wind loading on the launch pad. This analysis was begun with initial results presented.

### 9.1.1 Shroud Packaging

Three basic options for launch of the NTP Mars transfer vehicle have been investigated. These options are based on variations in payload shroud diameter and degree of vehicle assembly done on the ground. All configurations mass take into account debris shields (armor) and ASE packaging mass equal to 13% of the vehicle cargo sections (lofted mass).

The first option describes the baseline NTP vehicle, figure 9-4. The next option illustrates the baseline NTP concept, including 7.6m diameter transfer habitat and subsystem array, configured for launch within a 14m diameter payload shroud, figure 9-5. The forward section of the vehicle is attached by truss structure to a plumbing manifold, and the vehicle structure consists of stacking truss sections. The shape of the section has been modified to adapt to a new TMI/MOC propellant tank length. The propellant tank length and diameter were changed to better utilize the larger payload shroud. The aft section of the NTP differs from the baseline by using a 14m diameter ellipsoidal TEI propellant tank, and the attached radiation shield and engine assembly are consistent with the baseline concept. On-orbit assembly is achieved by launching a single "core" and assembly platform, and then subsequently mating the TMI/MOC tanks in a four launch procedure, not including crew delivery. As a delta to this option, the payload shroud envelope was sized to include an MEV lander and descent aerobrake. The aerobrake shown folds down and away from the attached MEV, allowing the aerobrake to fit over the forward part of the core, reducing overall shroud length.

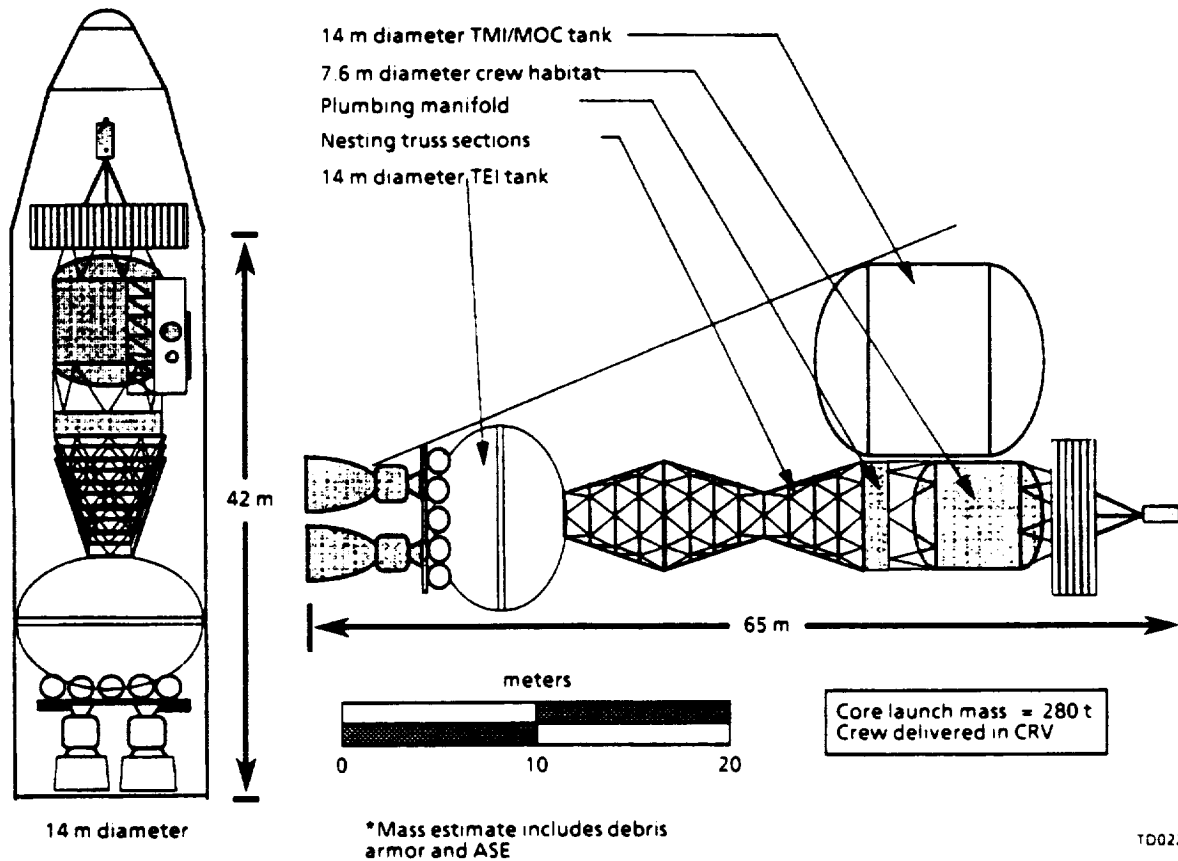

Figure 9-5. Baseline NTP Vehicle Configured for 14 m Diameter Launch Shroud

The last option makes use of current work on Biconic MEV landers, and integrates the "core" of the vehicle with the biconic on a single launch vehicle of 12-m diameter, and 250 tonne lift capacity, figure 9-6. This configuration requires minimal on orbit operations, limited to deployment of a telescoping truss section that extends the nuclear engines and shield approximately 20 meters beyond the forward core. This ensures minimal radioactive "scattering" at the crew habitat. This deployment also requires that plumbing from the manifold be extended and attached on orbit. This operation can probably be accomplished through robotics, and might even be done as part of the truss deployment. This launch option has the advantage of significantly reducing on-orbit assembly, reduces the number of launches to five, and could allow the crew to be launched with the transfer vehicle. However, it accepts radiation heating of the propellant in the drop tanks during the trans-Mars injection burn, a telescoping truss arrangement that still must be more defined to be workable and a Mars orbit ascent stage that is a portion of the piloted biconic nose section. A comparison of these three configurations and two all in one core stage launches, one with the lander/"flower petal" aerobrake and one without are shown in figure 9-7.

### 9.1.2 Length Sizing by Pad-Wind Loading

A parametric load/deflection analysis was carried out for an optimum payload shroud size selection. Shrouds of varying lengths and diameters were subjected to wind gusts of 50 to 100 kts.

Three shroud lengths were considered:	30m, 42m, 50m
Five shroud diameters were considered:	10m, 12m, 14m, 16m, 18m
Three wind velocities were considered:	50kts, 75kts, 100kts

#### Assumptions:

Payload mass (including shroud) = 150 mt

Launch load = 4g

Sea Level air density

Drag coefficient for a cylindrical shape,  $C_d = 1.0$

Shroud material = 7075 Aluminum

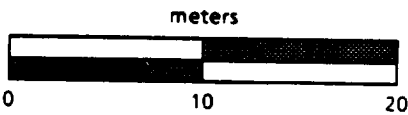
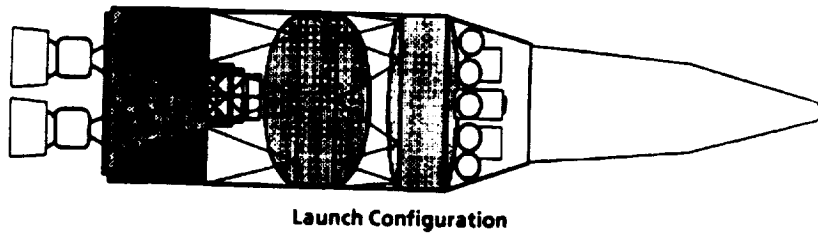
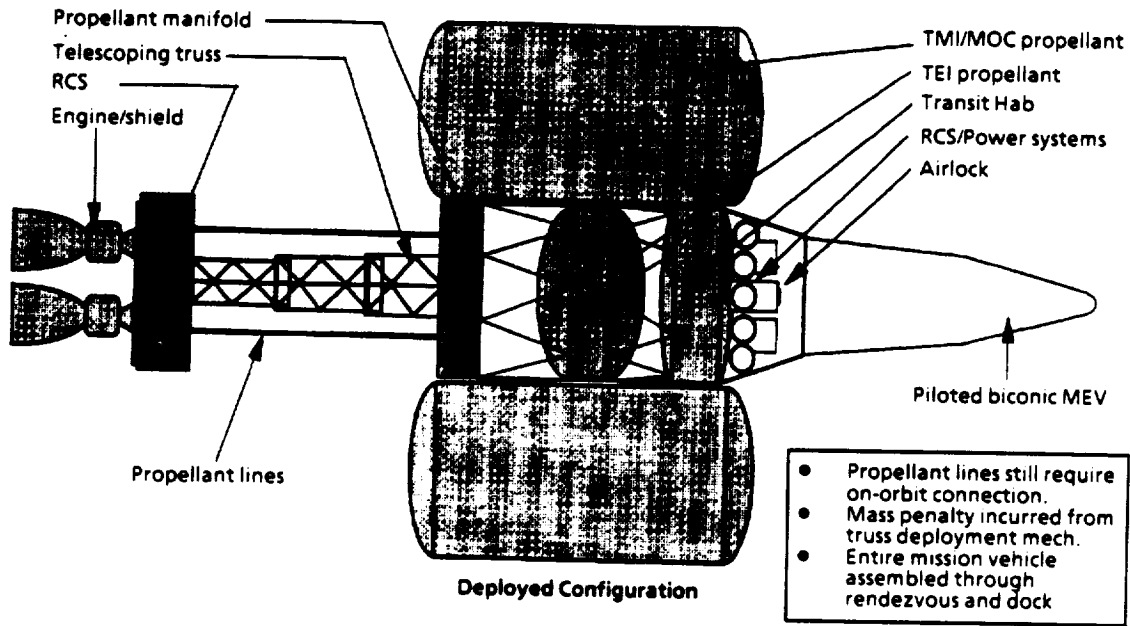

TD023

**Figure 9-6a. Launch Optimized NTP Vehicle and Biconic MEV (Configuration)**

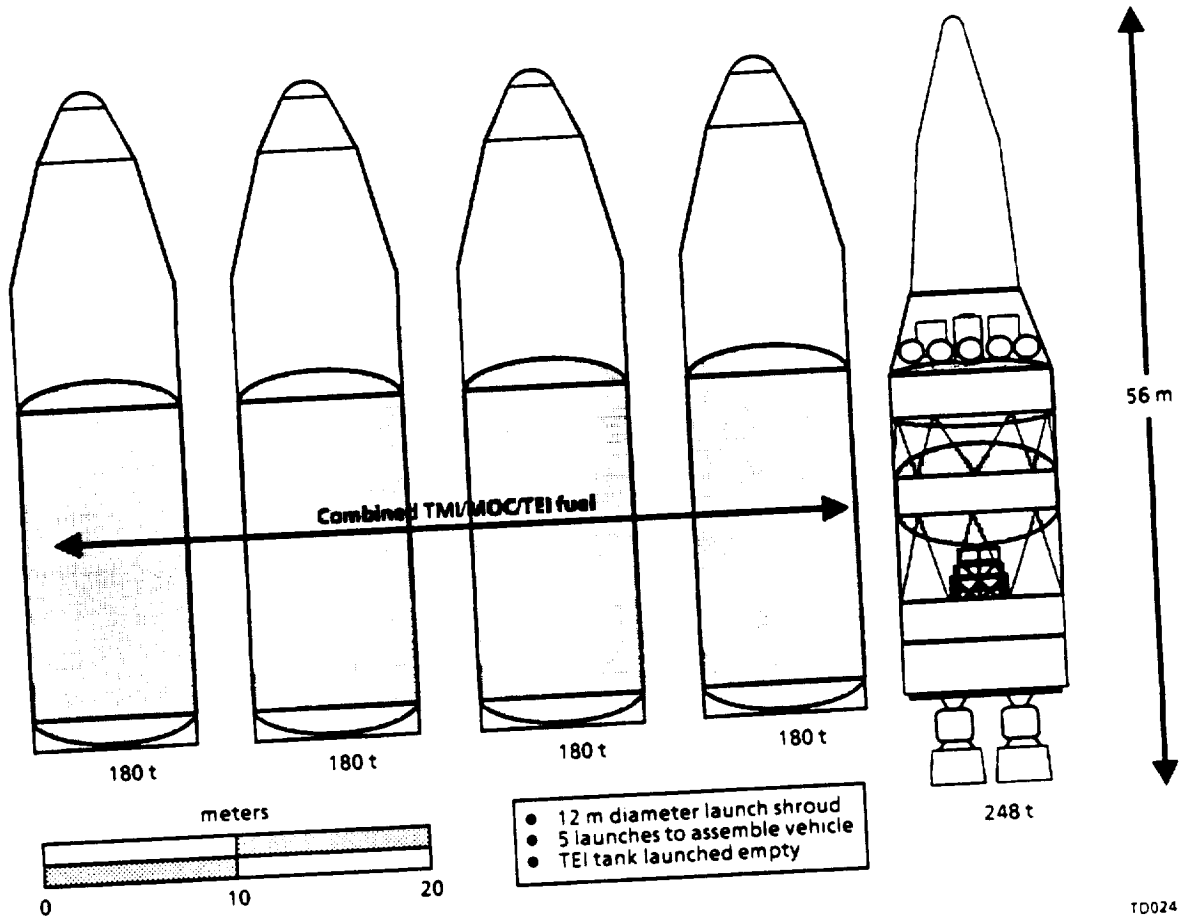

\* mass estimate includes debris armor and ASE

Figure 9-6b. Launch Optimized NTP Vehicle and Biconic MEV (Manifest)

T0024

\* mass estimate includes debris armor and ASE

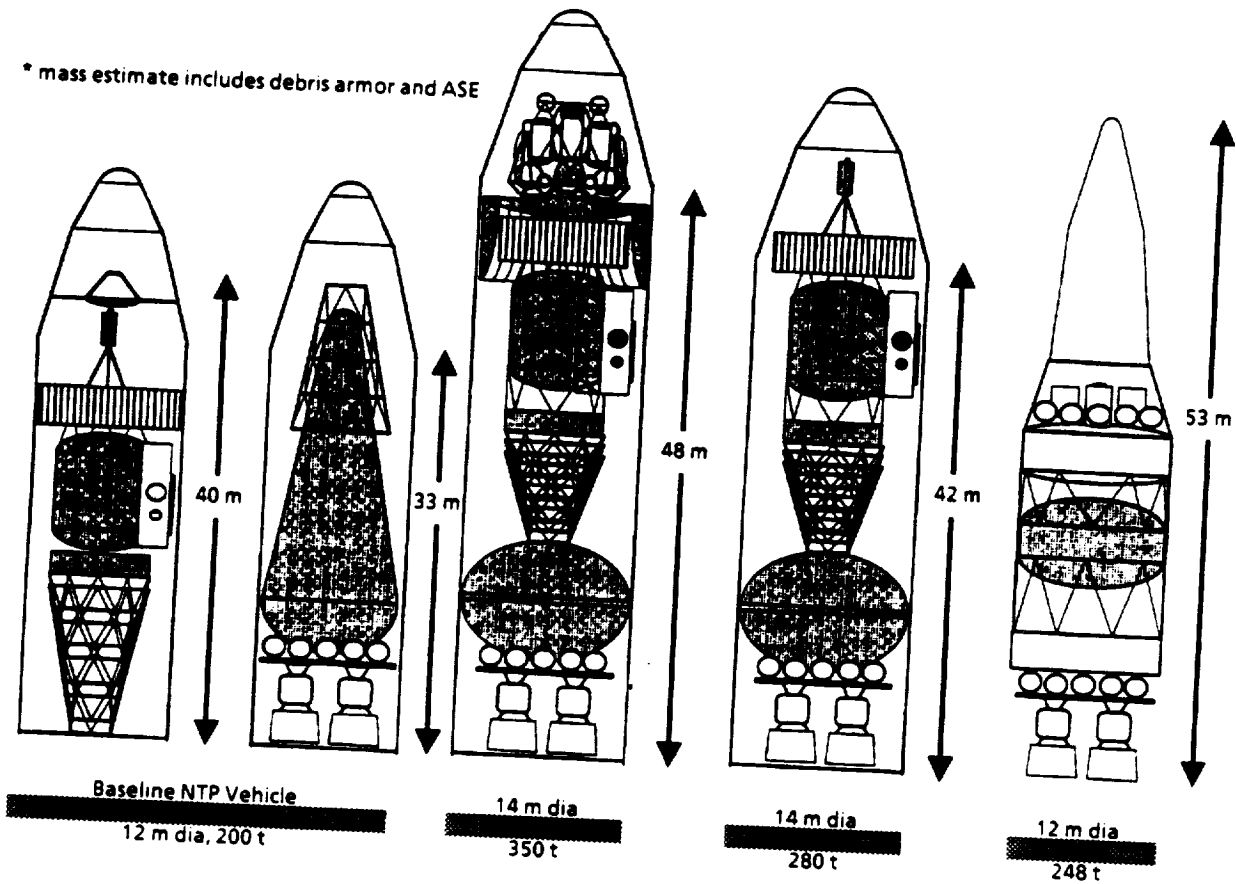

Figure 9-7. Launch Vehicle Comparison

TD025

**Procedure:**

A preliminary sizing for the shroud was performed using 4g launch loading. Skin thickness and moment of inertias were calculated as functions of shroud diameter. Wind loading for each of the three cases (50 kts, 75 kts, and 100 kts) was computed as a function of shroud length and diameter. Maximum deflection was calculated for each variable. The results of these calculations are shown in figures 9-8 and 9-9.

Over the entire range of the parameters studied, the deflections ranged from 0.0023m to 0.1254m. The 30-m long shroud was shown to be the most promising length. It showed almost no change in deflection with varying diameter and very little change with varying wind gusts.

D615-10062-2

Total Mass = 15000 kg  
 Total Load = 5883600 N @ 4g  
 Shroud Area = 0.01422396 M<sup>2</sup>  
 Aluminum:  
 E = 7.1008E+10 Pa  
 σyield = 4.14E+08 Pa

Shroud Length L (m)	Shroud diameter D (m)	Wind velocity kts	Shroud thickness t (m)	Moment of inertia I m <sup>4</sup>	Wind loading w (N/m)	Maximum deflection y (m)
30	10	50	0.00045	1.4224	4068	0.0041
	10	75	0.00045	1.4224	9152	0.0092
	10	100	0.00045	1.4224	16270	0.0163
	12	50	0.00038	2.0483	4881	0.0034
	12	75	0.00038	2.0483	10982	0.0076
	12	100	0.00038	2.0483	19524	0.0136
	14	50	0.00032	2.7879	5695	0.0029
	14	75	0.00032	2.7879	12813	0.0066
	14	100	0.00032	2.7879	22778	0.0116
	16	50	0.00028	3.6413	6508	0.0025
	16	75	0.00028	3.6413	14643	0.0057
	16	100	0.00028	3.6413	26032	0.0102
	18	50	0.00025	4.6086	7322	0.0023
	18	75	0.00025	4.6086	16473	0.0051
	18	100	0.00025	4.6086	29286	0.0091
42	10	50	0.00045	1.4224	4068	0.0157
	10	75	0.00045	1.4224	9152	0.0352
	10	100	0.00045	1.4224	16270	0.0627
	12	50	0.00038	2.0483	4881	0.0131
	12	75	0.00038	2.0483	10982	0.0294
	12	100	0.00038	2.0483	19524	0.0522
	14	50	0.00032	2.7879	5695	0.0112
	14	75	0.00032	2.7879	12813	0.0252
	14	100	0.00032	2.7879	22778	0.0448
	16	50	0.00028	3.6413	6508	0.0098
	16	75	0.00028	3.6413	14643	0.0220
	16	100	0.00028	3.6413	26032	0.0392
	18	50	0.00025	4.6086	7322	0.0087
	18	75	0.00025	4.6086	16473	0.0196
	18	100	0.00025	4.6086	29286	0.0348
50	10	50	0.00045	1.4224	4068	0.0315
	10	75	0.00045	1.4224	9152	0.0708
	10	100	0.00045	1.4224	16270	0.1258
	12	50	0.00038	2.0483	4881	0.0262
	12	75	0.00038	2.0483	10982	0.0590
	12	100	0.00038	2.0483	19524	0.1049
	14	50	0.00032	2.7879	5695	0.0225
	14	75	0.00032	2.7879	12813	0.0506
	14	100	0.00032	2.7879	22778	0.0899
	16	50	0.00028	3.6413	6508	0.0197
	16	75	0.00028	3.6413	14643	0.0442
	16	100	0.00028	3.6413	26032	0.0787
	18	50	0.00025	4.6086	7322	0.0175
	18	75	0.00025	4.6086	16473	0.0393
	18	100	0.00025	4.6086	29286	0.0699

Figure 9-8. Windload Data

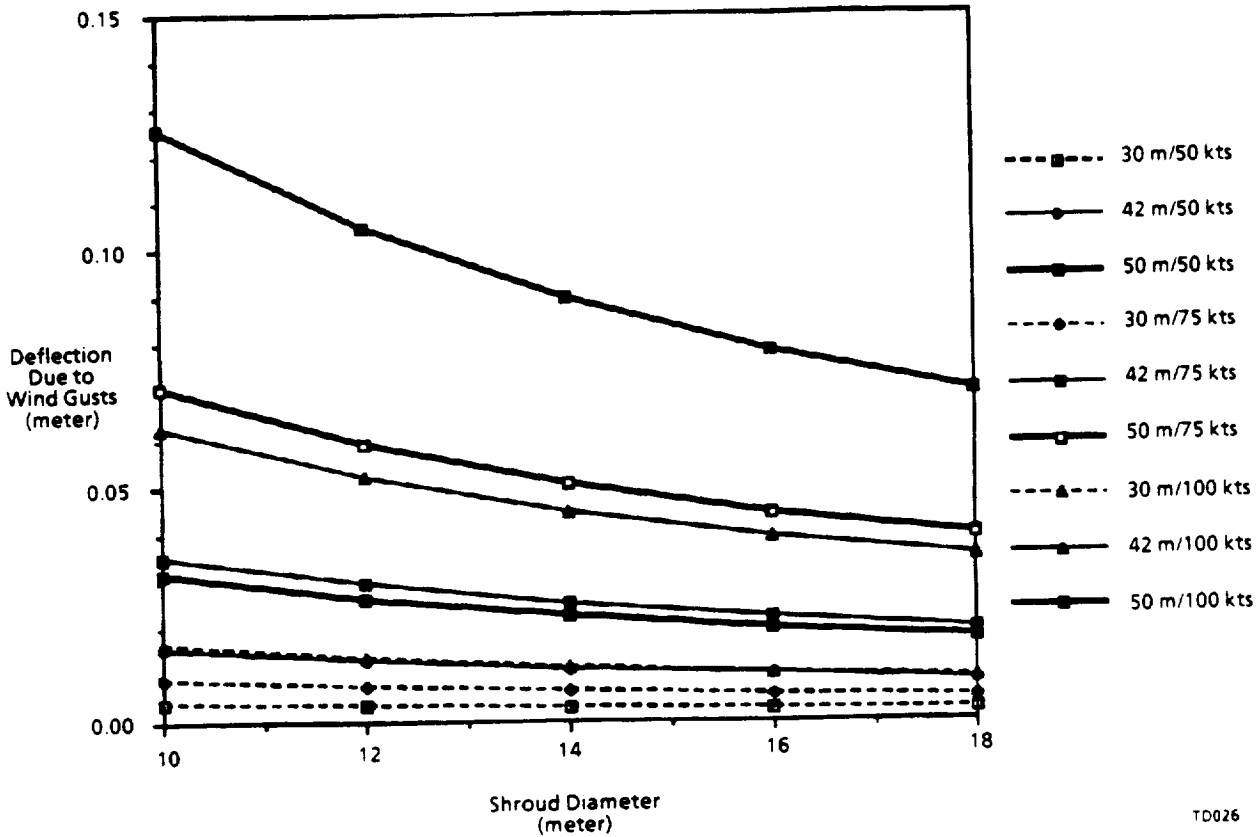

Figure 9-9. Shroud Size Study

## 9.2 PLATFORM CONCEPTS

Two concepts were investigated for LEO assembly utilities, with the I-beam (figs. 9-10 and 9-11) being a "large dry dock" for the growing NTP vehicle and the Saddle (fig. 9-12) being a "minimum" approach. The I-beam uses none of the NTP resources and, as a redundant resource, it can supply the vehicle with emergency power and communications if required. It is large enough to provide parts storage around the perimeter, decreasing if not eliminating the need for special CTV delivery/retrieval (debris shield) trips. The saddle is a smaller robotics and reaction control system platform that uses the vehicle systems as much as possible. It provides maneuver capability to the vehicle before the propellant tanks are in place and the vehicle RCS is active. The robotic assembly walking arms used for assembly are controlled from this platform.



D615-10062-2

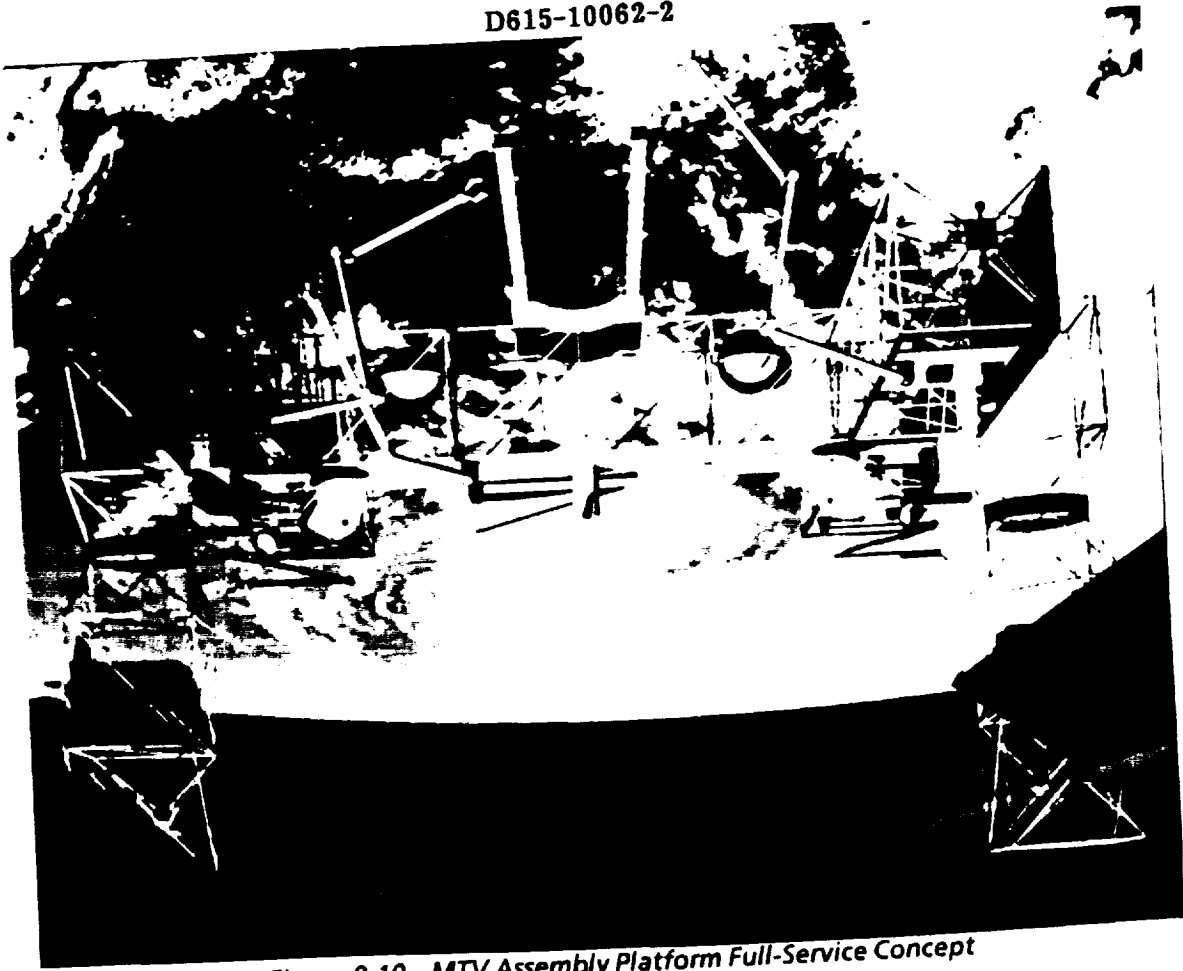
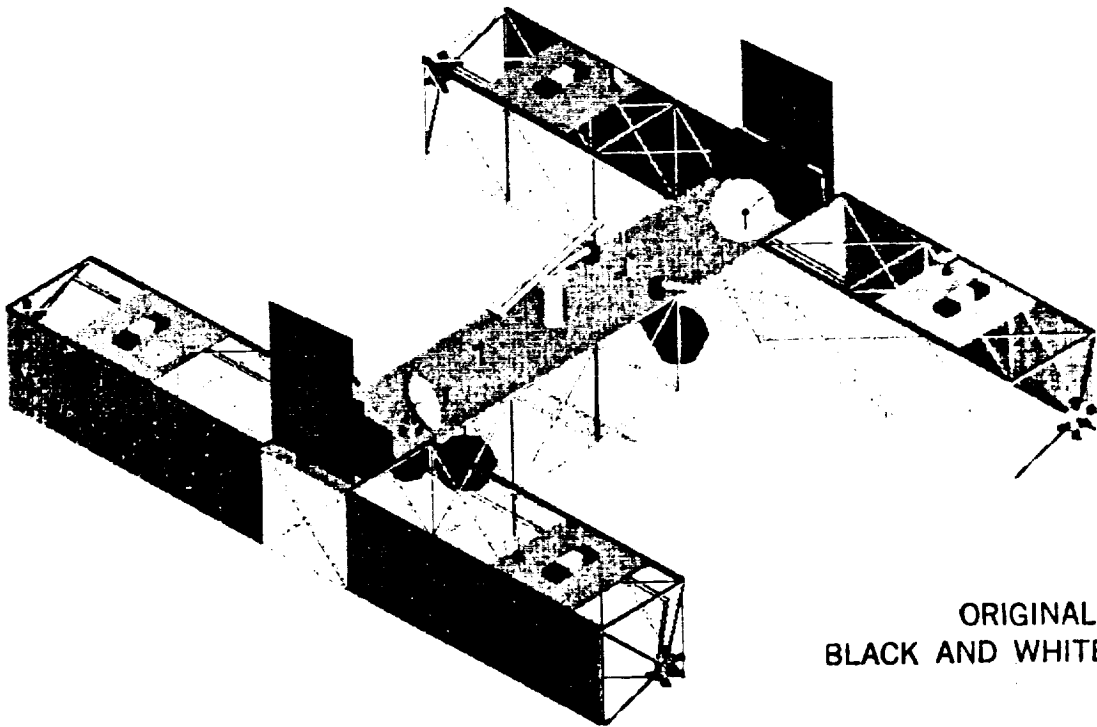
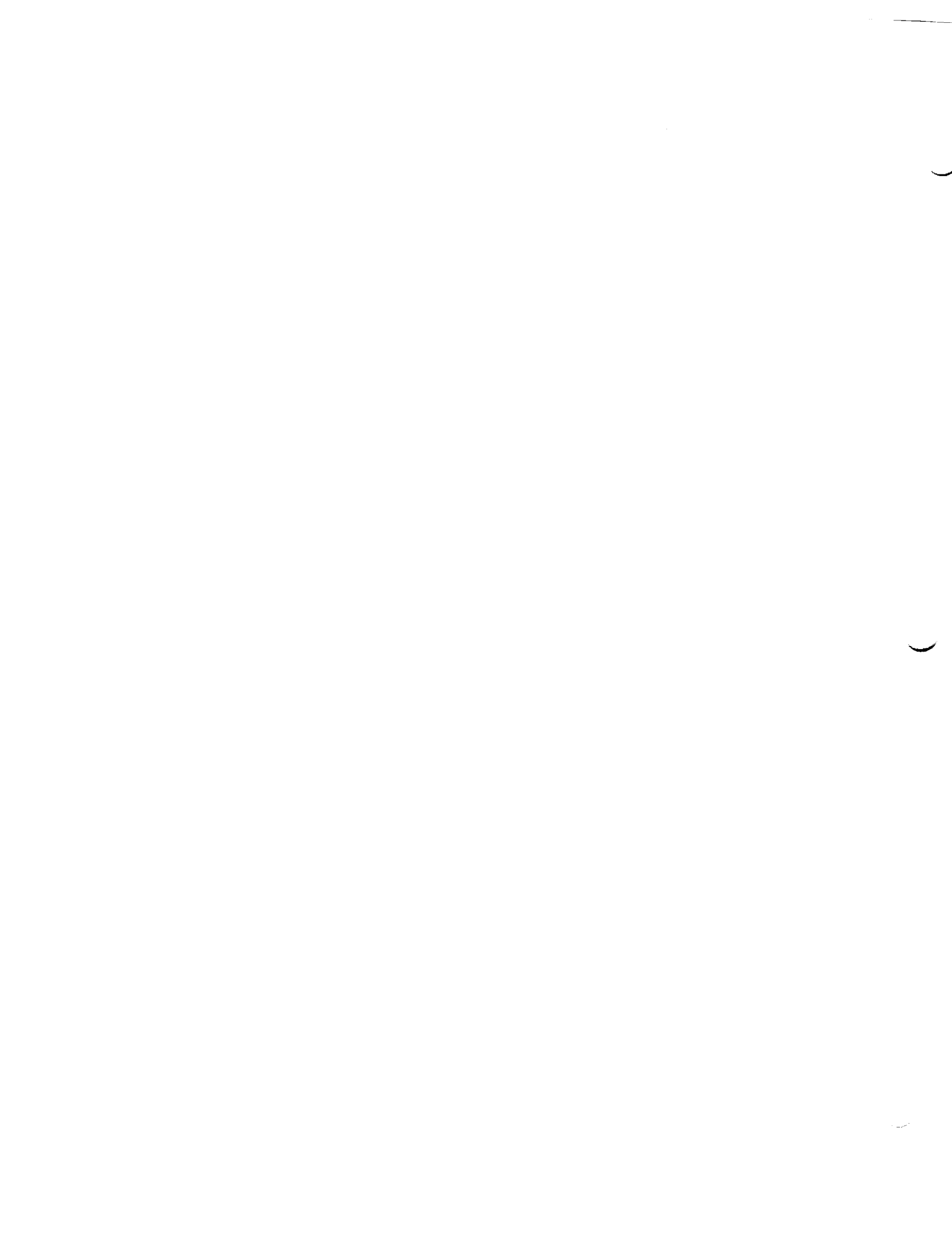

Figure 9-10. MTV Assembly Platform Full-Service Concept



ORIGINAL PAGE  
BLACK AND WHITE PHOTOGRAPH

Figure 9-11. NTP Platform Full-Up Configuration



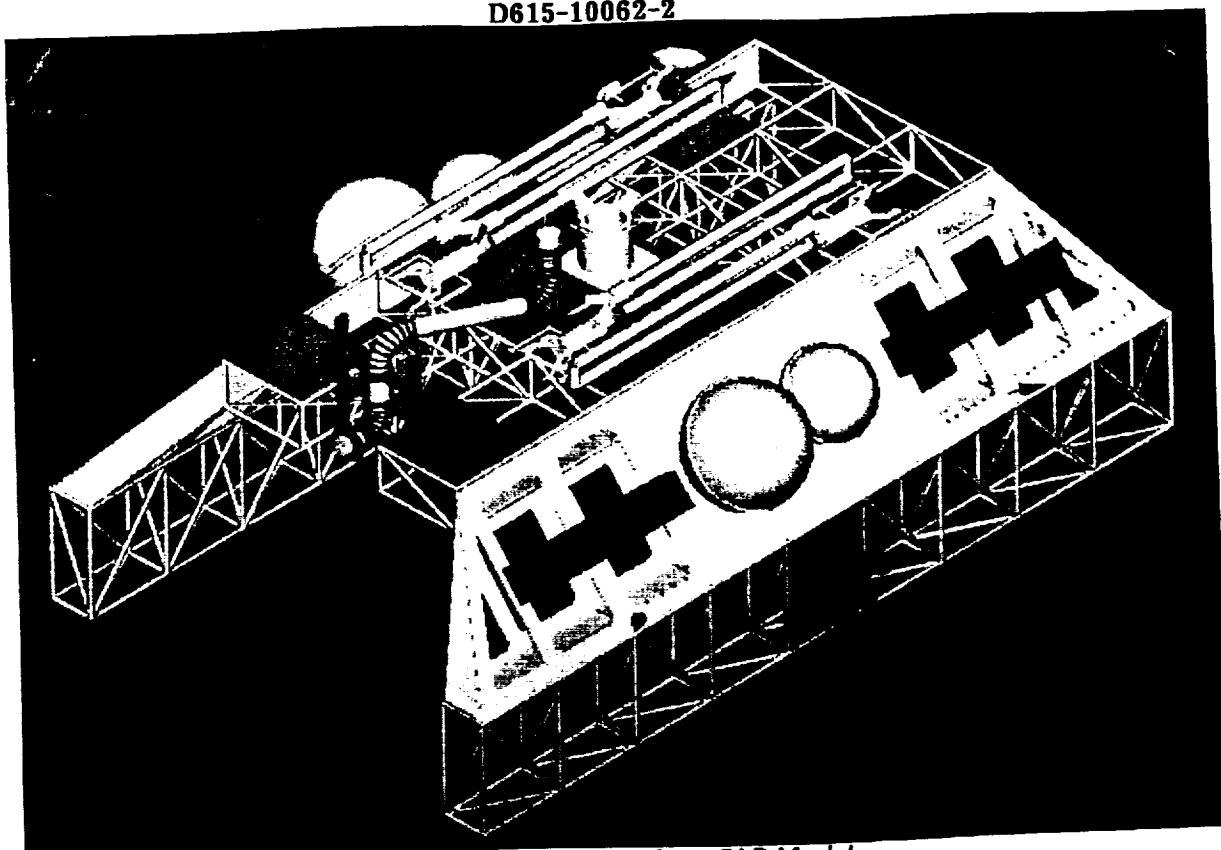

*Figure 9-12. Saddle Platform CAD Model*

### **9.2.1 I-Beam Platform**

A preliminary I-Beam Assembly Platform Parts List and Weights Statement has been completed. The results of the parts evaluation and the weight estimates are shown in figures 9-13a to 9-13b, Assembly Platform Parts List series. The weight estimates are based on existing hardware, where possible, or on the weight of component parts. As much "off-the-shelf" or modified "off-the-shelf" hardware is used. Further material on the I-Beam platform may be found in reference 2.

### **9.2.2 Saddle Platform**

The Saddle Platform design has been completed with a parts list/weights statement for this assembly platform configuration. A 1/200 scale drawing of the saddle platform on the first vehicle element as launched is shown in figure 9-14 and in more detail in figure 9-15. This platform will have four mobile (inchworm type) remotely controlled robotic arms (fig. 9-16) that grapple, carry and offload the payloads, disengage the packed major elements, manipulate them into position and perform the element attachments. It will additionally serve as the LEO reaction control system for the maneuvers that must be performed in order to station keep and co-orbit with the SSF. Its third main task is to provide a platform to perform top-off refueling of the full up vehicle prior to Mars departure. Communications for these operations is provided by six RF antennae with communications packages, one for each arm and each function

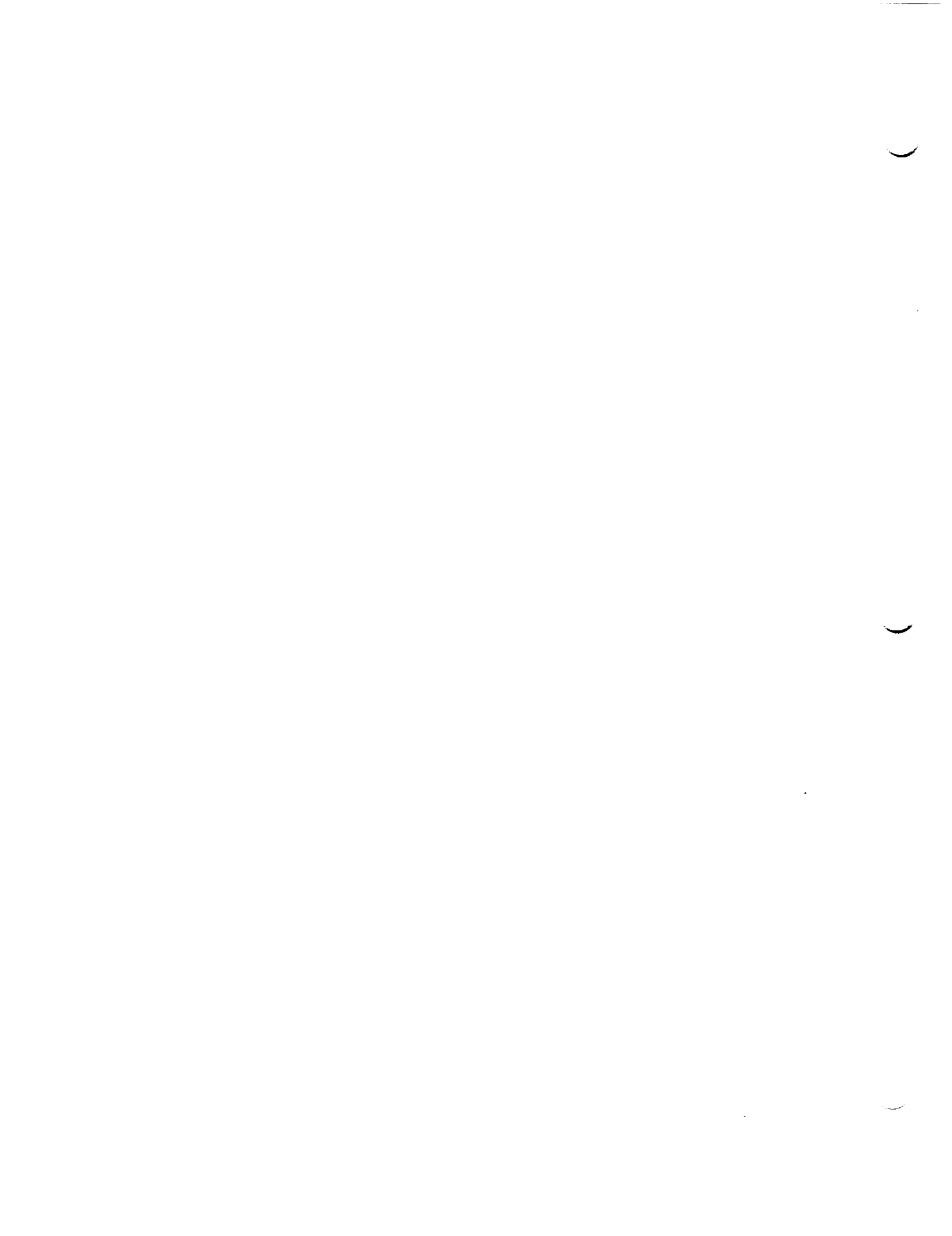

Item	Item Description	Quantity	Mass	Source	Manufacturer
Solar Array System	Photovoltaic arrays with radiators, modified integrated equipment assembly (MIEA), alpha joint, one beta joint, one set of PV arrays (SSF configuration from alpha joint to station 3), 5 m cubic truss	2	23 mt estimated (total)	Old Space Station design	Prime: Rockwell Alternate: TBD
Auxiliary batteries	Additional batteries not in the MIEA	2 sets	1 mt		
Truss structure	5m x 5m x 5m truss cube pattern of 10 cm dia. composite members with conductive wire embedded in the surface for charging control. Entire surface is seven bay end pieces on a 4-bay cross piece.	1 set	17 mt estimated (total)	Old Space Station design	Prime: MacDonnell-Douglas Alternate: TBD
Thruster pod	5 thruster grouping of 25-pound thrust GO <sub>2</sub> /H <sub>2</sub> thrusters, initially built for the Space Station, manifolded together	4	0.06t total (16 kg each)	Old Space Station design	Prime: Rockwell International Alternate:
Propellant lines	Combination of fixed and flex lines of TBD length, that will deploy with the end pieces (flex) and be hardlined to the propellant tanks and thruster pod manifold 1 H <sub>2</sub> line and 1 O <sub>2</sub> line	4 sets	0.04t total (42 kg each)	Current terrestrial design	Prime: Alternate:
GO <sub>2</sub> tank and gas	Insulated tank, 2 meter dia., that can be removed and replaced	2	0.349t (197 kg each)	Space Station	Prime: Pressure Systems Inc.
GH <sub>2</sub> tank and gas	Insulated tank, 2.7 meter dia., that can be removed and replaced	2	0.510t (255 kg each)	Space Station	Prime: Pressure Systems Inc.
Propellant Manifold	Manifold that allows one tank set to feed two thruster pods	2	0.2t total		
Control Moment Gyros (CMG)	Station keeping and position sensing	8	0.05t (total)	Current Available	Prime: Ithaco Alternate: TBD
Antennae:					
High Gain	Ground, SSF, and CTV com. 2.7 m dia.	2	0.2t (total)	Similar Pioneer upgraded electronics	
Omni-Directional	Backup communications, 1 meter	4	0.04t (total)	TDRS/Comm. Sats.	
Robot/ Data	Visual, digital 1 meter dia.	2	0.12t (total)	Com. Sats.	
RF	Proximity operations, robot control 46cm by 23 cm cone	6	0.12t (total)	Com. sats., exploration vehicles	
Mobile Remote Manipulator System (MRMS)	15 meter "strongarm" used for maneuvering into place large assembly elements. It is on a mobile base that translates the length of the end piece but does not translate the central crosspiece. The base is on a rail system that will be part of the deployed truss.	4	4.0t total (1.0t each)	From Space Station designs	
Fixed Remote Manipulator System (FRMS)	12-meter arms fixed to the central crosspiece that will be used to guide in the HLLV cargo to the docking port, help remove the cargo and hand it off to the MRMS for assembly or storage	2	1.2t total (600 kg each)	From Space Station/Space Shuttle designs	
Robot Walker	A TBD sized, self-contained system with dexterous manipulators that can "inchworm" itself along the platform, vehicle and HLLV to assist in actual assembly, component removal/storage and fine manipulation work	2 to 4	0.8t for 2	Various current walker designs (MacDonnell-Douglas, Carnegie-Mellon, etc)	

Total estimated Platform weight full up:  $41.1 + 1.59 + 6.0 + 4.7 + 26.2 = 79.59t$  ( $\approx t$ , with 30% growth  $\approx 104t$ )

Figure 9-13. Assembly Platform Parts List (I-Beam)

D615-10062-2

Item	Item Description	Quantity	Mass	Source	Manufacturer
Power distribution net	Power distribution system that will handle the power demands from the temporary arrays for initial deployment, and any other functions not covered by the MIEAs in the permanent array package	2	2.0t (1.0 t ea. All electronics, cabling & shielding)	Standard requirement	
Data management system (DMS)	Handles communication linkage, robot control, data linkage, sensor system identifications	2	1.5 t (.75 ea.)	Standard requirement	
Power switching unit (PSU)	Handles power switching during occultation that is not handled by the MIEAs in the permanent array package, and all switching with the temporary arrays	2	0.5 t (250 kg each)	Standard requirement	
Berthing port	Standard berthing port on a 2-meter standoff for docking the HLLV to the platform	1	0.1 t (100 kg each)	Space Station	
Lighting/camera post	Swivel mounted camera and lighting assembly on a 1-meter post for wide angle observations	2	0.2 t (100 kg each)		
Temporary arrays	Small deployable/retractable arrays that will power the initial platform deployment. Each array has 2 panels 2 meters by 25 meters	2	0.4 t (200 kg each)		
Initial deployment mechanism (IDM)	Jackscrew/telescoping mechanism that pushes out the folded end pieces to deploy them on the initial flight	4	3.0 t (750 kg each)	Extendible exit cones, SSF deployment strategies	
Rail crawler	Supporting undercarriage that will extend a pulling mechanism that will work in both direction along the rails (forward and back)	1	5.0 t	SSF RMS translation strategies	
Rails	44.5 meter segmented rails that will be fitted along the truss of the vehicle (makes the platform independent of truss configuration), which will allow the platform to translate the vehicle for assembly. The rails are segmented to allow the removal of several sections to clear the tank installation area	2 (one set)	4.0 t (both rails)		
Outside panels	Lightweight paneling (Al/composite?) that will be set up with attachment points for part storage	14 maximum (5m x 5m) 12 nominal	14.2 t for 12		

Figure 9-13. Assembly Platform Parts List (I-Beam) (Concluded)

(position communications and telemetry). One small one-meter antenna was added as a visual data and communications control link. Any additional storage needs not provided in the spaces of the platform truss (debris shielding) will be transferred to and from a CTV docked at the central berthing port. The platform will ride on a set of extending rails that run the length of the vehicle core (from the MCRV connection point to the beginning of the aft tank diameter expansion) that will allow access to the full extent of the core assembly points and clear the tank connection areas. Sketches of the Saddle platform have been made and the CAD model generated in figure 9-12. A mass statement for the saddle platform giving the expected mass for each of the vehicle parts with a 30% total mass growth is listed in figure 9-17.

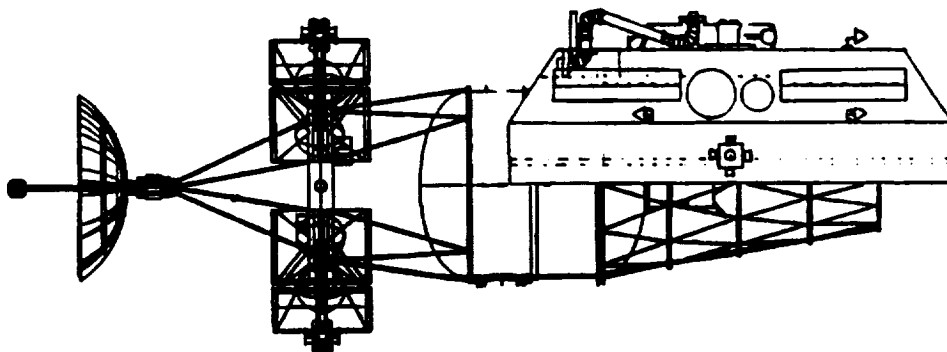

Figure 9-14. Saddle Assembly On Vehicle Core

TD030

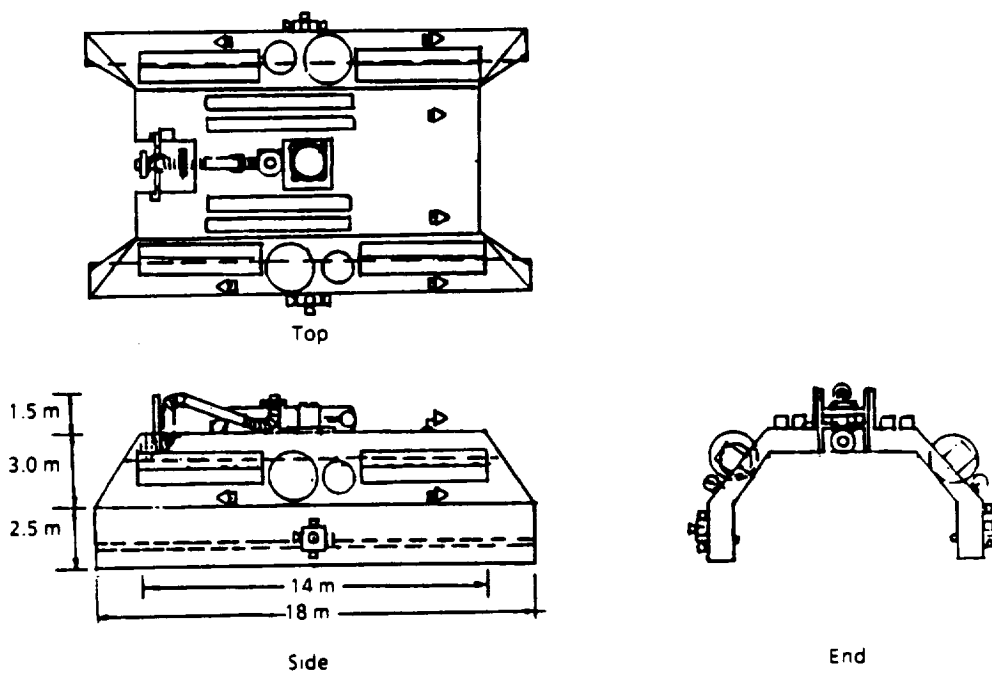

Figure 9-15a. Saddle Assembly Platform

TD031

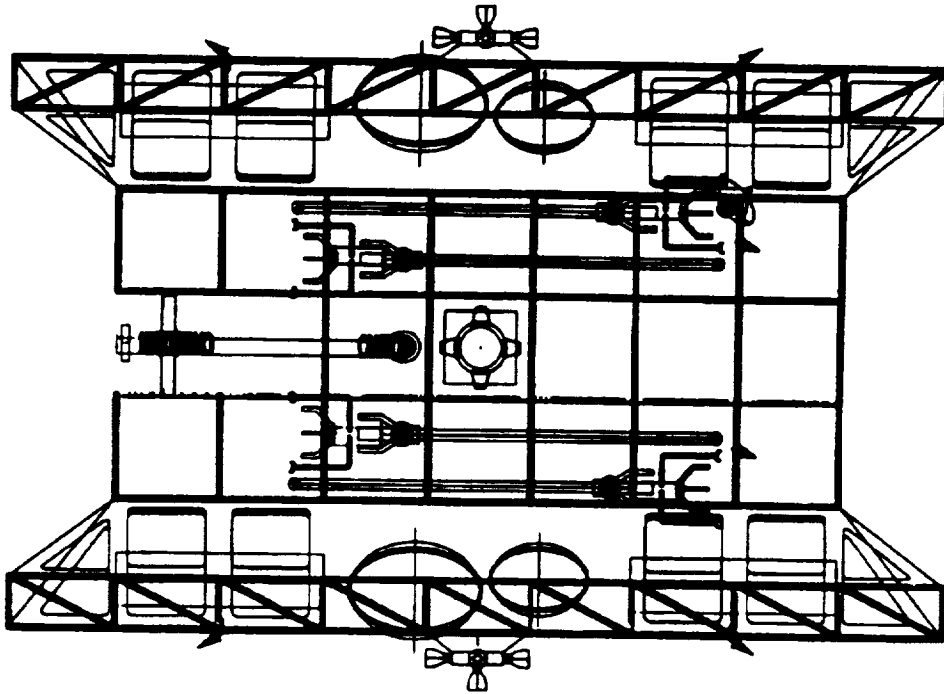

Figure 9-15b. Saddle Platform: Top View

TD032

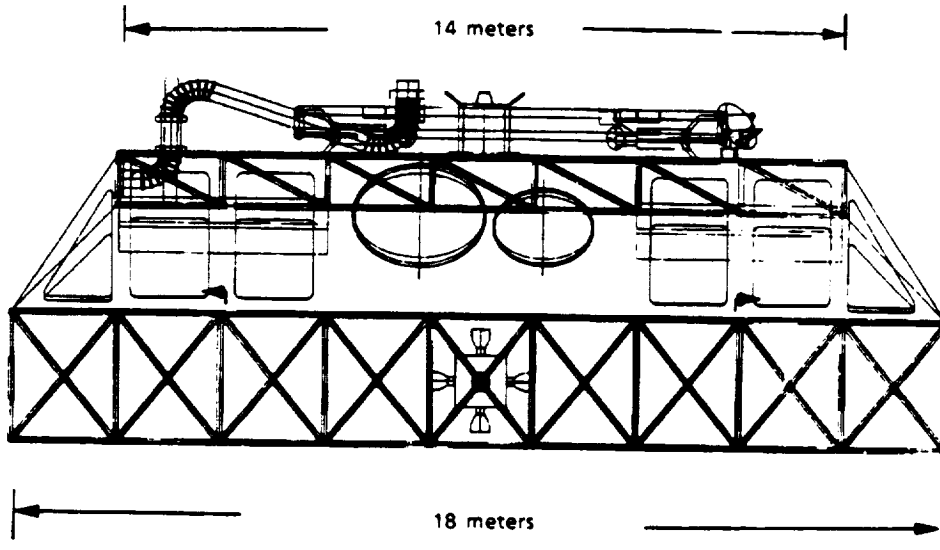
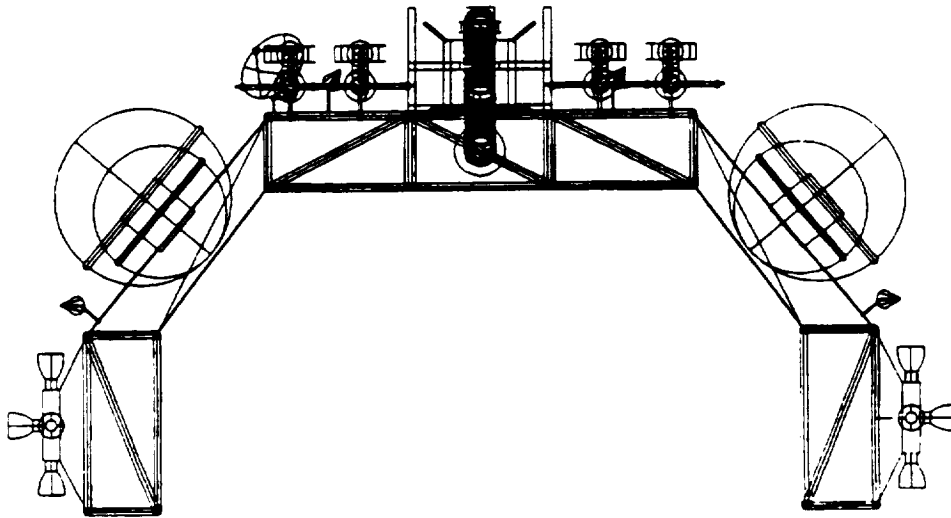

Figure 9-15c. Saddle Platform: Side View

TD033





TD034

Figure 9-15d. Saddle Platform: End View

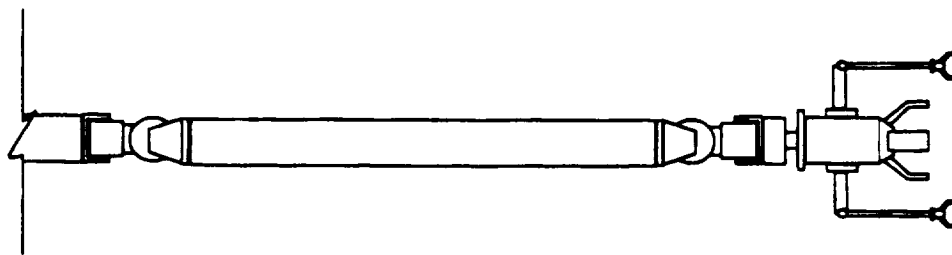

TD035

Figure 9-16. Robotic Arm Detail

### 9.3 METEOROID/ORBITAL DEBRIS PROGRAM (MOD)

Debris shield mass trades for probability of no penetration (PNP) in LEO orbit have been made using the Meteoroid/Orbital Debris Simulation Program (MOD). Several simulations were done for debris shields over the habitat, central tanks and aft tank-engine assembly in PNP versus shield mass. These data were based on the worst possible case of a 6 year on-orbit stay time (from 2010 through 2016) with a target .99 PNP, and were used in the calculation of lofted mass in section 9.1 on packaging and sizing. They were the heaviest expected configurations.

Reducing the on-orbit stay time did lighten the expected mass. Data for the aft tank-engine assembly, a central tank and habitat with the input conditions for one years LEO residence are given in figures 9-18a through 9-18c. The knee of the PNP versus Shield Mass curve is shown in these figures, but the minimum acceptable mass has not been pinpointed. Reevaluating the data for the currently recommended PNP of .95 will lighten the expected shield mass even further.

Item	Item Description	Quantity	Mass
Antennae	Communications between ground, SSF, vehicle, platform and the walking robots	6	0.12 t total
Walking robotic arms	12-meter inchworm type arms with self-contained batteries and vehicle power connections used for manipulating major vehicle elements and performing fine connections	4	2.4 t total
Fueling section	Plumbing, flange and "pumping" facility for transferring top-off propellant from an HLLV to the vehicle	1	0.5 t
Platform structure	Assembly platform basic structure, of trusswork, assembled on the ground and launched fully configured (hard lined) with the first launch element	1	6 t
Berthing port	Keyed passive berthing port to allow the docking of a CTV, CRV or HLLV payload at the platform	1	0.1 t
Vehicle com. bus	Data, communications and power transfer connection between the vehicle and the platform	2	0.2 t total
Rail system	Extending rail segments that allow the assembly platform to translate up and down the vehicle	2 rails	4 t
Solar arrays	Small 6 x 20 meter arrays used to give power to the saddle platform and charge the robotic arm batteries	4	5t total
MIEA	Modified Integrated Equipment Assembly which will act as a power distribution, switching and integration system	2	600 kg total
Auxiliary batteries	Additional power storage and emergency supply source	1 set	600 kg total
Thruster pods	Attitude control propulsion system, consists of 5 thrusters in a manifold for each pod assembly	2	32 kg total
Propellant lines	Fixed lines from the GO <sub>2</sub> and GH <sub>2</sub> tanks to the thruster pods	2 sets	10 kg total
GO <sub>2</sub> tanks and gas	Gaseous oxygen propellant oxidizer	2	0.349 t total
GH <sub>2</sub> tanks and gas	Gaseous hydrogen propellant fuel	2	0.510 t total
Crossfeed propellant manifold	Crossfeed manifold for the propellant lines to permit both propellant tank sets to supply both thruster pods	1	0.1 t
CMGs	Control moment gyros for station keeping and position sensing	4	25 kg total
Total Mass			20.546 t

Total mass estimate with a 30% growth ~ 26.71 t

Figure 9-17. Saddle Assembly Platform Parts List

## 9.4 DELTA-V AND DESCENT ANALYSIS

### 9.4.1 Introduction

Analyses and results shown in this section were in direct support to nuclear thermal propulsion-Mars transportation system sizing efforts. The topics include:

- a. Delta-V Sets
- b. Mars parking orbit descriptions
- c. 2016 TEI delta-V reduction
- d. Low-L/D landing site access
- e. High-L/D landing site access
- f. Nuclear reactor disposal.

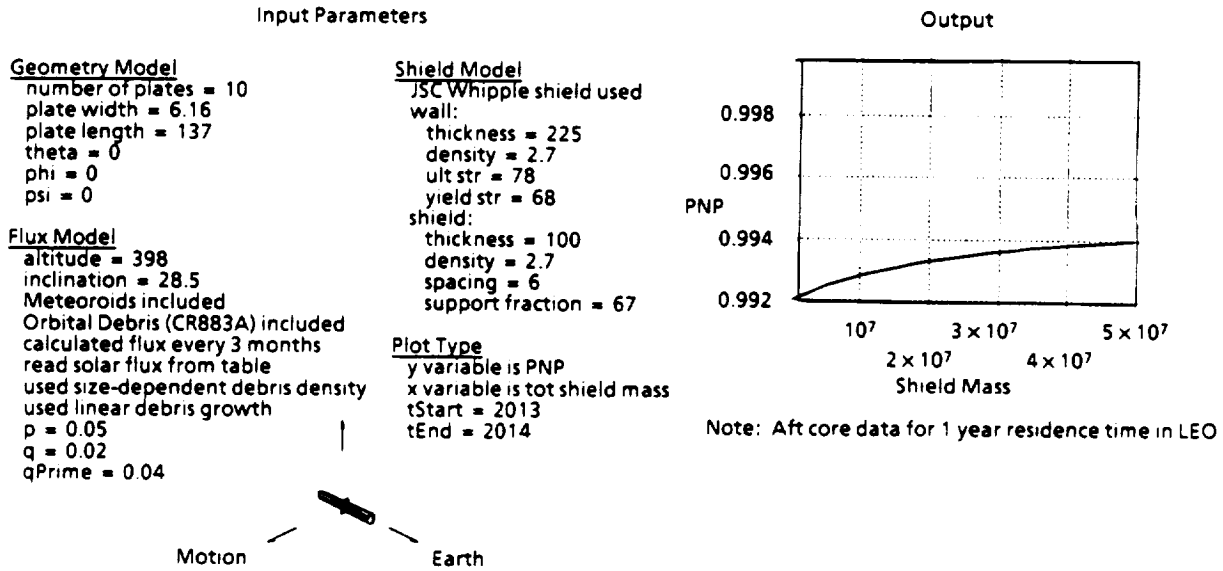

Figure 9-18a. LEO Debris Shielding Model-1

TD036

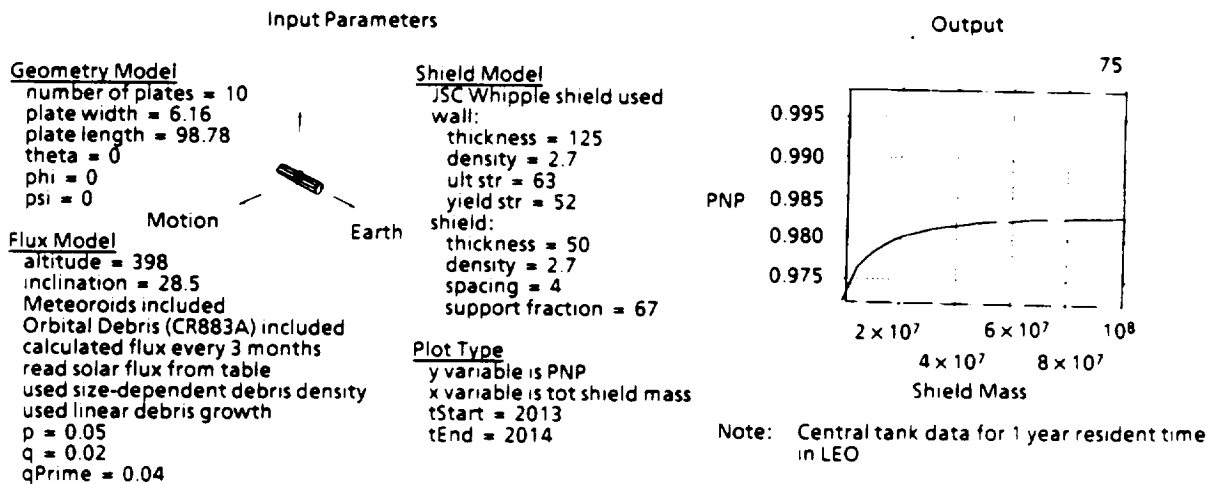

Figure 9-18b. LEO Debris Shielding Model-2

TD037

### 9.4.2 Delta-V Sets

Mission delta-V profiles are required as data input to vehicle sizing algorithms. The delta-V data provided in sections 9.4.2.1 and 9.4.2.2 represent distributed minimum energy trajectory data derived from patched conic algorithms. Section 9.4.2.1 describes Boeing optimized trajectories where the parking orbits are minimum delta-V and elliptical, and the transfers times are of intermediate durations. Section 9.4.2.2 describes delta-V data for NASA Level II mission dates with Boeing optimized elliptical parking orbits and with significantly faster transfer times than the Boeing transfer

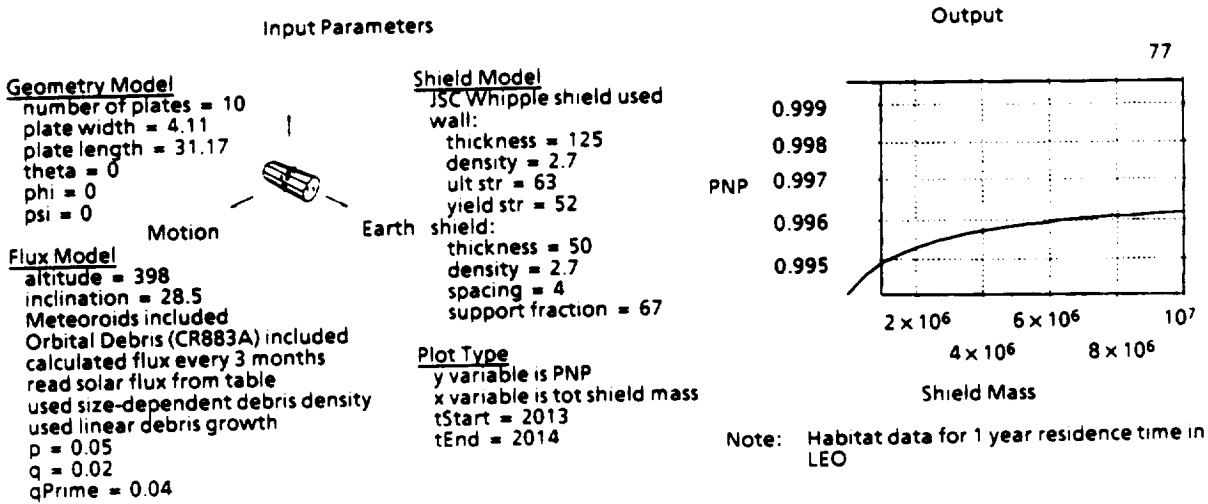

Figure 9-18c. LEO Debris Shielding Model-3

TD038

times. The net results of faster transfer times is essentially higher-energy missions. Section 9.4.2.3 provides data indicating reserves, losses, midcourse contingencies, and reactor cool-down budgets. These off-nominal fuel requirements increase the end-to-end mission delta-V.

9.4.2.1 2012-2020 Mission Delta-V Data, Boeing

Boeing generic mission data and delta-V components for the opportunity years 2012 through 2020 are provided in figure 9-19. Mission data provided includes gravity, plane change, and apsidal rotation losses. An in-plane capture with a periapsis-to-periapsis transfer is assumed for MOI, with the exception of the 2016 abort mission. The 2016 mission abort includes an off-periapsis MOI maneuver to reduce the TEI delta-V (see section 4).

The mission data divided into the categories of cargo missions 1 and 2 and piloted missions 1 through 4, along with their related abort mission options are shown in figure 9-19. General ground rules that were followed in analyzing the mission opportunities described in figure 9-19 are given below:

- a. If a swingby can be found, aborts utilize a Venus swingby (VSB) on Earth return to reduce mission delta-V requirements.
- b. If no VSB can be found on Earth return leg of abort, then a deep-space maneuver on return is utilized to reduce mission delta-V (see 2018 mission).
- c. In the effort to analyze only intermediate fast transfers times, no missions with transfer times of less than 150 days were analyzed. Intermediate transfer times have a moderate impact on the total delta-V budget.

Mission type	Launch date	TMI* ΔV	Outbound (days)	MOI* ΔV	Mars Stay - time (days)	TEI* ΔV	Return (days)	Return V inf*	Mission Duration (days)	Total ΔV	Abort Type
Cargo 1	11/9/11	3960	300	982	---	---	---	---	300	4942	---
Cargo 2	12/4/13	3988	294	1184	---	---	---	---	294	5172	---
Piloted 1	1/17/14	4318	175	3457	100	3840	290	5482	565	11615	---
Abort Option 1	1/17/14	4318	175	---	flyby	1224	376.6	5166	552	5542	flyby
Abort Option 2	Piloted 1 has sufficient delta-V budget for abort from surface of more than 50 days before nominal departure										surface
Piloted 2**	3/14/16	4152	170	2200	610	1720	150	8072	930	8072	---
Abort Option 1	3/14/16	4152	170	---	flyby	1776	275	5484	445	5928	flyby
Piloted 2***	2/25/16	4022	157	3790	575	3680	160	8997	907	11492	---
Abort Option 2	2/25/16	4022	157	4060	31	3740	246	7200	434	11822	surface
Piloted 3	5/26/18	4034	170	1340	610	2000	150	3585	930	7374	---
Abort Option	5/26/18	4034	170	---	flyby	2551, 1549†	312	7066	482	8134	flyby
Piloted 4	7/13/20	4205	170	1620	600	2434	150	6539	920	8259	---
Abort Option	7/13/20	4205	170	---	flyby	1599	346	7033	516	5804	flyby

NOTE: TMI g-loss = 300 m/s, MOI g-loss = 50 m/s, TEI g-loss = 30 m/s, TMI worst plane change = 400 m/s for 2014 and 100 m/s for 2016 - 2020.

- \* Delta-V and V-inf are in the units of m/s.
- \*\* Optimized for a Mars flyby abort.
- \*\*\* Optimized for an abort from surface within 31 days of arrival.
- † Deep space maneuver of 1549 on 5/5/19.

Figure 9-19. 2012 - 2020 Mission Delta-V Data

**Cargo Missions.** Cargo mission 1 supports the 2014 piloted mission 1, and cargo mission 2 supports the 2016 piloted mission 2. Cargo mission 2 arrives at Mars while the 2014 mission astronauts are on the surface of Mars. Thus, the cargo supporting the 2016 mission could be used to support the 2014 crew in an emergency event. The cargo missions are minimum energy conjunction style missions with transfer times of approximately 300 days and delta-V of about 5000 m/s. These cargo missions are close to the lowest energy missions possible for their concomitant opportunity years.

**2014 Piloted Mission.** Piloted mission 1 is an opposition style mission with a relatively short stay time of 100 days nominal and a total delta-V requirement of 11615 m/s. This 2014 mission is defined within Synthesis Architecture 1 (ref. 22) as the first piloted mission and is slated as an opposition style mission. The Earth return trajectory utilized a Venus swingby in route, lowering the Earth return Vhp and lowering the Mars TEI delta-V. This mission has the necessary delta-V budget required for an early return of greater than 50 days before the nominal Earth return date. The 2014 opportunity scenario and corresponding delta-V set was used to size the Boeing Mars transportation vehicle and is considered the reference opportunity.

**2016 Piloted Mission.** Piloted mission 2 is launched during the 2016 opportunity date and has two options, viz. 2\*\* and 2\*\*\*. The first option is a conjunction type mission with the relatively long Mars stay time of 610 days and a total delta-V of 8072 m/s. This mission option was optimized for a Mars flyby abort and therefore does not have the delta-V capability for an abort from orbit or surface. The abort mission profile for piloted 2\*\* is designated as abort option 1 and indicates a lower total delta-V of 5928 m/s, which is in part attributed to no occurrence of a capture maneuver in a flyby abort scenario.

In the case of the 2016 piloted 2\*\*\*, the mission was optimized for an abort from surface requirement, reflected in the higher total delta-V as compared to the 2\*\* mission. The delta-V requirement for this mission is 11492 m/s for a successful mission (no abort is required). If an abort from surface is necessary, the total delta-V required is 11822 m/s for an abort within 31 days of Mars arrival. This mission can also be considered as the first piloted mission of Synthesis Architecture 4 having an opposition type profile with a short stay time of 31 days and having an indigenous early departure capability corresponding to the 2014 opposition mission abort capability. An early return of the Synthesis Architecture 4 opposition mission could occur any time within 31 days of nominal Mars arrival.

**2018 Piloted Mission.** Piloted 3 corresponds to a 2018 conjunction style mission with a Mars stay time of 610 days and a total delta-V of 7374 m/s. This total delta-V is the lowest mission delta-V of the four mission opportunities analyzed, reflecting the over all "easy" opportunity year of 2018. No Venus swingby opportunity could be found for the 2018 return trajectory to aid in lowering the delta-V requirements for an aborted mission. This mission was thus optimized for a flyby abort capability with a deep-space maneuver of 1549 m/s on 5/5/19 during the Earth return trajectory. The deep-space maneuver can be thought of as replacing the gravity assist that could be provided by Venus if the planetary geometry was correct for a Venus swingby on the 2018 return leg.

**2020 Piloted Mission.** Piloted 4 corresponds to a 2020 conjunction style mission with a Mars stay time of 600 days and a total delta-V of 8259 m/s. There was no counterpart mission provided by Level II (see the following section of Level II missions). This mission was analyzed and optimized only for a flyby abort scenario, but a Venus swingby opportunity does exist on the Earth return trajectory and, therefore, an abort from capture could be analyzed (as 2016 was analyzed).

### 9.4.2.2 Reference Delta-V Set, Level II

Level II mission data and delta-V components for the opportunity years 2012 through 2018 are shown in figure 9-20. Mission data provided includes gravity, plane change, and apsidal rotation losses. An in-plane capture with a periapsis-to-periapsis transfer is assumed for MOI. In the next to the last column, a comparison is made to indicate savings that may be realized with elliptical vs circular parking orbits: elliptical orbit can save approximately 2 km/s for some Level II mission.

Architecture ref.	Opportunity year/type	Maneuver/ dates	Level 2 ideal delta-V	Finite burn loss	Plane change loss	Elliptic orbit savings	Elliptic orbits delta-V
1	2012 cargo conjunction	TMI 11/28/11	3653	300	100	N/A	4053
		MOC 8/6/12	2538	50	N/A	1198	1340
1	2014 crew opposition	TMI 2/1/14	4127	300	100	N/A	4627
		MOC 7/1/14	5299	50	N/A	1259	4090
		TEI 9/29/14-12/4/14	4370	30	72	1042	3430
1	2014 cargo (for 2016)	TMI 1/17/17	3808	300	100	N/A	4208
		MOC 8/29/14	2802	50	N/A	1192	1660
1	2016 crew conjunction	TMI 4/11/16	4958	300	100	N/A	5358
		MOC 8/08/16	4700	50	N/A	1120	3630
		TEI 5/19/18-8/17/18	4212	30	37	989	3290
4	2016 crew opposition	TMI 3/12/16	3789	300	100	N/A	4189
		MOC 8/04/16	4685	50	N/A	1175	3560
		TEI 9/23/18-5/11/17	5454	30	54	-32	5570
1 & 4	2018 crew conjunction	TMI 6/18/18	4615	300	100	N/A	5015
		MOC 10/01/18	3916	50	N/A	976	2990
		TEI 8/8/20-11/1/20	5309	30	46	703	4606

Figure 9-20. Reference Delta-V Set, Synthesis Report

### 9.4.2.3 2014 Reserves, Losses, Mid-Course

A delineation of the 2014 reference mission excess fuel requirements is shown in figure 9-21 and provides additional information concerning the end to end delta-V budget that was used in sizing the Mars transportation vehicle. Those requirements are indicated as reserves, losses, midcourse, and reactor cool down. For reserves and reactor cool down, the excess fuel requirements are provided as a percentage of the total applicable maneuvers.

	Explanation	$\Delta V$ (m/s)	Comments
Reserves	Provided for contingencies	---	2% of maneuver TMI, TEI descent, and ascent
Reactor cool down	NTP operational requirement	---	3% of maneuver TMI, MOI, and TEI
Midcourse	Correction for TMI, MOI, TEI, and Venus swingby	10	Provided by RCS; recharges each 15 to 20 days. Use main engine if greater $\Delta V$ needed
Losses	g-loss estimates	50 30	~ on MOI ~ on TEI These values will be updated by numerical integration
	Parking orbit plane and apsidal	263	Losses on arrival and departure from parking orbit

Figure 9-21. 2014 Reserves, Losses, Midcourse, Reactor Cool Down

**9.4.3 Mars Parking Orbit Descriptions**

An end-to-end minimum energy mission requires the optimization of the Mars parking orbit, in addition to optimizing the interplanetary trajectories (minimum energy means lowest energy missions relative to particular transfer dates and times that have been chosen as "fast", i.e., Mars direct transfers from 90 to 170 days). Minimum energy elliptical parking orbits will generally vary widely in period, inclination, periapsis latitude, and periapsis lighting from opportunity year to opportunity year. This variation in parking orbit as a function of opportunity year is described in section 9.4.3.1. A comparison of elliptical and circular parking orbits for Boeing and NASA Level II missions, emphasizing that circular parking orbits are significantly higher in mission energy requirements is described in 9.4.3.2.

**9.4.3.1 Parking Orbits Depictions**

Depicted in figure 9-22 are Mars parking orbits for the piloted missions 2014 through 2018. The 2016 opposition mission is included to satisfy possible requirements for abort from Mars parking orbit. For each parking orbit, the inclination, period, periapsis latitude, and periapsis longitude has been chosen to minimize the Mars departure delta-V and provide daylight landing over a range of latitudes. The range of latitudes chosen is between 20 degree north or south of the maritian equator, providing a plethora of potential landing sites with scientific merit.

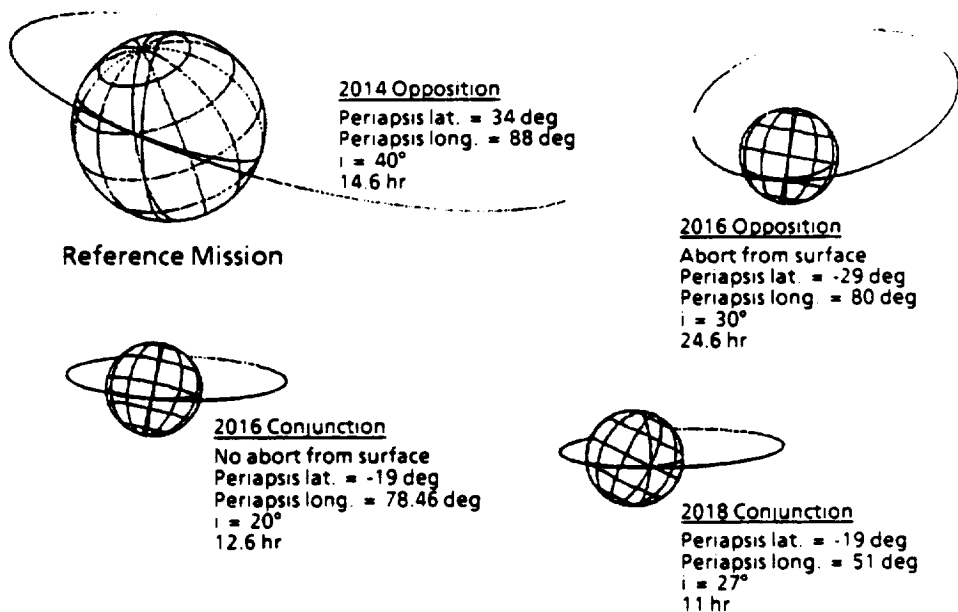

TD039

Figure 9-22. Mars Parking Orbits



### 9.4.3.2 Parking Orbit Delta-V

Provided in figure 9-23 is a comparison of circular with elliptical parking orbits for Boeing generic missions and the NASA Level II reference missions. Comparisons are made for the 2014 and 2016 opposition (short Mars stay time) missions as well as the 2016 and 2018 conjunction (long Mars stay time) missions. The delta-Vs are found from the sum of MOI and TEI for the mission opportunity dates indicated in figures 9-19 and 9-20. As shown in figure 9-23, optimized elliptical Mars parking orbits can require 1 to 2 km/s less delta-V than corresponding circular Mars parking orbits.

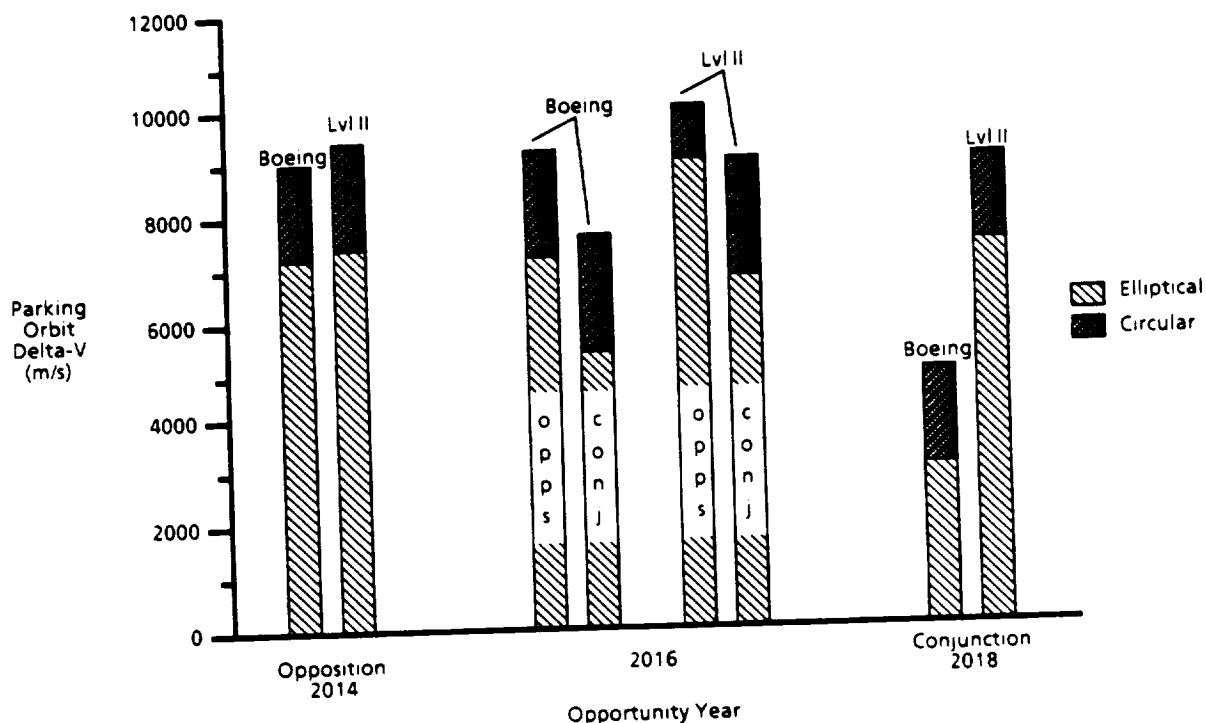

Elliptical parking orbits require 1000 to 2000 m/s less capture delta-V than circular parking orbits require.

Figure 9-23. Parking Orbit Delta-V

### 9.4.4 2016 TEI Reduction

The 2016 opportunity for Synthesis Architecture 1 is a long stay conjunction mission (Boeing's 575 day stay) designed with relatively fast transfers, reducing the astronaut exposure to harmful space radiation. This mission also meets the requirement to provide vehicle performance allowing for an early return (abort) within approximately 30 days from Mars arrival. It should be noted, however, that the NTP Mars transportation system has been baselined on the 2014 opposition (short stay time) class mission. With the intent of assuring the 2016 TEI delta-V is less than or equal to the 2014 TEI delta-V, analysis was performed showing that the 2016 TEI delta-V could be reduced to the level of the 2014 mission TEI delta-V. The results of this TEI delta-V reduction analysis are given in sections 9.4.4.1 and 9.4.4.2.

**9.4.4.1 Analysis Parameters and Procedure**

This section attempts to clarify the relationship between the MOI delta-V and the MOI maneuver position on the approach hyperbolic trajectory. It will be shown that the required delta-V to capture in the optimal elliptical parking orbit is related to the position that the MOI impulse is made on the approach trajectory. Note that the position of MOI defines the periapsis of the parking orbit. Shown in figure 9-24 is the relationship of minimum MOI and minimum TEI with a parameter termed Psi. Psi is the angle between the tail of the arrival V-infinity vector and the point on the arrival hyperbola that MOI impulse occurs, as shown in figure 9-25. A comparison of MOI and TEI for the 2014 reference mission with the 2016 mission is found in figure 9-24. The periapsis-to-periapsis transfer impulse is indicated by "periapsis transfer" and an off periapsis transfer impulse is indicated by "off-periapsis transfer". It is clear that the TEI for the 2016 mission can be lowered by a related increase in the MOI. The net effect is a decrease in 2016 total mission delta-V that results from a decrease in Mars departure apsidal-misalignment losses.

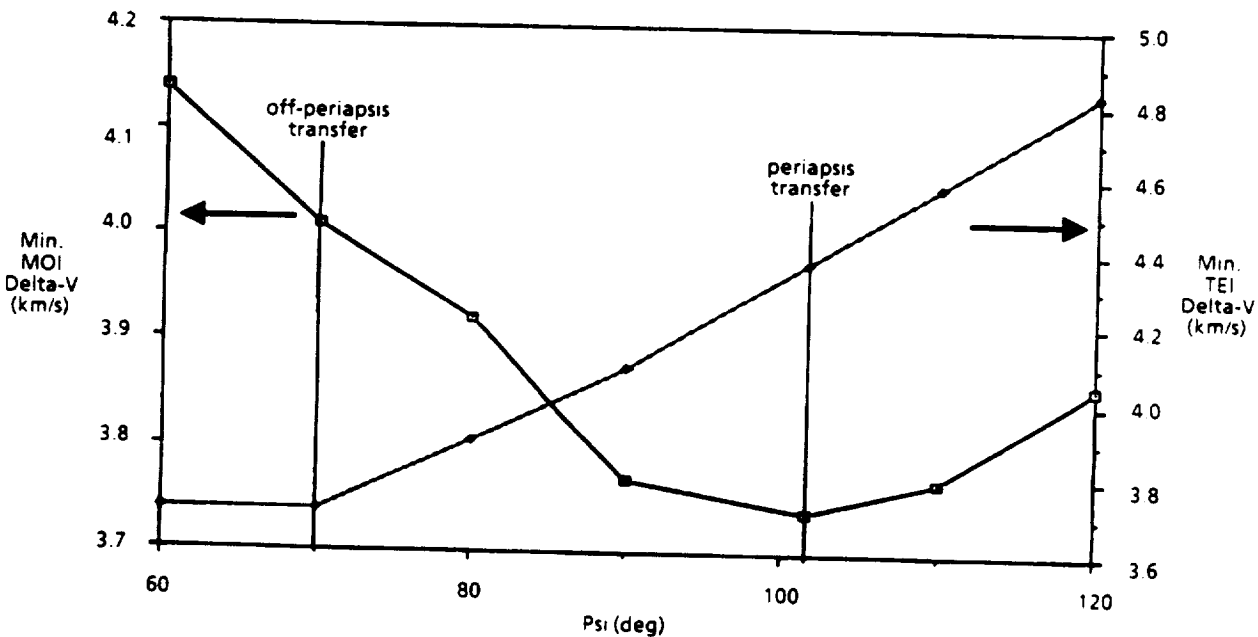

Parking orbit delta-V is dependent upon the angle Psi at MOI

TD040

**Figure 9-24. 2016 Opposition, Split Delta-V**

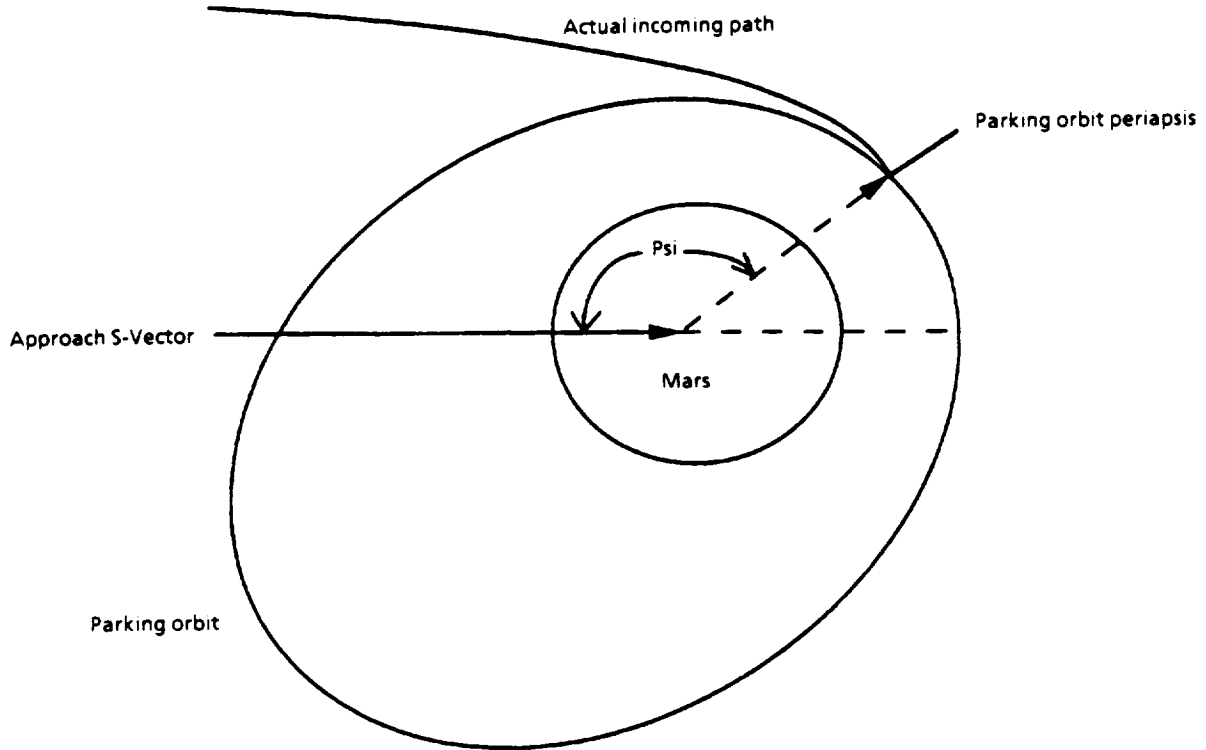

TD041

Figure 9-25. Definition of Angle Psi

9.4.4.2 MOI/TEI Split Delta-V Budget

Continuing the discussion of the 2016 delta-V split, the data of figure 9-26 is provided as a delta-V budget for the 2016 opposition mission. The off-periapsis maneuver on the 2016 Mars approach reduced the plane and apsidal losses by over 600 m/s, with a reduction in the total delta-V of 390 m/s. The 2016 TEI delta-V was reduced to below the 2014 TEI delta-V, thus, showing that the 2016 TEI stage can be identical to the 2014 TEI stage. Also, the 2016 early departure requirements can still be met.

Delta-V Budget (m/s)						
Mission	MOC maneuver	TMI	MOC	TEI	Plane & apsidal losses	Total delta-V
2014 Ref	Periapsis	4318	3457	3840	263	11,595
2016 Abort	Periapsis	4022	3740 + 50*	4370 + 30	1060	12,212
2016 Abort	Off periapsis	4022	4010 + 50	3710 + 30	400	11,822

- Vehicle sized by 2014 reference mission delta-V
- Vehicle must meet 2016 abort from surface delta-V requirement
- Reduction in 2016 TEI to below 2014 reference mission TEI by apsidal rotation of arrival parking orbit
- \* The values preceded by a "+" sign are estimated g-losses.

Figure 9-26. 2016 Split Delta-V

#### **9.4.5 Low-L/D MEV Landing Site Access**

The MEV performance requirements play a significant role in sizing the NTP Mars transportation system. An ongoing issue in MEV configuration concerns the L/D requirements for meeting the sometimes conflicting landing requirements such as daylight landing in conjunction with landing anywhere in a Mars latitude range of 20 degrees north or south. The current section indicates the results of an investigation performed to ascertain the viability of using an MEV with L/D of 0.2 to meet the previously mentioned landing requirements, and meet those requirements for the widely varying elliptical parking orbits of opportunities 2014 through 2018. It should be noted that the 2014 reference mission and the 2018 mission represent the extremes of landing geometries that were encountered for the missions analyzed.

##### **9.4.5.1 2014 Landing Site Access**

The analysis results of this section were derived from an assumed 2014 elliptical parking orbit initial descent conditions as indicated below:

- entry altitude = 100 km
- entry latitude = 40 degree
- entry longitude = 0 degree (assumed)
- apoapsis altitude = 21,800 km
- periapsis altitude = 40 km
- inclination = 41.5 degree
- argument of periapsis = 129.8 degree
- periapsis latitude = 36 degree
- periapsis lighting angle = 7 degree.

The 2014 parking orbit, shown in figure 9-27, will allow a daylight landing within latitudes of 40 degree north/south of the martian equator. This landing range can be achieved with a controlled atmospheric skip-out of a vehicle with max L/D of 0.2.

##### **9.4.5.2 2018 Landing Site Access**

The 2018 parking orbit, shown in figure 9-28, has a periapsis longitude of 51 degree east of the noon meridian and 19 degree south, with a node position close to the evening terminator. This southerly location of periapsis in conjunction with the position of the node relative to the terminator restricts accessible daylight landing sites of the low L/D vehicle to approximately 0 to 20 degree south. For a modest parking orbit delta-V penalty, a northerly approach to Mars can be made that will allow access to landing sites from 0 to 20 degrees north.

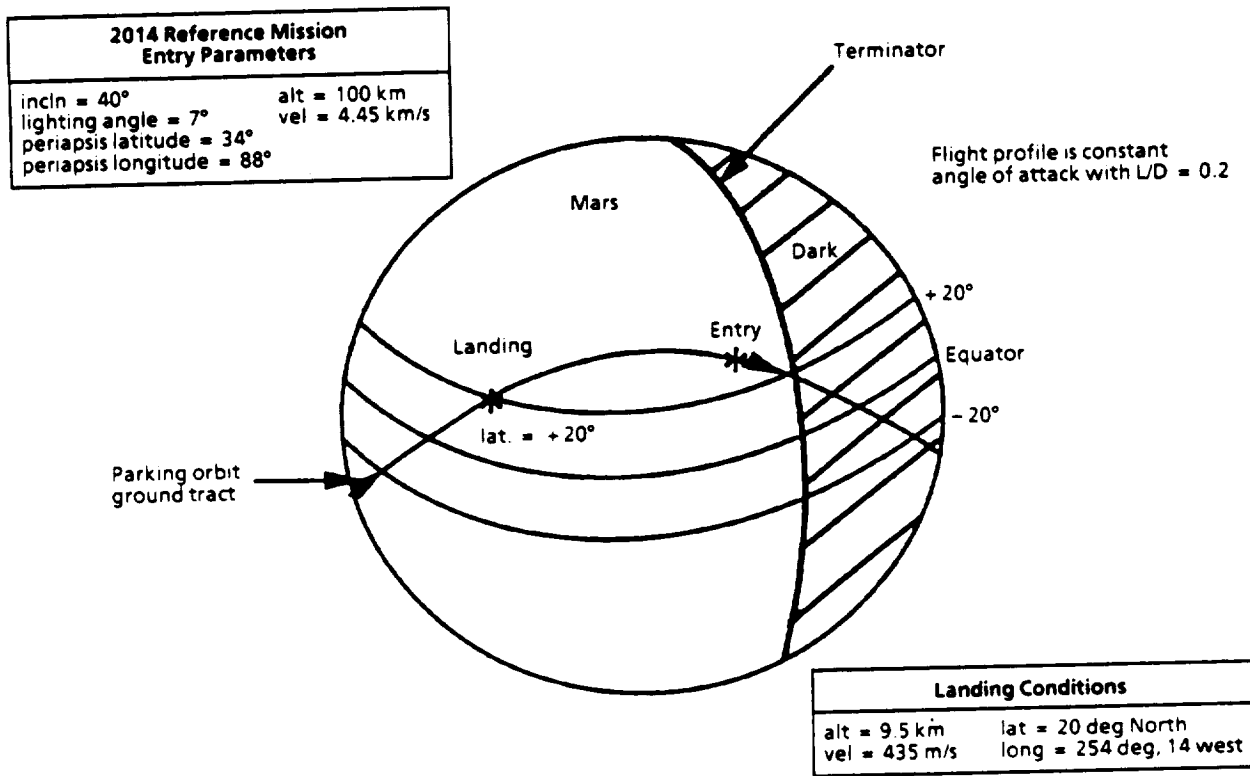

T0042

Figure 9-27. 2014 Landing Site Access

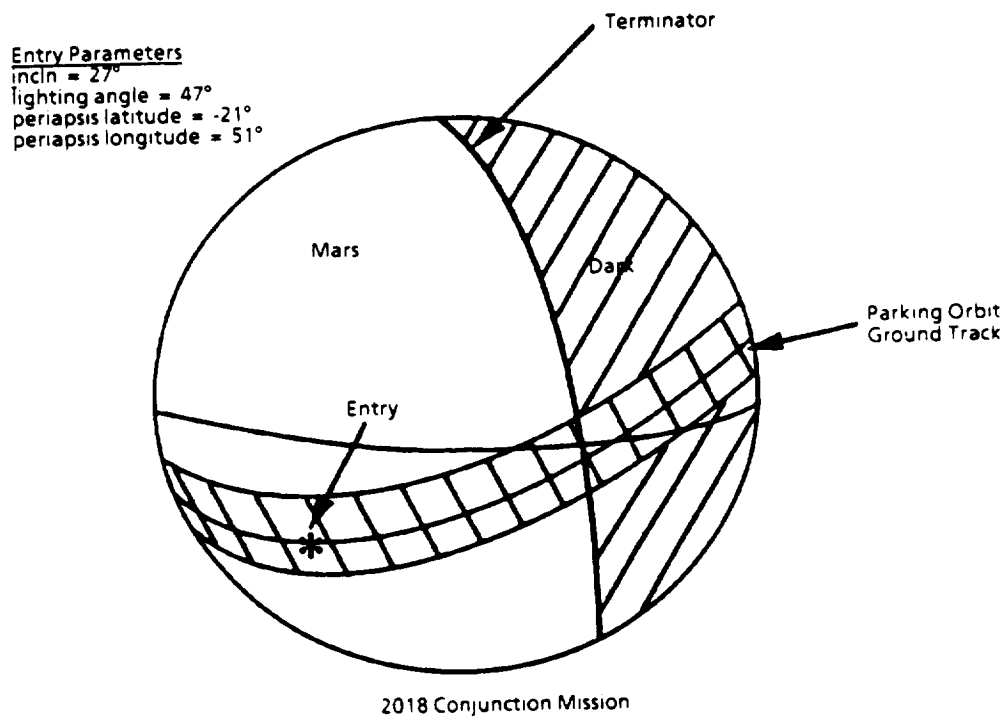

Figure 9-28. 2018 Landing Site Access

T0043

#### **9.4.6 High-L/D MEV Landing Site Access**

An analysis was performed to provide some indication of the extent to which a high L/D vehicle could traverse the surface of Mars. The results of simulated MEV trajectory optimizations to maximize the southerly latitude and thereby attempt an approach to the martian south pole are provided in the following sections. Trajectories were simulated for an MEV with max L/D = 1.6 (section 9.4.6.1) and with max L/D = 1.3 (section 9.4.6.2). All analysis results of this section were derived from an assumed 2014 elliptical parking orbit initial descent conditions as indicated in section 9.5.5.1. Final descent conditions are MEV relative velocity = 0 and, as previously mentioned, final latitude was maximized in the southerly direction.

##### **9.4.6.1 Polar Access with HMEV**

To gauge the landing site access capability of the high-L/D MEV with max L/D = 1.6, a simulated descent was made in an effort to approach the martian south polar region. In this simulation, the only control variable was roll and, therefore, the angle of attack was constant, implying a constant L/D descent. The initial and final conditions of this descent are given in figure 9-29 (the initial conditions are essentially identical to the 2014 reference mission initial conditions, section 9.4.5.1). The end martian latitude calculated is approximately 85 degree south; the Martian permanent south-polar-icecap begins at 85 degree south. Also, the martian permanent north-polar-icecap begins at approximately 75 degree north. Thus, the HMEV may be able to reach either the Martian north or south polar icecap region.

##### **9.4.6.2 Polar Access with Biconic**

In a similar fashion, an analysis was performed to gauge the landing site access capability of the high-L/D biconic based MEV with max L/D = 1.3. A simulated descent was made with this vehicle in an effort to approach the martian south polar region. In this simulation, the only control variable was roll and, therefore, the angle of attack was constant, implying a constant L/D descent. The initial and final conditions of this descent are given in figure 9-30. The initial conditions are essentially identical to the 2014 reference mission initial conditions, section 9.4.5.1. The end martian latitude is approximately 72 degree south, with the martian permanent south-polar-icecap beginning at 85 degree south. Also, the martian permanent north-polar-icecap begins at approximately 75 degree north. Thus, the biconic MEV probably cannot reach the permanent south-polar-icecap, but may be able to reach the martian north-polar-icecap region.

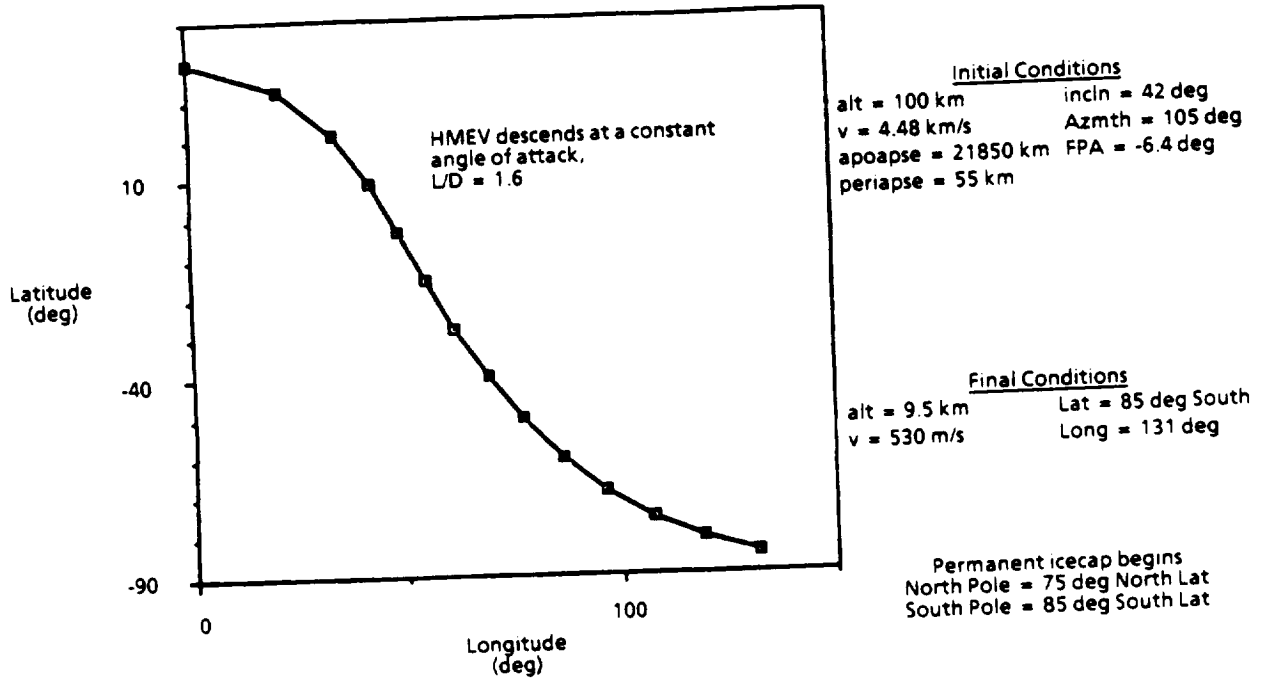

The HMEV may be capable of reaching a landing site within the north or south polar icecap

Figure 9-29. Polar Access with HMEV Lander

TD044

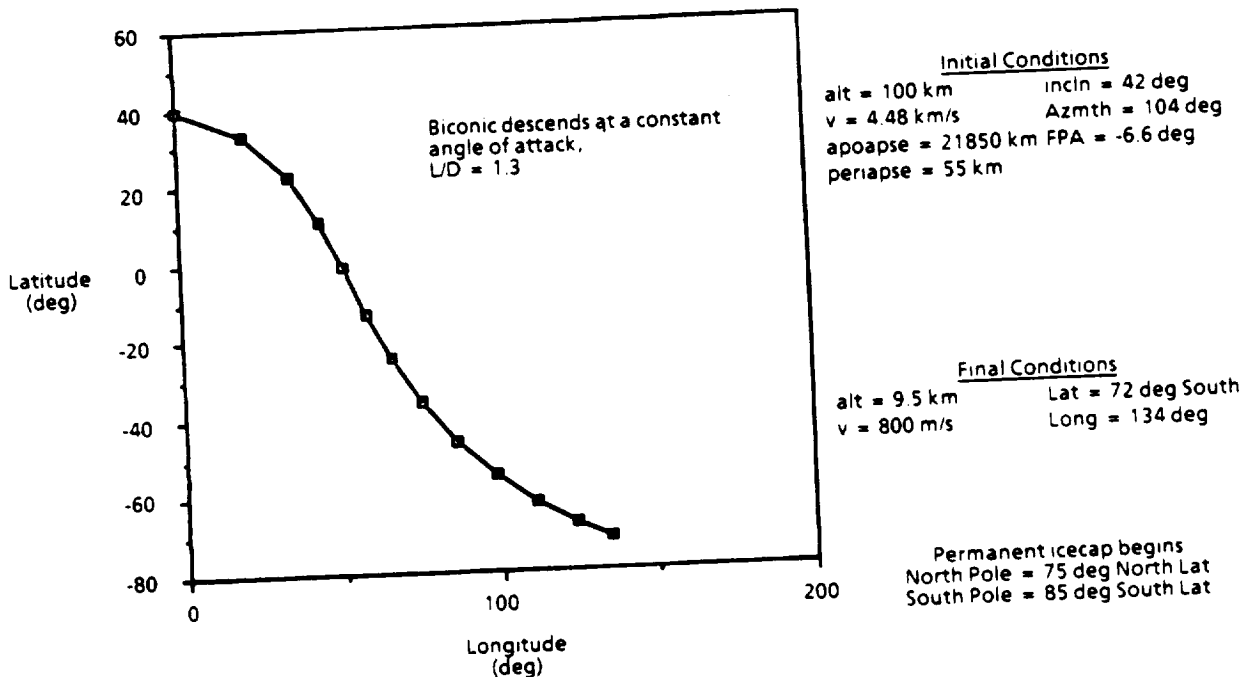

The Biconic may be capable of reaching a landing site within the north polar icecap.

Figure 9-30. Polar Access With Biconic Lander

TD045

#### 9.4.7 Nuclear Reactor Disposal

Provided are options for the disposal of spent nuclear reactor propulsion modules in a way that precludes or reduces the chances of Earth biosphere contamination with nuclear waste from the reactor. A spent reactor is defined by a nuclear thermal propulsion system reactor that has been operated over one or more Mars missions and has come to the end-of-life usefulness. The reactor may or may not have propulsive abilities remaining. If the reactor does not have self propulsive abilities and if it is in safe Earth parking orbit, then it will be assumed that measures will be taken to affix a dedicated disposal vehicle to the spent reactor to facilitate appropriate delivery to safe disposal orbit.

##### 9.4.7.1 Safe Disposal Orbits

There have been several nuclear safe disposal orbits proposed: circular orbit between Earth and Venus, circular orbit between Earth and Mars, and circular orbits about Earth. The most promising from a low probability of Earth impact standpoint appears to be a circular orbit of 0.85 AU between Earth and Venus.

##### 9.4.7.2 Nuclear Reactor Disposal Options

Listed below are some option scenarios for delivery of the spent nuclear reactor to a safe disposal orbit of 0.85 AU.

- a. Dedicated disposal vehicle delivers reactor from shorter safe Earth parking orbit to safe disposal orbit between Earth and Venus; crew cab may be removed for reuse prior to disposal.
- b. Nuclear Thermal Propulsion system delivers itself from safe Earth parking orbit to safe disposal orbit between Earth and Venus; crew cab may be removed for reuse prior to disposal.
- c. NTP vehicle performs Earth gravity assist at Earth return. Subsequent maneuvers will be required to circularize orbit to safe disposal orbit. For reuse purposes, crew habitat could be separated and aerocaptured (unmanned) at Earth.

##### 9.4.7.3 NTP Reactor Disposal by Powered Earth Gravity Assist

Each of the above three option should be studied in greater depth to ascertain their impact on mission delta-V budgets. In this analysis, however, only the Earth gravity assist option has been analyzed.

A nuclear reactor disposal delta-V summary and comments chart is found in figure 9-31. For the 2014 and 2016 opposition missions, maneuver delta-Vs were found to be on the order of 4.5 km/s. These maneuvers placed the vehicle in a nuclear safe circular orbit of 0.85 AU. The 2016 and 2018 conjunction missions, however, have excess Earth return Vhp which do not provide a sufficient turning angle to perform the Earth gravity assist disposal maneuver.



Disposal Maneuver: Earth gravity assist with propulsive maneuvers at Earth and at periapse (0.85 AU) of target orbit.\*

Opportunity	Delta-V km/s	Comments
2014 opposition	4.43	Earth Vhp = 5.48 km/s; Earth closest approach radius - 113,000 km; Earth delta-V = 3.14 km/s
2016 opposition	4.68	Earth Vhp = 7.2 km/s; Earth closest approach radius - 27,000 km; Earth delta-V = 3.39 km/s
2016 conjunction	--	Insufficient turning angle to perform disposal maneuver; Earth Vhp = 9 km/s**
2018 conjunction	--	Insufficient turning angle to perform disposal maneuver; Earth Vhp = 3.59 km/s**

\* Recommended approach is an unpowered Earth-Venus gravity assist, requiring no delta-V. (Need further work to identify/assess disposal profiles.)

\*\* The Earth return Vhp could be reduced to increase the turning angle; this would significantly increase total delta-V for disposal maneuver.

Figure 9-31. Reactor Disposal Delta-V

An alternative approach to targeting a circular nuclear safe orbit would be to utilize an unpowered Earth-Venus gravity assist to place the spent reactor in an elliptical orbit with periapse at Venus' orbit and the apoapse of 1 AU. Also, in the case of the 2016 high Earth return Vhp of 9 km/s, an unpowered Earth-Jupiter gravity assist may be feasible, placing the vehicle in a high inclination orbit about the sun.

#### 9.4.8 Summary

Several conclusions may be drawn from the delta-V and descent analysis study.

Mars optimal parking orbits differ widely from mission to mission, and landing site access will likewise differ.

Reserves, reactor cool-down, midcourse, and losses have been accounted for in vehicle sizing.

Elliptical parking orbits require 1 to 2 km/s less delta-V than circular parking orbits.

Vehicle sized for 2014 opposition mission can be made compatible with the 2016 abort from surface delta-V requirements by making an off-periapsis capture maneuver.

For the 2014 opposition mission, a low L/D MEV can land at daylight sites within lat = 20 degree north or south through partial skip-out.

For the 2018 conjunction mission, low L/D MEV daylight landing sites are within the southern hemisphere.

The Biconic lander may reach the northern polar icecap. The HMEV lander may reach the northern or southern polar icecap.

Disposal of spent nuclear reactor into a "nuclear safe" orbit requires delta-V ≈ 4.5 km/s; recommended approach is a low delta-V Earth-Venus gravity assist into an orbit with low probability of Earth impact.

## 10.0 LUNAR DRESS REHEARSAL ANALYSIS

### 10.1 INTRODUCTION

The Lunar Dress Rehearsal (LDR) task encompasses both the definition and the characterization of a piloted lunar mission in which a prototype Mars transfer vehicle is utilized for a checkout mission prior to committal to a multimission Mars program. The program time table utilized in this study calls for a lunar checkout mission in 2010, to precede a first piloted Mars flight of 2014. This corresponds to the timetable originally set forth in the 1991 Synthesis Group Report Mars transportation implementations (ref. 22).

The primary objective of this study was to examine and characterize several options for a lunar dress rehearsal for the first piloted Mars mission. The lunar mission serves to validate key Mars vehicle subsystems and mission operations necessary to the initial Mars flight. The rehearsal mission crew will evaluate the spacecraft in its operational environment, as well as provide mission planners an opportunity to evaluate their response to their habitat for a duration approximating that of an Earth-Mars transfer mission. By remaining within Earth-Moon space (close proximity as compared to Earth-Mars distances), an emergency Earth return trip time of several days rather than months is always available. In this way, some of the risks associated with the initial use of the nuclear thermal propulsion system and the closed-cycle ECLS crew habitation systems will be reduced over that of a first-time use of these elements at the more remote Mars distances encountered on the initial 2014 Mars flight.

In the STCAEM study, the broad initial base was selectively narrowed as the study progressed. Some detailed analyses was concentrated on specific, clearly defined SEI missions outlined in the Synthesis Report. With the selection of NTP as the preferred propulsive technology, and recommendation for a first piloted Mars flight in 2014, came a co-lateral requirement for a lunar mission to flight qualify the propulsion system and other essential technologies.

The major emphasis presented in this section involves the identification and assessment of a prototype Mars vehicle system, and a mission plan circumscribing the validation of those hardware systems and mission operations unique to the Mars missions.

#### 10.1.1 Specific Areas of Investigation

Simulating the zero-g and radiation environment effects of the Earth-Mars outbound trajectory will be accomplished by operating, maintaining and monitoring the spacecraft for 175 days in lunar orbit. This will supplement SSF findings relative to crew response to long duration habitability factors and provide the essential in-space operational experience with the prototype vehicle necessary for its flight qualification for

subsequent Mars flights. Priority items included assessments of the influence of ETO launch vehicle packaging (shroud size limitations) and on-orbit vehicle assembly operations in LEO on vehicle design. Of primary importance to the qualification of a prototype vehicle is the postflight inspection of the two major hardware systems developed and utilized solely for Mars missions; the NTP and transfer habitat systems. Other investigations included identifying Mars surface mission elements to be delivered to the Moon, planning a lunar flight test of the Mars excursion vehicle ascent system and evaluating options to the reference mission plan.

## **10.2 MISSION PROFILE**

### **10.2.1 Earth-Moon-Earth Transfer**

A dual-engine NTP system is utilized for all major mission phases, including a three burn periapsis Earth departure to demonstrate the startup/shutdown cycling capability and post-burn cooldown operation that would be necessary for the later Trans Mars Injection (TMI) burn sequence. This system is to be as nearly identical to that of the piloted Mars mission vehicles as the development cycle will permit. After a 4-day outbound cruise period with capture into lunar orbit, a chemical LEV delivers the prototype Mars surface habitat module to the surface, where a 12-to-60-day surface mission is conducted as a means of partially 'simulating' a Mars surface mission. The low g-level Mars surface habitat module and its associated support systems hardware will be validated, as well as surface crew exploration activities anticipated for the initial Mars stay. The delivered surface hardware systems may be supplemented by existing lunar outpost power and rover systems. Subsequent to the surface mission, the NTP transfer vehicle departs lunar orbit for its return trip before being propulsively recaptured into either a LEO or a high elliptical Earth orbit.

### **10.2.2 Reuse**

Because of the relatively short NTP engine burn time associated with lunar missions (approximately 1-1/2 hours total for the four burns), at least 75 percent of the expected engine operational life (in hours) is still available for use on follow up lunar missions, or for either the initial Mars cargo flight in 2012 or piloted flight in 2014. By returning the spacecraft to LEO, the crew transfer habitat module and NTP system are accessible for a detailed post-flight on-orbit inspection and would be available for reuse on subsequent missions. A significant front end cost reduction might result for the follow on Mars program, by completely eliminating the necessity for manufacture, launch and assembly of one "core" vehicle element (i.e. propulsion, habitat, and structural/interconnect systems). The additional resupply and reassembly required for reuse would be limited to providing a MEV, propellant tanks, and consumables.

### 10.2.3 Abort Modes

The transfer vehicle carries a Crew Return Vehicle (CRV) with a chemical propulsion Earth return stage, similar to the Apollo service module, to provide mission abort capability in case of main propulsion system failure.

## 10.3 VALIDATION OF MARS MISSION UNIQUE HARDWARE

The LDR task activity mandates a total mission transfer time of 175 days and a lunar surface stay time of 12 to 60 days. The 175-day mission duration approximates the outbound trip time of the initial 2014 Mars mission. The following key subsystems are to be validated over the course of the mission:

### Space Transfer Vehicle Systems

1. Nuclear Thermal Propulsion systems
2. Transfer vehicle crew habitat module system
3. Mars vehicle truss strongback/interconnect system
4. Long term LH<sub>2</sub> cryogenic propellant storage.

### Surface Habitat Systems

5. Mars surface crew habitat systems

### Surface Access Vehicle Systems

6. MEV ascent stage
7. Crew Return Vehicle

### Aerobrake Technology

8. MEV descent aeroshell

Optional Earth entry test separate from transfer vehicle mission.

## 10.4 SPACE TRANSFER VEHICLE DESCRIPTION

Application was made of the preassembled tank/truss/propellant line NTP vehicle configuration, a refinement of the deployable truss NTR vehicle design developed earlier in the STCAEM study, to satisfy the requirements of the Synthesis Report Mars missions. This configuration was originally presented in the STCAEM Phase 2, Final Report (ref. 2), following a favorable assessment of its suitability to minimizing on-orbit assembly operations, launch vehicle packaging difficulties, and required ETO flights.

### 10.4.1 Transfer Vehicle Systems

The lunar dress rehearsal vehicle 'core' configuration includes two NTP engines at 75,000 lbf (333.6 kN) thrust each, a tungsten/boron carbide/lithium hydride radiation shadow shield, an aft tank/RCS assembly, an interstage 'spine' truss structure that includes expendable tank attachment and connect provisions, a Mars transfer crew habitat, power, thermal control, attitude control and communications utility services, a LEV, and a small Apollo type, chemical propellant Earth return stage for a contingency abort return, figure 10-1. This core configuration is launched in two 30-meter length by 12-meter diameter payload shrouds, with a 150-metric ton payload capability launch vehicle. Trans lunar injection H<sub>2</sub> propellant is provided in a single hydrogen tank launched separately. These three vehicle sections are berthed together at the two truss interface connect points in LEO. Separate propellant line installation is not required.

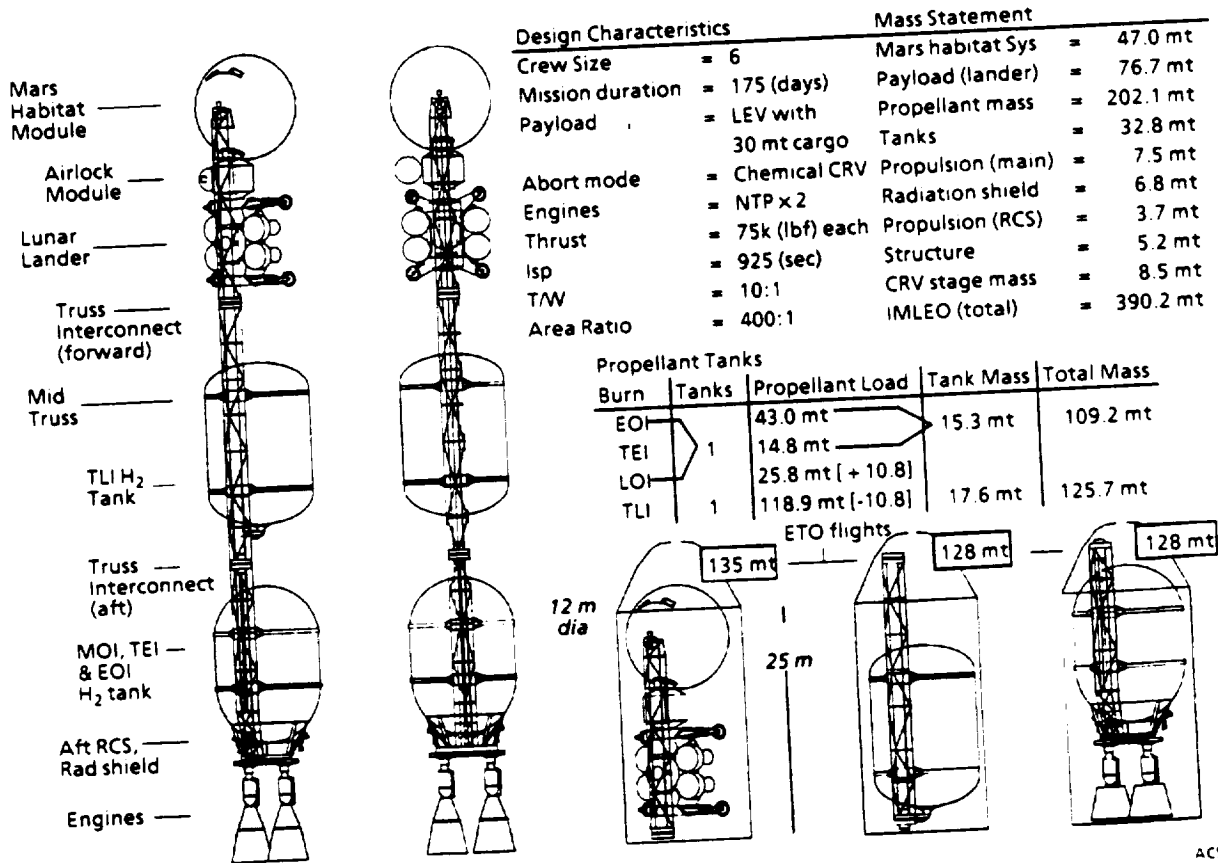

ACS086

Figure 10-1. Nuclear Thermal Propulsion Lunar Dress Rehearsal

**10.4.2 Transfer Vehicle Performance and Mass**

Vehicle IMLEO is shown as a function of lander mass and lander cargo mass in figure 10-2. For a nominal LEV delivered surface payload requirement of 30 mt, with vehicle return to LEO, the transfer vehicle IMLEO is about 400 mt. For return to a high energy elliptical orbit, IMLEO is about 315 mt.

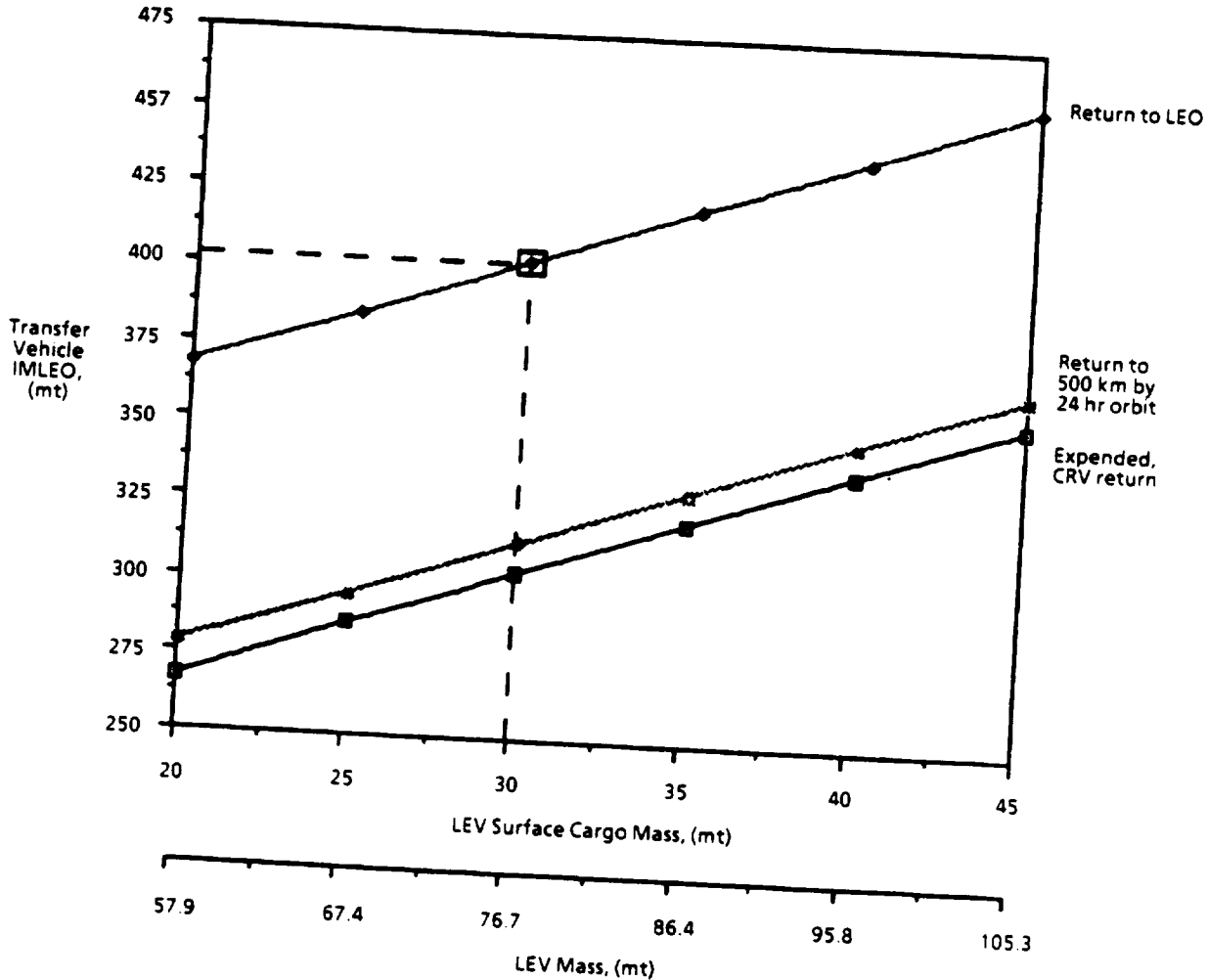

Figure 10-2. Vehicle Mass Variation with Surface Payload

**10.4.3 Transfer Vehicle Propulsion System**

RD016

The nuclear engines are advanced prismatic fuel or particle-bed engines with a thrust-to-weight ratio of 10 or greater. Isp is baselined at 925 seconds. This Isp corresponds to a 2700 K reactor fuel element temperature, a 1000 psia chamber pressure and a nozzle expansion ratio of 400. Liquid hydrogen is pressure fed, with warm hydrogen gas utilized for tank pressurization during burns. Vehicle tanks are passively insulated with multilayer insulation and vapor-cooled shields; active refrigeration is not

used. Both engines are operated for all maneuvers unless one is inoperable. Mission rules provide for return-to-Earth abort in the event an engine failure. Reactor and engine-vehicle integration data (beyond that gathered during ground tests) needed to resolve NTP specific issues, or for engine qualification, include, but are not limited to, the following:

- a. Start cycle influence on fuel element cracking and reactor life. Mars missions will require a total of 5 major burn maneuvers, including a three burn Earth departure maneuver. The impact of these thermal cycles on fuel element matrix/coating delamination and subsequent atomic H<sub>2</sub> fuel element erosion is an important indicator of reactor life expectancy.
- b. Maximum reactor temperature and reactor life. The impact of the 1.5 hour lunar mission reactor operation time at peak temperature on fuel element integrity will provide additional data beyond that provided by ground testing.
- c. Dual engine neutronic interaction influence on reactor control. Close proximity between two reactors may influence reactor neutronic control systems. Any undesirable 'control linkage' existing between the reactors is to be assessed. As an option for validating the 'engine out' failure margin requirement, a deliberate midburn single reactor shutdown might be undertaken as a means of determining what residual neutronic influence the shutdown reactor might have on the operational reactor.
- d. Aft tank heating effects. Close placement of the aft H<sub>2</sub> propellant tank to the reactors may result in exaggerated H<sub>2</sub> boiloff if adequate radiation heating insulation is not provided. This may be difficult to simulate during a static ground test.
- e. Real time measurement of transfer habitat radiation levels. Determining transfer habitat module NTP generated radiation dose as a function of engine burn time and H<sub>2</sub> propellant shielding influence would be desirable, and would serve as a data point for verification of analytical radiation code predictions used during the vehicle design phase. The lower delta-V lunar mission results in a lower level of reactor total fission product buildup than that of the later higher delta-V Mars missions. Predicted NTP Mars crew habitat generated radiation dosages can be extrapolated from lower levels generated on the lunar mission.

#### 10.4.4 Transfer Vehicle Crew Systems

The transfer habitat is an aluminum composite-reinforced metal matrix pressure vessel with unreinforced interior secondary structures. It provides full-service crew systems with private quarters, galley/wardroom, command and control, health maintenance, exercise and recreational equipment, and science and observation posts. Crew suggestions pertaining to placement and operation of habitat systems will allow for needed internal geometry reconfiguration and refinements prior to initial Mars missions.

#### 10.4.5 Radiation Sources

Mars mission radiation exposure to the crew is a primary concern to mission planners due to the variety of radiation sources and uncertainties involved with estimating their magnitude and frequency. The exact levels and frequencies of exposure accumulated over the course of a Mars mission, and the biological sensitivity of astronauts to these radiation sources are difficult to quantify. The uncertainties in this area are threefold:

- a. The quantitative characteristics of the radiation in space are poorly known (i.e., number of particles, energy spectrum etc.)
- b. The interactions of high-energy particles with various shield material are in doubt
- c. The effects of the particles of different energy on human tissue (i.e., the relative biological effectiveness) are largely unknown.

A real-time measurement of actual radiation dosages impacting the vehicle habitat module in an environment outside the Earth magnetosphere will serve to validate internal geometric attenuation methods. The primary radiation sources to be shielded against are:

- a. Van Allen. A belt of trapped radiation surrounds the Earth except in the polar regions. Two zones of intense radiation exist within the belt. The interzone contains many electrons, but more importantly, a large number of protons, of energies of over 30 mev confined to altitudes between about 400 and 5,000 nautical miles. The outer zone extends over a much wider range of altitudes but is mostly composed of electrons, which are easily stopped by a thin sheet of metal.

To minimize large Earth departure gravity losses for the high delta-V Mars missions (brought on by small vehicle thrust-to-weight ratio at Earth departure), a three burn periapsis maneuver is employed. This would mean that three passes would be made through the Van Allen belt.



- b. **Cosmic Ray.** Cosmic radiation consists of very energetic atomic nuclei, over 90 percent of which are protons. However, heavier particles, such as alpha particles, comprise more than 30 percent of the total by weight and also have far more deleterious effects on man. Cosmic-ray fluxes exhibit a significant variation with time which is related to solar activity.
- c. **Solar Flares.** At irregular intervals, the Sun emits bursts of radiation which are classified according to the area of the visible disturbance on the Sun's surface. Class 1 and 2 flares occur almost continuously, but their accompanying radiation is believed to be sufficiently low in energy that it is stopped by even thin walls. Class 3 flares, which occur on the average of about once a month, emit mostly protons (of energies up to 500 mev) with possibly 10 percent alpha particles.
- At rare intervals there occur giant major flares. These are large flares of the Class 3 category which may emit up to 10,000 times the usual intensity radiation with particle energies as high as 20 bev. The greatest portion of shielding attenuation is aimed at this Class of event.
- d. **Nuclear Propulsion (NTP).** NTP reactor radiation is composed of gamma rays and neutrons, which are of fairly low energy in comparison with the naturally occurring particles.

The above information on radiation sources and uncertainties was condensed from reference 23.

Dedicated radiation shielding is not provided in the baseline Mars transfer vehicle habitat module; radiation dose calculations indicate that the shielding provided by the transfer habitat structure, systems and consumables is adequate to protect the crew, assuming the crew uses the galley as a storm shelter during severe solar proton events.

#### 10.4.6 Transfer Vehicle Attitude Control Propulsion System

Attitude control is provided by a biprop  $N_2O_4/MMH$  propulsion system. Nuclear engines have low-rate gimbal capability for center of gravity tracking; the attitude control propulsion system provides attitude damping during thrust periods.

#### 10.4.7 Transfer Vehicle Truss Strongback/Interconnect System (Structures)

Propellant tanks are constructed of aluminum-lithium alloy, or metal matrix composites pressurized to 25-35 psia. Intertank and other main structures employ advanced composites for reduced mass. The truss strongback or 'spine' uses a simple rigid (load carrying) truss arrangement that allows for preassembly and integration of tanks, propellant lines, pressurant lines, and other umbilicals directly to the truss at the ground station assembly building. These elements are preassembled and flown in the

ETO vehicles as complete preintegrated units to minimize the on-orbit assembly task. The transfer vehicle is divided into three elements as shown in figure 10-1. This configuration was developed as a means to minimizing the complexity and number of assembly tasks required on orbit, as well as for facilitating launch vehicle packaging. All tank gas pressurant lines, power lines and communication lines, (i.e. cable trays) are connected at these two interfaces. Only a single H<sub>2</sub> propellant connection is required at the aft-truss interconnect. Filled tanks are flown up to orbit. The only assembly required on-orbit is the joining of the three vehicle segments at the two truss interconnect planes. This represents the absolute minimum in assembly operations that is possible for a three ETO vehicle delivery to orbit. It may be possible to eliminate the need for an assembly platform altogether by attaching RMS/RCS packages to two of the three vehicle elements to provide for autonomous self assembly. A description of the ETO flight manifests is given below. No less than two operations is possible. Further reductions in assembly operations can only be achieved by utilizing larger ETO vehicles that can deliver the complete spacecraft in a fewer number of flights.

#### 10.4.8 Earth-to-Orbit Vehicle Flight Manifests

Three flights are planned to perform this portion of the mission:

- a. Flight one delivers the transfer habitat system, forward truss section CRV/chemical abort stage, solar panel system and the LEV.
- b. Flight two delivers the TLI tank/midtruss assembly.
- c. Flight three delivers the engine/aft tank/RCS assembly.

### 10.5 VALIDATION OF MARS MISSION UNIQUE OPERATIONS

In-orbit and in-flight operations unique to the Mars mission will be conducted to insure that the capability to accomplish these operations is in place before the first Mars mission elements are delivered to orbit. These operations are listed according to their chronological order in the mission timeline, figure 10-3.

#### 10.5.1 On-Orbit Assembly/Assembly Platform

On orbit delivery and construction of the vehicle assembly platform precedes all other space activities. This platform, co-orbiting with SSF in LEO will serve the rehearsal and all Mars missions. Its design may be transfer vehicle configuration dependent and specific. It is delivered as a one piece unit and assembles spacecraft sections utilizing SSF or ground control. The optimal extent of automation vs. man-in-the-loop control/monitoring vs. EVA assistance was not addressed in this study. After assembly, preflight checkout tests are conducted before the crew board the craft. Additional checkouts and crew training follow, with the vehicle under assembly platform control until the spacecraft is given authority to separate and fly in formation in LEO

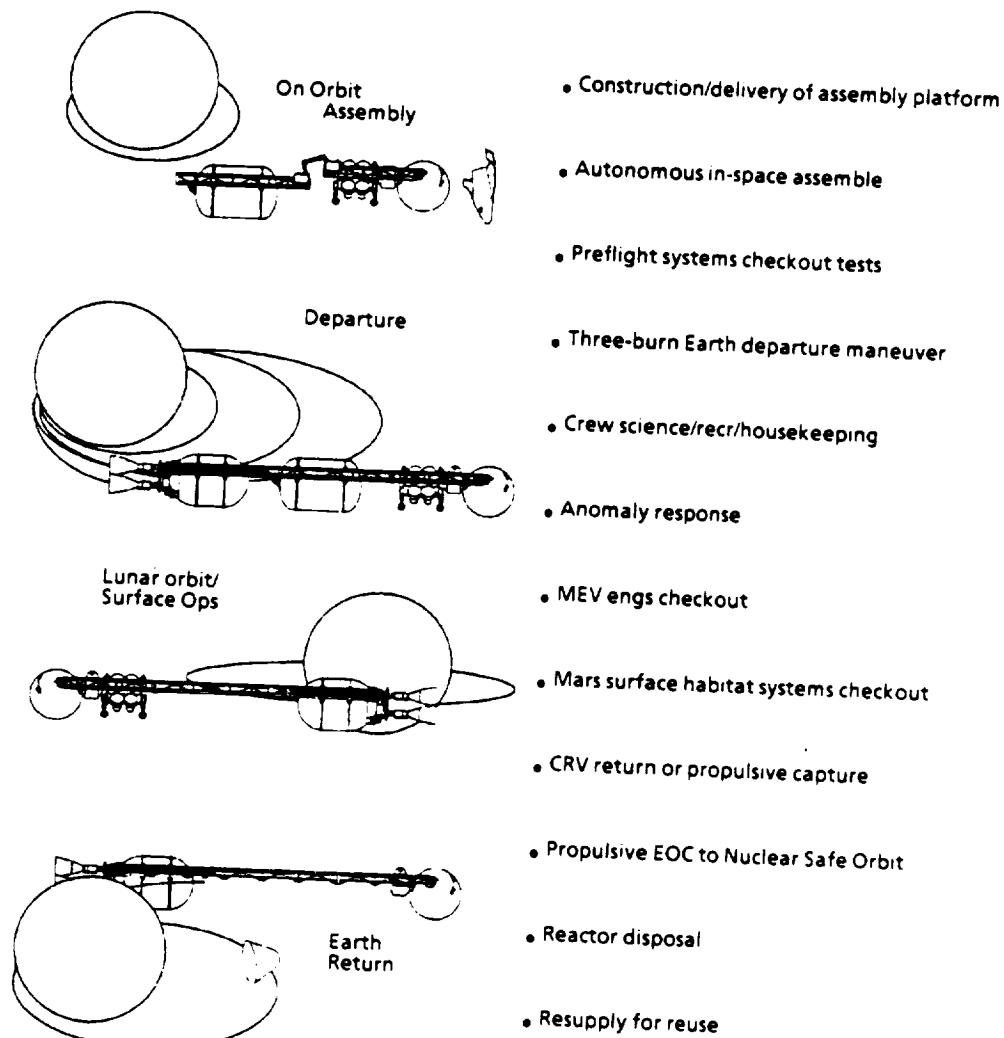

Figure 10-3. Validation of Mars Mission Unique Operations at the Moon

ACS087

with SSF and the assembly platform. The delivery, assembly and checkout sequence for the rehearsal mission may represent the first truly autonomous vehicle construction task in space. Validation of these operations is key to meeting the Mars program assembly timetables planned for the 2012 - 2018 time period, as proposed in the Synthesis Report.

### 10.5.2 Outbound Flight/Lunar Arrival/Lunar Orbit

During this phase, crew science/recreation/vehicle housekeeping and maintenance activities are carried out. Anomaly response, as required, is carried out and documented for hardware modification/upgrades for the Mars flight vehicles. Propellant tank jettison occurs at the end of Earth departure and lunar capture burns. LEV descent engine checkout tests may be conducted as a review for the Mars missions.

### 10.5.3 Surface Operations

The following operations fall into this category: (1) Mars surface habitation systems checkout (see section 10.6); (2) Mars surface power systems checkout; (3) verification of surface system control and monitoring of orbiting transfer vehicle capability; and (4) Mars ascent flight test (see section 10.8).

### 10.5.4 Inbound Flight

On the inbound flight, there is continuation of crew science/recreation/housekeeping/maintenance and anomaly response activities. Also, crew response to zero-g isolated environment data is documented. Real-time radiation assessments are continued.

### 10.5.5 Earth Return

In this category are the following: (1) propulsive vehicle EOC burn for return to LEO, (2) EOC burn for return to nuclear safe orbit, (3) reactor disposal option, or (4) CRV return to SSF or splashdown.

## 10.6 SURFACE MANIFEST

A surface stay duration of 90 days is planned for the 2014 first piloted Mars mission as outlined in the Synthesis Group Report. A JSC supplied surface habitation/exploration manifest for this mission is given in figure 10-4. The total cargo allotment according to this manifest, to be delivered and deployed at Mars, is 115 metric tons. This equates to more than 1.2 metric tons of mass per day of stay time and 15 metric tons per individual crew member. This total includes two surface habitat modules, two airlocks, surface power generation equipment, spares, exploration equipment and other items. It was assumed in this study that a lunar lander capable of delivering up to about 30 metric tons would be available. A vehicle meeting this requirement is briefly described in section 10-7. It was determined that the rehearsal mission would deliver one LEV cargo load to the surface, which means that only about one quarter of the planned 90 day Mars surface mass could be delivered and operated on the Moon for checkout purposes. Those elements selected for the rehearsal flight are indicated in figure 10-4 as the boxed items, including a 23.9 metric ton outfitted habitat module, a 5.5 metric ton airlock and 1 metric ton of communication equipment. It was also assumed that surface power is available to these systems from a lunar outpost or base power supply. The rehearsal mission surface stay time must be commensurate with the surface habitation systems actually delivered. A question arises as to what extent a crew of 6 outfitted with a 30-ton portion of the planned 115-ton manifest can validate the surface systems necessary to the follow-on Mars missions, especially the conjunction class missions that are characterized by stay times of as much as 600 days.

		<u>Flight Mass</u>	<u>Total</u>
<u>Flight 1</u>			
	Equipment: offloading/construction	5.75	34.81
	Power: Martian module (100 kW)	5.98	
	Power management and distribution	2.50	
	Rover: Pressurized Mars	6.50	
	25 kW power cart	6.00	
	Experiment/sample trailer	3.45	
	Flare warning system	0.23	
	Mars geology/exobiology equipment	0.56	
	----	----	
	----	----	
~30 mt	<u>Flight 2</u>	<u>Flight Mass</u>	<u>Total</u>
			34.84
Habitat, Airlock & Equipment →	Habitat Module 1 (Martian)	23.85	
	Airlock: 2 person, Martian	5.50	
chosen for Lunar validation	Communication equipment, Martian	0.94	
	Habitat analytical lab instruments	0.15	
	Biomedical lab	0.50	
	Discretionary	0.30	
	----	----	
	----	----	
	<u>Flight 3</u>	<u>Flight Mass</u>	<u>Total</u>
			34.75
	Habitat Module 2 (Martian)	25.50	
	Airlock: 2 person, Martian	5.50	
	Power: Mars PVA/RFC system (25 kW)	2.65	
	----	----	
	----	----	

Figure 10-4. Mars Surface Exploration Manifest - 2014, 90-day stay

### 10.7 SURFACE HABITAT SYSTEM DELIVERY

It was assumed in the analysis that a "heavy delivery" lunar cargo lander would be available for a 2010 mission. Initial lander work was concerned primarily with refinement of an earlier STCAEM study Lunar Excursion Vehicle single-stage lander design for application as the delivery vehicle for the prototype Mars surface crew habitat module and airlock. This lander design, outfitted in its piloted/cargo configuration was chosen because of its effectiveness in delivering the combination of a single large surface habitat module of up to 30 metric tons and a six man excursion crew cab.

### 10.7.1 Lunar Lander Application

This vehicle provides for unassisted cargo downloading directly to the surface by mounting the cargo underneath its propellant tankage/propulsion system instead of above it or to each side. Positioning the cargo in this fashion is the key to providing for safe and efficient unloading operations. The cargo module or pallet is attached from above to the cargo bay, which lies below the base of the engine extension frame structure and propellant tanks. LO<sub>2</sub>/LH<sub>2</sub> main engines at 475 Isp and N<sub>2</sub>O<sub>4</sub>/MMH storable propellant RCS thrusters at 300 Isp are used.

This 'undercarriage' design specifically eliminates the difficulties inherent to the 'top-loaded' and 'side-loaded' cargo lander designs since no assistance is required from a separate overhead crane or gantry type off-loader (top-loader lander design requirement), and the cargo does not have to be divided for side placement (side-loader lander design requirement). Increased access to the cargo by surface transporters, ease of cargo ejection for an emergency descent abort maneuver, immediate cargo drop for emergency ascent to orbit, and contiguous placement of the surface habitat module and excursion crew modules are the advantages provided by this configuration. A flatbed surface transporter can be carried underneath the cargo for immediate transport after touchdown. The design incorporates lessons learned from terrestrial cargo delivery helicopter operations, reference 24.

### 10.7.2 Lander Mass and Performance

Required lander mass is plotted vs. surface cargo mass (Mars habitat module in this case) for two versions of this vehicle type: the piloted/cargo version, and an unmanned cargo only design, figure 10-2. The cargo only version differs in the lack of the crew cab and ascent propellant. With 30 metric tons of cargo, the piloted version weighs approximately 76 metric tons including descent and ascent propellant.

## 10.8 MARS ASCENT STAGE CHECKOUT TEST AT THE MOON

Demonstrating MEV ascent stage performance prior to committal to piloted flight is the objective of this addition to the baseline mission plan. Propulsion systems, flight control systems, and propellant thermal insulation systems are three key technologies to be validated in a lunar test of a Mars ascent system. Testing of a Mars only lander on the lunar surface as an option in a development and test program was considered as early as 1967 in one major MEV study, reference 25.

### 10.8.1 Flight Plan for Propulsion and Flight Control Systems

The propulsion and flight systems can be demonstrated by an unmanned ascent to lunar orbit flight. Selection of a descent stage for delivery of the prototype Mars ascent stage are presented for three options.

- a. Option One. Assuming that some form of lunar transportation system is already operational by 2010, an option entails the utilization of a pre-existing lunar vehicle descent stage for delivery of the Mars ascent stage test article. Since current analyses tend to favor cislunar optimal single-stage vehicles, however, a significant modification to the lunar lander design would be necessary to configure a two-stage vehicle consisting of a lunar system descent stage with the MEV ascent stage as its second stage.
- b. Option Two. This option consists of utilizing a prototype MEV descent stage as the descent delivery stage. The MEV must accommodate entry heating and will employ aerodynamic braking to reduce descent propellant mass; the lunar vehicle descent is unaffected by descent heating and cannot make use of aerobraking. Since this stage is primarily an aero-deceleration driven design, a modification would be necessary for its use as a delivery stage for a lunar test. Following this approach, a complete two stage Mars excursion vehicle would have to be delivered 2 or 3 years earlier than would otherwise be necessary, compressing an already busy hardware delivery schedule.
- c. Option Three. Due to the extent of the modifications necessary to either a LEV single stage or MEV aerobraked stage, the development of a 'one use only' descent stage from either of these two options might be undesirable. A lower cost alternative is available that can satisfy the test objective. The reference MEV ascent stage test article propellant tank capacity is sized to provide the 4500 to 5000 (m/s) of martian ascent delta-V needed to reach the transfer vehicle orbit for rendezvous. In contrast to this, the sum of both the lunar descent and ascent-to-orbit burns is approximately 3900 (m/s), well below the capability of a MEV ascent stage if flown with its tanks completely full. Consequently, it is proposed that this ascent stage fly both the lunar descent and ascent to orbit maneuver as a single stage, with the sole addition of a minimum weight landing leg set for touchdown. Option three was assessed as making minimal impact to the development schedule and cost.

### 10.8.2 Cryogenic Propellant Thermal Insulation Validation

Advanced passive thermal insulation systems required of the high Isp cryogenic propellant propulsion systems need validation over long periods in the space environment. The performance of the insulation systems are of critical importance; uncertainty

concerning their capability would force a program decision to drop that technology in favor of the significantly lower performing storable propellant systems, reducing the available cargo delivery capacity of the MEV for all but the long stay conjunction missions. Cryogenic thermal insulation systems are very sensitive to failures in the vacuum jacket system, reference 26. Small penetrations in the jacket could result in a significant loss in thermal insulation integrity, resulting in H<sub>2</sub> boiloff rates so excessive that surface mission activities would of necessity be abandoned to effect an immediate ascent to orbit while sufficient propellant was still in the tanks. Therefore, for MEV ascent stage designs utilizing the cryogenic propellants, the test plan should allow a reasonable period of thermal insulation system exposure to the environment of space to validate analytical predictions of boiloff rates and meteoroid damage assessments to vacuum shell integrity.

### 10.8.3 Mars Descent Aerobrake Qualification Flight

The approach to an MEV test plan is outlined in this section. An MEV checkout test plan involves boosting the Mars excursion vehicle to LEO and allowing it to descend to Earth in such a manner as to duplicate, as much as possible, the loadings and velocities that will be encountered on Mars mission descents. Because of the differences in gravity fields and atmospheres between the Earth and Mars, descent corridor entry conditions and trajectory profiles will necessarily be different. The entry to descent point will be higher to compensate for a more dense Earth atmosphere, however it is not possible to match the lapse rate with that of Mars. Offloading weight could compensate for the larger Earth gravity under steady state conditions but that would influence the dynamics and controllability of the vehicle, an important checkout point, and therefore offloading is not considered. It is assumed that actual flight hardware is to be used, i.e., a full scale version of the MEV. It is clear that the entire flight corridor of a Mars descent cannot be reproduced in its entirety, but we can match one or more points or segments of that trajectory. The hypersonic portion of the flight is deemed as most important for testing, as the more severe loads are placed on the vehicle in this regime. The potential Mars flight corridors can be uniquely defined by dynamic pressure vs. relative velocity profiles. A constant angle of attack is maintained during the hypersonic portion of the descent. Thus, the plan is to determine an Earth descent which will most nearly match a nominal dynamic pressure vs. relative velocity profile with emphasis on the hypersonic regime. It will be desirable to examine as much of the corridor as possible, therefore it might be possible to extend the flight test domain by investigating a skip out trajectory which would intersect the corridor multiple times. Finally, analysis must verify that a boost vehicle is capable of placing the descent vehicle in desired entry corridor. No further analysis has been done at this point.



### 10.9 LUNAR DRESS REHEARSAL MISSION SCHEDULES

Schedules were developed from data generated in Phase 1 of the STCAEM study, references 27 and 28. These, together with the program schedule generated from the Stafford Committee Report, dictate the timing and extent of the required development.

Program Full Scale Development (FSD) was based on the required commitment to project FSD for the reactor and engine development to produce a flight qualified, man rated system available for integration into and testing of mission flight article prior to the first launch date in mid- 2010.

Man rating involves qualifying several critical early-needed Mars systems that will be placed in trial checkout by the lunar dress rehearsal. These items, previously identified, are shown on individual schedules under the man rating heading. These do not constitute the entire systems that must be developed. As an example, the ECLS is part, but not the whole, of the required habitat development. The habitat development, therefore, is shown as a separate schedule. Some items have an importance that is not apparent from the program schedule; an example of this is the Self-Check techniques, where the procedures must be incorporated into other systems prior to their qualification testing. This indicates that there is some cross schedule influence. Where possible, those items that directly affect each other are shown in the same schedule page. As many as possible of the schedules that have a major impact on the overall program were done in the time available in this study. These schedules are shown in figures 10-5 to 10-7.

### 10.10 FOLLOW ON LUNAR MISSIONS

Early exploration, extended exploration, and exploitation of lunar resources represent three categories of manned lunar operations. If SEI plans eventually call for extended exploration or resource exploitation, a period of heightened lunar operations would be entered into which would create the need for larger accumulations of equipment on the Moon. Extended operations in this phase would call for a further reduction in transportation costs. Reusable surface-to-orbit vehicles would be used at the Earth and at the Moon, and a reusable ferry would carry the larger payloads between their orbits. NTP vehicles such as the one described may provide economy over other propulsion vehicles such as the lunar chemical propulsion vehicle, paving the way for the accomplishment of two national space program goals.

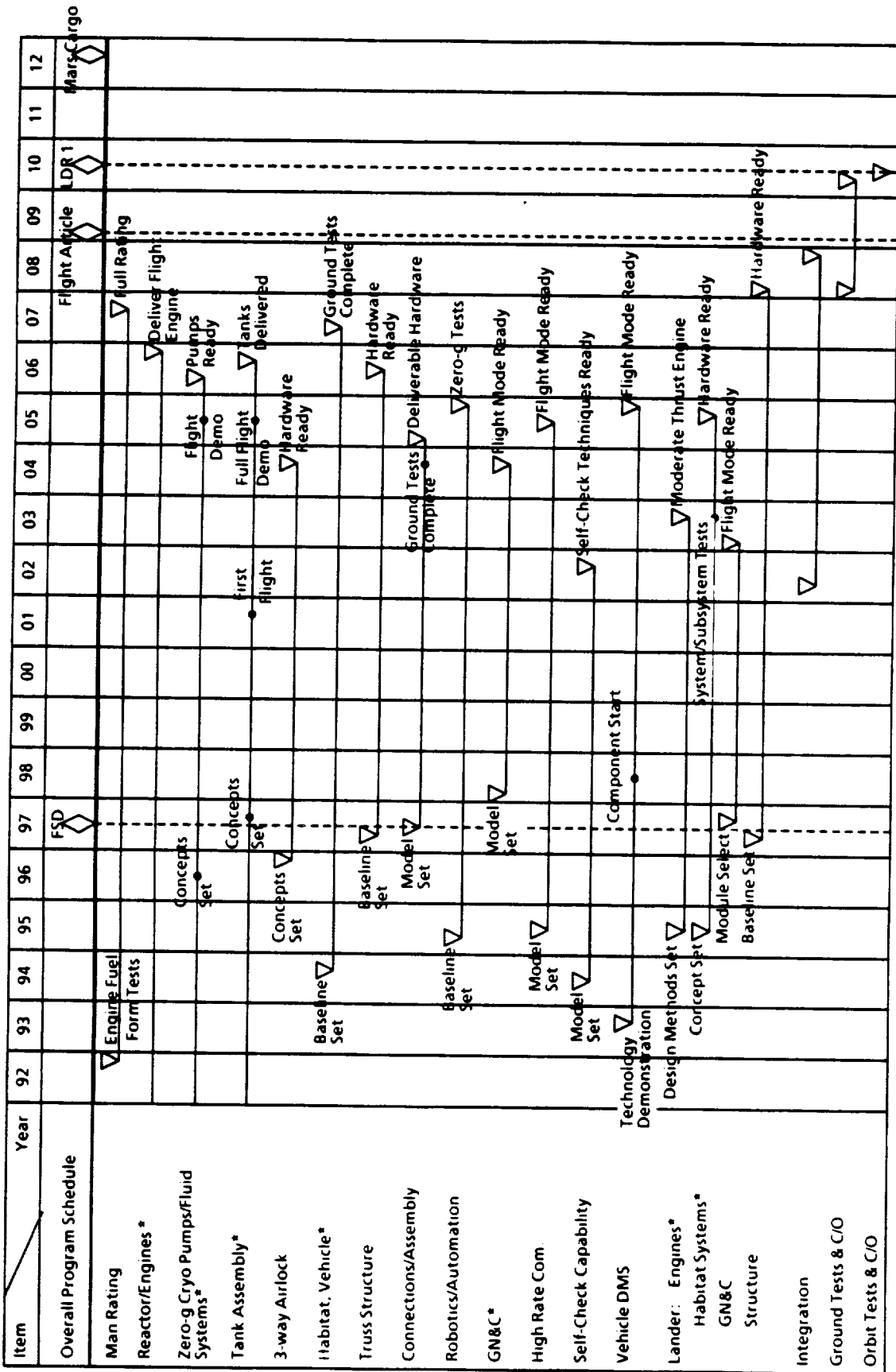

Figure 10-5. Lunar Dress Rehearsal - Top Level Development Schedule

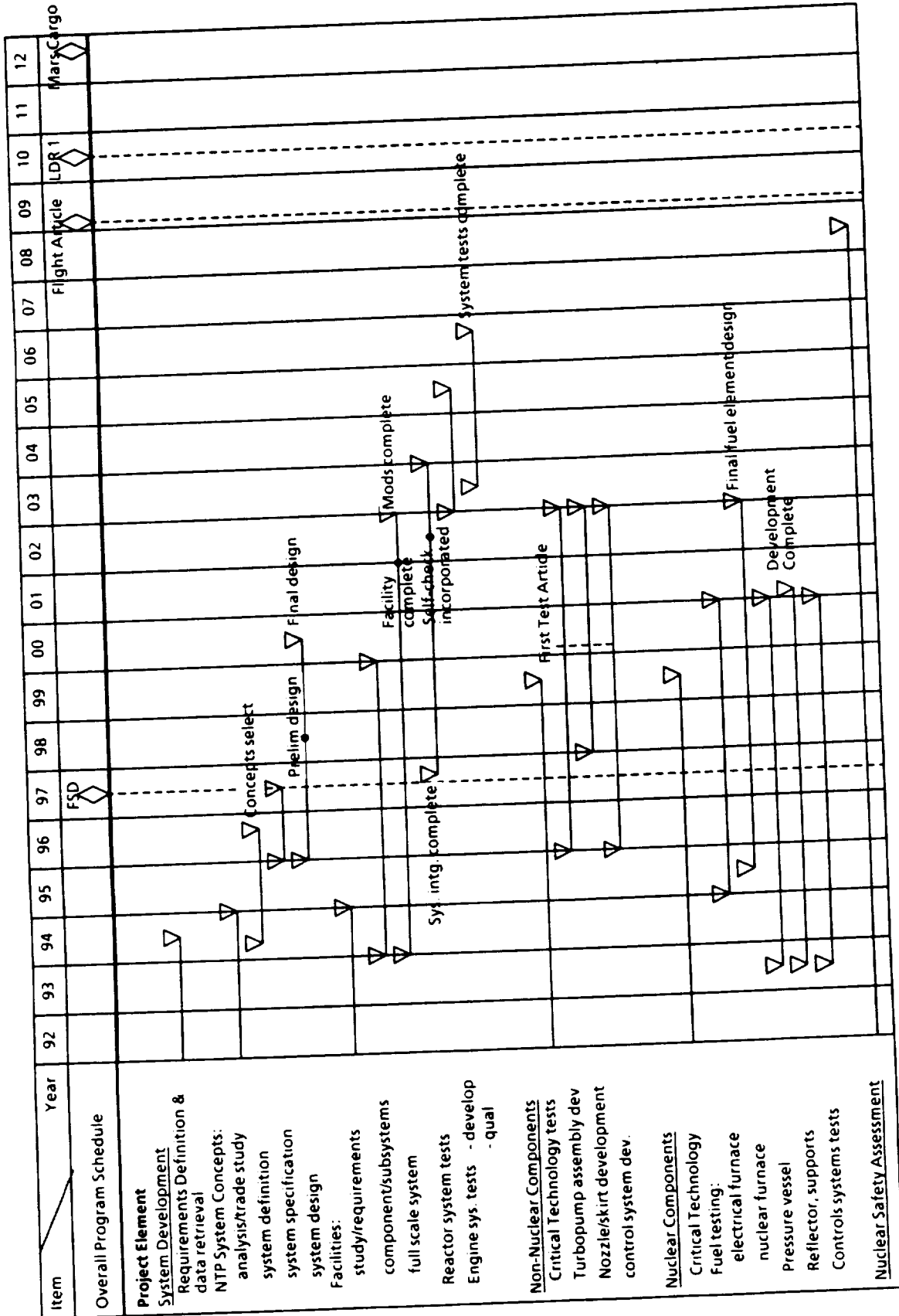

Figure 10-6. Lunar Dress Rehearsal - NTP Engine Development

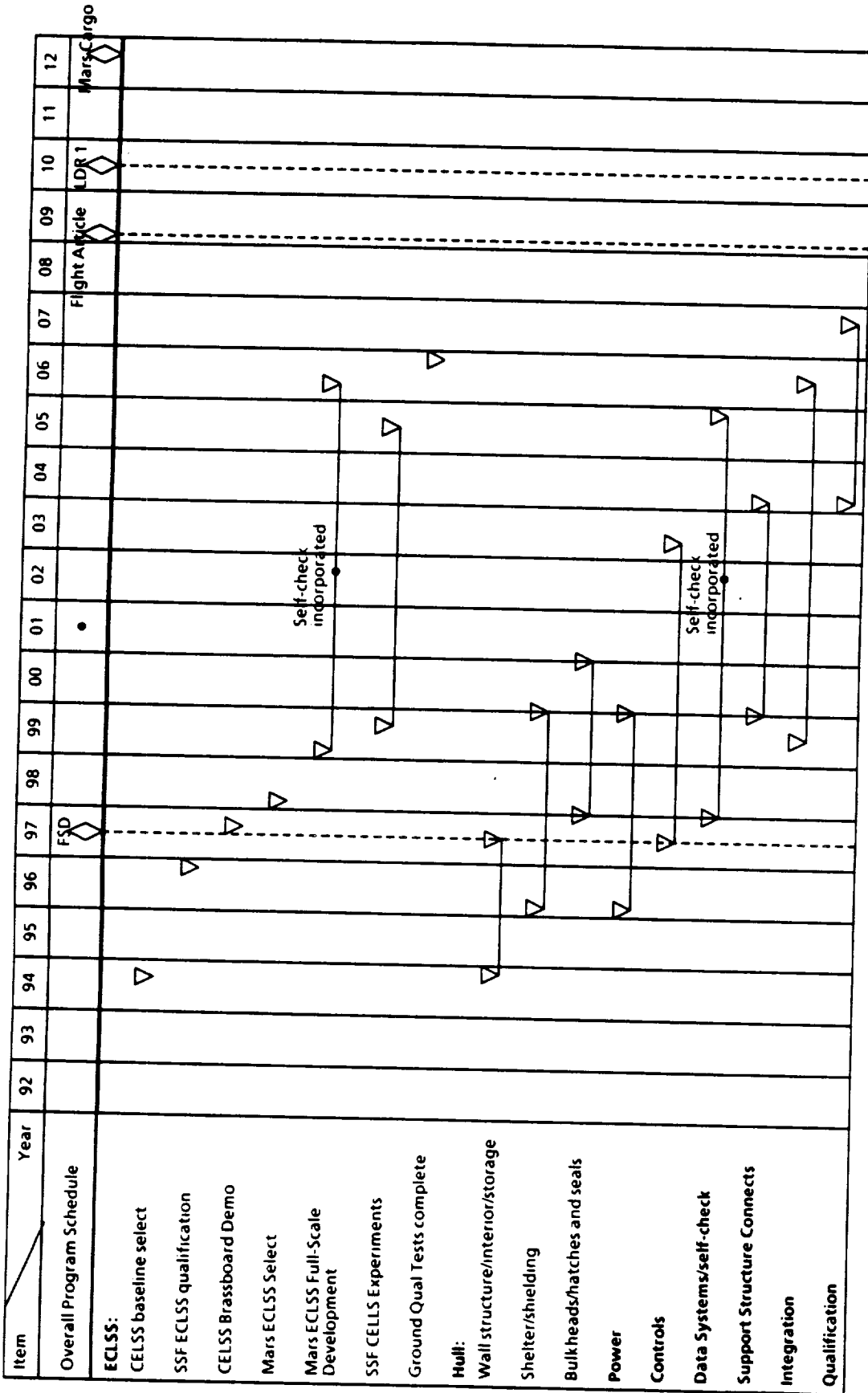

Figure 10-7. Lunar Dress Rehearsal - Vehicle Habitat

## 11.0 MARS EXCURSION VEHICLE OPTIONS

The Mars Excursion Vehicle options task examines aerobrake concepts which could result in reduced heating with extended crossrange capability, and integral launch. The analysis covers a broad range of L/D from 0.2 to 2.0 with a close coupling between the materials, structural analysis and aerothermodynamic analysis for concept design.

### 11.1 SYMMETRIC BICONIC CONCEPTS

During the course of the STCAEM contract, several aerobrake shapes have been examined as options for the Mars excursion vehicle in descent only mode (i.e., nuclear thermal propulsion mission profiles). Shown in figure 11-1 is a summary of these concepts, all of which have been discussed in either the STCAEM Phase 1 or the Phase 2 reports (refs. 1 and 2) except for the symmetric biconic shapes. Biconic concepts were analyzed during the current study in order to provide an alternative means of placing the MEV into orbit without on-orbit assembly while still providing adequate crossrange capability and reduced heating. Integral launch of a biconic Mars excursion vehicle (BMEV) will pose an even simpler problem than that of the side launched high L/D MEV of the earlier studies as the entire vehicle will be in line without a center of gravity (c.g.) offset. The biconic concepts have a base diameter of 10 to 12 meters to fit atop a heavy lift launch vehicle (HLLV).

#### 11.1.1 Parametric Study

A parametric study of biconic cone angles and radii was performed to arrive at a biconic concept which provided a high L/D (>1.0) at large angles of attack, with aerodynamic performance comparable to the HMEV, and also allowing adequate packaging volume for the Mars surface habitat. Constraints and initial limits were used to aid in ruling out nonfeasible concepts. The independent variables used for this analysis included the base  $\theta_b$  and nose cone  $\theta_n$  half angles, the intermediate radius to base radius ratio  $R_i/R_b$ , and the nose cone radius to base radius ratio,  $R_n/R_b$ . A graphical definition of these parameters is displayed in figure 11-2.

For the initial study, the following ranges were examined:

$$\begin{aligned}\theta_n &= 8^\circ \text{ to } 16^\circ \\ \theta_b &= 4^\circ \text{ to } 7^\circ \\ R_i/R_b &= 0.7, 0.8, 0.9\end{aligned}$$

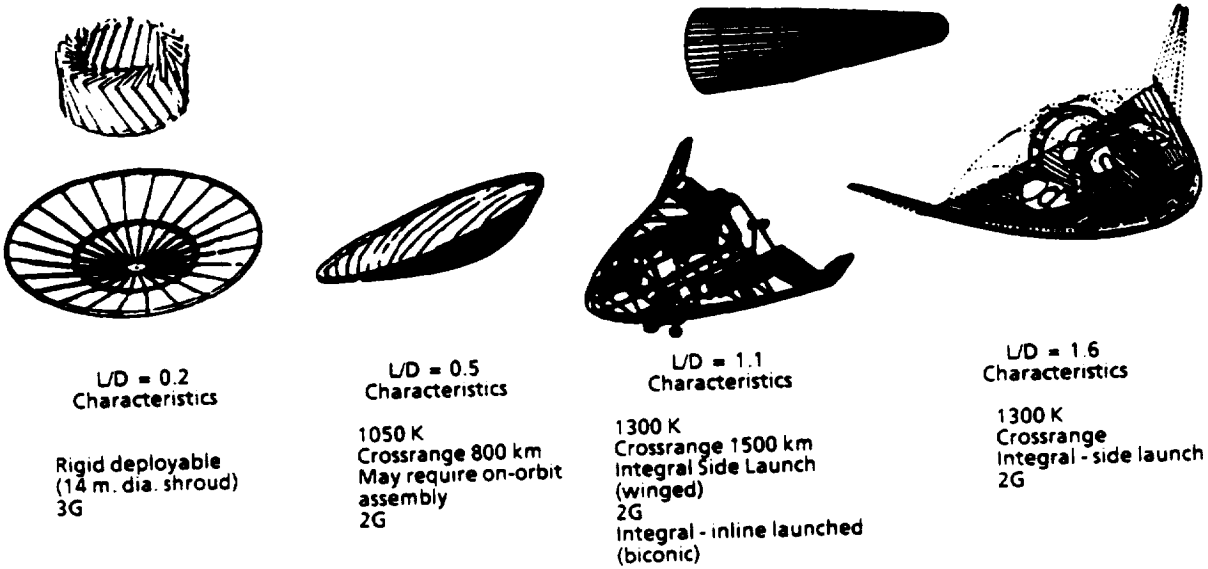
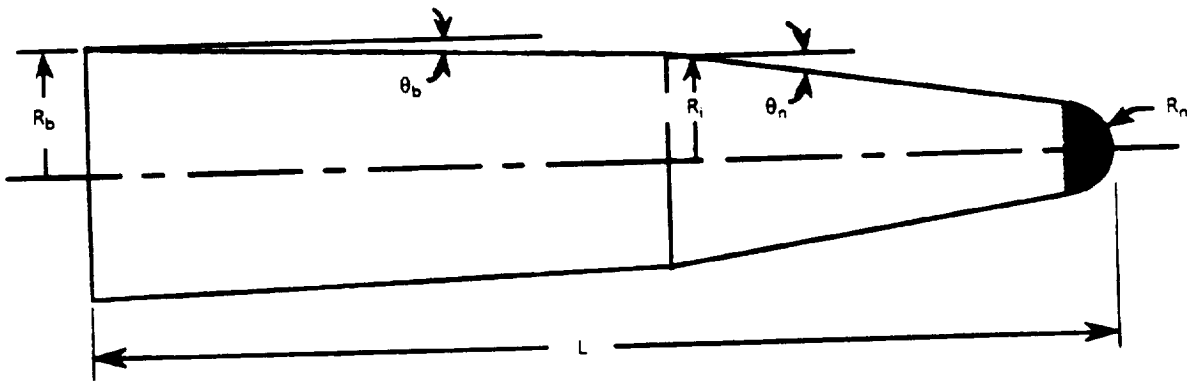

Figure 11-1. Types of Aerobrake Shapes Examined

TD001



$\theta_b$  = base cone half angle       $R_b$  = base radius  
 $\theta_n$  = nose cone half angle       $R_i$  = intermediate radius  
 $L$  = Length                               $R_n$  = nose radius

Figure 11-2. Biconic Geometry Parameters

TD002

The nose-to-base radius ratio was fixed at 0.33. This fixes the actual nose radius at 2 m for an HLLV with a 12 m shroud and 1.65 m for a 10 m shroud. The 2 m value corresponds to a nose radius which would result in minimal heating for an aerocapture maneuver at Mars (ref. 1). For the MEV descent only vehicle, aerocapture is not applicable and thus the nose radius should be as large as possible to reduce convective stagnation point heating. However, in order to decrease the drag, the nose radius needs to be small. The 2 m value was used as a compromise between heating and drag.

Aerodynamics of the biconic concepts were evaluated using the AERO program. This analysis used Modified Newtonian Impact Theory to compute the pressures at large angles of attack. Although this theory is in error at low angles of attack, it is adequate for initial concept screening.

The concepts' aerodynamic characteristics were evaluated at a trim angle of attack of  $20^\circ$ . All aerodynamic coefficients were computed using the plan area as the aerodynamic reference area ( $A_{ref}$ ). This reference area is nondimensional as the base radius was set equal to unity, for this study. The lift-to-drag ratio as a function of drag coefficient times the nondimensional reference area ( $C_D^*A_{ref}$ ) is displayed in figure 11-3. This figure shows the results for many biconic shapes, and is actually a function of all of the aforementioned independent variables. In this figure, concepts which fall in the upper right corner of the graph are the most desirable. The large  $C_D^*A_{ref}$  values give small ballistic coefficient values which would result in lower heating and higher pull up altitudes. Values of  $C_D^*A_{ref}$  for the biconics range from 1.3 to 1.5. If a 30-m length is assumed for both the HMEV ( $L/D = 1.6$ ) and the biconics, the resulting scaled  $C_D^*A$  (where A is the dimensional area) would be  $92 \text{ m}^2$  and  $32 \text{ m}^2$  respectively. With identical masses assumed, this difference in  $C_D^*A_{ref}$  would result in a 65% increase in ballistic coefficient over that of HMEV. Thus, these biconics will result in lower pull-up altitudes and the resulting heating will potentially be higher than the HMEV entry.

A large  $L/D$  value for the biconics is needed to provide aerodynamics similar to the HMEV. For this analysis, the  $L/D$  values were weighed with greater importance (best when  $L/D$  is 1.5 or greater). From figure 11-3, the better configuration is the one with a  $4^\circ$  base cone half angle,  $8^\circ$  nose cone half angle, and  $R_i/R_b = 0.7$ . The concepts will be numbered as "a bc de fg", where a is the base cone half angle, bc is the nose cone half angle, de is the intermediate radius percentage, and fg is the nose radius percentage. Therefore, the selected concept will be numbered 408.7033.

The effects of varying the nose cone half angle on  $L/D$  are more easily readable in figure 11-4. Smaller nose cone angles result in higher  $L/D$  values. The intermediate radius ratio was fixed at 0.7 for this calculation.

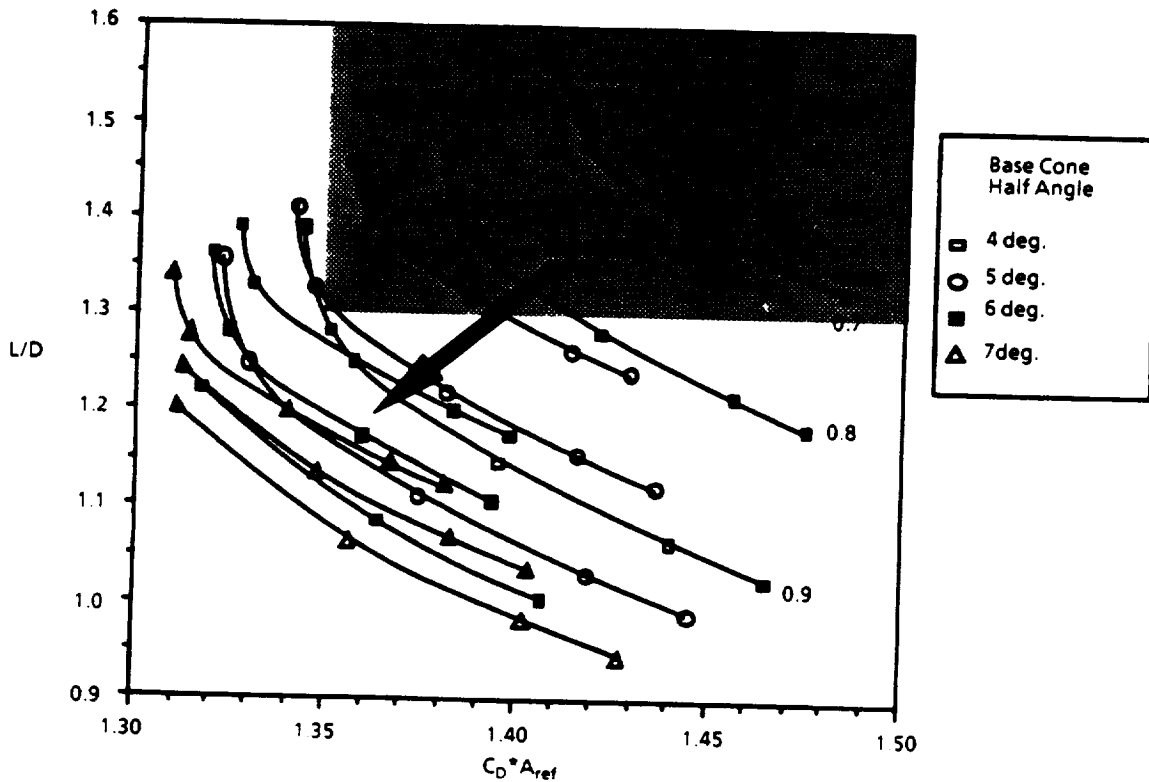

Figure 11-3. Biconic Lift And Drag Values

TD003

The location of the center of pressure (CP) plays a large role in the ability to package a biconic concept. Due to the generally narrow volumes of biconics, it is most favorable for packaging to have the CP located farther aft where the radius is the largest. However, this does not mean right against the base. The normalized  $x_{CP}$  location (distance from the base along the x-axis) is shown with a fixed base cone half angle of  $4^\circ$  in figure 11-5. It can be observed that the best L/D and  $x_{CP}/L$  combination occurs for the 408.7033 biconic configuration.

From this analysis, the 408.7033 biconic concept was selected as the initial symmetric biconic shape. This concept provides an L/D of approximately 1.5 at a  $20^\circ$  trim angle of attack. The overall length of this concept, with a 6-m base radius, is 43 m. The aerodynamic coefficients, for Concept 408.7033, as a function of angle of attack are displayed in figure 11-6.

### 11.1.2 Additional Studies

Further analysis was required to arrive at additional biconic concepts in order to reduce the overall length of the biconic MEV configurations. The Concept 408.7033 resulted in a 43-m length when scaled up to the 12-m launch shroud diameter. This aspect ratio (length/base radius) provided large longitudinal volumes, which are excessive for MEV surface habitat requirements. In order to decrease the aspect ratio and reduce the length of the MEV, additional concepts were evaluated.



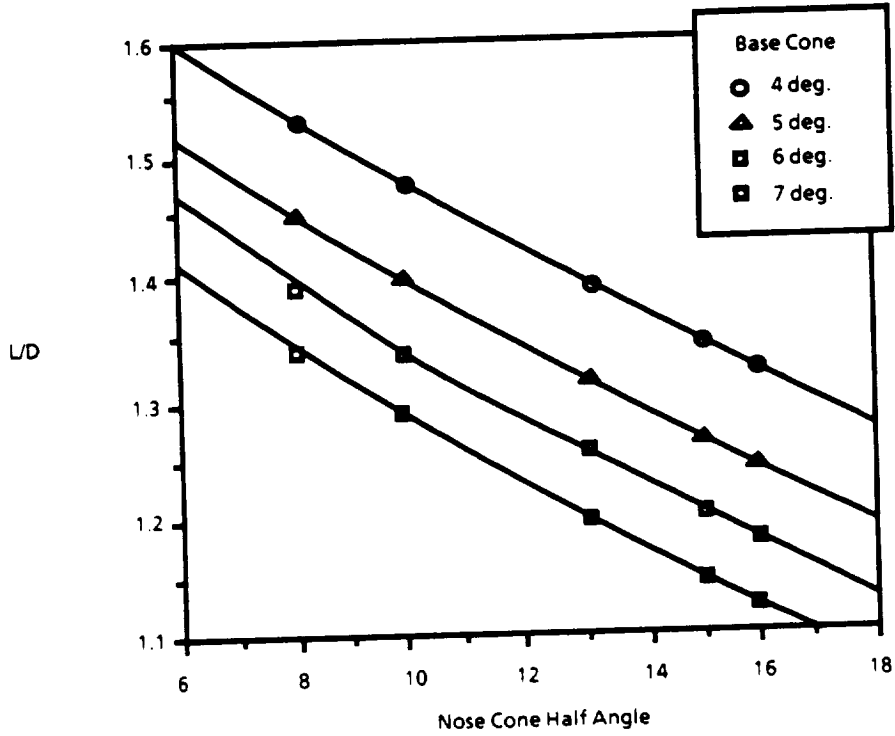
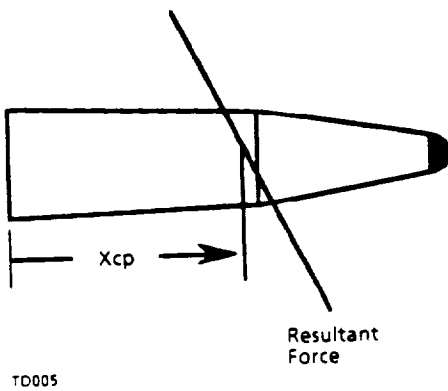

Figure 11-4. Nose Cone Angle Effects



TD005

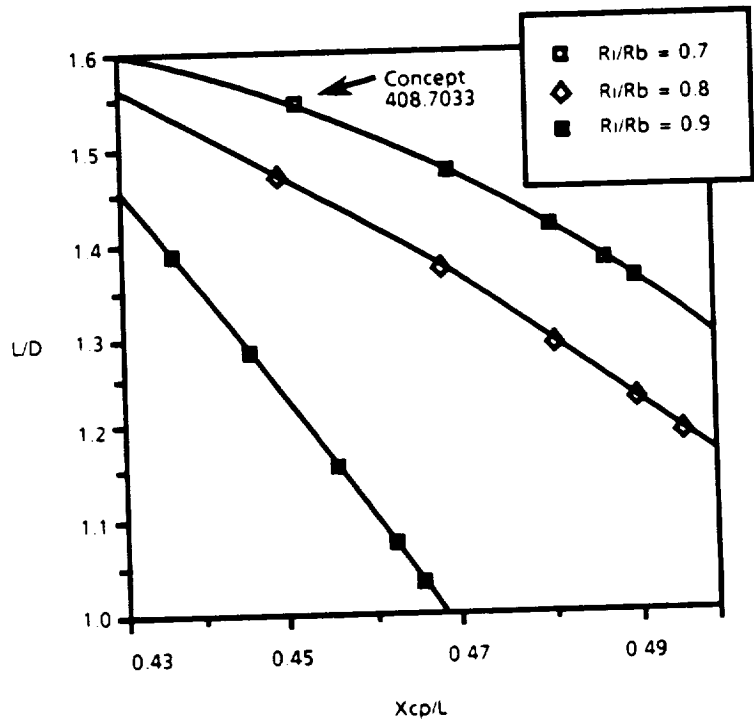

Figure 11-5. Center of Pressure Locations

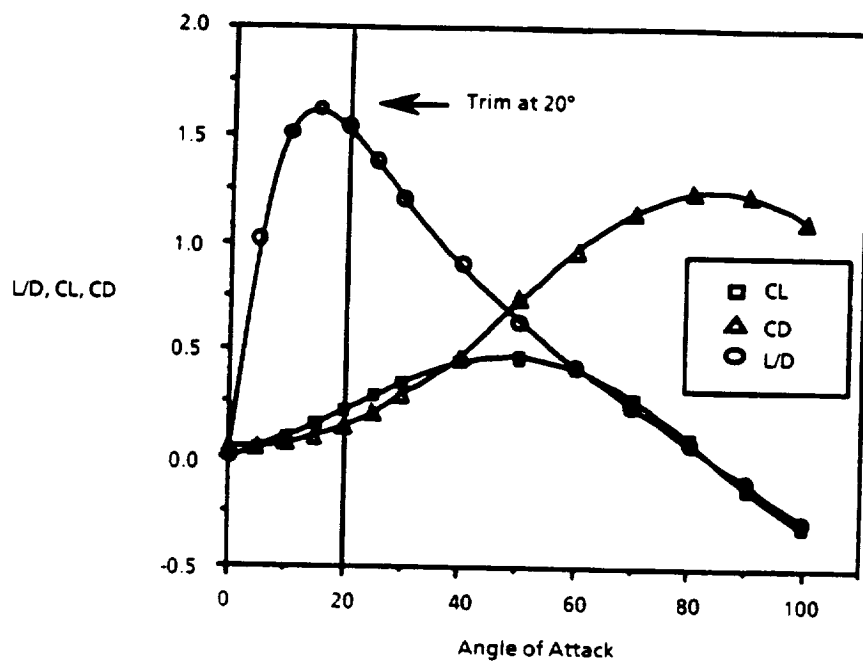

Figure 11-6. Concept 408.7033 Aerodynamic Parameters

TD006

A reduction in the length of these vehicles and thus a decrease in the aspect ratio was accomplished by increasing the intermediate radius of the shapes. However, as evident in figure 11-3, as  $R_i/R_b$  increases, the  $L/D$  decreases, which is not desirable. To avoid a reduction in  $L/D$ , smaller nose radius ratios were investigated in combination with the larger intermediate radius ratios. For this extended examination, the following parameter ranges were examined:

$$\theta_n = 4^\circ \text{ to } 7^\circ$$

$$\theta_b = 8^\circ \text{ to } 16^\circ$$

$$R_i/R_b = 0.7, 0.75, 0.8$$

$$R_n/R_b = 0.1667, 0.2, 0.33$$

A comparison of some of these biconic shapes with the Concept 408.7033 is shown in figure 11-7. The majority of these newer concepts have smaller aspect ratios and nose radii in comparison to Concept 408.7033. The  $L/D$  as function of  $C_D \cdot A_{ref}$  for these updated shapes is shown in figure 11-8 along with the 408.7033 reference point. From this graph, it is noticeable that the product of  $C_D \cdot A_{ref}$  is much smaller than that of the previous concept. Although these smaller values are less desirable, they will result in roughly a 10% increase in the ballistic coefficient, which is not significant. One other

point to note is that as the nose radius ratio decreased, the L/D increased, which is a direct function of the drag decrease or  $C_D^* A_{ref}$  decrease. Based on the values in figure 11-8, the best concepts are the  $4^\circ$  base cone half angle shapes, as they fall in the upper right portion of the graph.

Of the  $4^\circ$  base cone shapes, the 412.7516, 414.7516, 412.7520, 513.7520, and 414.7520 (where 412.7516 =  $4^\circ$  base,  $12^\circ$  nose,  $R_i/R_b = 0.75$  and  $R_n/R_b = .1667$ ) provide the best aerodynamic performance. For preliminary concept definition, the 414.7516 concept was examined in greater detail, as it results in values which are closest to the 408.7033 concept except in length. The aspect ratio (length/ $R_b$ ) of the 414.7516 concept is 6.04, which will result in a shorter more compact MEV configuration when compared to the 408.7033 values of 7.2.

As a result of the reduced nose radii for these shorter bionics, the heating rates that the MEV will encounter will increase. For the descent only MEV, convective heating is the only significant contribution to the stagnation point heating rates. The heating to the stagnation point varies inversely as the square root of the nose radius. The previous nose radius of 0.33 or a 2-m radius with a 6-m base diameter resulted in lower heating rates than the newer value of 0.1667 or 1 m for a 6-m base diameter (value for selected concept 414.7516). A graph of the peak stagnation point heating as a function of nose radii for an MEV descent is shown in figure 11-9. As can be seen, the heating rates increase significantly as the nose radius goes below one meter. The decrease in nose radius from two meters to one meter results in only a 40% increase in convective heating or temperatures of approximately 1450 K. This will result in the potential need for the use of a light weight ablator or reradiative TPS covering, instead of hot structure only, in the stagnation point region. However, as this is a small area, the additional TPS will not be a significant weight increase. Once again, a reduction in the nose radius was required to keep the L/D high while decreasing the overall length of the vehicle.

The lift and drag coefficients as a function of angle of attack for the 414.7516 concept and the HMEV are displayed in figure 11-10. The L/D ratios for these vehicles are displayed in figure 11-11. The aerodynamic parameters for the HMEV are shifted only slightly as compared to the biconic MEV 414.7516 concept. However, there is a significant difference in reference areas thus making the total lift-and-drag forces differ. For the pitching moment coefficients, the c.g. or reference point was chosen at the  $x_{CP}$  location for a  $20^\circ$  trim angle of attack. The 414.7516 biconic displays static stability in that the slope of the  $C_M$  vs.  $\alpha$  curve, shown in figure 11-12, is negative for the higher angles of attack. At the lower angles of attack ( $\alpha < 10^\circ$ ), the slope turns positive.

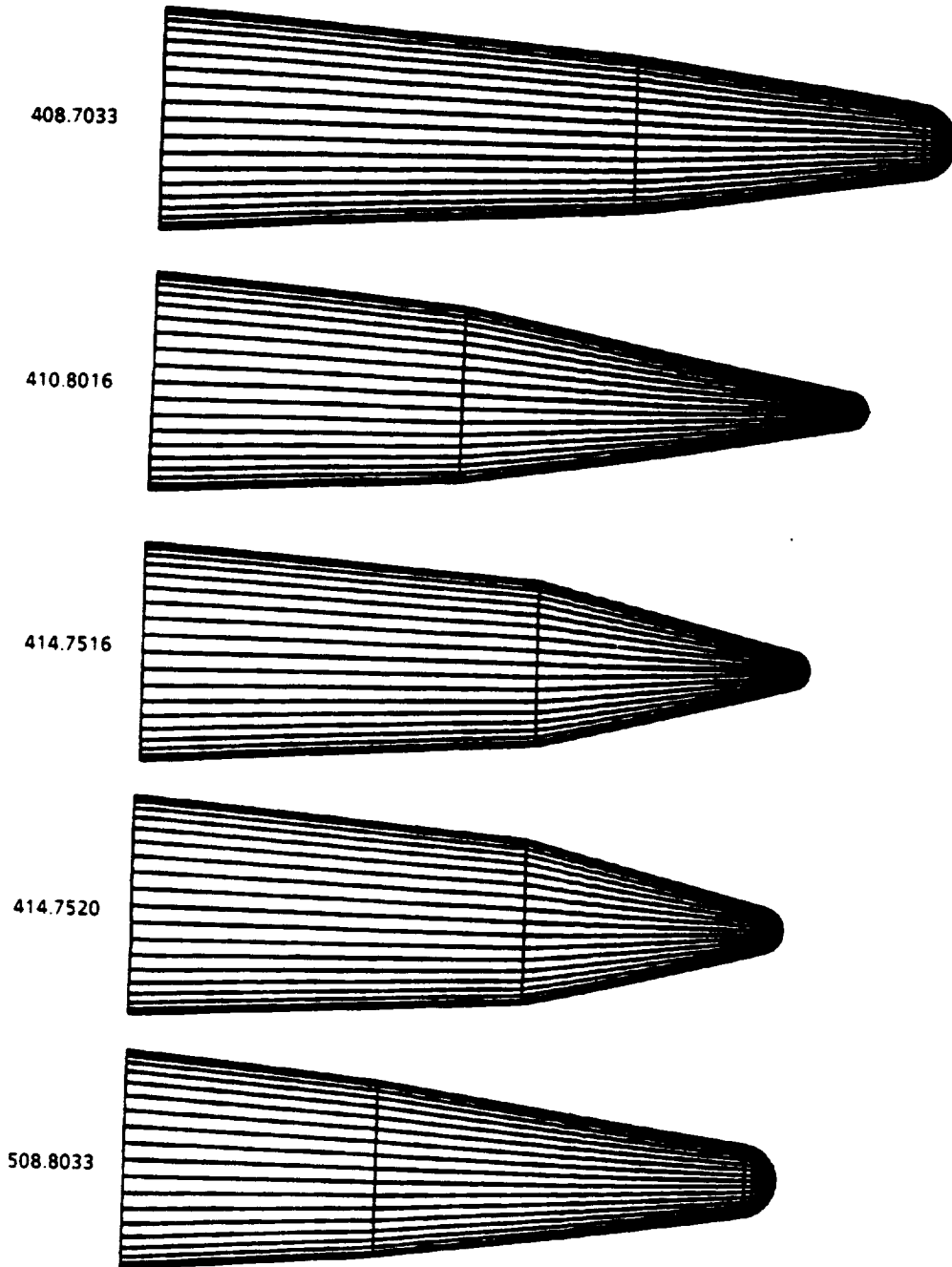

Figure 11-7. Comparison of Biconic Shapes

TD014

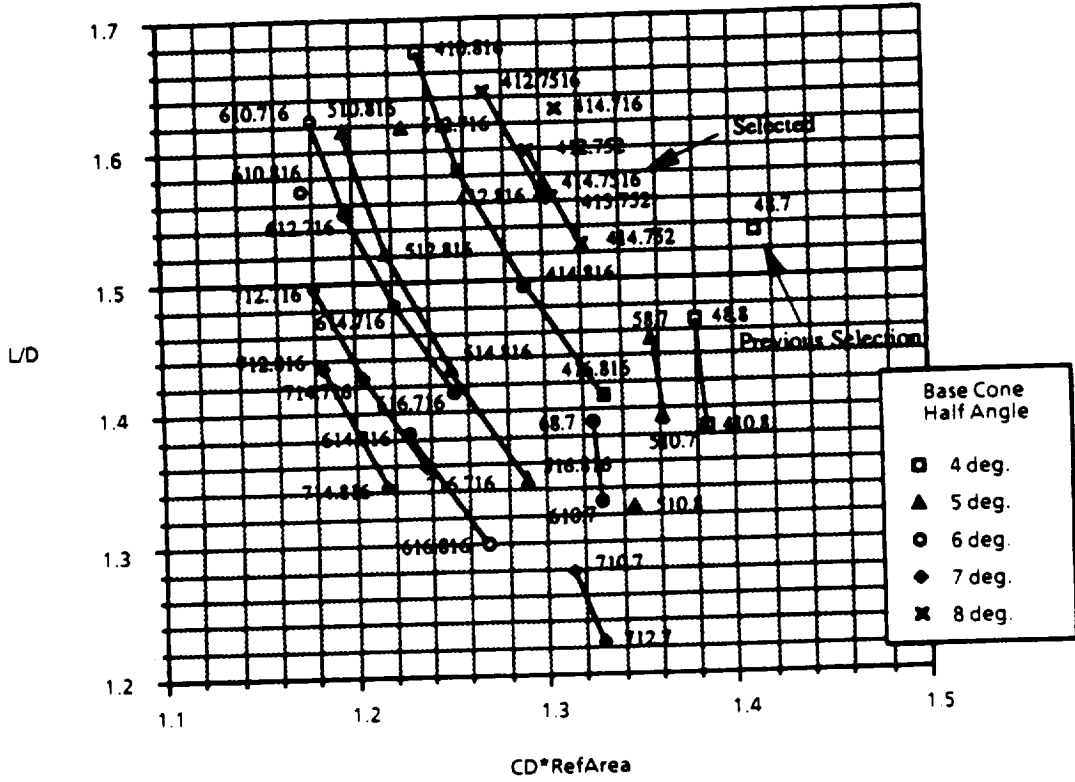

Figure 11-8. Biconic Lift and Drag Values

TD008

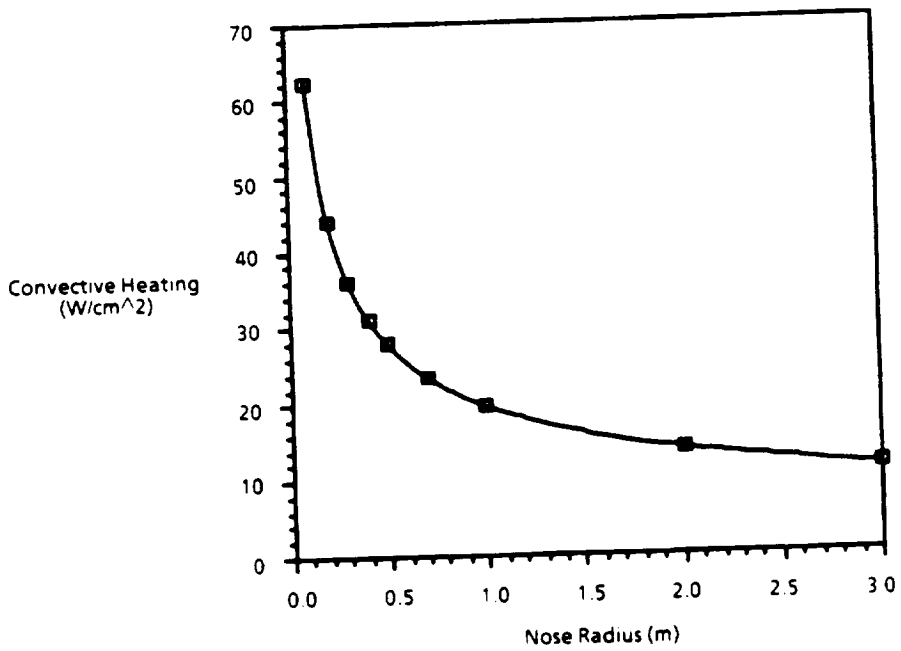

Figure 11-9. Scaled Peak Heating Rates for BMEV Descent

TD009

The values at lower angles of attack are invalid as Newtonian Impact Theory was used, which does not give good results at low angles of attack, and additionally no viscous drag forces were included in the preliminary screenings. A more detailed analysis is required to determine the fully defined aerodynamic characteristics of the biconics.

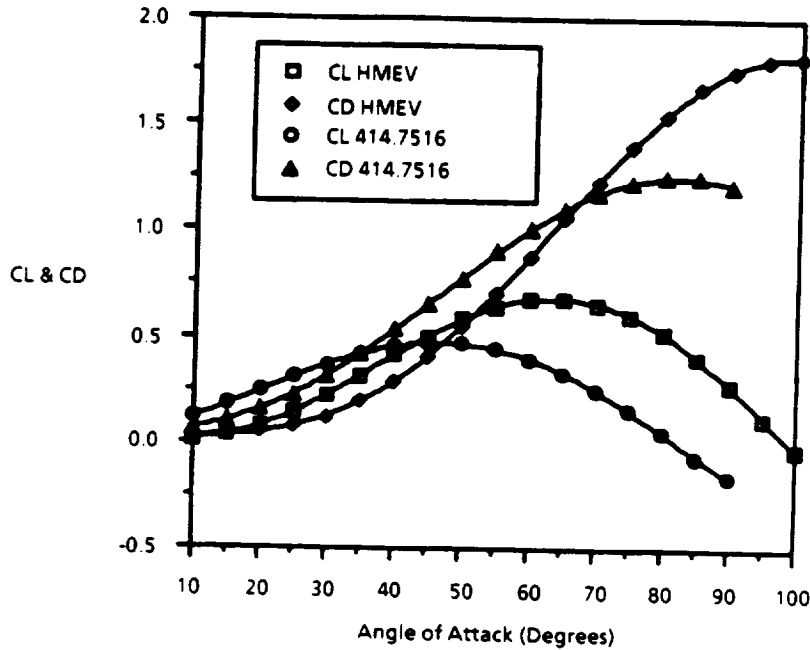

Figure 11-10. Aerodynamic Coefficients for BMEV and HMEV

TD010

### 11.1.3 Biconic MEV Structural Analysis

A simplified structural analysis was performed in order to estimate an approximate weight of the biconic MEV, Concept 408.7033.

#### 11.1.3.1 Loading

A total (vehicle plus payload) mass of 57.2 mt was assumed for this evaluation. Dynamic pressure  $q$  was calculated for a 4g, 20° entry loading as follows:

$$q_{\infty} = 0.1054 * g * Mass = 24116 Pa$$

The biconic vehicle was divided into three sections, section 1 (4 deg), section 2 (8 deg), and the nose cone as shown in figure 11-24. Pressure coefficients,  $C_p$ , vary along the diameter but are constant along the length of each respective section. For a simplified analysis,  $C_p$  along the largest diameter of sections 1 and 2 were averaged.

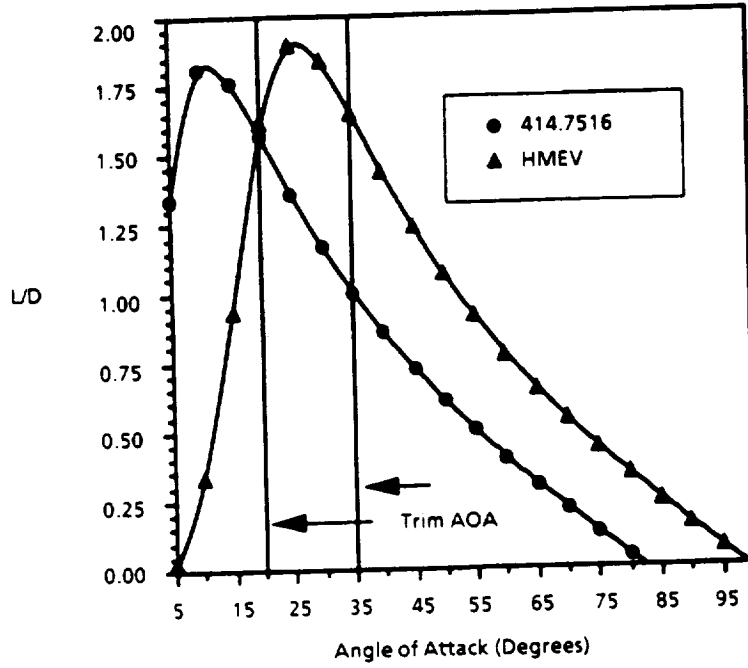

Figure 11-11. Lift-to-Drag Ratios for BMEV and HMEV

TD011

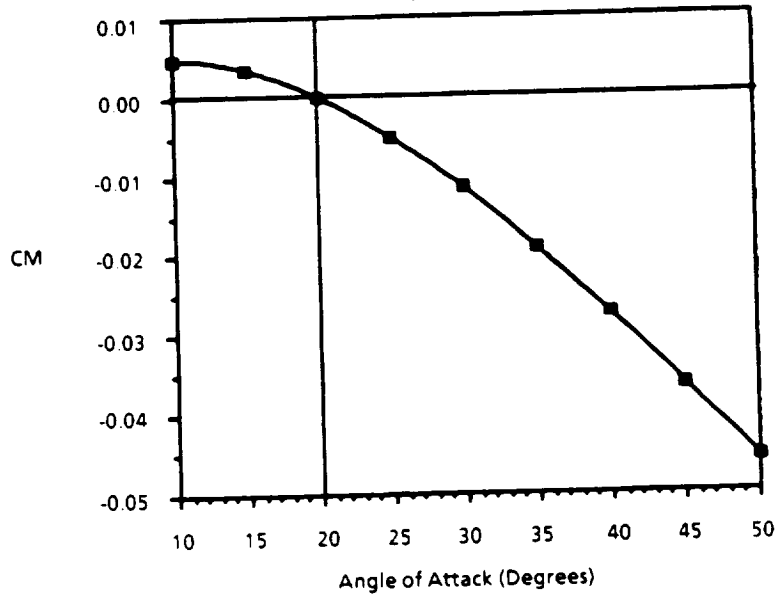

Figure 11-12. Moment Coefficient for Concept 414.7516

TD012

Each  $C_p$  was applied along the length of the respective section to provide a constant pressure distribution. Since the nose section has double curvatures (semi-spherical), maximum  $C_p$  was applied there. Distributed loading per unit length of each section was calculated as follows:

$$w_i = F / L_i = q_{00} * C_{pi} * Diameter_i \quad (N/m)$$

where,

$$F = \text{Total load (N)}$$

$$C_{pi} = \text{Coefficient of pressure for section (i)}$$

$$L_i = \text{Length of section (i)}$$

### 11.1.3.2 Analysis

The biconic was analyzed as a beam with the assumption that the mass of each section was acting through its centroid. A free body diagram was constructed for this beam with lengthwise distributed pressure loading reacted at the centroids. Shear and moment diagrams were developed to find the maximum moment as shown in figure 11-13.

Using the maximum bending moment and radius for each section and a factor of safety of two (2), a minimum required thickness,  $t_i$ , was calculated. (For simplicity longerons and frames were not considered). The material for the biconic was assumed to be titanium, Ti-4Al-6V. The calculated skin thicknesses for each section were as follows:

$$t_i = \text{Moment} / \left( \pi * \sigma_{yield} * R^2 \right)$$

$$t_1 = 2.9894 * E-3 \text{ meter}$$

$$t_2 = 2.7290 * E-3 \text{ meter}$$

$$t_3 = 2.7290 * E-3 \text{ meter}$$

Material volumes for each of the sections and the nose radius were calculated using the geometry and the skin thicknesses and the total mass was calculated using the volumes and the titanium density:

$$\text{Total Mass} = \text{Volume} * \rho = 14,750 \text{ kg}$$



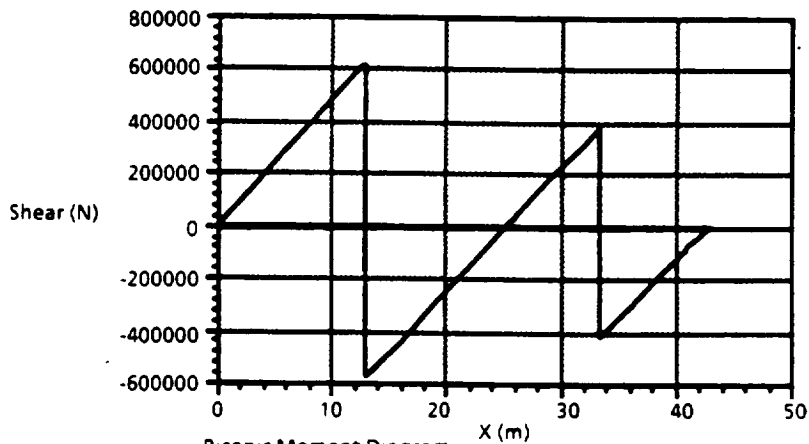
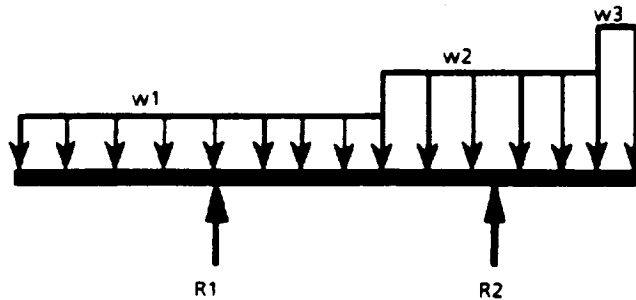
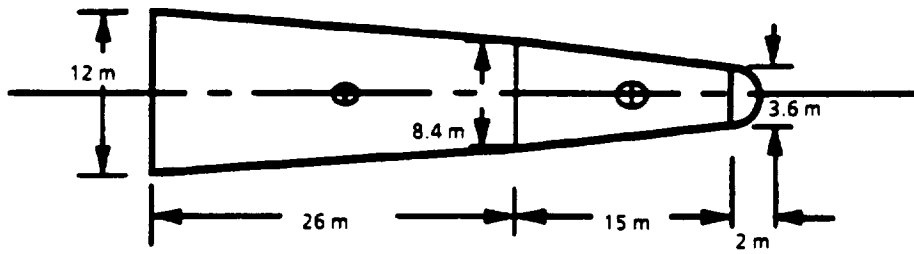

Shear Diagram

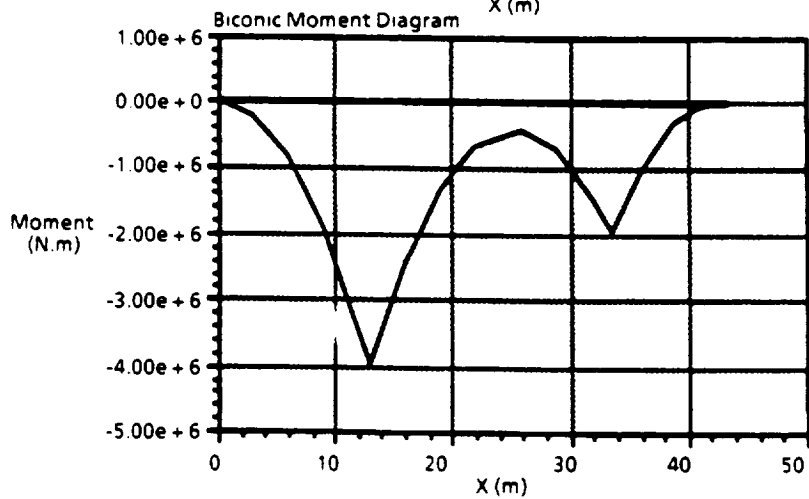

Moments Diagram

TD046

Figure 11-13. Concept 408.7033, Loading, Shear, and Moment Diagrams

The calculated mass is only a conservative approximation and will be updated as the biconic configuration becomes better defined. Ti-6Al-4V alloy was chosen for the face sheets for its high specific strength and the fact that it can withstand prolonged exposure to temperatures of up to 750°F without loss of ductility.

#### 11.1.4 MEV Biconic Lander

The MTS analysis work consisted of development of configurations for Mars landing vehicles, utilizing a biconic shape body. Issues addressed were the size and placement of the surface habitat cargo and the location of engines and propellant tanks. A biconic shape was selected to provide an L/D of about 1.5, and a packaging study was done to determine the minimum size biconic body required. The resulting shape has a base diameter of 8 meters, and an overall length of 24.5 meters (fig. 11-14). For the cargo vehicle, the surface habitat it carries is a 2-level pressure vessel located at the c.g. of the vehicle, providing the crew with a total living area of 120-square meters. Area requirements were derived from NASA standards, architectural standards and terrestrial analogies (fig. 11-15). The habitat structure is integral with the lander airframe and does not need to be "unloaded". The crew lander carries an ascent vehicle, which consists of storable propellant and tankage, four 18-klb engines, and a crew cab for six (fig 11-16). Either vehicle can abort during descent or launch from the surface. Previous biconic designs located balanced sets of engines on either side of the c.g. of the vehicle, landing the vehicle on its "side", or located engines in the base area, landing the vehicle on its "tail". The current concept utilizes a cluster of four engines located below the c.g. and the payload. In the event that an engine fails during descent, the opposite engine would shut down in order to balance thrust, and the remaining two engines would throttle up to continue the landing maneuver. The crew and cargo MEVs are essentially the same vehicle; however, the descent engines are placed farther apart in the crew version to allow room for the ascent engines.

#### 11.1.5 Biconic MEV Summary

The selection of a final biconic concept will involve an iterative process with the configuration layout and the aerodynamic characteristics of the shape. This will include determining in detail the system placements such as the surface habitat, ascent and descent engines, etc. The design process will hopefully lead to a BMEV with the minimum dimensions capable of packaging both the crew version and cargo versions in a common external structure.

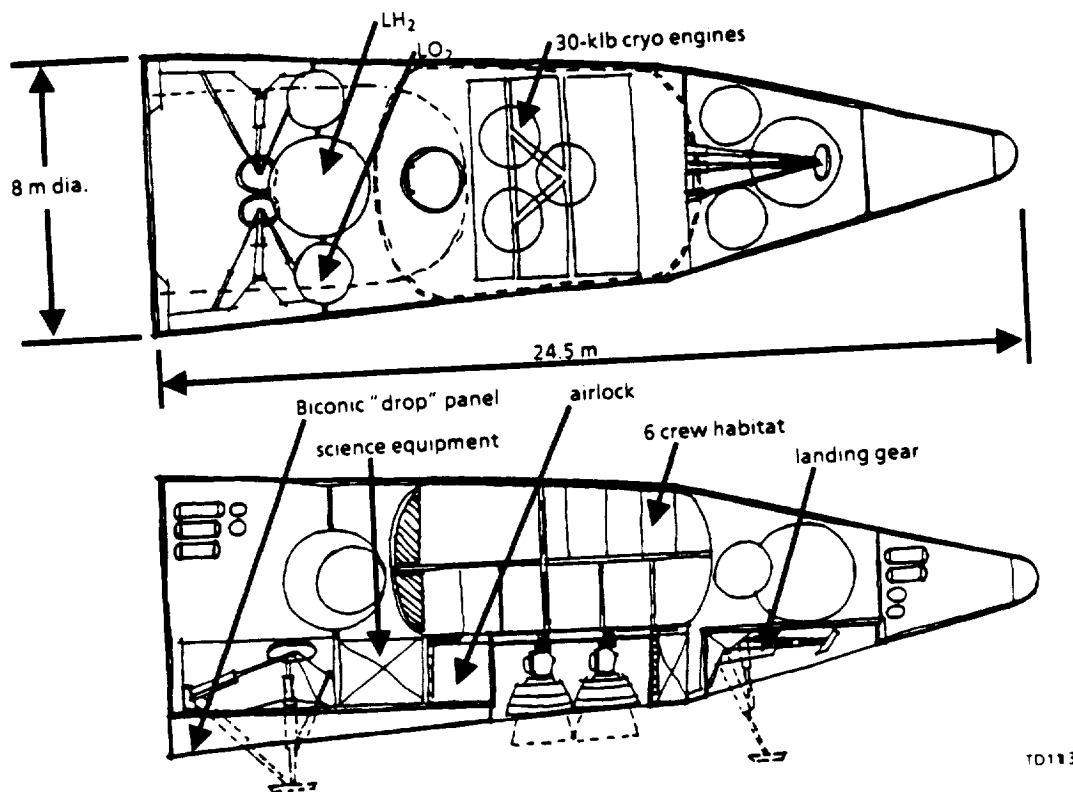

Figure 11-14. Biconic MEV Lander 6 Crew Habitat

## 11.2 STRUCTURAL ANALYSIS - LOW L/D AEROBRAKE (MEV)

### 11.2.1 Background

Low L/D aerobrake structure was evaluated for Mars aerocapture maneuver loads. Analysis included aerodynamic as well as thermal loading. Mars excursion vehicle (MEV) is a low L/D ( $\sim 0.5$ ) blunt hyperboloid aerobrake which is 30 meters in length (fig. 11-17) and has a total payload-plus-aerobrake mass of 84 metric tons. The payload truss structure is attached to the aerobrake at four points.

Aerobrake structure under investigation is a sandwich shell with 3.81 cm deep aluminum (5056 Al) core and 0.173 cm thick titanium (Ti-6Al-4V) face sheets. Ti-6Al-4V alloy was chosen for the face sheets for its high specific strength and the fact that it can withstand prolonged exposure to temperatures of up to 750°F without loss of ductility. It has a curved rim which is stiffened by increasing the core depth to 5.0 cm and face sheet thickness to 0.2 cm in order to reduce excessive deformations observed during preliminary analysis of the baseline configuration (one cross-section for all structure) with aerodynamic loads. The final configuration is shown in figure 11-17.

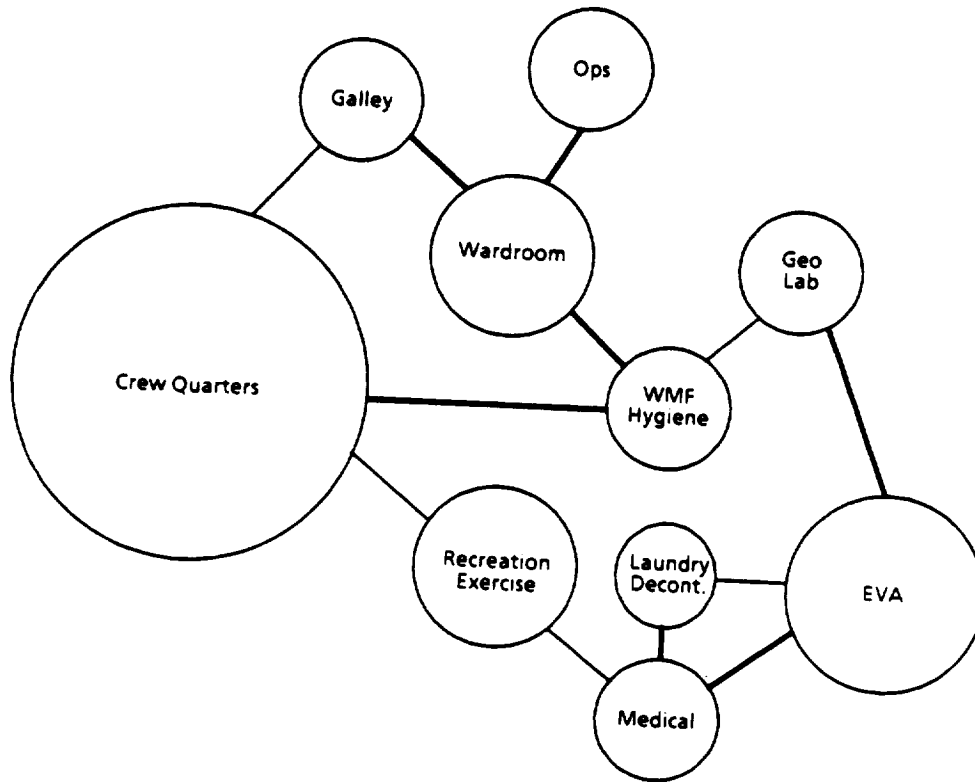

Proximity Diagram

**Area Allocations**

Crew Quarters: (12)	36.0 m <sup>2</sup>
Wardroom	20.0 m <sup>2</sup>
Galley	4.0 m <sup>2</sup>
WFM/hygiene: (2)	4.0 m <sup>2</sup>
Laundry	1.0 m <sup>2</sup>
Recreation/exercise	10.0 m <sup>2</sup>
Medical	3.0 m <sup>2</sup>
EVA	10.0 m <sup>2</sup>
Operations: (2 workstations)	4.0 m <sup>2</sup>
Life sciences lab:	6.0 m <sup>2</sup>
Geochemistry and Petrology lab	6.0 m <sup>2</sup>
Circulation (15%)	16.0 m <sup>2</sup>
<b>Total Area</b>	<b>120.0 m<sup>2</sup></b>

Figure 11-15. Biconic MEV/Habitat Internal Arrangement

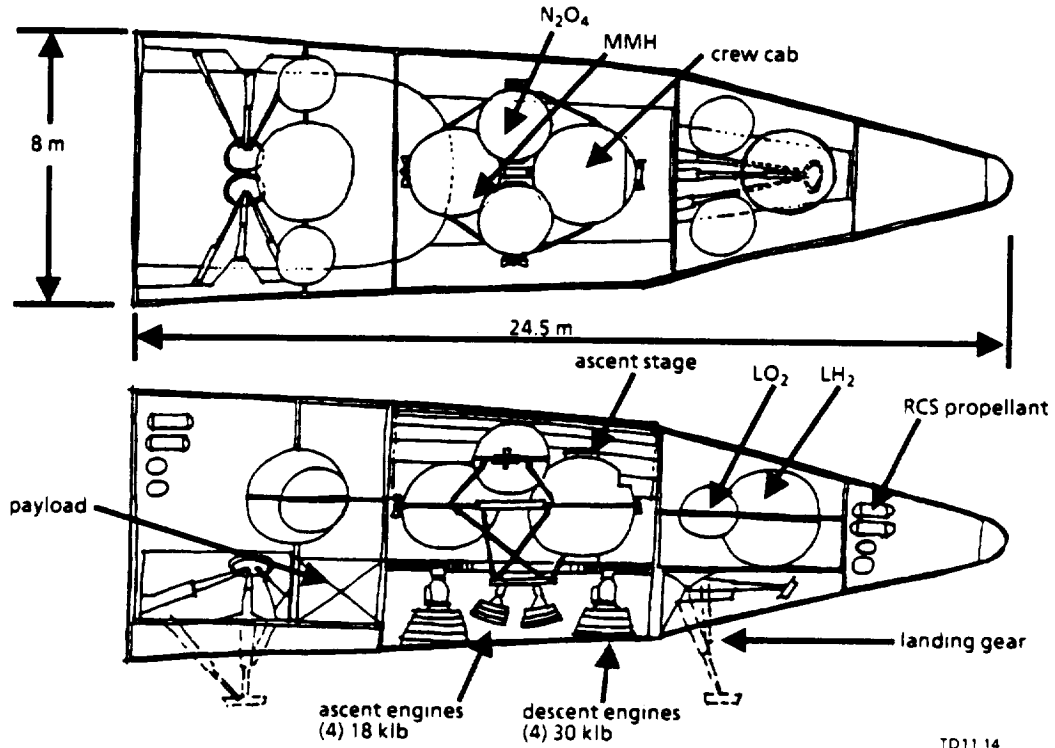

Figure 11-16. Biconic MEV Crew Vehicle

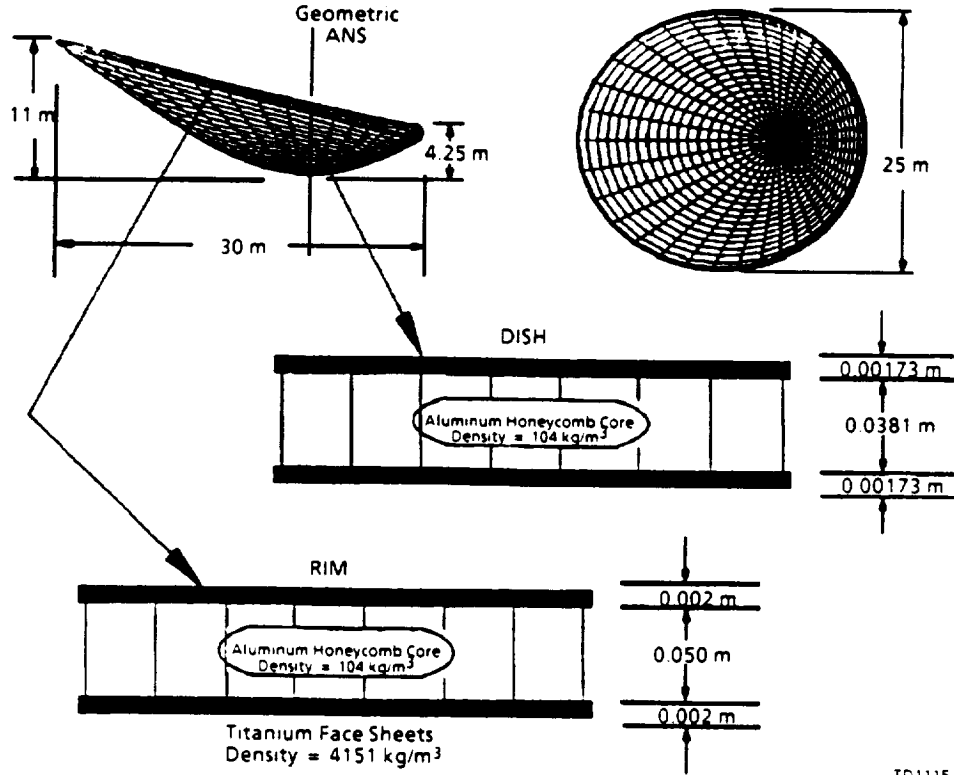

Figure 11-17. Low L/D Aerobrake - Preliminary Configuration

### 11.2.2 Finite Element Model

A Finite Element Model for the MEV sandwich shell structure was generated using PATRAN as a pre-processor. Honeycomb sandwich was simulated as a monolithic titanium plate by giving it proper bending stiffness and coupling of that of a sandwich. A variable thickness TPS was considered which would provide a constant back surface temperature of 750°F. Constant temperature distribution on the titanium face sheet would eliminate the possibility of hot spots on the structure providing an even thermal expansion and would result in an optimal TPS mass. (Note: TPS was not part of this analysis.) The model included the curved rim (or lip) which was omitted from the previous FE Models. The curved rim provides stiffness to the free edge and helps cut down the deformations. Baseline analysis was performed with the rim having the same cross-sectional dimensions as the dish structure. Results from the baseline analysis showed large deformations at the rim. The rim cross-section was then modified to increase stiffness. Final analysis is based on this modified rim configuration figure 11-17.

The model consisted of mostly QUAD elements. The use of relatively stiffer Triangular elements was kept to a minimum. A mesh was generated which would provide a minimum number of elements without compromising the true geometry and curvatures. The model (NASTRAN data deck) had 1032 CQUADR, 40 CTRIA3 elements, and 1093 grids resulting in 6448 degrees of freedom. Each payload attachment location was modeled as a surface having 17 grid points, all of them constrained for translation in the x, y, and z directions. The model is shown in figure 11-18.

Material properties used in the analysis are as follows;

	E (Pa)	G (Pa)	$\mu$	$\rho$ (Pa)	$\sigma_{ty}$ (Pa)	$\sigma_{cy}$ (Pa)	$\sigma_{su}$ (Pa)
Face Sheets	1.103e11	0.427e11	0.310	4.429e3	11.030e8	10.617e8	6.894e8
Honeycomb	0.690e11	0.270e9	0.330	2.656e3	2.4133e8	0.965e8	1.448e8

### 11.2.3 Loads

Since max aerodynamic pressure and max thermal loads do not occur at the same time (they are out of phase) each max loading condition was evaluated separately.

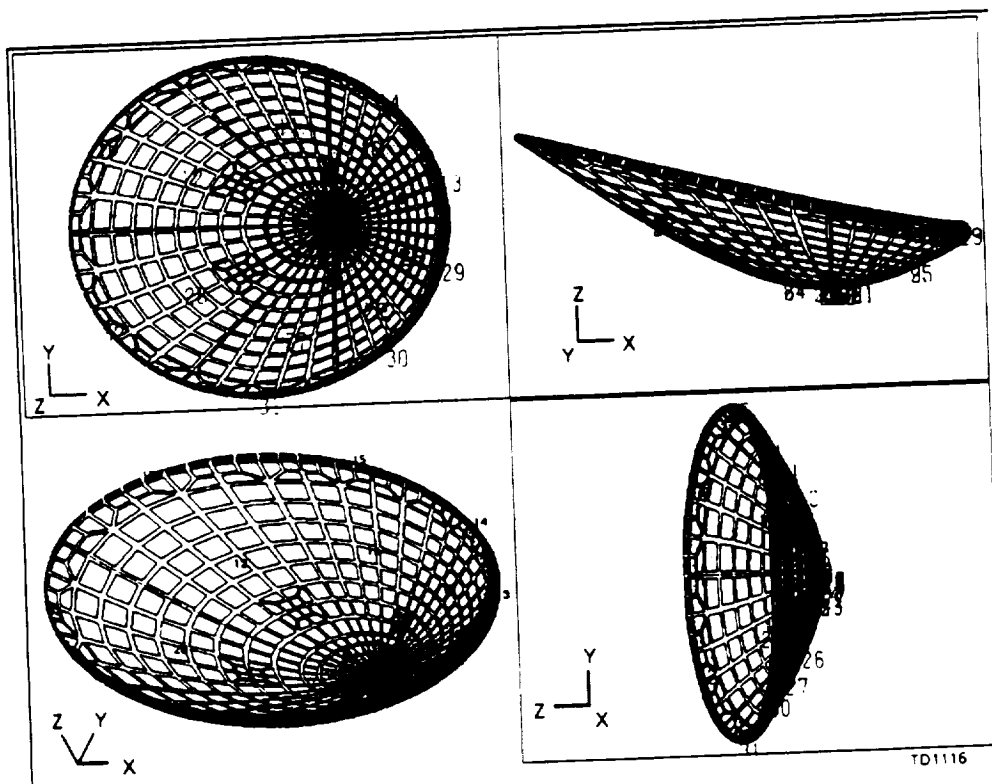

Figure 11-18. Low L/D Aerobrake - Finite Element Model

### 11.2.3.1 Aerodynamic Load Distribution

Pressure distribution ( $C_p$ ) over the aerobrake surface for a  $20^\circ$  entry angle was obtained from the AERO program. Using this  $C_p$  distribution, a three dimensional pressure surface was created using PATRAN. The three-dimensional pressure surface constituted the unit loading case. Applied pressure load vectors are shown in figure 11-19. Pressure loading for the 6-g peak aerocapture maneuver was generated by calculating the dynamic pressure ( $q_\infty$ ) for an 84 mt mass at 6g's ( $q_\infty = 7318$  Pa) and multiplying the unit loading ( $C_p$ ) by this dynamic pressure.

### 11.2.3.2 Thermal Load Condition

There is a time lag between peak "g" loading and peak heating. Peak heating occurs at the stagnation point on the TPS outer surface some  $\Delta t$  seconds following the peak "g" loading. Due to the thermal conductivity of the TPS, it takes another 50 to 100 seconds for the titanium face sheets to reach the design temperature of  $750^\circ\text{F}$ . By this time the "g" loading reduces to less than one "g" (fig. 11-20). It was therefore decided to treat thermal loading with 1.0g aero loading as one case and the peak "g" loading without thermal loading as another. For the thermal loads analysis, a constant temperature change from  $0^\circ\text{F}$  to  $750^\circ\text{F}$  was applied across the entire outer surface of the aerobrake.

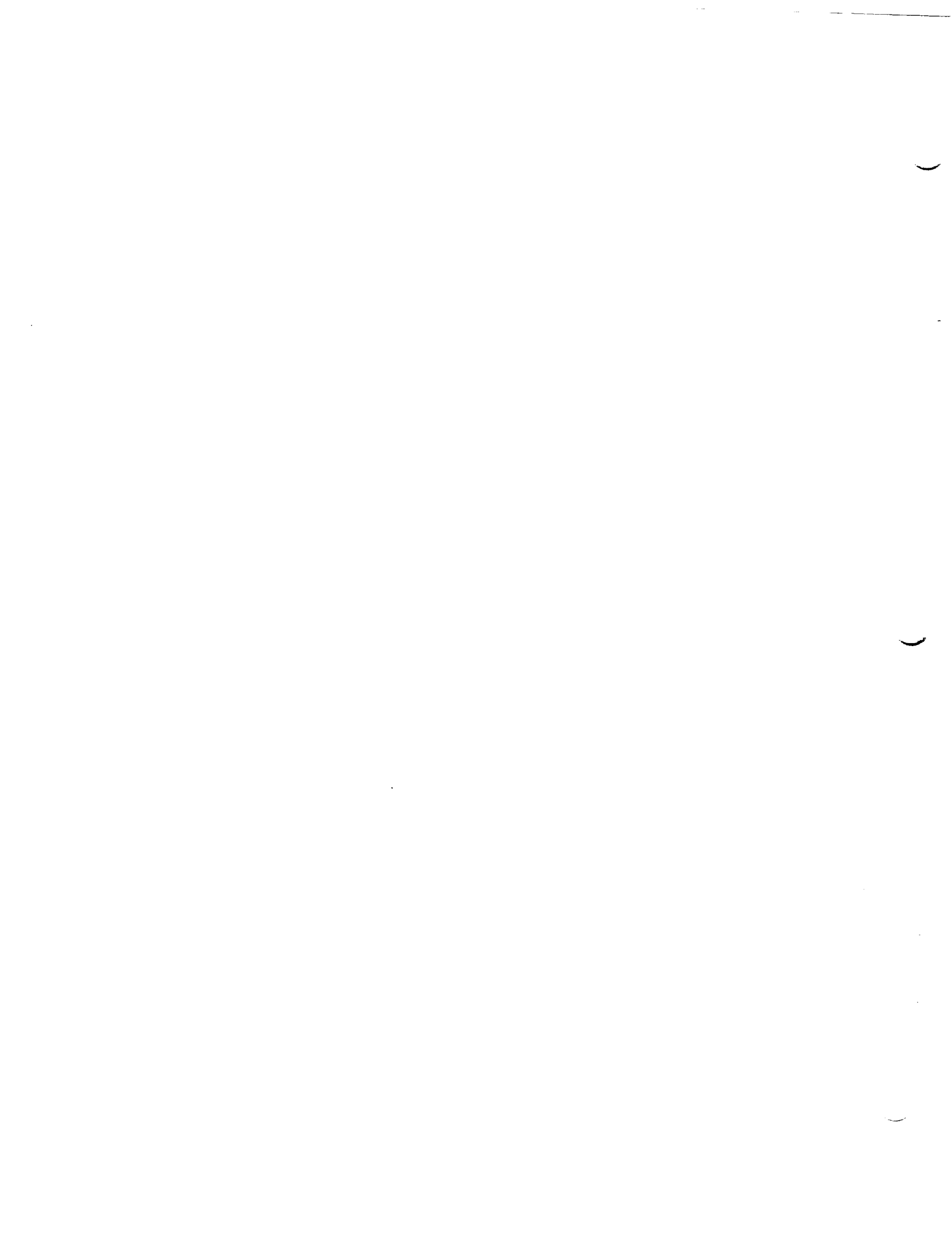



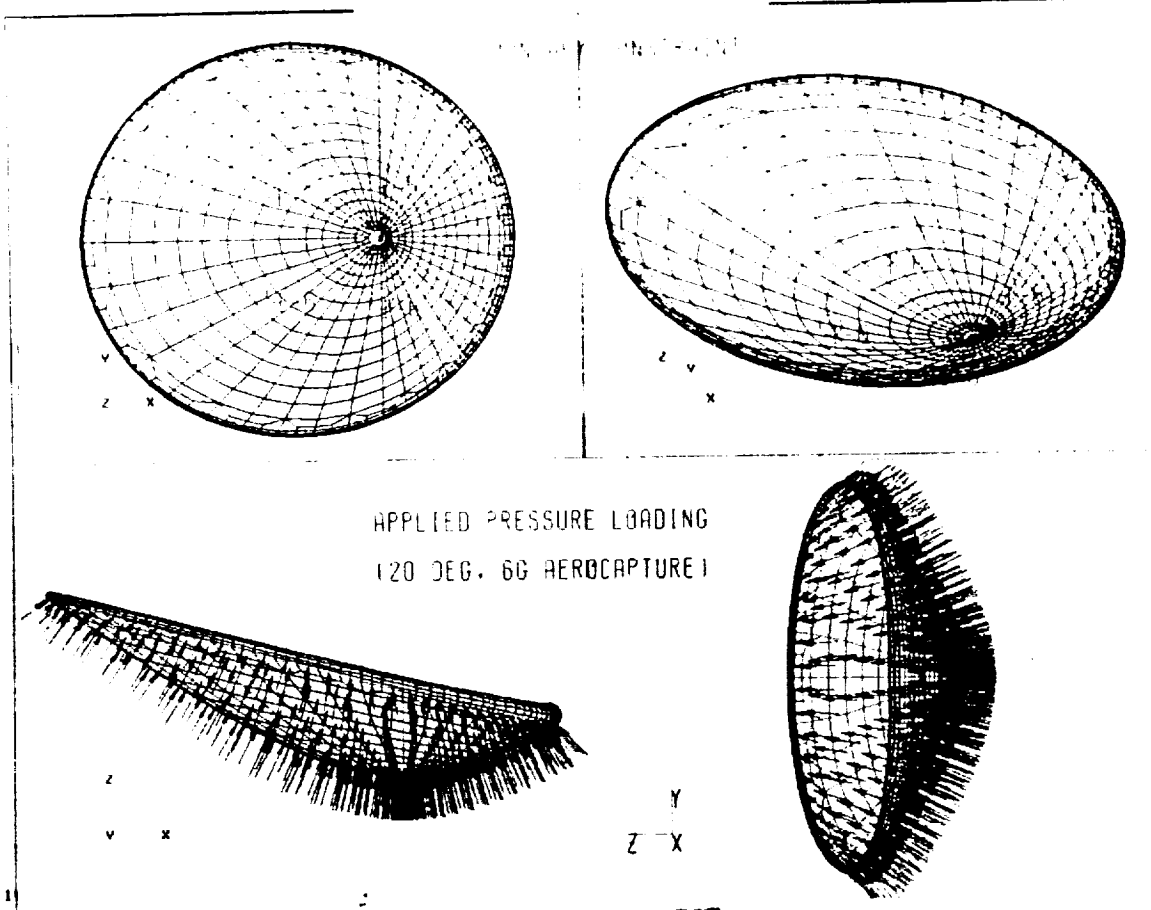

Figure 11-19. Loads and Boundary Conditions

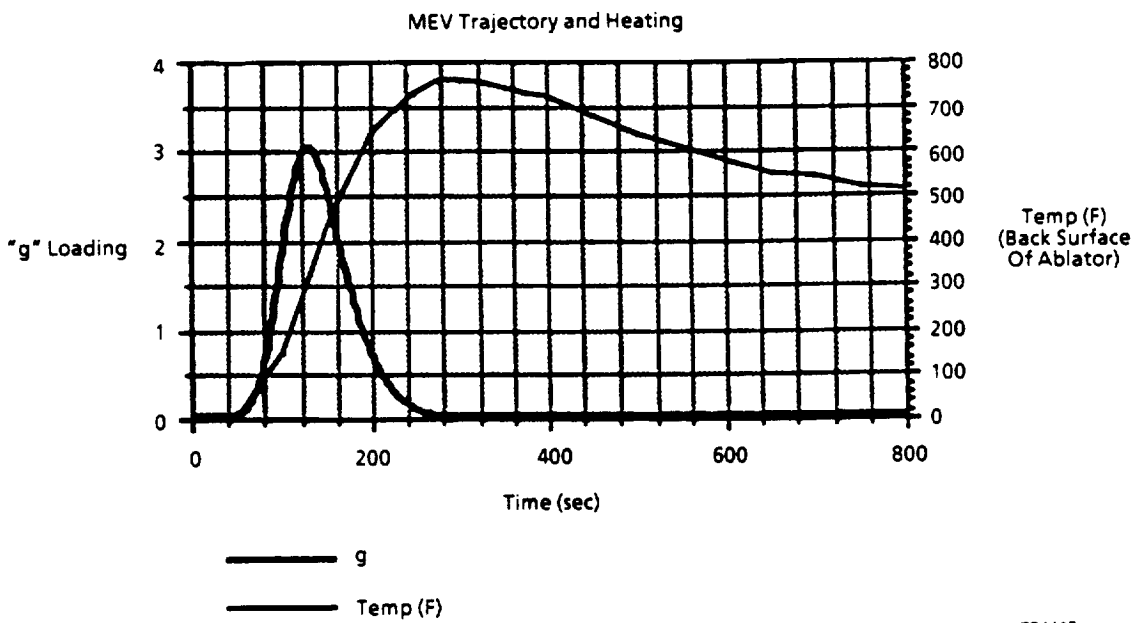
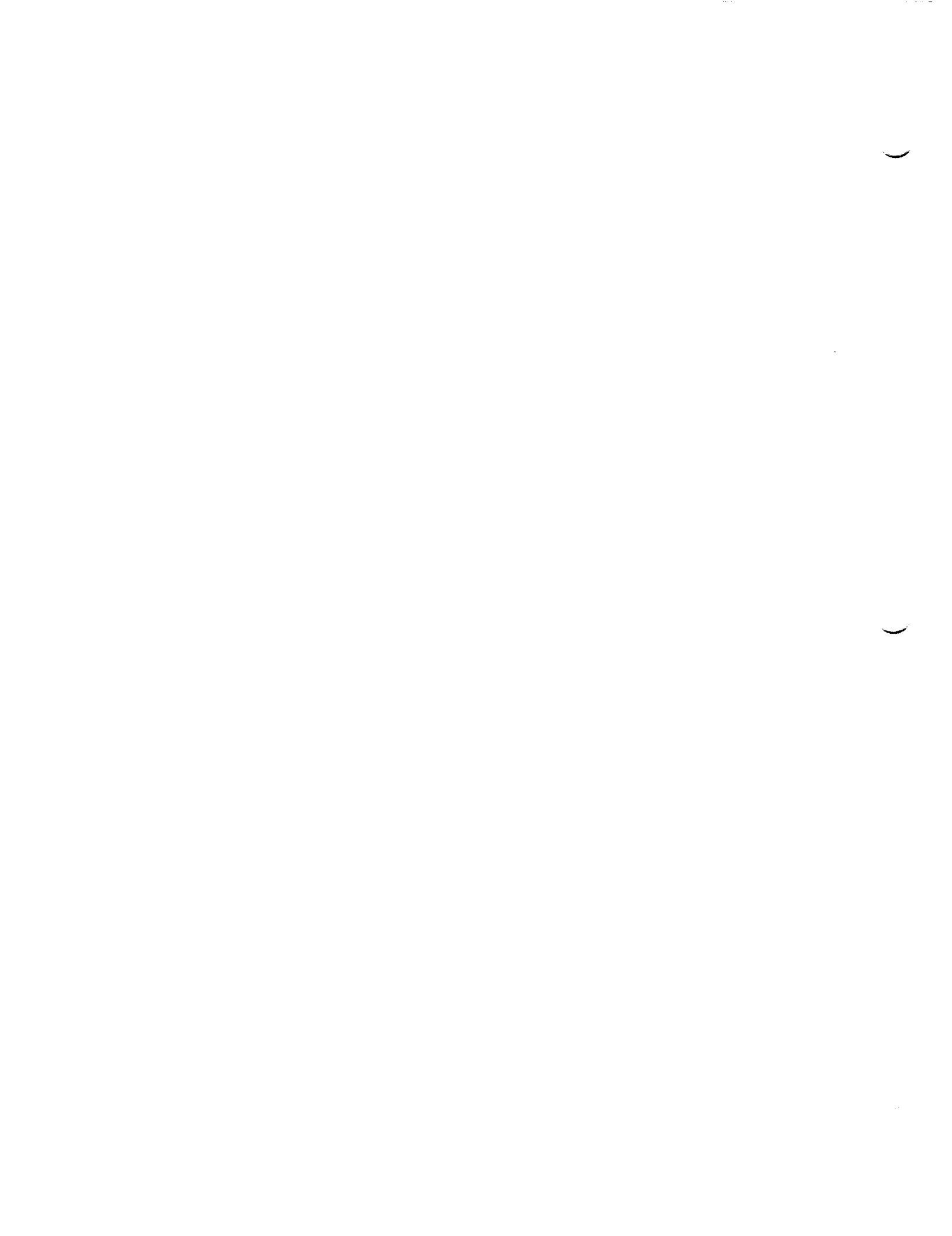

Figure 11-20. Peak "g" Loading vs. Peak Heating



## 11.2.4 Analysis Results

### 11.2.4.1 Aerodynamic Analysis Results

Structural analysis was performed using NASTRAN/ver 66, Linear Static Sol 101 on the Silicon Graphics workstation. PATRAN was utilized for post-processing. The results of the baseline analysis without a stiffened rim showed that the structure is stiffness critical. Maximum displacement at the trailing edge was approximately 0.55m. The total mass for the aerobrake was approximately 16 mt.

In order to improve stiffness and reduce large deformations, the baseline configuration was revised. The most promising change included stiffening the rim since this is where the largest deformations occurred. Stiffness increase was accomplished by increasing the face sheet thickness from 0.00173m to 0.0020m and the core thickness from 0.0381m to 0.050m for the rim structure. New cross-section is shown in figure 11-17. Dish structure below the rim was left unchanged.

This modification resulted in a structural weight increase of 1.4mt (8.75%) but it reduced the maximum deformations by almost 50%. Results from this analysis are shown below. Deformed shapes and the displacement and stress fringe plots are shown in figures 11-21 through 11-23. There is a potential for further reduction in weight with design optimization and selection of advanced composite materials.

Maximum displacement at the trailing edge rim	~ 0.26m
Maximum displacement at the leading edge rim	~ 0.18 m
Margin of safety for maximum principal stress	~ 3.0
Mass of the face sheets (From NASTRAN)	~ 12.95 mt
Mass of the core (Hand calculated)	~ 4.40 mt
Total mass of the aerobrake	~ 17.35 mt

### 11.2.4.2 Thermal Analysis Results

NASTRAN Solution 101 was used to carry out the analysis with PATRAN utilized to perform the post processing function. A uniform temperature change of 750°F along with one "g" loading resulted in a maximum deflection of about 10.5 cm. The max deflection occurred between the two aft MEV attach points as shown in figure 11-24. The max deflection was considered to be very small due to the fact that it was less than 0.4% of the largest dimension of the aerobrake. An exaggerated deformation plot, figure 11-25, is provided for visualization purpose. Highest stresses occurred at the 4 MEV attach points. The yield strength margin of safety was calculated to be about 40%. A fringe plot of the Von Mises stress distribution is shown in figure 11-26.

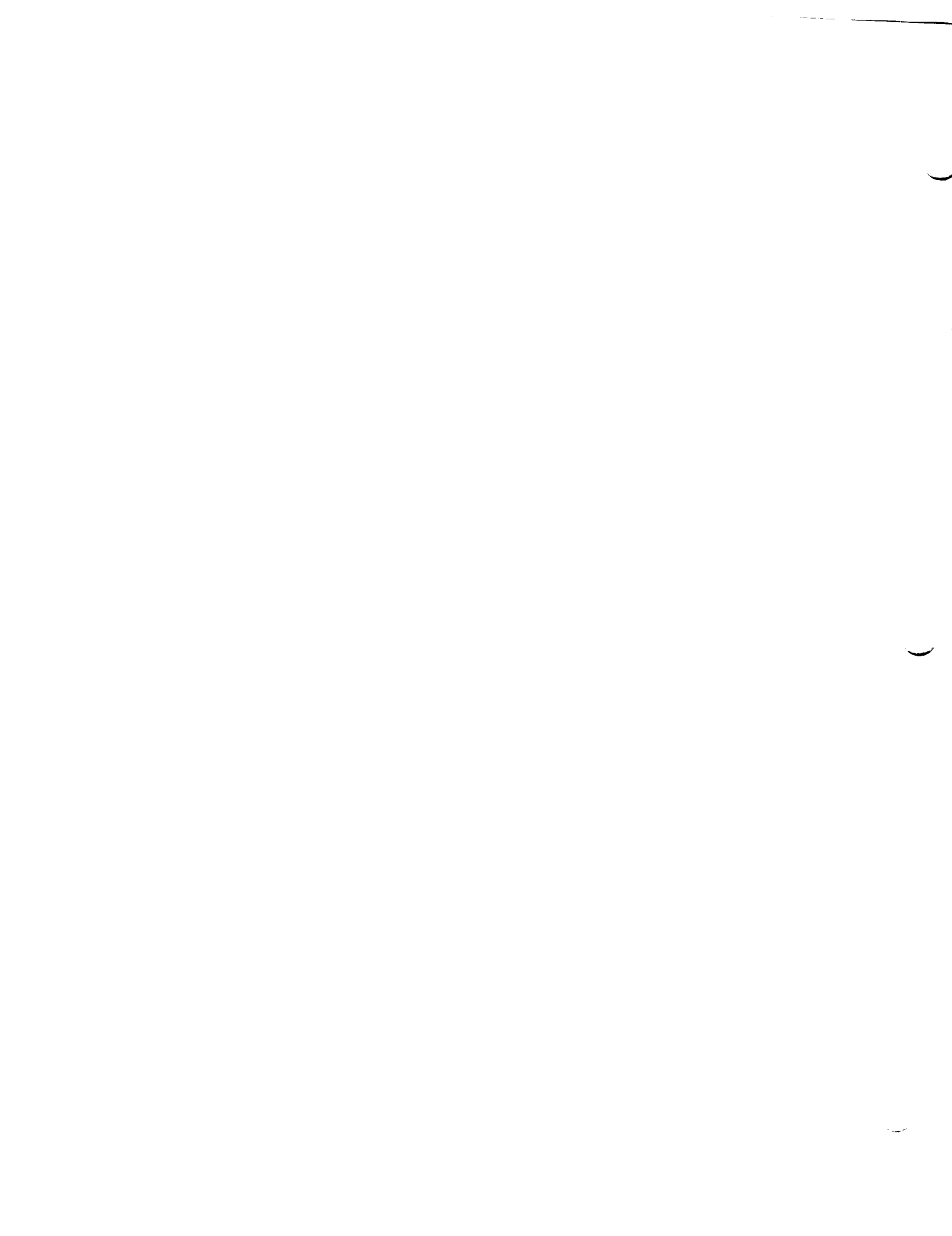

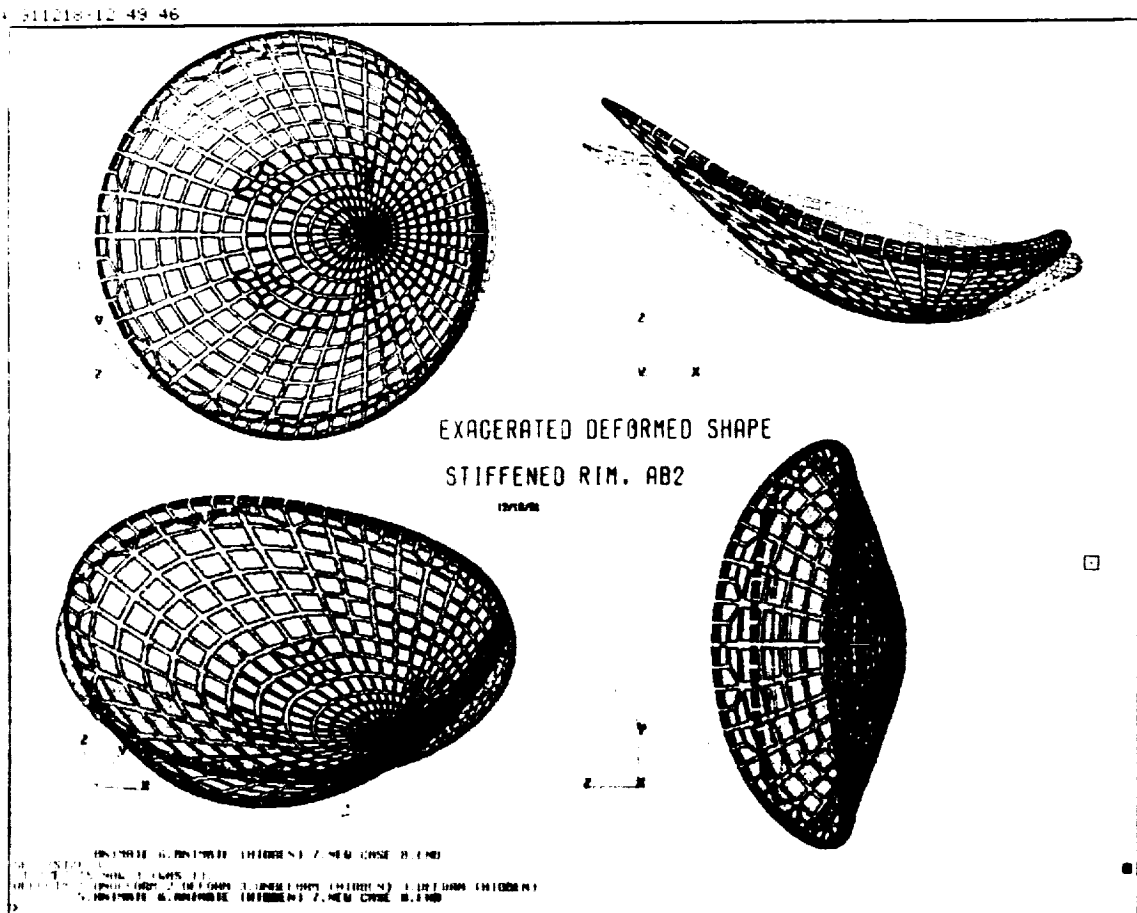

Figure 11-21. Exaggerated Deformed Shape, Blue - Undeformed, Black - Deformed - Aero Load.

11.2.5 Conclusions

A summary of the results is provided as follows;

	<u>Aeroloading (6g)</u>	<u>Thermal Loading</u>
Maximum displacement	26 cm	11 cm
Max Disp. to Max Dimension Ratio	0.87%	0.35%
Max Principal Stress	2.31e08 Pa	6.80e08 Pa
Stress Margin of Safety	389%	62%

Low L/D thermal analysis shows that while the deflections are lower when compared with peak "g" loading case, the stresses produced by the peak heating are higher. Slightly higher stresses in the peak heating case may be attributed to the fact that the MEV payload was not modeled along with the aerobrake model. In reality the truss structure that will be used to attach the MEV payload to aerobrake will not be as rigid as the current model constraints and will flex under thermal expansion of aerobrake reducing local deflections and stresses both. There is a potential for further design refinements and mass optimization with advanced materials.

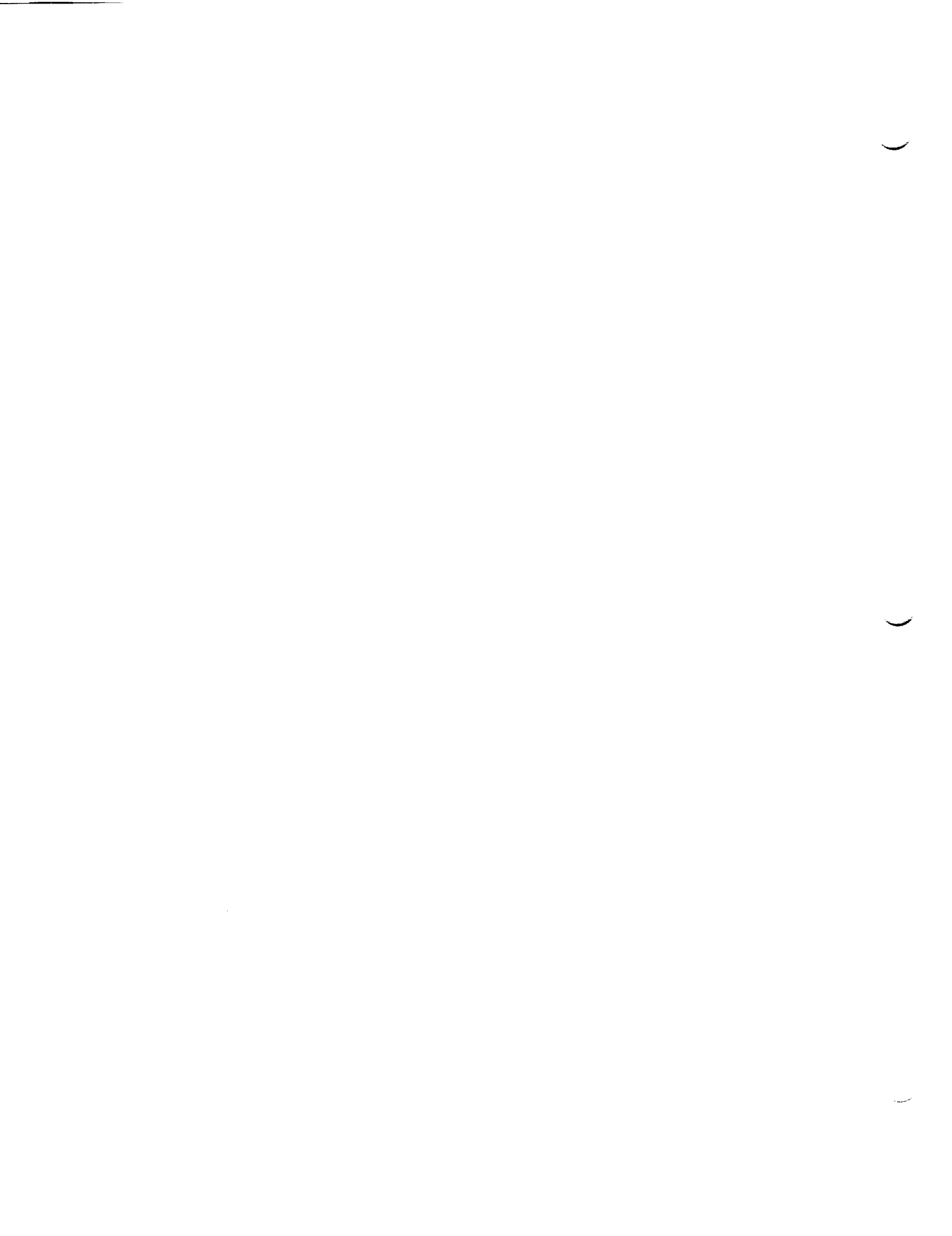

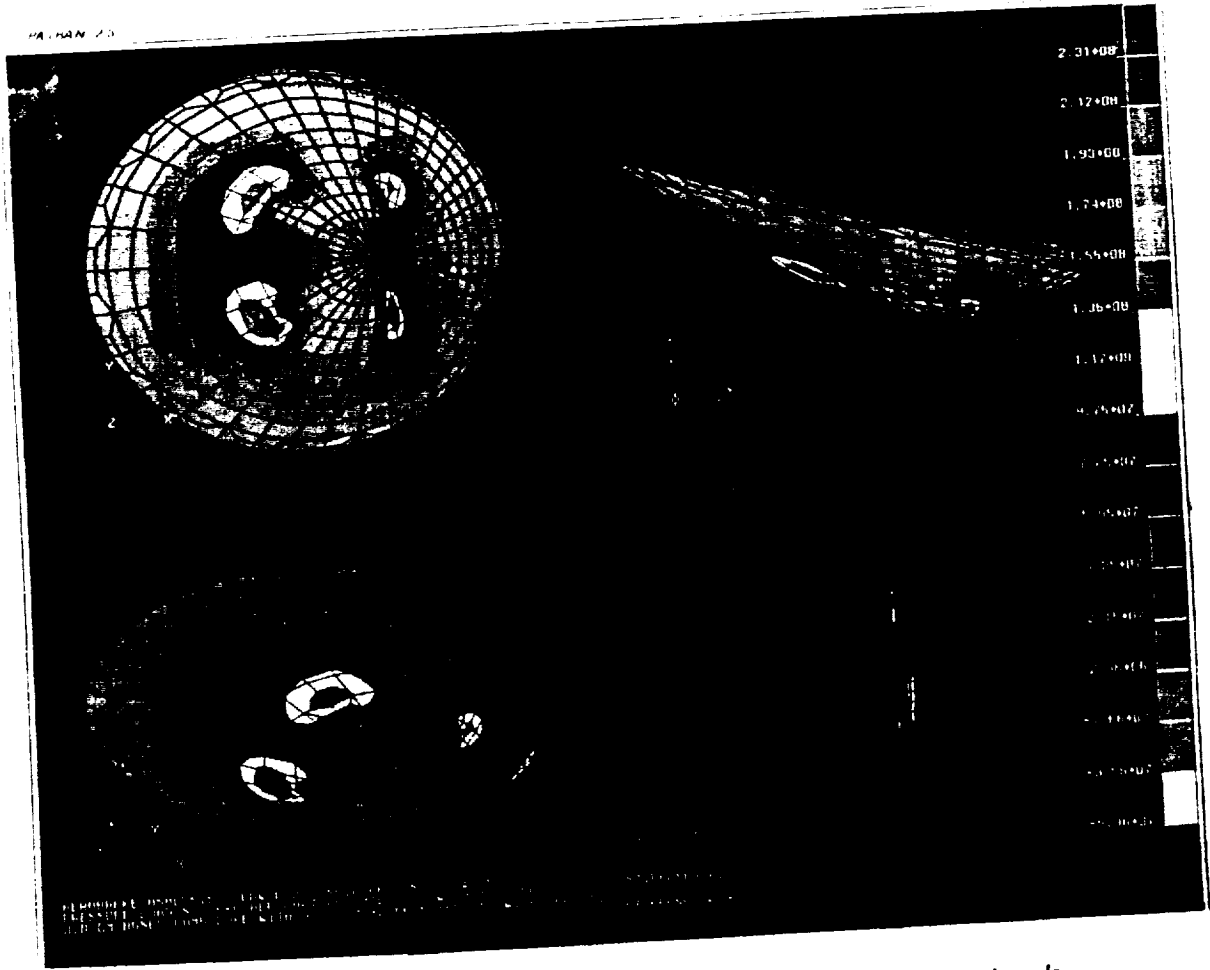

Figure 11-22. Major Principal Stresses on the Outer Surface (Pa) - Aero Loads

ORIGINAL PAGE  
BLACK AND WHITE PHOTOGRAPH





4 311 18-12 53 27

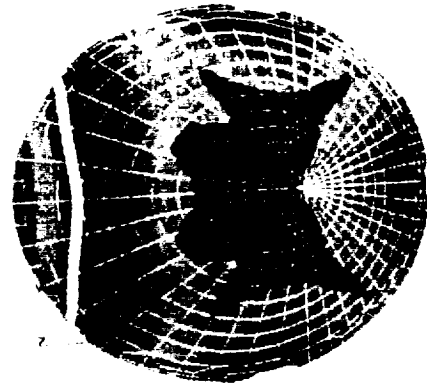

MAGNITUDE OF TOTAL DISPLACEMENT  
12/18/91

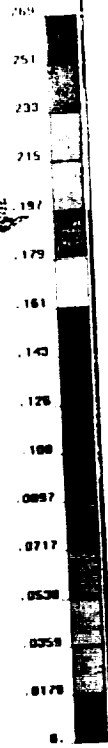
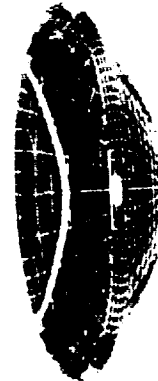
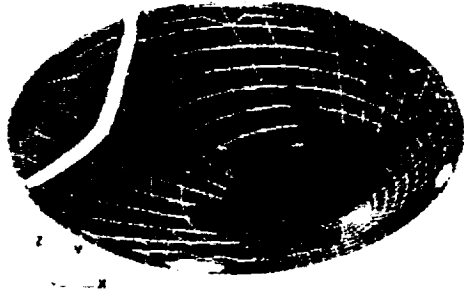

PARAMETER: ANALYSIS: LAM L/S CONE ANALYSIS (L/200-51)  
 FILE SOURCE: I:\A230\166-63\RESULTS\N110\DISPLACEMENTS\1\LEVEL 2  
 3.8 ON HOLEY CARD CASE WITH 0.17500 M2 FORCE SHEETS (WITH OFFSET)  
 COORDINATE SYSTEM: COORDINATE SYSTEMS TO DEFINE THE START OF THE TITLE  
 SCALE: 0.17500  
 UNIT: METERS  
 COLOR: 1: RED 2: GREEN 3: BLUE 4: CYAN 5: MAGENTA 6: YELLOW 7: BLACK 8: WHITE  
 1: MAGNITUDE OF TOTAL DISPLACEMENTS (METERS)

Figure 11-23. Magnitude of Total Displacements (meters) - Aero Loads

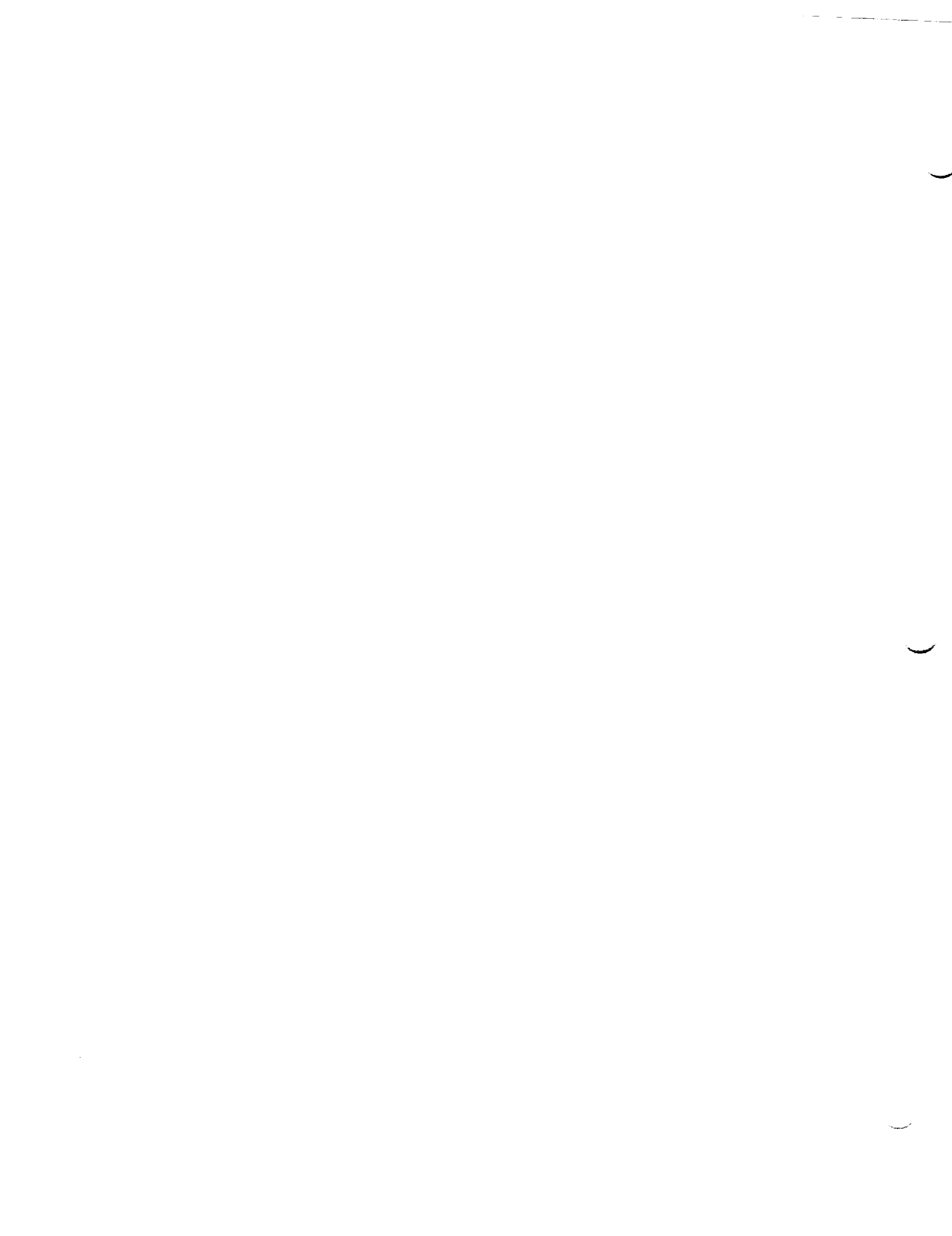

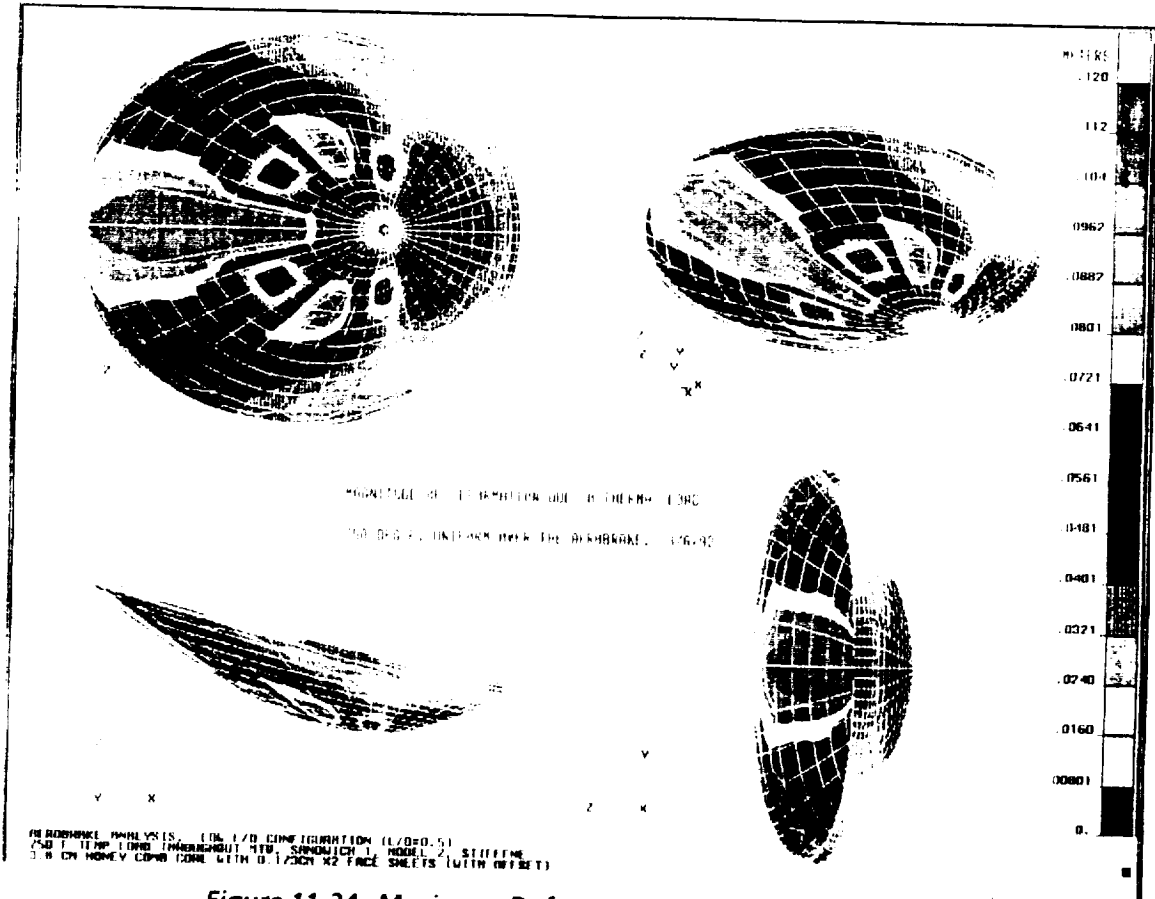

Figure 11-24. Maximum Deformations Due to Thermal Loads

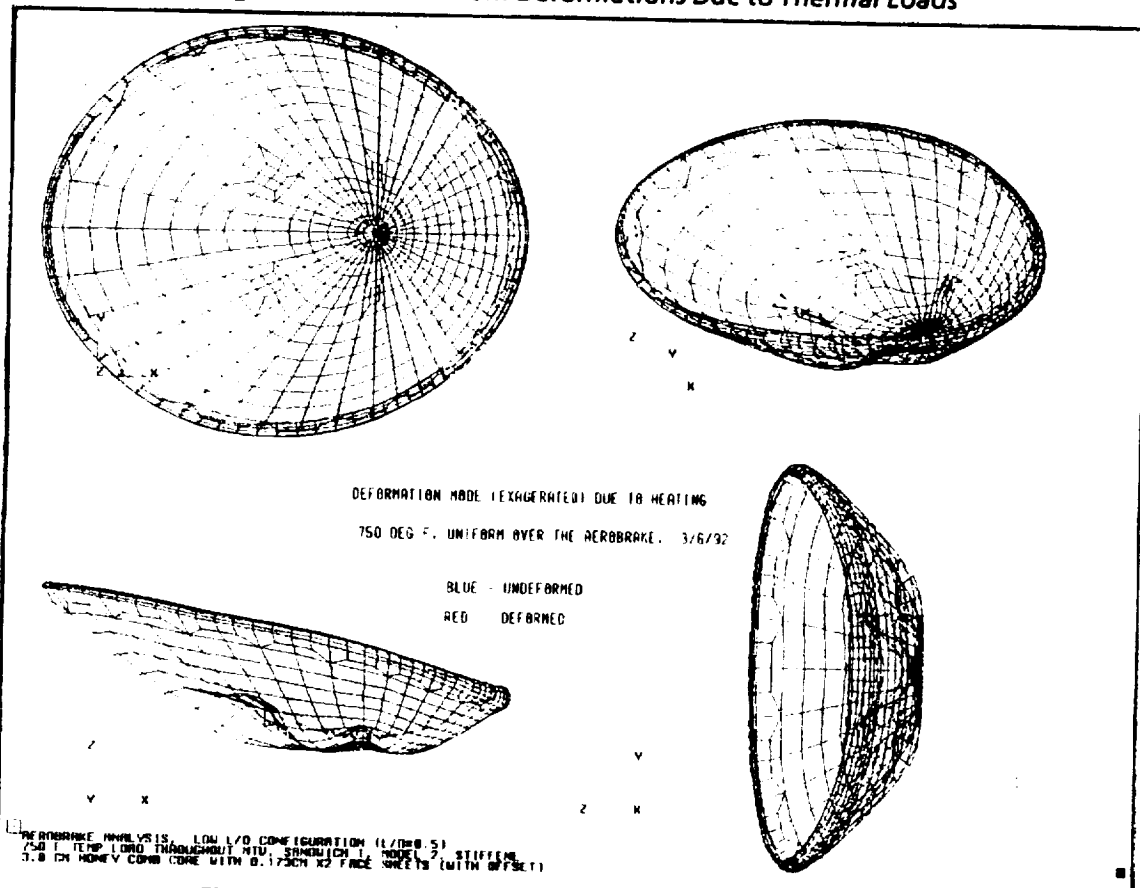
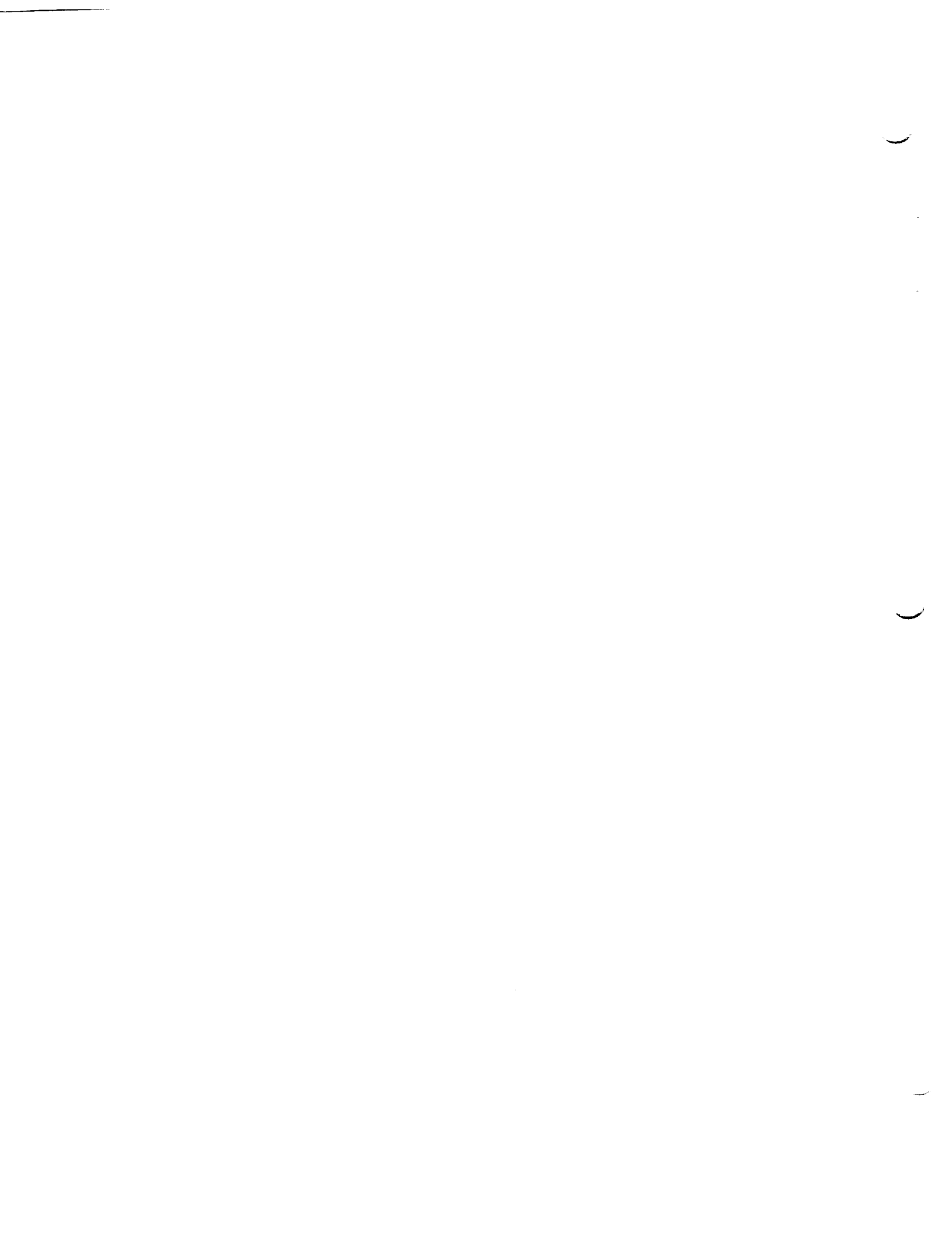

Figure 11-25. Exaggerated Deformation Plot - Thermal Loads



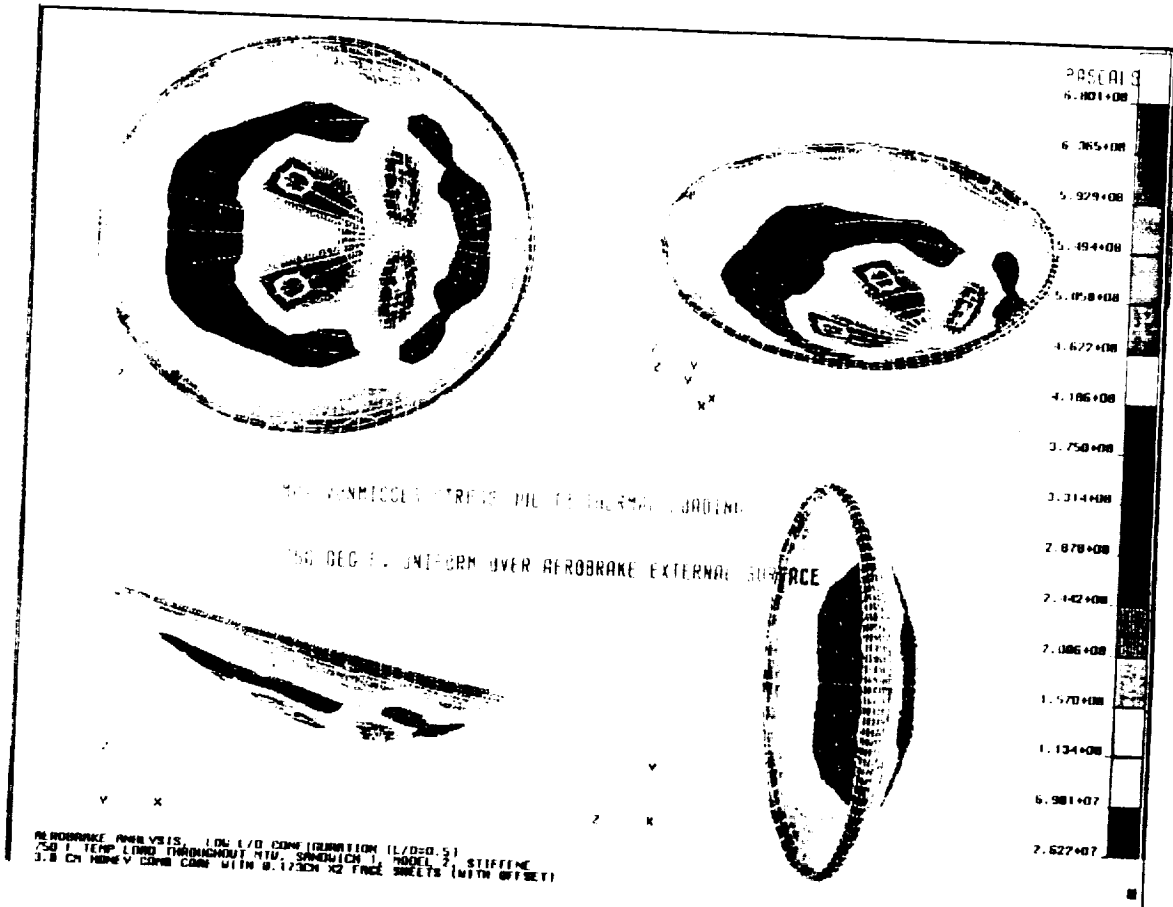
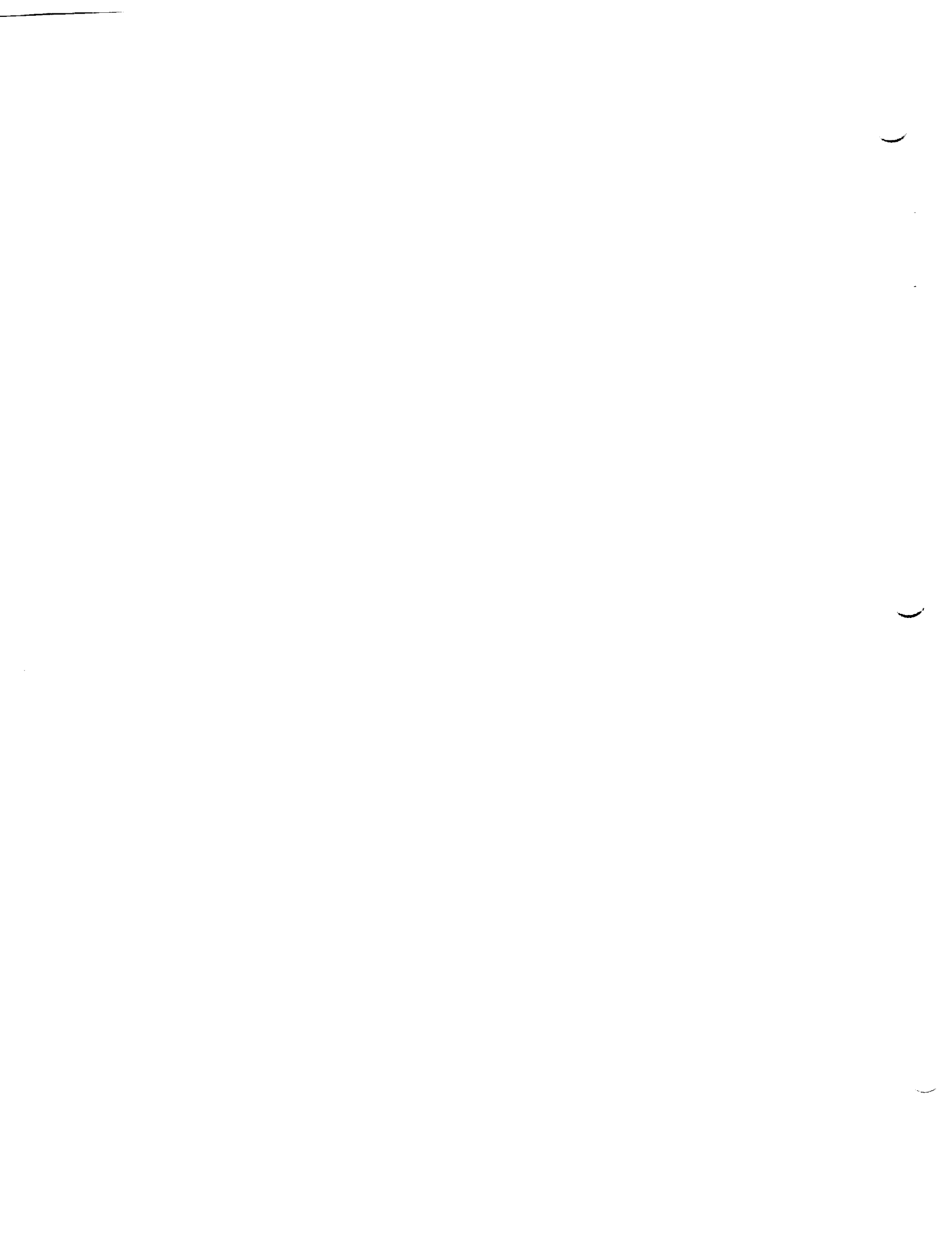

Figure 11-26. Maximum Stresses Due to Thermal Loads



## 12.0 CONCLUDING REMARKS

The major significance of this report is the completion of a design study for a First Lunar Outpost (FLO) habitat suitable for an early return to the Moon. Objectives of the study were to develop a habitation system capable of integral launch and turnkey operation on the lunar surface, requiring no operational procedures other than normal checkout, and no construction or surface transportation equipment, to place the habitat into mission support operations on the lunar surface. These objectives were met with the exception that an original target of 25 metric tons habitat system mass was exceeded (the later target of 30 t. was met). Avenues were identified for reaching the 25-t. target should this become important.

Two main habitat options were defined, both derived from the Space Station Freedom habitat. The first option was as direct a derivative as possible; it looks very much like the Freedom hab and uses the Freedom subsystems with in most cases less than 10% change. This is the lowest cost option for an early FLO mission without a defined evolution requirement. The second option employs Freedom subsystems with little more change except modified rack geometry. The habitat structural shell and arrangement are changed to a 6.5-meter diameter ellipsoid with an eye towards evolution to Mars transfer and surface habitats of larger internal volume, suitable for the larger crews and longer durations of Mars missions. The ellipsoid can be stretched by adding 6.5-meter diameter cylinder sections, resulting in a configuration for Mars use very like the optimum Mars transfer habitat configurations identified by earlier STCAEM parametric studies of habitation system designs. The ellipsoidal design is significantly more expensive for the FLO mission, but appears to be the most economic approach to an overall lunar/Mars program, assuming an overall program is well enough defined to proceed along an evolutionary path.

The Mars systems studies reported herein completed a phase of Mars mission/transportation system studies that began with the "90 Day Study" in 1989 and ended with analyses of implementation of the Synthesis architectures. These studies provided a broad and versatile data base for Mars transportation systems analyses. Further development of the Mars data base is appropriate when architectures and mission strategies evolve beyond those conceived by the Synthesis Group studies.

REFERENCES

1. "Space Transfer Concepts and Analysis for Exploration Missions," Phase 1, Final Report, Boeing Defense & Space Group, Huntsville D615-10030-2, March, 1991
2. "Space Transfer Concepts and Analysis for Exploration Missions," Phase 2 Final Report, Boeing Defense & Space Group, Huntsville D615-10045-2, December, 1991
3. "Lunar Campsite Concept", performed under NASA Contract NAS8-37857, Space Transfer Concepts and Analyses for Exploration Missions, Boeing Document D615-10034, May 1991.
4. "Space Station Freedom WP01 Mass Properties Report", Boeing Document D683-10275-15, December 15, 1991.
5. "Space Station Freedom WP01 Reports, Electrical Power and Energy Status", Boeing Document D683-10238-38, February 15, 1992.
6. "Baseline Configuration Document", Space Station Program Office, SSP 30255, Issue A, Draft 1, February 28, 1992.
7. Personal Communication, Boeing SSF engineers (structures, ECLSS, power, thermal), February - March, 1992.
8. "First Lunar Outpost Requirements and Guidelines (FLORG)," Johnson Space Center, ExPO-T1-920001, 1 April 1992.
9. "Space Transfer Concepts and Analyses for Exploration Missions, Technical Directive 11, Final Report," Boeing Defense & Space Group, Huntsville D615-10054, May 1992.
10. Personal Communication, JSC medical personnel, February - March, 1992.
11. Personal Communication, R. Hage, NASA Marshall Space Flight Center, March, 1992.
12. Personal Communication, C. Cathcart, U.S. Army Natick Research, Development and Engineering Center, November, 1991.
13. Personal Communication, M. Barrett and B. McKinley, April 1992.
14. Algera, R. and Dixon, G.A., "Design of a Portable, Collapsible Hyperbaric Chamber, ILC Dover.
15. "Material Flammability Considerations", A Presentation by Dennis Griffin, NASA/MSFC and Dr. Michael Pedley, NASA, JSC.
16. "Space Crew Radiation Exposure Analysis System Based on a Commercial Stand-Alone CAD System"; M. H. Appleby, M. J. Golightly, and A. C. Hardy. Paper presented at the 22nd International Conference on Environmental Systems, Seattle Washington, July 13 - 16, 1992. SAE Paper #921372
17. Personal Communication, A. C. Hardy, NASA Johnson Space Center, December, 1990.



18. Personal Communication, A. C. Hardy, NASA Johnson Space Center, September, 1991.
19. "Alenia Spazio S.P.A., MPLM Mass Properties Report", D.R.D. No. DR-7, May 28, 1992.
20. "Robotic Lunar Surface Operations: Engineering Analysis for the Design, Emplacement, Checkout and Performance of Robotic Lunar Surface Systems", NASA Contract NAS2-12108, Boeing D615-11901, 2 January 1990.
21. Harnage, M. J. Jr, "Lessons Learned for Application to Space Station" Grumman Space Systems, July 1988.
22. "America at the Threshold", The Synthesis Group on America's Space Exploration Initiative, May, 1991
23. Himmel, S. C., Dugan, J. F., Jr., Luidens, R. W., and Weber, R. J. "Nuclear-Rocket Missions to Mars," Aerospace Engineering, July, 1991
24. Donahue, B. D., "Logistics Impacts and Lunar on Mars Lander Design," AIAA 91-4131, November, 1991
25. Canetti, G. S., "Definition of Experimental Test for a Manned Mars Excursion Module," North American Rockwell Corporation Contract #NAS9-6464, 1966 - 68
26. "Evacuated Reflective Insulation in Cryogenic Service," American Society for Testing and Materials, Annual Book of ASTM Standards, C740-82
27. "Space Transfer Concepts and Analysis for Exploration Missions, IP and ED Volume I: Major Trades, Books 1 and 2," Boeing Aerospace and Electronic, Huntsville D615-10026-1, March, 1991
28. "Space Transfer Concepts and Analysis for Exploration Missions, IP and ED Volume 6: Lunar Systems," Boeing Aerospace and Electronics, Huntsville D615-10026-6, March 1991

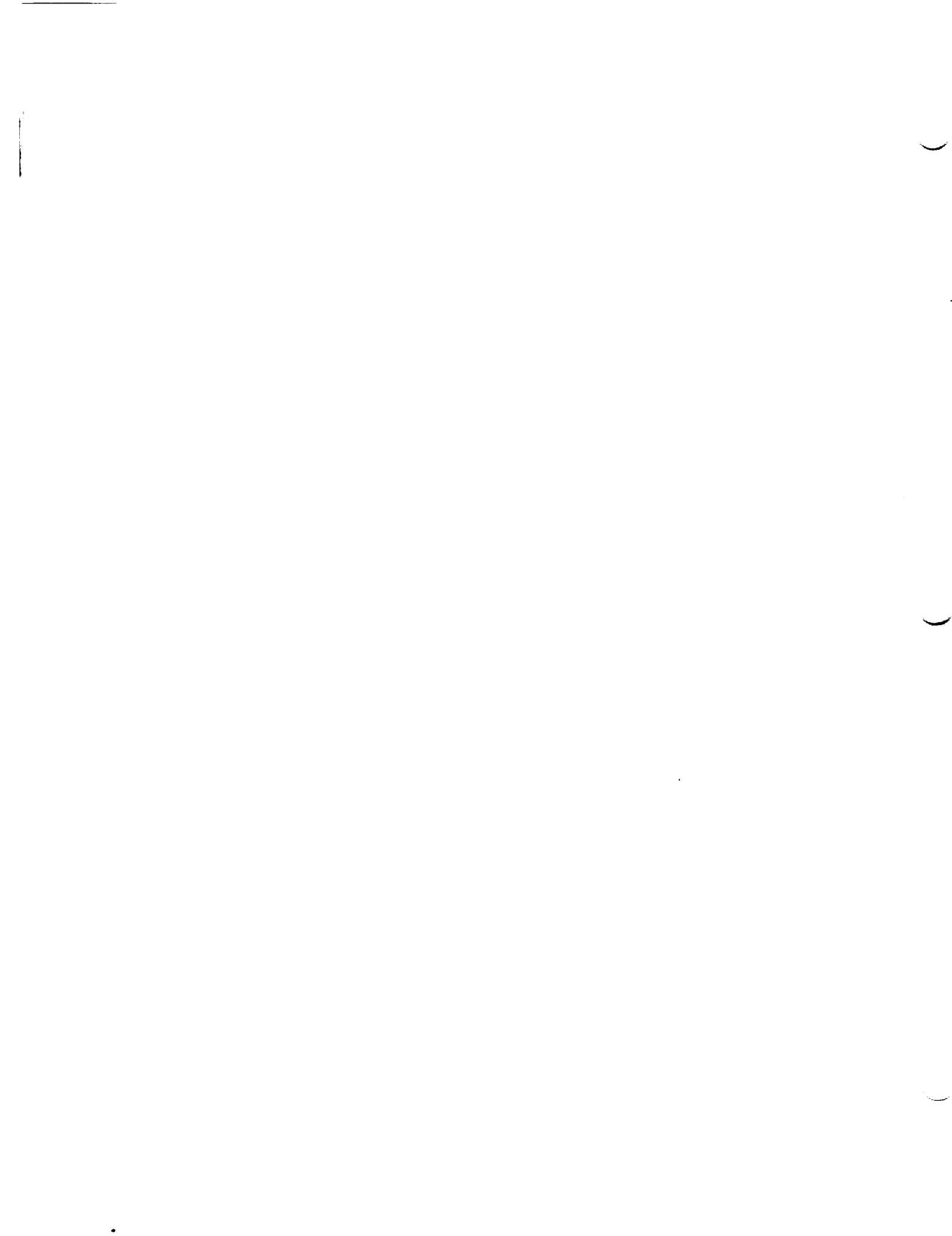

# Appendix A

## Boeing Mass Breakdown Details

Integrated Baseline FLO Hab Module and Systems Mass Breakdown

Category	Name	System	Subsystem	Mass (kg)	SSF Growth	Comment/Sources
<b>Structures</b>						
PS1	Primary		Fwd bulkhead	577.00	9%	SSF HAB A Mass Properties Report (12/15/91)
PS2			Aft bulkhead	581.50	9%	
PS3			Cylinder skin, rings, launch support	2016.20	5-13%	
	Sub			3174.70		
SecS1	Secondary		Windows & MMDS	<del>879.20</del> 576.80	11-16%	Removes lower half of MMDS & its attach struct from cylinder (296.4 kg), which is protected by lander, but retains windows (109.3 kg) and MMDS for endcones
SecS2			Endcone mounting, Standoff assy, etc.	793.03	12-20%	SSF HAB A DI Includes 491 lbs of rack -related structure which is removed from here and distributed within the rack-based systems
SecS3			Hatch/track - axial	<del>239.10</del> 116.55	13%	Replaces one module hatch (116.55 kg) with use of airlock hatch
SecS4			Window shutter	6.35	18%	
SecS5			Berthing mech/support	<del>249.60</del> 0.00	5-18%	Assumed to not be needed for lunar outpost (possible future growth may use some other means of attachment)
	Sub			<del>2149.28</del> 1492.73		Structure necessary to actually tie airlock into module structure will be estimated and captured with the airlock masses. Masses here maintain assumption that SSF Hab-A structure is appropriate and sufficient for
			Rack pivot details	6.90		Necessary to add back 6.985 kg for the four sets of rack pivot details (book kept under PACK) which are actually part of the standoffs !
			1/6 g flooring	75.00		Due to lunar gravity, some type of flooring is needed which should be easily removable (for floor rack removal and access) - should investigate PLM ground loading flooring (including track for moving racks around)
			Rack mobility mechanism	77.30		Based on SSF GSE, needed to move, exchange, relocate racks in lunar gravity environment (for changeout, forming radiation shelter, etc.)

9/25/92

page 1

Integrated Baseline FLO Hab Module and Systems Mass Breakdown

Category	Name	System	Subsystem	Mass (kg)	SSF Growth	Comment/Sources
Sub				3329.98 4826.83		As a note, there appears to be a discrepancy in the Mass Properties Report of 13.18 lbs in FWD/INT Endcone. We will assume here that the masses are correct.
Dist Sys - Endcone/ Standoff-Mounted Utilities						
EP1	Endcone - fwd/ext	EPDS		0.00		SSF HAB A Mass Properties Report (12/15/91)
EP2	Endcone - fwd/int	EPDS	Remote switch	0.71		
			Cable Assy	12.47		
			Sensor/effector cable	2.26		
			SPDA struct. and integ.	32.15		
			Feedthru(DDCU)	2.19		
			RPDA utility rails	4.25		
			RPC's	47.85		
			DC-DC converter	50.00		
				151.88	5%	
				0.00		
EP3	Endcone - aft/ext	EPDS				
EP4	Endcone - aft/int	EPDS	Remote switch	0.71		
			Cable Assy.	12.47		
			Sensor/effector cable	2.26		
			SPDA	32.15		
			Feedthru, DDCU	2.19		
			RPDA Utility rails	4.25		
			RPC Modules	47.85		
			Converter, DDCU	50.00		
				151.88	5%	
			Lighting	21.44		
EP5	S/off - ceiling/starboard	Sub EPDS				
			Cable Assy.	13.97		

Integrated Baseline FLO Hab Module and Systems Mass Breakdown

Category	Name	System	Subsystem	Mass (kg)	SSF Growth	Comment/Sources
			Utility outlet	4.29		
EP6	S/off - floor/	Sub EPDS	Cable Assy.	39.70	5%	
EP7	S/off - floor/port	EPDS	Cable Assy.	15.58	5%	
			Sensor/effector cable utility outlet	9.07		
			Lighting	4.29		
EP8	S/off - ceiling/port	Sub EPDS		61.56	5%	
				21.44		
			Cable Assy.	26.49		
			Sensor/effector cable	2.26		
EP9	Cylinder	Sub		50.19	5%	
				0.00		
				470.79		
EC1	Endcone - fwd/ext	ECLSS-ACS	Vent and Relief assy.	8.57		SSF HAB A Mass Properties Report (12/15/91)
12.23			Plumbing	0.72		
		Sub		9.29	5-28%	
		ECLSS-ARS	Non-prop. vent	2.94	5-28%	
EC2	Endcone - fwd/int	ECLSS-THC	Bacteria filter	<del>13.66</del>		This mass is associated with intermodule ventilation (IMV) which is deleted since no other module is present (other O2/N2 feedthru assumed sufficient for airflow)
				0.00		
109-69			Isolation valve	<del>4.67</del>		This mass is associated with intermodule ventilation (IMV) and deleted
45.95			Duct, cab air	0.00		This mass is associated with intermodule ventilation (IMV) and deleted
			welds	<del>0.12</del>		This mass is associated with intermodule ventilation (IMV) and deleted
				0.00		

Integrated Baseline FLO Hab Module and Systems Mass Breakdown

Category	Name	System	Subsystem	Mass (kg)	SSF Growth	Comment/Sources
			cable, sensor effector	<del>2.26</del> 0.00		This mass is associated with intermodule ventilation (IMV) and deleted
		Sub		<del>25.65</del> 0.00	5-28%	Total IMV mass deleted is 144.6 lbs - including portions in AFT/INT Endcone and a small part of one Av Air/Crossover rack
		ECLSS-ACS	Pres. equal. valves	<del>9.99</del> 0.00		This mass deleted since no berthing vestibule exists for integrated baseline; O2/N2 feeds between AVL & module should suffice; V&R also available
			Vent & relief assy	8.76		
			O2/N2 control and dist.	<del>24.66</del> 13.71		Portion which incl inter-module O2/N2 blkhd feeds deleted (connection between module & AVL maintained at other end) - alt. atmos resupply prov. by hyperbaric AVL
			Plumbing	<del>12.05</del> 0.00		This plumbing assumed to be part of inter-module O2/N2 bulkhead feeds, which have been deleted as discussed
			cable, sensor effector	5.66		
		Sub		<del>66.22</del> 28.13	5-28%	
		ECLSS-FDS	Flame detector	1.52		
			Portable fire extinguisher	5.23		
			Fluid CO2	2.72		
			Sensor/effector cable	0.90		
		Sub		10.37	5-28%	
		ECLSS-ARS	Sensor/effector cable	2.26		
			CO2 vent system	2.93		
		Sub		5.19	5-28%	
		ECLSS-WRM	Sensor/effector cable	2.26	5-28%	
			Bulkhead penetration	<del>1.42</del> 0.00		This mass is associated with water venting which is deleted assuming that no excess water will be present or
EC3	Endcone - aft/ext	ECLSS-WRM				
<del>44.59</del> 0.00			Vents	<del>33.65</del> 0.00		This mass is associated with water venting which is deleted assuming that no excess water will be present or

Integrated Baseline FLO Hab Module and Systems Mass Breakdown

Category	Name	System	Subsystem	Mass (kg)	SSF Growth	Comment/Sources
			Isolation Valve	<del>9.52</del> 0.00		This mass is associated with water venting which is deleted assuming that no excess water will be present or
		Sub		<del>44.59</del> 0.00	5-28%	
EC4	Endcone - aft/int	ECLSS-THC	Fan, IMV	<del>5.14</del> 0.00		This mass is associated with intermodule ventilation (IMV) which is deleted since no other module is present (other O2/N2 feedthru assumed sufficient for airlock)
<del>96.54</del> 57.90			Isolation Valve	<del>4.67</del> 0.00		This mass is associated with intermodule ventilation (IMV) and deleted
			Ducting	<del>25.22</del> 0.00		This mass is associated with intermodule ventilation (IMV) and deleted
			Welds	<del>0.12</del> 0.00		This mass is associated with intermodule ventilation (IMV) and deleted
			Sensor/effector cable	<del>2.26</del> 0.00		This mass is associated with intermodule ventilation (IMV) and deleted
		Sub		<del>97.41</del> 0.00	5-28%	Total IMV mass deleted is 144.6 lbs - including portions in FWD/INT Endcone and a small part of one Av Air/Crossover rack
		ECLSS-ACS	Pressure Equalization valve	<del>1.23</del> 0.00		This mass deleted since no berthing vestibule exists for integrated baseline; O2/N2 feeds between A/L & module should suffice; V&R also available
			O2/N2 control and dist.	29.52		
			Sensor/effector cable plumbing	5.67		
		Sub		1.71		
				<del>38.13</del> 36.90	5-28%	
		ECLSS-ARS	Sensor/effector cable plumbing	2.27		
				0.64		

9/25/92

page 5



Integrated Baseline FLO Hab Module and Systems Mass Breakdown

Category	Name	System	Subsystem	Mass (kg)	SSF Growth	Comment/Sources
			Feed-thru	1.45		
		Sub		4.36	5-28%	
		ECLSS-FDS	Flame detector	1.52		
			Portable fire ext.	5.24		
			Sensor/effector cable	0.90		
			CO2-fluid	2.72		
		Sub		10.38	5-28%	
		ECLSS-WRM	Sensor/effector cable	2.26		
			plumbing	4.00		
		Sub		6.26	5-28%	
EC5	S/off - ceiling/starboard	ECLSS-THC	Fan	5.19		Fan assumed needed for circulation to smoke detectors in packed standoffs
<del>159.95</del> 153.50			Ducting	<del>145.14</del> 139.29		Portion of this mass is associated with extended module delta (8") which is deleted since no need is assumed for
			Insulation	5.52		
		Sub		<del>155.66</del> 150.00	5-28%	Total extended module delta (8") mass deleted is 17.22 lbs - including portions in Floor/Starboard Standoff
		ECLSS-FDS	Sensors	1.63		
			CO2 release valve	1.19		
			Sensor/effector cable	0.68		
		Sub		3.50	5-28%	
EC6	S/off - floor/starboard	ECLSS-THC	Fan	5.19		Fan assumed needed for circulation to smoke detectors in packed standoffs
<del>91.3</del> 89.34			Valves	8.47		
			Ducting	28.80		
			Sensor/effector cable	5.60		
		Sub		48.06	5-28%	
		ECLSS-ARS	Plumbing	0.54	5-28%	
		ECLSS-FDS	Sensors	1.63		
			Valves	1.19		
			Plumbing	9.14		

Integrated Baseline FLO Hab Module and Systems Mass Breakdown

Category	Name	System	Subsystem	Mass (kg)	SSF Growth	Comment/Sources
			Ductwork	<del>0.77</del> 0.00		Portion of this mass is associated with extended module delta (8") which is deleted since no need is assumed for
		Sub	Sensor/effector cable	0.45	5-28%	Total extended module delta (8") mass deleted is 17.22 lbs - including portion in Ceiling/Starboard Standoff
		ECLSS-WFM	Sensor/effector cable	11.33		
			Plumbing	<del>4.59</del> 3.40		Portion of this mass is associated with extended module delta (8") and deleted for Outpost
			Fluid-water	13.60		
		Sub		<del>29.52</del> 28.33	5-28%	Total extended module delta (8") mass deleted is 17.22 lbs - including portion in Ceiling/Starboard Standoff
EC7	S/off - floor/port	ECLSS-THC	Fan	5.19		Fan assumed needed for circulation to smoke detectors in packed standoffs
<del>118-96</del>			Ductwork	29.94		
112.73			Sensor/effector cable	6.79		
		Sub	Sensor/effector cable	41.92	5-28%	
		ECLSS-ACS	plumbing	2.26		
				3.17		
		Sub		5.43	5-28%	
		ECLSS-ARS	Sensor/effector cable	13.60		
			plumbing	0.59		
		Sub		14.19	5-28%	
		ECLSS-FDS	Sensors	1.63		
			plumbing	5.38		
			Sensor/effector cable	0.45		
		Sub		7.46	5-28%	
		ECLSS-WFM	Sensor/effector cable	29.46		
			plumbing	<del>6.89</del> 4.79		Portion of this mass is associated with STS Fuel Cell Water transfer which is deleted for the Outpost (but may be there if water from lander(s) used ?)

Integrated Baseline FLO Hab Module and Systems Mass Breakdown

Category	Name	System	Subsystem	Mass (kg)	SSF Growth	Comment/Sources
			Fluid	13.60 9.48		Portion of this mass is associated with STS Fuel Cell Water transfer and deleted (but may be there if water
		Sub		<del>49.05</del> 43.73	5-28%	
EC8	S/off - ceiling/port	ECLSS-THC	Fan	5.19		Fan assumed needed for circulation to smoke detectors in packed standoffs
72.14			Ductwork/insulation	22.43		
			Sensor/effector cable	6.11		
		Sub		33.73	5-28%	
		ECLSS-ARS	plumbing	0.67	5-28%	
		ECLSS-FDS	Sensors	1.63		
			plumbing	15.10		
			Sensor/effector cable	0.45		
		Sub		17.18	5-28%	
		ECLSS-WRM	Sensor/effector cable	13.60		
			plumbing	6.96		
		Sub		20.56	5-28%	
EC9	Cylinder	ECLSS-ACS	Module atmosphere	147.40	5-28%	
				<del>848.19</del> 691.19	5-28%	
DM1	Endcone - fwd/ext	DMS	none	0		SSF HAB A Mass Properties Report (12/15/91)
DM2	Endcone - fwd/int	DMS	Cabling	16.38		
			Feedthrus	1.81		
			Transducer	0.54		
			Acoustic sensor	2.06		
			Ring Concentrator	22.67		
			Display panel	2.26		
			MDM-large	20.86		

Integrated Baseline FLO Hab Module and Systems Mass Breakdown

Category	Name	System	Subsystem	Mass (kg)	SSF Growth	Comment/Sources
			EMADS			
			Signal processor	9.07		
			SDP "A" populated chassis	16.66		
				16.78		
			Mass storage unit (2)	62.60		SSF LAB A Mass Properties Report (12/15/91) - SDPs don't seem to exist in Hab A mass properties, but will be needed for Outpost (SDP "B" also included on other end)
DM3	Sub Endcone - aft/ext	DMS		171.69	5-28%	SSF LAB A Mass Properties Report (12/15/91) - MSUs don't seem to exist in Hab A mass properties, but will be needed for Outpost (2 exist on SSF Lab A and both are
DM4	Endcone - aft/int	DMS	Cabling	0.00		
			Cabling	16.38		
			Feedthrus			
			Transducer	1.81		
			Acoustic sensor	0.54		
			Ring Concentrator	2.06		
			Display panel	22.67		
			MDM-large	2.26		
			EMADS	20.86		
			SDP "B" populated chassis (2)	9.07		
				16.78		SSF LAB A Mass Properties Report (12/15/91) - SDPs don't seem to exist in Hab A mass properties, but will be needed for Outpost (SDP "A" also included on other end; both SSF Lab A SDP "B"s are included here)
DM5	S/off - ceiling/starboard	Sub		92.43	5-28%	
DM6	S/off - floor/	DMS	Cable	0.00		
			Cable	19.33		
			Fiber distribution/data			
			Time dist. bus	6.27		
				4.99		
DM7	S/off - floor/port	Sub	Cabling and Dist. bus	30.59	5-28%	
DM8	S/off - ceiling/port	DMS	Cabling and Dist. bus	61.20	5-28%	
DM9	Cylinder	DMS	Cabling and Dist. bus	30.60	5-28%	
			Thermographic scanner	19.05	5-28%	

Integrated Baseline FLO Hab Module and Systems Mass Breakdown

Category	Name	System	Subsystem	Mass (kg)	SSF Growth	Comment/Sources
	DMS Sub			405.56		
IA1	Endcone - fwd/ext	IAV		0.00		SSF HAB A Mass Properties Report (12/15/91)
IA2	Endcone - fwd/int	IAV	Crew wireless battery chrg.	7.31		
			Fiber optic cable	0.09		
IA3	Endcone - aft/ext	Sub		7.40	5-28%	
IA4	Endcone - aft/int	IAV	Microphone	0.00		
			Camera body	1.43		
			Zoom lens	10.64		
			Fiber optic cable	3.69		
				0.09		
IA5	S/off - ceiling/starboard	Sub		15.85	5-28%	
		IAV		0.00		
IA6	S/off - floor/	IAV	Antenna	9.07		
			Fiber optics	5.94		
IA7	S/off - floor/port	Sub		15.01	5-28%	
		IAV	Fiber optics	13.20	5-28%	
IA8	S/off - ceiling/port	IAV	Fiber optics	5.37	5-28%	
IA9	Cylinder	IAV		0.00		
	IAV Sub			56.83		
MS1	Endcone - fwd/ext	Man-Systems	Handrail	6.55		SSF HAB A Mass Properties Report (12/15/91) - This mass will be retained but assumed part of 1/6th-g furniture and accommodations
			Slidewire	2.26		This mass will be retained but assumed part of 1/6th-g furniture and accommodations

Integrated Baseline FLO Hab Module and Systems Mass Breakdown

Category	Name	System	Subsystem	Mass (kg)	SSF Growth	Comment/Sources
			Berth vestibule	1.90		This mass will be retained but assumed part of 1/6th-g furniture and accommodations
MS2	Endcone - fwd/int	Sub		10.71	5-20%	
		Man-Systems	Handrail assy.	1.02		This mass will be retained but assumed part of 1/6th-g furniture and accommodations
			Closeouts	23.15		
MS3	Endcone - aft/ext	Sub		24.17	5-20%	
		Man-Systems	Handrail	6.55		This mass will be retained but assumed part of 1/6th-g furniture and accommodations
			Slidewire	2.26		This mass will be retained but assumed part of 1/6th-g furniture and accommodations
MS4	Endcone - aft/int	Sub		10.71	5-20%	
		Man-Systems	Handrail assy.	1.02		This mass will be retained but assumed part of 1/6th-g furniture and accommodations
			Closeouts	23.15		
MS5	S/off - ceiling/starboard	Sub		24.17	5-20%	
		Man-Systems	Closeouts	2.30	5-20%	
			Closeouts	2.30		
MS6	S/off - floor/	Man-Systems	Closeouts	2.30		
			Sensor/effector cable	4.53		
		Sub		6.83	5-20%	
MS7	S/off - floor/port	Man-Systems	Closeouts	2.30		
			Sensor/effector cable	22.67		
		Sub		24.97	5-20%	
MS8	S/off - ceiling/port	Man-Systems	Closeouts	2.30		
			Sensor/effector cable	4.53		
		Sub		4.53		

Integrated Baseline FLO Hab Module and Systems Mass Breakdown

Category	Name	System	Subsystem	Mass (kg)	SSF Growth	Comment/Sources
MS9	Cylinder	Sub Man-Systems	Handrail	6.83	5-20%	This mass will be retained but assumed part of 1/6th-g furniture and accommodations
			slidewire	6.19		
				1.98		This mass will be retained but assumed part of 1/6th-g furniture and accommodations
				1.49		This mass will be retained but assumed part of 1/6th-g furniture and accommodations
			Aisle partition assy.	7.14		This mass will be retained but assumed part of dust containment shield near airlock
		Sub		16.80	5-20%	
				127.49		
	Man-Sys Sub					
TC1	Endcone - fwd/ext	TCS	Insulation Blanket	33.42	5%	SSF HAB A Mass Properties Report (12/15/91)
TC2	Endcone - fwd/int	TCS	Insulation	2.04		
			Paint	4.50		
			Tubing, cables,	17.78		
			Fluid - water	10.89		
			Cold plates	22.14		
			Rack flow control assy	6.81		
		Sub		64.16	5%	
TC3	Endcone - aft/ext	TCS	Plumbing	29.73		
			Heater	4.76		
			Heat Exchanger	16.37		
			Transducer	0.95		
			Temp sensor	0.27		
			Insulation Blanket	33.42		
		Sub		85.50	5%	
TC4	Endcone - aft/int	TCS	Plumbing	50.24		

Integrated Baseline FLO Hab Module and Systems Mass Breakdown

Category	Name	System	Subsystem	Mass (kg)	SSF Growth	Comment/Sources
			Valve	1.31		.
			Cold plate	24.42		.
			Bulkhead penetration	3.23		.
			Sensor effector cable	4.53		.
			Heater	1.05		.
			Fluid (water)	10.88		.
			Paint	2.04		.
			Insulation	4.49		.
TC5	S/off - ceiling/starboard	Sub TCS	Plumbing	102.19	5%	.
				6.66		.
			Insulation	6.42		.
TC6	S/off - floor/	Sub TCS	Plumbing	13.08	5%	.
				10.29		.
			Sensor/effector cable	9.07		.
			Insulation	5.90		.
			Fluid (water)	13.60		.
TC7	S/off - floor/port	Sub TCS	Plumbing	38.86	5%	.
				39.50		.
			Insulation	6.42		.
			Sensor/effector cable	15.87		.
			Fluid(water)	13.60		.
TC8	S/off - ceiling/port	Sub TCS	Plumbing	75.39	5%	.
				16.93		.
			Insulation	6.42		.
			Sensor/effector cable	15.87		.
			Fluid(water)	36.28		.
TC9	Cylinder	Sub TCS	Insulation blanket	75.50	5%	.
			Paint	216.98		.
				13.74		.
				230.72	5%	.
	TCS Sub			718.82		



Integrated Baseline FLO Hab Module and Systems Mass Breakdown

Category	Name	System	Subsystem	Mass (kg)	SSF Growth	Comment/Sources
Endcone and Standoff Sub				<del>2625.68</del>		
				2470.68		
Rack-Based Functions						
Avionics Air		ECLSS-THC	Valves	4.22	5-23%	SSF HAB A Mass Properties Report (12/15/91) - Our current integrated baseline assumes the present SSF avionics air change to a distributed system; however, mass, power, and design not known - therefore, previous Av Air masses kept as analog
		63.56	Sensors	0.10		
			Av Air cooling assy.	45.73		
			Ductwork	9.66		
			Insulation	3.85		
Sub		ECLSS-THC	Av Air assy	45.73		
		112.29	Valves, sensors, ducts	66.56		Total IMV mass deleted is 144.6 lbs - including portions in FWD/INT Endcone and AFT/INT Endcone
				175.05		This represents the total av air mass from previous crossovers; individual racks maintain their "older" av air numbers as analog as well (better numbers will be used once available - mid July ?)
Floor1	EVA Stowage					
					17%	SSF HAB A Mass Properties Report (12/15/91) -Contents of this rack are included elsewhere as part of EMU spares and expendables

Integrated Baseline FLO Hab Module and Systems Mass Breakdown

Category	Name	System	Subsystem	Mass (kg)	SSF Growth	Comment/Sources
	Sub		Rack Attachments	95.80	11%	
Floor2	Personal/ CHECS Storage		Rack Structure	72.62	16-17%	SSF HAB A Mass Properties Report (12/15/91) - Personal contents of this rack are included in consumables; CHECS included within total for CHECS rack
			Rack Attachments	26.15		
			Cleanups	3.12		
	Sub	90.11	Drawers	86.99		
				189.58		
Floor3	Galley Stowage #1		Rack Structure	72.62	16-17%	SSF HAB A (based on Galley/Wardroom Storage Rack) Mass Properties Report (12/15/91) - Contents of this rack are included elsewhere as part of food and galley
			Rack Attachments	26.15		
			Cleanups	3.12		
	Sub		Drawers	86.99		This mass will be retained but assumed part of 1/6th-g furniture and accommodations
				191.56		
Floor4	Galley Stowage #2		Rack Structure	72.62	16-17%	SSF HAB A Mass Properties Report (12/15/91) - Based on Galley Storage (food for crew included under consumables)
			Rack Attachments	26.15		
			Cleanups	3.12		
	Sub		Drawers	87.00		This mass will be retained but assumed part of 1/6th-g furniture and accommodations
				191.31		

Integrated Baseline FLO Hab Module and Systems Mass Breakdown

Category	Name	System	Subsystem	Mass (kg)	SSF Growth	Comment/Sources
Floor5	Critical ORUs	Rack	Rack Structure	72.62	16-17%	SSF HAB A Mass Properties Report (12/15/91) - Necessary and desired spares for Outpost not yet defined - this acts as a placeholder only
		M/S	Rack attachments Closeouts	26.85 3.12		
		518.71	Drawers ORUs (?)	86.99 428.60	5%	This bogey mass is equivalent to SSF Hab-A ORU
	Sub			618.18		
Starboard1	SPCU/EVA Storage	Rack	Rack structure	72.62	5-28%	SSF HAB A Mass Properties Report (12/15/91) - Generic rack utilities and structure based on Urine Processor as analog
		ETS	Rack attachments Cable Assy	35.58 3.97	5-23%	
		14.79	ETC ETM	7.03 1.81		
		DM6	SPCU (5-28/91) Lava LAVA	1.97 20.86		
		TCS	Disconnected tubing	5.17		
		18.73	Rack for control Assy Cable Assy Insulation Rigid wire	6.81 3.15 0.98 2.72		
		EMSS/TTC	EMSS/TTC EMSS/TTC	6.45		
		EDSS-FIS	Disconnected cable Assy	2.59		
		1.84	Fire indicator panel CO2 diffuser line	0.68 0.69		
		M/S-Sinc	Rack closeout Utility panel closeout	1.95 3.12		
	EVA		SPCU - suit drying Assy #1	7.67	25%	SSF WP02 Mass Properties Report (Jan 91) - One of the two SPCUs is captured here (other SPCU and controls sets are located across the aisle)
	31.25		SPCU - rack ventilation Assy #1	4.85	25%	
			SPCU - don/doff Assy #1	17.01	25%	



Integrated Baseline FLO Hab Module and Systems Mass Breakdown

Category	Name	System	Subsystem	Mass (kg)	SSF Growth	Comment/Sources
			Surf sampler kit	0.50	5-12%	*
			H2O microb kit	1.10	5-12%	*
			Tissue couler	10.80	5-12%	*
			Intra chgd part direct	54.40	5-12%	*
			Rad detection monitor	0.90	5-12%	*
			Physicians equip	11.30	5-12%	*
			Exam light	5.00	5-12%	*
			Blood collection kit	6.80	5-12%	*
			Phys monitoring sys	12.70	5-12%	*
			Other (to meet JSC #)	425.40		Add'l mass to meet Boeing understanding of input from JSC (for Monitoring & Countermeasures, 160 kg; for Supplies, 170 kg; and for CHecS Equip, 338 kg = 668 kg) (Also, assumed that radiation detection equip incl in this mass - see Memo 2-H895-MHA-92-003)
				<b>653.12</b>		
Starboard3	Science/ DMS/ Comm Workstation			22.62	5-28%	SSF HAB A (based on SSF LAB A ECWS Rack) Mass Properties Report (12/15/91) - ECWS assumed adequate for Outpost mission (SDPs and MSUs added in endcones and portable MPAC added below)
			Back enclosure	23.34		*
			Back attachments	7.00		*
			Back	1.84		*
			Keyboard	2.27		*
			Hand controller	2.27		*
			Fixed MPAC processor	22.68		*
			Portable MPAC without processor	6.00		Assumed value for 2 plug-in keyboards with flat panel displays (would use module processors for computing)
			Flat panel display	27.22		*
			Control panel	33.11		*
		IAV	ATU	9.50		*
		40.41	ABC	6.34		*
			Audio cable assy	0.48		*
			Video recorder	13.75		*
			Video I/F unit	10.24		*
			Fiber optic cable	0.10		*
			Rack flow control assy	6.81		*
			Cock plates	17.12		*

Integrated Baseline FLO Hab Module and Systems Mass Breakdown

Category	Name	System	Subsystem	Mass (kg)	SSF Growth	Comment/Sources
			ECSS-THC Valve, support, cushion	1.85		*
			ECSS-FPS camera, disconnector, fire	2.82		*
			ECSS-FPS Fire indicator panel	0.56		*
			ECSS-FPS CO2 release valve	1.19		*
		Man-Systems	Task light	3.10		*
		39.49	IMS bar code reader	11.91		*
			AV tapes, etc	9.75		*
			Restraints hardware	1.42		*
			Chair	5.97		*
			Single drawer	3.24		*
				<b>319.41</b>		
Starboard4	Science				5-28%	SSF HAB A Mass Properties Report (12/15/91) - Based on SSF Lab A Maintenance Workstation
			ECSS-THC Valve	3.37		*
			ECSS-FPS camera, disconnector, fire	2.82		*
			ECSS-FPS Fire indicator panel	0.56		*
			ECSS-FPS CO2 release valve	1.19		*
			Task light	3.10		*
			IMS bar code reader	11.91		*
			AV tapes, etc	9.75		*
			Restraints hardware	1.42		*
			Chair	5.97		*
			Single drawer	3.24		*
				<b>319.41</b>		
			ECSS-THC Valve	3.37		*
			ECSS-FPS camera, disconnector, fire	2.82		*
			ECSS-FPS Fire indicator panel	0.56		*
			ECSS-FPS CO2 release valve	1.19		*
			Task light	3.10		*
			IMS bar code reader	11.91		*
			AV tapes, etc	9.75		*
			Restraints hardware	1.42		*
			Chair	5.97		*
			Single drawer	3.24		*
				<b>319.41</b>		

This mass will be retained but assumed part of 1/6th-g furniture and accommodations

Integrated Baseline FLO Hab Module and Systems Mass Breakdown

Category	Name	System	Subsystem	Mass (kg)	SSF Growth	Comment/Sources
			Man-systems Restraints, handrails	6.4		This mass will be retained but assumed part of 1/6th-g furniture and accommodations
			18.95	5.96		
			Drawers	7.48		
			Fluid system serv & leak test equip.	101.7	18%	
		FSS	Maintenance Workstation	279.10	5%	
		Experiment	Local controller	20.90	5%	
		665.07	Test eq. meters, etc.	51.00		
			Autoclave	34.90		This particular instrument serves as analog to appropriate lunar LSE
			Battery charger	10.00		This piece of equipment assumed still needed for Outpost and mass retained as is
			Cleaning equip	18.10		This piece of equipment assumed still needed for Outpost and mass retained as is
			Oscilloscope	24.00		This piece of equipment assumed still needed for Outpost and mass retained as is
			Dosimeter	29.90		This piece of equipment assumed still needed for Outpost and mass retained as is
			Etching equip	6.00		This particular instrument serves as analog to appropriate lunar LSE
			Fluid handling tools	65.00		This particular instrument serves as analog to appropriate lunar LSE
			Gen purpose hand tools	59.00		This piece of equipment assumed still needed for Outpost and mass retained as is
			Mass measurement devices	39.90		This particular instrument serves as analog to appropriate lunar LSE

Integrated Baseline FLO Hab Module and Systems Mass Breakdown

Category	Name	System	Subsystem	Mass (kg)	SSF Growth	Comment/Sources
			Specimen labeling	5.00		This piece of equipment assumed still needed for Outpost and mass retained as is
			Surgery dissection tools	20.00		
			Wipes, etc.	2.27		This particular instrument serves as analog to appropriate lunar LSE
	Sub			958.79		
Starboard5	Crossover/ Cabin Air/ MTICS	Pack	Rack structure	102.10	5-28%	SSF HAB A Mass Properties Report (12/15/91) - PEP mass and complement are unknowns that were not identified in SSF report
			Back restraints	20.00		
			Cabin Air	3.00		
			HTC	7.00		
			HTC	1.00		
			HTC	1.00		
			HTC	1.00		
			HTC	1.00		
			Plumbing	16.26	5-23%	Internal TCS taken from previous AV Air/TCS/Crossover TCS Mass
			Pump Assy.	74.16		
			Controls	18.01		
			Sub Assy	5.15		
			Regenerative HX (9000W)	10.72		
			Field Water	2.73		
			HTC	0.97		
		ECLSS-THC	Cabin Air Assy.	106.00	5%	
			Valves, ducts, etc.			Water separator mass included as portion of this assembly (centrifugal separator may be replaced by passive 1/6 g system)
		139.2		33.20	5%	
		ECLSS-FCS	Sensor	0.81		
			CO2 Valve	1.19		
			Fire Indicator Panel	0.68		
			Quick Disconnect	0.57		



Integrated Baseline FLO Hab Module and Systems Mass Breakdown

Category	Name	System	Subsystem	Mass (kg)	SSF Growth	Comment/Sources
			Man-systems enclosure 5.76	5.06		
			CO2 diffuser ring 0.63	0.63		
			Hardware assy 0.70	0.70		
	Sub			439.18		This mass will be retained but assumed part of 1/6th-g furniture and accommodations
CeilingNonRack	Depress Pump Assembly		Attachment structure 35.58		5-28%	Airlock depress pump does not reside in a standard rack (due to interference with Crewlock) but this mass assumed to represent structure necessary to hold pump and supporting utilities
		ERTS	Canine assy 1.97		5-23%	Utilities for pump assembly based on Urine Processor
		ERTS	REC 1.03			
		ERTS	RTD 1.81			
		DAS	20V DC to 28VDC 1.97			
		ICS	Large MDM 20.86			
		ICS	Disconnector assembly 5.17			
		ICS	Rack for control assy and pump 8.81			
		ICS	Insulation 8.15			
		ICS	Pack for RTD 8.88			
		ECSS-THE	Valves, sensors, diffuser 2.72			
		ECSS-THE	WMS, interlock plug 6.45			
		ECSS-FRS	Disconnector, valve, sensor 2.58			
		ECSS-FRS	Fire indicator panel 0.68			
		ECSS-FRS	CO2 diffuser ring 0.63			
		M/S-Struc	Rack enclosure 1.95			
		ECSS-FRS	Utility panel enclosure 3.12			
		EVA	Pump assy 78.10		8%	SSF WP02 Mass Properties Report (Jan 91)
		116.7	Valves	38.60	25%	
	Sub			222.06		

Integrated Baseline FLO Hab Module and Systems Mass Breakdown

Category	Name	System	Subsystem	Mass (kg)	SSF Growth	Comment/Sources
Celling 1	ECLSS Water Storage			165.62	5-28%	SSF HAB A Mass Properties Report (12/15/91) - Outpost assumed to require less water than SSF
				35.57		.
				5.04		.
				7.03		.
				1.89		.
				8.1		.
				0.57		.
				0.57		.
				0.57		.
				0.63		.
				165.90	-10%	Reduced by deletion of 2 of 3 "3-way elect. act valve's assoc with change below; Press ORU mass kept along with existing pump (functions unclear)
				157.03		
				391.20	-10%	Reduced by deletion of 2 of these 3 water tanks (Outpost water needs are much lower than SSF, due mainly to no laundry and no every-day shower)
				110.40		
				15.33	-10%	.
				5.06		.

9/25/92

page 23

Integrated Baseline FLO Hab Module and Systems Mass Breakdown

Category	Name	System	Subsystem	Mass (kg)	SSF Growth	Comment/Sources
	Sub			671-20		Pump for moving water in gravity assumed to be handled by combination of existing press ORU and existing pump (TBD)
				442.43		
Ceiling2	ECLSS Water Processor	Pack	Rack structure	72.62	5-28%	SSF HAB A Mass Properties Report (12/15/91) - Outpost assumed to require less (half) water than SSF
			Rack attachments	35.67		
			Cable Assy	5.96		
			EPIS	7.03		
			12-79	1.80		
			RPC	6.61		
			RPOA	3.15		
			Flow control Assy	5.17		
			old plate	4.54		
			plumbing	0.88		
			Fluid(water)	1.24		
			Insulation	0.09		
			ECLSS-TRC Valves	1.51		
			5-84	2.38		
			ECLSS-ACS N2 pack-lev. fit Assy	1.42		
			1-77	5.33		
			Function Assy	7.14		
			(N2 800 in rack Assy)	0.81		
			895-31	1.19		
			O2 Pack Lev. fit Assy	0.68		
			ECLSS-FIB Sensor	0.57		
			3-88	0.53		
			CO2 valve	351.07	~13%	
			Fire indicator panel			
			Quick disoriented			
			CO2 diffuser line			
			ECLSS-WRM	312.88		Reduced by deletion of obsolete data for recycle pump (45.48 lbs) and RO assembly (38.72 lbs) - Press ORU mass kept along with existing pump (functions unclear)
			ECLSS water processor Assy.			
				110.12	~13%	
			Water (incl tanks ??)	30.83	~13%	
			Process control water quality monitoring			



Integrated Baseline FLO Hab Module and Systems Mass Breakdown

Category	Name	System	Subsystem	Mass (kg)	SSF Growth	Comment/Sources
		157.87	Plumbing	3.95 3.52		Reduced by deletion of the RO brine tubing (0.94 lbs) which is considered part of the obsolete RO assembly discussed above (other potential deletions remain TBD)
			Fluid-water	6.25		
			Man systems closures	5.06		
	Sub			346.22		
				345.79		
Ceiling4	Expanded ECLSS ARS/ACM			72.92	5-28%	SSF HAB A Mass Properties Report (12/15/91) - Expanded to include redundant MCA and CRM assemblies (utilities based on Urine Processor rack above)
			Rack structure	44.54		
			Rack attachments	9.46		
			Cable Assy	1.15		
			INSULATION	7.03		
			PIPE	1.80		
			WALL	20.86		
			2nd MCA/COA assy	0.81		
			2nd MCA/COA assy	3.15		
			plumbing	0.14		
			Fluid-watery	2.72		
			Insulation	0.98		
			ECLSS-THE VENT	0.22		
			8.45	0.09		
			ECLSS-FIS SAMPLE	2.12		
			3.89	0.81		
			CO2 valve	1.19		
			Fire indicatn panel	0.88		
			Quick disconnect	0.57	5%	
			CO2 diffuser line	0.69	5-23%	
			ECLSS-ARS ACM assy	100.64	5%	
			MCA/COA assy	66.63	5%	
			2nd MCA/COA assy	66.63	5%	
			Sample line	0.05	5%	



Integrated Baseline FLO Hab Module and Systems Mass Breakdown

Category	Name	System	Subsystem	Mass (kg)	SSF Growth	Comment/Sources
	Sub			435.88		
Port1	SPCU/ Airlock Controls		Rack structure	72.62	5-28%	SSF HAB A Mass Properties Report (12/15/91) - Generic rack utilities and structure based on urine processor as analog
			Rack attachments	95.58		
			Cable Assy	9.97	5-23%	
			FEC	7.83		
			FFDA	1.81		
			EMPCG 28VDC	1.97		
			EMPCU	20.66		
			EMPCU	5.17		
			Decompress. Utility	6.81		
			Rack low control Assy	9.15		
			Tool plan	0.98		
			Insulation	2.72		
			Flg. Assy	0.45		
			EMPCU - 12VDC battery	2.59		
			EMPCU - 12VDC battery	0.68		
			EMPCU - 12VDC battery	0.53		
			EMPCU - 12VDC battery	1.95		
			EMPCU - 12VDC battery	3.12		
			EMPCU - 12VDC battery	18.10	25%	SSF WP02 Mass Properties Report (Jan 91) - Second of the two SPCUs as well as controls are captured here (other SPCU located across the aisle; SSF has these two racks adjacent - impact unknown)
	EVA		SPCU - power supply and battery charger	10.21		
	272.09		SPCU - battery storage locker	25.54		
			SPCU - oxygen reg & distr	74.84		
			SPCU - H2O reg & distr	4.85		
			SPCU - rack ventilation assy #2	36.88		
			SPCU - umbilical I/F panel	8.53		
			SPCU - hose set	11.93		
			SPCU - cable set	7.67		





Integrated Baseline FLO Hab Module and Systems Mass Breakdown

Category	Name	System	Subsystem	Mass (kg)	SSF Growth	Comment/Sources
			C&W panel	9.10		
			C&W panel mounting HW	1.70		
			Man-systems closures	6.06		
			Sub	303.02		
Port3	Galley (Oven/ DD/ Handwash)			72.82	5-28%	SSF HAB A Mass Properties Report (12/15/91) - Based on Galley/ Oven/ Drink Dispenser rack plus new Handwash (based on handwash in WMC)
			Rack structure	17.89		
			Rack Attachments	9.97		
			Cable tray	1.97		
			Cable tie	7.09		
			HW	1.81		
			Plumbing	5.17		
			Flow control (FF)	6.61		
			Cold plate	3.15		
			Insulation	0.88		
			Fluid control	2.72		
			Valve	1.23		
			Sensors	0.09		
			Humidity	0.44		
			Sensors	0.61		
			CO2 valve	1.19		
			Fire indicator panel	0.68		
			Subst disconnect	0.57		
			CO2 diffuser line	0.63		
			Valve	0.47		
			Plumbing	2.34		
			Man-systems Oven	63.80	15%	
				50.15		Reduced by estimate of convection portion of the oven (30.10 lbs); microwave portion is retained - this change chosen for its reduction in power req'ts, too
			Water dispenser	74.80	15%	
				277.79		

Integrated Baseline FLO Hab Module and Systems Mass Breakdown

Category	Name	System	Subsystem	Mass (kg)	SSF Growth	Comment/Sources
		264.14	Handwash I/F structure Wardroom table and I/Fs Stowage	36.20 21.70 45.20 28.10	5% 15% 15%	
			Restrooms/Handrails Circuits	2.83 5.96		This mass will be retained but assumed part of 1/6th-g furniture and accommodations
	Sub			-413.26 399.61		
Port14	Waste Management Compartment			121.36	5-28%	SSF HAB A Mass Properties Report (12/15/91)
		ECLSS-WM	Commode/urinal assy		19%	Commode/urinal urine fan/seperator mass included as portion of this assembly (centrifugal separator may be replaced by passive 1/6 g system)
		Man-Systems	Waste Mgmt Compartment Handwash Local controller Handrail Circuits	52.39 36.24 1.43 0.70 5.07	5%	This mass will be retained but assumed part of 1/6th-g furniture and accommodations
	Sub			329.26		

Integrated Baseline FLO Hab Module and Systems Mass Breakdown

Category	Name	System	Subsystem	Mass (kg)	SSF Growth	Comment/Sources
Port5	Crossover/ TCS/Cabin Air	Pack	Rack structure	102.10	5-28%	SSF HAB A Mass Properties Report (12/15/91)
			Rack attachment	29.88		
		EPLS	Cable assy	8.97		
		12.81	FFC	7.03		
			FPDA	1.81		
		TCS	Fluid disconnects	15.26		
		115.26	ITCS pump assy	74.16		
			System flow control assy	11.19		
			Rack flow control assy	6.81		
			Cold plate	3.15		
			Tubing	1.00		
			Fluid water	2.72		
			Insulation	0.97		
		ECLSS-THC	Cabin Air assy	105.99		water separator mass included as portion of this assembly (centrifugal separator may be replaced by passive 1/6 g system)
		140.45	Valves, sensor	4.33		
			Diffuser	0.36		
			Ducts and welds	29.77		
		ECLSS-LCS	N2 rack-assy (F. base)	2.38		
		7.1	N2 rack feed thru	1.43		
			N2 bumper	3.33		
		ECLSS-FPS	Sensor	0.82		
		9.89	CO2 release valve, disconnect, line	2.39		
			Fire indicator panel	0.68		
		Man-Systems	Handrail	0.70		This mass will be retained but assumed part of 1/6th-g furniture and accommodations
		5.77	Closeouts	5.07		

Integrated Baseline FLO Hab Module and Systems Mass Breakdown

Category	Name	System	Subsystem	Mass (kg)	SSF Growth	Comment/Sources
	Sub			417.10		
Ops1	Ops storage (located in endcone of Outpost)					SSF HAB A Mass Properties Report (12/15/91) - All mass associated with Ops Storage included in consumables below (assumed to be stored sans rack in empty hatchway)
Rack-based Sub				9097.47		
				8816.70		
Habitat Sub				17047.13		
				16114.01		
Radiation Protection				TBD		Awaiting further requirements definition; current analysis shows doses below artificial limits for
Airlock	Airlock			1818.30		Best guess at Crewlock mass from WP02 data (see 3/27 breakdown and 6/22 comparison with Dave Kissinger's/JSC numbers for more details) Estimate for adaptation hardware
	Hab-to Airlock Adapter			272.20		
	Tools and Toolbox			553.20		From SSF WP02 Mass Properties Report (toolbox itself masses 344.7 kg, which is hefty; Δ2 reductions include only minimal tool complement with 15% mass fraction for toolbox)
	Dust Mitigation and Removal			57.20		
				15.00		This bogey includes 15 kg for vacuum (w/ filter and recirculation) and/or electrostatic removal (assume 1 kW peak, 2 % duty cycle) - other dust control mass under expendables

Integrated Baseline FLO Hab Module and Systems Mass Breakdown

Category	Name	System	Subsystem	Mass (kg)	SSF Growth	Comment/Sources
	External Lights			12.00	15%	Estimated mass for two EVA lights to be used for near-module activity during lunar night (power estimated at 0.2 kW, 5% duty cycle)
Sub				<del>2070.70</del> 2174.70		
External Support Systems						
	External System Support Structure			2064.00		Estimate for stairs, platforms (catwalks), A-frame hoist and elevator platform, integration structure for ECLSS and RFC tanks, radiator support, etc.
	C&T			40.00		
	External IA&V		External cameras (2)	31.70		Estimate based on AFT/INT Endcone IAV (microphone mass retained but assumed to be mass for dust control
	Thermal Control System		External transport	60.00		Sized for using a heat pump during the lunar day
			Radiator	435.00		
			Radiator insulation	25.00		
	Sub			520.00		
	Power		Reactants	1406.60		High pressure (3000 psi) stored O2/H2 reactants for regenerable fuel cell operation
			Tanks	2632.20		
			Arrays, fuel cells, etc.	963.00		All power and thermal masses based on needs of reference layout (thermal includes metabolic load from
			Array deployment and support structure	449.00		Calculated from estimated loads and by scaling from SAFE
	Sub			5450.80		

Integrated Baseline FLO Hab Module and Systems Mass Breakdown

Category	Name	System	Subsystem	Mass (kg)	SSF Growth	Comment/Sources
	Gas Conditioning Assembly			257.90		Based on one O2 string and one N2 gas conditioning strings from SSF GCA (without any structure, tanksets, fluid, or insulation - assumed provided elsewhere)
	Sub			8364.40		
Consumables	Crew water					Closed system needs included in above ECLSS numbers
	Food			360.00		4 people for 45 days (2 kg/p-d)
	Clothing			245.00		3 lbs per person-day
	Galley/Wardroom (non-food)		Wipes, bags, etc.	103.00		
	ECLSS expendables		AR	20.60		
			WRM	129.40		
			WM	11.00		
			THC	10.00		
	Sub			171.00		
	Make-up gas		Repress, Airtlock loss, module leakage	378.80		2 represses, 10% airtlock loss for 22 EVAs, standard leakage; includes hi-pressure tankage
	Metabolic oxygen			185.40		This assumes cryo storage (high pressure storage would mass much higher). These numbers include tanks.
	EVA sublimator water			167.60		16 lbs/EVA for 2 people for 7 hours (22 EVAs per mission)
	Suit expendables			166.30		Based on JSC's 3/6/92 value

Integrated Baseline FLO Hab Module and Systems Mass Breakdown

Category	Name	System	Subsystem	Mass (kg)	SSF Growth	Comment/Sources
	Suit spares			74.80		Based on JSC's 3/6/92 value
	Dust Control			97.00		This bogey includes 90 kg for disposable coveralls, 5 kg for brushes, and 2 kg for double-sided contact paper
	CheCS			80.00		Based on JSC information
	Personal Hygiene			45.80		From HAB A Mass Report ?
	Ops storage		Camera, cleaning, etc.	182.80		From HAB A Mass Report ?
	Off Duty			84.20		See 2/5/92 report from JSC
	Maintenance			113.20		See 2/5/92 report from JSC
	Science			50.00		Assumed number for internal science
	Sub			2504.90		
	Growth			1477.20		Contingency growth will be based on : for power, 15% of tanks, 15% of array, 28% of all else (incl 28% on array deployment and support structure), 0% on reactants; 28% for external structure;
						28% on external TCS; and 28% on external C&T; with no growth on consumables

Integrated Baseline FLO Hab Module and Systems Mass Breakdown

Category	Name	System	Subsystem	Mass (kg)	SSF Growth	Comment/Sources
Rack Reduction				-649.00		Δ2 Identified a potential 30% rack mass reduction due to the elimination of Shuttle "pseudo-forcing functions" which should not be a consideration for our launch vehicle (more detailed analysis pending)
<b>TOTAL</b>				<b>29986.21</b>		



## **Appendix B**

# **Boeing and MSFC System Mass and Rationale**

## Integrated Baseline FLO Hab Module and Systems Mass Breakdown

Outpost Hab Status (mass in kg)	Boeing Reference Mass	MSFC FLO Mass	Rationale for Difference
System	TD13	07/20/92	
Module Structure	6345	7302	Main differences due to Boeing reduction of
<i>Primary</i>	3968		four racks (to accommodate Crewlock) and
<i>Secondary/Mechanisms</i>	859		assumed 30% mass savings for remaining 20
<i>Racks</i>	1518		racks by removing STS-specific forcing functions
External Structure	2064	1614	Different configuration
ECLSS	2990	3000	Differences in FDS, ARS, and WRM assumptions
Medical Support	668	445	Minor different assumptions?
Crew Systems	1402	1694	Minor different assumptions?
<i>Endcone/Standoff Support</i>	127		
<i>Rack Support/Stowage</i>	471		
<i>Workstation Support</i>	28		
<i>Galley/WR Functions</i>	220		
<i>PHS Functions</i>	126		
<i>Critical ORUs</i>	429		
Dedicated Radiation Protection	Not Required	150'	Boeing assumed limits are met w/o add'l shielding
CDMS	856.0	863	Minor different assumptions?
<i>DMS</i>	686.9		
<i>IAV</i>	97.4		
<i>External C&amp;T</i>	71.7		
Power System	4755	3476	Different solar array materials and power levels/ margins chosen
<i>Internal</i>	711		
<i>External (excl. reactants)</i>	4044		
Thermal Control System	1782	1990	Boeing reference includes heat pump system (resulting in different and smaller radiator)
<i>Internal</i>	1282		
<i>External</i>	520		
Airlock System	2710	4236	Main differences in interpretation and application of SSF Crewlock data (including structures, internal EVA Systems, Utility distribution hardware, and external EVA equipment)
<i>SPCU/Controls</i>	303		
<i>Hyperbaric Support</i>	115		
<i>Depress Pump</i>	117		
<i>Airlock/Adaptor/Tools</i>	2175		
<b>Systems Subtotal</b>	<b>23572</b>	<b>24770</b>	
<i>Contingency</i>	<b>1477</b>	<b>2477</b>	Boeing based on 15-28% of External Systems
<b>Total Systems</b>	<b>25049</b>	<b>27247</b>	
<b>Consumables</b>	<b>2505</b>	<b>1506</b>	Different assumptions?
<b>Fuel Cell Reactants</b>	<b>1407</b>	<b>1336</b>	
<b>EVA Suits</b>	<b>With Crew</b>	<b>635</b>	Different approach
<b>Internal Science Equip</b>	<b>767</b>	<b>62</b>	Different capabilities
<b>External Gas Conditioning</b>	<b>258</b>		
<b>Total Landed</b>	<b>29986</b>	<b>30786</b>	

Structures & Mechanisms Comparison

FLO Structures and Mechanisms	Boeing Mass (kg)	MSFC Mass (kg)	Rational for Difference
<b>Habitat Module</b>			
Primary Structure	3968	4299	Boeing mass places rack-specific items ("Equip Mounting Shelf-Rack", "Faceplate", and "Rack Essentials Panel") with racks mass
Secondary Structure/ Mechanisms	859	673	Both masses have deleted berthing mechanisms; MSFC mass reduction of MMDS greater; Boeing mass deletes one hatch (replaced by Crewlock hatch) and includes 152.3 kg for 1/6g flooring & rack mobility aid
Racks	1518	2330	Boeing mass removes four racks to accommodate Crewlock and reduces remaining 20 racks by 30% due to assumed lack of STS-specific "pseudo-forcing functions"
<b>Module Subtotal</b>	<b>6345</b>	<b>7302</b>	
<b>External Support Structure</b>	<b>2064</b>	<b>1614</b>	Different configurations and assumptions?
<b>Structure/Mechanism Total</b>	<b>8409</b>	<b>8916</b>	

**FLO Habitation System**

**Environmental Control and Life Support System**

**ECLSS - General Description**

- ECLSS System is based on SSF Hab-A architecture and capabilities:
  - relative positions of ECLSS equipment identical to SSF Hab-A, w/ECLSS tier located on ceiling instead of floor (dust concerns)
  - "open" air and "closed" water systems (both sized for FLO)
  - distributed avionics air system (mass of previous centralized system kept as analog until better estimates available)
  - maintained one ACMA and one TCCS with original sampling lines
  - maintained both Cabin Air assemblies from SSF Hab-A
  - added redundant carbon dioxide removal assembly
  - added redundant major constituent analyzer assembly
  - deleted intermodule hardware (except that needed for Crewlock)
- ECLSS hardware mass in endcones and standoffs identical to SSF Hab-A
- ECLSS hardware mass in non-ECLSS racks based on similar SSF rack
  - internal EVAS (SPCU, Hyperbaric Support, Depress Pump Assembly) support modeled from Urine Processor rack and generic systems
  - CHeCS support also based on Urine Processor rack and generic systems
  - other racks based directly on SSF counterpart

**ECLSS - Subsystem Masses**

FLO ECLSS Subsystem	Boeing Mass (kg)	MSFC Mass (kg)	Rational for Difference
THC	811	520	Mass for new distributed system not defined (old centralized numbers used)
ACS	263	279	Boeing number includes internal only (GCA, at 258 kg, and make-up/metabolic gases bookkeeping separately)
ARS	6503	583	Both MSFC and Boeing include redundant MCA; Boeing includes 1 ACMA (MSFC: 0); Boeing includes 1 TCCS (MSFC: 2); Boeing includes all original sampling H/W (MSFC: 0)
FDS	120	136	Boeing includes for 17 powered racks (MSFC: 12)
WRM	1025	1078	Boeing includes two full water storage tanks, one each in Water Storage and Water Processing Racks in order to allow use from one while the other is being filled (MSFC: 1)
WM	121	121	
<b>Total Internal ECLSS Mass</b>	<b>2990</b>	<b>2717</b>	MSFC also includes 282 kg for high pressure tanks for a total ECLSS mass of 300 kg

**ECLSS - Issues**

- Location of ECLSS tier on ceiling may affect existing design
  - movement of fluid through module in lunar gravity
  - some standoff-to-rack interfaces may desire to be at the top rather than bottom of rack (impacting pivot operations/utility designs)
  - ECLSS tier standoff-to-rack interfaces may desire to be at both ends of the rack to optimize utility distribution
- Agreement on complement of FDS, ARS, and WRM equipment remains TBD
  - FDS H/W is 17 powered racks per layout (MSFC: 12)
  - ARS: both have redundant MCA  
1 ACMA included (MSFC: 0)  
1 TCCS included (MSFC: 2)  
all original sampling hardware included (MSFC: 0)
  - WRM: one water storage tank (and fluid) in both Water Storage and Water Processing racks in order to allow use from one while collection in the other (MSFC: 1 tank in Water Processing rack only)
- Definition of THC system not yet complete
- Nominal operation at 10.2 psia may involve design and safety impacts

## Medical Support/Radiation Protection Mass

FLO Medical Support	Boeing Mass (kg)	MSFC Mass (kg)	Rational for Difference
Monitoring and Countermeasures	160	?	Boeing mass based on discussions and understanding with JSC Human Factors group. This complement provides some basic surgical/dental and emergency first aid capabilities with the philosophy of being able to monitor crew health in order to learn about but not necessary correct <i>in-situ</i> problems associated with the lunar environment
Medical Supplies	170	100	
CHeCS Equipment	338	345	
<b>Total Med Support Mass</b>	<b>668</b>	<b>445</b>	
<b>Total Dedicated Radiation Protection Mass</b>	<b>0</b>	<b>150</b>	Boeing analyses currently show doses received in a reconfigured storm-shelter (using existing habitat mass) during a single large flare to be below proposed requirements (9 rem); however, requirements which are ultimately imposed with regard to ALSPE rate and dose limits, total exposure limits, number and size of survivable flares, abort strategies, etc. will affect the optimal shielding mass and arrangement

**Crew Systems- General Description**

- Crew System masses are based on SSF Hab-A
  - masses for restraints and mobility aids are kept as analog to one-sixth gravity furniture and accommodations
  - rack and endcone closeout masses are increased by 50 kg to account for additional dust containment needs
  - stowage drawers are assumed the same as used on SSF
  - waste management hardware mass is assumed identical to lunar system
  - galley has been modified by the addition of a handwash (for a total of two in the FLO habitat) and deletion of convection oven (microwave remains) with only a table acting as a "wardroom"
- Internal systems Critical ORUs are included under Crew Systems and represents approximately 5% of the internal systems mass (placeholder only - maintainability analyses TBD)
- Crew bunks are envisioned to be constructible cots which "plug-in" to rack seat tracks
- Stowage needs and assessment are currently being examined

**Crew System Masses**

FLO Crew Systems	Boeing Mass (kg)	MSFC Mass (kg)	Rational for Difference
Endcone/Standoff Support	127	88	Boeing mass based on SSF Hab-A numbers (R&MA mass to represent 1/6th g accommodations)
Rack Support/Stowage	471	234	Boeing mass based on SSF numbers in accordance with reference FLO layout (overall stowage assessment still pending)
Workstation Support	28	380	Boeing mass based on SSF Lab-A numbers
Galley/WR functions	220	497	Boeing mass based on SSF Hab-A numbers (includes deployable table; handwash added to active Galley rack; convection oven deleted with microwave remaining)
PHS Functions	126	in ECLSS	Boeing mass based on SSF Hab-A numbers
Critical ORUs	429	within each system	Boeing mass for Critical ORUs represents bogey for spares (~5% of active int sys)
<b>Total Internal Crew Systems Mass</b>	<b>1402</b>	<b>1694</b>	MSFC total from July report (known individual masses do not equal total)

## CDMS Masses

FLO CDMS	Boeing Mass (kg)	MSFC Mass (kg)	Rational for Difference
Internal DMS	687	419	Boeing mass based on SSF numbers in accordance with reference FLO layout (including ECWS, MSUs, and SDPs from Lab-A)
Internal Audio/Video	97	355	
<b>Internal CDMS Subtotal</b>	<b>784</b>		
External C&T	72	89	Boeing mass based on S-Band Earth links (using DSN) and VHF surface links with 240 kbps voice and 10 Mbps video/data; also includes external camera for EVA viewing
<b>Total CDMS Mass</b>	<b>856</b>	<b>863</b>	

**Power and Thermal Control Systems Comparison**

FLO Power Systems Mass	Boeing Mass (kg)	MSFC Mass (kg)	Rational for Difference												
<b>Power System - External</b>															
Power system hardware	3595	2698	Reduced mass of GaAs array offset by higher peak power Slightly different power level and margin												
Fuel cell reactants	1407	1336													
			<table border="1"> <tr> <td colspan="3">Power levels (kW)</td> </tr> <tr> <td></td> <td>Boeing</td> <td>MSFC</td> </tr> <tr> <td>Nt.-av/peak</td> <td>9.01/13.52</td> <td>9.1/na</td> </tr> <tr> <td>Day-av/peak</td> <td>13.3/20*</td> <td>10.5/na</td> </tr> </table>	Power levels (kW)				Boeing	MSFC	Nt.-av/peak	9.01/13.52	9.1/na	Day-av/peak	13.3/20*	10.5/na
Power levels (kW)															
	Boeing	MSFC													
Nt.-av/peak	9.01/13.52	9.1/na													
Day-av/peak	13.3/20*	10.5/na													
Array Support Struct	449	112	Sized for 1/6 g loading, and scaled from SAFE data where applicable												
<b>Power System - Internal</b>	711	666	Boeing mass based on SSF numbers in accordance with reference FLO layout												
<b>Power System Total</b>	<b>6162</b>	<b>4812</b>													
<b>Thermal System - External</b>															
External transport	60	89	Boeing number does not include power system penalty (~7 kg)												
Radiator	435	619	Boeing number includes heat pump												
Radiator insulation	25	60	Heat pumped radiator smaller												
			<table border="1"> <tr> <td colspan="3">Radiator areas (m<sup>2</sup>)</td> </tr> <tr> <td></td> <td>Boeing</td> <td>MSFC</td> </tr> <tr> <td></td> <td>62.8 (22.6 kW cap)</td> <td>110 (10 kW cap)</td> </tr> </table>	Radiator areas (m <sup>2</sup> )				Boeing	MSFC		62.8 (22.6 kW cap)	110 (10 kW cap)			
Radiator areas (m <sup>2</sup> )															
	Boeing	MSFC													
	62.8 (22.6 kW cap)	110 (10 kW cap)													
<b>Thermal System - Internal</b>	<b>1262</b>	<b>1222</b>	Includes both active and passive internal TCS subsystems. Boeing mass based on SSF numbers in accordance with reference FLO layout												
<b>Thermal System Total</b>	<b>1782</b>	<b>1990</b>													

\* Includes Heat pump power penalty



Crewlock/EVAS Status

FLO Crewlock/EVAS Component	Boeing Mass (kg)	MSFC Mass (kg)	Rational for Difference
<b>• Structures and Mechanisms</b>	<b>1532.7</b>	<b>1819.0</b>	
Crewlock cylinder section	152.9	140.0	Unknown (different data?)
Crewlock EVA bulkhead ring	264.0	264.0	
Crewlock IVA bulkhead ring	326.6	330.0	
Longerons and struts	40.6	41.0	
Isogrid panel/support angles	93.0	67.0	JSC removed 35%
MM/D shield	79.2	52.0	JSC removed 35%
EVA/IVA hatches/mech	228.1	232.0	
Non-rack/rack support struct	17.8	52	Unknown (different data?)
Crewlock rack	58.3	58.0	
1/6 g internal/external struct		59.0	Boeing incl overall 1/6g # w/hab
Pass-thru lock		38.0	Boeing incl in hab EVAS
IV yoke		152.0	Function of item not clear
Keel trunnion ftg and pins		46.0	Similar est. for 3 marked items
Transportation pins (2 keels)		16.0	
1/2 Equipment Lock end dome		64.0	Function of item not clear
Hab/Crewlock interface (est)	272.2	208.0	
<b>• Internal EVA Systems</b>	<b>656.3</b>	<b>1103.0</b>	Unknown
Crewlock hyperbaric supp	121.2		Boeing incl HECA/h/b Itg assembly
Hab EVAS (SPCU, H/B, pump)	535.1		Boeing incl internal EVAS only
<b>• Other Distributed Hardware</b>		<b>585.0</b>	This H/W assumed part of hab burden (incl racks, dist systems, etc.) necessary to support internal EVAS; thus, incl as part of Boeing hab systems
<b>• Crewlock EVA Hardware</b>	<b>428.9</b>	<b>396.0</b>	This hardware assumed to include distributed systems, umbilicals, plumbing, insulation, and airlock controls which are located within Crewlock
<b>• External EVA Equipment</b>	<b>92.0</b>	<b>333.0</b>	Included in Boeing estimates are tools and toolbox (reduced in Δ2 from 553.2 kg to 57.2 kg), small internal dust vacuum, external lights, and R&MA
<b>TOTAL MASS</b>	<b>2709.9</b>	<b>4236.0</b>	

Consumables

FLO Consumables Mass	Boeing Mass (kg)	MSFC Mass (kg)	Rational for Difference
<b>• Crew Accommodations</b>	<b>1134.0</b>	<b>833.0</b>	
Crew Quarters	0.0	30.0	No Crew Quarters on FLO?
Clothing	245.0	244.0	
Off Duty	84.2	40.0	Boeing mass based on JSC 2-5-92 report
Photography	} 182.8	15.0	} Boeing mass based on SSF Hab-A Hab-A "Ops Storage" number
Workstation		0.0	
Food & Galley Supply	463.0	464.0	
Personal Hygiene	45.8	15.0	Boeing mass based on SSF Hab-A
Housekeeping	113.2	75.0	Boeing mass based on SSF Hab-A Boeing mass based on JSC 2-5-92 report for "Maintenance"
<b>• Life Support</b>	<b>735.2</b>	<b>332.0</b>	<b>MSFC mass for initial charge only'; Boeing mass includes 45 day supply</b>
Water (Closed Loop)	in hab	61.2	Boeing mass incl 220.5 kg (incl tanks) initial charge in habitat ECLSS mass
Oxygen	305.2	30.0	Boeing mass: 119.8 kg (make-up for 2 represses, airlock loss, leakage) + 185.2 kg (metabolic) incl tankage
Nitrogen	259.0	68.5	Boeing mass incl make-up (w/tanks)
ARS expendables	20.6	} 172.3	
WRM expendables	129.4		
WM expendables	11.0		
THC expendables	10.0		
<b>• Health Maintenance</b>	<b>80.0</b>	<b>onboard</b>	<b>Boeing mass based on telecon discussion with JSC human factors</b>
<b>• Science</b>	<b>50.0</b>	<b>0.0</b>	<b>Boeing mass is an assumed number</b>
<b>• EVA</b>	<b>505.7</b>	<b>241.0</b>	
EMU Expendables	166.3		Boeing mass based on JSC 3-6-92 #
EMU Spares	74.8		Boeing mass based on JSC 3-6-92 #
Dust Control	97.0		Boeing mass includes 90 kg for disposable coveralls, 5 kg for brushes, and 2 kg for double-sided contact paper
<b>• Spares</b>	<b>in hab</b>	<b>4236.050.0</b>	<b>Boeing includes 429.0 kg for Critical ORUs (as a placeholder) under Crew System in the habitat module</b>
<b>TOTAL CONSUMABLES MASS</b>	<b>2504.9</b>	<b>1506.0</b>	<b>MSFC consumables mass for 45 day resupply is 1746.0 kg (addition of appropriate MSFC initial charge and resupply mass may reduce differences further)</b>

## EVA Suits/Contingency Factor

FLO Mass	Boeing Mass (kg)	MSFC Mass (kg)	Rational for Difference
<b>Total EVA Suit Mass</b>	<b>Suits with Crew</b>	<b>635</b>	Boeing approach assumes that primary EVA suits will necessarily be brought by Crew due to: 1) need for EMUs during transit between Earth and Moon, Crew Lander and FLO; 2) special sizing for individual crewperson; 3) importance of ensuring availability and performance of suits. Boeing consumables numbers do include suit spares and other suit needs for FLO mission.
<b>Total Contingency Mass</b>	<b>1477</b>	<b>2477</b>	Boeing contingency based on ratio for power, 15% of tanks, 15% of array, 28% of all else (incl 28% on array deployment and support structure), 0% on reactants; 28% for external structure; 28% on external %TCS; and 28% on external C&T; with no growth on consumables. All SSF growth allowances are maintained by not increased in Boeing numbers. MSFC contingency represents 10% of total habitat mass.

## Internal Science Support Mass

FLO Internal Science Support	Boeing Mass (kg)	MSFC Mass (kg)	Rational for Difference
Science Workbench	300		Boeing mass based on Maintenance Workstation (MWS) in SSF Lab-A. The MWS chosen as analog to generic glovebox or workbench for conduction internal science (examination, sampling, etc.)
Science Equipment	365		Boeing mass based on Lab Support Equipment from SSF Lab-A to represent generic materials/life sciences instruments
Fluid System Servicer and Leak Detection Equipment	102		Boeing mass based on SSF numbers and bookkeeping (location and function of FFS remains TBD)
Sample Prep. Instruments		18	
Imaging Instruments		24	
Spectrometers		20	
<b>Total Internal Science Mass</b>	<b>767</b>	<b>62</b>	

## **Appendix C**

# **Power Budget Dormant Operation**

**D615-10062-2**

**Lunar Campsite Internal Systems Budget Summary - Dormancy**

- All Loads in Watts -

	Connected Load	Duty Cycle (%)	Av. Load
<b><u>Electrical Power Distribution System (EPDS)</u></b>			
Lights	360	0	0
Cable power losses	114	100	114
<b><u>Data Management System (DMS)</u></b>			
Ring concentrators	48	100	48
E&W control panel	7.5	0	0
EMADS	10	100	10
Multiplexer-demultiplexer (MDM)	156	100	156
Standard Data Processors (SDP)	276	100	276
Mass Storage Unit (MSU)	320	25	80
<b><u>Signal Processor Interface</u></b>			
Data acquisition signal proc.	40	100	40
<b><u>Internal Audio &amp; Video</u></b>			
Crew wireless unit batt.	22.5	0	0
Camera body	34.3	1	0.34
Zoom lens	9.2	0.2	0.02
audio bus coupler	39.9	0	0
Video sketching unit	104.5	1	1.05
Audio terminal units	56	0	0
Portable video monitor	155	0	0
<b>Totals</b>	<b>1753 W</b>		<b>725 W</b>
<b><u>Thermal Control System (TCS)</u></b>			
Rack flow control assembly.	91	25	23
Crossover assembly	56	~0	~0
ITCS pump assembly.	150	100	150
System flow control. assembly.	14	50	7
<b><u>Temp. &amp; Humidity Control. (ECLSS-THC)</u></b>			
Isolation valves	100	~0	~0
Rack air control. valves	28	0.025	0.01
Avionics air fan	260	100	260
Av. air - I/F box	10	100	10
Cabin air - electrical I/F	25	100	25
Cabin air fan	90	100	90
Fan, ceiling ventilation	22	~0	~0
<b><u>Atmosphere Control (ECLSS-ACS)</u></b>			
Isolation valve	2.4	100	2.4
Line press. sensor	1.8	100	1.8
Line temperature sensor	0.02	100	0.02
O <sub>2</sub> /N <sub>2</sub> discharge diffuser	6.8	100	6.8
PCA firmware controller	14	100	14
Vent & relief subassembly	1	100	1
<b>Totals</b>	<b>872 W</b>		<b>591 W</b>

**Lunar Campsite Internal Systems Budget Summary - Dormancy (Continued)**

- All Loads in Watts -

	Connected Load	Duty Cycle (%)	Av. Load
<u>Galley/Wardroom</u>			
Handwash			
Diverter motor	1.8	0	0
Local control	1.6	0	0
Signal cond.	6	0	0
Temp. meas.	0.5	0	0
H <sub>2</sub> O supply	309	0	0
H <sub>2</sub> O dispenser			
Chiller	280	0	0
Electronic control	16	0	0
Flow control assembly	144	0	0
Heater assembly	210	0	0
Insertion/dispensing	57	0	0
Elec. converter (120-28 VDC)	2.9	0	0
Microwave oven	600	0	0
<u>Science/workbench</u>			
Bar code reader	20	0	0
Light fixture	50	0	0
Converter	9.6	0	0
Local controller	68	~0	~0
Control electronics	31.3	0	0
Control panels (2)	25	0	0
Delta press sensors (5)	50	0	0
Press. transducers/sensors	31.5	0	0
Temperature. sensors	0.4	0	0
Vacuum cleaner	237.5	0	0
<u>Miscellaneous. Science Equipment</u>	500	0	0
<u>Water Storage</u>	70	20	14
<u>Water Processing</u>			
Water processor	600	0	0
Process control H <sub>2</sub> O quality	100	~0	~0
Urine processing			
Distillation assembly	175	0	0
Embedded control	30	0	0
Fluid control assembly	5	0	0
Fluid pump ORU	70	0	0
Pressure control	5	0	0
Purge pump	70	0	0
<b>Totals</b>	<b>3777 W</b>		<b>14 W</b>

**Lunar Campsite Internal Systems Budget Summary - Dormancy (Continued)**

- All Loads in Watts -

	Connected Load	Duty Cycle (%)	Av. Load
<u>Air Revitalization System (ECLSS-ARS)</u>			
CO <sub>2</sub> vent valve	40	0	0
Atmosphere comp. monitor	531	25	133
CO <sub>2</sub> removal assembly	523.4	0	0
Converter	7.2	100	7.2
THC supply valve	20	100	20
Heater	150	25	37.5
TCCS - elec. I/F assembly	10	25	2.5
TCCS - flow control assembly	15.4	25	3.9
Flow meter & cable	1.6	100	1.6
<u>Science/DMS/Comm./Workstation</u>	996	27	265
<u>Crew Health (ChCS)</u>	911	0	0
<u>Fire Detection/Suppression</u>			
Fire detector	14	100	14
CO <sub>2</sub> release valve	800	0.25	2
Sensors, smoke - duct & area	23.8	100	23.8
<b>Totals</b>	<b>4043 W</b>		<b>511 W</b>
<u>Waste Management</u>			
Commode/urinal assembly			
C/U - commode fan	50	0	0
Compactor	130	0	0
User panel	25	0	0
<u>M/S Hygiene</u>			
Waste management compartment			
Cabin air fan	30	10	7
Cabin air heater	100	8	8
Cabin air temperature sensor	10	10	1
Lighting system	30	0	0
Local controller	27	0	0
Handwash			
Diverter motors	1.8	0	0
Local control	1.6	0	0
Signal cond.	6	0	0
Temp meas	0.5	0	0
H <sub>2</sub> O supply	309	0	
<b>Totals</b>	<b>721 W</b>		<b>16 W</b>



**Lunar Campsite Internal Systems Budget Summary - Dormancy (Concluded)**

- All Loads in Watts -			
	Connected Load	Duty Cycle (%)	Av. Load
<u>Hab Growth (scaled from SSF: ~5.4% Pavq)</u>	164	100	164
<u>Gas Conditioning Assembly (GCA)</u>			
GCA - N <sub>2</sub>			
N <sub>2</sub> cond. assembly	113.6	20	22.7
N <sub>2</sub> growth	9.1	20	1.8
GCA - O <sub>2</sub>			
O <sub>2</sub> cond. assembly	108.8	20	22
O <sub>2</sub> growth	8.7	20	1.7
<u>RPC Modules</u>	156	100	156
<u>External Communication Equipment</u>	150	100	150
<u>Rad. Ht Pump (for avg. + 10%) (day/nt)</u>	1474/150	100	1474/150
<b>Totals</b>	<b>2184/860 W</b>		<b>1992/818 W</b>

**Lunar Campsite Overall Power Budget Summary - Dormancy**

- All Loads in Watts -		
	Connected Load	Av. Load
EPDS/DMS/SPI/IAV	1753	725
TCS/TCH/ACS	872	591
Galley/Wardroom	1629	0
Science	2019	265
Water storage/Processing	1125	14
Air Revit. System	1298.6	206
Crew Health	911	0
Fire Detection/Suppression	838	40
RPC Modules	156	156
External Comm. Equipment	150	150
Waste Management	205	0
M/S Hygiene	516	16
Gas cond. Assembly	240	48
Heat Pump - Day	1474	1474
- Night	150	150
Grand Totals: - Day	13351W	3849 W
- Night	12027 W	2525 W

Note: Airlock Power (average and connected) = 0 W

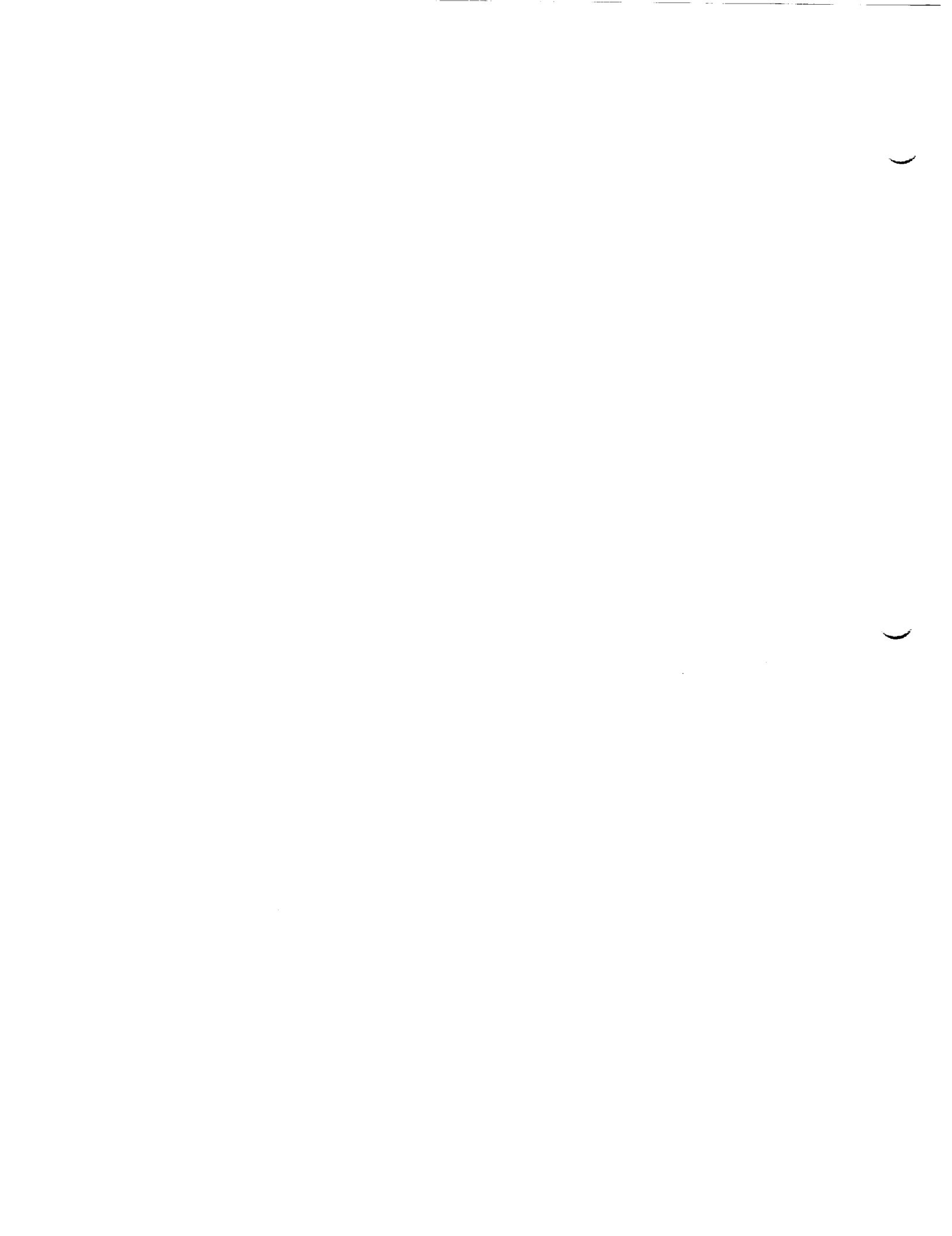

## **Appendix D**

# **Power Budget Details Crew Onboard Operations**

**D615-10062-2**

**Lunar Campsite Internal Systems Power Budget Summary - Δ2**

- All Loads in Watts -

	Connected Load	Duty Cycle (%)	Av. Load
<u>Electrical Power Distribution System (EPDS)</u>			
Lights	360	50	180
Cable power losses	196	100	196
RPC modules	312	100	~312
<u>Data Management System (DMS)</u>			
Ring concentrators	48	100	48
C&W control panel	7.5	100	7.5
EMADS	10	100	10
Multiplexer-demultiplexer (MDM)	480	100	480
Standard Data Processors (SDP)	276	100	276
Mass Storage Unit (MSU)	320	100	320
<u>Signal Processor Interface</u>			
Data acquisition signal proc.	40	100	40
<u>Internal Audio &amp; Video</u>			
Crew wireless unit batt.	22.5	10	2.25
Camera body	34.3	10	3.5
Zoom lens	9.2	2	0.18
Audio bus coupler	39.9	40	16
Video switching unit	104.5	10	10.5
Audio terminal units	56	30	17
Portable video monitor	155	5	7.75
<b>Totals</b>	<b>2471 W</b>		<b>1927 W</b>
<u>Thermal Control System (TCS)</u>			
Rack flow control assembly	91	25	23
Crossover assembly	56	~0	~0
ITCS pump assembly	150	100	150
System flow control assembly	14	50	7
<u>Temp. &amp; Humidity Control. (ECLSS-THC)</u>			
Isolation valves	100	~0	~0
Rack air control valves	28	0.025	0.01
Avionics air fan	749	100	749
Av. air - I/F box	10	100	10
Cabin air - electrical I/F	25	100	25
Cabin air fan	519	100	519
Fan, ceiling ventilation	22	~0	~0
Standoff fans	317	100	317
<u>Atmosphere Control (ECLSS-ACS)</u>			
Isolation valve	2.4	100	2.4
Line press. sensor	1.8	100	1.8
Line temperature sensor	0.02	100	0.02
O <sub>2</sub> /N <sub>2</sub> discharge diffuser	6.8	100	6.8
PCA firmware controller	14	100	14
Vent & relief subassembly	1	100	1
<b>Totals</b>	<b>2257 W</b>		<b>1976W</b>

Lunar Campsite Internal System Power Budget Summary - Δ2 (Continued)

	- All Loads in Watts -		
	Connected Load	Duty Cycle (%)	Av. Load
<u>Galley/Wardroom</u>			
Handwash			
Diverter motor	1.8	4.2	0.075
Local control	1.6	100	1.6
Signal cond.	6	100	6
Temp. meas.	0.5	100	0.5
H <sub>2</sub> O supply	309	9	28
H <sub>2</sub> O dispenser			
Chiller	280	0.7	196
Electronic control	16	100	16
Flow control assembly	144	16.7	24
Heater assembly	210	0.7	147
Insertion/dispensing	57	16.7	9.5
Elec. converter (120-28 VDC)	2.9	100	2.9
Microwave oven	600	2	12
<u>Science/workbench</u>			
Bar code reader	20	75	16
Light fixture	50	10	5
Converter	9.6	32	3.1
Local controller	68	~0	~0
Control electronics	31.3	33	10.3
Control panels (2)	25	33	8.25
Delta press sensors (5)	50	33	16.5
Press. transducers/sensors	31.5	33	10.3
Temperature sensors	0.4	40	0.16
Vacuum cleaner	237.5	5	11.9
Miscellaneous Science Equipment	500	10	50
<u>Water Storage</u>	70	20	14
<u>Water Processing</u>			
Water processor	600	33	200
Process control H <sub>2</sub> O quality	100	~0	~0
Urine processing			
Distillation assembly	175	16.5	29
Embedded control	30	100	30
Fluid control assembly	5	100	5
Fluid pump ORU	70	17	12
Pressure control	5	17	0.83
Purge pump	70	1.4	1
<b>Totals</b>	<b>3777 W</b>		<b>861 W</b>

Lunar Campsite Internal Systems Power Budget Summary - Δ2 (Continued)

- All Loads in Watts -

	Connected Load	Duty Cycle (%)	Av. Load
<u>Air Revitalization System (ECLSS-ARS)</u>			
CO <sub>2</sub> vent valve	40	0.001	0.0004
Atmosphere comp. monitor	531	(nt/day) 25/100	133/531
CO <sub>2</sub> removal assembly	523.4	100	523.4
Converter	7.2	100	7.2
THC supply valve	20	100	20
Heater	150	57	85.5
TCCS - elec. I/F assembly	10	100	10
TCCS - flow control assembly	15.4	100	15.4
Flow meter & cable	1.6	100	1.6
<u>Science/DMS/Comm./Workstation</u>	996	59	595
<u>Crew Health (CHeCS)</u>	911	10	91
<u>Fire Detection/Suppression</u>			
Fire detector	14	100	14
CO <sub>2</sub> release valve	800	0.25	2
Sensors, smoke - duct & area	23.8	100	23.8
<b>Totals</b>	<b>4043 W</b>		<b>1522/1920 W</b>
<u>Waste Management</u>			
Commode/urinal assembly			
C/U - commode fan	50	2.5	1.25
Compactor	130	0.55	0.72
User panel	25	100	25
<u>M/S Hygiene</u>			
Waste management compartment			
Cabin air fan	30	70	21
Cabin air heater	100	8	8
Cabin air temperature sensor	10	100	10
Lighting system	30	20	6
Local controller	27	100	27
Handwash			
Diverter motors	1.8	4.2	0.075
Local control	1.6	100	1.6
Signal cond.	6	100	6
Temp meas	0.5	100	0.5
H <sub>2</sub> O supply	309	9	28
<b>Totals</b>	<b>721 W</b>		<b>135 W</b>

**Lunar Campsite Internal/External Systems Power Budget Summary - Δ2 (Concluded)**

- All Loads in Watts -			
	Connected Load	Duty Cycle (%)	Av. Load
<u>Hab Growth (scaled from SSF: ~5.4% Pavq)</u>	342	100	342
<u>Gas Conditioning Assembly (GCA)</u>			
GCA - N <sub>2</sub>			
N <sub>2</sub> cond. assembly	113.6	100	113.6
N <sub>2</sub> growth	9.1	20	9.1
GCA - O <sub>2</sub>			
O <sub>2</sub> cond. assembly	108.8	100	108.6
O <sub>2</sub> growth	8.7	100	8.7
<u>External Communication Equipment</u>	150	100	150
<u>Rad. Ht Pump (for avg. + 10%)</u>	3787/300	100	3787/300
<b>Totals</b>	<b>4519/1032 W</b>		<b>4519/1032 W</b>

**Lunar Campsite Overall Power Budget Summary - 2**

- All Loads in Watts -		
	Connected Load	Av. Load
EPDS/DMS/SPI/IAV	2471	19273
TCS/TCH/ACS	2257	1976
Galley/Wardroom	1629	443.6
Science	2019	727
Water storage/Processing	1125	292
Air Revit. System	1298.6	796
Crew Health	911	91
Fire Detection/Suppression	838	40
External Comm. Equipment	150	150
Waste Management	205	27
Hab Growth	516	108
M/S Hygiene	342	342
Gas Cond. Assembly	240	240
Heat Pump - Day	3787	3787
-Night	300	300
Airlock - Day	6674	2371
-Night	6674	1551
<b>Grand Totals: - Day</b>	<b>24463 W</b>	<b>13318 W</b>
-Night	<b>20976 W</b>	<b>9011 W</b>

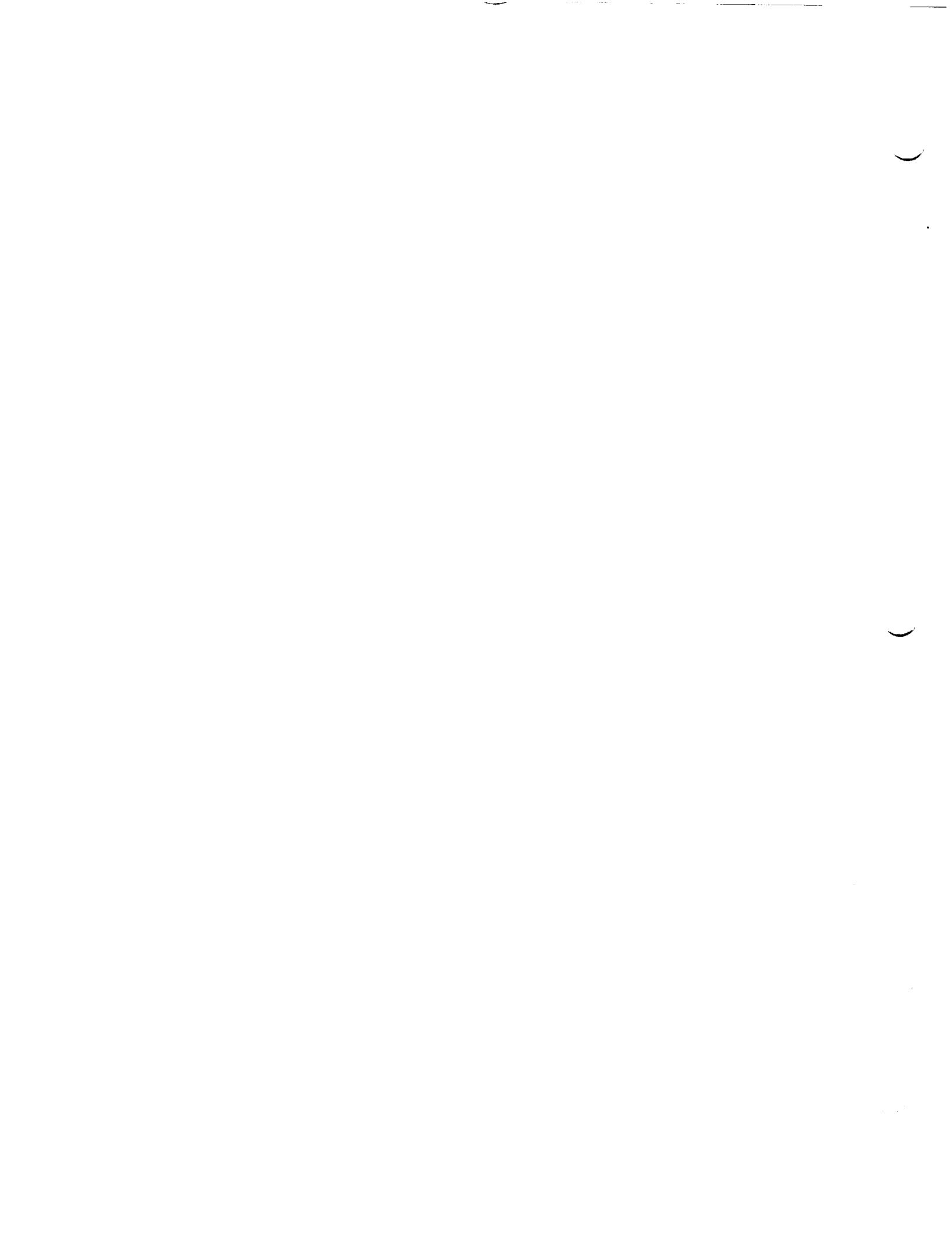



# Appendix E

## Surface Mission Timeline

2nd Manned Surface Mission Timeline (Double EVA)

8/21/92

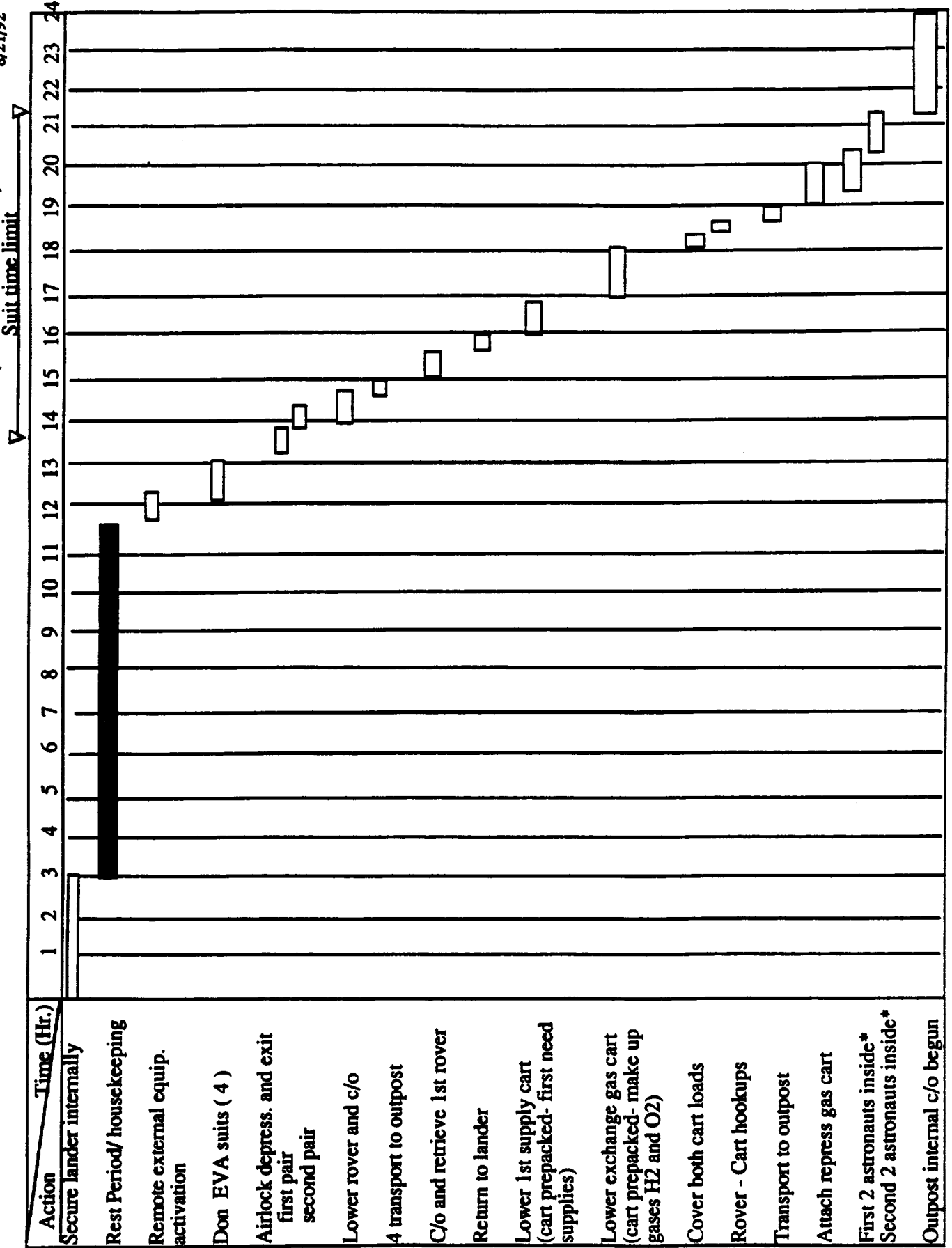

\* includes dust off time

## 2nd Manned Surface Mission Timeline page 2

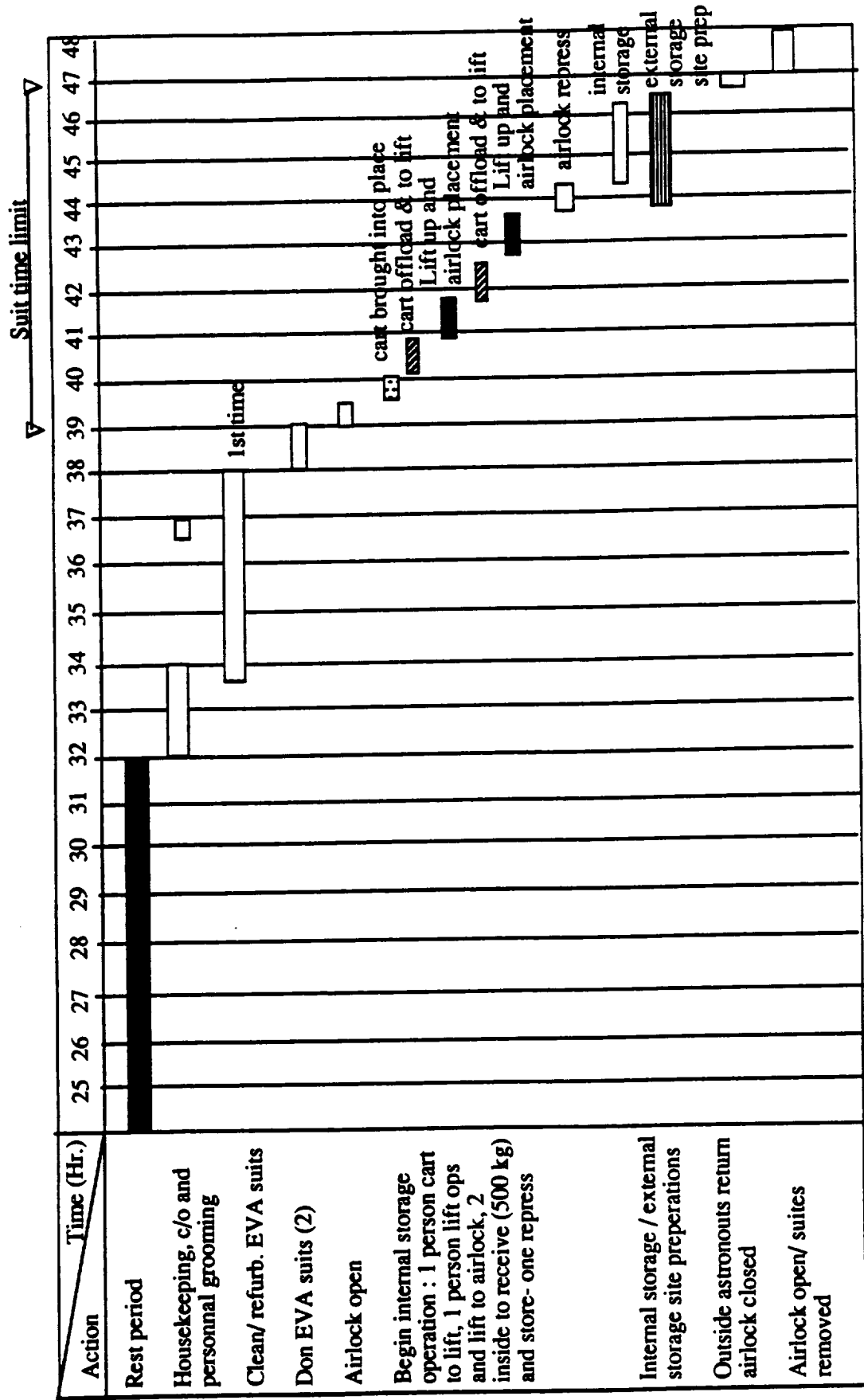

2nd Manned Surface Mission Timeline  
page 3

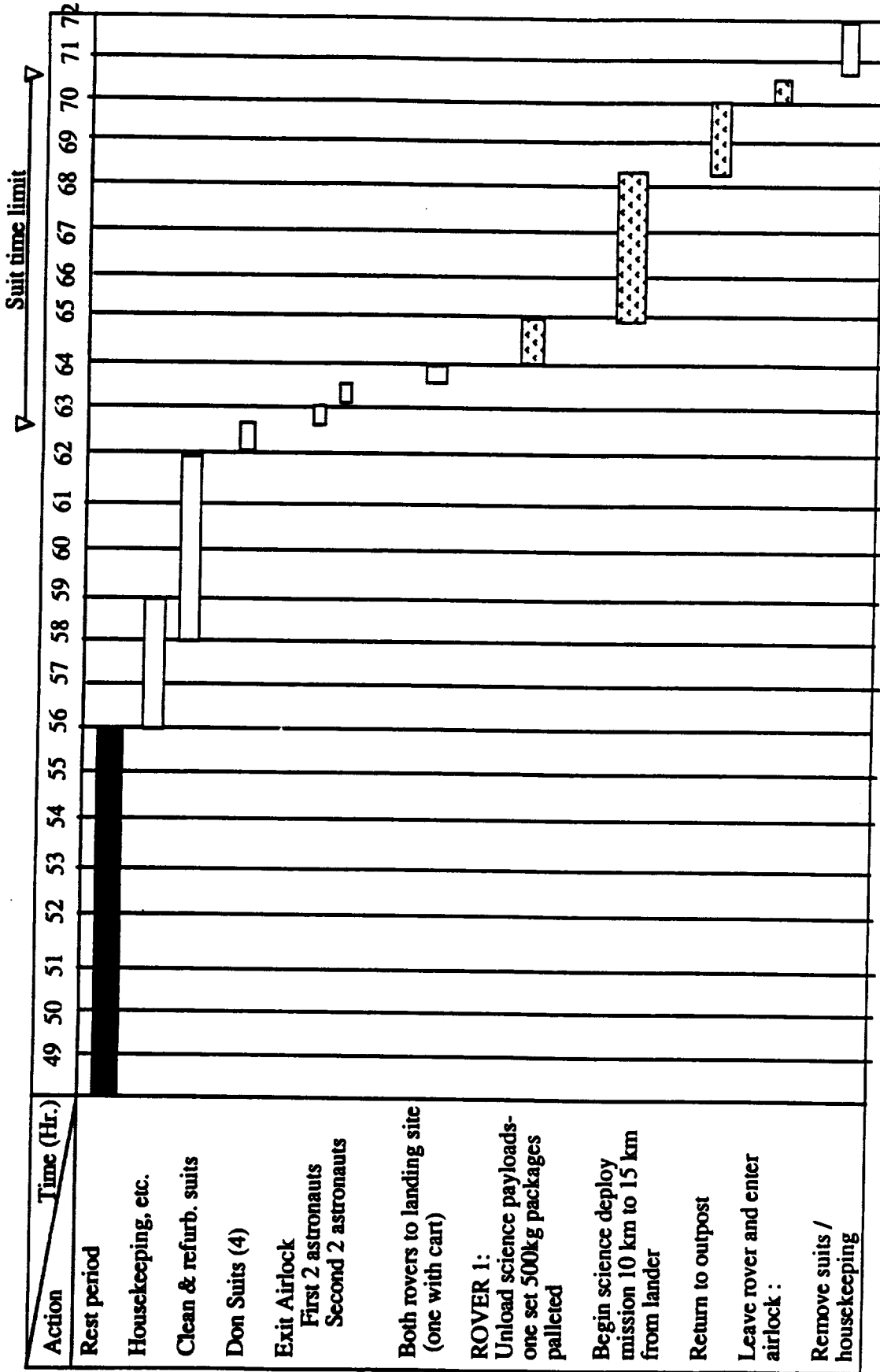

**2nd Manned Surface Mission Timeline**  
**page 3 con't**

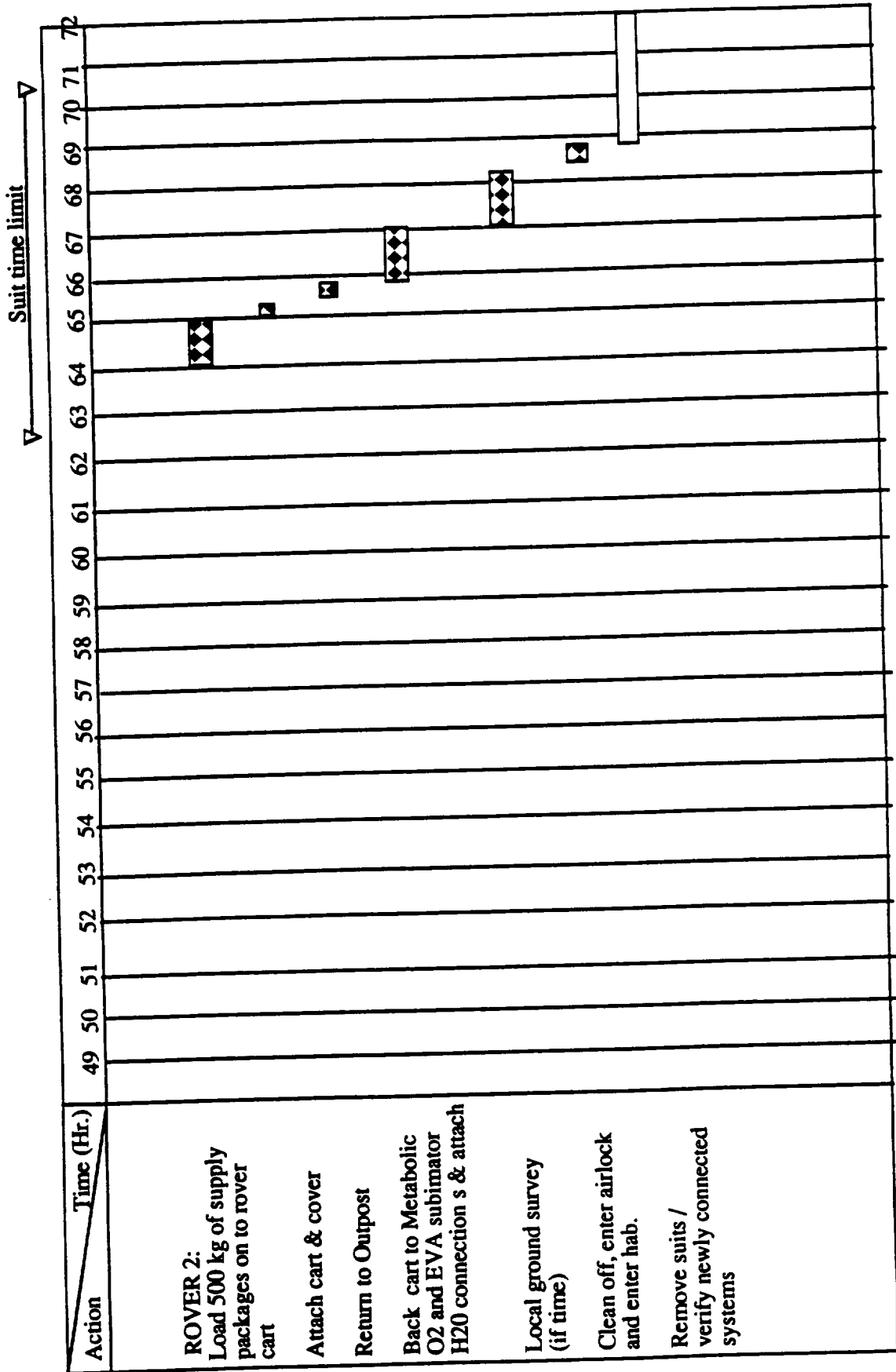

# 2nd Manned Surface Mission Timeline page 4

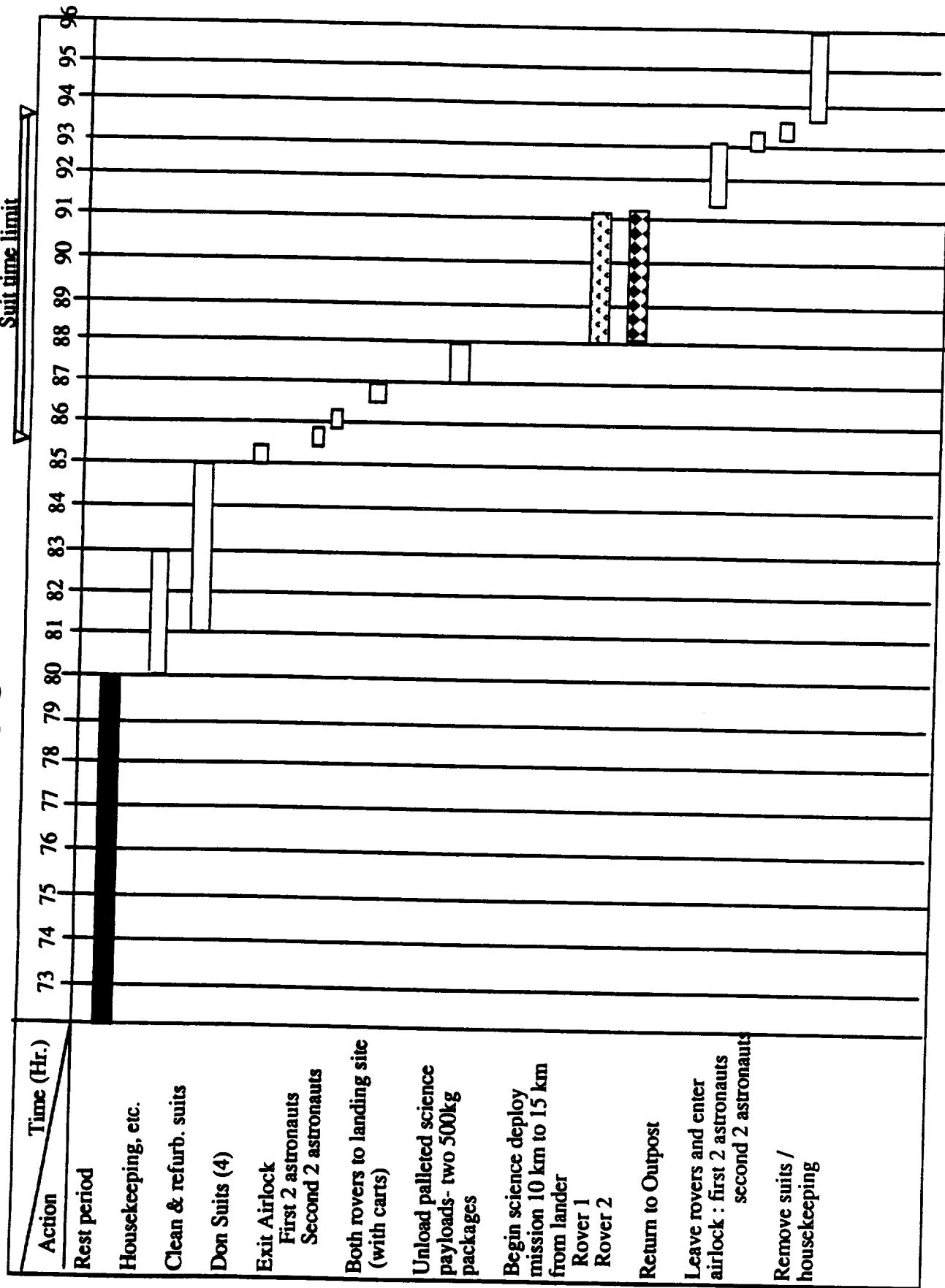

# 2nd Manned Surface Mission Timeline page 5

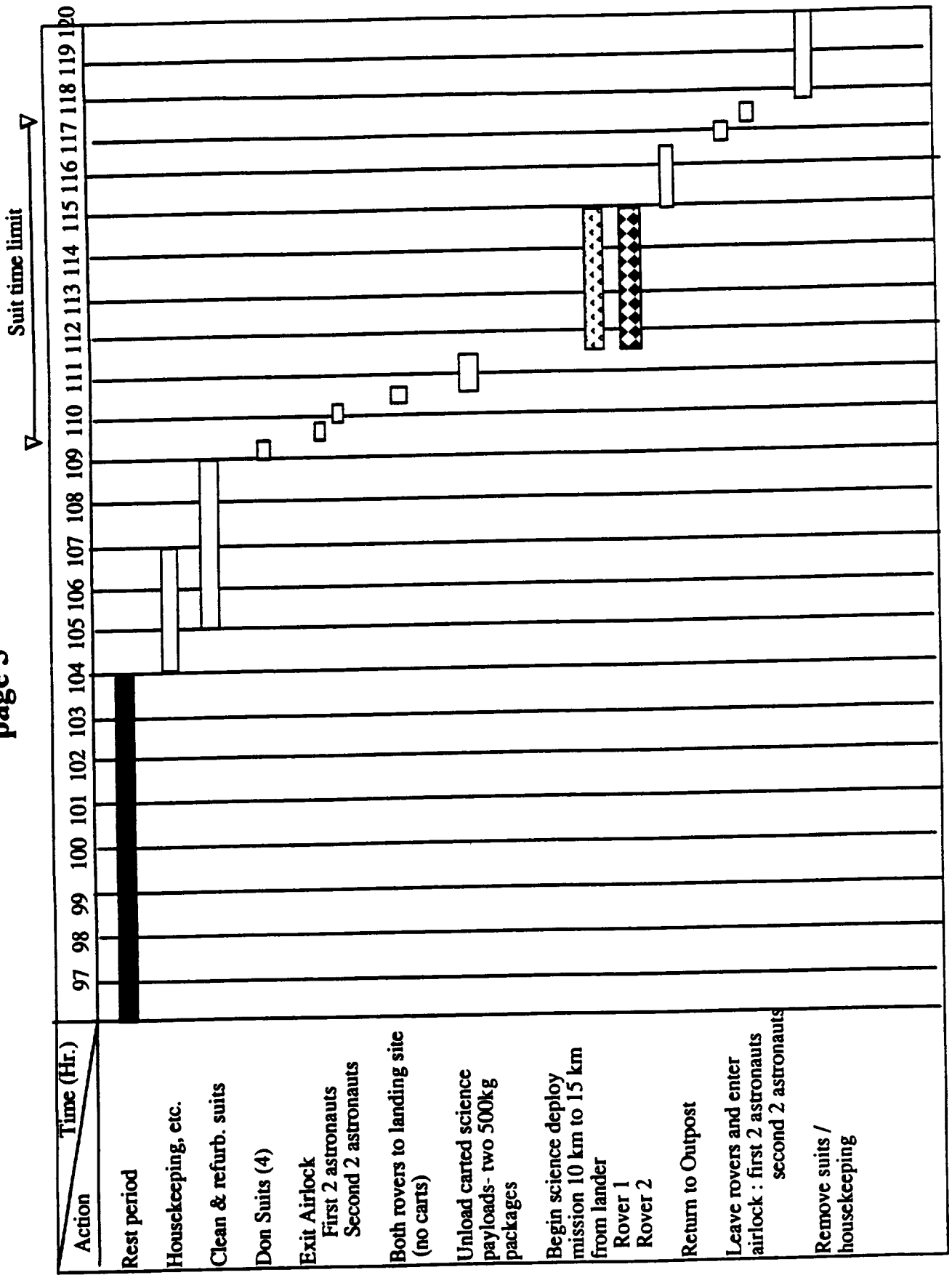

**2nd Manned Surface Mission Timeline**  
**page 6**

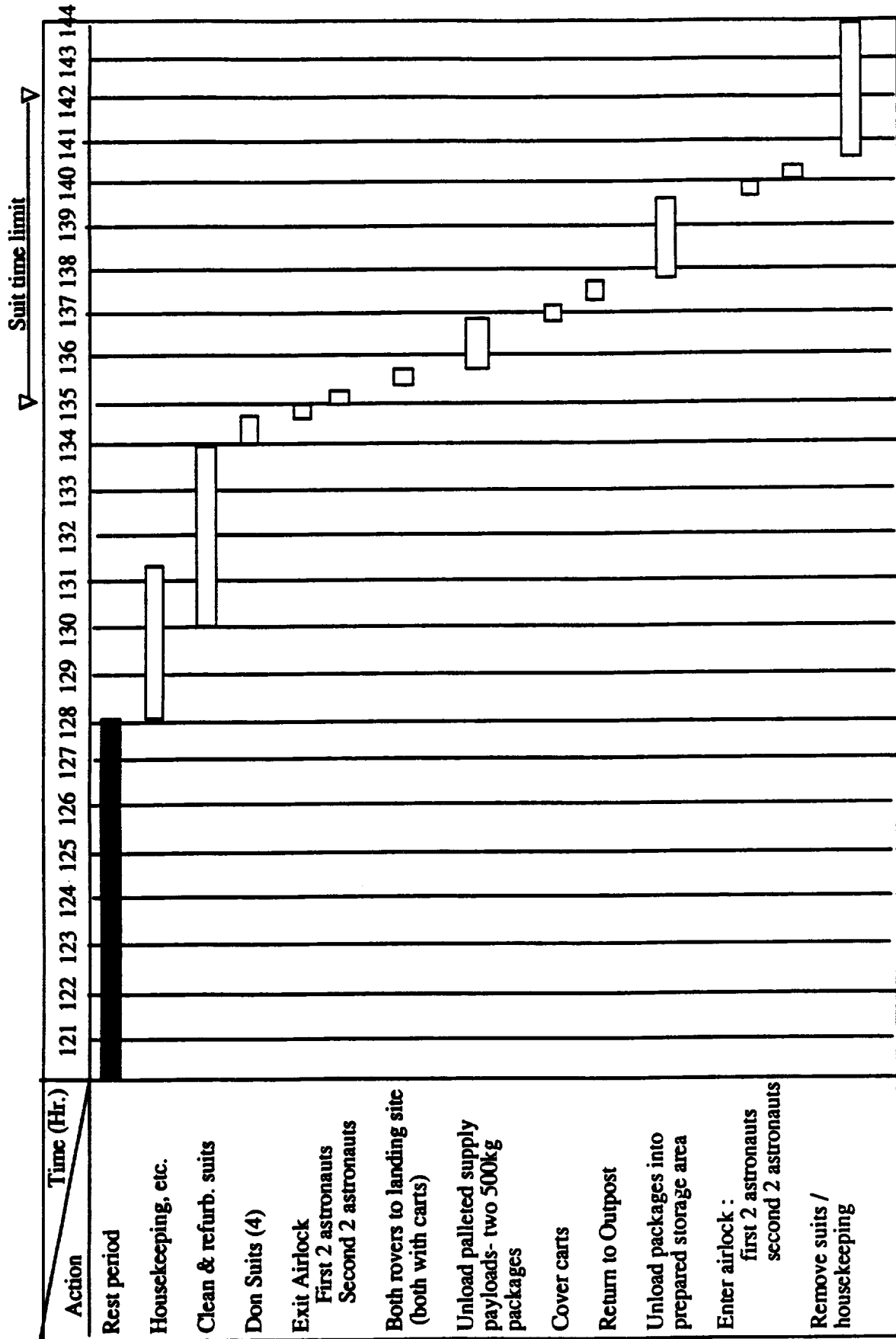



# 2nd Manned Surface Mission Timeline

page 7

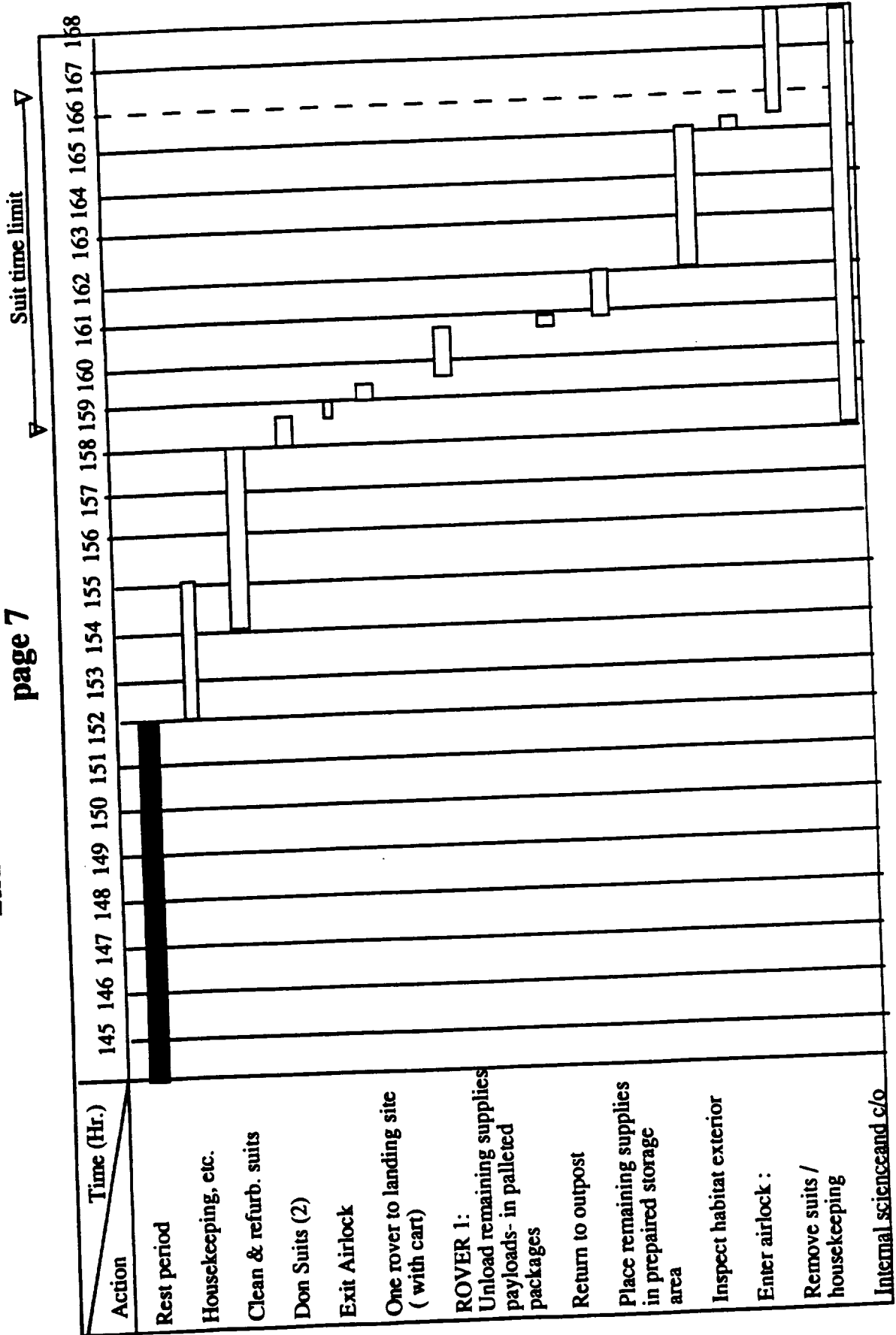

7/6/92

**MISSION TIMELINE (single EVA)**

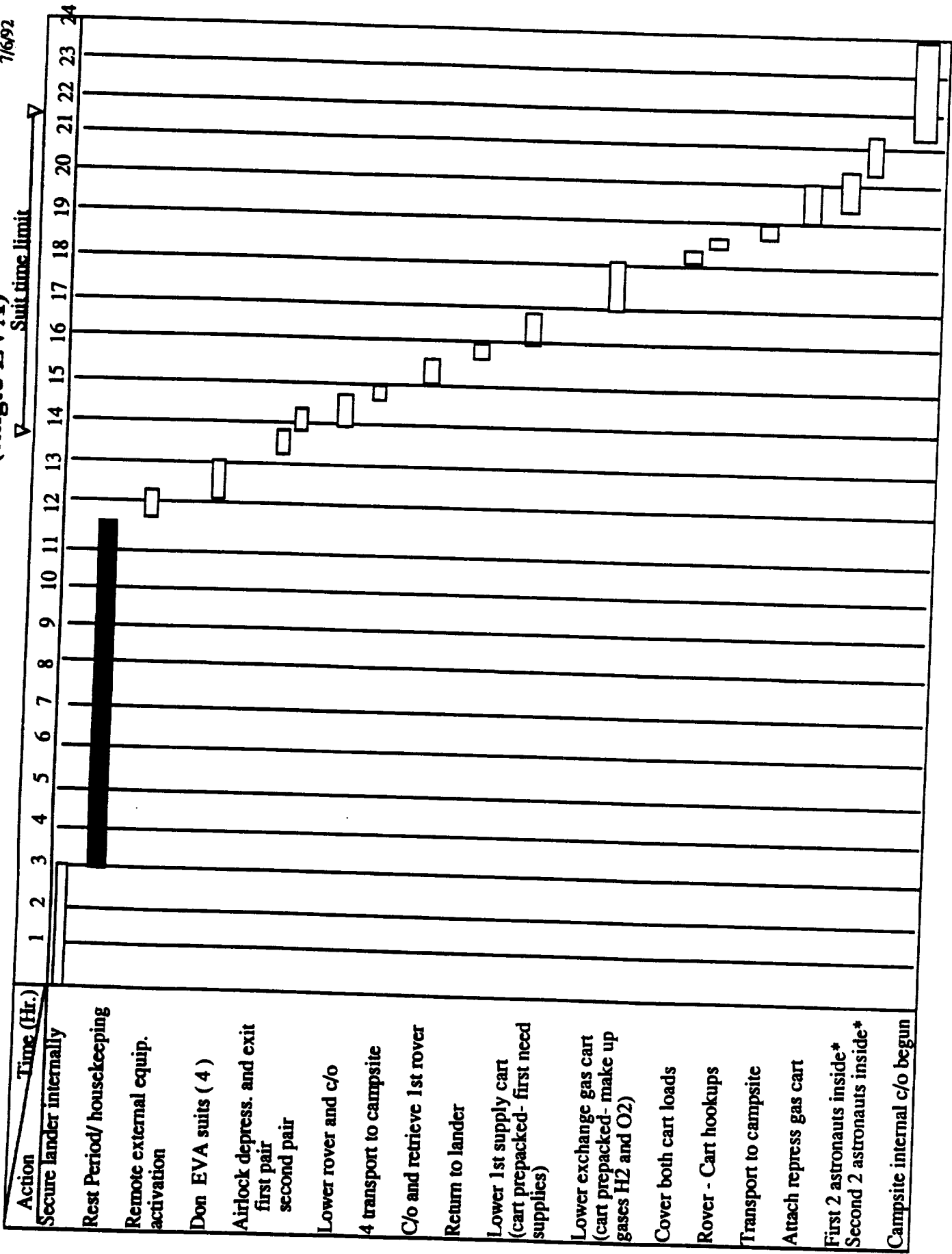

# 2nd Manned Surface Mission Timeline (Single EVA)

page 2

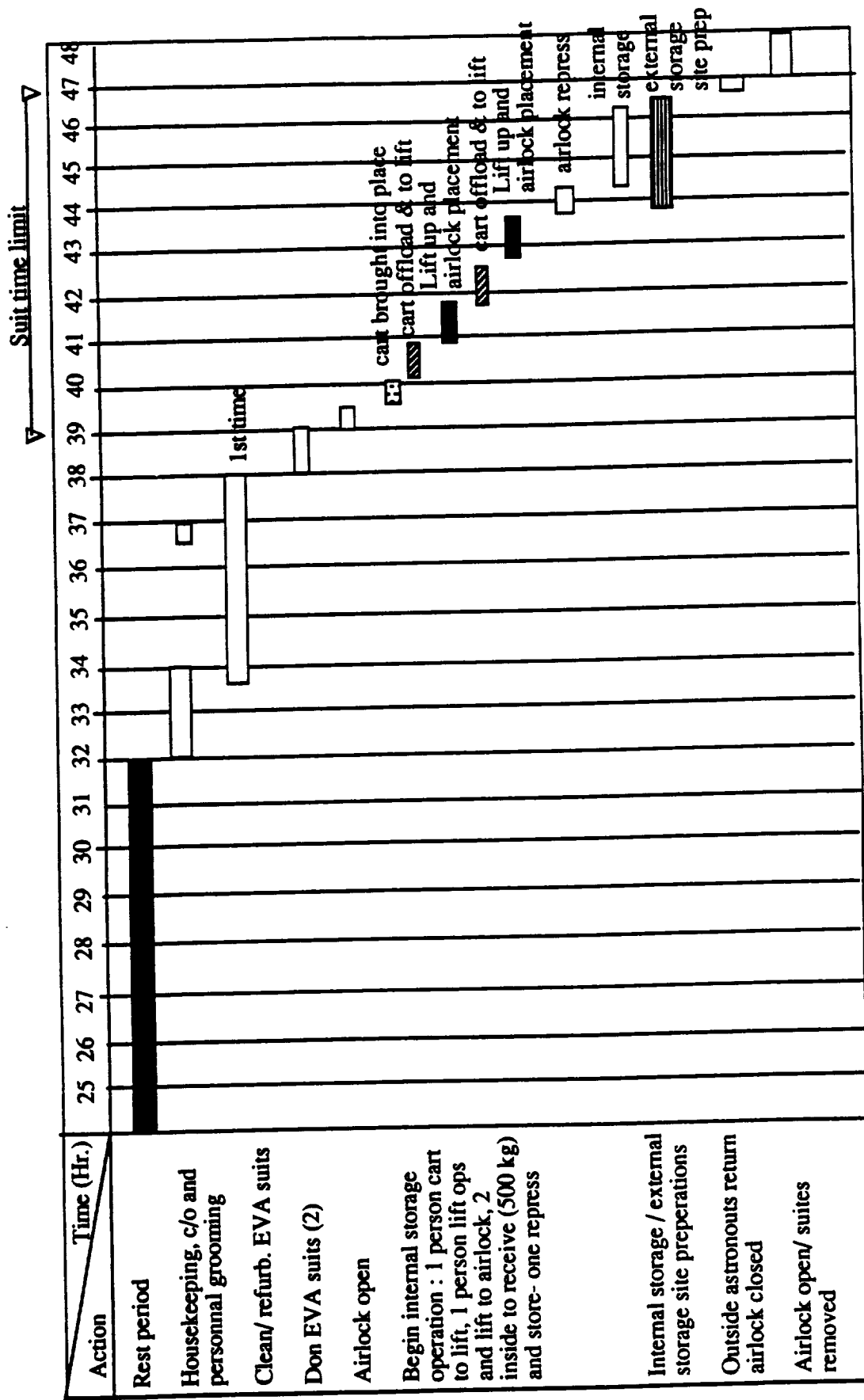

2nd Manned Surface Mission Timeline (single EVA)

page 3

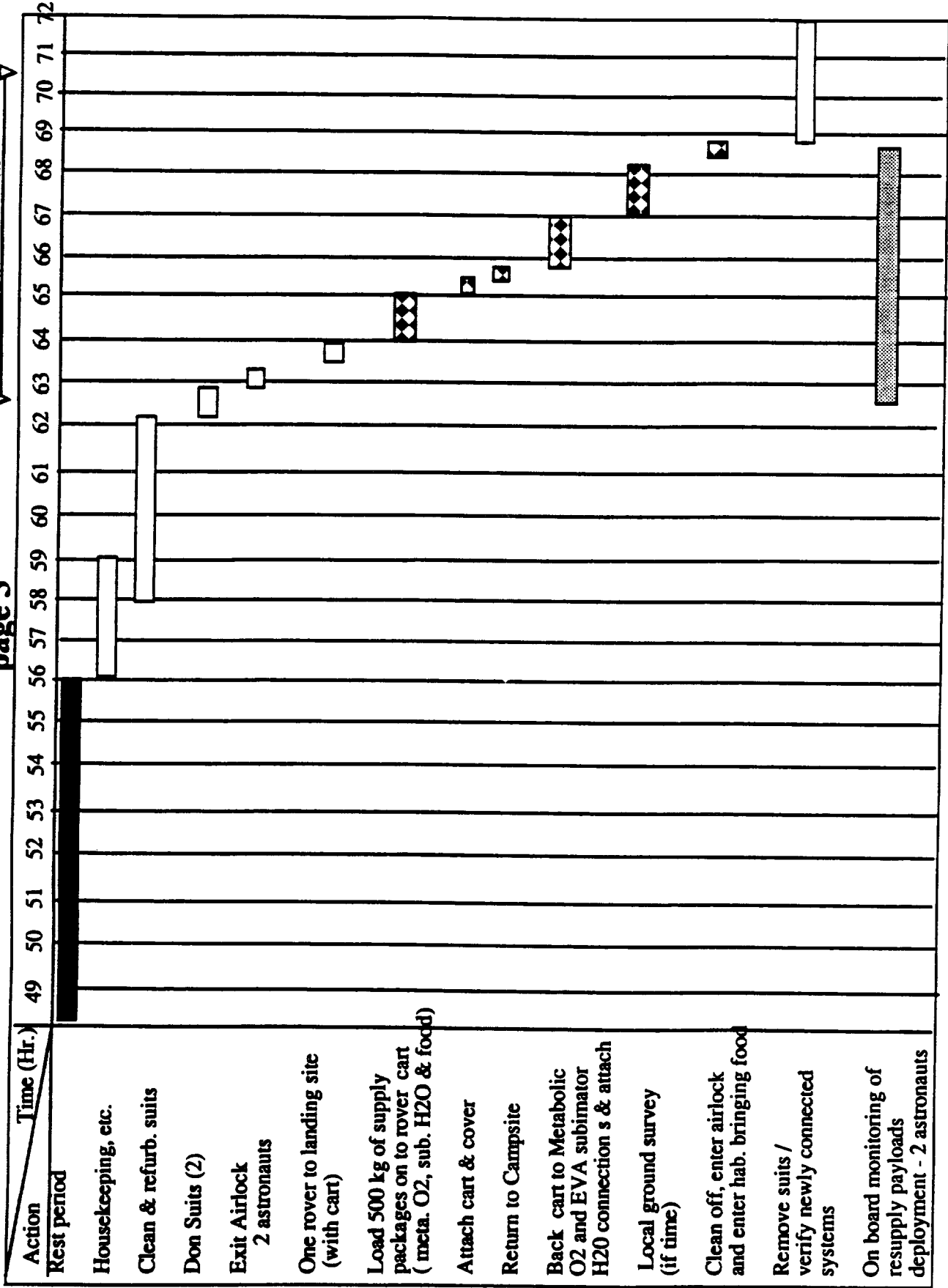

# 2nd Manned Surface Mission Timeline (single EVA)

page 4

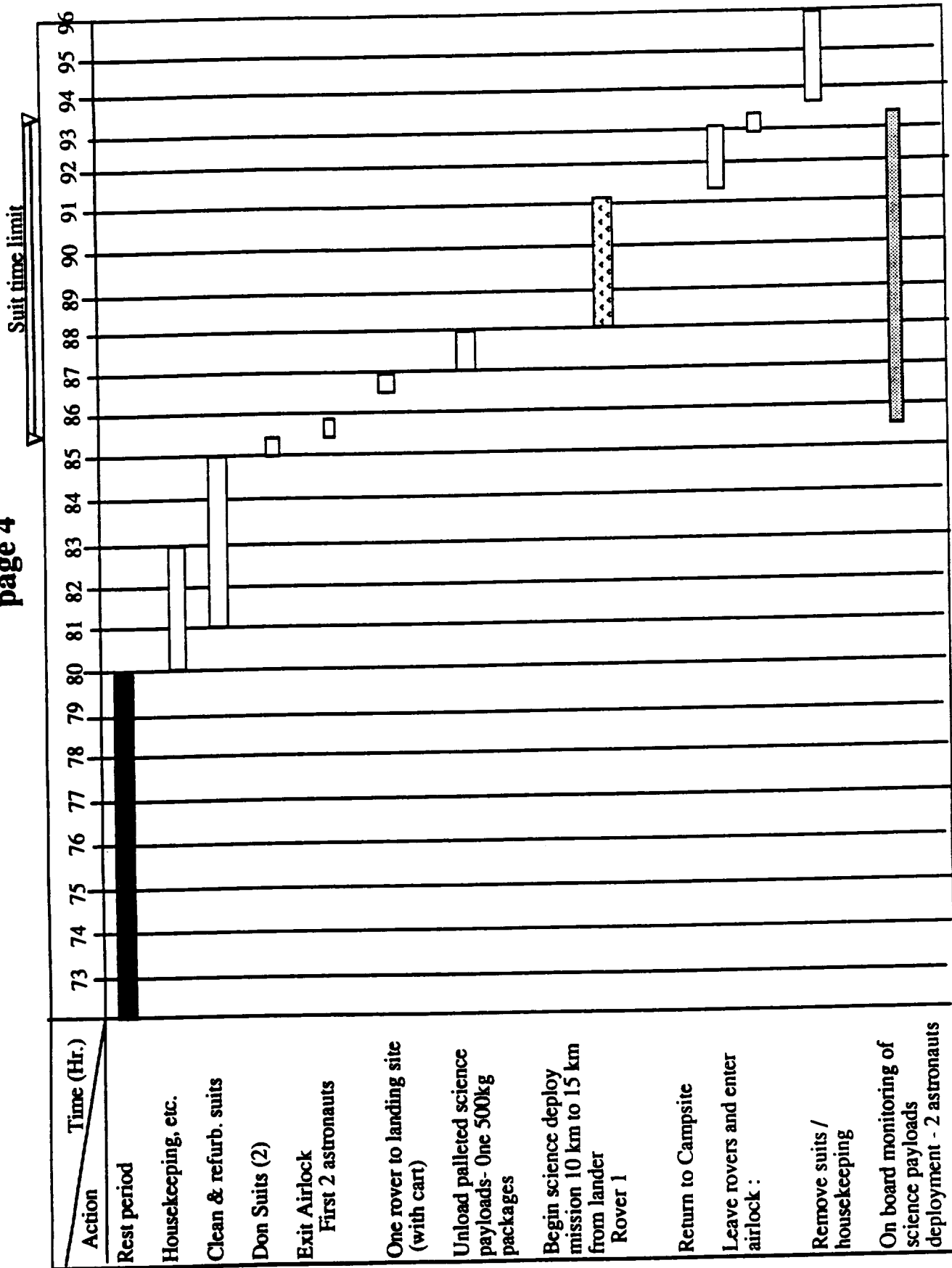

2nd Manned Surface Mission Timeline (single EVA)

page 5

Suit time limit

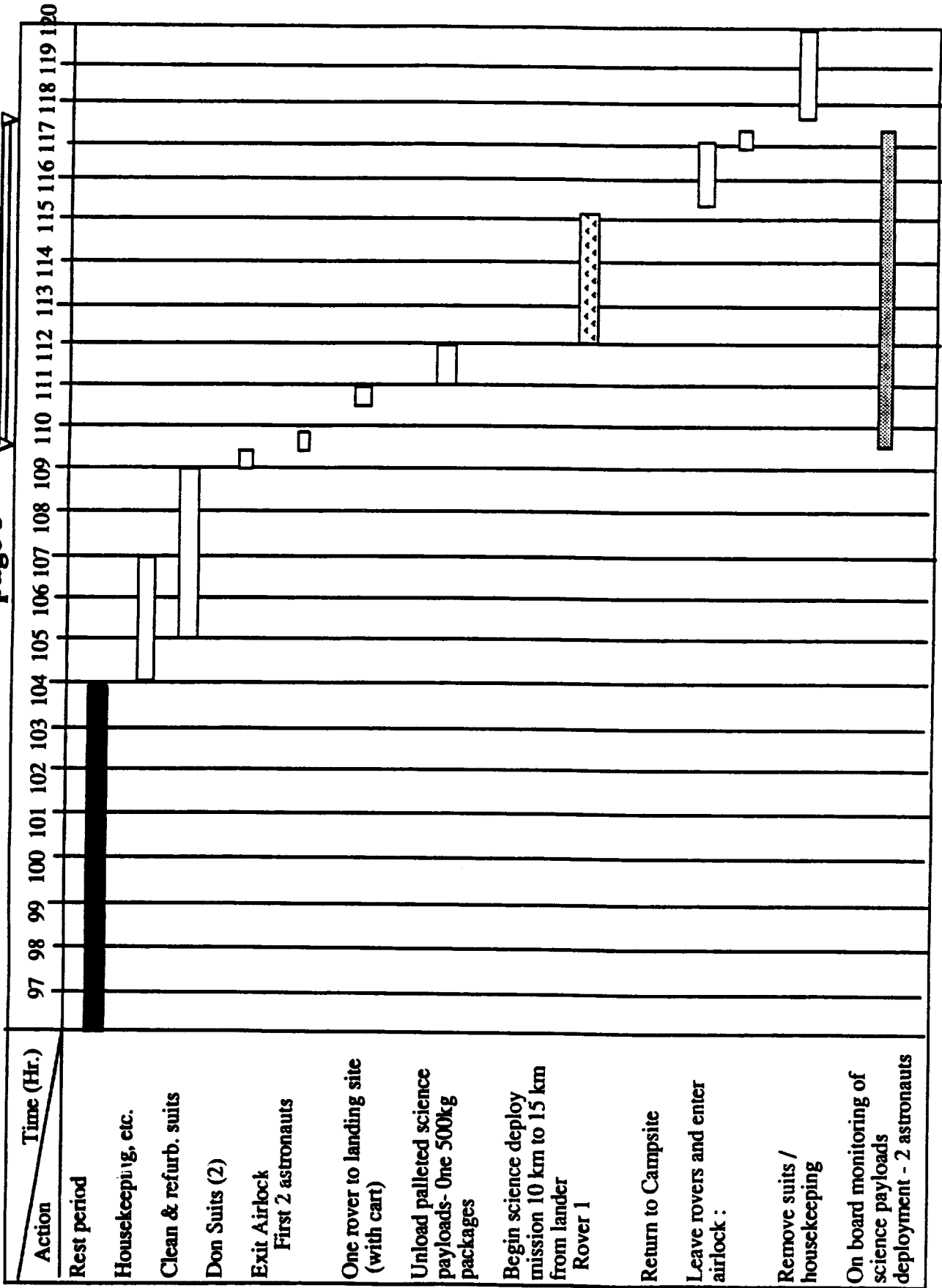

# 2nd Manned Surface Mission Timeline (single EVA)

page 6

Suit time limit

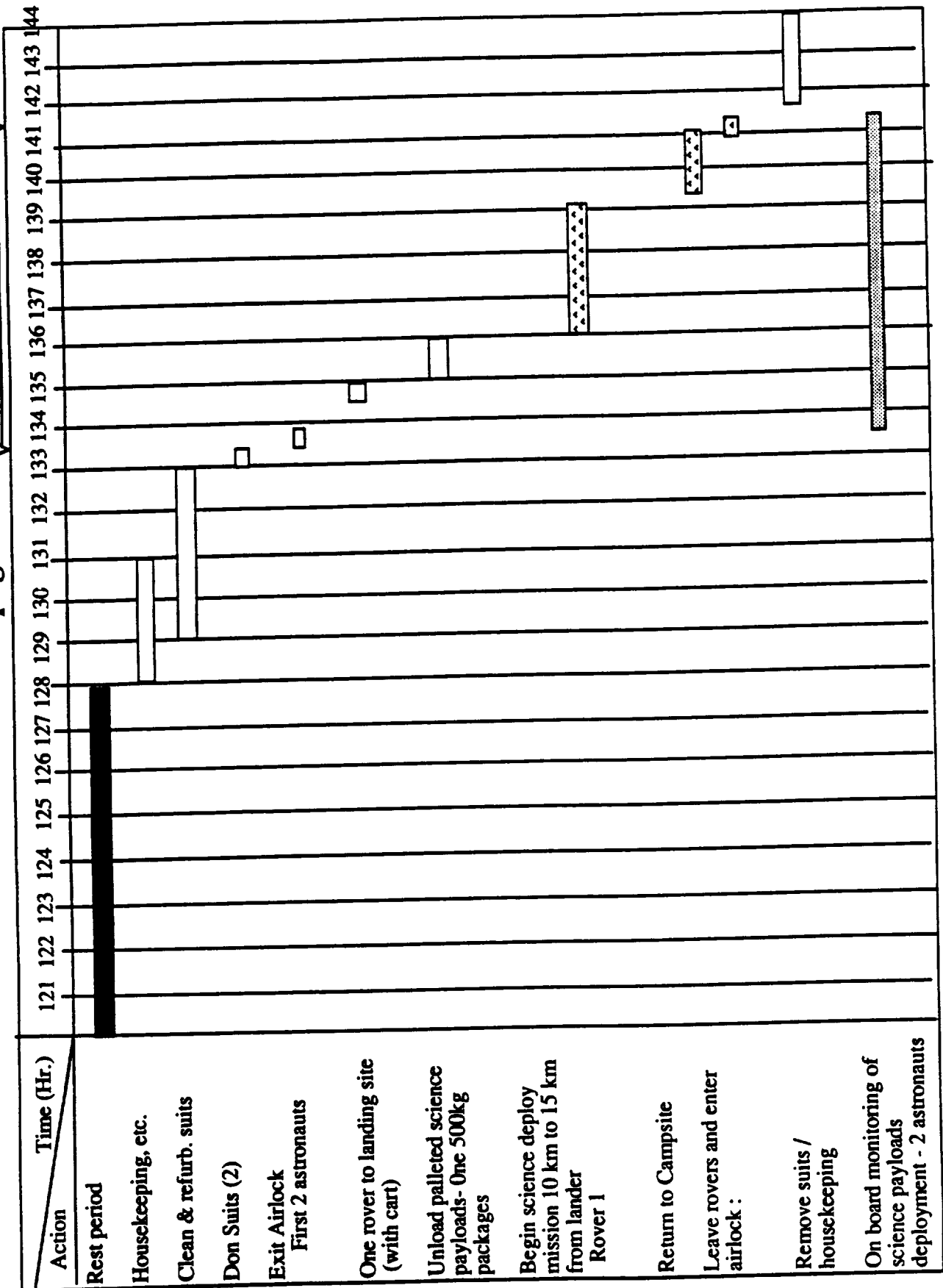

# 2nd Manned Surface Mission Timeline (single EVA)

page 7

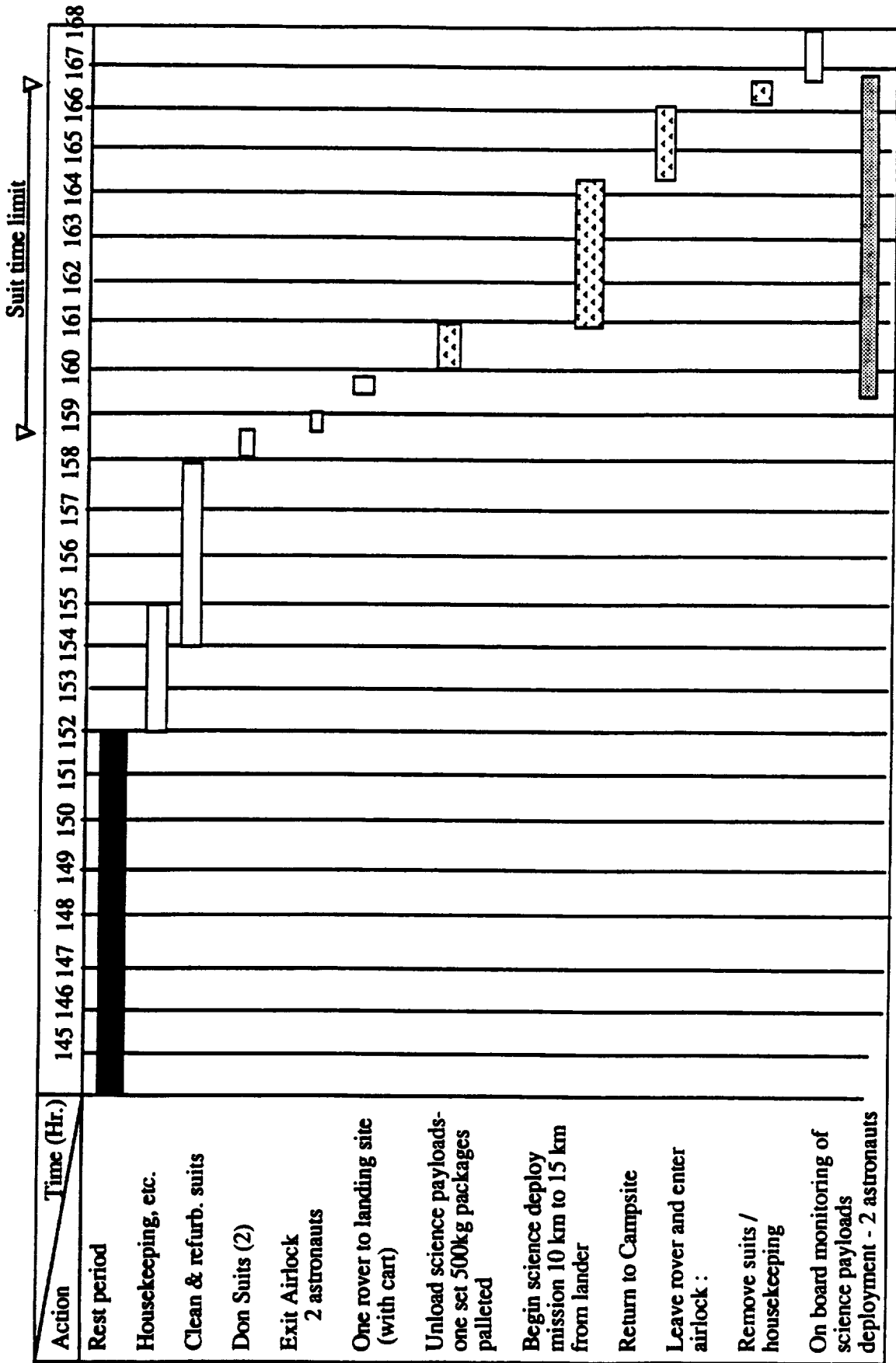



**2nd Manned Surface Mission Timeline (single EVA)**  
**page 8**

Suit time limit

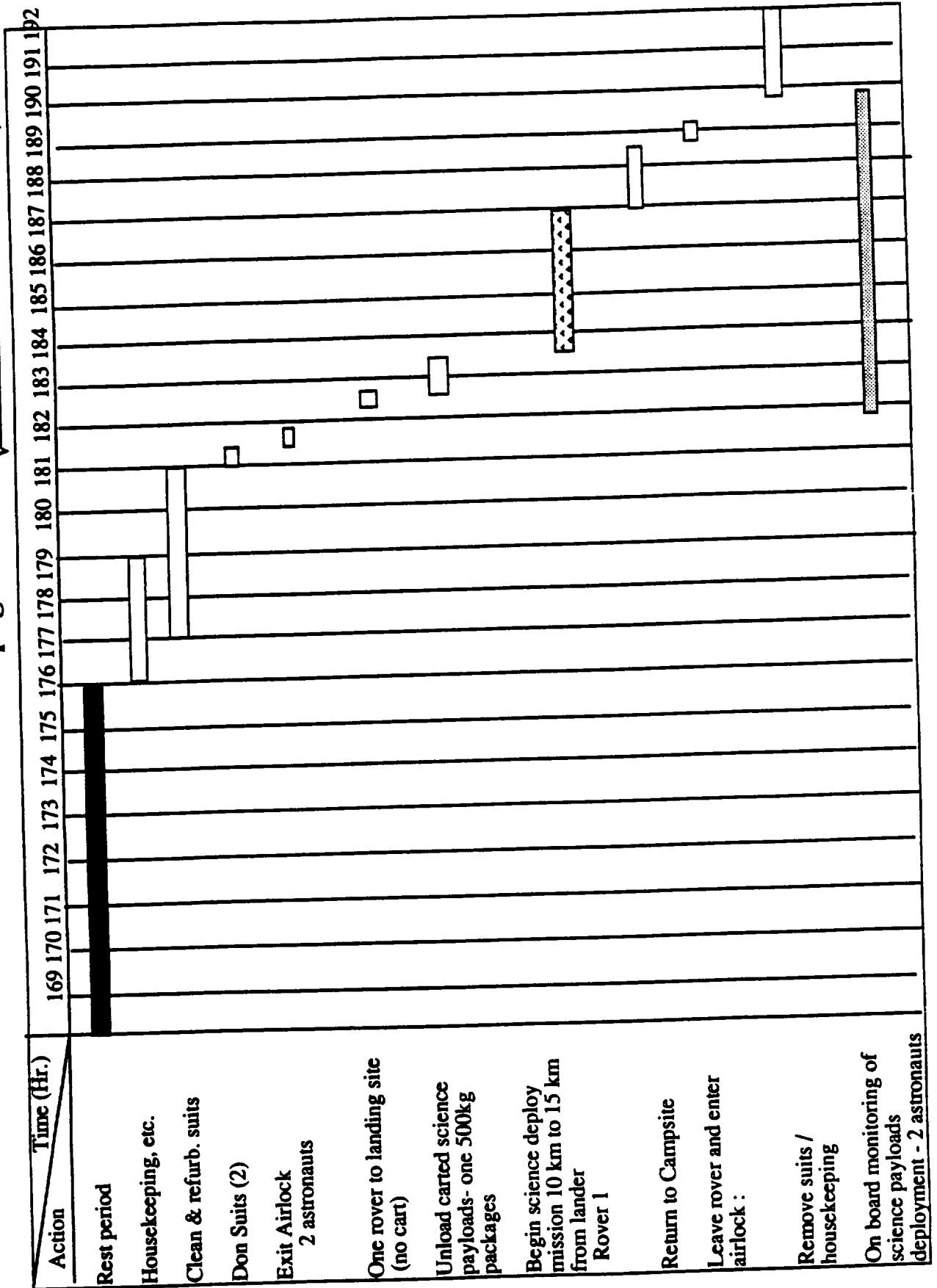

**2nd Manned Surface Mission Timeline (single EVA)**  
**page 9**

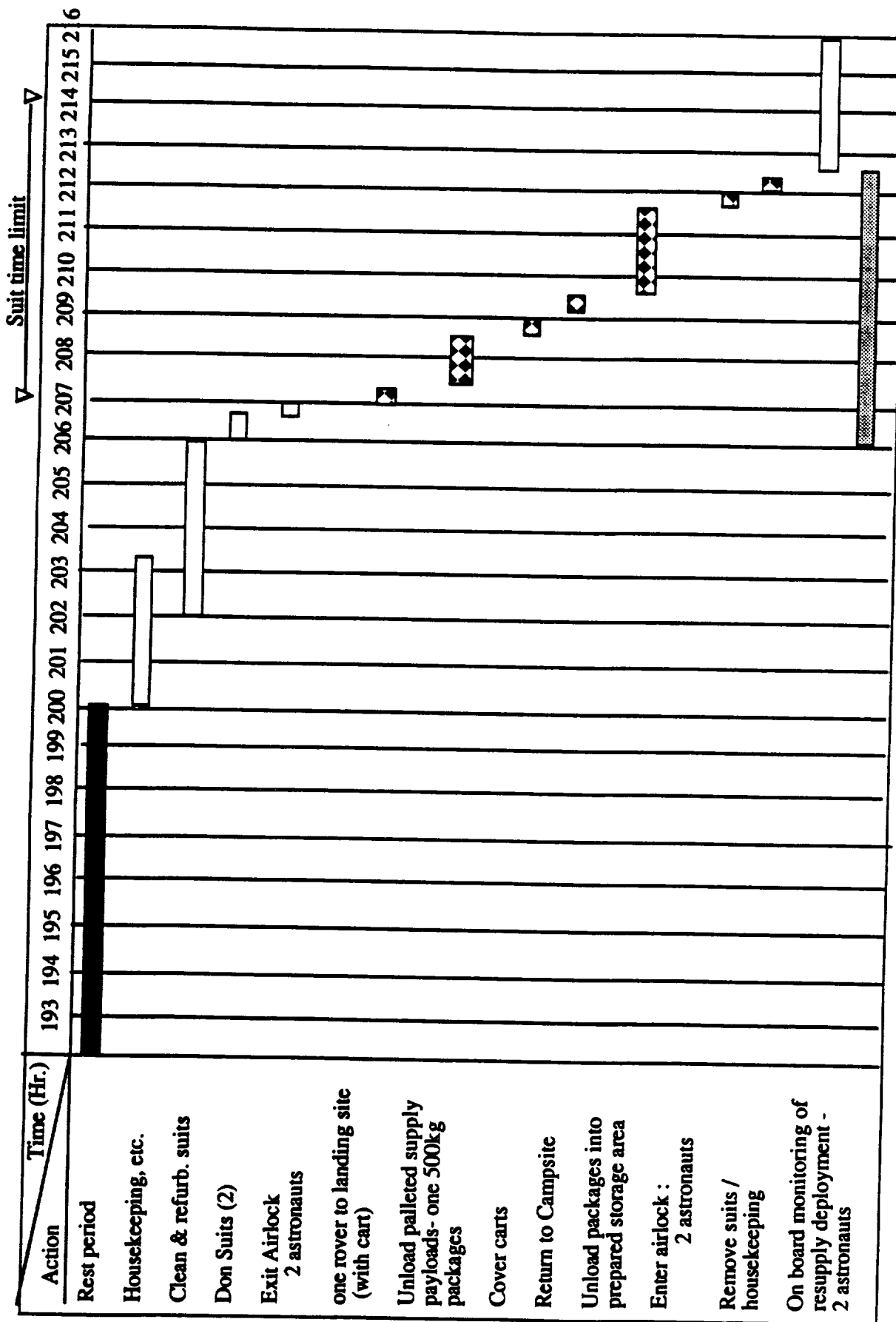

**2nd Manned Surface Mission Timeline (single EVA)**  
**page 10**

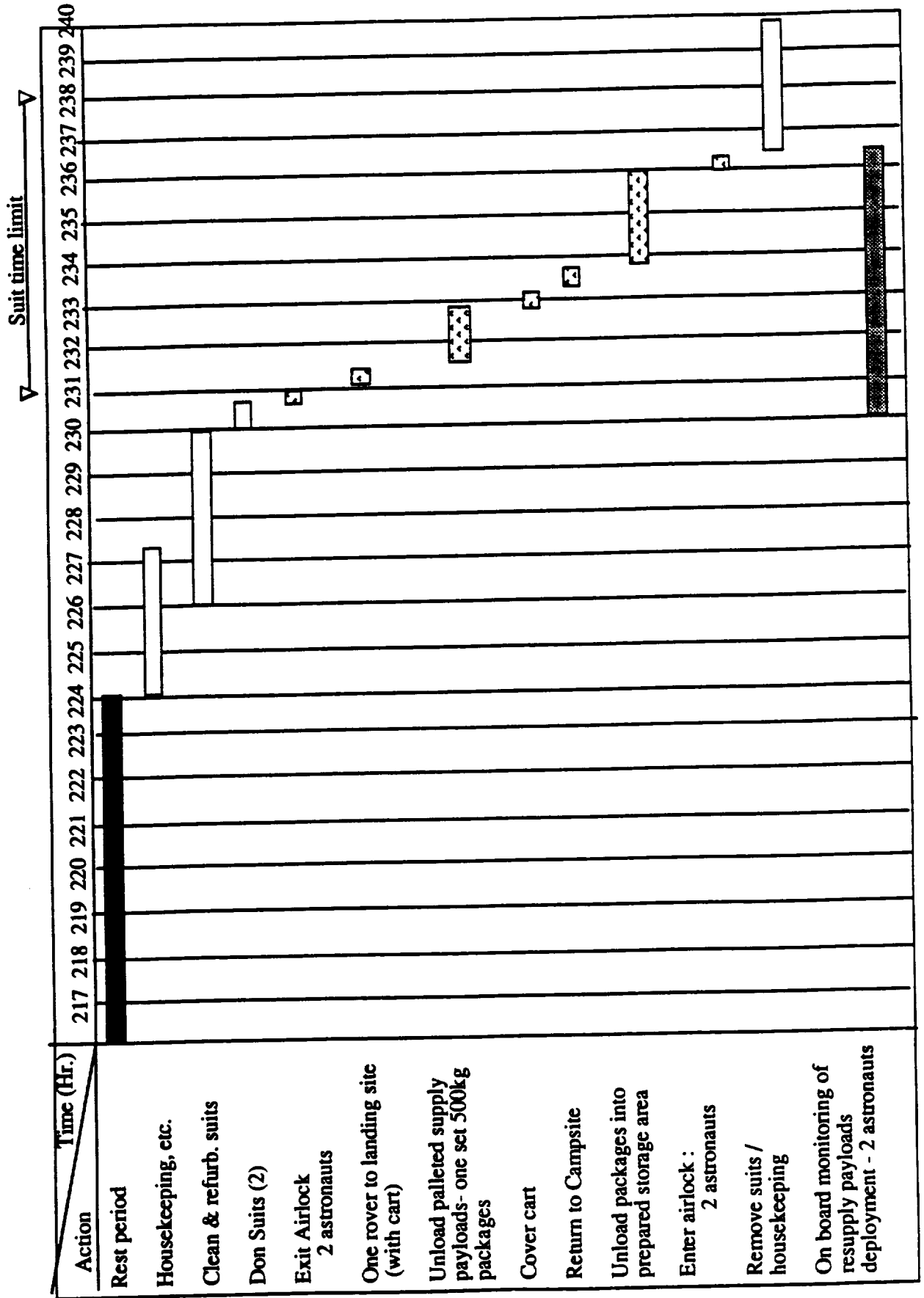

**2nd Manned Surface Mission Timeline (single EVA)**  
**page 11**

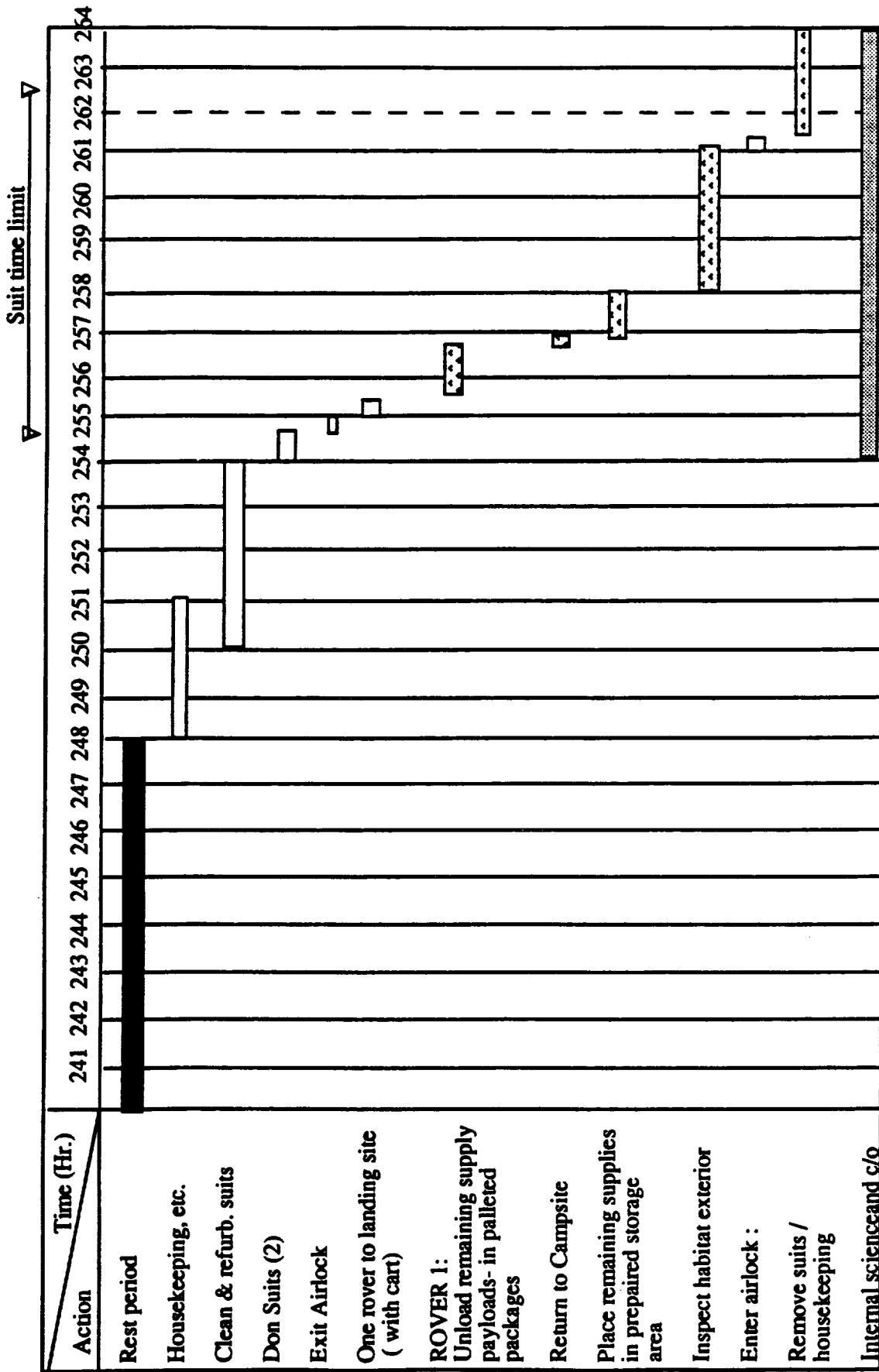

**Preliminary Estimate of EVA Task Time Single EVA**

- Estimated total available suit time- 38 day mission total time  
 - 7 days of total dark (no Earthshine)  
 - 31 days with potential EVA time  
 31 days at 16 hr./day EVA + 2 days of double EVA (32 hr.) on landing and leaving = 528 hr. EVA
- Estimated task time and percentage of available time:

<u>Task</u>	<u>Time Description</u>	<u>Task Time</u>	<u>% total EVA</u>
Crew mission initiate and terminate	Initiate = 4(3.5 hr.), terminate = 4(5 hr)	34 hr	6.4%
Total airlock time including dust off and suit covering	first day = 4(2.17 hr.), last day = 4(2.17 hr.) 29 hr. at 0.5 hr. per ingress and egress for 2 suits	46.36 hr	8.8%
Resupply Operations includes:	4(4.5 hr.) initial, 2(4(7 hr.)) normal transfer, 2(4.9 hr.) final transfer, 14 hr. at 30 min./ day for 28 days in & out for 2 suits	112.8 hr	21.4%
- loading carts			
- preparing sites			
- storing resupply			
- resupply transfer to and from outpost			
- take out garbage/bring in supplies			
- cart attachment at outpost			
Science Deployment	5(3.1 hr.) for 2	31 hr.	5.9%
Exploration traverse	5(3.9 hr.) for 2	39 hr.	7.4%
Unallocated time		264.84 hr.	50.1%

**Preliminary Estimate of EVA Task Time Double EVA**

- Estimated total available suit time- 38 day mission total time  
 - 7 days of total dark (no Earthshine)  
 - 31 days with potential EVA time  
 16 days at 16 hr./day EVA + 15 days of double EVA (32 hr.) on landing and leaving = 752 hr. EVA
- Estimated task time and percentage of available time:

<u>Task</u>	<u>Time Description</u>	<u>Task Time</u>	<u>% total EVA</u>
Crew mission initiate and terminate	initiate = 4(3.5 hr.), terminate = 4(5 hr)	34 hr	4.5%
Total airlock time including dust off and suit covering	first day = 4(2.17 hr.), last day = 4(2.17 hr.) 4(15 x 0.5 hr.) per ingress and egress for 4 suits, 2(16 x 0.5 hr.) for 2 suits	63.36 hr	8.4%
Resupply Operations includes:	4(4.5 hr.) initial, (4(7 hr.)) normal transfer, 3(2(7 hr.)) split, 2(4.9 hr.) final transfer, plus 30 min./day for 15 days in and out for 4 suits	118 hr	15.7%
- loading carts			
- preparing sites			
- storing resupply			
- resupply transfer to and from outpost			
- take out garbage/bring in supplies			
- cart attachment at outpost			
Science Deployment	2(3.1 hr.) for 4 + 2(3.4)	31.6 hr	4.2%
Exploration traverse	2(3.9 hr.) for 4 + 2(2.5)	36.2 hr.	4.8%
Unallocated time		468.84 hr	62.4%

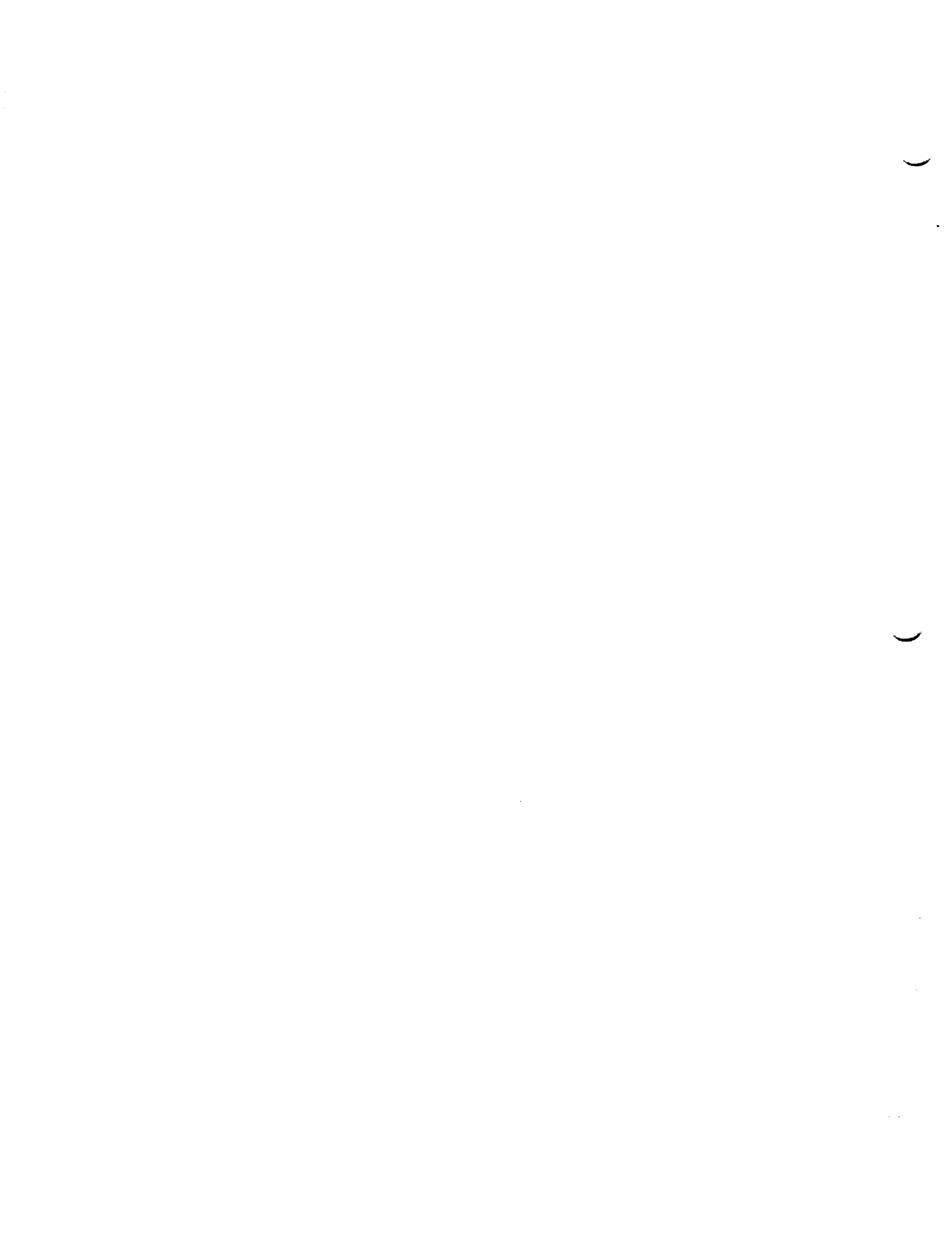

# **Appendix F**

## **FLO Habitation System Critical Spares Assessment**

- Critical items for the First Lunar Outpost will eventually be defined and analyzed in accordance with classical parameters:
  - Criticality classification due to failure modes and effects (FMEA)
  - Mean time between failures (MTBF)/mean time to repair (MTTR)
  - Redundancy philosophies and schemes
  - Degraded modes and scenarios
  - Maintenance and logistics operations
- Identification of spares needed for critical functions will use these same criteria in addition to:
  - Overall ORU definition (pertinent to FLO and lunar environment)
  - Volume allocation studies (especially for pre-positioned ORUs)
  - Other spares needed for routine, non-critical changeout
- Spares studies must be developed for the full set of FLO systems:
  - Habitat and internal systems (including airlock, EVA systems, EMUs)
  - External systems (including landers)
  - Payloads (including rovers)
  - Crew return vehicle
- Current assessment is preliminary and focused on spares identified to support crew survival or FLO survival functions:
  - SSF functional failure tolerance categories 1C or 1 (per requirements)
  - SSF H/W criticality defined by failure modes and effects analysis
- Several SSF references are available for habitat systems:
  - SSP 30000 (PDRD), Sec 3.0, Rev K contains SSMB Functional Failure Tolerance Requirements (however, critical ORUs remain TBD)
  - D683-10318-1 (Resupply/Return Analysis, ORU Candidates List, Volume 1) contains statistical data from ORU logistics analyses
  - D683-10318-2 (Volume 2) contains reliability and maintainability data to complement Volume 1
  - D683-10220-1 (Critical Items List) contains critical items identified by FMEA for each of the SSF systems
- SSFP is currently defining its critical spares needs with results expected in the CDR timeframe (~April 1993)
- External and other systems critical spares needs will be estimated from reference concepts

**Some questions to be answered**

- Guidelines are needed to establish a reasonable preliminary spares list:
  - SSF ORU requirements are not available
  - Limited payload volume and mass are available on FLO
  - FLO is not permanently manned, but only tended for 45 days
  - Ensuring operability during unmanned periods may drive system redundancy as much as or more than manned requirements
- "Hot" vs. "cold" spares must be considered (balancing on-line redundancy with in-situ repair capability)
- Differences between FLO and SSF failure to tolerance requirements, system design, and mission focus must be addressed in developing critical spares estimates
- Is SSF MTC or PMC failure tolerances or some other scheme more appropriate for FLO?

*Figure F-1. FLO Habitation System, Critical Spares Assessment - Overall*



Resource	Function	Functional Category/Criticality	Implementing ORU	Mass (kg)	Volume (m <sup>3</sup> )	
1. Respirable Atmosphere	1.1 O <sub>2</sub> /N <sub>2</sub> Storage (external?)	1C/ 1R 1R 1R	<ul style="list-style-type: none"> <li>• Make-up/Metabolic O<sub>2</sub></li> <li>• Make-up N<sub>2</sub></li> <li>• Gas conditioning assembly</li> </ul>	119.8/185.4	0.26/0.15	
				259	0.67	
					O <sub>2</sub> /N <sub>2</sub>	O <sub>2</sub> /N <sub>2</sub>
				292.5/292.5	2.37/2.37	
				O <sub>2</sub>   N <sub>2</sub>	O <sub>2</sub>   N <sub>2</sub>	
	1.2 O <sub>2</sub> /N <sub>2</sub> Distribution	1C/ 1R 1R 1R 1R	<ul style="list-style-type: none"> <li>• Isolation valve assemblies</li> <li>• Jumper assemblies</li> <li>• Transducers</li> <li>• Check valves</li> </ul>	1.13   1.13	0.001   0.001	
				8.84   8.84	0.001   0.001	
				0.68   0.68	0.0001   0.0001	
				0.68   0.68	0.001   0.001	
	1.3 O <sub>2</sub> /N <sub>2</sub> Pressure Control	1C/1R 1R	<ul style="list-style-type: none"> <li>• Pressure control panel</li> <li>• Press. equalization valves</li> </ul>	8.35	0.054	
				2.31	0.003	
	1.4 CO <sub>2</sub> Removal	1C/1R 1R 1R 1R 1R 1R	<ul style="list-style-type: none"> <li>• Desiccant/sorbent bed</li> <li>• CO<sub>2</sub> pump</li> <li>• Selector valve</li> <li>• Wire harness</li> <li>• Temperature sensor</li> <li>• Blower/precooler unit</li> <li>• Pressure transducer</li> </ul>	36.28	0.177	
				7.26	0.005	
				1.36	0.002	
				1.36	0.011	
				0.32	0.0003	
				4.54	0.019	
	1.5 Air Particulate & Microbial Control	1C/3 1R 1 1R 3	<ul style="list-style-type: none"> <li>• Cabin air bacteria filter assy</li> <li>• Supply rack air cntrl valve</li> <li>• Cabin air/IMV bact filter</li> <li>• Return rack air cntrl valve</li> <li>• IMV bacteria filter assy</li> </ul>	5.08	0.019	
				3.18	0.010	
				2.54	0.009	
1.13				0.007		
13.61				0.059		
1.6 Cabin Air Temp and Humidity Control	1C/1R 1R 1R 1R 1R 1R 1R 1R 1R	<ul style="list-style-type: none"> <li>• Heat exchanger</li> <li>• Fan group</li> <li>• Temperature cntrl chk vlv</li> <li>• Outlet temperature sensor</li> <li>• Water separator</li> <li>• Electrical interface box</li> <li>• Inlet temperature sensor</li> <li>• Liquid sensor</li> <li>• Inlet</li> </ul>	72.47	0.336		
			20.50	0.040		
			8.21	0.025		
			0.77	0.0005		
			18.87	0.088		
			17.51	0.041		
			0.77	0.0005		
			2.09	0.007		
			2.27	0.035		
			1.7 Circulation	1C/	See above - may be enough	
1.8 Vent and Relief	1C/	• Vent & relief subassembly	8.35	0.009		
1.9 Atmosphere Composition Monitoring	1C/1R 1R 1R 1R 1R 1R 1R 1R 1R 1R 1R 1R 1R 1R 1R 1R	<ul style="list-style-type: none"> <li>• MCA data &amp; cntrl assy</li> <li>• Mass spectrometer assy</li> <li>• COA assembly</li> <li>• Low voltage pwr supp assy</li> <li>• MCA/TCM series pump</li> <li>• MCA sample distr assy</li> <li>• EMI filter</li> <li>• TCM data and control assy</li> <li>• Gas chromo/mass spec assembly</li> <li>• TCM heater controller assy</li> <li>• PCM assembly</li> <li>• PCM 100 micron filter assy</li> <li>• TCM parallel pump assy</li> <li>• TCM sample distr assy</li> <li>• TCM oxidizer evaporator</li> <li>• 2μ PCM filter assembly</li> <li>• Verification gas assembly</li> <li>• MCA chassis assembly</li> <li>• TCM chassis assembly</li> </ul>	8.12	0.025		
			10.34	0.018		
			10.52	0.005		
			3.22	0.004		
			1.36	0.004		
			2.04	0.003		
			1.72	0.002		
			8.12	0.002		
			30.98	0.029		
			7.53	0.005		
			17.87	0.005		
			9.98	0.001		
			1.72	0.001		
			2.90	0.001		
			4.76	0.001		
			0.09	0.001		
			2.36	0.011		
17.87	0.005					
17.87	0.005					
1.10 Trace Contaminant Monitor	1C/ 1R	See MCA ORU data above				

Figure F-2. FLO Habitation System, Critical Spares Assessment - Habitat

D615-10062-2

Resource	Function	Functional Category/ Criticality	Implementing ORU	Mass (kg)	Volume (m³)
1. Respirable Atmosphere	1.11 Trace Containment Control	1C/1R 1R 1R 1R 1R 1R	<ul style="list-style-type: none"> <li>• Charcoal bed</li> <li>• Post-sorbent bed</li> <li>• Catalytic oxidizer</li> <li>• Electronic interface assy</li> <li>• Flow meter</li> <li>• Blower</li> </ul>	33.96 3.66 12.06 4.54 0.95 —	0.076 0.008 0.024 0.004 0.0002 —
	1.12 Avionics Air Temperature and Humidity Control ??		Assumed part of internal thermal control ORU data		
<b>Total, excluding external spares:</b>				<b>476.65</b>	<b>1.2022</b>
<b>External spares only:</b>				<b>1,149.2</b>	<b>5.82</b>
2. Food	2.1 Food Storage	21C/	MREs or 45 day supply - Listed separately	360.0	0.58
<b>Total:</b>				<b>360.0</b>	<b>0.58</b>
3. Water	3.1 Water Storage	1C/1R 1R 1R 1R 1R 1R 1R 1R 1R 1R 1R 1R 1R	<ul style="list-style-type: none"> <li>• PCWQM fluids ORU</li> <li>• PCWQM main segment</li> <li>• Gas/liquid separator</li> <li>• Water storage ORU</li> <li>• Water delivery</li> <li>• Microbial check valve</li> <li>• Sterilization loop</li> <li>• Electrical interface box</li> <li>• Waste water storage</li> <li>• Unibed</li> <li>• Catalytic reactor</li> <li>• Ion exchange</li> <li>• Particulate filter</li> </ul>	10.20 19.18 9.30 72.2 19.14 1.72 21.27 18.14 48.30 57.16 24.94 15.37 7.62	0.029 0.021 0.034 0.381 — 0.005 0.115 0.058 0.191 0.052 0.106 0.011 0.008
	3.2 Water Processing	1C/1R	See H <sub>2</sub> O Storage data above		
<b>Total:</b>				<b>324.54</b>	<b>1.427</b>
4. Personal Hygiene	4.1 Urine Collection	1C/ 1 1 1 1	<ul style="list-style-type: none"> <li>• Odor/bacteria filter</li> <li>• Urine fan/separator</li> <li>• Urinal hose assembly</li> <li>• Oxone delivery assembly</li> </ul>	1.78 6.44 0.36 9.22	0.003 0.007 0.0002 0.025
	4.2 Urine Storage 4.3 Fecal Waste Collection	1C/ 1C/ 1 1 1 1 1 1 1 1 1	<ul style="list-style-type: none"> <li>TBD</li> <li>• Fecal odor/bacteria filter</li> <li>• Fecal fan</li> <li>• Plenum bacteria filter</li> <li>• Compactor</li> <li>• Transport tube</li> <li>• Seat</li> <li>• Waste storage canister</li> <li>• User service panel</li> <li>• Electrical interface box</li> </ul>	1.64 3.01 0.10 7.70 9.95 2.33 0.91 1.96 4.93	0.003 0.006 0.002 0.001 0.011 0.007 0.012 0.001 0.017
4.4 Fecal Waste Storage	1C/	TBD			
<b>Total:</b>				<b>50.33</b>	<b>.3202</b>
5. EVA Capability	5.1 Ingress to Habitat & Repressurization	1C/	TBD		
	5.2 Crew Retention	1C/	May not be applicable		
<b>Total:</b>					
6. Provide Crew with System Status and Data	6.1 Core Comm to/from Ground control Personnel (Audio/Data)	1/1R	• Audio Terminal Unit	10.88	0.020
		1R	• Internal audio controller	12.25	0.018
		1R	• Audio bus coupler	5.67	0.110
		1R	• Audio Interface Unit	6.30	0.110
<b>Total:</b>				<b>35.1</b>	<b>.258</b>

Figure F-2. FLO Habitation System, Critical Spares Assessment - Habitat (Continued)

D615-10062-2

Resource	Function	Functional Category/ Criticality	Implementing ORU	Mass (kg)	Volume (m <sup>3</sup> )
7. Power	7.1 Provide Power to Category 1 Functions	1/ 1R	• Secondary pwr dist assy	30.61	0.156
			• 6.25 TBF connector	—	—
			• Remote pwr dist assembly	17.23	0.028
			• Utility outlet panel	2.27	0.003
			• Primary cable assembly	—	—
			• Secondary cable assembly	—	—
			• Tertiary cable assembly	—	—
			• Gen light lamp housing assembly	1.59	0.004
			• Remote control unit	0.36	0.001
			• Lighting cable assembly	—	—
			• Gen light baseplate/ballast	1.81	0.004
			• Rack electrical power cable	—	—
			• Airlock lamp housing assy	1.59	0.004
	• Airlock baseplate/ballast	1.81	0.004		
	7.2 Provide Power to Category 1C Functions	1C/1R	See ORU list above	—	—
<b>Total:</b>				<b>57.27</b>	<b>.204</b>
8. DMS	8.1 Data Management for Category 1 Functions	1/	TBD		
	8.2 Data Management for Category 1C Functions	1C/	TBD		
<b>Total:</b>					
9. TCS	9.1 Power Generation Heat Acquisition, Transport, and Rejection	1/	• External Systems		
	9.2 Thermal Support to Category Functions	1/	• Avionics Air:		
			- Heat exchanger	50.98	0.399
			- Fan	22.13	0.036
			- Check valve	2.36	0.015
			- Outlet temp sensor	0.77	0.0005
			- Filter	0.86	0.003
			- Inlet temp sensor	0.45	0.0003
			- Delta pressure sensor	1.27	0.004
			- Inlet	3.72	0.062
			• TCS:		
			- Flex tube assemblies	2.98	0.008
			- Pump package assembly	74.15	0.133
	- System flow control assy	11.19	0.029		
	- Rack flow control assy	6.81	0.013		
	- Gas trap	7.53	0.002		
	- Filter	2.00	0.0003		
	- could plates (multiple)	52.20	0.186		
- Heat exchangers (mult)	13.44	0.016			
- Crossover/feedthru assy	33.07	0.059			
- Remote shut-off valve	1.63	0.002			
- CTB Heater	7.98	0.063			
	9.3 Thermal Support to Category 1C Functions	1C/	See TCS ORU data above		
	9.4 Thermal Mgmt and Control	1/	• External Systems(?)		
<b>Total:</b>				<b>295.52</b>	<b>1.0311</b>
10. Health and Status Monitor	10.1 Health and Status Monitor of Category 1 Functions	1/	TBD		
	10.2 Health and Status Monitor for Category 1C Functions	1C/	TBD		
<b>Total:</b>					

Other resources and/or associated functions have less critical failure tolerance requirements

Figure F-2. FLO Habitation System, Critical Spares Assessment - Habitat (Concluded)

- Several of these ORUs currently identified as critical seem questionable:
  - Food Storage (what does this mean - amount or locations?)
  - Fecal/urine collection
  - Portions of the power system
  - Portions of the thermal control system
- Some critical functions specific to SSF have not been included:
  - Provide interface to Space Shuttle
  - Assembly and Checkout
  - Command and control (orbit, attitude, navigation)
- Critical spares for some FLO functions not yet identified:
  - Non-WP01 items (DMS, DDCUs, etc.)
  - Airlock and EVA systems
  - CH<sub>e</sub>CS
  - External systems
  - Lander systems
  - Payloads
  - Crew vehicle

***Figure F-3. FLO Habitation System, Critical Spares Assessment - Issues***

# **Appendix G**

## **Proposed Evaluation Criteria**

## G.1 INTRODUCTION

This appendix contains preliminary thoughts directed at the need for rationale, methodology, and evaluation criteria in conducting trade studies and assessment analyses of alternative FLO habitation elements. Comparison of different concepts requires standard guidelines and figures of merit which may be appropriately and consistently applied in order to arrive at a design which "best" meets the imposed requirements and constraints. The following represents an initial exercise in defining some of the aspects involved with measuring the "goodness" of a concept and relating this value to other concepts. Significant effort remains to establish an agreed set of objectives, parameters, weights, and sensitivities which is useful to FLO development.

## G.2 CONTEXT OF GROWTH

A range of lunar program candidates which may incorporate campsites (such as the First Lunar Outpost) as an intermediate activity is shown in figure G-1. While program candidates represent "how" one might do something on the Moon, figure G-2 provides a set of "what" may be done in terms of potential lunar mission candidates. As no surprise, the matrix in figure G-3 relating the program (of figure G-1) to the mission, shows that grander missions require larger programs; however, any mission may require similar precursor programs and smaller programs may be capable of certain aspects of most missions (colonization is probably an exception). One purpose of these listings is to give some perspective and potential goals for what is called "growth"; that is, if one evaluation criterion for FLO concepts is an ability to "grow", a definition is needed in terms of capabilities (mission) and Outpost plans (programs). Simply being able to plug more modules to an existing FLO hab may not be sufficient accommodations for "growth".

1. Remote Sensing (Ground or Earth-orbit based)
2. Lunar Satellites
3. Lunar Landers ("Surveyor", Artemis, etc.)
4. Telerobotic/robotic operations
5. Sorties (Apollo-class, rovers?)
6. Outpost (60 days > duration > 3 days)
7. Outpost Extensions
8. Permanent Base
9. "Lunar City"
10. "Terra-Forming"
11. Self-Sustaining Society

Not necessarily exclusive categories but represent depth of lunar commitment (funding, activity, schedule, etc.)

*Figure G.1. Lunar Program Candidates*

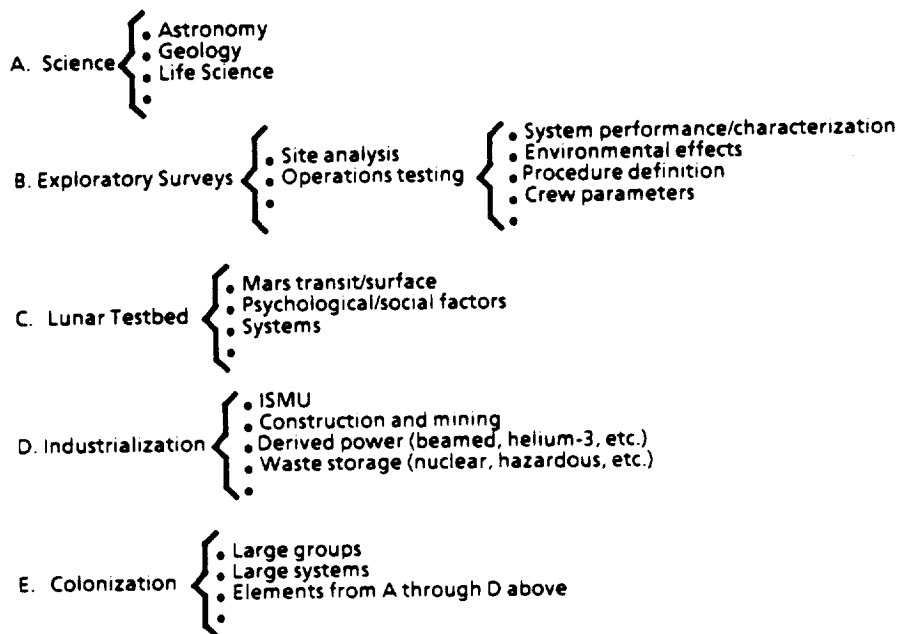

Figure G.2. Lunar Mission Candidates

Mission \ Program	1	2	3	4	5	6	7	8	9	10	11
A	•	•	•	•	•	•	•	•	•	•	•
B			•	•	•	•	•	•	•	•	•
C			○	○	○	○	•	•	•	•	•
D				○	○	○	○	•	•	•	•
E								○	•	•	•

Figure G.3. Lunar Mission vs. Program Viability

**G.3 EVALUATION CRITERIA DEVELOPMENT**

A fundamental understanding of the standard methodology used in conducting analyses and trade studies is offered in figure G-4. Starting from this perspective and employing practices used on the Space Station Freedom Program as a basis, the evaluation criteria included as figures G-5 through G-9 are proposed for discussion. The weight percentages given in figure G-5 are taken directly from SSFP and may not be applicable to FLO; however, in considering different aspects and goals of FLO, the criteria seemed to boil down to the same as used for SSFP. Namely, a concept may be evaluated in terms of its accommodating the mission, its cost, and its capacity for growth (including internal upgrading). Examples of what may be involved below these highest level criteria are provided, in some cases, to a fourth indentation. Many of the data necessary to quantify each of these would not be available until design had significantly matured; thus, it is understood that any set of evaluation criteria must be

tailored to fit the question without biasing the result or neglecting important considerations. This feature of evaluation criteria development can be challenging but should be facilitated by ensuring that the "master set" captures all recognized concerns and that all involved parties agree to its use and function.

- Usually based on a recognized set of ground rules, assumptions, and evaluation criteria derived from program goals and requirements
- Involve measuring cost vs. benefit of alternative concept to a baseline system design or operation
- Evaluation criteria usually established from program objectives:
  - Objectives translated into measurable parameters
  - Weighting factors (out of 100%) selected for each based on perceived importance
  - Consistent scale applied for range of "goodness"
- An alternative can be eliminated if it fails to meet "non-tradeable" requirements of safety, physics, etc. as defined for a program
- More than one alternative may be "close to best"
- Subjectivity reduced by ensuring agreement with all involved parties
  - Standards established
  - Sensitivities understood

Figure G-4. Analysis and Trade Study Methodology

• User Accommodations	40%		
- Capability of system		20%	
• Facilities			10%
• Environment			10%
• Resources (in-situ and away)			10%
- Time for mission		20%	
• "Up" vs. "down" time			10%
• Duty schedule			10%
• Crew skills/size/mix			10%
• Cost	45%		
- Cost risk		10%	
• Schedule			7%
• Performance			7%
• Uncertainties			7%
- Life cycle cost		35%	
• Commonality			7%
• Mass and volume			7%
• DDT&E and production			7%
• Operations			7%
• Distribution			7%
• Growth	15%		
- Mission flexibility		5%	
• Types			2.5%
• Locations			2.5%
- Technology transparency		5%	
- Expandability		5%	
TOTAL	100%	100%	100%

Figure G-5. Proposed Evaluation Criteria



- User Accommodations
  - Capability of system
    - Facilities
      - Mission support
        - Tracking/communication/relay
        - Launch and landing
        - Payload centers
      - Mission performance
        - Devoted mission payload quantity
        - Depth of devoted mission payload
        - Mission activation
        - Mission diversification/robustness
  - Environment
    - Location
    - Thermal
    - Gravity
    - Radiation
  - Resources (in-situ and away)
    - Pressurized area/volume (habitability and stowage)
    - Access (pre-launch, post-launch, EVA, and IVA)
    - Power (and thermal)
    - Launch availability/rate
    - Data rate
    - Laboratory services
    - Protection (radiation, dust, etc.)

**Figure G-6. Breakdown of User Accommodations, Capability of System**

- User Accommodations (continued)
  - Time for mission
    - "Up" vs. "down" time
      - Mean time between failures/mean time to repair
      - Maintainability
      - Redundancy scheme
      - Spares philosophy/accommodation
      - Abort strategy/impacts
  - Duty schedule
    - Devoted mission payload time
    - Housekeeping time
    - Crew time (eating, sleeping, rest, etc.)
    - MTBF/MTTR (again?)
    - Total mission time
  - Crew skills/size/mix
    - Specialists plus command plus support plus?
    - Requirements vs. desirement
    - International goals?

**Figure G-7. Breakdown of User Accommodations, Time for Mission**

- Cost
  - Cost risk
    - Schedule
      - Program milestones
      - Phasing
      - Related or precursor programs
      - Technology development programs
      - Manufacturability
    - Performance
      - Technology maturity
      - Degree of existing hardware/software
      - Understanding of requirements/environment
    - Uncertainties
      - Fidelity and maturity of estimates
      - Contingency and reserves
      - Similar histories

*Figure G-8. Breakdown of Cost, Cost Risk*

- Life cycle cost
  - Commonality
    - Element/system/component levels
    - Previous/future
  - Mass and volume
    - Launch costs
    -
  - DDT&E and production
    -
  - Operations
    - Resupply
    - Maintenance/repair/refurbishment/replacement
    - Construction
    - Management
    - Support
  - Distribution
    - International partners
    - Other programs, agencies, etc.
    - Commercial applications

*Figure G-9. Breakdown of Cost, Life Cycle Cost*

- Growth
  - Mission flexibility
    - Types
    - Locations
      - Equator to poles, near to far side
      - Transportability
  - Technology transparency
  - Expandability
    - Connectability
    - Removability

*Figure G-10. Breakdown of Growth*

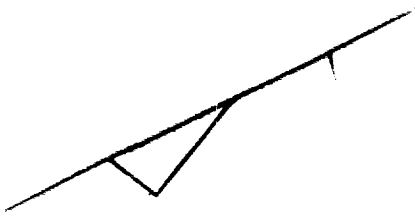

Fig 2