

FILE COPY  
NO. 6

FILE COPY  
NO. I-W

TECHNICAL NOTES.

NATIONAL ADVISORY COMMITTEE FOR AERONAUTICS.

CASE FILE  
COPY

\_\_\_\_\_  
No. 34  
\_\_\_\_\_

THE 300 H.P. BENZ AIRCRAFT ENGINE.

By

Dr. A. Heller.

\_\_\_\_\_  
Translated from  
"Zeitschrift des Vereines Deutscher Ingenieure,"  
By  
Paris Office, N.A.C.A.  
\_\_\_\_\_

FILE COPY

To be returned to  
the files of the National  
Advisory Committee  
for Aeronautics  
Washington, D. C.

January, 1921.



NATIONAL ADVISORY COMMITTEE FOR AERONAUTICS.

---

TECHNICAL NOTE NO. 34.

---

THE 300 H.P. BENZ AIRCRAFT ENGINE.

By

Dr. A. Heller.

---

Translated from  
"Zeitschrift des Vereines Deutscher Ingenieure,"\*  
by  
Paris Office, N.A.C.A.

---

The following description of the Benz 12-cylinder engine is a final example of the extensive development of aircraft engine construction in the German Empire. During the last few years, the firm of BENZ has evolved this type of engine which was first designed and constructed towards the end of 1914, but which was then temporarily set aside for the time being in favor of the simpler six-in-line construction because of the urgent need for standardizing aircraft engines.

The latest 300 H.P. aircraft engine, with its 12 cylinders placed at an angle of  $60^{\circ}$  (Figs. 1 to 6) not only realizes a long-cherished conception which had been amply tested from a constructional point of view, but has also received such refinement in detail due to the extensive working experiences of the last few years that it may be described as a perfect example of modern German aircraft engine construction. Such being the case, a detailed description of the development of the constructional points of the engine may be justifiable, as given below.

The engine has 12 cylinders of 135 mm. bore and 150 mm. stroke. Each pair of cylinders serves one of the crank-pins of the six-throw shaft and the engine normally produces 300 H.P. on the ground, at 1800 r.p.m. with the carburetor at full throttle - which is only possible temporarily; and under the same conditions at 2000 r.p.m., the engine develops 400 H.P.

The engine is a so-called "altitude" engine, its decrease of power with diminishing air density being compensated by over-dimensioning the cylinders and over-compressing up to a certain altitude. A normal propeller is driven by means of

---

\* Annual Volume 1920, p.35.



a rotary reduction gear mounted on the crank-case, the gear ratio being 29:19. Its weight without water, oil charge, propeller boss, ignition magneto and the engine exhaust manifolds is about 430 kg., which would be about 1.43 kg/HP as relative to normal power on the ground.

The construction of the cylinders (see Figs. 7 & 8), which are interchangeable and are set comparatively deep in the crankcase in order to diminish the width of the engine, is especially characterized by the use of inner cylinders made of forged steel and screwed into a cast-iron cylinder head (Figs. 7, 9 & 10). To prevent the possible penetration of cooling water into the combustion-chamber at the screwed connection of these two parts, the top rim of the steel cylinder liner is jammed into a groove in the cylinder-head when screwed down, the cylinder head being bent slightly outwards so that the top rim of the steel tube is turned up sufficiently for it to press firmly against the side of the groove. In screwing it on, the cement filling of the groove is squeezed out through minute holes bored for the purpose. The bushings of the spark plugs are screwed into the upper part of the steel sleeve, and then autogeneously welded to ensure perfect tautness at those points. When the cylinder has been tested at 30 times the working internal pressure, it is fitted with a water-cooling jacket made of sheet steel from 1 to 2 mm. in thickness. This cooling jacket is autogeneously welded to the steel sleeve as well as to the cast-iron cylinder head. Experience shows that there is no difficulty in welding sheet steel to cast iron.

BENZ & Co. have been comparatively slow in adopting the use of steel cylinders in aircraft engines and thereby ensuring a considerable saving in the weight of the engine. This may be traced to their desire to avoid the decreased reliability entailed in working with steel cylinders when cast iron pistons were used. Even when such pistons were plentifully oiled and carefully measured for compression conditions, they showed a tendency to cause excessive friction; and this was really satisfactorily overcome only when each piston was separately ground into its own special cylinder. This is a process which would seriously hamper production and would render it almost impossible for a piston to be changed in the course of flying. When aluminum alloy pistons were introduced, BENZ & Co. immediately adopted the use of steel cylinders.

The cylinders are fixed on the specially adapted roof-like milled top side of the crankcase, each with 4 screws placed as close as possible to the axis of the cylinder. The cylinder flanges, which are comparatively large in size, are milled as far as possible with a view to economizing in weight. The cylinder heads are so closely jammed against the ends of



the water-jacket sleeves that they can be made sufficiently tight by means of simple rubber rings covered with sheet-steel washers (SKF Schellen). This tightness has been maintained even when the rubber washers were of rather poor quality.

The cylinders are served by a large intake valve and two small exhaust valves (Figs. 11 & 12), by which means there is no danger of the deformation of the exhaust valve at high temperatures. All the valves are operated by a camshaft located between the two rows of cylinders by means of push rods and single and double rocker arms (Figs. 11 to 15). These rocker arms are all mounted on ball bearings. The camshaft, with its 5 bronze bearings, can be drawn out with the bearing when the guides of the push rods are removed and the screws of the camshaft bearing loosened.

Double springs of very low constructional height being used for the intake valves and partly sunk in the cylinder heads, the valve rocker of the intake valve can be brought obliquely under the double rocker of the exhaust valves and the push rods are thereby kept at the requisite distance from one another and from the cylinder heads. The entire construction of this mode of valve-operation, as compared with the usual method using special casing with enclosed camshaft on top, is marked by the relatively easy accessibility of the valves, springs and rockers, and the facility with which the valve rocker bearings can be lubricated. The ball-bearing of the valve rockers, filled with lubricant only when the engine is built or thoroughly overhauled, actually needs no further oiling. This type, which was first introduced in the Imperial Prize Engine, in 1912, has so well proved its worth that the use of ball bearings has been adopted for the valve rockers of other engines with the camshaft located below.

In operating, attention must be given to the necessity for leaving a play of about 0.4 mm. between the valve stem and the valve rocker tappet pin when the engine is warm, so that the valves may be thoroughly closed by the time the engine is cool. Special importance must also be attached to there being a similar amount of play for all the collectively-driven exhaust valves.

Each of the valve-stems is connected with the valve spring by a two part cone. This cone is located in one of the grooves of the valve stem, and is held fast by the pressure of the spring.

As the valve stem heads are tempered, the edges of the groove must not be hard enough to cause scratching. To prevent the valve from falling freely into the cylinder in case of breakage of the valve spring, and thereby doing great damage, the cone is held in the spring collar by an expanding ring. A former method of locating the valves in an extension of the cylinder-head, in



such a manner that they could not fall through, has been almost entirely abandoned on account of the difficulties involved in the interior structure of the valve, and furthermore, as it ensures so little security from damage; the valve-collars alone being often wrenched off, in which case, there is no way to prevent falling.

The push rods are lengths of seamless steel piping with rounded wooden pegs fastened with pins at both ends. The force of the valve springs alone holds them between the valve tappets and the rocker, and they can therefore easily be taken out if necessary.

The construction of the pistons (Figs. 16 to 18), which are made of the usual aluminum-copper-zinc alloy cast in an outer chill-mold with an inner sand-core, is characterized by tubular steel bushing, cast in the piston pin bosses. By means of these bearings, it is also possible to give considerable length to the connecting rod bearing on the piston pin. The piston pins are open at the ends and are secured laterally by conical pegs which enter the eyes from below. The drag weight of the piston, as influenced by friction, can be compensated within a few grammes by an oil drip ring on the lower interior rim of the piston. By this method, a piston of any series may be built into the cylinder of an engine without disturbing the compensation of the whole. The pistons are fitted into the cylinders by four small high-rimmed cast-iron washers. For aluminum pistons, much depends upon this jointing, as they require a comparatively large amount of play when fitted into the cylinder, on account of the great expansion of the jointing due to heat.

The use of aluminum pistons is one of the progressive steps of later years both from a thermo-technical as well as a purely practical point of view, and they are now regarded as a useful factor in the technics of power-propelled vehicles of the future. Their use is attended by many practical advantages, especially with regard to economy in the wear of the cylinders, which do not, even after many years' wear, need to be reground as at present. Should the pistons become worn, for instance, from insufficient oiling, not the cylinders but the pistons only would be affected, and the latter are far more easily renewed. One of the strongest arguments against the general use of engines with welded cylinders is thus done away with. From a thermo-technical viewpoint, the good heat-conducting properties of aluminum are an advantage on account of the comparatively low temperatures that always prevail on the upper side of the piston wall, and which can be detected by the absence of fused oil residue. This prevents the seizing of the piston rings by fusion, which frequently causes derangement when cast-iron pistons are used. It has been repeatedly proved that the power of an engine can be raised 10 H.P. with a certain number of



revolutions and under other similar conditions, by the installation of an aluminum piston. Mean effective piston pressures of 9atm. or even more can also be obtained on high speed engines without any hardness or jolting in running, and all these advantages are due to the good heat-conducting quality of the piston. The comparative coolness of the top side of the piston prevents the intake mixture from heating too rapidly, and thereby improves the cylinder charge, while the degree of compression ratio that can be attained without risk of spontaneous combustion is greater, and the highest possible mean piston pressure is attained later with aluminum pistons as compared with cast-iron. Taken as a whole, the saving in weight by the use of aluminum pistons applied to automobile engines rather than aircraft engines is no more than cast-iron as the short pistons of the latter require the addition of ribs for stiffening.

The structural formation of the master connecting-rod (Figs. 19 to 24), is remarkable for the successful location of the joint of the crankpin end, which is as far as possible from the immediate influence of the forces acting from the piston, and also because the screws securing the crankpin end are so precisely threaded as to lessen the risk of their shearing. This does not obviate the need of using studs for the connection on one side, although blank bolts that could be pushed through would be preferable. The bolt or pin connecting the secondary-rod to the master-rod, is securely held in a clamp-bearing. Bronze bearings are used between the secondary connecting-rod and the bolt and the usual bronze cap white metal bearing on the crankpin for the master-rod. The stems of the connecting-rods are round, and are bored from the piston end in order to ensure a tubular cross-section specially capable of resistance to bending and inside which the oil channel leading to the piston-pin can easily be located.

The engine fittings are arranged on the principle that the comparatively inaccessible end at the propeller should be left as free as possible when the engine is mounted on an airplane. On the other hand, the constructional length of the engine should be curtailed as much as possible in order to avoid any detrimental influence on the turning ability of the airplane. For the same reason, the carburetors, which are joined in couples each supplying 3 cylinders, and the magneto driven by the camshaft are located in the space between the cylinder rows, while the spark-plugs, with the pumps for fuel, oil, and water are placed at the rear end of the engine within reach of the pilot's seat.

In lubricating the engine, the process of continually adding small quantities of fresh oil to the ever-circulating oil has been replaced by simple rotary lubrication; the piston pumps formerly used are now replaced by gear-wheel pumps, which



are far more easily driven and are of simpler construction. The former prejudice against simple rotary lubrication, based on the more rapid wearing of the crankshaft bearings through coal and metal dust impurities in the oil, has been proved to be unjustified in experiments made with power impelled vehicles, while in the case of aircraft engines, in particular, the frequent renewal of the entire oil supply must be taken into account. As applied to gear-wheel pumps, its reliability was at first considered doubtful, as the gear-wheels must be caulked at the sides in the case, and the caulking cannot be replaced later. Experience has shown, however, that the gear-wheel pump supplies sufficiently high oil pressure even after long usage, and that it never loses its tightness to such an extent as to allow the oil to flow back into the crankcase out of the oil reservoir through the pump-case when the engine remains stationary for any length of time, and by so doing to involve difficulties at starting. A safety device, specially constructed to remedy that defect, consisting of a piston kept open by the oil pressure and weighed down by a spring, can therefore be dispensed with.

The triple gear-wheel pump located at the lowest part of the crankcase consists of three separate pumps (Fig. 25), one of which (1) drives the oil through a nozzle collector into the distribution piping, which is installed on the outside of the crankcase and is therefore easily accessible for cleaning purposes (Fig. 1). This method of installing the distribution piping is now preferred to that of locating it in the crankcase and connecting it with the bearings by transverse boring, experience having proved that cast aluminum has a strong tendency to become porous when the distribution pipe leads into it, and that the boring in question soon loses its tightness.

From the principal bearings, the oil flows under pressure, through tubes bored in the crankshaft, to the crank-pin end, then through the tubular interior of the connecting-rod to the piston-pin, which is hollow and thus distributes the excess of oil on the inner surface of the cylinder swept by the piston. The regularity of the lubrication functions is checked by a manometer at the distribution piping, the pressure of which should never be lower than 0.5 atm.

Two more oil pumps (II and III) draw off the oil used in the engine, to the front and rear ends of the crankcase, and force it back into the oil-tank. This prevents the oil from collecting at one end of the engine during the climb or in the course of a nose dive, and also from oiling the cylinder excessively.

A method proposed by BENZ & Co. for the construction of the oil tank is shown in Figs. 26 and 27. Its corrugated outer wall forms a part of the fuselage covering and is therefore



effectively cooled by the wind caused by flight. The oil first enters at a by means of a partition wall and reaches the jacket b of the tank, where it is strongly cooled. If the jacket is full, or coated with congealed oil through intense cold, the oil passes through the projecting rim c into the interior of the tank, from which it can flow, in turn, through the aperture d into the piping leading to the oil-pump. The tank must be provided with a ventilating orifice of about 5 cm. in width, so located that the oil cannot run out either in climbing or in steep gliding flight.

A horizontal sheet-iron collective piping is attached to each of the oil vapor exhaust pipes (Fig. 1) in order to carry off the oil vapor from the crankcase. From them, the vapor is carried downwards and into the open air by means of pipes fitted with oil-receptacles, cut off obliquely at the open ends in such a manner that the sucking effect of the wind created by flight can be utilized at will.

The fuel installation, (Fig. 28), which has been constructed on lines conceived after many years of practical experience, consists of a principal reservoir a with an auxiliary reservoir b built beside it, a fuel-pump c worked by the engine, a hand-pump d with a fuel scavenger e and super-compression valve f in the pressure pipe of the pump; from valve f, the feed-pipe equipped with a manometer g is conducted into the carburetor. The principal reservoir is filled with fuel from the auxiliary tank, and is likewise under pressure of the outside air, so that in case of damage by gunfire or similar cause, it cannot discharge its contents too quickly. If the contents of the principal tank have run out, however, a safe landing may be effected by means of the contents of the auxiliary tank, as the fuel pumps can be fed by either tank. The amount supplied by the fuel pumps is considerably greater than that required by the engine. The surplus passes through supercompression valve f into a receiver, from which it either flows back into the auxiliary tank or into the principal tank, according to the manner of its adjustment. This disposal of the fuel leaves each fuel pump free to act independently of the other, the functioning of the whole being thus assured even when the engine pump may be out of order. The fuel is therefore always supplied to the carburetor under constant super-compression, in which respect it has the advantage over the ordinary device with auxiliary tank, in which the fuel pressure at the carburetor varies considerably in accordance with the angle of the airplane and the inbuilding of the auxiliary tank.

The fuel pump (Fig. 29) consists of an ordinary piston-pump with an aluminum case a, bronze bearings b and slightly adjusted piston c, to which the fuel flows over a combined sieve-scavenger and water separator d, the bottom of



which can be unscrewed, and an intake ventilator e borne down by its own weight. The pump is slowly driven by the control-wheels of the engine, by means of a transmission screw. In its original form, as used on the 220 HP aircraft engine, it was worked with glycerine as auxiliary fluid. Duration tests soon prove, however, that there is perfect safety in working even when the piston inducts the fuel directly, though the interior of the piston must, in such cases, be filled from time to time with viscous oil.

Every time it descends, the piston pump drives the sucked-in quantity of fuel-mixture over the ventilator f, which is similarly loaded by its own weight, into the so-called super-compression ventilator (see Fig. 30) which simultaneously compensates the pulsations of the fuel-pump, somewhat as an air tank. The cap-like body of the ventilator is inverted over the free end of the exhaust-pipe; the caulked rim of the ventilator being held down by a spring, the tension of which can be so regulated by means of the screw lid that the compression of the fuel at the carburetor amounts to about 0.2 to 0.25. Any surplus supplied by the fuel-pump over the amount required to maintain that pressure and supply the consumption in the carburetor flows down obliquely into the tank (see Fig. 28) surrounding the super-compression valve, which is conducted to the open air. Any marked variation in the fuel pressure is a sign that the air contained in the air-tank has escaped. When working empty, it is necessary only to open an air-tap in the intake piping for a time to enable the air-tank to be refilled with air.

The carburetors (see Figs. 31 to 35) are welded together in pairs and covered with a water-jacket; they adjoin the super-compression valve in the same direction as the fuel piping. In the float chamber a, the fuel is taken at b and scavenged through a fine sieve c and kept at a constant height in the usual manner. At this height, it also becomes stationary in the principal nozzle d (see Fig. 34) of the carburetor, which is connected with the float tank by the calibrated boring e of the bottom screw. In its starting position, the throttle valve f (see Fig. 33) releases only one auxiliary bore, g, of the case; a finely bored auxiliary nozzle h directly supplied with fuel from the carburetor, penetrates into the bore g and the strong aspiration thus engendered at the upper edge of the auxiliary nozzle (which may easily be adjusted by changing the position of the air valve) enables the fuel to be well inducted and pulverized even when the engine is working slowly. As the pressure on the upper edge of the principal nozzle d augments, through the widening of the throttle opening and increasing engine speed, the fuel becomes so much the more highly aspirated and pulverized in proportion and auxiliary air enters through the aperture i between the pipes k and l (Fig. 34), penetrates to the principal nozzle through fine borings m and thereby promotes



the pulverization of the fuel and prevents the mixture from becoming too rich in fuel.

The method of carburetor construction above described is based on the French Claudel Carburetor Model and has many recommendations. It is easy of access, and the nozzle can be easily adjusted and taken out from above; its main air stream is perpendicular to the main nozzle, so that the fuel stream branches off at right angles and pulverizes well. The fuel supply which collects at the bottom of the principal nozzle when the engine works slowly, also makes it possible for the throttle to open to its full extent suddenly after a gliding flight until it is quite near the ground, without there being any risk of the engine's "jib-ing" before the fuel has time to flow in through the bottom opening of the principal nozzle. Another advantage lies in the fact of there being no need for the usual auxiliary air apertures, controlled by the throttle valve and limited by curves, as such apertures can never be quite accurately adjusted, and each separate carburetor must therefore be adapted to the engine for which it is intended.

The double spark plugs attached to each cylinder for reasons of safety are independently charged by two dynamos (Robert BOSCH Co., Ltd., Stuttgart) with 12 plates of 12 poles. The dynamos are driven obliquely from the rear-end of the engine by means of ordinary spring coupling (see Fig. 3). They are symmetrically ranged, and constructed for anti-clockwise rotation and a very simple method is obtained for adjusting the sparking point by means of the rods.

The cooling water pump is installed at the end of the gear wheel intended for the auxiliary command at the back of the engine, that is, at a spot where the entire contents of the water-jacket and pipes can be discharged. The shaft of the pump is set in ball bearings at the upper end supported by a special block, while the lower end, terminating in a bronze bearing, supports a fixed wheel secured by a pin. The pump has an opening in the middle pipe, and two outlet pipes; it conveys the cooling water on each side of the engine into a main pipe, and this again conveys the principal stream directly through the adjacent cylinder heads, so that the valve heads are most effectively cooled. A weaker auxiliary stream of cooling water penetrates the cylinder jacket from below through a distribution piping, and a flow of water is thus obtained in the direction of the cylinder heads.

An important part of the engine is the reducing gear, its function being that of keeping the number of revolutions of the propeller within such limits that the propeller efficiency may be good notwithstanding the much-desired increase in the number of revolutions of the engine. The type in question is



the outcome of years of experiment, unsuccessful until now for the very reason that with gear wheels, strong wearing of the wheels could not be prevented in the course of long working, even with larger wheel dimensions. As regards reliability, this type may be classed with the only really durable foreign engine gear - that is, the Rolls Royce Co.'s gear --though it has the advantage over the latter on account of its great simplicity. The gear has been specially designed to attain the greatest possible transmission ratio for each revolution of the gear wheels, at the same time without exceeding the regulation limits for all-over dimensions and weight. The number of revolutions of the propeller, estimated at about 900 r.p.m. for geared aircraft engines, is therefore augmented to 1180 r.p.m., a speed which is also compatible with satisfactory propeller efficiency.

The outer part of the gear is connected with the flange of the crankshaft by inside gear work, and the central wheel is fixed. It is therefore provided with a lever, made to revolve on the gear-box and adjustable to some extent, and the unavoidable oscillations of the crankshaft are thus compensated. The four star-wheels, all set on one star, revolve between these two rings of wheels and thus drive the propeller, which is attached to the star. The crankshaft is cast in one piece with the star and runs on two strong ball-bearings, the inner one located at the end of the crankshaft, the outer one in the gear-case. On this shaft, the fixed central wheel of the gear rests on two ball-bearings, and it is this artifice alone which enables the propeller to be driven by the star. Special care had been bestowed on the location and setting of the star-wheels, which attain an extremely high number of revolutions. Each of them revolves on two double ball-bearings, which are filled with balls and thus work without cages, experience having shown that ball-cages are not capable of withstanding the stress brought to bear upon them during flight. The bearings are lubricated from the interior by oil flowing from the crankshaft cavity. When mounting, the star-wheels can be laid in a regular line along their respective notched discs by turning the cones, which are slightly eccentrically turned; by this means, the peripheral forces are evenly distributed over several teeth. The double bearing built into the front end of the crankshaft prevents longitudinal displacement of the crankshaft at the gear. By means of the projecting hexagonal edge, the gear can easily be taken down.

In a newer type of the valve, the regulating lever of the fixed gear wheel (which lever hangs downwards), and one of the ball bearings are dispensed with by the direct transfer of the rotational moment of the fixed wheel to the front flange and to the gear box through a rotary coupling.

The propeller is attached to an auxiliary flange by the usual hub and short bolt, and the flange is secured to the ball-end of the rear shaft by a key.



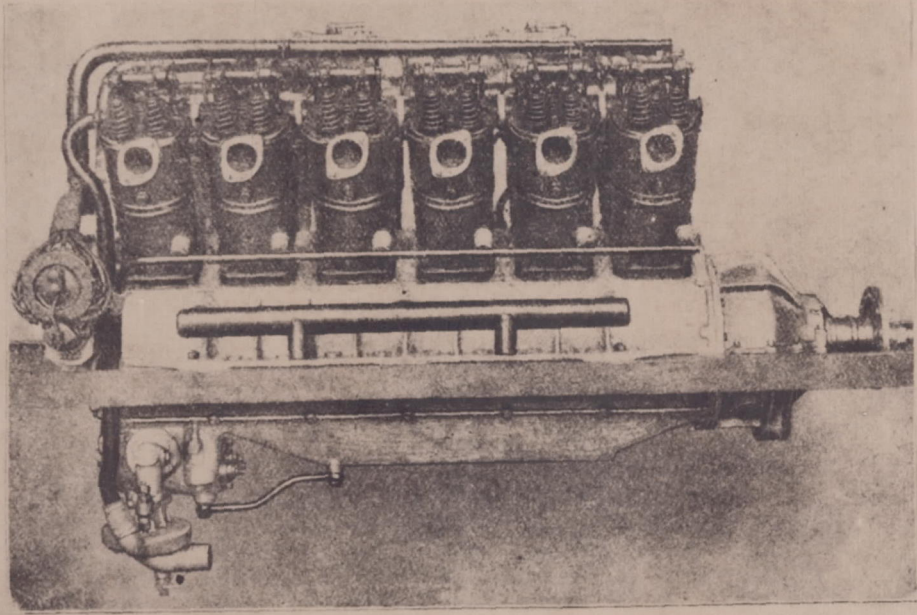

Fig. 1.

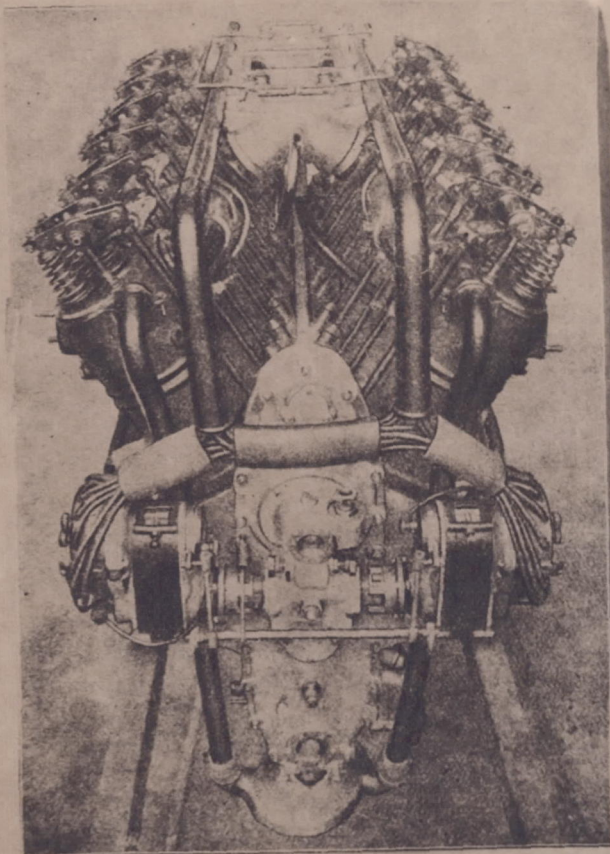

Fig. 2.

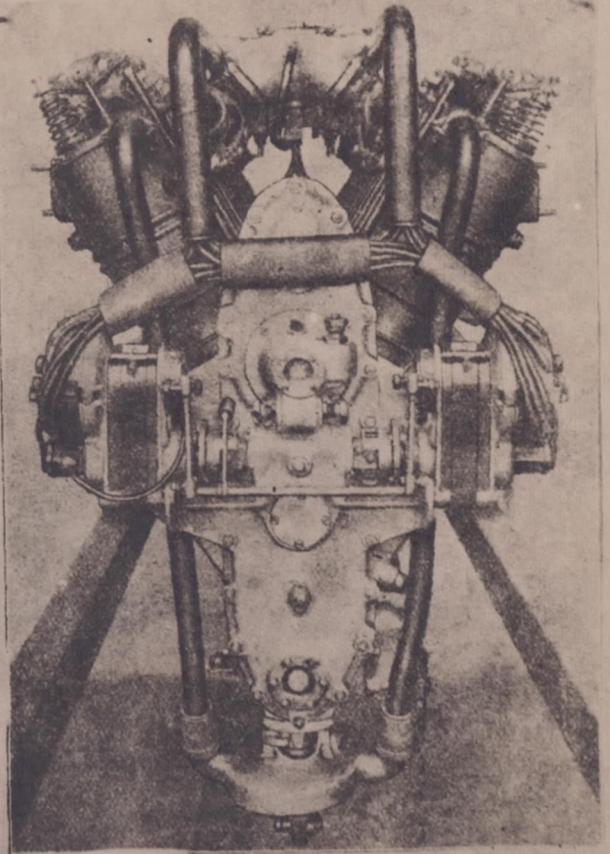

Fig. 3.



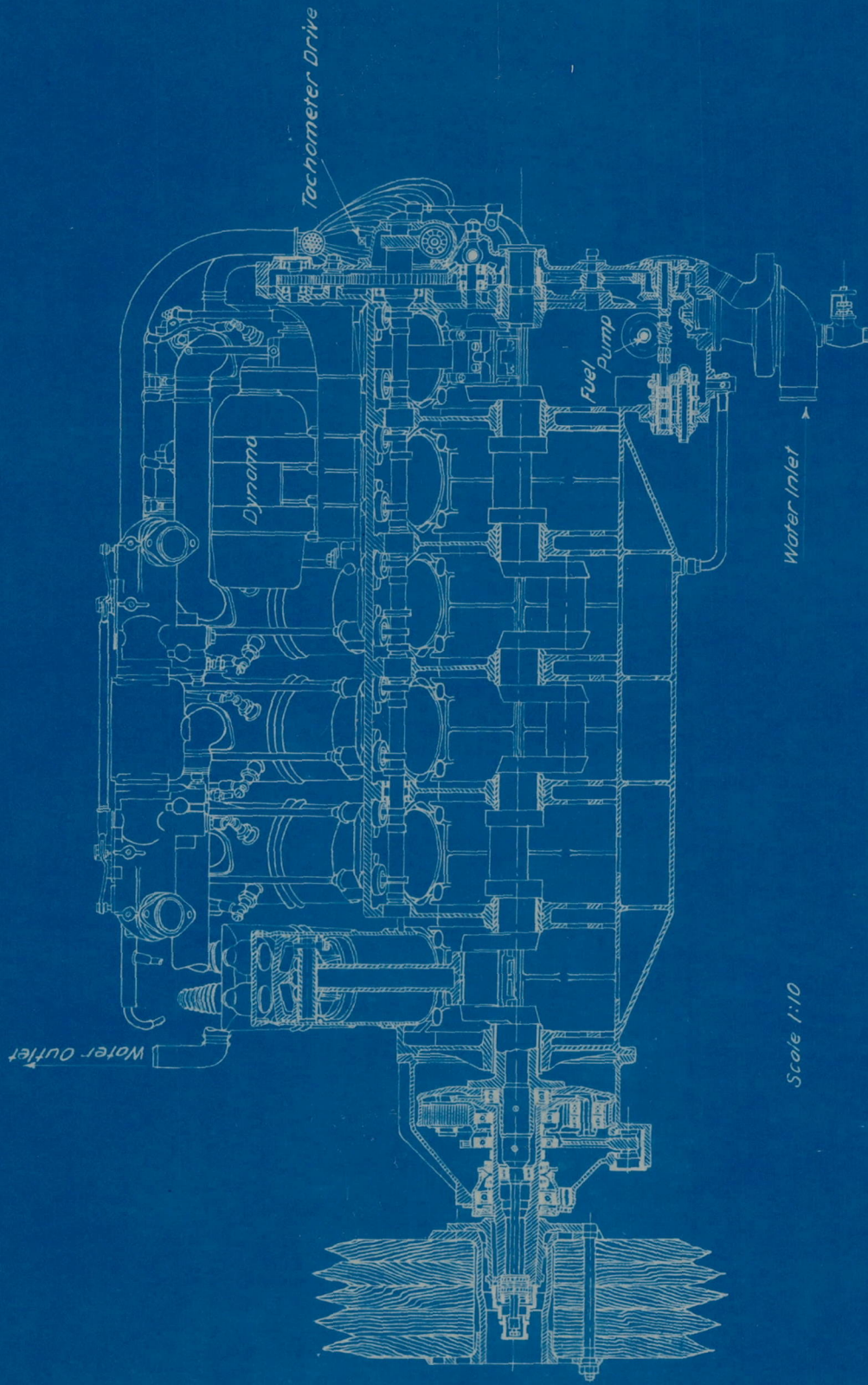
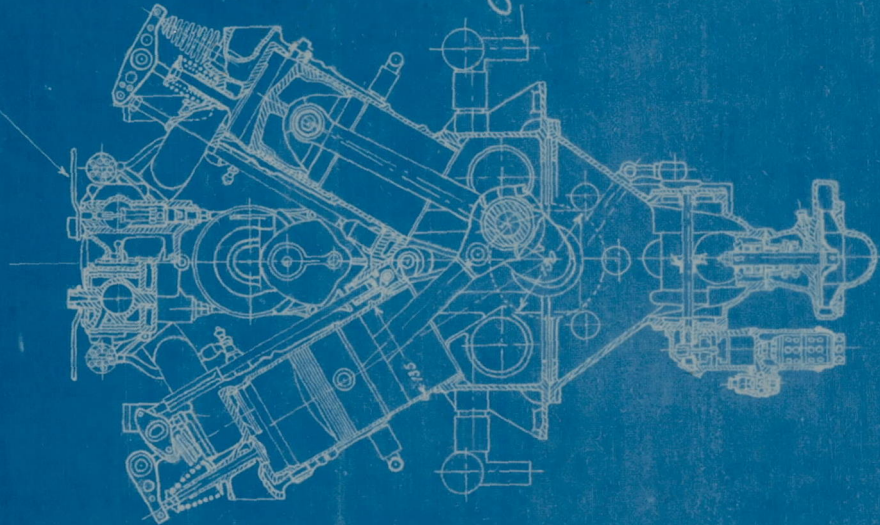

Fig. 4.



*Carburetor Lever.*



*Fig. 5.*

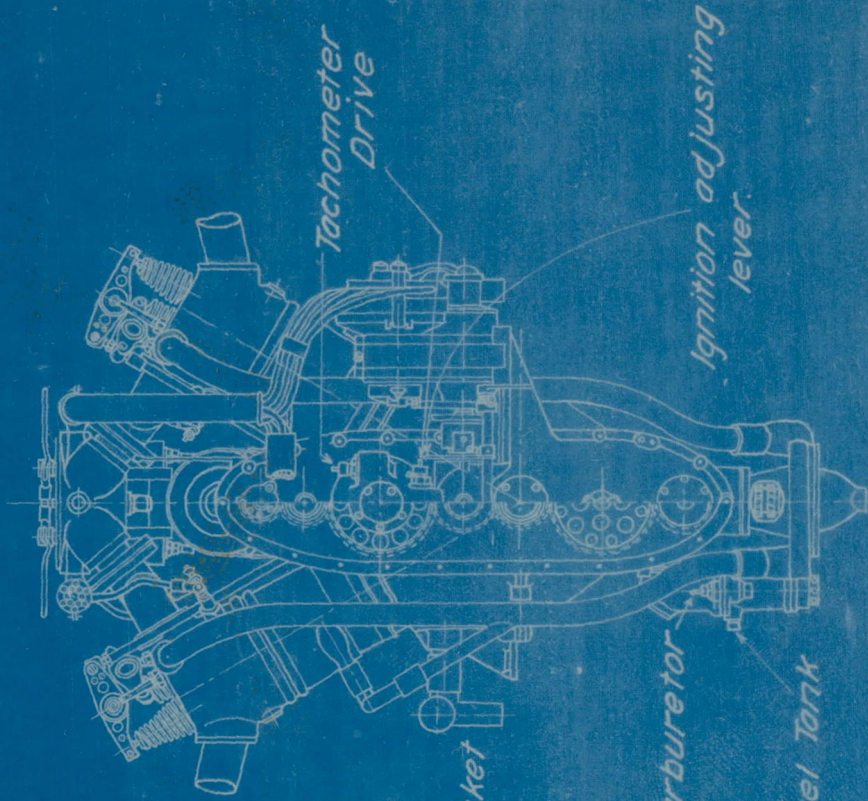

*Fig. 6.*

*Crank angle bracket to air spring.*

*To Carburetor*

*From Fuel Tank*

*Scale-1:10*



Part plan and section

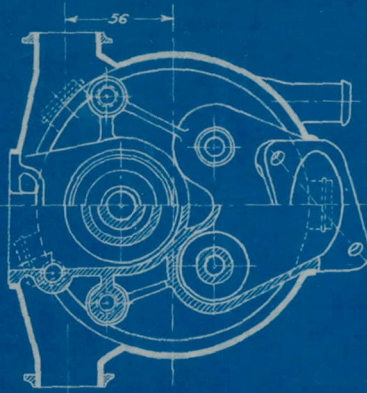

Fig. 10.

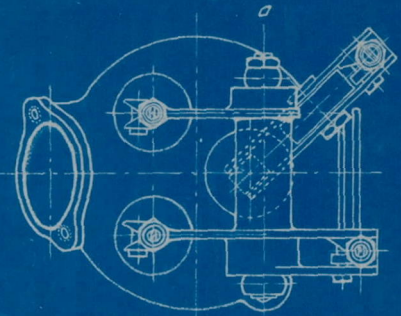

Fig. 12.

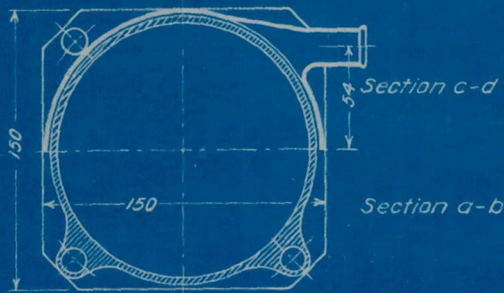

Fig. 9

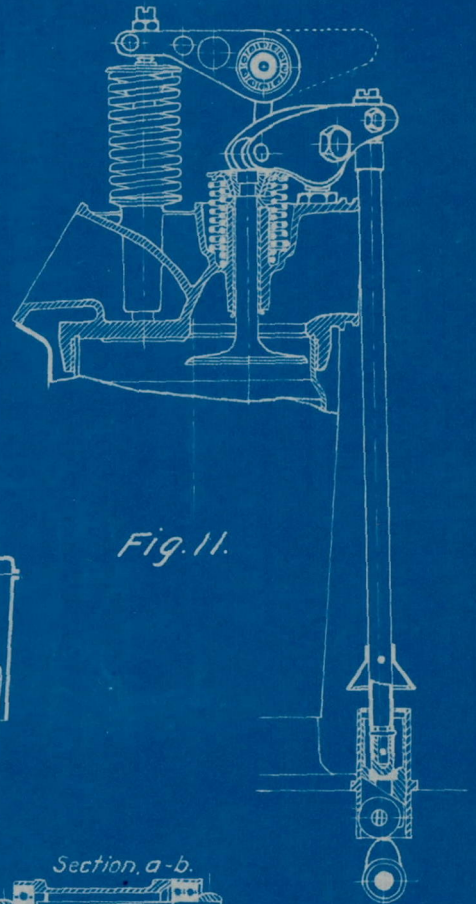

Fig. 11.

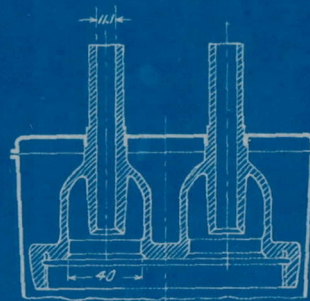

Fig. 8.

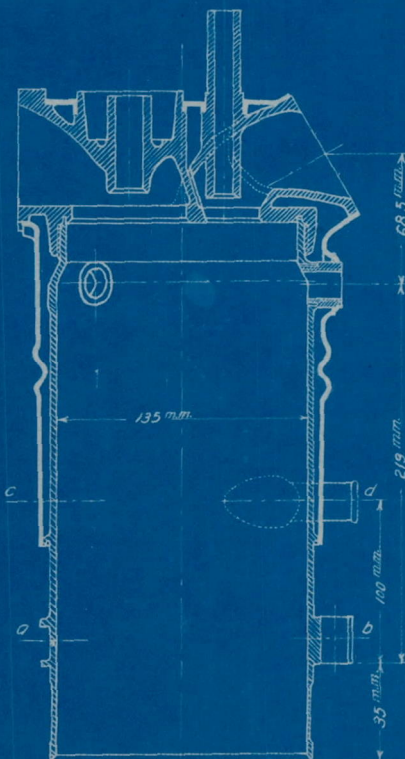

Fig. 7.

Cylinder  
Figs. 7-8-9-10.

Scale 1:4.

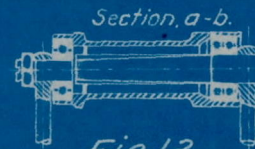

Fig. 13.

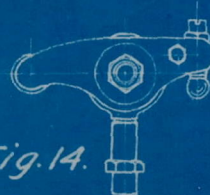

Fig. 14.



Fig. 15.

Valve Gear  
Figs. 11-12-13-14-15.



Master Connecting Rod.

Fig. 19 to 24.

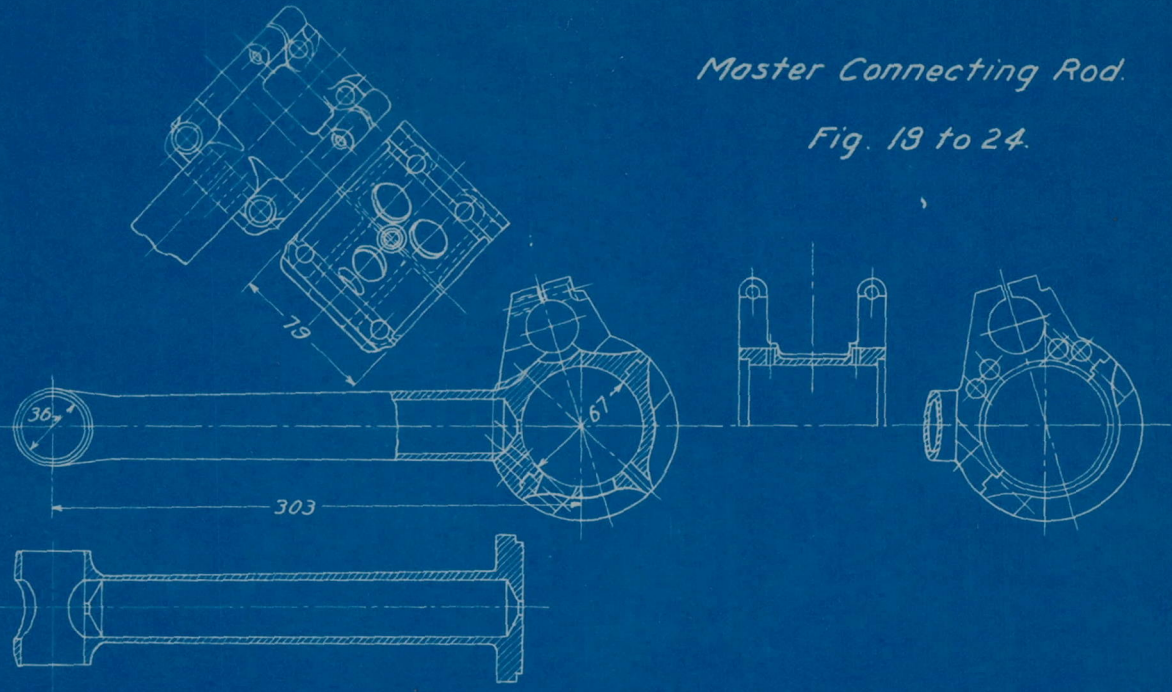

Aluminum Piston.

Oil Return Holes.

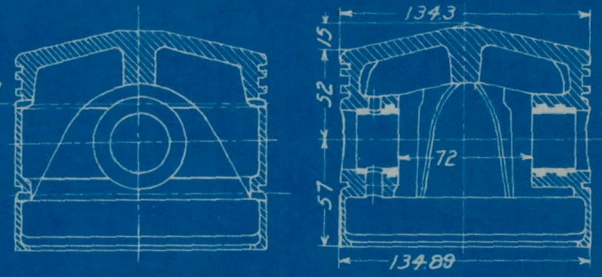

Fig. 16 to 18.

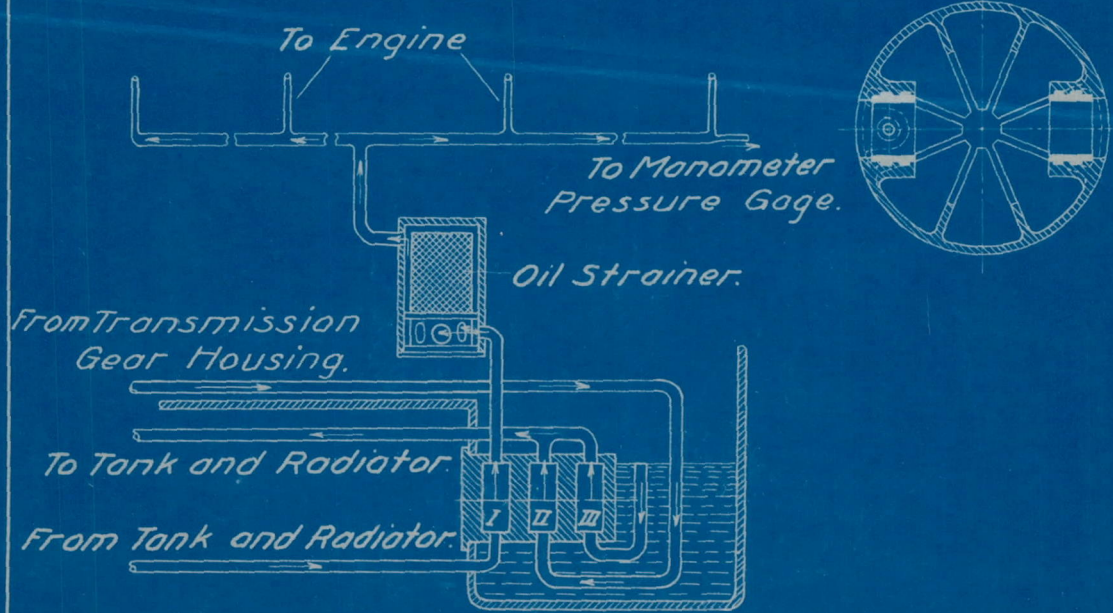
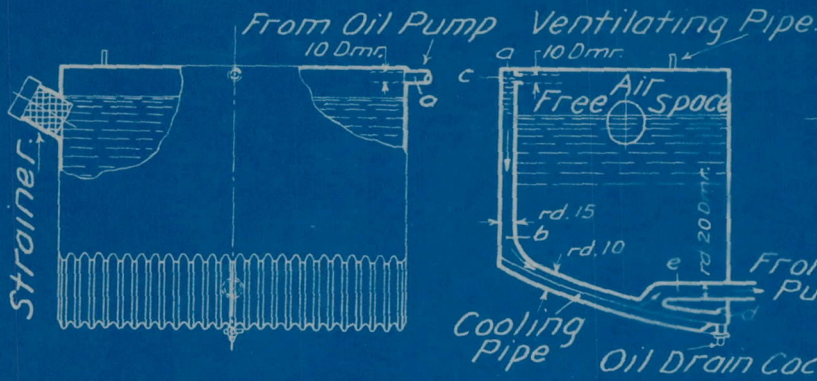

Diagram of Oiling System.

Fig. 25.





Oil Tank with Radiator.  
Figs. 27 and 26.

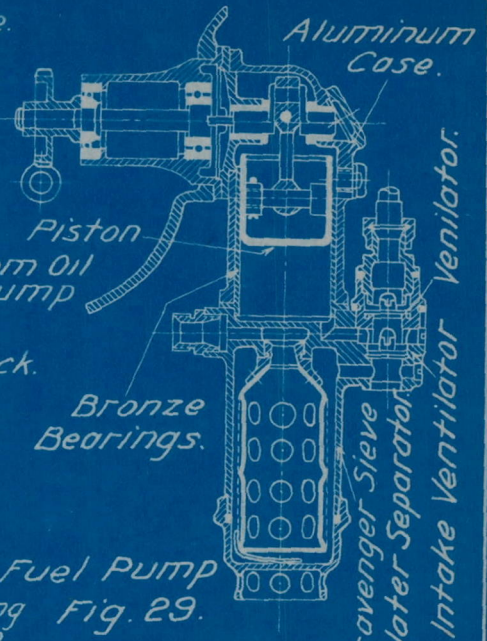

Fuel Pump  
Fig. 29.

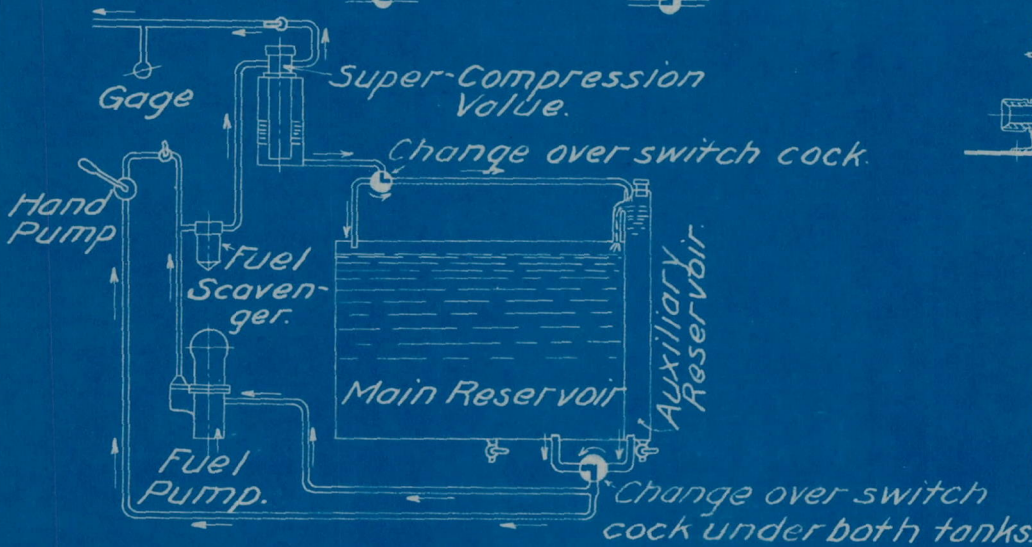
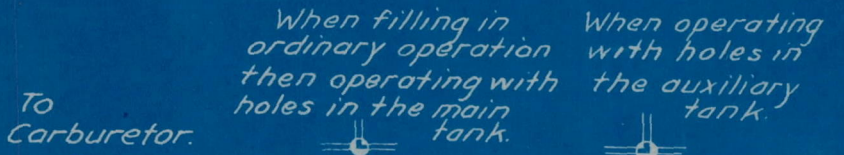

Fuel Pump  
Fig. 28.

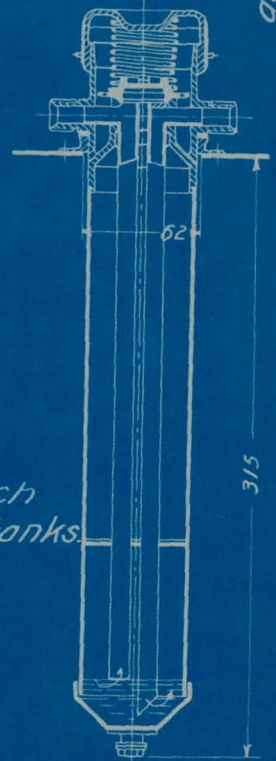

Pressure Valve  
Fig. 30.



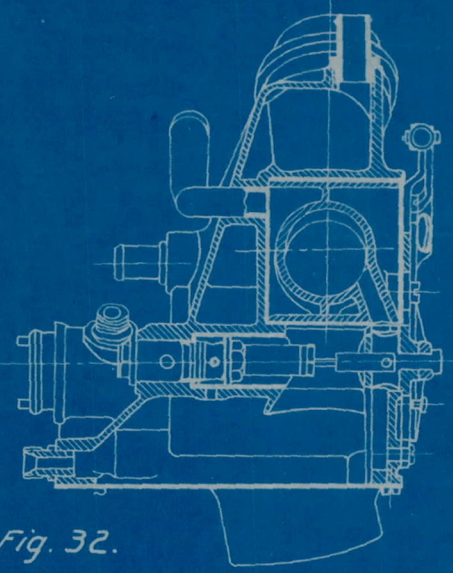

Fig. 32.

Section A-B.

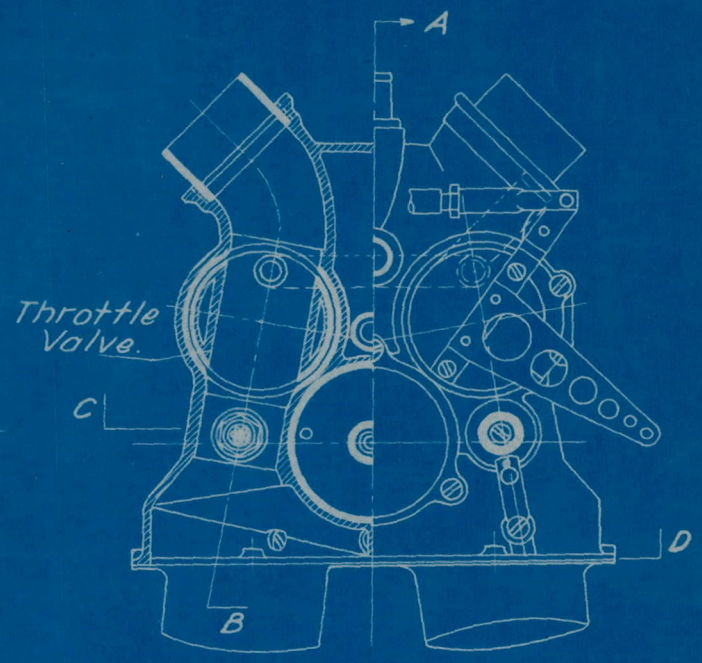
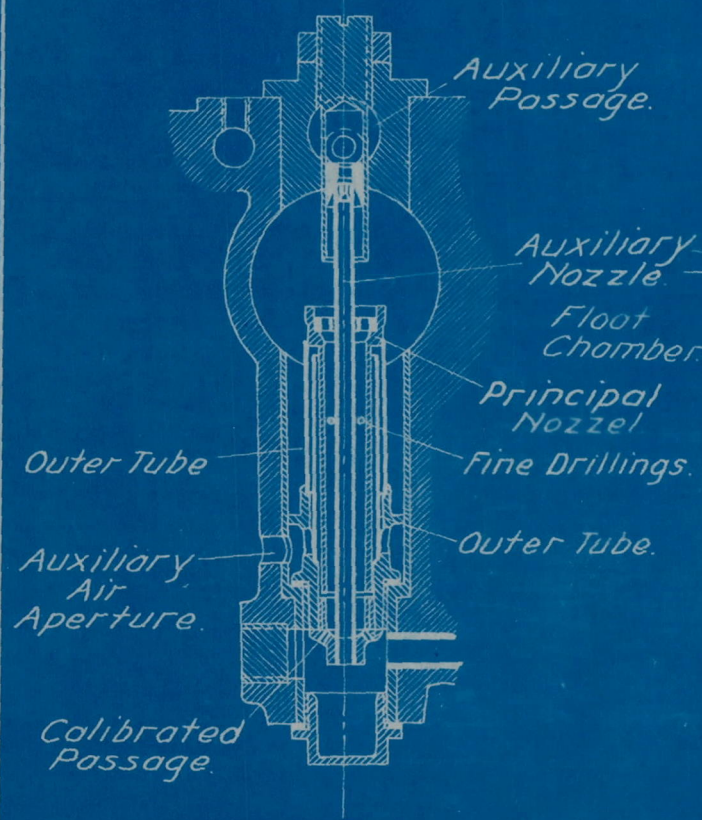

Fig. 31.

CARBURETOR



Section of Jet Control Valve.

Fig. 34.

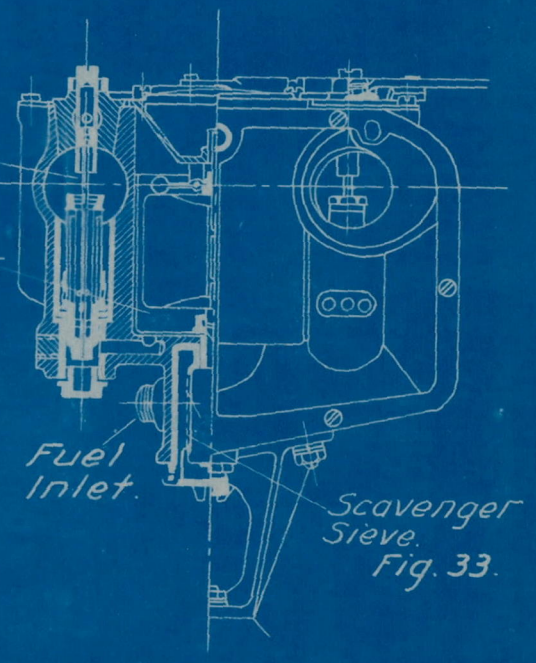

Section C-D.

Fig. 33.