

Library, L. M. H. N.

Handwritten scribbles and a large dark mark.

TECHNICAL NOTES
NATIONAL ADVISORY COMMITTEE FOR AERONAUTICS

No. 331

RATE OF HEAT TRANSFER FROM FINNED METAL SURFACES

Progress Report on Investigations at
Aeronautical Engineering Department,
Massachusetts Institute of Technology.

By C. Fayette Taylor and A. Rehbock

Washington
January, 1930

TECHNICAL NOTE NO. 331.

RATE OF HEAT TRANSFER FROM FINNED METAL SURFACES.

Progress Report on Investigations at
Aeronautical Engineering Department,
Massachusetts Institute of Technology.

By C. Fayette Taylor and A. Rehbock.

Summary

The object of this series of investigations is to evaluate the factors which control the rate of heat transfer to a moving current of air from finned metal surfaces similar to those used on aircraft engine cylinders. As a result of this work, it is hoped to establish data which will enable the finning of cooling surfaces to be designed to suit the particular needs of any specific application.

To date most of the work has been done on flat copper specimens 6 inches square, upon which have been mounted copper fins with various spacings. The range of spacings so far used has been from 1/2 inch to 1/12 inch. All fins have been of copper 1 inch deep, 6 inches long, and .020 inch thickness.

These specimens have been tested in a small wind tunnel, with air flow parallel to the base plate and fins, at air velocities ranging from 50 miles per hour to 160 miles per hour. The specimens are electrically heated to a known temperature and the heat transfer is measured by the electrical input.

The results of the investigation are given in the form of curves included with this report. In general, it has been found that for specimens of this kind the effectiveness of a given fin does not decrease very rapidly until its distance from adjacent fins has been reduced to 1/9 or 1/10 of an inch. A formula for the heat transfer from a flat surface without fins has been developed, and an approximate formula for the finned specimens is also suggested.

Further work contemplated includes the careful measurement of effective air velocities between the fins and experiments to determine the effect of changing the fin depth, and the fin length parallel to the air stream.

Introduction

In spite of the fact that much experimental work has been done to determine the heat transfer coefficient of various surfaces exposed to a current of air, and considerable mathematical work has been done with regard to the ideal shape for cooling fins (See Bibliography), it appears that very few experimental data are available with regard to the effect of fin spacing, shape, length, etc., on the over-all heat transfer coefficient of finned surfaces such as those used on engine cylinders and radiators. The research work which has been carried out by the Aeronautical Engineering Department of the Massachusetts Institute of Technology on this subject, has been planned for the

purpose of investigating the relationship of these variables to the over-all coefficient. It is hoped that as a result of this investigation the design of cooling fins for aircraft engines and for other purposes can be carried out upon a rational basis, as opposed to the empirical methods heretofore employed.

This research work has been carried out under the auspices of the Subcommittee on Power Plants for Aircraft of the National Advisory Committee for Aeronautics, who have acted as a steering committee in cooperation with members of the staff of the Massachusetts Institute of Technology. The apparatus was constructed and preliminary results were obtained by A. R. Rogowski, S.M., 1928, and most of the experimental data were obtained by F. M. Bondor, S.M., 1929, to both of whom much of the credit for the work up to date is due.

Considerable thought was given to the question of the form of specimen which should be used. A cylindrical specimen was suggested but was discarded because of the enormous variation in air velocity and turbulence which exists around the periphery of a cylinder with its axis at right angles to the air stream. The flat specimen parallel to the air stream was finally decided upon as being most nearly representative of the general case of heat transfer from a surface exposed to a stream of air. With this type of specimen the velocity of air past the surface can be easily measured and turbulence reduced to a minimum.

Copper was selected as the material for the specimens since it is obtainable in the approximately pure state and its conductivity is accurately known. Furthermore, it is easily soldered and relatively noncorrosive. It is believed that if the characteristics of copper specimens are accurately determined, the results can be mathematically converted to apply to other materials on a basis of their relative conductivity.

Description of Apparatus

A special wind tunnel was constructed to furnish the air stream for cooling the specimen (See Figs. 1 and 2). This tunnel is about 10 feet long over-all, of Venturi shape, octagonal in section. The working section or "throat" of the tunnel is parallel for 2 feet and is 12 inches across flats. Air is drawn into the tunnel by a 35 hp Sturtevant centrifugal fan driven by a constant speed electric motor. Variations in air velocity are obtained by throttling the fan outlet. The tunnel is divided longitudinally by a plywood partition $\frac{1}{2}$ inch thick, the entering edge of this partition extending a considerable distance ahead of the tunnel entrance in order to eliminate turbulence from this source. The heat transfer specimens are fitted into this partition and exposed to the cooling air on both sides. They are so installed that the outer surfaces of the base plates are flush with the two sides of the partition. The specimens are located at the center of the throat of the tunnel and are insu-

lated from the wooden partition by hard asbestos board.

Each specimen consists essentially of two copper plates $1/8$ inch thick and $6-3/4$ inches square, clamped on either side of an electrical heating element consisting of nichrome ribbon wound on an asbestos slab. The working portion of each plate is 6 inches square, which leaves a margin of $3/8$ inch outside the heater and the fins, into which machine screws are set at frequent intervals to hold the two sides of the specimen together and to clamp them firmly against the heating element. A thin sheet of mica is interposed between the nichrome ribbon and each copper plate to furnish electrical insulation. Details of construction of the specimens are shown in Figures 2, 3, 4 and 6.

The cooling fins, 6 inches long and 1 inch deep in every case, were soldered into shallow grooves in the specimen. Pure tin was used for the soldering operation in order to secure a high melting temperature. All fins used to date have been of copper sheet .020 inch thick.

The heat dissipated by the specimen was measured by the electrical input to the heater with suitable corrections for the heat lost around the $3/8$ margin of the specimen. For details of the method of determining the marginal heat loss, see Appendix I. Direct current was supplied to the heater through a variable rheostat.

The base temperature of the specimen was measured by four copper constantan thermocouples, located as shown in Figure 4. The leads from these thermocouples were carried out through grooves on the inside of each copper base plate as illustrated. A single constantan wire only was necessary, since the plate acted as the copper element of the couple. The location of these thermocouples was such as to give as nearly as possible the average temperature of the plate, an exploration by a contact thermocouple having been made to establish these positions.

Fin tip temperatures were obtained on the central fin of each specimen at five points spaced at various distances from the entering end of the fin. These consisted of constantan wires peened into the edge of the fin. The electrical connections used for the thermocouples and heater are shown in Figure 5.

The velocity of the air stream was measured by a Pitot tube located opposite the center of the specimen and 3 inches distant from the plate surface. Considerable care was exercised to insure the nearest practicable approach to nonturbulent air flow in the tunnel. In order to reduce to a minimum the turbulence caused by the entering edge of the fins, these were sharpened to a knife-edge at one end. The other end was left square. When the sharpened edge faced upstream, this was called the "streamlined" condition and when the other edge faced upstream, this was denoted as the "unstreamlined" condition. Tests were made under both conditions to determine the effect of the turbu-

lence caused by the "unstreamlined" entering edge.

Eleven double-faced specimens were used. One of these was a specimen without finning, 6-3/4 inches square, used for the purpose of determining the heat loss from the base surface. The second specimen (See Fig. 6) was also without finning, but was 6-3/4 inches parallel to the air stream by 2-13/16 inches at right angles to the air stream. The purpose of this small specimen was to assist in determining the marginal losses. The fact that the ratio of cooling surface to margin was different in the case of the two plates, furnished means for calculating the marginal losses, for the details of which Appendix I should be consulted. Nine finned specimens were provided, whose pitch from center to center of adjacent fins was 1/2 in., 1/3 in., 1/4 in., 1/6 in., 1/7 in., 1/8 in., 1/9 in., 1/10 in., and 1/12 in. respectively.

All specimens were carefully cleaned with acid before test to insure a uniform color and condition of the surface.

In addition to the thermocouples already mentioned, couples were provided at a number of points around the periphery of the specimen, the temperature readings of which were used in the computation of marginal losses. The usual method of providing for marginal losses in heat transfer tests is to supply what is known as a "guard ring," which consists of an electrically heated metallic ring around the margin of the specimen which is kept at the same temperature as the specimen. Since the "guard ring"

and the periphery of the specimen are held at the same temperature, there could be no transfer of heat between the two, and marginal losses would be eliminated. After careful consultation with physicists having considerable experience with apparatus of this kind, the "guard ring" was rejected on account of the difficulty of holding it at the same temperature as the specimen for its entire periphery and also because it would complicate the mechanical set-up to an unreasonable extent. The method previously referred to, of measuring and correcting for the losses, is believed to be just as accurate as the use of a "guard ring" would have been, under the practical limitations of the latter in this particular case.

Test Procedure

The test of each specimen was commenced with the "streamlined" edge as the leading edge. The blower was started and the throttle at the exit end of the tunnel opened to its full open position. In this position the velocity past the specimen was the maximum. The current was then allowed to flow through the heater until the desired temperature was reached. After the plate had reached the desired temperature, fifteen minutes were allowed for the asbestos surrounding the specimen to come to an equilibrium condition. As soon as equilibrium had been reached, readings were taken of the ammeter, voltmeter, room temperature, humidity, Pitot tube, manometer, barometer, plate temperature at

four points, marginal temperature at four points, and the fin tip temperature at five points. At each velocity a check run was made. During every run precautions were taken to insure a practically constant room temperature, and a constant flow of current. When a run was completed for a specimen with the streamlined edge as the leading edge it was taken out of the tunnel, turned around so that the unstreamlined edge became the leading edge and put back into the tunnel, and the readings taken on the same day as the streamlined readings were taken. The watt input to the specimen with the unstreamlined edge as the leading edge was the same as the watt input to the specimen with the streamlined edge as the leading edge, the temperature therefore being slightly different in the two positions. Since this difference was small, however, it did not affect the heat transfer coefficient appreciably.

After all the specimens were run at several air velocities, the small plain plate, the standard plain plate, and the 1/4 and 1/7 pitch specimens were run with a constant velocity and a varying temperature, to determine whether the absolute value of the temperature had any effect on the heat transfer coefficient.

In order to determine the effect on heat transfer of enameling the surface, the 1/4 pitch specimen was covered with an extremely thin coating of black enamel and baked at a temperature of 400 degrees Fahrenheit. It was run first at several velocities and constant temperature, then with constant velocity

at different temperatures.

In the case of the runs at various temperatures and the runs on the enameled specimen, only the streamlined edge was used as the leading edge.

Method of Computation

The chief factor of interest in almost every case is the heat transfer coefficient of the specimen per unit of base area. The coefficient used to denote this is the letter "a" in the following formula:

$$\frac{Q}{A} = a \rho \Delta T \quad (\text{See table of symbols})$$

The coefficient of heat transfer per unit of total area, including both base and fin surface is denoted by "a'" in the following formula:

$$\frac{Q}{A'} = a' \rho \Delta T.$$

The "fin tip temperature difference," plotted in Figures 7 to 16, is the difference between the temperature of the fin tip and the temperature of the air in the tunnel.

In all of the above formulas the symbols used are as follows:

- Q = b.t.u. transfer per hour
- A = the base area in square inches (except margin).
- A' = total area, square inches (except margin).

- a = b.t.u. per hour per square inch base area per degree Fahrenheit difference between base temperature and air.
 a' = b.t.u. per hour per square inch total area per degree Fahrenheit difference between base temperature and air.
 ρ = air density relative to the density at 29.92 inches of mercury barometer and 70°F. This reference density = 0.0749 pounds per cubic foot.
 T = temperature of base plate degrees Fahrenheit absolute.
 ΔT = temperature difference between base and air, degrees Fahrenheit.
 Δt = temperature difference between fin tip and air, degrees Fahrenheit.
 V = air velocity in tunnel, 3 inches from base, miles per hour.
 P = pitch of fins, center to center, inches.
 H = b.t.u. per hour electrical input.

R e s u l t s

The heat transfer coefficient (a), per unit of base area, is shown in Figure 17 plotted against the total area of the specimen. The dotted lines are for the "unstreamlined" condition, the solid lines for the "streamlined." In Figure 17 the straight line indicates the heat transfer coefficient at 158 miles per hour, if the finned specimens had had the same coefficient as the plain plate. The departure of the 158 miles per hour curve from the straight line indicates the drop in effectiveness of the cooling surface, due to (1) the decrease in temperature of

the fins from root to tip, (2) the decrease in air velocity between the fins as compared to the air velocity over the surface of the plain plate at the same tunnel velocity, (3) the greater rise in temperature of the air as it passes through the channels between the fins than the rise over the surface of the plain plate, and (4) mutual radiation between the fins.

Figure 18 shows a plotted against air velocity.

Figure 19 shows fin "efficiency" plotted against pitch, taking the efficiency of the $\frac{1}{2}$ -inch pitch specimen as 100%. Fin efficiency is defined as the ratio of heat transfer coefficient a' per total area of the $\frac{1}{2}$ -inch specimen at the same air velocity. It is noticeable that the decrease in fin efficiency with decreasing pitch becomes more rapid below 1/9 pitch. In this connection it is interesting to note that 1/9 pitch is the largest pitch where the fin tip temperature does not reach a maximum near the downstream end of the specimen (See Fig. 13) at some air speed.

An attempt has been made to break down the coefficient (a), into its various components, assuming that (a) is a function of T , V , and P . In order to do this, (a) was plotted against velocity on logarithmic paper for the streamlined specimens, as shown in Figure 20. It will be seen from this plot that (a) varies as an exponential function of the velocity, and that this function is practically the same for all of the streamlined finned specimens. The average exponent for V for the streamlined finned

specimens, as measured by the slope of these lines, is 0.747. For the unfinned specimens the slope appears to be 0.662, although the points in this case are so far disbursed from a straight line that this can only be a very approximate value. Figure 21 shows the same plot for the "unstreamlined" specimens, which indicates that in this case the variation of a with velocity is not strictly exponential, since the curves are not straight. In Figure 22, (a) is plotted as a function of T on logarithmic paper for the 1/4 inch and 1/7 inch pitch specimens, and in Figure 23, for the plain plate. The results on the plate appear again to be open to question. These plots show the coefficient to vary as the -0.105 power of T for the 1/7 pitch finned specimen, as the $-.070$ power for the 1/4-inch pitch finned specimen, and very roughly as the -0.220 power of T for the plain plate. It is not conclusively demonstrated, however, that (a) is an exponential function of T , so that these results can be considered only very approximate. The fact that the viscosity of air increases with increasing temperature, may account for the negative sign of the exponent.

(a) was also plotted against P on logarithmic paper for the streamlined specimens as shown in Figure 24. Here the points appear to follow a straight line up to 1/9 pitch, the slope of this line being -0.773 .

As a result of the logarithmic plotting of a as a function of T , V , and P , the following approximate formula for a is

suggested:

$$a = 0.0202 T^{-0.09} V^{0.747} P^{-0.773}$$

The exponents for V and P (up to 1/9 pitch) are believed reasonably accurate, as shown by Figures 20 and 24, but the T exponent is considered open to question. Considering a as a function of V and P only, the following formula is probably sufficiently accurate for all engineering purposes:

$$a = 0.01312 V^{0.747} P^{-0.773}$$

This expression, of course, applies only to the special cases of these particular finned specimens. Increasing the fin thickness, for instance, would make the specimens approach more nearly the plain plate and would therefore reduce the value of the V exponent, as well as change the coefficient and the P exponent. Changing the depth, length, and material of the fins would also change the numerical values of coefficient and exponents.

In view of the scattering of the points for the plain plate as shown on Figure 20, it was decided to make an investigation of the available literature on heat transfer from a smooth metallic surface, in order to check the results of these tests with the work of other investigators. a was plotted against V on both logarithmic and Cartesian coordinates as shown in Figures 25 and 26. The various points on the curve in Figure 25 may be identified by reference to the key and bibliography. In view of

the technical difficulties involved in making investigations of this character, the agreement shown between the M.I.T. work and that of the other investigators is surprisingly good. The formula for this curve is as follows:

$$a = 0.00577 V^{0.725}$$

It is believed that this formula is accurate within limits sufficiently close for engineering purposes, and may be applied to smooth surfaces of size not too far from that of the flat specimens used.

Effect of Enameled Surface

Figure 27 shows the effect of enameling the 1/4 inch specimen with black enamel. This appears to reduce the coefficient a , especially at the higher velocities. This reduction is on the order of 5% at 150 miles per hour.

Effect of Aspect Ratio

It is evident that, with specimens of this kind, the length of the specimen parallel to the air stream will have a profound effect upon the heat transfer, due to the fact that the velocity of air between the fins probably decreases and the temperature of the air increases as the air passes from the entering edge toward the downstream end of the spaces between fins. This should cause a reduction in the heat transfer at the downstream end of the fins as compared to the upstream end. This

reduction in heat transfer should be indicated by an increase in fin tip temperature in passing from the upstream to the downstream end of the fin. In order to detect this, thermocouples were placed on the tip of the central fin of each specimen at various distances from entering edge, as can be seen in Figure 6.

Figures 7 to 16 inclusive, show Δt (difference between fin tip temperature and air) plotted against "aspect ratio," which for purposes of these experiments is defined as the ratio of the distance of the thermocouple from the entering edge of the fin to the depth of the fin, which depth in each case is 1 inch.

Referring to Figures 7 to 16 inclusive, it is interesting to note that at the lower speeds and for the larger values of P , the fin tip temperature appears to attain a maximum value before reaching the highest aspect ratio. This indicates that a condition of equilibrium has been reached which would probably carry along indefinitely as the length of the fins parallel to the air stream is increased. An explanation of this is offered by the supposition that at a certain distance from the entering edge of the fins the air reaches an equilibrium velocity, depending on the tunnel velocity, and reaches also an equilibrium temperature, due to the fact that the air between the fins is replaced by fresh air through turbulence. It would naturally be expected that the smaller the spacing between the fins and the higher the velocity, the longer would be the distance required

to attain such equilibrium conditions. It is quite obvious that equilibrium conditions have not been attained, in the length of finning available, at the higher velocities and smaller pitches. It would be interesting to find the equilibrium aspect ratio for all pitches by using specimens of greater length, and it is planned to do this at a later date.

F u t u r e W o r k

It is planned to continue work in this general field. To date, only the variable of pitch has been investigated to any considerable extent. Further investigation will be made of the effects of aspect ratio, fin depth, fin shape, and fin material. It is also planned to make a careful exploration of the air velocities between the fins of the present specimens in order to develop, if possible, a relation between air velocity between the fins and the heat transfer coefficient of the specimen. Eventually it is hoped to do some work on cylindrical specimens. This, however, must await the completion of the work on the flat specimens, which is considered fundamental.

A p p e n d i x I Calculation of Marginal Heat Losses

To determine the heat loss from the margin of the specimens the following method was used: Runs were made, for varying velocities with two plain plates of different size. The "standard plate" (6-3/4 inch x 6-3/4 inch) and the "small plate" (6-3/4 inch x 2-13/16 inch). For both plates the horizontal margins had the same area, but the vertical margin was shorter and the ratio of total margin to heated area was much greater for the small plate. Both plates were mounted in asbestos in the same way. The total heat input to either plate must equal the heat loss from the surface of the heated section plus the heat loss from the margin into the air stream and the asbestos. Expressed as an equation

$$H = A (a \rho \Delta T) + A_m (a_m \rho \Delta T_m)$$

H = b.t.u. per hour electrical input to specimen.

A_m = area of margin in square inches.

ΔT_m = temperature difference between margin and air.

a_m = margin coefficient, b.t.u./sq.in./°F/hr.

The above equation holds good for both the large and small plates. H , ΔT , ρ , and ΔT_m having been determined for both plates by test, and A and A_m by measurement, two simultaneous equations are available from which the values of the unknowns a and a_m may be calculated for any given air velocity. The

values of a_m so determined are plotted in Figure 28, and may be used to determine the marginal heat loss for any specimen, assuming that a_m is constant for any given air velocity.

For any finned specimen

$$a = \frac{H - A_m (a_m \rho \Delta T_m)}{A (\rho \Delta T)},$$

where a_m is obtained from the margin correction curve.

Massachusetts Institute of Technology,
Cambridge, Mass.,

B i b l i o g r a p h y

1. Harper 3d, D. R. and Brown, W. B. : Mathematical Equations for Heat Conduction in the Fins of Air-Cooled Engines. N.A.C.A. Technical Report No. 158, 1923.
2. Alcock, J. F. : Air Cooling. An Experimental Method of Evaluating the Cooling Effect of Air Streams on Air-Cooled Cylinders. N.A.C.A. Technical Memorandum No. 412, 1927.
3. Parsons, S. R. and Harper, D. R. : Radiators for Aircraft Engines. Bureau of Standards Technical Paper No. 211, 1922.
4. Lanchester, F. W. : Surface Cooling and Skin Friction. British A.C.A. R&M No. 94, 1913.
5. Stanton, T. E. (Part I)
Pannell, J. R. (Part II)
Stanton, T. E., and Marshall, Dorothy (Part III) : Heat Transmission Over Surfaces. Part I: Note on the Transmission of Heat from the Surface of a Hot Body to Fluids Flowing Over It; Part II: Experiments on Heat Transmission in the Case of Air Flowing through a Heated Pipe; Part III: Preliminary Note on the Effect of Surface Roughness on the Heat Transmitted from Hot Bodies to Fluids Flowing Over Them. Brit. A.C.A. R&M No. 243, 1916.
6. Stanton, T. E., Booth, H. C. and Marshall, Dorothy : On the Effect of Surface Roughness on the Heat Transmitted from Hot Surfaces to Fluids Flowing Over Them, with Special Reference to the Case of the Gills of an Air-Cooled Engine. Brit. A.C.A. R&M No. 271, 1917.
7. Taylor, G. I. : Conditions at the Surface of a Hot Body Exposed to the Wind. Brit. A.C.A. R&M No. 272, 1916.
8. Barr, Guy : On Dope Softeners. Brit. A.C.A. R&M No. 291, 1916.
9. Griffith, A. A. : On the Shape of Fins for the Cooling of Hot Surfaces by a Stream of Air. Brit. A.C.A. R&M No. 308, 1917.

Bibliography (Cont.)

10. Marshall, Dorothy : Further Experiments on the Relation between Skin Friction and Heat Transmission. Brit. A.C.A. R&M No. 1004, 1925.
11. Bryant, L. W.,
Ower, E.,
Halliday, A. S. : On the Convection of Heat from the Surface of an Aerofoil in a Wind Current. Brit. A.C.A. R&M No. 1163, 1928.
and
Falkner, V. M.
12. Gibson, A. H. : The Effect of Enameling on the Heat Transmission from Air-Cooled Surfaces. Brit. A.C.A. Report of Light Alloys Subcommittee, 1921.
13. Sage, C. S. : Journal American Society Heating and Ventilating Engineers, December, 1927.
14. McAdams, W. H.
and
Turner, S. D. : Discussion of Paper of C. S. Sage. : Journal American Society Heating and Ventilating Engineers, April, 1928.
15. Halpine & Finch : Heat Transfer from Finned Cylinders. (Thesis) Library of Massachusetts Institute of Technology.
16. Rogowski, A. R. : An Investigation of the Heat Dissipation Characteristics of Straight Cooling Fins in an Air Stream. (Thesis) Library of Massachusetts Institute of Technology.
17. Gibson, A. H. : The Air Cooling of Petrol Engines. Institution of Automobile Engineers. (British) February, 1920.
18. Walker, Lewis &
McAdams : Principles of Chemical Engineering, 2d edition.
19. Schmidt, E. : Die Waermuebertragung durch Rippen. Zeitschrift des Vereines deutscher Ingenieure, 1926. pp. 885 and 947.
20. Juerges, Dr. W. : Der Waermeuebergang an einer ebenen Wand. Beihefte zum Gesundheits-Ingenieur No. 19 Verlag von R. Oldenburg, Meunchen-Berlin, 1924.
21. Merkel. F. M. : Die Grundlagen der Waermeuebertragung. Verlag von Theodor Steinkopf, Dresden-Leipzig, 1927.

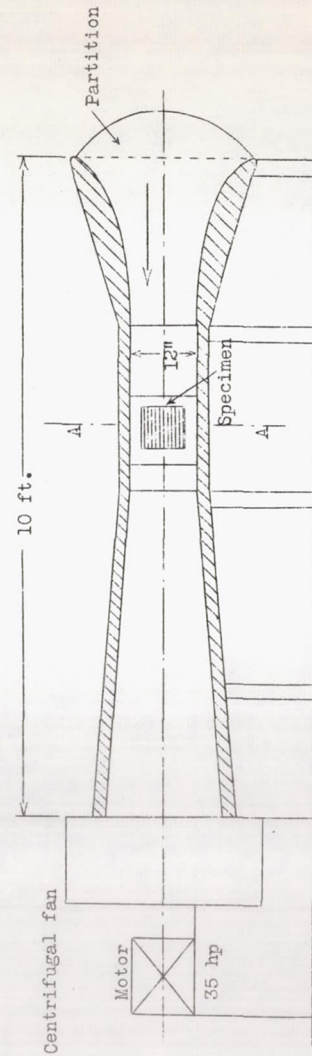

FIG.1 Wind tunnel

Wires for heating element and thermocouples.

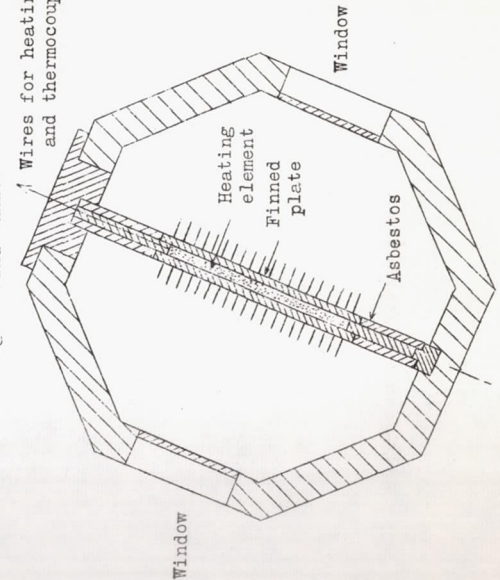

Fig.2 Cross-section A -A.

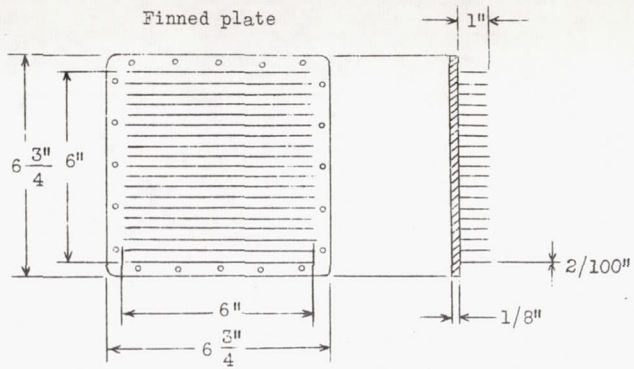

Fig. 3

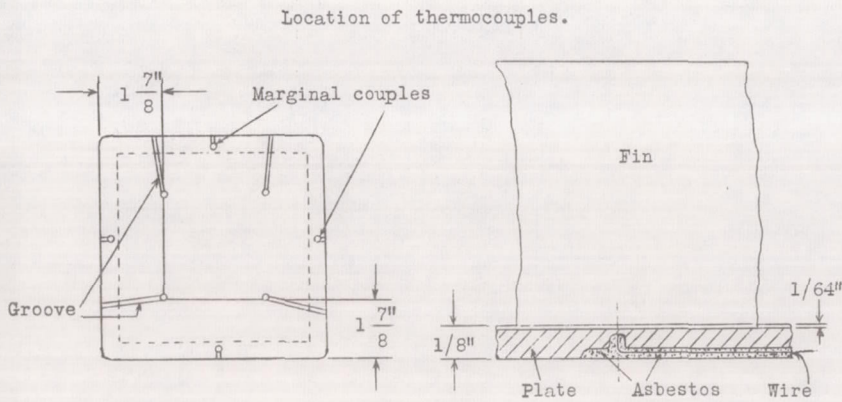

Fig. 4

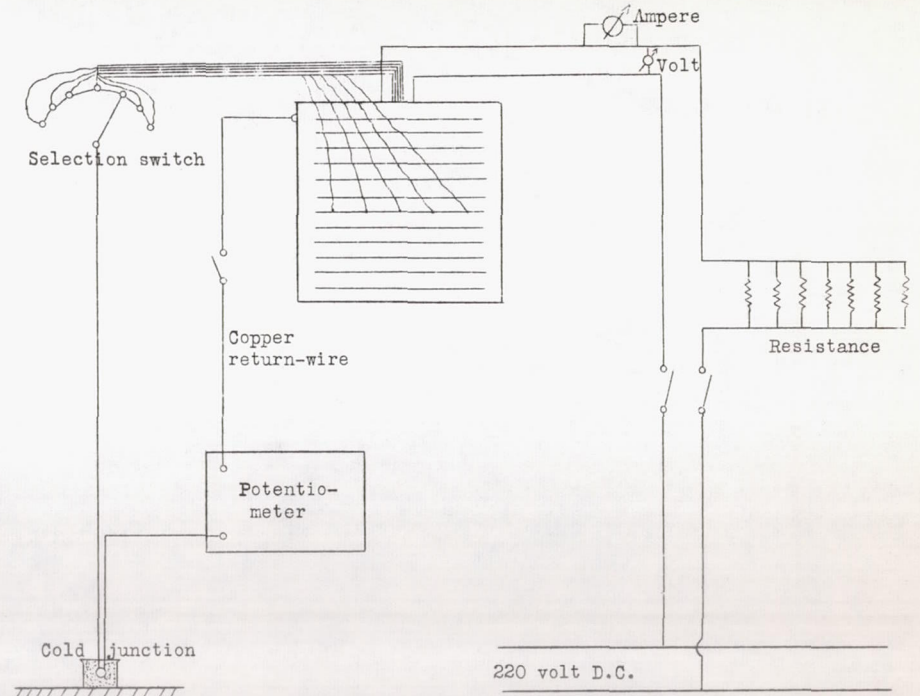

Fig. 5 Electrical connections used for heater and thermocouples.

Fig.6

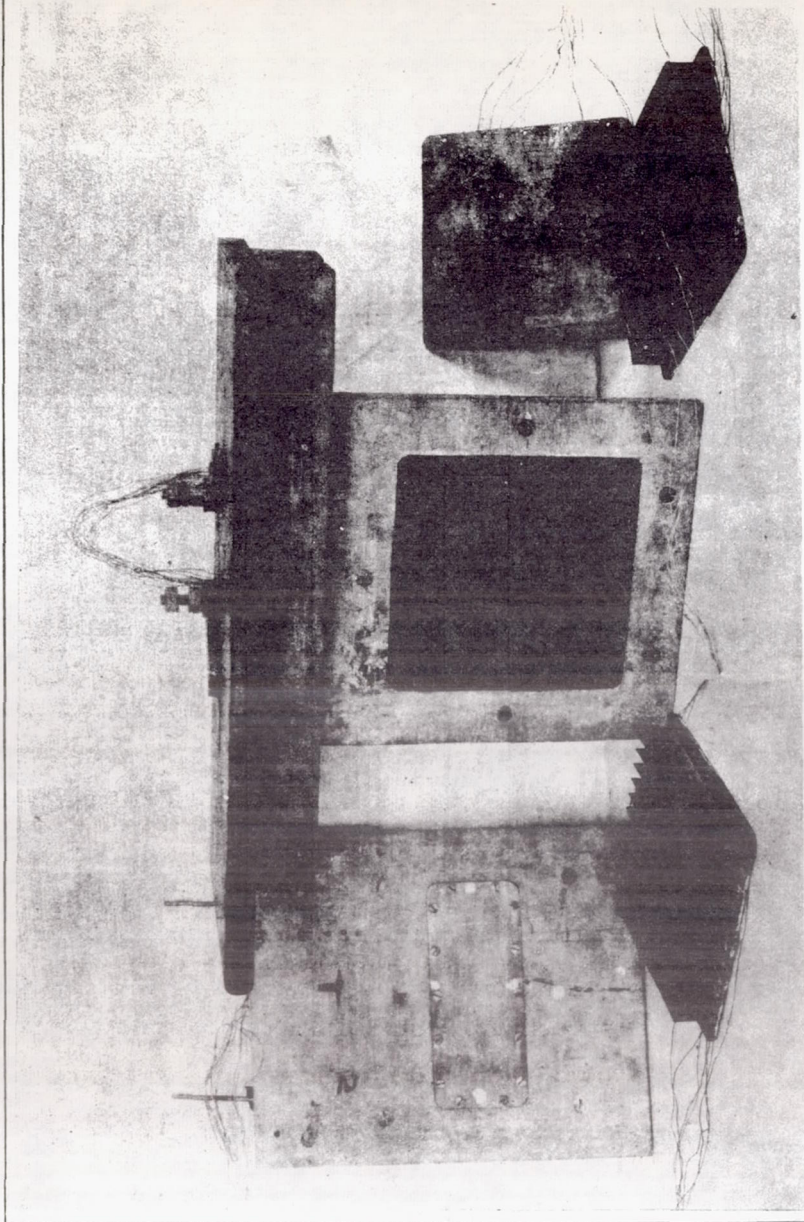

Fig.6

Fig.7

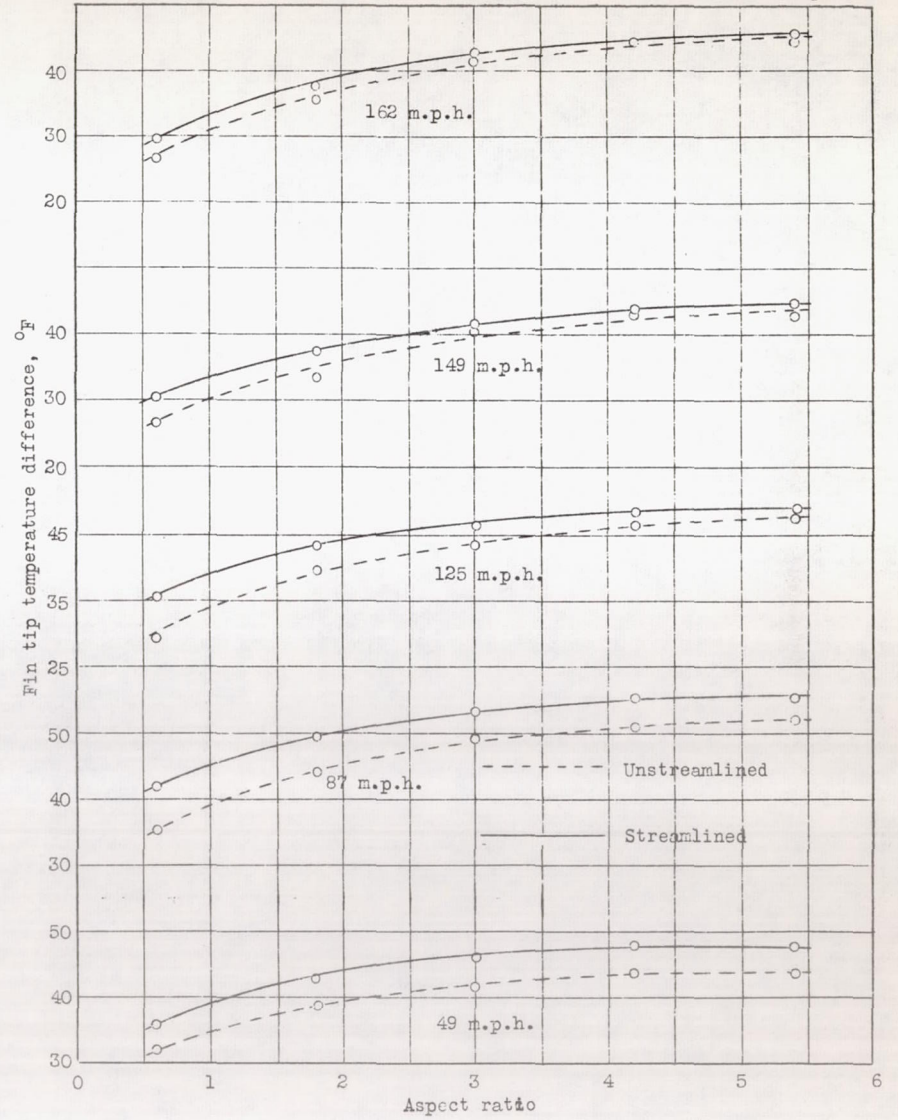

Fig.7 Effect of aspect ratio on fin tip temperature. 1/2 pitch.

Fig.8

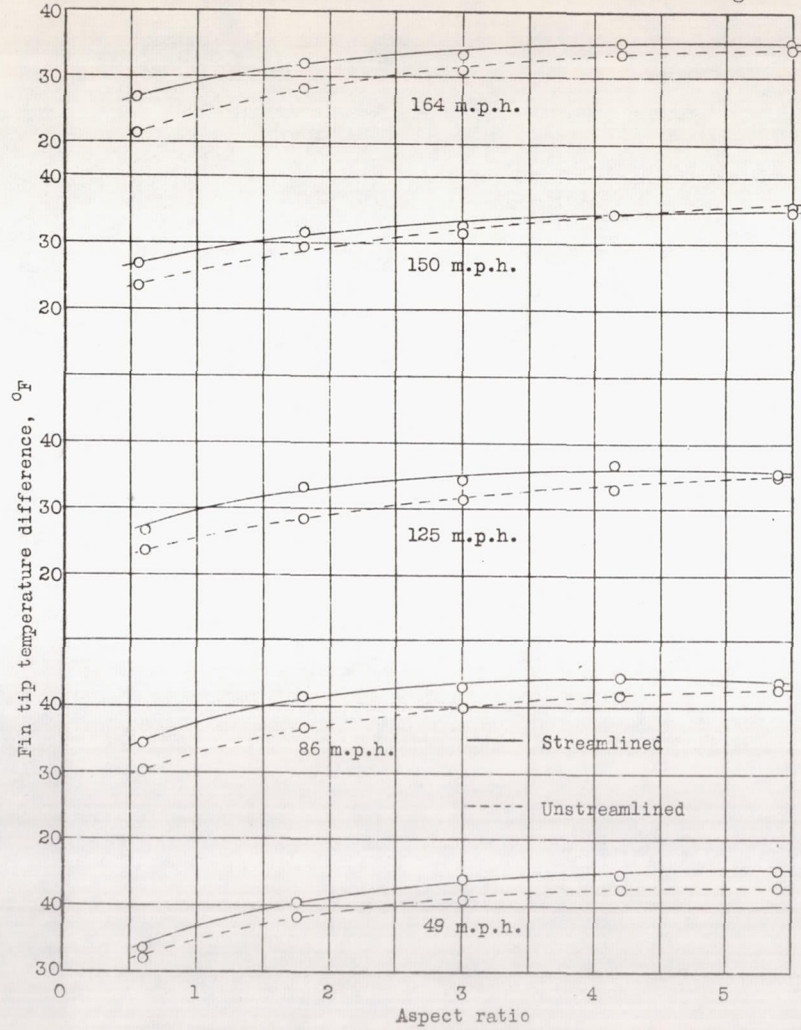

Fig.8 Effect of aspect ratio on fin tip temperature.1/3 pitch.

Fig.9

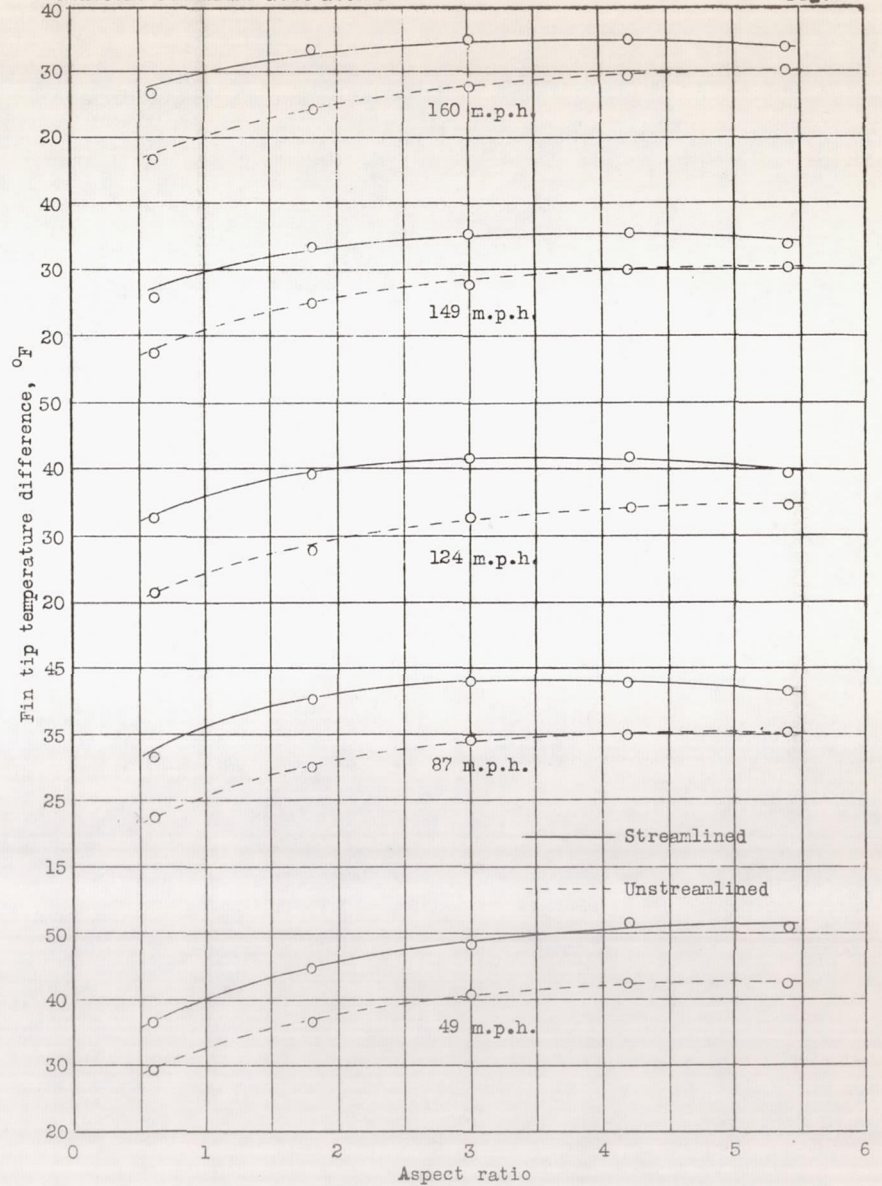

Fig.9 Effect of aspect ratio on fin tip temperature.1/4 pitch.

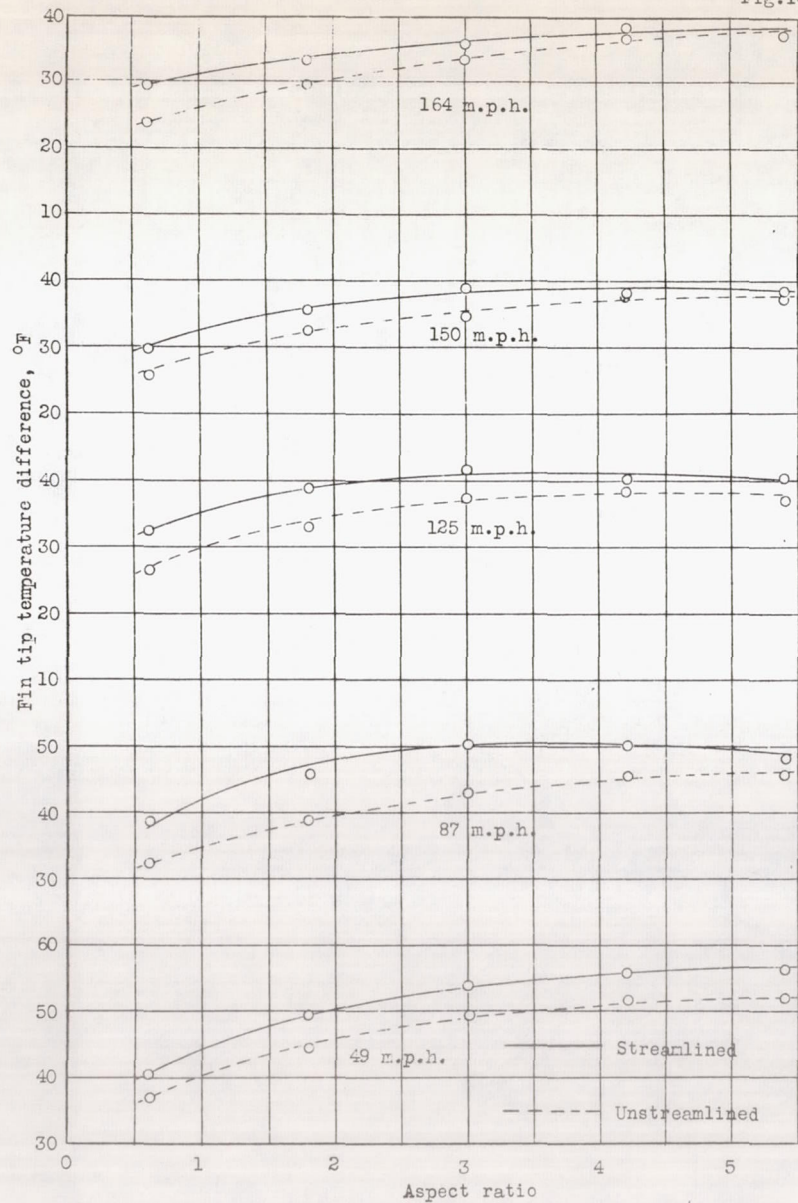

Fig.10 Effect of aspect ratio on fin tip temperature.1/6 pitch.

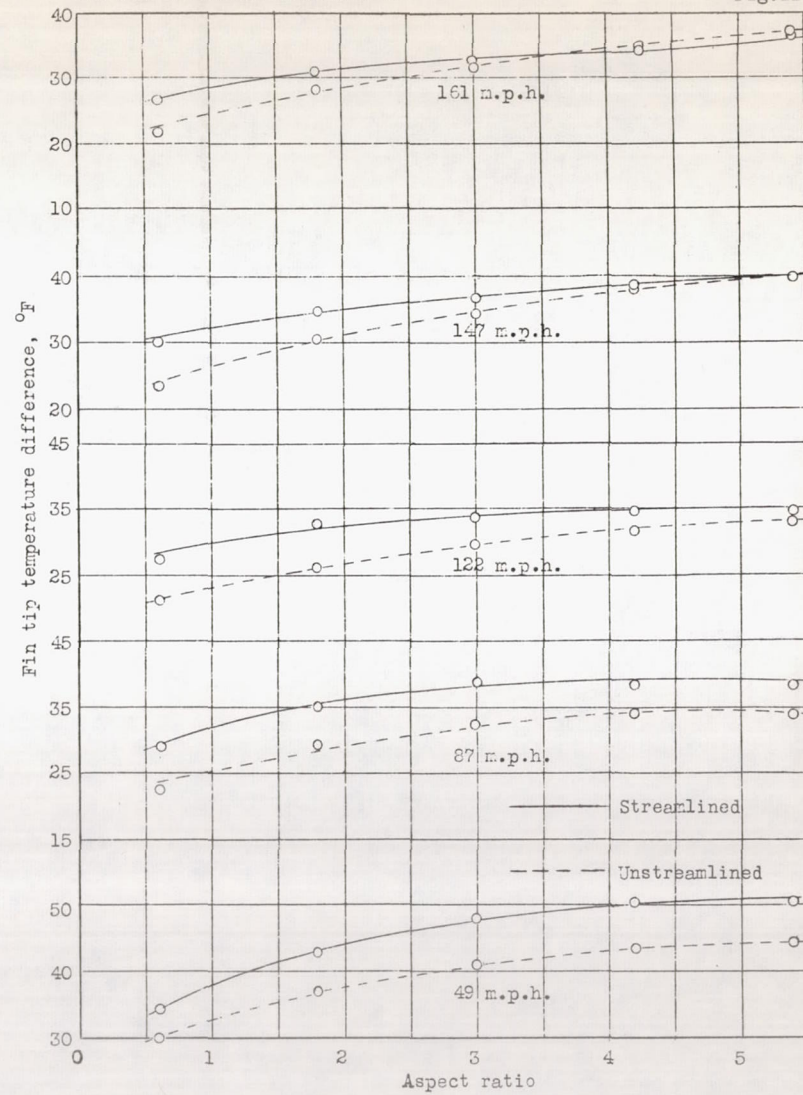

Fig.11 Effect of aspect ratio on fin tip temperature.1/7 pitch.

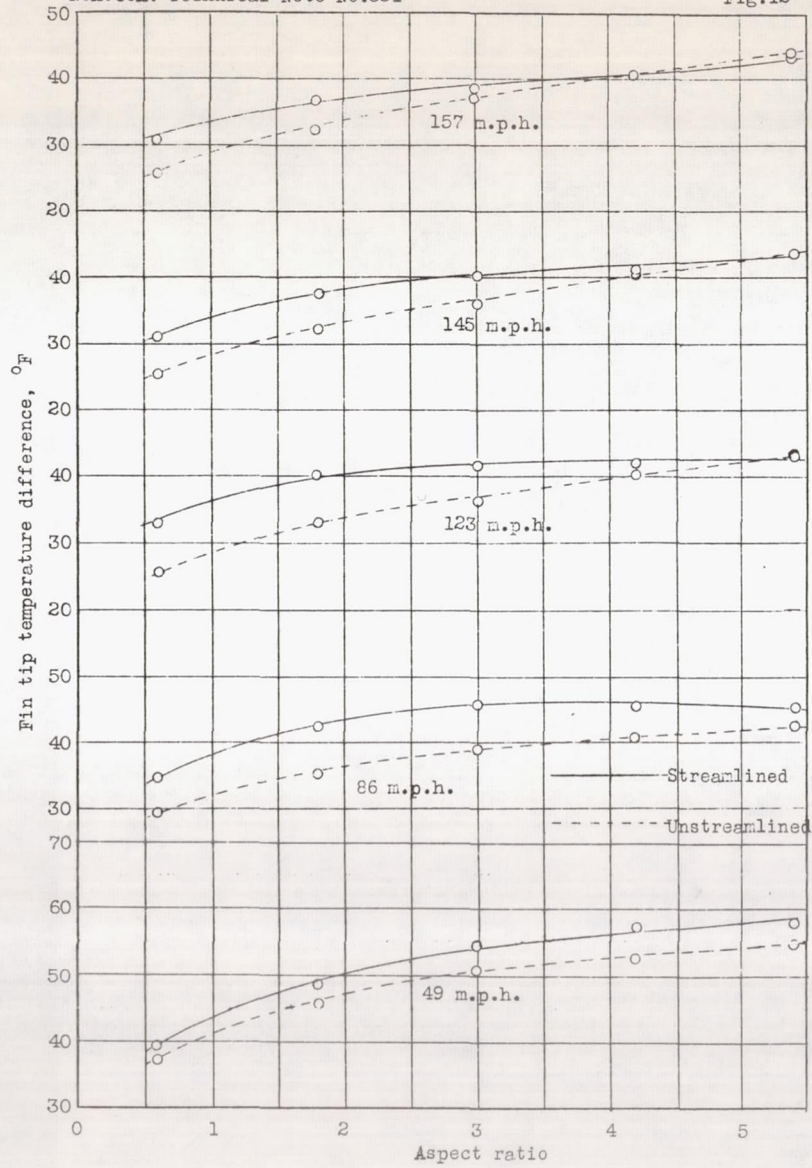

Fig.12 Effect of aspect ratio on fin tip temperature.1/8 pitch.

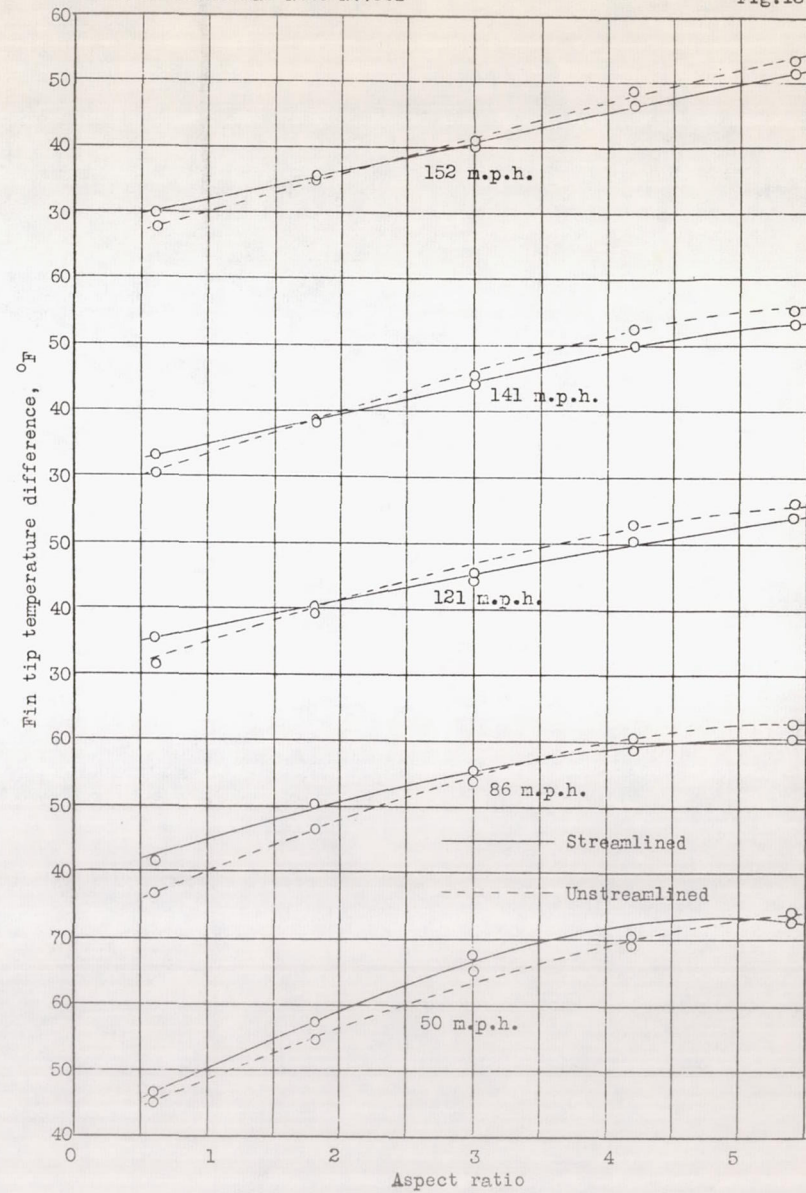

Fig.13 Effect of aspect ratio on fin tip temperature.1/9 pitch.

Fig.14

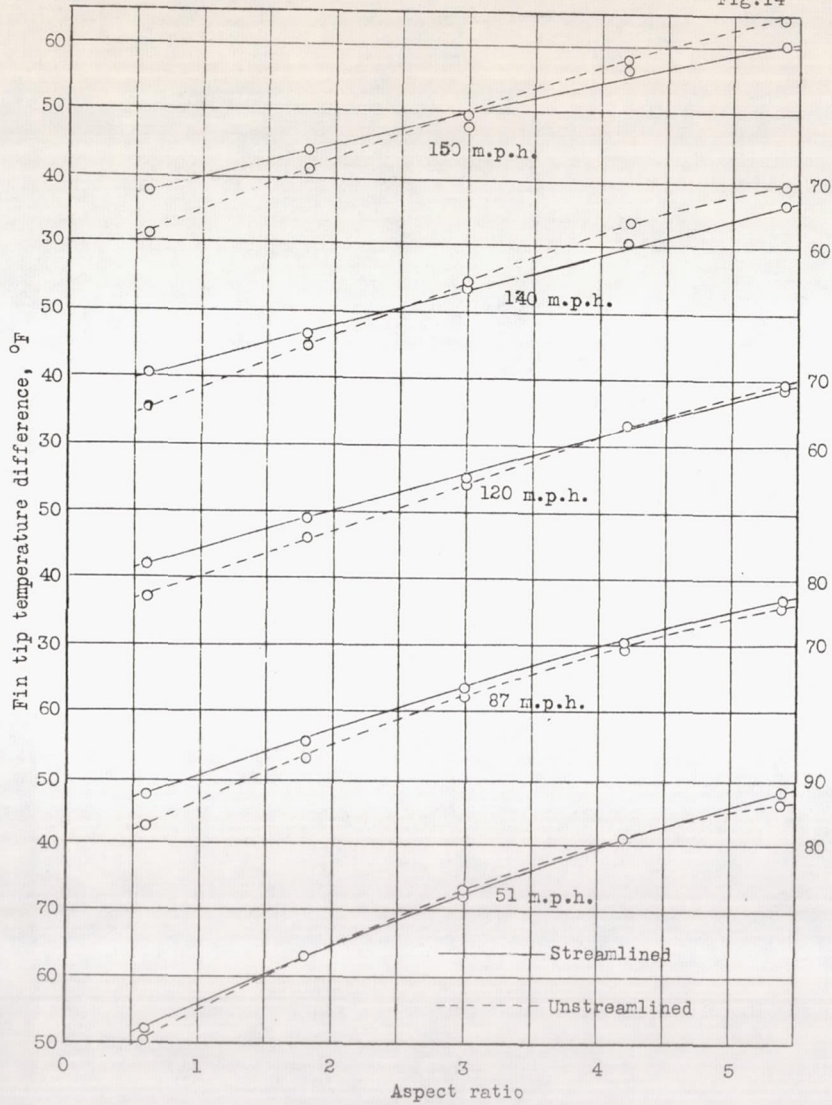

Fig.14 Effect of aspect ratio on fin tip temperature. 1/10 pitch.

Fig.15

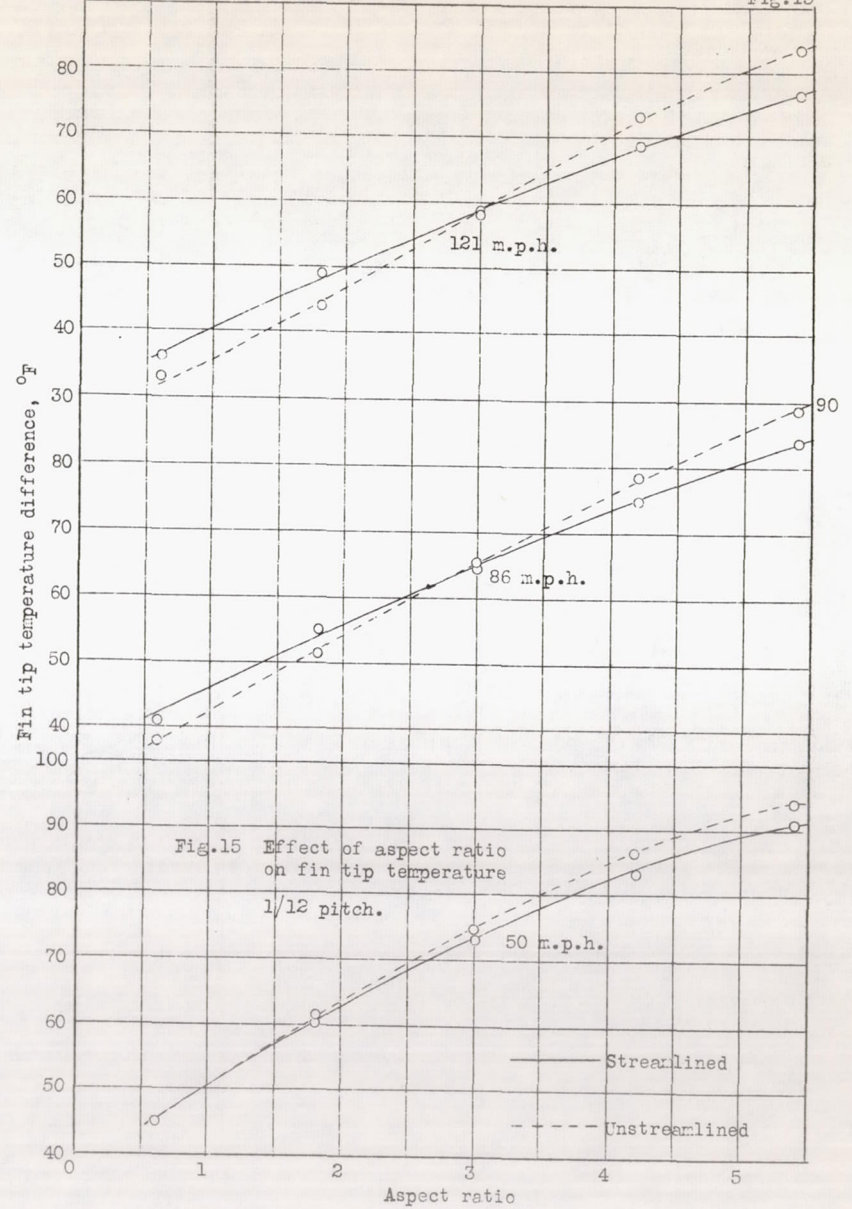

Fig.15 Effect of aspect ratio on fin tip temperature. 1/12 pitch.

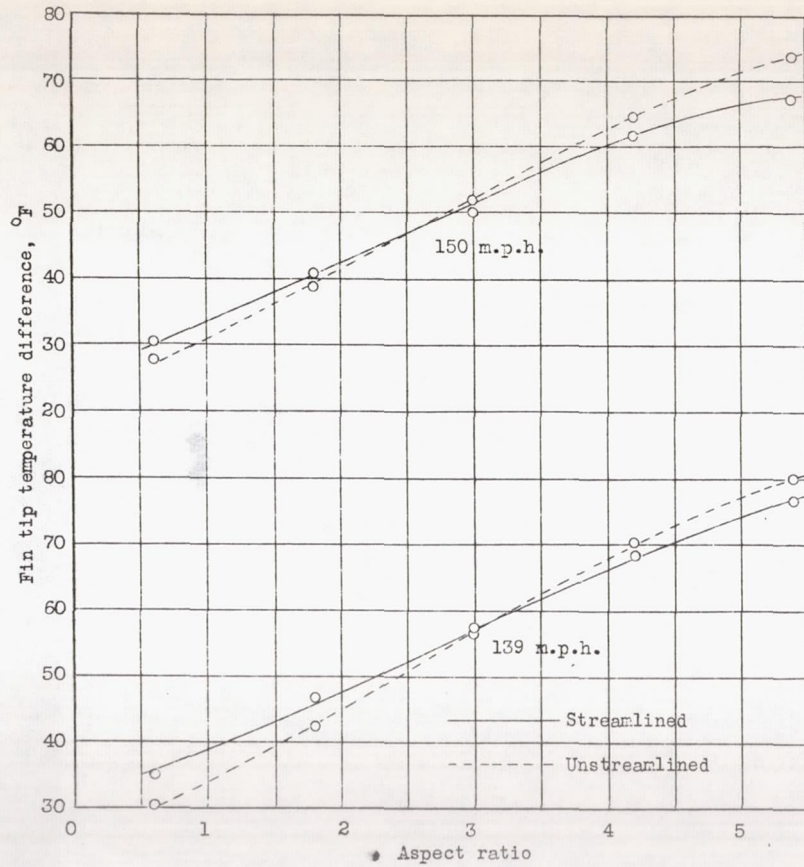

Fig.16 Effect of aspect ratio on fin tip temperature 1/12 pitch.

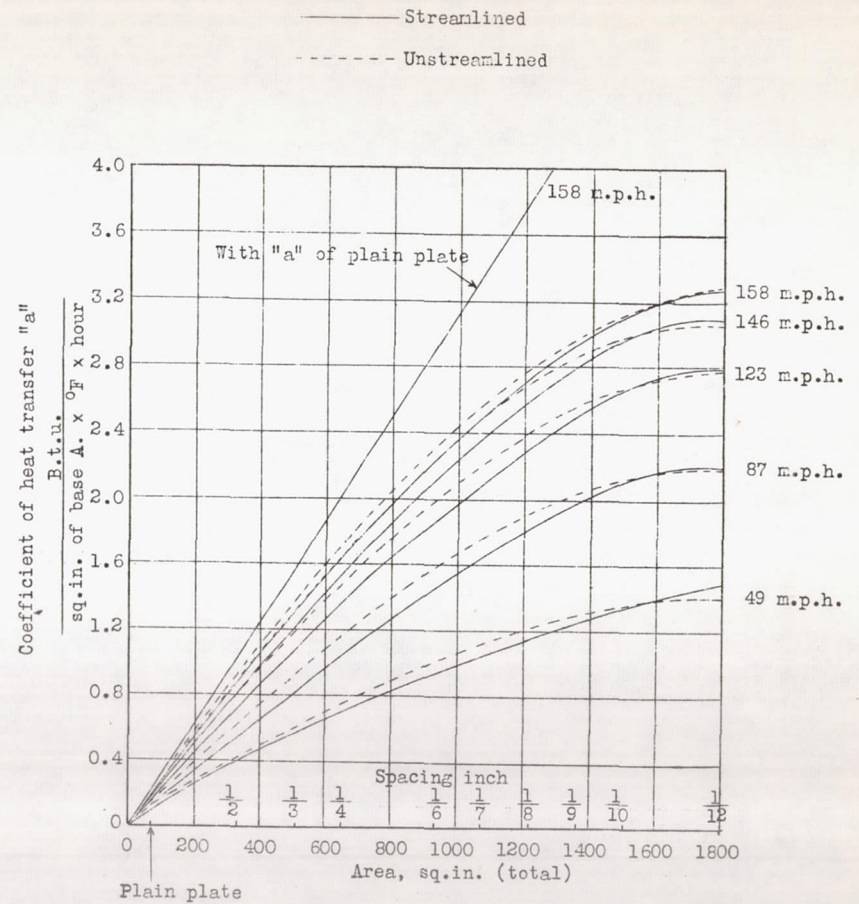

Fig.17 Effect of area and velocity on heat transfer.

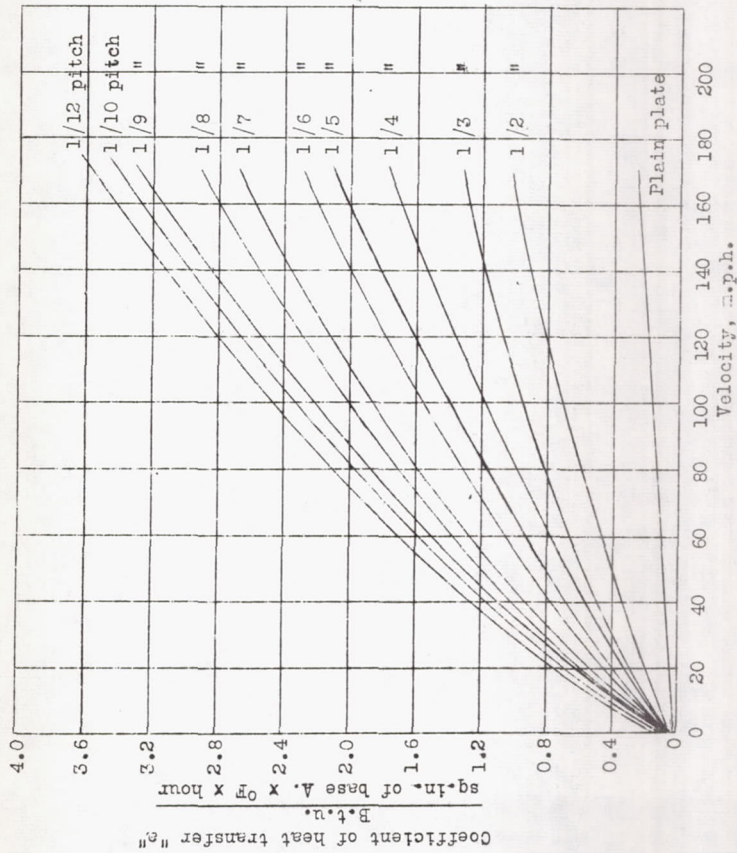

FIG. 18 Effect of velocity and area on heat transfer.

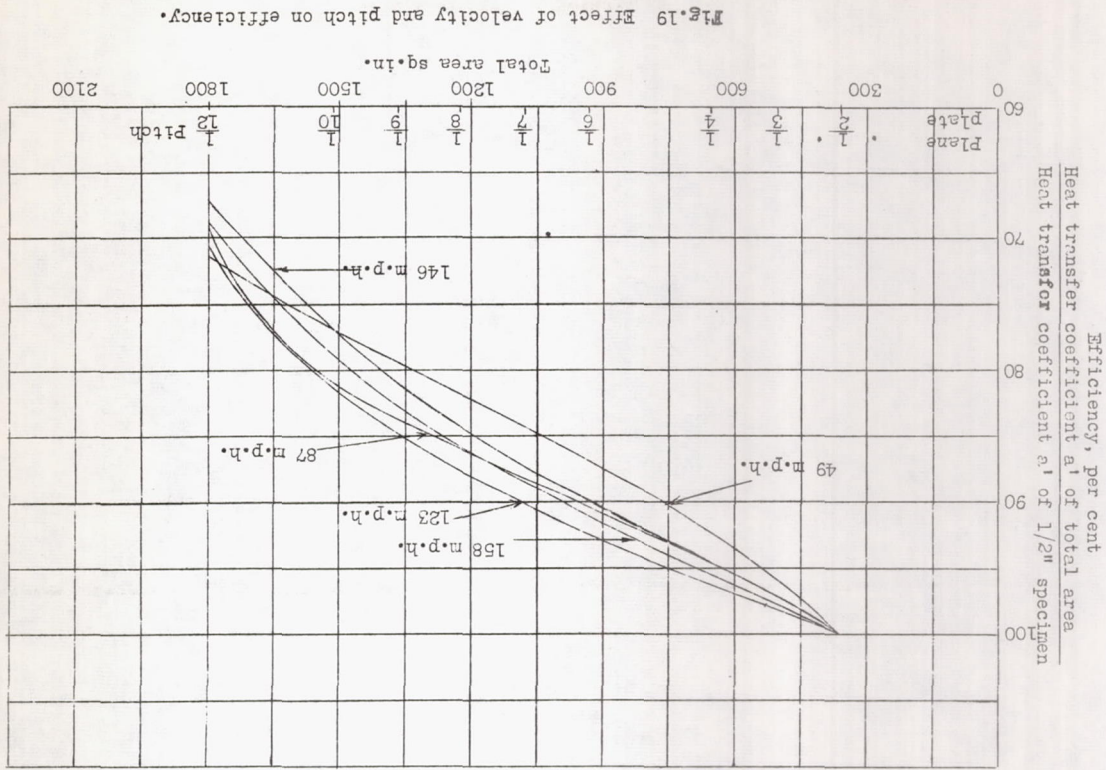

Fig. 19 Effect of velocity and pitch on efficiency.

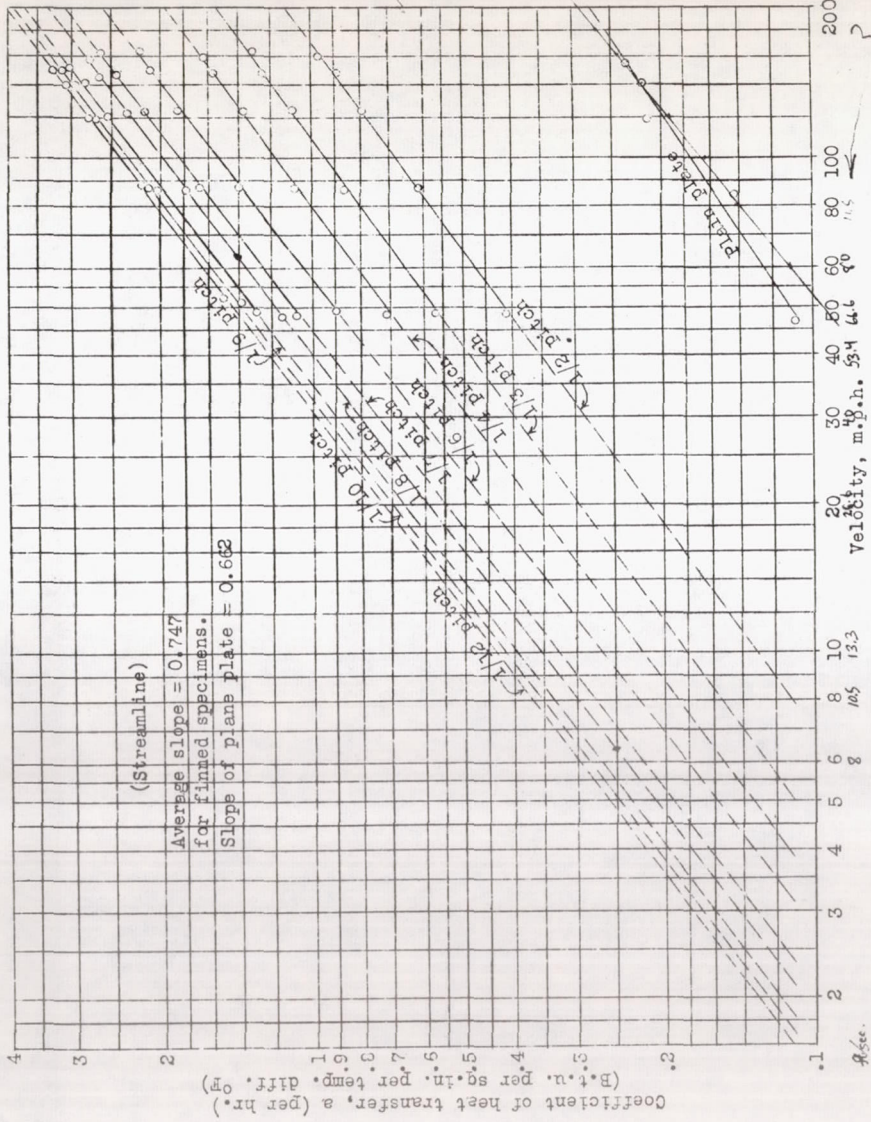

Fig.20 Relation of heat transfer to velocity.

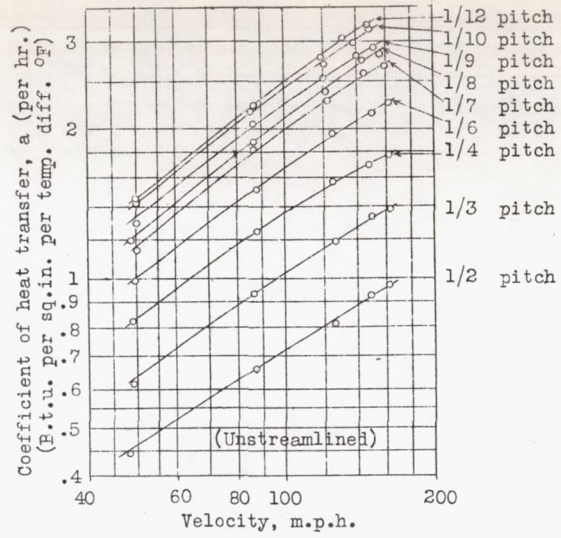

Fig.21 Relation of heat transfer to velocity.

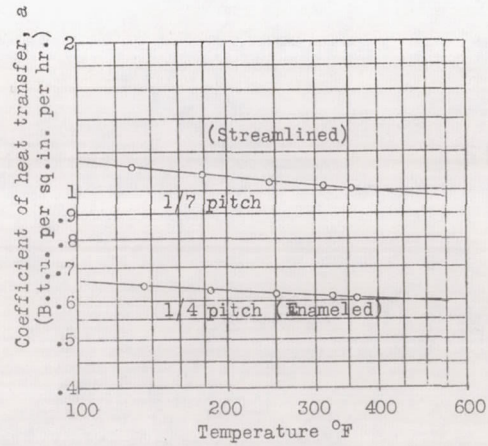

Fig.22 Relation of heat transfer to temperature.

Slope of 1/7 pitch = -0.105 Slope of 1/4 pitch = -0.070

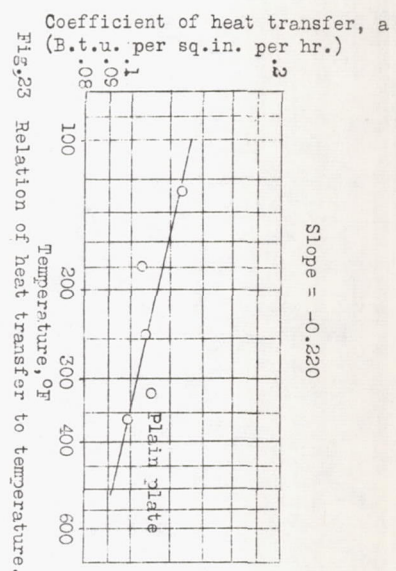

Fig. 23 Relation of heat transfer to temperature.

Figs. 23, 24.

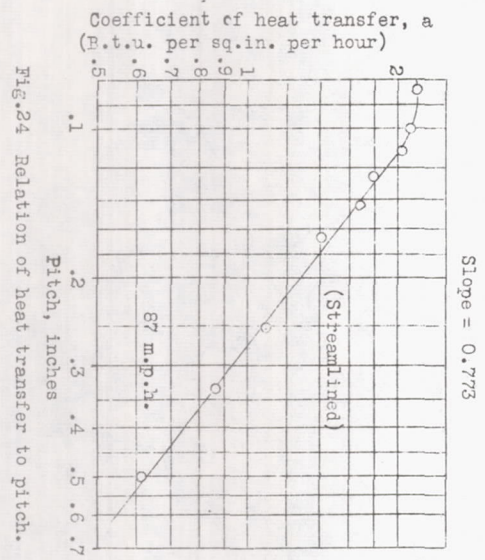

Fig. 24 Relation of heat transfer to pitch.

- × R.S. Riley, E.W. Conlon ($\alpha=5^\circ$) M.I.T. 29.
- + F.M. Bondor M.I.T. 29.
- ⊙ A.R. Rogowski M.I.T. 28.
- Dr. W. Juerges Germany 24.

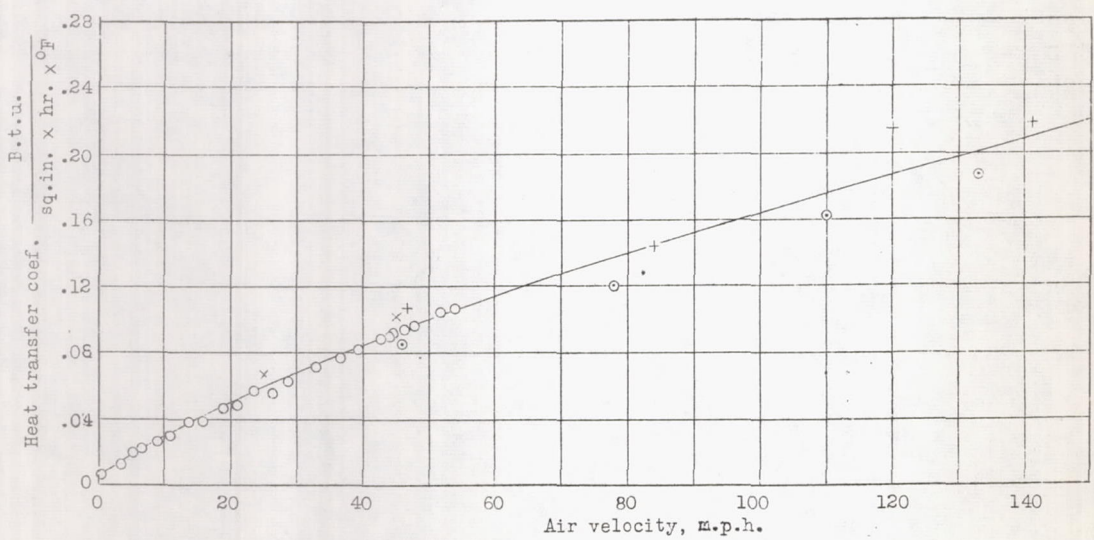

Fig. 25 Heat transfer coefficient vs. air velocity.

Fig. 25

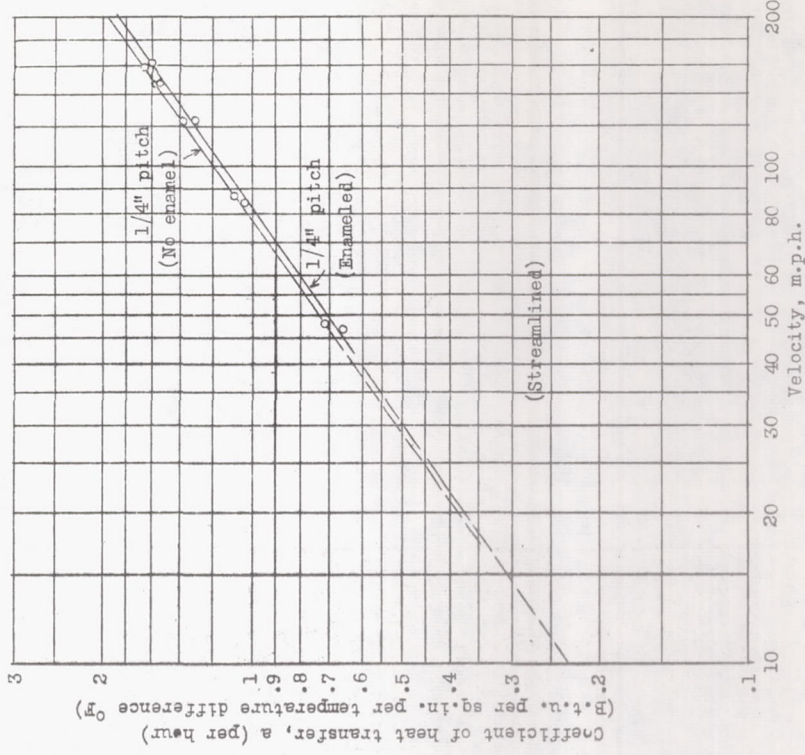

Fig.27 Relation of heat transfer to velocity.

Slope = 0.700 (Enameled)

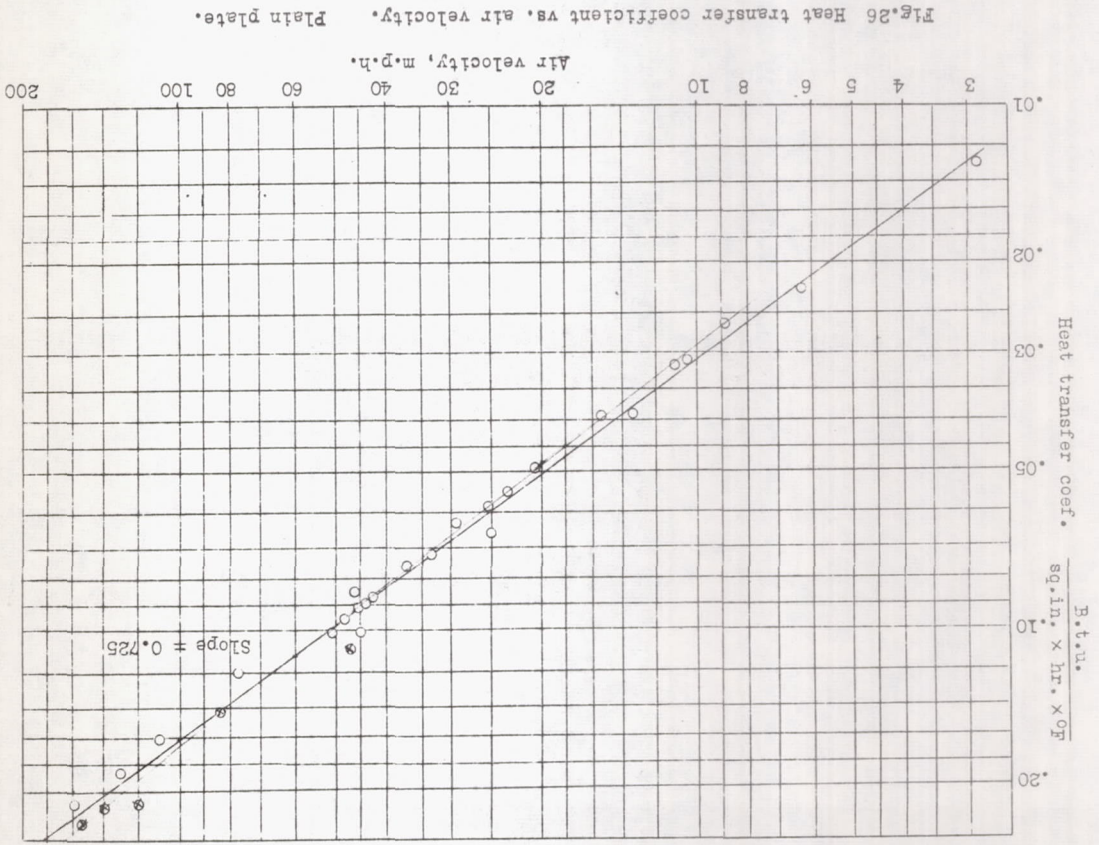
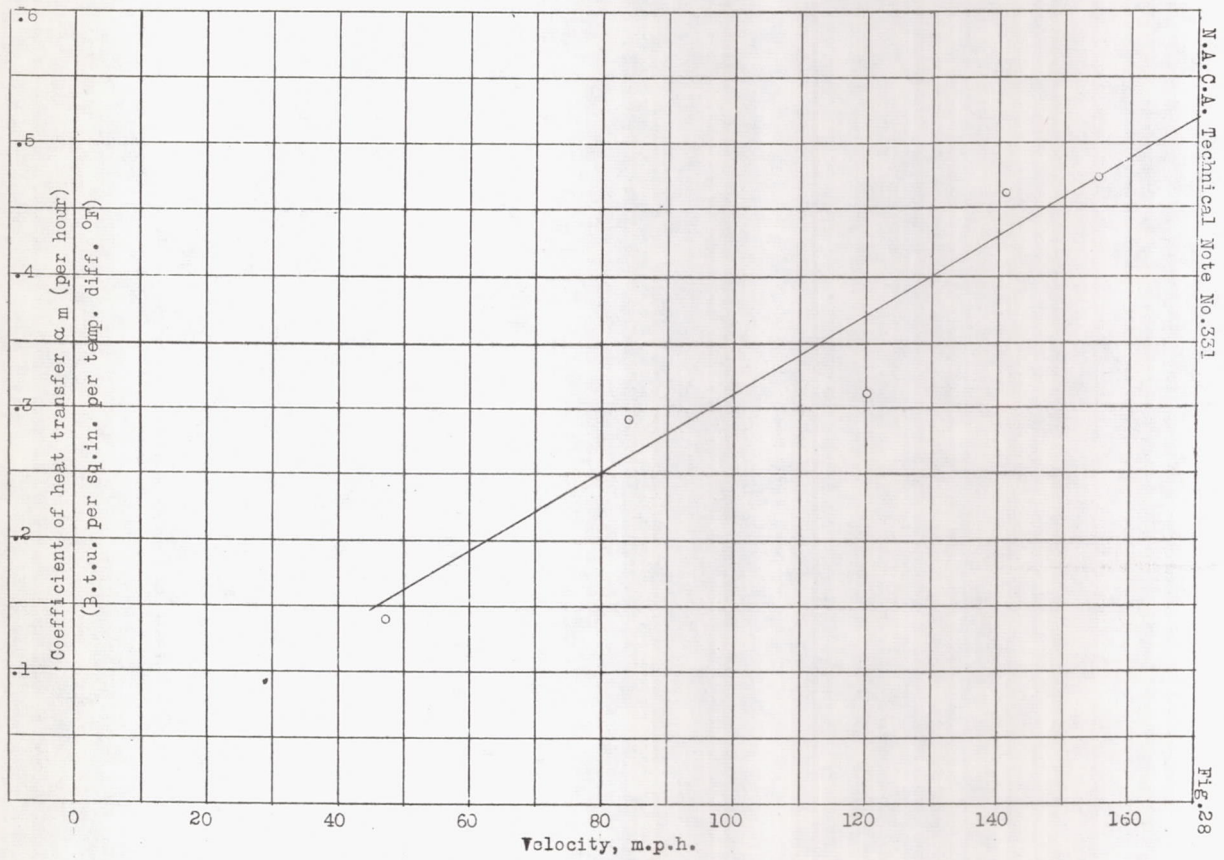

Fig.26 Heat transfer coefficient vs. air velocity. Plain plate.



N.A.C.A. Technical Note No.331

Fig.28

Fig.28 Correction curve for marginal loss.