

NATIONAL ADVISORY COMMITTEE

FOR AERONAUTICS

MAILED

OCT 1 1929

N 62 52320

TO: *Dr. Burgess*

TECHNICAL NOTES

CASE FILE
COPY

NATIONAL ADVISORY COMMITTEE FOR AERONAUTICS

No. 320

THE DRAG AND INTERFERENCE OF A NACELLE IN
THE PRESENCE OF A WING

By Eastman N. Jacobs
Langley Memorial Aeronautical Laboratory

Washington
October, 1929

NATIONAL ADVISORY COMMITTEE FOR AERONAUTICS.

TECHNICAL NOTE NO. 320.

THE DRAG AND INTERFERENCE OF A NACELLE IN THE PRESENCE OF A WING.

By Eastman N. Jacobs.

Summary

A wing-nacelle interference investigation was conducted in the Variable Density Wind Tunnel of the National Advisory Committee for Aeronautics, to determine why the N.A.C.A. cowling did not yield the expected increase in speed when adapted to the outboard nacelles of trimotored airplanes. The interference and drag of a combination of a wing and nacelle were measured for several different positions of the nacelle, and also, for several different forms of nacelle-to-wing fairing.

The results indicate that the drag and interference of a Wright Whirlwind engine nacelle with the N.A.C.A. cowling, when combined with a thick wing, can be reduced from its value as originally applied of 152 lb., to 25 lb. at 100 m.p.h., by changing its position and fairing it into the wing.

Introduction

With the better general understanding of the aerodynamic behavior of bodies there has come a growing interest in the problem of interference. This interest has been shown to be well justified by a few more or less haphazard investigations.

REPRODUCED BY
NATIONAL TECHNICAL
INFORMATION SERVICE
U.S. DEPARTMENT OF COMMERCE
SPRINGFIELD, VA. 22161

The National Advisory Committee for Aeronautics, realizing the importance of this problem, has formulated an extensive research program of which this investigation, dealing with the interference between an engine nacelle and wing without including propeller interference, may be considered a preliminary part. At present, the program is being carried further by testing combinations of nacelles and wings in the propeller research tunnel so that propeller interference effects may be included.

The problem of how a fuselage or nacelle should be combined with a wing in order to minimize adverse aerodynamic interference between them is probably one of the most important. This was demonstrated by flight tests of a trimotored Fokker F-7 conducted by the Flight Operations Division of the Committee's laboratory before and after applying the N.A.C.A. cowling to the engines. Tests on a nacelle alone in the propeller research tunnel had indicated that a marked increase in the high speed of the airplane might be expected from the application of the new cowling. However, the flight tests indicated only a slight increase in speed. The outboard engines on this airplane are so located that when the cowling was applied it came to within 3 inches of the lower surface of the wing. It seemed obvious that the failure to secure the expected increase in high speed must be due to interference effects between the nacelle and the wing. The present investigation was undertaken in the Variable Density Wind Tunnel to study this interference and the possibil-

ity of reducing it either by fairing the nacelle into the wing or by changing its relative position.

Since the results obtained were to be used as a guide in subsequent modifications to the full scale airplane, the tests in the tunnel were simplified so that the results could be made available as soon as possible. Tests were made with tunnel air pressures of 1 and 10 atmospheres on a one-tenth scale model nacelle mounted on a simplified wing. The lift and drag were measured only at angles of attack near zero degrees, corresponding to the angle of attack for high-speed flight of the airplane. The propeller was omitted altogether and no account was taken of its effect. Several different vertical positions of the nacelle were investigated as well as several types of fairing into the wing. The fore and aft position with respect to the wing was not changed.

Apparatus and Tests

The Variable Density Wind Tunnel and the theory underlying its operation are described in Reference 1. The tunnel, however, has since been rebuilt as an open throat type having an air stream at the test section 5 feet in diameter.

A rectangular wing of mahogany, 36 by 14-3/4 inches, was used in conjunction with the nacelles. The section of the wing was built according to the dimensions given in Figure 1, which were taken from the Fokker F-7 airplane wing at a station in the neighborhood of one of the nacelles. For this investigation

it was considered unnecessary to model the entire wing accurately, and by reducing the aspect ratio, it was possible to test a wing section and nacelle as large as one-tenth scale. The ends of the wing were rounded in order to reduce its drag, but otherwise it had a uniform section along the span.

Two nacelle models were used in the investigation, one of the conventional type and one similar to a nacelle having the N.A.C.A. cowling. The conventional nacelle, however, was tested only in one combination with the wing in order to determine its drag and interference as installed on the Fokker airplane.

The N.A.C.A. nacelle model was built one-tenth scale according to dimensions and drawings given in Reference 2. The main body was turned from one piece of wood and the nose cap from another (Fig. 5). These two parts were held in their proper relative positions by means of dowels passing through the cap and into the nacelle. These dowels, passing across the air space, also simulated the cylinders in the full scale nacelle. Some doubt was felt as to whether these dowels simulated the cylinders with sufficient accuracy; consequently, the drag of the nacelle alone was measured at a pressure of 10 atmospheres to obtain a check with the tests on a similar full scale nacelle in the propeller research tunnel. The results, expressed in pounds at 100 m.p.h., were as follows:

Variable Density Tunnel (1 atmosphere)	50
Variable Density Tunnel (10 atmospheres)	39
Propeller Research Tunnel	43

The Reynolds Number corresponding to the 10-atmosphere tests in the Variable Density Wind Tunnel was approximately one-half that of the tests in the Propeller Research Tunnel.

A nacelle simulating the original Fokker nacelle was also built so that the drag of the original combination could be measured. This model was made from measurements taken from the airplane. Figure 4 indicates the general shape of the nacelle and how the Wright Whirlwind engine was modeled. The drag of this nacelle and engine was measured, with the following results, expressed in pounds at 100 m.p.h.:

Variable Density Tunnel (10 atmospheres)	165
Propeller Research Tunnel	155

The last figure represents the result of a test in the propeller research tunnel on a nacelle of about the same proportions, but of somewhat better shape (Reference 2).

The nacelles were attached to the wing by three dowels, the exposed parts of which were reduced to approximate streamline strut sections. Force tests on each combination of wing and nacelle were made with air densities in the tunnel of 1 and 10 atmospheres at angles of attack of -4° , -2° , 0° , 2° , and 4° . A similar test was made on the wing without the nacelle and supporting struts.

The drag of the combination and the drag of the wing alone were plotted against lift. At a given lift the difference between the two values was taken as representing the additional drag incurred by the addition of a nacelle. This difference will be spoken of as the drag and interference of the nacelle.

R e s u l t s

Curves are plotted in Figures 2 and 3, representing the drag and interference, expressed in pounds at 100 m.p.h., of the nacelles under the various conditions. The curves in Figure 2 indicate the drag and interference of the nacelle when it is placed in various positions above and below the wing. In Figure 3 the effect of combining the nacelle with the wing in different ways is shown. In both figures the curves are plotted against the lift of the combination and the dotted line connecting a point on each curve indicates zero angle of attack which is approximately the condition of high-speed flight of the Fokker F-7 airplane. The small sketches on the figures designated A to H indicate approximately how the nacelle and wing were combined.

Combination A (Fig. 4) represents the original uncowled nacelle located as on the airplane and B (Fig. 5) represents the same location, but with the N.A.C.A. cowling. This is the condition for which dimensions are given in Figure 1. Combination C (Fig. 6) represents the same location except that the nacelle has been lowered a distance corresponding to 10

inches full scale. Combination D represents the nacelle lowered 30 inches from the original position, which is sufficient to allow the slip stream to pass under the wing. Combinations E and F represent nacelle locations above the wing, the distance from the top of the wing to the bottom of the nacelle being 10 inches for combination E, and 30 inches for combination F.

The results of fairing the nacelle into the wing are shown in Figure 3. Sketches indicating the type of fairing and position of nacelle are given on the figure. The photographs of the models (Figs. 7 to 12), indicate more accurately the fairing used in each case. As shown in the photographs, the fillets and, in some instances, all of the fairings, were formed from plasticine. Conditions G, H and I represent different types of fairing with the position of the engine unaltered. To obtain combination J, the cowling was raised to bring the top into the leading edge of the wing. For combination K, the cowling was raised sufficiently to give a slot of normal width for discharging the cooling air over the upper surface of the wing. Combination L represents a position of the nacelle in which most of its body is enclosed within the wing.

D i s c u s s i o n

This investigation, while limited in scope, indicates clearly the importance of interference effects and how adverse interference effects from nacelle-wing combinations may be re-

duced. The method of investigating the problem, that is, by testing small models at a Reynolds Number approaching that of full scale in the Variable Density Tunnel, while subject to some correction because the propeller is not included, has the decided advantage that alterations to the model may be easily and quickly made. This fact enables results to be produced more quickly and makes it feasible to experiment with small changes in fairing, which would be much more difficult were the tests conducted on a full scale combination.

The effect of propeller interference is usually measured by comparing the propulsive efficiency of a propeller-body combination with that of the propeller alone. The investigation of Reference 3 indicates that this is of secondary importance as compared with the interference effects here considered, provided that the propeller is not unreasonably close to a large object. Therefore, when applying these results, a suitable value for the propulsive efficiency may be taken from Reference 3, which will be slightly lower than the efficiency of the propeller alone.

Effect of Nacelle Position.-- Referring to Figure 2, the effect of changing the vertical location of the nacelle with respect to the wing may be studied. The original location below the wing is least efficient, having a drag and interference of 150 pounds at 100 m.p.h. The importance of this drag may be appreciated by considering that, on the assumption of 75 per cent

propulsive efficiency, the entire 200 hp of the engine would be required to overcome the drag and interference of the nacelle at an air speed of 155 m.p.h. Lowering the nacelle reduced the drag to 75 pounds in spite of the longer supporting struts, the drag of which is included with the nacelle drag and interference. Probably because of the additional strut drag, further lowering of the nacelle reduces the drag only slightly. When the nacelle is placed below the wing its drag decreases as the angle of attack is increased. When the nacelle is placed above the wing the opposite is true and the drag is higher for a given spacing even at small negative angles, so that placing the nacelle over a thick wing should be avoided.

Effect of Fairing the Nacelle into the Wing.— Figure 3 indicates that the most advantageous method of combining a nacelle and wing is to place the nacelle as far as possible within the wing. However, by simply filling in between the wing and nacelle with plasticine, as indicated in Figure 8, without changing the relative location, the drag was reduced from 152 pounds to 49 pounds at zero degrees angle of attack. It should be mentioned that a fairing similar to No. 7 when tried in flight seemed to burble on one side, apparently as a result of the slipstream rotation. Therefore, combinations similar to K and L seem more desirable aside from the fact that the drag is less without the propeller.

Previously it has not been considered desirable to enclose part of the nacelle within the wing because of the disturbing effect of the projecting cylinders on the flow over the wing. However, with a cowling of the engine similar to the N.A.C.A. cowling, this objection is largely removed and there seems to be no objection to utilizing the possible reduction in total frontal area. These results indicate that by changing from the usual combination A, to the best combination with the N.A.C.A. cowling L, the drag is reduced from 162 pounds to 25 pounds at 100 m.p.h., and zero degrees angle of attack.

Interference Effect on the Lift.— Referring to Figures 2 and 3, the effect of the nacelles on the lift of the wing is indicated by the horizontal displacement of the points connected by the dotted line indicating zero angle of attack. The intersection of the dotted line and the lift axis indicates the lift of the wing alone. The lift is reduced when the nacelle is placed below the wing and a further reduction results from closing the space between the nacelle and wing. The largest nacelle fairing G, caused the greatest reduction in lift and the combinations giving the lowest drag K and L, had very little effect on the lift. This interference effect on the lift is of importance mainly because of the indirect effect on the drag of the combination. The reduction in lift probably occurs mainly on that part of the wing in the neighborhood of the nacelle and it follows that if the lift is altered by the addition

of a nacelle, the distribution of lift along the span must depart further from the ideal elliptical distribution, causing, in turn, a greater induced drag at a given lift.

Scale Effect.-- The results of the low scale tests have not been given, because a comparison of the results obtained at 1 atmosphere pressure with those at 10 atmospheres showed that the scale effect is of secondary importance. However, it may be stated that the order of merit of the different combinations is about the same at the lower scale, but the drag of both the parts and of the combinations is from 25 to 50 per cent higher in most cases.

C o n c l u s i o n s

Sufficiently large adverse interference effects may be encountered when the N.A.C.A. cowling is applied to the nacelles of some airplanes, that practically no reduction in the total drag of the combination will result.

When a low drag nacelle is combined with a relatively thick wing, the lowest drag may be obtained by placing the nacelle so that it is partially enclosed within the wing.

The results of these model tests indicate that the drag and interference of a Wright Whirlwind engine nacelle with N.A.C.A. cowling when combined with a thick wing can be reduced from its value as originally applied of 152 lb. to 25 lb. at 100 m.p.h.

by changing its position and fairing it into the wing.

Langley Memorial Aeronautical Laboratory,
National Advisory Committee for Aeronautics,
Langley Field, Va., July 25, 1929.

R e f e r e n c e s

1. Munk, Max M.
and
Miller, Elton W. : The Variable Density Wind Tunnel of
the National Advisory Committee for
Aeronautics. N.A.C.A. Technical
Report No. 227, 1926.
2. Weick, Fred E. : Drag and Cooling with Various Forms
of Cowling for a Whirlwind Radial
Air-Cooled Engine-II. N.A.C.A. Tech-
nical Report No. 314, 1929.
3. Durand, W. F. : Interaction between Air Propellers
and Airplane Structures. N.A.C.A.
Technical Report No. 235, 1926.

13

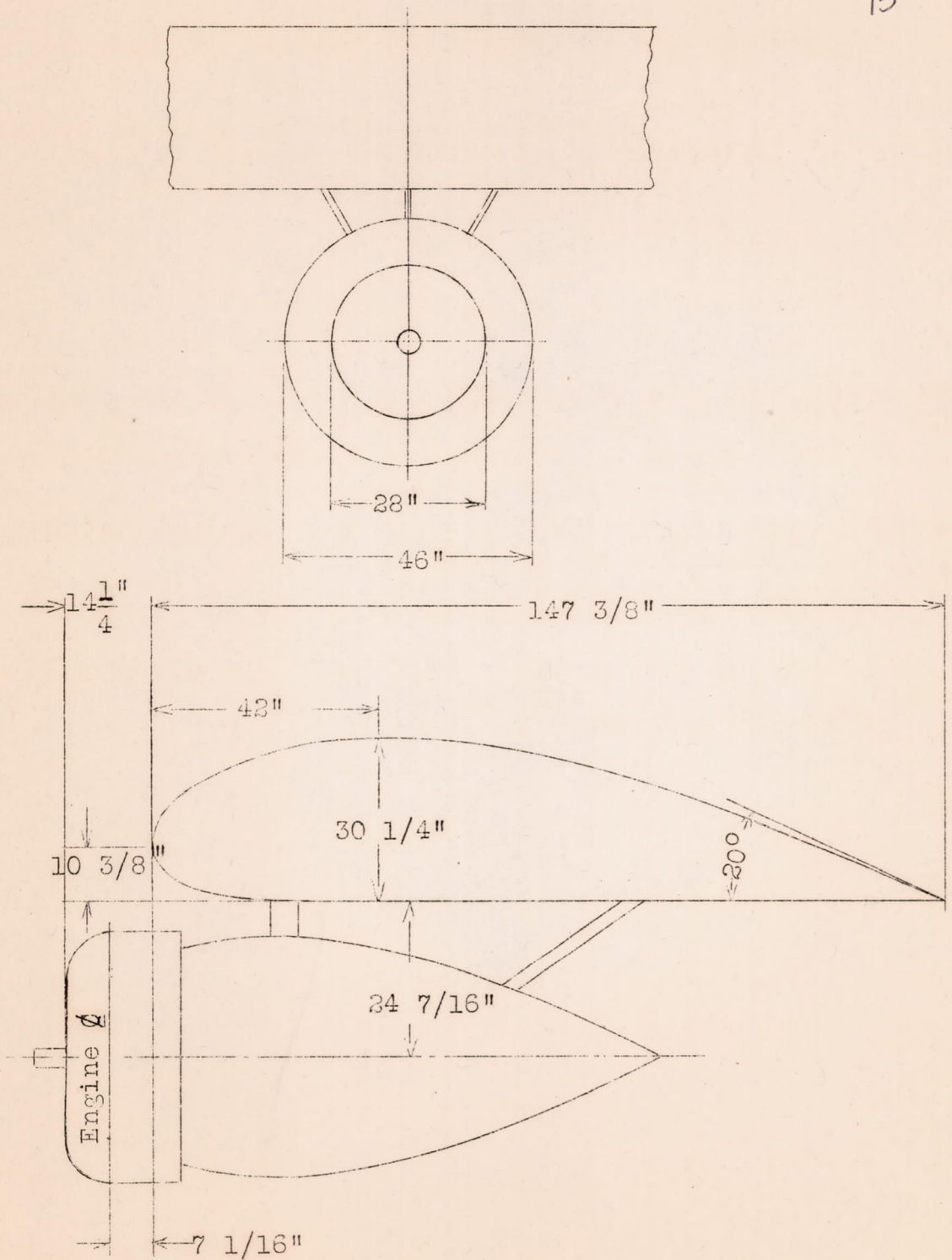

Fig.1 Nacelle and wing profile showing original nacelle location.

Drag of wing subtracted from drag of combination expressed in pounds at 100 miles per hour for Wright Whirlwind engine nacelle.

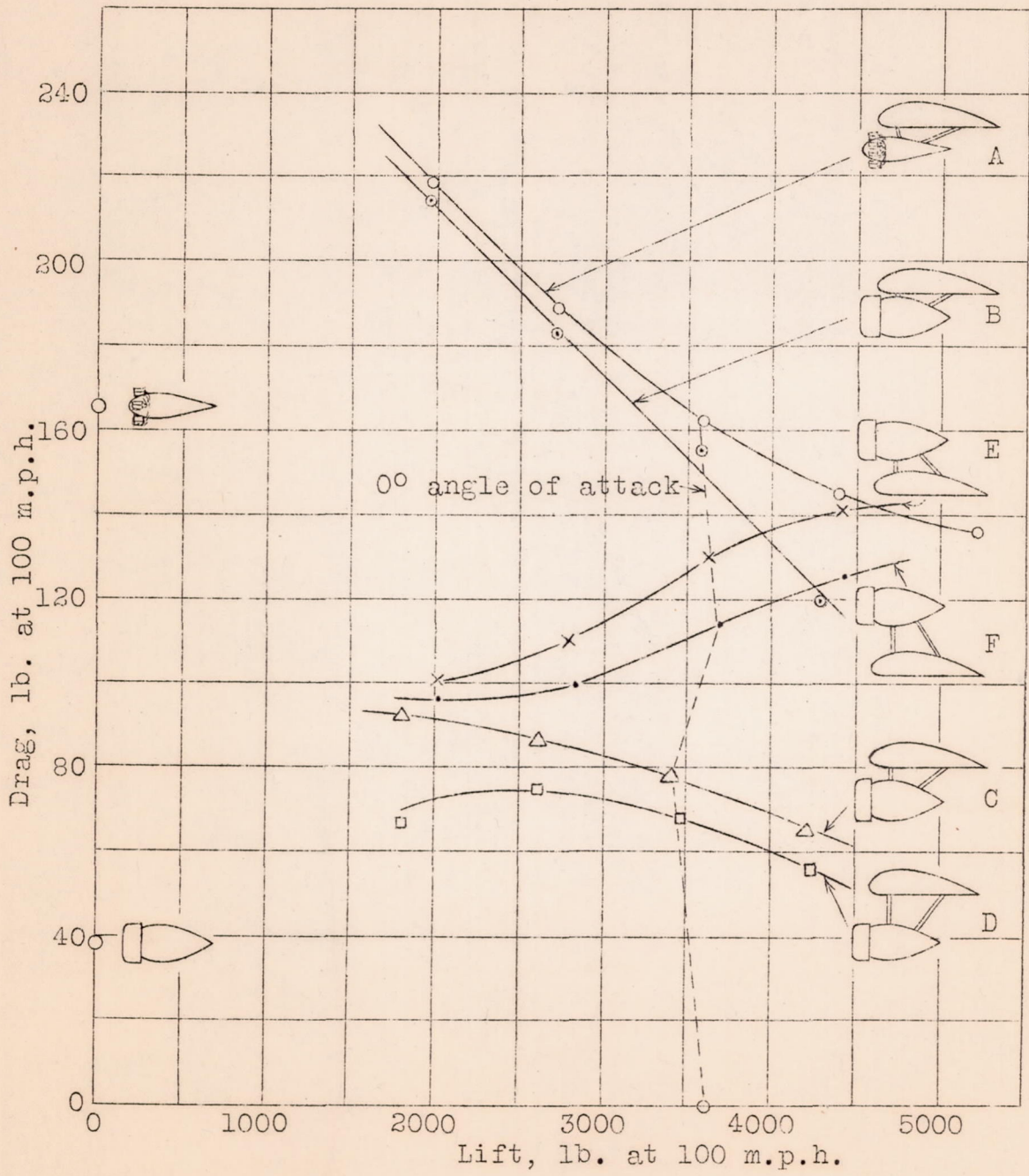

Fig.2 Effect of nacelle position.

Drag of wing subtracted from drag of combination expressed in pounds at 100 miles per hour for Wright Whirlwind engine nacelle. 15

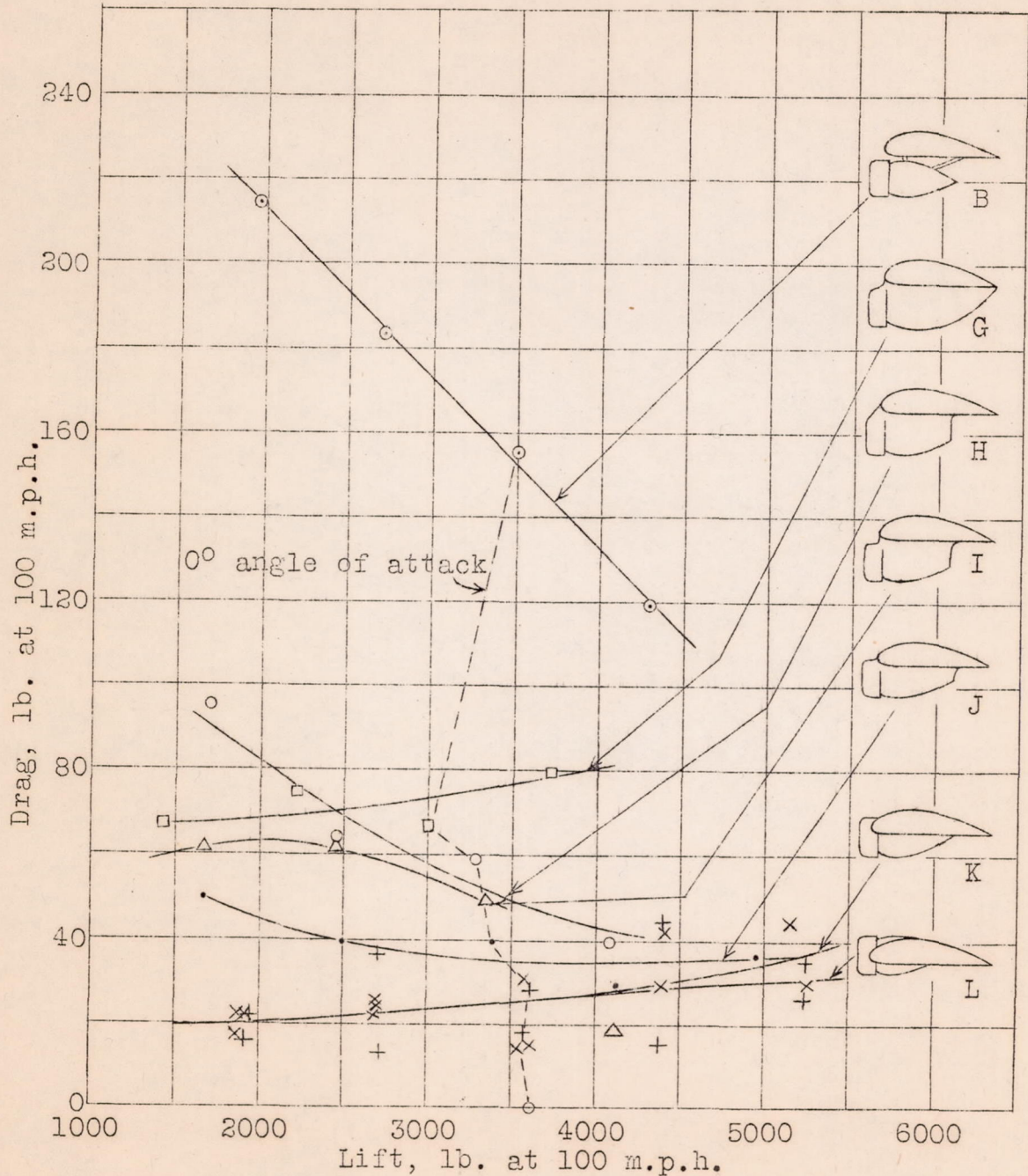

Fig.3 Effect of fairing nacelle into wing.

16

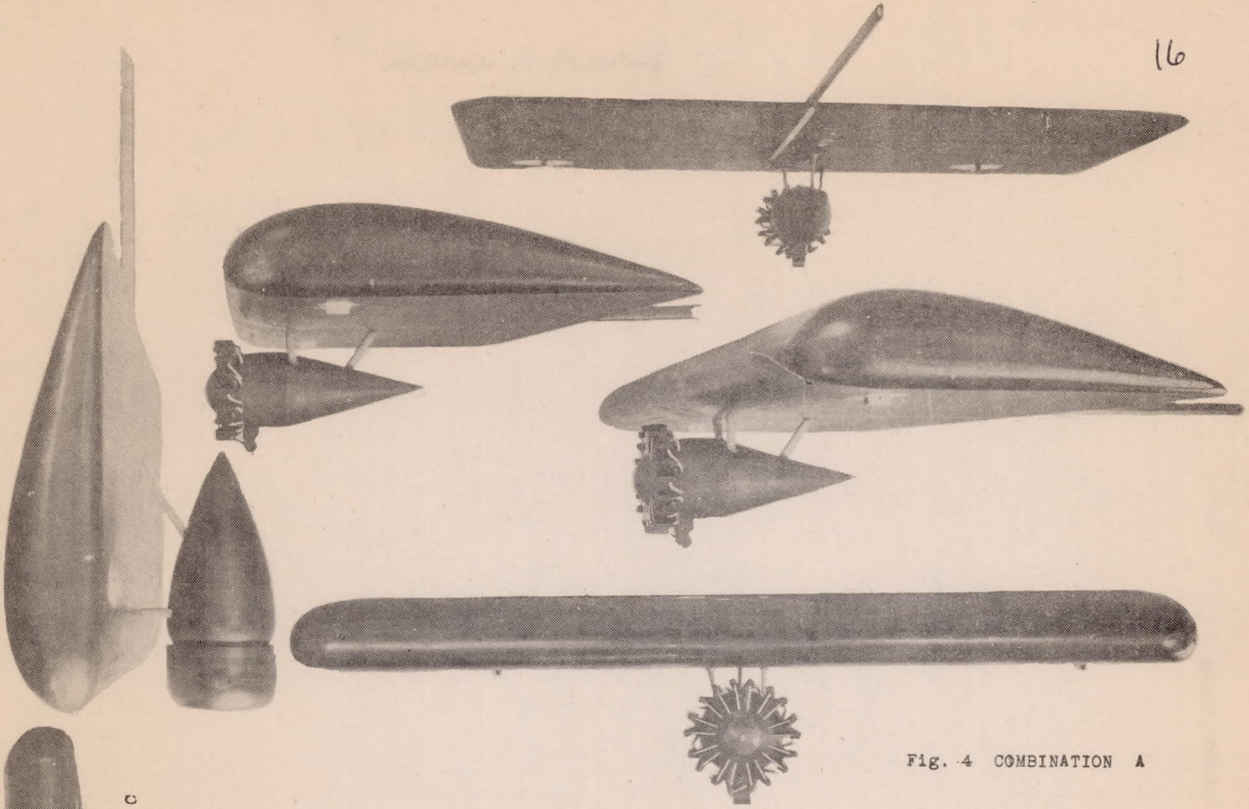

Fig. 4 COMBINATION A

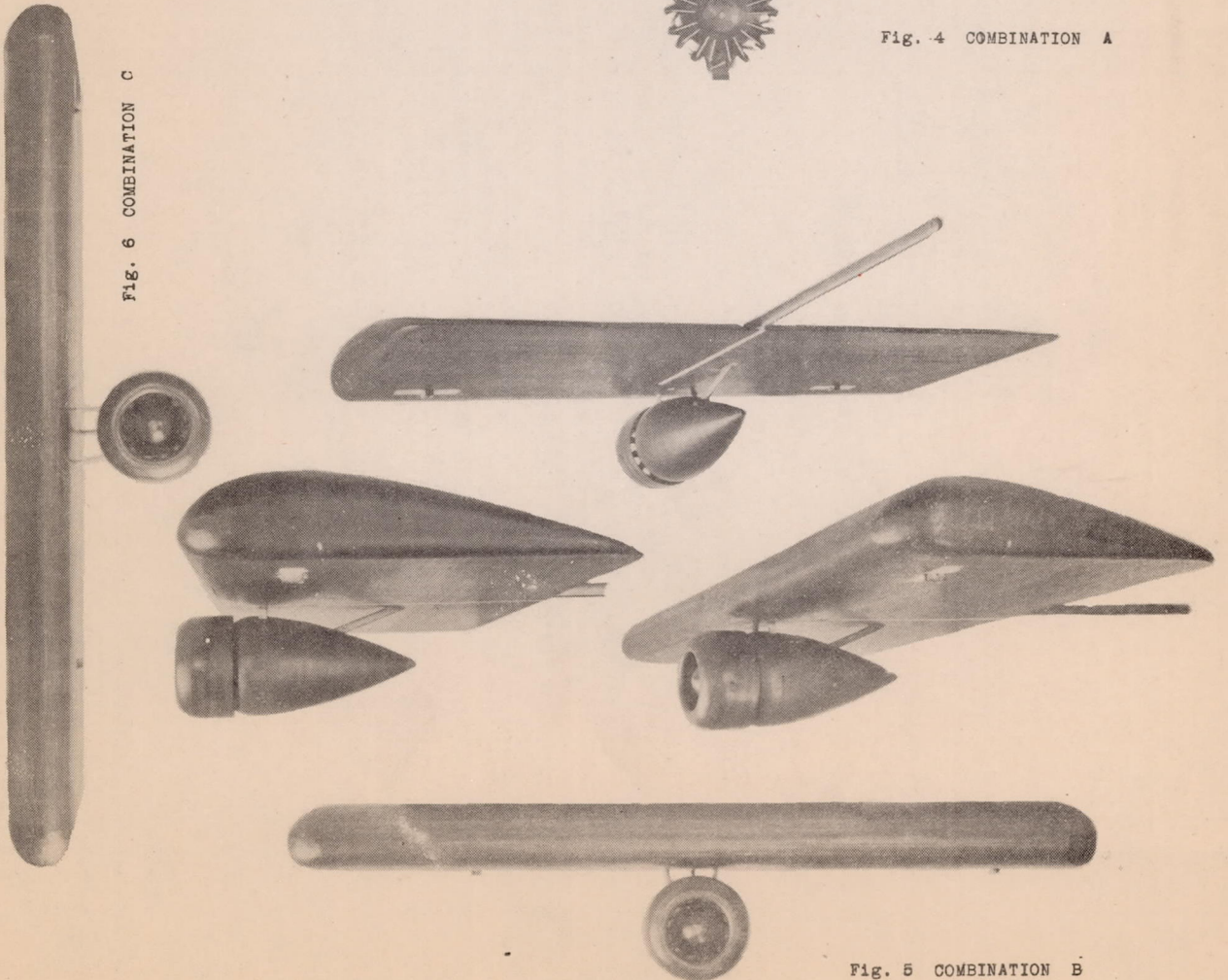

Fig. 5 COMBINATION B

Fig. 6 COMBINATION C



17

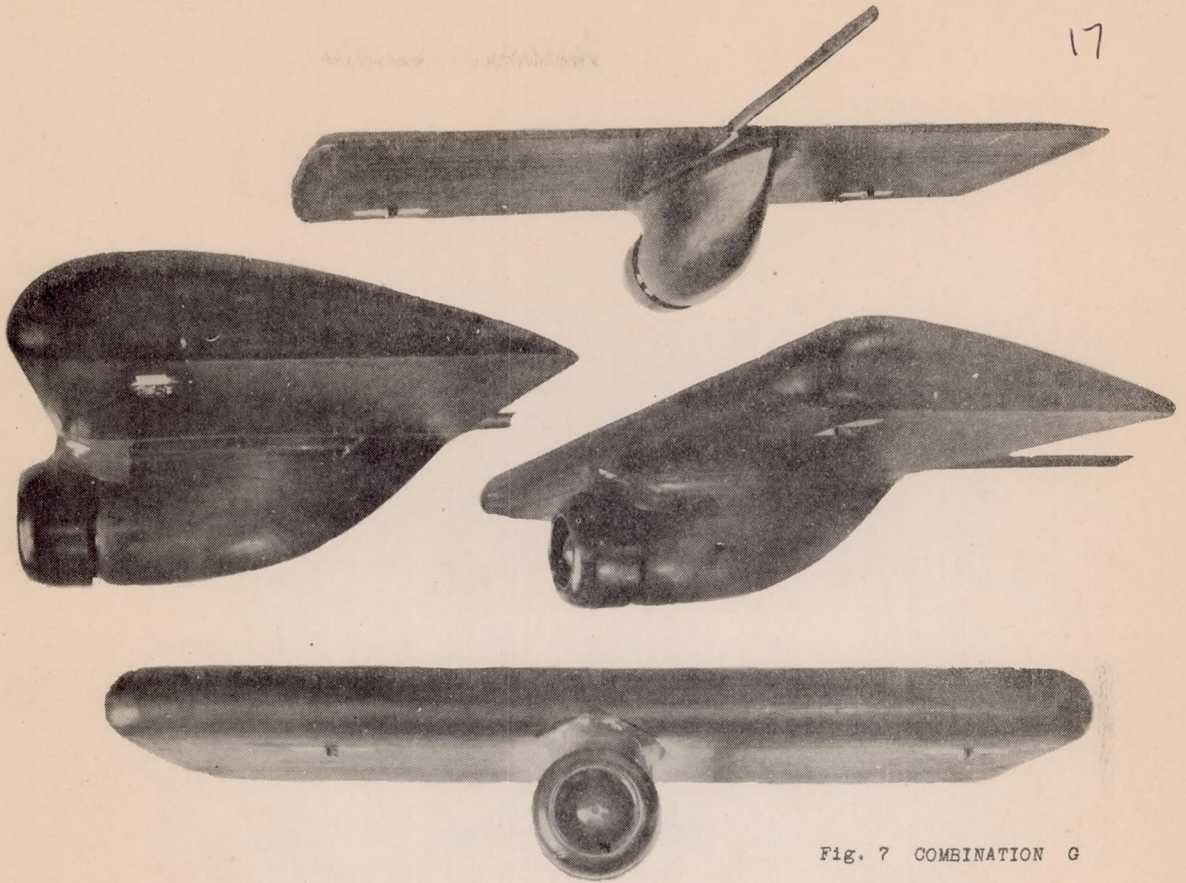

Fig. 7 COMBINATION G

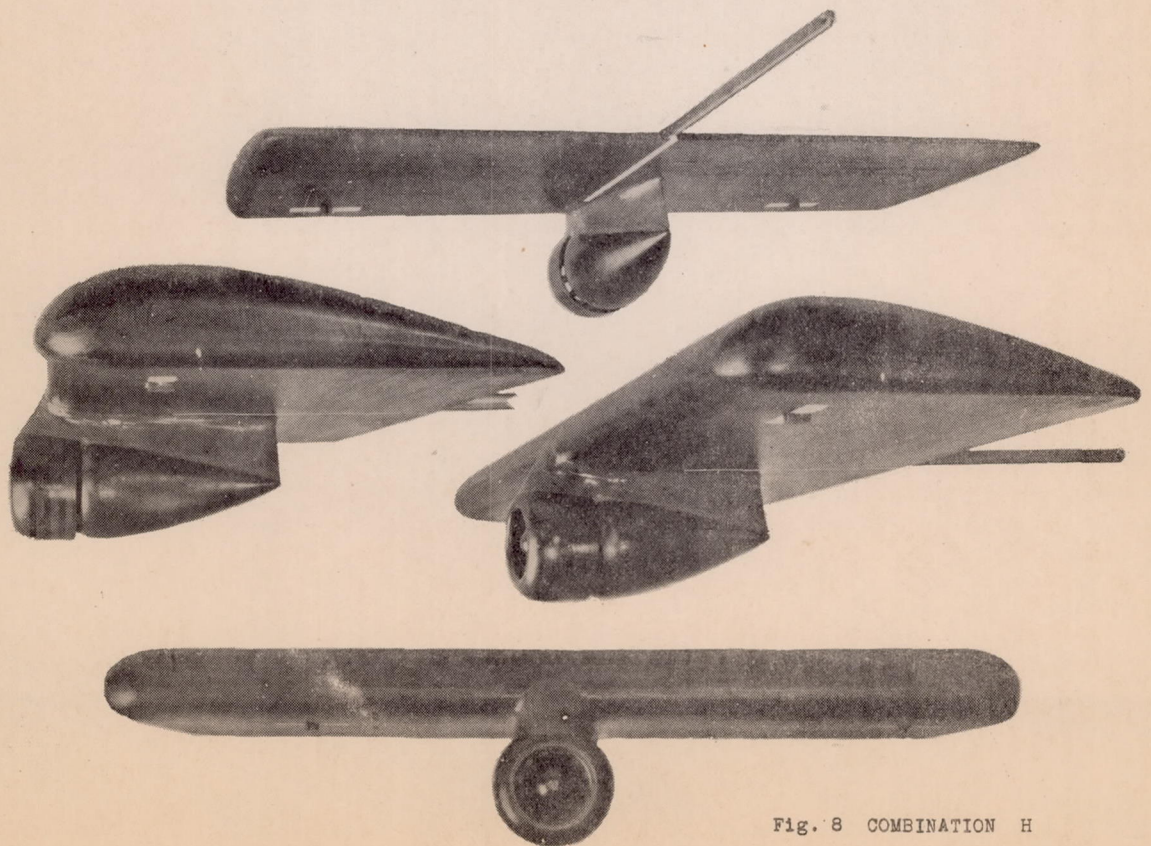

Fig. 8 COMBINATION H

18

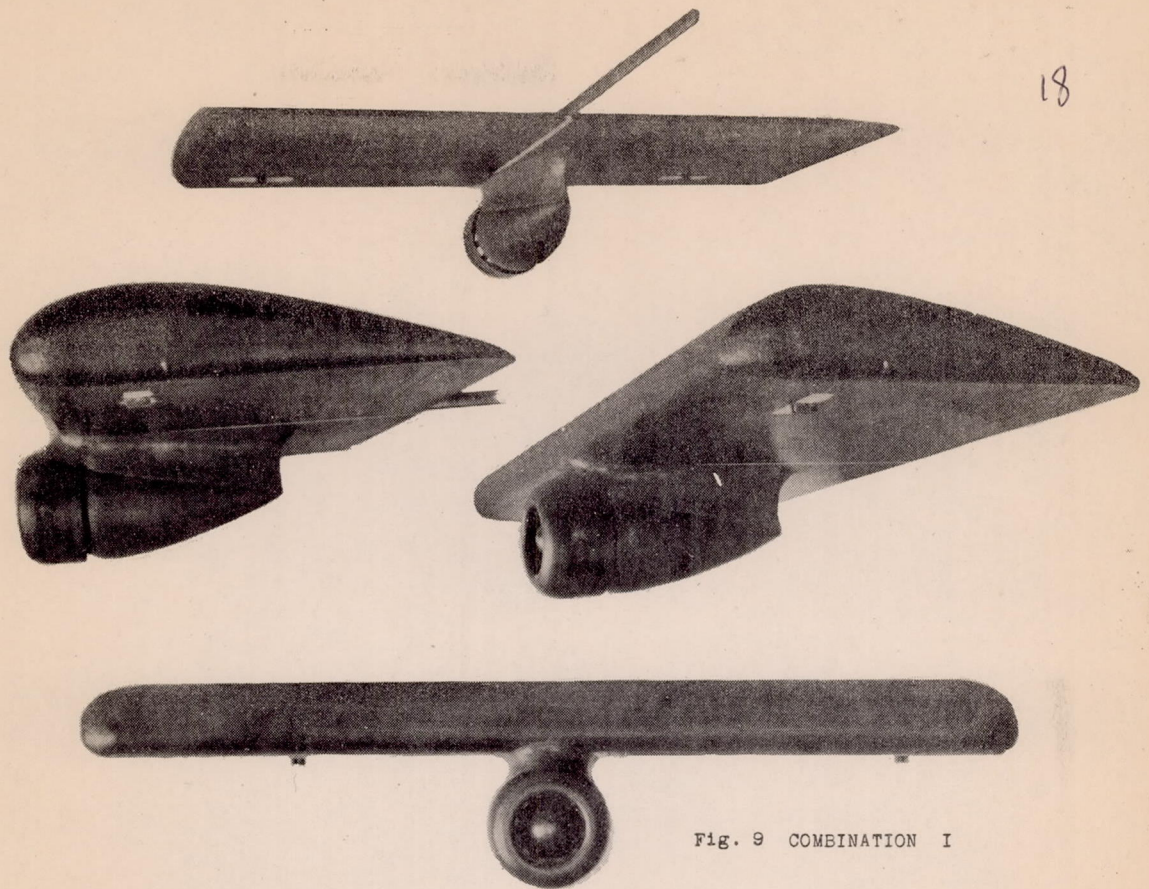

Fig. 9 COMBINATION I

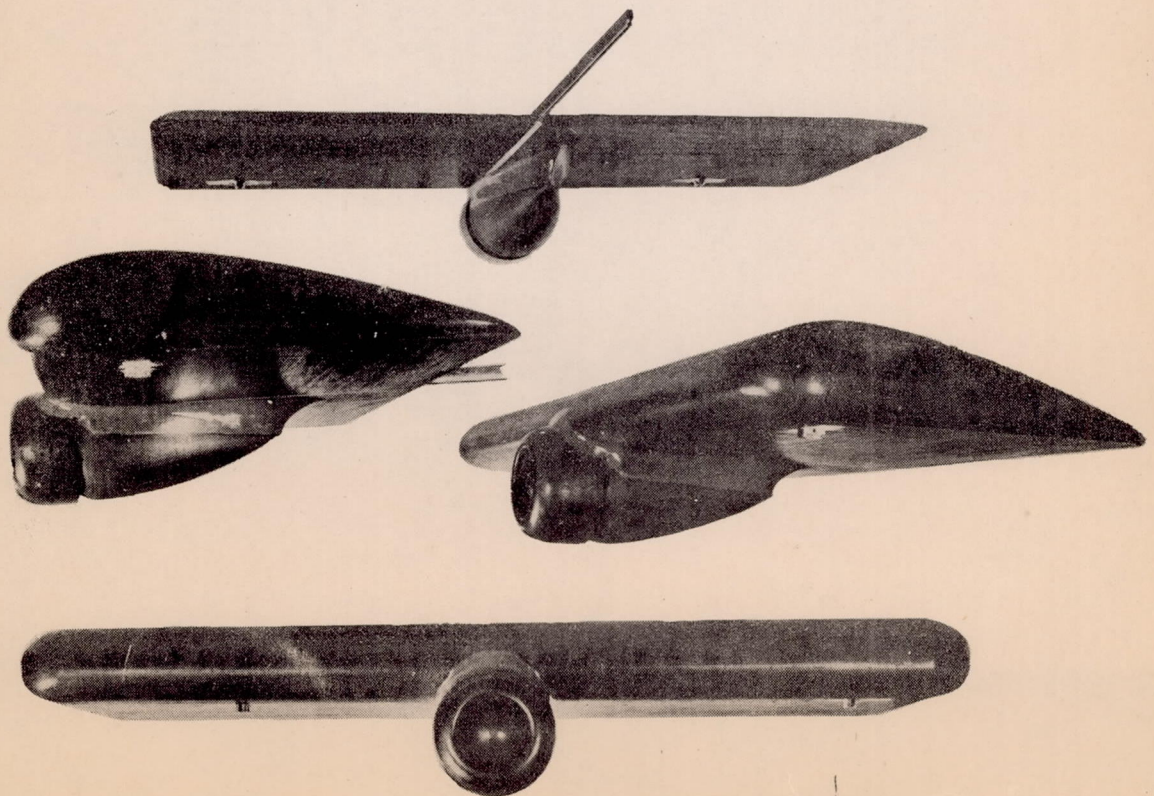

Fig. 10 COMBINATION J

19

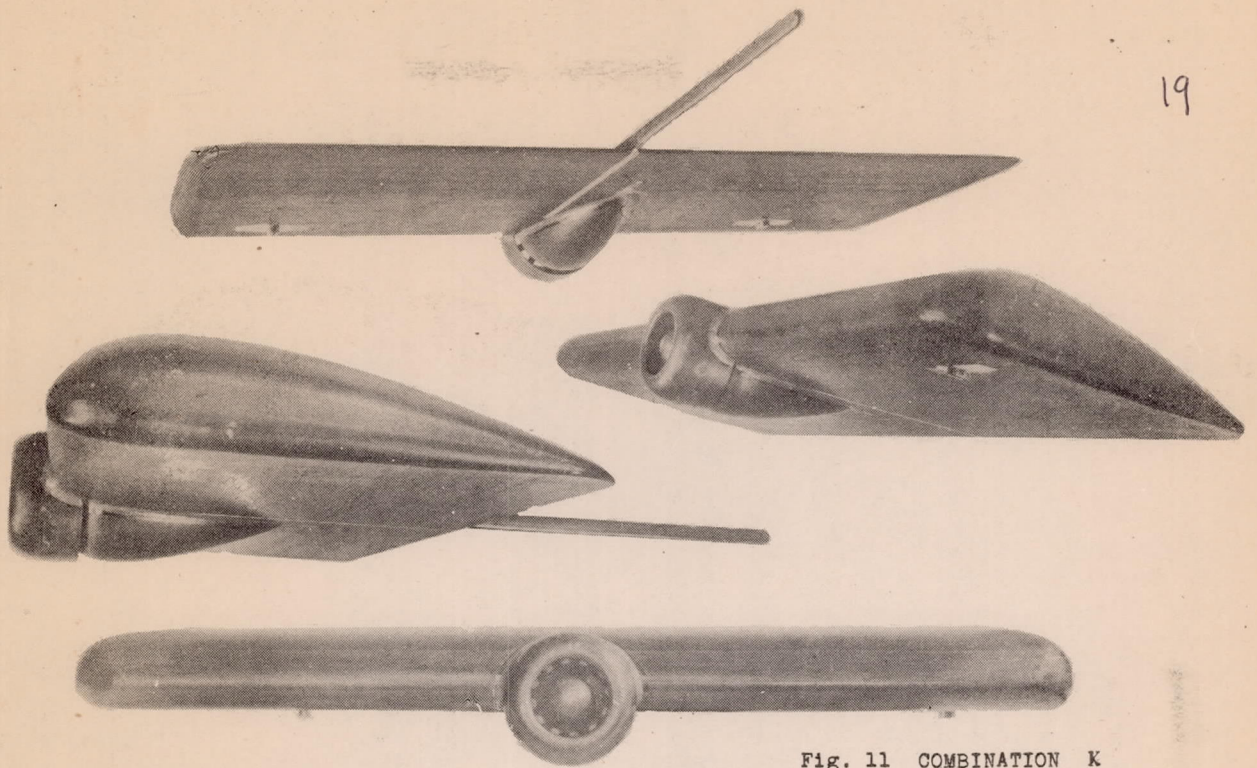

Fig. 11 COMBINATION K

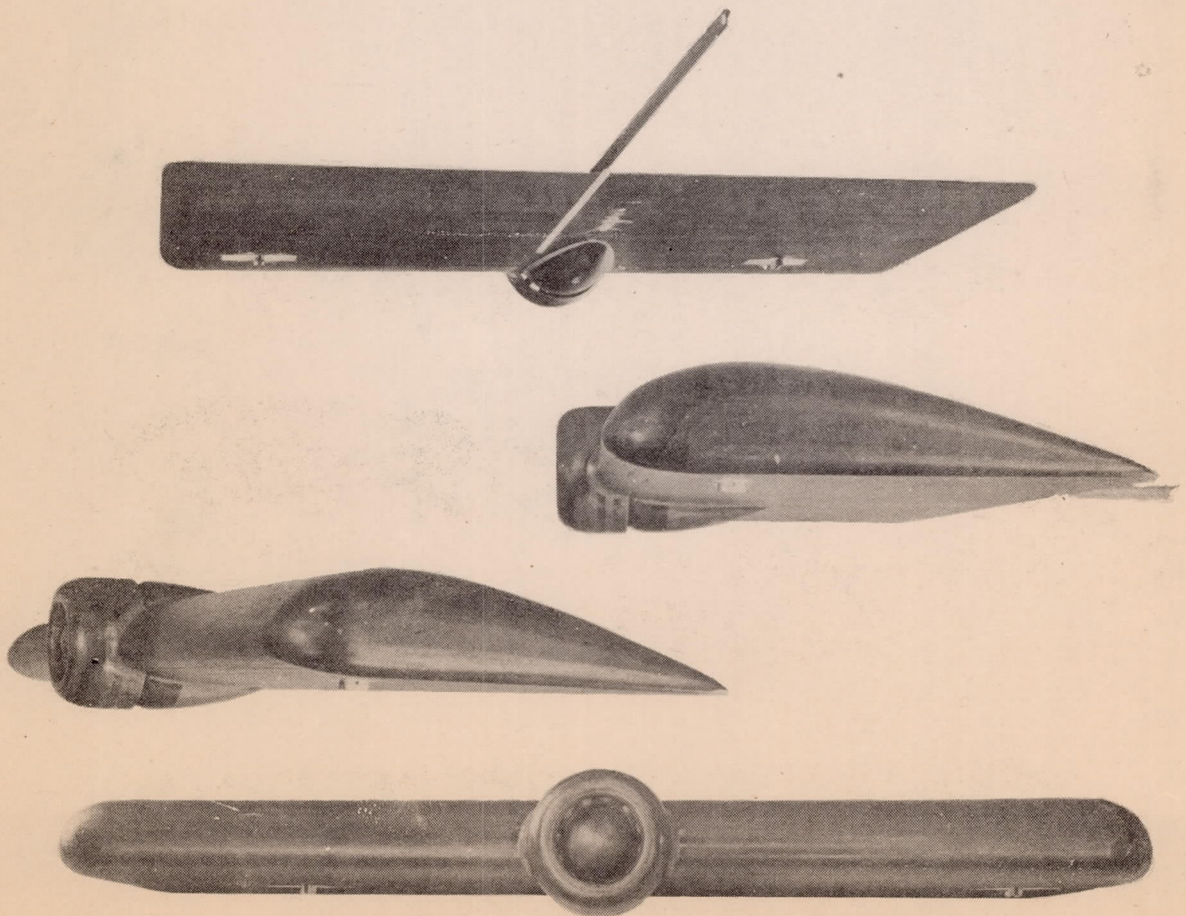

Fig. 12 COMBINATION L