

TECHNICAL NOTES

NATIONAL ADVISORY COMMITTEE FOR AERONAUTICS

TU- No. 489

AERODYNAMIC CHARACTERISTICS OF ANEMOMETER CUPS

By M. J. Brevoort and U. T. Joyner
Langley Memorial Aeronautical Laboratory

Washington
February 1934

Reproduced by
NATIONAL TECHNICAL
INFORMATION SERVICE
Springfield, Va. 22151

FILE COPY
To be returned to
the files of the National
Advisory Committee
for Aeronautics
Washington, D. C.

20

NATIONAL ADVISORY COMMITTEE FOR AERONAUTICS

TECHNICAL NOTE NO. 489

AERODYNAMIC CHARACTERISTICS OF ANEMOMETER CUPS

By M. J. Brevoort and U. T. Joyner

SUMMARY

The static lift and drag forces on three hemispherical and two conical cups were measured over a range of angles of attack from 0° to 180° and a range of Reynolds Numbers from very small up to 400,000. The problem of supporting the cup for measurement and the effect of turbulence were also studied. The results are compared with those of other investigators.

INTRODUCTION

The National Advisory Committee for Aeronautics, in cooperation with the Weather Bureau, undertook the problem of determining the laws governing the performance of a cup anemometer of the Robinson type. The investigation was intended to cover the characteristics of individual cups and of similar cups mounted on complete cup wheels. This report treats the static tests run on the individual cups.

The forces on hemispherical cups have already been measured over a small range of Reynolds Number. The work of Eiffel (reference 1) was of a preliminary nature performed in connection with measurements on spheres. Bradfield's tests (reference 2) were part of an investigation on complete cup wheels, no attempt having been made to determine the effect of Reynolds Number. Hansen's tests (reference 3) were made on both open and closed hemispherical cups at Reynolds Numbers ranging from 130,000 to 430,000.

In view of the fact that in service the cups on a cup wheel are subject to a very great range of velocities and considering the lack of satisfactory agreement between available data, it was considered desirable to extend and

repeat this work to determine the effect of Reynolds Number more completely.

A study was also made to determine the effect of various supports in several orientations with respect to the cup.

APPARATUS AND METHODS

All the measurements presented in this report were made in the model of the full-scale tunnel described in reference 4. A special balance was constructed for measuring the lift and drag on individual cups (fig. 1). Forces of the order of one gram could be measured accurately. The maximum load on each arm was limited to about one kilogram. Since the forces on the 6-inch cup considerably exceeded this limit at high velocities, a balance arrangement (fig. 2), assembled for subsequent tests, was utilized for the high-velocity part of the range.

The dimensions of the five cups used in this investigation are given in the following table; the conical forms are shown in figure 3.

<u>Cup number</u>	<u>Shape</u>	<u>Outside diameter, inches</u>
I	Hemispherical	4.03
II	Conical	4.56
III	Hemispherical	2.03
IV	Conical	4.70
V	Hemispherical	6.00

A velocity survey was made with and without the cup in the tunnel. A point was found above and in front of the cup at which air speed could be measured without interference from the cup and at which the true reading was maintained throughout the speed range. A calibrated pitot tube was used for measuring air speed. Owing to the lack of sensitivity of a pitot tube for low velocity, a hot-wire anemometer was used in this range. For comparison, the two ranges were always made to overlap.

RESULTS AND DISCUSSION

The results for cup I at 0° angle of attack are presented in the table. Similar tables for the complete range of angle of attack for all five cups are available upon request from the National Advisory Committee for Aeronautics.

The coefficients are defined as follows:

$$C_D = \frac{\text{force downstream}}{q A}$$

$$C_L = \frac{\text{force cross stream}}{q A}$$

$$C_N = C_D \cos \alpha + C_L \sin \alpha$$

$$R = \frac{VD}{\nu}$$

- where
- A is the cross-sectional area of the open face of the cup using outside dimensions.
 - V is the air speed
 - ν , kinematic viscosity
 - D, the outside diameter of the open face of the cup.
 - α , the angle of attack measured as indicated in figures 1 and 2.

The normal-force coefficient C_N is positive when the normal force is in the direction of rotation of a cup mounted on a cup wheel.

The results obtained for the five cups are shown in figures 4 to 10. These curves are a result of cross-plotting faired curves of the coefficients against Reynolds Number. Each of the original curves of a coefficient against Reynolds Number at a particular angle of attack was determined by passing a smooth curve through the greatest number of about 20 points. It was thought undesirable to assume beforehand any general form of curve inasmuch as no information is available that would allow the form of curve to be predicted.

Figures 4, 5, and 6 are cross-plots of the faired curves of cups I, III, and V. They check the results of Bradfield and Hansen (references 2 and 3). A more direct comparison at the same Reynolds Number is given in figure 11. Bradfield has discussed the discontinuity occurring at 45° angle of attack on the C_D curves. He found, on gradually varying the angle, that around 45° angle of attack the balance vibrated between two extremes. The points before and after this angle definitely fall on two different curves. The results presented here confirm Bradfield's observations and also exhibit singular points on the C_L curves in the range of angles of attack from 90° to 120° . The exact location of these singularities apparently depends largely upon the Reynolds Number.

In the C_D curve near the 90° angle of attack a minimum occurs which may be due either to the minimum exposed area or the highest effective Reynolds Number. Either factor would tend to lower the value of C_D .

At 180° angle of attack the value of C_D is practically the same as that obtained for a sphere below the critical Reynolds Number. Unfortunately, the maximum wind-tunnel speed was not high enough to permit an investigation above the critical Reynolds Numbers.

The conical cups (figs. 7, 8, 9, and 10) exhibit much the same tendencies as the hemispherical cups with the exception of cup II at 45° angle of attack for which the usual discontinuity does not occur. Later tests will show whether this property makes any material difference in the performance of a cup wheel employing this cup form.

All the cups show more or less regular trends with Reynolds Number for certain ranges of angle of attack. For instance, in the 90° to 135° angle-of-attack range, a definite increase in C_L with increase of Reynolds Number occurs. In the 0° to 60° range of angle of attack for the C_D curves, there is again definite indication of the dependence of the coefficients on Reynolds Number; but the relationships are not so simple as in the previous case, as may be observed in the 0 (very small) Reynolds Number curves, which are uniformly high.

A series of tests were performed to determine the effect of the mounting on the forces on the anemometer cups. A 6-inch cup was used with a $\frac{1}{2}$ -inch-diameter rod. Figure

12 gives C_D and C_L against angle-of-attack curves for the types of mounting shown on the same figure. The designation "plain cup" refers to a cup mounted with the rod extending from the bottom of the cup perpendicular to the open face of the cup. The rod is supported on the balance in a horizontal plane 60° to the air stream. This mounting was maintained undisturbed throughout the tests on the effect of mounting. In mounting 1 a rod was supported horizontally and parallel to the face of the cup with one end about $1/16$ inch from the leading edge of the cup. Mounting 2 is the same as 1 except that the end of the rod is brought to about $1/16$ inch from the trailing edge of the cup. In mounting 3, a rod is supported horizontally across the center of the cup face about $1/16$ inch in front of the cup. In mounting 4, a rod is supported through the center of the cup face extending to within $1/4$ inch from the back of the cup. In mounting 5, a rod is clamped vertically extending to $1/16$ inch from the under side of the cup. In mounting 6, a rod is soldered horizontally across the open face of the cup, and in mounting 7, a rod is soldered vertically across the open face of the cup.

These mountings were chosen not only for their connection to a study of individual cups, but also for their bearing on the effect of supports in a complete cup wheel. The plain-cup mounting is believed to be without support interference and this type of support has also been found satisfactory for drag measurements on spheres.

Mountings 1 and 2 correspond to the mountings used by Bradfield and Hansen (references 2 and 3). The curves of figure 12 show that a rod extending from the trailing edge has little effect as compared with a rod extending from the leading edge. The curves lead one to expect some discrepancy between the present results using mounting 5 and those of Bradfield and Hansen. The agreement of the results obtained using mounting 5 with those obtained using plain-cup indicates that mounting 5 is reasonably free of support interference. It is desirable to have the forces free from support interference so that the angle-of-attack range may be 0° to 180° instead of 0° to 360° .

Figure 11 gives a comparison of the results of this investigation with those of Bradfield and Hansen. The results show fair agreement except in the range of 40° to 120° angle of attack where the method of mounting is important, and in the range of 110° to 120° where the size of cup has an effect not accounted for by Reynolds Number.

In order to determine the effect of turbulence, a series of tests was made in which the normal turbulence of 0.4 percent, measured by the method outlined in reference 5, was varied up to 2.0 percent. Using for q the average dynamic pressure at the position of the cup, no dependence of the coefficients on turbulence could be detected.

Langley Memorial Aeronautical Laboratory,
National Advisory Committee for Aeronautics,
Langley Field, Va., November 13, 1933.

REFERENCES

1. Eiffel, G.: Nouvelles Recherches sur la Résistance de l'Air et l'Aviation Faites au Laboratoire d'Auteuil. H. Dunod et E. Pinat (Paris) 1914, p. 3.
2. Bradfield, F. B.: Aerodynamic Properties of a Hemispherical Cup. With Application to the Hemispherical Cup Windmill and Anemometer. R. & M. No. 712, British A.R.C., 1919.
3. Hansen, M.: Untersuchung einer offenen und geschlossenen Halbkugel. Ergb. Aero. Vers. zu Gottingen. IV. Lieferung, 1932, p. 108.
4. Theodorsen, Theodore, and Silverstein, Abe: Experimental Verification of the Theory of Wind-Tunnel Interference. T.R. No. 478, N.A.C.A., 1933.
5. Dryden, H. L., and Kueth, A. M.: Effect of Turbulence in Wind Tunnel Measurements. T.R. No. 342, N.A.C.A., 1930.

TABLE I. CUP I

α <u>0°</u>						α <u>10°</u>					
q cm water	V meters/ sec.	$R \times 10^{-4}$	C_D	C_L	C_N	q cm water	V meters/ sec.	$R \times 10^{-4}$	C_T	C_L	C_N
1.41	14.9	10.5	1.479	0	1.479	0.81	11.4	7.95	1.380	0.264	1.41
1.85	17.1	12.0	1.385	0	1.385	.61	9.3	6.90	1.380	.267	1.41
3.91	24.8	17.6	1.360	0	1.360	1.30	14.3	10.1	1.380	.266	1.41
4.57	27.0	19.0	1.386	0	1.386	1.87	17.3	12.1	1.381	.267	1.41
4.77	27.6	19.4	1.370	0	1.370	2.81	21.1	14.9	1.398	.268	1.42
5.50	29.6	20.9	1.409	0	1.409	3.66	24.0	17.0	1.390	.268	1.42
6.38	31.8	22.4	1.390	0	1.390	4.57	27.0	19.0	1.400	.272	1.42
6.32	31.7	22.4	1.388	0	1.388	5.46	29.5	20.8	1.397	.272	1.42
7.18	33.3	23.9	1.393	0	1.393	6.46	32.3	22.6	1.387	.270	1.42
8.05	36.0	25.3	1.396	0	1.396	7.31	34.2	24.1	1.400	.272	1.42
1.44	15.3	10.6	1.409	0	1.409	3.24	36.5	25.6	1.385	.275	1.43
1.15	13.5	9.5	1.405	0	1.405	.72	10.7	7.50	1.599	.320	1.53
.84	11.5	8.10	1.408	0	1.408	.60	9.3	6.35	1.335	.254	1.36
.59	9.7	6.80	1.417	0	1.417	.37	7.65	5.40	1.474	.285	1.50
1.23	14.0	9.8	1.381	0	1.381	.165	5.10	3.61	1.334	.232	1.34
.53	9.2	6.44	1.368	0	1.368	.077	3.50	2.47	1.224	.260	1.25
.23	6.0	4.25	1.311	0	1.311	.115	4.30	3.00	1.242	.194	1.26
.375	7.7	5.41	1.303	0	1.303	.033	2.30	1.61	1.390	.276	1.32
.129	4.5	3.20	1.574	0	1.574	.057	3.03	2.11	1.181	.181	1.20
.025	2.0	1.40	1.400	0	1.400						
.039	2.5	1.75	1.310	0	1.310						

THE UNIVERSITY OF CHICAGO

PH.D. THESIS

THE UNIVERSITY OF CHICAGO LIBRARY

THE UNIVERSITY OF CHICAGO
PH.D. THESIS
THE UNIVERSITY OF CHICAGO LIBRARY

1

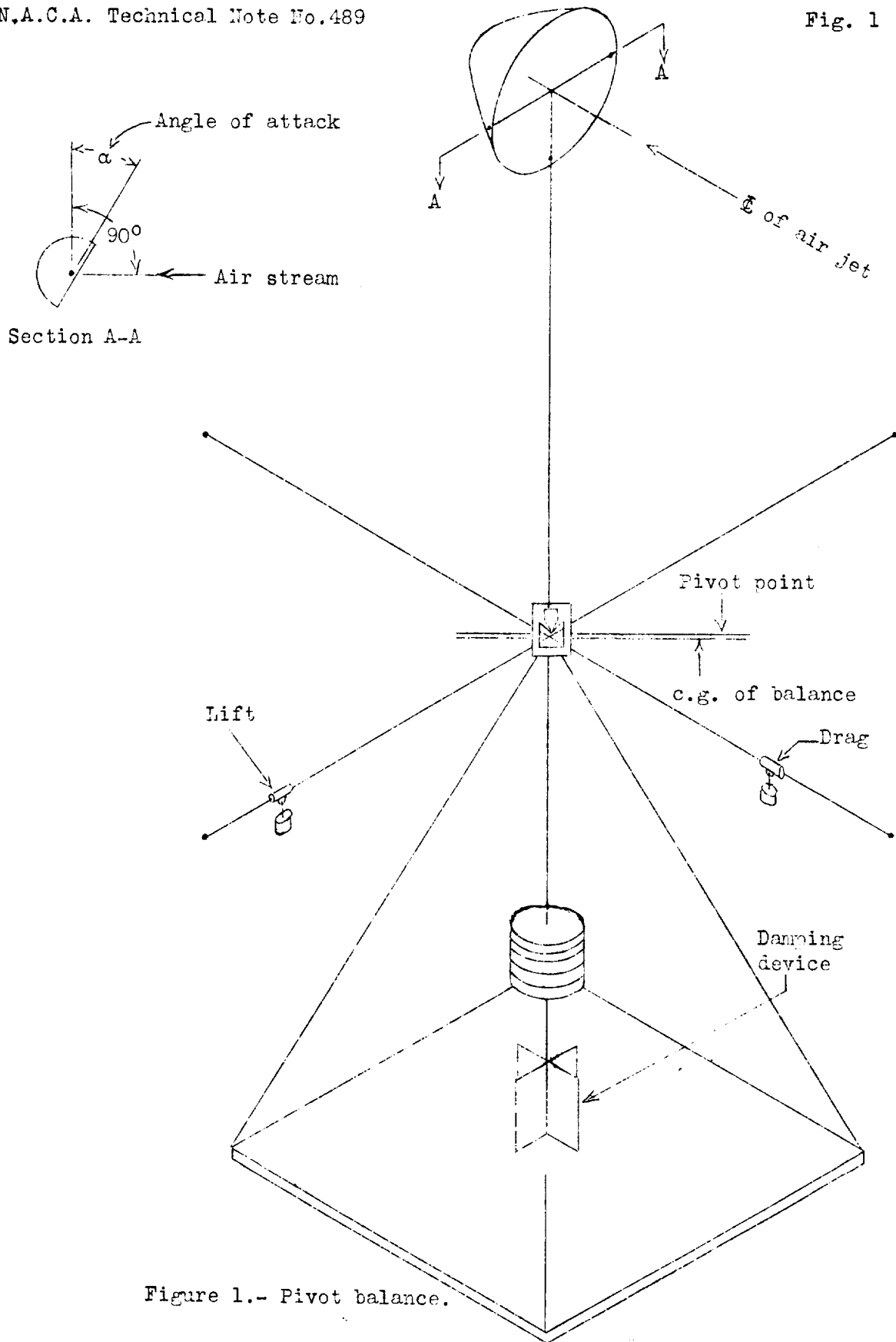
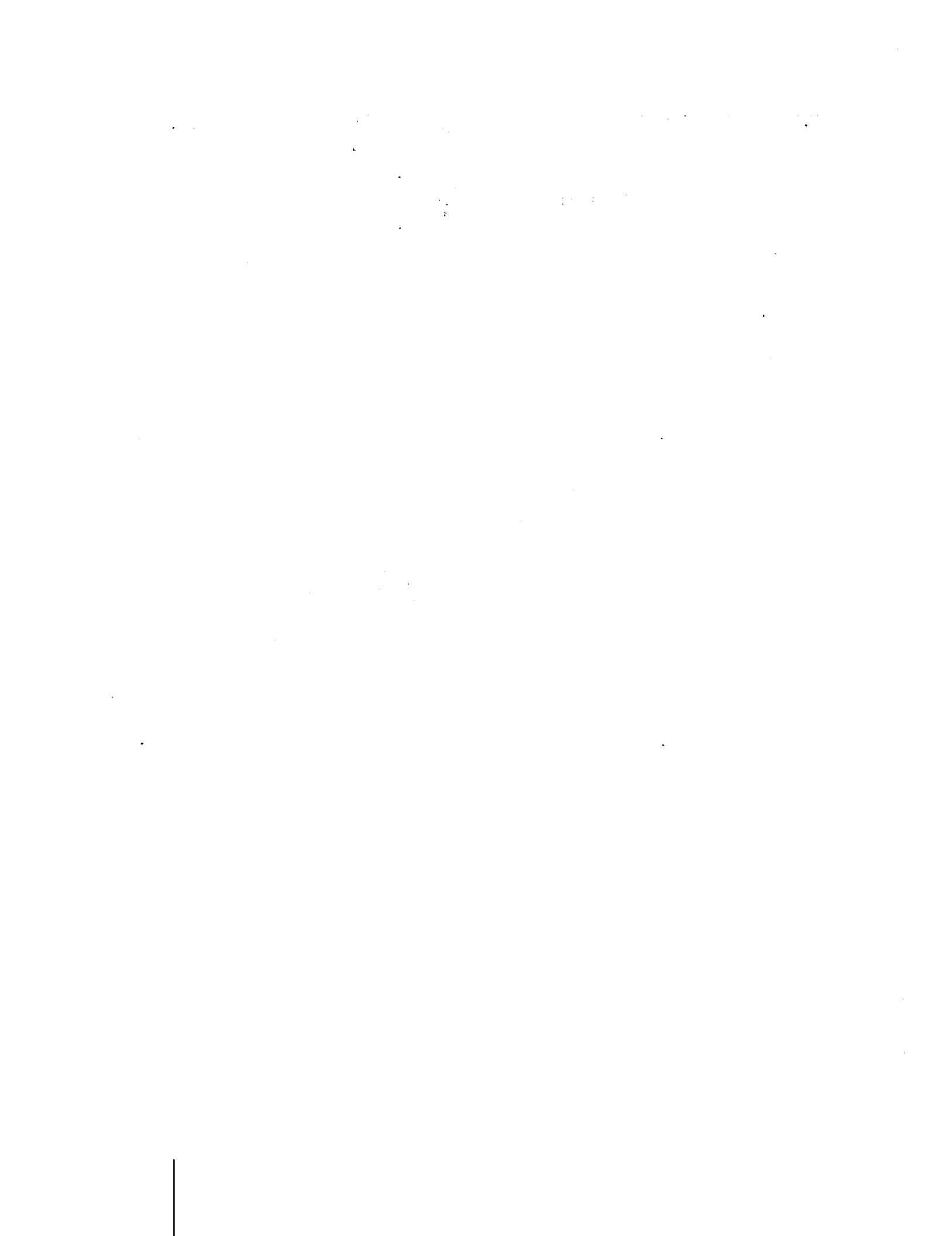

Figure 1.- Pivot balance.

8



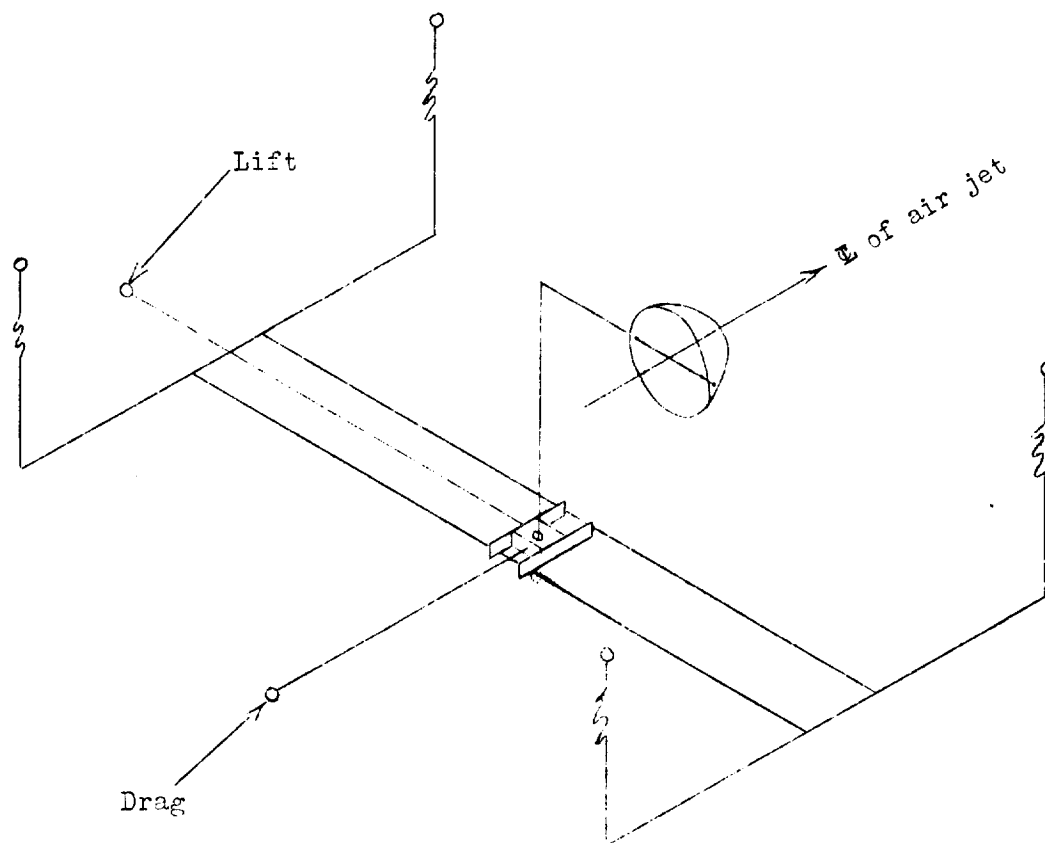
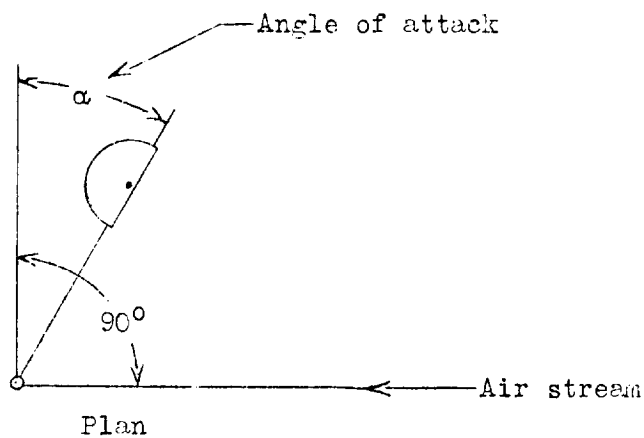
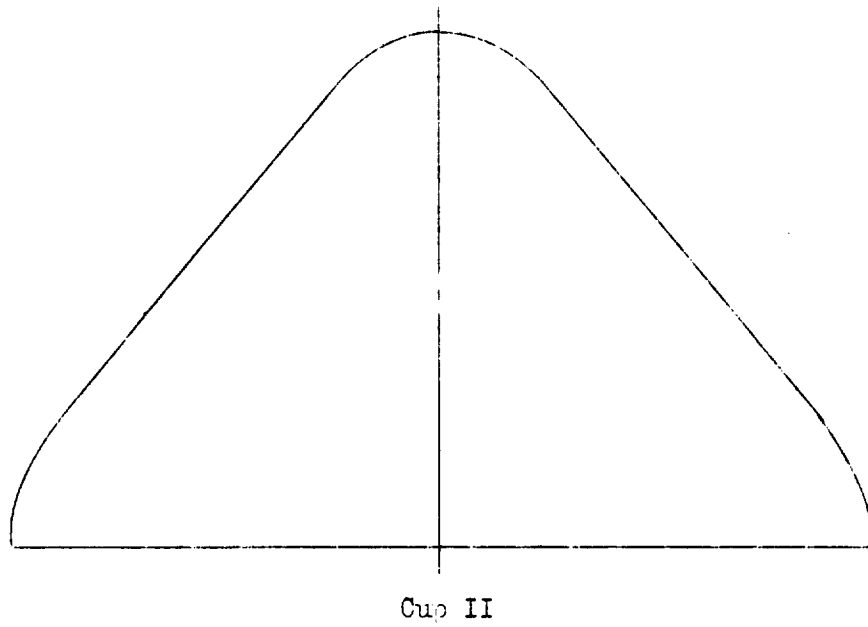
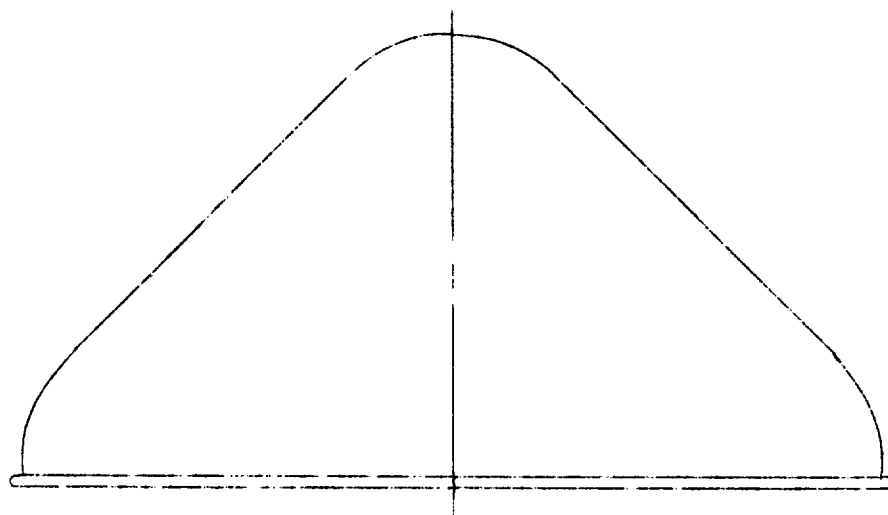

Figure 2.- Pendulum balance.



Cup II



Cup IV

Figure 3.- Conical form cups.



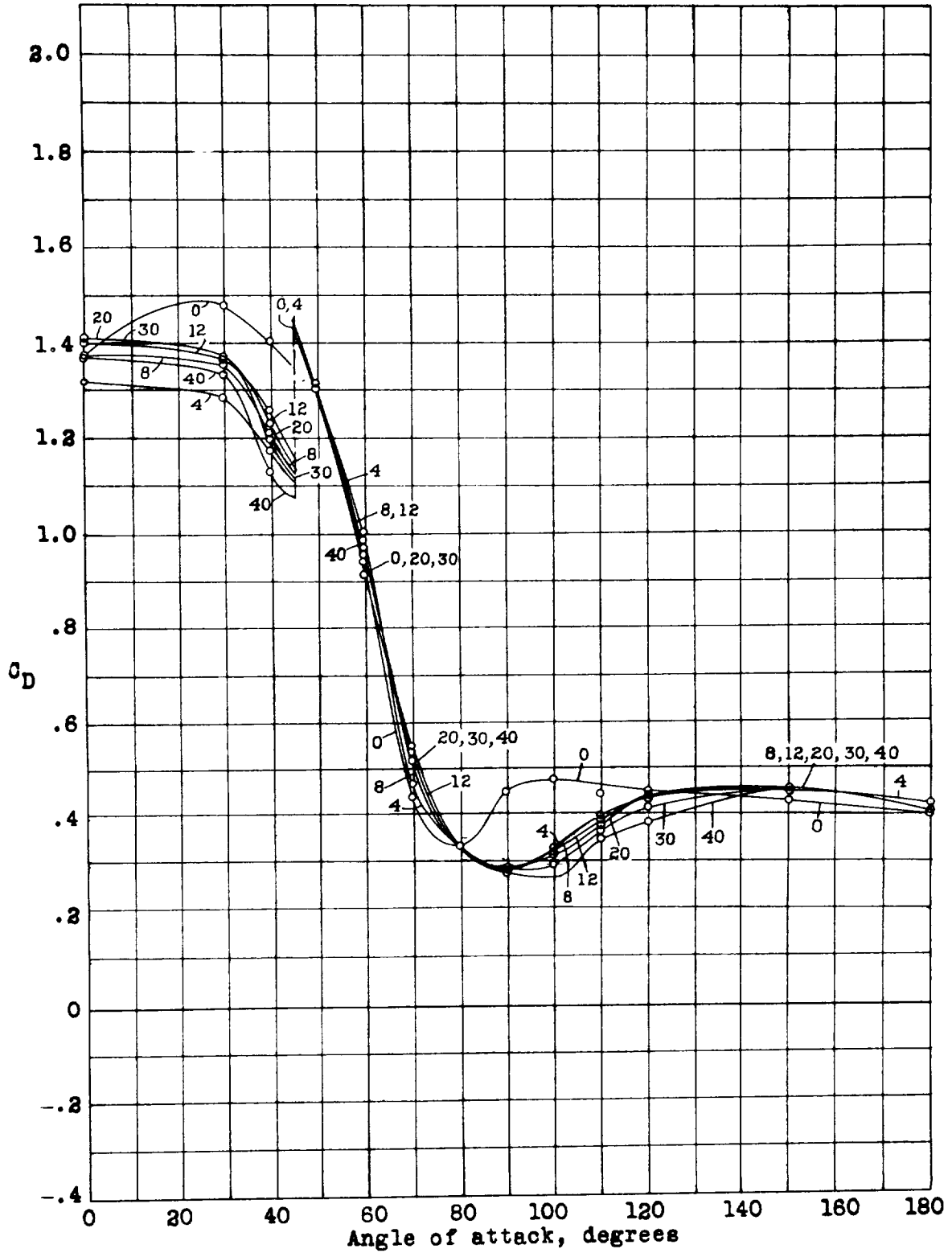

Figure 4.— Drag coefficient against angle of attack for hemispherical anemometer cups I, III, and V. Numbers indicate Reynolds Number $\times 10^{-4}$.

//

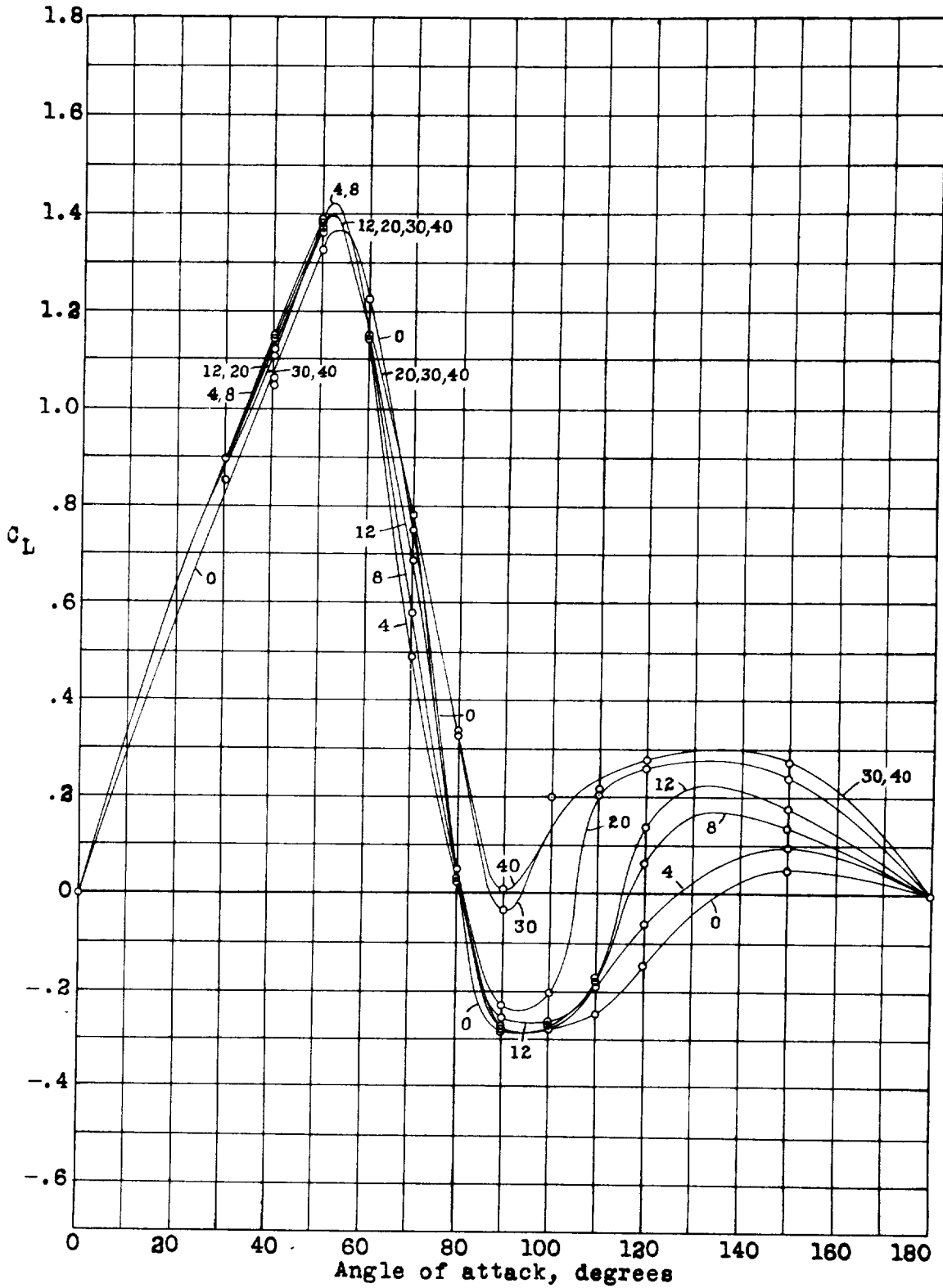

Figure 5.- Lift coefficient against angle of attack for hemispherical anemometer cups I, III, and V. Numbers indicate Reynolds Number $\times 10^{-4}$.

12

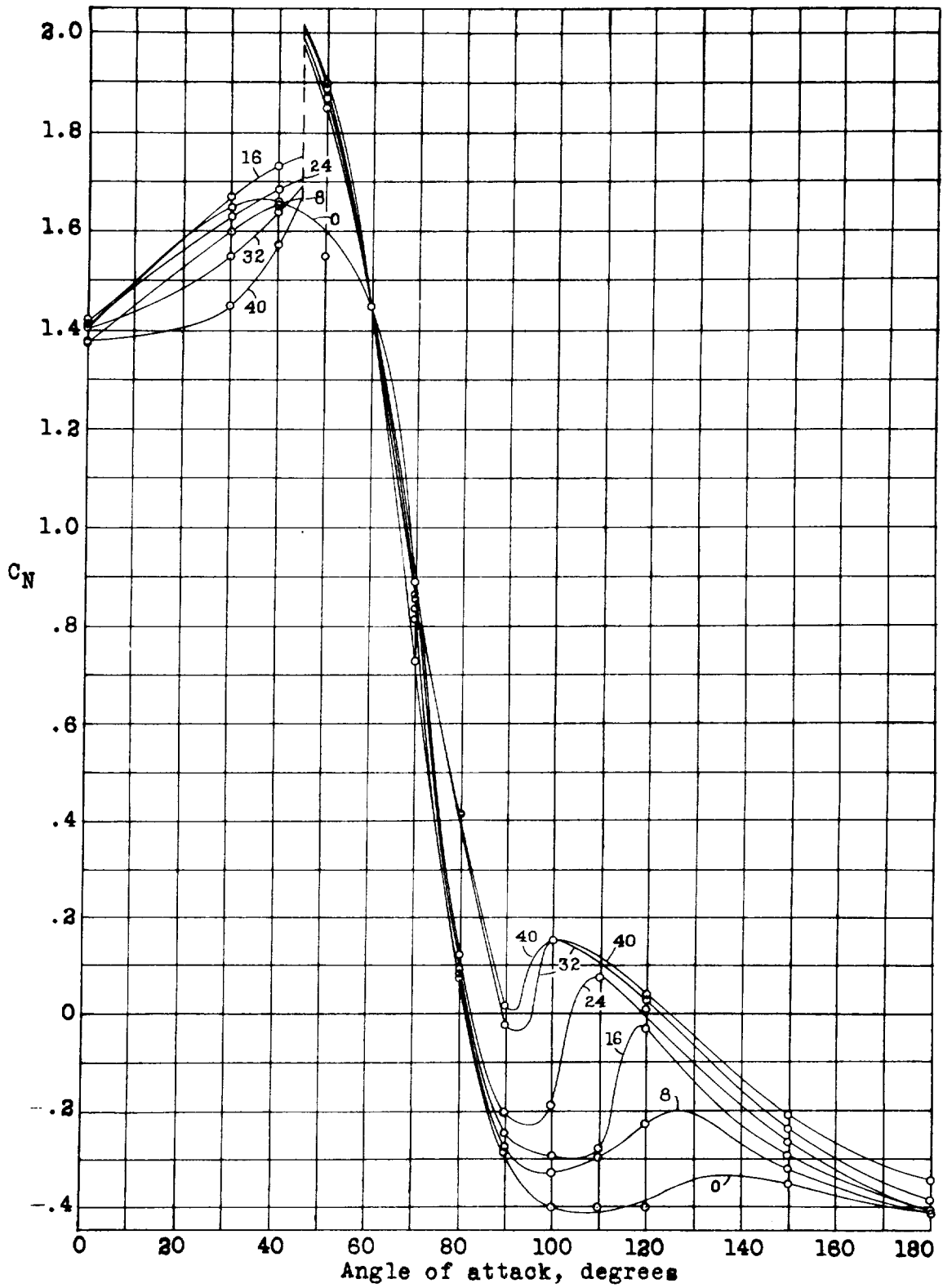

Figure 6.— Normal-force coefficient against angle of attack for hemispherical anemometer cups I, III, and V. Numbers indicate Reynolds Number $\times 10^{-4}$.



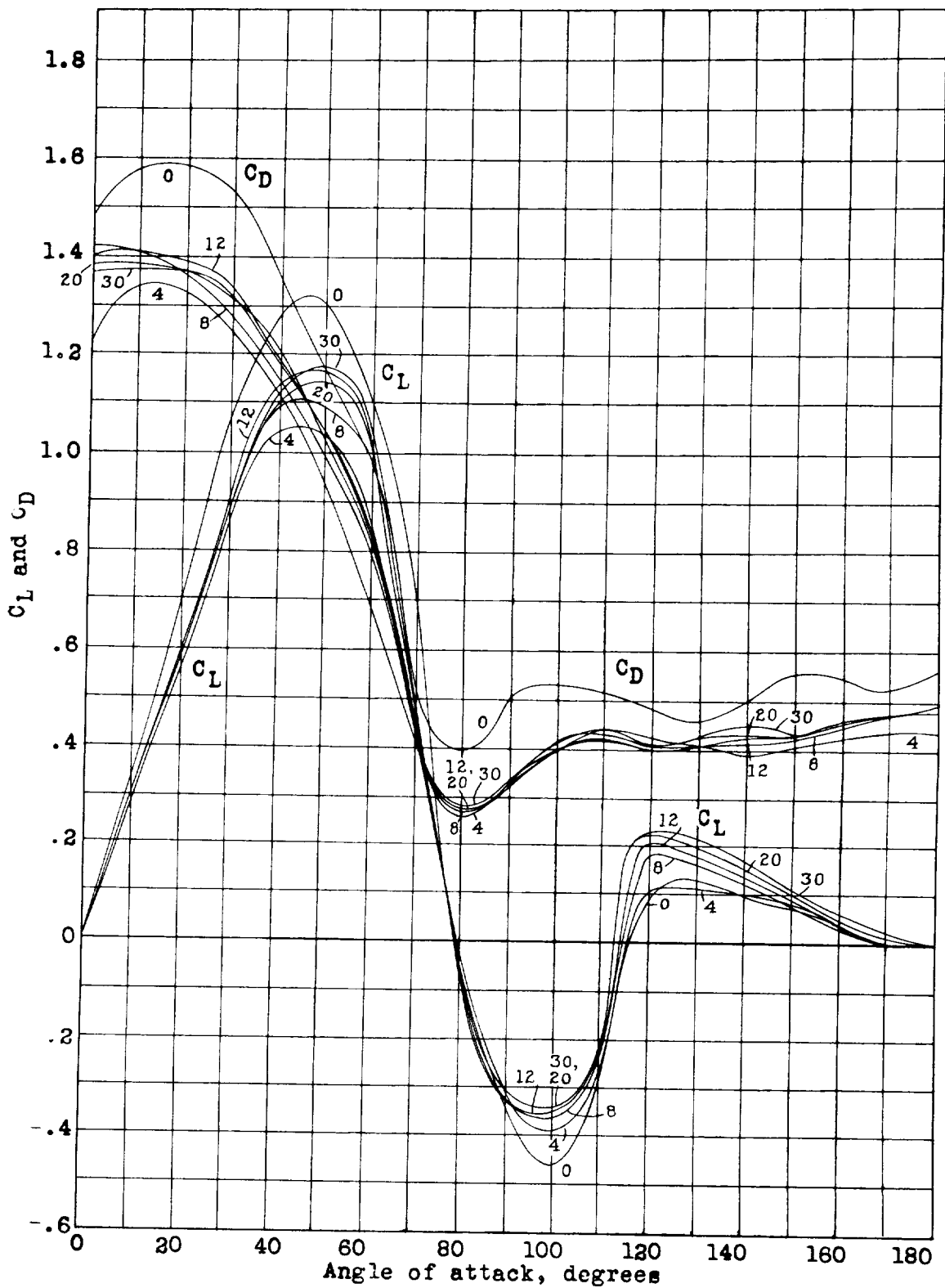

Figure 7.- Lift and drag coefficients against angle of attack for conical anemometer cup II. Numbers indicate Reynolds Number $\times 10^{-4}$.

14

1

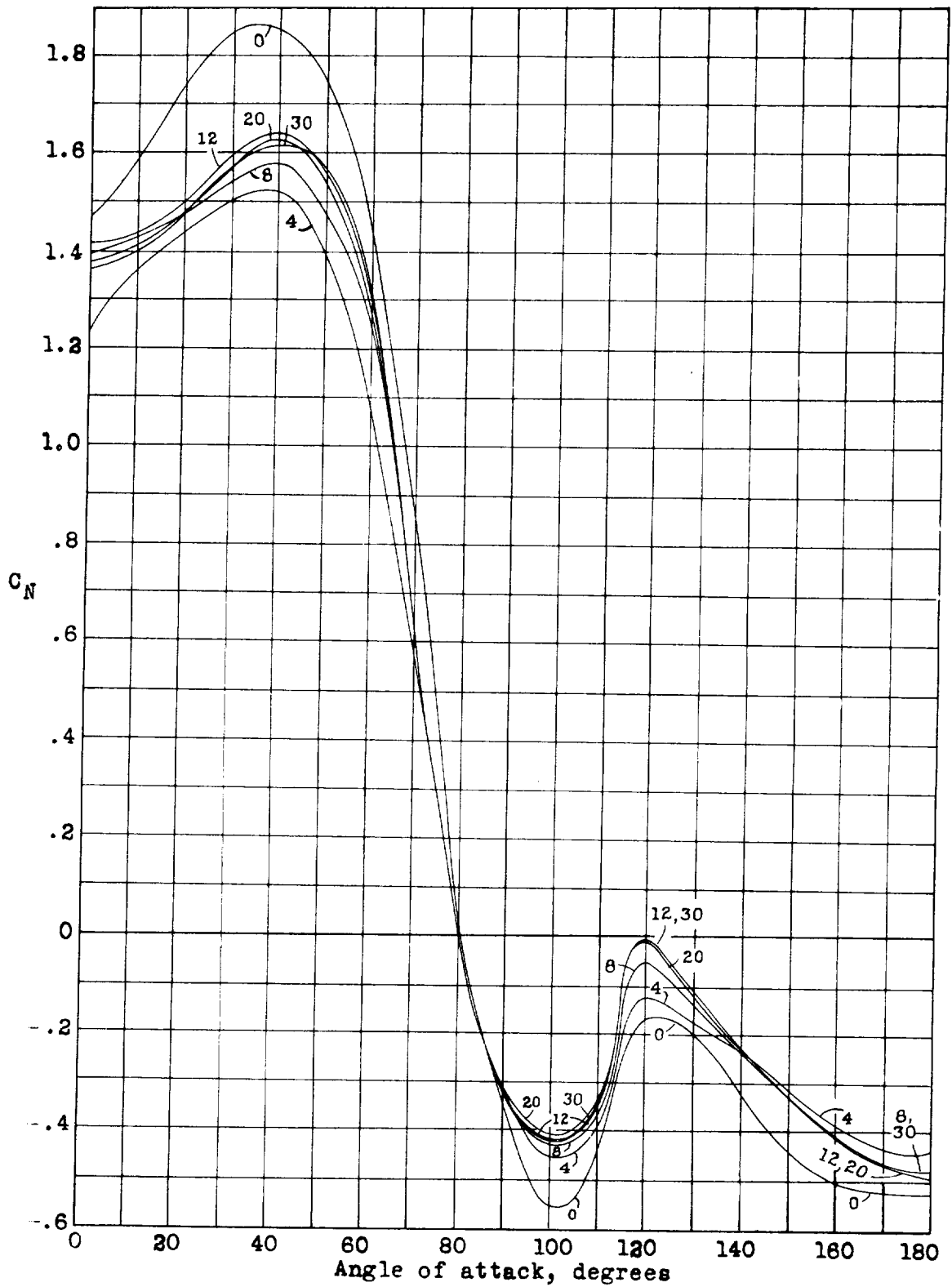

Figure 8.— Normal-force coefficient against angle of attack for conical anemometer cup II. Numbers indicate Reynolds Number $\times 10^{-4}$.

15

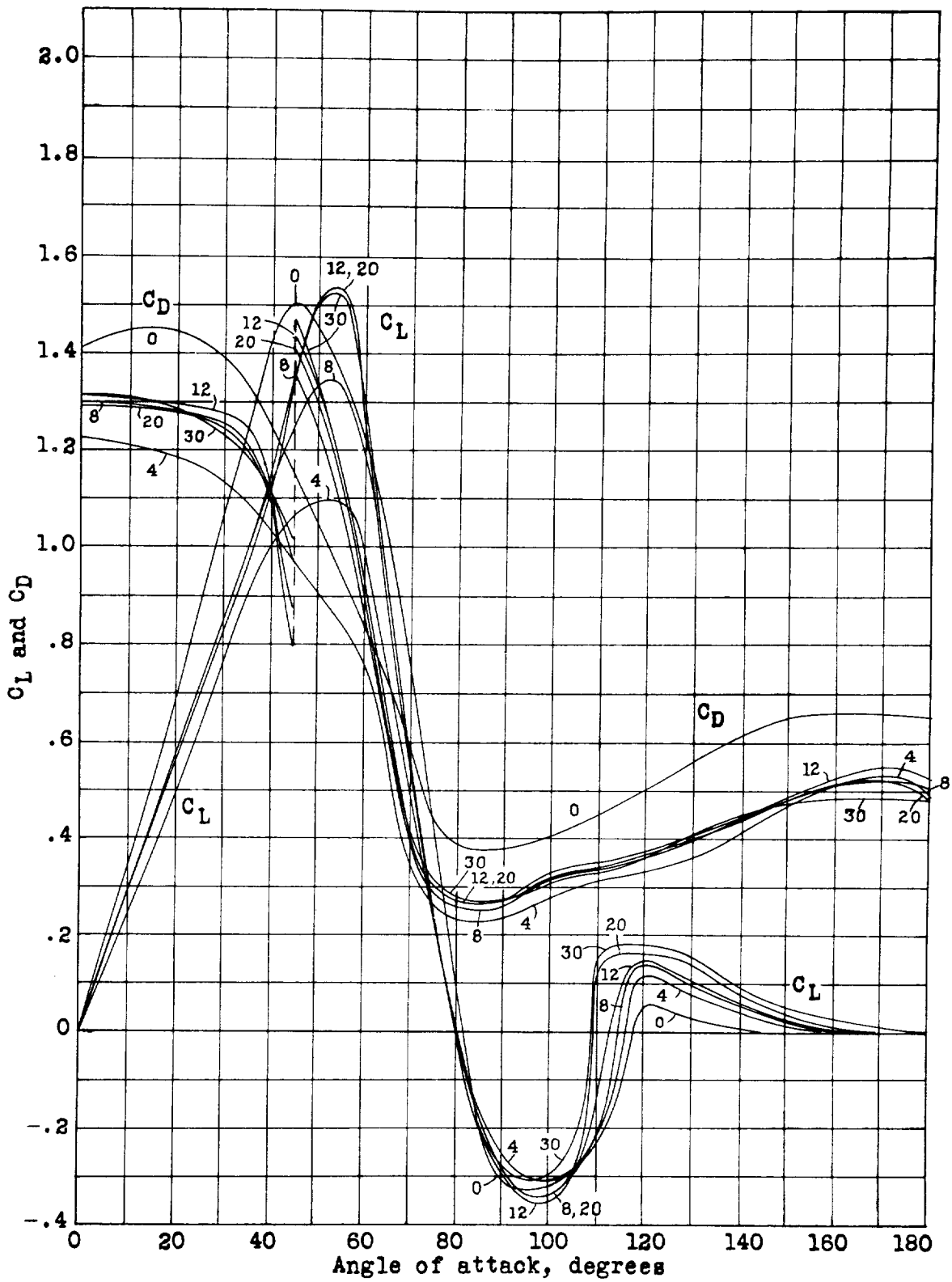

Figure 9.— Lift and drag coefficients against angle of attack for conical anemometer cup IV. Numbers indicate Reynolds Number $\times 10^{-4}$.

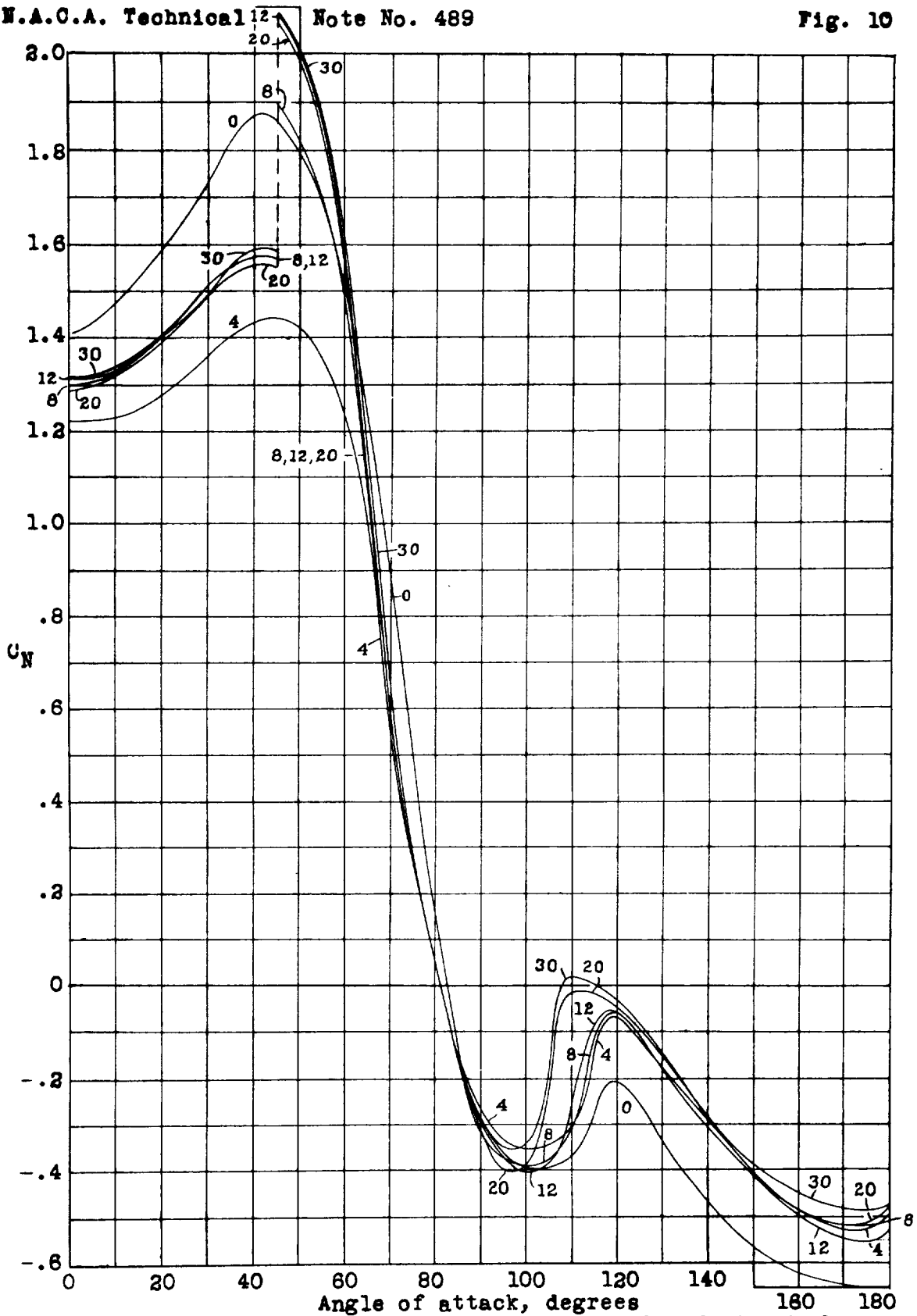

Figure 10.- Normal-force coefficient against angle of attack for conical anemometer cup IV. Numbers indicate Reynolds Number $\times 10^{-4}$.

17

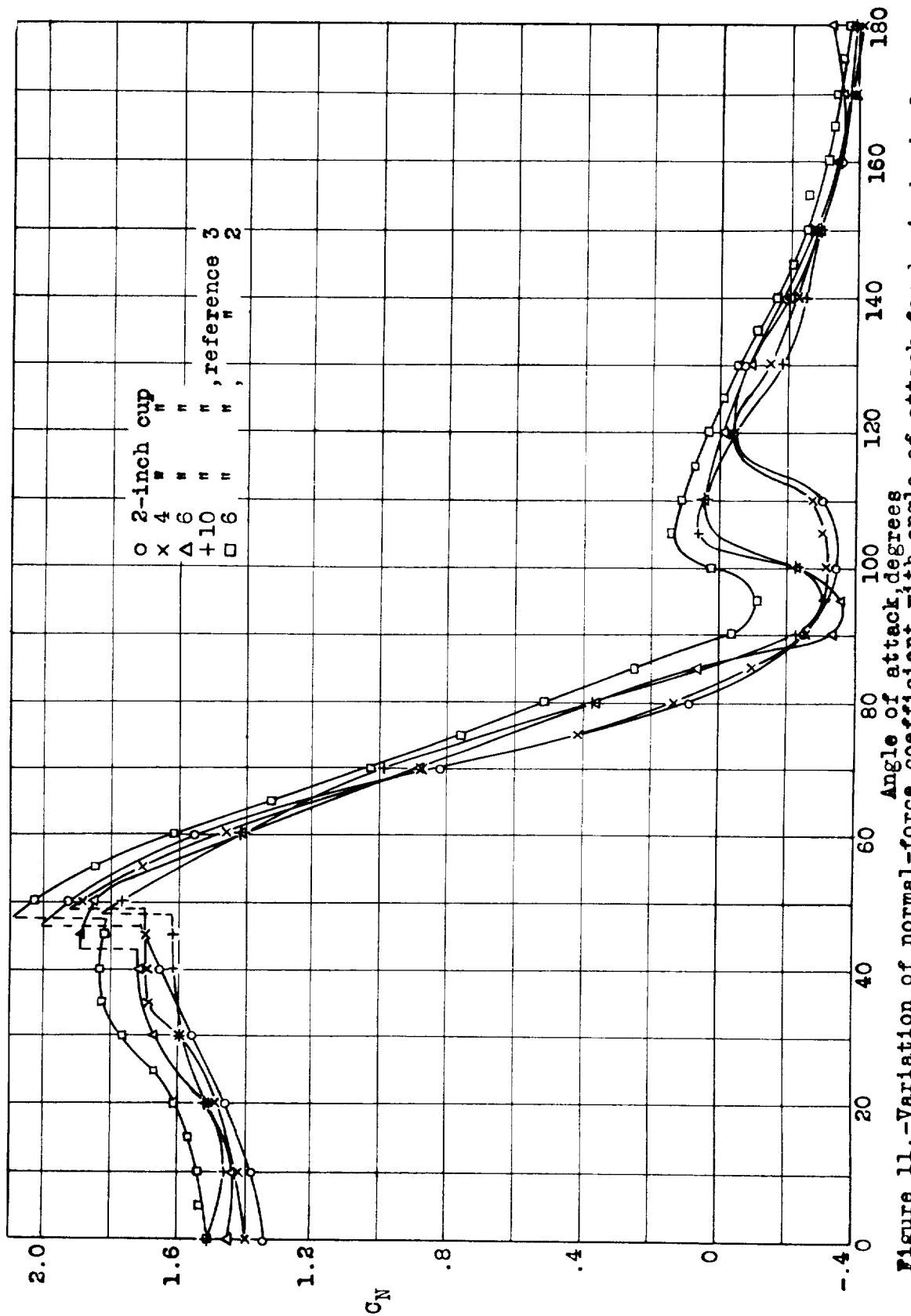

Figure 11.—Variation of normal-force coefficient with angle of attack for hemispherical cups.

[Handwritten signature]

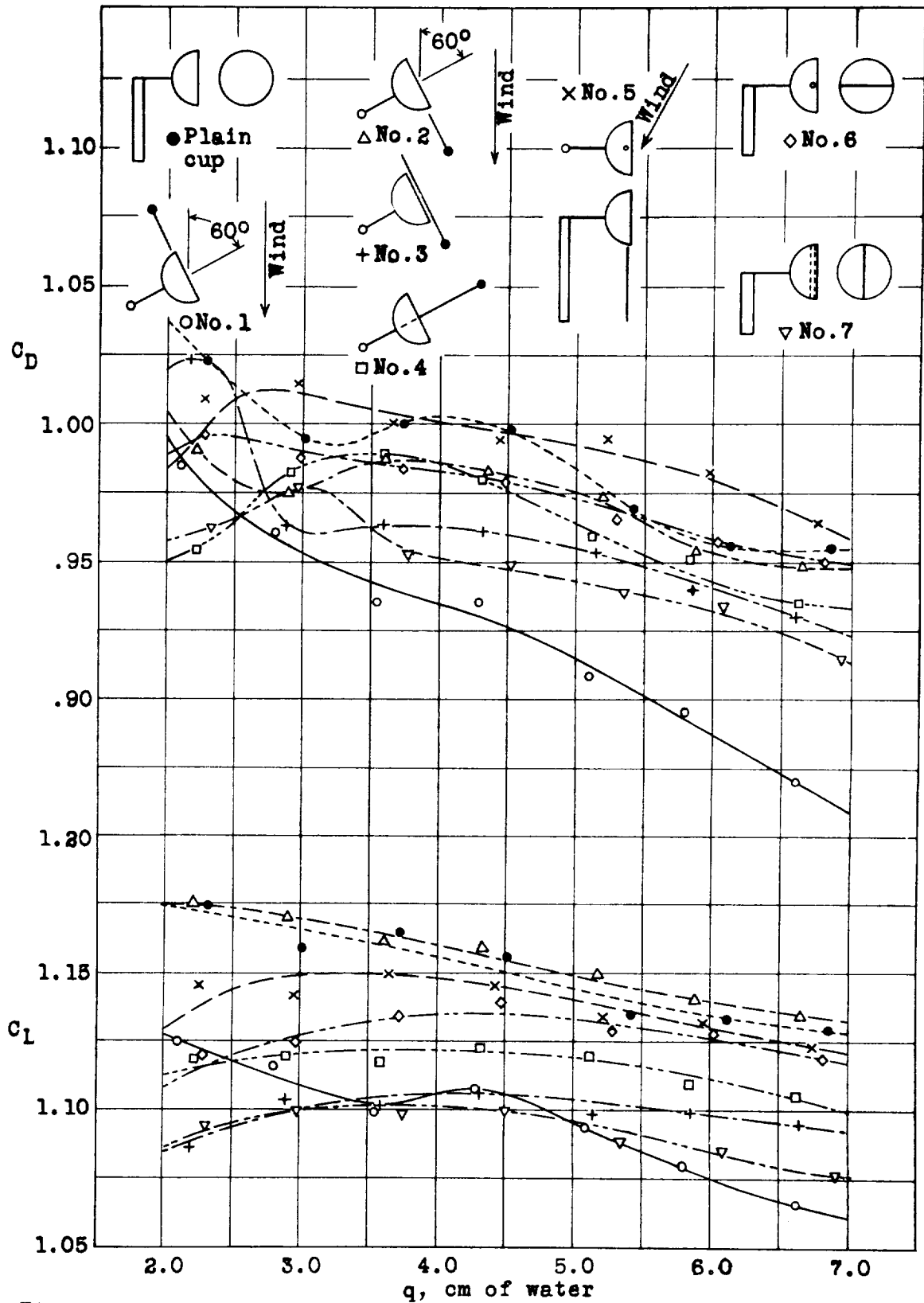

Figure 12.- Effect of mounting on lift and drag coefficients for a 6 inch hemispherical cup. Angle of attack = 60°.

19

