

**CASE FILE
COPY**

FILE COPY
NO. 2

NATIONAL ADVISORY COMMITTEE FOR AERONAUTICS

TECHNICAL NOTE

No. 1186

REVIEW OF AN INVESTIGATION OF CERAMIC COATINGS FOR
METALLIC TURBINE PARTS AND OTHER
HIGH-TEMPERATURE APPLICATIONS

By W. N. Harrison, D. G. Moore, and J. C. Richmond

National Bureau of Standards

THIS DOCUMENT ON LOAN FROM THE FILES OF

NATIONAL ADVISORY COMMITTEE FOR AERONAUTICS
LANGLEY AERONAUTICAL LABORATORY
LANGLEY FIELD, HAMPTON, VIRGINIA



Washington

March 1947

RETURN TO THE ABOVE ADDRESS.

REQUESTS FOR PUBLICATIONS SHOULD BE ADDRESSED
AS FOLLOWS:

NATIONAL ADVISORY COMMITTEE FOR AERONAUTICS
1724 F STREET, N.W.,
WASHINGTON 25, D.C.

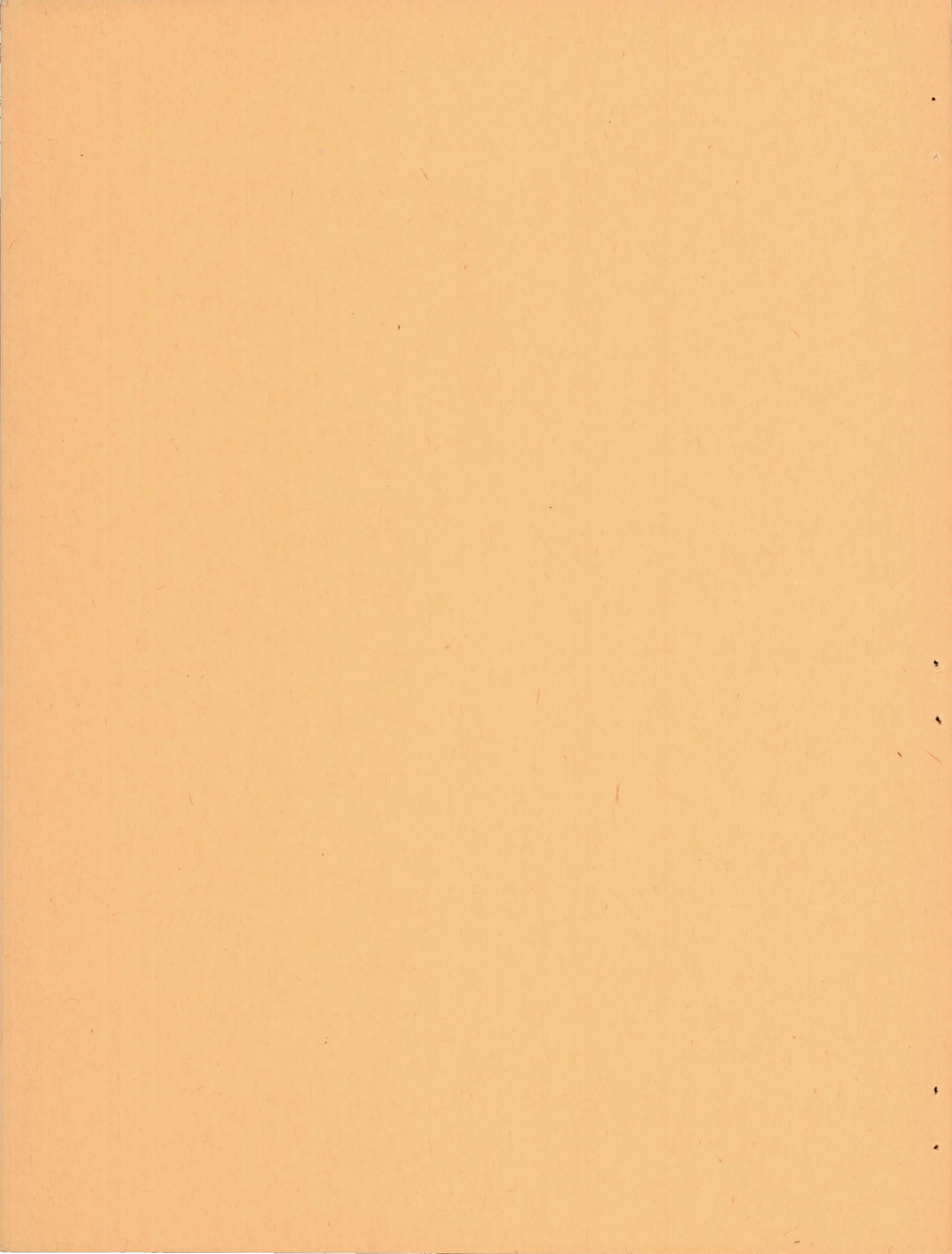

NATIONAL ADVISORY COMMITTEE FOR AERONAUTICS

TECHNICAL NOTE NO. 1186

REVIEW OF AN INVESTIGATION OF CERAMIC COATINGS FOR METALLIC TURBINE PARTS
AND OTHER HIGH-TEMPERATURE APPLICATIONS

By W. N. Harrison, D. G. Moore, and J. C. Richmond

SUMMARY

This investigation was undertaken in an effort to develop ceramic coatings that will prolong the life of alloys used in turbines, especially the blades, or permit their use at higher temperatures than would otherwise be practicable. In order to establish whether or not protective coatings can be developed that will effect such improvement, the following steps were taken: Refractory frits of high thermal expansivity were designed and smelted, various refractory admixtures were incorporated in different amounts, and the coatings were applied and fired at different temperatures on several alloys supplied for the work through the NACA.

Coated specimens were heated at high temperatures in air without load, and evaluation for further study was made on the basis of adherence, resistance to flaking, protection of the alloys against oxidation as indicated by increase in weight, and resistance of the coatings to deterioration as indicated by periodic microscopic examination. High-temperature treatments were also made under load in air, and in oxygen and steam. Some treatments consisted of prolonged application of load at high temperatures followed by tensile tests at room temperature or at high temperature. In some cases stress-rupture tests were made. In addition, greatly accelerated test conditions at high temperatures without load were achieved through the use of highly corrosive atmospheres, H_2S being notably effective.

These studies have so far led to the selection of several promising frits from over a hundred that were prepared and several promising coatings from numerous ones prepared by various refractory mill additions to these frits. It was found that some of the coatings will withstand 500 hours in air at 1500° F with little visible change, while serving to eliminate or greatly reduce the oxidation that occurred on uncoated alloys, which received the same treatment. The high-temperature load tests indicated that, at loads sufficiently low to permit a life of the alloy beyond 600 hours, some of the coatings had a significantly beneficial

effect. It was also found that some of the coatings permitted alloys S-816 and S-590 to retain approximately their initial 0.2-percent offset yield value under conditions that almost completely corroded the uncoated alloys, namely, heating in an H_2S atmosphere at $1350^{\circ}F$ for prolonged periods.

The microscopic examination of treated specimens indicated the importance of working toward the elimination of pores or other discontinuities in the coatings, some of which are connected with the evolution of gas at the surface of the alloys while the coatings are being fired.

INTRODUCTION

During 1942, a study was begun at the National Bureau of Standards to develop a ceramic coating that could be used to protect ordinary steel exhaust stacks which operate at temperatures up to a red heat and are subject to quick heating and sometimes to sudden cooling by rain or other water. A thin ceramic coating for steel of the SAE 1020 and similar types to be used at temperatures up to $1250^{\circ}F$ met these drastic requirements without significant damage and was presented to the armed services in August 1943. Subsequently, following suitable service tests, Army-Navy aeronautical specifications and Army Ordnance Department specifications were promulgated which called for the characteristics of this coating, and it was used on the exhaust pipes of amphibious trucks and also on the exhaust stacks of several models of aircraft. The success of this development served as a foundation for increased interest in the development of ceramic coatings for heat resisting alloys.

In May 1944, under the sponsorship and with the financial assistance of the National Advisory Committee for Aeronautics, the design, construction, and assembly of equipment to be used in development work on coatings for turbine blades and similar uses was begun at the National Bureau of Standards. The present report gives, in brief summary form, the progress of the investigation through December 1945.

DESCRIPTION OF EQUIPMENT

Preparation and Application of Coatings

Gas-fired pot furnances suitable for crucible batches of 2000 to 3000 grams were used for smelting all the frits. A gas-fired rotary furnace for batches of 35 to 50 pounds was used to smelt larger quantities of the frits selected for the more extensive tests. Smelting temperatures were controlled manually with the aid of an optical pyrometer.

One-gallon jar mills and five-gallon ball mills, as needed, were used for grinding the coatings. A laboratory-type sand-blast cabinet was used for cleaning the alloys prior to application of the coatings. This equipment was operated with an air pressure of 30 psi, the blasting medium being 60 mesh glass sand. The coatings were usually applied by spraying. An electrically heated drier with forced warm-air circulation was used for drying the coatings after spraying. An electric furnace was used for firing the specimens, which were suspended from a nickel-chromium rack for the purpose, and a recorder-controller was used to maintain the furnace at the desired temperatures.

Testing of Frits

A Fizeau-Pulfrich interferometer (see reference 1) was used for determination of the thermal expansion and softening point of the frits and coatings.

Fusion blocks were used to study the flow characteristics or refractoriness of the various frits. A description of the method and equipment is given in a publication of the National Bureau of Standards (reference 2).

Treatment of Specimens

Equipment for heating specimens in air without load.- The furnace used for long-time heating in air without load was electrically heated. A recorder-controller was used for obtaining constant temperatures within the range 1000° to 2200° F. The dimensions of the specimens subjected to this treatment were approximately 0.05 by 0.8 by 2 inches, as shown in figure 1(a).

Equipment for treating specimens at high-temperature under load.- Six resistance-type tube furnaces with individual temperature controllers were used. Temperature distribution over the gage length of the specimen was regulated by three variable transformers connected with separate sections of the furnace winding. Temperature measurements of the specimen were made by means of two thermocouples, one at the shoulder above the neck and one at the shoulder below. The two wires of each thermocouple were spot welded to opposite sides of the specimen. The temperature of each specimen as indicated by these thermocouples was held constant during the test to within $\pm 5^\circ$ F. The specimens were 20 inches long to permit gripping outside the furnaces (see fig. 1(c)). Figure 2 shows the furnaces and parts of the lever system for applying controlled loads to the specimens while heated.

Equipment for controlled-atmosphere tests.— Two resistance-type vitreous-silica-tube furnaces were used for controlled-atmosphere heating tests. The inside diameter of the fused silica tube was 2 inches and a platinum hanger was so arranged that eight tensile specimens 0.05 by 0.8 by 9.0 inches (see fig. 1(b)) could be suspended in parallel for test.

Tight fitting Pyrex glass end-caps with appropriate fittings were sealed to the cool ends of the impervious silica tube. During testing, gas was fed into the furnaces from storage tanks, the rate of flow being regulated by means of a pressure reducer and needle valve. The temperature inside each furnace tube was automatically controlled and recorded with the aid of a platinum, platinum-10-percent-rhodium thermocouple inserted through a sealed joint at the top of the furnace.

Examination and Testing of Treated Specimens

The room-temperature tensile properties of treated specimens were determined on a Riehle pendulum-type, hydraulically operated testing machine, equipped with an automatic stress-strain recorder. The specimen was stretched at a rate of approximately 0.03 inch per minute until 0.4- to 0.6-percent elongation had occurred in the 2-inch gage length, after which the rate was increased to 0.1 inch per minute until failure.

Tensile tests at high temperatures were made with a Southwark-Tate-Emery testing machine, used in connection with a furnace wound and controlled similarly to those shown in figure 2.

A binocular microscope with magnifications up to 120X and a petrographic microscope, arranged for oblique illumination so as to function as a metallurgical microscope, were used for examination of the specimens. Photomicrographs of selected specimens were made with the petrographic microscope.

EXPERIMENTAL PROCEDURE AND RESULTS

Formulation of Frits

Frits are the glassy constituents of the ceramic coatings and act as binders for the more refractory constituents. In order to produce coatings that would adhere to the high-expansion alloys and at the same time withstand the high operating temperatures, it was necessary to develop special frits with higher coefficients of thermal expansion and greater refractoriness than those ordinarily used in enameling operations. The difficulty in accomplishing these two modifications in properties simultaneously lies in the fact that, as a general rule, the changes in

composition that contribute to the one detract from the other. Nevertheless, by departure from conventional compositions it was possible to change both properties in the desired direction.

The four basic frits used as original points of departure in this development were (1) frit 11, a typical "hard" commercial-type ground-coat frit, (2) frit 226, a commercial-type ground-coat frit that was very refractory, but low in thermal expansivity, and (3) and (4) two special frits, 98 and 104, outside the commercial range.

The refractoriness was increased by making systematic additions of titania, silica, and feldspar, and by making substitutions of alumina and fluor spar for soda in the base composition. The expansivity of the refractory frits developed by these methods was increased by substituting lead oxide for boric oxide and titania for silica. The computation of chemical compositions of the smelted frits from the raw batches was supplemented by chemical analysis, for which the improvement of existing methods was involved for several constituents in these many-component systems. More than 100 different compositions of frits have been smelted.

Selected frits were tested for thermal expansion with the interferometer (reference 1) and for refractoriness with fusion blocks (reference 2). These two tests served as a basis for further selection, the most promising frits being given further test by trials in actual coatings, with varying kinds and amounts of other constituents. Four of the frits selected for more exhaustive tests, with various admixtures to form coatings, were 228, 256, 261, and 269.

Formulation and Application of Coatings

The formulation of coatings consisted essentially of blending the specially developed frits with varying refractory ceramic admixtures. Other mill additions besides the refractory admixtures were clay, water, and electrolyte. The time of grinding was controlled to govern the average particle size.

Among the ceramic admixtures tried were alumina, chromium oxide, cobalt oxide, manganese dioxide, nickel oxide, magnesium oxide, calcium silicate, calcium chromate, and calcium fluoride. The first three of these, singly and in combination, gave most promise; most of the others gave coatings having some characteristics that made them undesirable, such as lack of chemical stability, water solubility in the ball milling, or reaction with the base metal.

All coatings, after ball milling to the proper fineness, were applied by spraying to thicknesses of 0.001 to 0.004 inch onto the cleaned alloy surface. After spraying, the coating was dried at 230° F, after which it was fired.

The alloys to which the coatings were applied more extensively are included in the following list: 19-9DL, Inconel, 2520, 2520 + 2%Si, 18-8STi, S816, S-590, and 18-8 type 304.

Aluminum-oxide admixture.— Approximately 140 coatings were prepared with various grades of aluminum oxide as the principal refractory admixture. Forty different frits were used in this group of coatings, and the amount of alumina added varied from 20 to 60 percent of the total weight of frit plus alumina. The firing temperatures ranged from 1550° to 2300° F, depending both on the refractoriness of the coating and the degree of vitrification sought in the ceramic coating.

Among the most promising coatings with alumina as the chief admixture were the following:

<u>Coating</u>	<u>Frit</u>	<u>Alumina content (percent)</u>
L-2A	261	25
L-4A	261	35
L-6A	228	25

Combinations of alumina with other oxides also gave several promising coatings. Of the 66 coatings of this type, composition L-5AC was among the most promising. This coating is an alumina - chromic-oxide combination containing 70 percent frit 261, 20 percent A-1 alumina, and 10 percent chromic oxide.

Chromic-oxide admixture.— In a series of coatings using commercially pure chromic oxide with frits 228, 256, 261, and 269, two coatings were selected as among the most promising. These were A-305 and L-7C, both of which contained 30 percent Cr_2O_3 , the A-305 using frit 269, and the L-7C, frit 228.

Cobalt-oxide admixture.— Although cobalt oxide is less refractory than Al_2O_3 or Cr_2O_3 , it was used in a series of coatings with frits 228, 261, 256, and 269. These coatings were found to be outstanding in their resistance to chipping during long-time heating tests in air. The following are examples of these coatings:

<u>Coating</u>	<u>Frit</u>	<u>Cobalt- oxide content (percent)</u>
A-295	228	50
A-189	261	50
A-309	269	50

High-Temperature Treatment in Air without Load

In the development work on coatings, it was found that the majority of the coatings when first prepared had a good appearance and gave good coverage of the metal. When these coatings were heated for long periods, however, at a temperature of 1500° F, many of them changed considerably in appearance and some eventually flaked off the alloy. A treatment of 500 hours at this temperature in air was found sufficient to give an indication of which coatings should be chosen for more exhaustive study. The test was made in an electric furnace and the specimens subjected to these tests (see fig. 1(a)) were removed and allowed to cool each 24 hours so that thermal gradients would accentuate any tendencies of the coatings to chip or flake off.

Inspection of specimens, which was made periodically, consisted of an examination based on (a) freedom from chipping, (b) changes in appearance, (c) changes in microstructure of the coatings, and (d) changes in weight. Any specimen on which the coating had chipped appreciably when inspected was withdrawn from the test without further treatment. The other changes were noted, but did not necessarily eliminate the coating from further consideration.

During the 500 hours of heating there were considerable changes in microstructure of some of the coatings, whereas others showed little or no change. Photomicrographs of the same field on selected specimens were taken at 120 magnification before treatment and after 200 and 500 hours, respectively. Figure 3 shows three such views of coating L-6A on alloy S-590, which is an example of a type of coating that showed considerable deterioration during heating in air at 1500° F. Figure 4 is a series of photomicrographs of coating A-309 applied on alloy S-816, which is an example of a coating type that showed no appreciable change in the microstructure during the 500-hour heating treatment in air. The only visible change that occurred with this specimen was a small decrease in glossiness from a slightly glossy original condition. Figure 5 represents coating L-5AC as applied on alloy S-816, and illustrates the unusual property of self-sealing of discontinuities that were initially present.

For the specimens that did not undergo appreciable chipping and consequent vitiation of the significance of the results, a comparison of the gains in weight of uncoated specimens and the data obtained by weighing the coated specimens before and periodically during the heating tests indicated the degree of protection afforded the alloys against oxidation. Figure 6 shows change-in-weight curves of the seven uncoated alloys included in the latest test. Figure 7 shows similar curves of two specimens having coating L-4A fired to different stages of vitrification and an uncoated specimen of alloy S-590. The average thickness of the L-4A coatings was approximately 1 mil while that of the scale or oxide film on the bare alloy was about 0.3 mil. The advantage of the more vitrified (less porous) coating is demonstrated in this figure.

The heating tests at 1500° F in air in all cases indicated the importance of the thermal expansion of the alloy in relation to that of the coating. The coatings that had a tendency to chip invariably chipped first on the alloys with high thermal expansivity. The alloys showing the greatest tendency to produce chipping in the coatings were 19-9DL, 2520, and 18-8, while those of lower expansion that did not cause the same difficulties from chipping were Inconel, S-590, and S-816.

High-Temperature Treatment under Load in Various Atmospheres

Several combinations of conditions and test methods were tried in a search for those that would yield maximum information in the shortest test period. Experiments confirmed that the heat treatment which the metal received during the coating process had a distinct effect on the tensile properties of the metal, as shown in tables I and II. For each specimen coated and tested, therefore, an uncoated specimen was given as nearly identical heat treatment as possible. The uncoated companion specimen was treated in the same manner and at the same time as the coated specimen.

The metal 19-9-DL was used in the earlier tests, upon recommendation of the NACA. The initial procedure was to hold each specimen for a given period of time at a constant temperature, under constant load, after which the specimen was removed from the furnace and broken in tension at 1350° F.

The results of a series of such tests on coated and uncoated specimens of alloy 19-9-DL are given in table I. Probably the most striking difference between the coated and uncoated specimens is indicated in the last column of the table, which evaluates a phenomenon designated as a saw-tooth effect. This difference is illustrated in figure 8. The appearance of these specimens suggests that an intergranular corrosion may have occurred on the uncoated specimens but that it was prevented or retarded on the coated specimens. In every case, coated specimens in table I received an "A" rating, indicating a virtual absence of the saw-tooth effect. The ratings for the uncoated specimens varied from "B" to "D", the rating appearing to be affected to some extent by the firing treatment to which the specimen had been subjected prior to the high-temperature long-time loading. Unfired specimens and those fired at 1650° F received, in general, poorer ratings than those fired at higher temperatures. The data in table I all apply to only one alloy, however, and, taken in connection with other data, are not considered conclusive.

It was thought that stress-rupture tests might bring out the effect of the coatings but, since the equipment shown in figure 2 was not suitable for such tests with most alloys, it was necessary to use an alloy which would fail with little elongation, and the 2520 alloy was selected. By reference to table III and figure 9 it can be seen that, in air, the

driving the turbine in a jet-propelled plane must be heterogeneous and doubtless have fluctuating tendencies toward reducing or oxidizing conditions at any given location in the system. The question of erosion, due to the high velocity of the gases relative to the turbine blades and to any solid matter that may be carried in the gas stream, is one which can be suitably taken into account only by tests made under dynamic conditions. With respect to the tendency of the atmosphere toward oxidizing or reducing conditions, however, the treatments in oxygen and in hydrogen sulphide, which were used in this study, doubtless include the extremes of the range encountered in practice. It appears probable that coatings which protect the alloys well in these extreme atmospheres will also be effective in any atmosphere encountered under service conditions. On the other hand, it is not necessarily true that coatings which fail to give complete, prolonged protection of the alloys at high temperatures in atmospheres of H_2S and O_2 will also fail to do so under service conditions. The advantage is that accelerated tests, a term applicable especially to the H_2S treatments, permit the testing of a number of coatings within a reasonable period of time. From the information thus gained and a due consideration of the limitations of the accelerated test methods, it is believed that a basis will be afforded for selection of the comparatively few coatings which will be practicable to test in actual turbine installations. The possible value of insulating coatings that would permit higher gas temperatures without increasing the operating temperature of the turbine blades is not to be overlooked. It is apparent that the relative effectiveness of the coatings in protecting different alloys varies from one alloy to another. This fact emphasizes the importance of including in this study the alloys most used and most promising for future use in turbine blades.

CONCLUDING REMARKS

Data so far obtained indicate clearly that some ceramic coatings provide a high degree of protection for high-temperature alloys in a strongly corrosive atmosphere at elevated temperatures. The change-in-weight curves indicate that at least some coatings are capable of preventing or greatly retarding surface oxidation of the alloys in air at $1500^\circ F$ for at least 500 hours. Stress-rupture tests indicate that at loads low enough to ensure a life of over 600 hours for the uncoated alloy specimen, some of the ceramic coatings add significantly to the time required for failure. In an atmosphere as corrosive as H_2S several of the coatings tested provided such effective protection that alloys S-590 and S-816 retained approximately their initial 0.2-percent offset yield values in high-temperature treatments which almost completely disintegrated uncoated specimens.

Test procedures have been established, and indications which have been obtained as to the causes of failure of the coatings give promise of substantial further progress in the development of protective ceramic coatings.

National Bureau of Standards,
Washington, D. C., January 22, 1946.

REFERENCES

1. Saunders, James B.: Improved Interferometric Procedure with Application to Expansion Measurements. Nat. Bur. of Standards Jour. Res., vol. 23, 1939, p. 179.
2. Harrison, W. N., and Sweo, B. J.: Some Fusion Properties of Ground Coat Enamels as Influenced by Composition. Nat. Bur. of Standards Jour. Res., vol. 10, 1933, p. 189.

19-2-90B) were virtually corroded through in 189 hours of treatment. All the coated specimens of S-590 treated simultaneously in the same furnace did not decrease in yield value, as may be seen by comparison with the values for specimens 19-1, 19-4, and 19-5 in table II. The heat treatment, in fact, tended to give a moderate increase in yield value accompanied by a decrease in ultimate strength and a marked drop in elongation.

The fact that sealed coatings are more effective than porous ones is brought out in table IV (specimens 18-3 to 18-6 and especially 19-3 to 19-6). Coating H5AC was known to be very porous, and L-7C tightly sealed, at least at the beginning of the treatment. The greater effectiveness of coating L-7C in protecting the alloys is apparent from a comparison of the tensile properties of the specimens after treatment.

Figure 10 shows the specimens of alloy S-590, coated and uncoated, that were treated in an atmosphere of H_2S for 189 hours at $1350^\circ F$. At the left are the uncoated specimens which were almost corroded through; one of them broke of its own weight during the treatment. The coated specimens show increasing degrees of protection from left to right.

The attack through coatings A-189 and A-305 took the form of tubercles, consisting probably of sulfides of the alloying elements, and these are apparent in figure 10 as white specks. Very few of them, if any, are visible on coating L-2A. The specimens with coating A-305 shown in figure 11 offer a favorable opportunity for a study of the mechanism of the attack. The locations of the tubercles on these specimens correspond to the locations of discontinuities in the coating, which were visible under the microscope before the H_2S treatment and which appeared to result from gas evolution during firing of the coating. Figure 11(a) shows the appearance of coating A-305 at a magnification of 30X before the tubercles had begun to form; 11(b) shows the early stages of tubercle formation and 11(c) a more advanced stage. With continued treatment, growth of the nodules continues. The selective attack on the metal is illustrated in figures 12(a) and 12(b), which are photographs taken at 30X after the coating was removed by sandblasting. Figure 12(a) corresponds to 11(a), and 12(b) to 11(c). Figure 12(b) shows cavities resulting from selective attack where discontinuities occurred in the coating. Figure 12(c), which is a photomicrograph of coating L-2A as shown in figure 10, illustrates the appearance of a coating that gave successful protection of the alloy against the attack by H_2S at $1350^\circ F$. Figure 12(c) should be contrasted with figure 11(c).

ANALYSIS AND DISCUSSION

The service conditions that turbine blades are required to withstand are hardly subject to duplication in static laboratory tests. The gases

coated specimens broke somewhat sooner at the high loads, but for the stress range within which the alloy might be used, this relation was reversed. A "knee" in the stress-rupture curve for the uncoated metal occurred at 168 hours, while for the coated specimens none had occurred up to 672 hours. The values for the L-6A coatings and the uncoated companion specimens are not comparable with those having coating L-7C as the firing temperatures for applying the coatings were different.

Stress-rupture tests in steam and oxygen were also made. The results, given in table III, indicate an advantage to the coated specimens under the load conditions so far tried. Additional data will be required, however, before definite conclusions can be drawn.

High-Temperature Treatment in Various Atmospheres without Load

Tests made to secure data on the relative effectiveness of different coatings in protecting alloys heated in air are time consuming. Coatings that deteriorate or flake off may be discarded, but when the coatings do not appreciably deteriorate in, for example, 500 hours it is difficult to evaluate the protection they offer if the alloys themselves are resistant to deterioration at high temperatures in air. In order to obtain a more positive indication of the effectiveness of the coatings in protecting the alloys from the surrounding atmosphere, while at the same time reducing the time required to obtain such data on each coating selected for testing, it was decided to treat some of the specimens in an atmosphere that would be highly corrosive to the uncoated alloys.

Preliminary comparative tests were made of uncoated alloy specimens at 1350° F in atmospheres of air, oxygen, hydrogen, carbon monoxide, carbon dioxide, water vapor, chlorine, sulfur dioxide, and hydrogen sulfide. Of these, the sulfur gases were found to be more corrosive than any of the others. Hydrogen sulfide was considerably more corrosive than sulfur dioxide and was selected for use in most of these tests.

It was soon apparent that in an atmosphere of hydrogen sulfide at 1350° F all the ceramic coatings tested afforded some protection to the metal. In table IV it can be seen that the coated specimens after treatment had tensile properties superior to those of the corresponding uncoated specimens. This effect is conspicuous when specimens 18-1-86 and 18-2-87, which were uncoated alloy S-816, are compared with coated specimens of the same alloy treated simultaneously for 471 hours at 1350° F in H₂S. The uncoated specimens were completely corroded and specimens with coating A-189 (18-1-85B and 18-2-85B) retained over half of their initial strength. The other two pairs of specimens in this group, coated with L-2A and A-305, respectively, retained approximately their full initial yield value, as can be seen by comparison with values given in table II for specimens 18-1, 18-4, and 18-5. Uncoated specimens of alloy S-590 (19-90B and

APPENDIX A

The following data concerning the thermal history of certain alloys used in this study were furnished by the manufacturers:

"The S-590 and S-816 material was hot rolled at 2150/2200° F, annealed 25 minutes at 2180° F, air cooled, sandblasted, scrubbed, cold rolled one pass, buckled and sheared.

"The 2520 + 2% Si material was hot rolled 2080/2100° F, annealed 2150° F 10 minutes, and water quenched, sandblasted, scrubbed, cold rolled one pass, buckled and sheared.

"All of the inconel was furnished as standard cold rolled, soft temper, plain finish quality. The material received the following thermal treatment after final cold reduction:

- (a) Soft annealed in natural gas fired continuous furnace for approximately four (4) minutes at temperatures of 1850-1900° F;
- (b) Furnace cooled from annealing temperature to approximately 300° F in eleven (11) minutes and then withdrawn to air;
- (c) No solution treatment nor subsequent aging treatment was used."

TABLE I.-- RESULTS OF 172-HOUR TREATMENT AT 1350° F UNDER LOAD OF 5 KIPS PER SQUARE INCH, AND TENSILE TESTS FOLLOWING SUCH TREATMENT ON COATED AND UNCOATED SPECIMENS OF ALLOY 19-9DL

Specimen	Coating	Gage length ¹ (in.)	Fired 5 min. at (°F)	Test no.	Elongation in load test			Tensile test ³ at 1350° F	
					Over-all total (in.)	Between marks total ²		(0.2-per-cent off-set yield strength (ksi))	Saw-tooth ratings ⁴
						(in.)	(per-cent)		
6-9	L-7C	4.5	1650	3	0.25	---	---	19.3	A
6-B3	None	4.5	1650	3	.50	---	---	18.3	C
6-1	A-189 ⁵	4.5	1700	4	.19	---	---	20.4	A
6-B4	None	4.5	1700	4	.38	---	---	20.5	C
6-4	L-9AC	4.5	1850	5	.09	---	---	21.7	A
6-B5	None	4.5	1700	5	.19	---	---	21.6	D
6-B0	-do--	4.5	Unfired	6	.25	---	---	(?)	B
6-B8	-do--	4.5	1850	6	.09	---	---	21.7	C
6-29	L-7C	4.5	1650	7	.451	0.41	9.0	19.9	A
6-7B	None	4.5	1650	7	.365	.33	7.2	19.0	C
6-20	L-9AC	4.5	1850	7	.051	.03	.7	21.6	A
6-9B	None	4.5	1850	7	.055	(s)	---	22.3	B
6-37	A-189	4.5	1700	8	.284	.27	6.0	20.9	A
6-10B	None	4.5	1650	8	.232	.18	4.0	20.9	D
6-16	H-5AC	4.5	1800	9	.286	.26	5.8	21.3	A
6-16B	None	4.5	1800	9	.200	.19	4.2	21.1	B
6-23B	-do--	4.5	Unfired	10	.432	(s)	---	20.4	C
6-62B	-do--	2.25	-do--	10	.345	(s)	---	22.2	D
6-52	L-9AC	2.25	1850	11	.019	(s)	---	22.8	A
6-52B	None	2.25	1850	11	.071	(s)	---	24.0	C
6-21B	-do--	4.5	1650	14	.346	.30	6.7	21.5	D
6-60B	-do--	2.25	1650	14	.146	.11	4.8	21.3	C

¹ Nominal length of the parallel sided neck between shoulders.

² Marks were made at or near shoulders and include at least 1 in. more than the nominal gage length. They were placed in this position to avoid the possibility of obliteration by chipping of the coatings as a result of stretching in the neck. The in./in. value is computed by dividing the total elongation between marks by the nominal gage length (4 in.) on the assumption that the stretch occurred there.

³ Ultimate strengths are not given because, under the conditions of these tests at 1350° F, the values obtained for yield strength were more reliable.

⁴ Arbitrary rating in which A indicates virtual absence of saw-tooth effect and D indicates severe saw-tooth effect (fig. 8).

⁵ Fired 10 min.

⁶ Fired 7 min.

⁷ Stress-strain graph continuously curved.

⁸ Marks not visible at end of tests.

TABLE II.-- RESULTS OF TENSILE TESTS AT ROOM TEMPERATURE ON "AS RECEIVED"
AND ON FIRED BUT UNTREATED ALLOY SPECIMENS

Specimen	Alloy	Fired 5 min at (°F)	Vickers hardness no.	0.2 per- cent off- set yield strength (psi)	Ultimate tensile strength (psi)	Breaking strength (psi)	Elon- gation in 2 in. (percent)
6-1	19-9DL	2000	186	48,100	113,000	108,700	46
6-4	19-9DL	1650	224	56,200	120,100	116,800	3½
6-5	19-9DL	---	224	56,000	118,200	116,500	3½
8-1	Incone1 ¹	2000	137	32,400	91,700	85,700	43½
8-4	---do---	1650	142	36,800	94,000	89,000	41½
8-5	---do---	---	150	36,300	94,700	88,800	41½
12-1	25-20	2000	168	42,700	96,200	92,100	46
12-4	25-20	1650	168	46,200	97,400	92,900	42½
12-5	25-20	---	160	47,600	95,400	86,500	50½
13-1	18-8STi	2000	138	31,500	88,800	82,900	59½
13-4	18-8STi	1650	142	36,200	89,700	83,700	57½
13-5	18-8STi	---	138	38,200	89,900	84,900	61
17-1	2520+2%Si ¹	2000	251	40,300	93,800	86,200	64
17-4	2520+2%Si	1650	254	45,300	94,200	90,200	50½
17-5	2520+2%Si	---	247	43,900	95,100	65,400	51
18-1	S-816 ¹	2000	150	69,600	152,600	152,200	44
18-4	S-816	1650	148	75,100	146,300	146,300	21½
18-5	S-816	---	151	72,900	148,500	148,500	29
19-1	S-590 ¹	2000	220	57,200	126,500	126,500	32½
19-4	S-590	1650	230	64,200	125,200	125,200	23
19-5	S-590	---	215	66,600	127,800	127,800	18

¹See appendix A for thermal history "as received."

TABLE III.- RESULTS OF SOME STRESS-RUPTURE TESTS ON COATED AND UNCOATED SPECIMENS OF ALLOY 2520 AT 1350° F

Specimen	Coating	Tensile stress (psi)	Atmosphere	Duration of test (hr)
12-1-B	None	8,000	Air	620
12-1	L-7C	8,000	----do----	672
12-2-B	None	10,000	----do----	309
12-2	L-7C	10,000	----do----	293
12-3-B	None	12,000	----do----	168
12-3	L-7C	12,000	----do----	124
12-4-B	None	15,000	----do----	62
12-4	L-7C	15,000	----do----	47
12-8-B	None	8,000	----do----	805
12-8	L-6A	8,000	----do----	850
12-9-B	None	10,000	----do----	362
12-9	L-6A	10,000	----do----	341
12-16-B	None	12,000	----do----	267
12-13	---do---	15,000	----do----	89
12-10-B	---do---	8,000	O ₂	555
12-10	L-6A	8,000	O ₂	636
12-15-B	None	8,000	Steam	785
12-15	L-6A	8,000	Steam	963

TABLE IV.-- RESULTS OF TENSILE TESTS AT ROOM TEMPERATURE ON COATED AND UNCOATED SPECIMENS TREATED FOR VARIOUS TIMES IN HYDROGEN SULFIDE AT 1350° F

Specimen	Alloy ¹	Coating	Fired 5 min at (°F)	Treat-ment in H ₂ S (hr)	Tensile properties ²		
					0.2-per-cent off-set yield value (psi)	Tensile strength (psi)	Elon-gation in 2 in. (percent)
18-3	S-816	---	1650	62½	59,400	109,200	24½
18-4	S-816	L-7C	1650	62½	80,400	131,900	8
18-5	S-816	H5AC	2000	62½	71,900	131,400	13
18-6	S-816	---	2000	62½	61,400	108,100	16
19-3	S-590	---	1650	62½	44,900	80,000	7
19-4	S-590	L-7C	1650	62½	76,300	135,700	7
19-5	S-590	H5AC	2000	62½	58,100	110,300	11
19-6	S-590	---	2000	62½	40,400	75,600	17
17-7	2520+2%Si	A-307	1950	101	37,400	74,200	12
17-8	2520+2%Si	---	1950	101	19,500	23,400	2½
17-9	2520+2%Si	A-309	1750	101	40,000	82,000	15
17-10	2520+2%Si	---	1750	101	15,000	15,400	1
19-7	S-590	A-307	1950	101	64,100	107,000	4½
19-8	S-590	---	1950	101	29,100	54,800	6
19-9	S-590	A-309	1750	101	76,400	120,900	4
19-10	S-590	---	1750	101	32,900	62,100	9½
18-1-86B	S-816	L-2A-1	1750	471	68,000	109,700	6½
18-2-86	S-816	L-2A-2	1750	471	70,400	120,900	9½
18-1-85B	S-816	A-189-1	1700	471	47,000	63,500	5½
18-2-85B	S-816	A-189-2	1700	471	44,500	65,200	5
18-2-86B	S-816	A-305-1	1700	471	80,100	114,700	5
18-2-85	S-816	A-305-2	1700	471	72,900	108,700	3½
18-2-87	S-816	---	1700	471	(3)	(3)	(3)
18-1-86	S-816	---	1800	471	(3)	(3)	(3)
19-90	S-590	L-2A-1	1850	189	75,700	118,900	5½
19-2-95	S-590	L-2A-2	1850	189	65,700	114,800	5
19-2-97B	S-590	A-189-1	1700	189	64,700	109,000	3
19-91	S-590	A-189-2	1700	189	71,900	114,700	4½
19-2-90	S-590	A-305-1	1700	189	72,500	118,800	2½
19-2-96B	S-590	A-305-2	1700	189	70,800	119,400	3½
19-90B	S-590	---	1700	189	(3)	(3)	(3)
19-2-90B	S-590	---	1850	189	---	860	---

¹See appendix A for thermal history "as received."

²Based on dimensions of specimens prior to treatment.

³Specimen broke before testing.

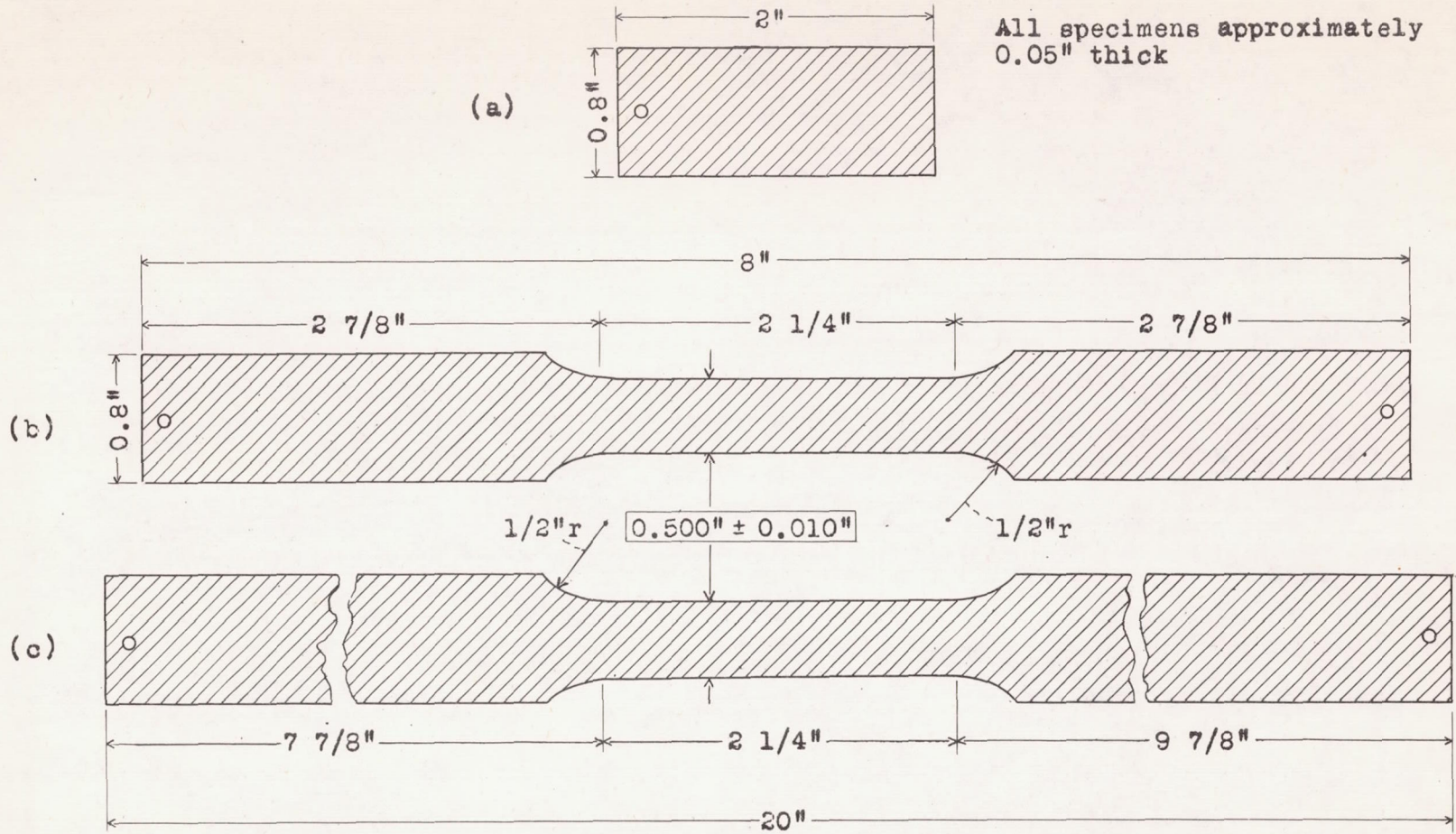

Figure 1.- Sketch of specimens used in the investigation of ceramic coatings.
 (a) Specimens used for heating without load.
 (b) Specimens for heating without load followed by tensile tests at room temperature.
 (c) Specimens for heating while under load. The 20-inch length provides for gripping outside the furnace.

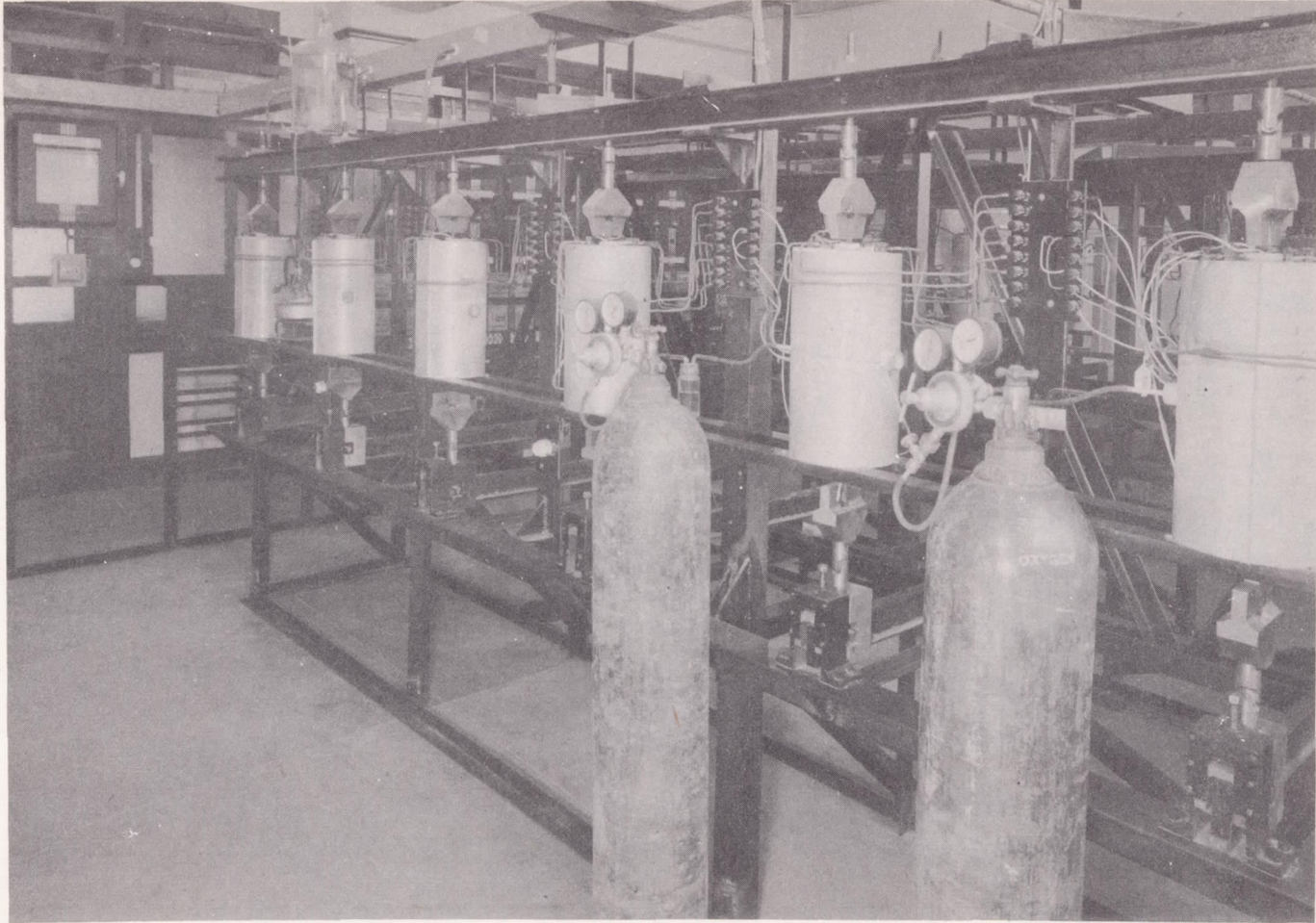
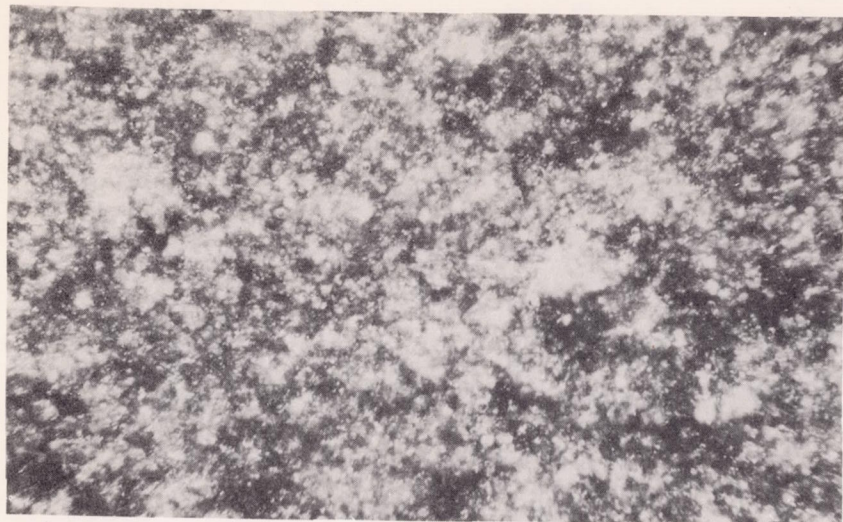
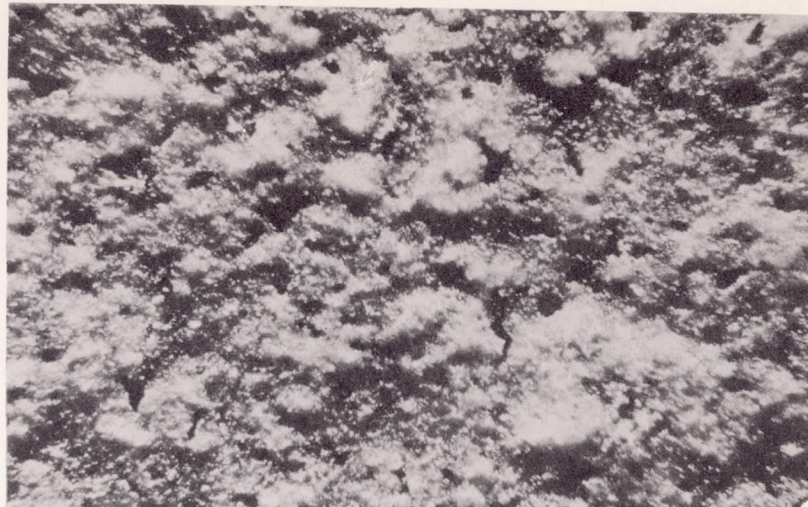

Figure 2.- Furnaces and lever systems for applying loads to 20-inch specimens. The pair at the left are operating with a steam atmosphere supplied by water dripping into a flask containing a filler of broken ceramic material and heated with an electric hot plate. The pair in the middle have an air atmosphere, and the pair at the right are operating with an oxygen atmosphere supplied from separate tanks provided with regulators.



(a) Before heat treatment.



(b) After 200 hours at 1500°F in air.



(c) After 500 hours.

Figure 3.- Photomicrographs at 120X of coating L-6A on alloy S-590. Note the development of discontinuities that did not initially exist. This coating underwent considerable deterioration during the first 200 hours with very little change in the next 300 hours.



(a) Before starting treatment.



(b) After 200 hours.

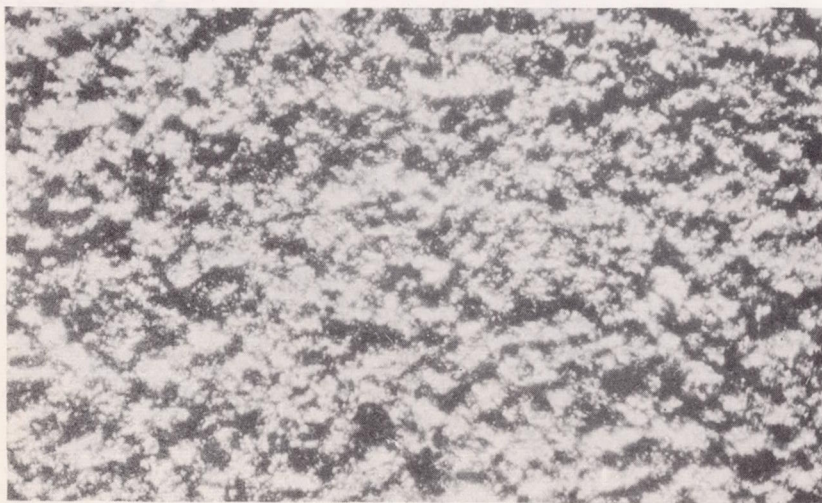

(c) After 500 hours.

Figure 4.- Photomicrographs at 120X of coating A-309 on alloy S-816, showing little or no change during 500 hours of heating in air at 1500°F.



(a) Before heating.

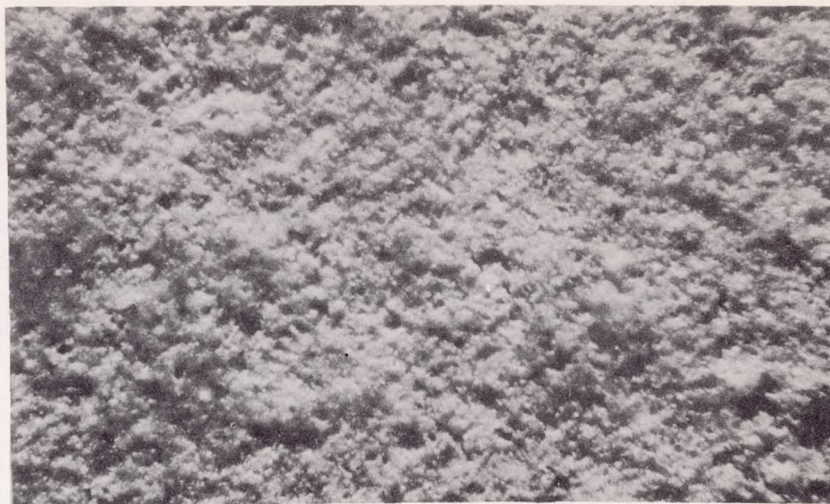

(b) After 200 hours.

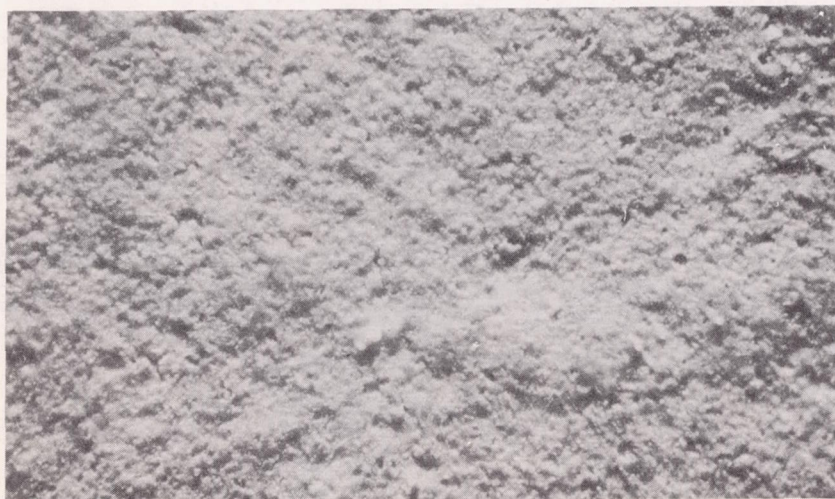

(c) After 500 hours.

Figure 5.- Photomicrographs at 120X of coating L-5AC on alloy S-816, showing a gradual healing of discontinuities initially present as the specimen was heated in air at 1500°F.

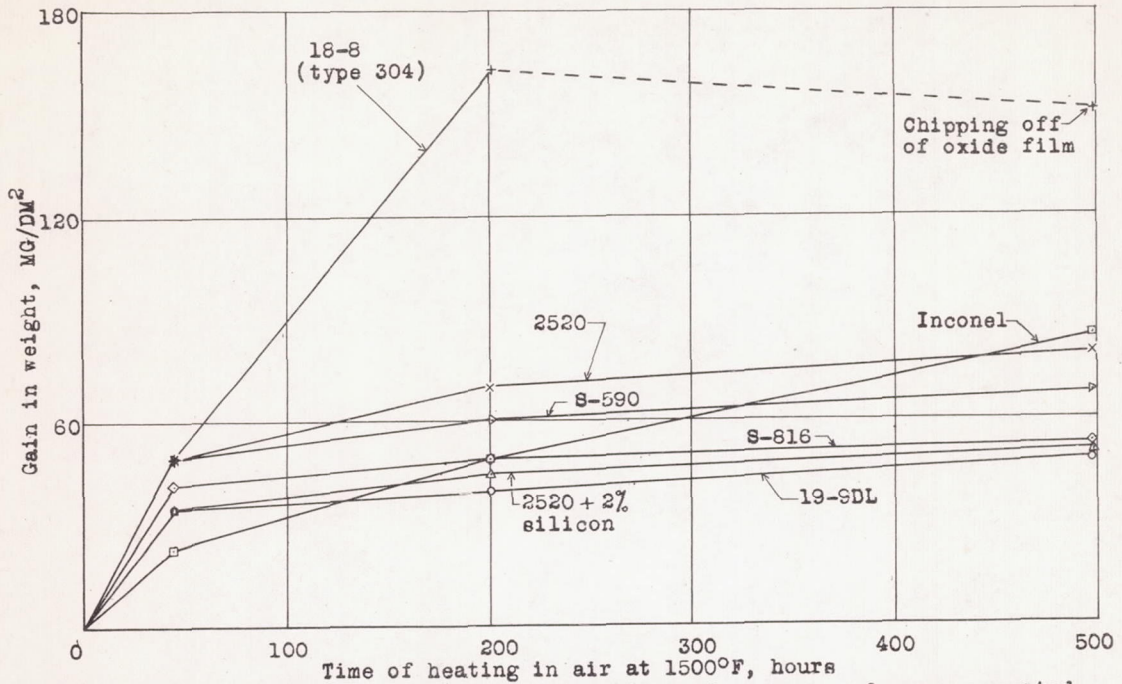

Figure 6.- Graph showing gain in weight, per unit surface area, of seven uncoated alloys due to oxidation during heating in air at 1500°F for 500 hours. The gain in weight of 18-8 alloy beyond 200 hours is not apparent because the oxide film flaked off in sufficient quantity to mask it.

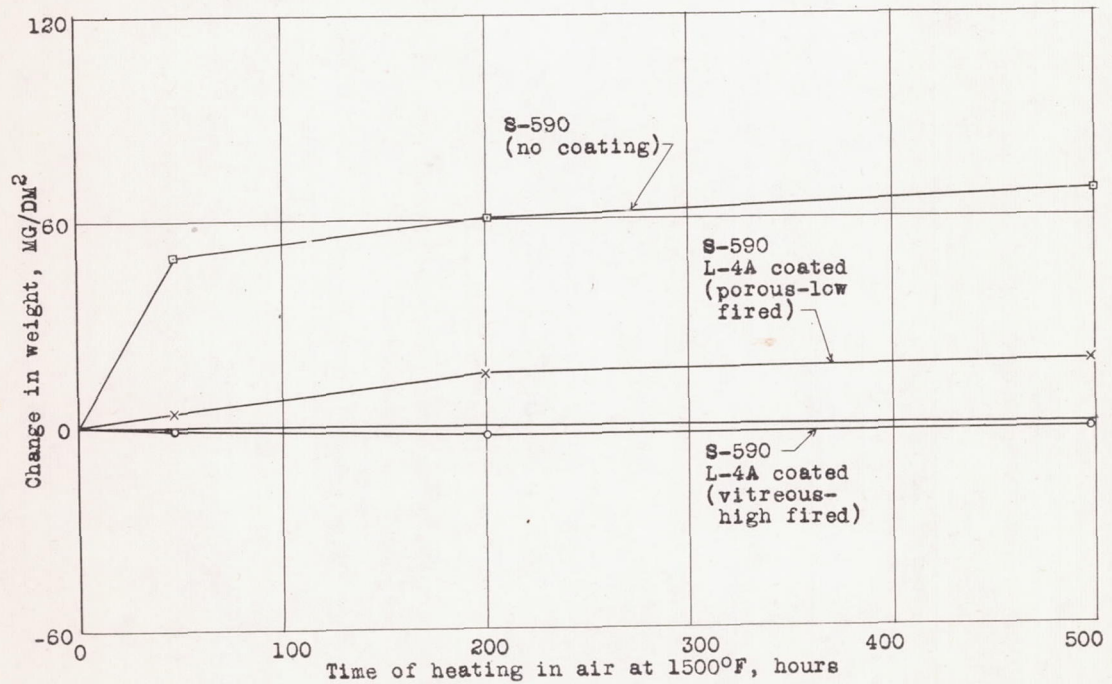

Figure 7.- Graph showing oxidation of uncoated alloy S-590 in terms of gain in weight, per unit surface area, when heated in air for 500 hours at 1500°F, and the inhibition of such oxidation when a porous coating or a sealed vitreous coating is applied.

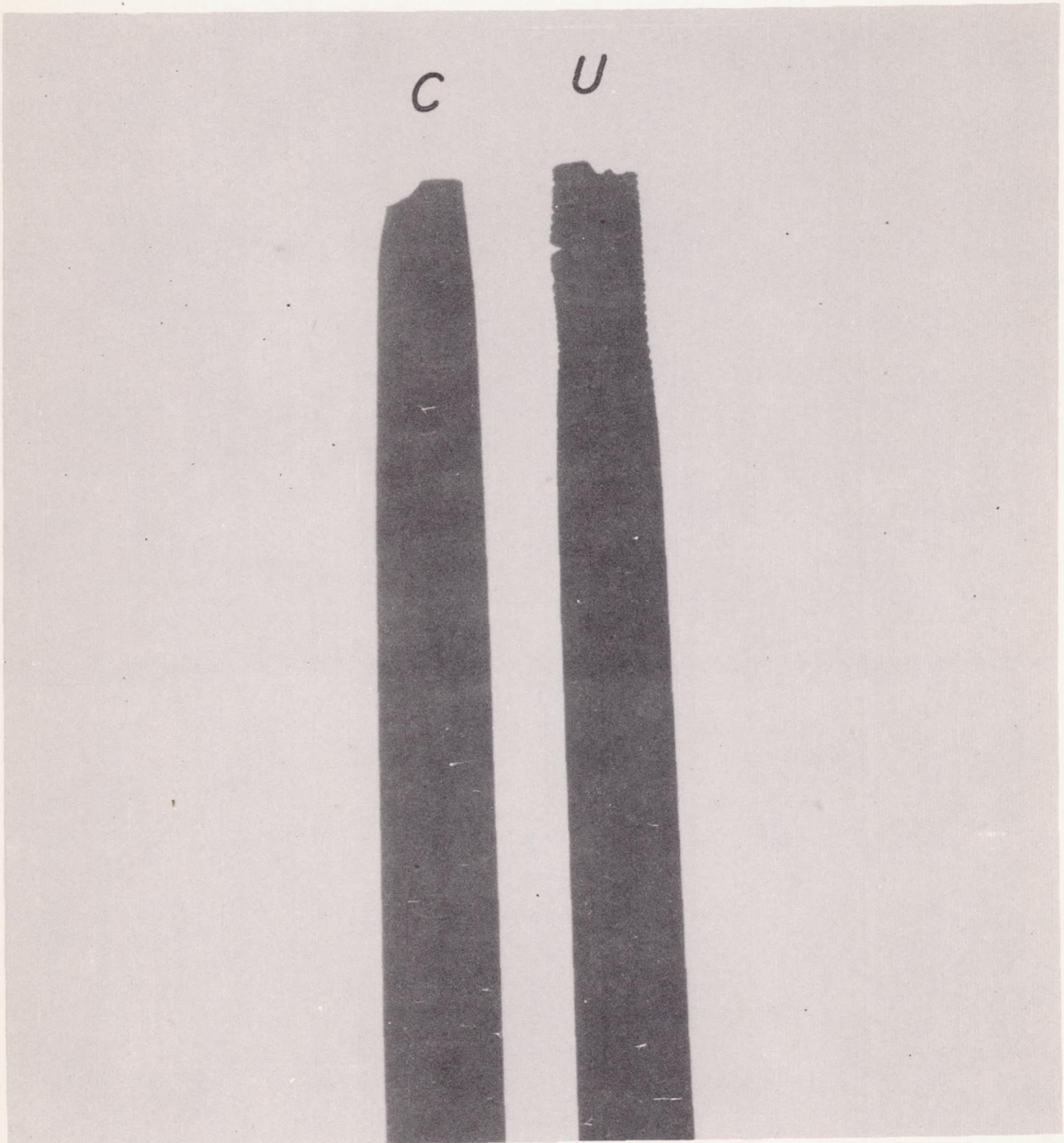

Figure 8.- Coated (C) and uncoated (U) specimens of 19-9 DL alloy held under tensile stress of 5,000 pounds per square inch at 1350°F for 172 hours and subsequently broken in a short-time tension test at 1350°F (table I, test 5). Note irregular silhouette (saw-tooth effect) of uncoated specimen resulting from widening of cracks produced in tension.

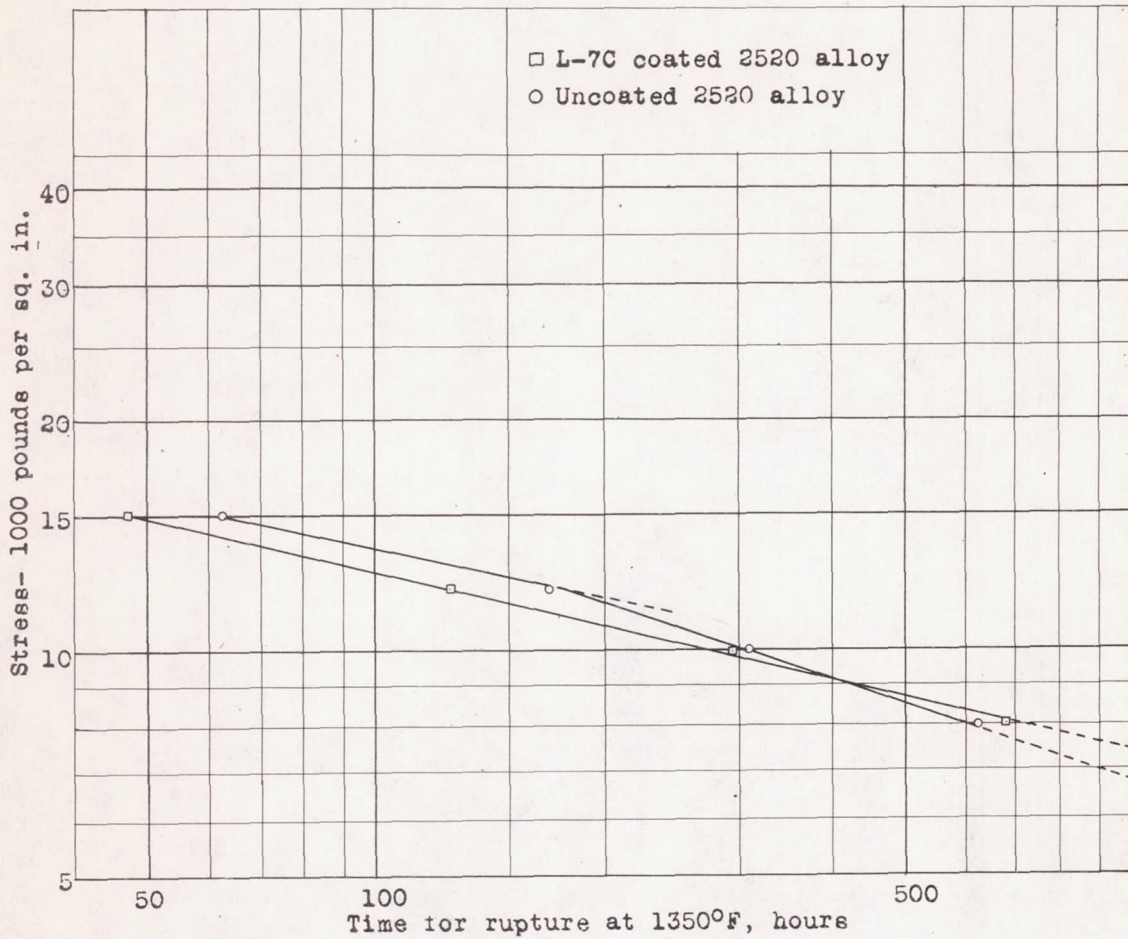

Figure 9.- Stress-rupture curves for uncoated and L-7C coated specimens of alloy 2520. Tests were made at 1350°F in air. Note that a "knee" occurs at 168 hours for the uncoated metal, but had not occurred for the coated specimens up to 672 hours.

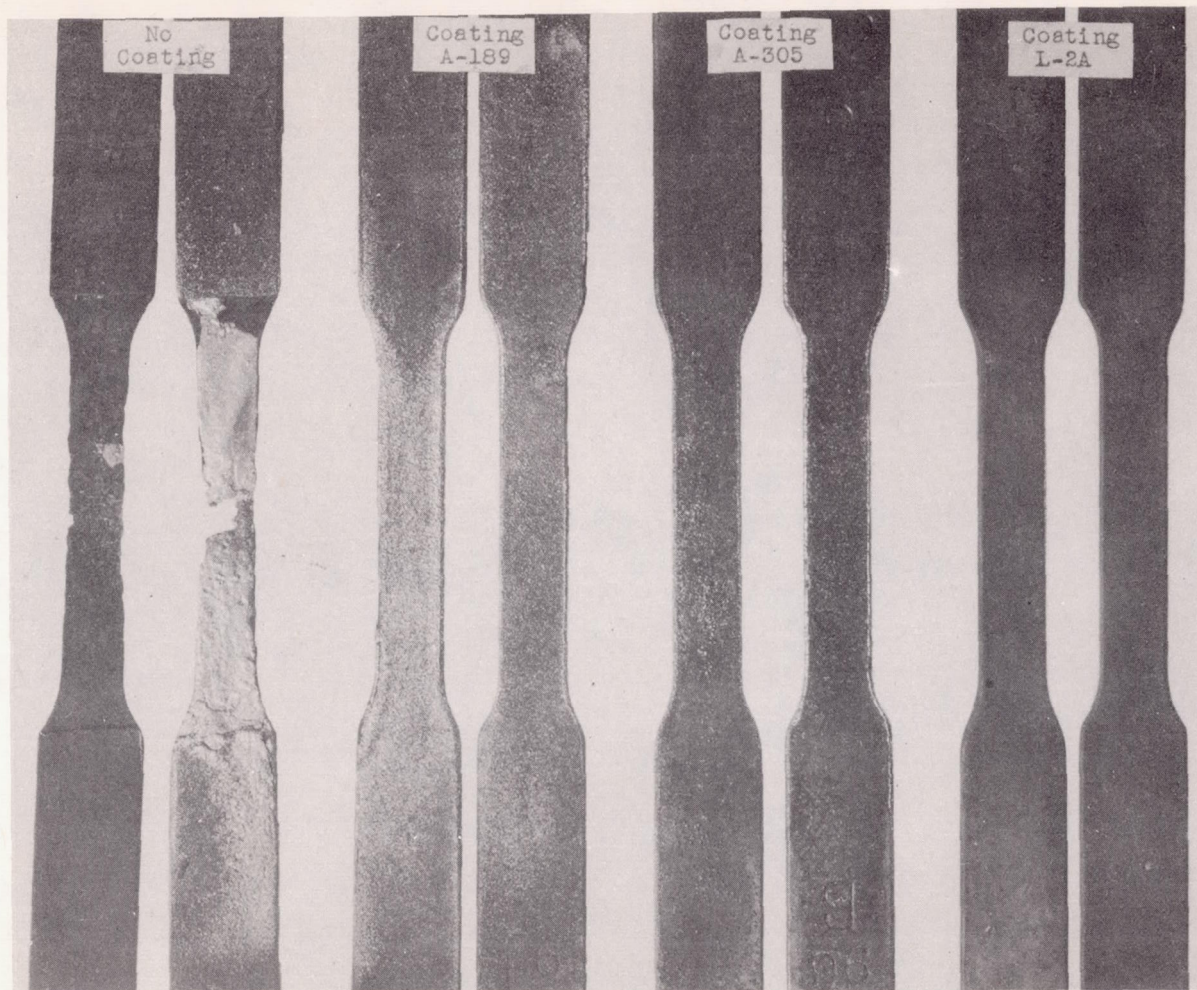

Figure 10.- Specimens of alloy S-590, coated and uncoated, which have been treated in an atmosphere of H_2S for 189 hours at $1350^{\circ}F$. The uncoated specimens at the left were almost completely corroded. The other three pairs of specimens have three different coatings as indicated, single coat at the left and double coat at the right in each pair. Attack through the coatings took the form of tubercules, which are apparent as light specks in the photograph. Note the decreasing number of such tubercules, indicating improved protective action of the coatings, from left to right.



(a) Condition of coating before tubercules had begun to form. Note discontinuities in the coating (probably caused largely by gas evolution from the metal during the firing process).



(b) Early stage of tubercule formation.

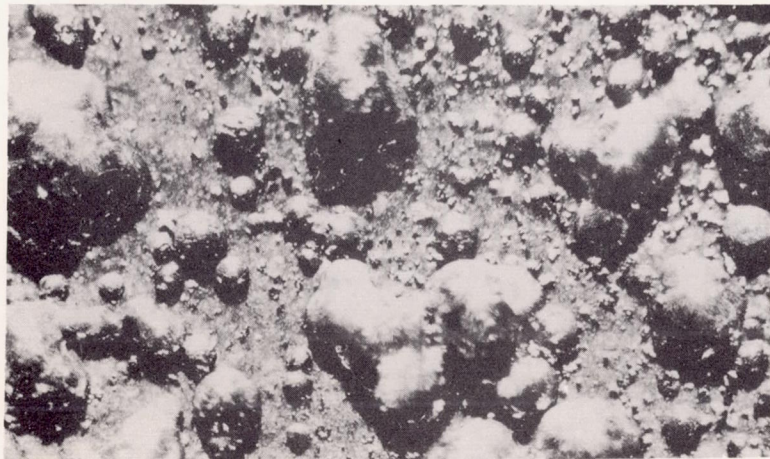

(c) Advanced stage of tubercule formation.

Figure 11.- Photomicrographs at 30X, showing development of tubercules. Areas shown are from specimen with coating A-305 (see fig. 10), which was treated at 1350°F in H₂S for 189 hours. Locations of the tubercules are controlled by the locations of the original discontinuities.

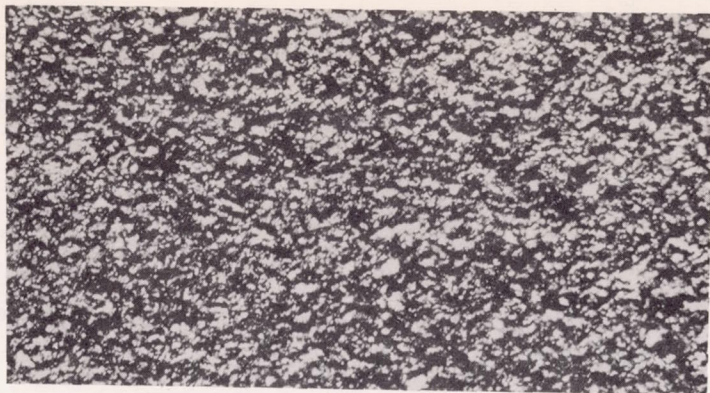

(a) No tubercles yet formed; corresponds to figure 11a.

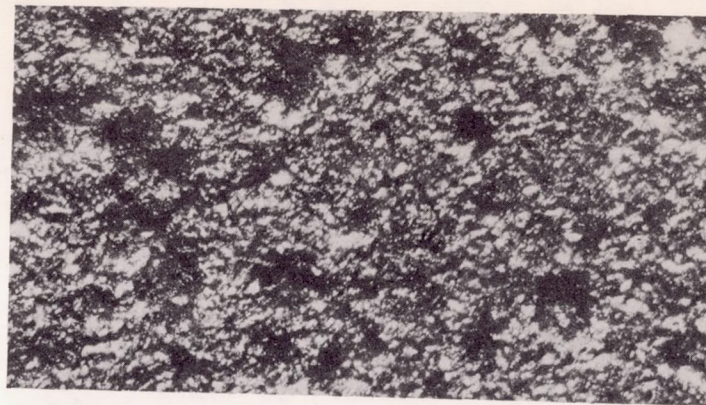

(b) Cavities in the alloy beneath the tubercles caused by attack of the H_2S atmosphere at $1350^{\circ}F$; corresponds to figure 11c.



(c) 30X magnified view of coating L-2A (see fig. 10) which withstood treatment with little or no formation of tubercles. This photomicrograph should be contrasted with figure 11c, which is a magnified view of coating A-305 (see fig. 10) after formation of tubercles.

Figure 12.- Photomicrographs at 30X, showing appearance of specimens shown in figure 11 after removal of coating by sand-blasting.