

Y3, N 21/5:6/3203

GOVT. DOC.

NACA TN 3203

# NATIONAL ADVISORY COMMITTEE FOR AERONAUTICS

TECHNICAL NOTE 3203

BUSINESS AND  
TECHNICAL DEPT.  
Aug 25 54

CONSIDERATIONS ON A LARGE HYDRAULIC JET CATAPULT

By Upshur T. Joyner and Walter B. Horne

Langley Aeronautical Laboratory  
Langley Field, Va.



Washington

July 1954

TECHNICAL NOTE 3203

CONSIDERATIONS ON A LARGE HYDRAULIC JET CATAPULT<sup>1</sup>

By Upshur T. Joyner and Walter B. Horne

SUMMARY

A survey of various types of catapults, which has been made in connection with the problem of accelerating a large (100,000 lb) car along a track to a speed of 150 miles per hour, is given. A hydraulic jet catapult is indicated as the best suited among these catapult types for the purpose intended, and various design problems of this type are treated. Equations are given for calculating the performance of the jet and of the test car, and consideration is given to the physical conditions affecting the jet flow. Design procedures are presented for the jet nozzle and for the bucket on the car which receives the jet and imparts thrust to the car.

The expected propulsive efficiency of the jet catapult is given and the effect of a side wind on the jet trajectory is calculated.

INTRODUCTION

In various connections with research and development there has arisen the necessity for accelerating a large mass along a track up to a high speed. With regard to a particular research requirement, it was necessary to consider acceleration of a 100,000-pound test car up to 150 miles per hour within a short distance. These requirements indicated catapult means for providing the acceleration.

A survey of various catapult mechanisms for use with this system was made. As a result of this survey, a simple hydraulic jet catapult was selected as the most suitable. It is believed that there may be general interest in the present study of the various catapults and that other applications exist for the hydraulic jet catapult which is given special consideration here. The purpose of this paper, then, is to present the survey and to describe the considerations given in the design of a hydraulic jet catapult on the basis that it is to be used in a system in which the maximum car velocity and the car weight are specified.

---

<sup>1</sup>Supersedes the recently declassified NACA RM L51B27, "Considerations on a Large Hydraulic Jet Catapult" by Upshur T. Joyner and Walter B. Horne, 1951.

The hydraulic catapult described herein consists of a single high-velocity jet of water which issues from a stationary nozzle at the starting end of a testing track and is directed at a return bucket mounted on the stern of the carriage or test car. This bucket (as in a Pelton wheel) turns the jet almost  $180^\circ$  and the return jet issues just below the incoming stream. The force on the bucket caused by this large rate of change of momentum in the jet is the force that accelerates the test car up to a desired velocity. The accelerating distance, or the maximum length of jet travel, is considered to be in the neighborhood of 400 feet.

After a brief survey of various types of catapults in the first part of the paper, a short analytical section which deals with the performance of the hydraulic jet catapult is presented. Subsequent to the analysis, consideration is given to the physical conditions affecting the jet flow. Also included are sections in which design procedures are outlined for the jet nozzle and for the return bucket on the car. Values of probable propulsive efficiencies as obtained from model tests are given for the jet-bucket system.

#### SYMBOLS

$\alpha$	nozzle elevation above horizontal, degrees
$\theta$	total angle through which jet is turned by bucket, degrees
$\rho$	air density taken at standard conditions, slugs per cubic foot
$A$	cross-sectional area of jet, square feet
$a$	acceleration, feet per second per second
$a_c$	acceleration of carriage due to jet reaction, feet per second per second
$a_L$	lateral acceleration of jet due to side wind, feet per second per second
$b$	width of bucket at start of turning section, feet
$C_D$	drag coefficient for side drag on jet due to cross wind
$d$	jet diameter, feet



$F_C$	force on carriage due to jet reaction, pounds
$g$	acceleration due to gravity, 32.2 feet per second per second
$n$	exponent for polytropic change in volume taken equal to 1.2 ( $pv^n = \text{Constant}$ )
$P$	arithmetic average air pressure used to accelerate water, pounds per square inch
$p$	instantaneous air pressure used to accelerate water, pounds per square inch
$p_0$	initial pressure of compressed air, pounds per square inch
$Q$	volume of water discharged during catapult stroke, cubic feet
$R = \frac{W_C}{wA(1 - \cos \theta)}$	
$s_C$	distance of carriage travel, feet
$s_L$	lateral displacement of jet due to side wind, feet
$t$	time, seconds
$t_C$	time of carriage run during catapult stroke, seconds
$t_j$	duration of jet discharge, seconds
$V_L$	average jet velocity, feet per second
$V_C$	carriage velocity, feet per second
$V_i$	instantaneous jet velocity at any point, feet per second
$V_j$	instantaneous jet velocity of efflux, feet per second
$V_{j_0}$	instantaneous jet velocity of efflux at $t_j = 0$ , feet per second
$V_w$	velocity of cross wind, feet per second
$v$	volume of compressed air, cubic feet
$v_0$	initial volume of compressed air, cubic feet



w	density of water, 62.4 pounds per cubic foot
$W_c$	weight of carriage, pounds
X,Z	coordinates of nozzle surface contour in table I
y	instantaneous trajectory height, feet
Subscript:	
max	maximum value

### SURVEY OF CATAPULT TYPES

Presented in this section is a survey of various types of catapults which might be suitable for accelerating a 100,000-pound test car up to a translational speed of 150 miles per hour. Because of the adverse effect of large acceleration on the measuring instruments which would be used, the peak acceleration is considered to be limited to about 3g. In order to illustrate the magnitude of the force involved during acceleration, an average acceleration of 2g, which would indicate a catapulting force of 200,000 pounds, may be taken. On an energy basis,  $75 \times 10^6$  foot-pounds of energy must be delivered to the car by the catapult. This catapult capacity was found to exceed by many times the capacity of the largest catapults developed up to this time and it follows that an adequate catapult had to be designed or developed for the case under consideration. A considerable amount of effort has, therefore, been spent in preliminary engineering studies and cost estimates of the various catapult systems. An adjective comparison between initial costs and operating costs of the various types of catapults considered is given in the following table and a more complete discussion of the catapult types follows the table:

No.	Type of catapult	Motivation	Initial costs (development and construction)	Operating costs
1	Dropping weight	Dropping weight (cable and sheave system)	Very high	Low
2	Flywheel	Flywheel (clutch, cable, and sheave system)	High	Low
3	Blowgun	Low-pressure, large-area piston (expansion of powder or compressed air)	High	High (with powder) Low (with air)
4	Slotted tube	-----do-----	High	High (with powder) Low (with air)
5	Piston	High-pressure, small-area piston (hydraulic and compressed air, compressed air or powder actuated)	High	High (with powder) Low (with compressed air)
6	Rocket	Reaction type, solid fuel propellant (adds extra weight to carriage)	Low	Very high
7	Rocket	Reaction type, liquid fuel propellant (adds extra weight to carriage)	Low	Medium
8	Hydraulic (jet)	Reaction type, water and compressed air (added carriage weight prohibitive)	Medium	Low
9	Rocket	Impulse type, solid fuel propellant	Medium	Very high
10	Rocket	Impulse type, liquid fuel propellant	High	Medium
11	Hydraulic (jet)	Impulse type, water and compressed air	Low	Low
12	Electropult	Squirrel-cage electric motor laid out flat	Very high	Low

The more conventional catapulting system (for example, numbers 1, 5, and 6) are discarded because of either high initial costs or high operating costs, or both. Navy experience with sheave and cable systems indicates that the requirements stated previously are beyond the probable limits for satisfactory operation of such systems; thus, because of this consideration and of high initial costs, the dropping weight, the fly-wheel, and the piston type of catapults are discarded.

The blowgun and slotted-tube types of catapults (numbers 3 and 4, respectively) utilizing compressed air showed some promise. The blowgun device employs a large tube with the car itself acting as the piston. It therefore has the serious disadvantage of limiting to an extreme degree the form, size, and height of drop of the test specimen, since nothing may project beyond the smooth car outline. In the slotted-tube catapult the test specimen is external and is connected to a piston in a slotted cylinder and therefore has the advantage that the car and test specimen are not limited as to dimensions. Both the blowgun and slotted-tube catapults, however, require expensive development and have a high initial cost.

A study of reaction type of catapulting systems discloses that no catapult or stored-energy system can be carried economically on the carriage itself. If the source of energy is carried on the carriage, the mass that must be propelled is increased by the weight of the propulsion system. Since the 100,000-pound value for carriage weight includes bare structural weight and model weight, use of a system such as described means that the energy of the catapult system must be increased to compensate for the added weight. Because of the added weight and the high operating costs, all the reaction types of catapults (numbers 6, 7, and 8) are not considered feasible.

Impulse jet systems employing any of the gases as the fluid medium (numbers 9 and 10) are of such low efficiency that they cannot be used economically.

Of the systems considered, the one system found that gives the required capacity at low initial cost and low operating cost is the hydraulic impulse system, number 11. One arrangement of this system is shown in figure 1.

The hydraulic impulse catapult shown operates on the same principle as the impulse turbine, except that a single bucket is used with straight run in contrast to the usual multibucket arrangement with a circular run. In the system shown, air is compressed into an air tank which is connected through an air control valve to the tank containing the working charge of water. The water tank has a nozzle directed at the jet-return bucket which is mounted at the stern of the carriage. Pressure is maintained



only in the air tank until immediately before the catapulting run, at which time the air control valve is opened. The water control valve outside the nozzle is then opened and the resultant jet drives the carriage down the track. The lower relative cost of this system is due largely to the lack of a complex mechanical connection to the test vehicle during the catapulting stroke. With this system, the cost of electrical pumping power and water make-up per maximum capacity run becomes a very minor part of the total operating costs. The system is described herein and the important engineering aspects are discussed.

#### MATHEMATICAL DEVELOPMENT

In this section, equations are developed for the jet flow, which is assumed to be ideal, and for the motion of the carriage which is catapulted by the jet. Because the available treatment of jet-bucket relations is concerned with the impulse of a jet on a succession of buckets on a wheel moving at constant speed and this treatment is not applicable to the present problem, an analysis is made which uses as much of the well-known treatment as is useful and makes modifications as required. Figure 2 illustrates the configuration being analyzed.

The equation for the velocity of efflux of the water jet from the nozzle as a function of time can be developed by recognizing that the volume of water discharged in any given time is equal to the increase in air-charge volume; also, use is made of the equation for polytropic expansion of air to determine the variation of air pressure with time and the equation for velocity of efflux to convert the variation of air pressure with time into the variation of jet velocity with time. These two relations in their familiar forms are given by the following two equations:

$$pv^n = \text{Constant} = p_0v_0^n \quad (1)$$

$$v_j = \sqrt{2g \frac{144p}{w}} \quad (2)$$

where  $p_0v_0$  in equation (1) represents initial conditions and equation (2) applies for  $p$  in pounds per square inch and  $w$  in pounds per cubic foot.

By use of equations (1) and (2), an expression can be obtained which gives the instantaneous jet velocity of efflux in terms of the initial conditions and the instantaneous volume of the air charge:

$$V_j = \sqrt{2g \frac{144p_0 v_0^n}{wv^n}} \quad (3)$$

Since the rate of increase of the air-charge volume is equal to the volume rate of water discharge by the jet, the following equation must hold:

$$\frac{dv}{dt} = V_j A \quad (4)$$

where  $A$  is the jet area.

By combining equations (3) and (4), the rate of change of air-charge volume is obtained in terms of the instantaneous air-charge volume and the initial conditions:

$$\frac{dv}{dt} = C_1 v^{-n/2} \quad (5)$$

where  $C_1 = A \sqrt{2g \frac{144p_0 v_0^n}{w}}$ .

Integration of equation (5) yields an expression for the instantaneous air-charge volume  $v$  as a function of time. Substitution of this expression in equation (3) gives the following equation for instantaneous jet velocity in terms of time of jet flow  $t_j$  and the initial conditions:

$$V_j = V_{j_0} (1 + C_2 t_j)^{-n/(n+2)} \quad (6)$$

where  $C_2 = \frac{(\frac{n}{2} + 1) V_{j_0} A}{v_0}$ . This equation for instantaneous jet velocity

is used in the following development of the equations of motion for the catapulted mass.

The equation of motion for the catapulted mass is developed in accord with Newton's second law; that is, the force exerted on the catapulted mass by the water jet is equal to the product of the catapulted mass and its acceleration.

The velocity of the water stream at the instant of impact upon the bucket is denoted by  $V_i$  and is the same as the jet velocity  $V_j$ , at the time  $t_j = t_c - \frac{s_c}{V_i}$ , where this expression takes into account the time of travel of the stream from the nozzle to the bucket. The water stream thus enters the bucket with a relative velocity  $V_i - V_c$  and, if it is turned through an angle  $\theta$  and is assumed to leave the bucket with the same relative velocity (no energy loss), the catapulting force exerted on the catapulted mass is given by the equation

$$F_c = \frac{W}{g} A(V_i - V_c)^2 (1 - \cos \theta) \quad (7)$$

Equating the force from equation (7) to the product of mass and acceleration gives the equation of motion, which may be written in the following form:

$$\frac{dV_c}{dt} = \frac{1}{R} (V_i - V_c)^2 \quad (8)$$

where  $R = \frac{W_c}{wA(1 - \cos \theta)}$ . The equation of motion given by equation (8)

has been integrated numerically for two sets of conditions; these conditions and the results are shown as part of figure 3.

In order to make a rapid survey of the effect of various parameters on catapult performance, an approximate solution to equation (8) can conveniently be made on the basis that the impact velocity  $V_i$  is considered constant at a value corresponding to the average water tank pressure. This average jet velocity is denoted by  $V_1$ , and equation (8) can then be written as follows:

$$a_c = \frac{1}{R} (V_1 - V_c)^2 \quad (9)$$

Equation (9) can be exactly integrated to give the following approximate equations of motion:

$$V_c = \frac{V_1^2}{\frac{R}{t_c} + V_1} \quad (10)$$



$$s_c = V_1 t_c - R \log_e \frac{V_1 t_c + R}{R} \quad (11)$$

Calculations, using equations (10) and (11), for the same conditions which were used in the numerical integration of equation (8) are shown also in figure 3 for comparison with the correct integrated values. For conditions where the initial air volume is 14.9 times as large as the water volume discharged, the approximate equations give results which are almost indistinguishable from the correctly integrated results. For the lower ratio of initial air volume to water discharge volume,

$\frac{V_0}{Q} = 2.7$ , however, a slight difference results from the exact and the approximate equations.

The results shown in figure 3 indicate that the approximate equations will give an accuracy which should be sufficient for most applications when the ratio of initial air volume to water volume discharged is in the neighborhood of 3 or more.

On the assumption that the approximate equations of motion are sufficiently accurate for practical use, approximate equations are developed herein for the other parameters of interest, such as the maximum height of the jet trajectory and the quantity of water discharged.

If it is assumed that the jet emerges from the nozzle with a velocity given by equation (2) for constant average pressure and that the jet leaves the nozzle at an angular elevation  $\alpha$  above the horizontal and follows a parabolic path, then the equations for a body falling freely can be used to obtain the following equation relating air tank pressure, maximum rise of the jet trajectory, and range, which is assumed equal to the catapulting distance:

$$s_c = 4y_{\max} \sqrt{\frac{144P}{wy_{\max}}} - 1 \quad (12)$$

The jet is assumed to have returned to its initial elevation at the end of the catapulting distance.

For a very flat trajectory and high pressure, which would probably be used in jet-catapult applications, the  $-1$  under the radical in equation (12) may be neglected for ease in subsequent calculations, and the equation can be rewritten to give the following equation for maximum trajectory height:

$$y_{\max} = \frac{s_c^2 w}{(16)(144P)} \quad (13)$$

The volume of water discharged during a catapult stroke is calculated simply as the product of the mean jet velocity, the nozzle cross-sectional area, and the time of duration of the discharge. The catapulted mass is initially very close to the jet nozzle and is considered to start moving at the same instant that the jet emerges from the nozzle. The jet control valve is closed at such time that the tail of the jet will reach the end of the catapult stroke at the same time as the carriage (see fig. 2). The time of duration of the jet discharge is, therefore, less than the time of carriage run by an amount equal to the time required for the tail of the jet to travel from the nozzle to the end of the catapult stroke. Based on the foregoing discussion, the equation for volume of water discharged can be stated as follows:

$$Q = V_1 A \left( t_c - \frac{s_c}{V_1} \right) \quad (14)$$

In order to obtain the value of  $Q$  in terms of average jet velocity  $V_1$  and the required terminal carriage velocity  $V_c$ , the following equations for  $t_c$  and  $s_c$  are obtained from equations (10) and (11):

$$t_c = \frac{RV_c}{V_1(V_1 - V_c)} \quad (15)$$

$$s_c = R \left( \frac{V_c}{V_1 - V_c} - \log_e \frac{V_1}{V_1 - V_c} \right) \quad (16)$$

These two equations, when substituted in equation (14), give

$$Q = AR \log_e \frac{V_1}{V_1 - V_c} \quad (17)$$

In order to display the interdependence of the several variables affecting the performance of the hydraulic jet catapult, figure 4 has been prepared for a catapult which will accelerate a 100,000-pound test carriage to 150 miles per hour. A similar figure would be required for each different set of catapult requirements considered, but the preparation is not arduous. The equations used in the preparation of this figure are equation (2) for jet velocity, using average air tank pressure  $P$ , equation (9) for initial carriage acceleration by setting  $V_c = 0$ , equation (16) for catapult stroke and jet area, equation (17) for the volume of water discharged during the catapult stroke, and equation (13) for the maximum height of the jet trajectory.



The usefulness of a chart such as shown in figure 4 is mainly in the preliminary planning stage. Every point on the chart represents a theoretical hydraulic catapult system which will meet the design requirement of accelerating the given mass to the required speed. The variation of such quantities as required air tank pressure, catapult stroke, initial acceleration, maximum height of trajectory, volume of water discharged, and jet area can be determined from the figure, and undesirable values of any of these quantities can be avoided. After a satisfactory set of conditions is reached for the specific design under consideration, detailed correction for losses and operating conditions can be considered in order to estimate the performance to be expected from a working installation.

As shown subsequently, some tests indicate that the average energy losses in the operation of the jet and bucket may be held to about 15 percent. These losses are considered to be compensated in the design described herein by dividing the nozzle area determined from figure 4 by the jet-bucket efficiency. If it is assumed that these losses have been compensated, all other values read from the chart may be used directly for design purposes. Other losses, such as carriage rolling friction and carriage wind resistance, also affect the design of the propulsion system. For the design considered, these losses were found to be of the order of 2 percent of the jet energy and are considered small enough to be neglected in the mathematical treatment.

As an aid to visualization of the tremendous power which could be developed by a hydraulic jet catapult such as has been described, performance curves are presented in figure 5 for the particular catapult represented by the design point indicated in figure 4. The nozzle area shown is for 100-percent efficiency. Correction of this area for practical efficiencies has been described. It can be seen from these performance curves that this catapult is expected to accelerate a test car weighing 100,000 pounds from rest up to 150 miles per hour (220 ft/sec) in the short time of 3.2 seconds and in a distance of only 400 feet.

There are several other quantities which will be required in a complete design after a suitable catapult design is selected from the chart, such as the required angular elevation of the nozzle, the height of impact of the jet on the bucket throughout the catapult stroke, and the lateral drift of the jet due to a side wind.

The angular elevation of the nozzle required to make the jet return to its initial elevation above the level track at the end of the catapult stroke is determined from the combination of the maximum required catapult stroke and the jet velocity of the tail of the jet as follows: From the velocity-time relation of a body falling freely, the time required for



the jet to reach its maximum height may be deduced and is given by

$$t = \frac{V_j \sin \alpha}{g}$$

The total horizontal distance traveled by the jet before returning to its initial elevation is, then,

$$s_{c_{\max}} = 2tV_j \cos \alpha$$

Elimination of  $t$  between these two equations gives

$$\sin 2\alpha = \frac{s_c g}{V_j^2} \quad (18)$$

The actual height of the point of jet impact on the bucket is of aid when computations are made of the over-turning moments imposed on the carriage by the jet. The calculation of this quantity for the case with a variable jet velocity is given here because the height of the point of impact for this case may at certain places be slightly greater than the value given by the parabolic approximation. Since the approximate equation (11) gives the carriage displacement-time curves very close to the true values (see fig. 3), this equation is used to calculate the carriage displacement. The jet leaves the nozzle along a straight line with an angular elevation  $\alpha$  and falls away from this line as a freely falling body. The time required for the stream to travel from the nozzle to the carriage would be  $s_c/V_j$ . With this knowledge, the height of the point of impact of the jet on the carriage bucket can be calculated from the following equation:

$$y = s_c \sin \alpha - \frac{g}{2} t_j^2 = s_c \sin \alpha - \frac{g}{2} \left( \frac{s_c}{V_j} \right)^2 \quad (19)$$

Equation (19) can be solved as follows: A value of  $s_c$  is chosen, and from equation (11) the corresponding value of  $t_c$  is found. These values are then used to establish corresponding values of  $t_j$  and  $V_j$  by means of the following relation

$$t_c = t_j + \frac{s_c}{V_j}$$

where, in this case, the interpretation to be placed on  $t_c$  is that it is the sum of the time of jet efflux  $t_j$  and the time required for particles of water leaving the nozzle at this time to travel the distance  $s_c$ . This relation, used in conjunction with equation (6), establishes the value of  $V_j$ . This value of  $V_j$ , when used with the chosen value of  $s_c$ , permits the height of the point of impact to be calculated by means of equation (19). This calculation is repeated for other values of  $s_c$  to cover the entire catapulting stroke.

The lateral drift of the jet due to side winds may become a serious consideration for a long-stroke catapult because of the increased size of the bucket required to receive the jet. The lateral drift may be calculated by equating the side force due to wind on unit length of jet to the product of mass of unit length and lateral acceleration. The plausible assumption is made that the lateral velocity of drift is negligible in comparison with side-wind velocity; therefore, the lateral acceleration may be regarded constant. The lateral-drift equation may be written as follows:

$$\text{Force} = \text{Mass} \times \text{Acceleration}$$

or

$$\frac{1}{2} \rho V_w^2 C_D d = \frac{\pi d^2}{4} \frac{w}{g} a_L$$

Solution for  $a_L$  and use of the equation for uniformly accelerated motion,  $s = \frac{1}{2} at^2$ , gives the amount of side drift  $s_L$  as

$$s_L = \frac{\rho C_D}{\pi \frac{w}{g} d} \left( \frac{V_w}{V_j} s_c \right)^2 \quad (20)$$

In this equation the drag coefficient  $C_D$  depends primarily on Reynolds number. For a Reynolds number range of 10,000 to 300,000, the coefficient  $C_D$  is almost constant at 1.2 and therefore equation (20) reduces to

$$s_L = \frac{0.000468}{d} \left( \frac{V_w}{V_j} s_c \right)^2 \quad (21)$$

This equation should be satisfactory for practical ranges of jet diameter and side-wind velocities.

## PHYSICAL CONDITIONS AFFECTING JET FLOW

The mathematical treatment of the catapult system is based on the assumption of ideal jet flow, which, more specifically, means a jet that can maintain its shape or integrity over the complete range of travel from the nozzle. The design of the particular catapult system under consideration requires that the jet be collected and returned by the bucket for a range of at least 400 feet. It has been found that the physical conditions affecting jet flow, such as entrance conditions to the nozzle, nozzle form, nozzle surface, and aerodynamic effects downstream from the nozzle, create appreciable disturbances to the jet and the question arose whether it would be possible to obtain a 400-foot jet length of acceptable integrity. The purpose of this section, therefore, is to delineate these various physical conditions and to show how their effects on the jet can be nullified or, at least, minimized.

Information and data on long-range jets were found to be very scarce with the exception of material on the jets produced by fire nozzles. It was decided, therefore, because of the availability of fire nozzles and of data on jets produced by fire nozzles, to initiate the investigation of jet flow by studying the effect on fire-nozzle jets when these previously mentioned physical conditions were improved. For example, bending the hose upstream from the nozzle was found to decrease considerably the amount of jet length having reasonable integrity. For another example, cleaning and polishing the inside surface of a fire nozzle was found to increase the range of good flow. Thus, by these and other similar tests a straight symmetrical approach to the nozzle and a smooth, polished, and faired internal nozzle surface, along with a smooth joint connecting the hose or play pipe to the nozzle, were found to be essential for maintaining the best long-range integrity of a fire-nozzle jet.

On the basis of these results, a nozzle of 3-inch diameter was designed and tested. The profile chosen for this original test nozzle was based on considerations of acceleration of the water, minimum boundary layer, and parallel flow at the nozzle exit. Figure 6(a) shows a photograph of a jet produced by this nozzle. The improvement in jet integrity because of better entrance conditions and nozzle design is apparent when figure 6(a) is compared with figure 7, a photograph of a jet produced by the 5-inch nozzle aboard a New York City fireboat. The fire-nozzle jet is seen to diverge immediately upon leaving the nozzle into two separate streams whereas the jet in figure 6(a) is practically nondivergent throughout its length. A study of high-speed motion pictures of the same jet as in figure 6 disclosed that visual observation of the established stream and still photographs (such as fig. 6) give a pessimistic impression as compared with the stream during the first few



seconds of operation because jet spray accumulates with time and therefore obscures the sharper stream boundaries that would otherwise appear. The spray shown in figure 6(b) has accumulated during an operating period of about 8 seconds, whereas the time of operation of the catapult considered herein is approximately only  $2\frac{1}{2}$  seconds. Further evidence that a relatively solid core exists in the midst of this spray is indicated by the fact that, at a distance of 300 feet from the nozzle, the jet cuts a narrow trench only 6 or 8 inches wide in the turf.

Smaller nozzles similar to this 3-inch-diameter nozzle were tested still further in order to determine the efficiency of the jet as a function of distance from the nozzle by recording the loads imposed by the jet on a flat plate by means of a small strain-gage type of dynamometer and comparing these loads with the theoretical jet impact forces. The results of these tests are shown in figure 8. These results indicate that all jet losses for these small jets, including shock losses caused by the impingement of a jet on a flat plate, averaged less than 5 percent for a distance up to about 125 jet diameters, equivalent to about one-fifth the scale catapulting stroke, and were negligible for the greater distances tested.

The purpose of the preceding tests has been to help determine whether it is possible to throw a jet 400 feet with sufficient integrity to be caught and returned by a bucket at that point, but these tests were performed only with equipment utilizing small-scale sizes and small-scale pressures. The results gained from these tests are promising; however, there remains the question of whether these results will still be valid when scaled up to full-size. The combination of jet size and nozzle pressure required by the propulsion system is beyond current engineering practice as far as can be determined, but there is no apparent change in the physical conditions upon going to larger and higher-velocity jets. The relative spray losses of a jet due to air friction on the outermost surface of the jet decrease rapidly as the jet diameter increases. In reference 1, data are given on how far a "good" stream can be thrown by a fire nozzle. These data are shown in figure 9 and indicate that a good stream can be thrown 270 feet in still air with a fire nozzle 2 inches in diameter operating at 250 pounds per square inch. This figure also indicates that the obtainable horizontal throw or reach of the good stream increases with both nozzle pressure and nozzle diameter. It seems probable, therefore, that a larger nozzle and higher pressure combination may be used to obtain a satisfactory jet with a length of 400 feet.

In addition to the preceding considerations, other factors, such as air entrainment, dissolved air, and cavitation, may influence jet flow; proper precautionary measures should therefore be taken to guard against adverse effects that these factors may cause.

In regard to air entrainment reference 2 states that the eddies which whirl out of the main stream are immediately retarded and disintegrated by the resistance of the air. Furthermore, voids caused by separation of water particles are immediately filled with air. A poor jet shows remarkable qualities to set in motion and carry along large quantities of air. These statements indicate that an initially poor jet contains the seeds of its own destruction by air entrainment. The nozzle must therefore be so designed that jet divergence and jet rotation are as small as possible. Such a nozzle is described in the section entitled "Nozzle Design."

The amount of dissolved air in water is shown in references 3 and 4 to be a function of the air pressure on the water and the length of time the water is exposed to the air. The dissolved-air problem becomes important as to its effect on jet integrity when the pressure is high and the exposure time long enough to produce nearly saturated conditions. If this water, which is saturated with air at high pressure, is allowed to flow from the nozzle as a free jet at atmospheric static pressure, the jet becomes extremely turbulent owing to the escape of air from the stream boundaries.

From reference 3, the following equation is given for the initial rate of absorption of air in water:

$$\frac{1}{S} \frac{dm}{dt} = k_L C \left( \frac{C_H}{C} - 1 \right)$$

where

$k_L$  liquid film coefficient (0.656 to 2.35 ft/hr)

$C_H$  saturation at high pressure, pounds per cubic foot

$C$  saturation at atmospheric pressure (0.0015 lb/cu ft)

$S$  interface area, square feet

$t$  time, hours

$m$  weight of gas, pounds

Since  $C_H$  varies almost directly with the pressure  $P$ , this equation may be written

$$\frac{1}{S} \frac{dm}{dt} = k_L C \left( \frac{P}{P_{atm}} - 1 \right)$$



where

$P$  pressure on air

$P_{atm}$  atmospheric pressure

From this equation it can be seen that the time of exposure of the water to the air and also the interface area should be held to a minimum. For a short period of exposure the air dissolved would probably be unimportant. For long exposure time, however, the dissolved air is important and, if a long exposure cannot be avoided, suitable mechanical means of separating the air from the water, such as a diaphragm, must be used.

If sharp edges or too abrupt changes of curvature occur in a nozzle, the resulting low pressure can cause cavitation, and that would be very detrimental to jet integrity. The nozzle shapes described in the next section have been designed so that conditions favorable to cavitation do not occur.

#### NOZZLE DESIGN

The purpose of this section is to describe the design of a nozzle which will deliver a nondivergent jet with uniform cross-sectional velocity. In reference 5, calculation of the required nozzle shape is made by means of the exact analogy between the potential fluid flow desired and the magnetic field that is created by two coaxial and parallel coils carrying electrical current. The electromagnetic solution is applied to fluid potential flow and one of the stream surfaces is chosen as a flow boundary. A family of these contracting passages is developed (see fig. 10), and surfaces  $a$  to  $h$  give cross-sectional throat-speed distributions, boundary layer being neglected, that are uniform theoretically within one-fifth of 1 percent. The distributions become less uniform for the outer cones, but variations from uniformity are still less than 1 percent even for the outermost one. Essentially, the same throat uniformities will occur in the case of real fluid flow as in potential flow, provided the upstream flow is uniform and the boundary layer is maintained very thin. The boundary-layer thickness is expected to be less than 0.004 inch for a nozzle with a 7-inch throat diameter. As an aid in the design of a nozzle, figure 10 and table I are presented, the data of which are taken from reference 5.

Although no measurements of nozzle efficiency were made on the potential-flow nozzle, dynamometer tests of nozzles of the original test shape indicate that the coefficient of discharge of such nozzles approaches 1.0. It seems reasonable to expect that the potential-flow nozzle will give as good results.



The inflow requirements are fairly simple but very important. The flow approaching the entrance to the nozzle should be parallel, should be of uniform velocity, and should have a minimum of turbulence. Any appreciable rotation about the jet center line in the approach flow would be disastrous. Because of the conservation of angular momentum, any rotational velocity in the approach flow would be greatly magnified in the nozzle, with the result that the jet would tend to expand owing to centrifugal force as soon as it is clear of the nozzle; early jet disintegration would then occur. A faired transition section for connecting the nozzle to the straight approach section should give satisfactory flow.

Cavitation in the potential-flow nozzle is not expected since the operating pressure range lies well above the vapor pressure of water, and the use of a smooth polished finish of the nozzle water surface should prevent local pressure drops due to a discontinuity of surface.

Reference 6 states that stainless steel of the 18-8 chrome-nickel type, used either as a forging or as a layer weld upon a mild-steel base, is best for operation under severe conditions. The working life of nozzles using this metal has exceeded 2 years of continuous operation. This metal, if used in the catapulting-system nozzle, should have a working life much greater than 2 years because of the intermittent usage of the system.

#### BUCKET DESIGN

The energy of the stream is transmitted to the carriage by the catching and turning of the water of the jet in a bucket attached to the rear of the carriage. It is known that maximum thrust efficiency is achieved by a bucket that can turn the jet through almost  $180^\circ$  and thereby obtain maximum carriage thrust. The bucket must be so designed that it can return this jet efficiently throughout the maximum catapulting range of 400 feet. Over this large range, however, significant vertical and lateral displacements to the jet can occur because of the effects of gravity and of side winds. These effects of gravity and of side winds on a long-range jet made it impossible to adopt, without investigation, the information available regarding impulse-turbine bucket design, the only other system utilizing power derived from a jet-bucket configuration. The impulse turbine is essentially a completely housed multiple-bucket short-range jet system in which the point of contact is quite precisely controlled.

A summation of these considerations indicates that what is needed for a bucket is a concentrating device, such as a cone, that can collect the deviated and expanded jet and deliver it to a turning section where the collected jet is turned through  $180^\circ$  for maximum energy transfer.

A test program was arranged therefore, wherein various small-scale bucket shapes were tested with regard to propulsive efficiency over scale jet ranges by recording the bucket loads introduced on a small strain-gage type of dynamometer and comparing these results with the theoretical jet-impact forces. Sketches and dimensions of the buckets investigated are shown in figure 11. Jets having diameters at the nozzle of  $1/2$  inch and  $1/4$  inch were used in testing these buckets. Figure 12 shows the propulsive efficiency of these buckets plotted against jet length for the two nozzle sizes. A study of the information on impulse-turbine buckets (references 6 to 8) in conjunction with these tests indicates that there are three important bucket design parameters, namely, the ratio of bucket width to jet diameter  $b/d$ , the angle of approach of the jet to the bucket surface, and the condition of the wetted bucket surface. These parameters are very important as regards the efficiency of any bucket. The ratio  $b/d$  is especially important in bucket design because of its large effect on bucket propulsive efficiency. Impulse-turbine bucket design indicates that the skin friction developed by a bucket and its corresponding energy loss is a function of this ratio. Too large a ratio results in excessive losses through skin friction whereas too small a ratio results in an overflowing bucket with its corresponding loss. Figure 13 shows the increase in bucket efficiency gained by decreasing this ratio from 12 to 6. This ratio was decreased by increasing the jet diameter from  $1/4$  inch to  $1/2$  inch. The efficiency gain was of the order of 9 percent.

The approach angle of the jet to the impact surface was found also to have an important effect on bucket propulsive efficiency. Pelton, in his development of the Pelton wheel (reference 8), found that the impingement of a jet on the edge of his cupped bucket, rather than in the center of the bucket, increased the efficiency considerably. This efficiency gain was due to the jet hitting the bucket where the jet path and the bucket surface were nearly parallel. From this point, the jet, following the bucket contour, was led gradually into a  $170^\circ$  reversal rather than reversing abruptly as was the case with a direct central jet impact on the bucket. The best possible jet entrance is tangential to the bucket but it has been found that deviations from this tangential entrance can be tolerated up to about  $15^\circ$  because of the relatively small energy losses involved.

The condition of the wetted bucket surface is an important consideration also. The ideal bucket surface is one that is as smooth and highly polished as is feasible. Such a surface reduces the erosive action of high-velocity jets, eliminates the turbulence and possible local shock effects resulting from a discontinuity of surface, and reduces the skin friction developed by the bucket.



So far only the design conditions applicable to any type of jet-bucket system have been described. The magnitude of the vertical and lateral deviations given a long-range jet by the action of gravity and of side winds must be determined before any design for the catapult-system bucket can be reached. The vertical deviation is a function of the jet velocity and nozzle angle and may be calculated from equation (19). Figure 14 shows the point of impact of the jet on the bucket throughout the maximum catapulting distance for the case of the facility under consideration. This curve furnishes the vertical-jet-displacement information necessary for this particular bucket design. The lateral jet displacement caused by side wind becomes of significance when the catapulting distances are long and when the catapult system is not protected from the wind. Figure 15 shows a typical lateral-displacement curve for a jet of given dimensions. The mathematical treatment of this problem has been discussed in the section entitled "Mathematical Development" (see equation (21)).

Figure 16 shows several views of a model bucket so designed as to include all the discussed design conditions. The variation in efficiency of this bucket due to lateral displacement and variation in jet length of a  $\frac{1}{2}$ -inch jet are shown in figure 17. These curves indicate that a properly designed bucket will have an efficiency range of 78 to 98 percent, depending upon where the jet strikes the bucket. The average jet-bucket loss is considered to be 15 percent.

The more refined bucket design shown in figure 18 makes use of an elliptical-cross-sectional cone rather than the circular-cross-sectional cone. This bucket resulted in some weight saving along with producing a more compact bucket. Although no efficiency tests were made on this bucket, it was found to give very satisfactory results when used in a working model.

Some care must be used in the selection of the material to be used for constructing the bucket. The experience gained in the construction of impulse-turbine buckets is available for this purpose. Reference 6 states that the material used for high-head buckets is cast steel, the medium grades of carbon steel being preferred. Heat-treated alloy steel is used to a limited extent but the practical problem in connection with this material is the difficulty in heat treatment following field repairs by welding. An increase in bucket life has been secured by the layer welding of 18-8 chrome-nickel stainless steel or other hard facings in the bucket bowls which are afterward ground smooth to true shape. The probability of fatigue failure occurring in the propulsion-system bucket is very small due to the intermittent usage expected of the catapult. Consequently, a higher design stress can be used in this bucket than in the case of the impulse-turbine bucket where the probability of fatigue



failure occurring is much greater due to the continuous operation of the turbine. It is also expected, because of this low frequency of catapult operation, that the possibility of damage due to cavitation occurring in the bucket will be small and, hence, can be neglected.

#### ADDITIONAL DESIGN PROBLEMS

One design problem that has not been previously mentioned is that of controlling the flow of water leaving the bucket. The water returned by the bucket possesses a large amount of power that could be damaging to the pressure tank foundations and track installations and injurious to personnel. Figure 19 shows how this return-water velocity varies over the catapulting distance. The curve shows that the return-water velocity varies from practically initial jet velocity at the start to about one-third the jet velocity at the end of the catapulting distance. A practical way to dispose of this return jet is to insert a shallow return-water tank between the tracks. A system of raised lateral louvers is placed over this tank. The bucket should be so designed that the return water is concentrated and directed through these louvers and into the tank as the carriage moves through the catapulting distance. The return-water energy is dissipated in this tank whereupon the water becomes available for re-use in the system.

The design of the water tank must be given careful consideration. It has been shown previously that the integrity of long-range jets depends upon symmetrical inflow to the nozzle and the avoidance of dissolved air in the water under high pressure. The water tank, therefore, must be so designed that these conditions are met. Figure 1 shows a tank design that meets these conditions. The water tank is made up of a vertical cylinder joined by means of a 90° elbow to a horizontal cylinder. The extreme end of the horizontal tank contains the potential-flow nozzle along with a transition section between the upstream nozzle face and the interior tank wall. The upper end of the vertical tank contains the connection leading to the high-pressure air supply along with a diffuser to distribute this air equally across the water surface of the tank. The flow of water through the nozzle is controlled by means of a quick opening and closing valve placed outside and over the end of the nozzle. The air flow into the water tank is controlled by a valve located between the air diffuser and the pipe leading from the air tank.

Symmetrical inflow to the nozzle is achieved primarily by making the horizontal tank and vertical tank of such volume that all the water discharged is initially located downstream from the elbow. With this arrangement, none of the water that passes through the elbow during a

catapult stroke ever reaches the nozzle. To minimize the turbulence generated in the water in passing through this elbow, turning vanes should be provided. By using a large contraction ratio (ratio of tank cross-sectional area to nozzle area), the velocity of water flow through the tank is held to a low value as compared with the water flow through the nozzle. Thus, the turbulence of the water upstream from the nozzle is held to a minimum. This water tank can be operated in such a manner as to minimize the problem of dissolved air by venting the water tank to atmospheric pressure until immediately before a catapult stroke when the high-pressure air will be admitted to the tank.

#### CONCLUDING REMARKS

From the studies reported the hydraulic jet catapult appears to be satisfactory for accelerating a 100,000-pound car to 150 miles per hour and to be cheaper than the other types considered. Model tests and other information indicate that a satisfactory jet should be obtained over the indicated design catapulting distance of 400 feet. Design requirements, such as provision of tanks and valves to operate at the required pressure, prevention of erosion and corrosion in the nozzle and bucket, control of the return-water jet, and so forth, offer problems; but it appears that these problems can be handled.

Langley Aeronautical Laboratory,  
National Advisory Committee for Aeronautics,  
Langley Field, Va., January 17, 1951.

## REFERENCES

1. Crosby, Everett U., Fiske, Henry A., and Forster, H. Walter: Handbook of Fire Protection. Ninth ed., National Fire Protection Assoc., 1941, figs. 1134, 1136B, and 1137B.
2. Howe, J. W., and Posey, C. J.: Characteristics of High-Velocity Jets. Proc. Third Hydraulics Conf., Univ. Iowa, Studies in Eng. Bull. 31, 1947, pp. 315-332.
3. Brown, F. Barton: Air Resorption in Water Tunnels. Rep. No. N-62, Contract NOrd-9612, Bur. Ord., Navy Dept., C.I.T., March 1949.
4. Adeney, W. E., and Becker, H. G.: The Determination of the Rate of Solution of Atmospheric Nitrogen and Oxygen by Water. Phil. Mag., pt. I, ser. 6, vol. 38, no. 225, Sept. 1919, pp. 317-337; pt II, ser. 6, vol. 39, no. 232, April 1920, pp. 385-404.
5. Smith, Richard H., and Wang, Chi-Teh: Contracting Cones Giving Uniform Throat Speed. Jour. Aero. Sci., vol. 11, no. 4, Oct. 1944, pp. 356-360.
6. Quick, Ray S.: Problems Encountered in the Design and Operation of Impulse Turbines. Trans. A.S.M.E., vol. 62, no. 1, Jan. 1940, pp. 15-27.
7. Lowy, Robert: Efficiency Analysis of Pelton Wheels. Trans. A.S.M.E., vol. 66, no. 6, Aug. 1944, pp. 527-538.
8. Durand, W. F.: The Pelton Water Wheel.
  - I - Developments by Pelton and Others Prior to 1880. Mech. Eng., vol. 61, no. 6, June 1939, pp. 447-454.
  - II - Developments by Doble and Others, 1880 to Date. Mech. Eng., vol. 61, no. 7, July 1939, pp. 511-518.



TABLE I  
 COORDINATES OF POTENTIAL-FLOW NOZZLE BOUNDARIES

[From reference 5, table 1]

Z	X											
	a	b	c	d	e	f	g	h	i	j	k	l
0	0.280	0.300	0.320	0.340	0.360	0.380	0.400	0.420	0.440	0.460	0.480	0.500
.1	.280	.300	.320	.340	.360	.380	.400	.420	.440	.460	.480	.500
.2	.280	.300	.320	.340	.360	.380	.400	.420	.440	.460	.480	.500
.3	.282	.302	.322	.342	.362	.382	.402	.422	.440	.460	.480	.500
.4	.284	.304	.324	.344	.364	.384	.404	.424	.442	.461	.480	.500
.5	.289	.309	.329	.349	.369	.389	.409	.429	.450	.464	.488	.506
.6	.298	.318	.338	.358	.381	.401	.421	.442	.462	.482	.502	.522
.7	.310	.330	.352	.375	.396	.418	.448	.461	.482	.504	.525	.547
.8	.326	.339	.360	.383	.406	.429	.450	.474	.511	.534	.556	.581
.9	.345	.370	.394	.419	.445	.469	.496	.519	.547	.571	.598	.626
1.0	.369	.396	.422	.450	.478	.505	.531	.561	.590	.619	.650	.681
1.1	.397	.426	.455	.484	.516	.546	.577	.610	.644	.676	.712	.750
1.2	.428	.460	.492	.526	.557	.594	.631	.665	.704	.743	.785	.830
1.3	.464	.499	.533	.572	.606	.648	.687	.730	.774	.817	.870	.922
1.4	.502	.541	.579	.622	.664	.708	.753	.802	.853	.907	.967	1.032
1.5	.543	.586	.630	.676	.724	.775	.827	.883	.940	1.008	1.078	1.160
1.6	.588	.636	.684	.736	.790	.846	.905	.970	1.037	1.115	1.197	1.294
1.7	.635	.689	.742	.800	.860	.921	.989	1.064	1.144	1.237	1.330	
1.8	.685	.744	.804	.866	.935	1.005	1.082	1.168	1.265	1.370		
1.9	.738	.803	.868	.938	1.014	1.093	1.182	1.280	1.396			
2.0	.793	.865	.936	1.016	1.100	1.190	1.290	1.405				
2.1	.852	.930	1.009	1.096	1.190	1.292	1.406					
2.2	.915	.997	1.084	1.180	1.286	1.401						
2.3	.979	1.069	1.164	1.269	1.386							
2.4	1.046	1.144	1.246	1.364								
2.5	1.116	1.222	1.331									



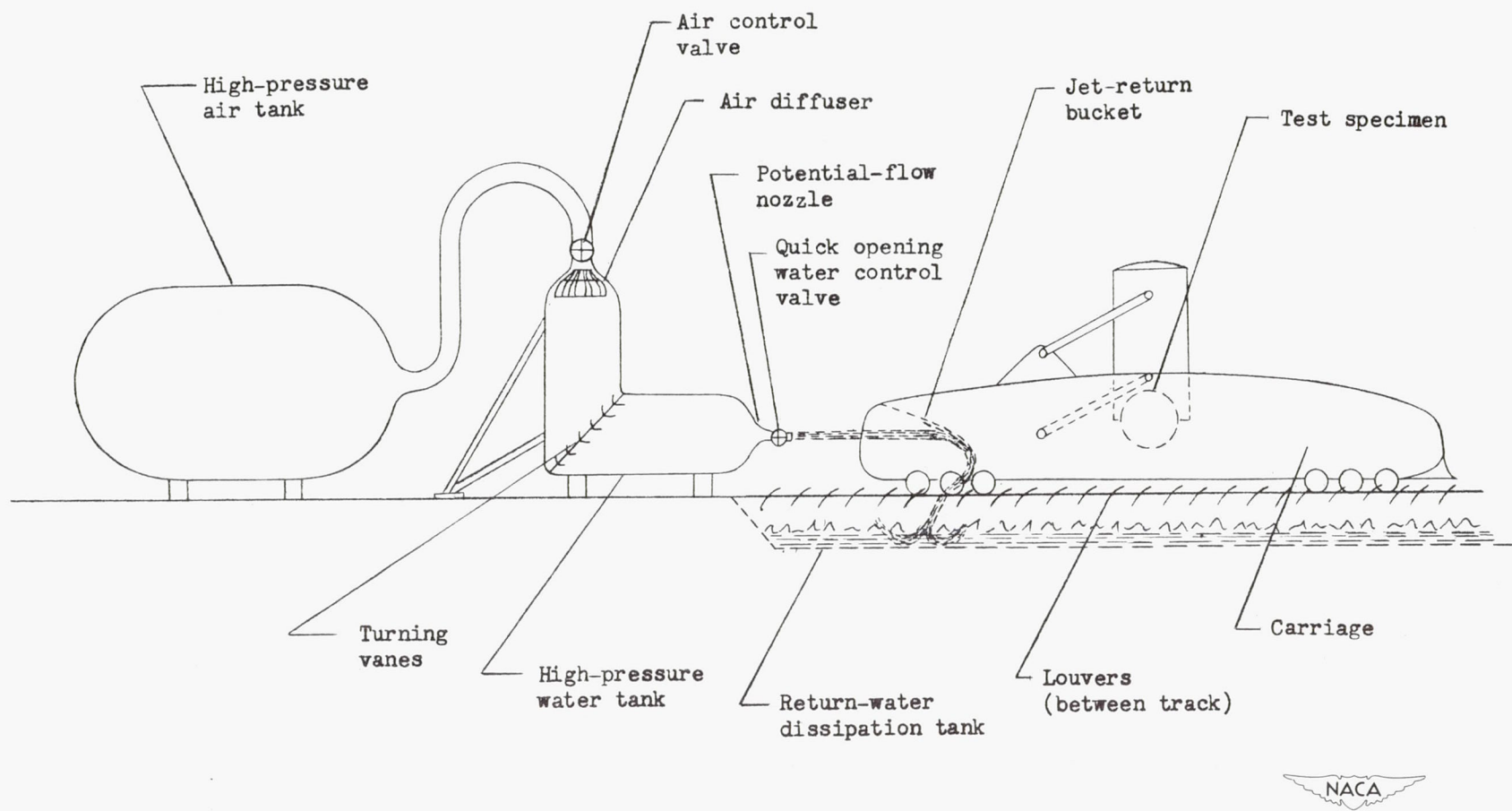

Figure 1.- Schematic drawing of hydraulic catapult system.

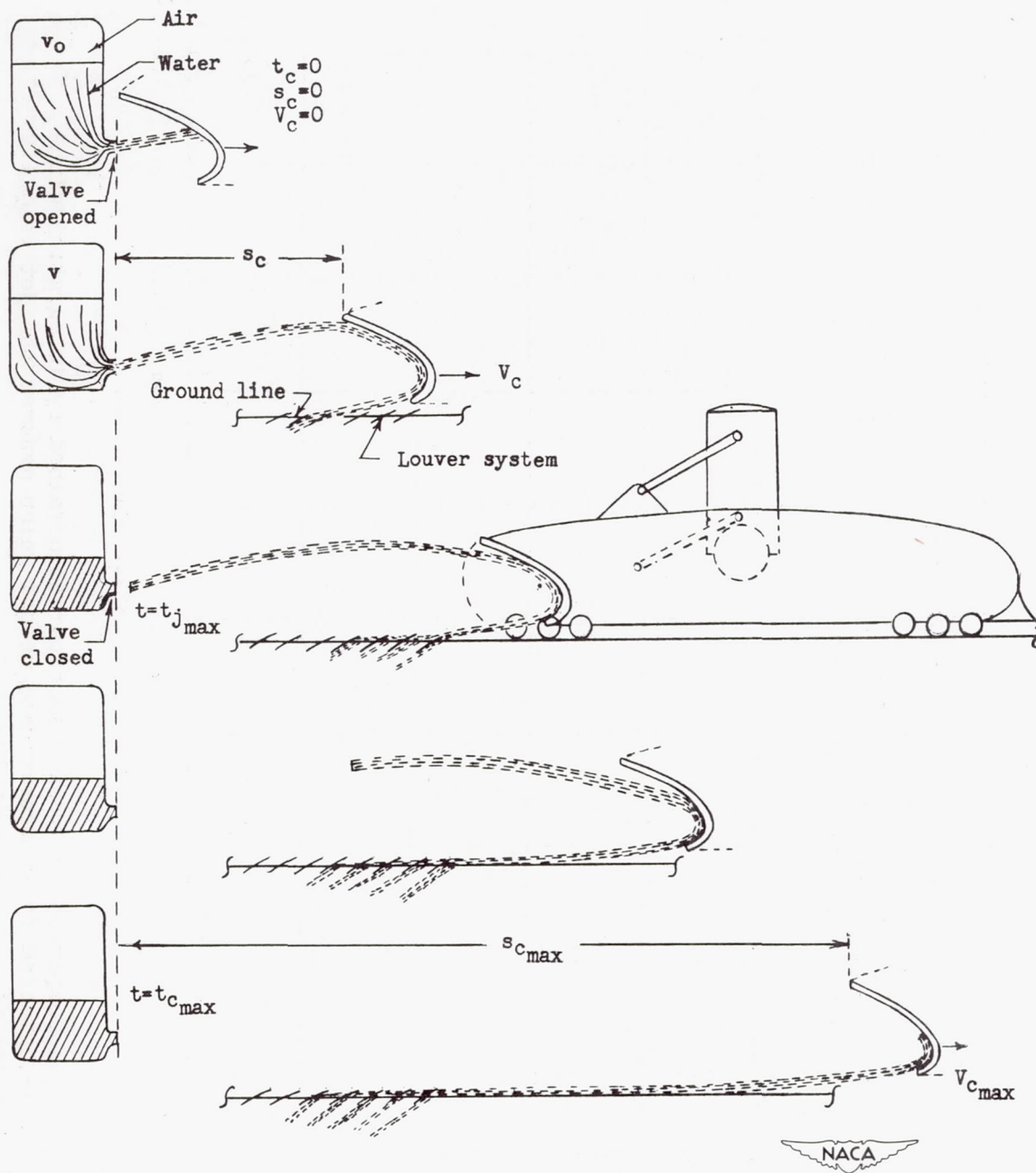

Figure 2.- Sequence of operations during a catapulting stroke.



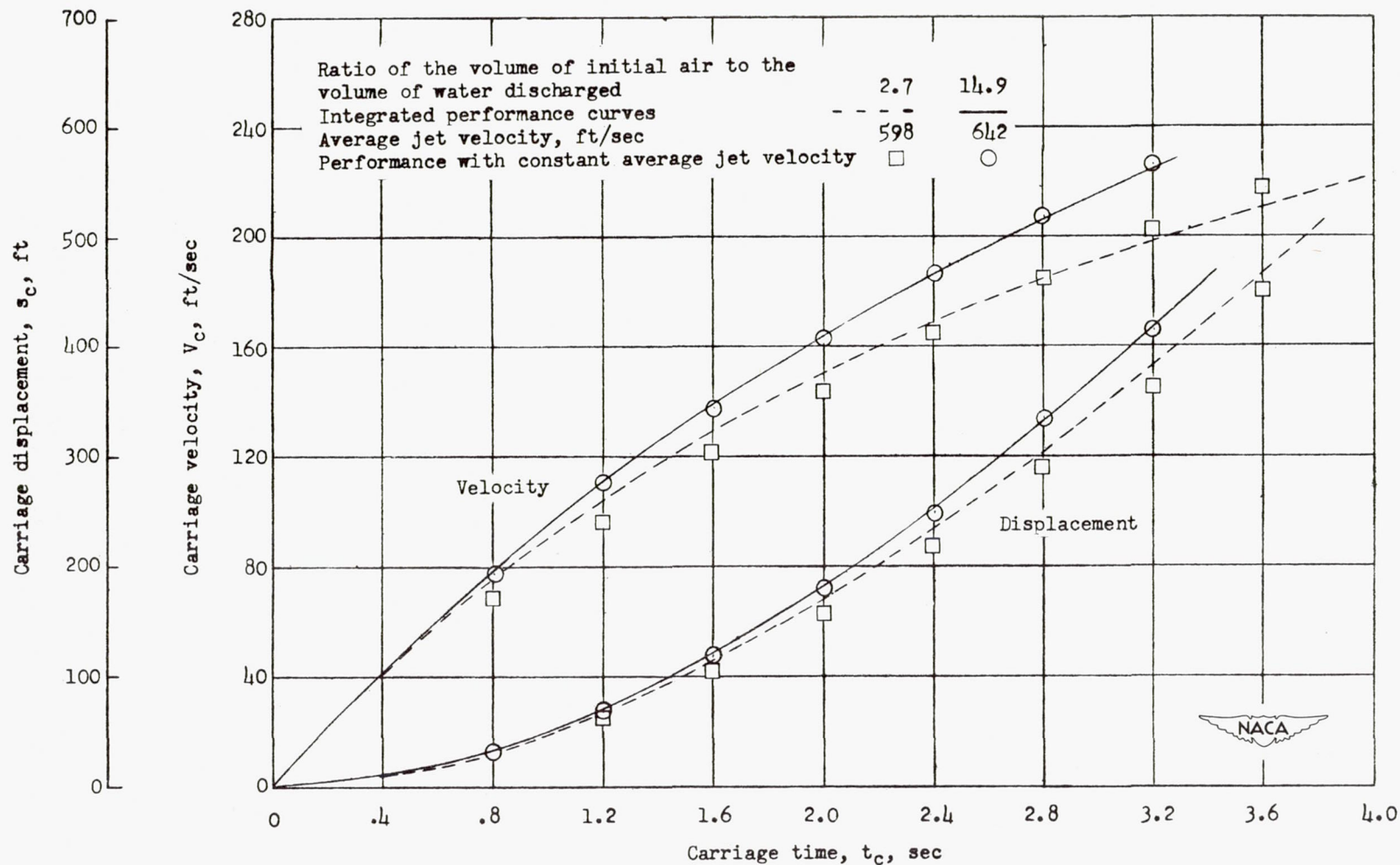

Figure 3.- Comparison of performance curves obtained by integration with those obtained by an approximate method which assumes the jet velocity constant at its average value.

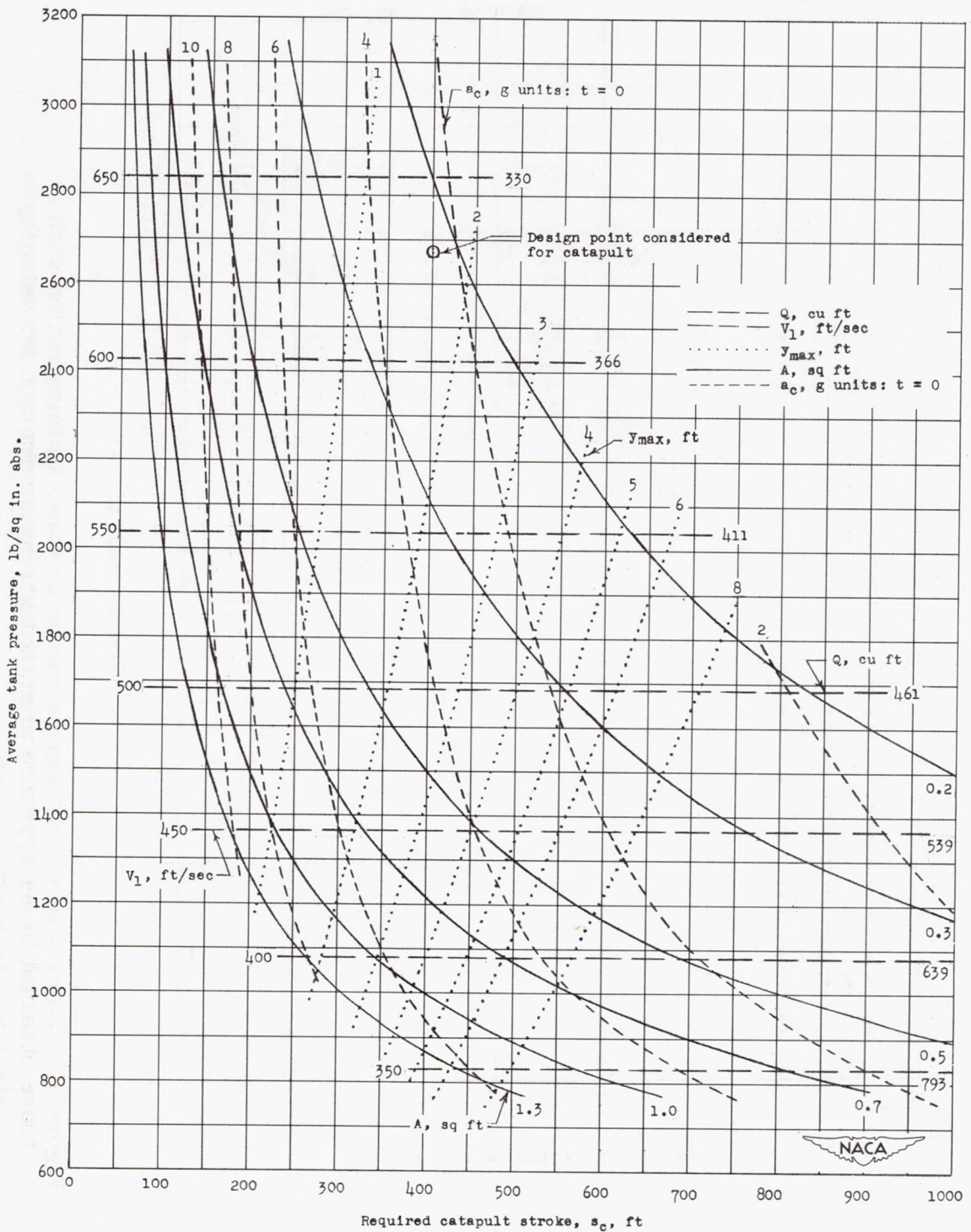

Figure 4.- Characteristics of a family of jets, any one of which will accelerate a 100,000-pound test vehicle to 150 miles per hour.

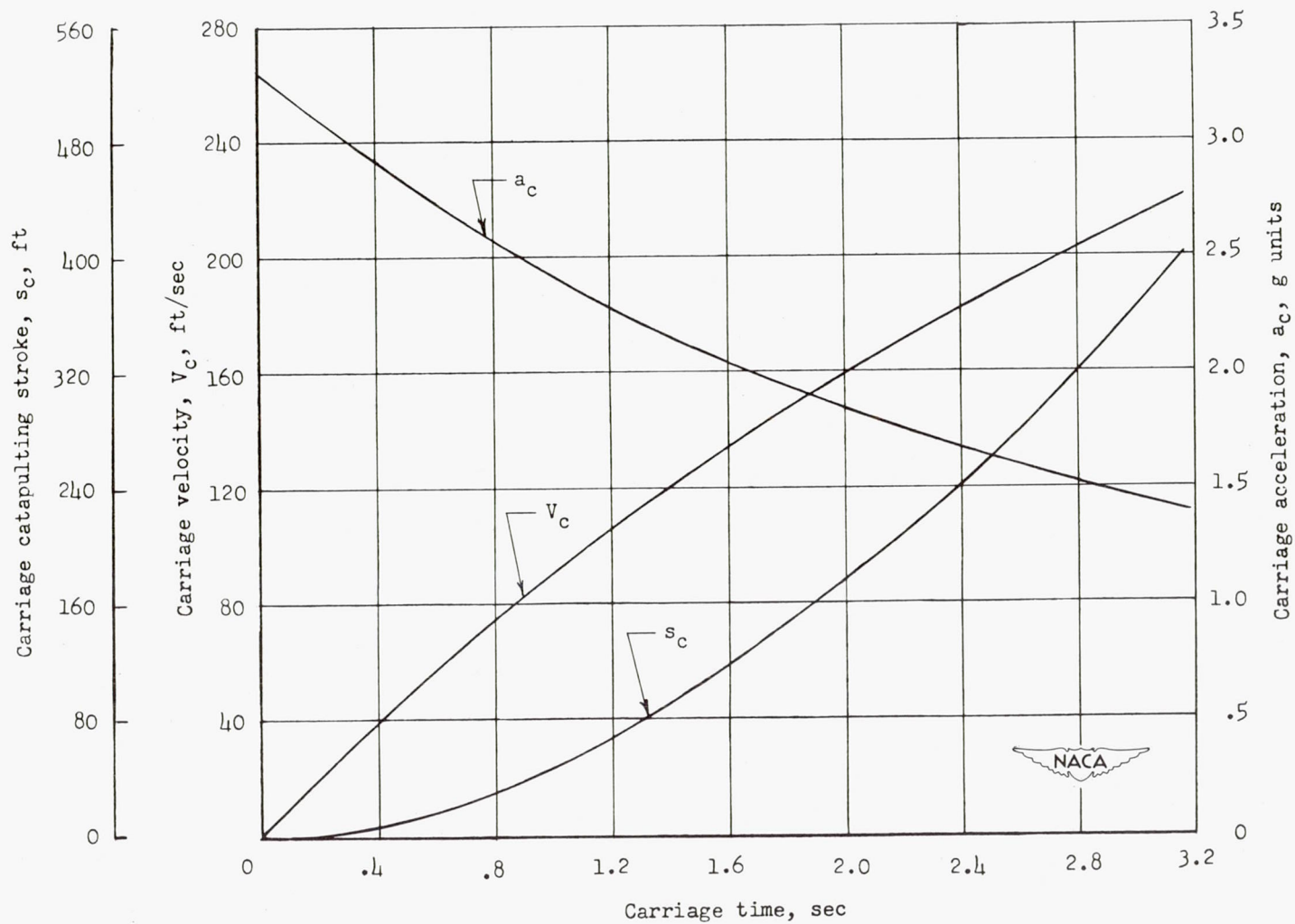
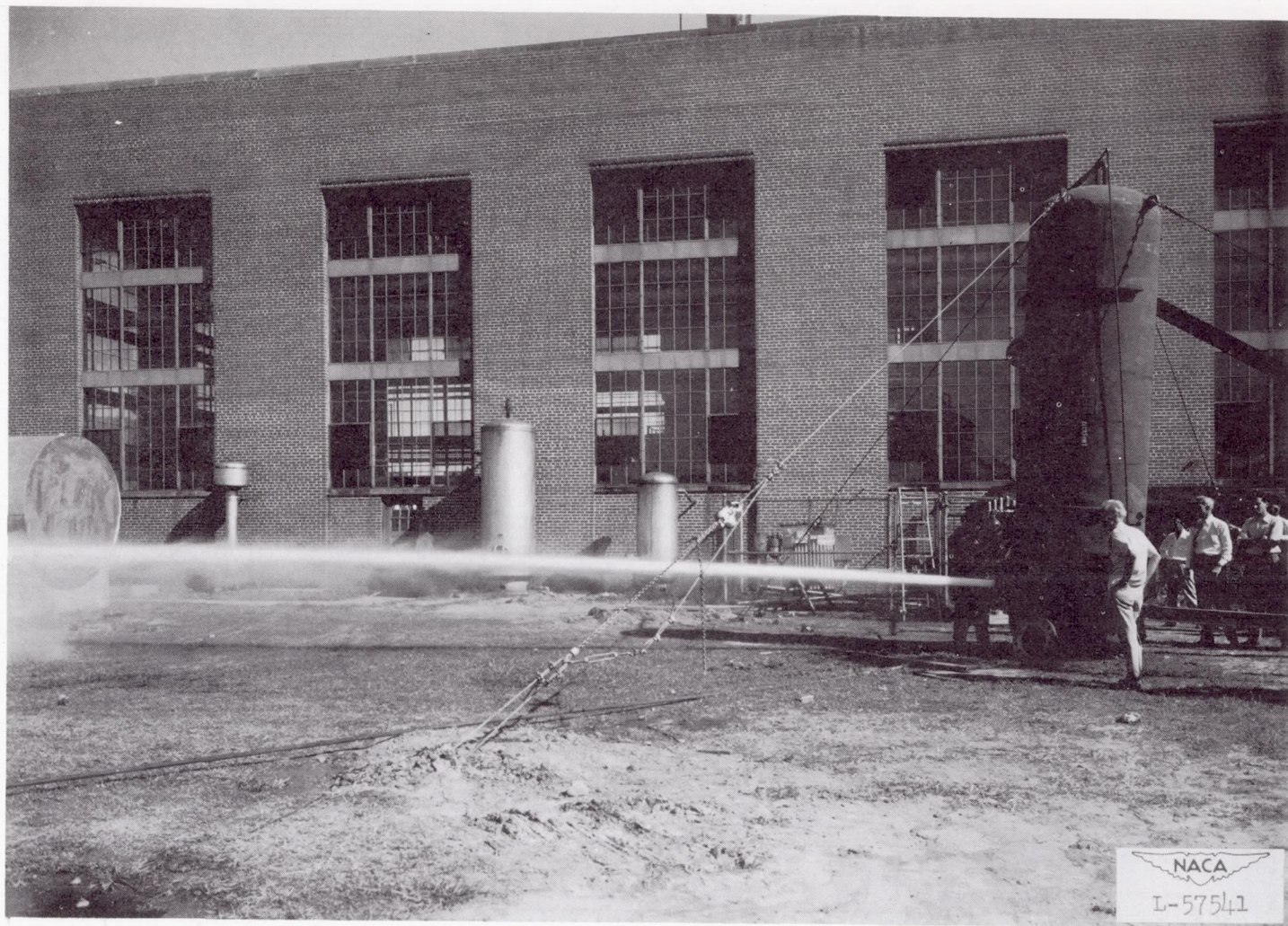

Figure 5.- Carriage performance characteristics. Average jet velocity, 633 feet per second; nozzle area, 0.2125 square foot; carriage weight, 100,000 pounds.





(a) Jet issuing from nozzle.

Figure 6.- Jet from 3-inch original test nozzle. Tank pressure, 220 pounds per square inch (approx.);  $\frac{1}{4}$ -scale catapulting stroke.





(b) Jet 200 to 300 feet from nozzle.

Figure 6.- Concluded.



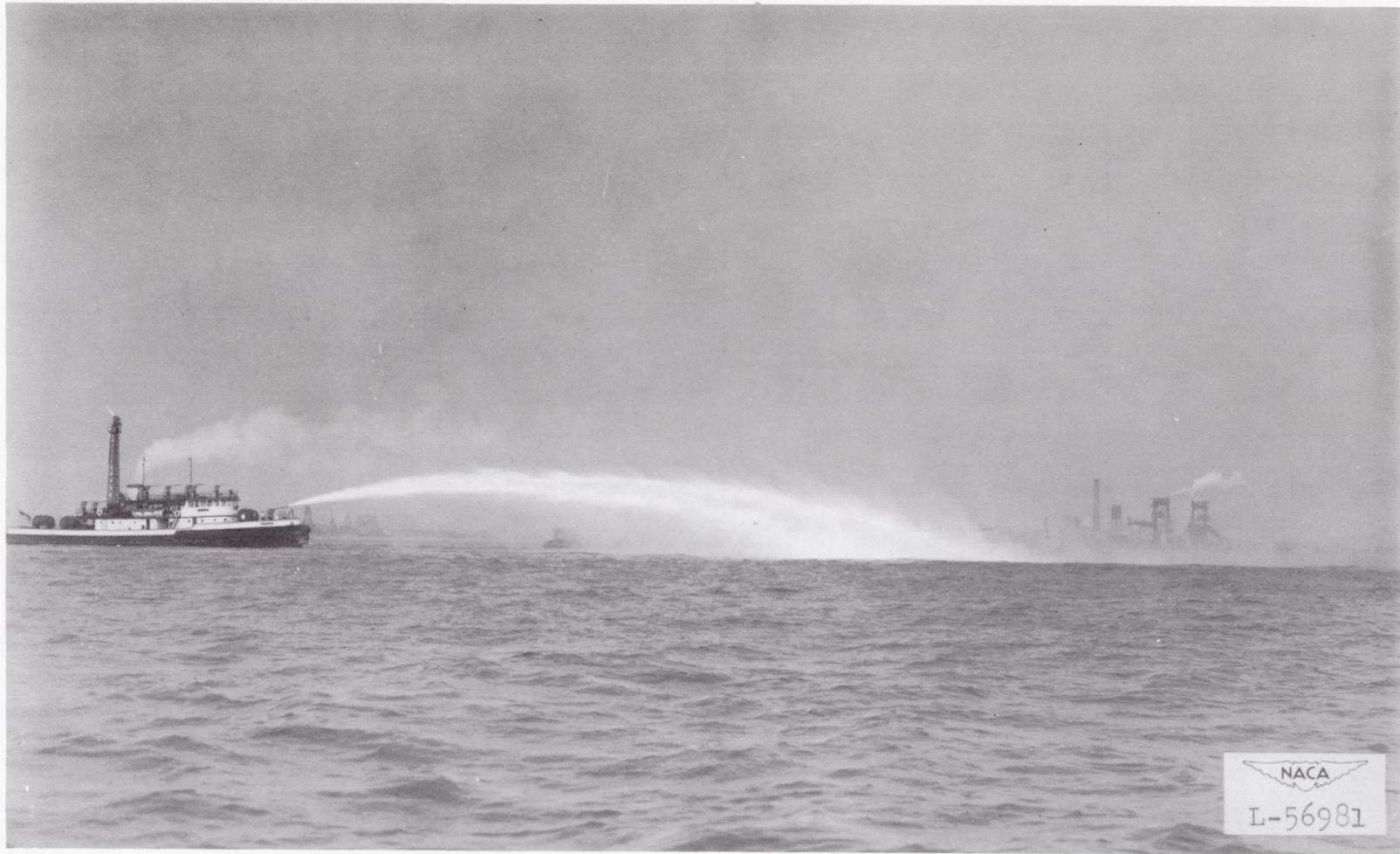

Figure 7.- Divergent jet resulting from relatively crude nozzle forms and poor entrance conditions. Jet issuing from 5-inch fireboat nozzle; pitot pressure, 260 pounds per square inch; wind, astern, 10 miles per hour.



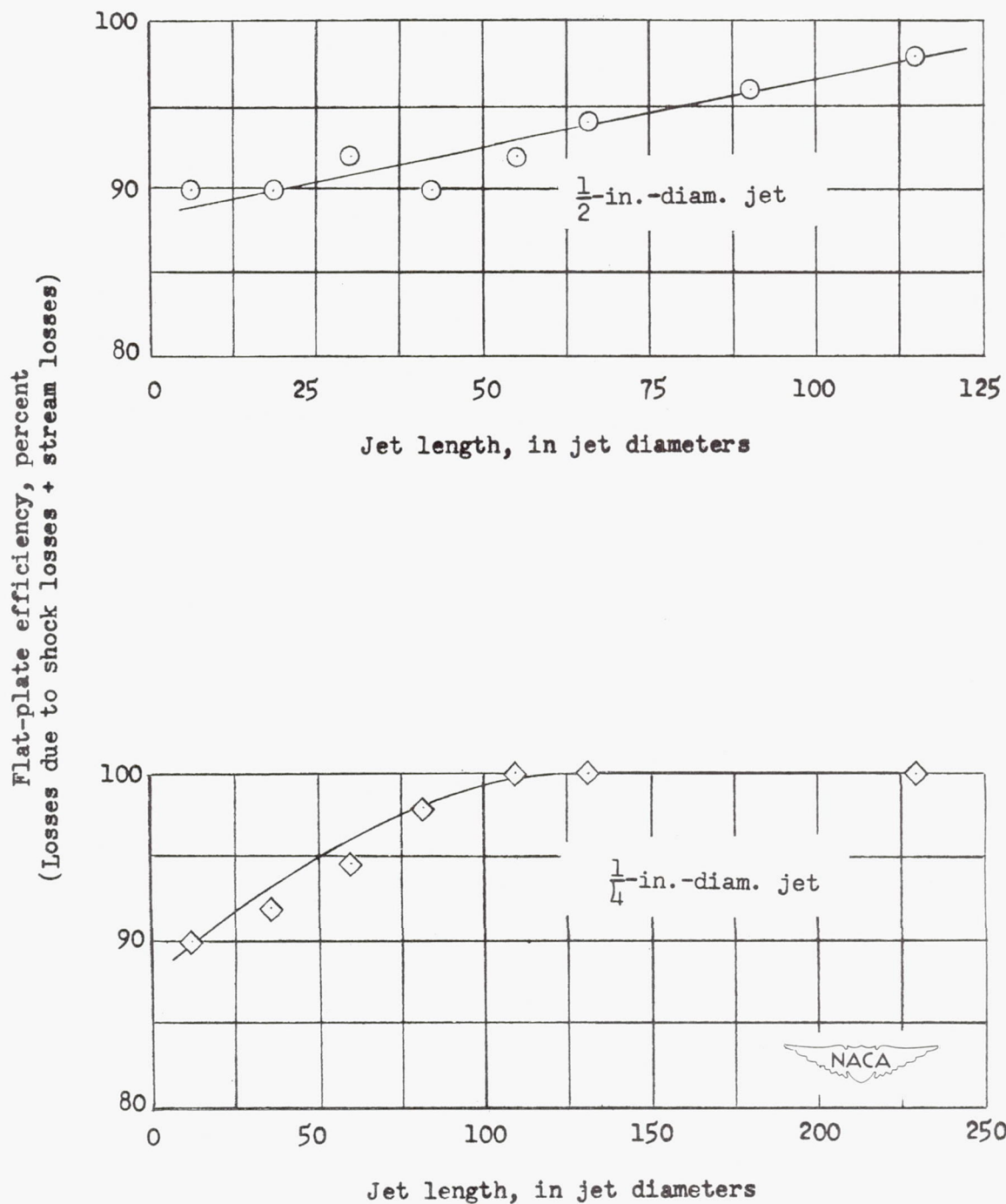

Figure 8.- Efficiency losses experienced by jets impinging on a flat plate (original test nozzle).

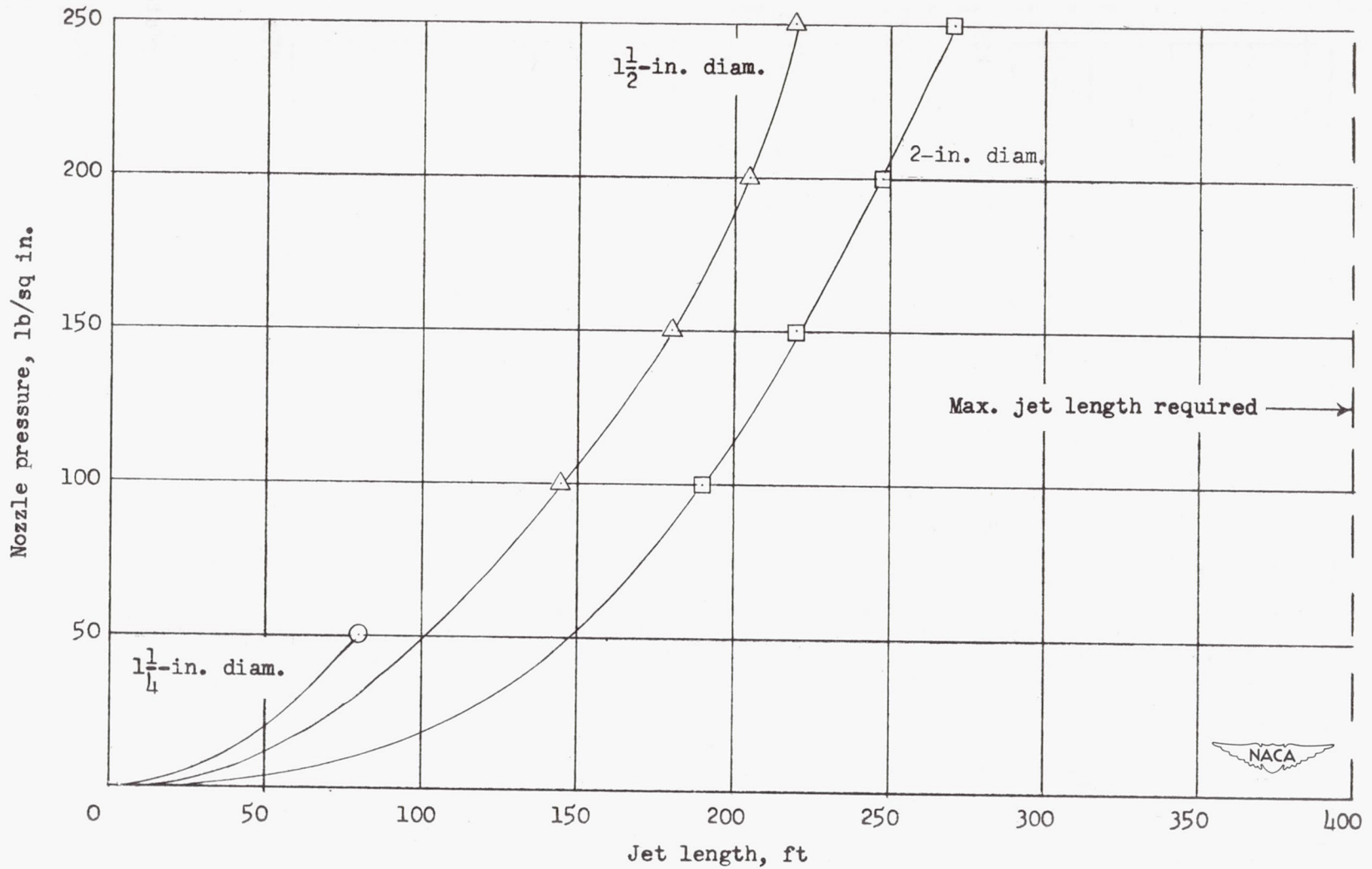

Figure 9.- Increase in "good" jet length by increasing nozzle diameter and nozzle pressure. (From reference 1.)

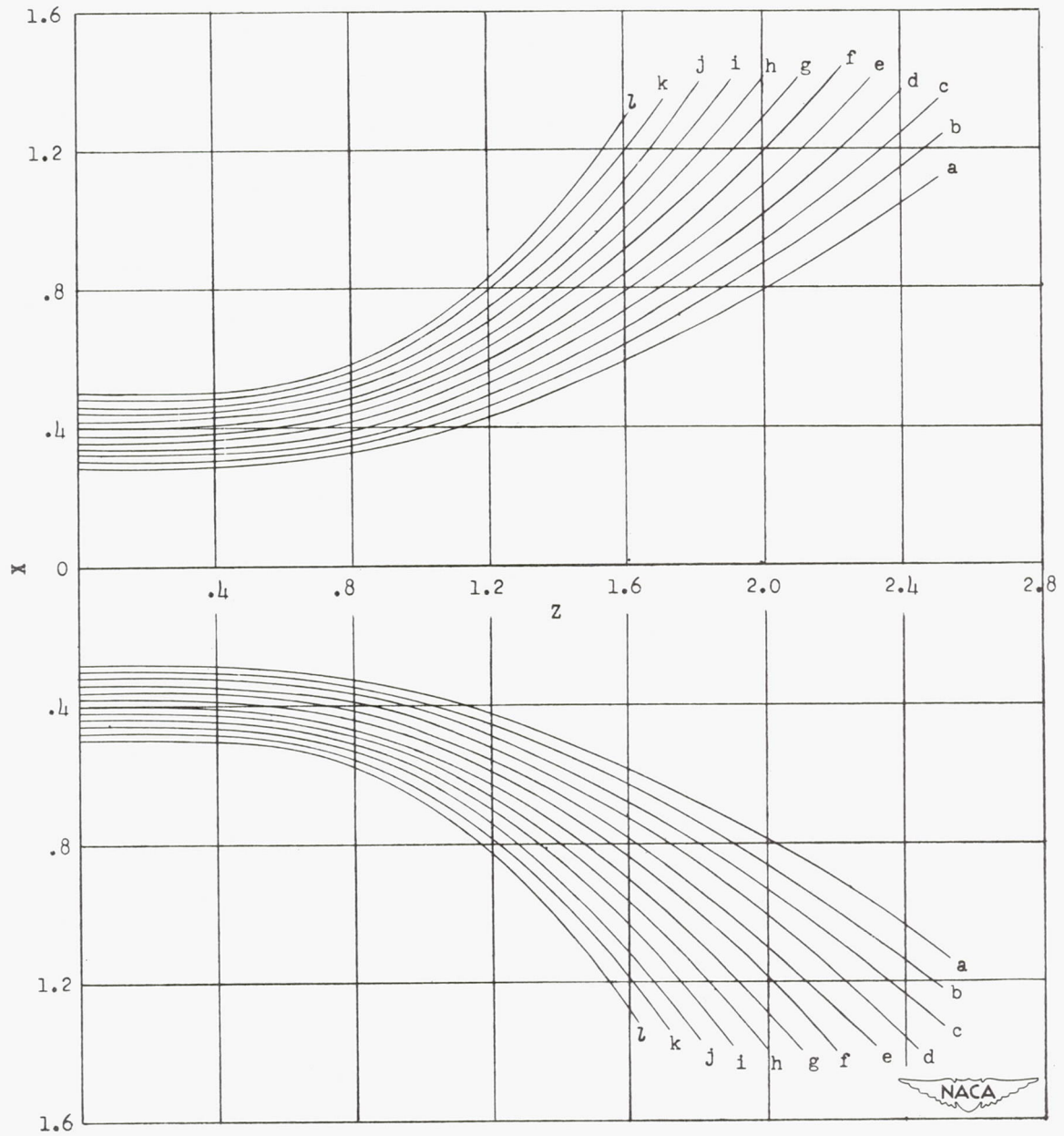

Figure 10.- Potential-flow nozzle boundaries. (Precision of uniformity of throat speed: a to h within 0.2 percent; i within 0.4 percent; j within 0.6 percent; k within 0.9 percent; l within 1 percent. From reference 5, fig. 6.)



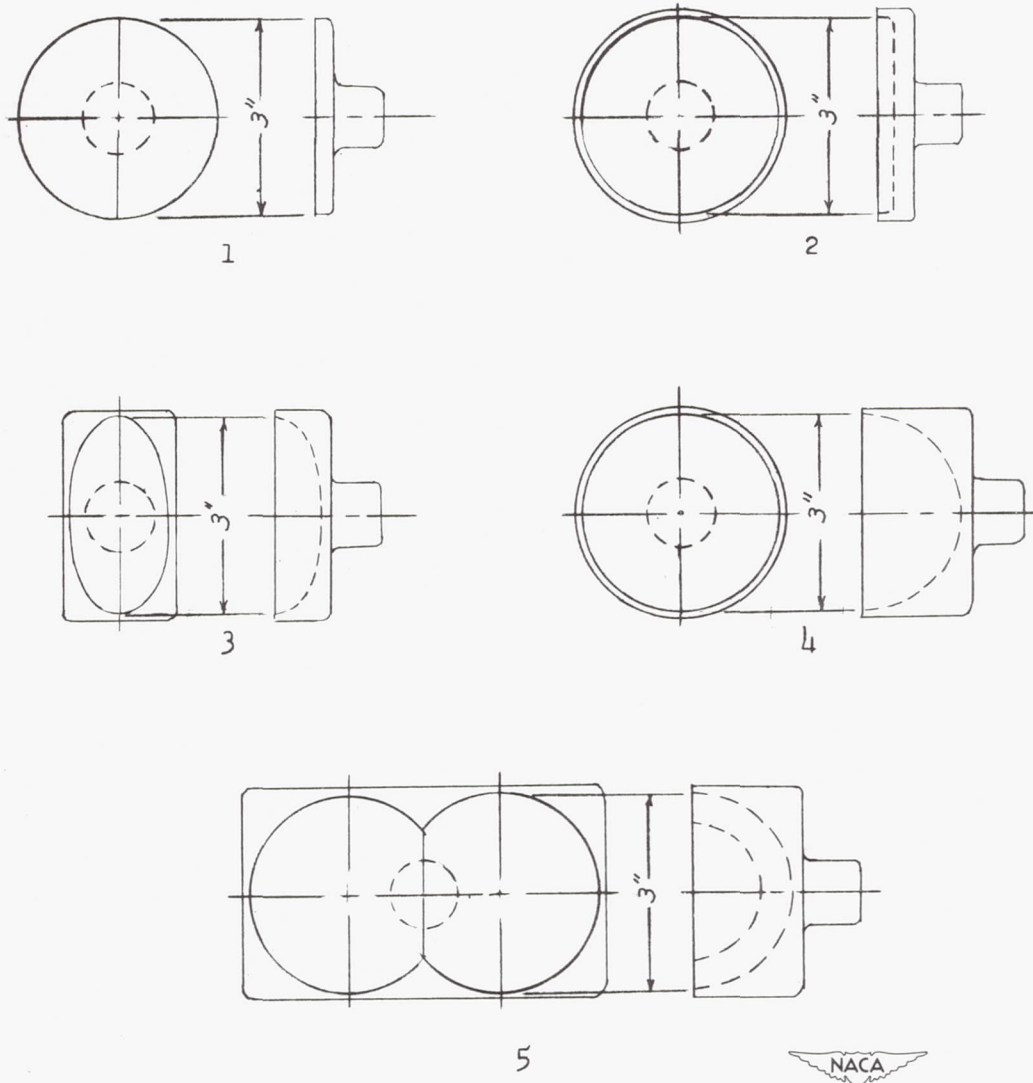

Figure 11.- Sketches of buckets used in preliminary tests of jet-catapult return bucket.

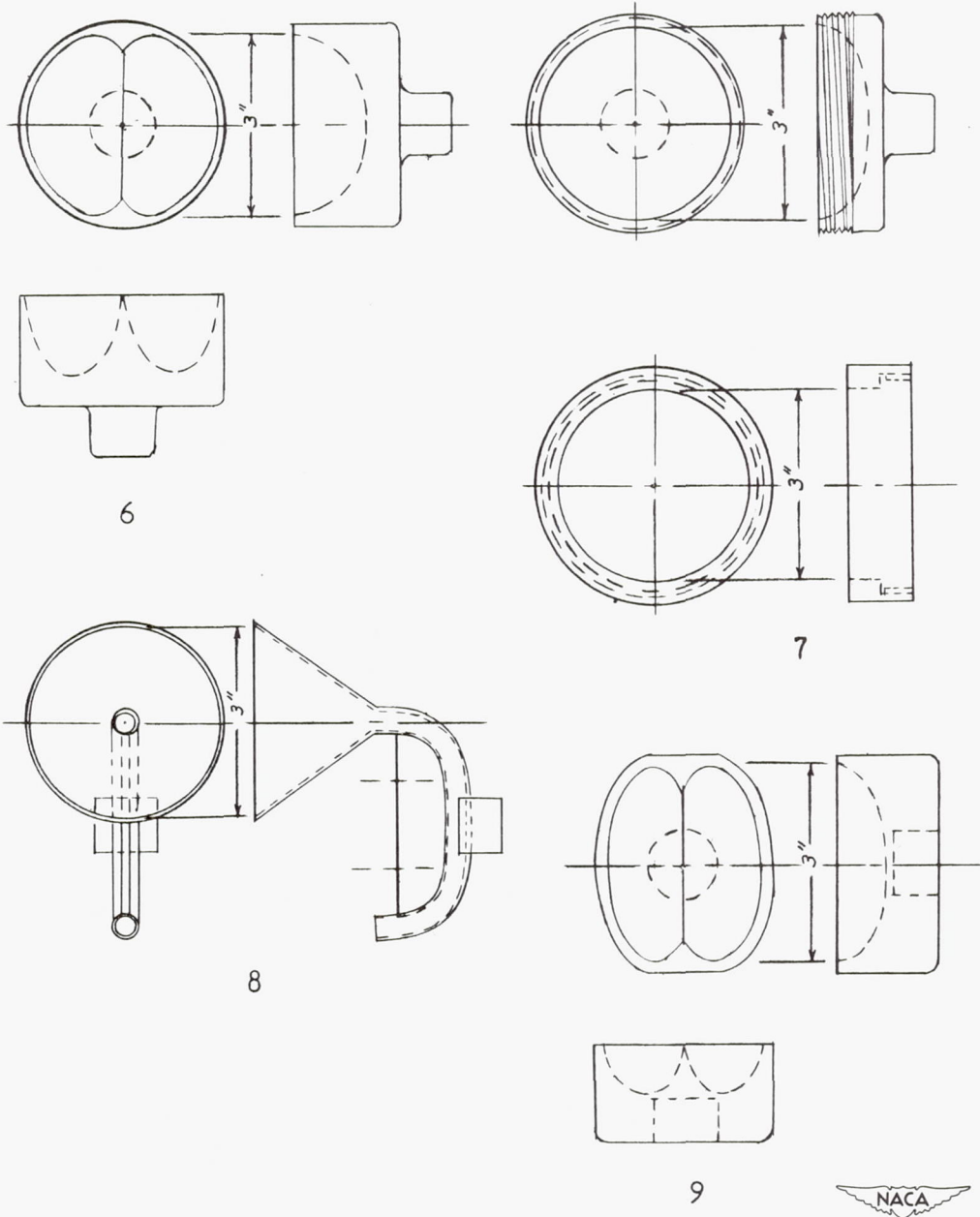

Figure 11.- Concluded.

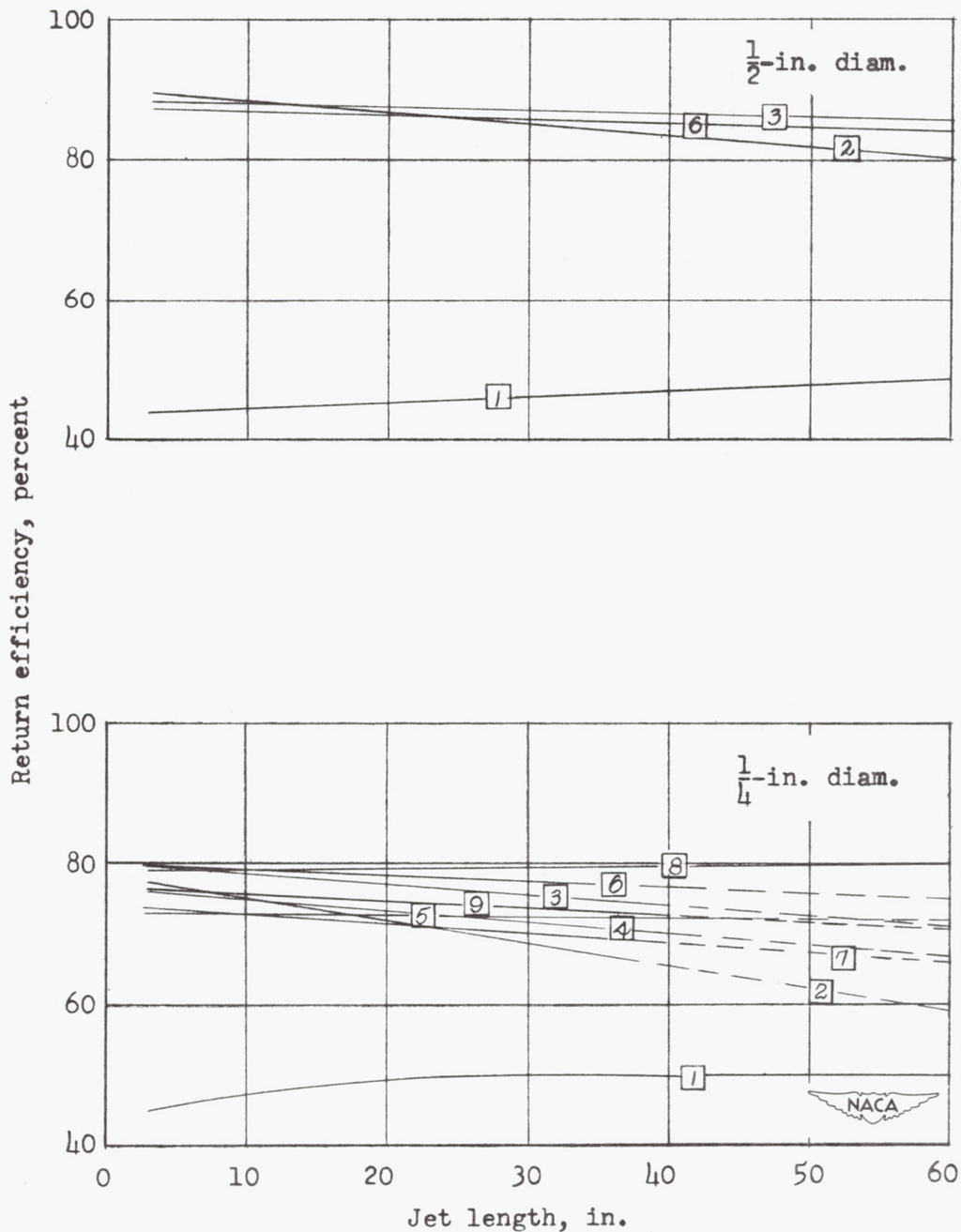
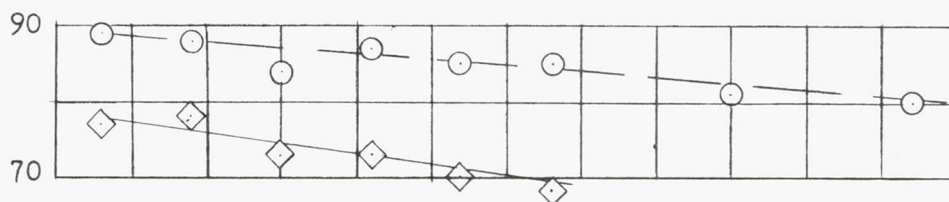

Figure 12.- Variation of return efficiency of preliminary buckets with increasing jet lengths (original test nozzle). (Numbers refer to sketch shown in fig. 11.)



○  $\frac{1}{2}$ -in. diam.,  $\frac{b}{d} = 6$   
 ◇  $\frac{1}{4}$ -in. diam.,  $\frac{b}{d} = 12$



(a) Bucket 2.

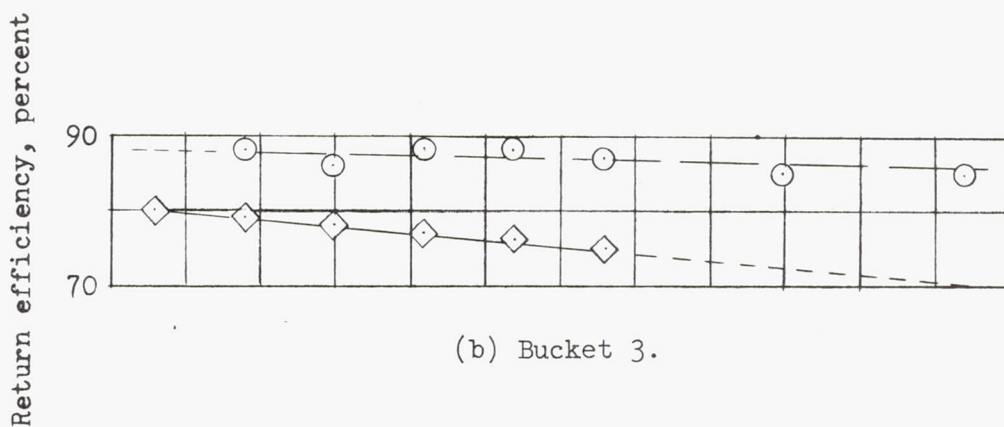

(b) Bucket 3.

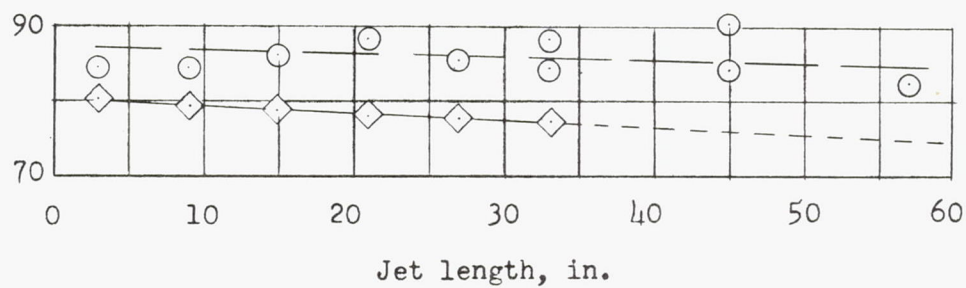

(c) Bucket 6.



Figure 13.- Increase in efficiency of return with decrease in  $b/d$  ratio (original test nozzle).

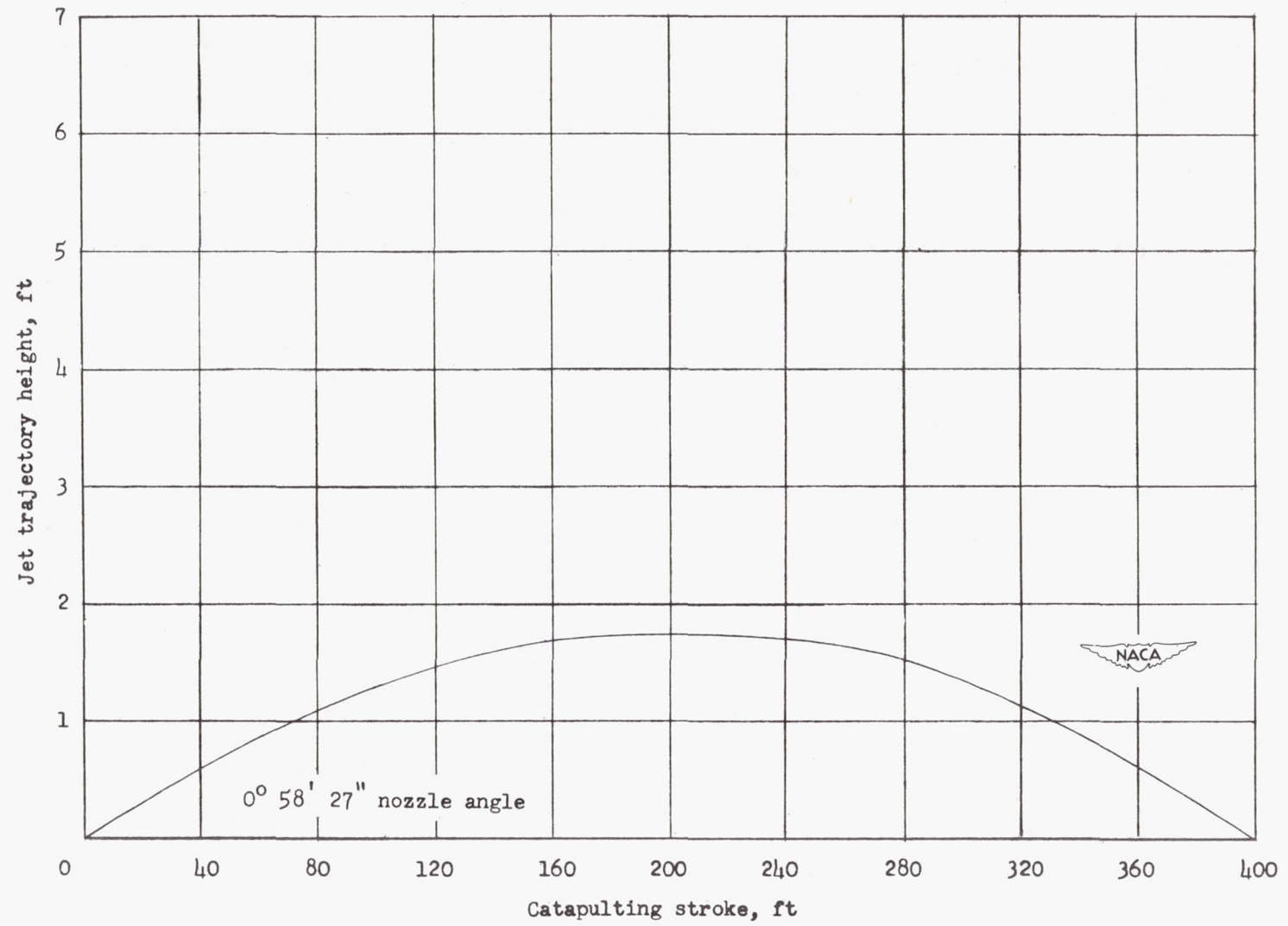

Figure 14.- Point of impact of jet on bucket throughout catapulting stroke after corrections for pressure drop.

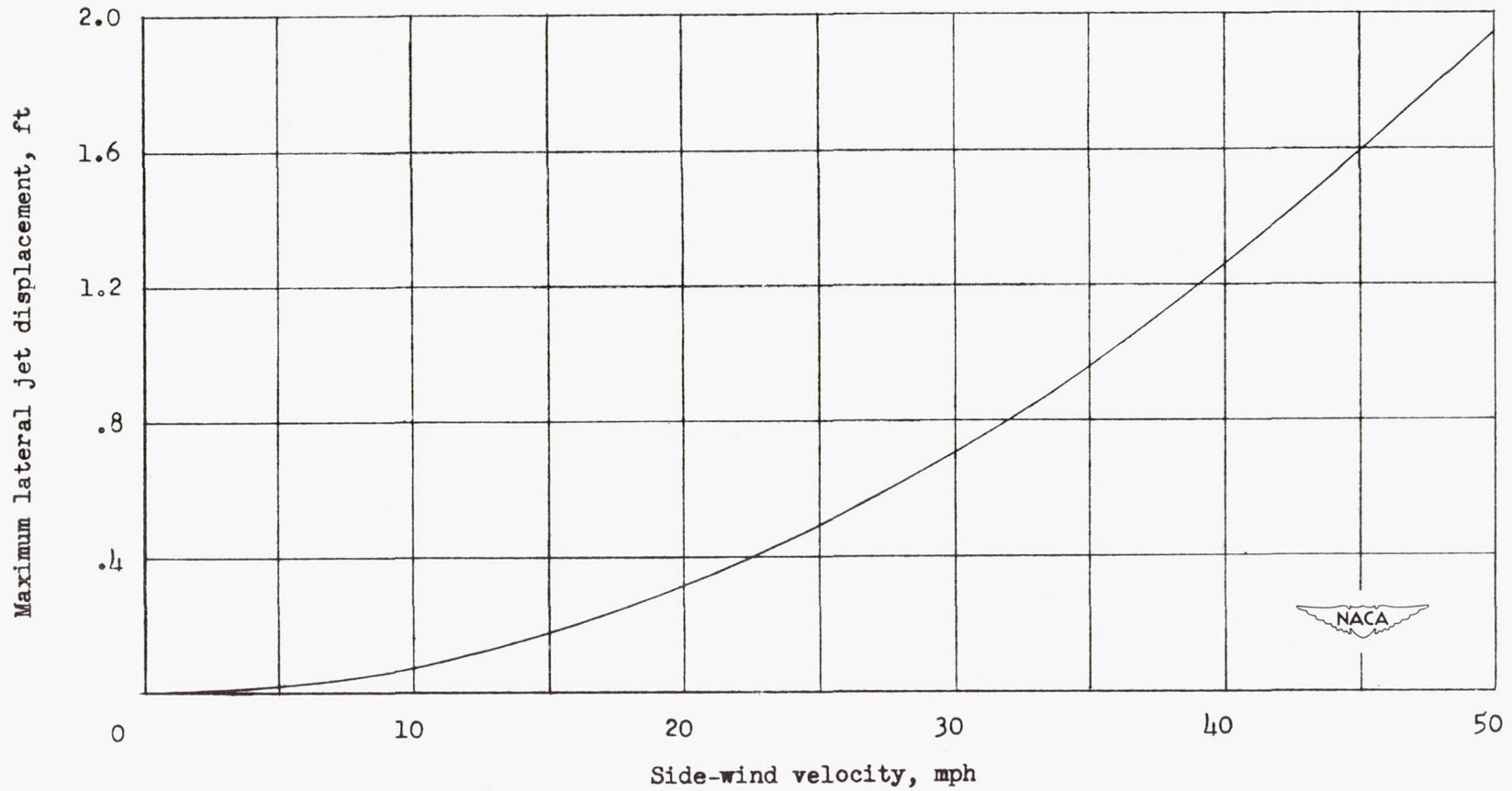
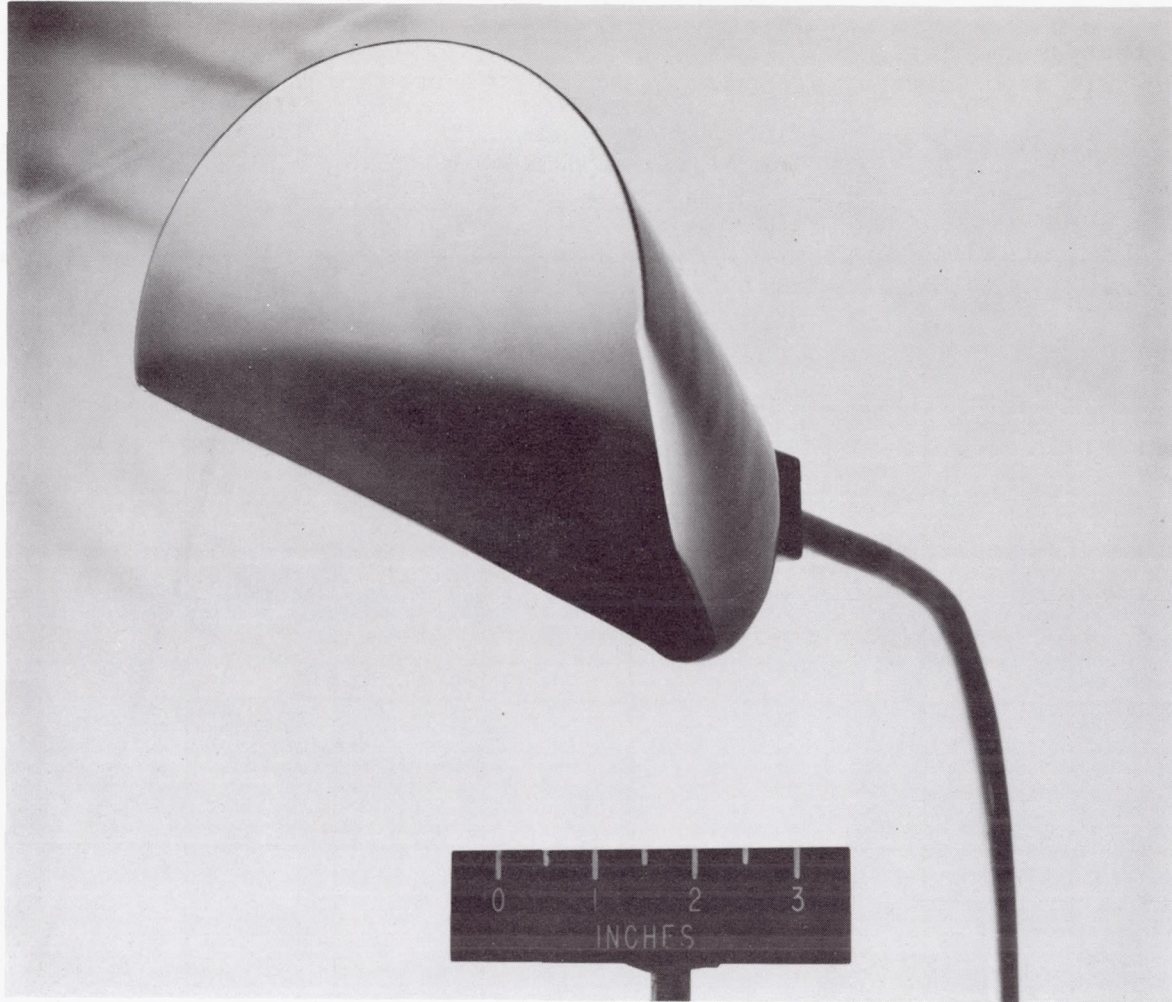

Figure 15.- Effect of side-wind on the lateral displacement of a high-speed jet. Jet diameter, 6.87 inches; jet velocity, 600 feet per second; jet length, 400 feet.





(a) Oblique rear view.

Figure 16.- Views of conical bucket used in tests.



L-68094

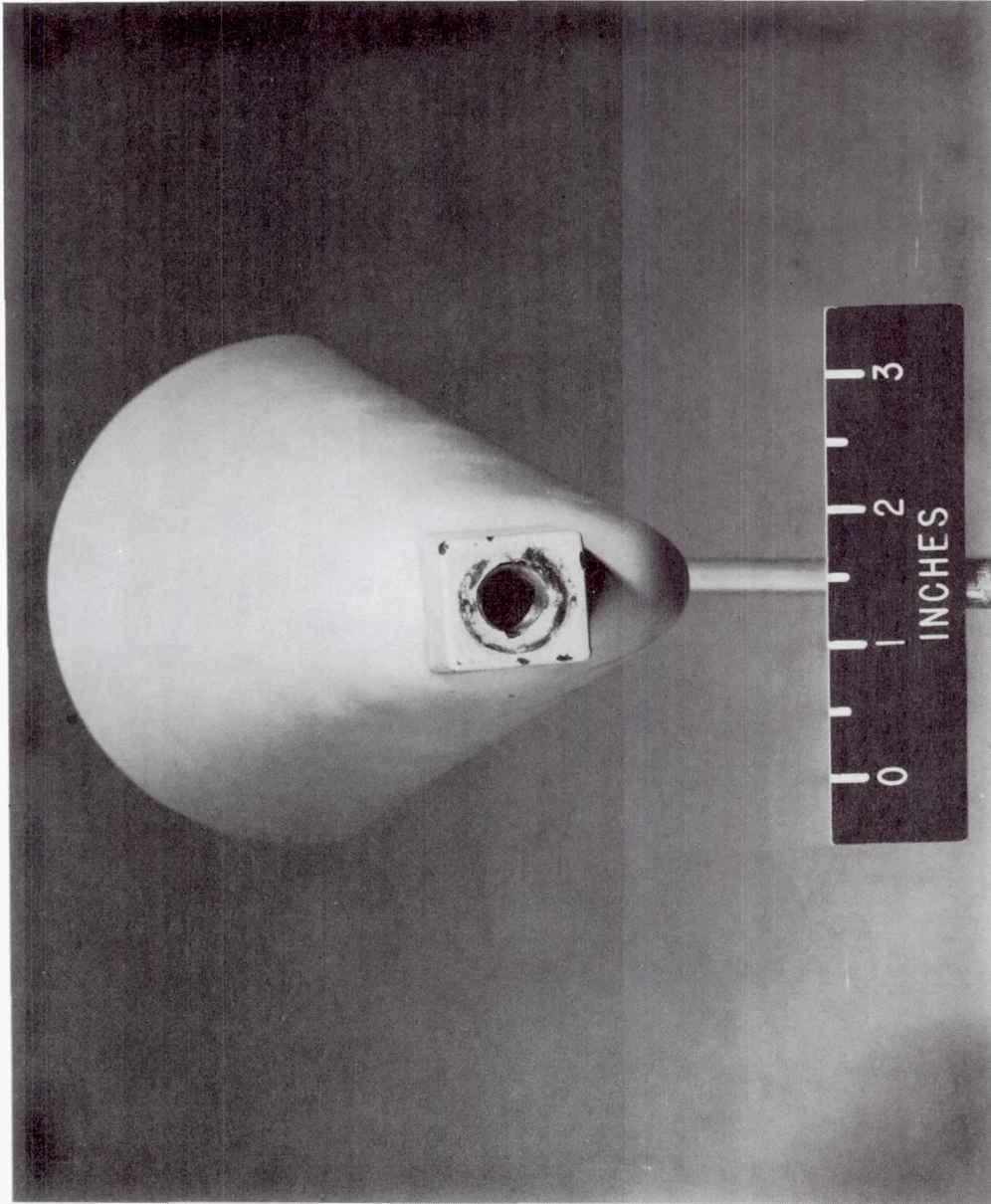

(b) Front view.

Figure 16.- Continued.



L-68093



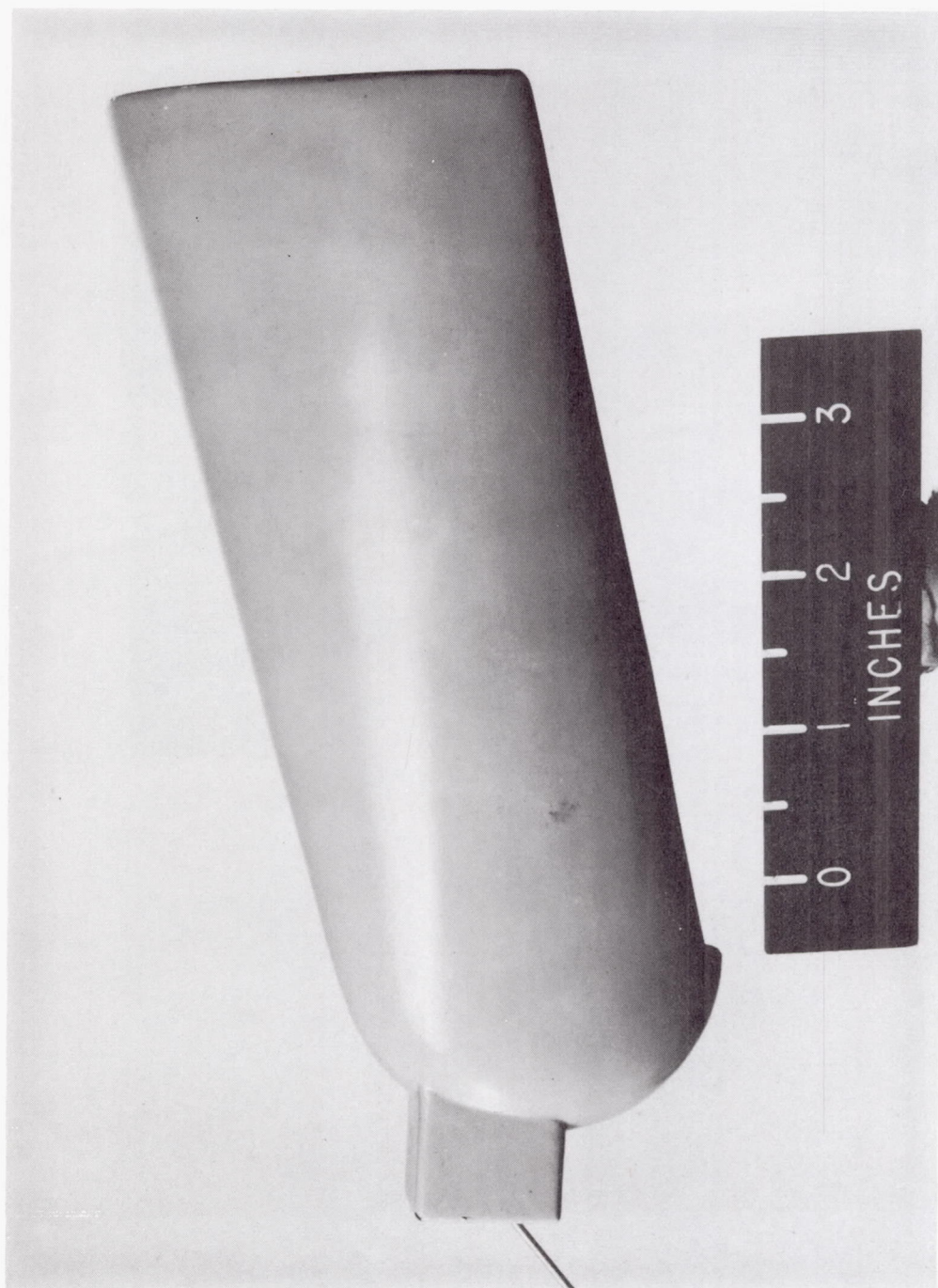

(c) Side view.

Figure 16.- Continued.



L-67851



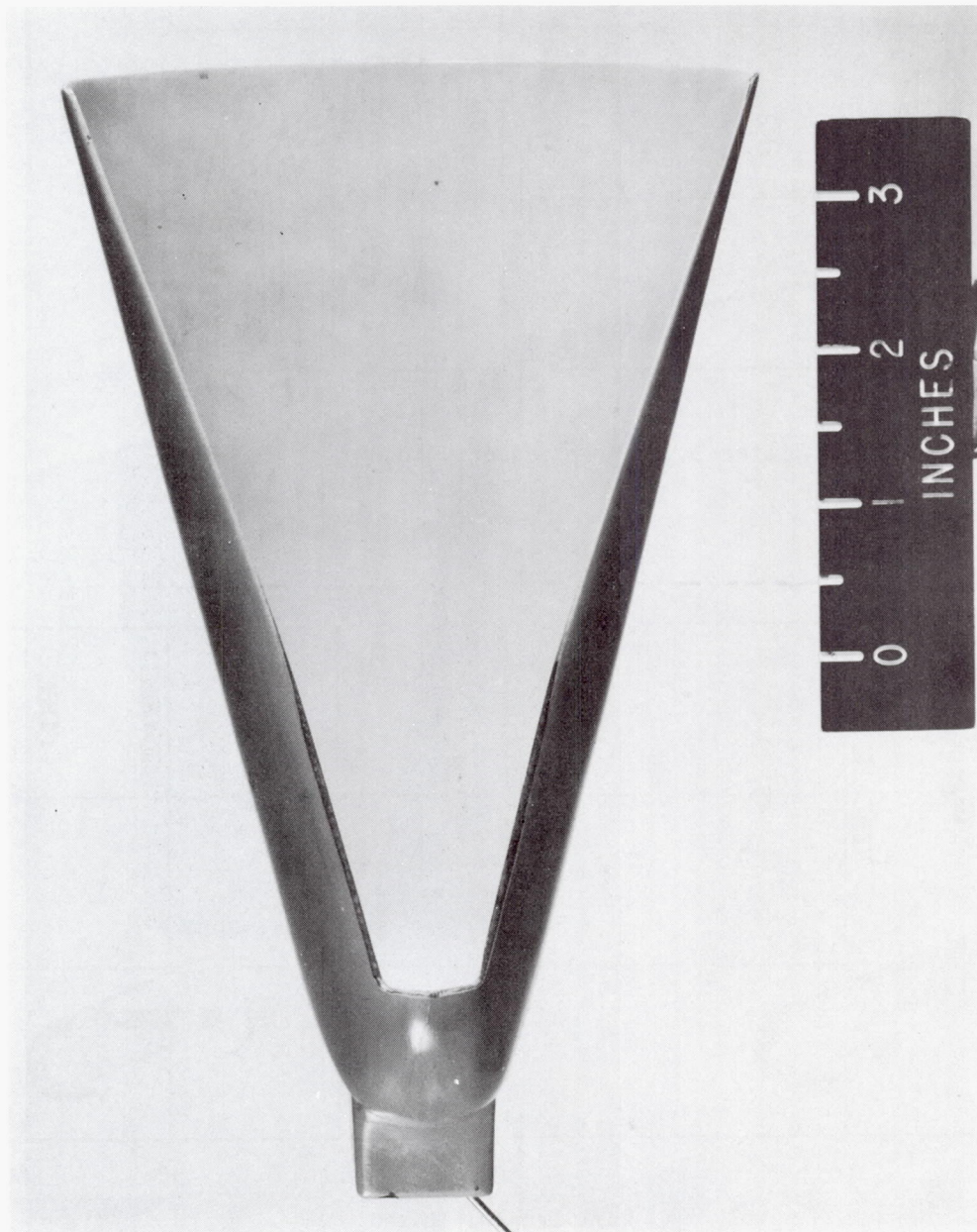

(d) Bottom view.

Figure 16.- Concluded.



L-67852

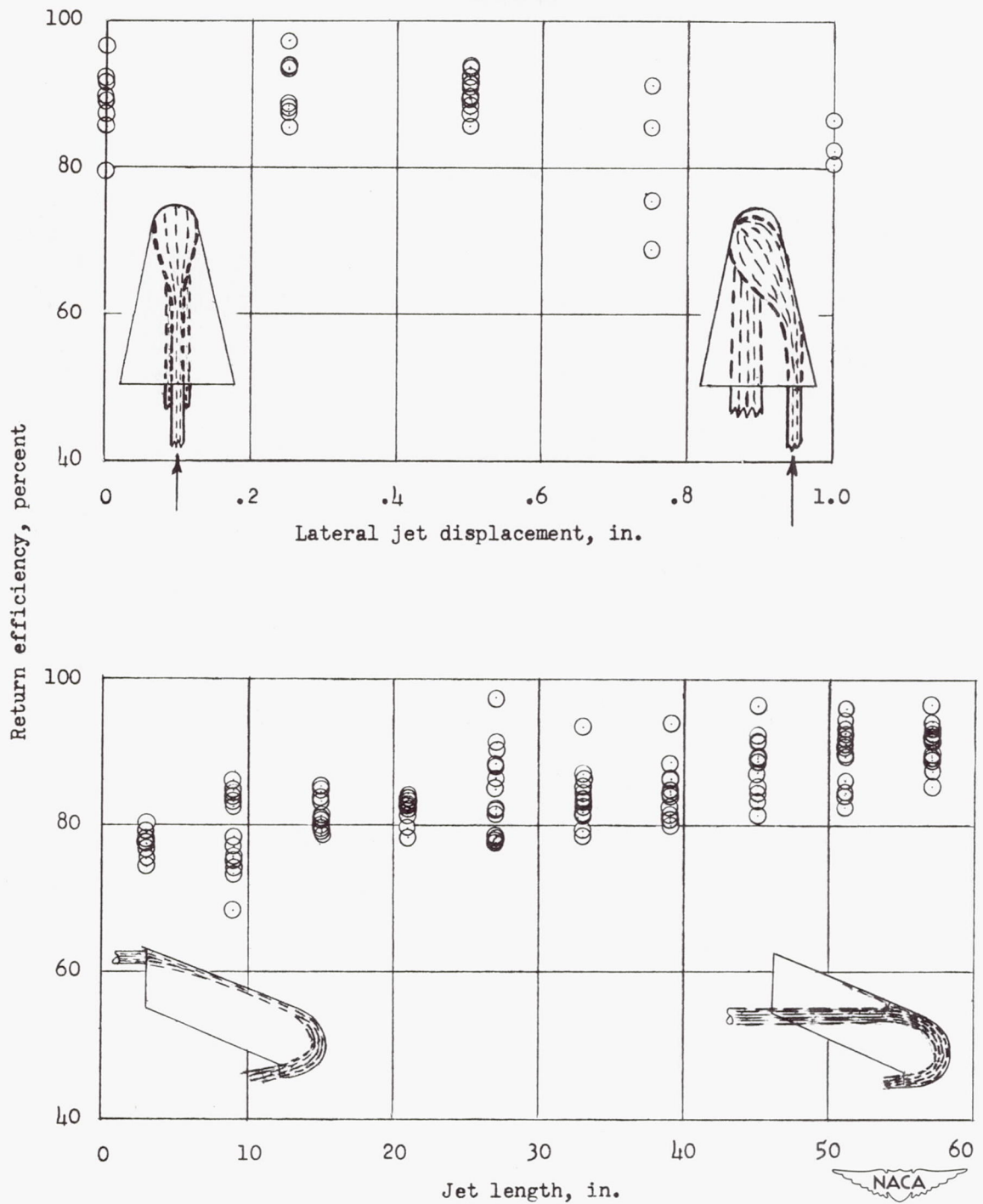

Figure 17.- Variation of return efficiency with jet length and with lateral jet displacement of circular-cross-section conical return bucket.

$\frac{1}{2}$  - inch jet.

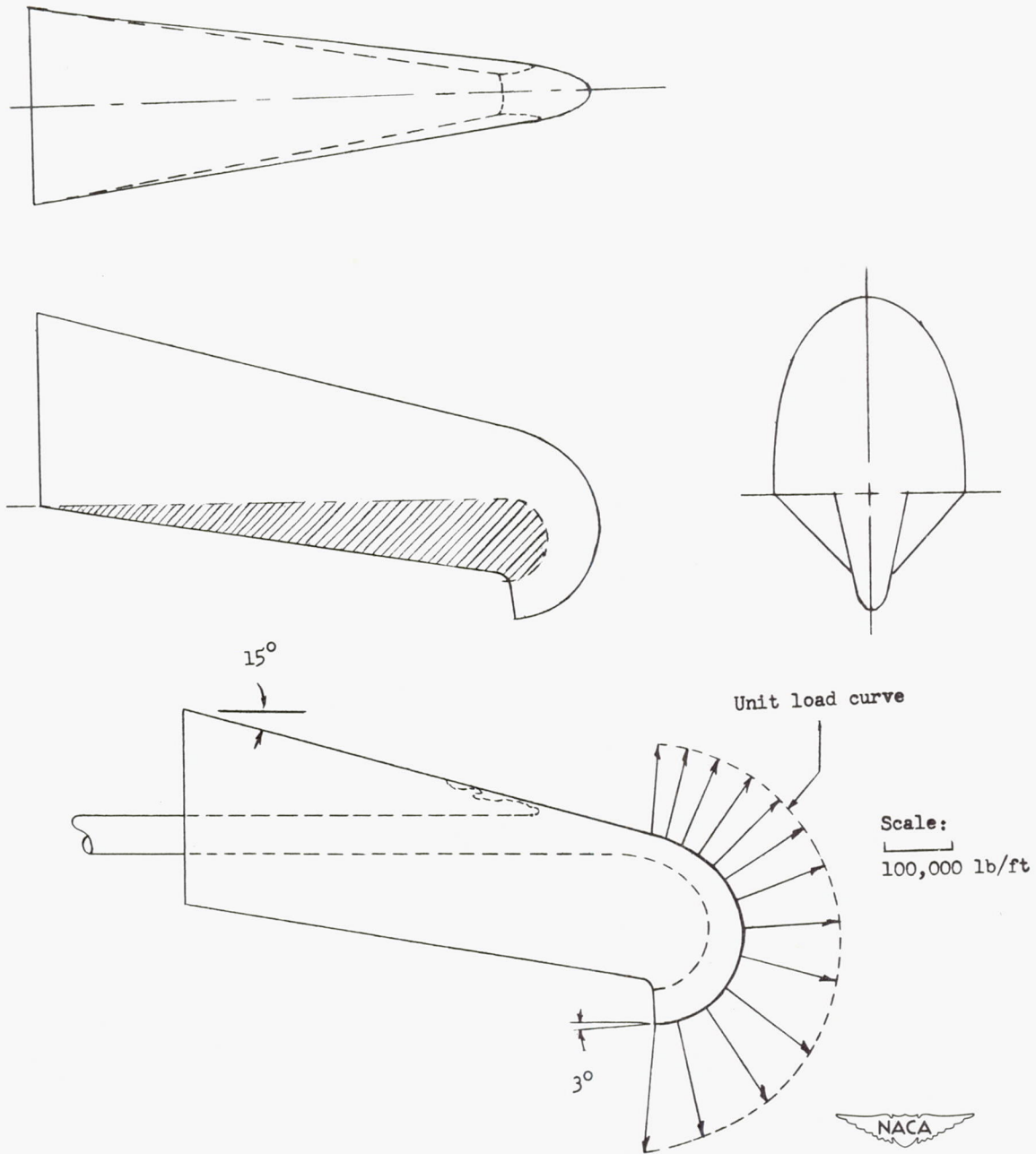

Figure 18.- Sketch showing final shape and loading diagram of jet-return bucket.



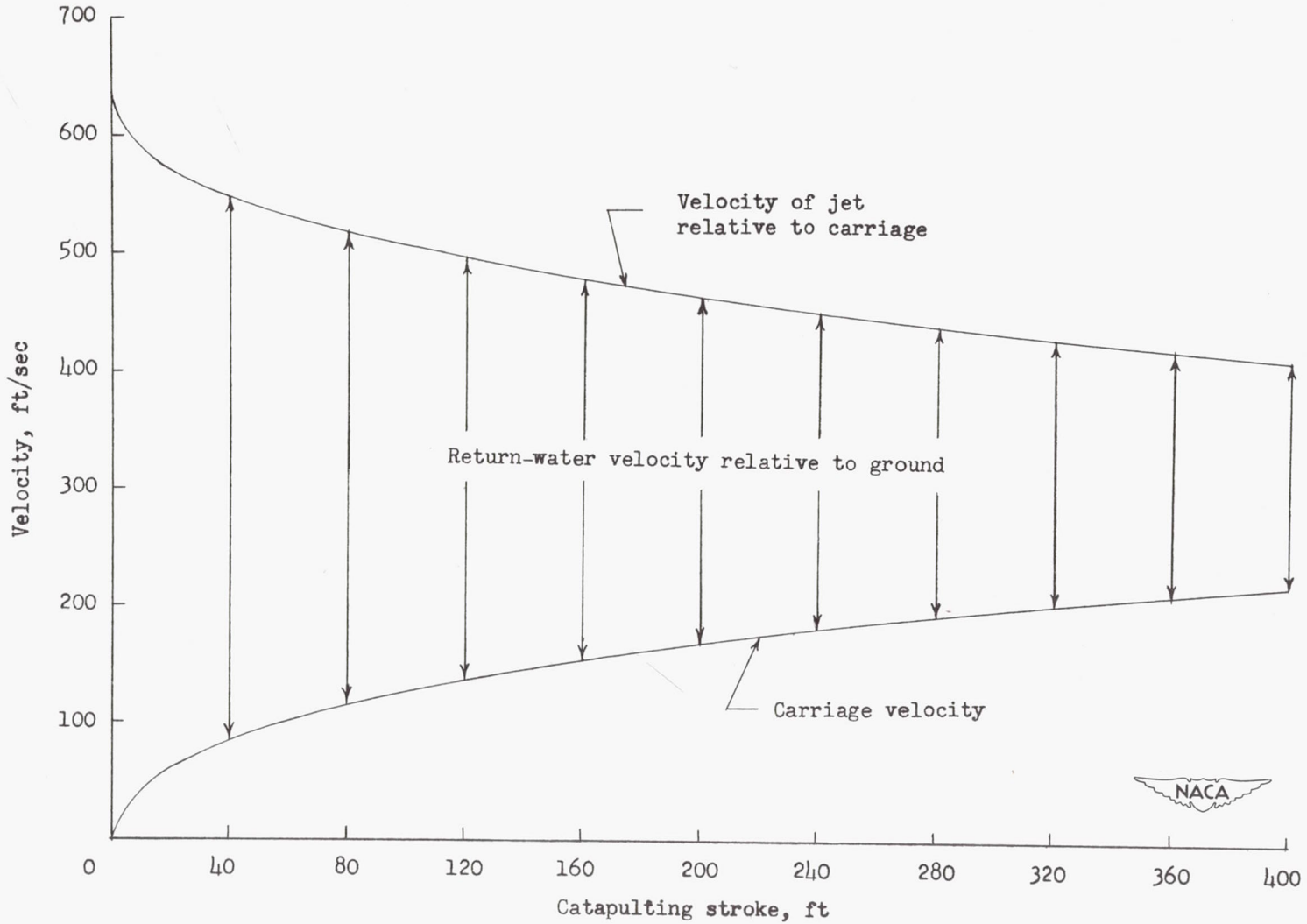

Figure 19.- Variation of return-water velocity relative to ground throughout catapulting stroke.