

Y 3, N 21/5: 6/3330

GOVT. DOC.

NACA TN 3330

NATIONAL ADVISORY COMMITTEE FOR AERONAUTICS

TECHNICAL NOTE 3330

INGESTION OF FOREIGN OBJECTS INTO TURBINE
ENGINES BY VORTICES

By Lewis A. Rodert and Floyd B. Garrett

Lewis Flight Propulsion Laboratory
Cleveland, Ohio



Washington
February 1955

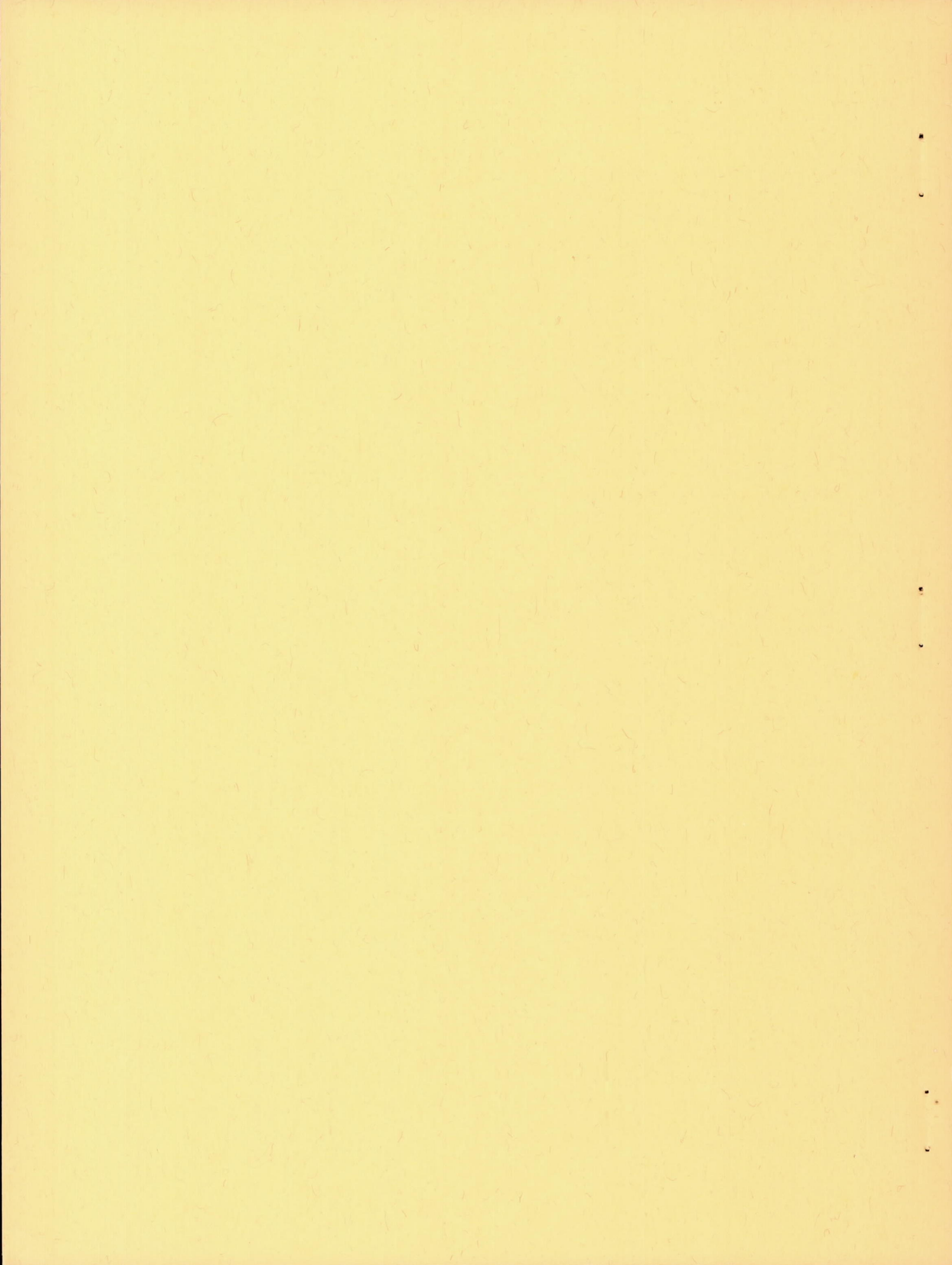

TECHNICAL NOTE 3330

INGESTION OF FOREIGN OBJECTS INTO TURBINE

ENGINES BY VORTICES

By Lewis A. Rodert and Floyd B. Garrett

SUMMARY

The ingestion of foreign objects by vortices formed between engine inlet and ground surface was investigated with a 5000-pound-thrust axial-flow jet engine. Pebbles, typical of objects that damage jet engines, were projected into the air by the vortices and were drawn into the engine by the high-velocity inlet-air stream. Vortex formation depended on engine speed, engine height, and surface wind. Pebbles lodged in surface cracks were more readily picked up than those exposed on a smooth surface.

Motion pictures prepared as a supplement to this report may be obtained on loan from NACA Headquarters, Washington, D. C.

INTRODUCTION

It is easily understood that objects may be thrown into an engine inlet by the discharge jet or wheels of other aircraft, or by the wheels of the aircraft in which the inlet is located. On the other hand, references 1 to 3 have shown that, not considering vortices, the inlet-air stream cannot lift objects from the ground surface and ingest them into the engine. The investigation reported herein was conducted at the NACA Lewis laboratory in order to determine whether the vortex is instrumental in drawing foreign objects into jet engines. The conditions under which a vortex may form between the jet-engine inlet and the ground surface and the forces generated by a vortex and by which objects are projected from the ground were considered. The fluid mechanics of the inlet vortex phenomenon remains for future study.

APPARATUS AND METHODS

The vortex study was made on an axial-flow jet engine mounted on a wing of an obsolete Air Force cargo airplane (fig. 1). Incidental observations were made of inlet vortices on other jet-engine installations in aircraft and test stands at the NACA Lewis laboratory. The length and cross-sectional area of the engine-inlet air duct approximated those

of a typical fighter jet engine. The cross-sectional diagram of the inlet duct shown in figure 2 indicates the entrance shapes and pertinent data on the protective screen, air-flow instrumentation, and duct dimensions. Tests were made with various inlet shapes in order to evaluate possible effects on vortex formation.

The characteristics of the jet engine and installation of interest in this study are as follows:

Rated engine speed, rpm	7950
Engine air mass flow at rated speed, lb/sec	100
Maximum allowable turbine-inlet temperature, °F	1600
Rated jet thrust, lb	5000
Distance from ground to engine center line, ft	8.5
Inlet area, sq ft	2.3

The engine was operated at atmospheric temperature and pressure conditions normally existent at the laboratory ground level (760 ft above sea level).

A wood platform 8 feet square on which the vortices were allowed to form was placed under the engine inlet. The vertical distance from the platform to the engine was controlled by raising the platform above the ground level. Variations in the surface of the platform provided for the study of water whirls at the vortex base, aerodynamic phenomena, and pebble ingestion into the engine. The platform surface on which the water-whirl studies were made is shown in figure 3. The platform construction provided for a water depth of not more than 1/2 inch. Aerodynamic effects were studied with the platform surface shown in figure 4. Nylon yarn tufts, located at the intersections of orthogonal lines spaced 6 inches apart, provided means for observing the motion of air at the platform surface. In order to study the traces of the random vortex movement, powdered talc was distributed on the platform surface. Pressure measurements were taken with six static orifices located on a line near the center of the platform and spaced 1/2 inch apart; however, data of limited value were recorded. The tufted area containing the pressure orifices was constructed on a 4-foot-square wooden surface attached to the 8-foot-square platform.

The helical motion of the vortices between the platform surface and the engine inlet was visualized by the release of powdered talc through a 1-inch-diameter hole in the platform near the pressure orifices. Figure 5 shows the arrangement for admitting the powdered talc to the vortex base and the relative positions of the pressure transmitters and orifices. The space containing the talc was vented to the atmosphere. The vortex sucked the powder up through the hole in the tufted board and thus automatically provided the powder burst at the vortex base when the vortex was near the pressure orifices.

The condensation of atmospheric moisture in the high-velocity regions near the vortex core also made possible visual observations on the occurrence and nature of vortices. Wet and dry bulb temperature readings were taken when condensation was observed.

Platform surfaces containing 1/4- to 1/2-inch pebbles are shown in figure 6. Small wire screen fences, 3/4 inch high and spaced 4 inches apart, prevented blowing the objects aside by the air motion around the vortex base on the surface shown in figure 6(a). The surface shown in figure 6(b) simulated several parallel crevices in air-base paving in which pebbles may accumulate. The simulated crevices were 3/4 inch deep. The width varied as shown in figure 6(b). It was intended that the lodging of pebbles in the crevices would prevent their being blown aside and thus allow the vortex base to pass directly over the entrapped objects. The fenced and slotted areas were constructed on 4-foot-square wooden surfaces and attached to the 8-foot-square platform. Pebbles were also exposed unconstrained on the platform shown in figure 3.

Engine-inlet air-flow data were observed visually on a multiple-tube manometer. The static pressure on the platform surface was measured with a variable-reluctance-type pressure transmitter and recorded on an oscillograph. The high rate-of-response characteristics of the variable-reluctance-type transmitter made possible the measurement of the rapid pressure changes at the pressure orifice when a vortex passed over. The instrument system was calibrated for rates of change in pressure on the order of those imposed as the base of the vortex moved across a surface orifice. Graphic observations of vortices were recorded with a 16-millimeter camera equipped with a synchronous-motor-driven timer and interconnected electrically with the oscillograph. The arrangement provided for the observation of the helical motion along the vortex simultaneously with the measurement of the vortex-core pressure.

RESULTS AND ANALYSIS

The formation of vortices between a jet-engine air inlet and the ground surface depended on engine power, wind velocity, and engine-inlet height above the ground surface. When the engine was operating at 100-percent rated speed and a wind was blowing from the rear at velocity varying from 12 to 17 miles per hour, vortices formed between the inlet and the ground surface, a distance of about 8 feet. When the engine was operated at about 80-percent rated speed and a side wind was blowing from behind the fuselage at 5 miles per hour, a vortex formed between the inlet and the airplane fuselage, a distance of 15 feet. Vortices formed between the engine inlet and the platform surfaces with the platform 4.5 feet below the inlet when the engine was operated at about 80-percent rated speed and a head wind was blowing with a velocity of from 10 to 15 miles per hour, and when the engine was operated at

3508

CX-1 back

about 50-percent rated speed with a head-wind velocity varying from 5 to 7 miles per hour. With the engine operating at idling speed (30-percent rated), a head wind from 1 to 5 miles per hour, and an inlet-to-surface height of 3.5 feet, vortices formed; however, the energy of the formation appeared to be significantly less than when the engine was operated at higher speeds.

Vortices were observed as a part of the present study, and incidentally in other NACA research, with inlet variations including those shown in figure 2, a pod installation inlet, and in engines without inlet fairings.

A typical example of a water whirl developed by a vortex formed between the engine inlet and a water surface under the inlet is shown in figure 7. The disturbance of the water surface indicates a circular motion of the air at the base of the vortex. The upward and outward motion of the water drops from the whirl indicates a helical path of the air between the platform surface and the inlet.

Under limited conditions, condensed atmospheric moisture formed near the center of the vortex, as shown in figure 8. The condensation of droplets in the vortex results from a static temperature equal to or less than the dewpoint temperature at the vortex pressures. The reduced temperature in the vortex core is indicative of a low-pressure region.

The vertical distance from the engine to the platform along the vortex shown in figure 8(a) was about 4.5 feet. The vortex shown in figure 8(b) extended from the engine to the ground, a distance of about 8 feet. The photograph shown in figure 8(b) was made as an incidental observation in an NACA investigation unrelated to the vortex study.

The helical path of the air streamlines around a vortex is shown by the sequence of photographs in figure 9. The position of the vortex is shown by the visible moisture around the core. The helical path is delineated by powdered talc sucked through the hole in the platform surface by the vortex. As seen from a complete sequence of motion pictures, and indistinctly shown in figures 9(e) and (f), the centrifugal forces uniformly displace the talc particles from the center. The slope of the helix, as well as the centrifugal displacement of the talc, suggests that the air-flow pattern would tend to toss objects outward as well as upward.

Physical observations, including the pressure at the base of a vortex on the platform for a typical formation, are as follows:

Atmospheric pressure, lb/sq ft	2052
Atmospheric temperature, °F	70.1
Dewpoint temperature, °F	58.0
Engine-inlet static pressure, lb/sq ft	1916
Outer radius of visible moisture along core, ft	0.05
Static pressure at vortex base, lb/sq ft	1776

Limited reference is made to these data; however, they are included because of the novelty of the phenomenon. The vortex base pressure was the maximum of several recordings and is believed to be representative of the pressure at or very near the vortex center. The vortex on which data are given in the preceding table was similar in appearance to that shown in figure 8(a).

The paths made in the powdered talc spread on the platform surface were indicative of the core area over which a strong vertical force exists. The paths of vortices formed during one period of research operations are shown in figure 10. The random motion of the vortex is noticeable. The results show that a significant part of the ground area under an engine inlet would be scanned by the vortex during a period of engine ground operation.

When placed on the platform surfaces and exposed to a vortex, pebbles were projected into the air by the forces acting at the vortex base. When exposed on a smooth surface (fig. 3) the tangential force around the vortex usually moved the pebbles away from the vortex path, although when several pebbles were grouped together some were projected into the air. Pebbles exposed on the platform surfaces shown in figures 6(a) and (b) were constrained by the surface obstructions and were projected into the air in numbers. The reaction of the pebbles as the vortex passed over was as though a small explosion had occurred, the pebbles being projected into the air in random directions. When the movement of the vortex across the surface was slow, or when momentary pauses in the motion occurred, more pebbles were projected into the air than when the vortex moved rapidly. Pebbles were disturbed along a narrow path, as would be expected from the data presented in figure 10.

When projected into the air by the forces acting at the vortex base, some pebbles traveled upward to and above the engine inlet. Objects were not observed to follow the path of the vortex core. If caught in the high-velocity inlet stream, the pebbles were drawn into the engine. The positions of a pebble during its movement from the platform surface into the engine inlet were recorded on motion-picture film and are shown in figure 11. The positions of other pebbles that were not drawn into the engine are also shown in the same motion-picture sequence. A view of the engine inlet duct after several vortices had projected pebbles into the air (fig. 12) reveals the large number of pebbles drawn into the inlet. These pebbles were projected from the platform surface 4.5 feet below the engine inlet.

DISCUSSION

This study has demonstrated that vortices occur and that the suction pressure at a vortex base can provide the impulse energy required to project a pebble into the region of an engine inlet. As would be expected, when projected near the high-velocity stream of the air inlet, objects are drawn into the engine. Without the inlet vortex, there is general agreement that the air flow into an engine will not cause the ingestion of objects from the ground (refs. 1 to 3). A vortex does not form often, although pilots and mechanics report occasional observations of the phenomenon. The projection of foreign objects into the engine by a vortex has additional requirements and is even less common.

The probability that an object will be ingested into an engine inlet by a vortex is the product of the multiple probabilities that a vortex will form and that an object will be projected into the high-velocity air inlet stream. Owing to the several conditions that must be met, the probability of ingestion will be small; however, probability of the ingestion of one object in several hundred exposures when imposed on all take-off and landing operations inevitably leads to a problem of significant magnitude.

Air flowing into an engine from all directions (fig. 13(a)) produces a region on the ground surface under the engine in which there is no flow and which is known as a stagnation region. One streamline of the air flow (dashed line in fig. 13(a)) will extend from the stagnation region on the ground to the inlet. All other streamlines terminate in the ambient atmosphere. Since a vortex may not cross streamlines and must terminate on a surface (ref. 4), the only streamline along which a vortex may form is the one which terminates at the stagnation region. Surface winds may limit the directions from which the air flow to the inlet originates, as shown in figure 13(b). If a high-velocity wind exists, all the flow into the engine may follow streamlines originating from the direction of the wind. When the flow originates in only one direction and in the ambient atmosphere, a stagnation region will not exist and a vortex cannot form.

Vortices were observed to form during the present investigation with surface head-wind velocities up to 15 miles per hour. A direct relation between engine speed and the maximum wind velocity at which vortices would form was noted, which indicates that increased engine air capacity will extend the range of wind velocity. When the engine jet exhaust was directed into the wind, vortices were obtained at higher wind velocities than when the inlet was directed into the wind.

When the wind velocity approached zero, vortices occurred very infrequently, even though the stagnation region under the engine may have existed. As noted in the vortex theorems of Helmholtz (ref. 4), circulation must exist in the air coming from the surrounding atmosphere if

a vortex is to form. Normally, circulation is present in the atmosphere when there is wind. When there is no wind, the only circulation possible is that which may be induced by the jet engine in the immediate vicinity of the aircraft. These considerations and the results of the present investigation lead to the observation that the formation of an inlet vortex requires a sink comparable in magnitude to that of a jet-engine inlet at cruise or rated power, operating in a wind of limited velocity. It can be expected that these conditions are experienced frequently during ground operations.

The exact mechanism by which an object is projected upward by the forces at the base of a vortex is not known; however, knowledge of vortex theory and observations made in the investigation lead to a possible partial explanation of the phenomenon. The flow of air at the vortex base is predominantly circular; however, a convergence toward the center is also believed to exist. When an object is located a short distance away from the vortex center, the object is acted upon by vertical and horizontal forces. The flow of air over the object at rest will result in a pressure reduction on the upper surface. While the object remains on the ground surface, there will be no air flow over the lower surface. Therefore, the pressure beneath the object will be influenced by the front and rear stagnation pressure regions and the stream static pressure on the sides, which collectively will generate a pressure beneath the object greater than the reduced pressure on the upper surface. On the basis of this concept, the object at rest will be subjected to a vertical lifting force. The pressure differences between the front and rear surfaces will result in a horizontal force. The effects of the vertical and horizontal forces were noted in the observations of water whirls, nylon tufts, and the paths taken by the powdered talc and pebbles.

If the object remains at rest on the ground surface until the vortex center passes over the object, the horizontal component of the resultant force becomes zero and the pressure reduction reaches a maximum on the upper surface. The pressure on the lower surface is probably influenced by the convergence of flow into the vortex core and, therefore, may be in the order of or greater than atmospheric pressure. On the basis of this analysis, the resultant vertical force reaches a maximum when the vortex passes over the object and may approach a unit pressure equal to the pressure depression in the vortex core. As the object reacts to the resultant force and moves away from the ground surface, the pressure distribution around the object will be changed and quite probably will result in reducing the vertical force. The maximum pressure pulse, therefore, is thought to be of brief duration, because the movement of the object reduces the forces initiating the motion. The pressure reduction measured on the platform surface may be computed by subtracting the static pressure at the vortex base from atmospheric pressure. In the case of the vortex for which physical data are given in a

preceding table, the maximum pressure reduction is 276 pounds per square foot. The area over which the pressure reduction is sufficient to lift objects is indicated approximately by the width of the vortex paths in figure 10.

The important observation is that objects large enough to cause engine damage were projected upward and drawn into the inlet of the 5000-pound-thrust test engine, at heights representative of current aircraft installations. Increases in engine size with accompanying increases in inlet-air flow can be expected to aggravate the problem of object ingestion.

Knowledge that foreign-object ingestion may be caused by vortices prompts consideration of means by which the lifting forces may be inhibited. In this connection, it may be of interest in future studies to determine whether or not retractable shields or screens located below and in front of the inlet will have a dissipative effect on the vortex. It is obviously desirable to search for solutions for the foreign-object problem that do not penalize aircraft performance. The removal of pebbles and other debris from the cracks as well as from the unbroken areas of air-base surfaces should reduce the problem.

Although beyond the scope of the present study, other possible deleterious effects from vortices have been noted. When the dewpoint temperature is below freezing and the vortex strength is sufficient to condense atmospheric moisture, ice may be formed in the engine inlet from clear air. Ice formed in the inlet by a vortex might not be detected in time to prevent damage, since, in the absence of clouds, the flight personnel might not be alert to the hazard. Precautionary measures should be taken against this hazard when the dewpoint is below freezing and the relative humidity is near saturation. Ice was observed on engine inlet parts following the operation during which the vortex shown in figure 8(b) occurred. The atmospheric temperature was 37° F, the dewpoint temperature was 22° F, and the case therefore was representative of a condition in which the condensed moisture would be supercooled.

CONCLUDING REMARKS

In the investigation conducted with a 5000-pound-rated-thrust axial-flow jet engine, pebbles typical of objects that damage jet engines were ingested by vortices at the engine inlet. The vortices, which extended from the inlet to the ground surface under the engine, were observed when the engine speeds were in the order of or greater than 50-percent rated speed. Atmospheric circulation is required to provide vortex circulation; however, no vortices were observed when the engine was operated at rated speed in a head wind in excess of 15 miles per hour. Vortices were observed to form when the engine height

was 8 feet above the ground with operation at rated speed. Increases in engine speed increased the wind-velocity and engine-height ranges over which vortices would form and thus indicated that the range of conditions over which vortices will form will be broadened by increasing the engine size.

A pressure difference between the lower and upper surfaces of an object is created as the base of the vortex passes over the object. The resultant force of the pressure difference projects the object into the air. Those objects reaching the region of the engine inlet are drawn in by the high-velocity air inlet stream.

Objects lodged in surface cracks are more easily projected into the air than are those exposed on smooth surfaces.

Lewis Flight Propulsion Laboratory
National Advisory Committee for Aeronautics
Cleveland, Ohio, November 22, 1954

REFERENCES

1. Klein, Harold: Small Scale Tests on Jet Engine Pebble Aspiration. Rep. No. SM 14895, Santa Monica Div., Douglas Aircraft Co., Inc., Aug. 1953.
2. Travers, William R.: Factors Against the Use of Turbojet Inlet Screens. Preprint No. 295, SAE, Apr. 1954.
3. Anon.: Foreign Object Damage. Northrop Service News, Northrop Aircraft Co., vol. IV, no. 7, Aug. 1954, pp. 6-7; 9.
4. Prandtl, L., and Tietjens, O. G.: Fundamentals of Hydro and Aero-Mechanics. First ed., McGraw-Hill Book Co., Inc., 1934.

3508

CX-2

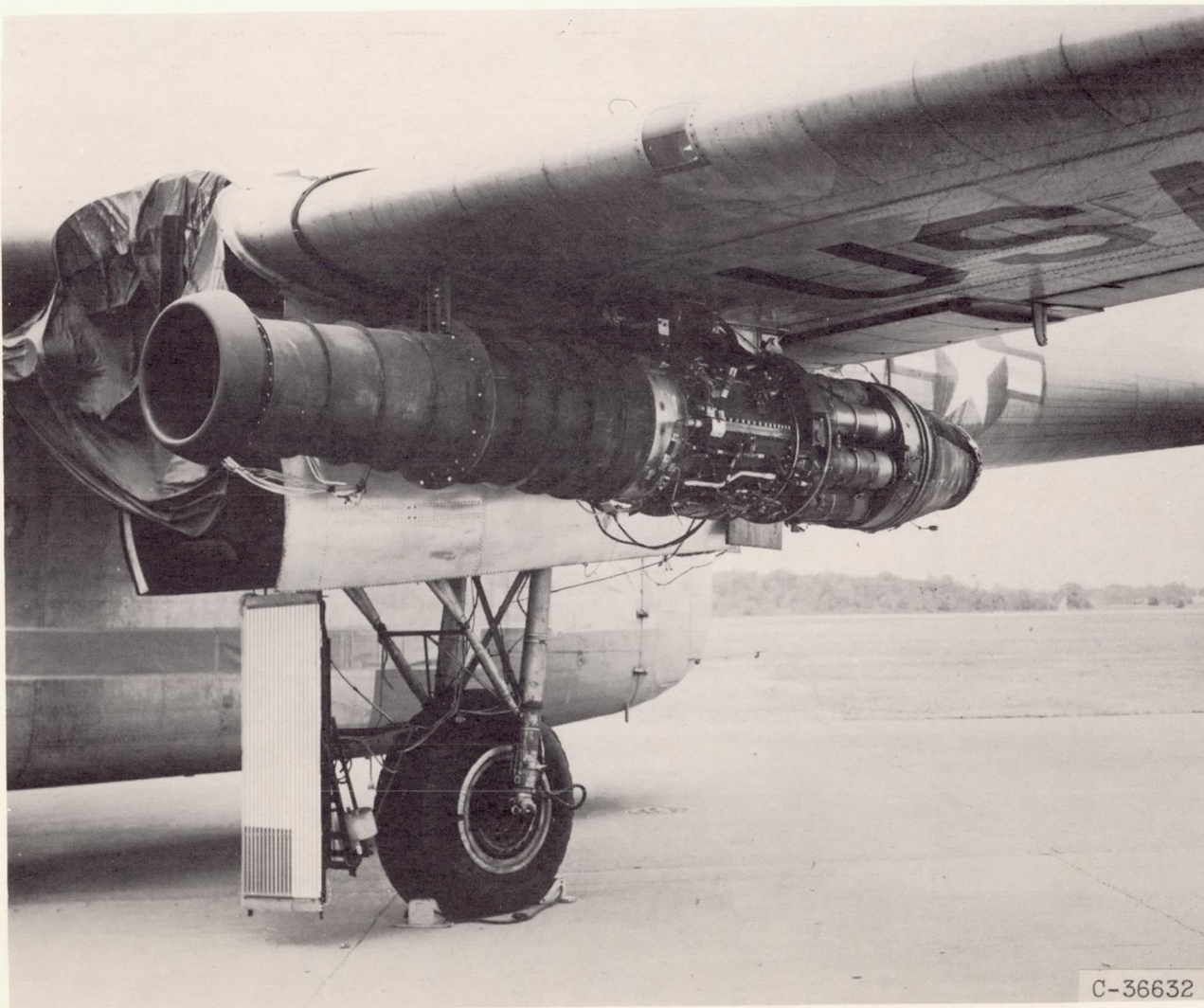

Figure 1. - Axial-flow jet engine mounted on Air Force cargo airplane for study of inlet vortices.

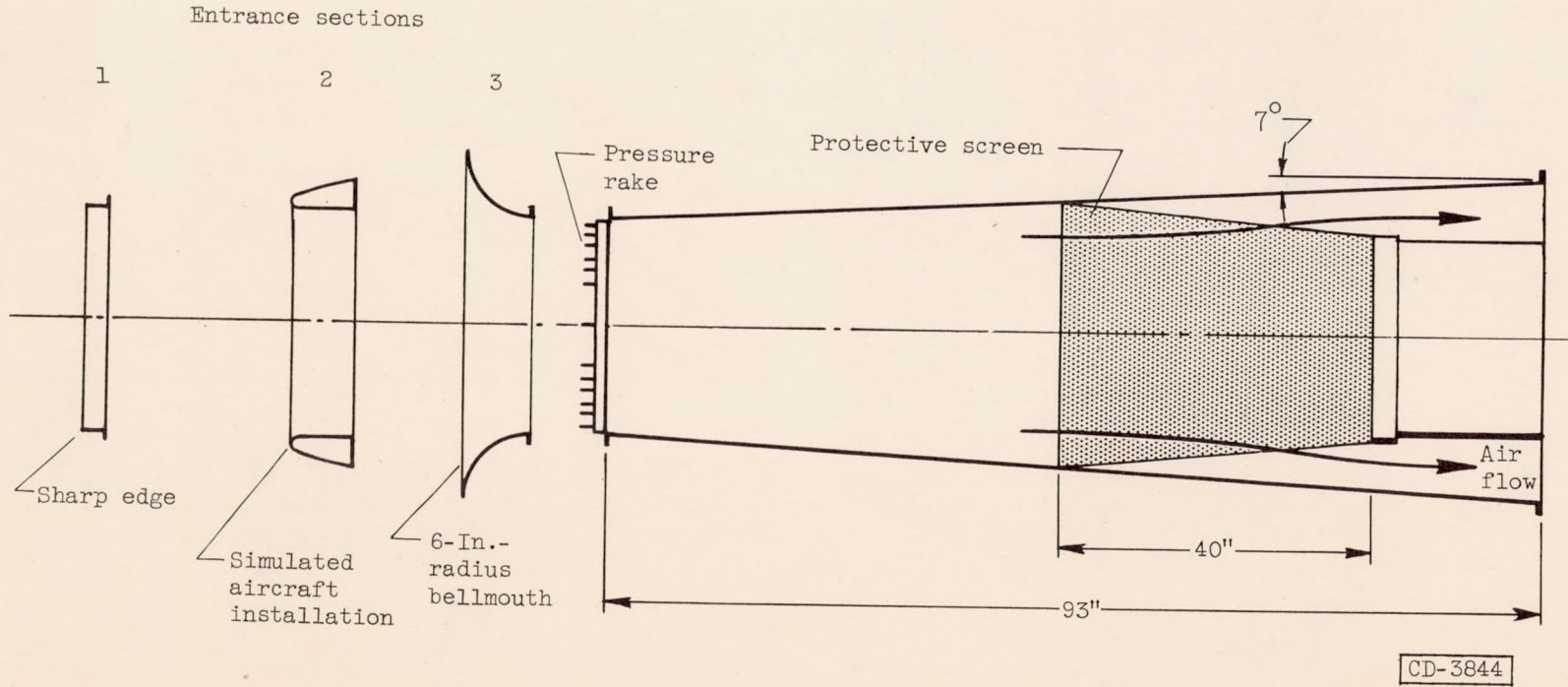

Figure 2. - Air inlet for jet engine.

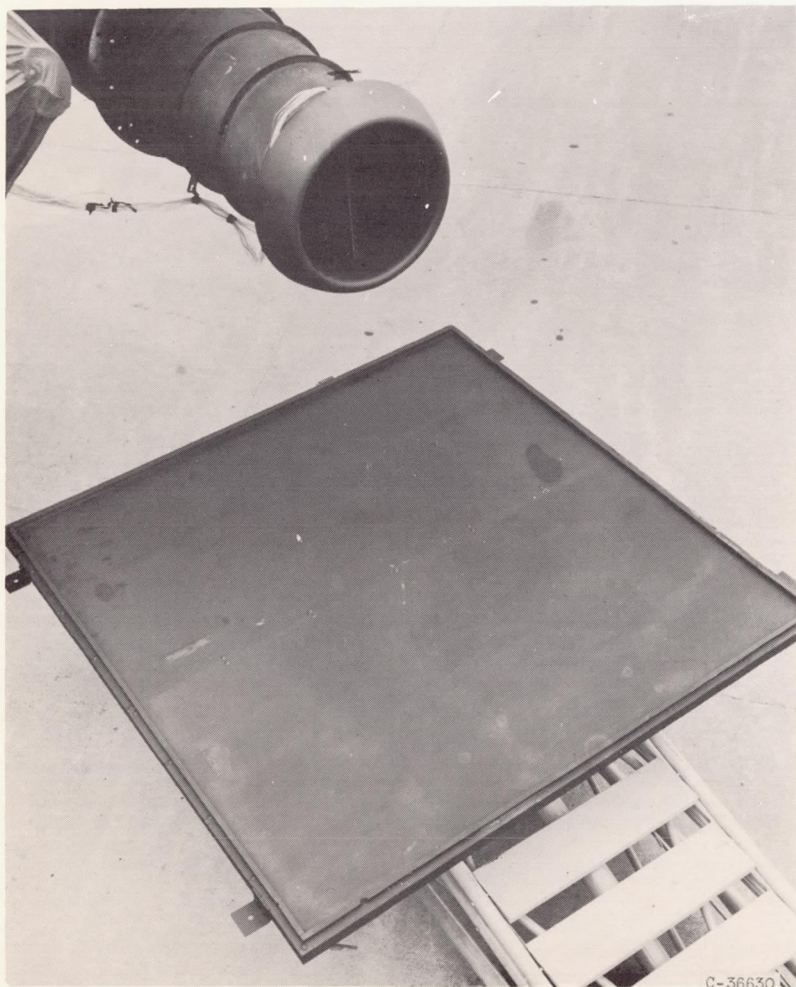

Figure 3. - Platform surface under engine inlet on which a shallow pool of water was contained for water-whirl studies.

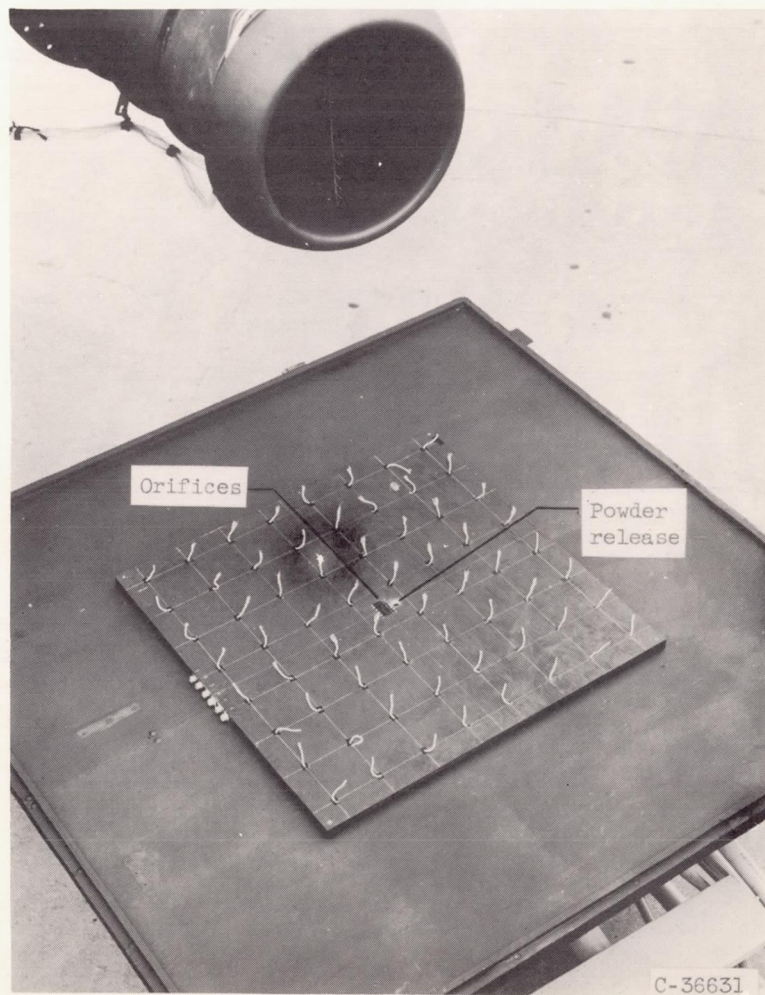

Figure 4. - Platform surface with tufts, pressure orifices, and powder release for study of pressure and velocity in vortices.

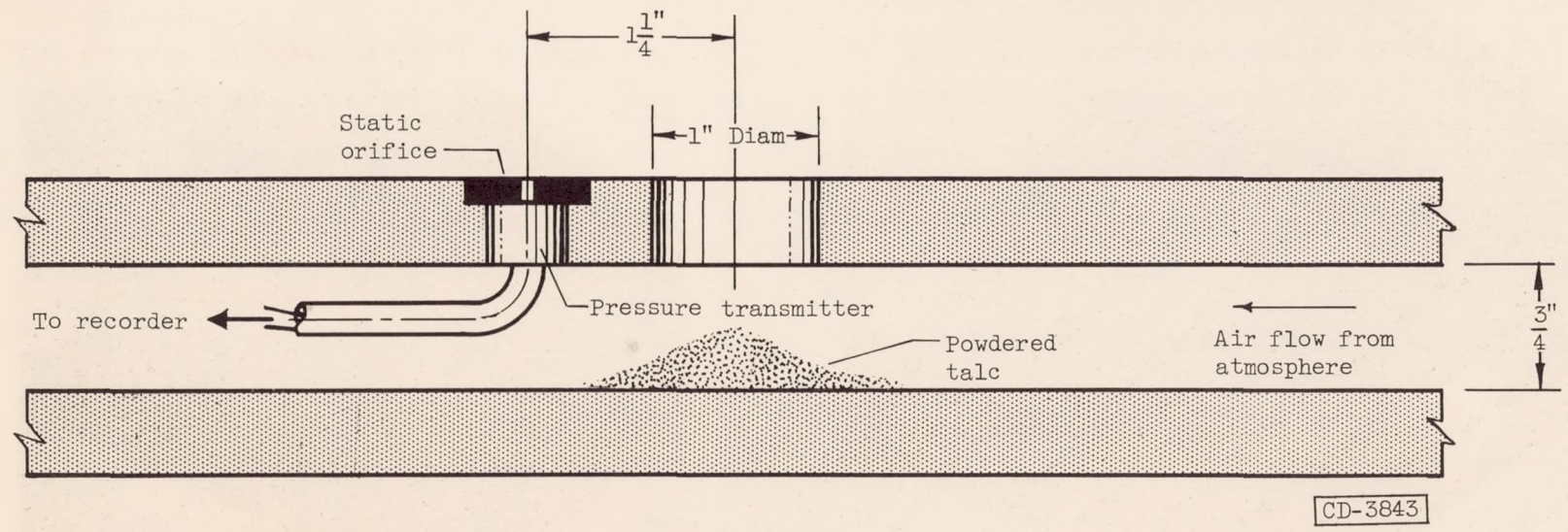
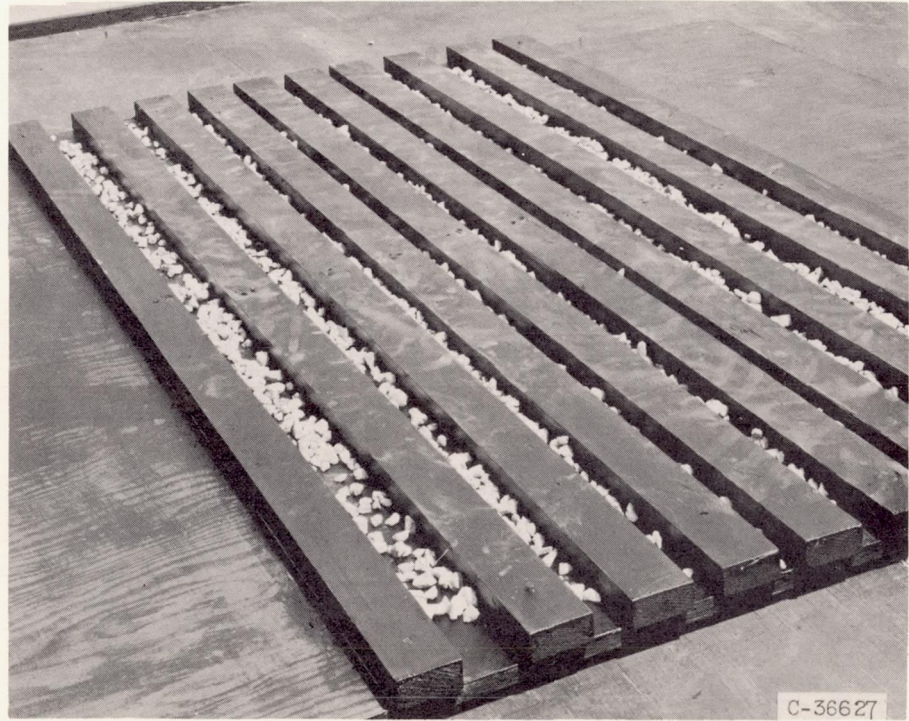

Figure 5. - Powder-release mechanism, showing schematically hole in platform surface and powder before being drawn through hole.



(a) Surface fenced with 3/4-inch screen at 4-inch spacing.



(b) Surface simulating cracks in paving.

Figure 6. - Platform surfaces on which 1/4 - to 1/2-inch pebbles were exposed.

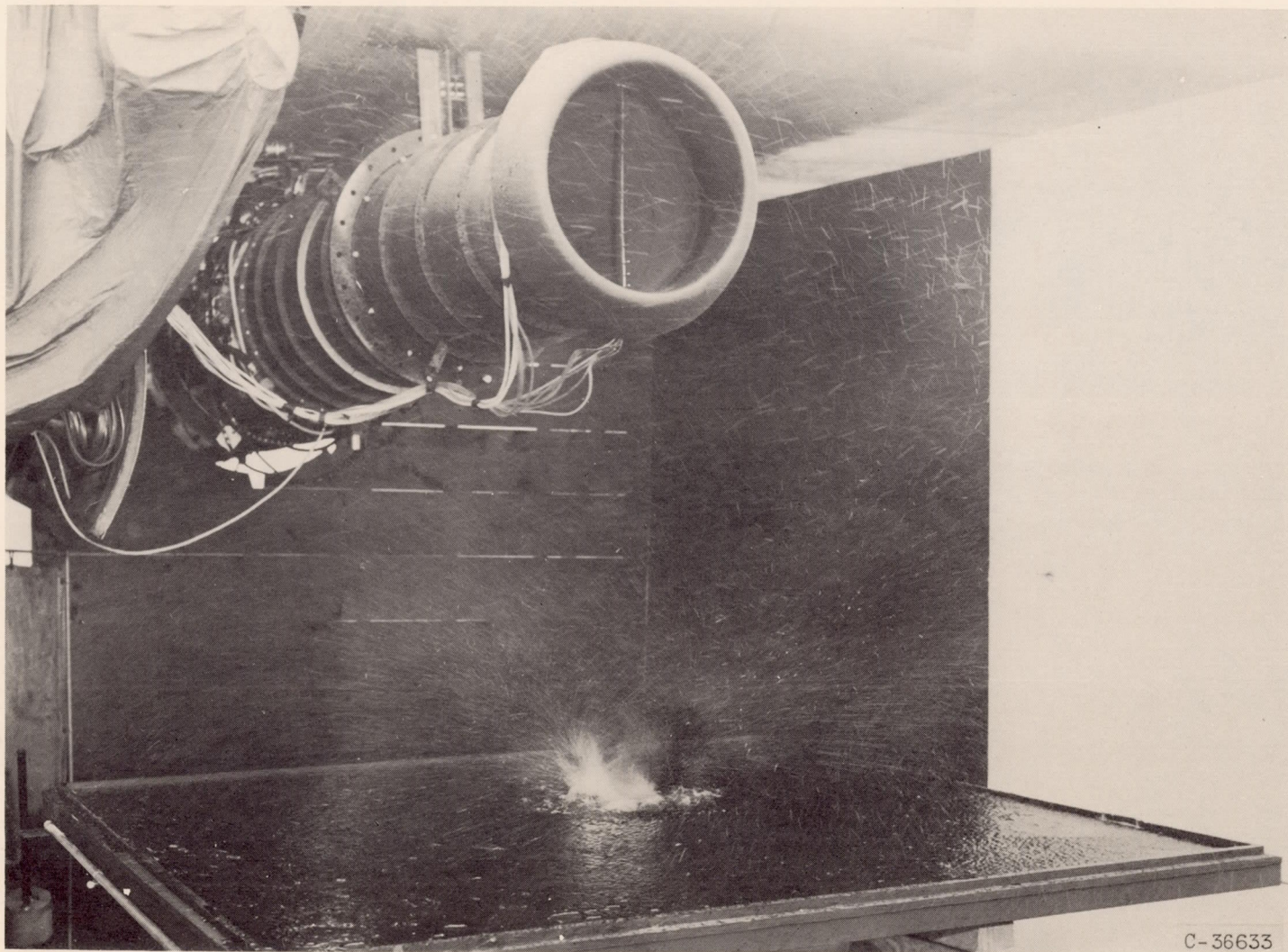

C-36633

Figure 7. - Water whirl formed by vortex from engine inlet.

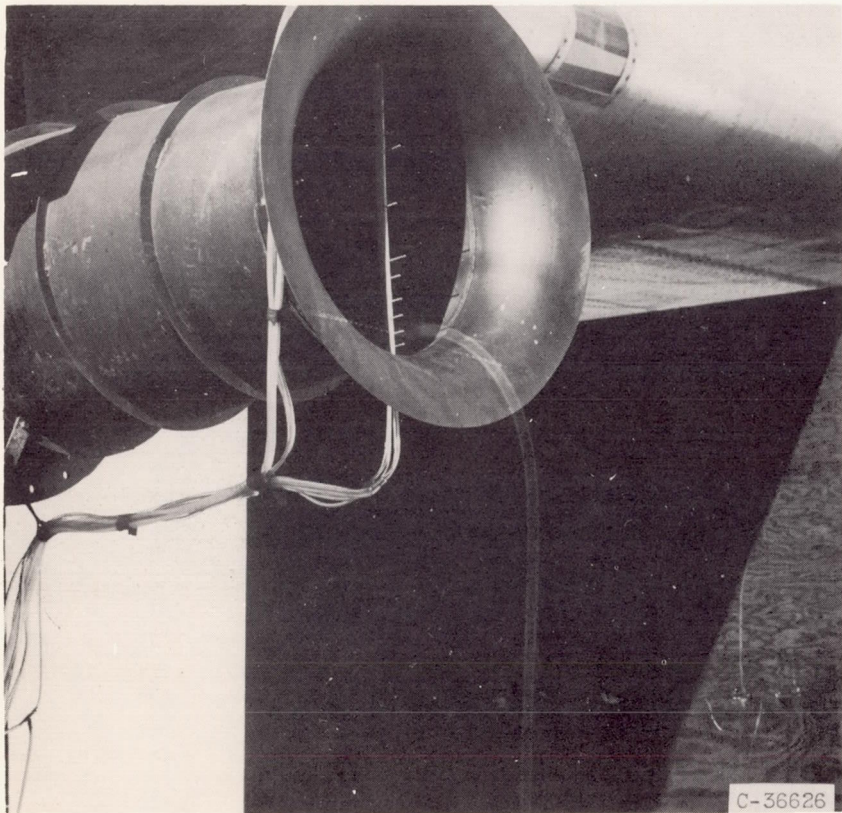

(a) Vortex 4.5 feet long formed at temperature of 76° F and dewpoint of 64° F.

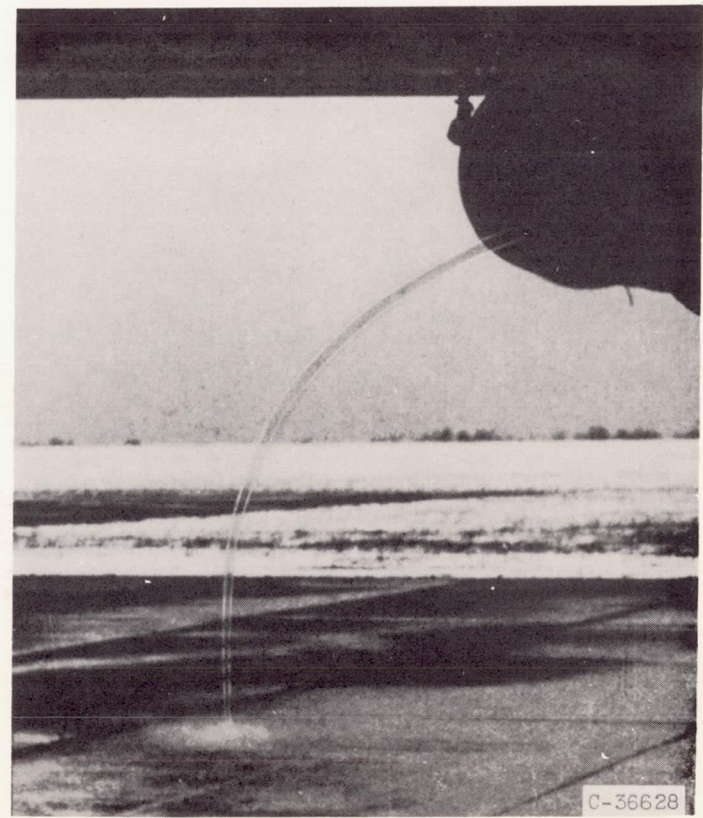

(b) Vortex 8 feet long formed at temperature of 37° F and dewpoint of 22° F (retouched).

Figure 8. - Atmospheric moisture condensed into visible water droplets in vortex core.

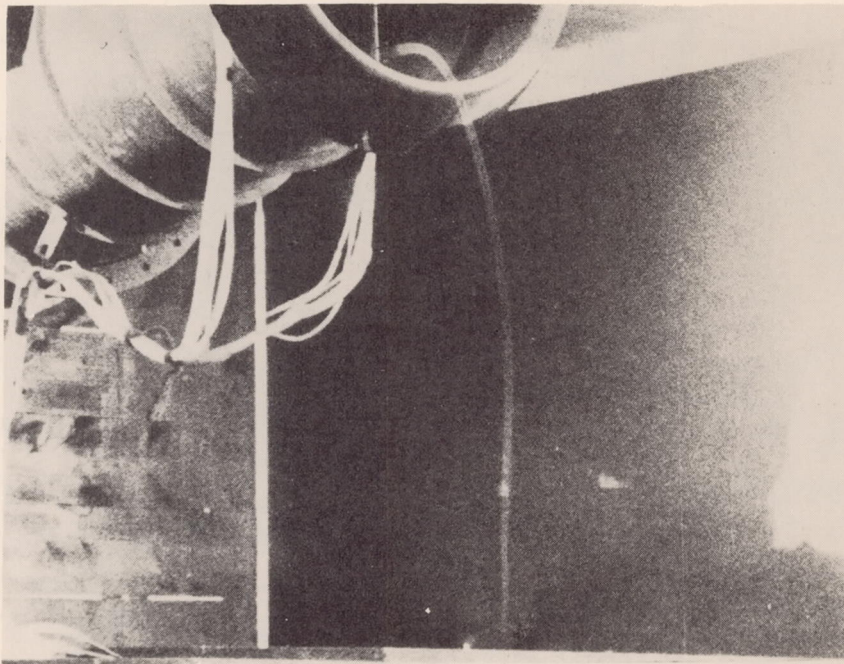

(a) Time, zero.

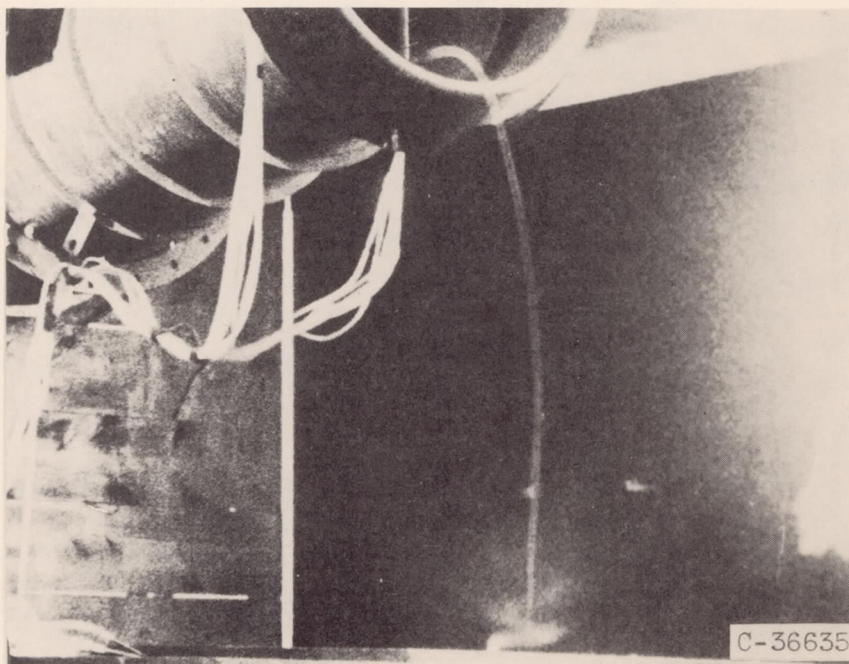

(b) Time, 0.03 second.

Figure 9. - Helical path of streamlines around condensed moisture in core, shown in selected motion-picture photographs of powdered talc released through hole in platform surface. Time of each picture indicates time after first photograph.

CX-3

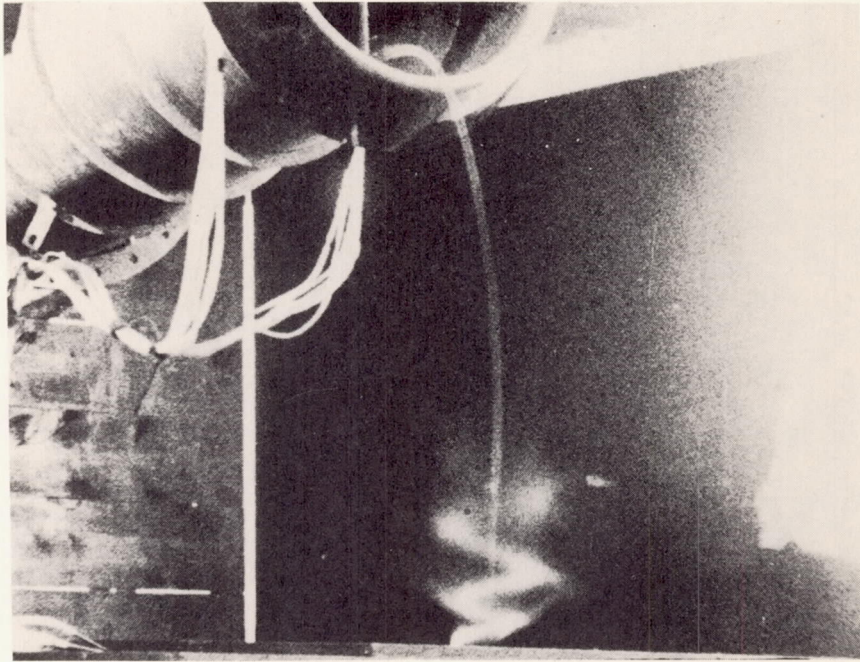

(c) Time, 0.06 second.

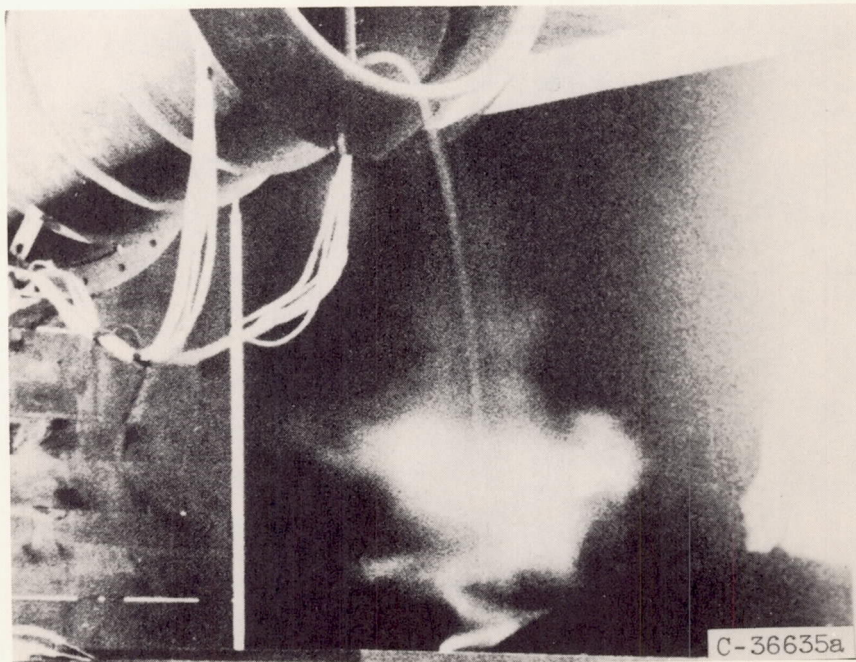

(d) Time, 0.12 second.

Figure 9. - Continued. Helical path of streamlines around condensed moisture in core, shown in selected motion-picture photographs of powdered talc released through hole in platform surface. Time of each picture indicates time after first photograph.

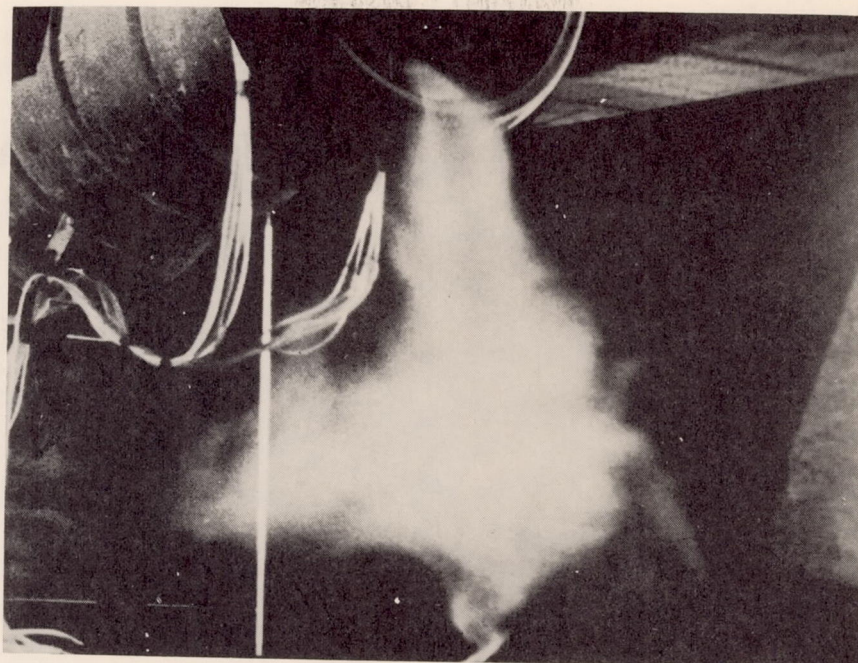

(e) Time, 0.41 second.

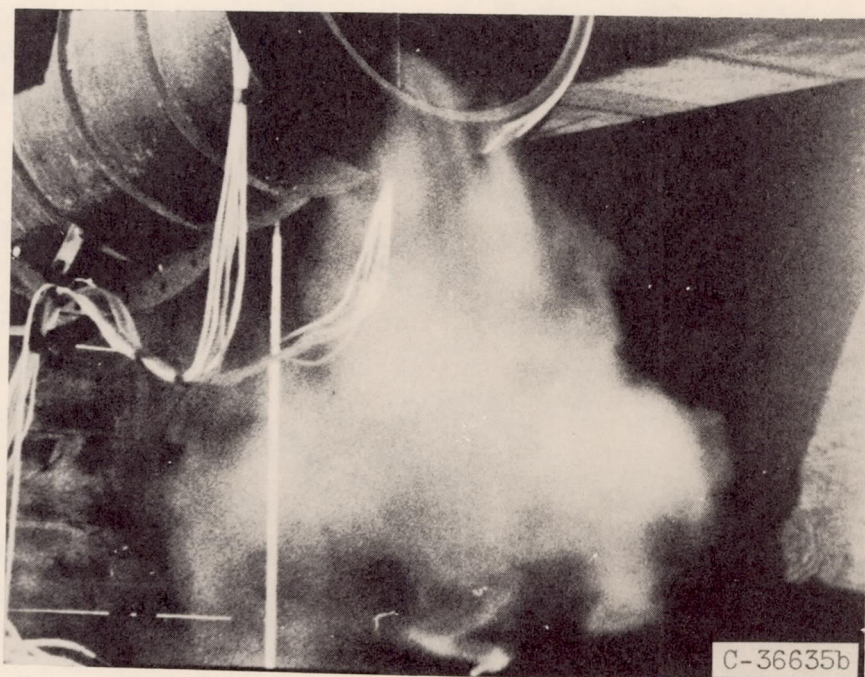

(f) Time, 0.53 second.

Figure 9. - Concluded. Helical path of streamlines around condensed moisture in core, shown in selected motion-picture photographs of powdered talc released through hole in platform surface. Time of each picture indicates time after first photograph.

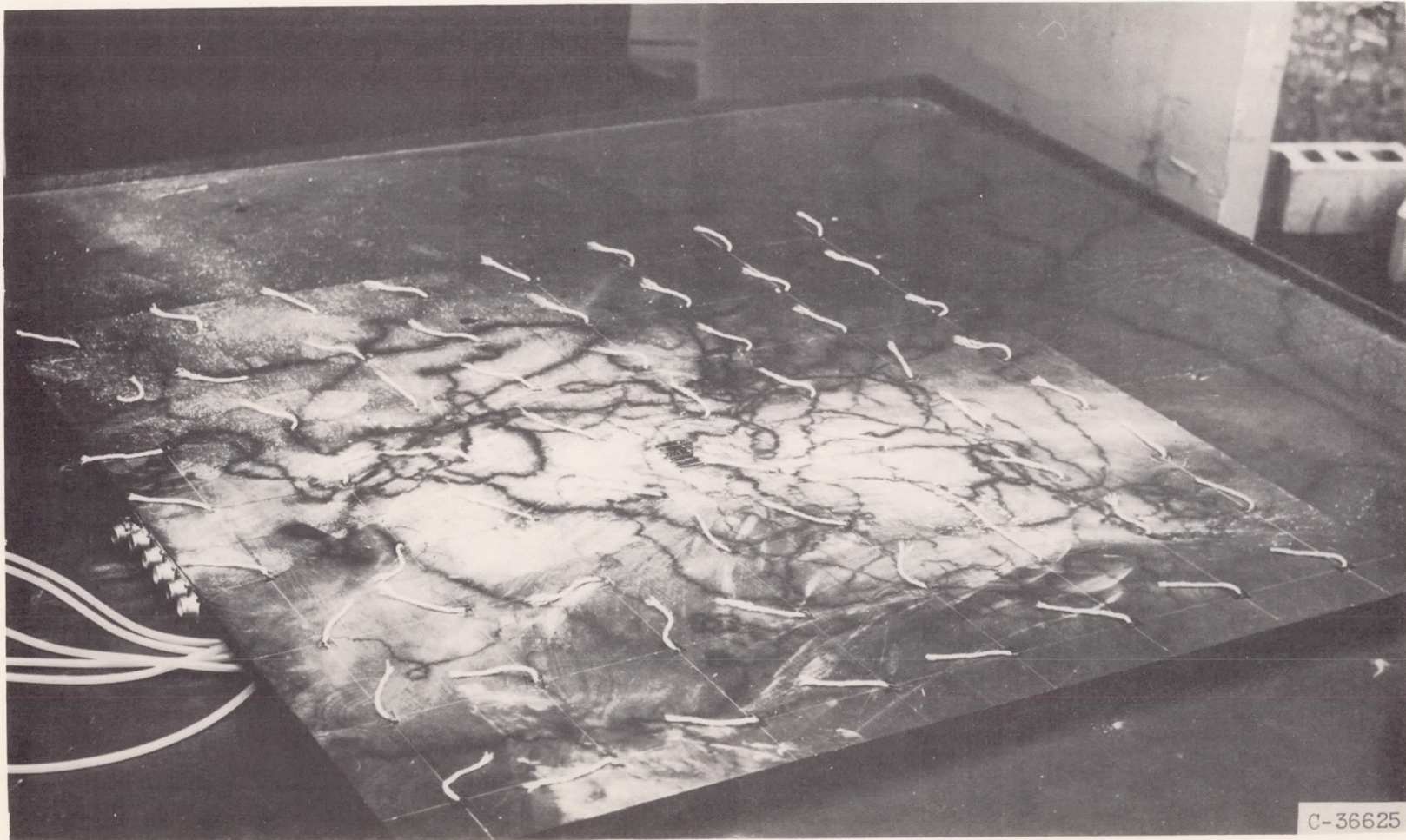
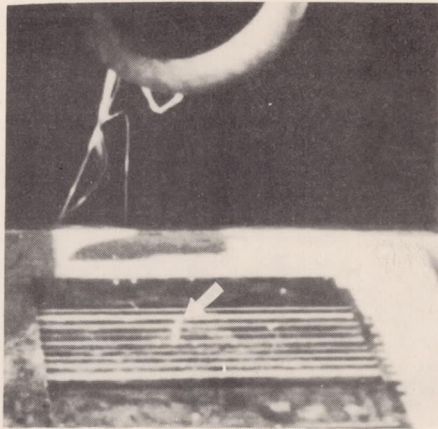
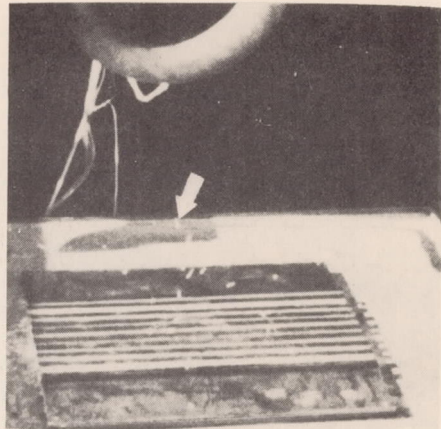

Figure 10. - Paths of vortex marked on platform surface by powdered talc in typical test run.



(a) Time, 0 second.



(b) Time, 0.1 second.

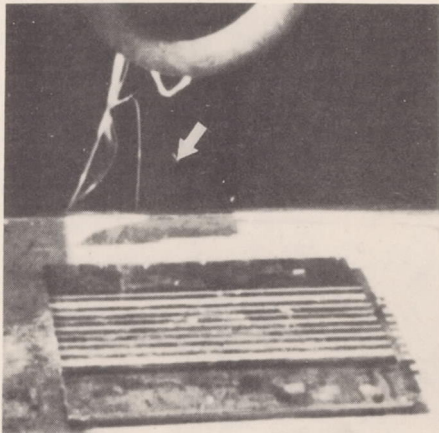

(c) Time, 0.2 second.

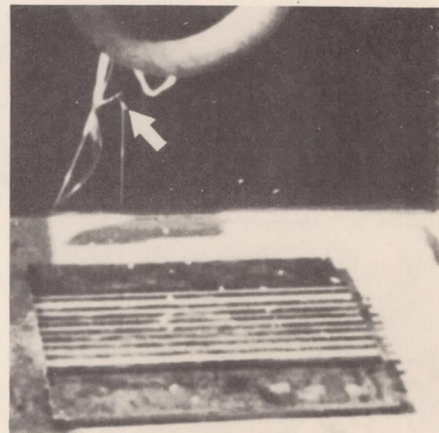

(d) Time, 0.3 second.

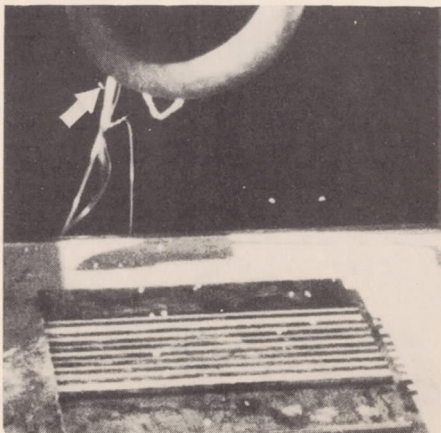

(e) Time, 0.4 second.

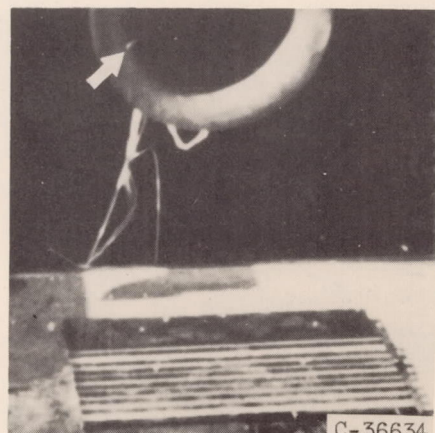

(f) Time, 0.6 second.

Figure 11. - Path of a pebble from platform surface, shown in series of motion-picture photographs.

3508

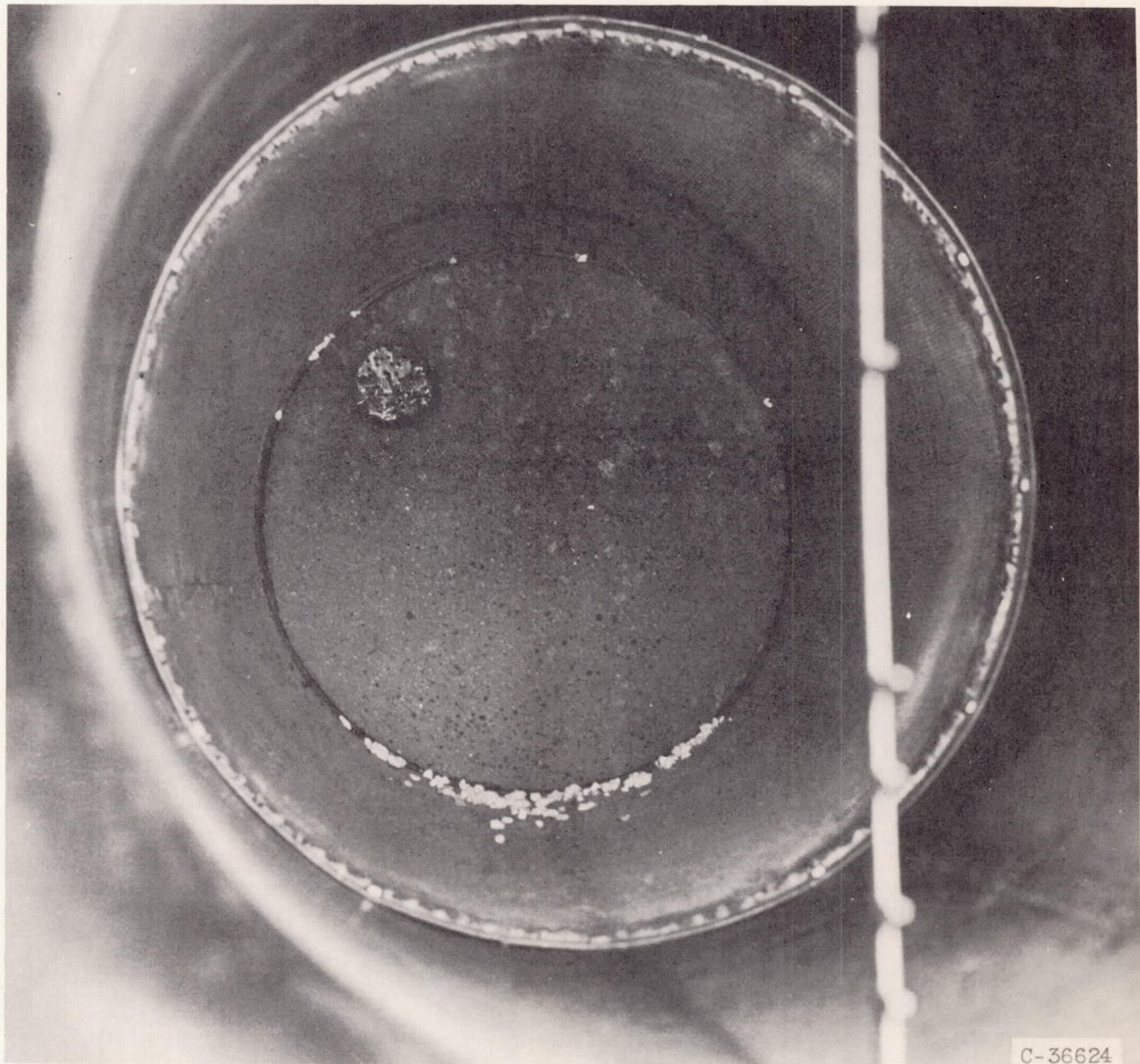
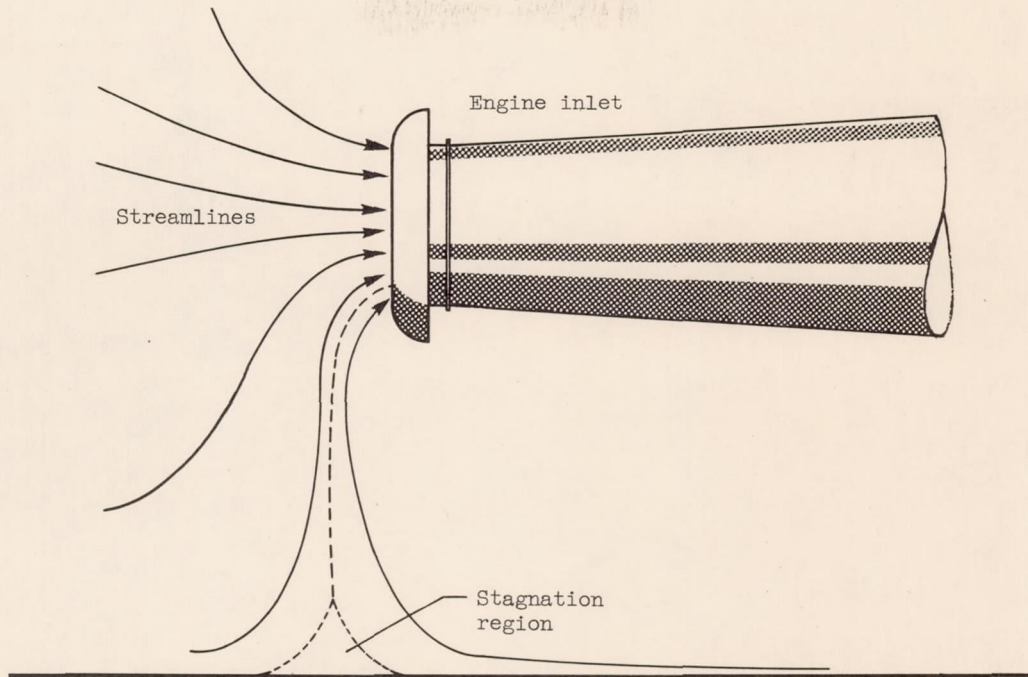
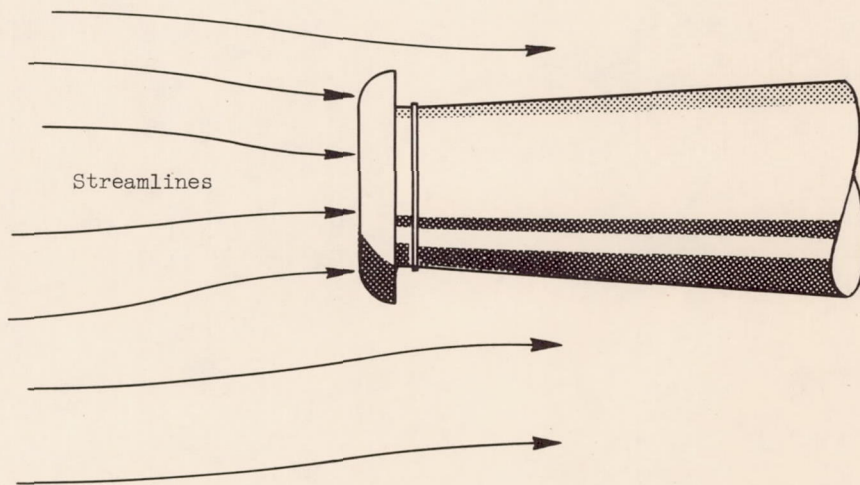

Figure 12. - Pebbles projected into engine inlet duct from platform surface by inlet vortex. (A screen prevented entrance of pebbles into engine.)



(a), Stagnation region under inlet, low wind velocity.



CD-3842

(b) No stagnation region, high wind velocity.

Figure 13. - Streamlines of flow into engine inlet.