

ex

NACA TN 4290

NATIONAL ADVISORY COMMITTEE FOR AERONAUTICS

TECHNICAL NOTE 4290

A FUSELAGE ADDITION TO INCREASE DRAG-RISE MACH NUMBER OF
SUBSONIC AIRPLANES AT LIFTING CONDITIONS

By Richard T. Whitcomb

Langley Aeronautical Laboratory
Langley Field, Va.

LIBRARY COPY

JUN 4 1958

LANGLEY AERONAUTICAL LABORATORY
LIBRARY, NACA
LANGLEY FIELD, VIRGINIA



Washington
June 1958



NATIONAL ADVISORY COMMITTEE FOR AERONAUTICS

TECHNICAL NOTE 4290

A FUSELAGE ADDITION TO INCREASE DRAG-RISE MACH NUMBER OF
SUBSONIC AIRPLANES AT LIFTING CONDITIONS¹

By Richard T. Whitcomb

SUMMARY

The addition of fuselage volume on top of the forward portion of a fuselage for the purpose of increasing the drag-rise Mach number of subsonic airplanes at lifting conditions is investigated. The additions have been designed on the basis of the area rule and other important considerations to provide greater practicability of application compared with shapings previously investigated. The addition increased the drag-rise Mach number by an increment of approximately 0.03 for a configuration having a wing with moderate thickness and 35° of sweepback at a lift coefficient of 0.3. A lesser increase was obtained for a configuration with a thicker wing. The additions increase the nonlinearities of the variations of pitching moment with lift.

INTRODUCTION

In order to obtain higher cruise speeds for most airplanes intended to fly at high subsonic speeds, the drag rise associated with the onset of shock waves at lifting conditions must be delayed. Unpublished data obtained from investigations at the Ames and Langley laboratories of the National Advisory Committee for Aeronautics have indicated that most area-rule fuselage shapings (ref. 1) not only reduced the transonic or supersonic wave drag but also delayed the drag rise. Special modifications of such fuselage shapings intended to provide greater practicability of application, as well as some improvement of effectiveness in delaying drag rise, are proposed herein.

For existing airplanes and for designs where the minimum fuselage dimensions are established by internal requirements, fuselage shapings intended to delay the drag rise usually would be accomplished by increasing the volume of the fuselage or by attaching appendages to the basic fuselage structure. The practicability of the application of such fuselage additions is generally increased by consolidating such additions on limited regions of the fuselage, inasmuch as this procedure generally results in a simplification and a reduction of weight of the fuselage structure and an

¹The information presented herein, together with other material subsequently found not to be significant, was previously given limited distribution as RM L58H09b by Richard T. Whitcomb.

increase in the usability of the added fuselage volume. Emphasis, therefore, has been placed on such concentrated additions in the present study. To determine the effectiveness of the fuselage additions proposed, tests have been made of a systematic group of such modifications with two representative wing-fuselage combinations at Mach numbers from 0.75 to 0.98.

SYMBOLS

a	vertical extension of fuselage addition from basic fuselage
C_D	drag coefficient
ΔC_D	incremental drag coefficient
C_L	lift coefficient
C_m	pitching-moment coefficient
M	Mach number
ΔM	incremental Mach number
r	fuselage radius
x	longitudinal fuselage coordinate
α	angle of attack

DESIGN CONSIDERATIONS

The onset of drag rise for an airplane with a relatively thick wing at cruise lift coefficients is usually caused primarily by boundary-layer separation on the upper surface of the wing resulting from the development of an initial shock wave above the wing. This separation is usually less severe on the fuselage and the inboard sections of the wing than on the midsemispan region of the wing. The difference is particularly great for sweptback wings (ref. 2). Fuselages shaped to improve the longitudinal area development for the airplane tend to reduce the strength of the initial shock over the inboard region of the wing and thereby to further increase the difference in extent of separation along the wing span. Increasing the lift on the less critical upper surfaces of the fuselage and the inboard sections of the wing and allowing thereby a decrease in lift on the more critical midsemispan region should result in a decrease

in boundary-layer separation in this region. It would be expected that the favorable effect of this reduction in separation on the midsemispan region of the upper surface would be considerably greater than any adverse effects of increasing the lift on the fuselage and inboard sections of the wing, and thus an overall improvement should result.

The localized increases of lift on the upper surfaces of the fuselage and inboard sections of the wing may be accomplished by incorporating camber in the fuselage. For the usual fuselage additions intended to improve the area developments, with forward and rearward additions above and below the wing, the desired camber is effectively obtained by adding vertically to the upper forward and lower rearward parts of such additions and subtracting vertically from the lower forward and upper rearward parts.

Inasmuch as the total lower fuselage addition and the upper rearward addition reduced as described in the preceding paragraph cannot affect to a large degree the boundary-layer separation on the upper surface of the wing, it would be expected that these additions to the fuselage would contribute relatively little to the reduction in total drag rise of the configuration. Therefore, the fuselage addition may be limited to the upper forward portion of the fuselage with little loss of effectiveness.

Unpublished experimental results indicate that the effectiveness of area-rule fuselage shaping in delaying drag rise is only slightly dependent on the lateral distribution of the shaping around the fuselage. Therefore, the development of fuselage camber through addition of volume, as well as the practicability of application, can be improved by concentrating the addition, limited as described in the preceding paragraph, on the top of the fuselage. A fuselage addition incorporated into the basic structure should probably be shaped to fair into the lines of the fuselage in a manner similar to that shown in figure 1(a). However, an addition to a basic fuselage structure could probably be concentrated laterally as shown in figure 1(b) without a significant loss of effectiveness or increase in skin friction.

Schlieren photographs have indicated that for the speed and lift conditions at which the fuselage shaping normally is most useful, the flow is usually supersonic to a considerable degree in a relatively large local region above the upper surface of the wing. Therefore, it would seem probable that the greatest reduction in the strength of the initial shock wave in this speed range might be obtained if the fuselage addition above the wing were shaped longitudinally to improve the area developments obtained with the oblique cutting planes associated with supersonic fields. Such a shape may be approximated by moving the shaping for a design Mach number of 1.0 (ref. 1) somewhat forward.

Because of the limitations of the area rule for the conditions under consideration, the use of detailed area developments in the design of the

shape of a fuselage addition would not seem justified. Furthermore, because of the extent of mixed flow for these conditions the use of potential theory to define optimum fuselage camber was not believed to be justified. Hence, the cambered fuselage shapes investigated herein were arrived at by simple, arbitrary procedures.

EXPERIMENTAL CONFIGURATIONS AND TESTS

The initial part of the investigation was made with an uncambered, moderately swept wing (fig. 1(c)) with moderate aspect ratio and section thicknesses. Later tests were made with a cambered swept wing (fig. 1(d)), which had higher aspect ratio and somewhat greater section thicknesses. In order to distinguish between the configurations, the design shown in figure 1(c) is referred to as the thin wing and that shown in figure 1(d) is referred to as the thick wing.

Design of Basic Configurations

The basic fuselage used in the present investigation is defined by the ordinates given in the first two columns of table I. The two wings of the experimental configurations were obtained by attaching fiber glass and plastic additions to the model used in the investigation of reference 3. Both had 35° of sweepback of the quarter-chord line. The thin wing had an aspect ratio of 3.85 and a taper ratio of 0.614. The wing sections varied linearly from an NACA 65A010 section at the wing-fuselage juncture to an NACA 65A006 section at the 0.60-semispan station, with an NACA 65A006 section from that station to the tip. The thick wing had an aspect ratio of 7.05 and a taper ratio of 0.38. The wing sections varied linearly from an NACA 65A213, $a = 0.5$ (approx.) section at the wing-fuselage juncture to an NACA 65A209, $a = 0.5$ (approx.) section at the 0.38-semispan station, with an NACA 65A209, $a = 0.5$ (approx.) section from that station to the tip. Neither wing had any built-in twist or dihedral. However, because of the relatively low stiffness of the fiber glass and plastic outboard extension for the thick wing, the tip region of this wing had considerable twist and dihedral while the wing was being tested.

Design of Fuselage Additions

All fuselage additions investigated, except one, were designed with cross sections layed out as shown in figure 1(a). Four additions, with the longitudinal profile contours shown in figure 2(a), were tested with the thin wing placed longitudinally with respect to the fuselage as shown in figure 1(c).

The primary addition shown in figure 2(a) is the initial attempt to obtain the most satisfactory consolidated addition for use with the thin wing. The shape of this addition was obtained by shifting a contour designed for a Mach number of 1.0 forward a distance of roughly 15 percent of the chord at the wing-fuselage juncture. The $M = 1.0$ shape was obtained by the following procedure. A relatively gradual concavity of the fuselage area development, with a length approximately equal to one-half the chord at the wing-fuselage juncture, was centered approximately 10 percent of the juncture chord ahead of the longitudinal station of the maximum cross-sectional area for the wing; a relatively sharp convex curvature was initiated at the station of the leading edge of the juncture; and the concave and convex regions were connected by a region with a relatively gradual rate of change of slope. The maximum height of this primary addition was arbitrarily chosen as one-half the fuselage maximum width.

The enlarged primary addition was obtained by increasing the ordinates of the primary addition by 50 percent. (See fig. 2(a).) The reduced primary addition was obtained by reducing these ordinates by 50 percent. The advanced primary addition was obtained by moving the ordinates of the primary addition in the region of the wing forward 10 percent of the wing-fuselage-juncture chord. The primary addition was also tested with the wing moved forward 1.0 inch, or 15 percent of the wing-fuselage-juncture chord, with respect to the position shown in figure 1(c). Inasmuch as this change placed the fuselage addition in a more rearward position with respect to the wing, this configuration is referred to as the "receded" primary addition. The primary addition has been investigated with the thin wing one-half fuselage radius above and below the center line of the fuselage. The other additions have been tested with the wing only in the lower position.

The primary and enlarged primary additions have also been investigated with the thick wing shown in figure 1(d). When used with this wing, these additions were modified from that used with the thin wing so as to have a somewhat sharper convex corner slightly farther forward. (See table I.) The concentrated primary addition, described in figure 2(c), has the same longitudinal area development as that for the primary addition in the region of the wing. However, forward of the maximum cross-sectional area for the additions, the area developments are significantly different.

Tests

The tests were made in the Langley 8-foot transonic tunnel over a Mach number range from 0.60 to 0.95 at a Reynolds number per foot of approximately 4×10^6 . The model was mounted for testing on a sting

support extending to the base of the fuselage. Forces and moments were obtained by use of an internal strain-gage balance. Tests were made without boundary-layer transition fixed by roughness strips.

RESULTS AND DISCUSSION

The variations of drag coefficient, angle of attack, and pitching-moment coefficient with lift coefficient for the various test configurations are presented in figures 3, 4, and 5, respectively. The pitching-moment coefficients have been determined about the Y-axis shown in figure 1. Variations of these parameters with Mach number for a lift coefficient of 0.3 are presented in figure 6. The results have been adjusted to the condition of stream static pressure at the base of the fuselage. Schlieren photographs of the shock patterns for several of the test configurations are presented in figure 7.

Drag Characteristics

Effect of primary fuselage addition.- For the configuration with the thin wing in a low position, the primary fuselage addition provides an increase in the drag-rise Mach number of approximately 0.03 for a lift coefficient of 0.3 (fig. 6(a)). The drag-rise Mach number has been arbitrarily chosen as the value at which $\Delta C_D/\Delta M = 0.10$. The increases for lower and higher lift coefficients are less than for a lift coefficient of 0.3. The reductions of shock-wave strength resulting in the delay of drag rise for a lift coefficient of approximately 0.25 are illustrated by the schlieren photographs of figure 7. For the configuration with the thick wing, the primary fuselage addition provides an increase in the Mach number for drag rise of approximately 0.02 (fig. 6(b)).

The drag benefits associated with the proposed addition appear to be of the same order as those obtainable with the Kùchemann "streamline" method for a comparable configuration. (See ref. 4, for example.) However, the practicability of application of the present addition normally should be considerably greater than that of an addition required to provide the Kùchemann shaping.

Effect of vertical position of wing.- With the thin wing in the high position, the effectiveness of the primary addition in delaying and reducing drag rise is essentially the same as with this wing in the low position (figs. 6(a) and (c)). However, with the wing in the high position, use of the primary addition results in a significant increase in drag for the higher lift coefficients at the lower Mach numbers (fig. 3(c)), an effect not present with the wing in the lower position (fig. 3(a)). It

is believed that this increase in drag may be attributed to flow separation on the upper surface at inboard sections of the wing, which results from the strong induced upwash associated with the convex portion of the addition. With the wing in the low position, the distance between the addition and the wing is increased, with a resulting reduction of the flow interference.

Effect of size of primary addition.- For the thin-wing configuration, reducing the size of the primary addition by one-half (reduced primary addition) resulted in roughly the same decrease of effectiveness (fig. 6(d)) in delaying the drag rise. For this same configuration, increasing the size of the primary addition by one-half (enlarged primary addition) caused a significant increase in drag coefficient throughout the Mach number range of the investigation. This increase in drag is probably due primarily to the separation of the boundary layer on the addition near the reversal of curvature indicated by the schlieren photograph (fig. 7). For the thick-wing configuration, increasing the size of the primary addition by 50 percent did not result in such an increase in drag (fig. 6(b)). These results and schlieren photographs not included herein indicate that the boundary-layer separation present on this enlarged addition when used with the thin wing has been essentially eliminated for this configuration. At the higher lift coefficients the enlarged primary addition provides less reduction in drag than does the primary addition, even for the thicker wing (fig. 3(b)). On the basis of these limited results, it appears that fuselage addition with maximum added areas roughly equal to that for the primary addition investigated should provide the most satisfactory effectiveness over a range of conditions for similar configurations.

Effect of longitudinal location of addition.- Movement of the primary addition rearward with respect to the thin wing to a location corresponding to a design Mach number of roughly 1.0 (the receded primary addition) results in almost a complete loss of effectiveness of the addition in delaying drag rise for a lift coefficient of 0.3 (fig. 6(e)). Movement of the primary addition forward a distance of 10 percent of the wing-fuselage-juncture chord (the advanced primary addition) results in a slight increase in drag coefficient throughout the Mach number range of the test for a lift coefficient of 0.3 (fig. 6(e)). The relative effectiveness of this addition in delaying the drag rise improves with an increase in lift coefficient at the higher Mach number (fig. 3(e)), because of the higher velocities above the wing associated with this increase of lift. These results indicate that for configurations similar to the present test model, the addition proposed should be located longitudinally in roughly the position of the primary addition.

Effects of concentrating primary addition.- Concentration of the added cross-sectional areas of the primary addition into the limited region shown in figure 2(c) results in only a slight loss of effectiveness in reducing drag rise (fig. 6(f)). This result indicates that the

initial onset of shock and drag rise is normally only slightly dependent on the shape of the fuselage ahead of the wing. Therefore, within the normal limitations of subsonic airplane design, the form of the fuselage addition in this region may be chosen on the basis of practicality or esthetics.

Lift and Pitching-Moment Characteristics

The various versions of the primary addition provide substantial changes of the pitching-moment coefficients in the positive direction, as would be expected. (See fig. 6, for example.) However, these pitching-moment-coefficient changes are rather critically dependent upon angle of attack and increase the nonlinearities in the pitching-moment curves. (See fig. 5.) In some cases severe pitch-up tendencies are encountered at rather low lift coefficients. (See fig. 5(b), for example.)

CONCLUDING REMARKS

The limited results presented herein indicate that a fuselage addition, concentrated on the upper, forward part of the fuselage, should result in appreciable increases in the drag-rise Mach number at lifting conditions for most conventional configurations intended for flight at high subsonic speeds. However, these additions increase the nonlinearities in the pitching-moment curves, and the possible consequences with regard to the longitudinal stability characteristics must, of course, be considered when applying these additions.

Langley Aeronautical Laboratory,
National Advisory Committee for Aeronautics,
Langley Field, Va., August 6, 1957.

REFERENCES

1. Whitcomb, Richard T.: A Study of the Zero-Lift Drag-Rise Characteristics of Wing-Body Combinations Near the Speed of Sound. NACA Rep. 1273, 1956. (Supersedes NACA RM L52H08.)
2. Whitcomb, Richard T.: An Experimental Study at Moderate and High Subsonic Speeds of the Flow Over Wings With 30° and 45° of Sweepback in Conjunction With a Fuselage. NACA RM L50K27, 1951.
3. Henry, Beverly Z., Jr.: A Transonic Wing Investigation in the Langley 8-Foot High-Speed Tunnel at High Subsonic Mach Numbers and at a Mach Number of 1.2 - Wing-Fuselage Configuration Having a Wing of 35° Sweepback, Aspect Ratio 4, Taper Ratio 0.6, and NACA 65A006 Airfoil Section. NACA RM L50J09, 1950.
4. McDevitt, John B., and Haire, William M.: Investigation at High Subsonic Speeds of a Body-Contouring Method for Alleviating the Adverse Interference at the Root of a Sweptback Wing. NACA TN 3672, 1956. (Supersedes NACA RM A54A22.)

TABLE I.- ORDINATES OF FUSELAGE ADDITIONS^a

Basic fuselage		Vertical extension, a, in., for -					
x, in.	r, in.	Primary		Enlarged primary		Reduced primary	Advanced primary
		Thin wing	Thick wing	Thin wing	Thick wing		
0	0	0	0	0	0	0	0
1.0	.58	0	0	0	0	0	0
2.0	1.04	0	0	0	0	0	0
3.0	1.36	0	0	0	0	0	0
4.0	1.56	.01	.01	.02	.02	0	.01
5.0	1.62	.12	.12	.17	.17	.06	.12
6.0	1.62	.24	.24	.35	.35	.12	.25
7.0	1.62	.34	.34	.50	.50	.17	.36
8.0	1.62	.44	.44	.65	.65	.22	.45
9.0	1.62	.52	.52	.77	.77	.26	.54
10.0	1.62	.59	.59	.88	.88	.29	.61
11.0	1.62	.66	.66	.98	.98	.33	.69
12.0	1.62	.73	.73	1.10	1.10	.36	.76
13.0	1.62	.79	.79	1.18	1.18	.39	.79
13.5	1.62	.81	.78	1.21	1.17	.40	.75
14.0	1.62	.78	.73	1.16	1.09	.39	.67
14.5	1.62	.72	.64	1.07	.96	.36	.55
15.0	1.62	.61	.53	.91	.79	.30	.42
16.0	1.62	.34	.31	.51	.47	.17	.20
17.0	1.62	.15	.13	.22	.20	.07	.06
18.0	1.62	.04	.03	.06	.05	.02	0
19.0	1.62	0	0	0	0	0	0
20.0	1.62	0	0	0	0	0	0
21.0	1.62	0	0	0	0	0	0
22.0	1.62	0	0	0	0	0	0
23.0	1.62	0	0	0	0	0	0
24.0	1.62	0	0	0	0	0	0
25.0	1.62	0	0	0	0	0	0
26.0	1.60	0	0	0	0	0	0
27.0	1.56	0	0	0	0	0	0
28.0	1.50	0	0	0	0	0	0
29.0	1.42	0	0	0	0	0	0
30.0	1.34	0	0	0	0	0	0
31.0	1.25	0	0	0	0	0	0
31.7	1.19	0	0	0	0	0	0

^aSee figures 1 and 2.

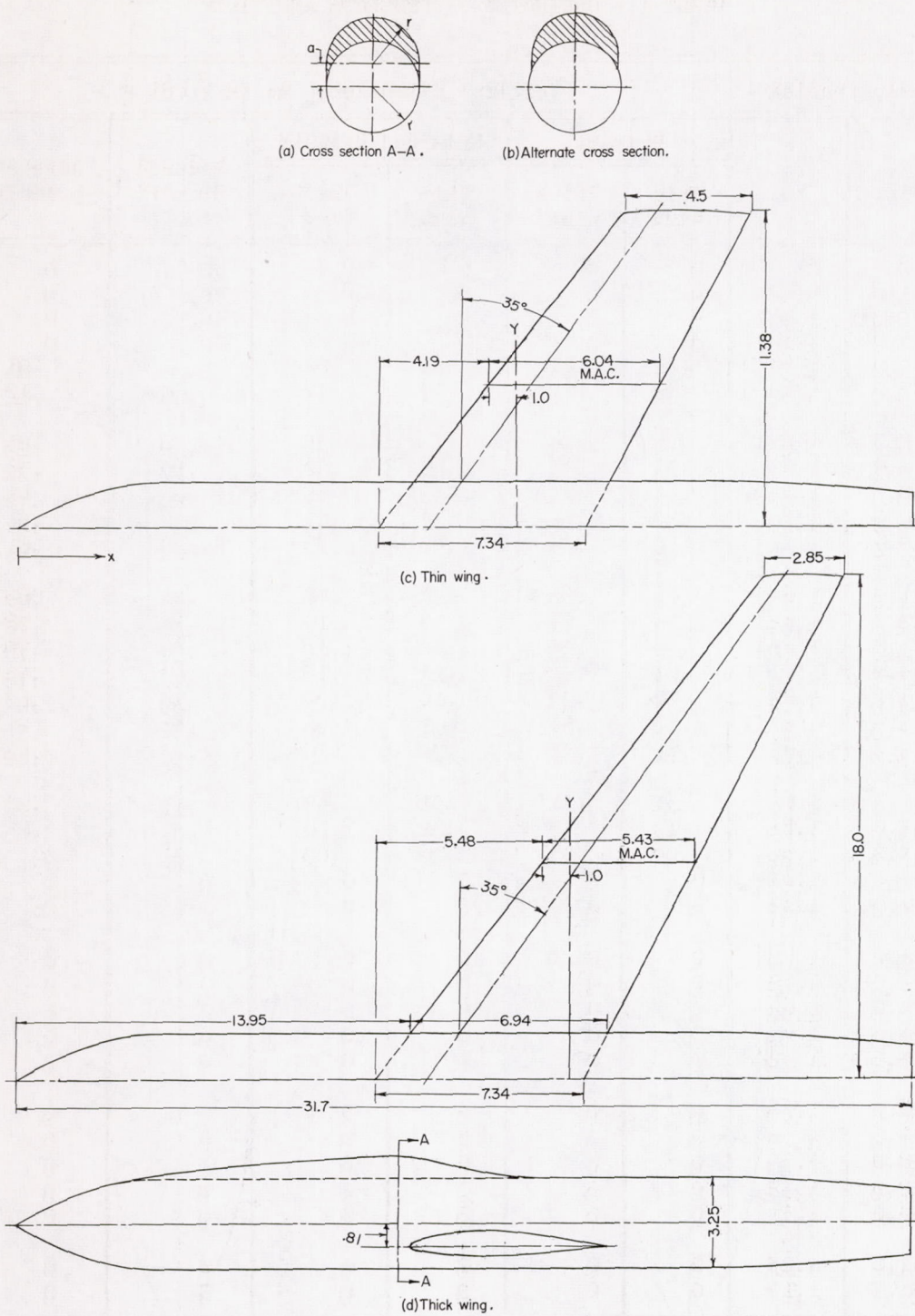
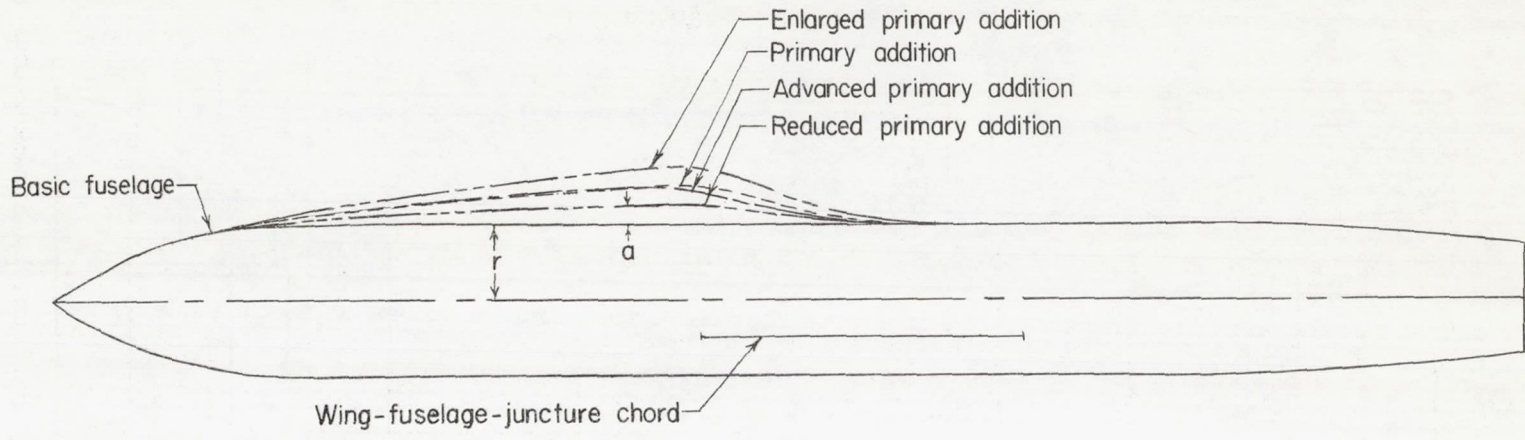
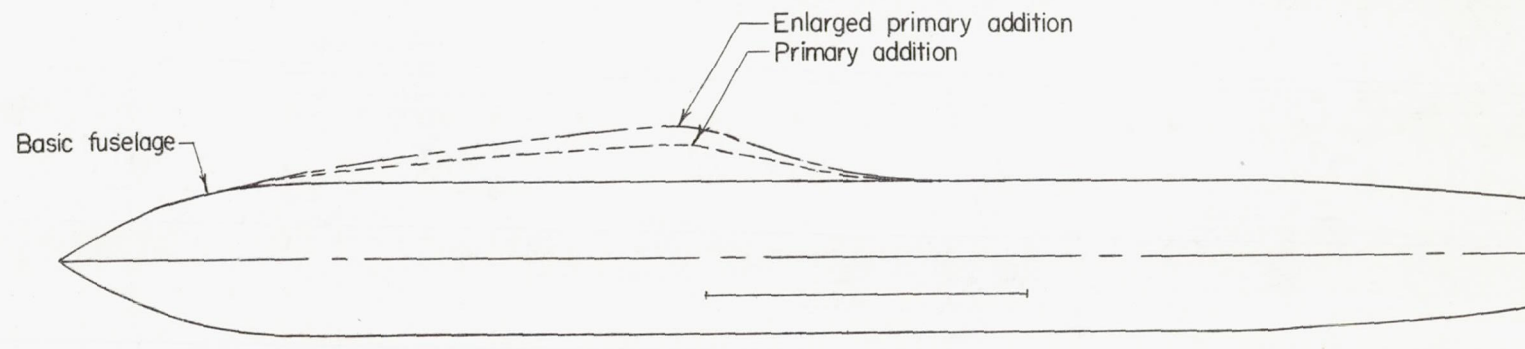

Figure 1.- Dimensions of experimental configurations. All dimensions are in inches.



(a) Additions with thin wing.



(b) Additions with thick wing.

Figure 2.- Contours of fuselage additions.

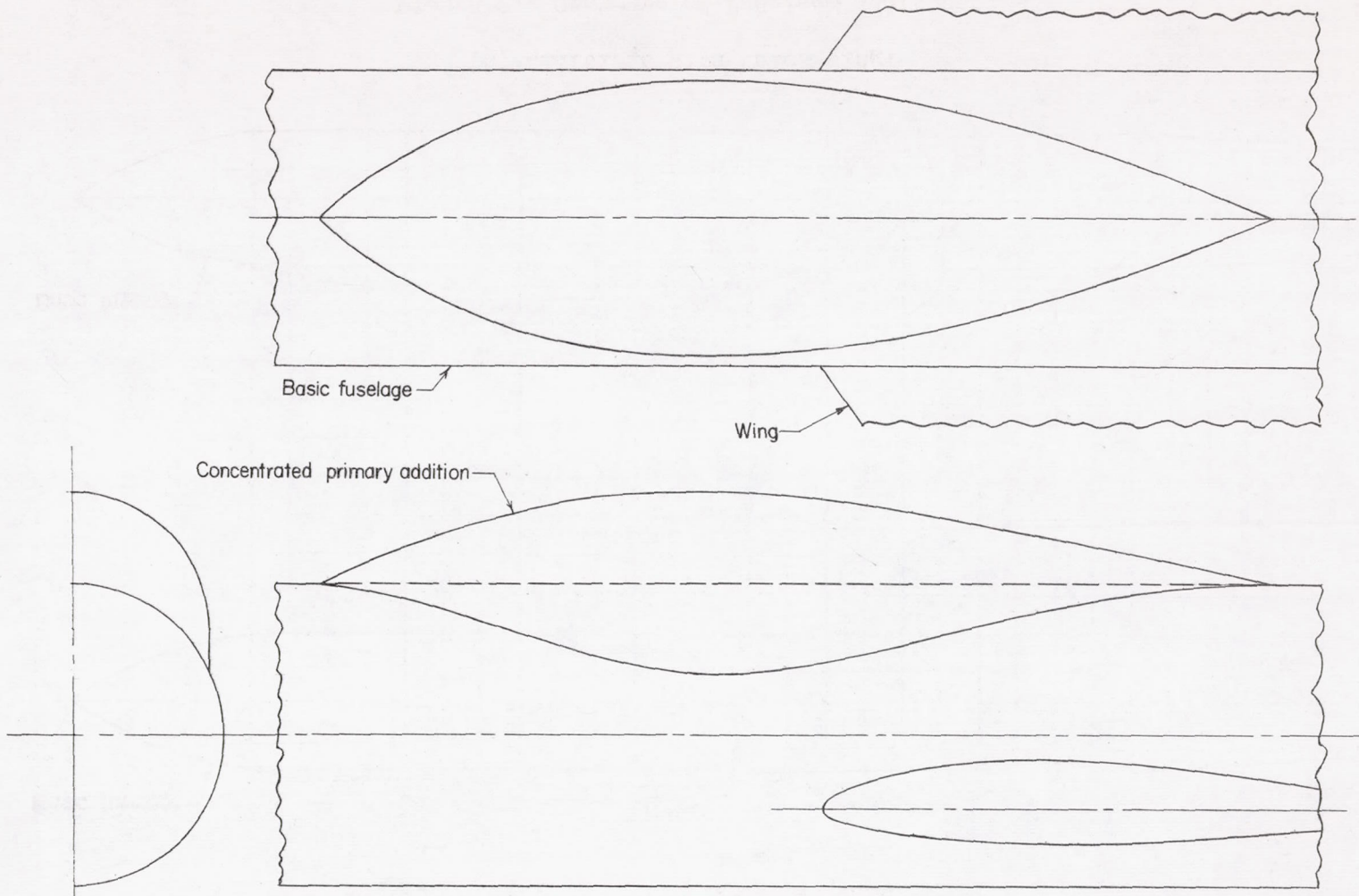

(c) Concentrated fuselage addition.

Figure 2.- Concluded.

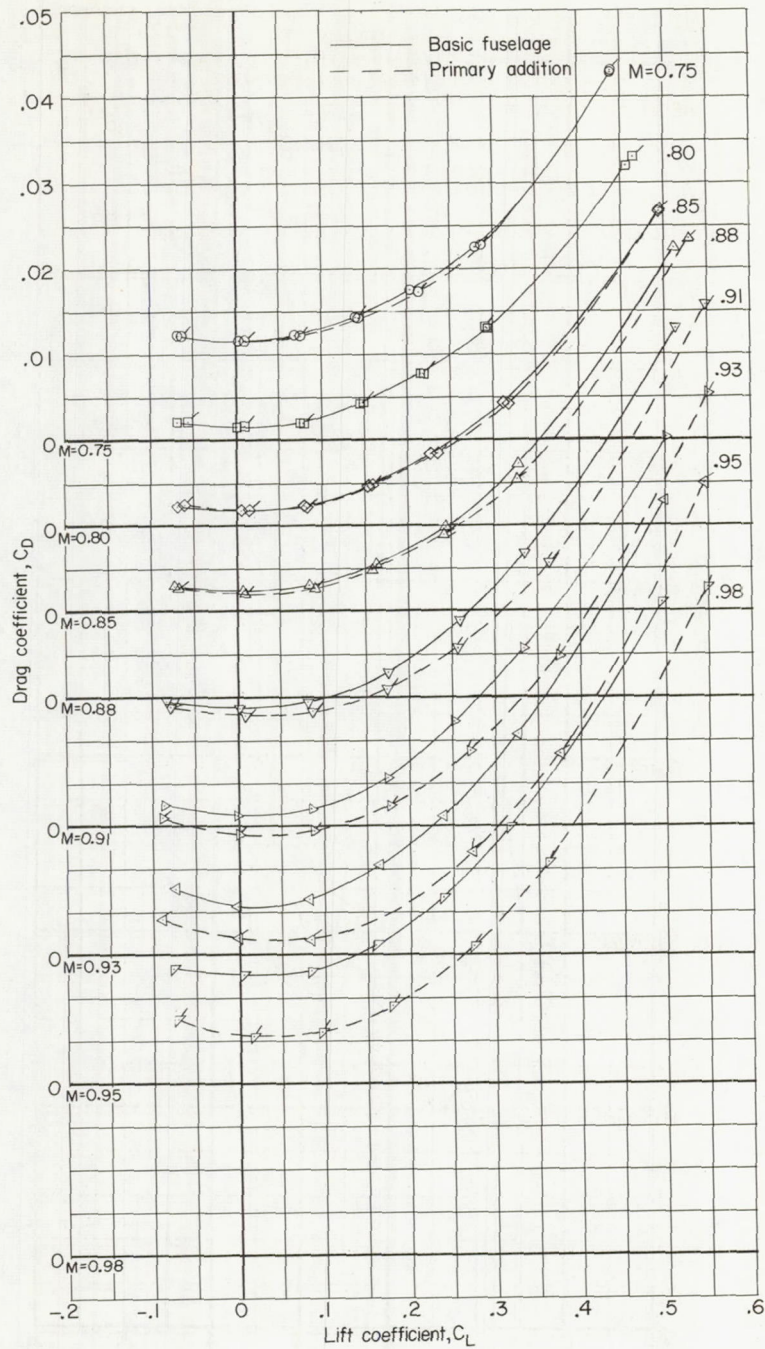

(a) Thin wing in low position; effects of primary addition.

Figure 3.- Variation of drag coefficient with lift coefficient at various Mach numbers for configurations investigated.

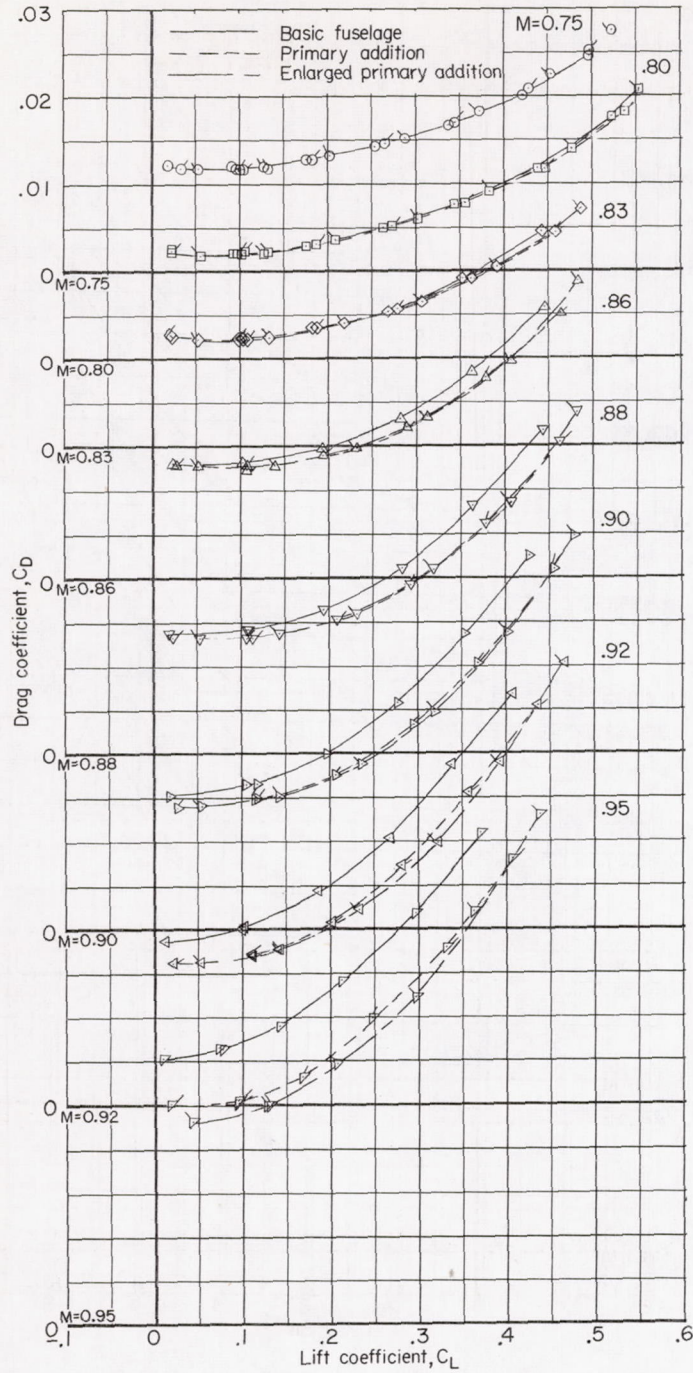

(b) Thick wing in low position; effects of primary addition.

Figure 3.- Continued.

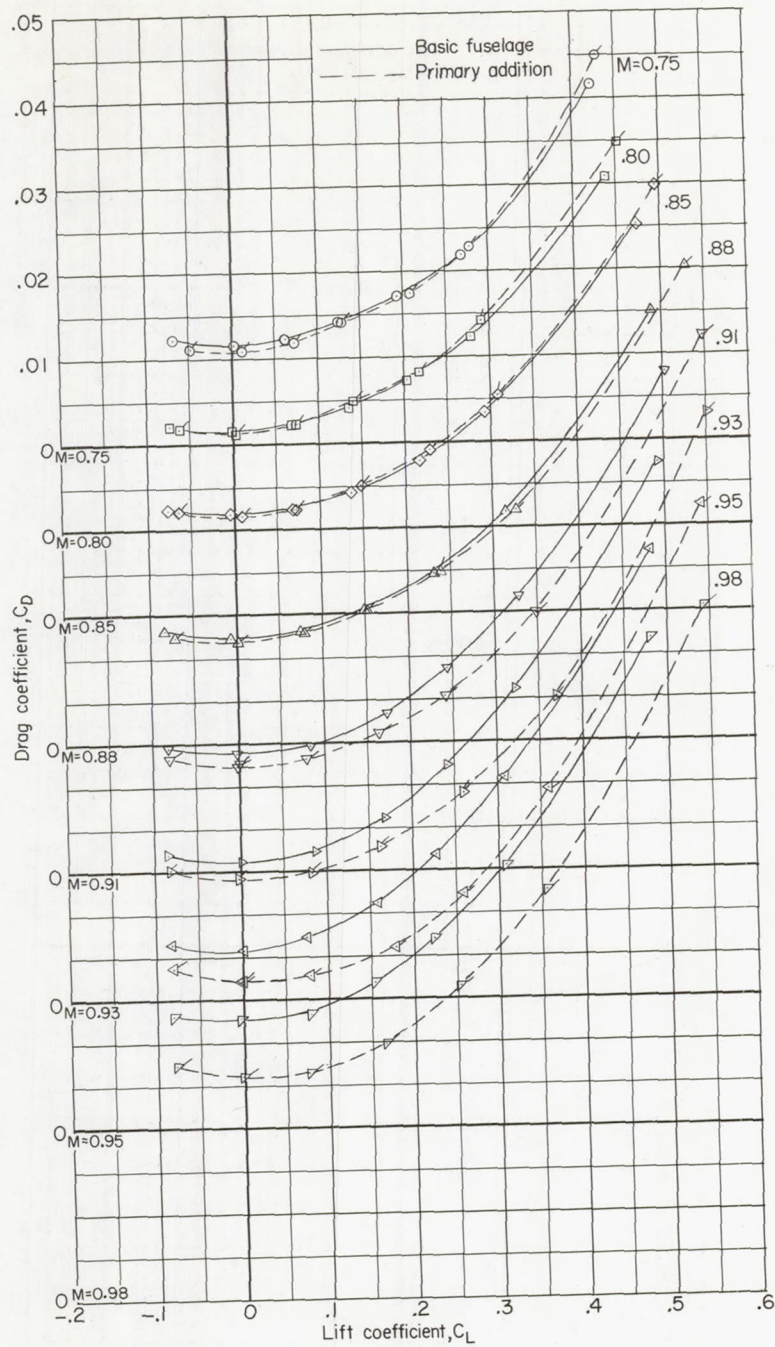

(c) Thin wing in high position; effects of primary addition.

Figure 3.- Continued.

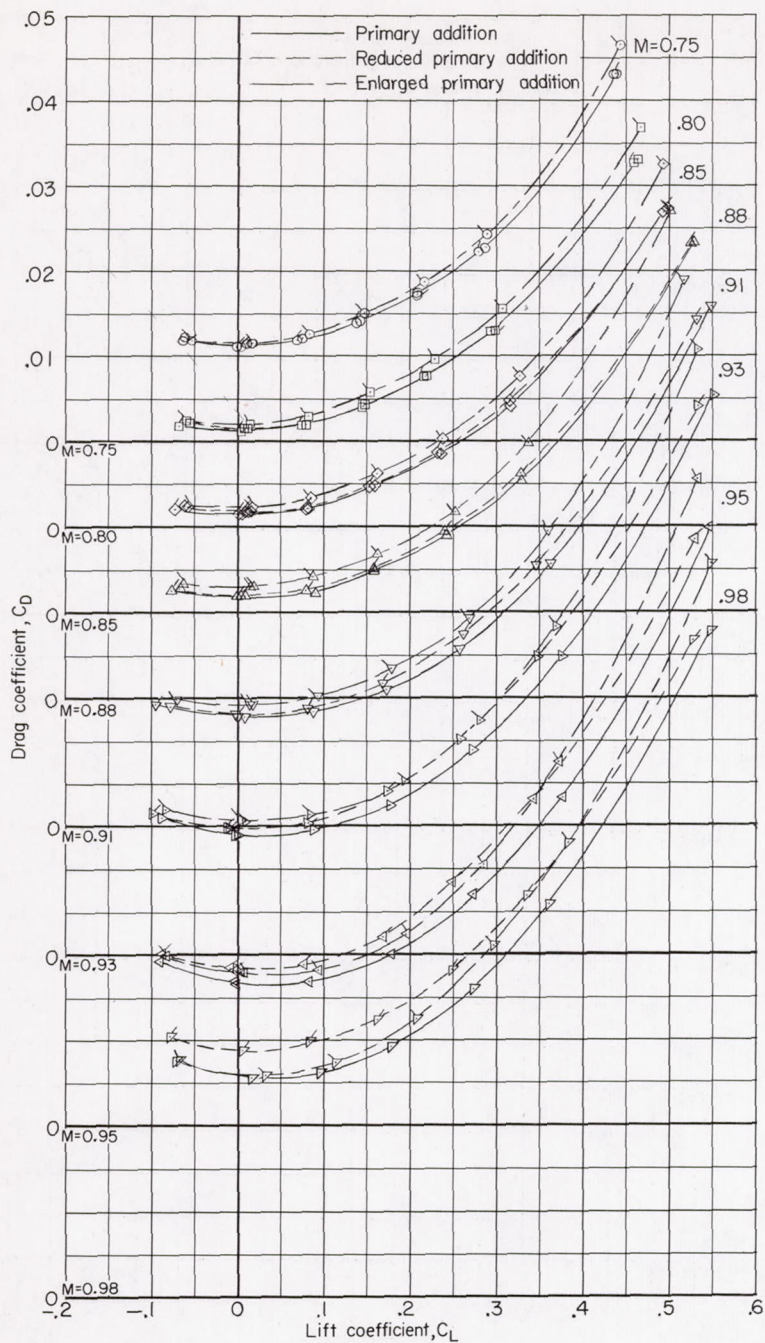

(d) Thin wing in low position; effects of addition size.

Figure 3.- Continued.

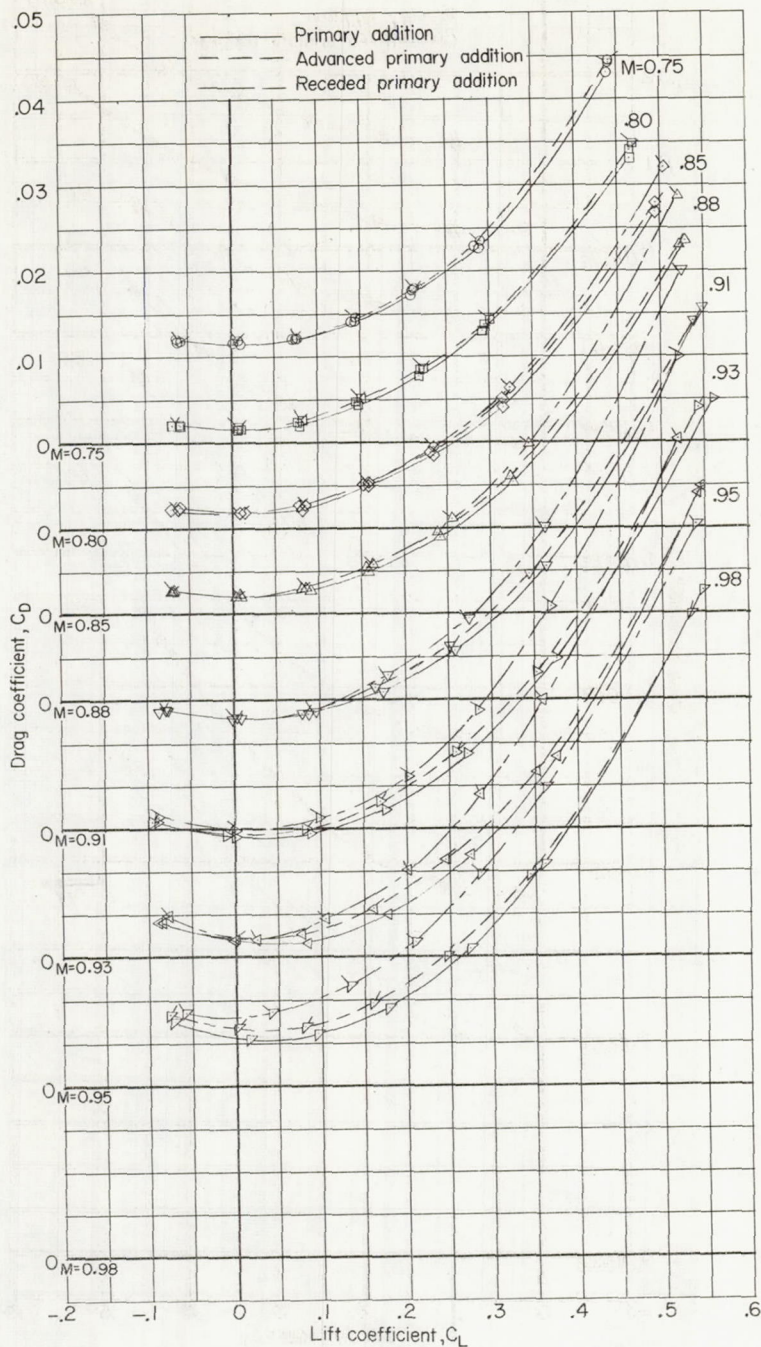

(e) Thin wing in low position; effects of longitudinal location of addition.

Figure 3.- Continued.

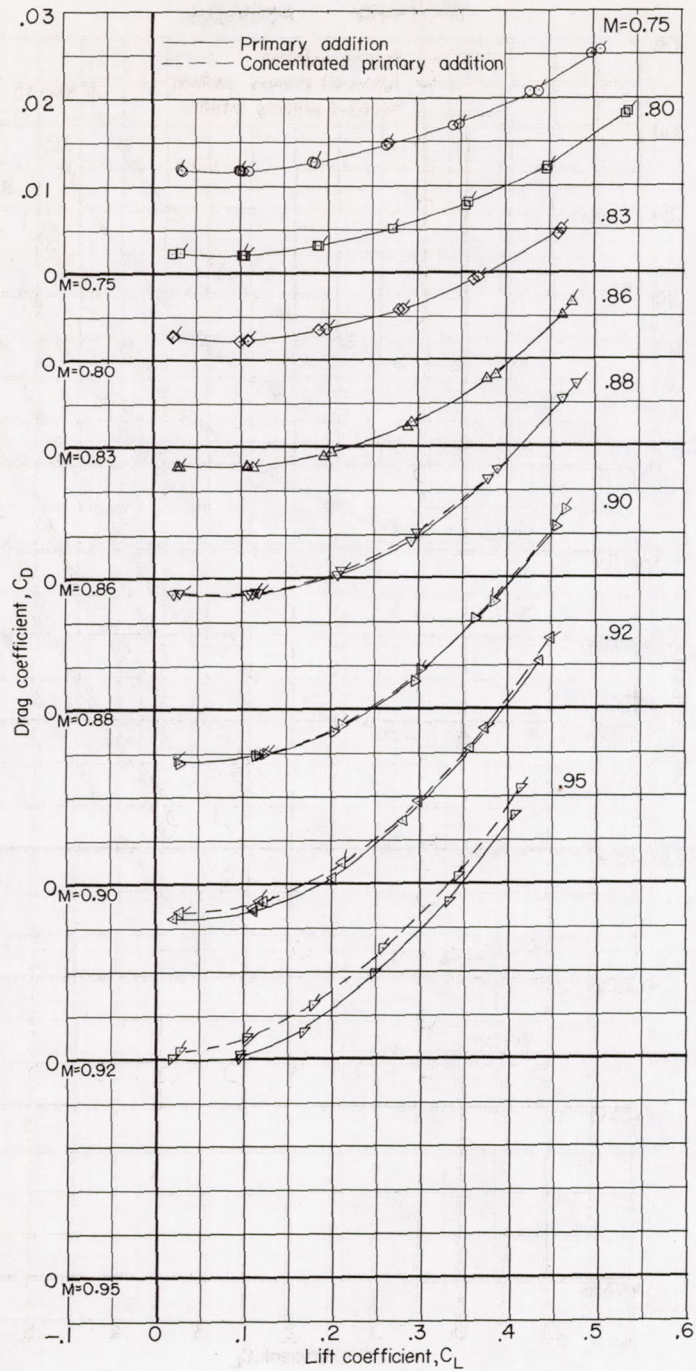

(f) Thick wing in low position; effects of concentrated primary addition.

Figure 3.- Concluded.

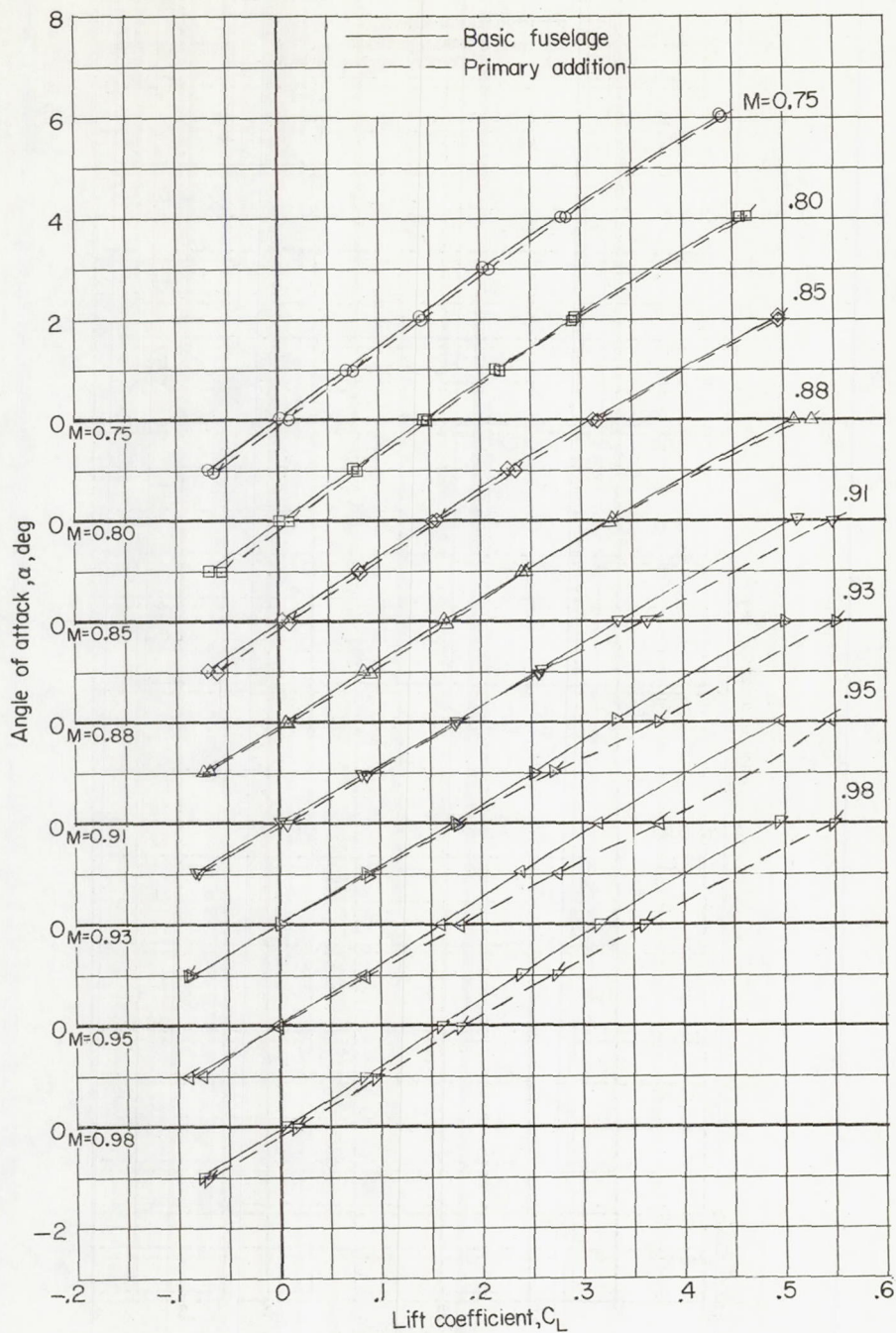

(a) Thin wing in low position; effects of primary addition.

Figure 4.- Variation of angle of attack with lift coefficient at various Mach numbers for configurations investigated.

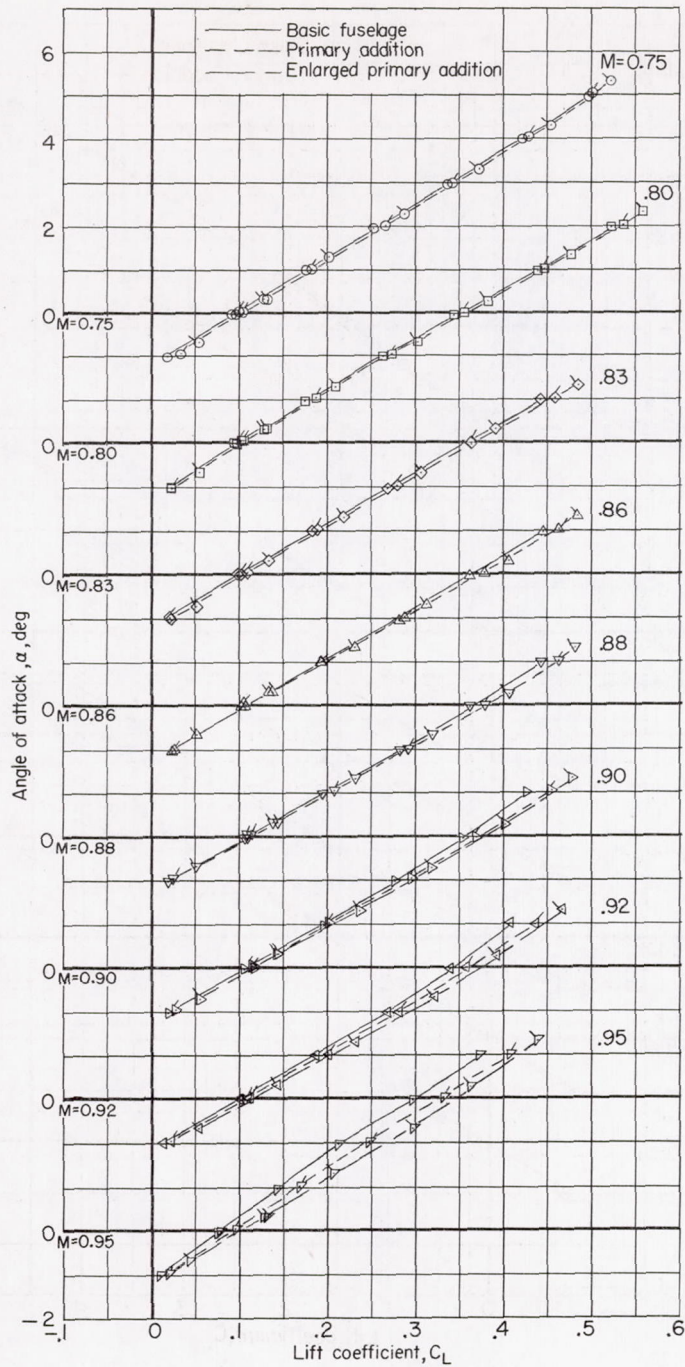

(b) Thick wing in low position; effects of primary addition.

Figure 4.- Continued.

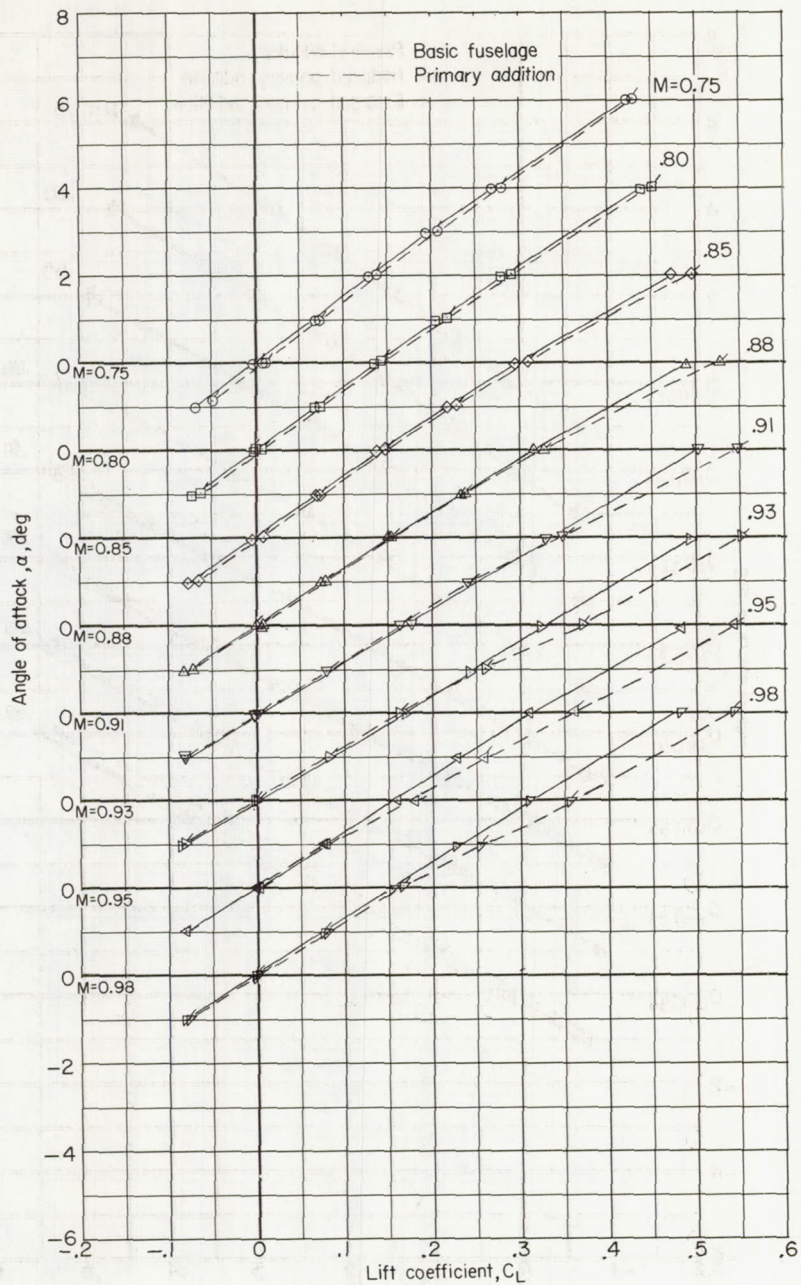

(c) Thin wing in high position; effects of primary addition.

Figure 4.- Continued.

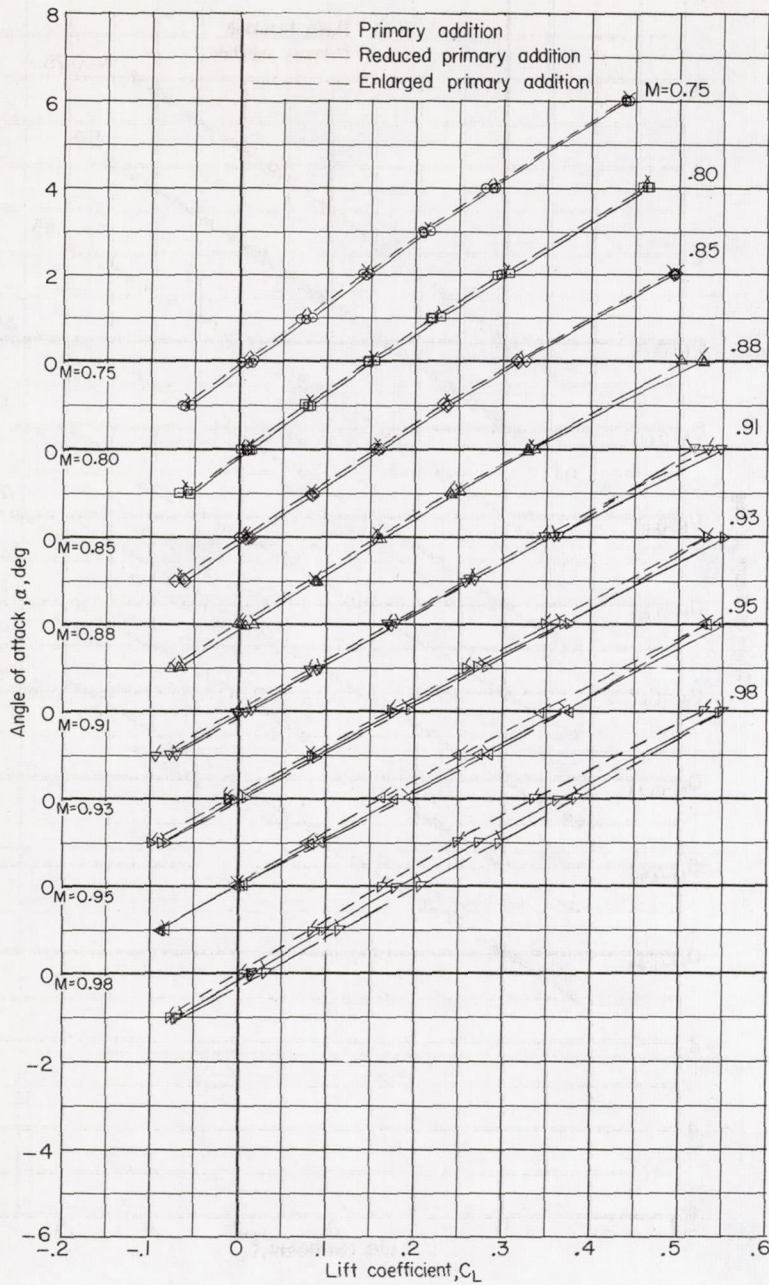

(d) Thin wing in low position; effects of addition size.

Figure 4.- Continued.

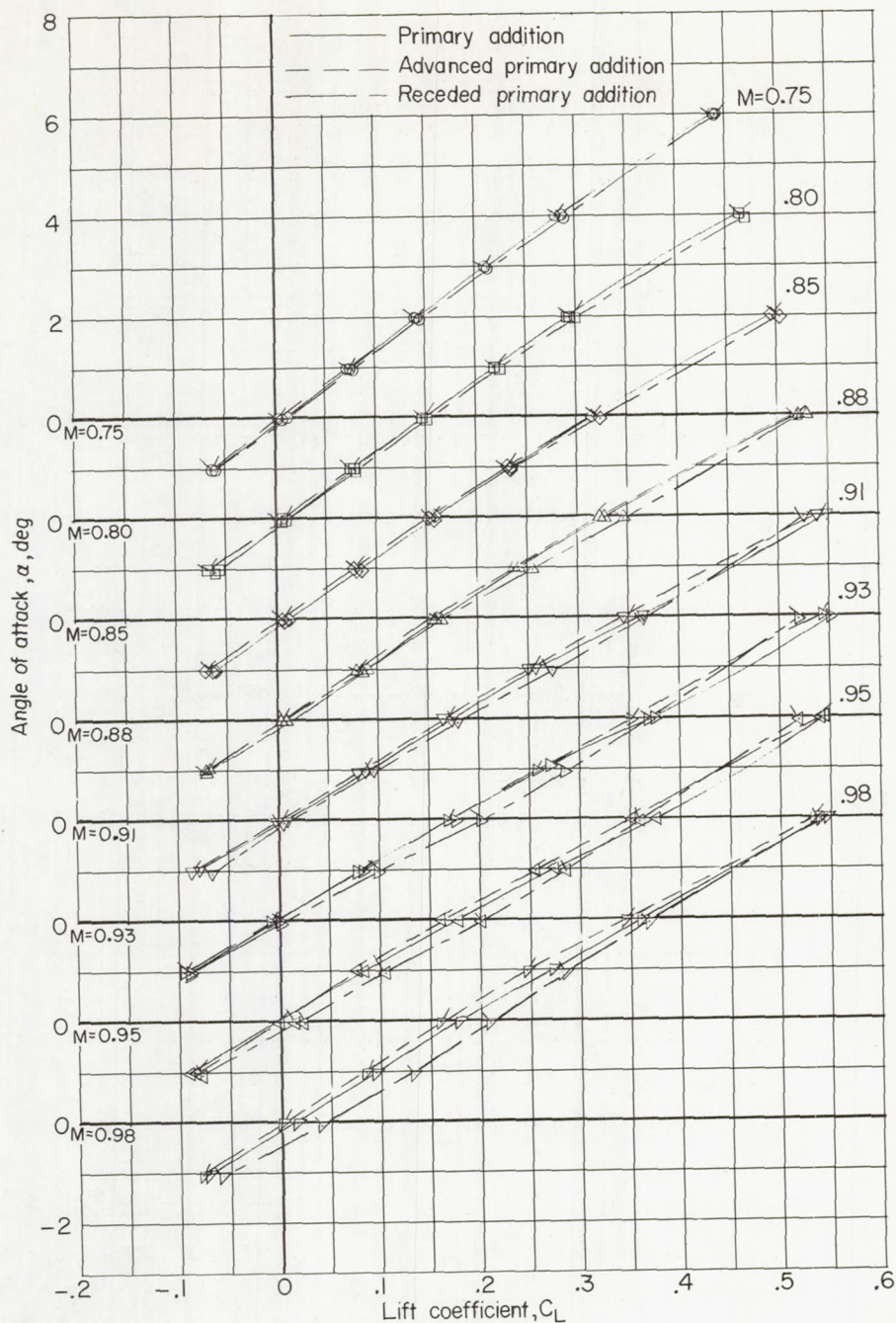

(e) Thin wing in low position; effects of longitudinal location of addition.

Figure 4.- Continued.

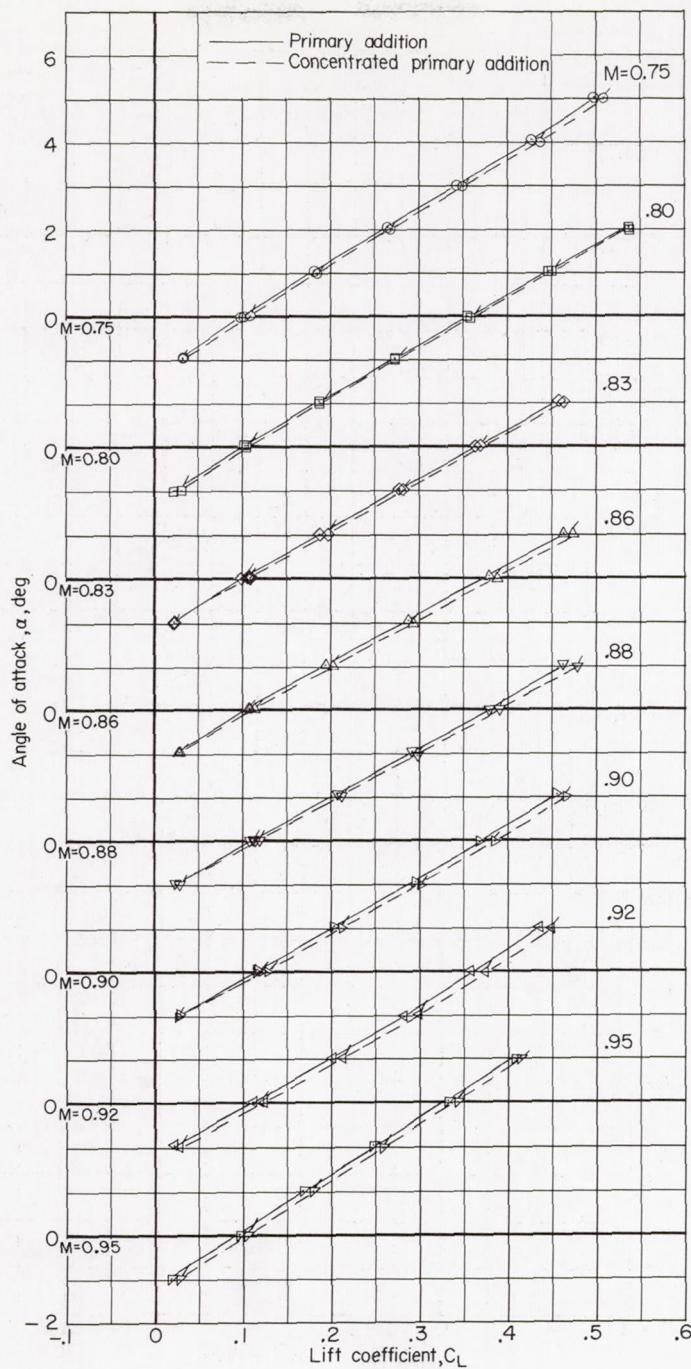

(f) Thick wing in low position; effects of concentrated primary addition.

Figure 4.- Concluded.

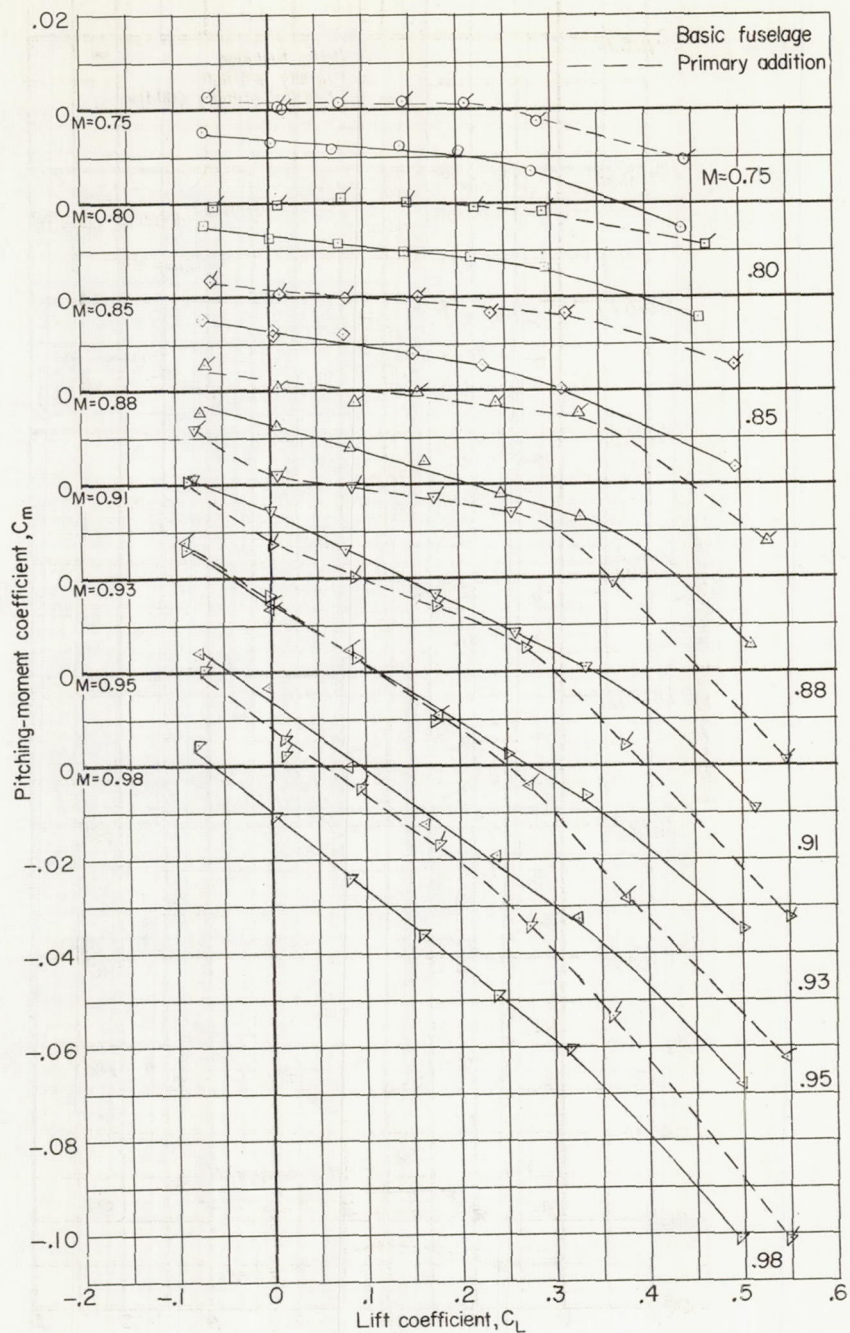

(a) Thin wing in low position; effects of primary addition.

Figure 5.- Variation of pitching-moment coefficient with lift coefficient at various Mach numbers for configurations investigated.

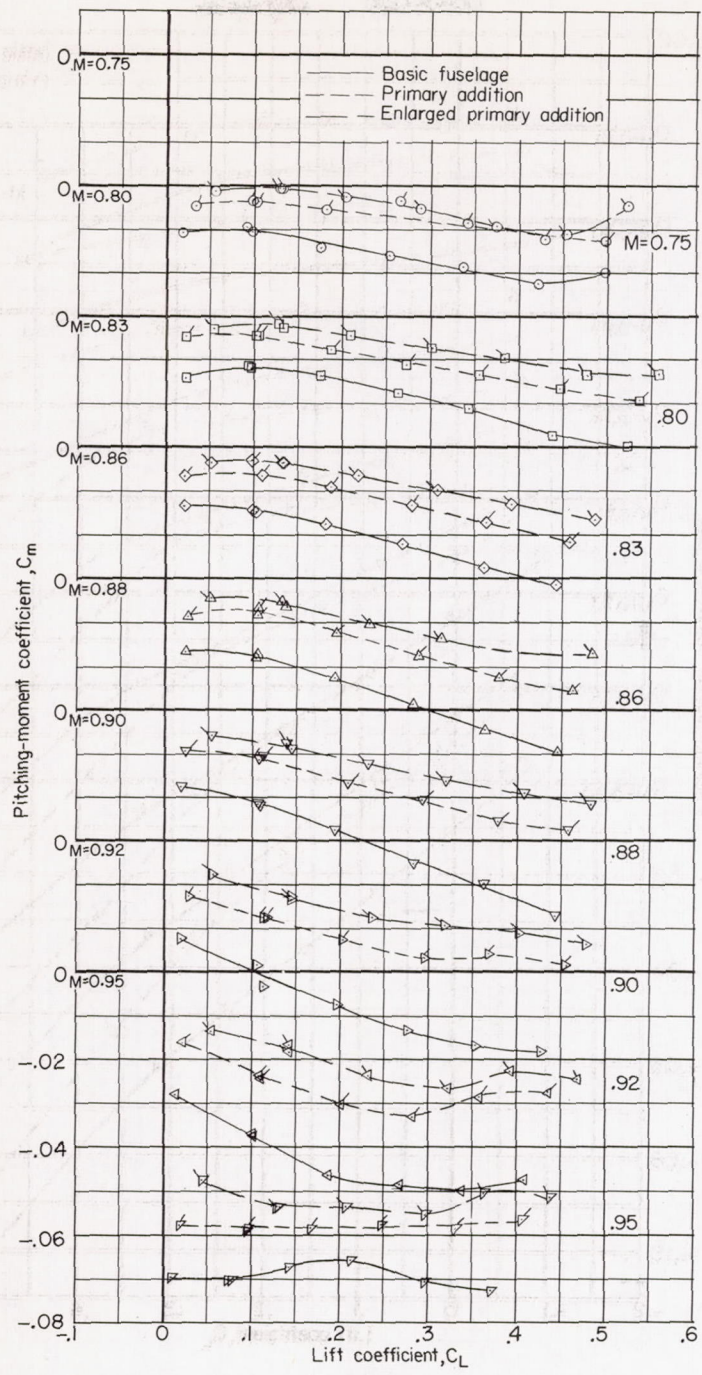

(b) Thick wing in low position; effects of primary addition.

Figure 5.- Continued.

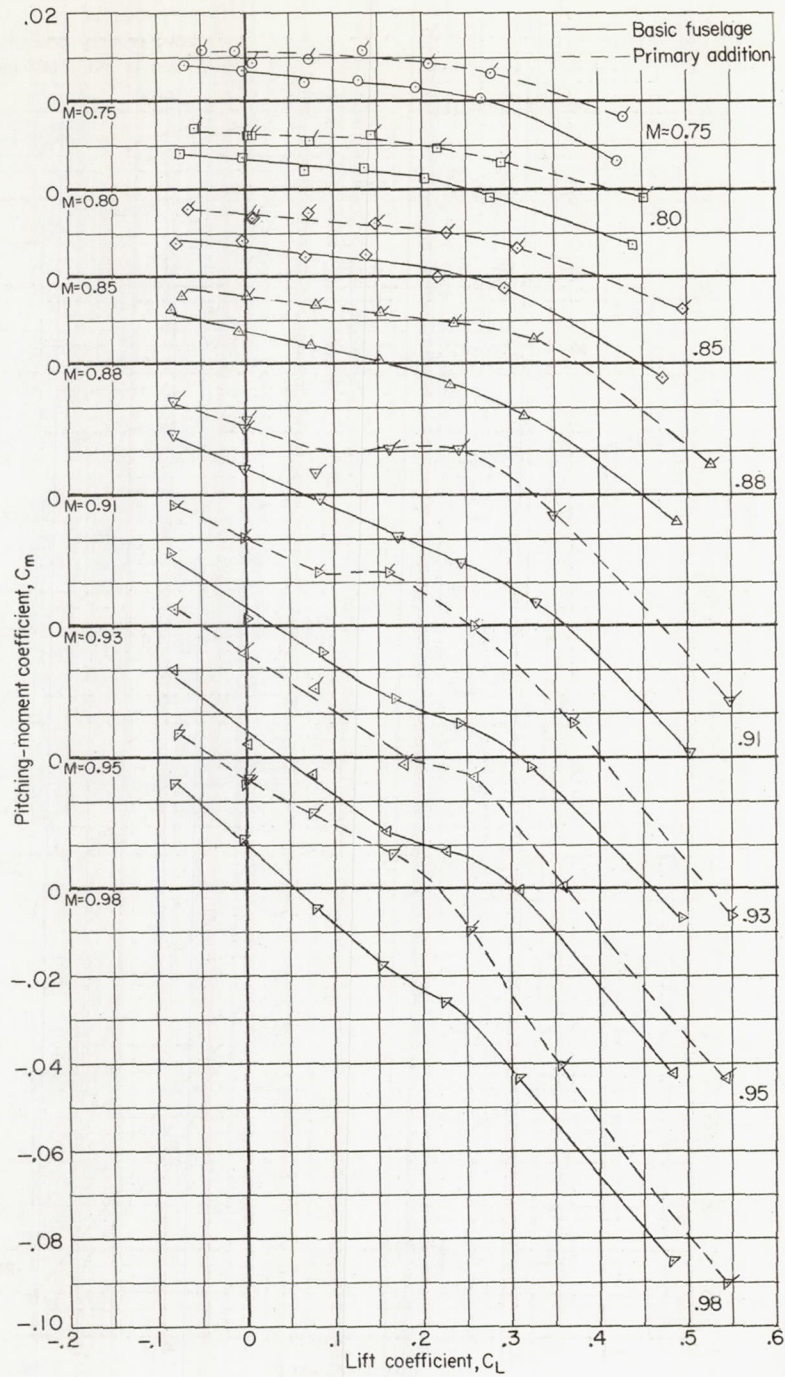

(c) Thin wing in high position; effects of primary addition.

Figure 5.- Continued.

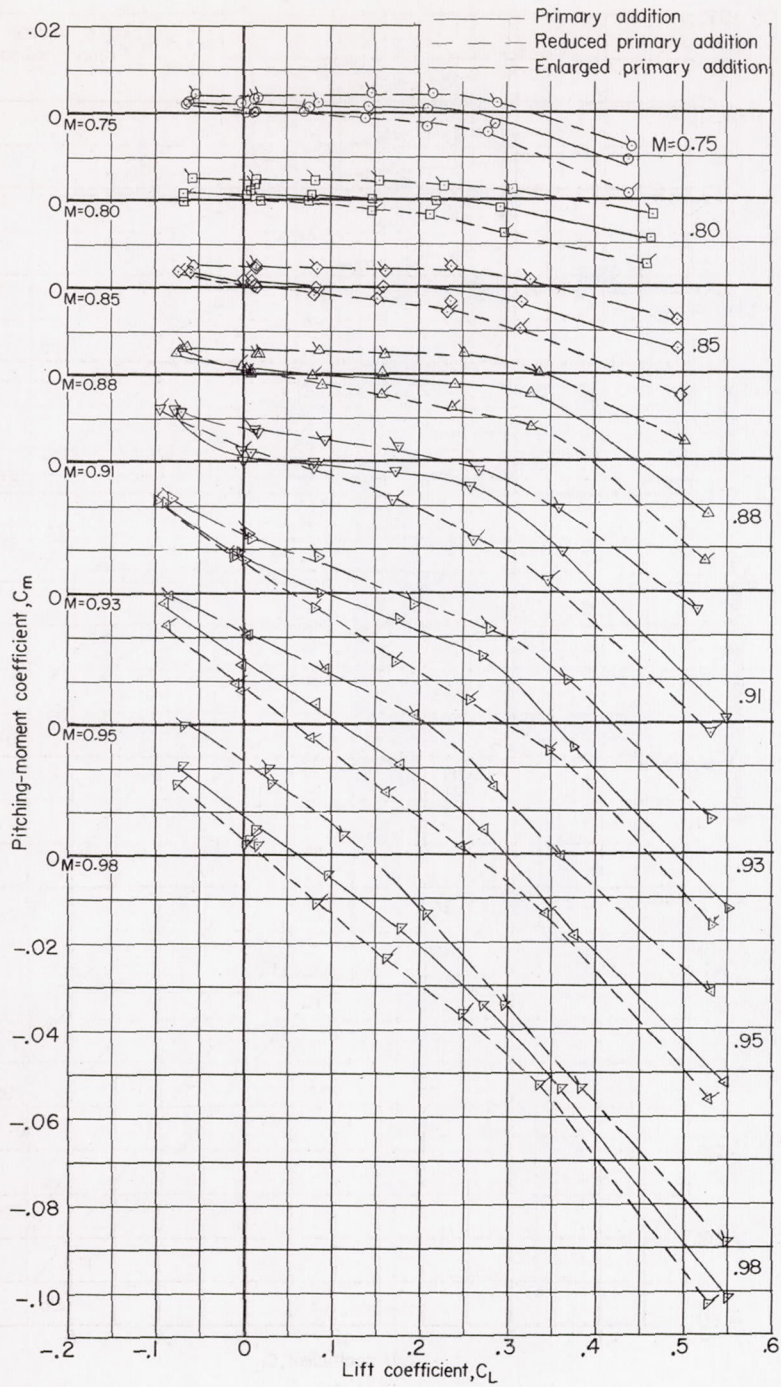

(d) Thin wing in low position; effects of addition size.

Figure 5.- Continued.

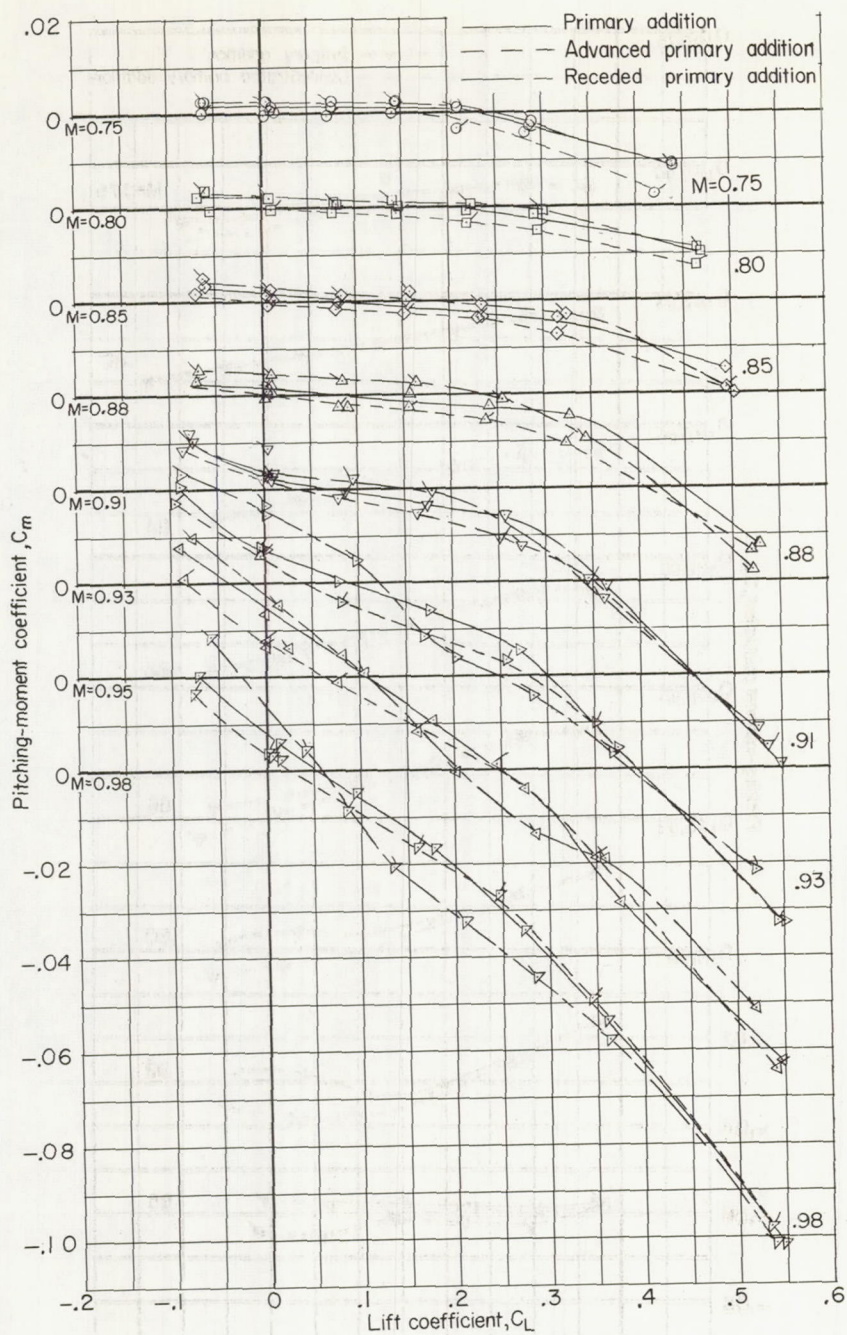

(e) Thin wing in low position; effects of longitudinal location of addition.

Figure 5.- Continued.

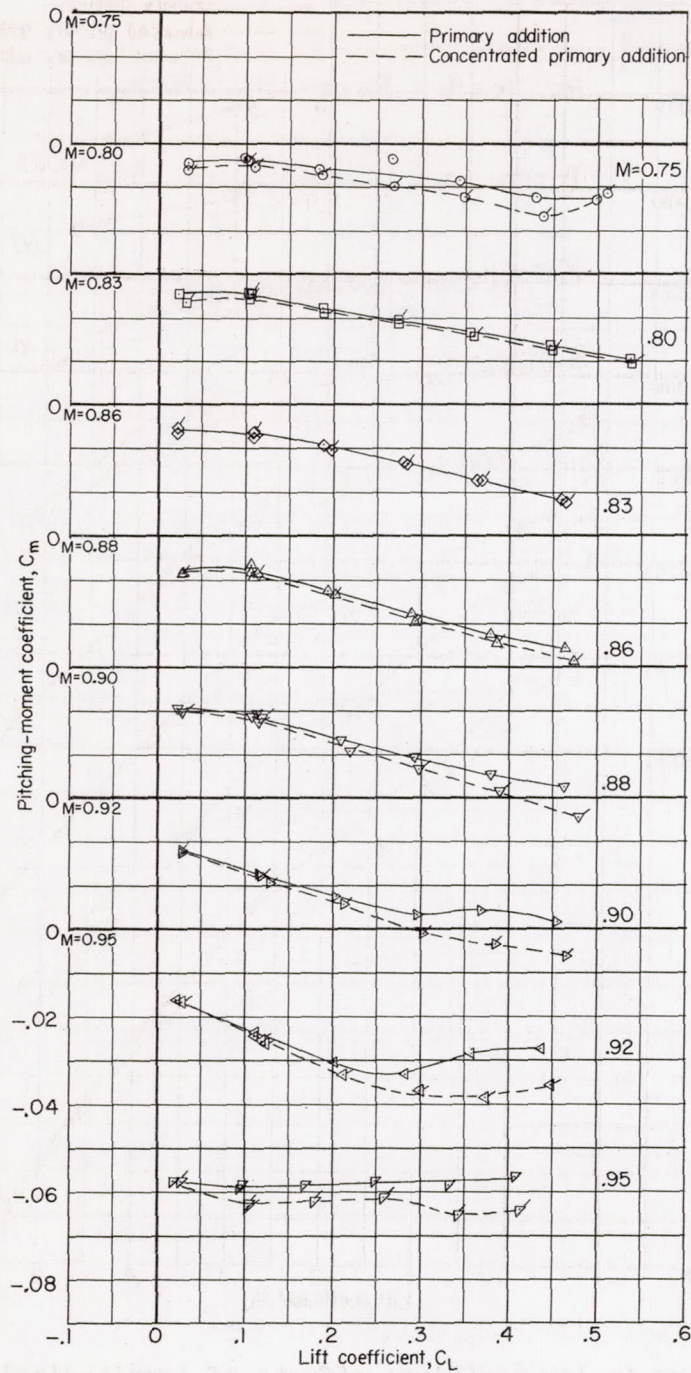

(f) Thick wing in low position; effects of concentrated primary addition.

Figure 5.- Concluded.

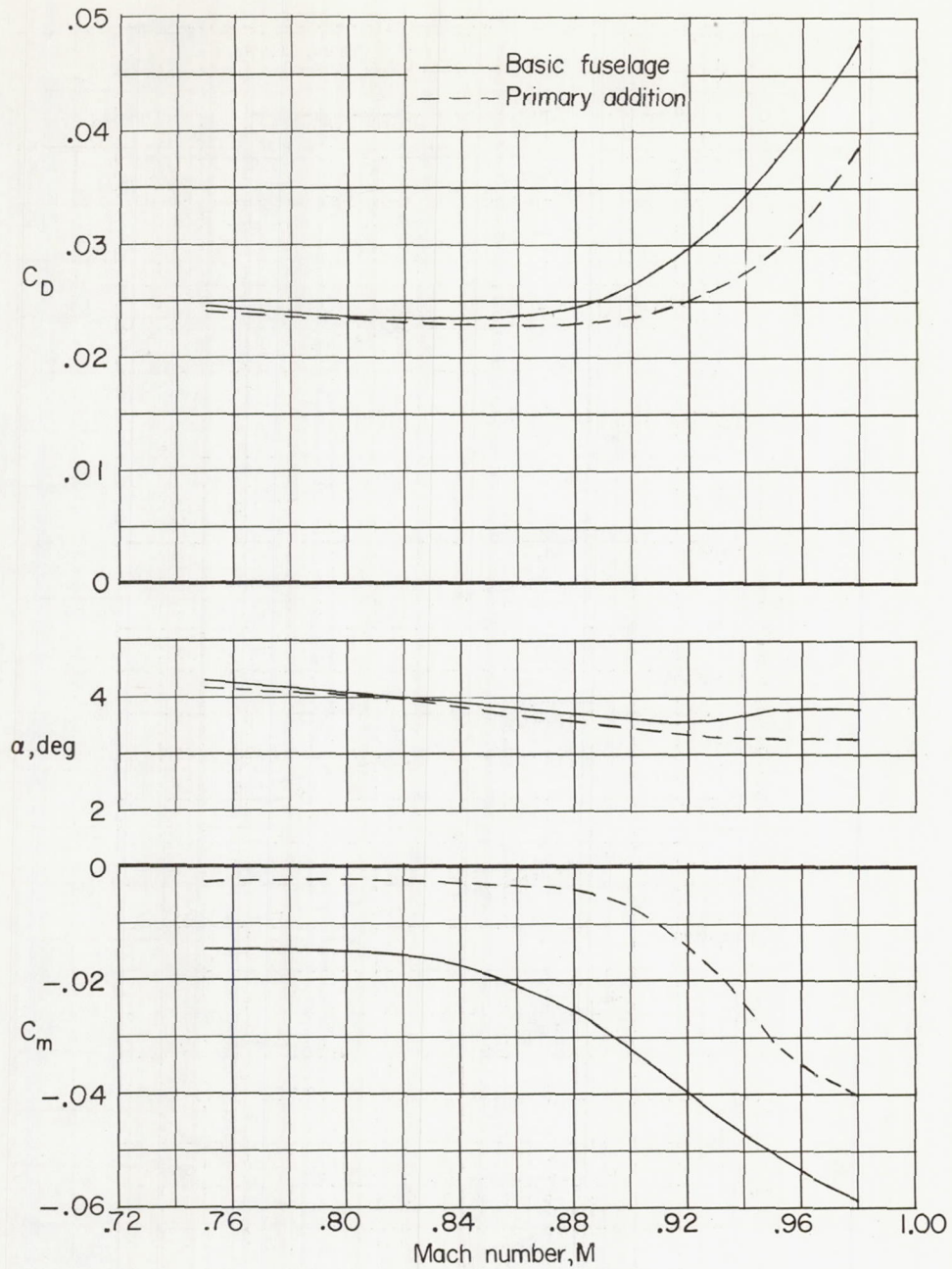

(a) Thin wing in low position; effects of primary addition.

Figure 6.- Variation of drag coefficient, angle of attack, and pitching-moment coefficients with Mach number for $C_L = 0.3$.

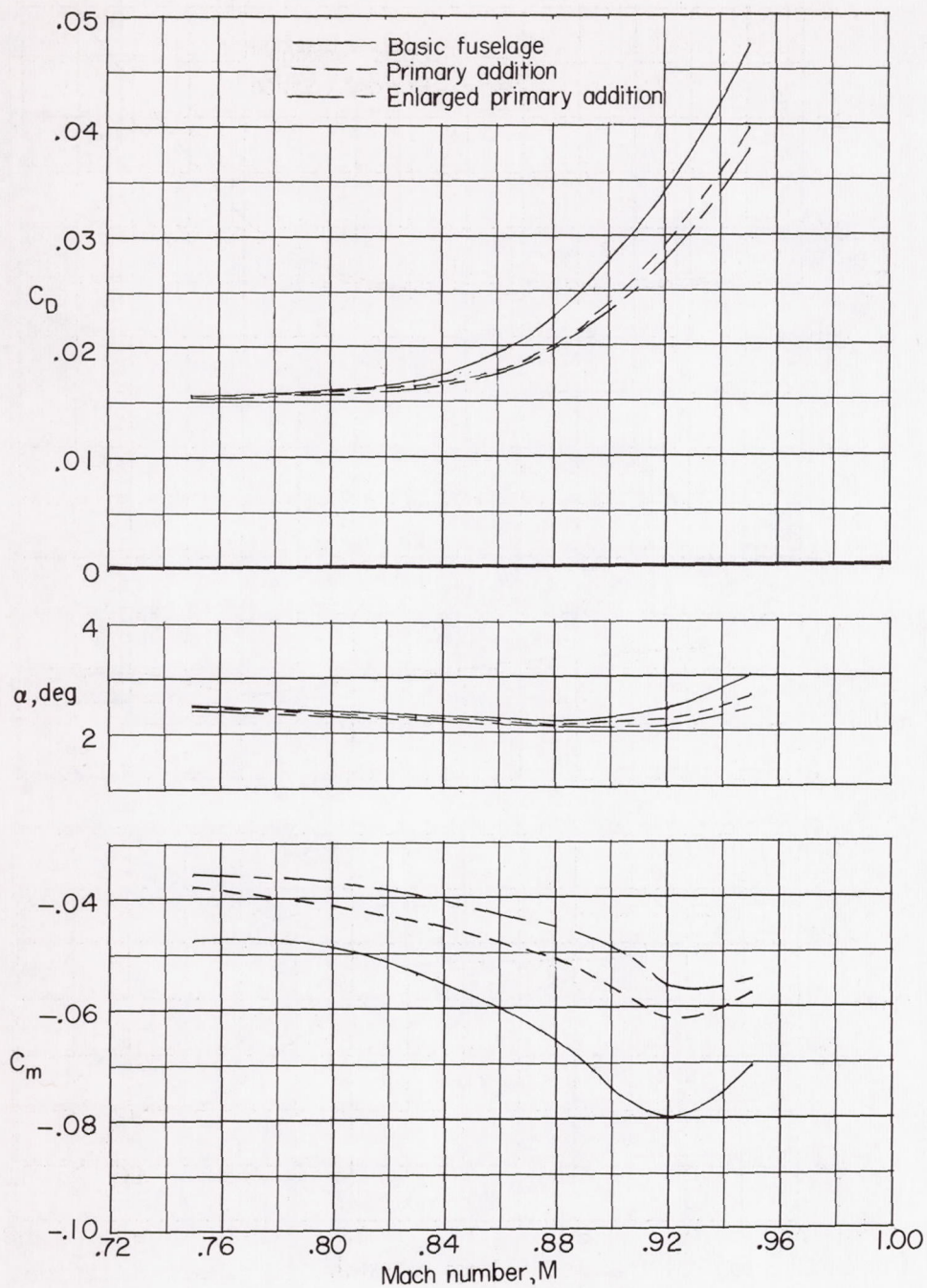

(b) Thick wing in low position; effects of primary addition.

Figure 6.- Continued.

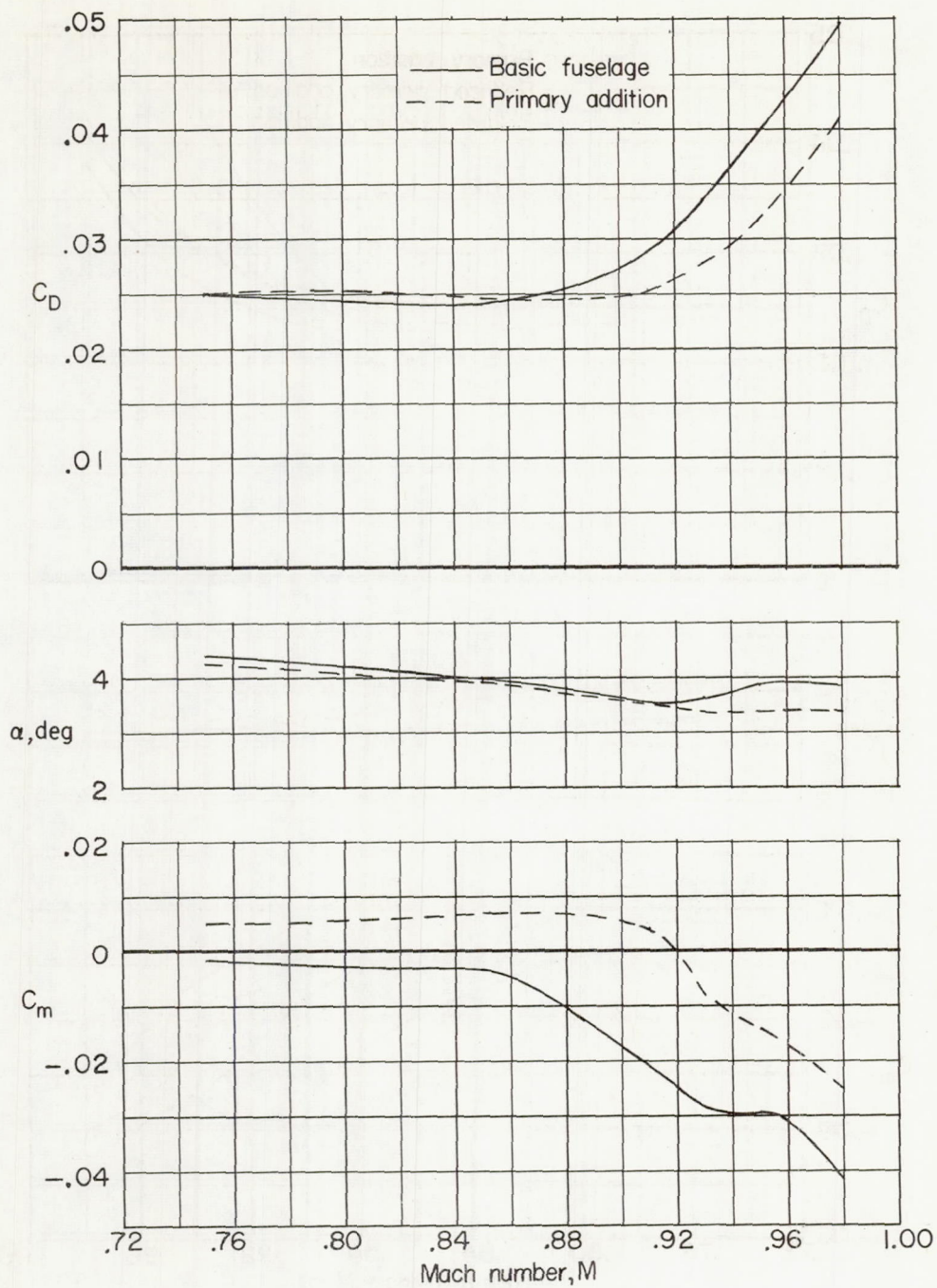

(c) Thin wing in high position; effects of primary addition.

Figure 6.- Continued.

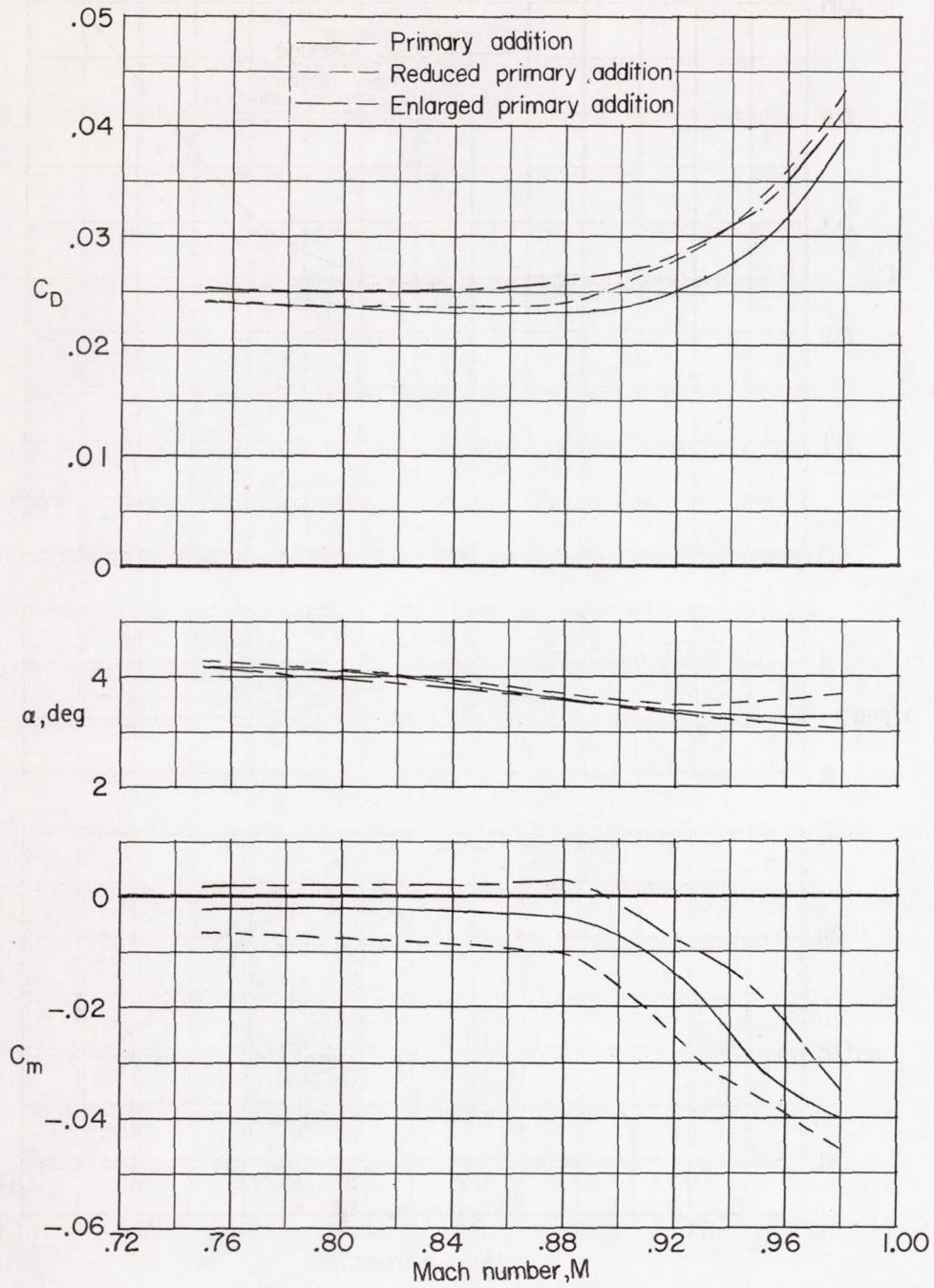

(d) Thin wing in low position; effects of addition size.

Figure 6.- Continued.

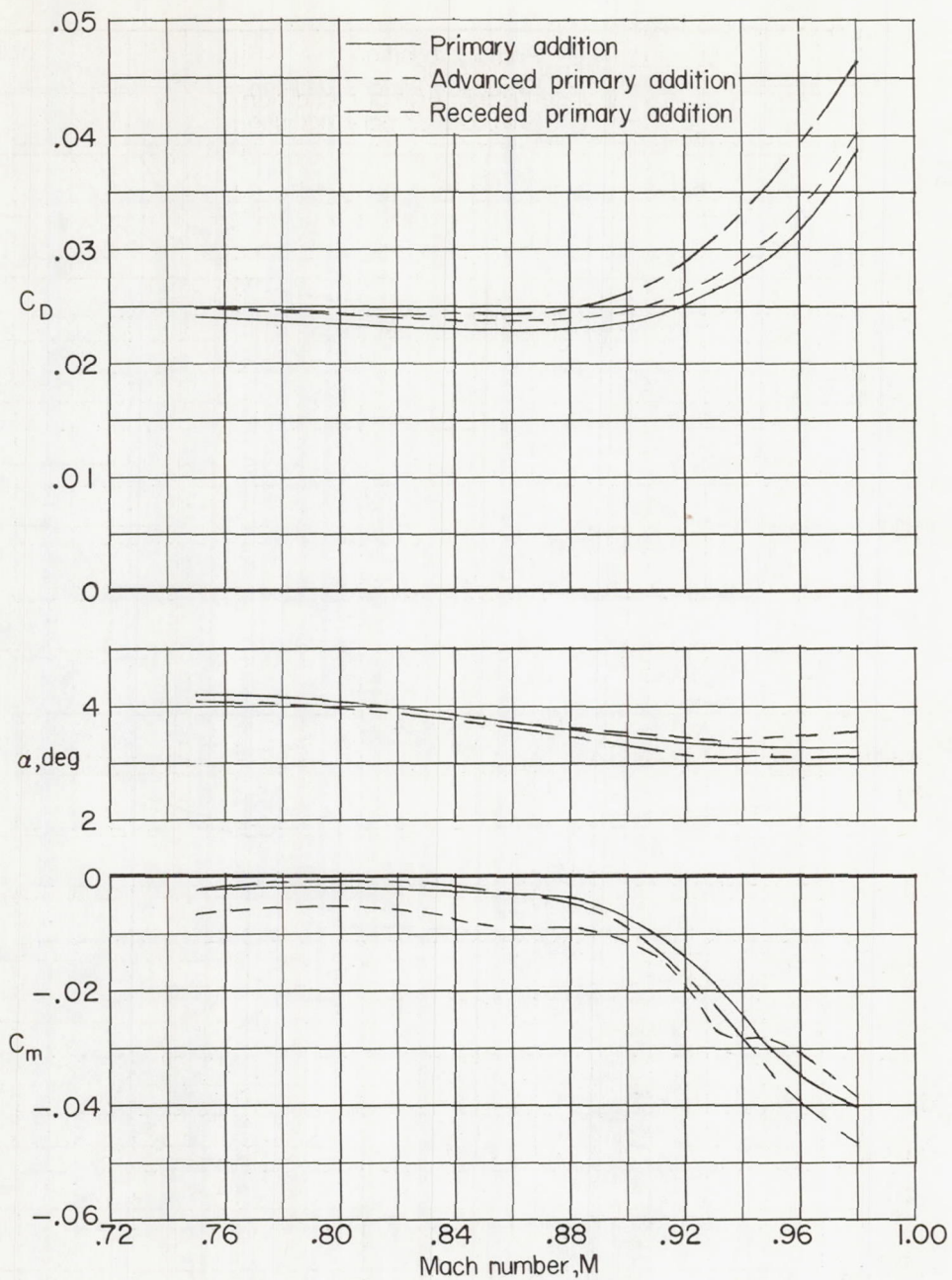

(e) Thin wing in low position; effects of longitudinal location of addition.

Figure 6.- Continued.

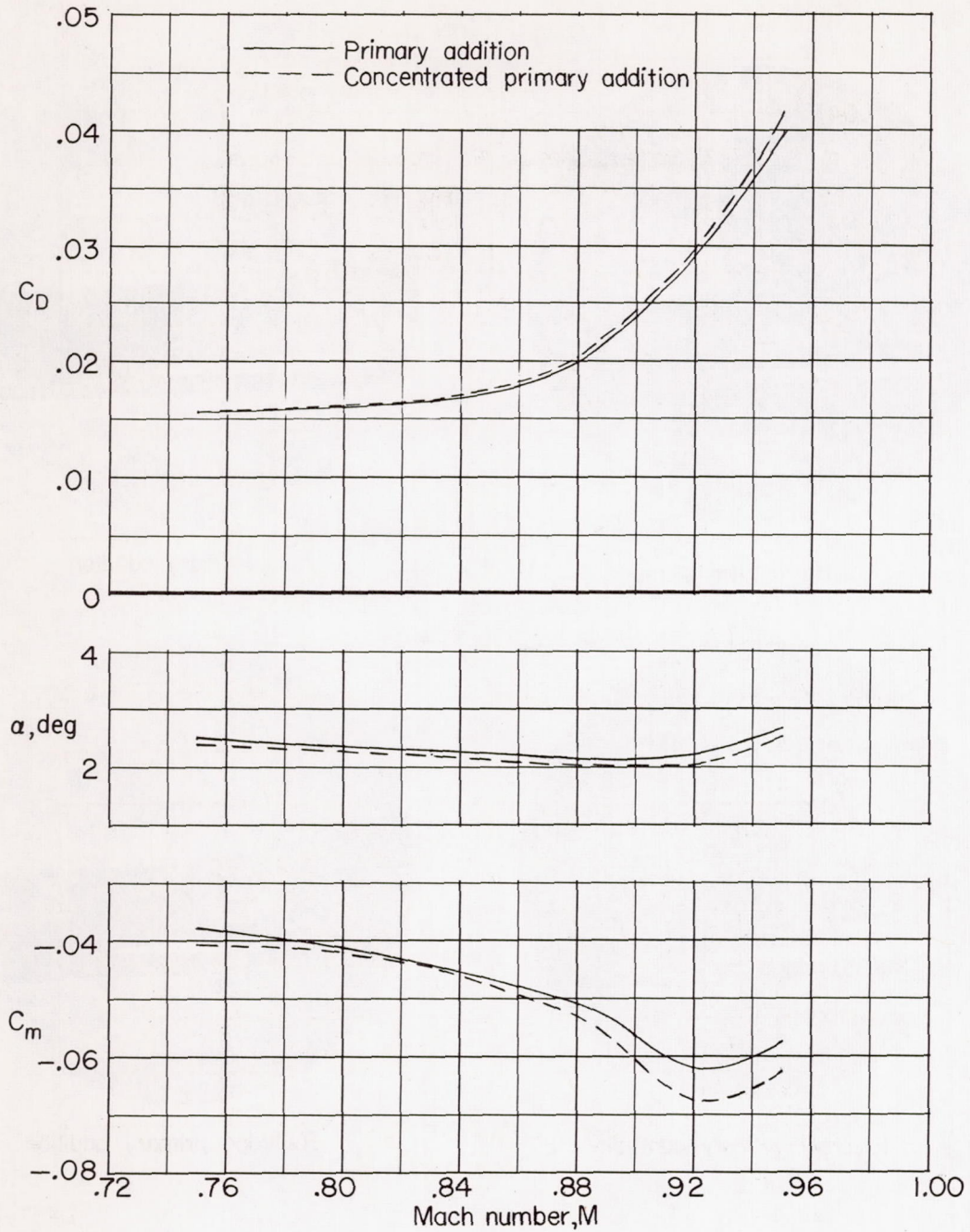

(f) Thick wing in low position; effect of concentrating primary addition.

Figure 6.- Concluded.

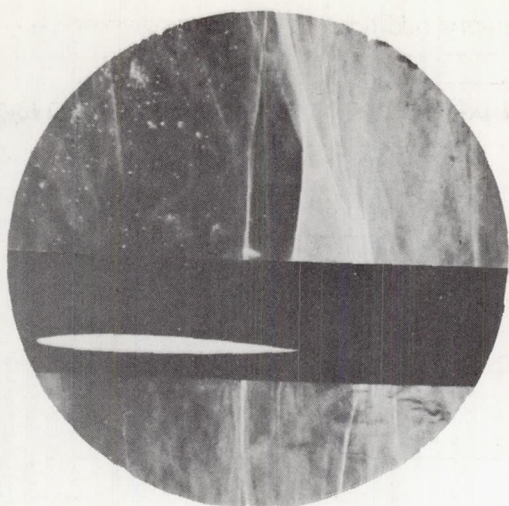

Basic fuselage

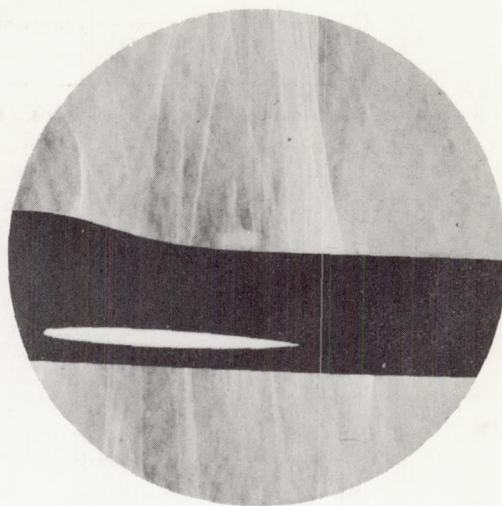

Primary addition

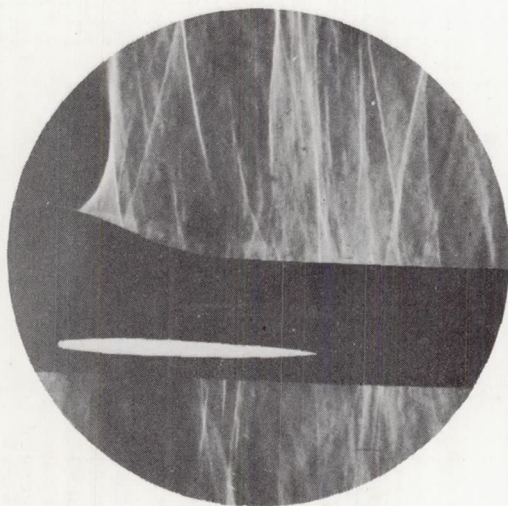

Enlarged primary addition

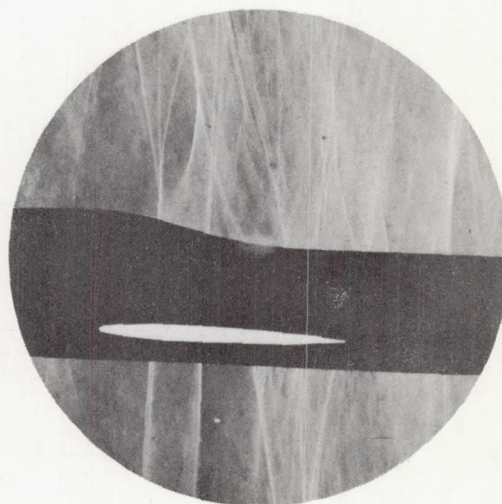

Receded primary addition

L-57-2733

Figure 7.- Schlieren photographs of wing-fuselage-juncture regions of configuration with thin wing in low position. Angle of attack, 3° ($C_L \approx 0.25$); Mach number, 0.91.