

CONFIDENTIAL

NACA RM No. L8E10



CASE FILE COPY

RESEARCH MEMORANDUM

FREE-FLIGHT INVESTIGATION OF THE ROLLING EFFECTIVENESS AT HIGH SUBSONIC, TRANSONIC, AND SUPERSONIC SPEEDS OF LEADING-EDGE AND TRAILING-EDGE AILERONS IN

CONJUNCTION WITH TAPERED AND UNTAPERED PLAN FORMS

By

H. Kurt Strass

Langley Aeronautical Laboratory
Langley Field, Va.

CLASSIFIED DOCUMENT

This document contains classified information affecting the National Defense of the United States within the meaning of the Espionage Act, USC 50:31 and 32. Its transmission or the revelation of its contents in any manner to an unauthorized person is prohibited by law. Information so classified may be imparted only to persons in the military and naval services of the United States, appropriate civilian officers and employees of the Federal Government who have a legitimate interest therein, and to United States citizens of known loyalty and discretion who of necessity must be informed thereof.

NATIONAL ADVISORY COMMITTEE FOR AERONAUTICS

WASHINGTON
July 23, 1948

CONFIDENTIAL

CLASSIFICATION CHANGED TO
UNCLASSIFIED
Authority MR. J. W. CROWLEY
CHANGE # 3047

8-17-55C

E.L.B.

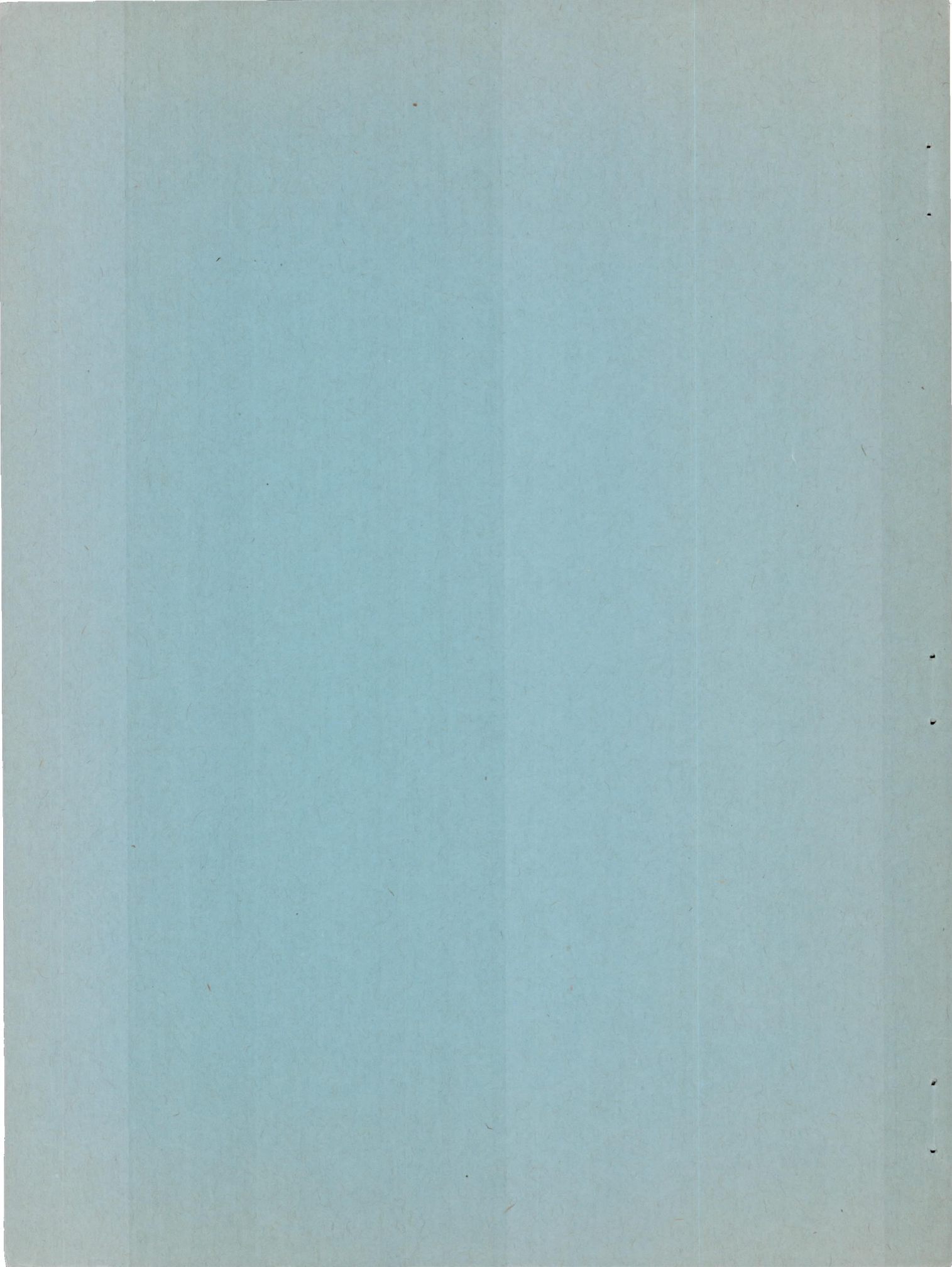

NATIONAL ADVISORY COMMITTEE FOR AERONAUTICS

RESEARCH MEMORANDUM

FREE-FLIGHT INVESTIGATION OF THE ROLLING EFFECTIVENESS AT
HIGH SUBSONIC, TRANSONIC, AND SUPERSONIC SPEEDS OF
LEADING-EDGE AND TRAILING-EDGE AILERONS IN
CONJUNCTION WITH TAPERED AND
UNTAPERED PLAN FORMS
By H. Kurt Strass

SUMMARY

Several rectangular and tapered wing configurations having leading-edge and trailing-edge ailerons have been tested as part of a general investigation of aerodynamic control at supersonic speeds which is being conducted by the Pilotless Aircraft Research Division of the Langley Laboratory utilizing rocket-propelled test vehicles.

The results show that use of the leading-edge aileron alone was ineffective or caused negative control until a high Mach number ($M \approx 1.4$) was attained. Above this Mach number the leading-edge aileron showed increasing effectiveness up to the highest Mach number reached ($M \approx 1.75$).

The leading-edge and trailing-edge ailerons in conjunction with the tapered plan form maintained good control over the entire Mach number range tested, with the rolling effectiveness $\frac{pb/2V}{\delta_a}$ always exceeding 50 percent of the value at $M = 0.8$, the effect of taper in plan form and thickness distribution being to minimize any abrupt changes in the variation of rolling effectiveness with Mach number.

INTRODUCTION

As part of a general investigation of wing-aileron rolling effectiveness being conducted by the Pilotless Aircraft Research Division utilizing rocket-propelled test vehicles in free flight at transonic and supersonic speeds, several wing configurations having leading-edge and trailing-edge ailerons have been tested.

This arrangement may have three advantages. At present it is being used to provide high lift at low forward speeds by drooping both the

leading-edge and trailing-edge ailerons. Also, it may be possible by means of a suitable linkage of the leading-edge and trailing-edge ailerons to partly balance their respective hinge moments. The third possible advantage is that the pitching moments generated by the leading-edge and trailing-edge ailerons may be partly counteracted, thus keeping the wing twist to a minimum. Recent unpublished information based on tests conducted in the Langley 9- by 12-inch supersonic blow down tunnel at $M = 1.9$ on a wing of similar configuration to the tapered one discussed in this report indicates that the possibility of counterbalancing more than a small fraction of the total hinge moment is remote. However, the pitching moments generated by the two ailerons nullify each other to a large extent.

The main purpose of the present tests was to determine the rolling-effectiveness characteristics of such an arrangement over a range of transonic and supersonic speeds. The RM-5 technique used is described fully in references 1, 2, and 3. In the present tests, two wing plan forms were employed: one wing was untapered and unswept; the other was highly tapered and unswept at the 50-percent-chord line. In conjunction with both plan forms, plain full-span leading-edge and trailing-edge ailerons were tested individually and in combination with each other.

SYMBOLS

$pb/2V$	wing-tip helix angle, radians
p	rolling velocity, radians per second
b	diameter of circle swept by wing tips, feet (with regard to rolling characteristics, this diameter is considered to be the effective span of the three-fin RM-5 models)
V	flight-path velocity, feet per second
C_D	drag coefficient based on total exposed wing area of 1.563 square feet
M	Mach number
b_1	diameter of circle swept by wing tips minus fuselage diameter
S_1	exposed area of two wing panels
A	exposed aspect ratio $\left(\frac{b_1^2}{S_1} \right)$

c	average exposed wing chord parallel to model center line
t	maximum wing thickness
δ_e	aileron deflection measured in plane perpendicular to chord plane and parallel to model center line

MODELS AND TESTS

Models

The general arrangement of the RM-5 test vehicles used in the present investigation is shown in figure 1. A photograph of a test vehicle with booster on the launcher is shown in figure 2.

The general arrangement of the wing-aileron configuration tested is shown in figures 3 and 4. For the untapered wings tested the airfoil section, which was of 0.049 thickness ratio, consisted of a flat-sided central section with fore and aft sections consisting of circular arcs which were tangent to the upper and lower surfaces at the 0.13 chord and 0.80 chord points, respectively, and which intersected at the leading edge and trailing edge. The leading-edge and trailing-edge ailerons were formed by deflecting the chord line at the 0.13 and the 0.80 chord points, respectively. The ailerons aerodynamically simulated sealed unbalanced ailerons. For the tapered wings tested (which were tapered in plan form and thickness distribution) the airfoil section at the center of the exposed semispan and parallel to the model center line was identical to the section used in the untapered wings. The ailerons were of constant chord equal to chords of the ailerons on the untapered wings. For all configurations, the exposed wing area was 1.563 square feet and the aspect ratio A was 1.75.

Tests

The launching of the test vehicles is accomplished at the Wallops Island test facility. The test vehicles are propelled by a two-stage rocket propulsion system to a Mach number of about 1.8. During a 10-second period of coasting flight following rocket-motor burnout, time histories of the rolling velocity are obtained with special radio equipment and the flight-path velocity obtained by the use of Doppler radar. These data, in conjunction with atmospheric data obtained with radiosondes, permit the evaluation of the aileron rolling effectiveness

in terms of the parameter $\frac{pb/2V}{\delta_a}$ as a function of Mach number. In

addition, the variation of drag coefficient with Mach number is obtained by a method involving the differentiation of the curve of flight-path velocity against time for power-off flight. The variation in Reynolds number with Mach number for the range of climatic conditions encountered during the tests is presented in figure 5. A more complete discussion of the testing technique is contained in references 1, 2, and 3.

The experimental accuracy is estimated to be within the following limits, although duplicate models tested during this investigation showed much better agreement:

$\frac{pb/2V}{\delta_a}$ (due to model constructional accuracy)	± 0.001
$\frac{pb/2V}{\delta_a}$ (due to limitations on the instrumentation).	± 0.0005
C_D (at subsonic speeds).	± 0.003
C_D (at supersonic speeds).	± 0.002
M	± 0.01

Inertia effects on the experimental values are believed to be negligible everywhere except in the regions where there are large changes in rolling velocity which generally occur between $M = 0.85$ and $M = 1.0$. In the region where the greatest changes in rolling velocity are experienced, the measured value may be in error by as much as 20 per cent, but on either side of this region the error is approximately 2 or 3 percent. (See reference 1.)

RESULTS AND DISCUSSION

The results of the present tests are shown in figures 6 and 7 as curves of $\frac{pb/2V}{\delta_a}$ and C_D against Mach number. It should be noted that the quantity $\frac{pb/2V}{\delta_a}$ is the ratio of $pb/2V$ to aileron deflection for a given aileron deflection and it is not intended to indicate the rate of change of $pb/2V$ with δ_a inasmuch as this relation may not be linear for certain Mach number ranges.

Untapered Configurations

Untapered plan form with 0.20-chord trailing-edge aileron only. - The rolling-effectiveness characteristics of the untapered wing with trailing-edge aileron deflected 5° (RM-5 Model 100) are shown in figure 6. In general, the variation of the rolling effectiveness with Mach number for this configuration is similar to that obtained previously for rectangular wings (reference 3). The configuration of the present tests exhibited a large reduction of effectiveness in the Mach number range from about 0.70 to 0.93, an abrupt increase of effectiveness in the Mach number range from about 0.95 to 1.00, and a continuous reduction of effectiveness above $M = 1.0$ to the maximum Mach number attained ($M \approx 1.7$). The effectiveness at $M = 1.7$ was about 27 percent of that at $M = 1.0$.

Untapered plan form with 0.13-chord leading-edge aileron only. - The rolling-effectiveness characteristics of the untapered wing with the leading-edge aileron deflected 5° (RM-5 Model 101) are shown in figure 6. The effectiveness of this configuration was zero or slightly negative for the subsonic region tested until $M = 0.92$ when a large negative gradient in the effectiveness curve developed which continued until a value of -0.0032 for $\frac{pb/2V}{\delta_a}$ was reached at $M = 1.0$. After this point,

the trend reversed and the rolling effectiveness gradually became more positive until at $M = 1.78$ the effectiveness had a maximum value of 0.0043 with indications of a further increase of effectiveness with Mach number. The configuration was ineffective or had opposite control for the Mach number range from $M = 1.46$ to the lowest value obtained ($M = 0.72$). Reference 4 presents further tests of a similar type airfoil in two-dimensional flow at low speeds which showed that the leading-edge aileron was relatively poor as a lift-generating device when used alone.

Untapered plan form with 0.13-chord leading-edge aileron in conjunction with the 0.20-chord trailing-edge aileron. - The results for the 0.13-chord leading-edge aileron deflected 5° in conjunction with the 0.20-chord trailing-edge aileron deflected 5° (RM-5 Model 102) are also presented in figure 6. The results for this configuration exhibit approximately the same characteristics as the summation of the results of the leading-edge and trailing-edge controls taken separately. In the region between $M = 0.80$ and $M = 1.05$, the effectiveness for the combination of leading-edge and trailing-edge controls was essentially the same as the trailing edge alone. However, in the region between $M = 1.05$ and $M = 1.45$, the combination had a marked decrease in effectiveness when compared with the trailing-edge aileron only. Above $M = 1.45$, the leading-edge aileron in conjunction with the trailing-edge aileron showed increasing effectiveness until the maximum Mach number of 1.76 was attained with the trend towards a still higher value of $\frac{pb/2V}{\delta_a}$ with increasing Mach number.

Tapered Configurations

Configuration with taper of 0.2.- The effect of taper in plan form and thickness on the rolling characteristics of all the configurations tested was to reduce the magnitude of any discontinuities existing in the variation of $\frac{pb/2V}{\delta_a}$ with Mach number.

Tapered plan form with 0.20-chord trailing-edge aileron only.- The variation of rolling effectiveness with Mach number for the configuration with the 0.20-chord trailing-edge aileron only deflected 5° (RM-5 Model 103) is presented in figure 7. This configuration exhibited a decrease of effectiveness in the Mach number range from $M \approx 0.93$ to $M \approx 0.95$ which was relatively small when compared to the untapered wing of figure 6. An abrupt increase in effectiveness is evident in the region between $M = 0.95$ to $M \approx 1.0$ when a continuous decrease in effectiveness started which continued until the highest Mach number attained for the test was reached at $M \approx 1.75$. The value for $\frac{pb/2V}{\delta_a}$ at this point was approximately 55 percent of the value at $M = 1.0$.

Tapered plan form with 0.13-chord leading-edge aileron only.- The rolling-effectiveness characteristics of the configuration with the 0.13-chord leading-edge aileron (RM-5 Model 104) only is presented in figure 7. This configuration exhibited little or zero effectiveness in the Mach number region from $M \approx 0.7$ to $M = 0.92$ when a sudden change in the variation of $\frac{pb/2V}{\delta_a}$ with Mach number resulted in the effectiveness curve reaching a value of -0.0013 at $M = 1.0$. There was little change in rolling effectiveness until $M = 1.2$ when the values of $\frac{pb/2V}{\delta_a}$ with Mach number began to become increasingly positive until at the highest Mach number attained ($M = 1.675$) the value of $\frac{pb/2V}{\delta_a}$ was 0.0019 . This configuration was similar to the untapered case in that it had opposite control in the region from $M \approx 0.92$ to 1.35 .

Tapered plan form with 0.13-chord leading-edge aileron in conjunction with the 0.20-chord trailing-edge aileron.- The results for the 0.13-chord leading-edge aileron deflected 5° in conjunction with the 0.20-chord trailing-edge aileron deflected 5° (RM-5 Model 105) are also presented in figure 7. As with the untapered case, this configuration had approximately the same rolling characteristics as the summation of the leading-edge and trailing-edge controls taken separately. In the Mach number region between $M \approx 0.80$ and $M \approx 1.30$ the leading-edge aileron in conjunction with the trailing-edge aileron exhibited similar characteristics to the trailing edge taken alone. However, at $M \approx 1.3$ the combination

of leading-edge and trailing-edge controls gained in effectiveness with increasing Mach number up to the highest value obtained, $M \approx 1.75$, with indications of a continuing increase with Mach number. The rolling effectiveness never dropped below 50 percent of the value at $M = 0.80$.

Drag Measurements

The drag-coefficient data obtained in the present investigation are included as a matter of interest and to illustrate the relation between transonic drag rise and control effectiveness. In examining these data, consideration should be made of the section angle-of-attack distribution along the wing span caused by model rotation. An interesting point to consider is the fact that within the accuracy of measurement the variation of drag coefficient with Mach number exhibited little change with aileron configuration on a given wing plan form.

CONCLUSIONS

The following conclusions are indicated by the results of flight tests of simulated plain, sealed, full-span, 0.13-chord leading-edge and 0.20-chord trailing-edge ailerons on wings of untapered and tapered plan forms:

1. The leading-edge aileron alone exhibited little or negative control until a high Mach number ($M \approx 1.4$) was reached when the rolling effectiveness became positive and exhibited a tendency to increase with Mach number up to the highest Mach number tested ($M \approx 1.75$).
2. The variation of effectiveness with Mach number for the trailing-edge aileron alone was typical for this type of control based on previous flight tests.
3. The effect of taper in plan form and thickness was to reduce the discontinuities in the variation of rolling effectiveness with Mach number.
4. The leading-edge and trailing-edge combination in conjunction with the tapered plan form maintained good control over the entire Mach number range tested. The rolling effectiveness never dropped below 50 percent of the value at $M = 0.80$.

Langley Aeronautical Laboratory
National Advisory Committee for Aeronautics
Langley Field, Va.

REFERENCES

1. Sandahl, Carl A., and Marino, Alfred A.: Free-Flight Investigation of Control Effectiveness of Full-Span 0.2-Chord Plain Ailerons at High Subsonic, Transonic, and Supersonic Speeds to Determine Some Effects of Section Thickness and Wing Sweepback. NACA RM No. L7D02, 1947.
2. Sandahl, Carl A.: Free-Flight Investigation of Control Effectiveness of Full-Span, 0.2-Chord Plain Ailerons at High Subsonic, Transonic, and Supersonic Speeds to Determine Some Effects of Wing Sweepback, Taper, Aspect Ratio, and Section Thickness Ratio. NACA RM No. L7F30, 1947.
3. Sandahl, Carl A., and Strass, H. Kurt: Additional Results in a Free-Flight Investigation of Control Effectiveness of Full-Span, 0.2-Chord Plain Ailerons at High Subsonic, Transonic, and Supersonic Speeds to Determine Some Effects of Wing Sweepback, Aspect Ratio, Taper, and Section Thickness Ratio. NACA RM No. L7L01, 1948.
4. Underwood, William J., and Nuber, Robert J.: Two Dimensional Wind-Tunnel Investigation at High Reynolds Number of Two Symmetrical Circular-Arc Airfoil Sections with High-Lift Devices. NACA RM No. L6K22, 1947.

CONFIDENTIAL

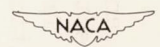
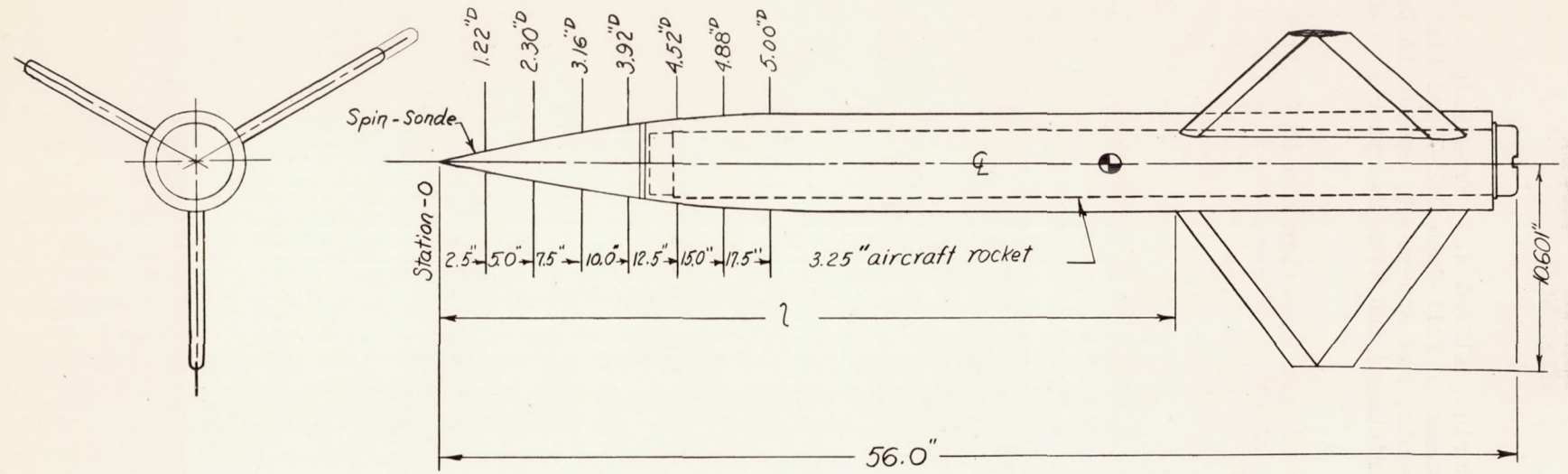

untapered	tapered
43.7"	38.5"

CONFIDENTIAL

FIGURE 1 - GENERAL ARRANGEMENT OF RM-5 MODELS.

1871

1871

1871

CONFIDENTIAL

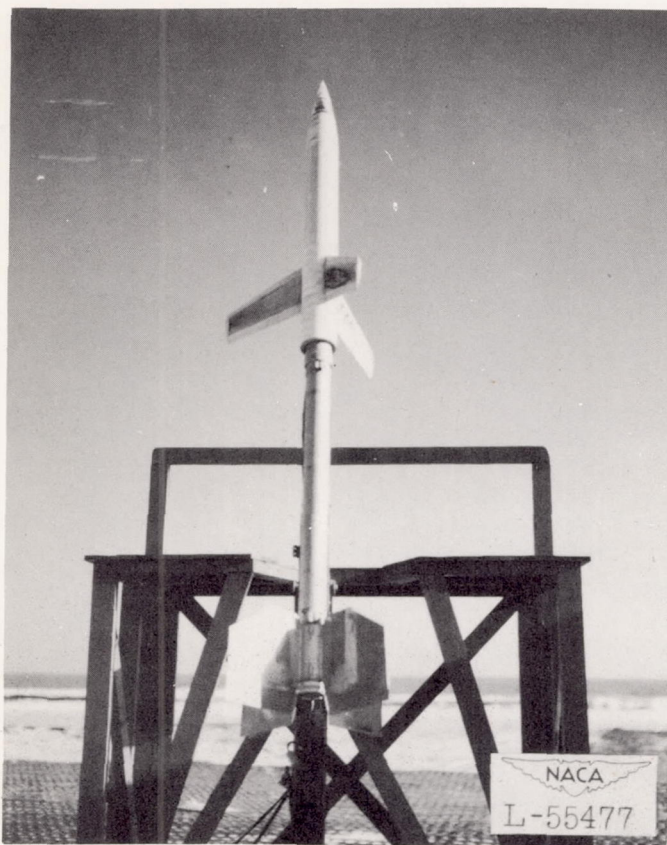
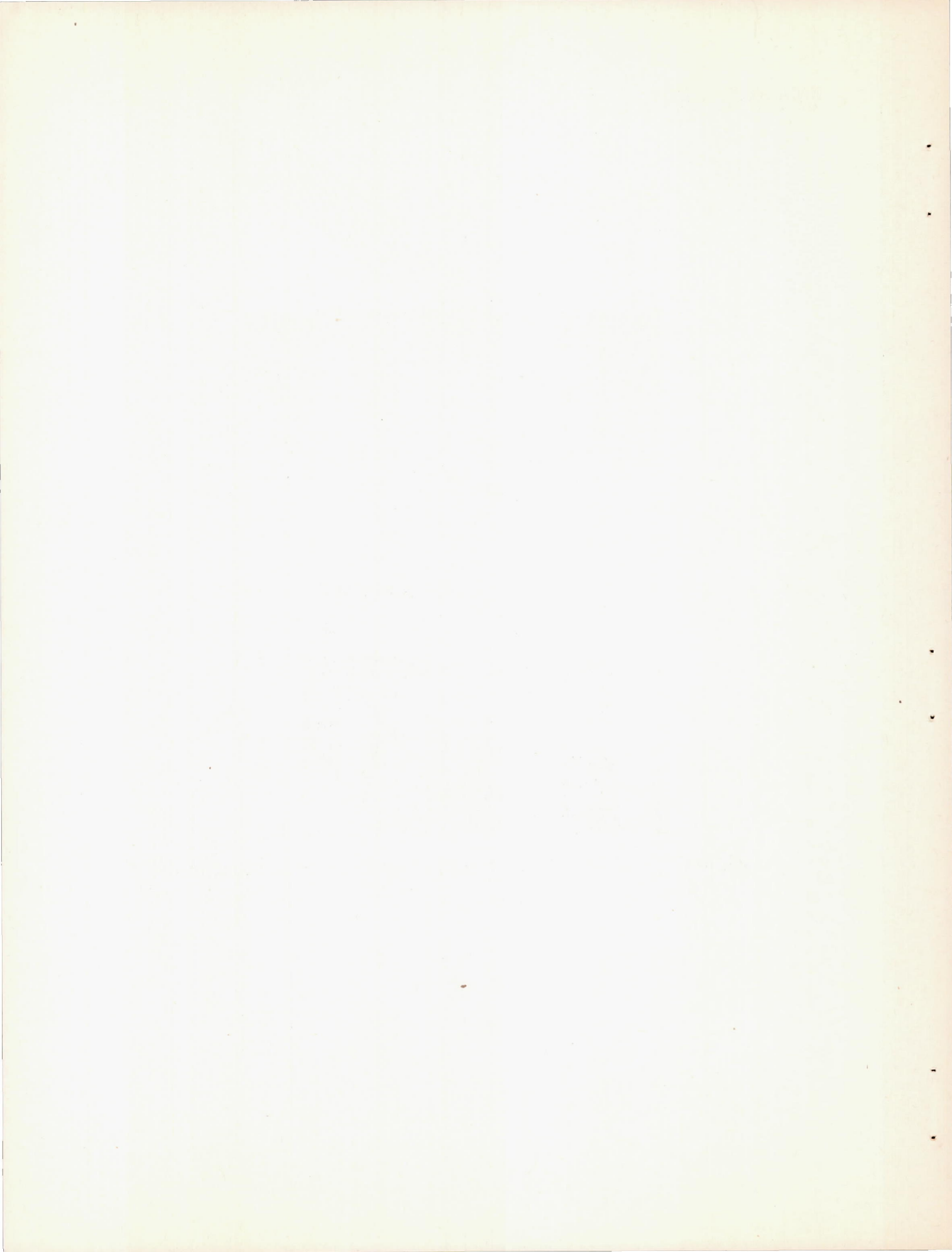

Figure 2.- Typical RM-5 test vehicle prior to launching.

CONFIDENTIAL



CONFIDENTIAL

NACA RM No. 18E10

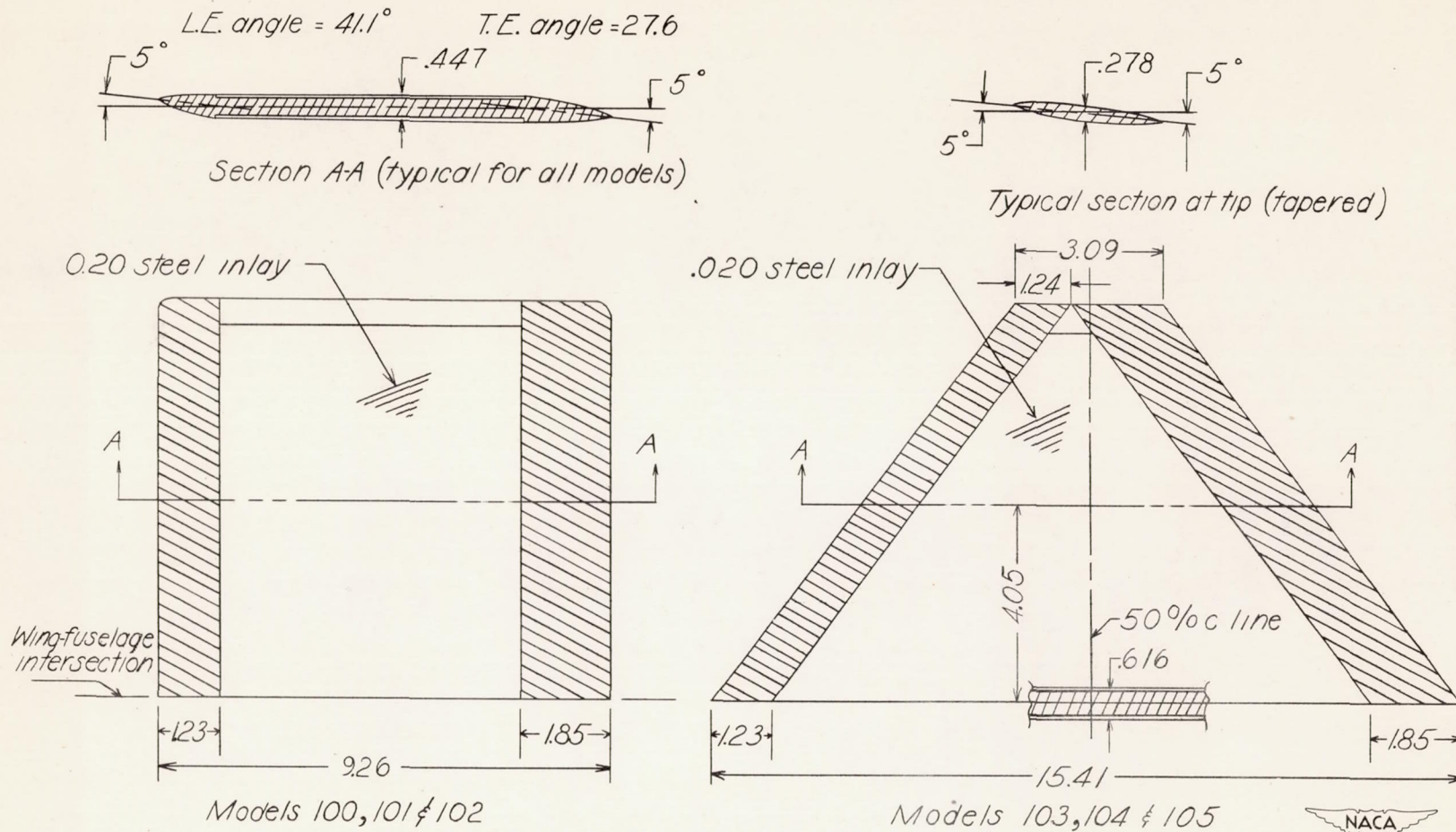
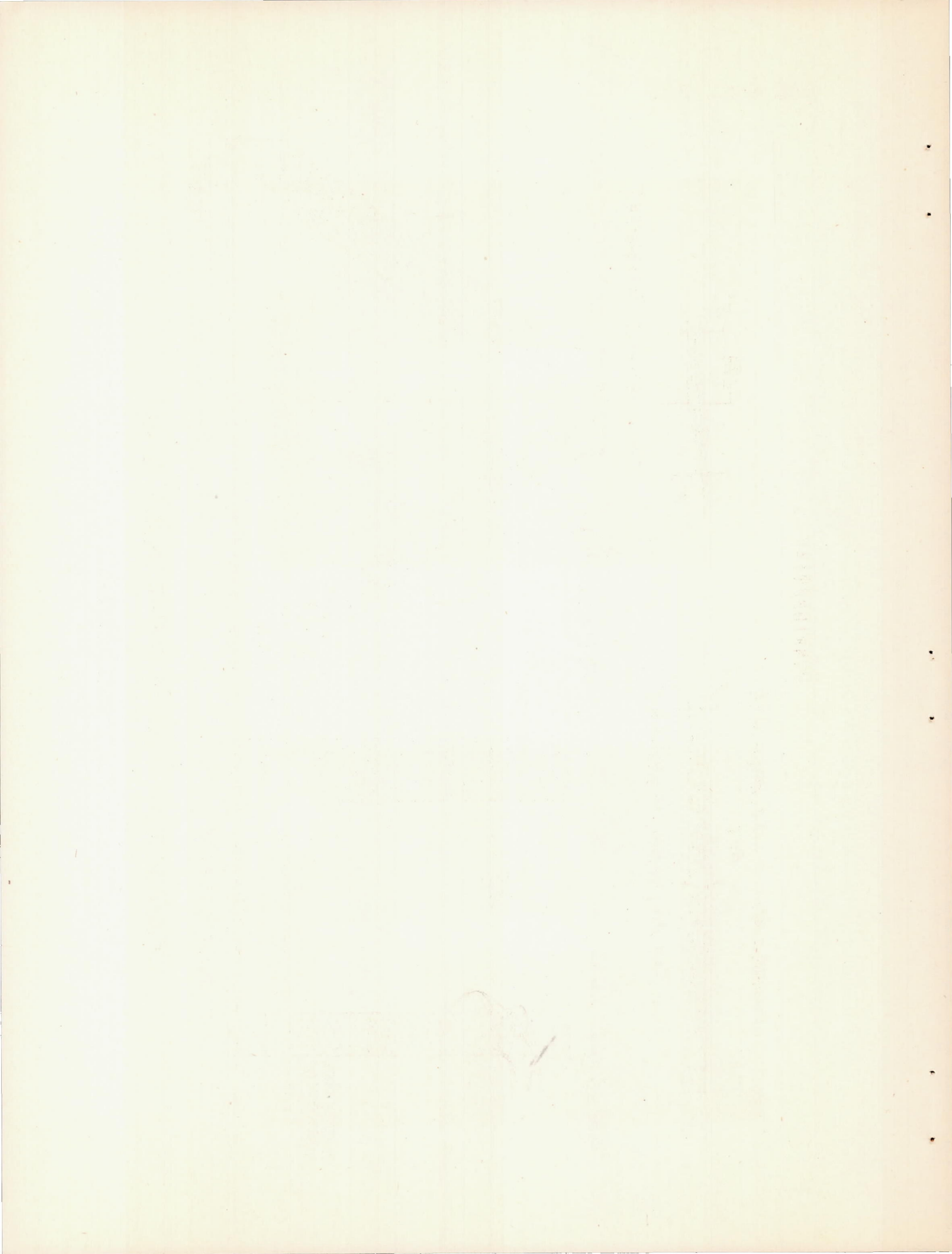
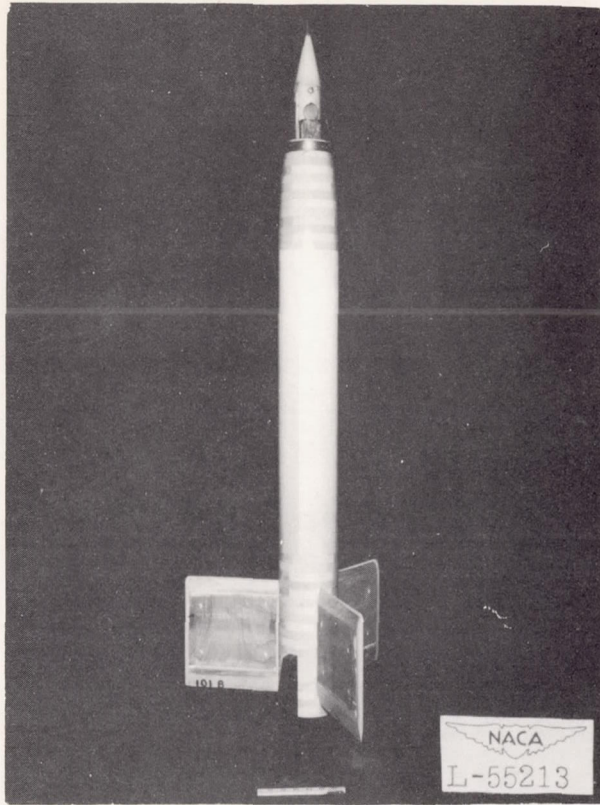

Figure 3.- Plan forms of RM-5 models tested.

CONFIDENTIAL



CONFIDENTIAL



(a) Untapered.

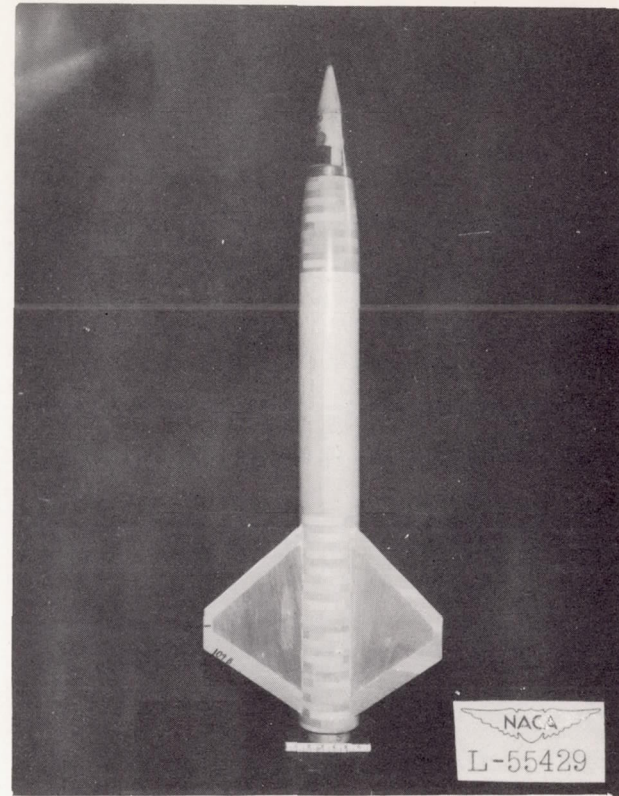

(b) Tapered.

Figure 4.- General arrangement of test vehicles.

CONFIDENTIAL

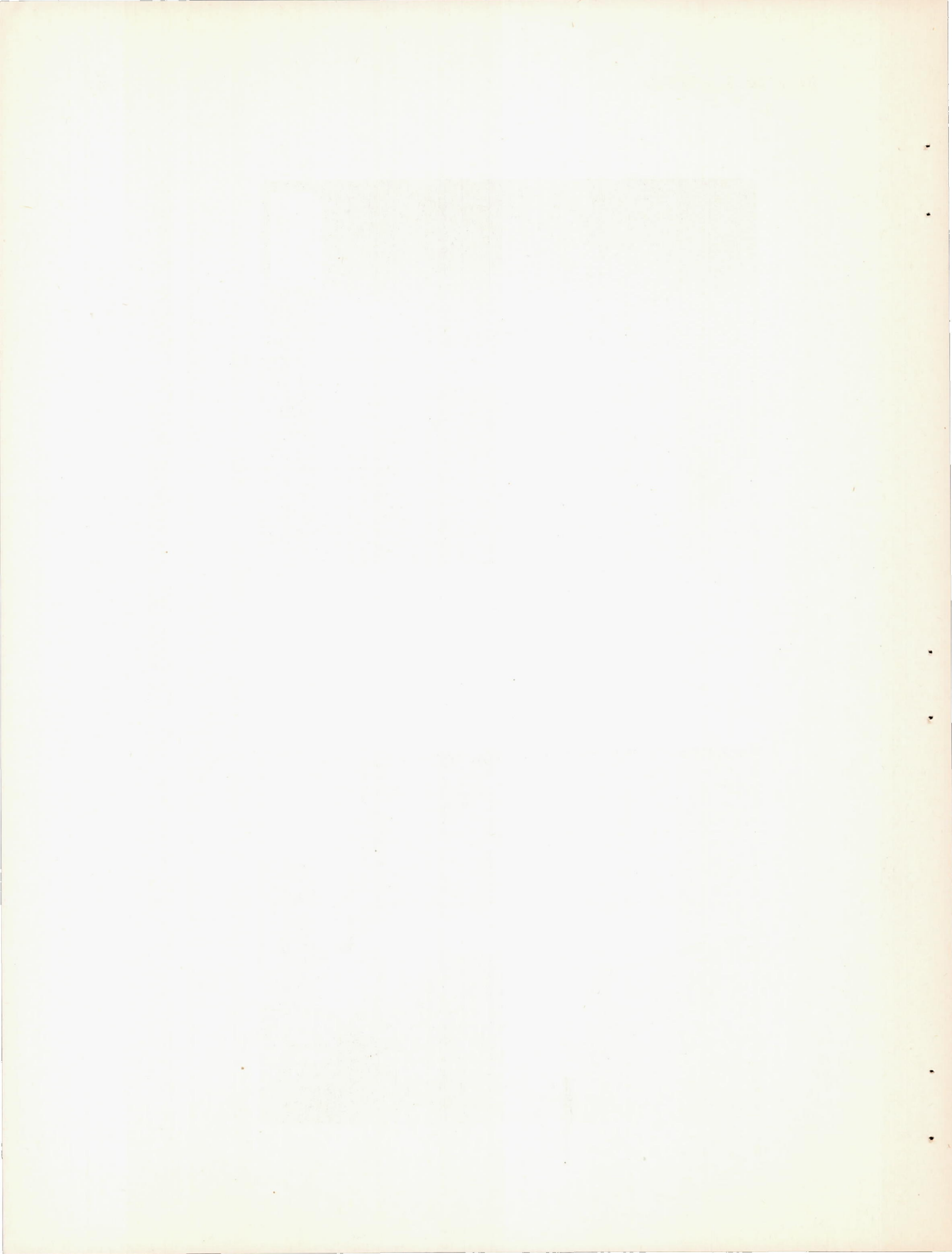

CONFIDENTIAL



Figure 5.- Variation of Reynolds number with Mach number for the range of climatic conditions encountered.

CONFIDENTIAL

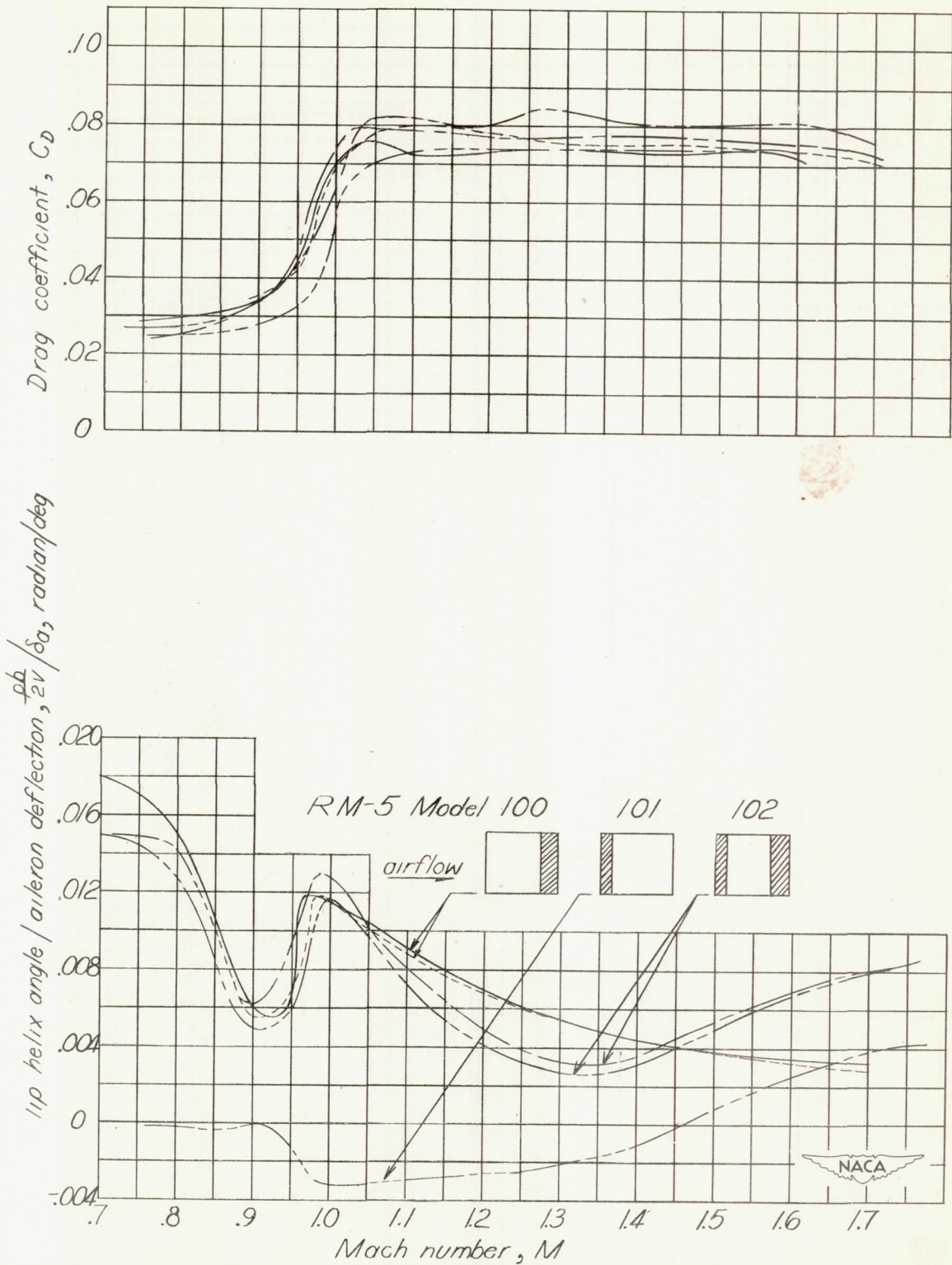

Figure 6.- Variation of tip helix angle and drag coefficient with Mach number.

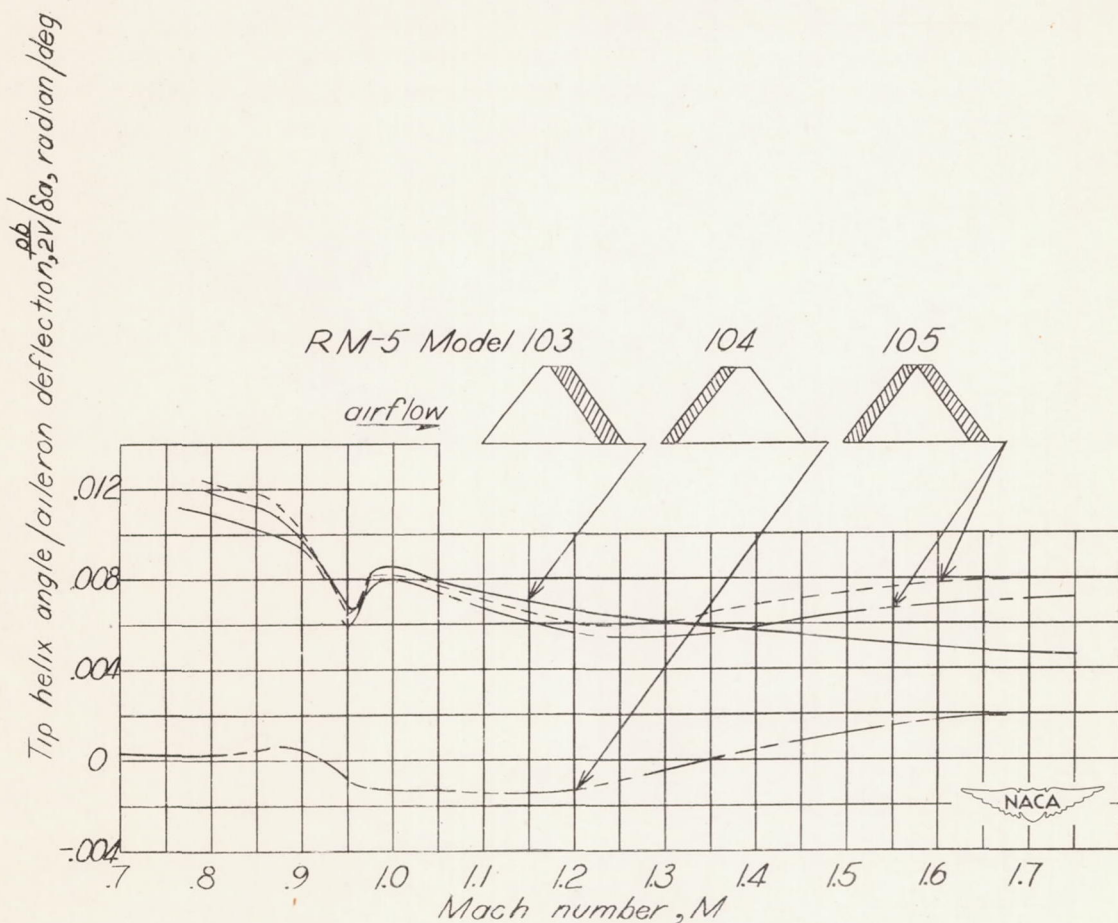
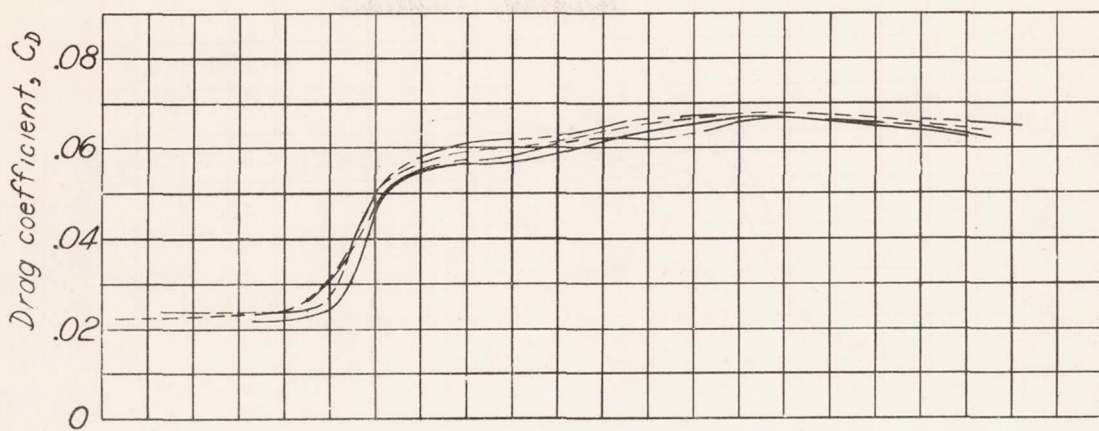

Figure 7.-Variation of tip helix angle and drag coefficient with Mach number.

