

CONFIDENTIAL

RM No. L9A12

NACA RM No. L9A12

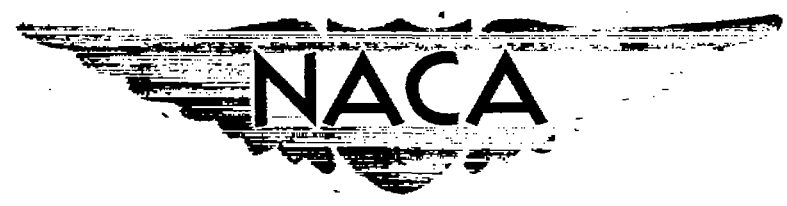

RESEARCH MEMORANDUM

AERODYNAMIC CHARACTERISTICS OF A 6-PERCENT-THICK
SYMMETRICAL DOUBLE-WEDGE AIRFOIL AT TRANSONIC
SPEEDS FROM TESTS BY THE NACA WING-FLOW METHOD

By

Lindsay J. Lina

Langley Aeronautical Laboratory
Langley Air Force Base, Va.

CLASSIFICATION CANCELLED

CLASSIFIED DOCUMENT

This document contains classified information affecting the National Defense of the United States within the meaning of the Espionage Laws, Title 18, USC 793 and 794. Its transmission or the revelation of its contents in any manner to an unauthorized person is prohibited by law. Information so classified may be imparted only to persons in the military and naval services of the United States, appropriate civilian officers and employees of the Federal Government who have a legitimate interest therein, and to United States citizens of known loyalty and discretion who of necessity must be informed thereof.

J. W. Crowley Date *1/5/54*
EO 10501
NOTA 1/15/54 See *note*
R7 2234

NATIONAL ADVISORY COMMITTEE FOR AERONAUTICS

WASHINGTON

March 4, 1949

UNCLASSIFIED

CONFIDENTIAL

NATIONAL ADVISORY COMMITTEE FOR AERONAUTICS

RESEARCH MEMORANDUM

AERODYNAMIC CHARACTERISTICS OF A 6-PERCENT-THICK
SYMMETRICAL DOUBLE-WEDGE AIRFOIL AT TRANSONIC
SPEEDS FROM TESTS BY THE NACA WING-FLOW METHOD

By Lindsay J. Lina

SUMMARY

Tests were made in the transonic range by the NACA wing-flow method to investigate the aerodynamic characteristics of a 6-percent-thick symmetrical double-wedge airfoil having a rectangular plan form of aspect ratio 4. Measurements of normal force, angle of attack, pitching moment, and chord force were made for a range of Mach numbers from 0.66 to 1.12. Reynolds number of the model ranged from about 360,000 to 810,000.

The results indicated an appreciable effect of Reynolds number on the aerodynamic characteristics. The slopes of the lift curves increased and the aerodynamic center moved rearward with increasing Reynolds number. A consistent effect of Reynolds number on the drag coefficient was not indicated.

The slope of the lift curve for the range of lift coefficients from 0.3 to 0.5 was greater than the slope taken from 0 to 0.2 lift coefficient and showed more abrupt variations with Mach number.

The aerodynamic center for the lower lift-coefficient range moved rearward to 30 percent chord as Mach number was increased to about 0.88, then forward to about 20 percent chord at Mach number 0.92, and finally rearward to about 30 percent chord for Mach numbers increased beyond 0.94. The aerodynamic center for the higher lift-coefficient range moved rearward somewhat erratically from 25 to 42 percent chord as the Mach number was increased from about 0.85 to 1.0. The maximum value of lift-drag ratio was about 12.5 for Mach numbers from 0.7 to 0.85 and then decreased to 6.5 with an increase in Mach number to 1.0.

INTRODUCTION

As part of the NACA program to investigate aerodynamic characteristics of airfoils in the transonic speed range, tests were made by the NACA wing-flow method of an aspect ratio 4, rectangular airfoil having a symmetrical double-wedge section 6 percent thick. The investigation covered a range of Mach numbers from 0.66 to 1.12 and included measurements of angle of

attack, pitching moment, normal force, and chord force. The drag at zero lift obtained in this investigation was reported in reference 1, but without the correction for tare of the end plate.

SYMBOLS

α	angle of attack
M	effective Mach number of the model
R	Reynolds number
C_L	lift coefficient
C_M	pitching-moment coefficient about half-chord location
C_D	drag coefficient

APPARATUS AND TESTS

The tests were made by the NACA wing-flow method in which a model is mounted in the high-speed flow over the wing of an airplane (references 2 and 3).

The rectangular airfoil model (fig. 1) had a symmetrical double-wedge section 6 percent thick and an aspect ratio, considering the wing surface as a reflection plane, of 4.0. The model was equipped with a circular end plate of one-chord diameter and was mounted about 0.03 inch above the surface of the airplane wing.

The chordwise variation of Mach number in the test region, shown in figure 2, was determined from measurements of static pressure along the surface of the airplane wing with the model removed. The effective Mach number and dynamic pressure for the model station were obtained from these results and measurements of the pressure variation normal to the wing surface. The corrections for the effect of local Mach number variations normal to the surface of the airplane wing were similar to those described in reference 4.

In order to obtain three different ranges of Reynolds numbers for the Mach numbers covered, tests were made in dives at high altitude (28,000 to 22,000 ft), medium altitude (18,000 to 12,000 ft), and low altitude (12,000 to 6,000 ft). The Mach numbers and Reynolds numbers covered in the tests are shown in figure 3. Continuous measurements were made in the dives of angle of attack of the model, normal force, chord force, pitching moment, free-stream impact and static pressures, and the airplane normal acceleration.

The model was continuously oscillated through an angle-of-attack range of about $\pm 6^\circ$. The rate of oscillation was about 20° per second.

RESULTS AND DISCUSSION

The variations with Mach number of the angle of attack, pitching-moment coefficient, and drag coefficient at constant values of lift coefficient are shown in figures 4, 6, and 8, respectively, for tests at the three altitudes. Since the airfoil was symmetrical, data for positive and negative lift coefficients were plotted together. The drag-coefficient data were corrected for the tare of the end plate, which was determined from tests of the end-plate alone, to be a nearly constant value at 0.004 based on the area of the model. The paired results of figures 4, 6, and 8 are plotted in figures 5, 7, and 9, respectively, to indicate the effects of the difference in Reynolds number associated with the different test altitudes. The variations with lift coefficient of the angle of attack, pitching-moment coefficient, and drag coefficient at several Mach numbers are presented in figures 10, 11, and 12, respectively. The rate of change of lift coefficient with angle of attack $dC_L/d\alpha$ and pitching-moment coefficient with lift coefficient dC_M/dC_L (aerodynamic-center position), taken between 0 and 0.2 and between 0.3 and 0.5 lift coefficient, are plotted against Mach number in figure 13.

The results of the tests indicated an appreciable effect of Reynolds number. The angle of attack and the pitching-moment coefficient at a constant lift coefficient (figs. 5 and 7) decreased with increasing Reynolds number. Accordingly the rate of change of lift coefficient with angle of attack increased and the aerodynamic center moved rearward with increasing Reynolds number. A consistent effect of Reynolds number on the drag coefficient was not indicated.

In general, the angle of attack at a constant lift coefficient decreased gradually with increase in Mach number up to a Mach number of about 0.9 (fig. 5). At Mach numbers between 0.9 and 1.0 the angle of attack varied slightly but somewhat irregularly for some of the lift coefficients. At higher Mach numbers the angle of attack showed practically no variations for lift coefficients up to 0.4.

The variation of lift coefficient with angle of attack in figure 10 indicated an increase in slope at an angle of attack between 2° and 3° , which became rather abrupt for the Mach number range from 0.90 to 0.94. While the exact nature of the flow phenomena is not known, tests on two-dimensional double-wedge airfoils at high subsonic speeds reported in reference 5 indicated that a rapid expansion to local supersonic flow occurred on the upper surface near the leading edge which reduced the separation on the

upper surface of the airfoil and increased the lift-curve slope for a small range of angles of attack. The slopes of the lift curves taken over a range of lift coefficients of 0 to 0.2 (fig. 13(a)) and over a range of lift coefficients of 0.3 to 0.5 (fig. 13(b)) were somewhat higher for the low-altitude run than for the higher-altitude runs. The slopes for the higher range of lift coefficients were greater but showed much larger variations for the range of Mach numbers of these tests. The slopes for both ranges of lift coefficients increased up to a Mach number of about 0.87. The slopes for the lower lift-coefficient range then remained essentially constant for a further increase in Mach number while the slopes for the higher range of lift coefficients, in general, decreased.

The pitching-moment coefficients at constant lift coefficients remained nearly constant for low lift coefficients and increased somewhat for the highest lift coefficient up to a Mach number of 0.80 (figs. 6 and 7), and then decreased for Mach numbers increasing from 0.80 to 0.88. This decrease was more pronounced for the higher lift coefficients. A large increase and then decrease of moment coefficient occurred at Mach numbers from about 0.89 to 0.96. At higher Mach numbers the moment coefficient remained nearly constant for the lower lift coefficients and gradually decreased with increasing Mach number for the higher lift coefficients. The variation of pitching-moment coefficient with lift coefficient in figure 11 indicated a large increase in the slope dC_M/dC_L for lift coefficients between 0 and 0.25 at Mach numbers 0.92 and 0.94. The slope dC_M/dC_L for lift coefficients from 0 to 0.2 (fig. 13(a)) indicated that the aerodynamic center moved rearward from about 25 to 30 percent chord as Mach number was increased from 0.80 to 0.88, then forward to about 20 percent chord with a further increase in Mach number to 0.92, and finally rearward to about 30 percent chord with an increase in Mach number to and above 0.94. The slope dC_M/dC_L for lift coefficients from 0.3 to 0.5 (fig. 13(b)) indicated that the aerodynamic center was at about 25 percent chord for Mach numbers up to about 0.85 and moved rearward somewhat erratically to about 42 percent chord with an increase of Mach number to about 1.0.

The variation of drag coefficient with Mach number (fig. 9) was small up to the Mach number corresponding to the start of the rapid drag rise for lift coefficients from 0 to 0.4. At a lift coefficient of 0.5 the drag coefficient decreased appreciably over this same range of Mach numbers. The drag rise was somewhat more rapid and occurred at a slightly higher Mach number for the higher lift coefficients. The drag coefficient at a given lift coefficient attained a maximum value at a Mach number of about 1.0. At higher Mach numbers the drag coefficient decreased somewhat for lift coefficients up to 0.2 and remained constant at the higher lift coefficients. The maximum value of lift-drag ratio (fig. 14) was about 12.5 for Mach numbers from 0.70 to 0.87 and decreased to 6.5 with an increase in Mach number to 1.0. The maximum lift-drag ratio occurred at lift coefficients between 0.2 and 0.3 for Mach numbers up to 0.8 and between 0.4 and 0.5 for Mach numbers greater than 0.85.

CONCLUDING REMARKS

The results of tests at transonic speeds (Mach numbers 0.66 to 1.12) by the NACA wing-flow method of a 6-percent-thick symmetrical double-wedge airfoil with an aspect ratio of 4 indicated an appreciable effect of Reynolds number on the aerodynamic characteristics. The slopes of the lift curves increased and the aerodynamic center moved rearward with increasing Reynolds number. A consistent effect of Reynolds number on the drag coefficient was not indicated.

The slope of the lift curve for the range of lift coefficients from 0 to 0.2 increased up to a Mach number of 0.87 and then remained essentially constant. The lift-curve slope for the range of lift coefficients from 0.3 to 0.5 increased up to a Mach number of about 0.87 and for further increases in Mach number showed a general decline. The slope of the lift curve for the range of lift coefficients from 0.3 to 0.5 was greater than for the lower range of lift coefficients. The variation of the lift-curve slope with Mach number was larger for the higher range of lift coefficients.

The aerodynamic center for lift coefficients from 0 to 0.2 moved rearward from about 25 to 30 percent chord as the Mach number was increased from 0.80 to 0.88, then forward to about 20 percent chord with a further increase in Mach number to 0.92, and finally rearward to about 30 percent chord with an increase in Mach number to and above 0.94. The aerodynamic center for lift coefficients from 0.3 to 0.5 was at about 25 percent chord for Mach numbers up to about 0.85 and moved rearward somewhat erratically to about 42 percent chord with an increase of Mach number to about 1.0. The maximum value of lift-drag ratio was about 12.5 for Mach numbers from 0.7 to 0.85 and then decreased to 6.5 with an increase in Mach number to 1.0.

Langley Aeronautical Laboratory
National Advisory Committee for Aeronautics
Langley Air Force Base, Va.

REFERENCES

1. Silsby, Norman S.: Comparative Drag Measurements at Transonic Speeds of 6-Percent-Thick Airfoils of Symmetrical Double-Wedge and Circular-Arc Sections from Tests by the NACA Wing-Flow Method. NACA RM No. L7B20, 1947.
2. Gilruth, R. R., and Wetmore, J. W.: Preliminary Tests of Several Airfoil Models in the Transonic Speed Range. NACA ACR No. L5E08, 1945.
3. Zalovcik, John A., and Adams, Richard E.: Preliminary Tests at Transonic Speeds of a Model of a Constant-Chord Wing with a Sweepback of 45° and an NACA 65(112)-210, $a = 1.0$ Airfoil Section. NACA ACR No. L5J16a, 1945.
4. Johnson, Harold I.: Measurements of Aerodynamic Characteristics of a 35° Sweptback NACA 65-009 Airfoil Model with $\frac{1}{4}$ -Chord Plain Flap by the NACA Wing-Flow Method. NACA RM No. L7F13, 1947.
5. Lindsey, W. F., Daley, Bernard N., and Humphreys, Milton D.: The Flow and Force Characteristics of Supersonic Airfoils at High Subsonic Speeds. NACA TN No. 1211, 1947.

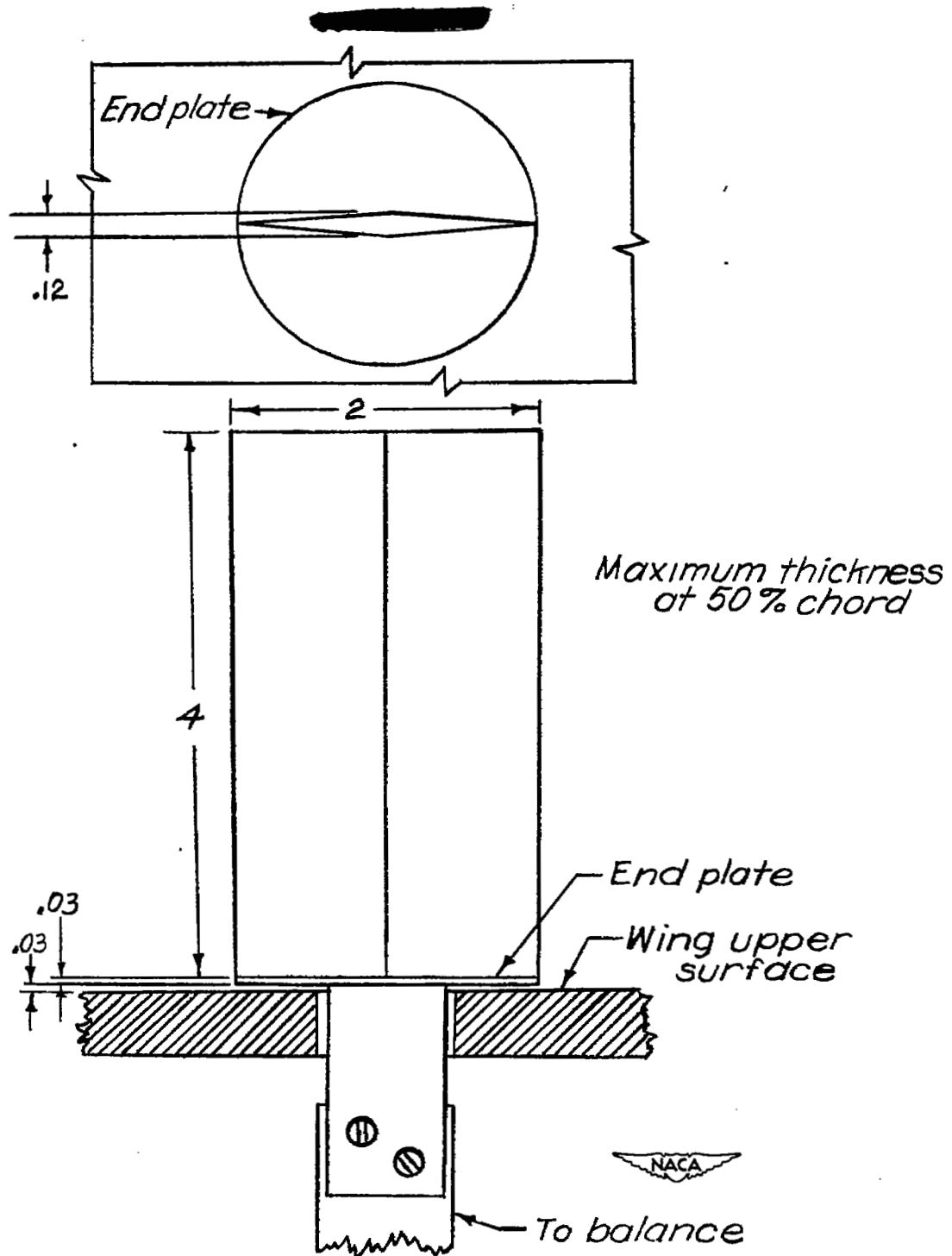

Figure 1.— Detail of model and method of mounting on airplane wing.
All dimensions in inches.

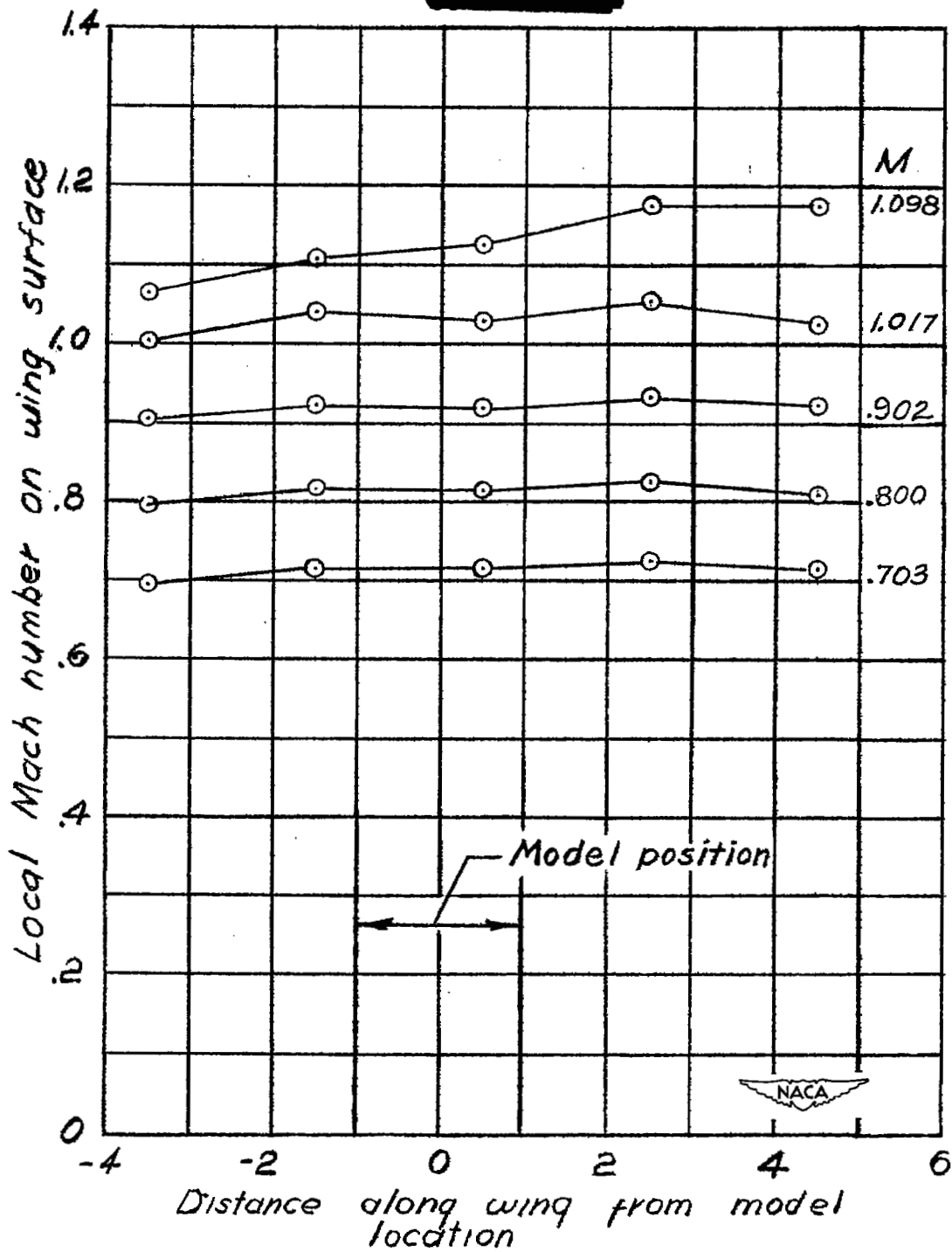

Figure 2.— Typical variation of local Mach number along the airplane-wing surface for several values of effective Mach number of the model.

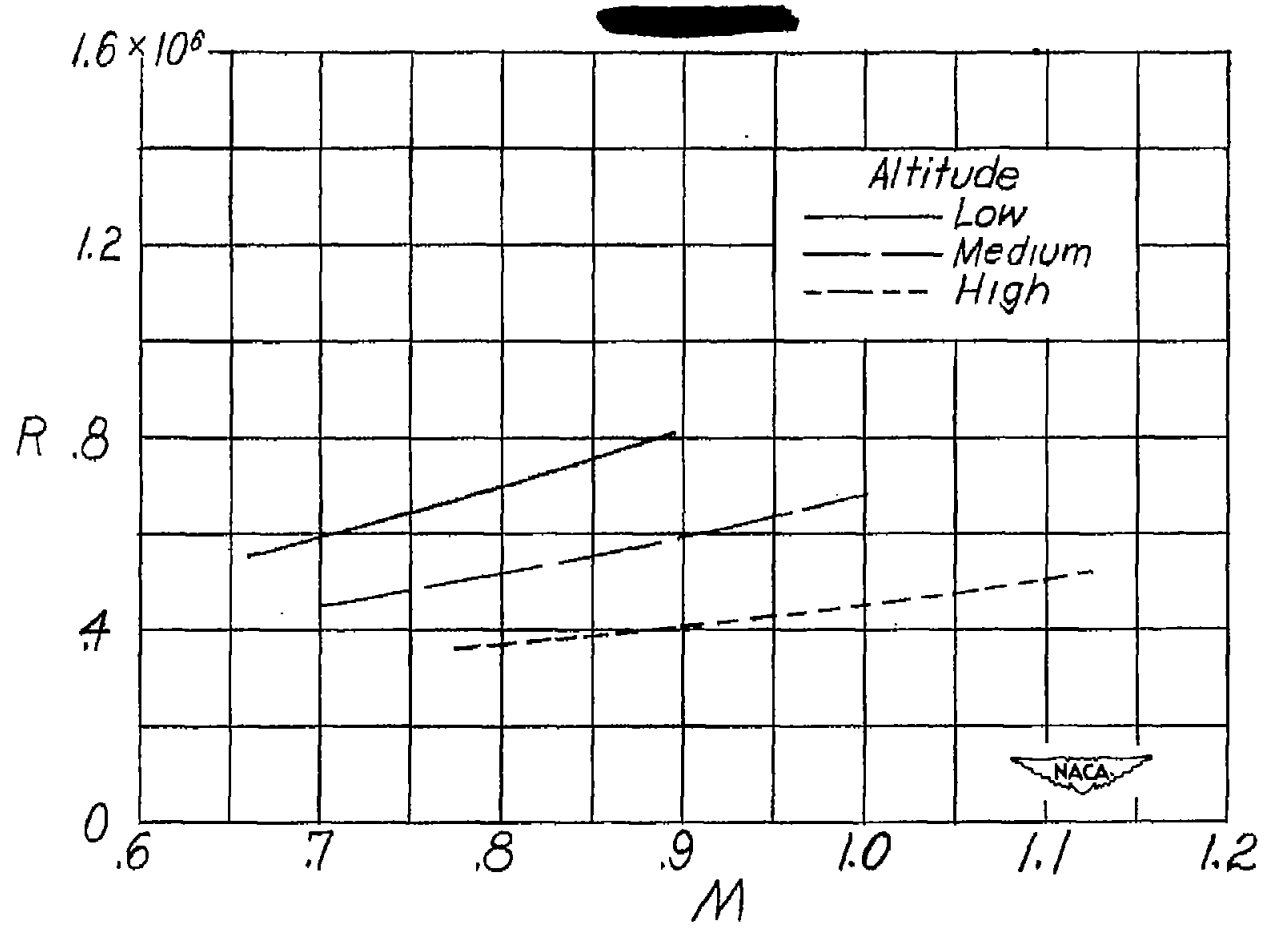
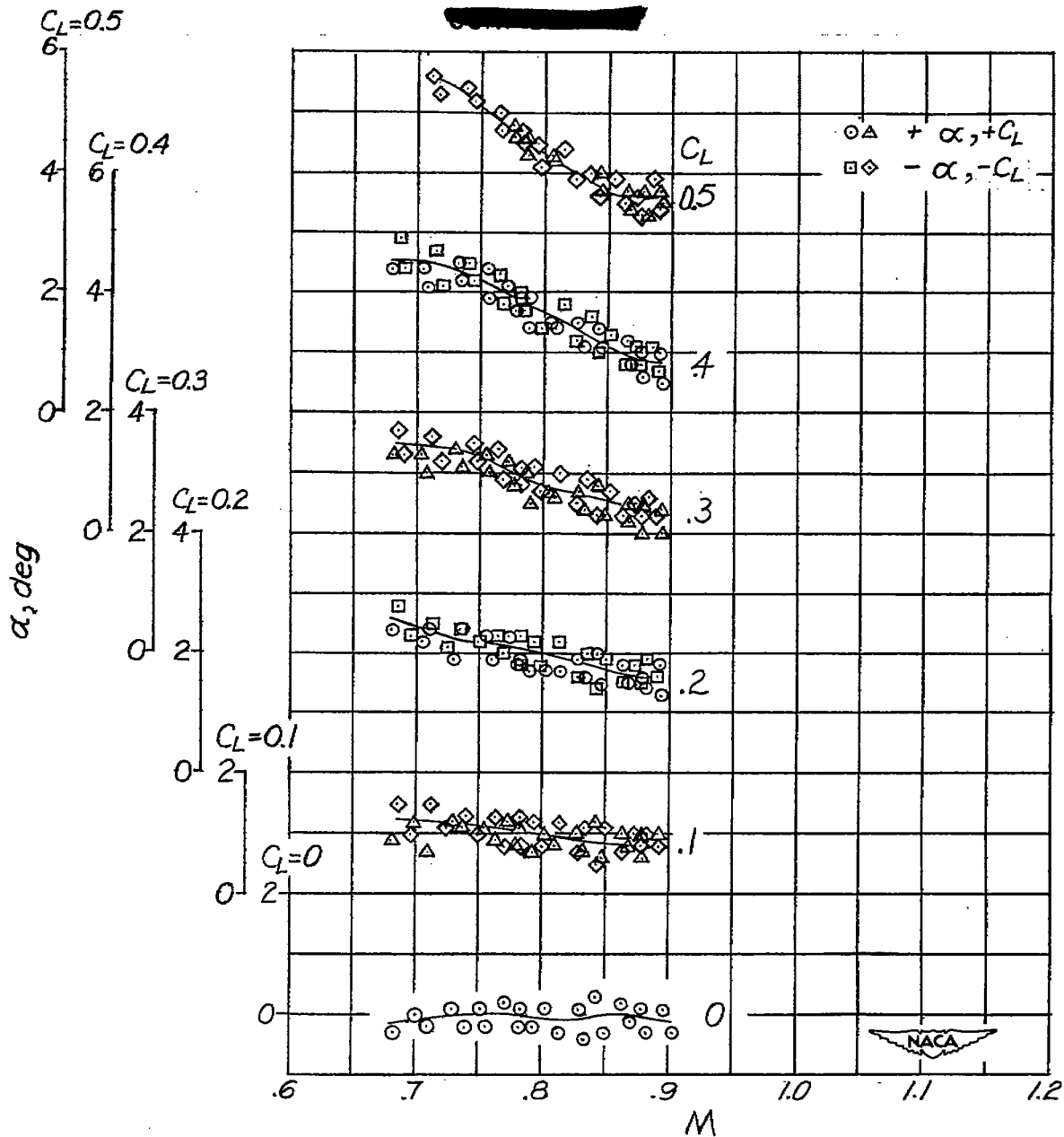
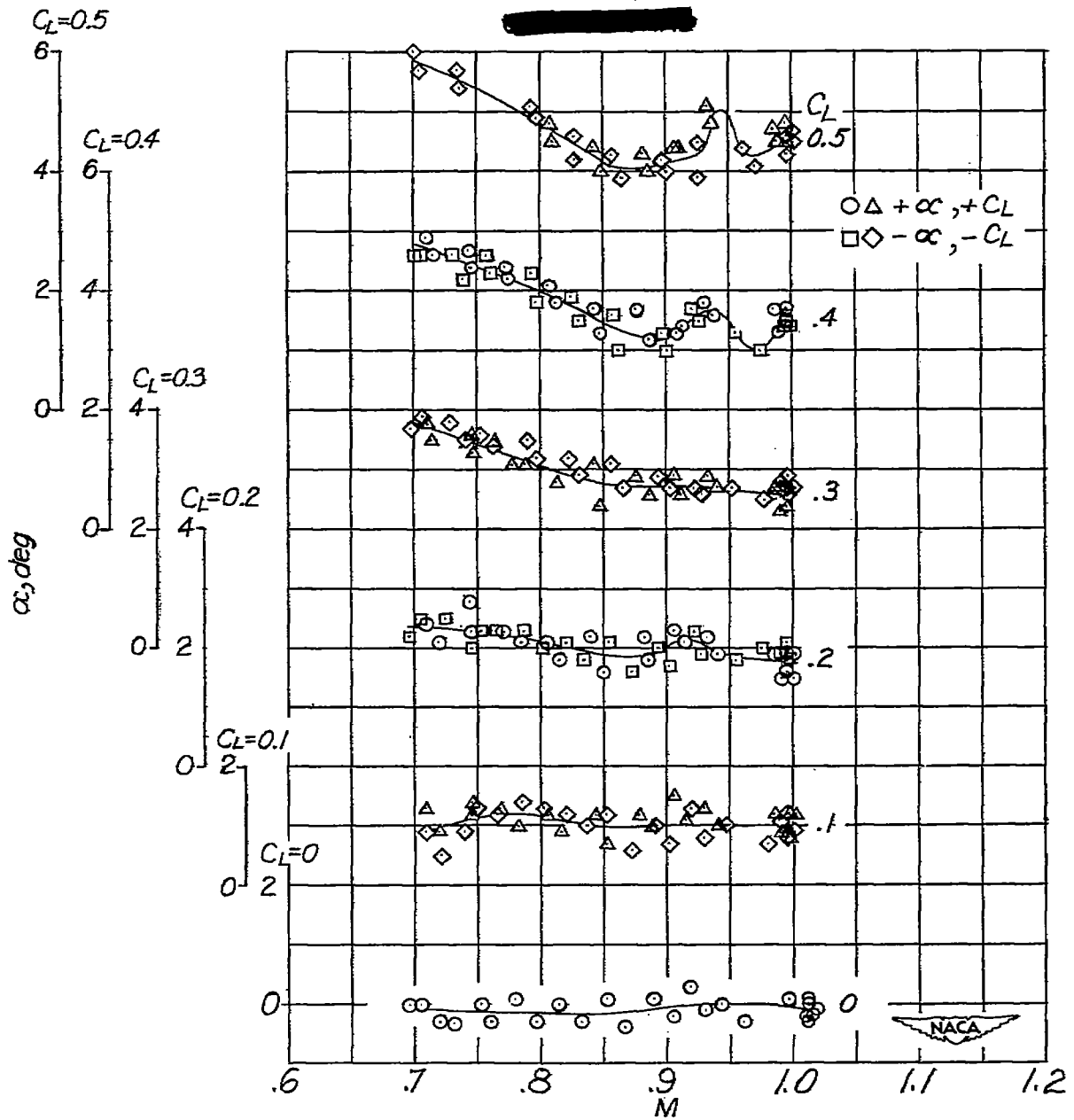

Figure 3.- Variation of Reynolds number with Mach number for tests at three ranges of altitude.



(a) Low-altitude dive, Reynolds numbers 5.55×10^5 to 8.10×10^5 .

Figure 4.— Variation with Mach number of angle of attack for several lift coefficients.



(b) Medium-altitude dive, Reynolds numbers 4.5×10^5 to 6.8×10^5 .

Figure 4.- Continued.

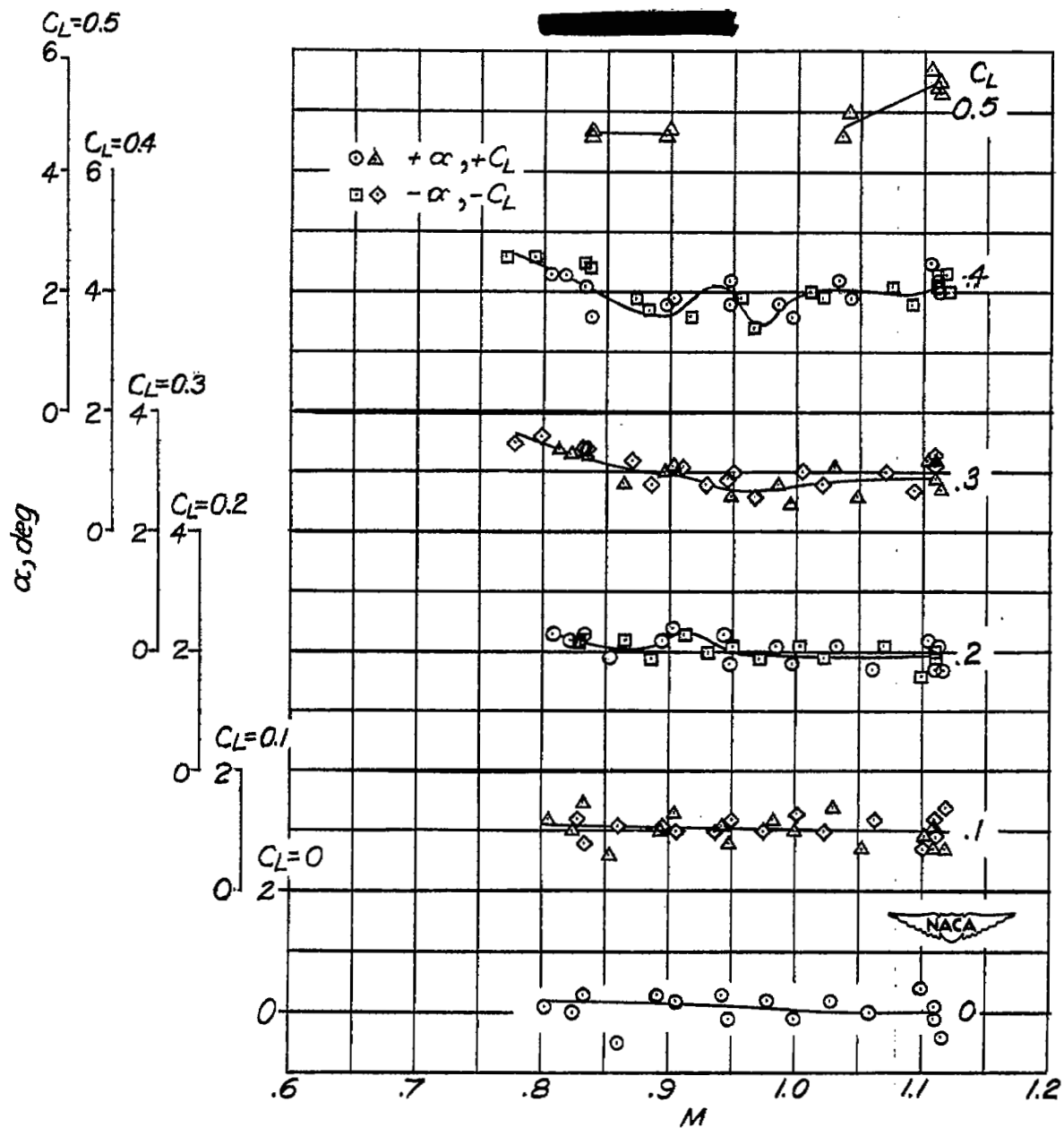

(c) High-altitude dive, Reynolds numbers 3.6×10^5 to 5.2×10^5 ,

Figure 4.— Concluded.

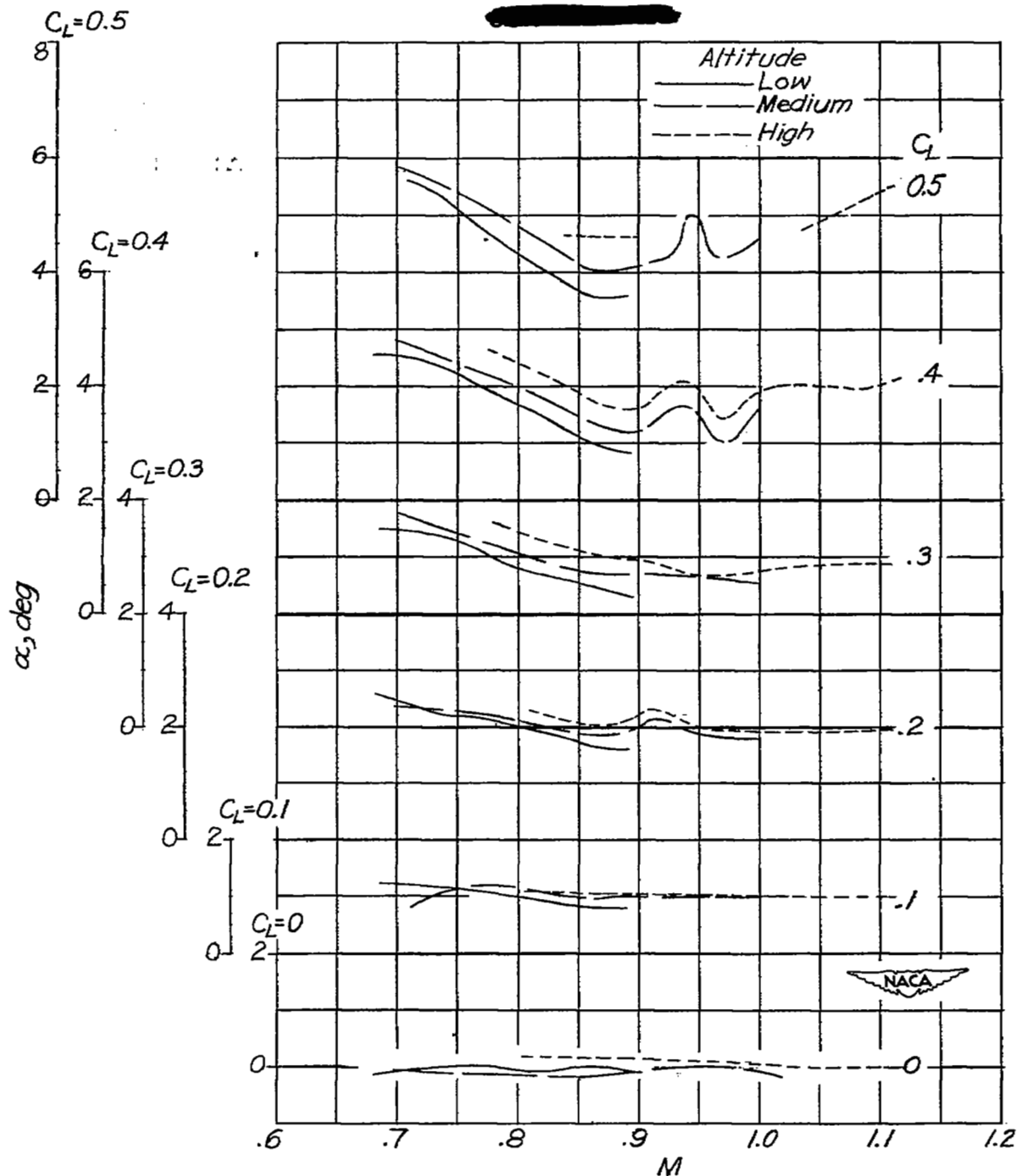
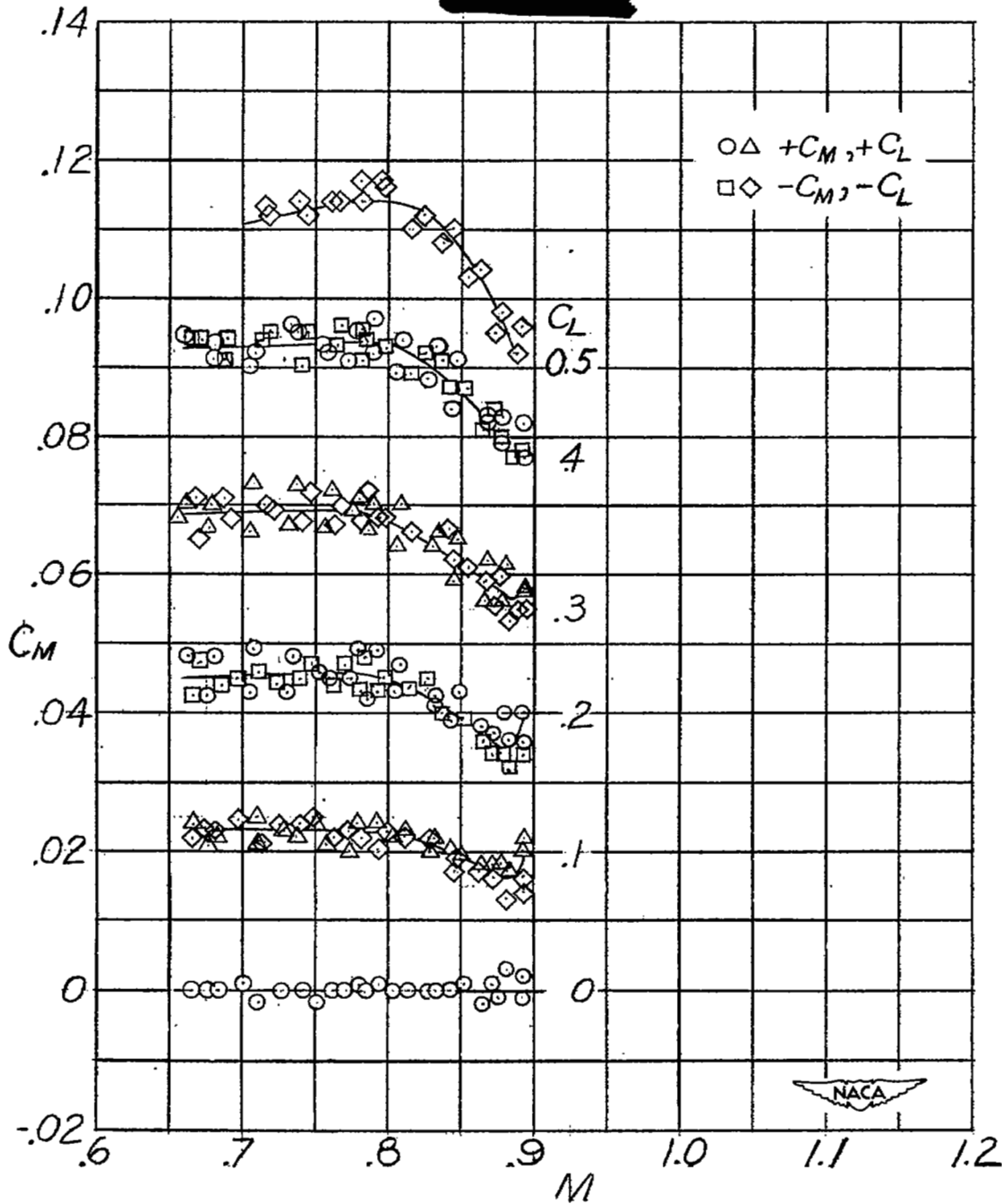
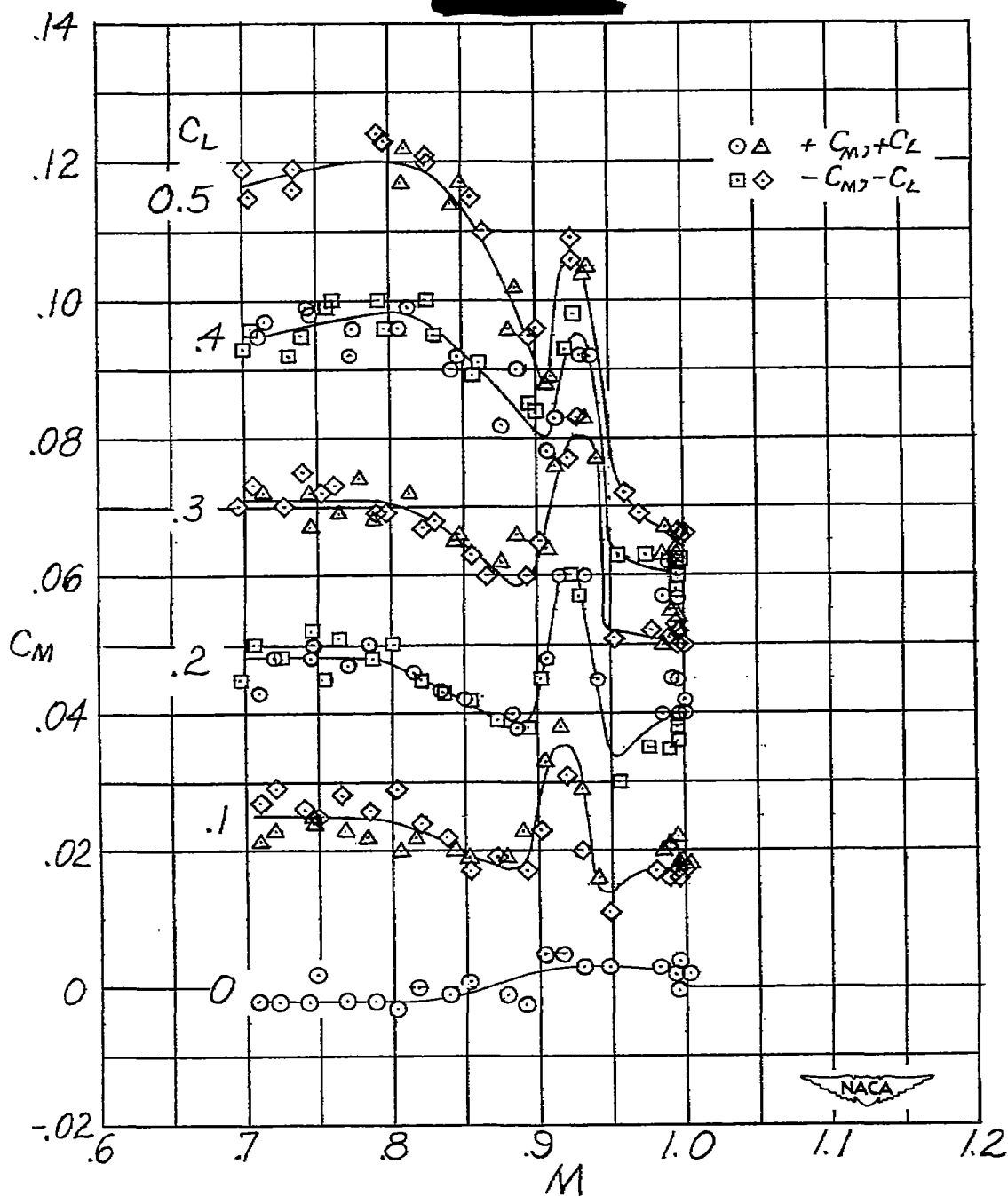

Figure 5.-- Variation with Mach number of angle of attack for several lift coefficients and three ranges of altitude.



(a) Low-altitude dive, Reynolds numbers 5.55×10^5 to 8.1×10^5 .

Figure 6.— Variation with Mach number of pitching-moment coefficient for several lift coefficients.



(b) Medium-altitude dive, Reynolds numbers 4.5×10^5 to 6.8×10^5 .

Figure 6.- Continued.

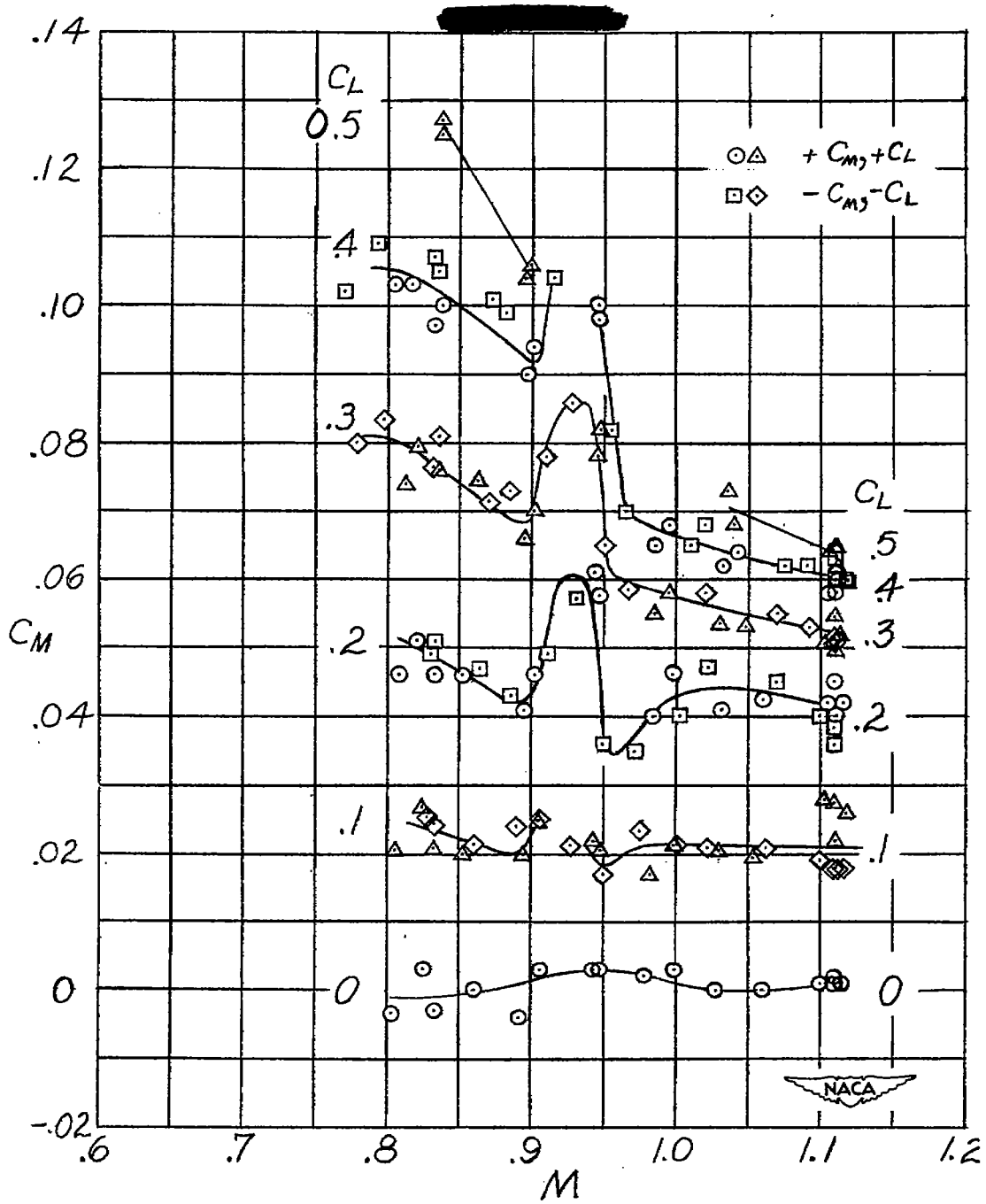

(c) High-altitude dive, Reynolds number 3.6×10^5 to 5.2×10^5 .

Figure 6.- Concluded.

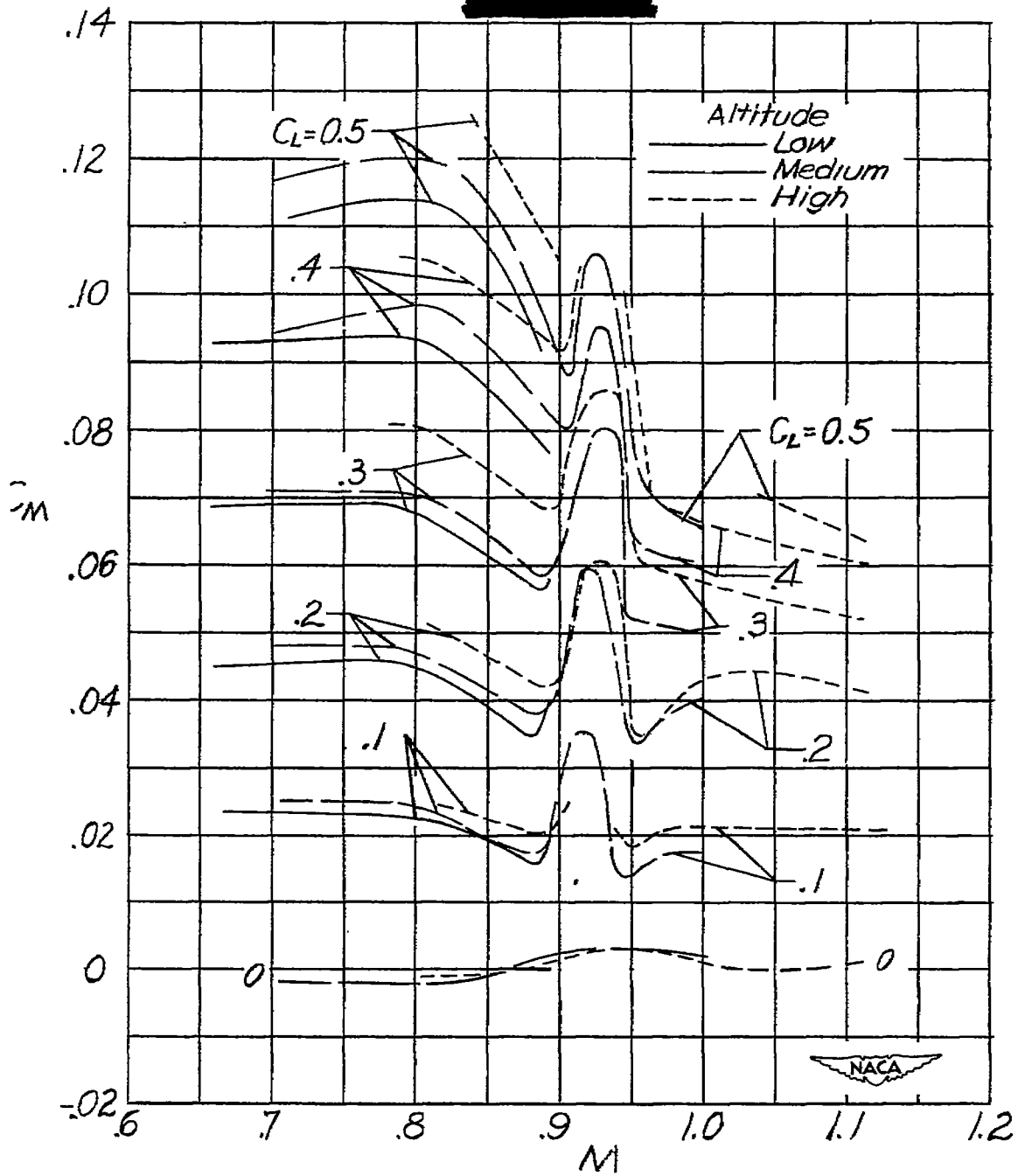
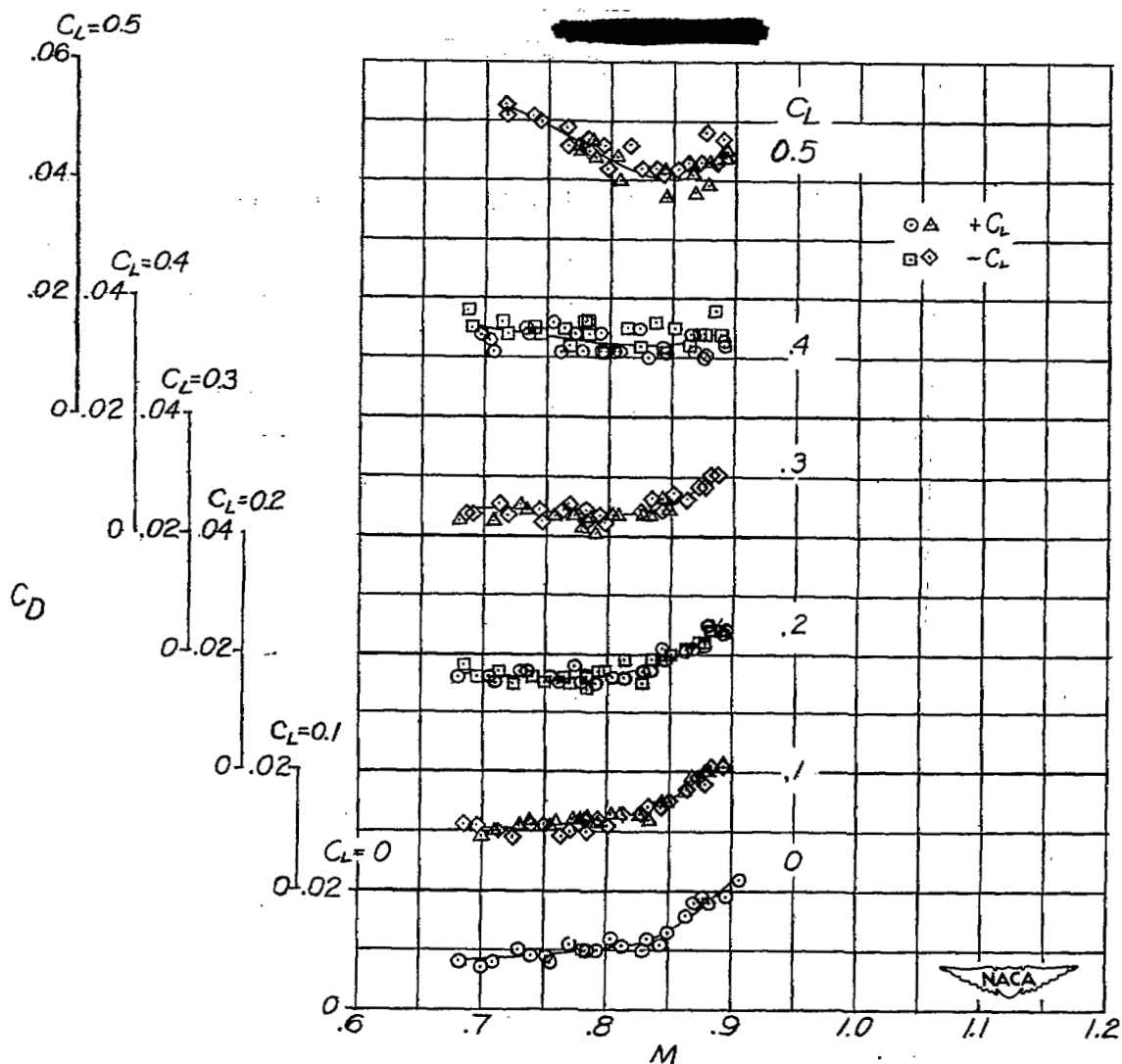
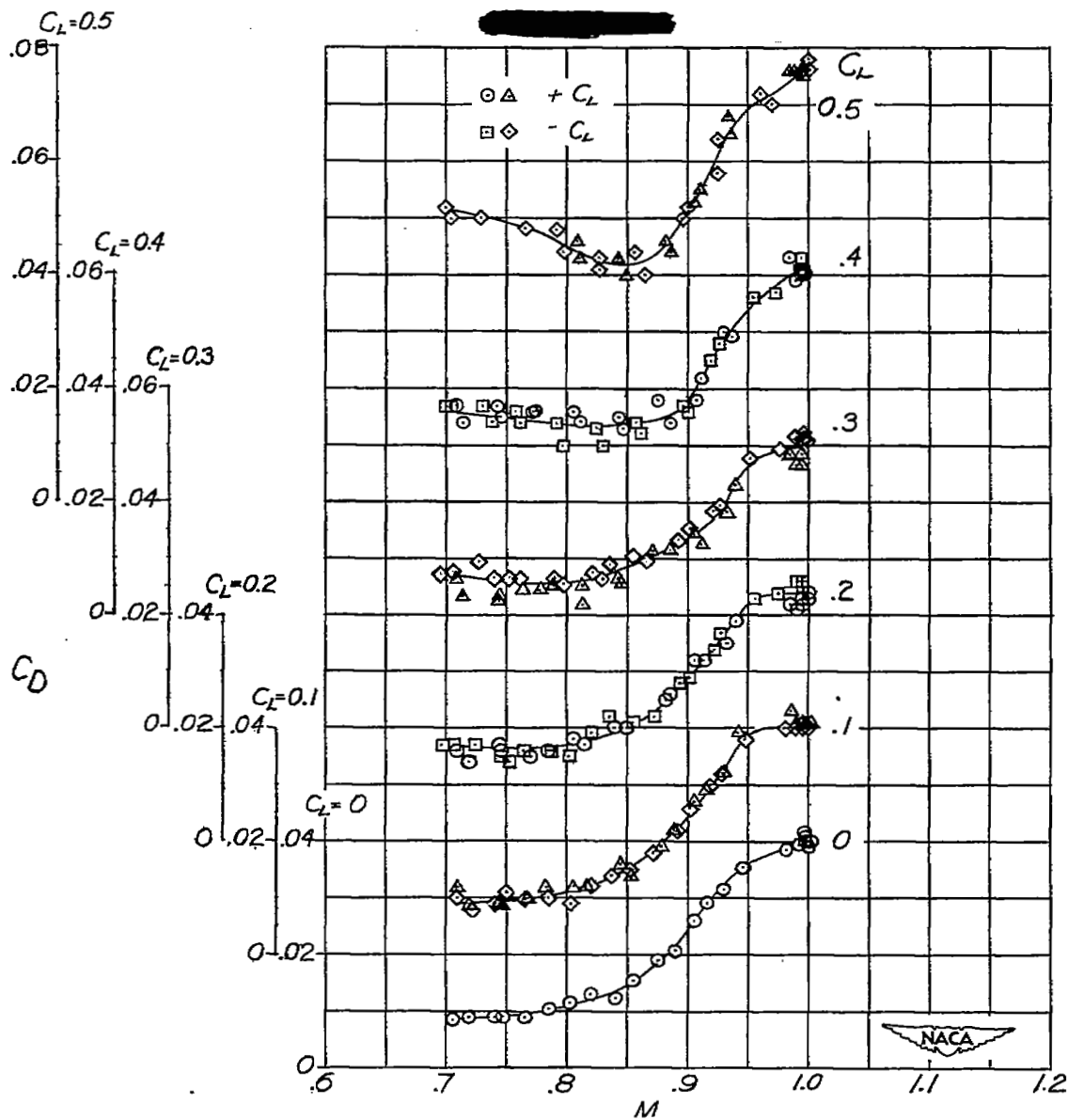

Figure 7.— Variation with Mach number of pitching-moment coefficient for several lift coefficients and three ranges of altitude.



(a) Low-altitude dive, Reynolds numbers 5.55×10^5 to 8.1×10^5 .

Figure 8.— Variation with Mach number of drag coefficient for several lift coefficients.



(b) Medium-altitude dive, Reynolds numbers 4.5×10^5 to 6.8×10^5 .

Figure 8.- Continued.

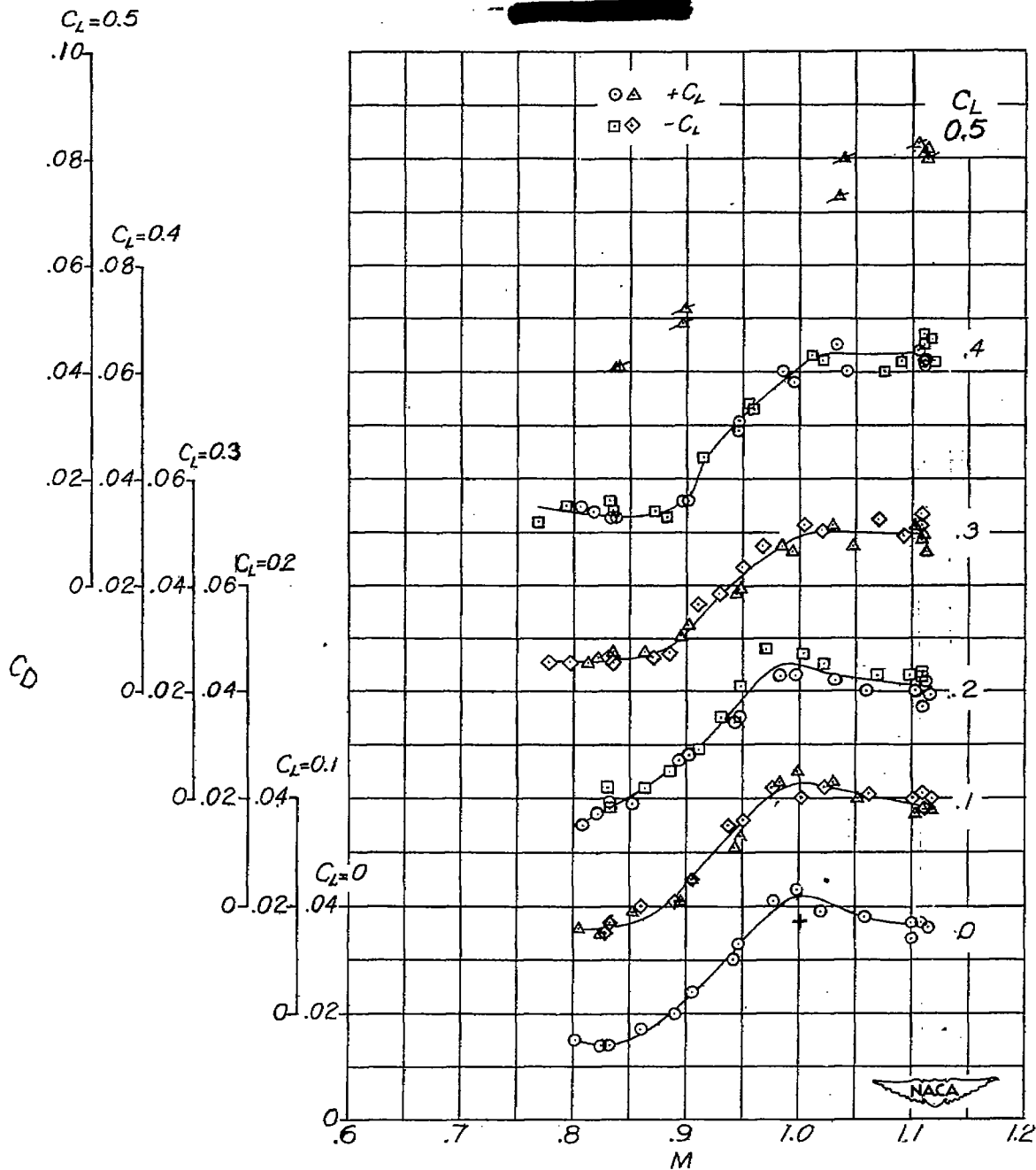

(c) High-altitude dive, Reynolds numbers 3.6×10^5 to 5.2×10^5 .

Figure 8.— Concluded.

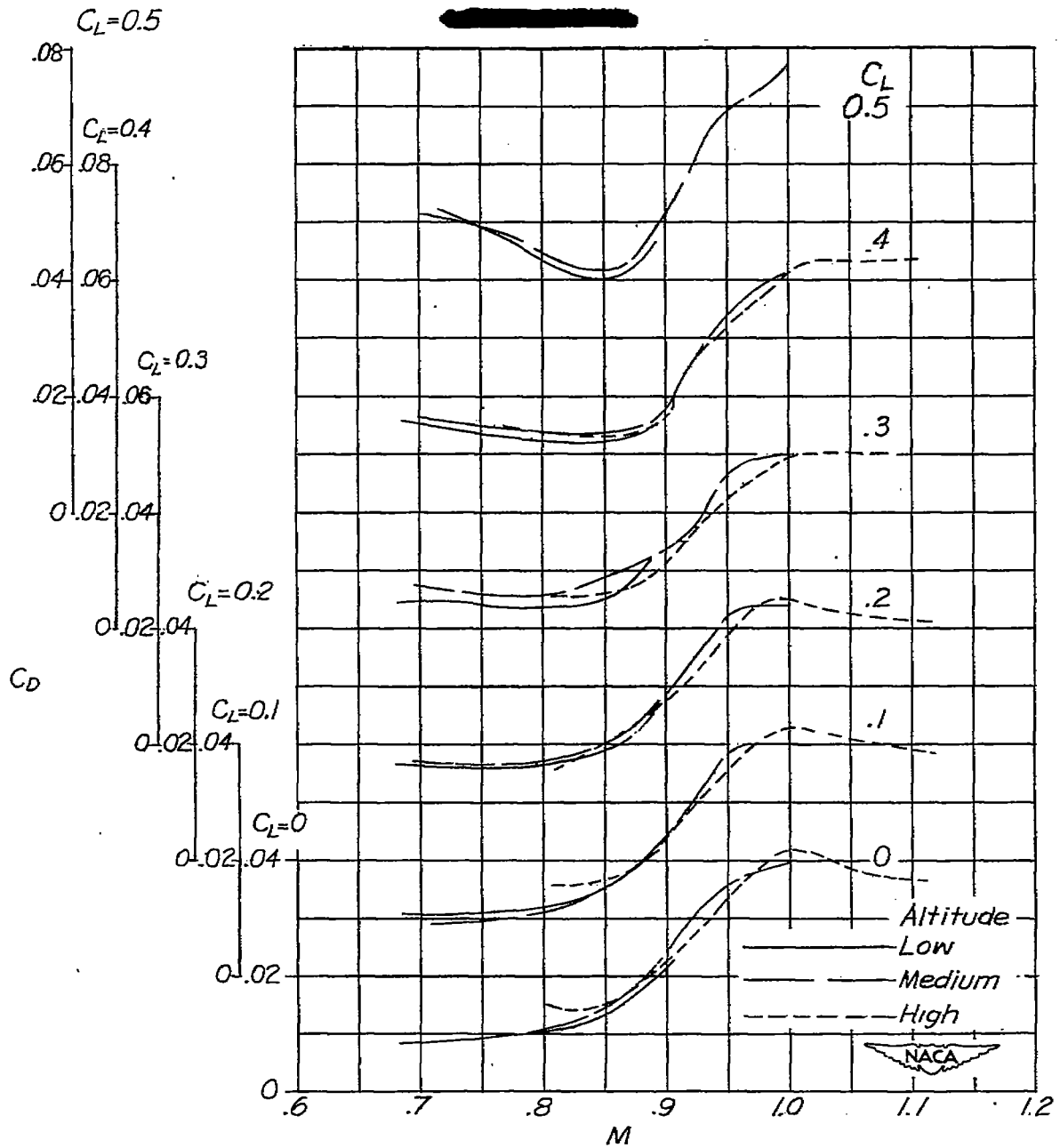

Figure 9.- Variation with Mach number of drag coefficient for several lift coefficients and three ranges of altitude.

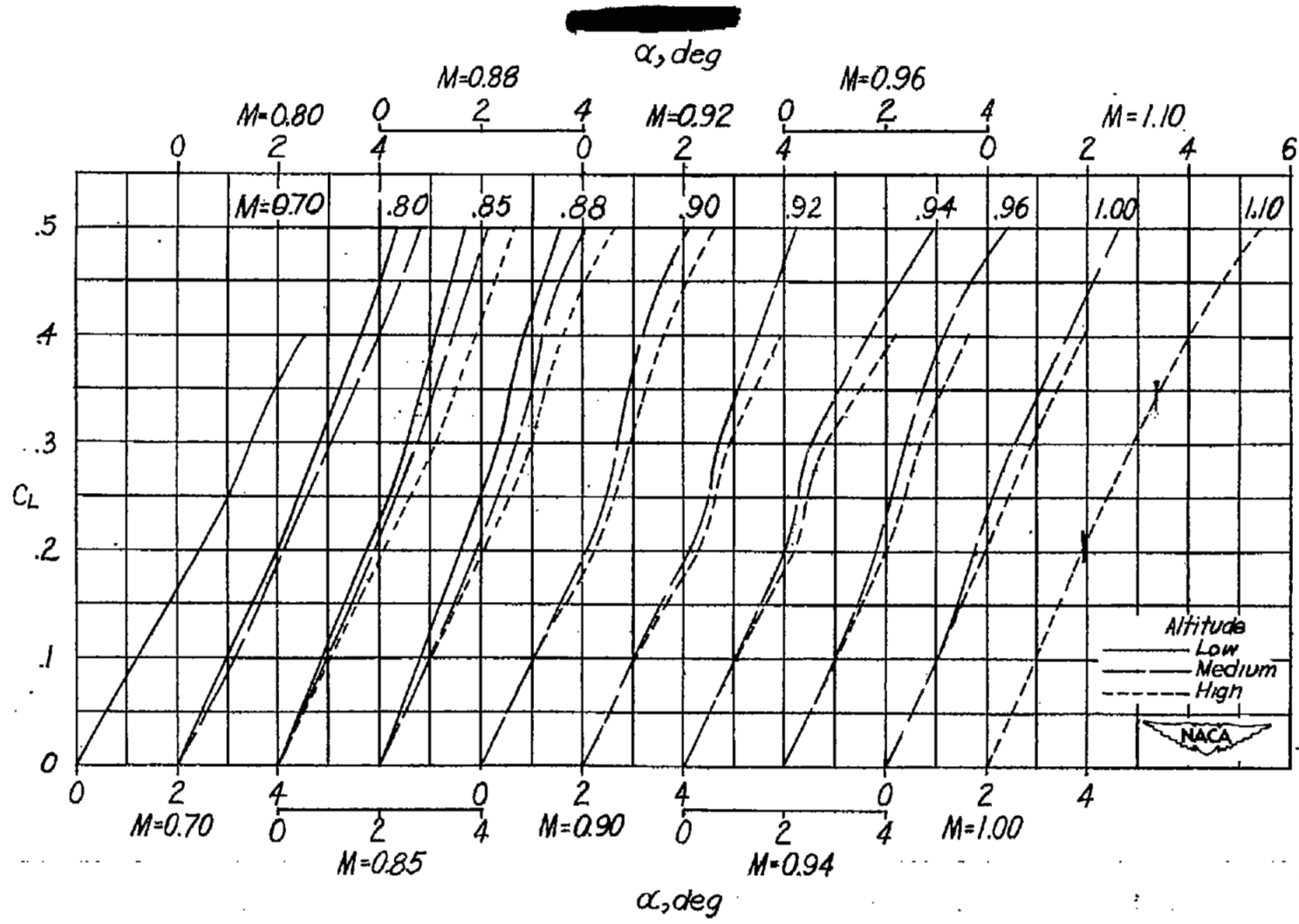

Figure 10.— Variation of lift coefficient with angle of attack for various Mach numbers.

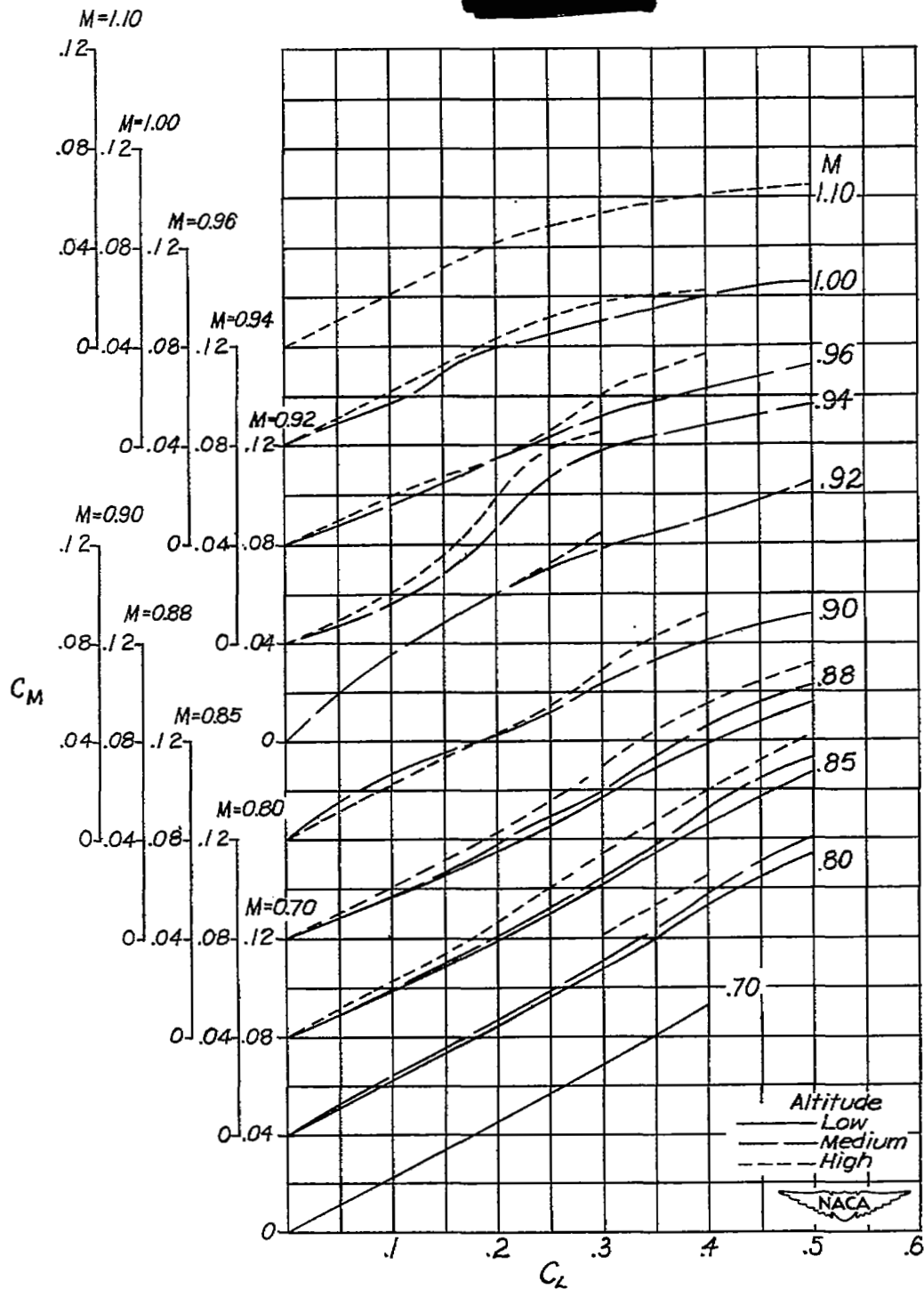

Figure 11.— Variation of pitching-moment coefficient with lift coefficient for various Mach numbers.

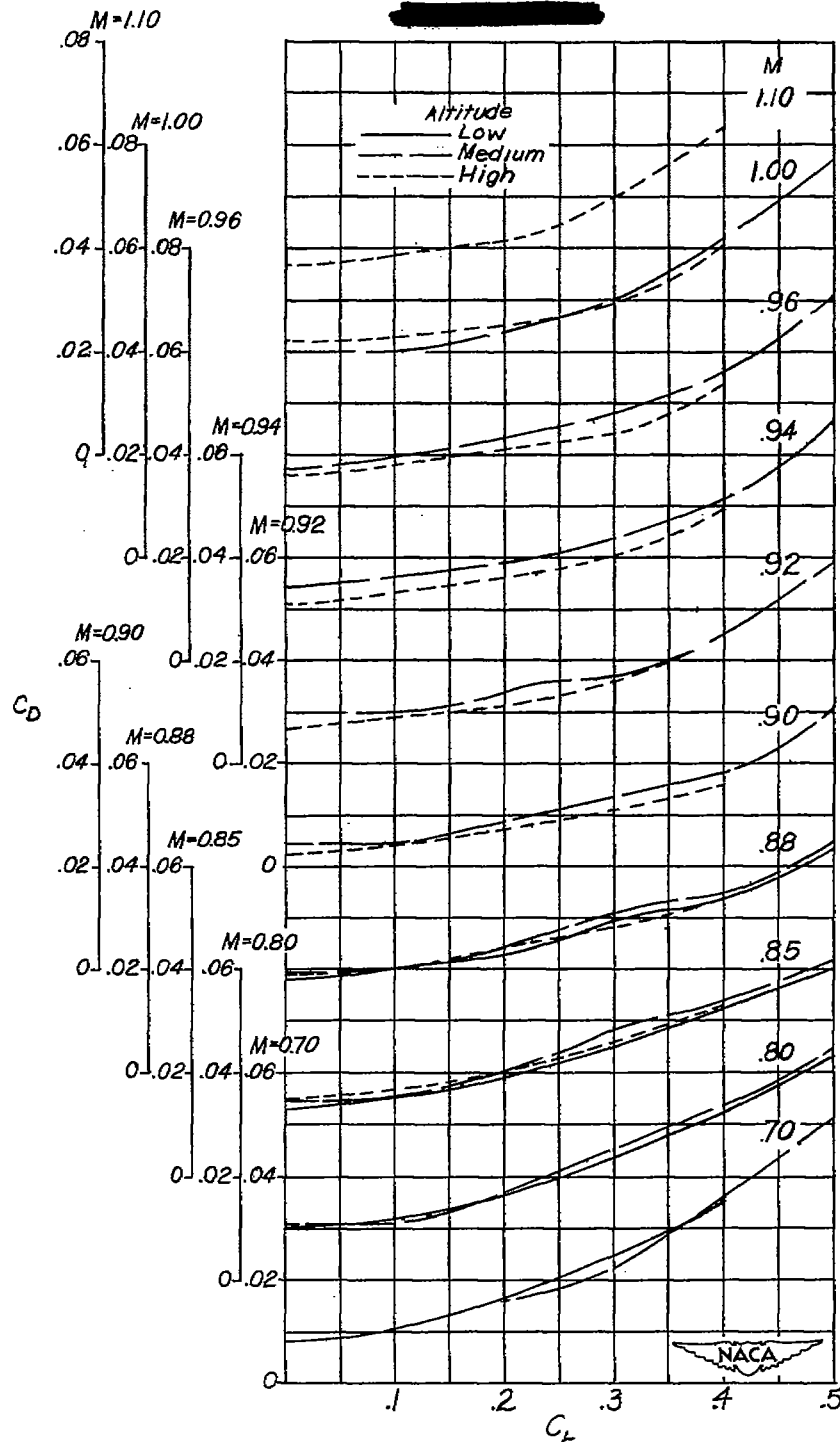
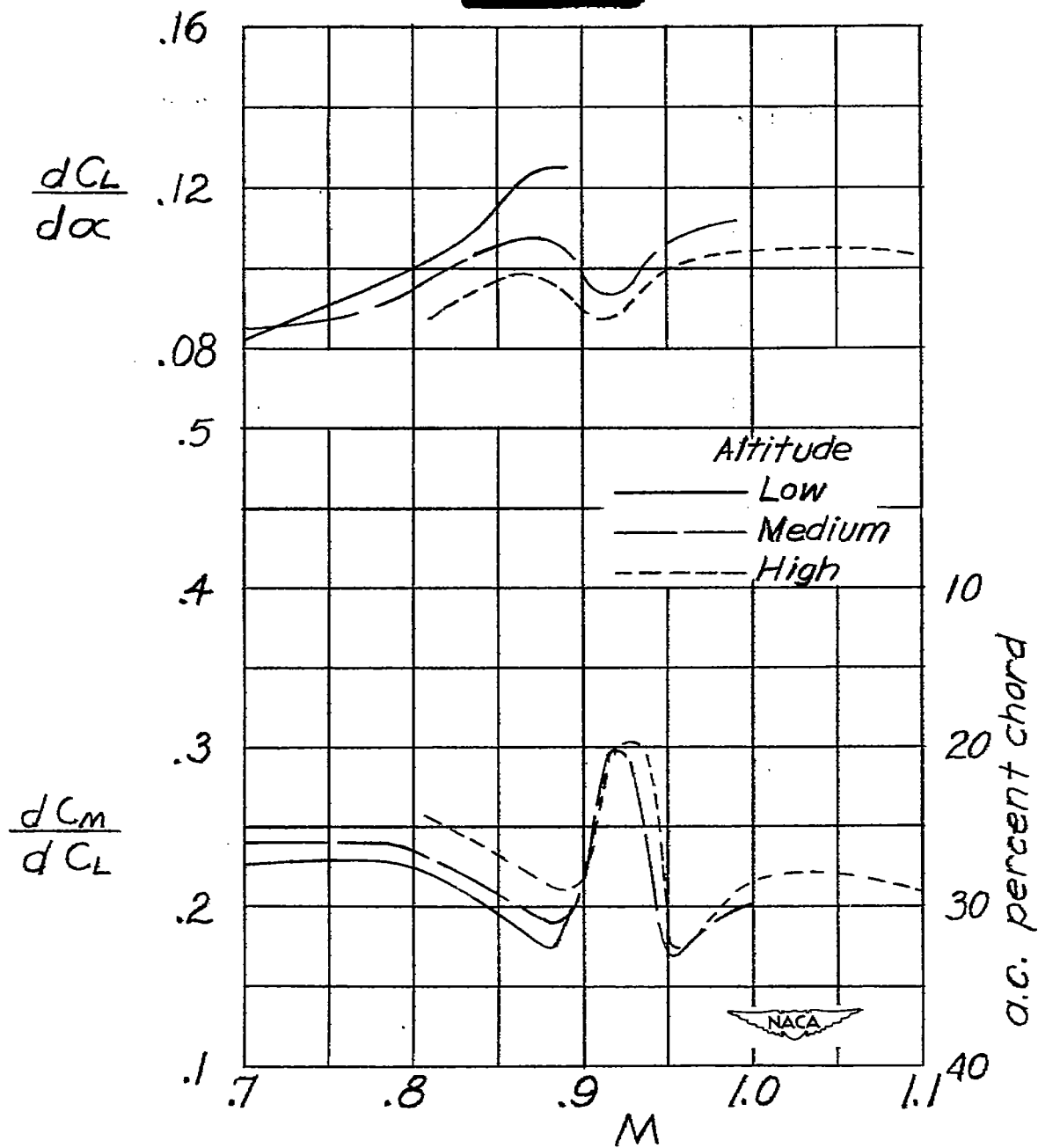
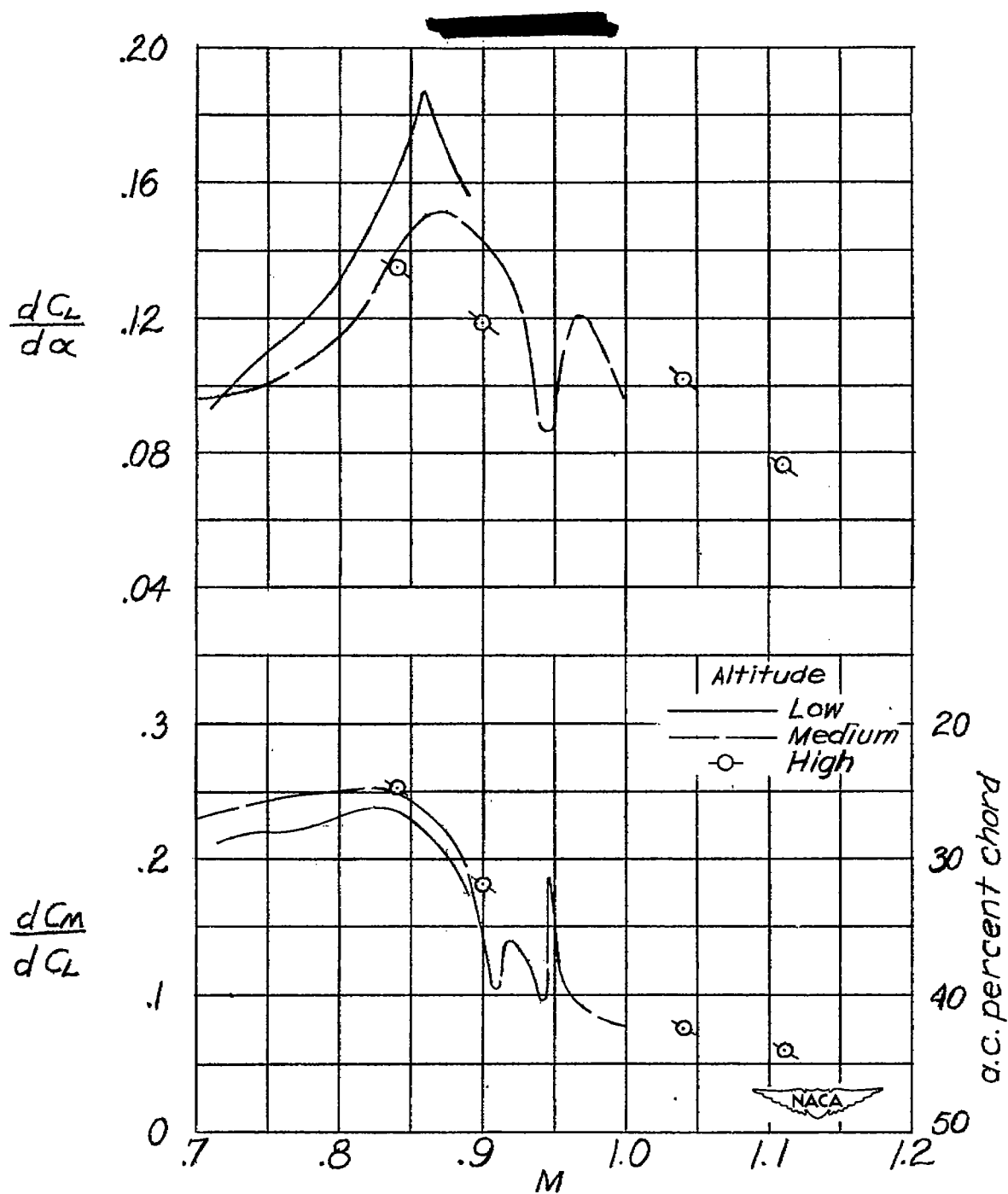

Figure 12.— Variation of drag coefficient with lift coefficient for various Mach numbers.



(a) Slopes taken for lift coefficients from 0 to 0.2.

Figure 13.— Variation with Mach number of $\frac{dC_L}{d\alpha}$ and $\frac{dC_M}{dC_L}$. Position of aerodynamic center also indicated.



(b) Slopes taken for lift coefficients from 0.3 to 0.5.

Figure 13.— Concluded.

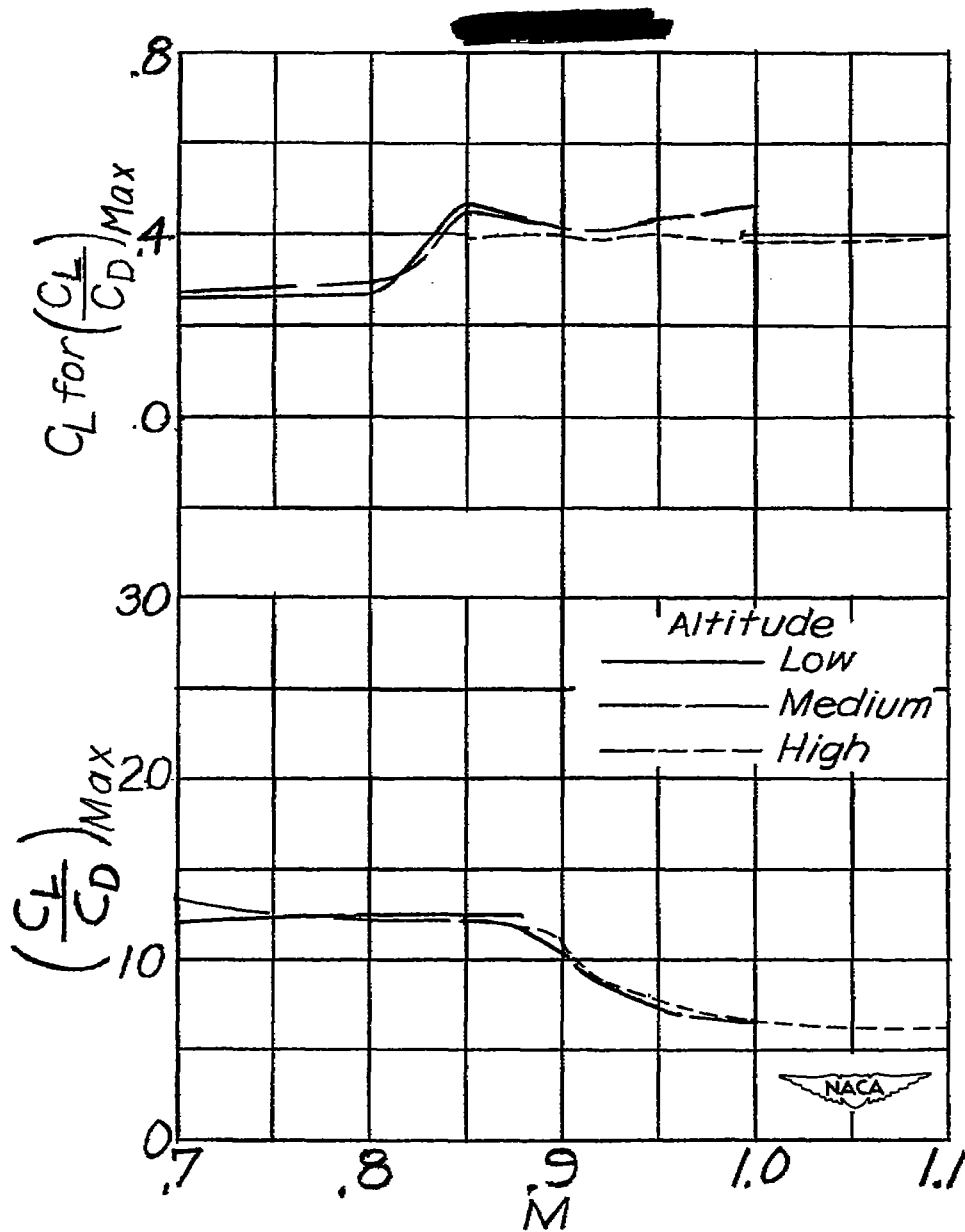

Figure 14.— Variation with Mach number of $(C_L/C_D)_{\text{max}}$ and lift coefficient for $(C_L/C_D)_{\text{max}}$.

NASA Technical Library



3 1176 01436 7115