

~~CONFIDENTIAL~~

Copy
RM L52J14

NACA RM L52J14

~~53-35-50~~

TECH LIBRARY KAFB, NM
014421

NACA

RESEARCH MEMORANDUM

A LOW-SPEED EXPERIMENTAL STUDY OF THE DIRECTIONAL
CHARACTERISTICS OF A SHARP-NOSED FUSELAGE
THROUGH A LARGE ANGLE-OF-ATTACK RANGE
AT ZERO ANGLE OF SIDESLIP

By William Letko

Langley Aeronautical Laboratory
Langley Field, Va.

RECEIPT SIGNATURE
REQUIRED

CLASSIFIED DOCUMENT

~~This material contains information affecting the National Defense of the United States within the meaning of the Espionage Laws, Title 18, U.S.C., Secs. 793 and 794, the transmission or revelation of which in any manner to an unauthorized person is prohibited by law.~~

NATIONAL ADVISORY COMMITTEE
FOR AERONAUTICS

WASHINGTON

November 19, 1952

319.98/13

~~CONFIDENTIAL~~

~~3293~~

7374

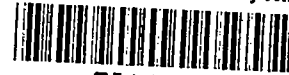

0144421

R NACA RM L52J14

~~CONFIDENTIAL~~

NATIONAL ADVISORY COMMITTEE FOR AERONAUTICS

RESEARCH MEMORANDUM

A LOW-SPEED EXPERIMENTAL STUDY OF THE DIRECTIONAL
CHARACTERISTICS OF A SHARP-NOSED FUSELAGE
THROUGH A LARGE ANGLE-OF-ATTACK RANGE
AT ZERO ANGLE OF SIDESLIP

By William Letko

SUMMARY

An investigation made in the Langley stability tunnel to determine the directional characteristics of a sharp-nosed fuselage through a large angle-of-attack range at zero angle of sideslip showed that the fuselage experiences a large increase in yawing moment as the angle of attack increases which is caused by asymmetrical disposition of the pair of trailing vortices emanating from the nose.

The results also showed that a ring or other roughness used on the nose caused (mainly by altering the vortex disposition) a large decrease in the yawing moment obtained at high angles of attack and, in fact, for some angles of attack the yawing moment was of a sense opposite to that obtained with a plain fuselage. Although the reason that the ring altered the vortex disposition has not been established, the use of a ring may be convenient for studying the reversal of vortex disposition and hence of load which has been found to be self-induced and to occur aperiodically for some fuselages in other investigations.

INTRODUCTION

The interest in the forces and moments experienced by bodies of revolution inclined to the line of flight arose originally in connection with airships. During the era of the subsonic airplane, interest in the forces and moments experienced by bodies lagged somewhat because of the relatively minor contribution of the airplane fuselage to the aerodynamic characteristics of the total airplane configuration. The advent of missiles and supersonic aircraft where the body is a major component of the configuration has again focused interest on body characteristics,

~~CONFIDENTIAL~~

AFCR 2293

especially bodies of revolution at relatively high angles of attack. As a result, the potential theory of reference 1 has recently been modified by such works as reference 2. In reference 2, some flow studies were made in conjunction with an analytical study of viscous effects on body characteristics. An interesting phenomenon was observed in these flow tests. The pair of vortices being discharged from the body became asymmetrical with respect to the body for some angles of attack with one vortex being closer to the body than the other and there occurred an unexplained aperiodic reversal of vortex disposition. Reference 2 also pointed out that the aperiodic changes in vortex disposition might induce, for a pitched body, undesirable forces and moments in yaw. A very recent paper (ref. 3) has shown that such fluctuating forces and moments do occur for a fin-stabilized body. Although no mention of fluctuating forces and moments was made in reference 4, the reference pointed out that asymmetrical rolling and yawing moments resulted for a sharp-nosed body above about 16° angle of attack at zero sideslip angle.

A phenomenon which, it was felt, could be attributed to the aperiodic reversal of the vortex disposition mentioned in reference 2 occurred in the calibration tests of a conical pitch and yaw tube in the Langley stability tunnel. The pressures measured by the yaw orifices of the tube in pure pitch were unsteady at high angles of attack and reversed aperiodically. The aperiodic reversal of pressure was eliminated when a small modification was made to the nose of the pitch and yaw tube.

Therefore, in order to determine the effects of nose modification on the directional characteristics in pitch of a sharp-conical-nose fuselage at high angles of attack, and in the hope that some light might be shed on the cause of the reversal of the vortex pattern observed in reference 2, an investigation of a fuselage with a sharp conical nose was made in the stability tunnel. The modifications consisted of increasing the roughness of the nose by use of a ring made of $\frac{1}{16}$ -inch wire located at different stations along the fuselage nose and also by covering a portion of the nose with carborundum grains. The effect of successively cutting off 1 and 3 inches of the nose was also investigated. Force measurements were made with a six-component balance system and the instantaneous yawing moment was also measured with a strain-gage balance. Some circumferential pressure measurements were made at one station on the model and the instantaneous differential pressure of two yaw orifices located in the nose of the model was also measured. The results of the investigation are presented herein.

SYMBOLS

The data presented are in the form of standard NACA coefficients of forces and moments which are referred to the body system of axes. The positive directions of forces, moments, and angular displacements are shown in figure 1. The coefficients and symbols are defined as follows:

C_N'	normal-force coefficient, N'/qS
C_Y	lateral-force coefficient, Y/qS
C_n	yawing-moment coefficient, N/qSd
N'	normal force, lb
Y	lateral force, lb
N	yawing moment, ft-lb
q	dynamic pressure, $\rho V^2/2$, lb/sq ft
ρ	mass density, slugs/cu ft
V	free-stream velocity, ft/sec
S	model frontal area, 0.0608 sq ft
d	maximum body diameter, 0.2783 ft
z	distance along fuselage axis, measured rearward from fuselage nose
r	fuselage ordinate, measured normal to fuselage axis (see fig. 2)
p	local orifice pressure
Δp	pressure difference between two yaw orifices located in fuselage nose
H	total head of free stream
α	angle of attack of fuselage center line, deg
β	angle of sideslip of fuselage center line, deg

MODEL AND APPARATUS

The fuselage used in the investigation was a body of revolution which was made of mahogany with a nose of brass. The fineness ratio of the fuselage was about 10.4. The nose portion of the fuselage was a cone of 15° included angle. The coordinates of the fuselage are given in figure 2 and a photograph of the fuselage mounted in the tunnel is given as figure 3. Twelve equally spaced orifices were located on the circumference of the fuselage at a station 17.675 inches from the nose. The pressures at these orifices were measured by an alcohol manometer. An electrical pressure pickup was built into the brass nose portion of the fuselage to determine the pressure difference between two yaw orifices located on the sides of the cone 2.125 inches from the nose of the fuselage. The fuselage was mounted through a strain gage to a strut which, in turn, was mounted on a six-component balance system. The strain gage was so arranged that it measured the instantaneous yawing moment of the fuselage about the fuselage axis while the balance system measured all six components, forces, and moments about the wind axes.

The instantaneous pressure difference between the yaw orifices and the instantaneous yawing moment measured by the strain gage were photographically recorded by an oscillograph.

A small rectangular tail (6 inches by 3 inches) of aspect ratio 2 was used in conjunction with the fuselage for some of the tests. (See fig. 2.)

TESTS

The tests were made in the 6- by 6-foot test section of the Langley stability tunnel. Most of the tests were made at a dynamic pressure of 98.3 pounds per square foot. Some configurations were tested at dynamic pressures of 64.3, 39.7, and 24.9 pounds per square foot in addition to the tests at 98.3 pounds per square foot. The maximum Reynolds number based on free-stream velocity and maximum fuselage diameter was approximately 500,000. The maximum Mach number was 0.26.

All tests were made with a dummy support strut and fairing in order to maintain symmetrical conditions near the body. Angles of attack were obtained by yawing the model in the tunnel. The angle-of-attack range was from 0° to 40° and, for most of the tests, the angle of sideslip was 0° . A few tests were made at -6° angle of sideslip for the same angle-of-attack range.

No wind-tunnel-wall or strut-tare corrections were applied to the data.

PRESENTATION OF DATA

The results of the present investigation are presented in figures 4 to 16. Although both the static and instantaneous yawing moments of the model were measured, most of the data presented are from the static measurements obtained with the balance system.

Some reproductions of film records are presented in figure 10 and the yawing moments determined from similar records are compared in figure 11 with the static moments obtained with the balance system. The values of yawing moments from the records used in the comparison were obtained by taking half the amplitude defined by two horizontal linear lines which bounded a majority of the wave traces of instantaneous yawing moment. Any strain-gage yawing moments presented are so identified in the figures.

RESULTS AND DISCUSSION

The variation of normal-force and yawing-moment coefficients (determined from balance-system readings) of the fuselage with angle of attack for zero sideslip angle is shown in figures 4 and 5, respectively, for several values of dynamic pressure. The normal-force coefficient shown in figure 4 increases with angle of attack as expected and, in general, increases with an increase in dynamic pressure for all the angles of attack tested. The yawing moment (fig. 5) is small and fairly constant up to about 15° angle of attack but increases rapidly above 15° and reaches a rather high maximum positive value at about 35° angle of attack. Repeat tests of the fuselage, which was a body of revolution, resulted in a yawing moment which consistently showed the same variation with angle of attack. With a perfectly symmetrical fuselage the variation would be expected to vary from test to test; that is, for one test the yawing moment might become more positive with angle of attack, whereas for the next test the yawing moment would become negative with angle of attack, depending on initial trends. The tendency of the yawing moment of the fuselage to become more positive with angle of attack in the present tests was found to be associated with model characteristics rather than tunnel test setup because a test (data not presented) with the model inverted showed the yawing moment to be in the same direction relative to the fuselage. An increase in dynamic pressure generally decreased the values of yawing moment in the angle-of-attack range near the angle for maximum positive yawing moment; however, the effect is not consistent for all angles of attack. (See fig. 5.)

The cross Reynolds numbers corresponding to the dynamic pressures of these tests were fairly low so that the critical cross Reynolds number

for a cylinder based on maximum fuselage diameter was attained at the highest dynamic pressure of the tests at about 25° angle of attack of the fuselage. It is believed, however, that even if the critical cross Reynolds number was reached at lower angles of attack, the general variation of the forces and moments with angle of attack would not be altered appreciably. Reference 2 indicates that for a body of revolution such as that of the present tests, in which the diameter of the body varies along the length, Reynolds number effects on the variation of forces and moments with angle of attack are small in contrast to the effects which would be expected on a body which mainly consists of a long, cylindrical portion of constant diameter.

Studies of records such as figure 10, which will be discussed later, showed that a reversal of lateral load with time was not obtained in the present tests. A reversal of lateral load with time was expected on the basis of previous tests. The loading on the fuselage tended to reverse, however, when the angle of attack was increased above 35° . This tendency is indicated by the large decrease in yawing moment and an actual change in sign of yawing moment for $q = 24.9$ pounds per square foot and angle of attack of 38° . (See fig. 5.) A change in direction of lateral load and yawing moment relative to that obtained for the plain model was obtained, however, even at angles of attack as low as 20° when a $\frac{1}{16}$ -inch-diameter wire was wrapped around the nose portion of the fuselage to form a ring 1 inch from the nose. (See fig. 6.) From the figure, it can be seen that the values of yawing moment are the same for ring-off and ring-on conditions up to 15° angle of attack. Above 15° angle of attack, the yawing-moment coefficients for the plain fuselage become more positive with angle of attack, whereas the yawing-moment coefficients for the model with the ring on the nose show an opposite tendency and become more negative as the angle of attack is increased. However, the absolute values of yawing moment are decreased. A study of the lateral-force coefficients presented in figure 6 indicates that the decrease in yawing-moment coefficients is caused by a reduction of lateral load and by a shift in center of pressure of the lateral load distribution.

A cursory tuft-probe examination at 35° angle of attack and very low speed showed an unsymmetrical vortex disposition along the plain fuselage. The disposition was unsymmetrical even for positions very near the nose of the body. The unsymmetrical disposition of the vortices was responsible for the large values of yawing moment obtained at angles of attack above 15° with the plain fuselage. This initial unsymmetrical disposition of vortices was considerably altered and appeared reversed when the ring was placed on the fuselage nose. This altered disposition of the vortices accounts for the difference in the variation of the lateral-load and yawing-moment coefficients with angle of attack obtained with the plain model and model with ring on the nose. The ring decreased the absolute values of yawing moment which a study of the lateral-force

coefficients, presented in figure 6, indicates is due to a reduction of lateral load and, also, to a shift in center of pressure of the lateral load distribution. The reversal in direction of load at one section of the fuselage caused by the ring can readily be seen in figure 7 which presents a comparison of the pressure distribution for the ringed and plain fuselage obtained around the periphery of the fuselage about $17\frac{1}{2}$ inches from the nose at a dynamic pressure of 64.3 pounds per square foot. The pressure distributions shown in the figure appear equal and opposite; this indicates an equal and opposite local lateral load. The pressure difference measured by the two yaw orifices, which should give a good indication of the magnitude of the lateral load at the yaw orifice location, indicates the reversal in direction of load due to the ring; however, the pressure difference is not of equal magnitude for both conditions. (See fig. 8.) The ring, therefore, must affect the pressures at different lengthwise stations to different extents which, of course, would not only decrease the resultant loading but would also cause a shift in the center of pressure. The mechanism behind the change in initial vortex disposition, and hence in the load brought about by the ring, is not apparent, but even when the model is at -6° sideslip angle giving the model a larger initial positive yawing moment, the ring still is capable of causing a reversal in direction of load at some angles of attack. (See fig. 9.) Results (not presented) of tests with the ring skewed about different radial axes in the plane of the ring did not have any apparent effect on the action of the ring in reversing the direction of load. From the foregoing discussion, it appears that the effects of the ring can overshadow not only the model characteristics that initially caused the yawing moment to increase positively with angle of attack but can overcome initial tendencies which are caused by an angle of sideslip of at least 6° which was the largest sideslip angle tested.

Records of the instantaneous yawing moment and yaw-orifice pressure difference are presented in figure 10 for the plain fuselage and fuselage with ring on 1 inch from the nose. From this figure it can be seen that the moments and pressures were very unsteady at high angles of attack. However, since the natural frequency of the model and strain gage, determined experimentally to be 45 to 50 cycles per second, is the predominant frequency of the yawing moments recorded, it is unlikely that the records of the yawing moments obtained give a reliable indication of either the frequency or amplitude of the forcing function. Although the natural frequency of the pressure pick-up system was not determined, the frequency appears very high and it is felt that any changes in pressure difference recorded (other than the high-frequency "hash" seen on most of the records) would be more representative of the forcing impulses than the yawing-moment records. In figure 10(b), a square-wave variation can be seen in the record of pressure difference for the model with ring on at 36° angle of attack. In the present tests, this was the only instance in which this type of variation was obtained; however, although

the magnitude of the pressure difference varied considerably, the value did not change sign as was the case in earlier tests of a plain conical-nose pitot tube. This variation indicates a periodic shifting but not a complete reversal of the original vortex disposition. The differences in shape of the fuselage and pitot tube rearward of the conical nose section (pitot tube had a straight, cylindrical portion of constant diameter) probably caused the fuselage results to be somewhat different than those expected on the basis of the tests of the conical-nose pitot tube.

A comparison of the yawing moment obtained from balance readings with values obtained from strain-gage records (such as fig. 10) by the procedure mentioned in the section "Presentation of Data" is shown in figure 11. The variation of yawing moment with angle of attack is seen to be similar in each case. The differences in values determined by the two methods can probably be attributed mainly to differences in strut-tare values which were not determined for either case.

The effects of varying the location of the ring from $\frac{1}{4}$ inch to 8 inches from the nose of the model on the yawing moment of the model can be seen in figure 12. As the distance of the ring from the nose increases, the effectiveness of the ring in reducing the yawing moment appears to decrease and the first 3 inches of the fuselage nose apparently is the most critical region so far as altering the load on the fuselage is concerned. Tests of a fuselage having a short elliptical nose showed that the ring had only a small effect on the yawing moment of the fuselage.

The effects of cutting 1 and 3 inches off the nose of the fuselage resulting in a blunt nose can be seen in figure 13. The yawing moments were of opposite sign to those obtained with the plain fuselage at angles of attack above 25° and the yawing moments were small throughout the angle-of-attack range in contrast to those obtained with the plain fuselage.

In the course of the present investigation it was found that the loading on the fuselage could also be reversed by increasing the roughness of the nose by using carborundum grains. Figure 14 shows that the effect of the carborundum grains on the yawing-moment coefficient is very similar to that of the ring.

In figure 15 is shown a comparison of the yawing moments of the plain fuselage and of the fuselage with a rectangular tail of aspect ratio 2. The general variation of yawing moment is the same for both cases but, in the angle-of-attack range between 20° and 30° , the tail-on configuration has a smaller yawing moment than the plain fuselage, possibly because of the effects of the asymmetrical vortex distribution on the tail. At higher angles of attack, the tail is probably at least partly outside the region of influence of the vortices. The effects of the ring

on the tail-on configuration (fig. 16) is similar to that obtained when the ring is used with the plain fuselage; however, the ring is not quite as effective in reversing the moments as it was with the plain fuselage.

CONCLUDING REMARKS

An investigation made in the Langley stability tunnel to determine the directional characteristics of a sharp-nosed fuselage through a large angle-of-attack range at zero angle of sideslip showed that the fuselage experiences a large increase in yawing moment as the angle of attack increases which is caused by asymmetrical disposition of the pair of trailing vortices emanating from the nose.

The results also showed that a ring or other roughness used on the nose caused (mainly by altering the vortex disposition) a large decrease in the yawing moment obtained at high angles of attack and, in fact, for some angles of attack the yawing moment was of a sense opposite to that obtained with a plain fuselage. Although the reason that the ring altered the vortex disposition has not been established, the use of a ring may be convenient for studying the reversal of vortex disposition and hence of load which has been found to be self-induced and to occur aperiodically for some fuselages in other investigations.

Langley Aeronautical Laboratory,
National Advisory Committee for Aeronautics,
Langley Field, Va.

~~CONFIDENTIAL~~

REFERENCES

1. Munk, Max M.: The Aerodynamic Forces on Airship Hulls. NACA Rep. 184, 1924.
2. Allen, H. Julian, and Perkins, Edward W.: Characteristics of Flow Over Inclined Bodies of Revolution. NACA RM A50L07, 1951.
3. Mead, Merrill H.: Observations of Unsteady Flow Phenomena for an Inclined Body Fitted With Stabilizing Fins. NACA RM A51K05, 1952.
4. Burk, Sanger M., Jr., and Hultz, Burton E.: Static Longitudinal Stability and Dynamic Characteristics at High Angles of Attack and at Low Reynolds Numbers of a Model of the X-3 Supersonic Research Airplane. NACA RM L50L19, 1951.

~~CONFIDENTIAL~~

~~CONFIDENTIAL~~

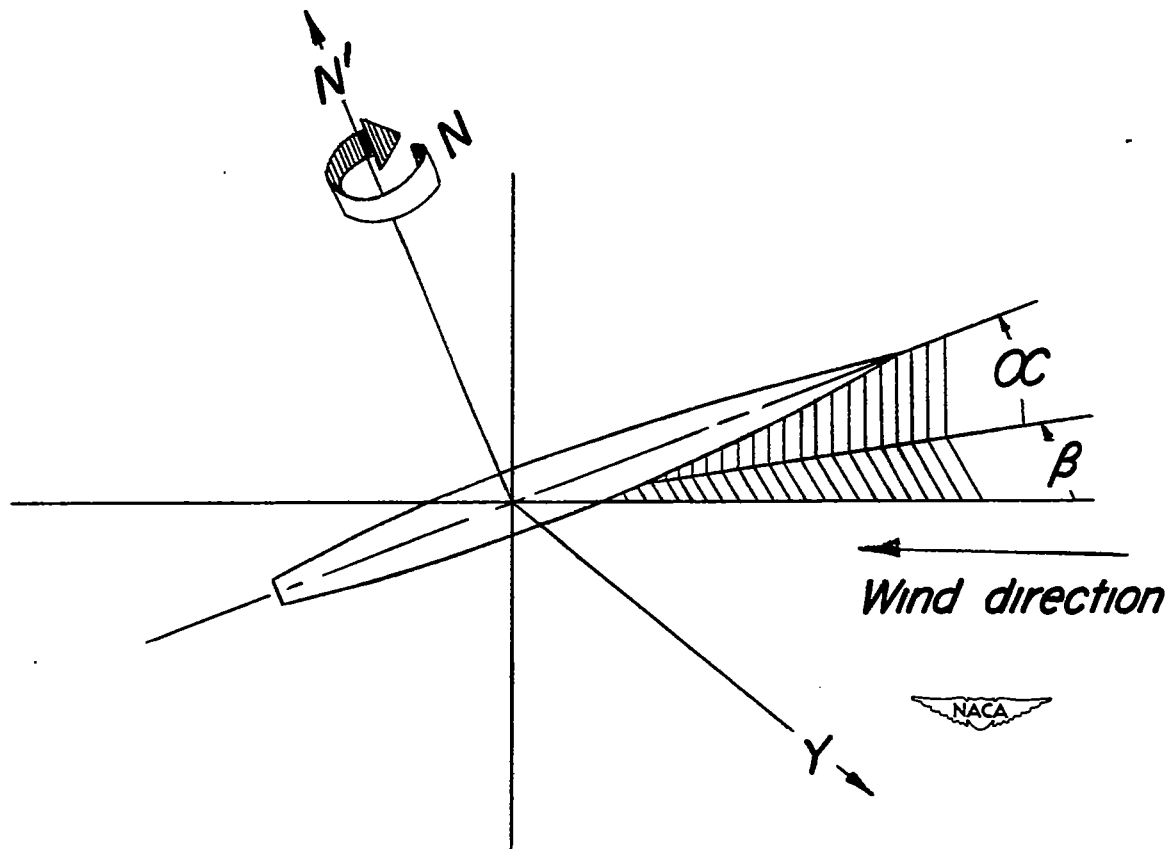
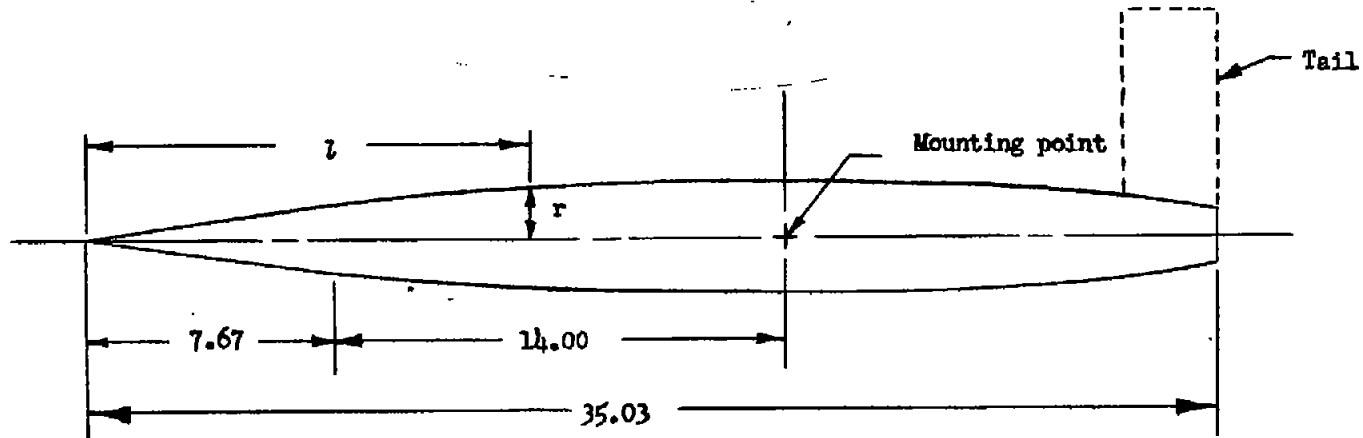

Figure 1.- System of axes used. Arrows indicate positive direction of angles, forces and moments.

~~CONFIDENTIAL~~



First 7.67 inches of fuselage is a cone of 15° included angle

l , in.	r , in.
0	0
7.67	1.010
9.67	1.230
11.67	1.388
13.67	1.496
15.67	1.572
17.67	1.624
19.67	1.656
21.67	1.668
23.67	1.652
25.67	1.608
27.67	1.536
29.67	1.424
31.67	1.252
33.67	1.012
35.03	.800

NACA

Figure 2.- Fuselage coordinates and sketch of model.

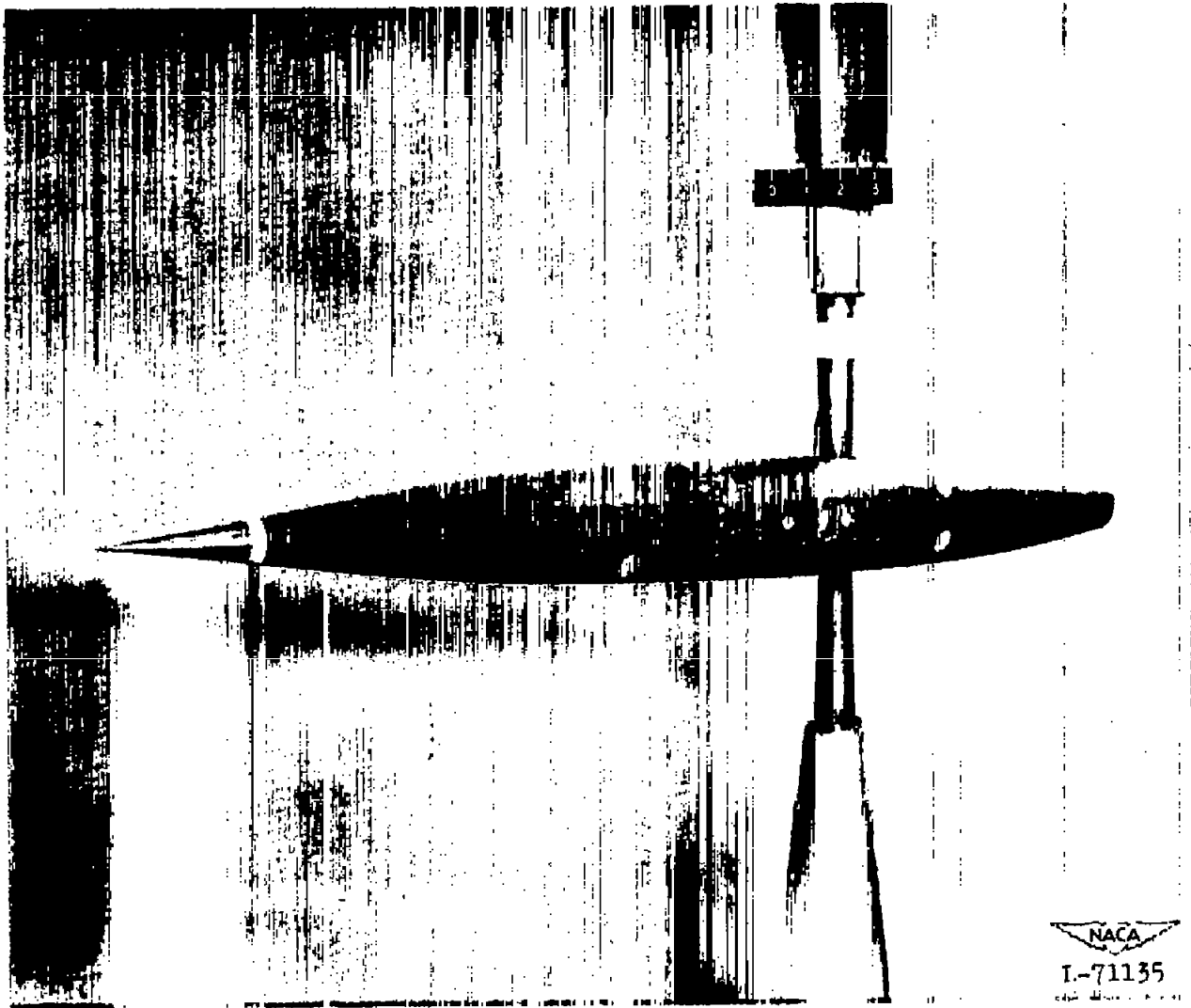

Figure 3.- Model mounted in Langley stability tunnel.

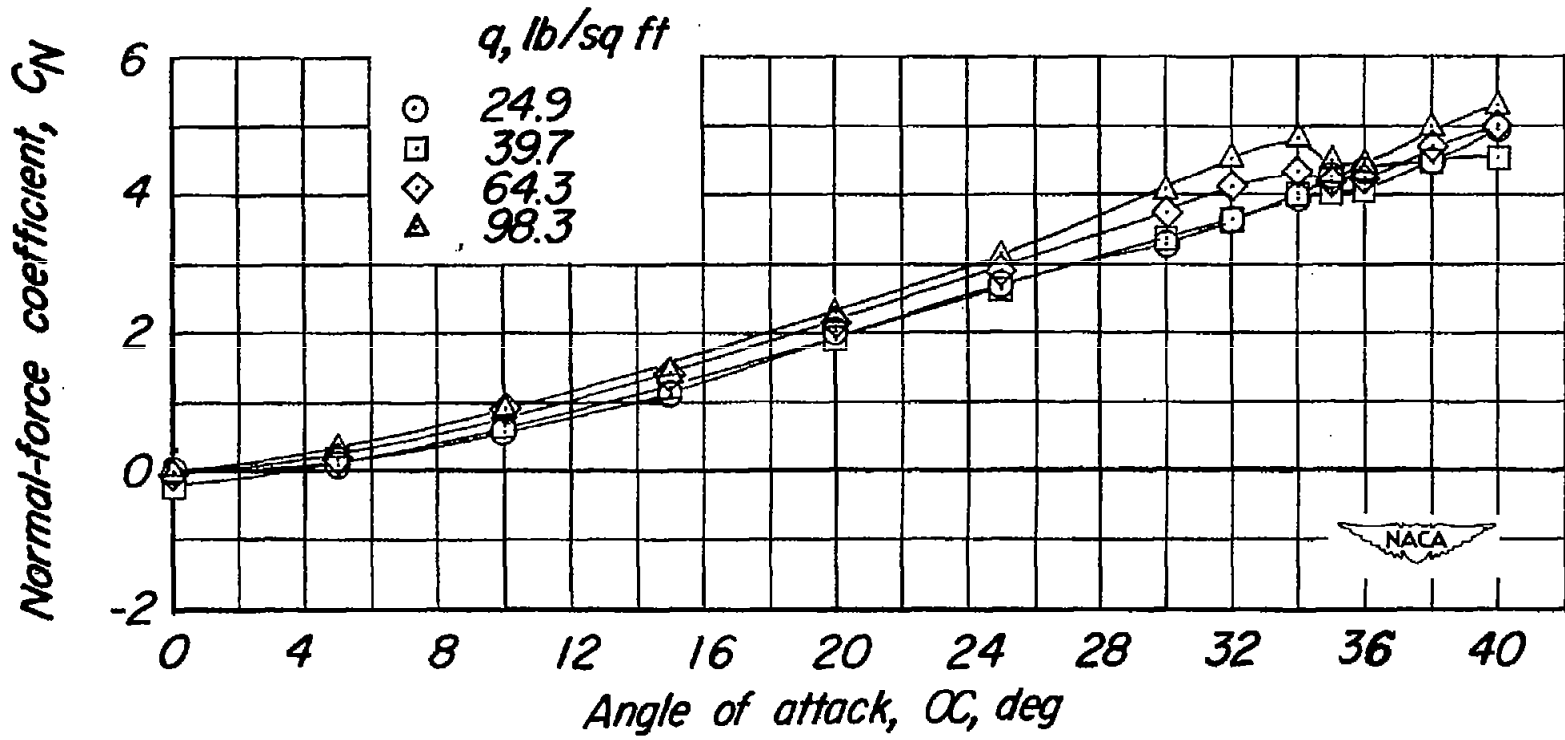

Figure 4.- Effect of dynamic pressure on the variation of fuselage normal-force coefficient with angle of attack. $\beta = 0^\circ$.

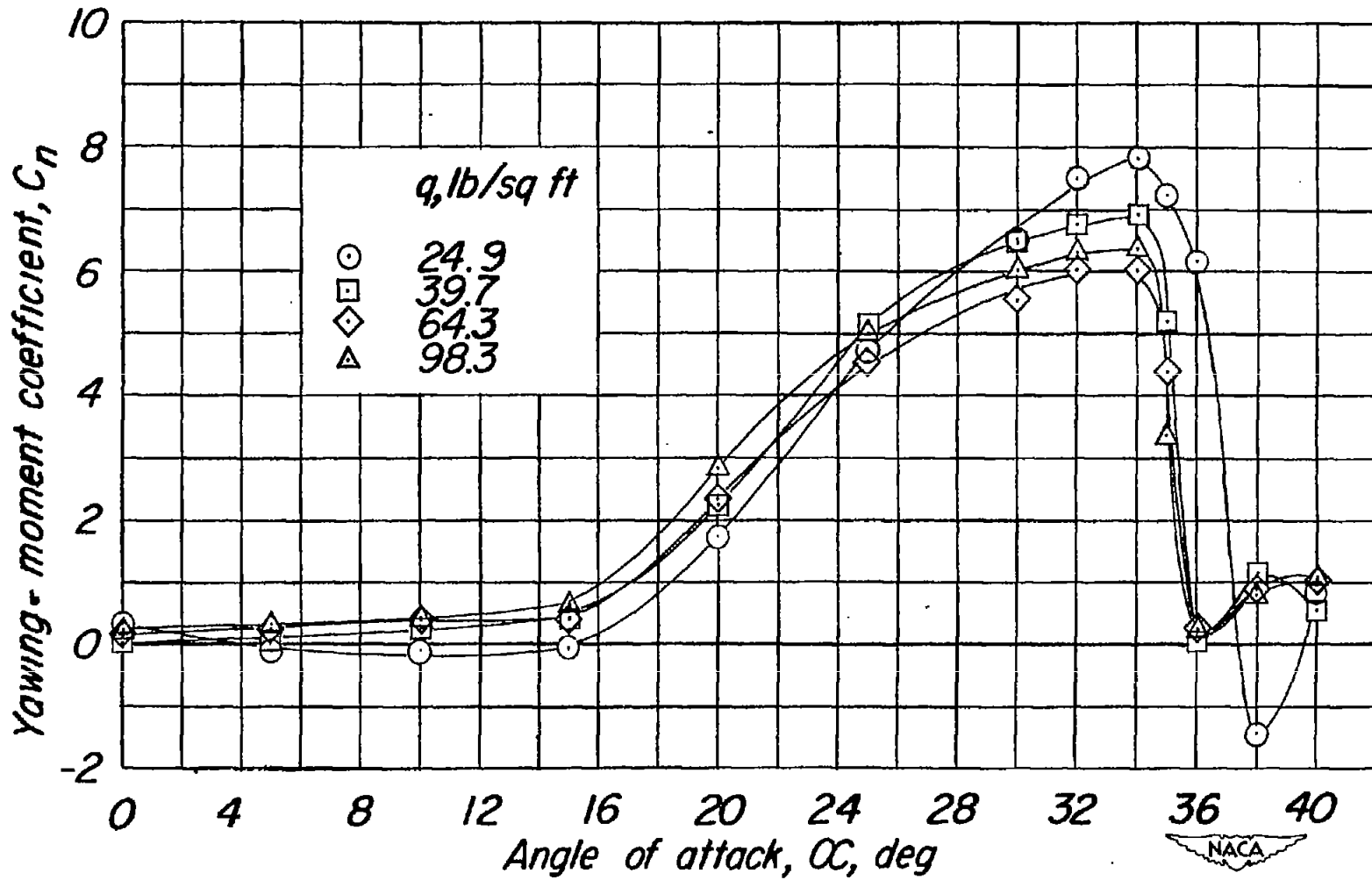

Figure 5.- Effect of dynamic pressure on the variation of fuselage yawing-moment coefficient with angle of attack. $\beta = 0^\circ$.

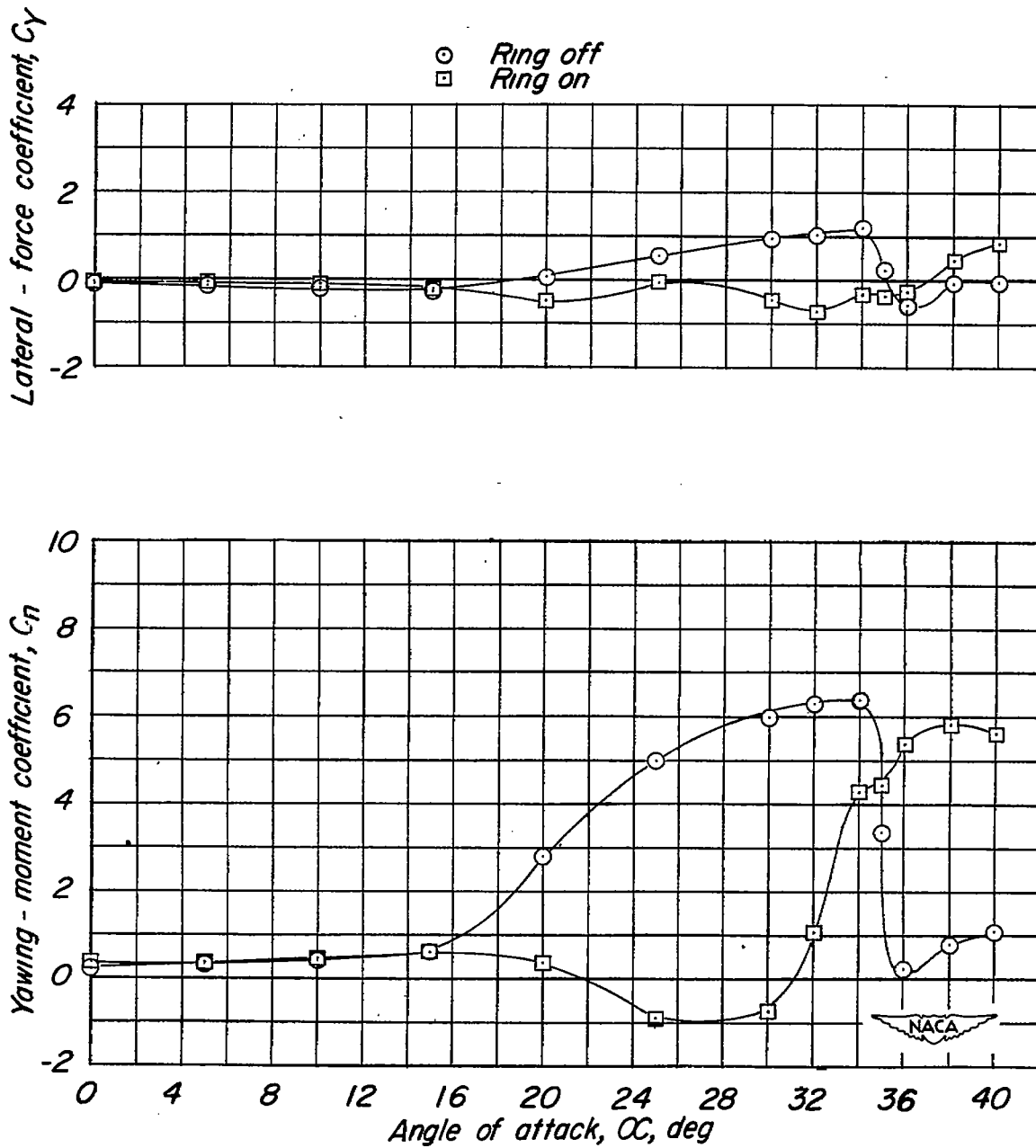

Figure 6.- Comparison of the yawing-moment and lateral-force coefficient variation with angle of attack of plain fuselage and fuselage with $\frac{1}{16}$ -inch-diameter ring located 1 inch from the nose. $\beta = 0^\circ$; $q = 98.3$ pounds per square foot.

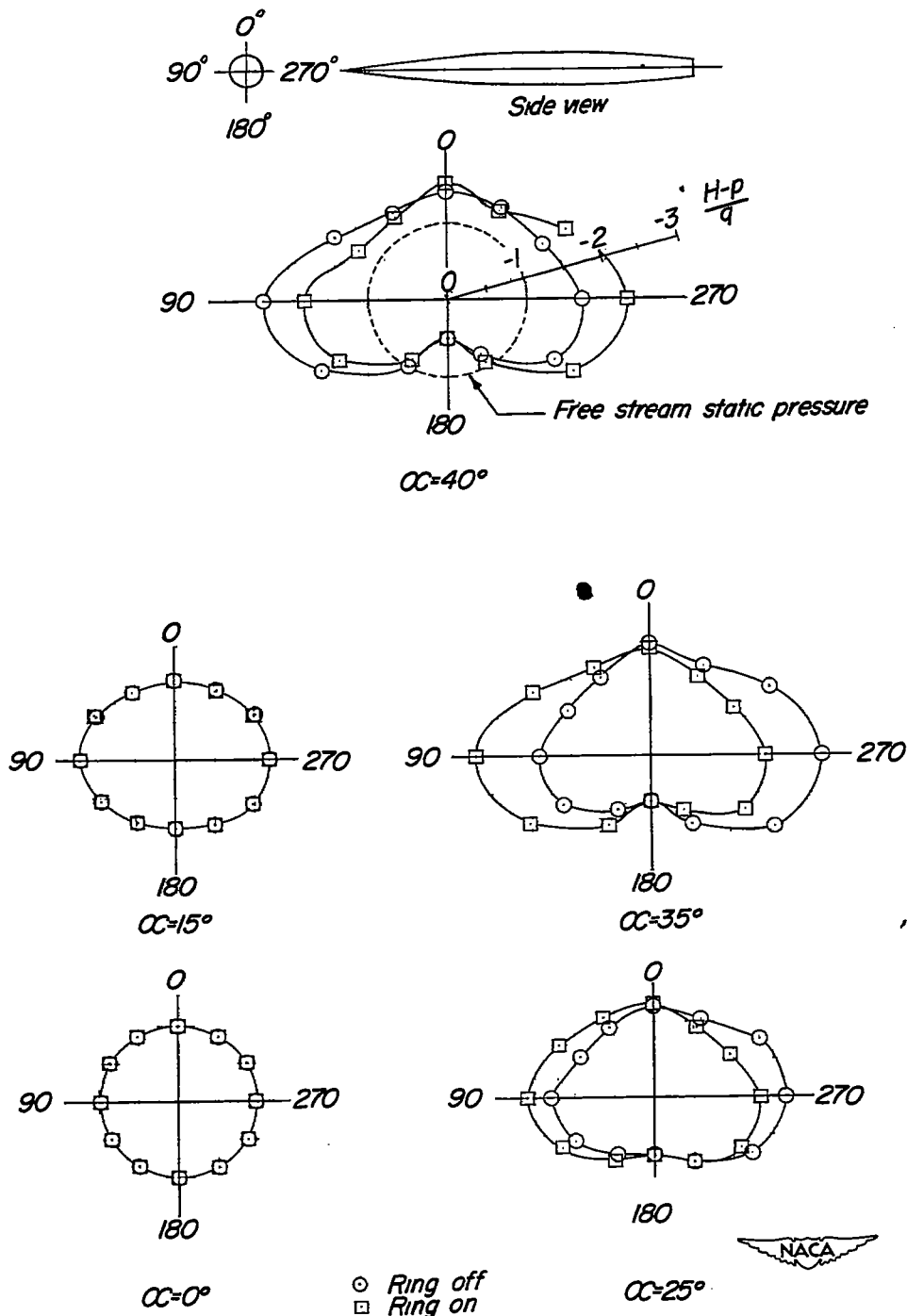

Figure 7.- Comparison of the circumferential pressure distribution at $17\frac{1}{2}$ inches from the nose of the plain fuselage with that obtained for fuselage with ring located 1 inch from the nose. $\beta = 0^\circ$; $q = 64.3$ pounds per square foot.

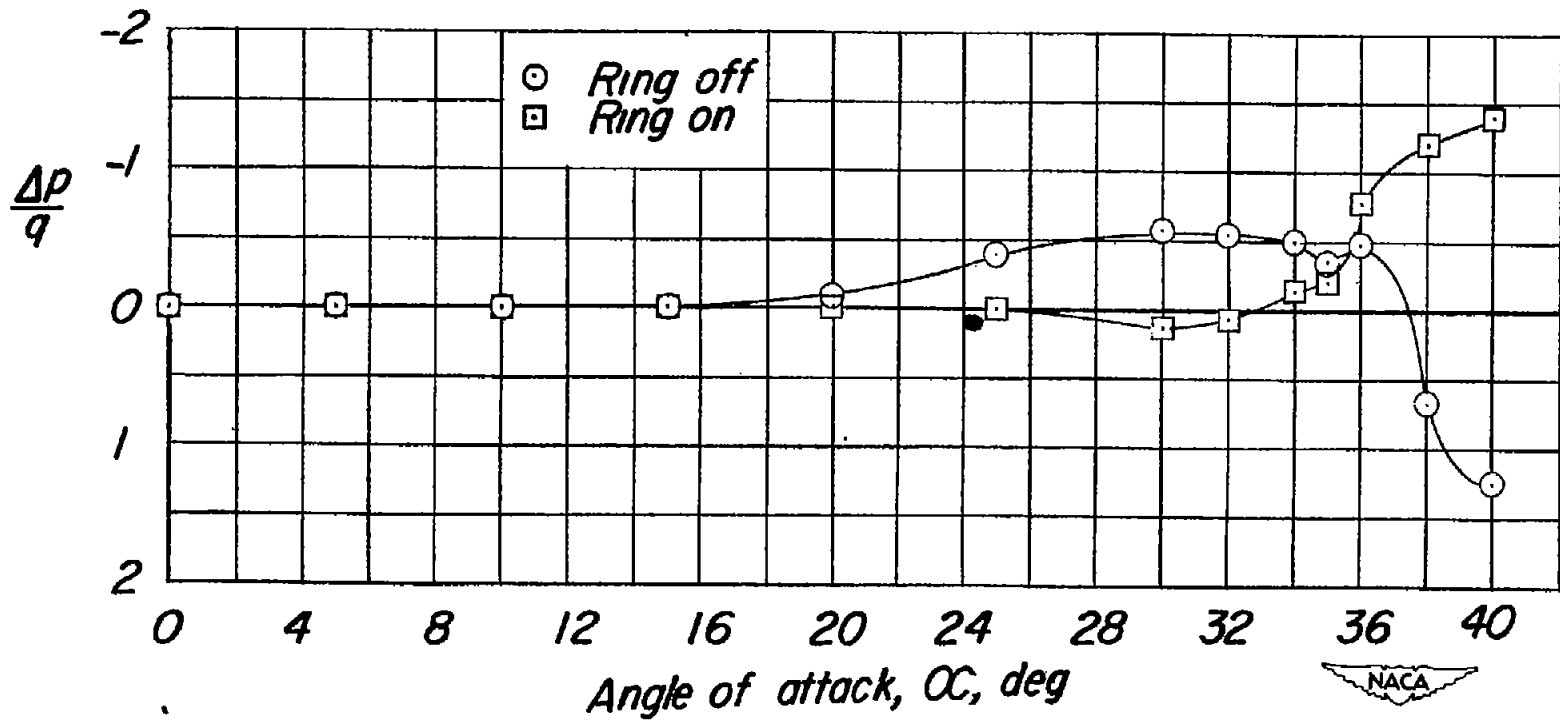

Figure 8.- Variation with angle of attack of the pressure difference measured by yaw orifices for the plain fuselage and fuselage with $\frac{1}{16}$ -inch-diameter ring 1 inch from fuselage nose. $\beta = 0^\circ$;
 $q = 98.3$ pounds per square foot.

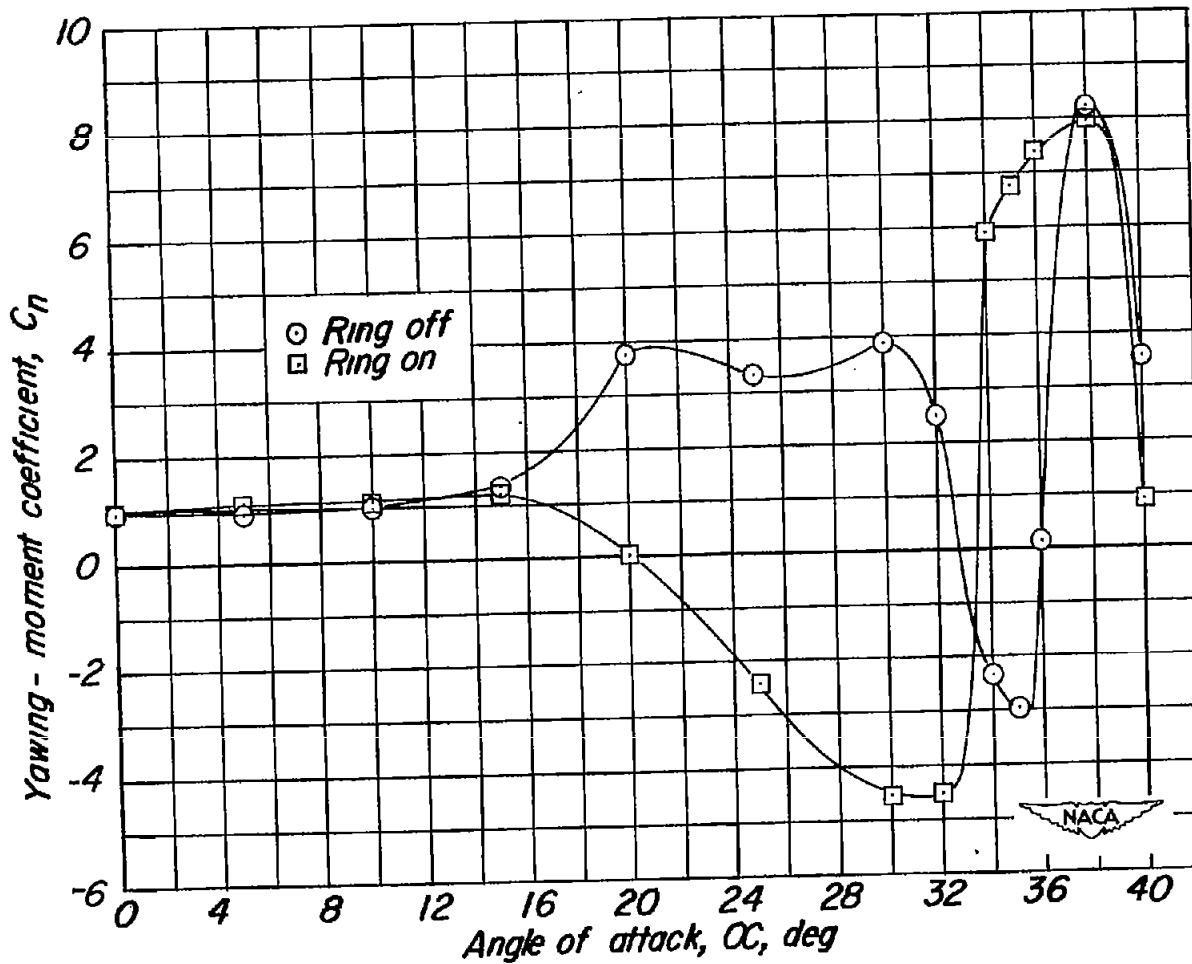
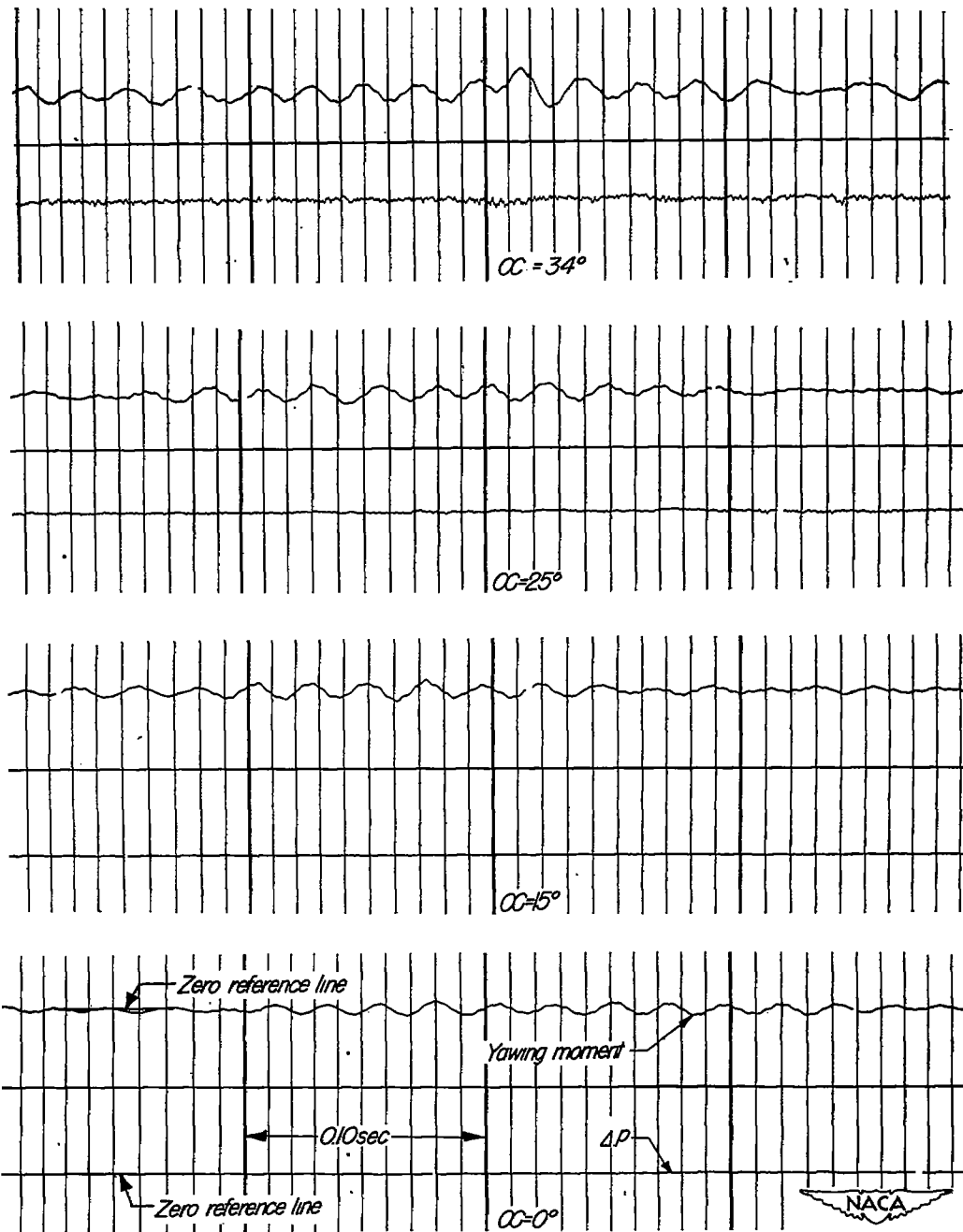
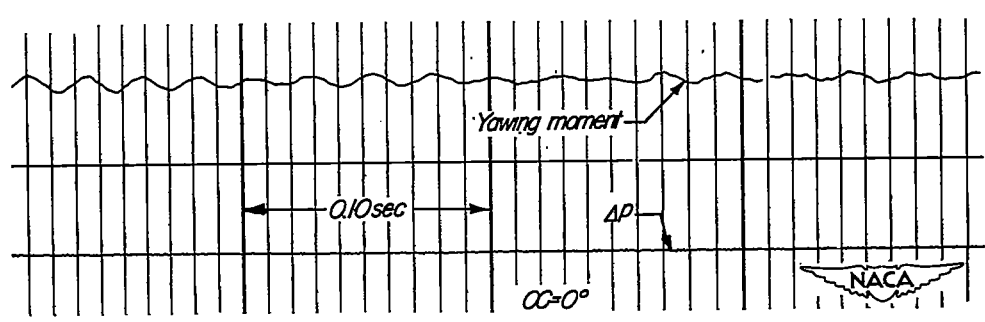
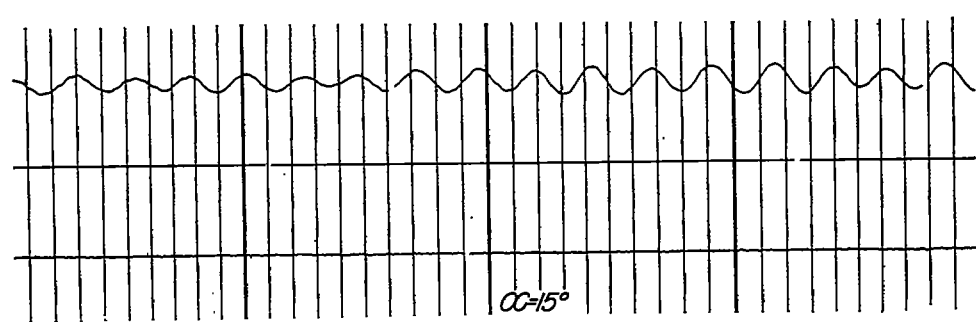
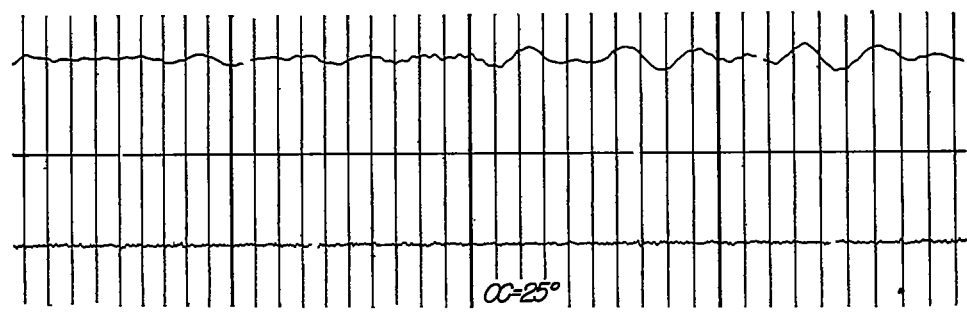
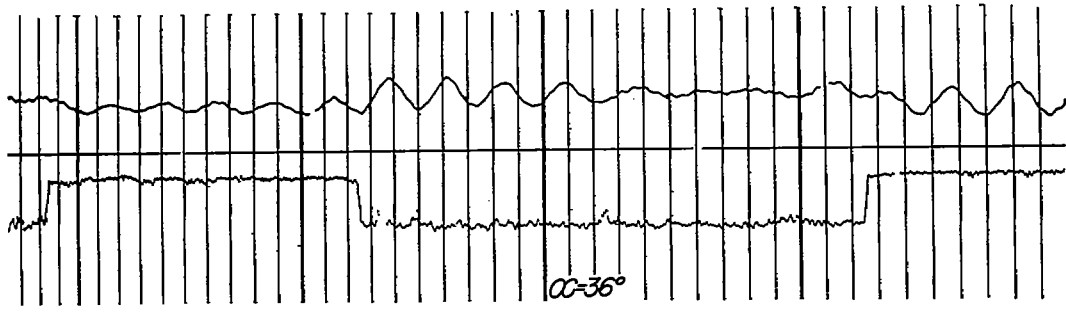

Figure 9.- Effect of small sideslip angle on the yawing-moment coefficient variation with angle of attack of plain fuselage and of the fuselage with $\frac{1}{16}$ -inch-diameter ring located 1 inch from the nose. $\beta = -6^\circ$; $q = 98.3$ pounds per square foot.



(a) Ring off.

Figure 10.- Records at several angles of attack of the instantaneous yawing moment and yaw-orifice pressure difference for the plain fuselage and fuselage with $\frac{1}{16}$ -inch-diameter ring located 1 inch from the nose. $\beta = 0^\circ$; $q = 98.3$ pounds per square foot.



(b) Ring on.

Figure 10.- Concluded.

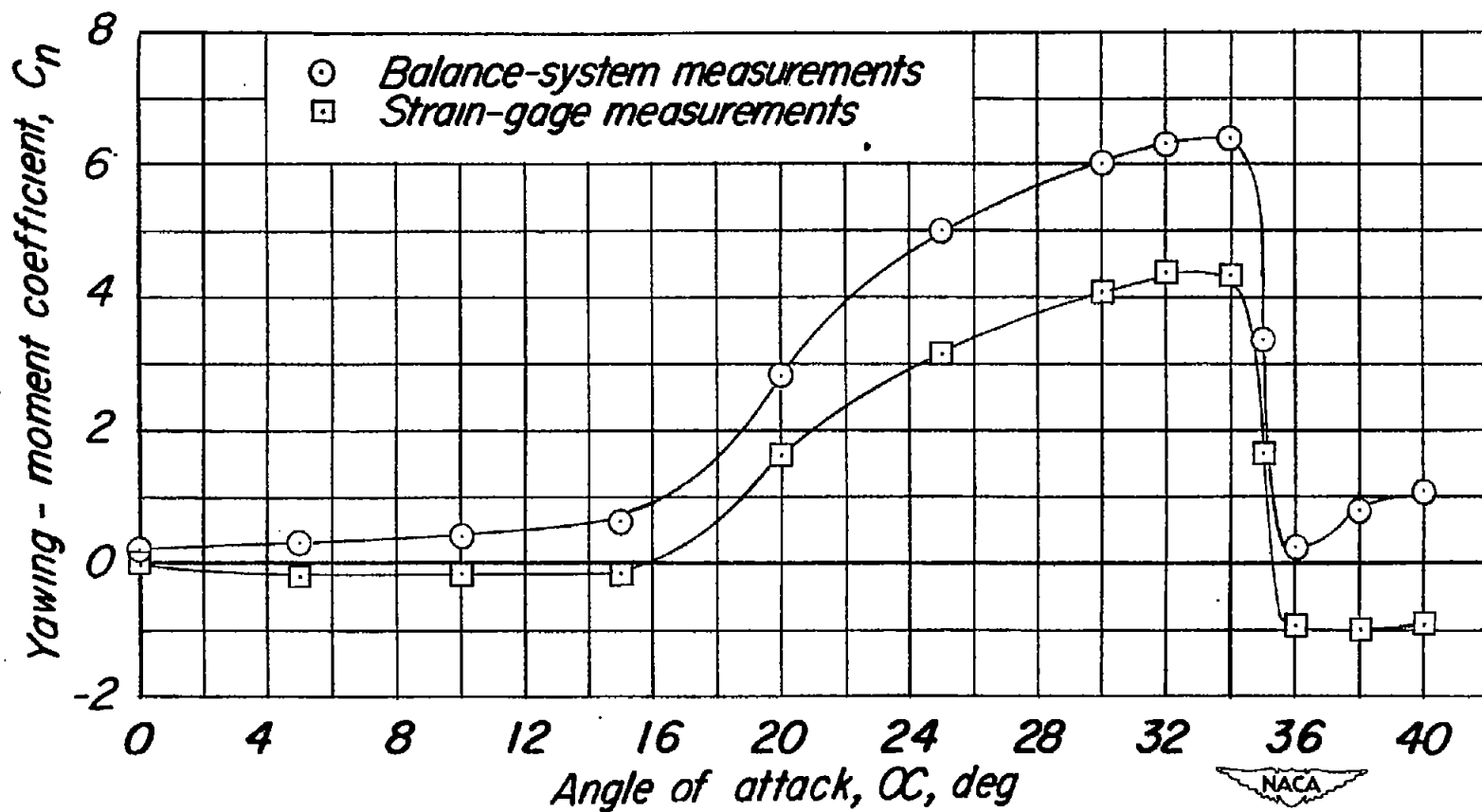

(a) Plain fuselage.

Figure 11.- Comparison of the variation of yawing-moment coefficient with angle of attack as obtained from balance measurements with that obtained from strain-gage records. $\beta = 0^\circ$; $q = 98.3$ pounds per square foot.

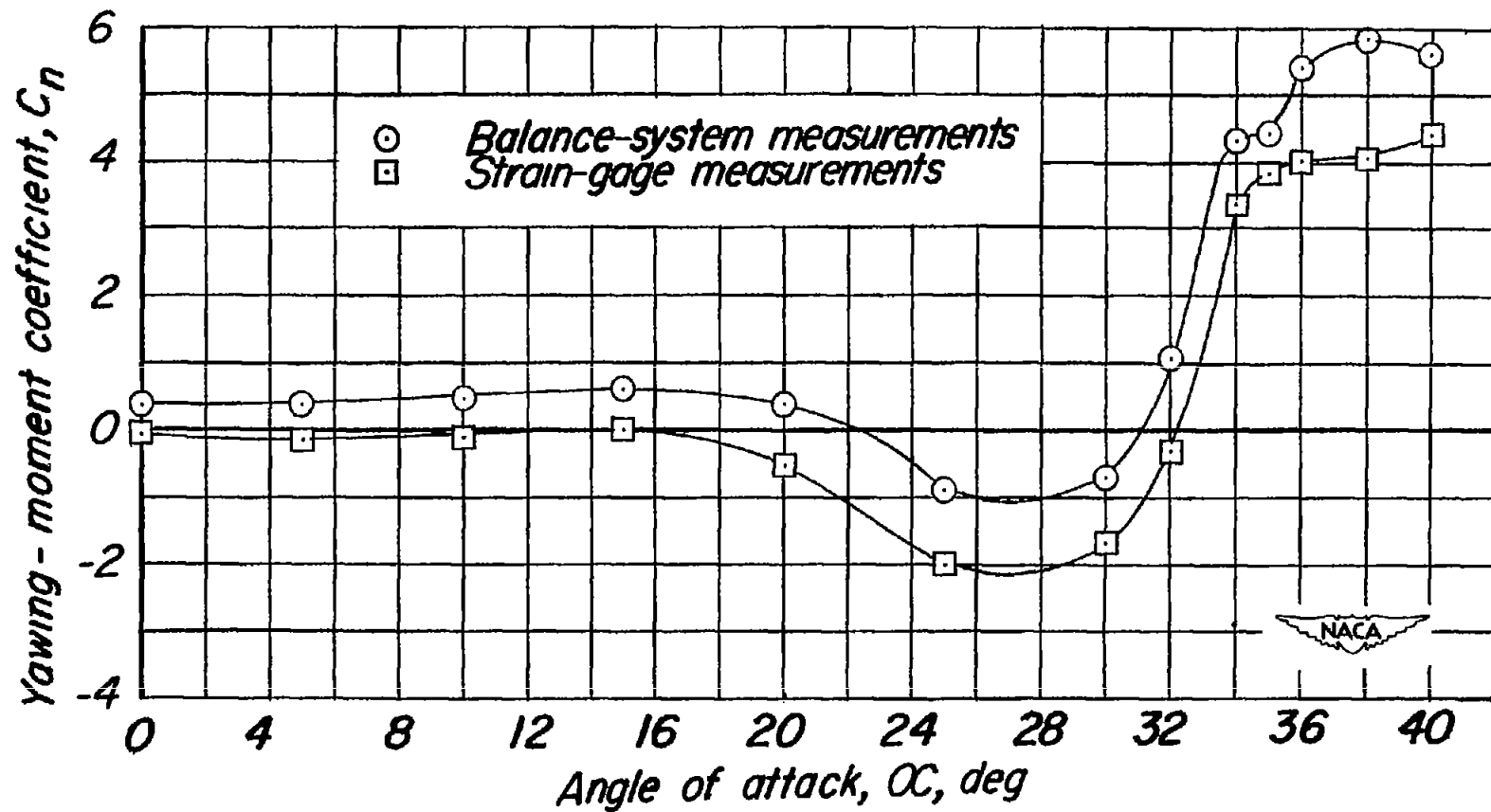

(b) Fuselage with $\frac{1}{16}$ -inch-diameter ring 1 inch from nose.

Figure 11.- Concluded.

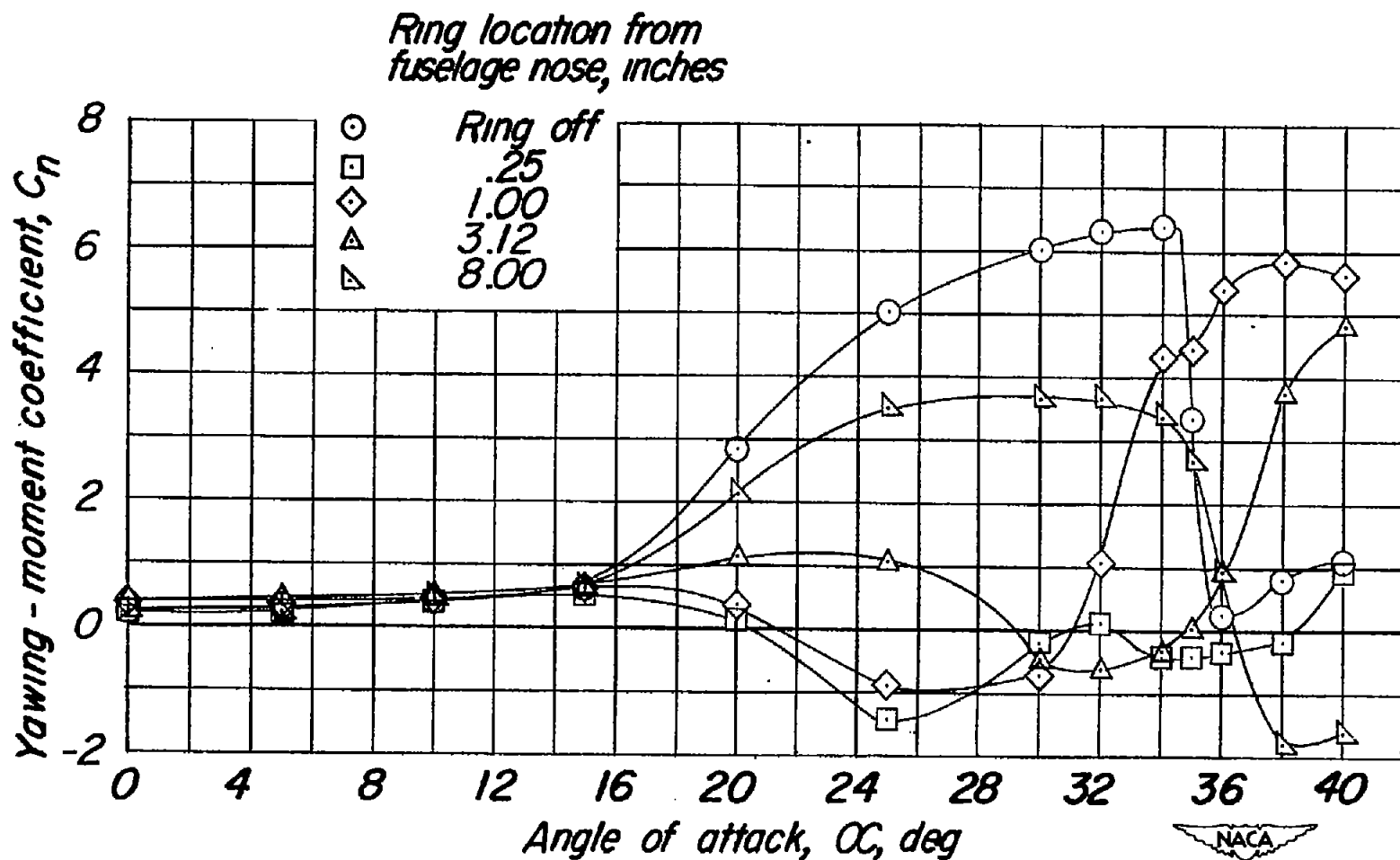

Figure 12.- Effect of location of $\frac{1}{16}$ -inch-diameter ring on the variation of model yawing-moment coefficient with angle of attack. $\beta = 0^\circ$; $q = 98.3$ pounds per square foot.

CONFIDENTIAL

CONFIDENTIAL

Yawing - moment coefficient, C_n

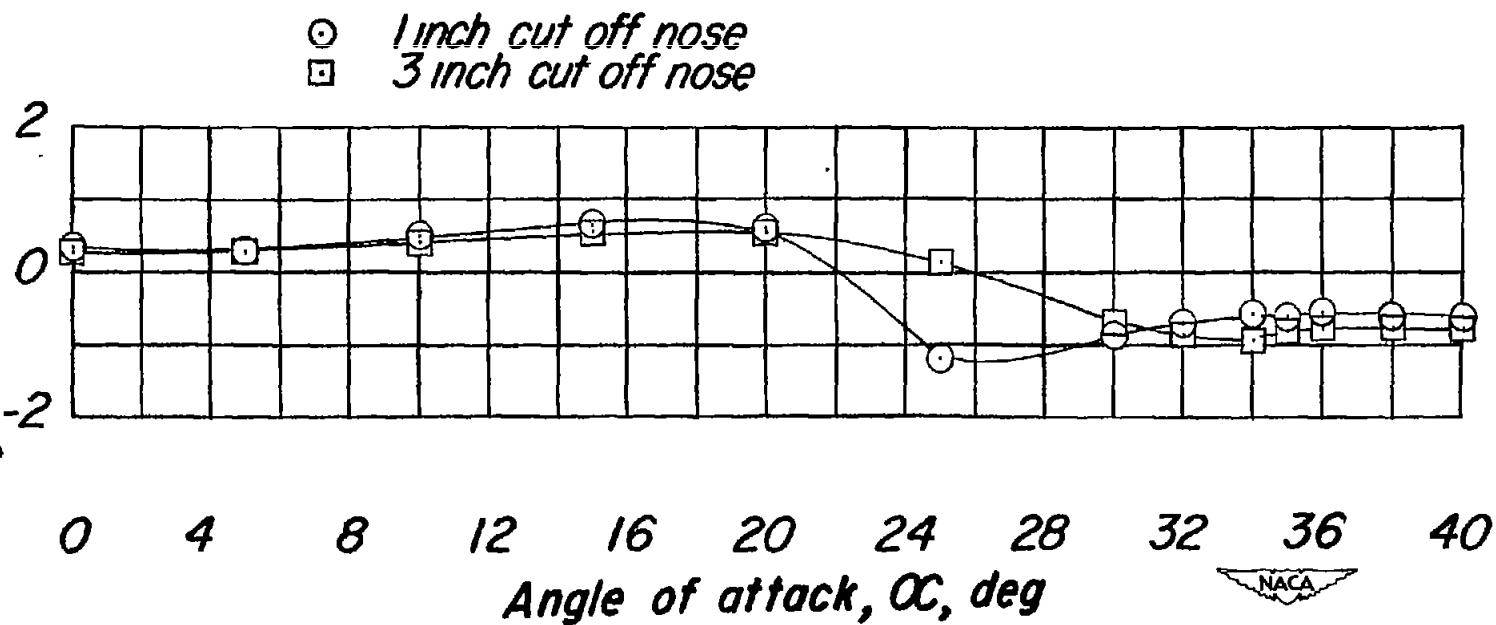

Figure 13.- Variation of yawing-moment coefficient with angle of attack for fuselage with 1 and 3 inches cut off the nose. $\beta = 0^\circ$; $q = 98.3$ pounds per square foot.

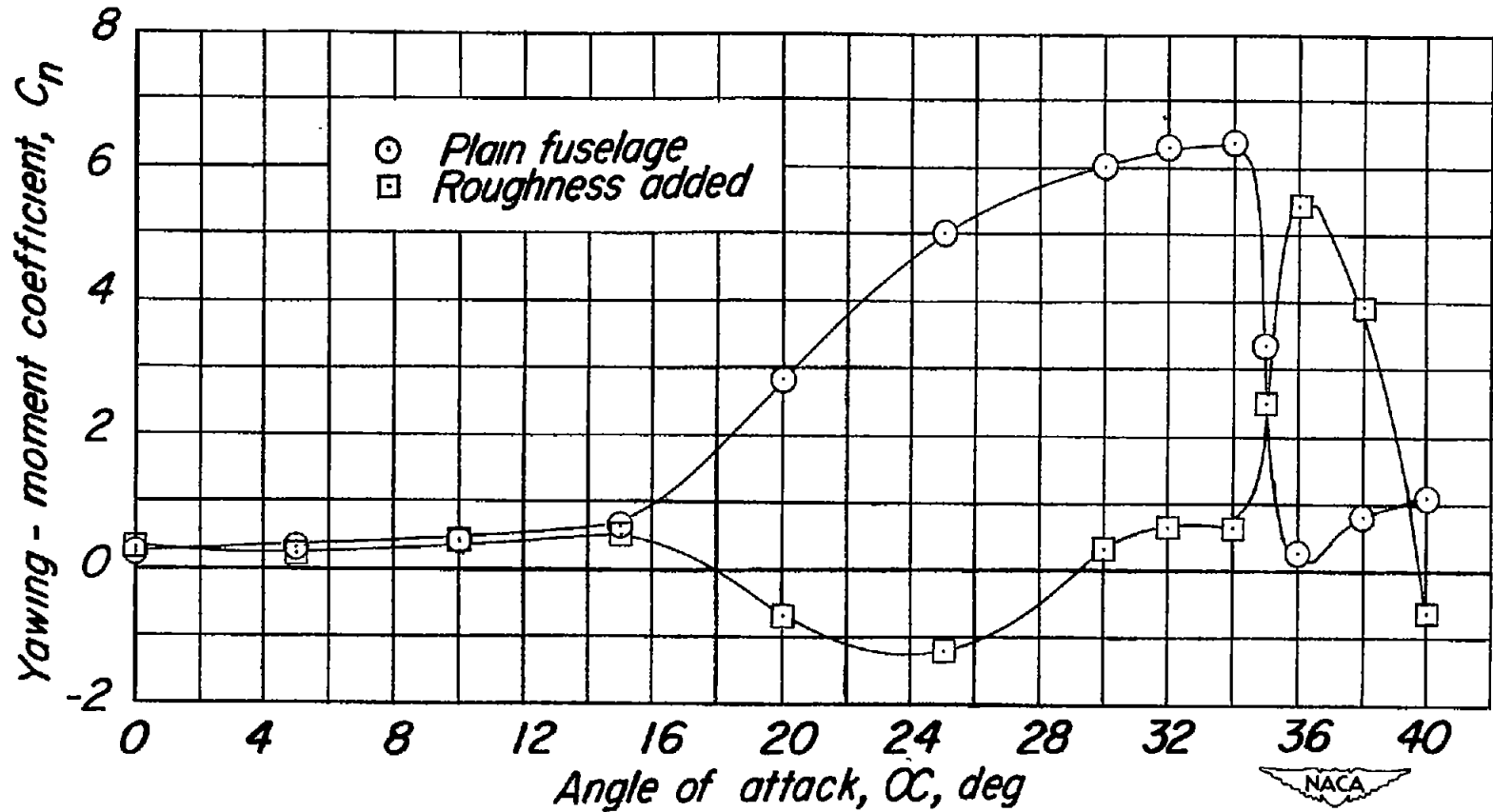

Figure 14.- Comparison of the yawing-moment coefficient variation with angle of attack for plain fuselage and fuselage with first 2 inches coated with carborundum grains. $\beta = 0^\circ$; $q = 98.3$ pounds per square foot.

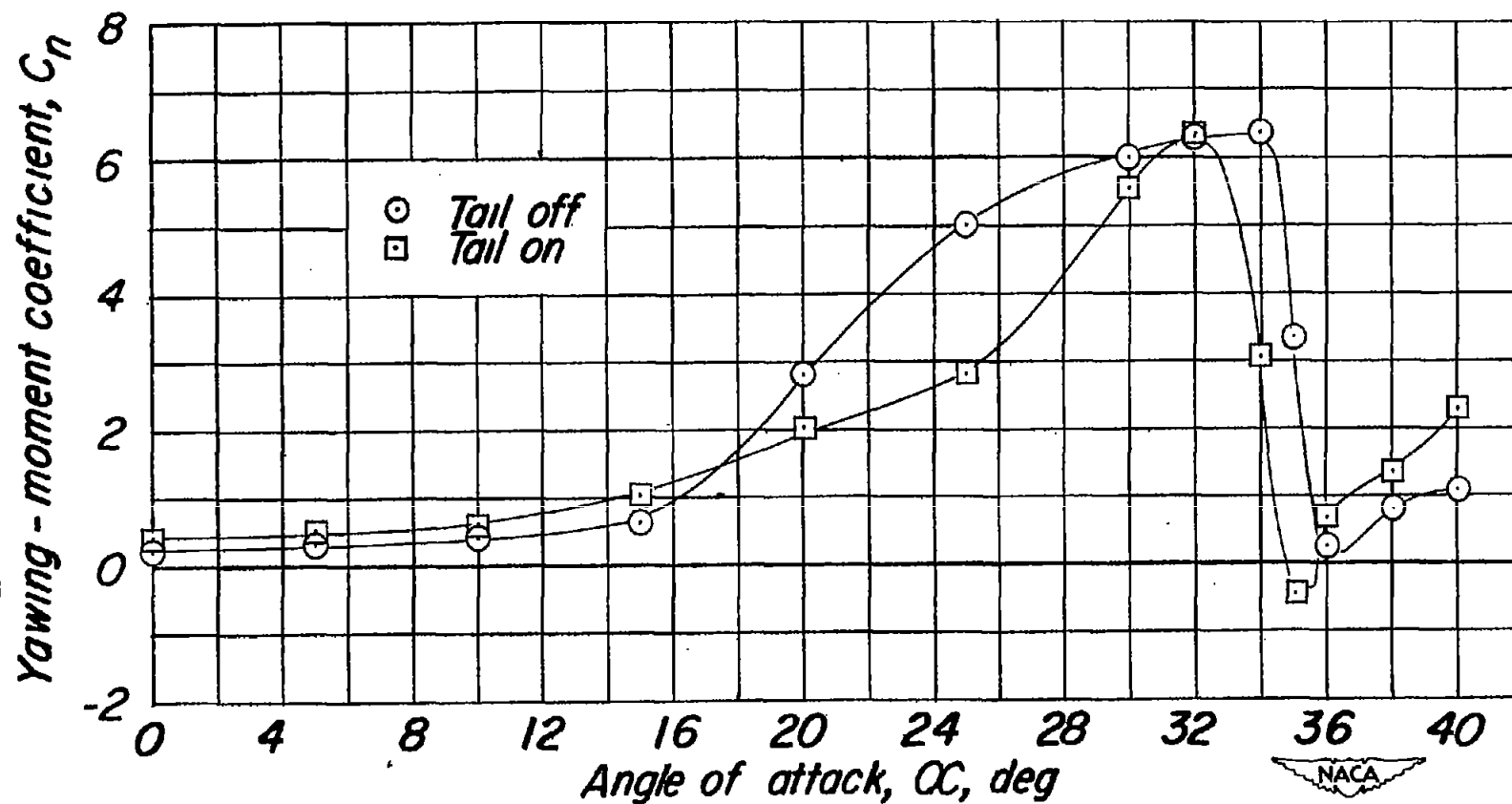

Figure 15.- Comparison of the yawing-moment coefficient variation with angle of attack for the plain fuselage alone and for the plain fuselage with tail of aspect ratio 2. $\beta = 0^\circ$; $q = 98.3$ pounds per square foot.

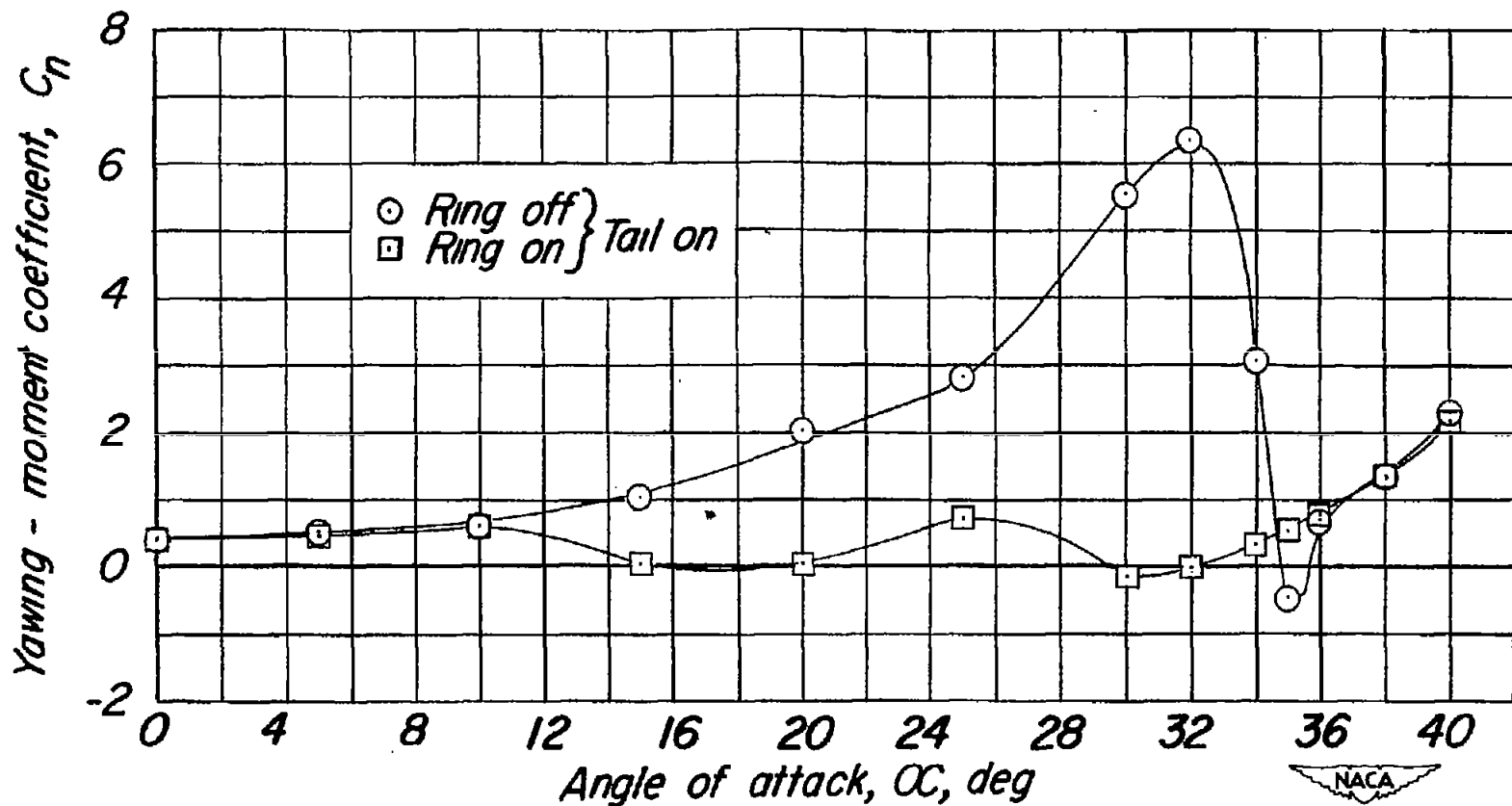

Figure 16.- Comparison of the yawing-moment coefficient variation with angle of attack for the plain fuselage with tail and the ringed fuselage with tail. $\frac{1}{16}$ -inch-diameter ring 1 inch from fuselage nose. $\beta = 0^\circ$; $q = 98.3$ pounds per square foot.