

~~CONFIDENTIAL~~

Copy
RM L53C23

NACA RM L53C23

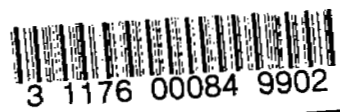

RESEARCH MEMORANDUM

THE EFFECT AT HIGH SUBSONIC SPEEDS OF A
FLAP-TYPE ALLERON ON THE CHORDWISE PRESSURE DISTRIBUTION
NEAR MIDSEMI SPAN OF A TAPERED 35° SWEEPBACK WING OF ASPECT
RATIO 4 HAVING NACA 65A006 AIRFOIL SECTION

By Alexander D. Hammond and Barbara M. Keffer

Langley Aeronautical Laboratory
Langley Field, Va.

~~CLASSIFICATION CANCELLED~~

Authority *NACA Res. Lab.* Date *3/16/56*
RN 97
By *741277* *3/27/56* 893

CLASSIFIED DOCUMENT

This material contains information affecting the National Defense of the United States within the meaning of the espionage laws, Title 18, U.S.C., Secs. 793 and 794, the transmission or revelation of which in any manner to an unauthorized person is prohibited by law.

NATIONAL ADVISORY COMMITTEE FOR AERONAUTICS

WASHINGTON

May 6, 1953

~~CONFIDENTIAL~~

[REDACTED]
NATIONAL ADVISORY COMMITTEE FOR AERONAUTICS

RESEARCH MEMORANDUM

THE EFFECT AT HIGH SUBSONIC SPEEDS OF A
FLAP-TYPE AILERON ON THE CHORDWISE PRESSURE DISTRIBUTION
NEAR MIDSEMI-SPAN OF A TAPERED 35° SWEEPBACK WING OF ASPECT
RATIO 4 HAVING NACA 65A006 AIRFOIL SECTION

By Alexander D. Hammond and Barbara M. Keffer

SUMMARY

An investigation was made in the Langley high-speed 7- by 10-foot tunnel through a Mach number range from 0.60 to 0.95 to determine the effects on the chordwise pressure distributions of deflecting a flap-type aileron on a swept wing. The semispan 35° sweptback wing had an NACA 65A006 airfoil section, an aspect ratio of 4, and a taper ratio of 0.6.

The results of the investigation are presented as curves of chordwise pressure distributions near the midspan of the flap-type aileron (0.46-wing-semispan station).

INTRODUCTION

The use of flap-type ailerons for lateral control has been the subject of a large number of investigations at both low and high speeds. These investigations have for the most part dealt with force measurements to determine the effects of various flap-type ailerons on the characteristics of both swept and unswept wings. There is, however, very little information concerning the aerodynamic loads on swept wings equipped with flap-type ailerons at high subsonic speeds. In order to obtain some information on such loads and on the flow in the vicinity of an aileron on swept wings, chordwise pressure measurements have been made at one spanwise location on the upper and lower surfaces of a 35° sweptback semispan wing equipped with a one-half-semispan sealed aileron having a chord of 20-percent local wing chord in the Langley high-speed 7- by 10-foot tunnel.

[REDACTED]

For these tests the flap-type aileron was deflected through a deflection range from -30° to 30° . The tests were made at Mach numbers from 0.60 to 0.95 for an angle-of-attack range from 0° to 20° except where the angle-of-attack range was limited by tunnel choking at the high Mach numbers.

SYMBOLS

M	Mach number
P	pressure coefficient, $\frac{P_l - P}{q}$
p	free-stream static pressure, lb/sq ft
p_l	local static pressure, lb/sq ft
p_a	atmospheric pressure
q	free-stream dynamic pressure, lb/sq ft
α	angle of attack, deg
\bar{c}	mean aerodynamic chord of wing, $\frac{2}{S} \int_0^{b/2} c^2 dy$, 1.020 ft
S	twice wing area of semispan model, 4.00 sq ft
b	wing span, ft
c	local chord, ft
x	chordwise coordinate of the pressure orifice measured in a plane parallel to plane of symmetry, ft
y	spanwise distance from plane of symmetry, ft
Λ	angle of sweep of the quarter-chord line, deg
δ	deflection of aileron, deg

APPARATUS AND MODEL

The model used in this investigation was a semispan sweptback-wing model mounted vertically in the Langley high-speed 7- by 10-foot tunnel with the ceiling serving as a reflection plane.

The geometric characteristics and dimensions of the wing are shown in figure 1. The wing was made of steel and had 35° sweepback of the quarter-chord line, an aspect ratio of 4, a taper ratio of 0.6, and had no twist or dihedral. The wing had NACA 65A006 airfoil sections parallel to free stream.

The pressure orifices were located on the upper and lower surfaces at the 46-percent-semispan station. The chordwise positions of the orifices are listed in table I. The difference in the chordwise positions between the positive δ and the negative δ resulted from the testing technique used in obtaining the data.

TESTS

All the tests were made in the Langley high-speed 7- by 10-foot tunnel. The data presented in this report are representative of a flap-type aileron deflected from -30° to 30° through a Mach number range from 0.60 to 0.95 at angles of attack from 0° to 20° . However, since the model was symmetrical, it was found convenient to fix the aileron at a given positive aileron deflection and test through the positive and negative angle-of-attack range; this procedure explains the differences in the chordwise ordinates given in table I for the positive and negative aileron deflections. The Reynolds number varied from about 3.1×10^6 at $M = 0.60$ to about 4.0×10^6 at $M = 0.95$ when based on the wing mean aerodynamic chord.

PRESENTATION OF DATA

In order to make these data available, the pressure distributions (plots of P against chord) are being presented without integration or discussion. It is felt, however, that the pressure data, as presented, will be useful in the prediction of the local chordwise wing loadings and in the prediction of some of the aileron loads for aileron configurations similar to those of this investigation.

The chordwise pressure distributions as obtained in this investigation on a 35° sweptback tapered wing equipped with a flap-type aileron are presented in figures 2 to 14. The solid vertical line at 80-percent-chord station on the figures indicates the position of the aileron hinge line. The dotted portions of the pressure plots were portions of the curve for which there were an insufficient number of orifices to determine definitely the exact fairing for the pressure curve. The angle of attack shown on the figures has not been corrected for air-stream misalignment and tunnel-wall effects.

The following discussion describes the procedure used in obtaining the data for the figures as presented. Each orifice on the upper and lower surfaces of the wing was connected to a manometer tube the location of which on an arbitrary unit length of the manometer board corresponded to the location of the orifice on the wing chord with $\delta = 0$. Photographs were made of the manometer board and the chordwise pressure distributions were faired on blueprints made from the negatives. These blueprints were later bleached and used for final figures. It should be noted, therefore, that the vertical scale for these plots is a function of the tunnel Mach number and that the horizontal scale is, of course, the same for all figures.

Langley Aeronautical Laboratory,
National Advisory Committee for Aeronautics,
Langley Field, Va.

TABLE I.- LOCATION OF PRESSURE ORIFICES

Chordwise position of orifices on upper surface			Chordwise position of orifices on lower surface		
Orifice	Percent chord		Orifice	Percent chord	
	Positive δ	Negative δ		Positive δ	Negative δ
1	0	0	1	2	1
2	1	2	2	6	4
3	4	6	3	10	8
4	8	10	4	$21\frac{1}{3}$	15
5	15	$21\frac{1}{3}$	5	$30\frac{1}{3}$	$25\frac{1}{3}$
6	$25\frac{1}{3}$	$30\frac{1}{3}$	6	$41\frac{1}{3}$	$35\frac{1}{3}$
7	$35\frac{1}{3}$	$41\frac{2}{3}$	7	$50\frac{2}{3}$	$45\frac{2}{3}$
8	$45\frac{2}{3}$	$50\frac{2}{3}$	8	$58\frac{2}{3}$	$55\frac{2}{3}$
9	$55\frac{2}{3}$	$58\frac{2}{3}$	9	65	63
10	63	65	10	68	67
11	67	68	11	71	69
12	69	71	12	74	72
13	72	74	13	77	73
14	73	77	14	82	75
15	75	82	15	$85\frac{1}{3}$	81
16	81	$85\frac{1}{3}$	16	$88\frac{1}{3}$	83
17	83	$88\frac{1}{3}$	17	$91\frac{1}{3}$	$87\frac{1}{3}$
18	$87\frac{1}{3}$	$91\frac{1}{3}$	18	$94\frac{1}{3}$	$90\frac{1}{3}$
19	$90\frac{1}{3}$	$94\frac{1}{3}$	19	$97\frac{1}{3}$	$93\frac{1}{3}$
20	$93\frac{1}{3}$	$97\frac{1}{3}$	20	$99\frac{1}{3}$	$96\frac{1}{3}$
21	$96\frac{1}{3}$	$99\frac{1}{3}$	21		$98\frac{1}{3}$
22	$98\frac{1}{3}$				



Complete Model Characteristics

Area 4 sq ft

Aspect ratio 4

Taper ratio 0.6

NACA 65A006 airfoil section

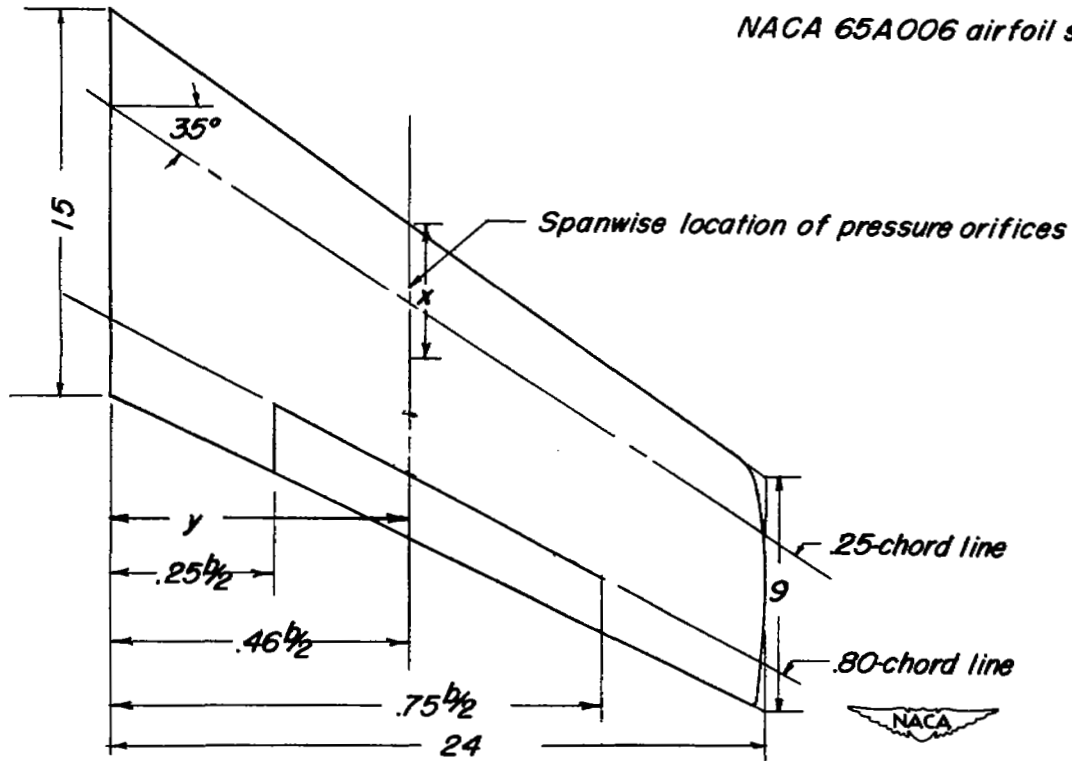
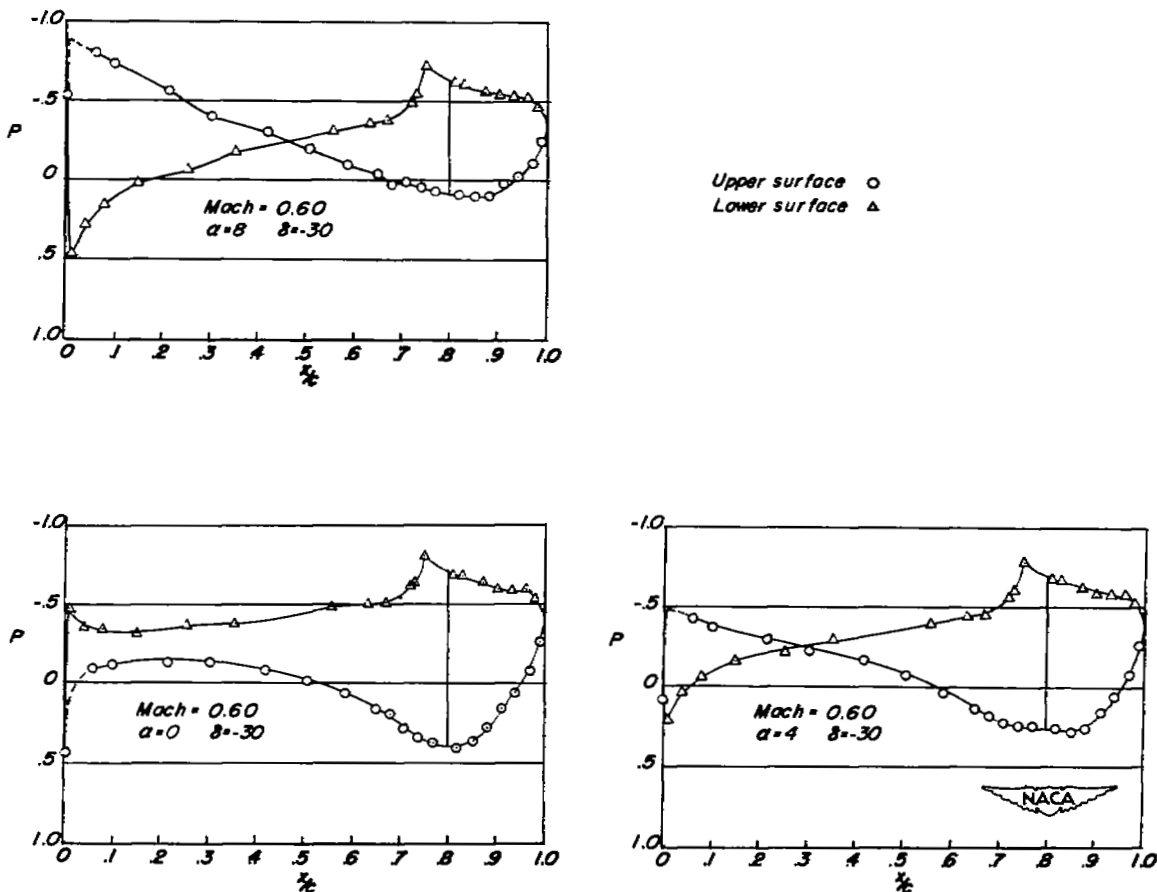
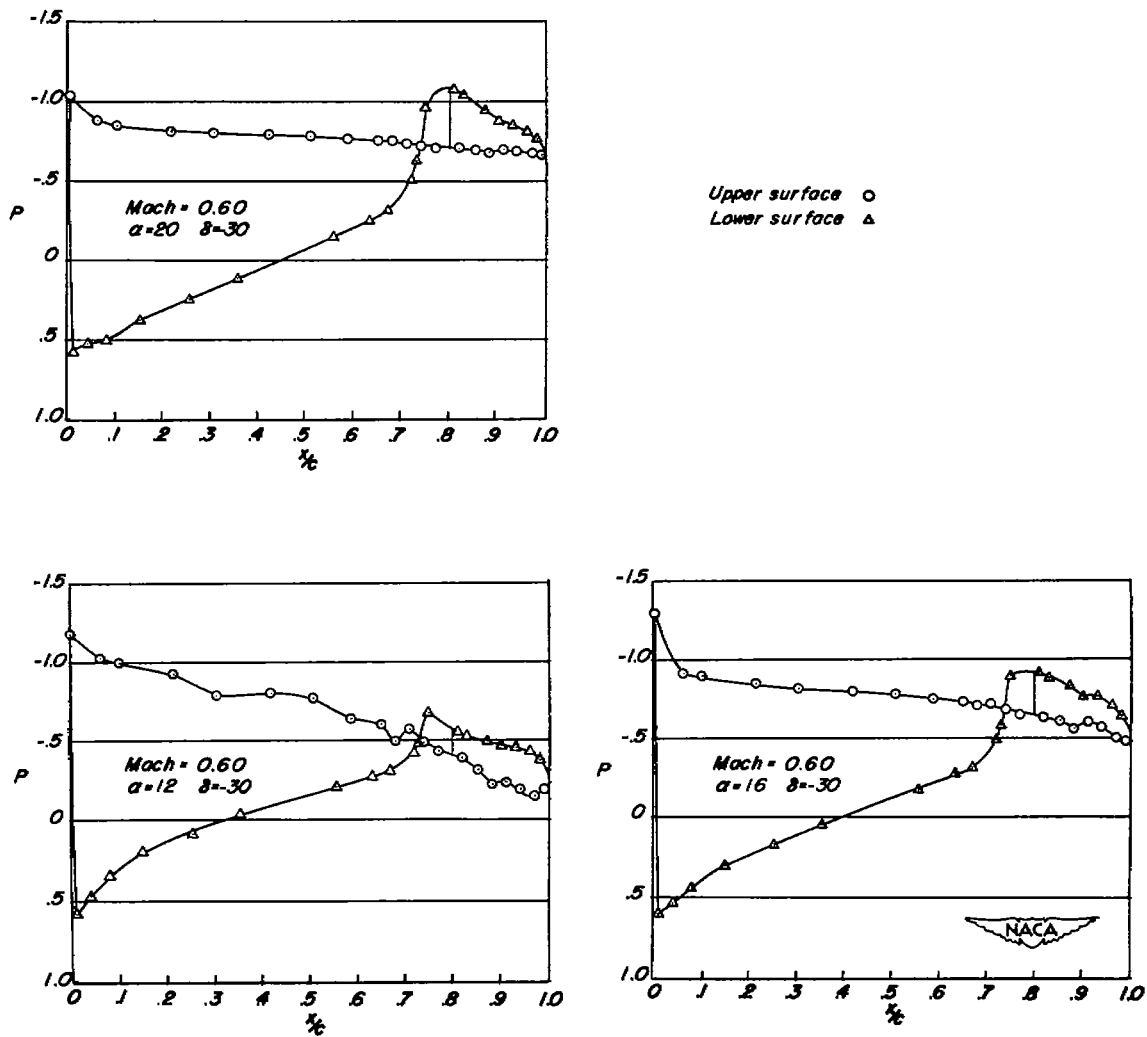

Figure 1.- Geometric characteristics of the 35° sweptback wing equipped with a flap-type aileron. All dimensions are in inches unless otherwise noted.



(a) M = 0.60.

Figure 2.- Chordwise pressure distribution over a 35° sweptback wing, at the 46-percent-semispan station, equipped with a flap-type aileron. $\delta = -30^\circ$.



(a) $M = 0.60$. Concluded.

Figure 2.- Continued.

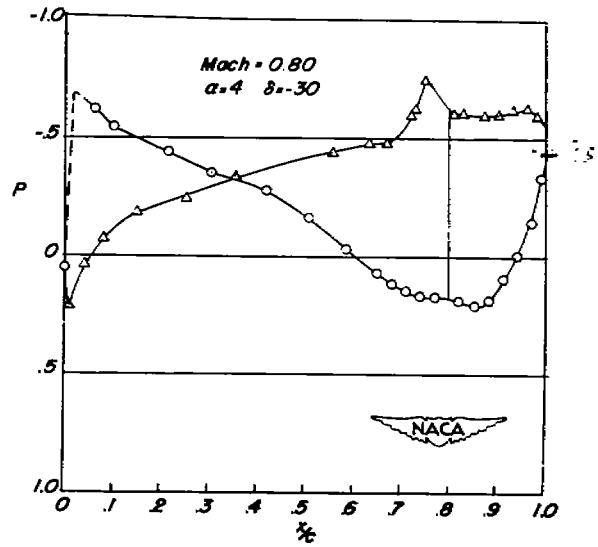
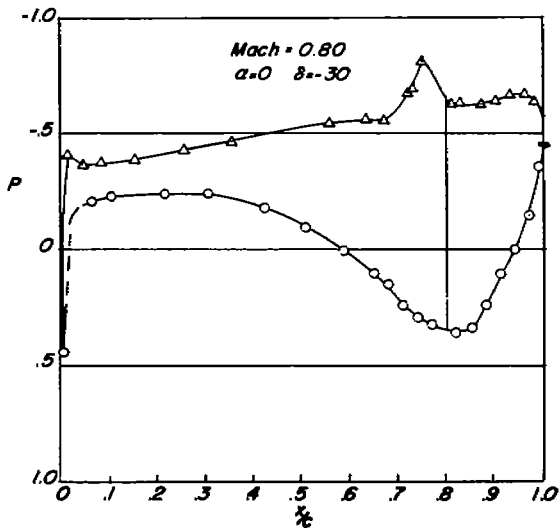
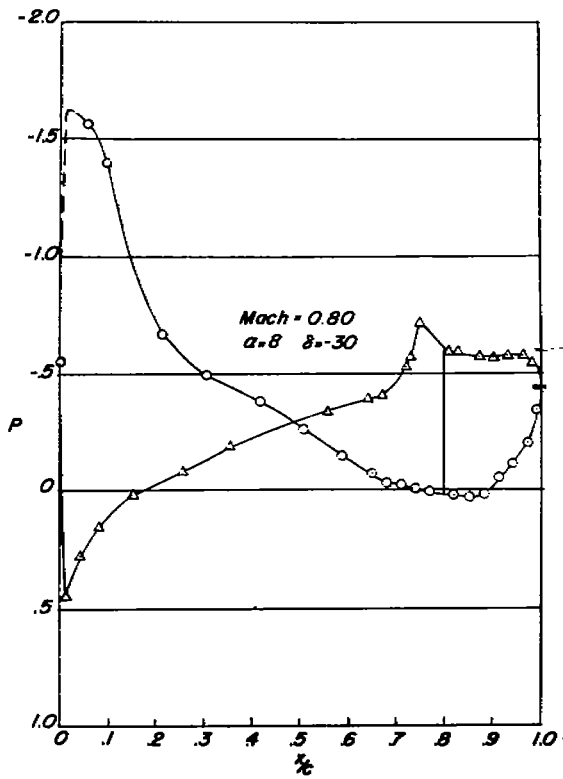

(b) $M = 0.80$.

Figure 2.- Continued.

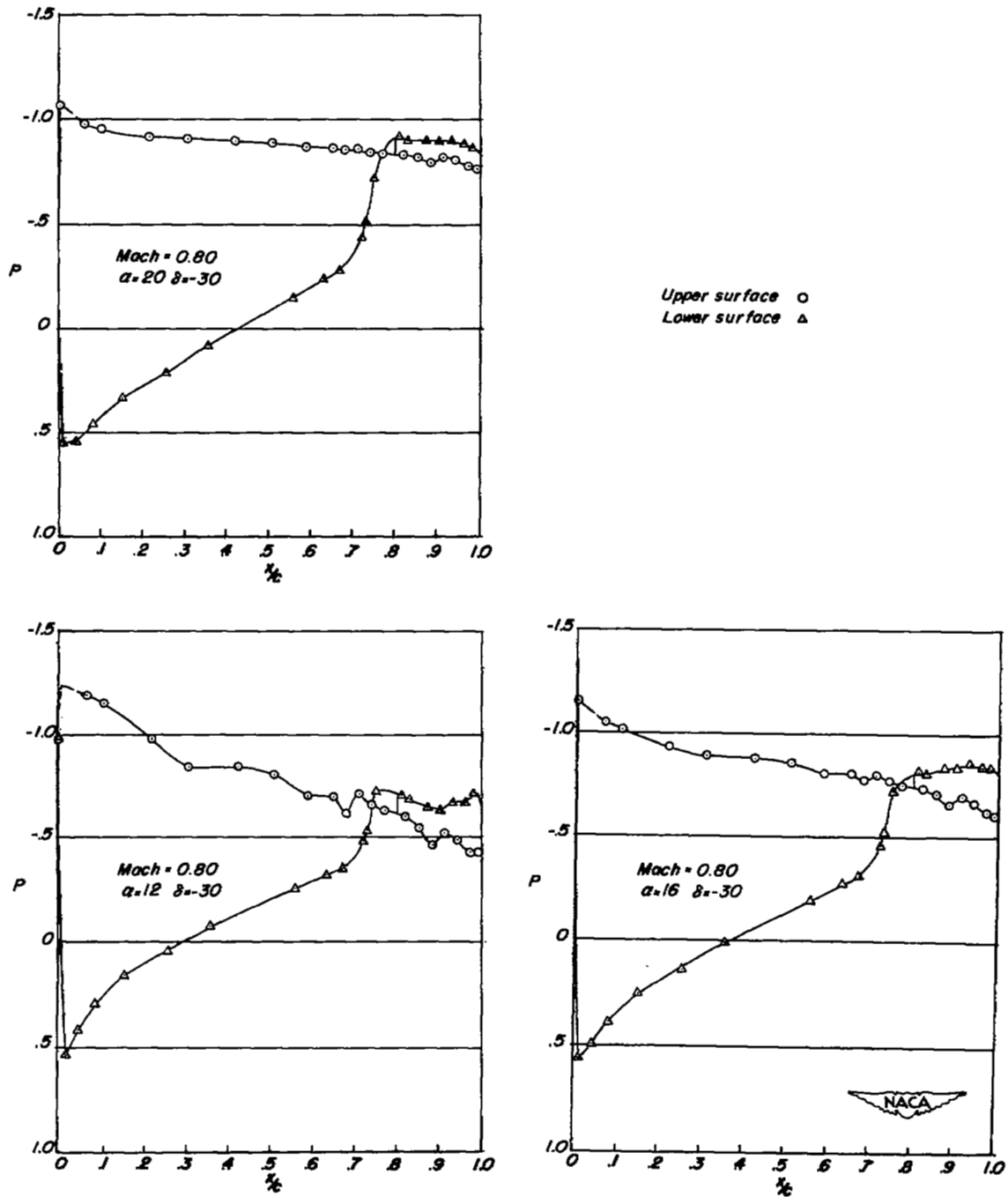

(b) $M = 0.80$. Concluded.

Figure 2.- Continued.

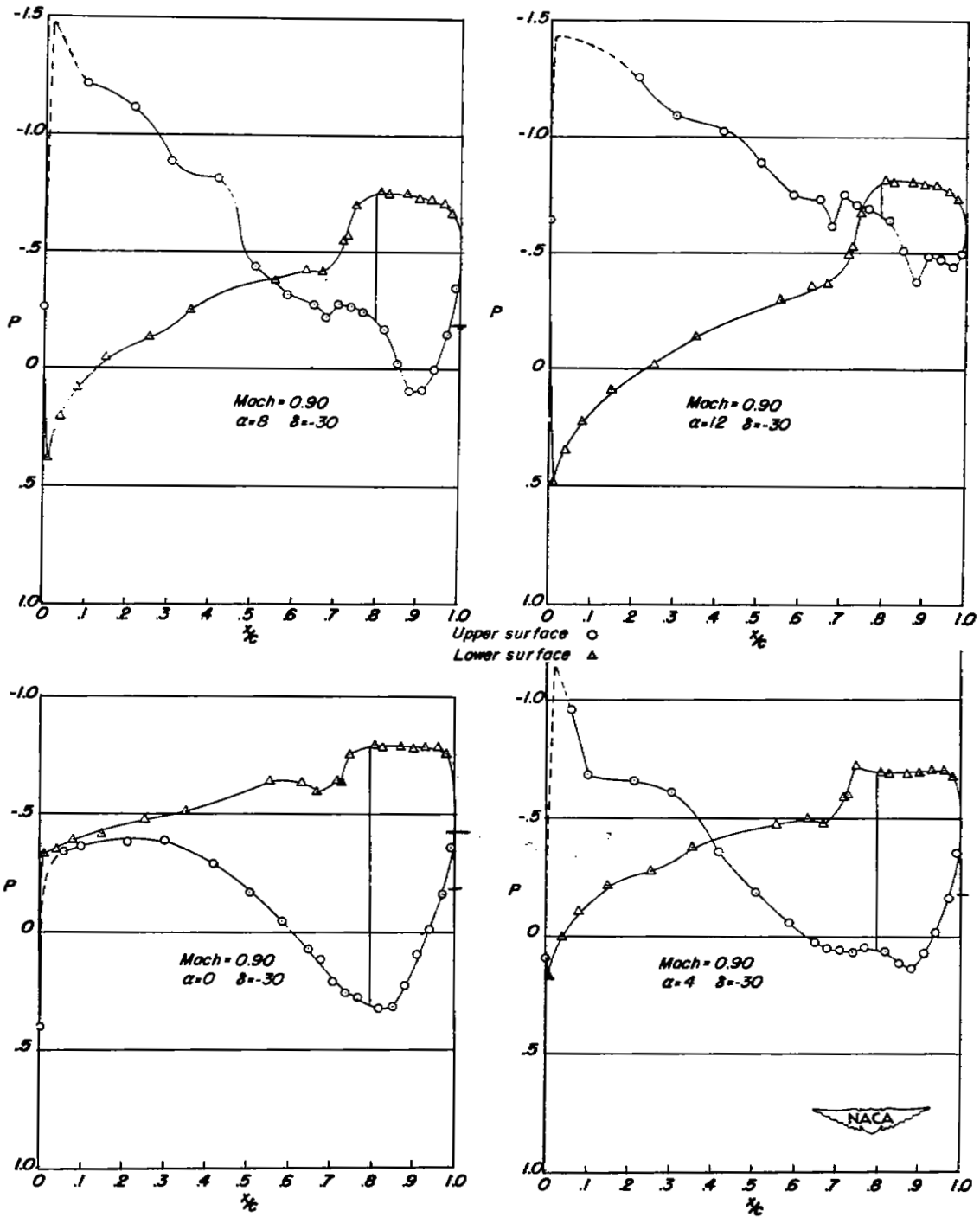

(c) $M = 0.90$.

Figure 2.- Continued.

(d) $M = 0.95$.

Figure 2.- Concluded.



(a) $M = 0.60$.

Figure 3.- Chordwise pressure distribution over a 35° sweptback wing, at the 46-percent-semispan station, equipped with a flap-type aileron. $\delta = -25^\circ$.

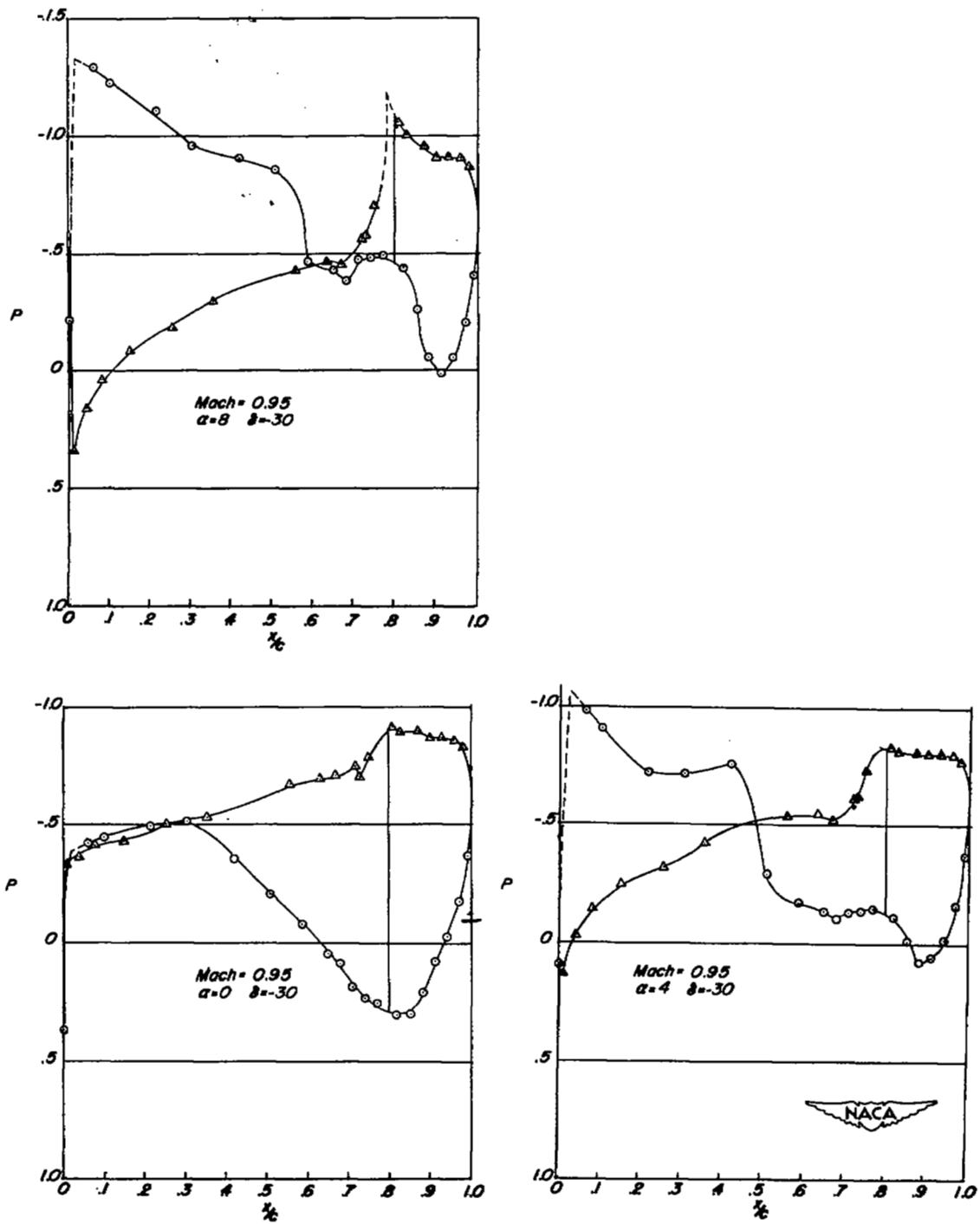
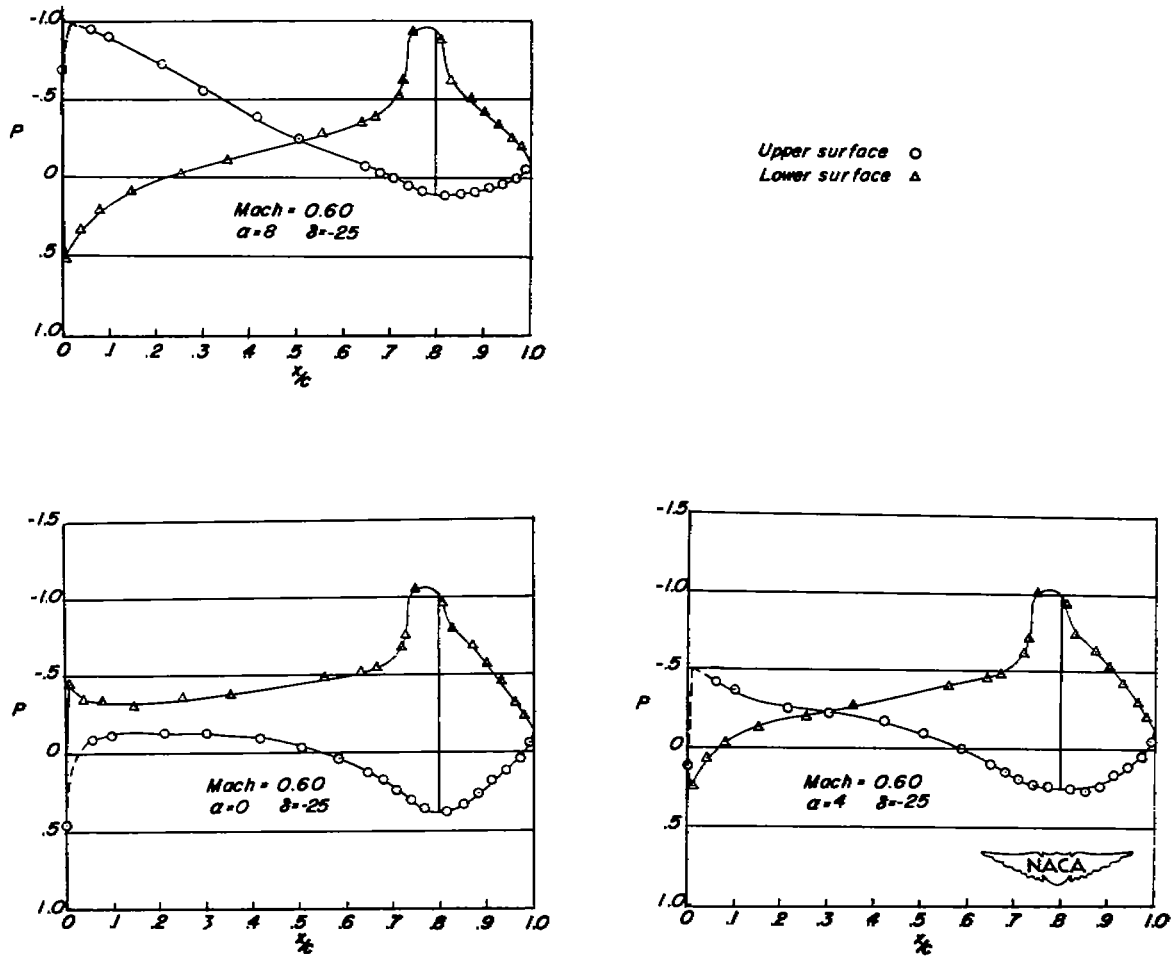
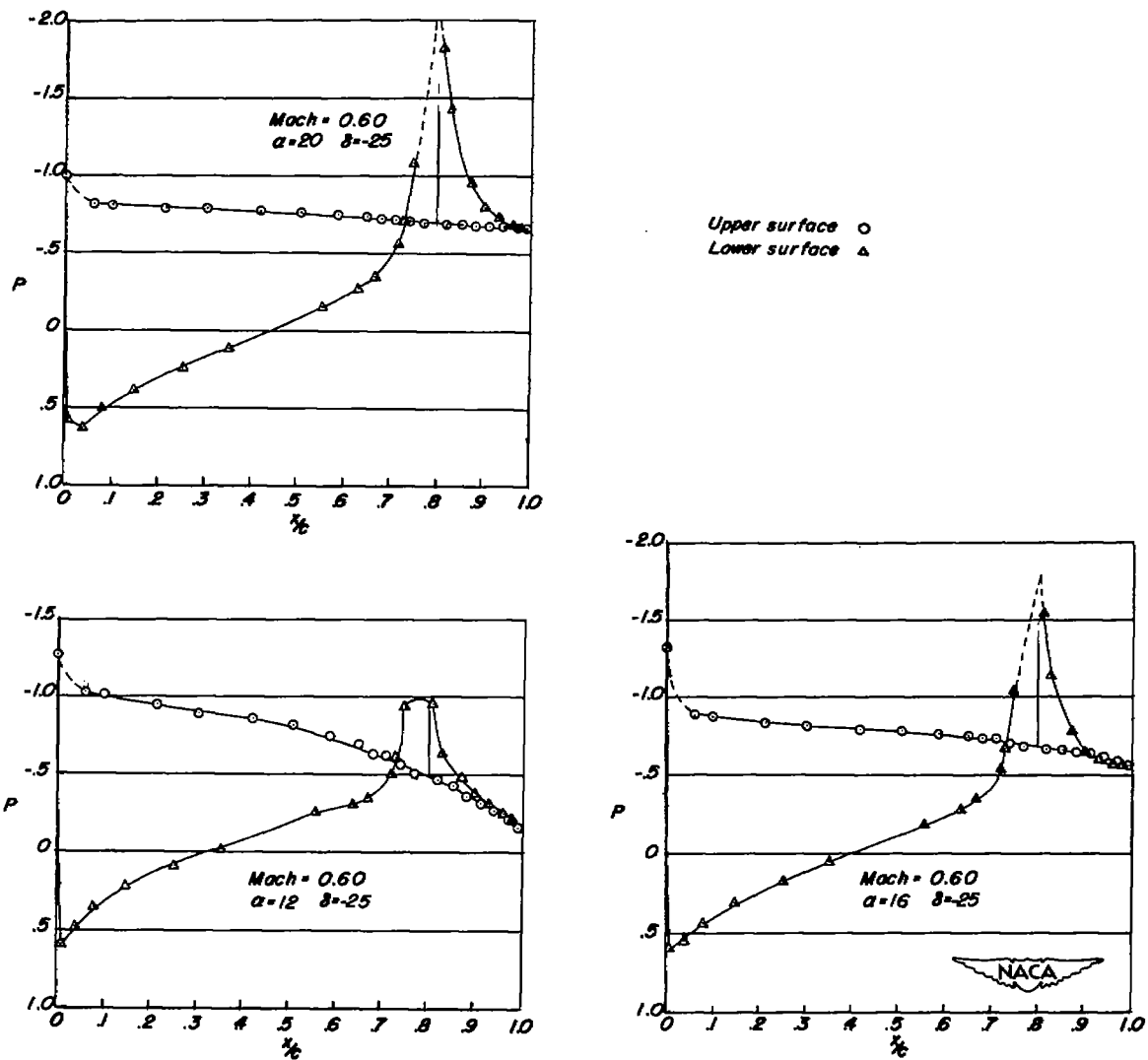

(a) $M = 0.60$. Concluded.

Figure 3.- Continued.

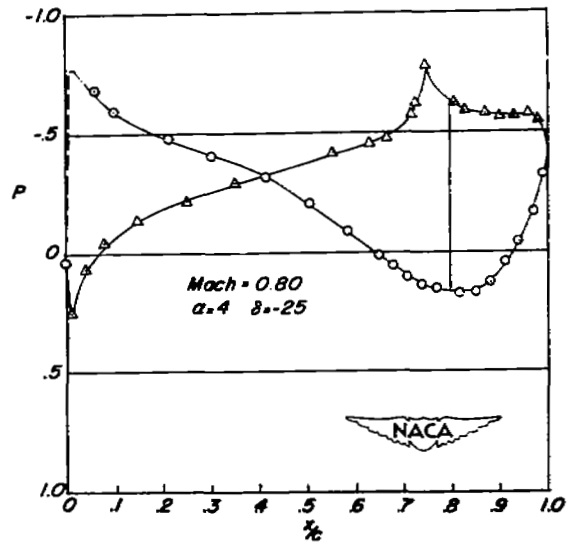
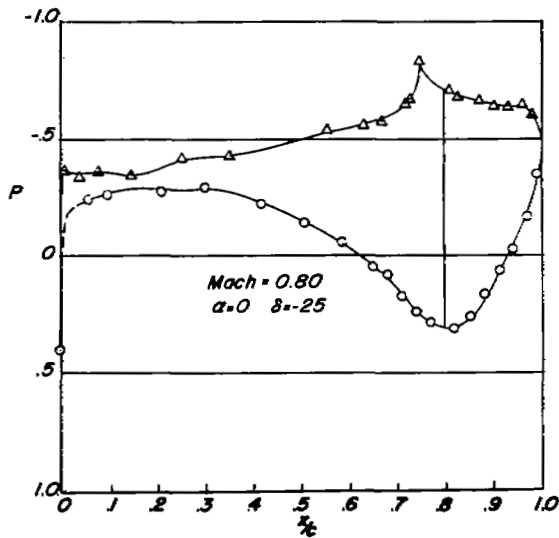
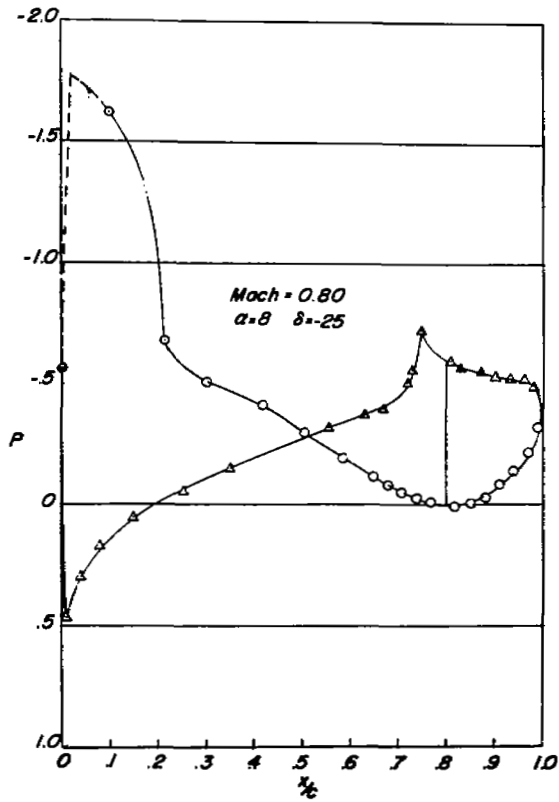

(b) $M = 0.80$.

Figure 3.- Continued.

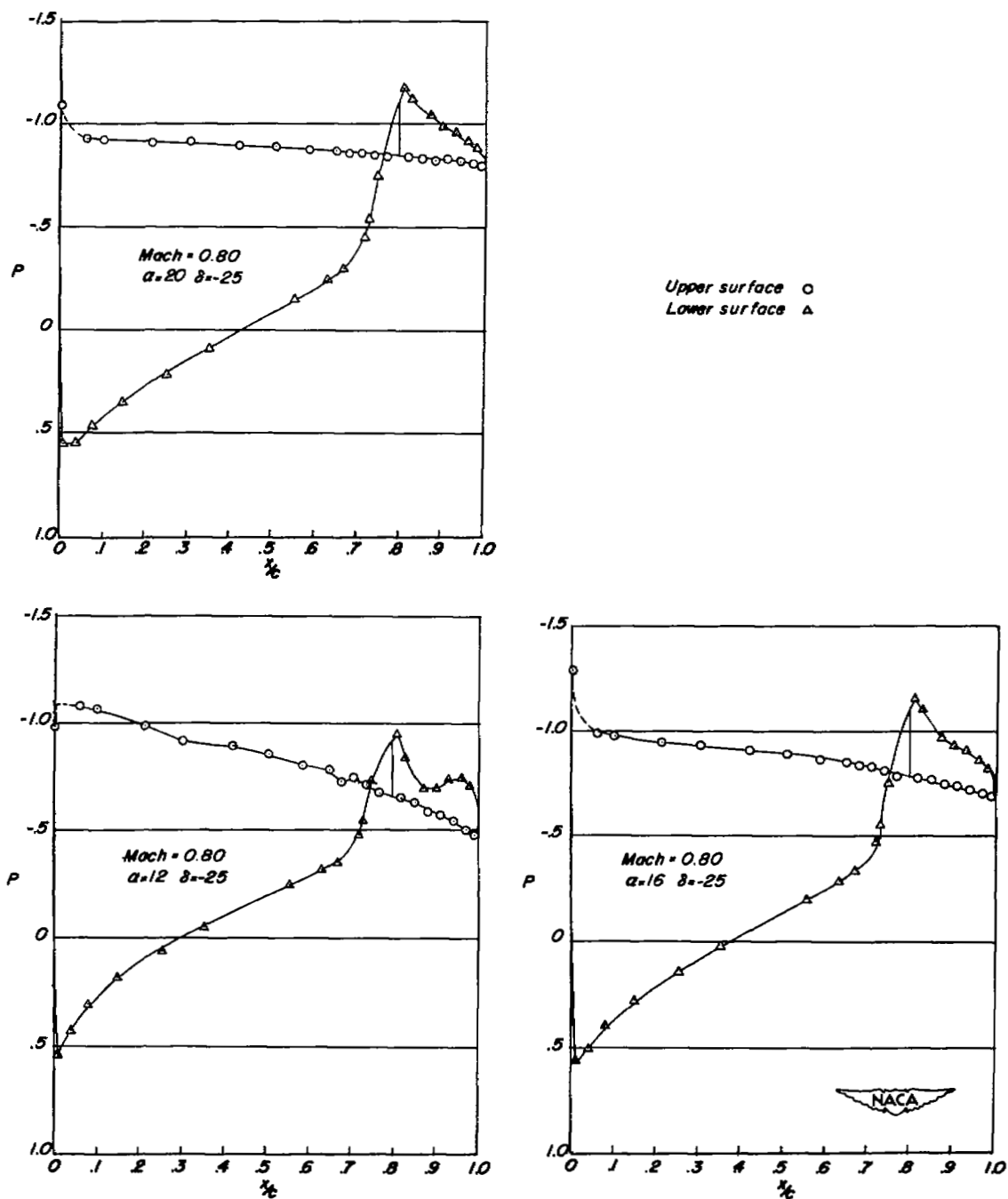

(b) $M = 0.80$. Concluded.

Figure 3.- Continued.

(c) $M = 0.90$.

Figure 3.- Continued.



(d) $M = 0.95$.

Figure 3.- Concluded.

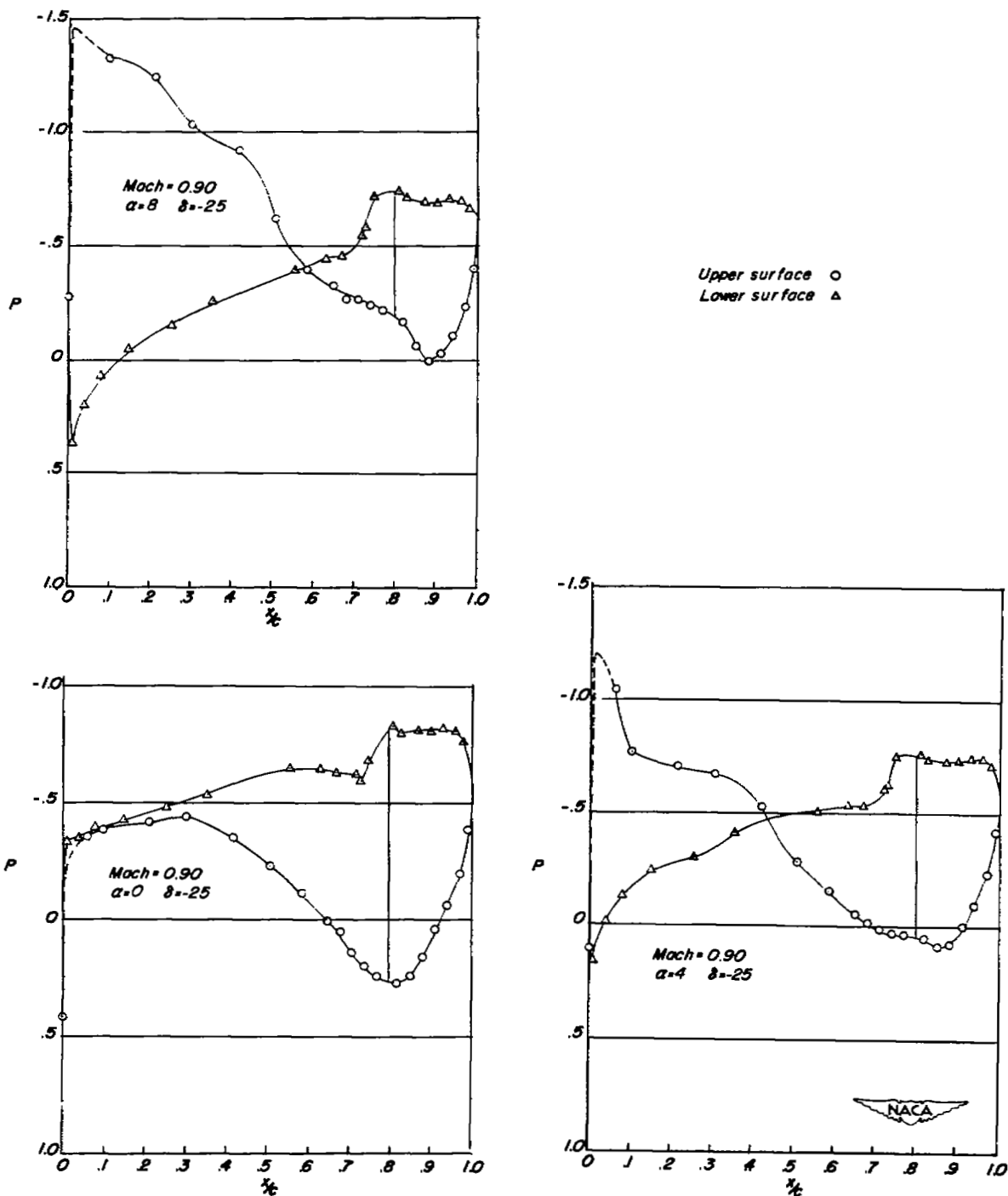
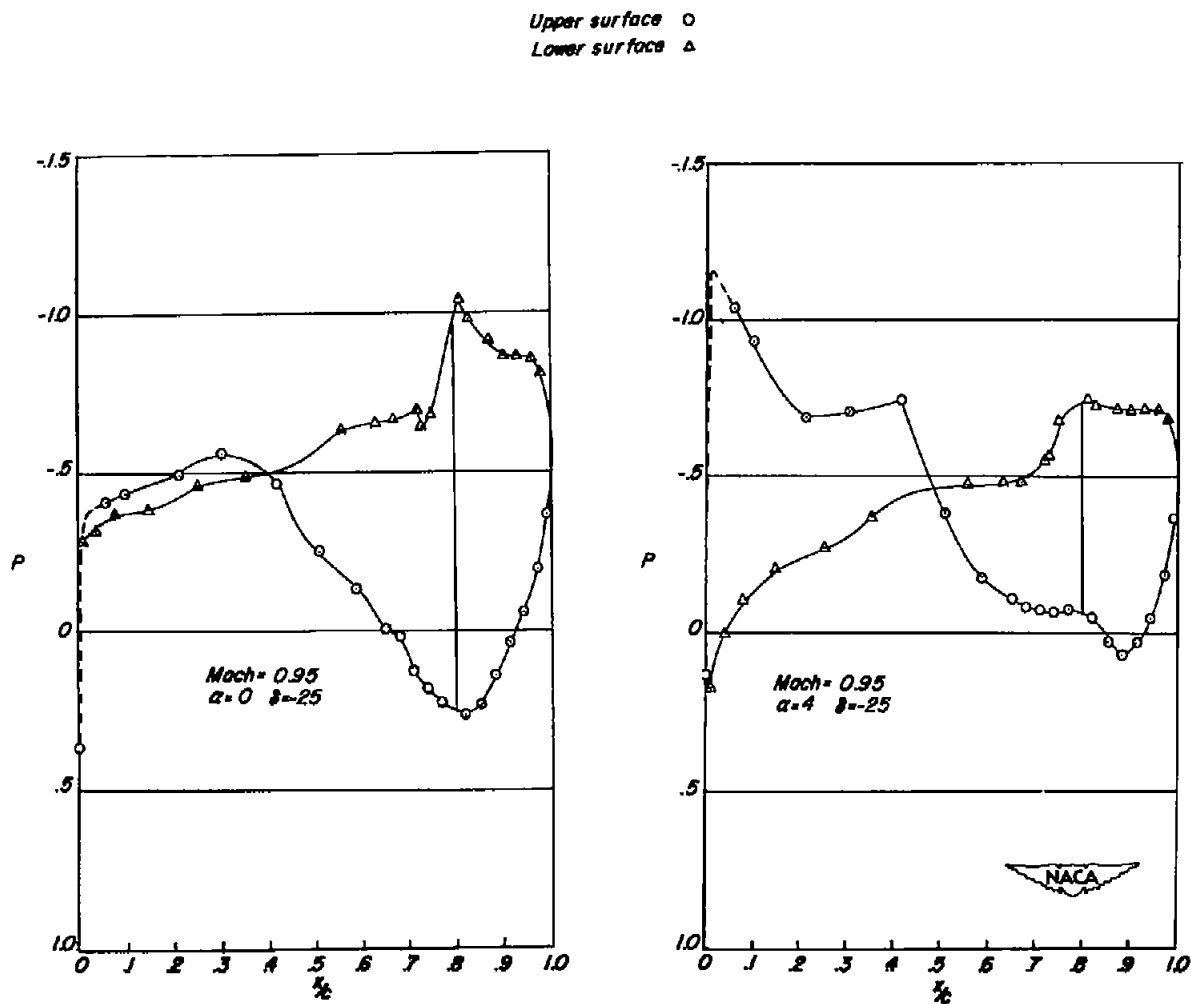
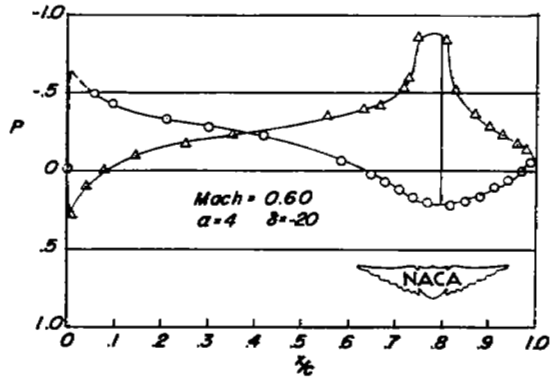
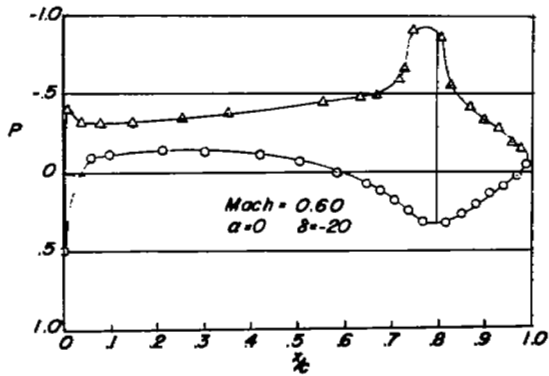
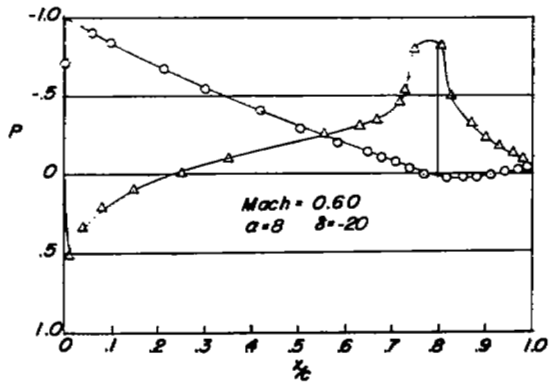

(a) $M = 0.60$.

Figure 4.- Chordwise pressure distribution over a 35° sweptback wing, at the 46-percent-semispan station, equipped with a flap-type aileron. $\delta = -20^\circ$.

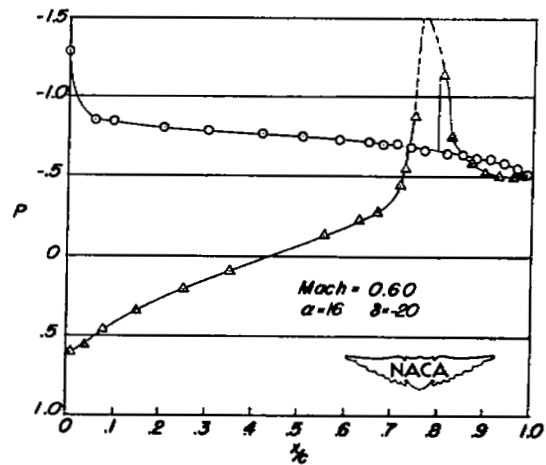
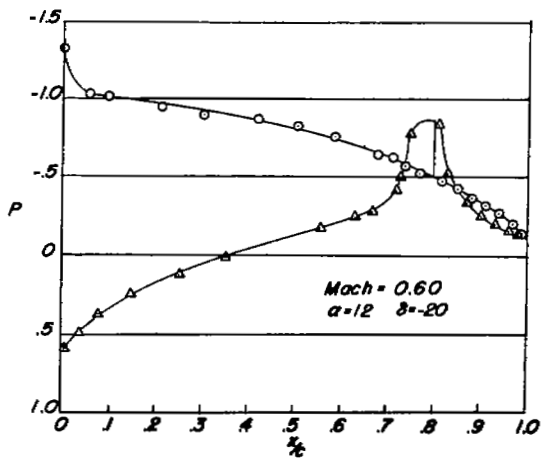
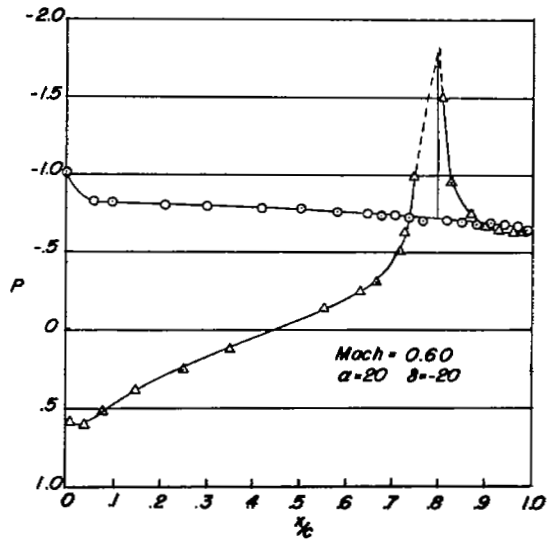

(a) $M = 0.60$. Concluded.

Figure 4.- Continued.

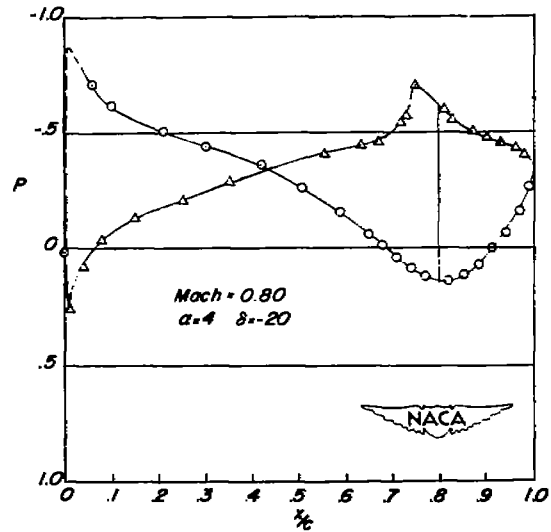
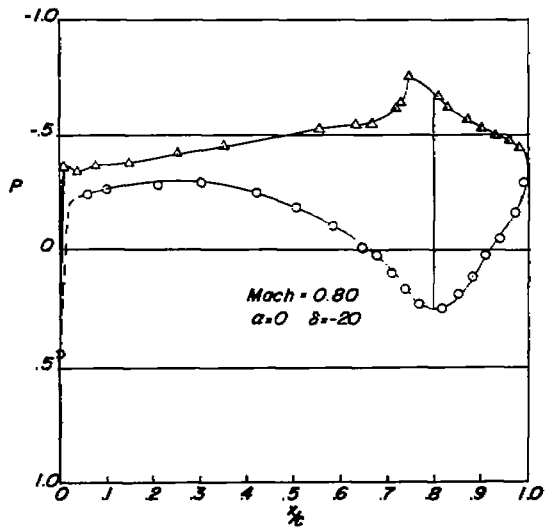
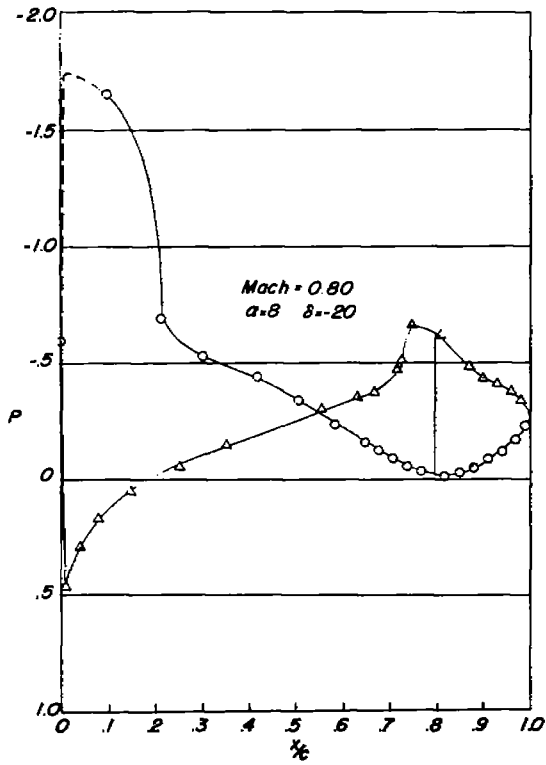

(b) $M = 0.80$.

Figure 4.- Continued.

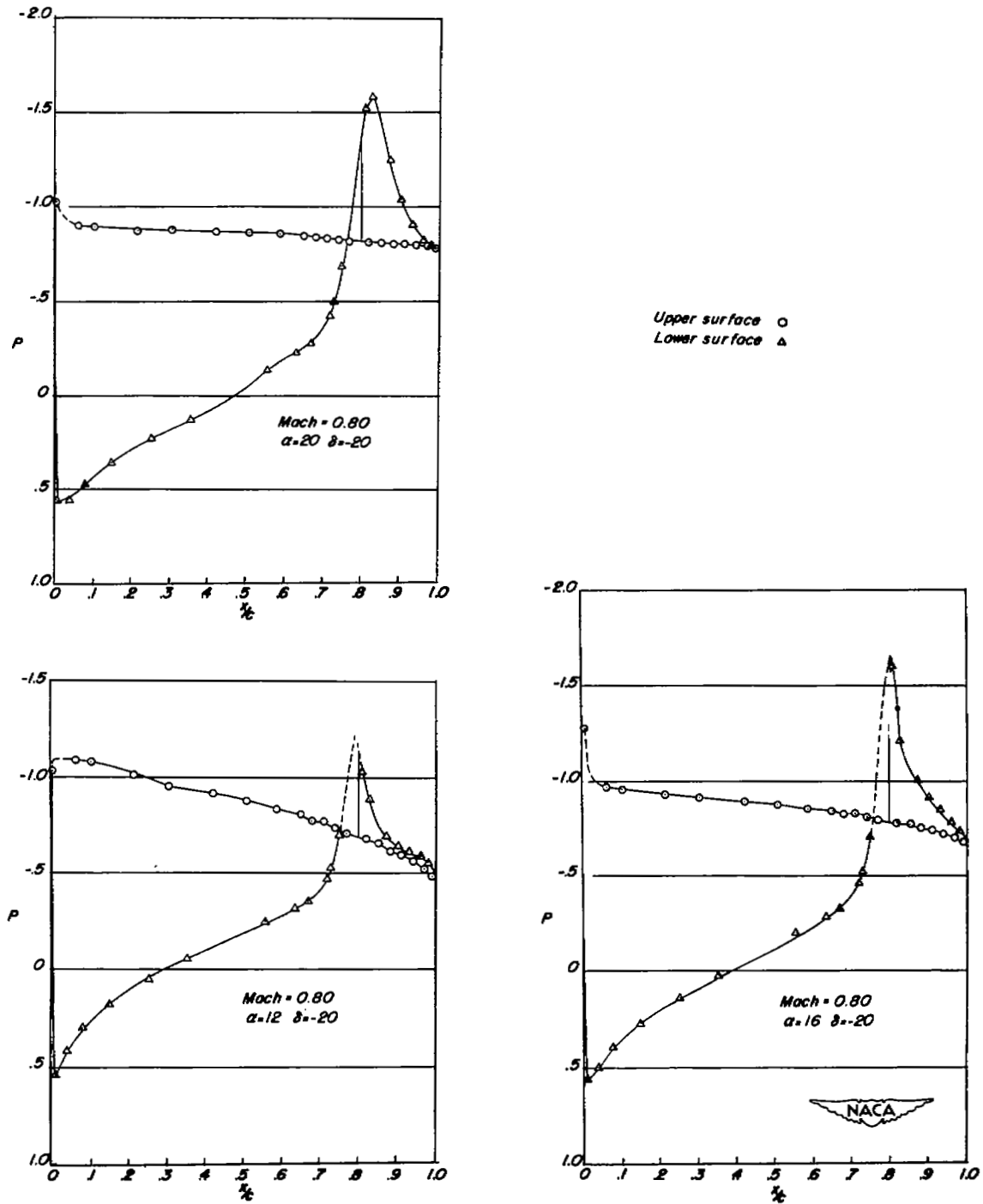

(b) $M = 0.80$. Concluded.

Figure 4.- Continued.

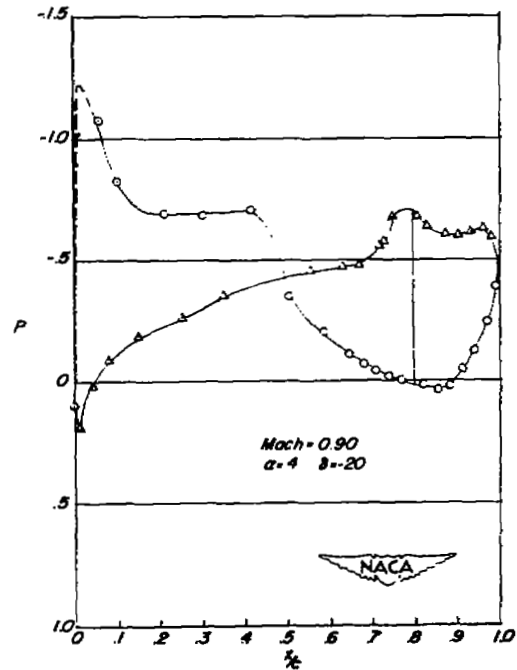
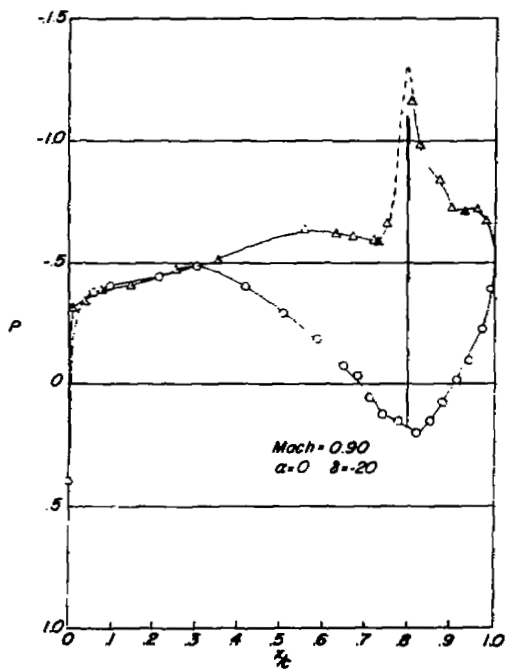
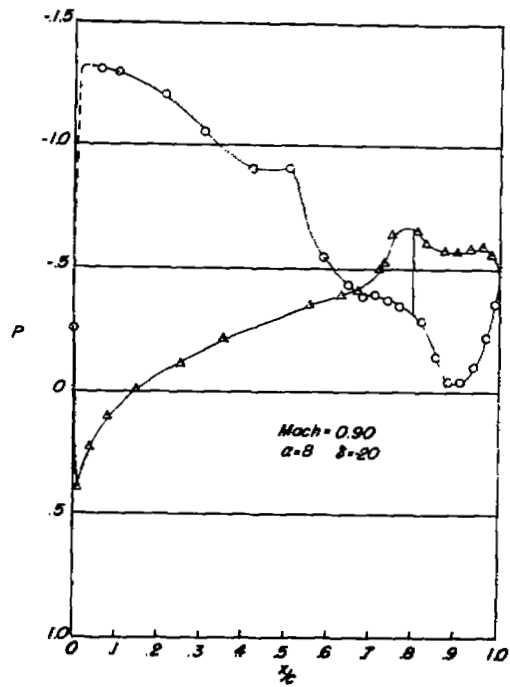

(c) $M = 0.90$.

Figure 4.- Continued.

Upper surface ○
Lower surface ▲

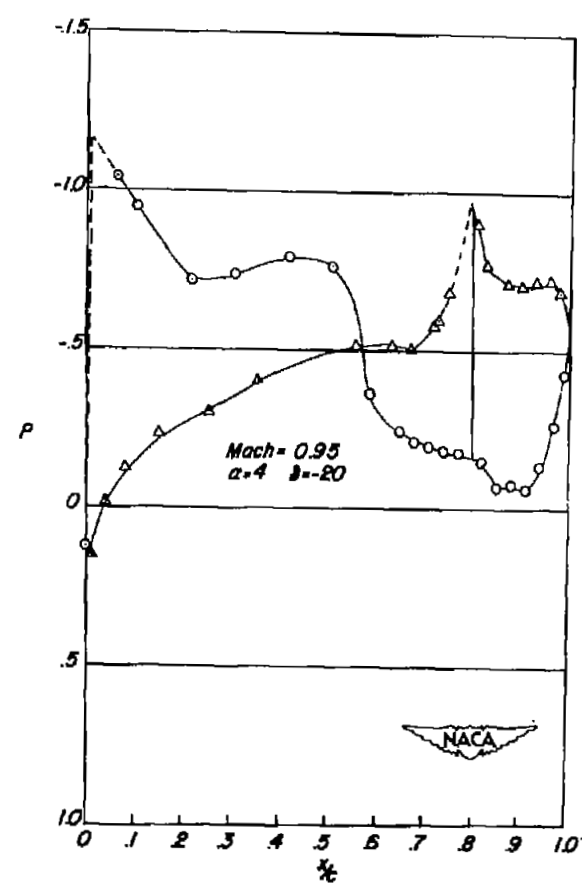
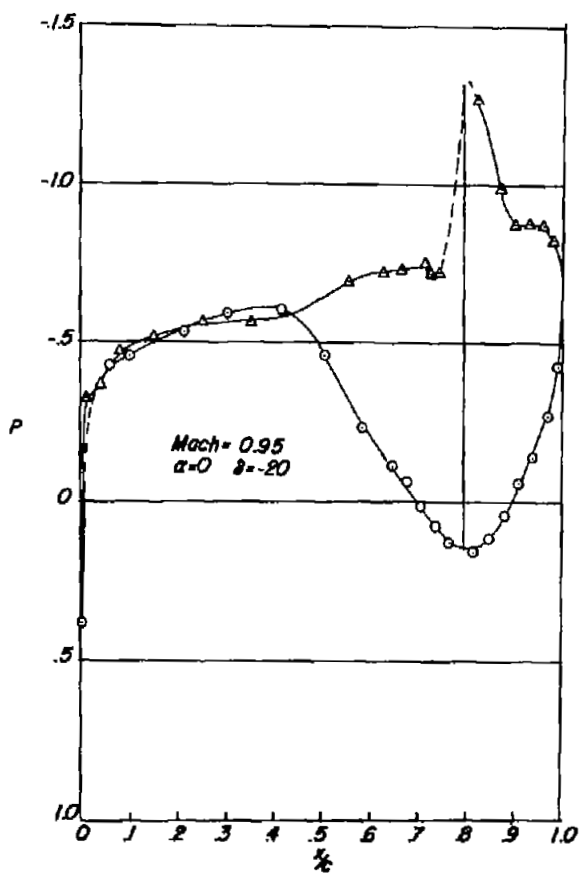

(d) M = 0.95.

Figure 4.- Concluded.

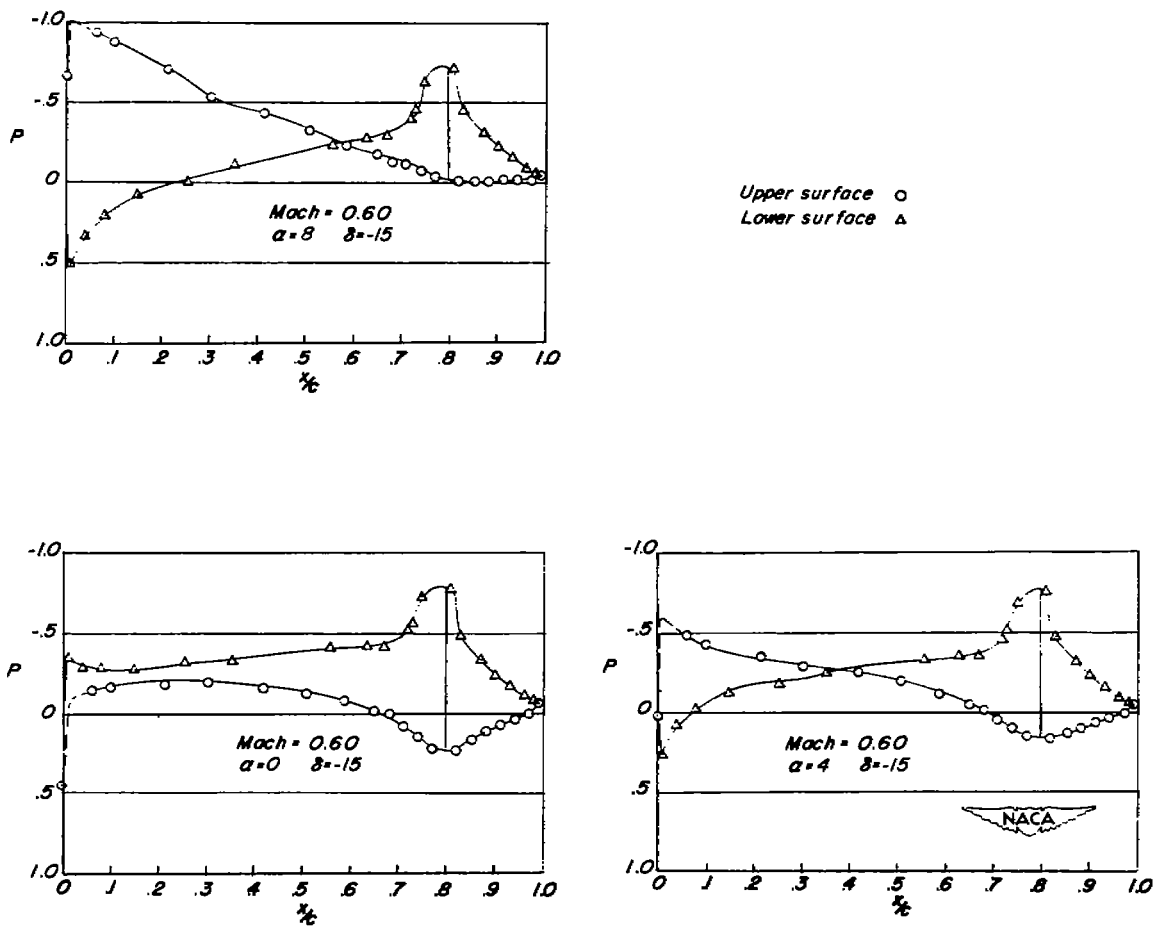

(a) M = 0.60.

Figure 5.- Chordwise pressure distribution over a 35° sweptback wing, at the 46-percent-semispan station, equipped with a flap-type aileron. $\delta = -15^\circ$.

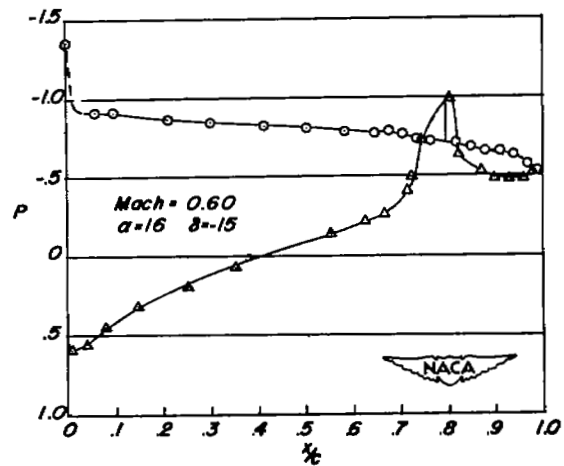
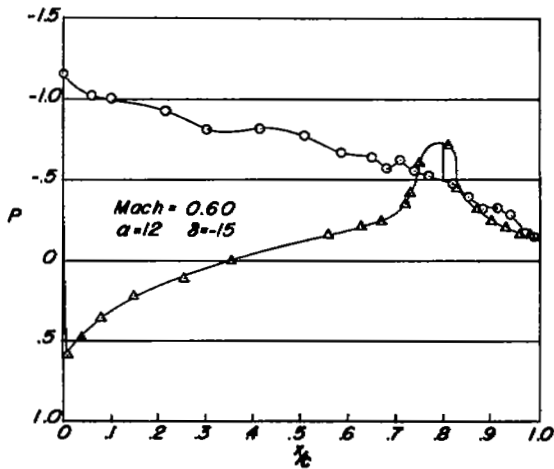
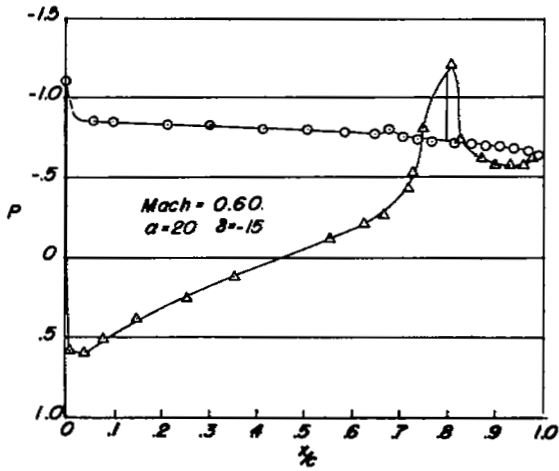

(a) $M = 0.60$. Concluded.

Figure 5.- Continued.

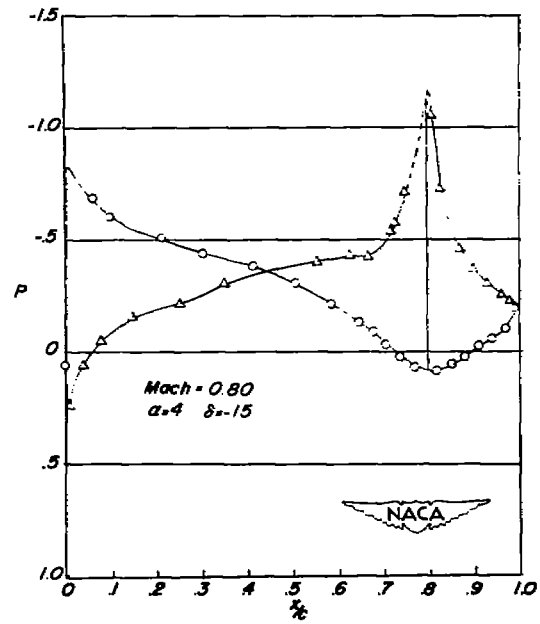
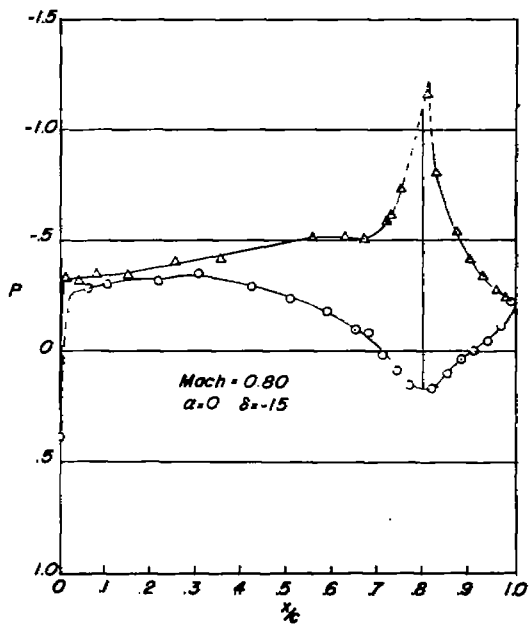
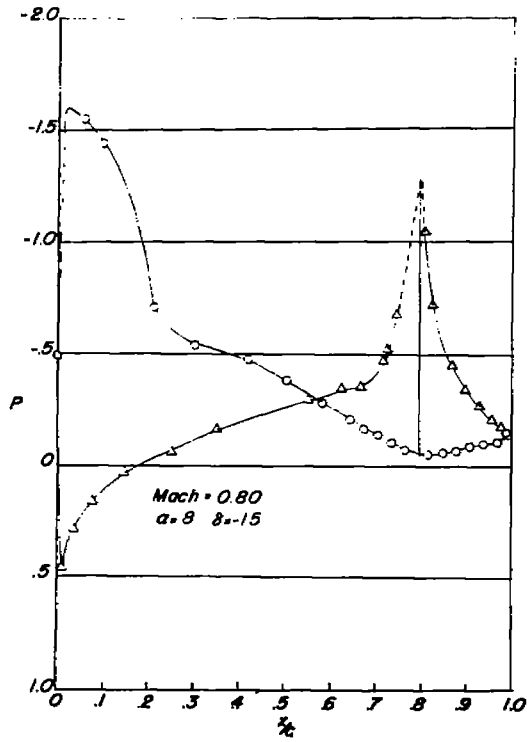

(b) $M = 0.80$.

Figure 5.- Continued.

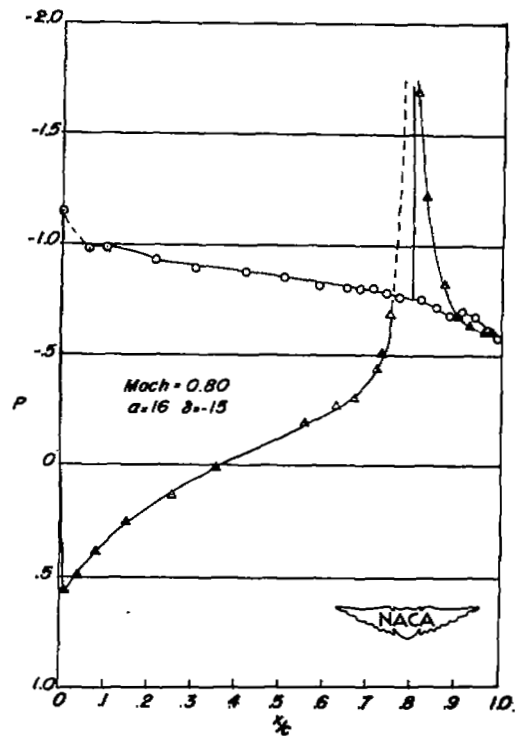
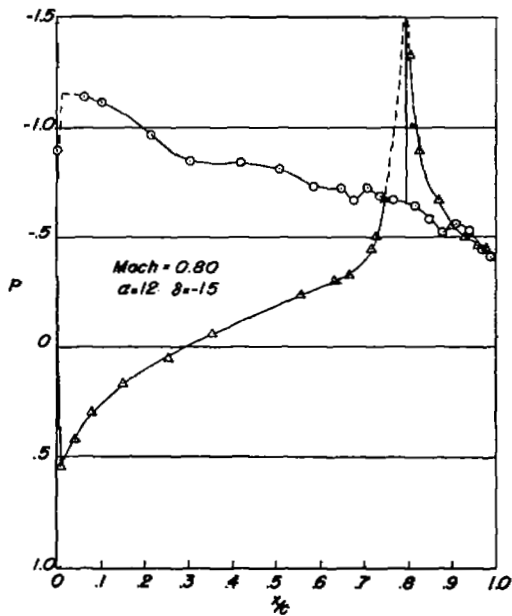
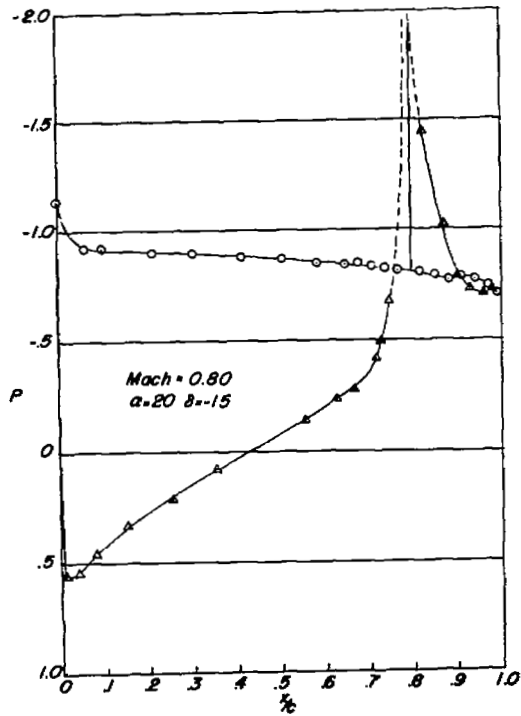

(b) $M = 0.80$. Concluded.

Figure 5.- Continued.

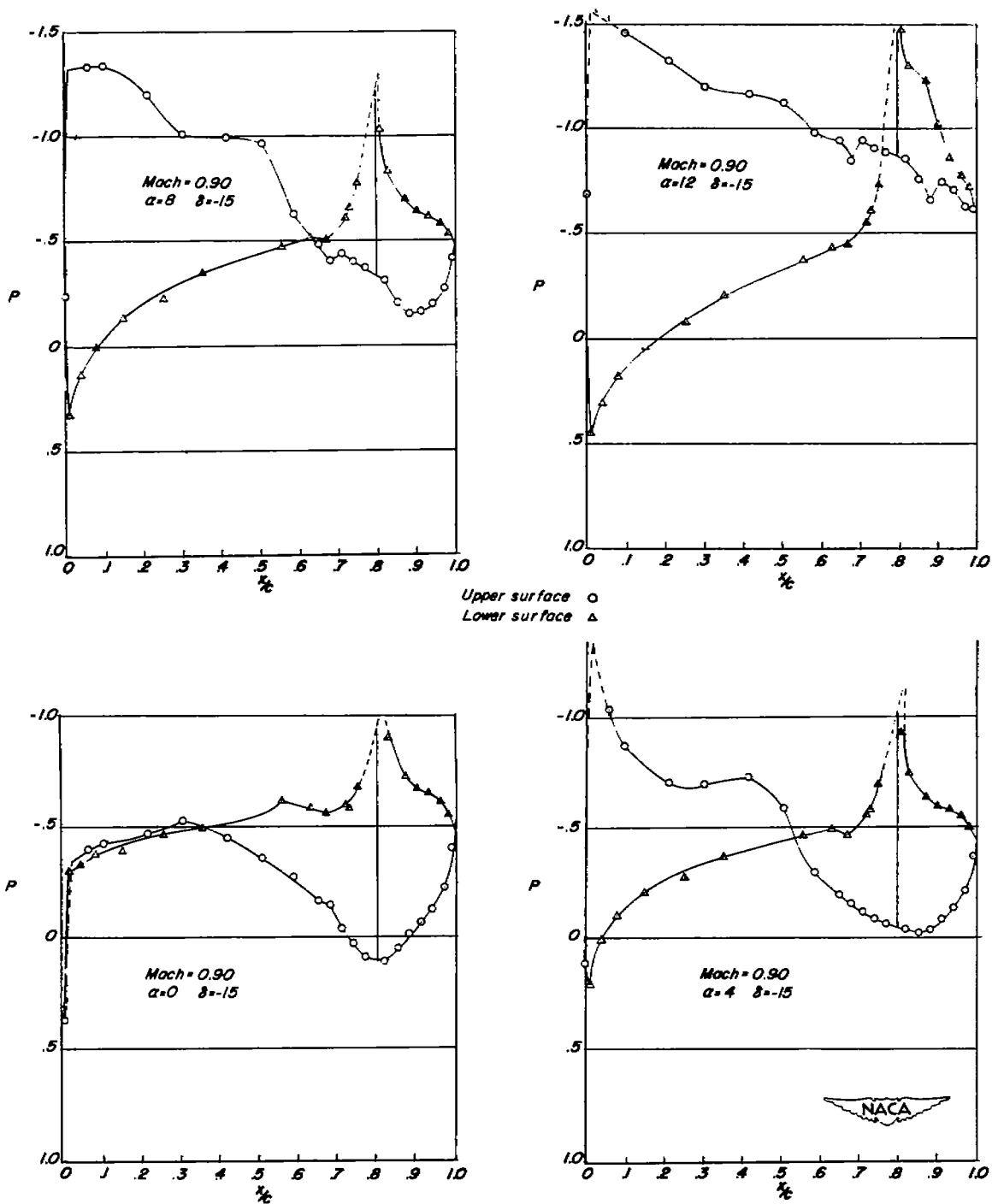

(c) $M = 0.90$.

Figure 5.- Continued.

(d) $M = 0.95$.

Figure 5.- Concluded.



(a) M = 0.60.

Figure 6.- Chordwise pressure distribution over a 35° sweptback wing, at the 46-percent-semispan station, equipped with a flap-type aileron. $\delta = -10^\circ$.

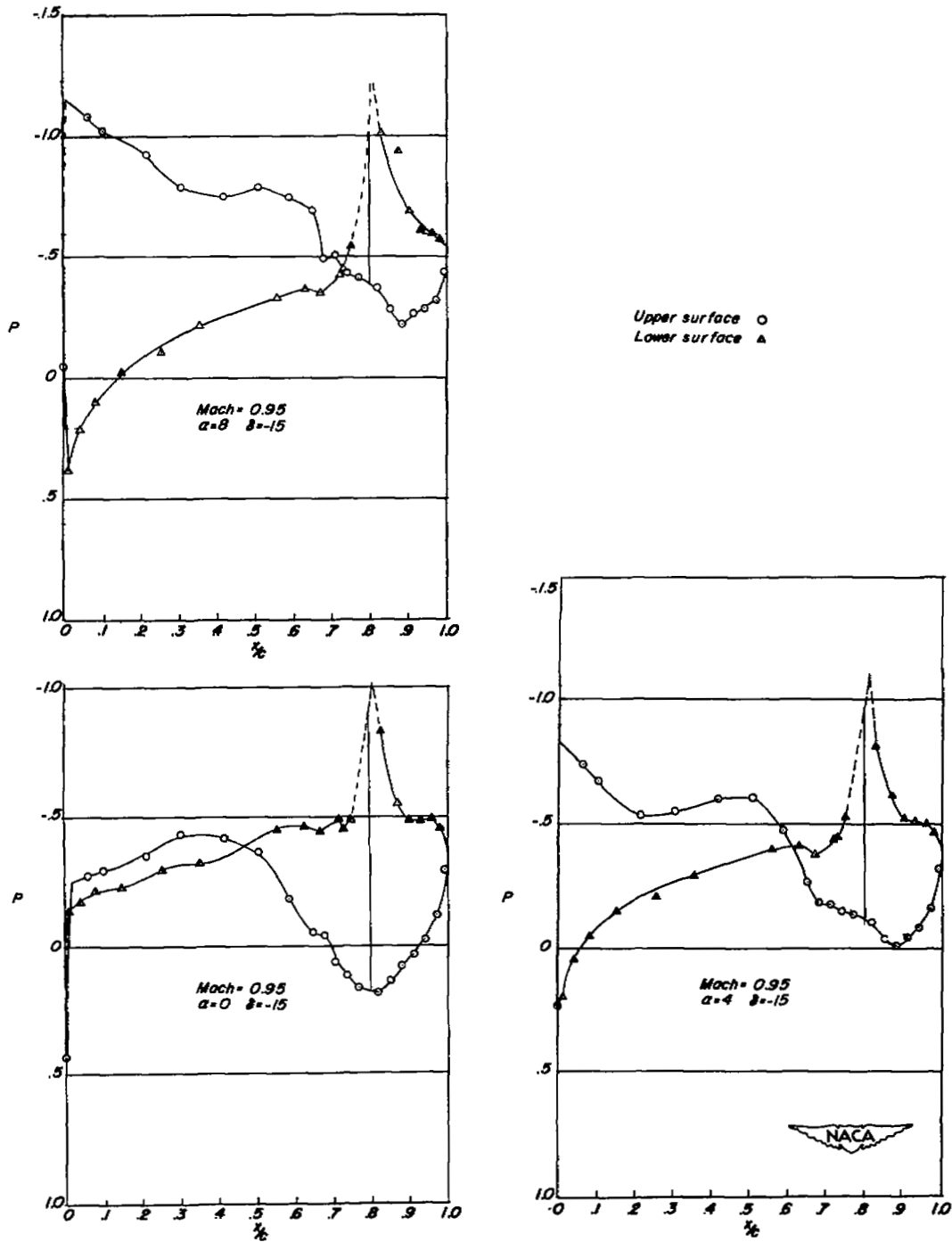
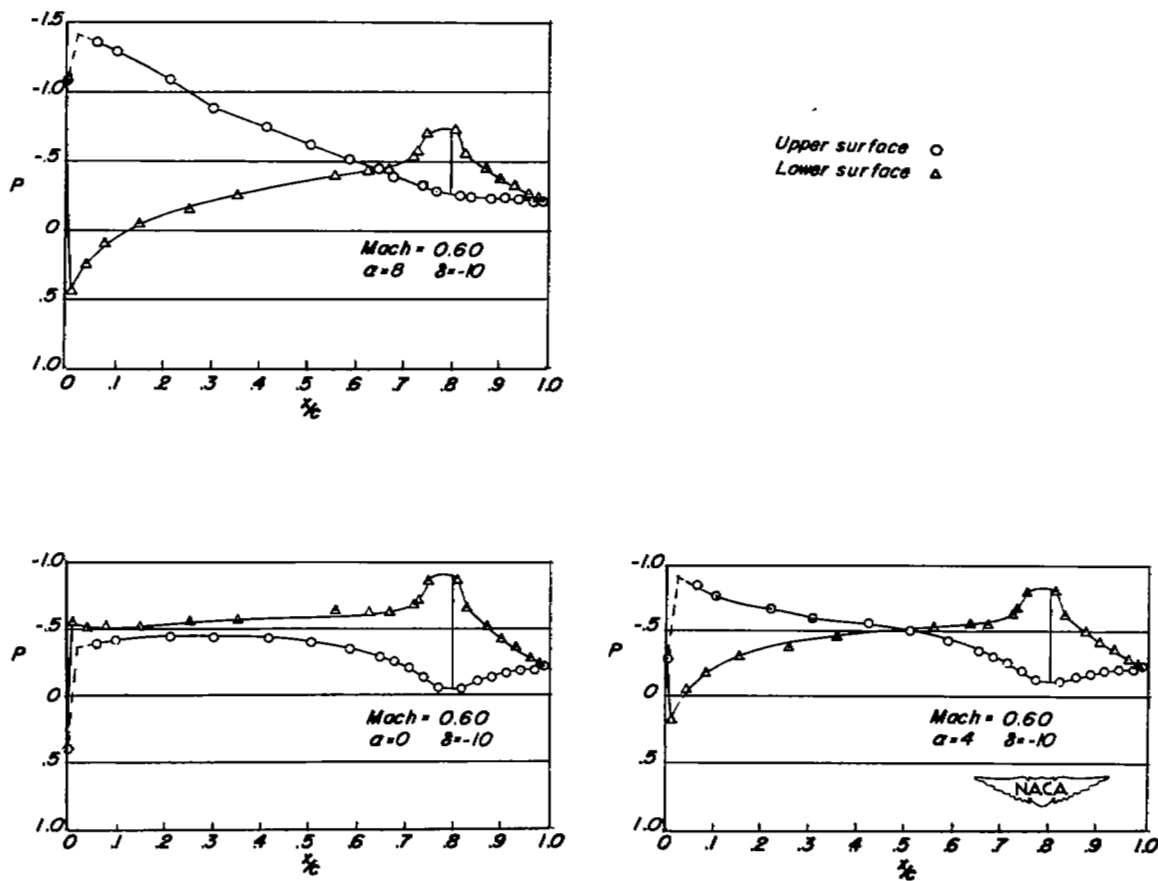
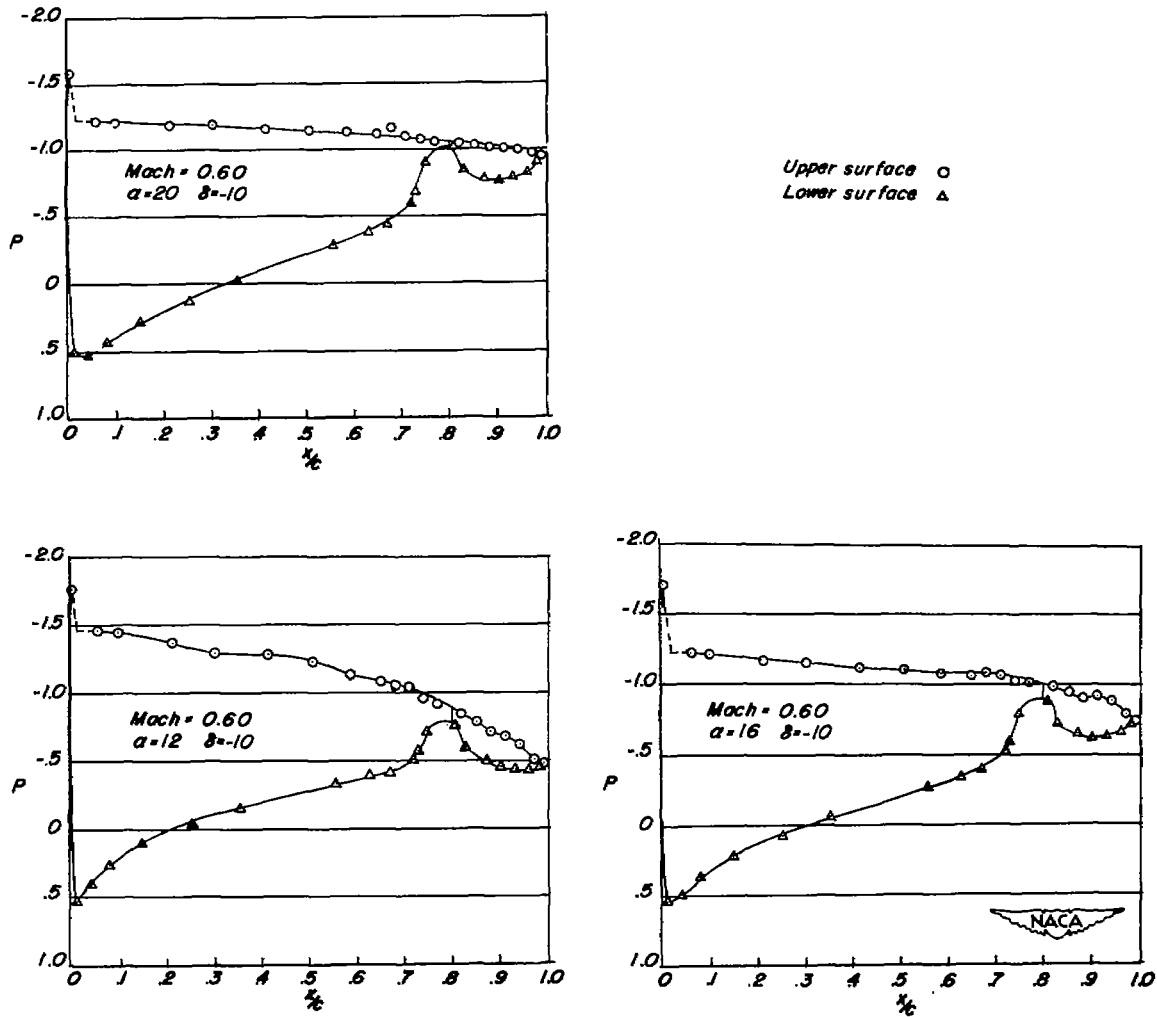

(a) $M = 0.60$. Concluded.

Figure 6.- Continued.

(b) $M = 0.80$.

Figure 6.- Continued.



(b) $M = 0.80$. Concluded.

Figure 6.- Continued.

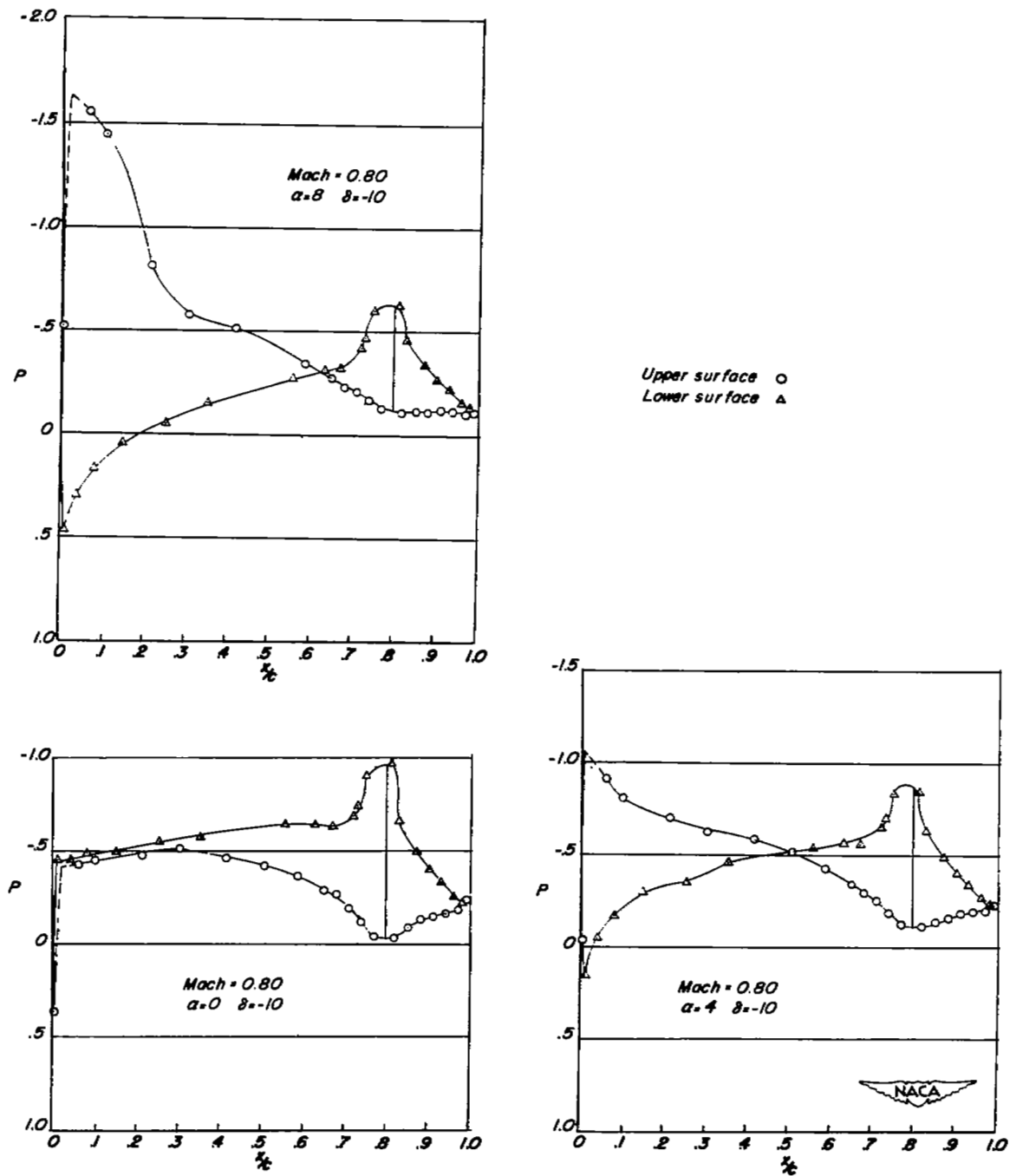
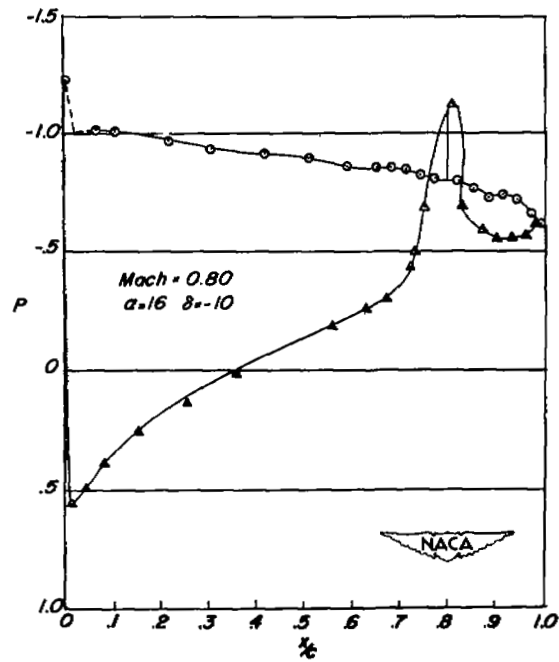
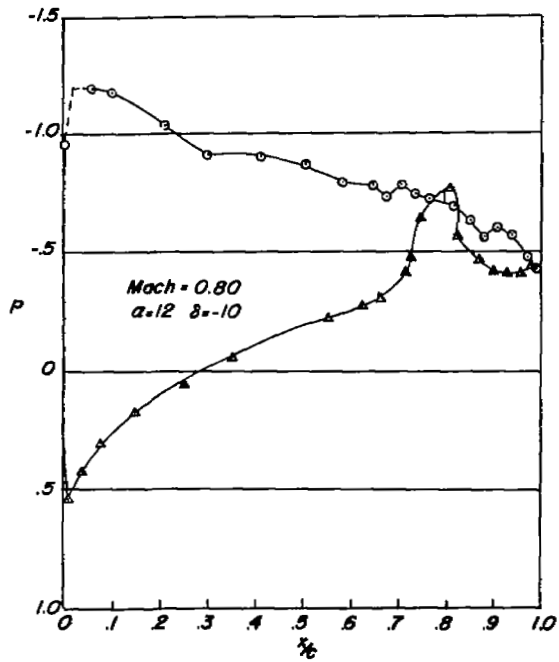
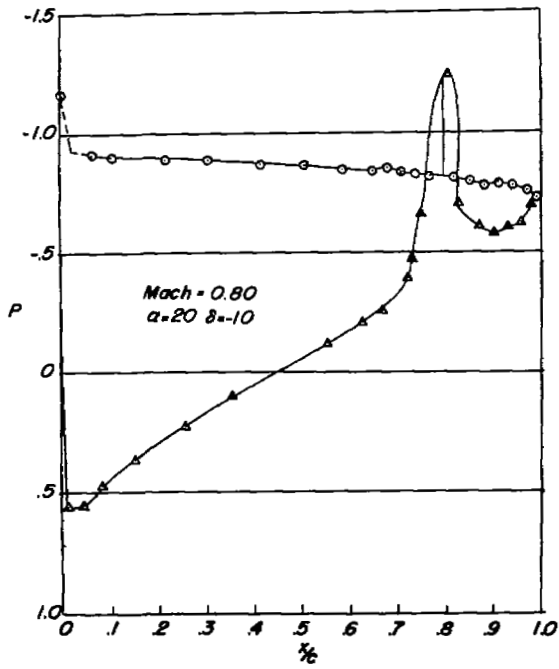
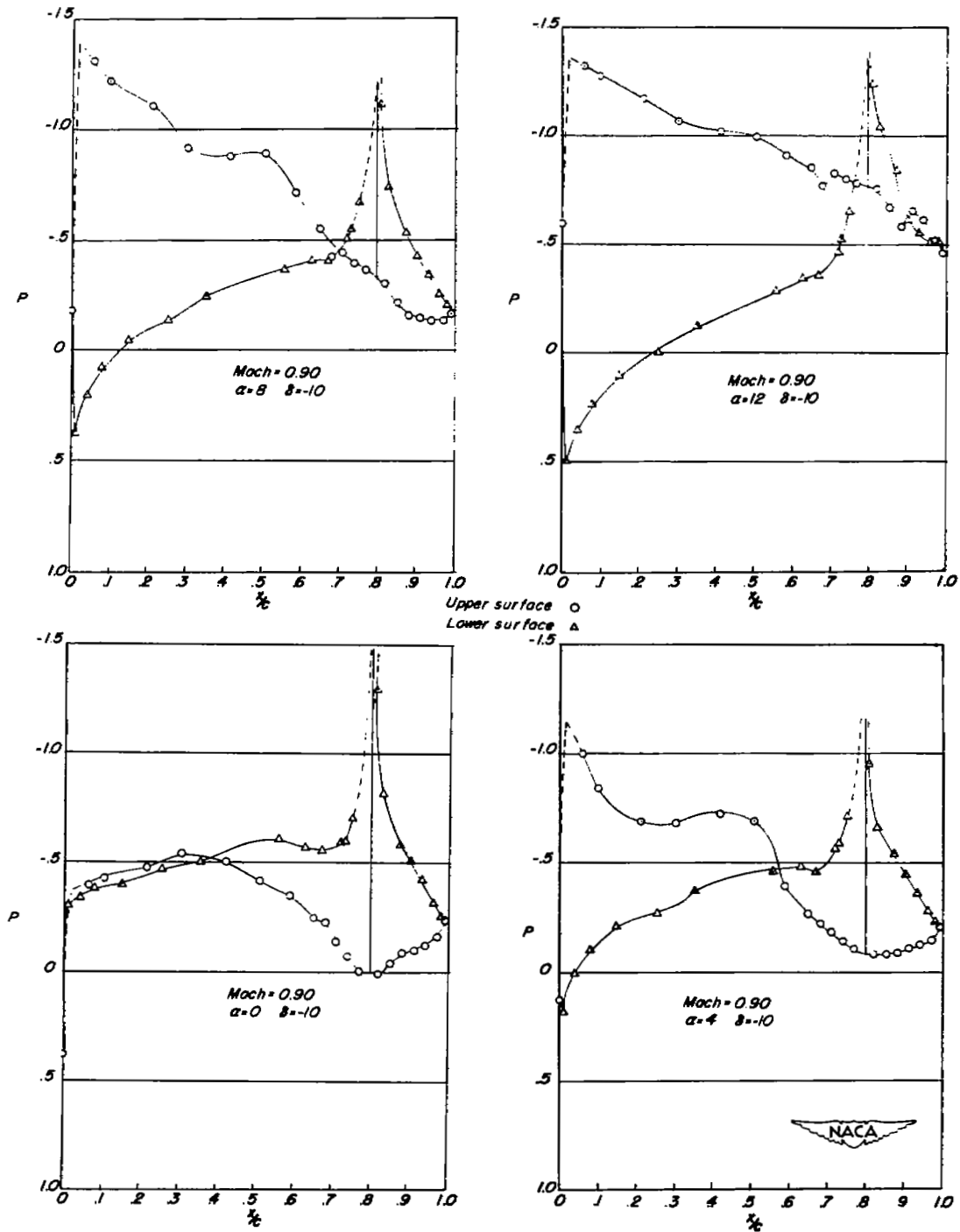

(c) M = 0.90.

Figure 6.- Continued.

(d) $M = 0.95$.

Figure 6.- Concluded.

(a) $M = 0.60$.

Figure 7.- Chordwise pressure distribution over a 35° sweptback wing, at the 46-percent-semispan station, equipped with a flap-type aileron. $\delta = -5^\circ$.

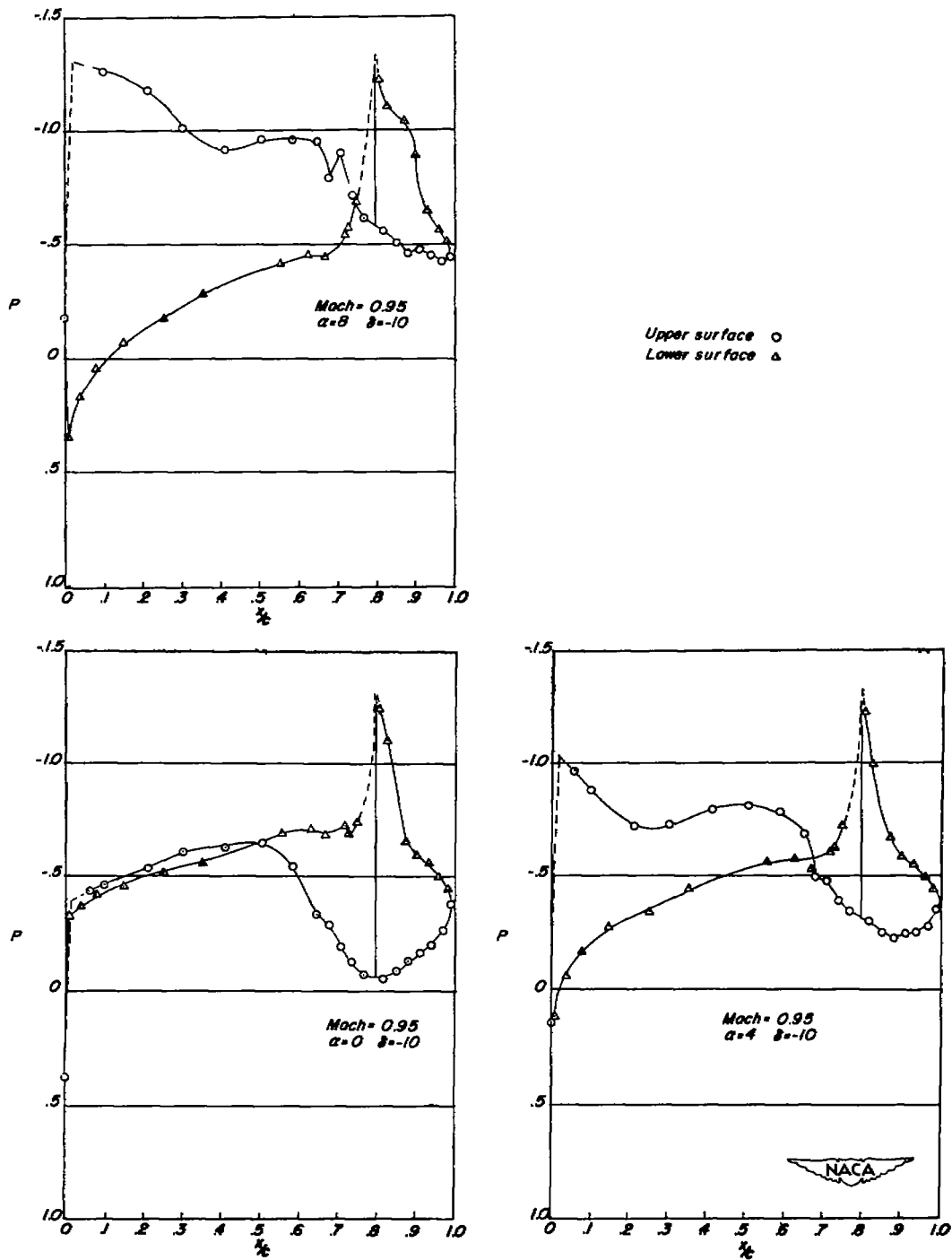

(a) $M = 0.60$. Concluded.

Figure 7.- Continued.

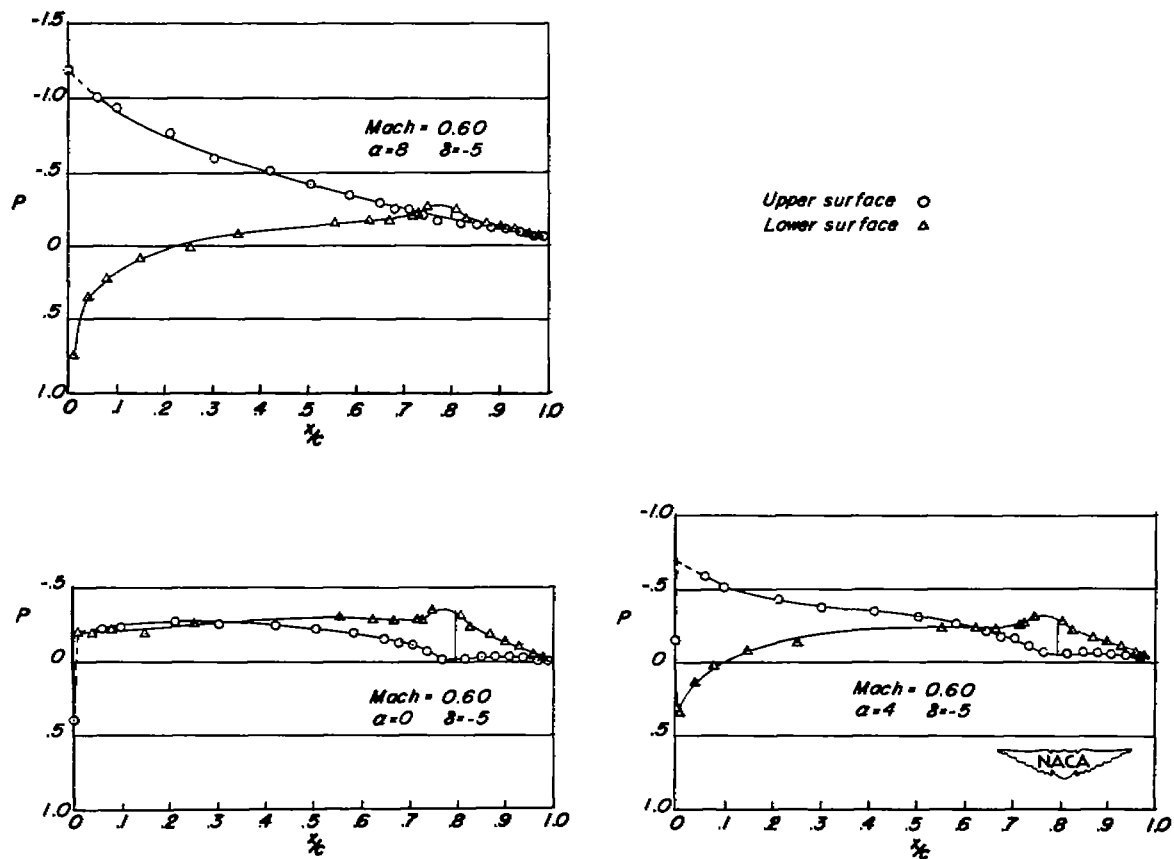
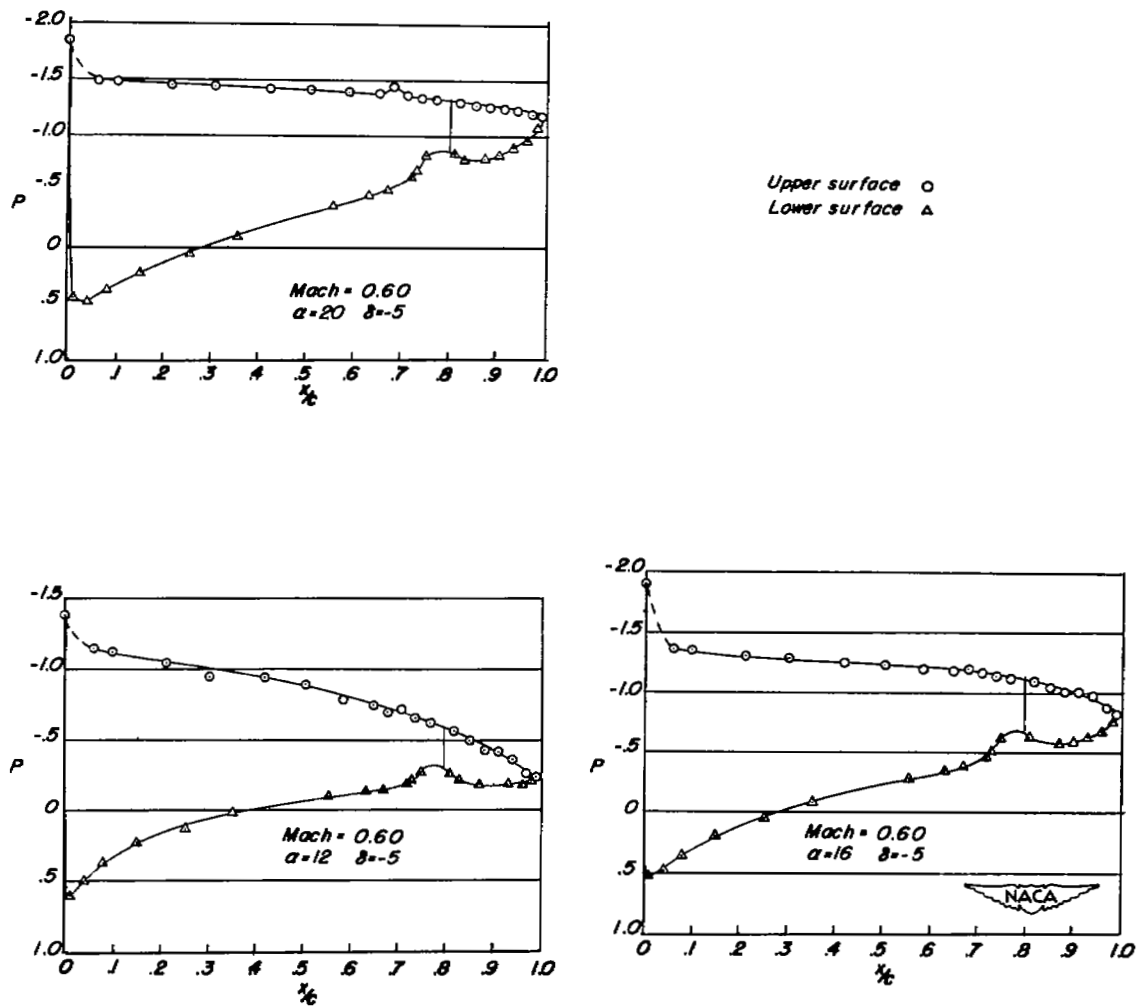
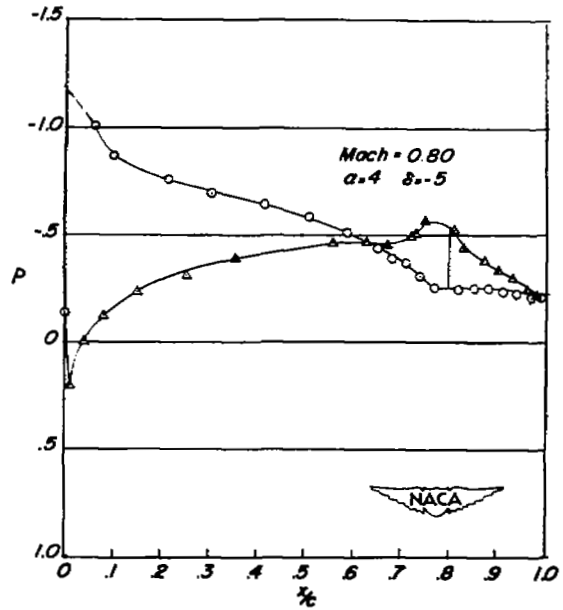
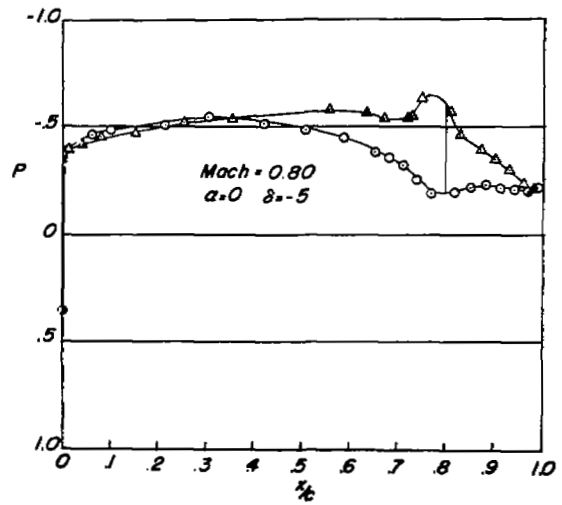
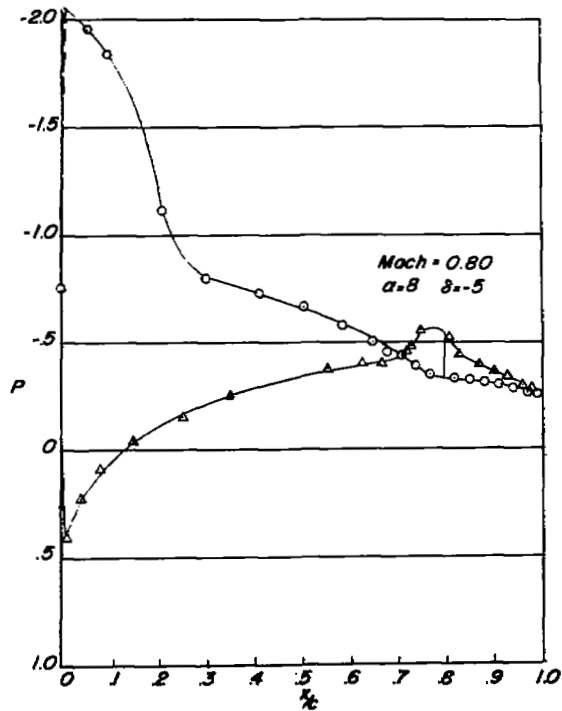

(b) $M = 0.80$.

Figure 7.- Continued.

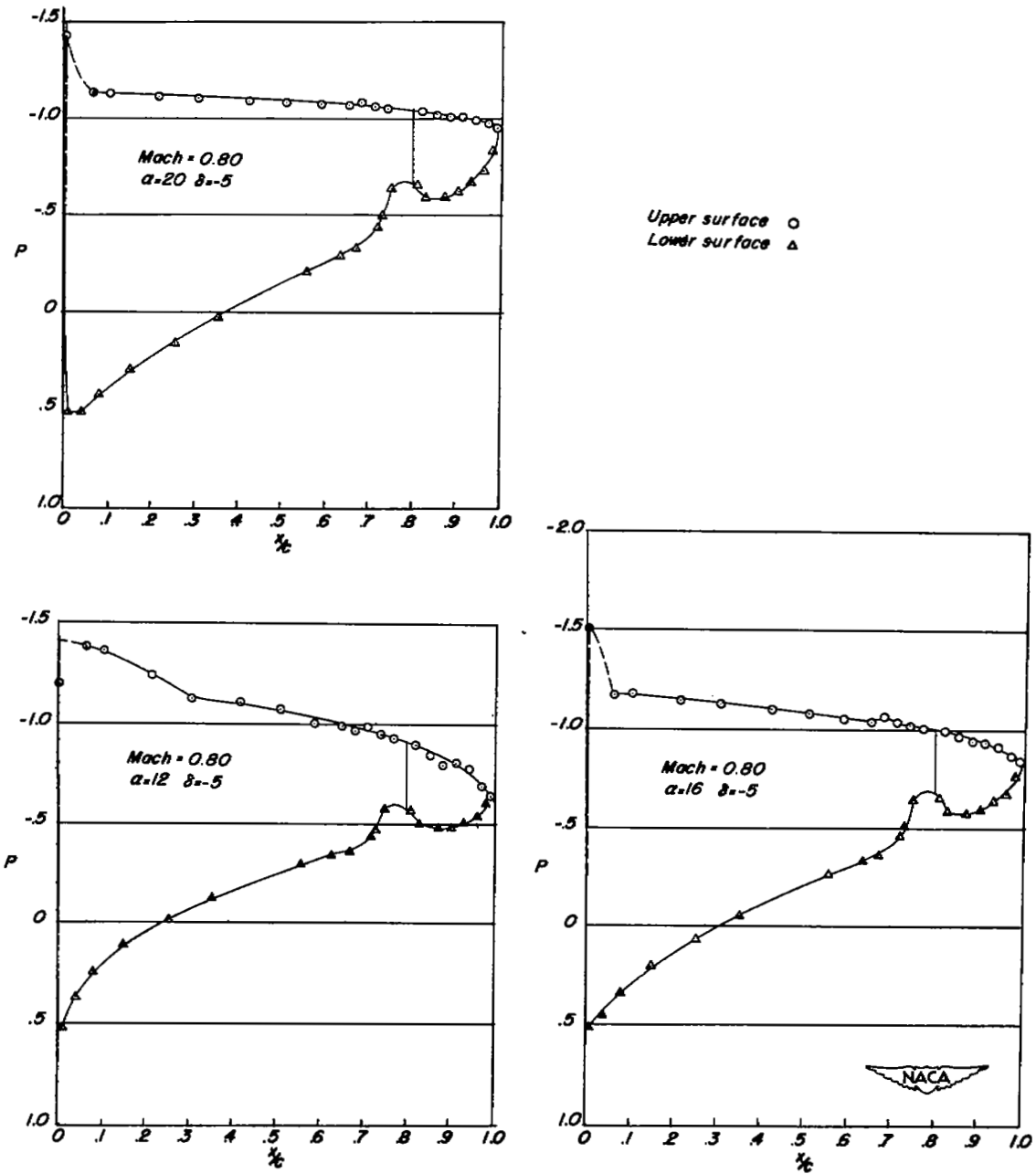

(b) $M = 0.80$. Concluded.

Figure 7.- Continued.

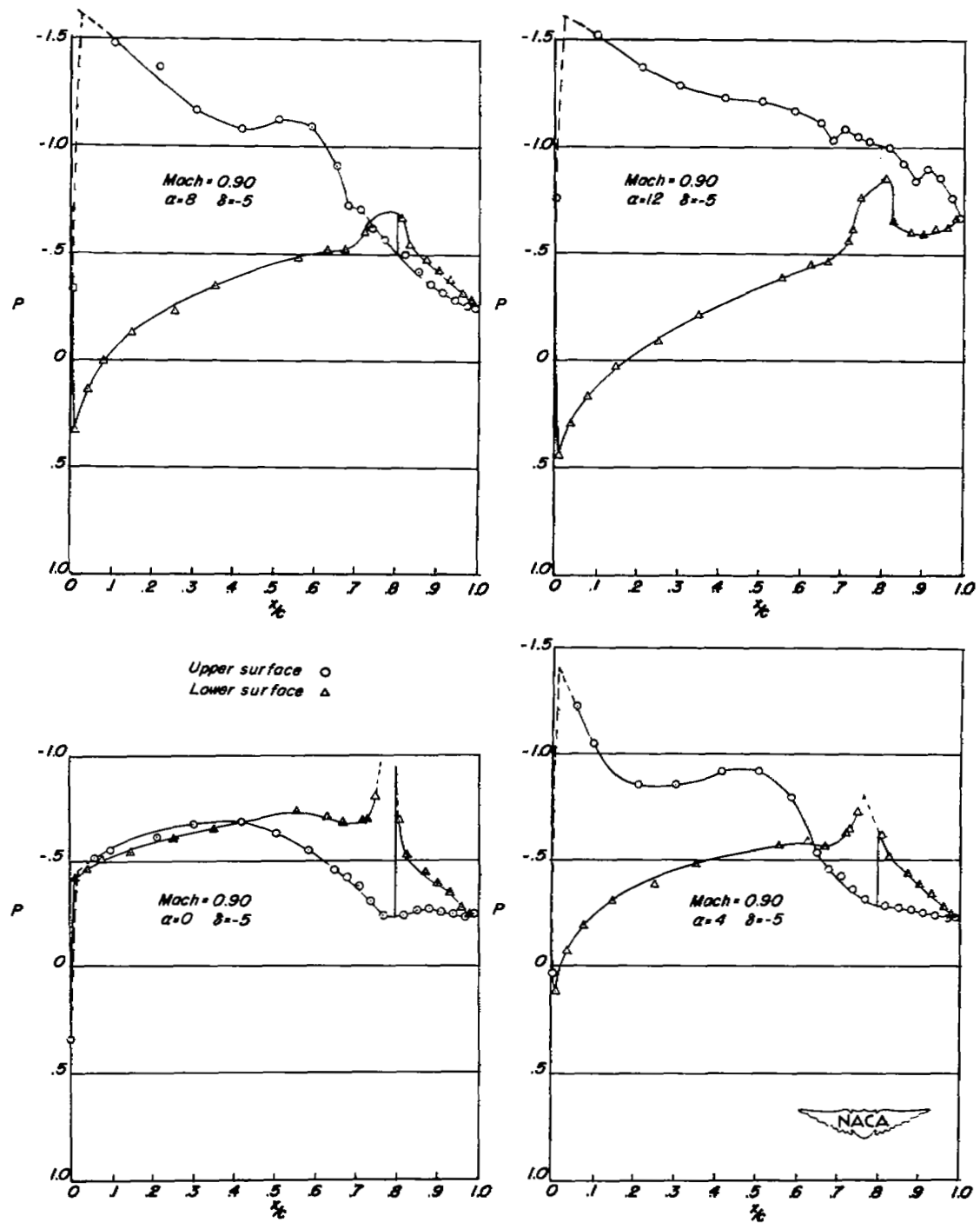

(c) $M = 0.90$.

Figure 7.- Continued.

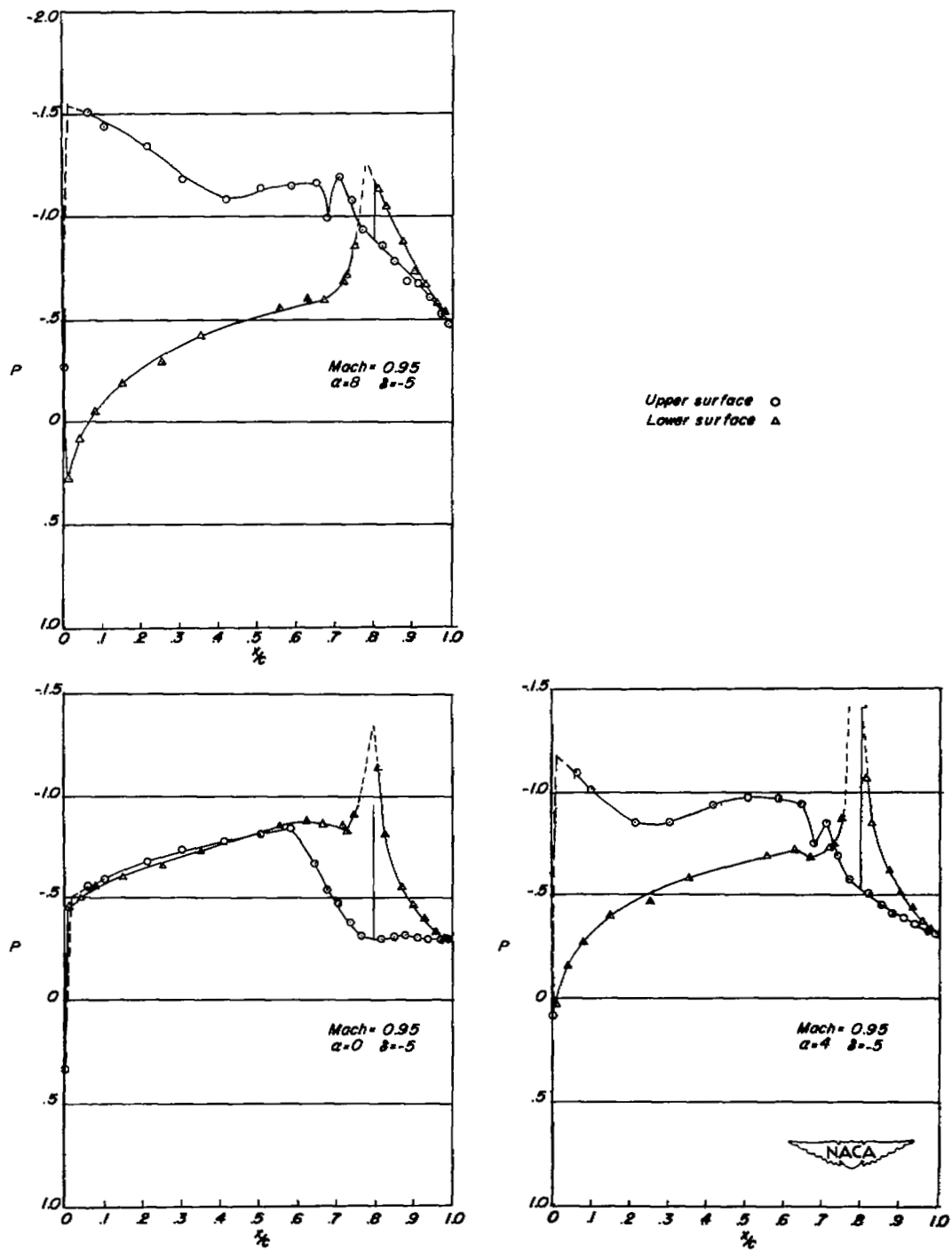

(d) $M = 0.95$.

Figure 7.- Concluded.

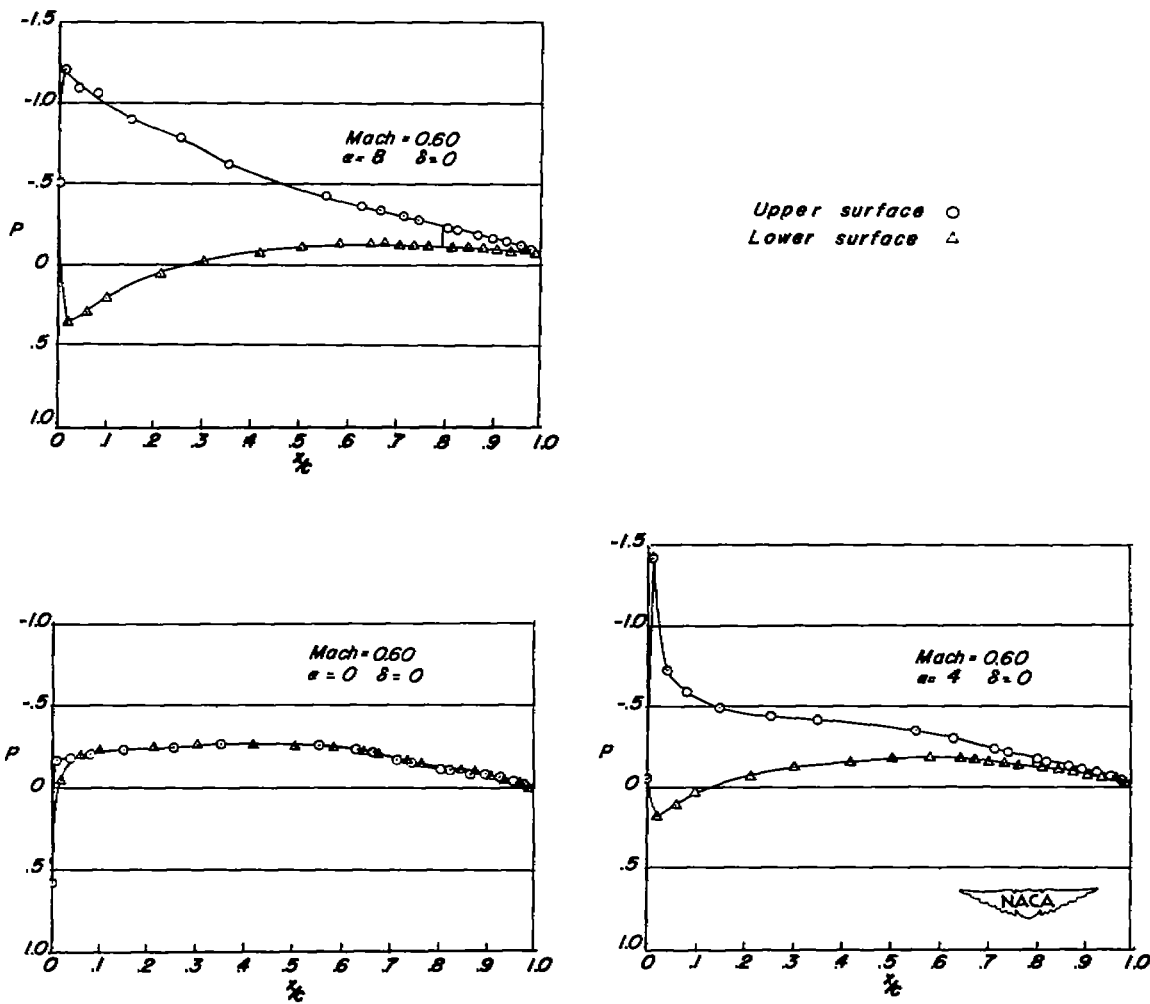

(a) $M = 0.60$.

Figure 8.- Chordwise pressure distribution over a 35° sweptback wing, at the 46-percent-semispan station, equipped with a flap-type aileron. $\delta = 0$.

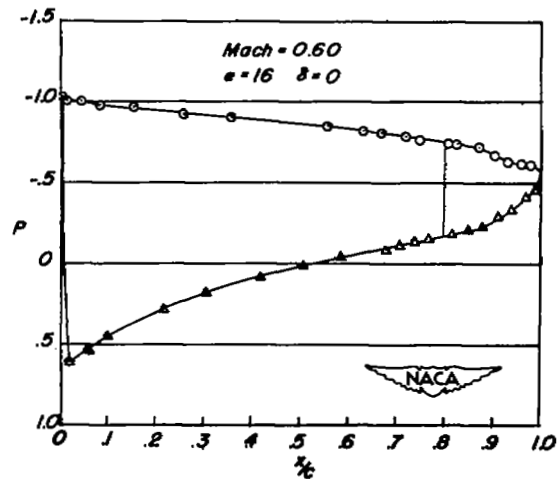
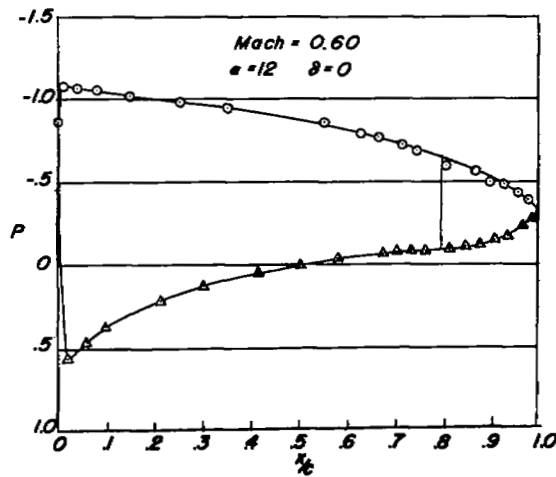
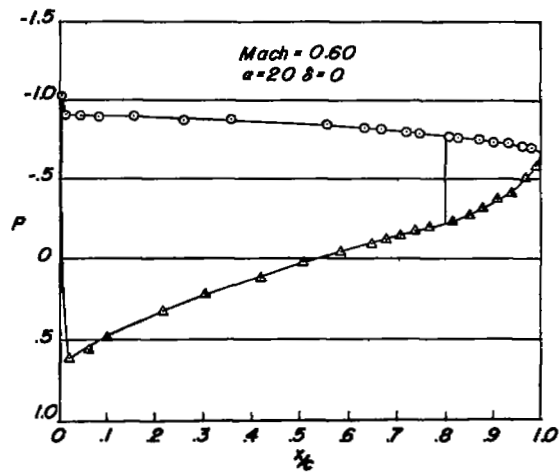

(a) $M = 0.60$. Concluded.

Figure 8.- Continued.

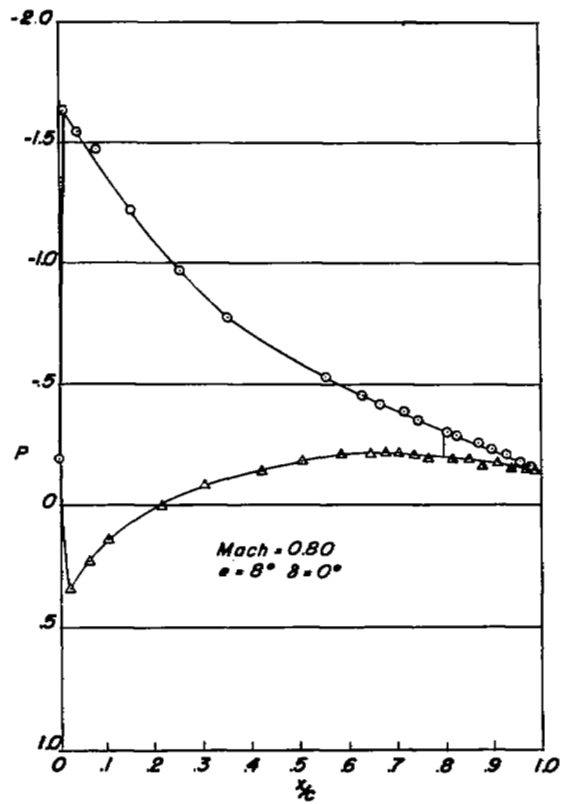

Upper surface \circ
 Lower surface \triangle

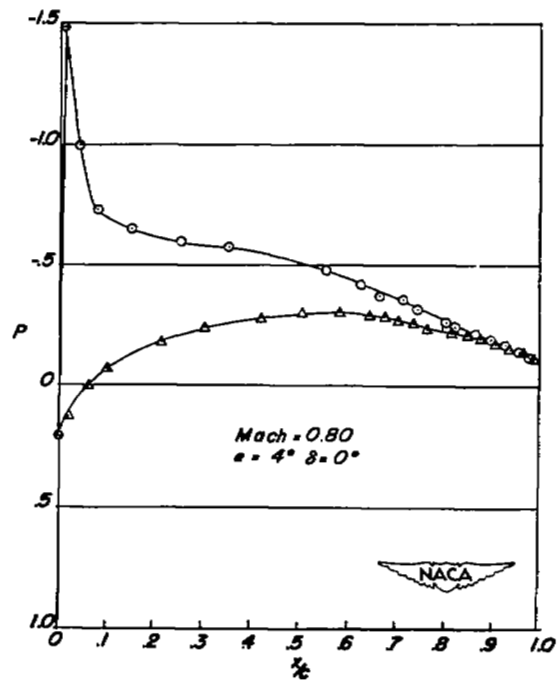
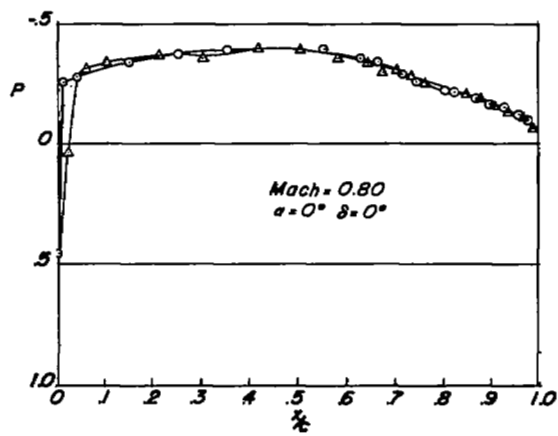

(b) $M = 0.80$.

Figure 8.- Continued.

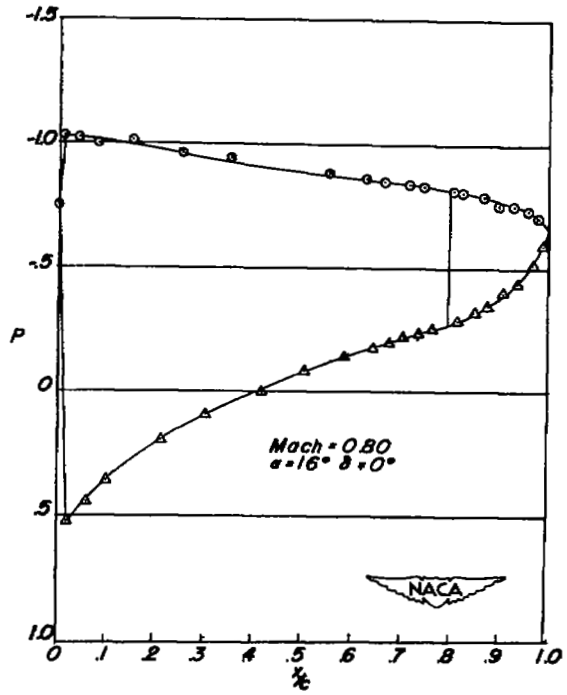
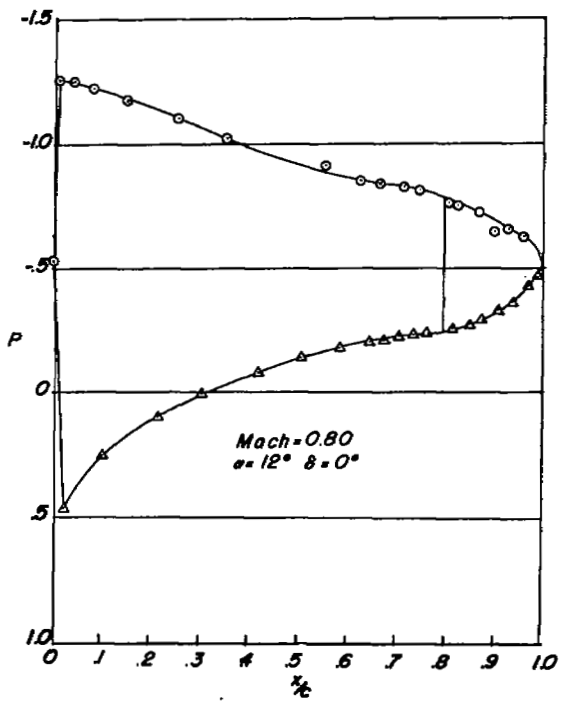
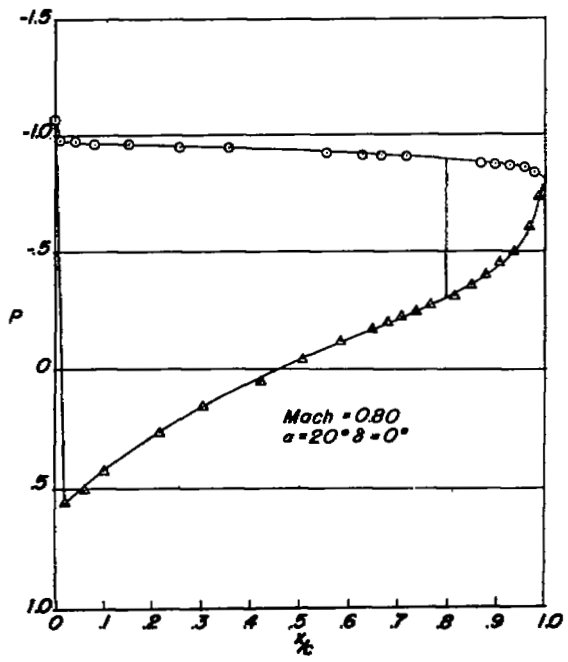

(b) M = 0.80. Concluded.

Figure 8.- Continued.

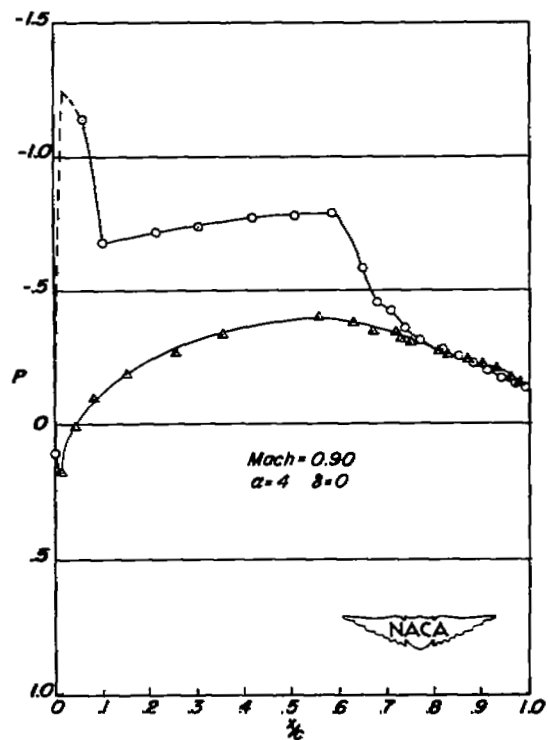
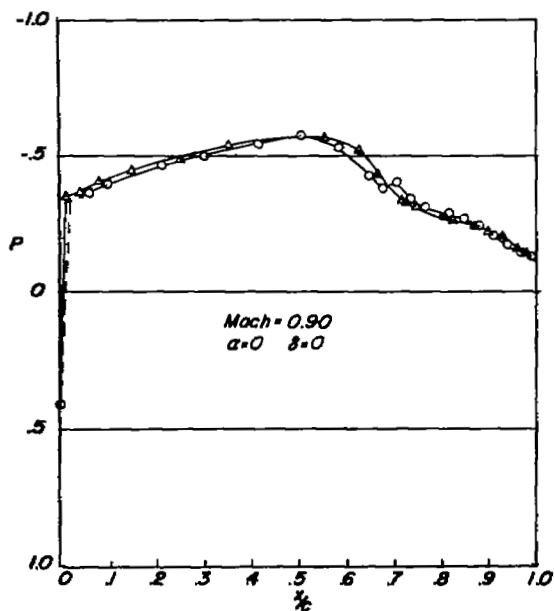
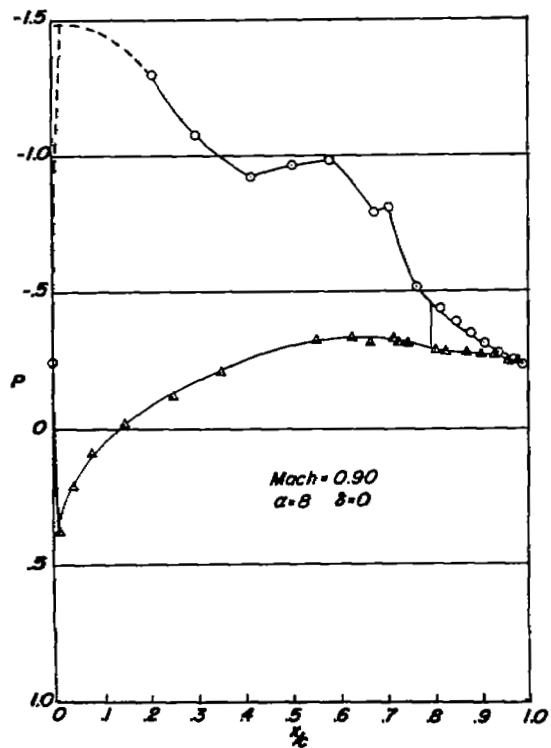

(c) $M = 0.90$.

Figure 8.- Continued.

Upper surface ○
Lower surface △

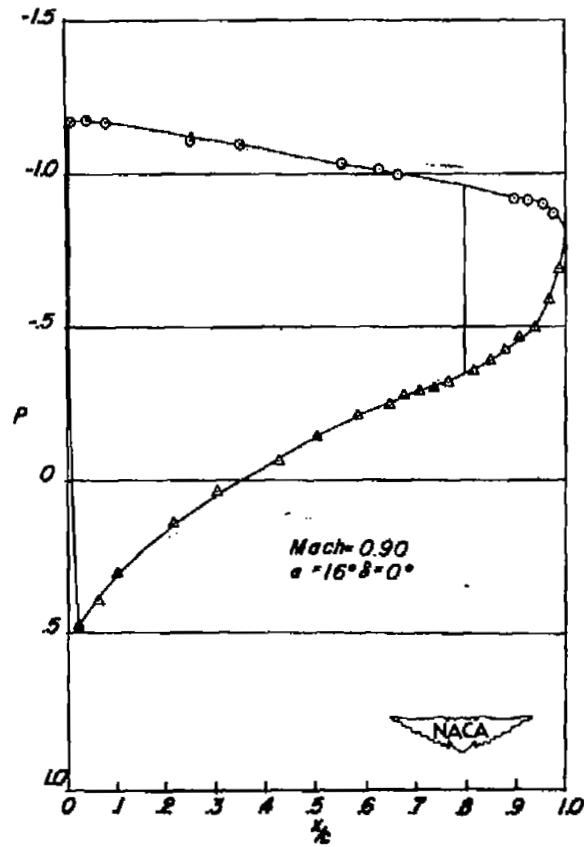
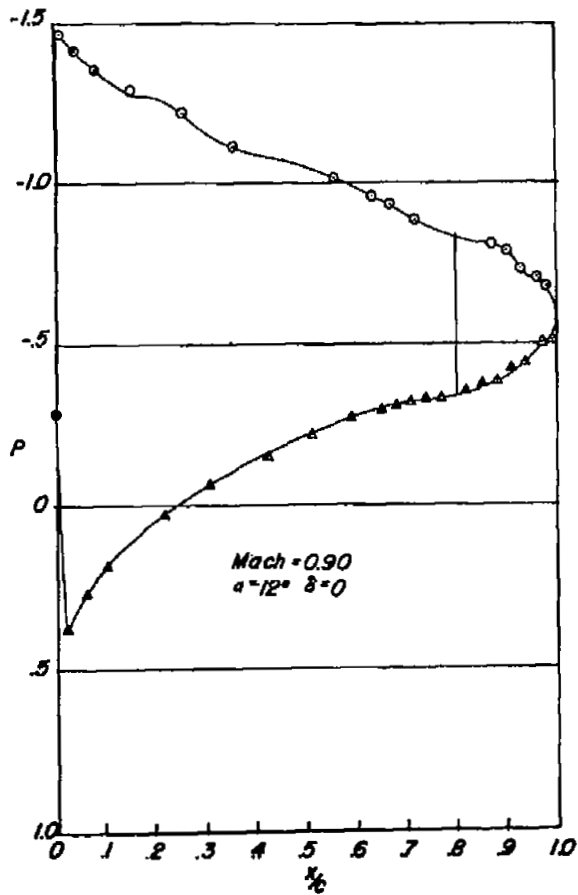

(c) $M = 0.90$. Concluded.

Figure 8.- Continued.

(d) $M = 0.95$.

Figure 8.- Concluded.

(a) $M = 0.60$.

Figure 9.- Chordwise pressure distribution over a 35° sweptback wing, at the 46-percent-semispan station, equipped with a flap-type aileron. $\delta = 5^\circ$.

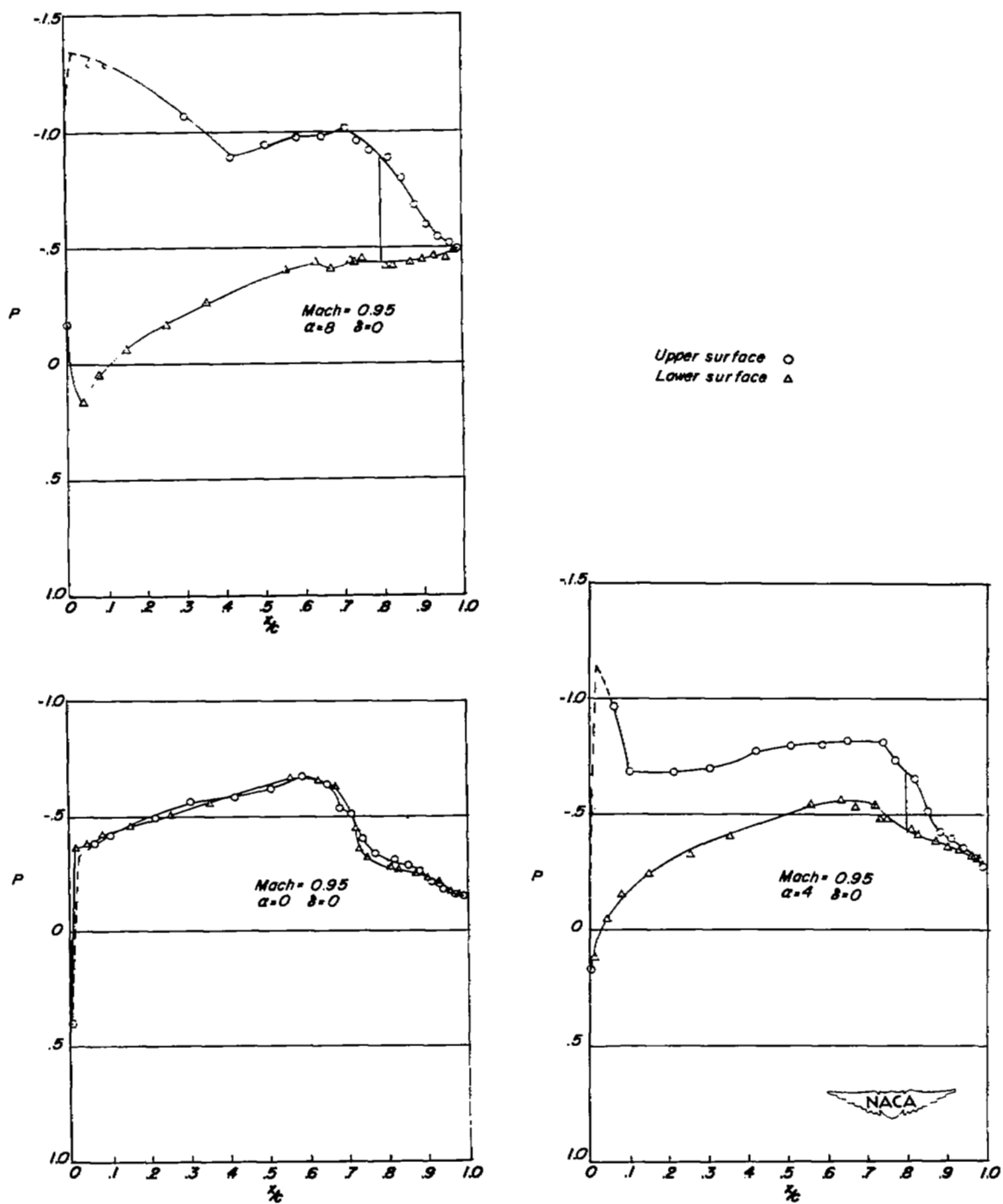

(a) M = 0.60. Concluded.

Figure 9.- Continued.

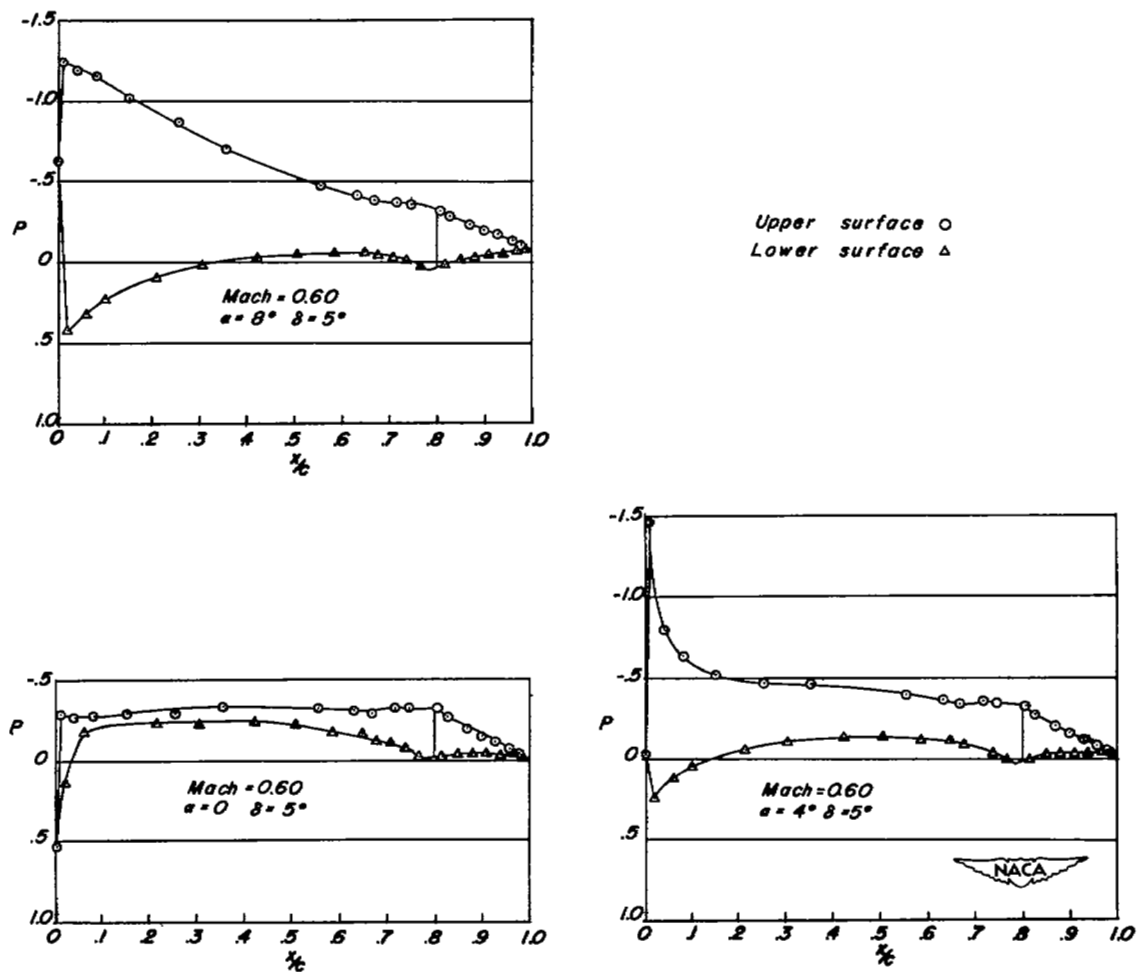
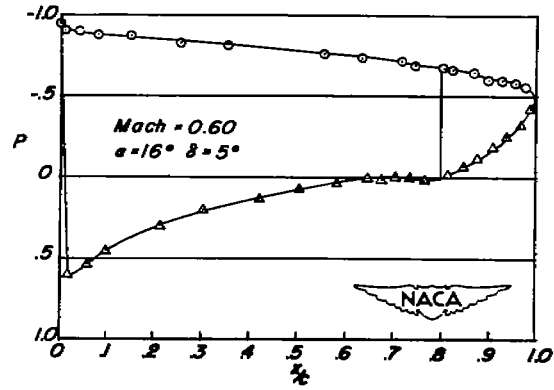
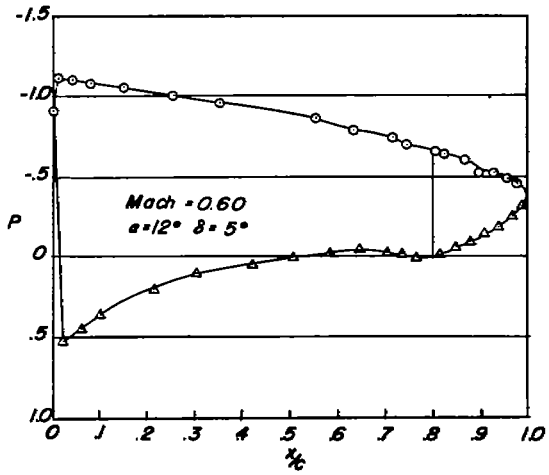
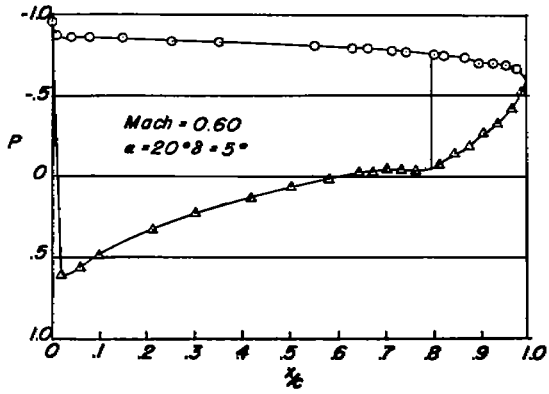
(b) $M = 0.80$.

Figure 9.- Continued.



Upper surface \circ
 Lower surface Δ

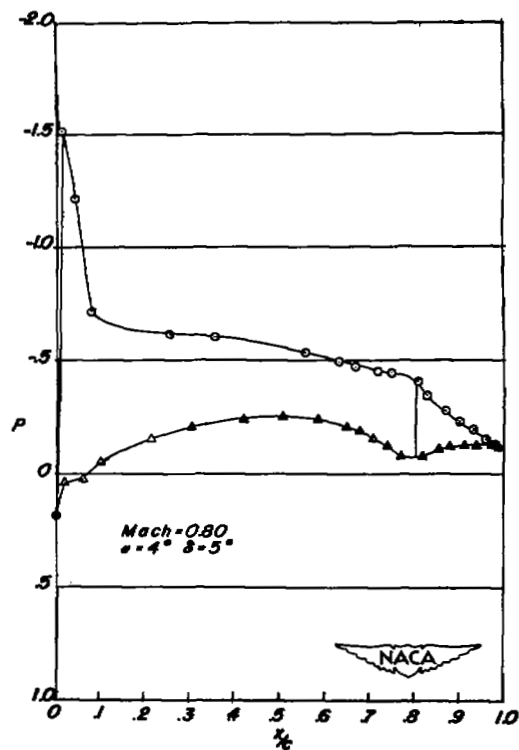
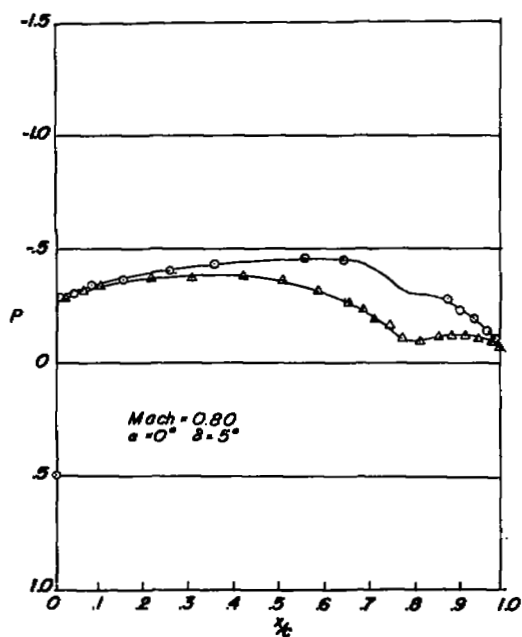
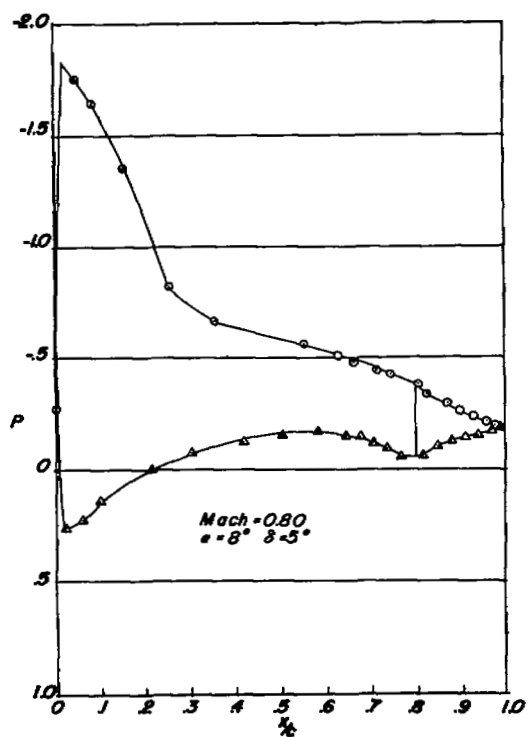
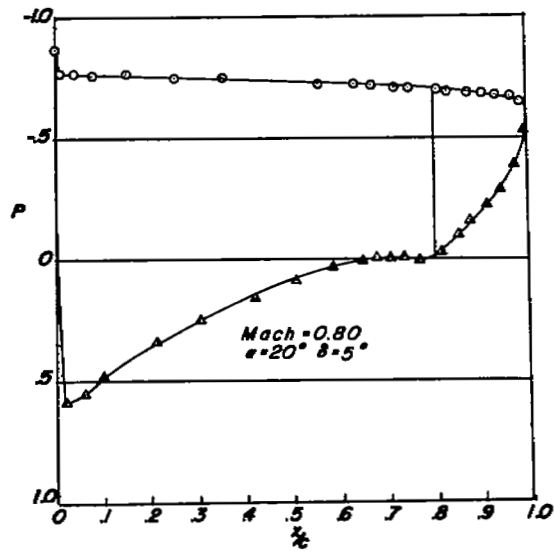
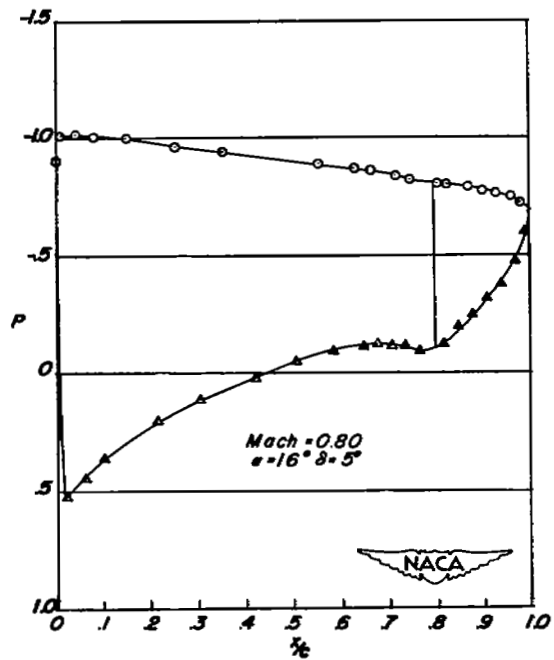
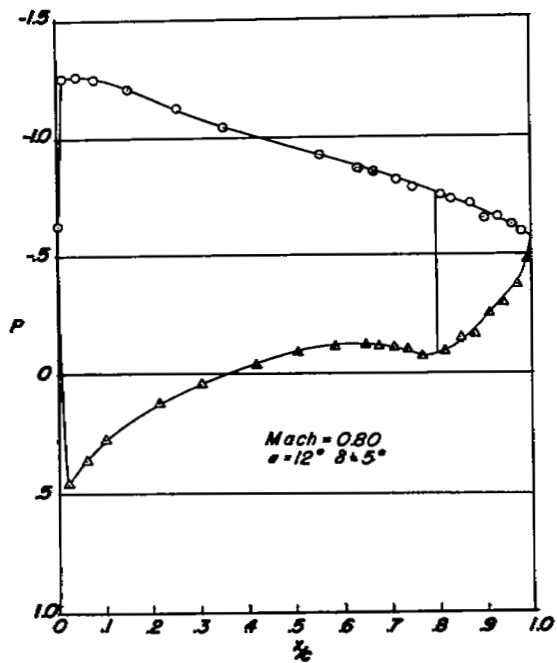

(b) $M = 0.80$. Concluded.

Figure 9.- Continued.

(c) $M = 0.90$.

Figure 9.- Continued.

Upper surface \circ
Lower surface \triangle

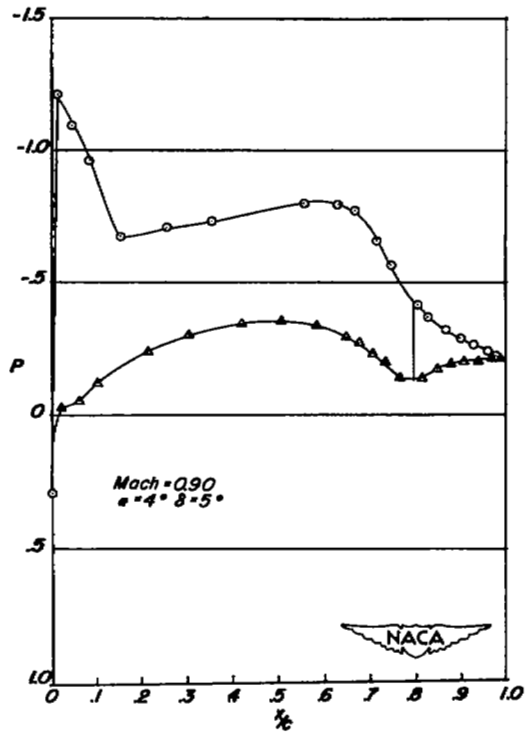
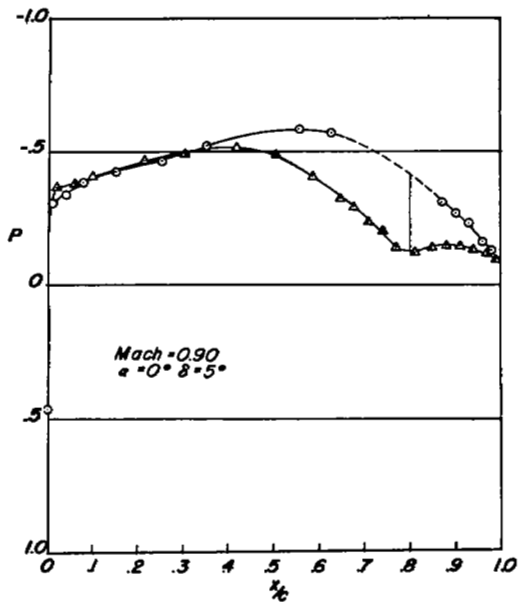
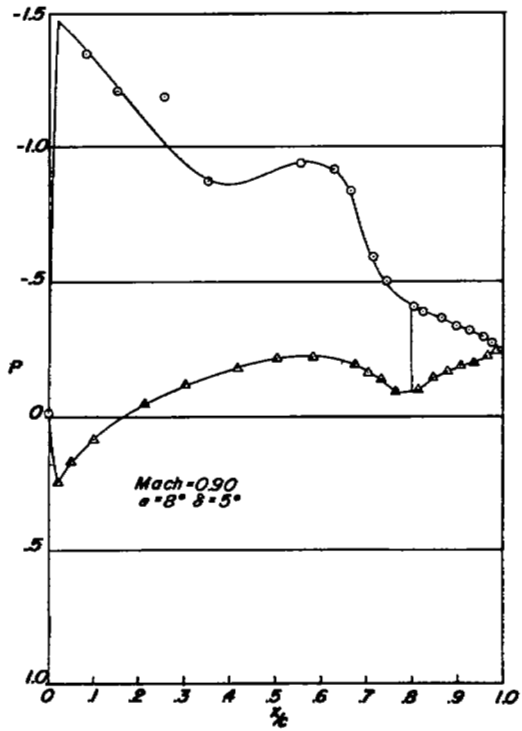
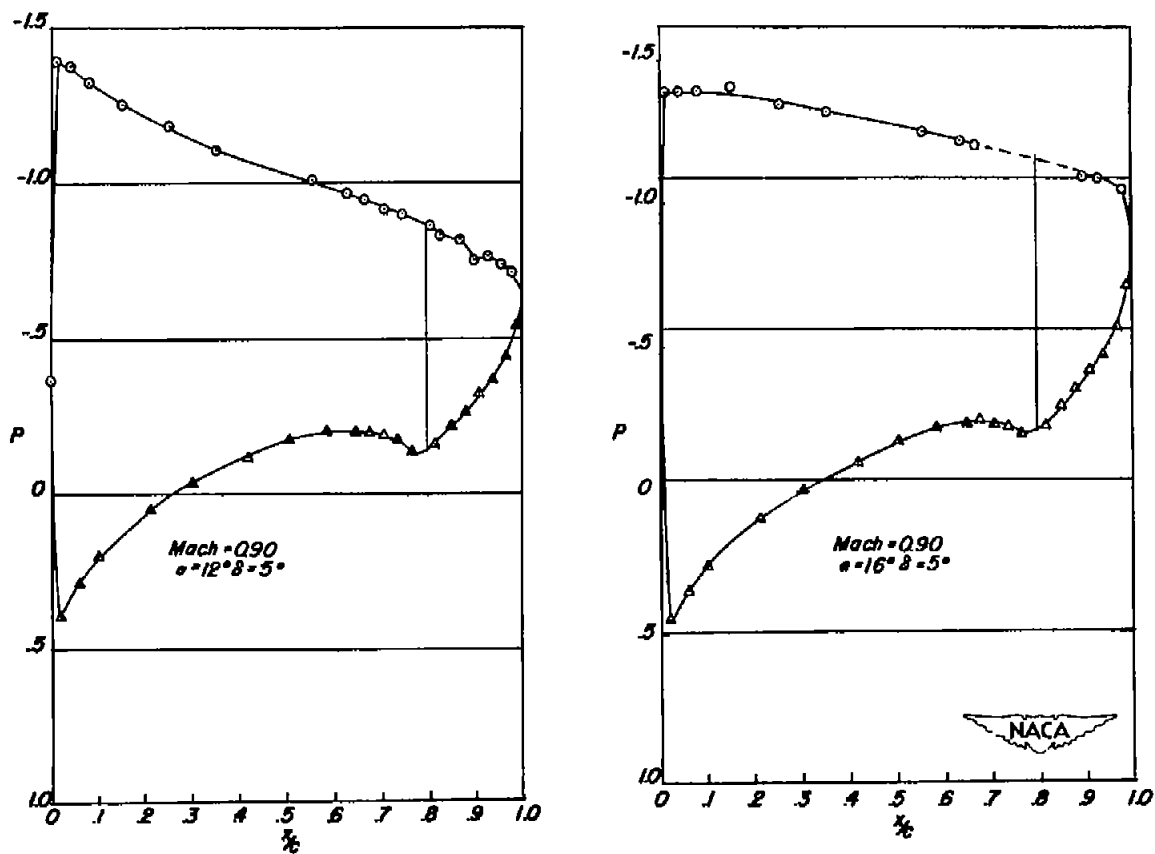

(c) $M = 0.90$. Concluded.

Figure 9.- Continued.

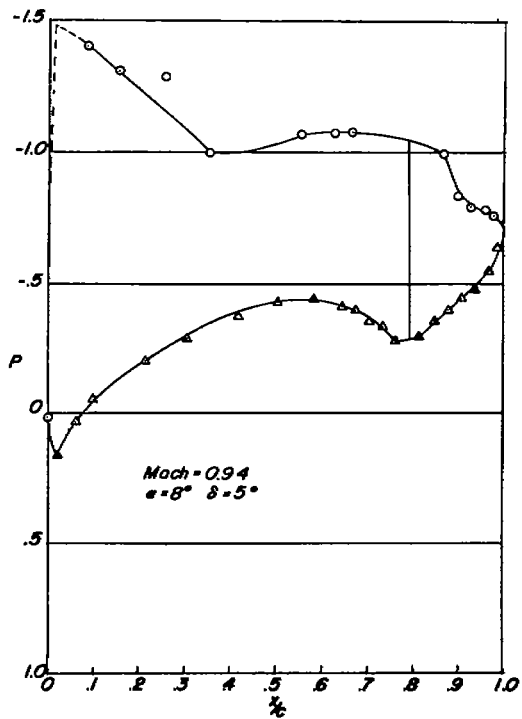

Upper surface \circ
Lower surface \triangle

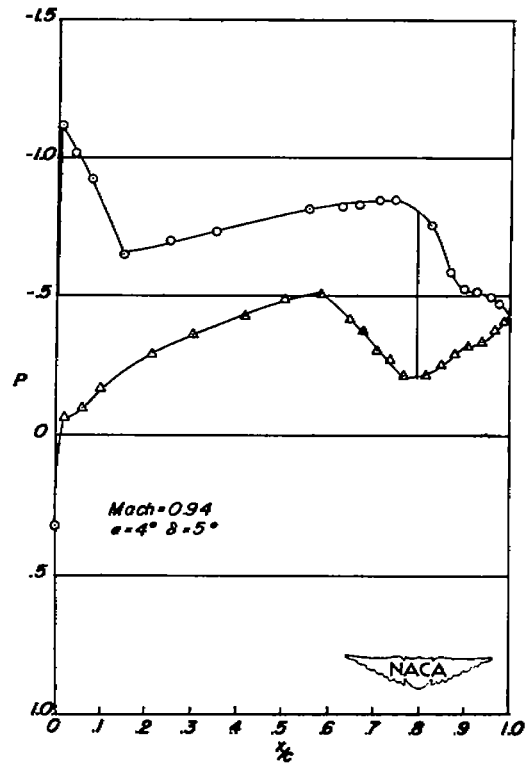
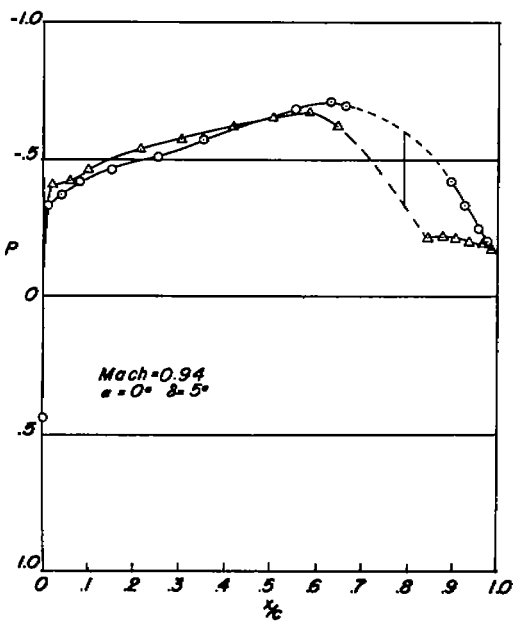

(d) $M = 0.94$.

Figure 9.- Concluded.

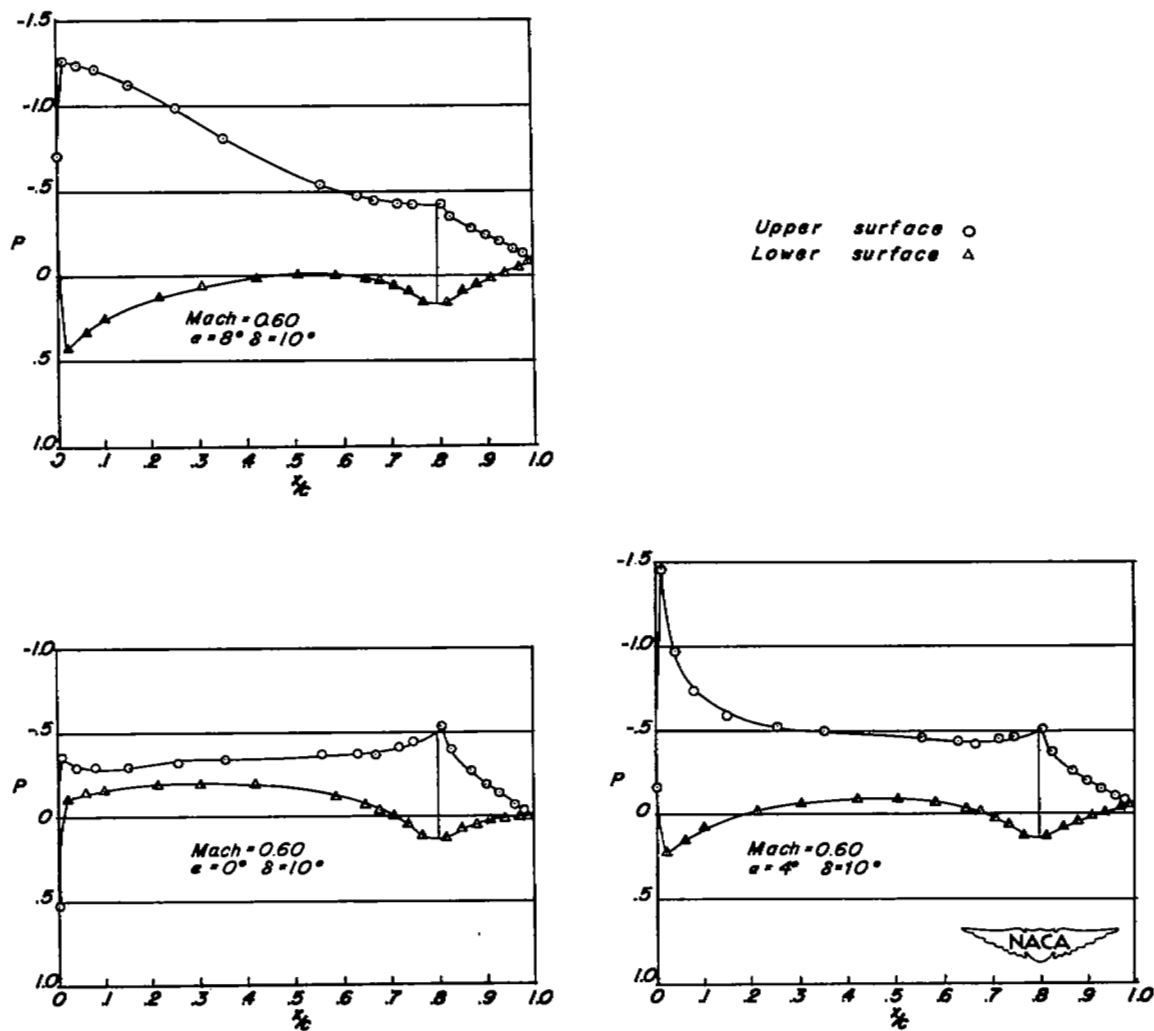

(a) M = 0.60.

Figure 10.- Chordwise pressure distribution over a 35° sweptback wing, at the 46-percent-semispan station, equipped with a flap-type aileron. $\delta = 10^\circ$.

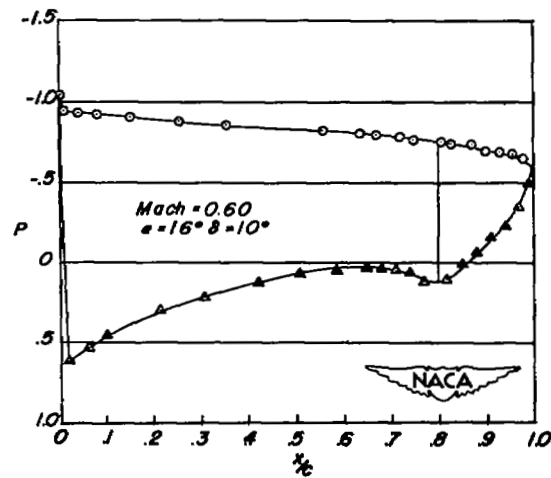
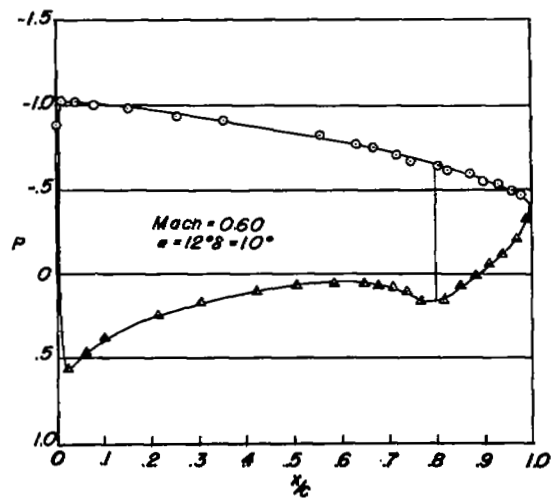
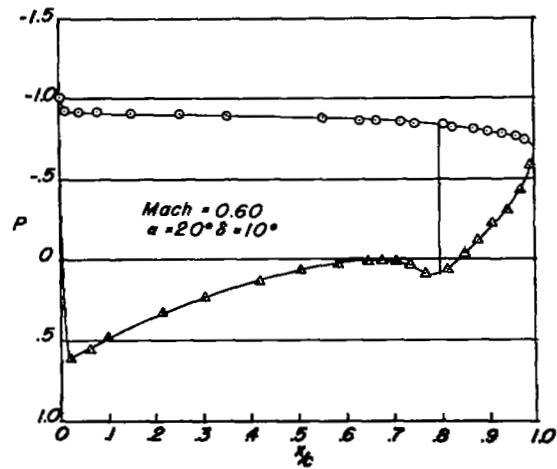

(a) M = 0.60. Concluded.

Figure 10.- Continued.

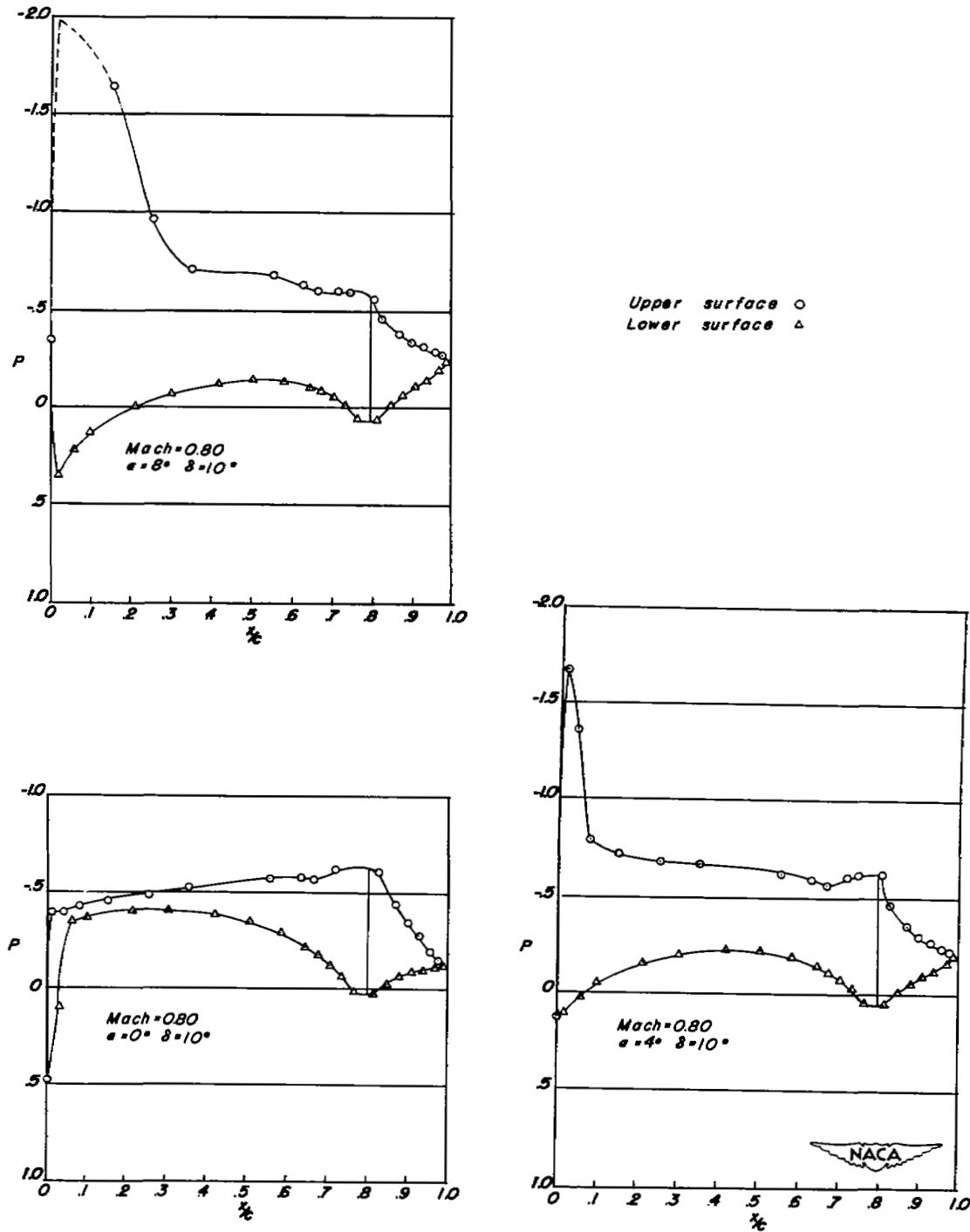

(b) $M = 0.80$.

Figure 10.- Continued.

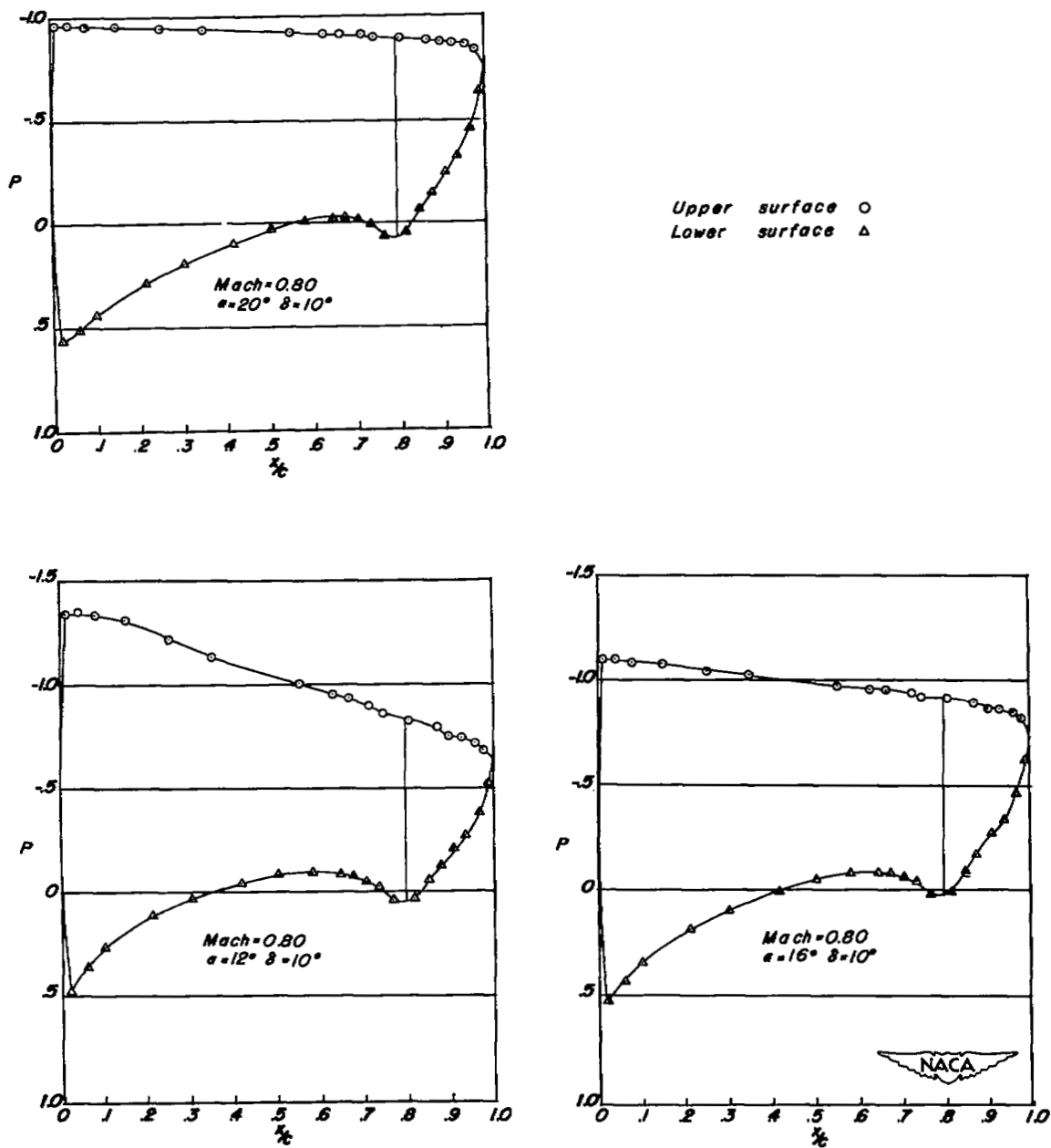

(b) $M = 0.80$. Concluded.

Figure 10.- Continued.

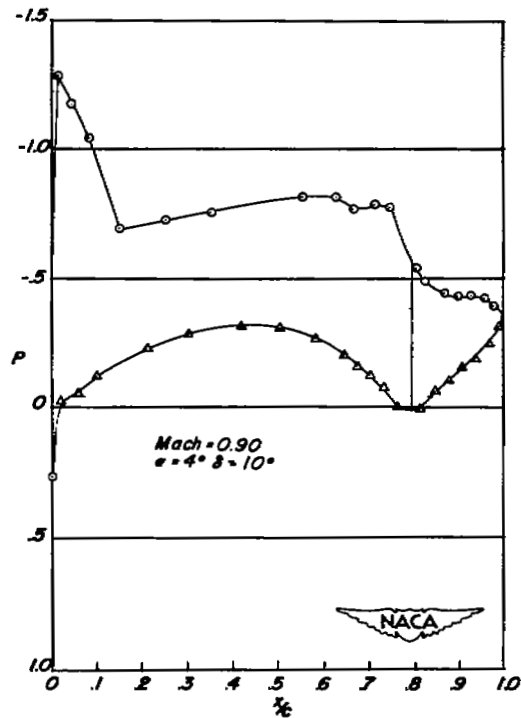
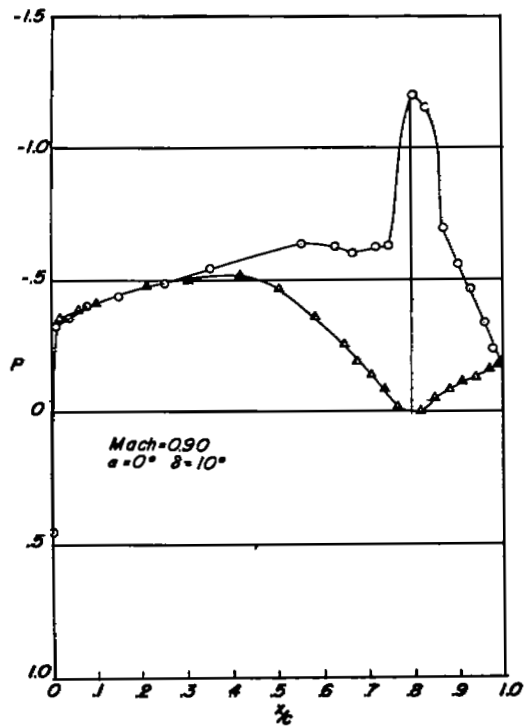
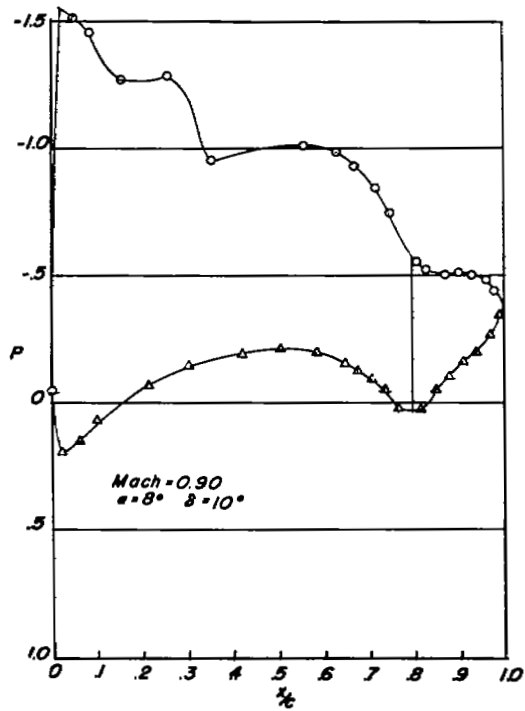

(c) $M = 0.90$.

Figure 10.- Continued.

Upper surface ○
Lower surface △

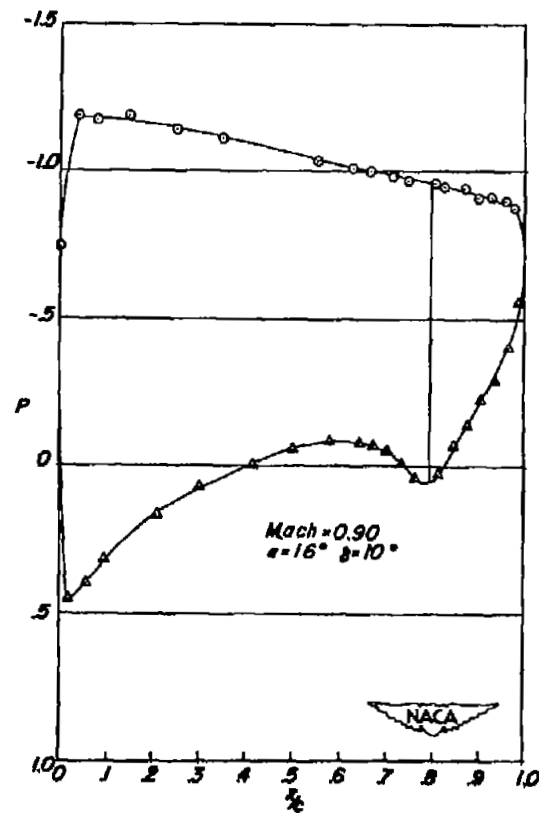
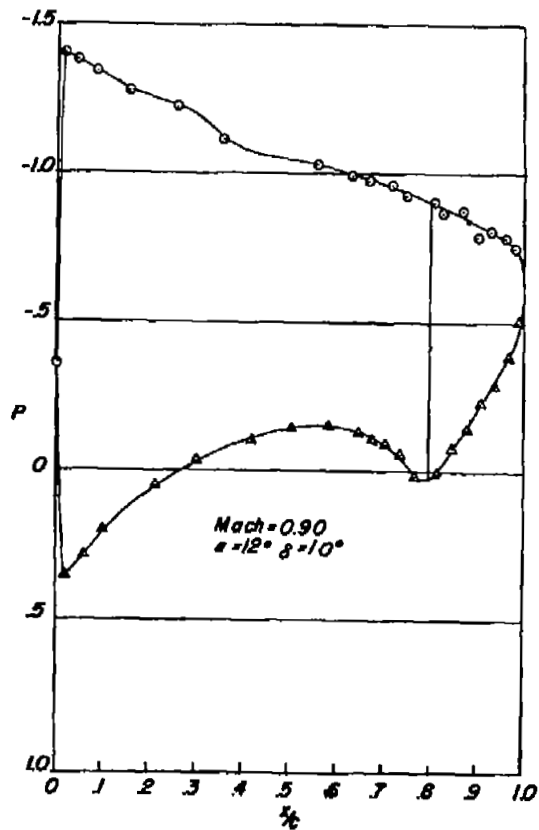

(c) $M = 0.90$. Concluded.

Figure 10.- Continued.

Upper surface ○
Lower surface △

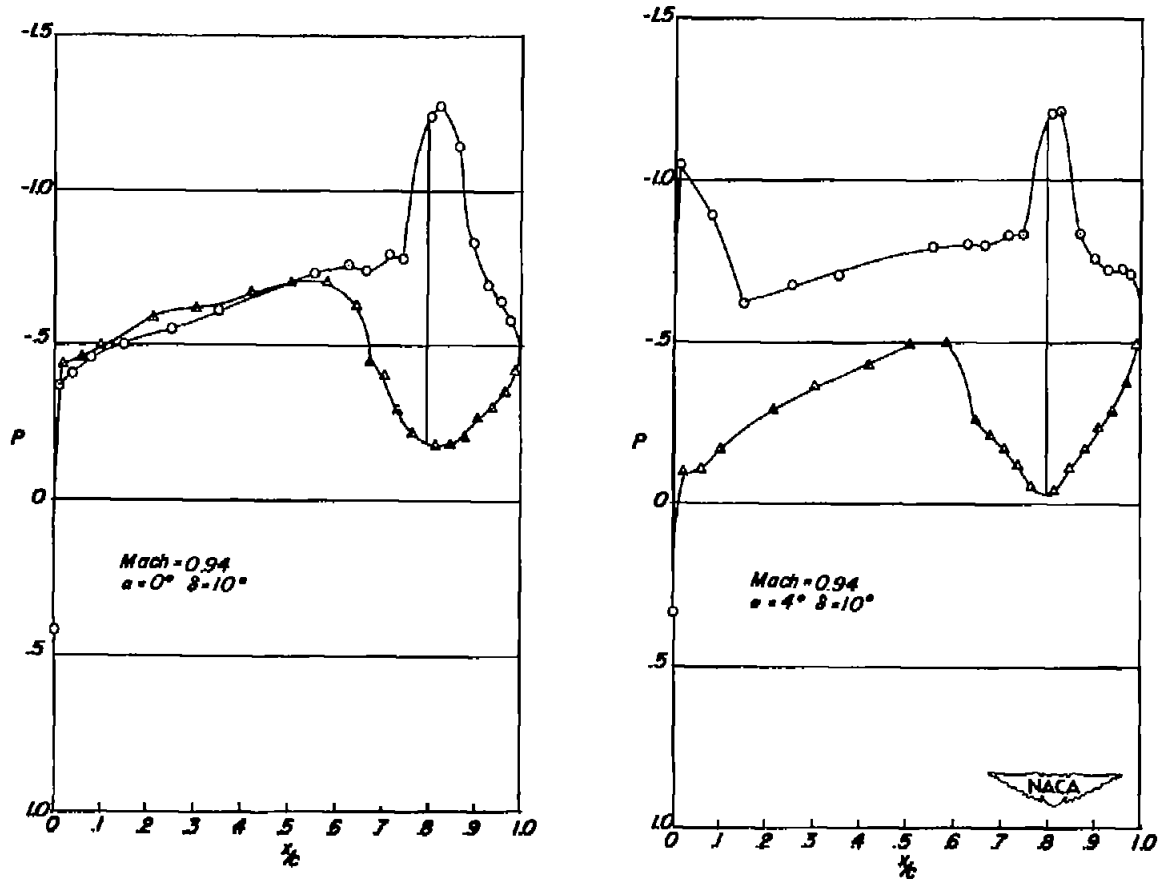

(d) $M = 0.94$.

Figure 10.- Concluded.

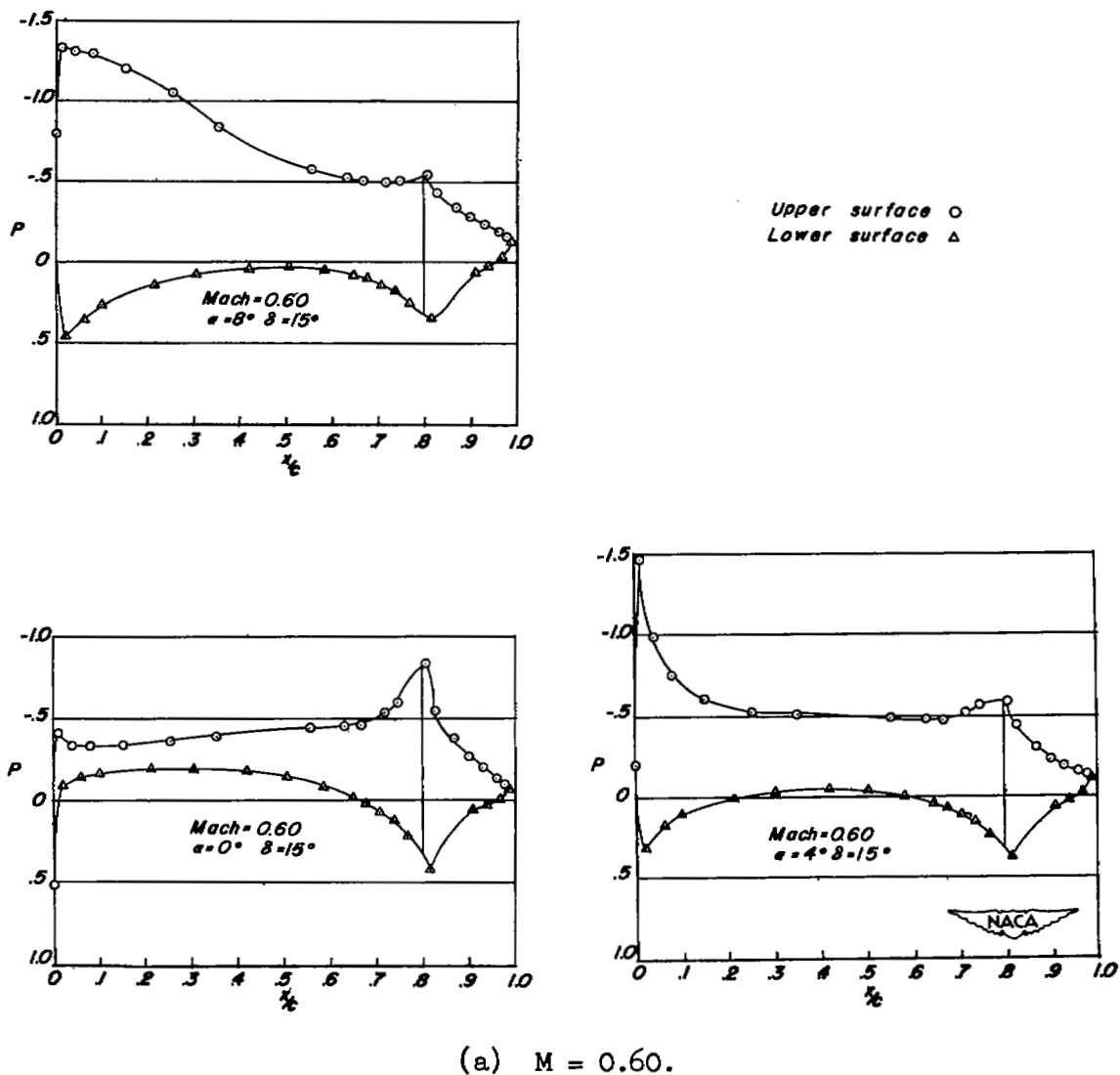
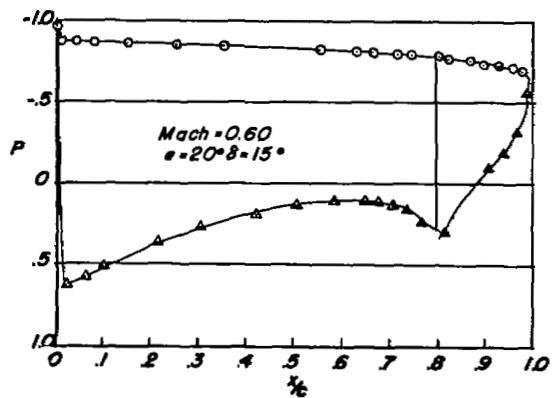
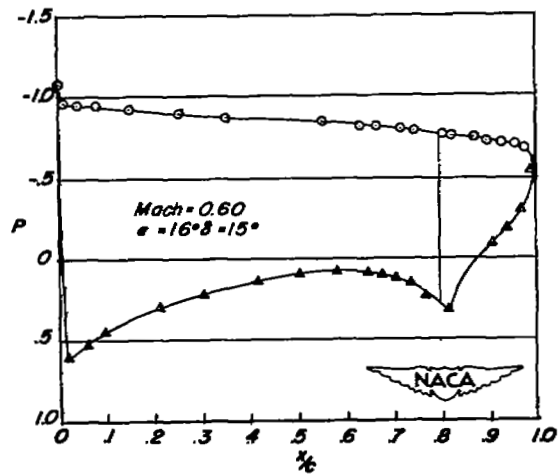
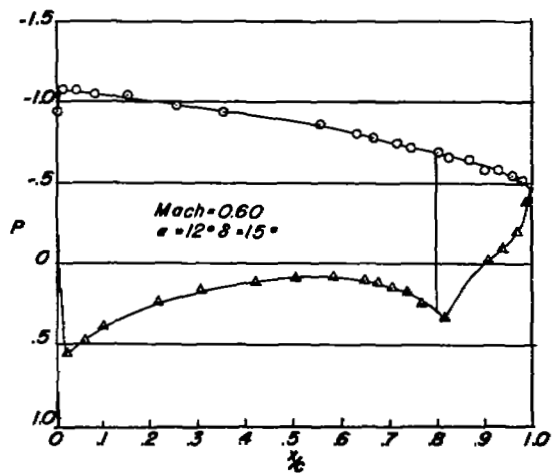

Figure 11.- Chordwise pressure distribution over a 35° sweptback wing, at the 46-percent-semispan station, equipped with a flap-type aileron. $\delta = 15^\circ$.



Upper surface O
Lower surface Δ



(a) $M = 0.60$. Concluded.

Figure 11.- Continued.

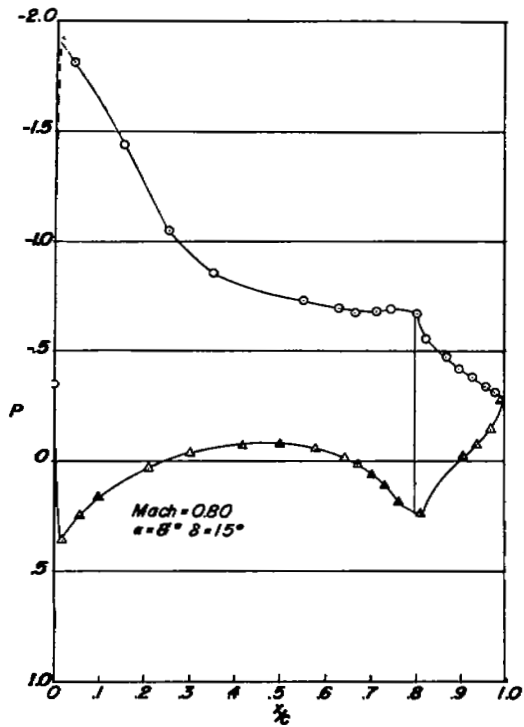

Upper surface \circ
Lower surface \triangle

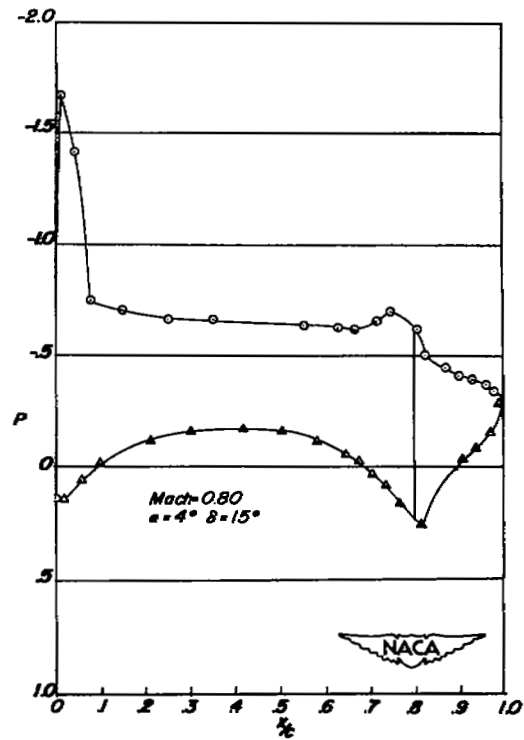
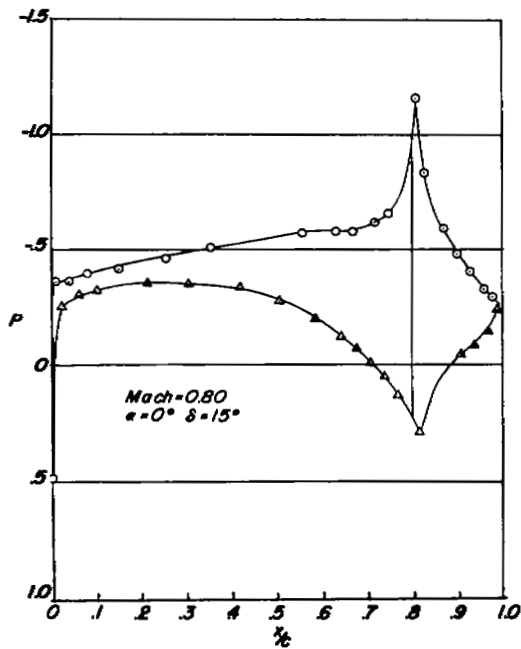

(b) $M = 0.80$.

Figure 11.- Continued.

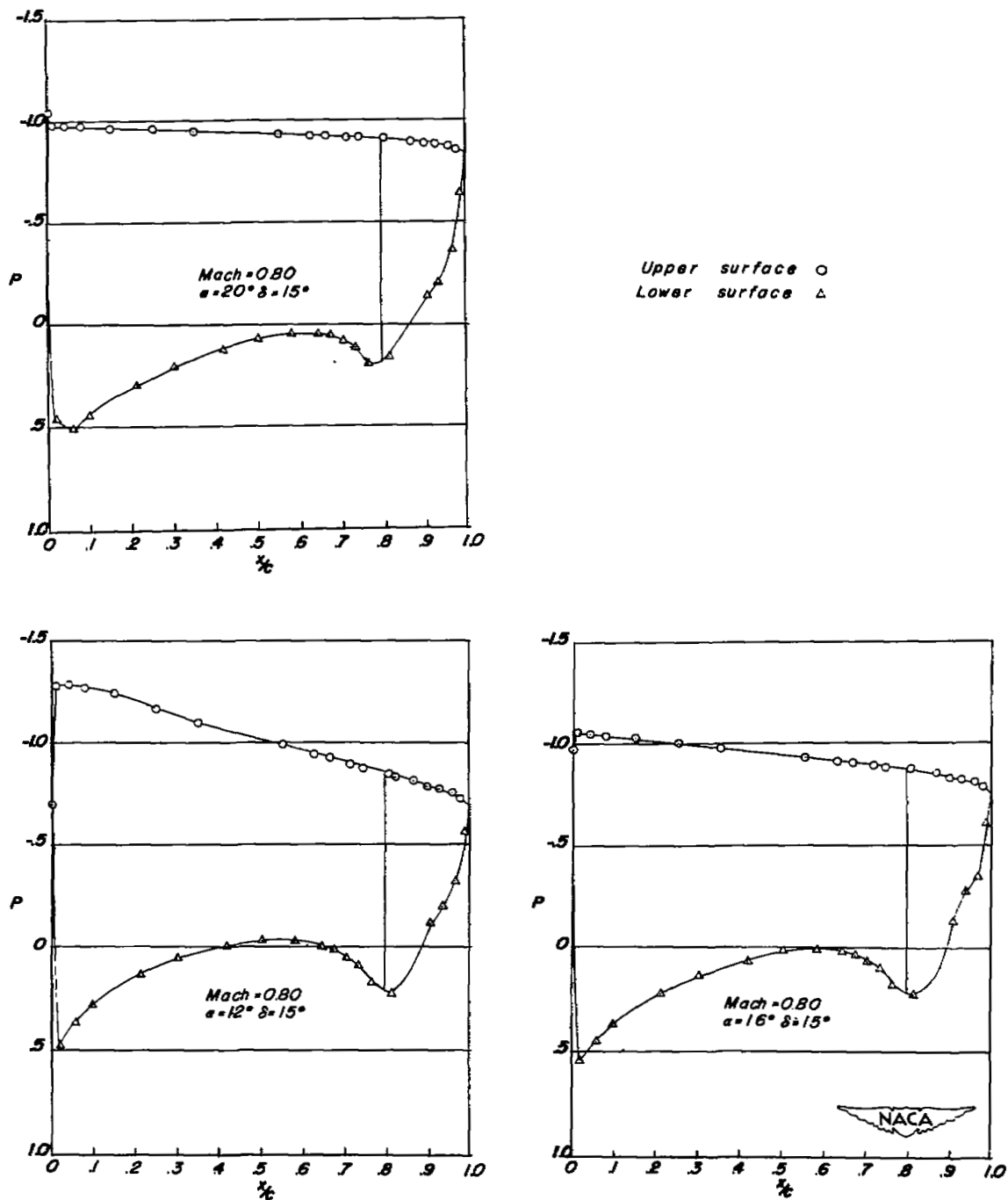

(b) M = 0.80. Concluded.

Figure 11.- Continued.

Upper surface ○
Lower surface △

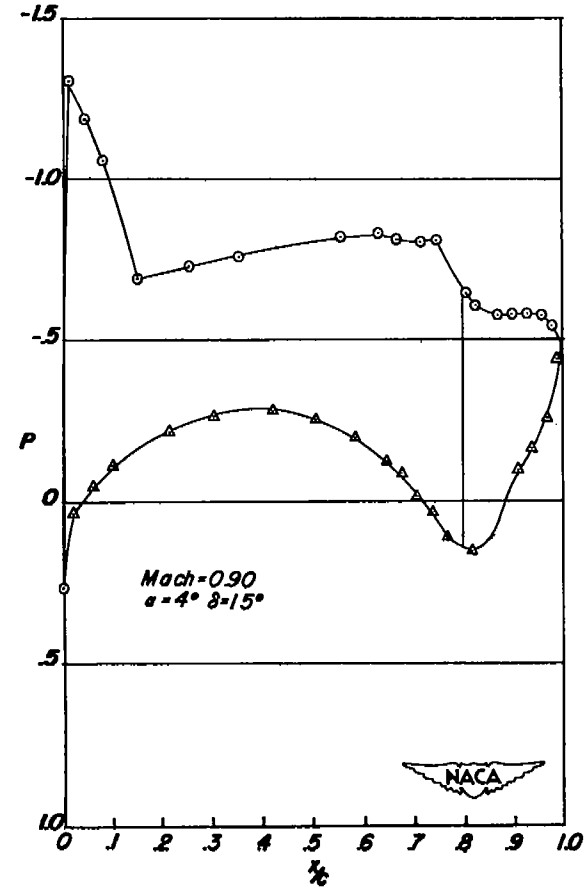
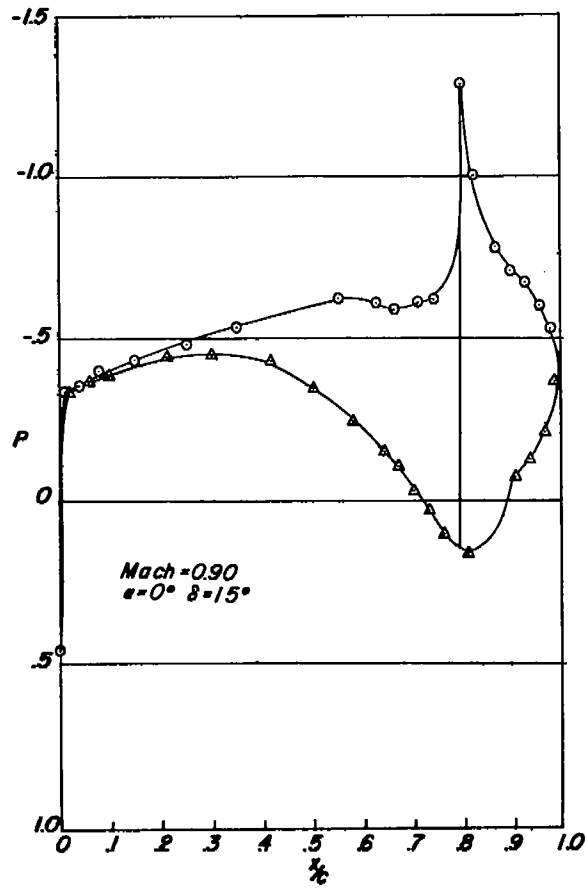

(c) $M = 0.90$.

Figure 11.- Continued.

Upper surface ○
Lower surface △

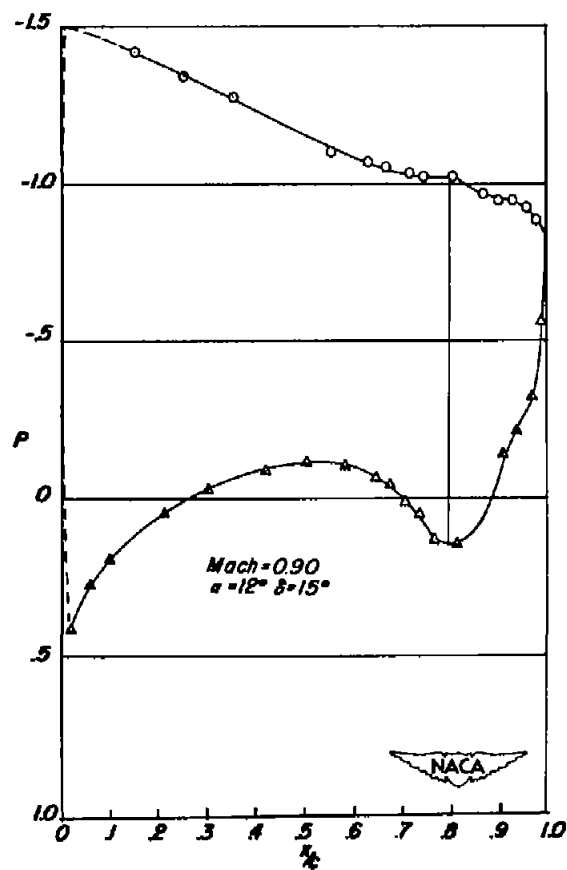
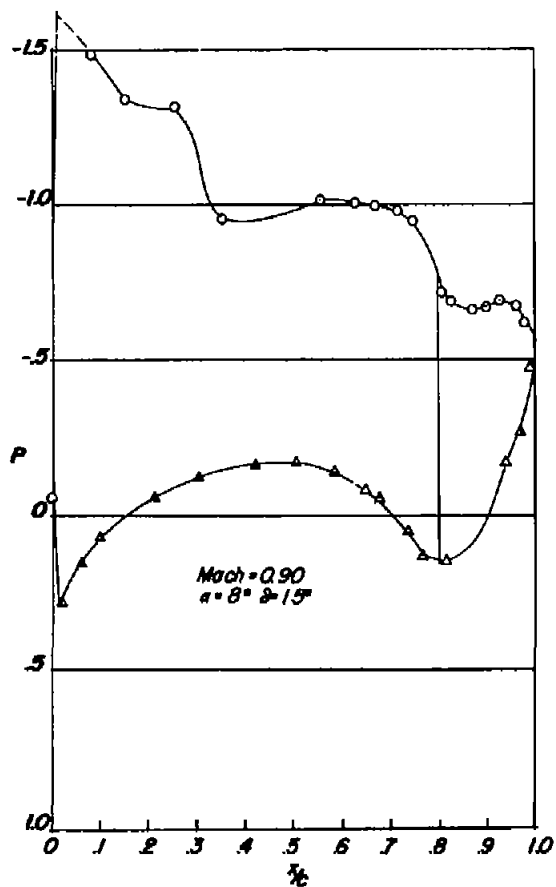

(c) M = 0.90. Concluded.

Figure 11.- Continued.

Upper surface ○
Lower surface △

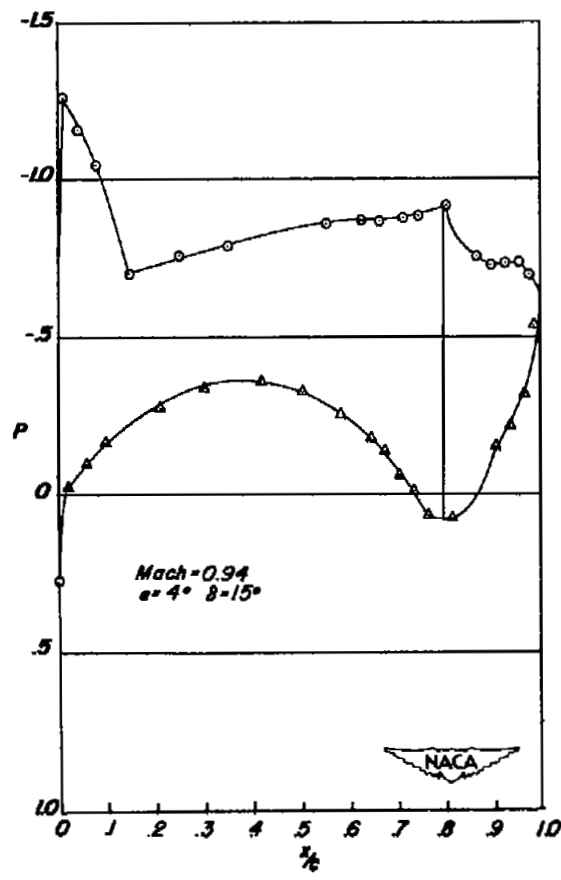
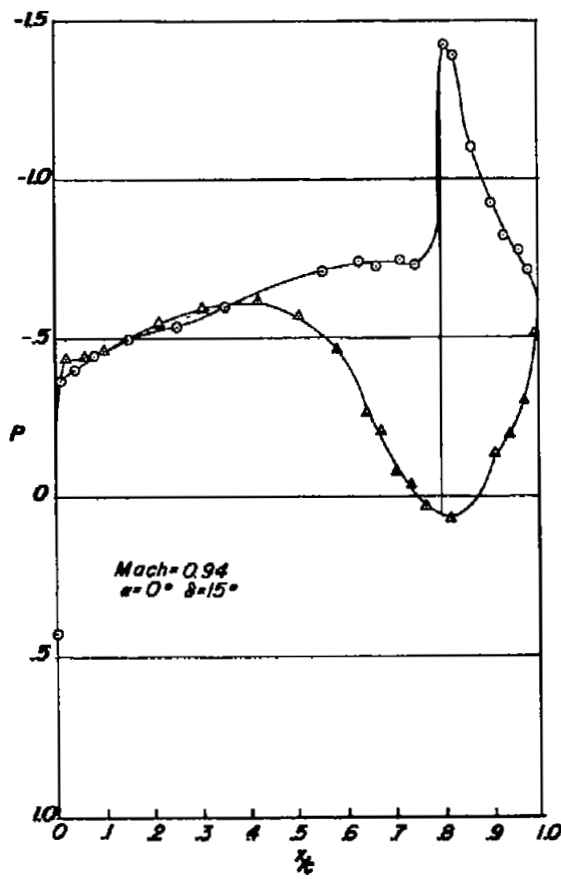

(d) $M = 0.94$.

Figure 11.- Concluded.

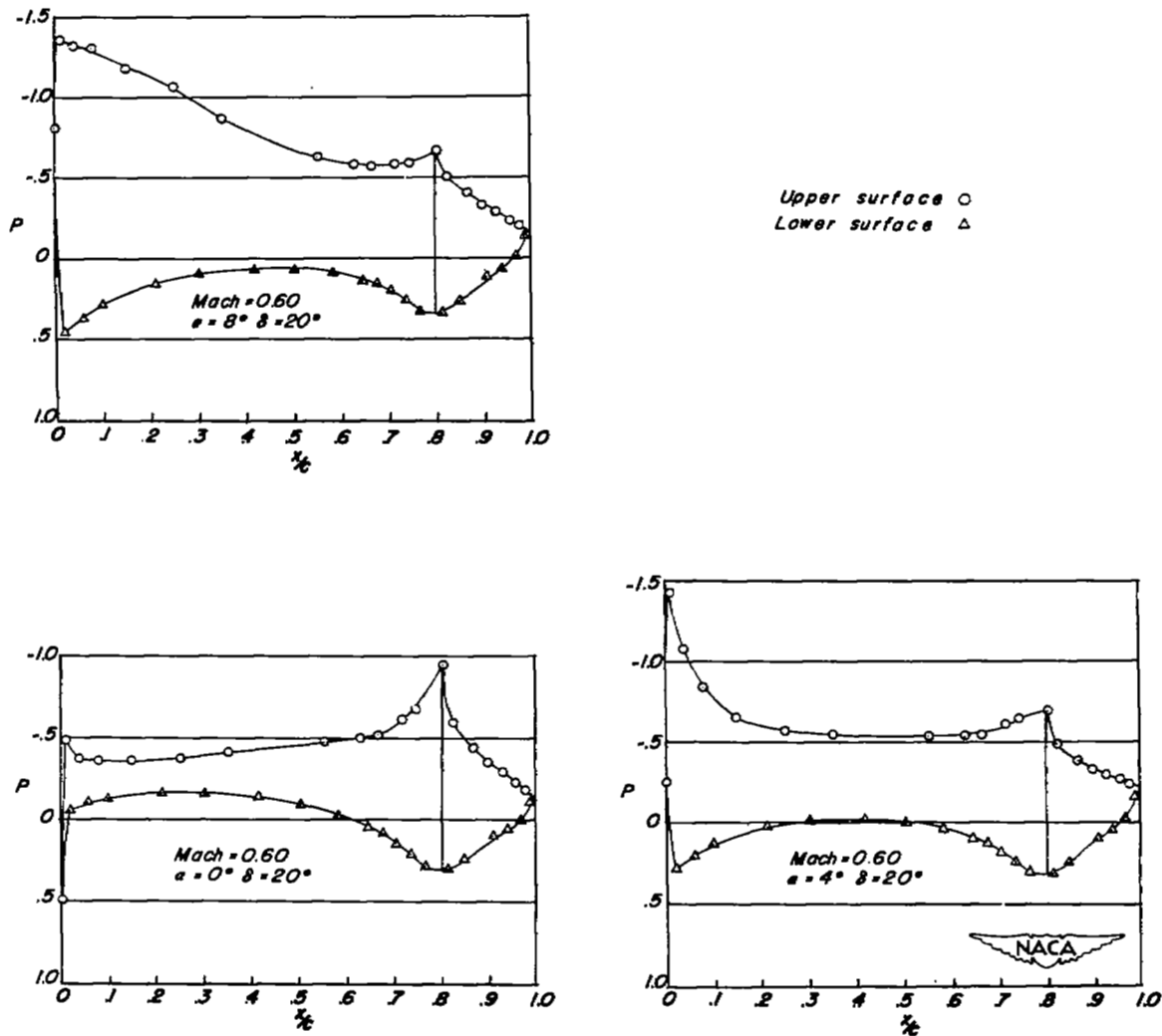

(a) $M = 0.60$.

Figure 12.- Chordwise pressure distribution over a 35° sweptback wing, at the 46-percent-semispan station, equipped with a flap-type aileron. $\delta = 20^\circ$.

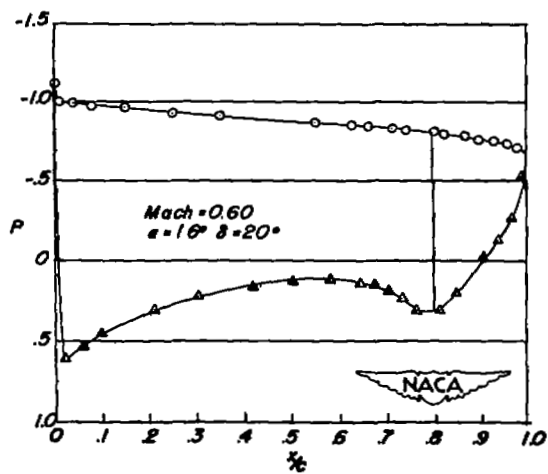
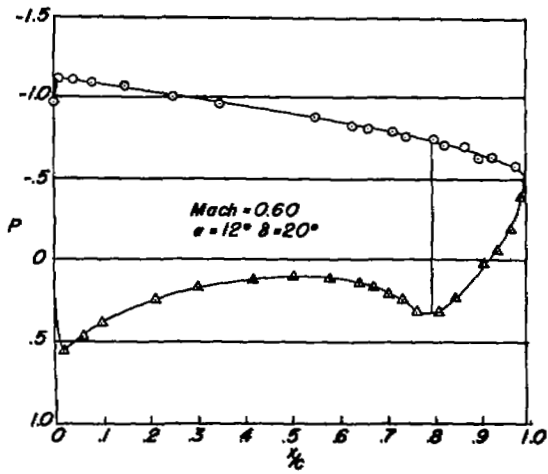
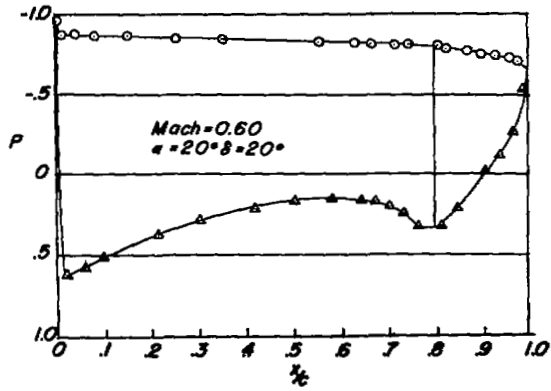

(a) $M = 0.60$. Concluded.

Figure 12.- Continued.

(b) $M = 0.80$.

Figure 12.- Continued.



(b) $M = 0.80$. Concluded.

Figure 12.- Continued.

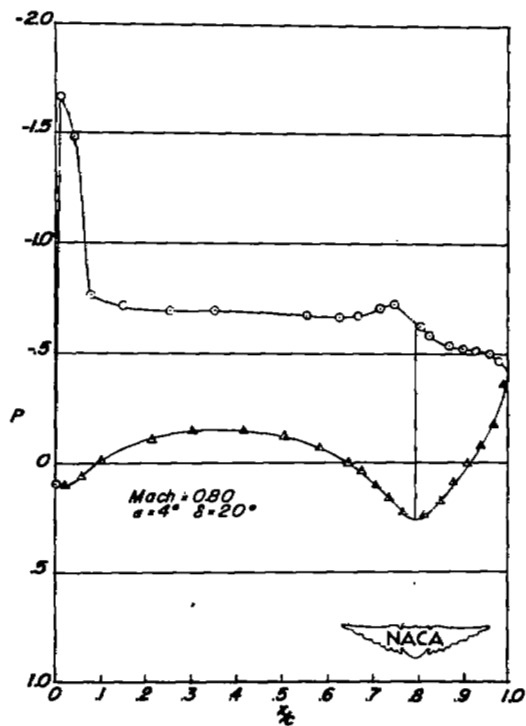
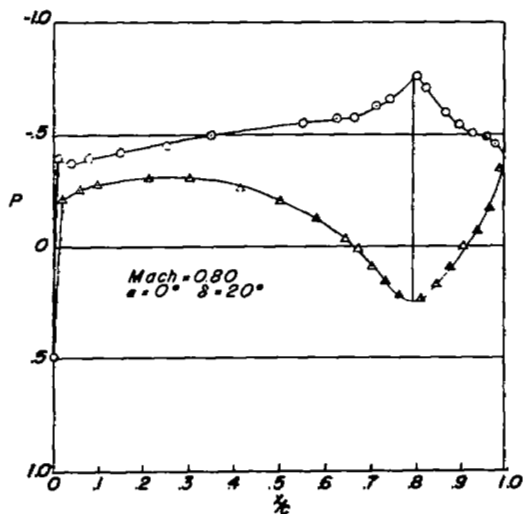
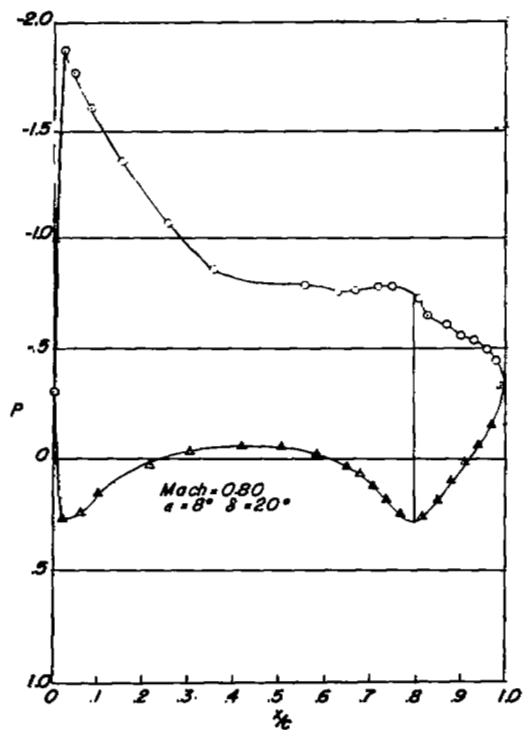
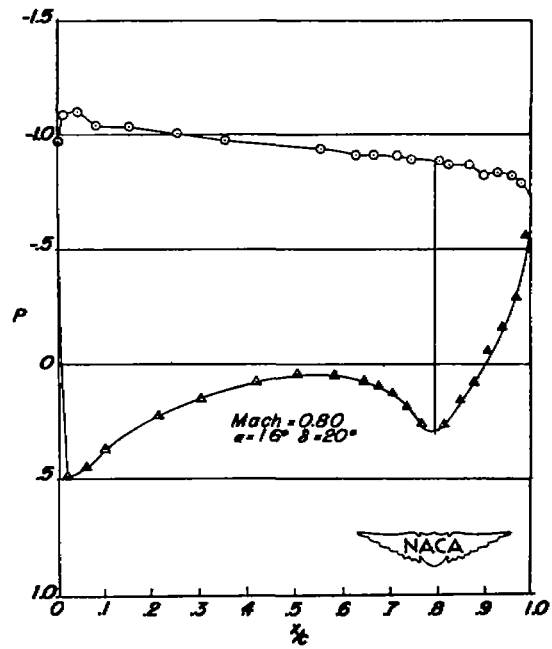
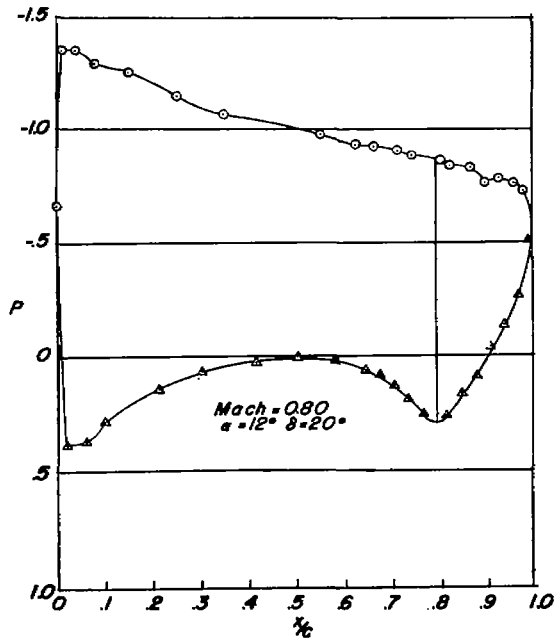
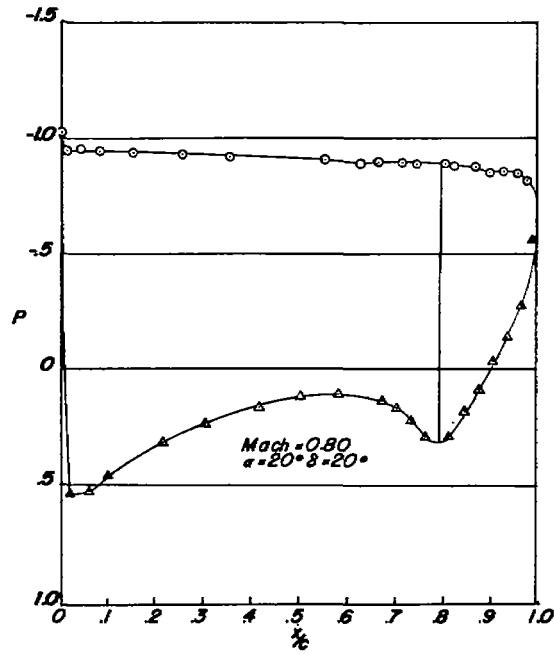
Upper surface ○
Lower surface △

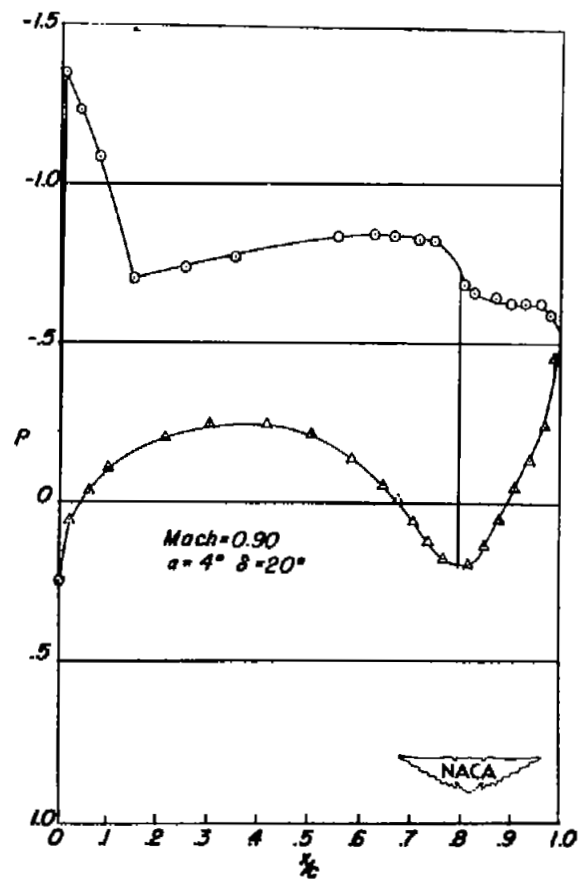
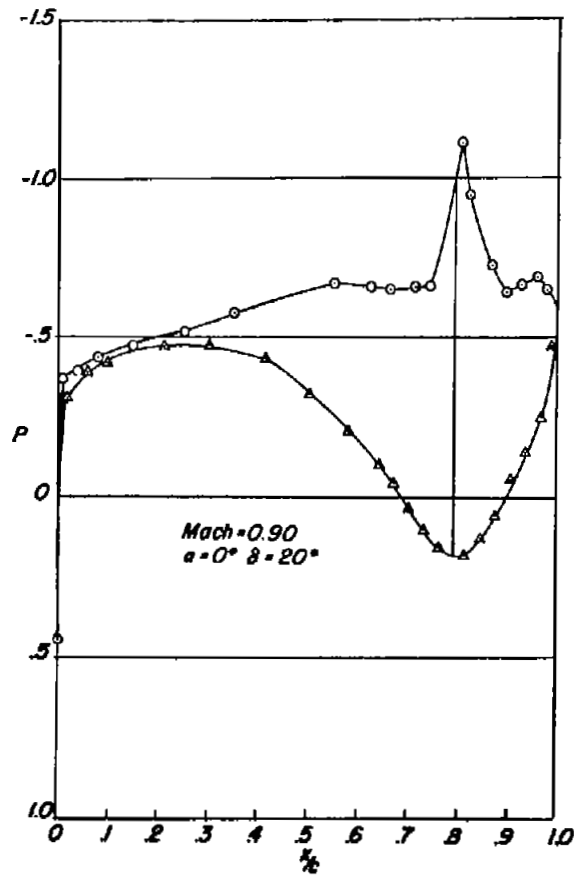

(c) M = 0.90.

Figure 12.- Continued.

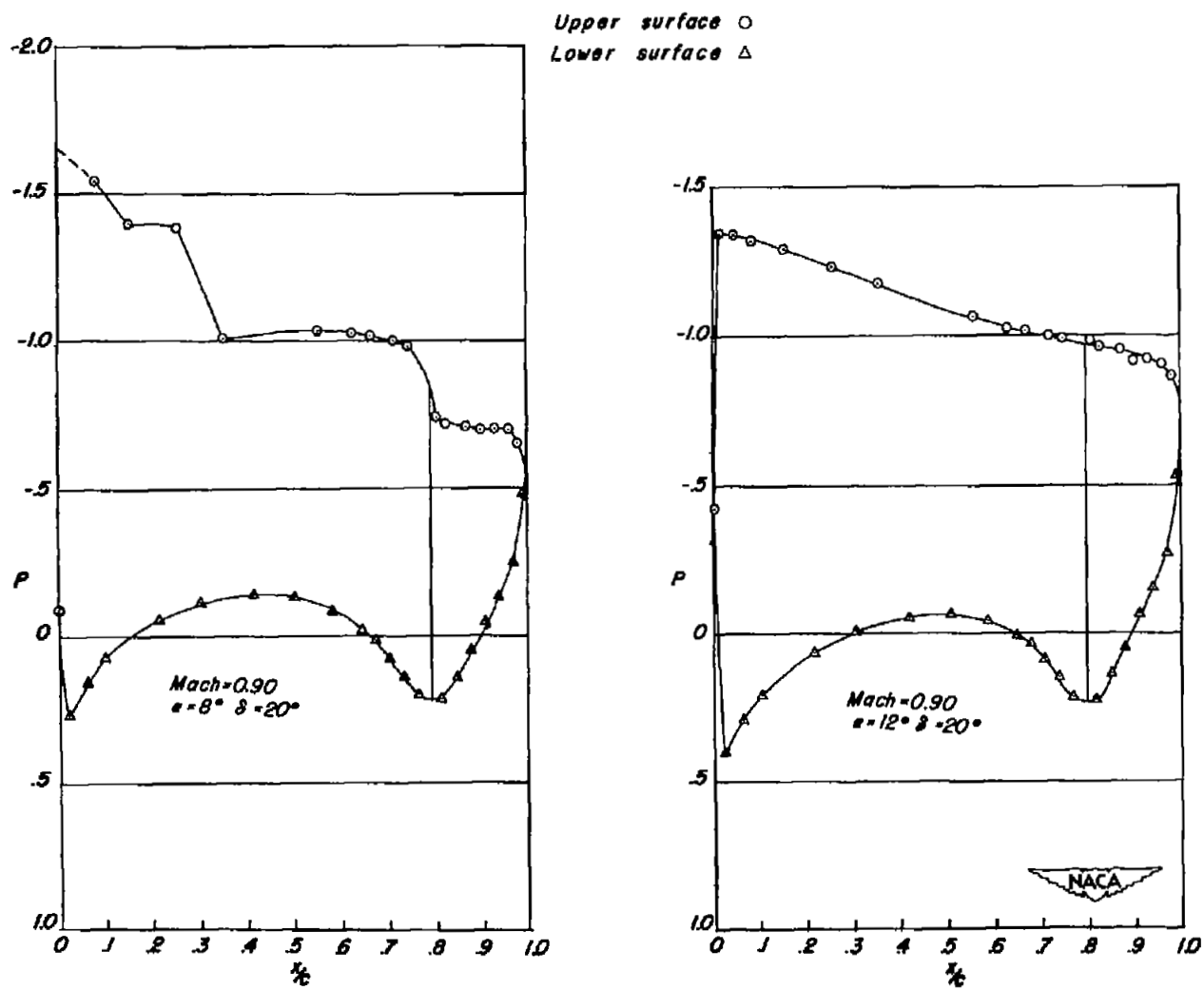

(c) $M = 0.90$. Concluded.

Figure 12.- Continued.

Upper surface ○
Lower surface △

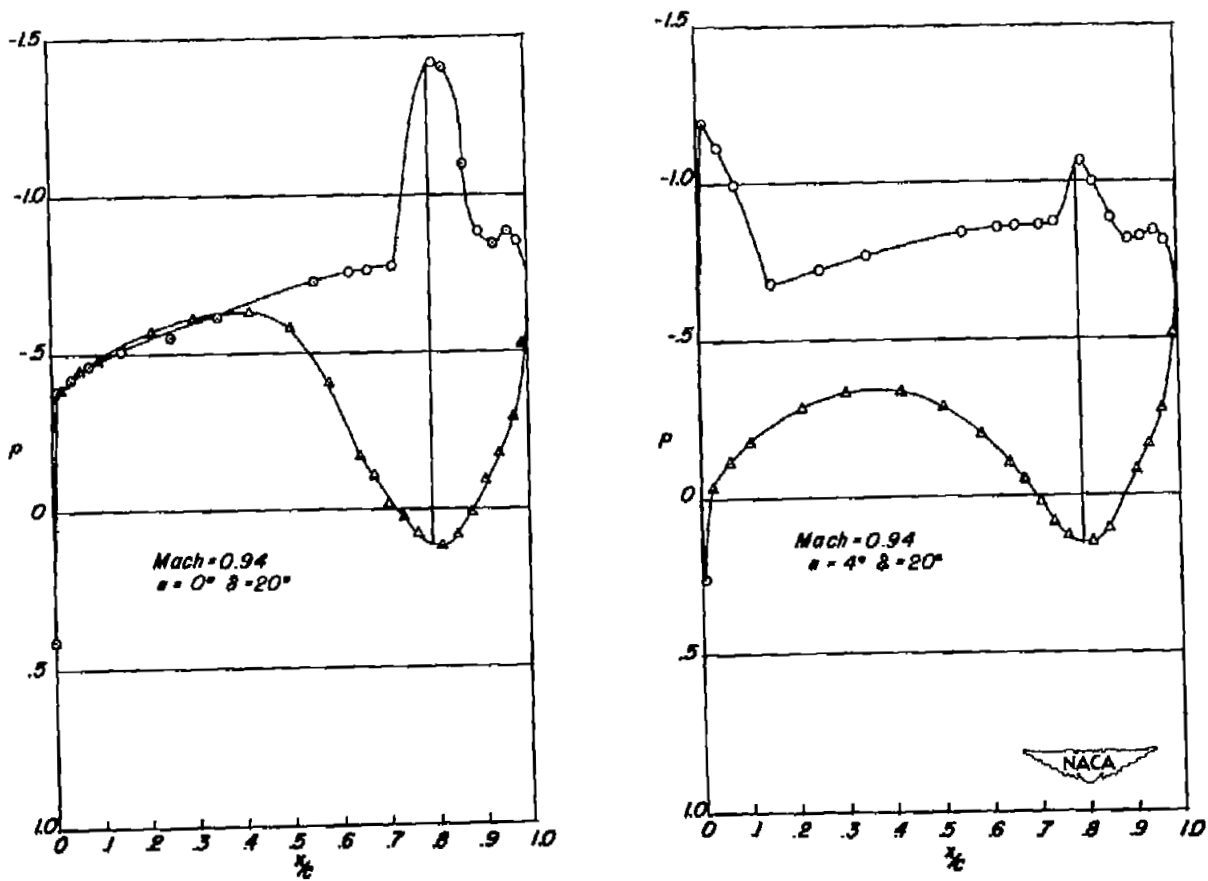

(d) $M = 0.94$.

Figure 12.- Concluded.

(a) $M = 0.60$.

Figure 13.- Chordwise pressure distribution over a 35° sweptback wing, at the 46-percent-semispan station, equipped with a flap-type aileron. $\delta = 25^\circ$.



(a) M = 0.60. Concluded.

Figure 13.- Continued.

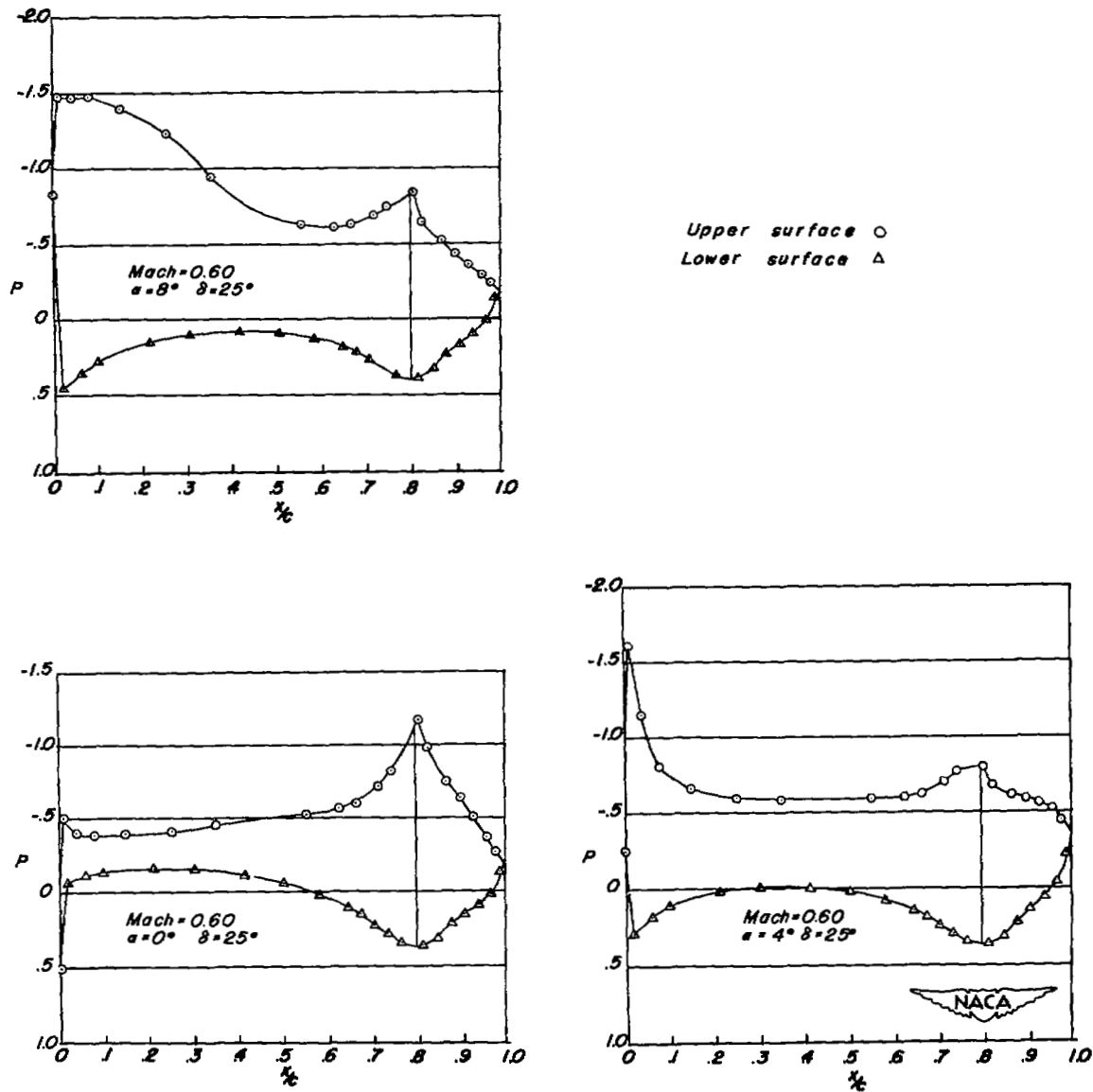
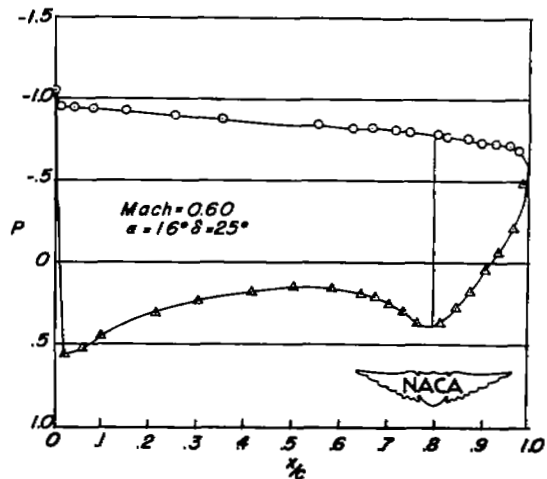
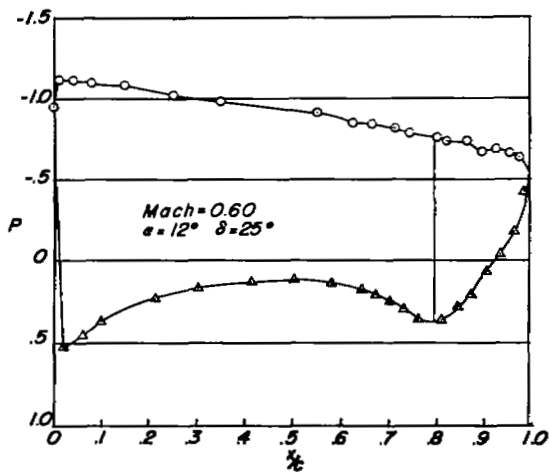
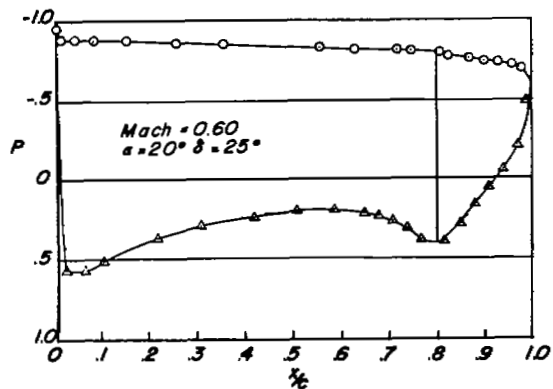
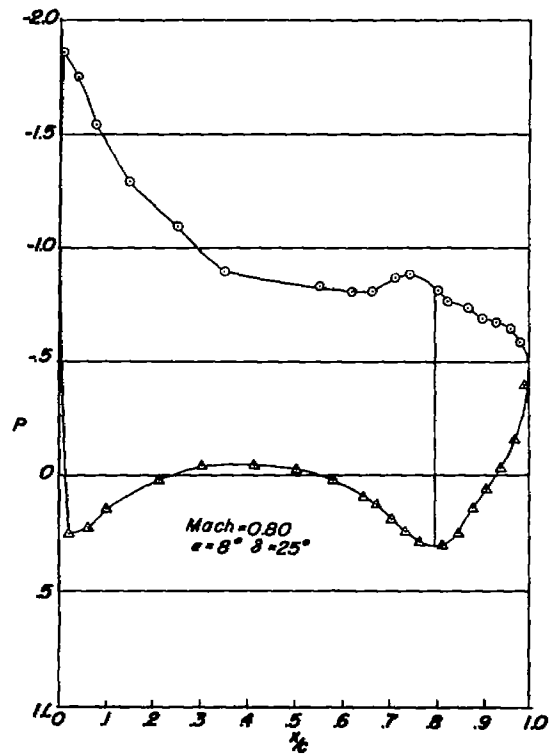

Upper surface \circ
Lower surface Δ

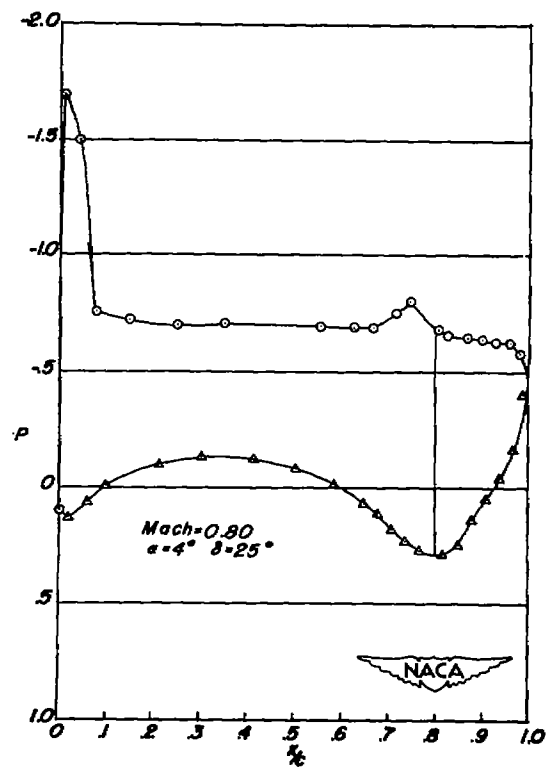
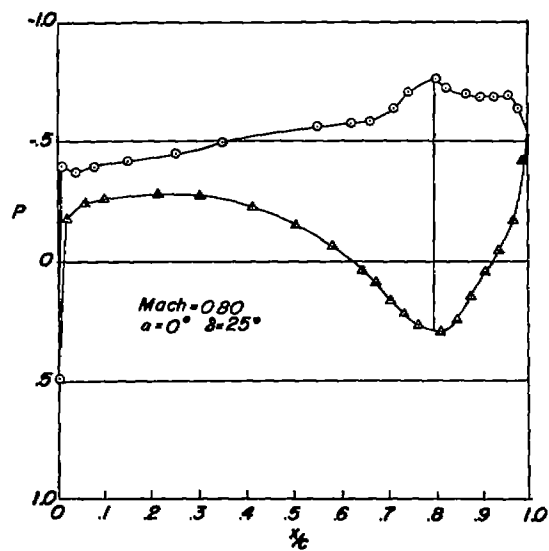

(b) $M = 0.80$.

Figure 13.- Continued.

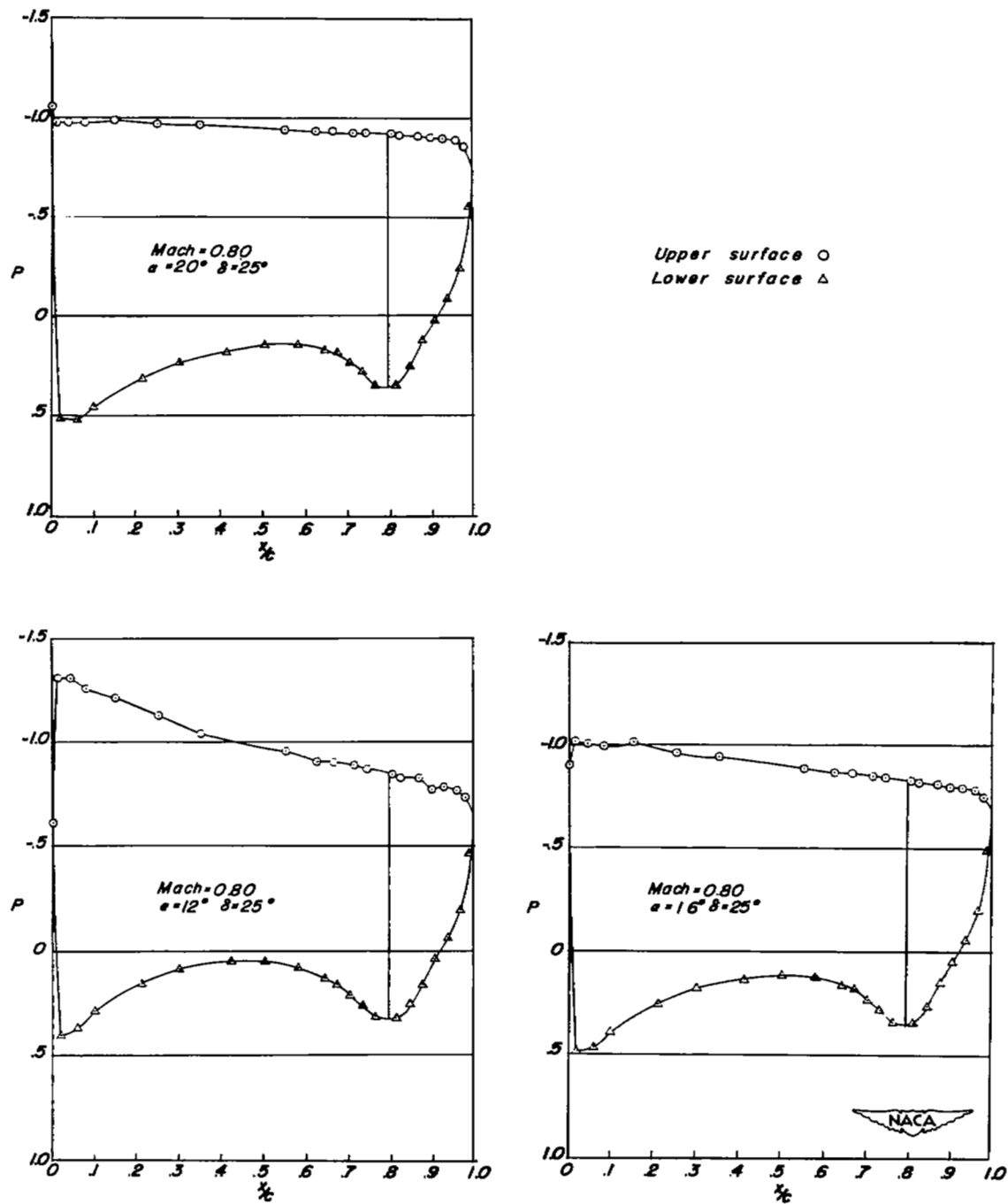

(b) $M = 0.80$. Concluded.

Figure 13.- Continued.

(c) $M = 0.90$.

Figure 13.- Continued.

Upper surface ○
Lower surface △

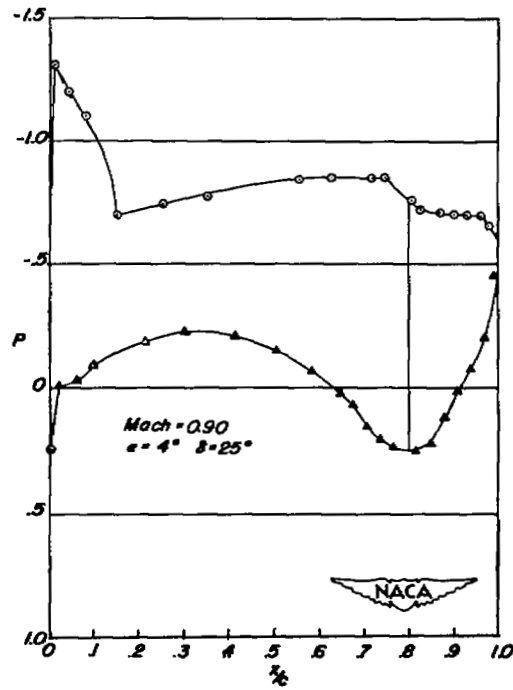
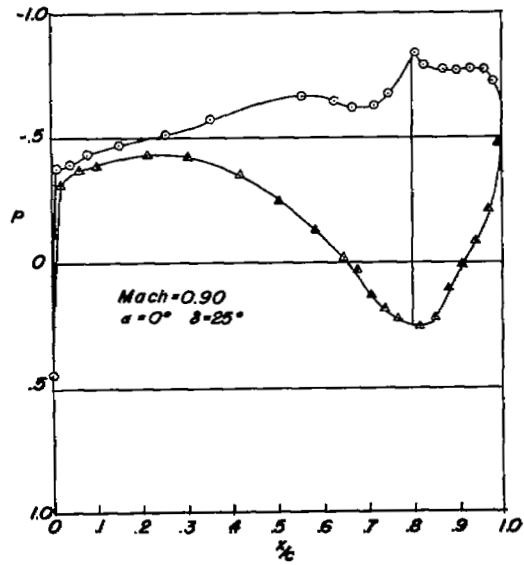
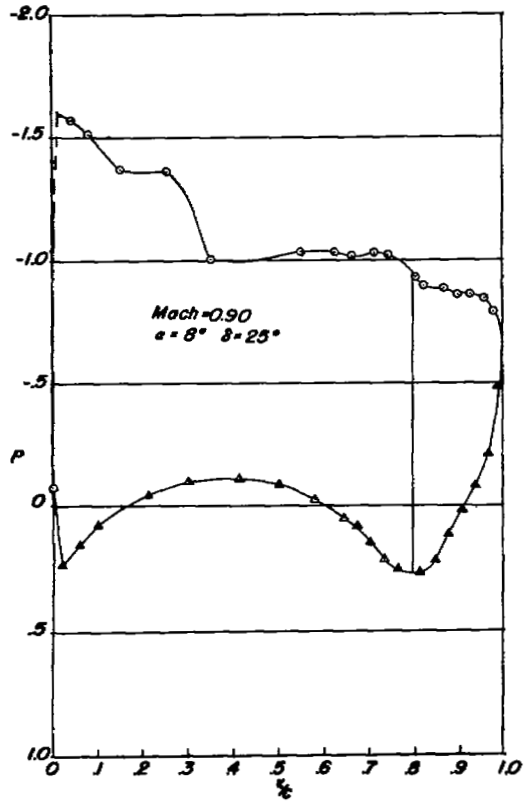
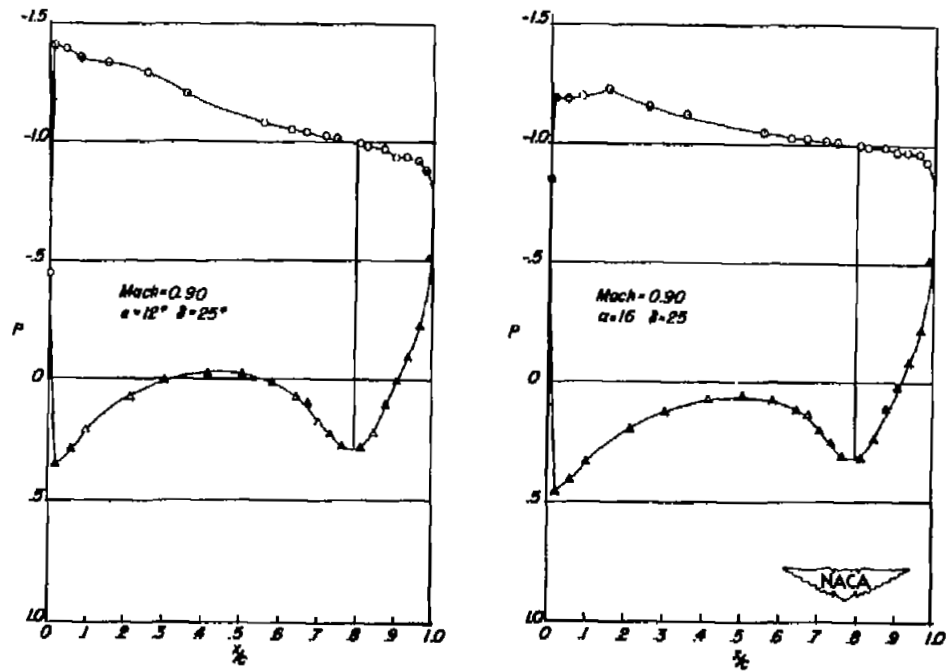

(c) $M = 0.90$. Concluded.

Figure 13.- Concluded.

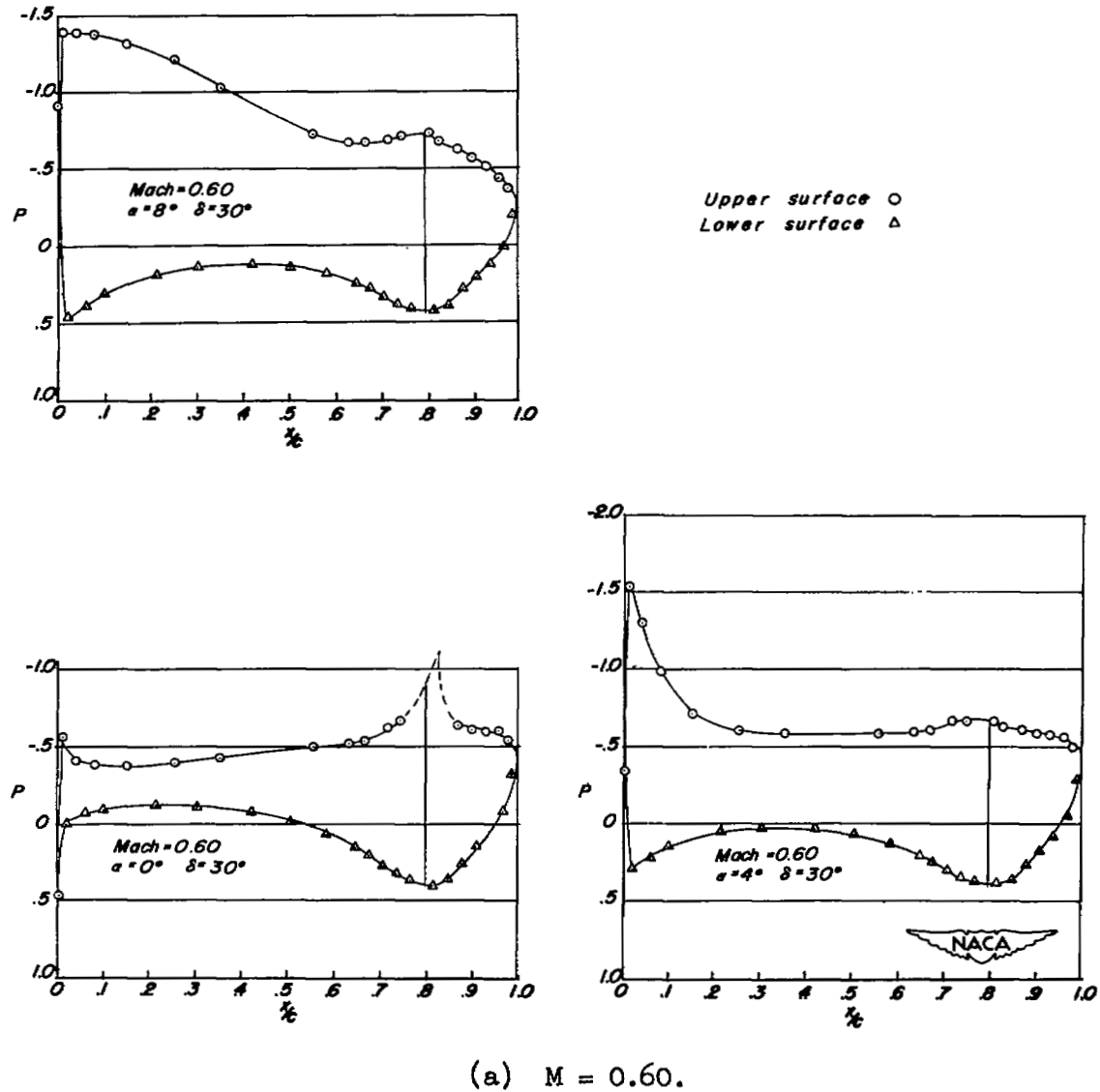
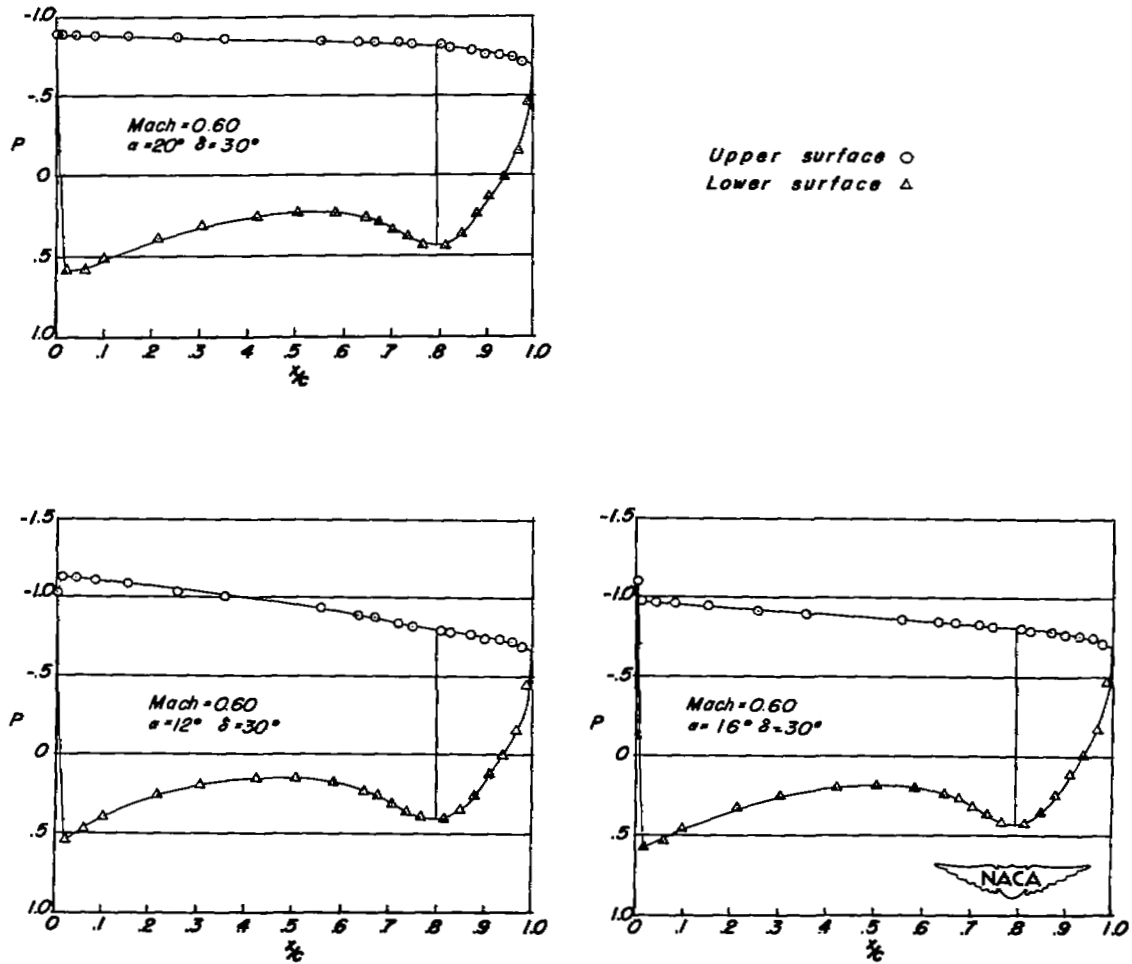

Figure 14.- Chordwise pressure distribution over a 35° sweptback wing, at the 46-percent-semispan station, equipped with a flap-type aileron. $\delta = 30^\circ$.



(a) $M = 0.60$. Concluded.

Figure 14.- Continued.

(b) $M = 0.80$.

Figure 14.- Continued.



(b) $M = 0.80$. Concluded.

Figure 14.- Continued.

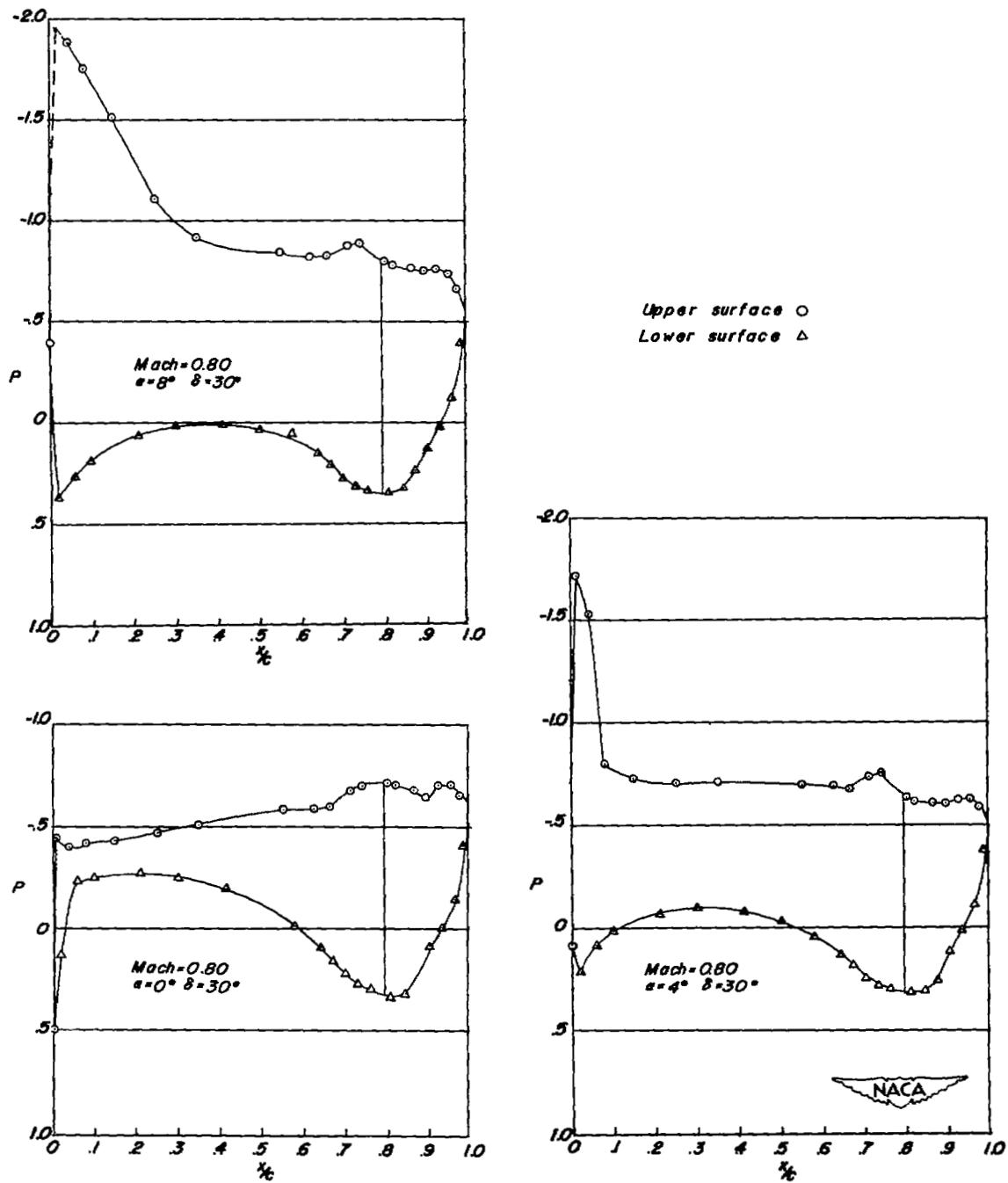
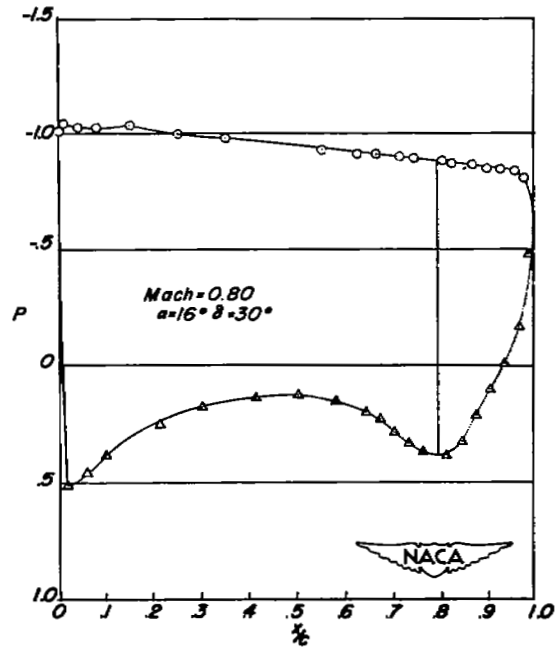
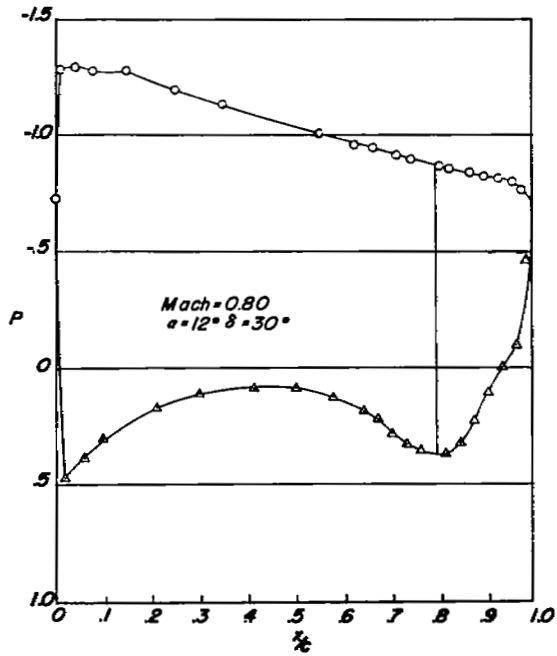
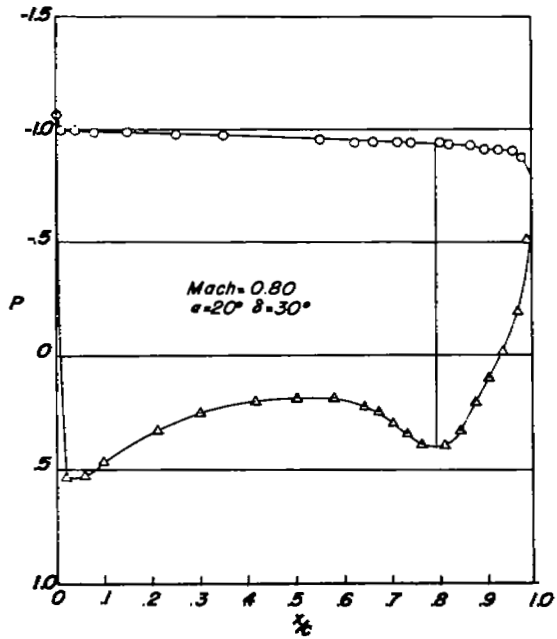
(c) $M = 0.90$.

Figure 14.- Continued.

Upper surface \circ
Lower surface Δ

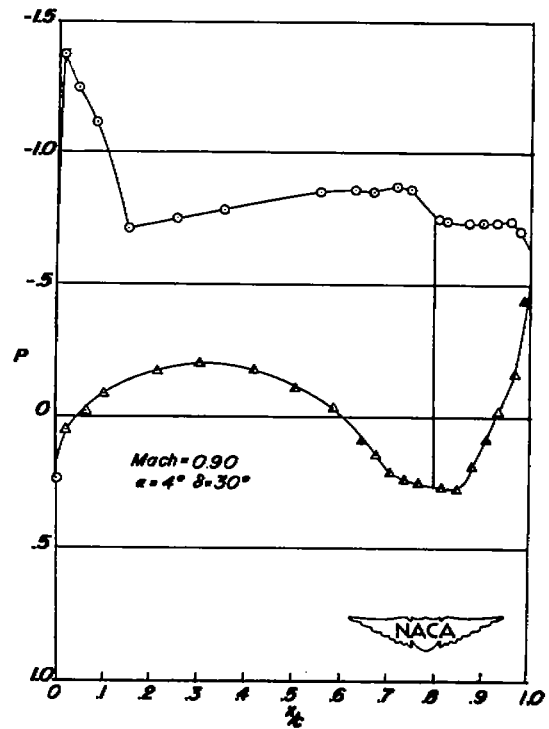
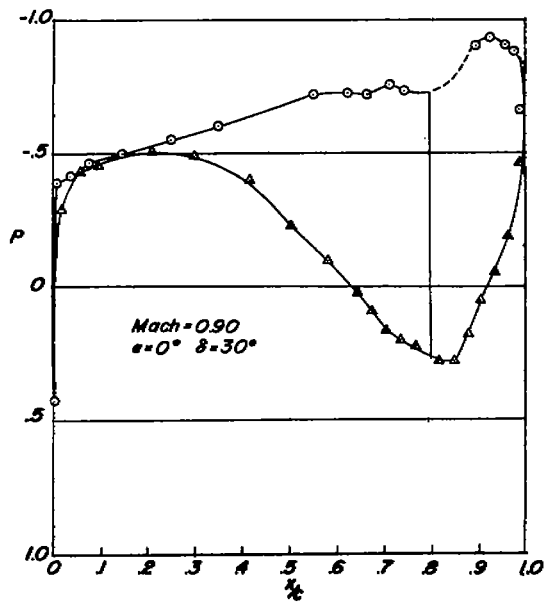
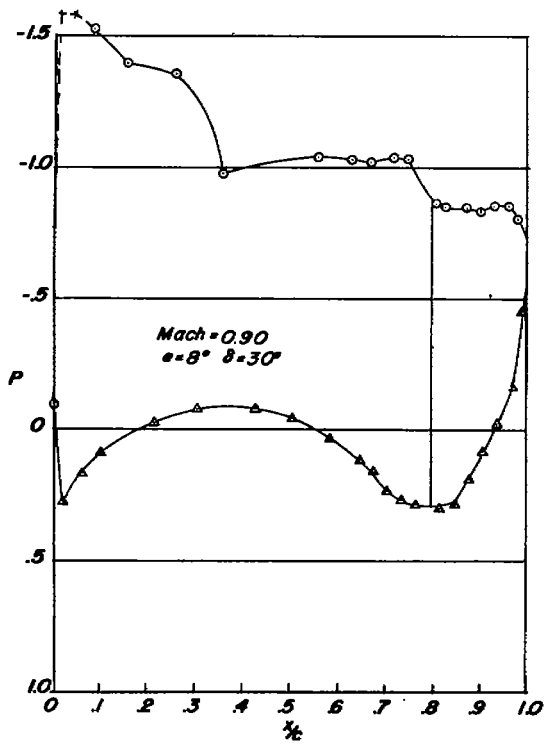
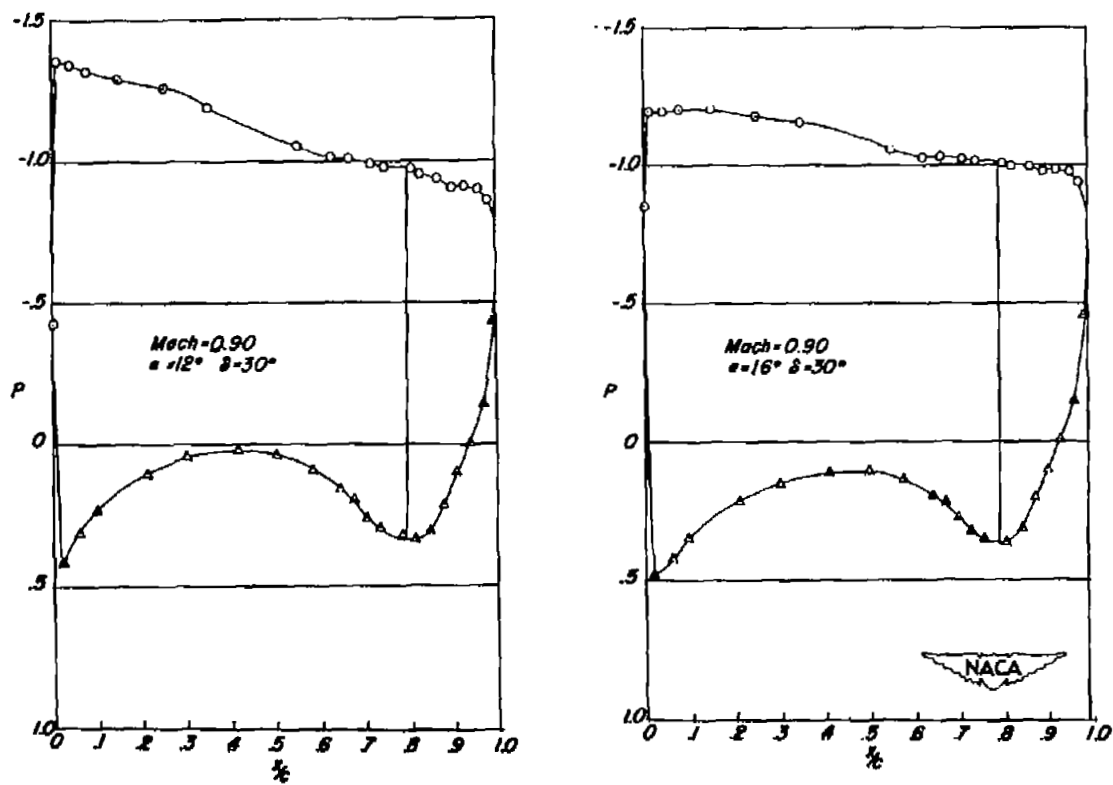

(c) $M = 0.90$. Concluded.

Figure 14.- Concluded.