

CONFIDENTIAL

Copy
RM E53C20

NACA RM E53C20



RESEARCH MEMORANDUM

EFFECT OF FUELS ON COMBUSTION EFFICIENCY OF 5-INCH
RAM-JET-TYPE COMBUSTOR

By Thaine W. Reynolds

Lewis Flight Propulsion Laboratory
Cleveland, Ohio

CLASSIFICATION CANCELLED

Authority *NACA Rea. Abs.* Date *5/14/56*

RN 101

By *MDTA* *6/4/56* See

CLASSIFIED DOCUMENT

This material contains information affecting the National Defense of the United States within the meaning of the espionage laws, Title 18, U.S.C., Secs. 793 and 794, the transmission or revelation of which in any manner to an unauthorized person is prohibited by law.

**NATIONAL ADVISORY COMMITTEE
FOR AERONAUTICS**

WASHINGTON
May 22, 1953

CONFIDENTIAL

NASA LIBRARY
LEWIS RESEARCH LABORATORY

NATIONAL ADVISORY COMMITTEE FOR AERONAUTICS

RESEARCH MEMORANDUM

EFFECT OF FUELS ON COMBUSTION EFFICIENCY OF 5-INCH

RAM-JET-TYPE COMBUSTOR

By Thaine W. Reynolds

SUMMARY

Combustion-efficiency data were obtained for a 5-inch ram-jet-type combustor employing a simple V-gutter flame holder. The data, which are for homogeneous fuel-air mixtures of 14 pure fuels and 2 fuel blends, cover a range of inlet static pressures and velocities. The data are shown to correlate with the following parameter for all of the fuels tested except carbon disulfide:

$$\frac{P^{0.3} T}{V^{0.8}} \left(\frac{U_f}{U_{ref}} \right)^{1.1}$$

where P is the inlet pressure in atmospheres, T is the inlet temperature in $^{\circ}R$, V is the inlet velocity in feet per second, U_f is the maximum fundamental flame velocity in feet per second, and U_{ref} is the maximum fundamental flame velocity of the reference fuel in feet per second. This relation was arrived at experimentally and also analytically from an assumption that the combustion proceeded by an increase of the flame-front area through turbulence in the combustor and that the flame propagated at the fundamental flame speed of the fuel-air mixture.

INTRODUCTION

An understanding of the basic processes controlling combustion in a ram-jet engine is one of the ultimate goals of research. The phase of this broad objective with which this report is concerned is a study of the flame propagation mechanism in a simple ram-jet-type combustor.

Equations predicting the variation of combustion efficiency with inlet parameters have been derived for both ram-jet and turbojet combustors from models based on the assumption that some second-order reaction is controlling the combustion rate according to the classical

rate equation (refs. 1 to 3). A recent investigation of a single turbo-jet can combustor has indicated that the combustion efficiency variation with fuels can be correlated with the maximum fundamental burning velocity (ref. 4).

In reference 5, the results of an investigation of the effects of inlet pressure, temperature, and velocity on the combustion efficiency of gasoline-air mixtures in a ram-jet combustor are reported. An empirical parameter was established which correlated the effect of the inlet variables on the combustion efficiency. A model of the combustion process was proposed in which it was assumed that the turbulent mixing of the incoming fuel-air mixture with the burning gases downstream of the flame holder was controlling the combustion rate. In this model it was assumed that the mixing rate was a function of the inlet Reynolds number and that the flame propagated through the unburned mixture at the fundamental flame speed. A parameter was arrived at which is identical to the empirically derived parameter involving the inlet variables, but which also has a term predicting the variation of combustion efficiency with the flame speed of the fuel. This parameter is included in the following equation:

$$\eta = 7.0 \frac{P^{0.3} T}{V^{0.8}} \left(\frac{U_f}{U_{ref}} \right)^{1.1} \quad (1)$$

which was shown to apply for efficiencies in the range 20 to 80 percent, where flame spreading was independent of wall effects.

The objective of the present study was to continue the investigation into the combustion mechanism by determining the variation of combustion efficiency with several pure fuels and fuel blends in a simple ram-jet-type combustor. Such a determination would further establish the validity of the flame-speed term in equation (1), providing a useful empirical equation, and perhaps yield more data in support of the proposed or some other combustion mechanism. Accordingly, the results of combustion-efficiency measurements on a 5-inch ram-jet-type combustor with 14 pure fuels and 2 blends of propylene oxide and isopentane are reported herein and compared on the basis of equation (1).

SYMBOLS

The following symbols are used in this report:

- c_p mean heat capacity of fuel vapor from T to T_e ,
Btu/(°F)(lb fuel). (A value of 0.5 was used for all fuels.)
- f/a weight fuel-air ratio
- $(f/a)_s$ stoichiometric weight fuel-air ratio

2817
CS-1 back

H_c	lower heating value of fuel, Btu/lb
ΔH_e	enthalpy difference between exhaust gases and inlet mixture, Btu/lb original air
ΔH_j	enthalpy rise of cooling jacket water, Btu/lb original air
ΔH_s	enthalpy difference between exhaust gases and inlet mixture for stoichiometric f/a, Btu/lb original air
ΔH_w	enthalpy rise of quench water, Btu/lb original air
K	constant
L_v	latent heat of vaporization, Btu/lb
$(L_v)_T$	latent heat of vaporization at T, Btu/lb
P	inlet static pressure, atm
Re	Reynolds number
T	inlet-mixture temperature, °R
T_e	exhaust-gas temperature, °R
U_f	fundamental flame speed, ft/sec
U_{ref}	fundamental flame speed for reference fuel, ft/sec. (Taken as 1.4 ft/sec for gasoline.)
V	inlet velocity, ft/sec
η	combustion efficiency, percent

Superscripts:

a,b constants

APPARATUS AND PROCEDURE

The combustor and the piping used in this investigation were the same as those used in reference 5. A schematic diagram of the setup is shown in figure 1. The air-control unit, which differed from that used in reference 5, is shown in figure 1. Two sliding plates operated by an actuator were used to expose the desired number of holes to the air in the tank. The pressure drop at all times was more than enough to give sonic flow through the holes; therefore, the rate of air flow was not affected by burner-pressure changes.

Fuel was introduced through an air atomizing spray bar 10 feet upstream of the flame holder. The latent heat of vaporization of some of the fuels investigated was relatively high; thus, considerable variation in the combustor-inlet mixture temperature resulted as the fuel-air ratio was varied. Homogeneity of the inlet mixture was checked by fuel-air-ratio traverses at the combustor inlet.

The flame holder was a $1\frac{1}{2}$ -inch-wide straight V-gutter of approximately 45° included angle and blocked about 38 percent of the combustor cross-sectional area. Ignition was accomplished by a hydrogen-oxygen pilot flame in the wake of the V-gutter; the pilot was turned off after the burner was ignited. A variable-area exhaust nozzle was used to control the combustor-inlet pressure.

Quench water was introduced through two air-atomizing water spray bars at the exhaust-nozzle outlet to reduce the gas temperature to about 600° F. The combustion efficiencies were calculated by an enthalpy balance.

$$\eta = 100 \frac{\Delta H_w + \Delta H_e + \Delta H_j}{H_c(f/a)}$$

In this report the rich-mixture combustion efficiencies were calculated differently from those reported in reference 1. The enthalpy of the combustion products for rich mixtures was calculated as follows for the data of this report:

$$\Delta H_e = \Delta H_s + \left[(f/a) - (f/a)_s \right] \left[(L_v)_T + c_p(T_e - T) \right]$$

The difference between this method and that of reference 1 is that, previously, the last bracketed term on the right included the heat of combustion of the fuel.

In order to get a wide variation in the value of the inlet-flow parameter $P^{0.3}T/v^{0.8}$ for each fuel, with the limited quantity of the fuels that was available, the data were taken at an inlet static pressure of 20 inches of mercury absolute, inlet-mixture temperatures of about 200° F, and at two inlet velocities, about 180 and 280 feet per second. Some of the higher-flame-speed fuels, such as propylene oxide and carbon disulfide, which would operate at lower pressures, were also run at 10 inches of mercury absolute.

Combustion efficiencies at an equivalence ratio of 1.0, from plots of combustion efficiency against equivalence ratio, were selected at each operating condition for correlation with the inlet-flow parameter and values of the maximum fundamental flame speed reported in the literature.

RESULTS AND DISCUSSION

A list of the fuels investigated and a summary of some of their physical properties are shown in table I.

The results of the combustion-efficiency measurements for the pure fuels and the fuel blends are shown in table II, and plots of combustion efficiency against fuel-air ratio are shown in figures 2 to 17. The peak combustion efficiencies for all the fuels occurred near stoichiometric fuel-air ratio. Some of the curves do not extend from lean to rich blow-out because of insufficient fuel. It will be noted that some of the fuels, namely, *n*-pentane (fig. 2), pentene-2 (fig. 6), and cyclohexane (fig. 5), have a break in the curves at the higher velocity condition near the stoichiometric point. Some unexplainable change in the burning occurred on going to slightly rich mixtures and a higher level of combustion efficiency resulted. For the points of comparison, the lean sides of the curves have been used.

It was desired to compare these results with the results from reference 5, wherein it was found that

$$\eta = 7.0 \frac{P^{0.3} T}{V^{0.8}} \left(\frac{U_f}{U_{ref}} \right)^{1.1} \quad (1)$$

where *P* is expressed in atmospheres, *T* in °R, *V* in feet per second, and *U_f* is in feet per second. This equation was arrived at in the following manner: It was assumed that the rate of mixing of the incoming fresh mixture with the burned gas downstream of the flame holder was controlling the combustion process. The combustion was assumed to be progressing through an increase of flame area, because of this mixing, with the flame propagating into the unburned mixture at the fundamental flame speed. It was further assumed that this rate of mixing was a function of the inlet Reynolds number. Whether the mixing is caused by the scale and intensity of the turbulence associated with Reynolds number or by the actual velocity, density, and viscosity of the air stream all related to one another in the form recognized as Reynolds number is not differentiated here. However, it is quite reasonable that velocity, density, and viscosity would affect turbulent mixing at the flame front and would influence the extension of flame area. With these assumptions,

it is shown in reference-5 that the following expression for combustion efficiency results:

$$\eta = K Re^a \left(\frac{U_f}{V} \right)^b \quad (2)$$

The range of combustion efficiencies over which this expression would be expected to hold is limited to from about 20 to 80 percent as discussed in reference-5. Equation (2) was put in terms of inlet-flow parameters by assuming that the flame speed was proportional to the inlet temperature to the 1.4 power and independent of pressure, giving

$$\eta = K \left(\frac{PV}{T^{1.7}} \right)^a \left(\frac{T_i^{1.4}}{V} \right)^b \quad (3)$$

Values of $a = 0.3$ and $b = 1.1$ reduced this expression to

$$\eta = K \frac{P^{0.3} T^{1.03}}{V^{0.8}} \quad (4)$$

which was the expression found empirically to correlate the effect of inlet-flow variables. The temperature dependence of flame speed for the other fuels may be different from that used in equation (4) and may yield a different relation of combustion efficiency to inlet temperature for different fuels. However, in the experimental data reported, only pressure and velocity were varied significantly so that no differences, if they exist, would be apparent from these data.

A summary of the data from figures 2 to 17, at an equivalence ratio of 1.0, is given in table III. A log-log plot of combustion efficiency at an equivalence ratio of 1.0 against maximum fundamental flame speed for a value of the inlet-flow parameter $\frac{P^{0.3} T}{V^{0.8}}$ equal to about 6.5 is shown in figure 18 for the pure fuels. Also shown on this figure is a line of slope 1.1 which was indicated as required by the previous analysis. It is seen that the combustion efficiencies for the fuels follow the predicted trend with flame speed.

The results of the combustion-efficiency measurements on the blends of propylene oxide and isopentane are shown in figure 19 wherein combustion efficiency divided by the inlet-flow parameter is plotted against blend percentage. For comparison, flame speed of these blends is also shown. The flame speeds of the blends were not experimentally determined. However, it has been reported that for some blends the flame speed of the

blend follows a reciprocal blending relation (ref. 6):

$$\frac{100}{\text{Flame speed of blend}} = \frac{\text{Mole percent of component A}}{\text{Flame speed of A}} + \frac{\text{Mole percent of component B}}{\text{Flame speed of B}} \quad (5)$$

The flame speeds of the blends reported in table I were calculated by use of this relation. The similarity in the shape of the curves presented in figure 19 indicates that the combustion efficiency of the blends is related to the flame speed as might be expected.

Data of table III are plotted in figure 20 along with the gasoline line from figure 7 of reference 5. Here it can be seen that all the fuels follow the correlating parameter reasonably well with the exception of carbon disulfide. Carbon disulfide gave combustion efficiencies which were higher than would be anticipated from the flame-speed relation alone. This fuel has a very low ignition energy and this may contribute in some manner to its improved combustion efficiency.

SUMMARY OF RESULTS

The results obtained in investigating the combustion efficiency of a 5-inch-diameter ram-jet-type combustor employing a straight V-gutter flame holder and homogeneous fuel-air mixtures of 14 pure fuels and two blends of pure fuels are summarized as follows:

1. The data obtained with all the pure fuels, except carbon disulfide, were correlated by the equation

$$\eta = 7.0 \frac{P^{0.3} T}{V^{0.8}} \left(\frac{U_f}{U_{ref}} \right)^{1.1}$$

where P is combustor-inlet static pressure in atmospheres, T is combustor inlet mixture temperature in $^{\circ}R$, V is combustor inlet velocity in feet per second, η is combustion efficiency in percent, U_f is the maximum fundamental flame velocity for the pure fuel in air in feet per second, and U_{ref} is the flame velocity of the reference fuel (taken as 1.4 ft/sec for the above relation).

2. Carbon disulfide gave combustion efficiencies higher than would be anticipated on the basis of its flame speed alone, indicating that some other property, possibly ignition energy, should also be considered in the combustion mechanism.

3. The combustion efficiencies of the blends of propylene oxide and isopentane were also correlated with the flame speed relation when the flame speeds were calculated according to the reciprocal blending relation of Payman and Wheeler

$$\frac{100}{\text{Flame speed of blend}} = \frac{\text{Mole percent of component A}}{\text{Flame speed of A}} + \frac{\text{Mole percent of component B}}{\text{Flame speed of B}}$$

Lewis Flight Propulsion Laboratory
National Advisory Committee for Aeronautics
Cleveland, Ohio

REFERENCES

1. Frost, E. E., Morris, K. G., Petrein, R. J., and Weiss, M. A.: Progress Report on Study of Combustors for Supersonic Ram-Jet. Rep. No. PDN 5740, Oct. 1, 1951 - March 31, 1952. Process Div., Esso Labs., Standard Oil Div. Co., June 30, 1952. (Contract NOrd-9233 SOD/CM-735.)
2. Childs, J. Howard: Preliminary Correlation of Efficiency of Aircraft Gas-Turbine Combustors for Different Operating Conditions. NACA RM E50F15, 1950.
3. Graves, Charles C.: Effect of Oxygen Concentration of the Inlet Oxygen-Nitrogen Mixture on the Combustion Efficiency of a Single J33 Turbojet Combustor. NACA RM E52F13, 1952.
4. Wear, Jerrold D., and Dittrich, Ralph T.: Performance of Pure Fuels in a Single J33 Combustor. I - Five Liquid Hydrocarbon Fuels. NACA RM E52J03, 1952.
5. Reynolds, Thaine W., and Ingebo, Robert D.: Combustion Efficiency of Homogeneous Fuel-Air Mixtures in a 5-Inch Ram-Jet Type Combustor. NACA RM E52I23, 1952.
6. Payman, William, and Wheeler, Richard Vernon: The Propagation of Flame Through Tubes of Small Diameter, Part II. Jour. Chem. Soc., Trans. (London), vol. CXV, 1919, pp. 36-45.
7. Anon.: Survey of Bumblebee Activities. Bumblebee Series Rep. No. 113, Appl. Phys. Lab., Johns Hopkins Univ., Nov. 1949. (Contract NOrd 7386 with Bur. Ord., U. S. Navy.)

TABLE I. - PHYSICAL PROPERTIES OF SOME FUELS AND FUEL BLENDS INVESTIGATED

Fuel	Boiling point, °F	Stoichiometric fuel-air ratio, f/a	Lower heat of combustion, H_c , Btu/lb	Latent heat of vaporization at boiling point, L_v , Btu/lb	Maximum fundamental flame speed, U_f , ft/sec (a)	$\left(\frac{U_f}{1.4}\right)^{1.1}$	Minimum estimated purity, mole percent
n-Pentane	96.9	0.0655	19,500	153.6	1.46	1.05	99.0
n-Heptane	209.2	.0662	19,160	136.0	1.39	.99	99.5
Isococtane	210.6	.0662	19,065	116.7	1.32	.94	99.6
Cyclohexane	177.3	.0680	18,680	153.7	1.43	1.02	92.0
Pentene-2	97-98	.0680	19,300	^a 155.0	1.63	1.18	95.0
Benzene	176.2	.0754	17,260	169.3	1.57	1.13	99.0
Propionaldehyde	120.0	.1050	12,420	215.0	1.64	1.19	95.0
Diethylether	94.1	.0899	14,560	151.0	1.67	1.21	99.0
Propylene oxide	120.0	.1050	13,120	234.0	2.22	1.66	95.0
Acetone	133.0	.1050	12,280	220.0	1.44	1.03	99.0
Methylcyclohexane	213.6	.0680	18,650	138.9	^b 1.40	1.00	99.0
Carbon disulfide	94.1	.1825	6,270	155.0	1.95	1.44	99.0
Neohexane	121.5	.0659	19,160	131.2	1.26	.89	95.0
Isopentane	82.2	.0655	19,450	145.7	1.39	.99	85-90
Gasoline (62-octane)	-----	.0667	18,850	^b 150.0	^b 1.40	1.00	-----
2/3 Propylene oxide - 1/3 isopentane, by weight	-----	.0873	15,230	205.0	^c 1.89	1.39	-----
1/3 Propylene oxide - 2/3 isopentane, by weight	-----	.0749	17,350	177.0	^c 1.62	1.17	-----

^aData from ref. 7 except where noted.^bEstimated value.^cCalculated from eq. (5).

NACA

2817

CS-2

TABLE II. - COMBUSTION EFFICIENCY DATA FOR 14 PURE FUELS AND 2 FUEL BLENDS IN
5-INCH RAM-JET-TYPE COMBUSTOR

(a) Benzene

Inlet static pressure, P, atm	Inlet-mixture temperature, T, °R	Inlet-mixture velocity, V, ft/sec	Air flow, lb/sec	Inlet density, lb/cu ft	Inlet temperature before fuel, °R	Fuel-air ratio, f/a	Equivalence ratio	Combustion efficiency, η, percent
0.69	670	183	1.05	0.0411	721	0.0619	.821	66.6
.69	663	182	1.05	.0413	723	.0677	.898	70.8
.69	660	181	1.05	.0415	723	.0746	.990	68.7
.69	653	179	1.05	.0420	723	.0810	1.073	67.8
.69	649	178	1.05	.0422	723	.0876	1.160	63.7
.69	644	177	1.05	.0425	723	.0937	1.243	59.1
.69	639	176	1.06	.0431	723	.0996	1.320	53.5
.69	---	---	1.06	-----	723	.1061	1.410	(a)
.69	668	185	1.06	.0412	723	.0612	.812	67.4
.69	---	---	1.06	-----	723	.0562	.745	(b)
.69	680	284	1.60	.0403	729	.0576	.763	47.7
.69	675	282	1.60	.0406	729	.0616	.816	48.0
.69	670	281	1.60	.0407	730	.0661	.876	49.6
.69	667	276	1.58	.0410	730	.0712	.934	51.6
.69	663	277	1.60	.0413	731	.0750	.994	52.6
.69	660	277	1.60	.0413	731	.0794	1.052	51.5
.69	656	272	1.59	.0418	731	.0846	1.122	49.6
.69	654	272	1.59	.0419	731	.0889	1.179	47.1
.69	---	---	1.59	-----	731	.0554	.735	(b)
.69	---	---	1.59	-----	731	.0936	1.241	(a)

^aRich blow-out.

^bLean blow-out.



TABLE II. - COMBUSTION EFFICIENCY DATA FOR 14 PURE FUELS AND 2 FUEL BLENDS IN
5-INCH RAM-JET-TYPE COMBUSTOR - Continued

(b) Propylene oxide

Inlet static pressure, P, atm	Inlet-mixture temperature, T, °R	Inlet-mixture velocity, V, ft/sec	Air flow, lb/sec	Inlet density, lb/cu ft	Inlet temperature before fuel, °R	Fuel-air ratio, f/a	Equivalence ratio	Combustion efficiency, η , percent
0.68	605	168	1.05	0.0448	689	0.0903	0.857	80.9
.68	579	160	1.05	.0469	690	.1203	1.148	62.9
.68	556	158	1.07	.0486	690	.1471	1.400	60.4
.68	---	---	1.07	-----	---	.1681	1.600	(a)
.68	603	168	1.06	.0450	696	.1048	1.000	81.5
.68	573	159	1.05	.0473	697	.1348	1.280	64.1
.68	550	153	1.05	.0491	697	.1621	1.450	55.8
.68	643	267	1.58	.0422	712	.0682	.650	52.1
.68	636	264	1.58	.0427	715	.0762	.725	62.2
.68	631	263	1.58	.0430	717	.0839	.799	67.6
.69	626	263	1.60	.0436	718	.0905	.861	71.4
.73	620	248	1.62	.0470	720	.0968	.922	76.3
.77	616	230	1.60	.0497	720	.1063	1.012	72.7
.78	607	223	1.59	.0510	720	.1147	1.090	62.7
.78	602	220	1.59	.0517	721	.1204	1.148	56.4
.79	583	215	1.61	.0536	722	.1389	1.320	50.8
.79	---	---	1.61	-----	---	.0639	.609	(b)
.33	615	263	.79	.0215	699	.0914	.870	54.0
.33	614	268	.81	.0216	698	.0832	.793	54.0
.33	618	267	.80	.0214	697	.0774	.737	49.8
.33	---	---	.80	-----	---	.0715	.680	(b)
.33	605	262	.79	.0219	697	.0965	.919	54.0
.33	596	255	.79	.0222	695	.1044	1.000	51.3
.33	591	252	.79	.0224	694	.1108	1.052	52.7
.33	583	249	.79	.0227	693	.1174	1.120	47.2
.33	579	247	.79	.0229	693	.1241	1.182	43.5
.33	574	245	.79	.0230	692	.1308	1.245	41.8
.33	---	---	.79	-----	---	.1523	1.450	(a)

^aRich blow-out.^bLean blow-out.

NACA

2817

CS-2 back

TABLE II. - COMBUSTION EFFICIENCY DATA FOR 14 PURE FUELS AND 2 FUEL BLENDS IN
5-INCH RAM-JET-TYPE COMBUSTOR - Continued

(c) n-Pentane

Inlet static pressure, P, atm	Inlet-mixture temperature, T, °R	Inlet-mixture velocity, V, ft/sec	Air flow, lb/sec	Inlet density, lb/cu ft	Inlet temperature before fuel, °R	Fuel-air ratio, f/a	Equivalence ratio	Combustion efficiency, η, percent
0.67	648	194	1.11	0.0408	703	0.0744	1.137	57.8
.67	643	193	1.11	.0412	703	.0781	1.193	53.9
.67	---	---	1.11	-----	703	.0821	1.254	(a)
.67	650	195	1.11	.0408	703	.0698	1.067	64.2
.67	652	196	1.11	.0406	703	.0657	1.002	66.9
.67	655	198	1.11	.0404	705	.0613	.936	69.1
.67	658	198	1.11	.0402	706	.0572	.873	68.9
.67	661	199	1.11	.0400	707	.0531	.810	64.2
.67	665	201	1.11	.0398	707	.0491	.750	61.4
.67	---	---	1.11	-----	---	.0448	.684	(b)
.67	654	196	1.11	.0405	710	.0741	1.131	58.2
.67	658	198	1.11	.0402	709	.0636	.971	67.1
.67	661	199	1.11	.0400	709	.0593	.906	66.8
.67	665	200	1.11	.0398	710	.0551	.841	67.3
.67	---	---	1.11	-----	---	.0456	.696	(b)
.67	672	282	1.55	.0394	711	.0530	.809	45.8
.67	666	284	1.58	.0397	708	.0564	.861	46.6
.67	662	281	1.57	.0400	707	.0610	.931	48.4
.67	658	279	1.57	.0403	706	.0654	1.000	49.8
.67	652	278	1.58	.0406	706	.0694	1.060	54.0
.67	650	277	1.58	.0408	705	.0737	1.126	48.8
.67	646	275	1.58	.0410	705	.0780	1.191	42.5
.67	---	---	1.58	-----	---	.0780	1.191	(a)
.67	---	---	1.58	-----	---	.0483	.737	(b)
.67	668	286	1.58	.0396	702	.0489	.746	44.3
.67	656	281	1.58	.0404	701	.0625	.954	49.9
.67	652	279	1.58	.0406	702	.0668	1.020	54.4
.67	---	---	1.58	-----	---	.0782	1.194	(a)

^aRich blow-out.

^bLean blow-out.

NACA

TABLE II. - COMBUSTION EFFICIENCY DATA FOR 14 PURE FUELS AND 2 FUEL BLENDS IN
5-INCH RAM-JET-TYPE COMBUSTOR - Continued

(d) Pentene-2

Inlet static pressure, P, atm	Inlet-mixture temperature, T, °R	Inlet-mixture velocity, V, ft/sec	Air flow, lb/sec	Inlet density, lb/cu ft	Inlet temperature before fuel, °R	Fuel-air ratio, f/a	Equivalence ratio	Combustion efficiency, η , percent
0.67	660	192	1.08	0.0401	710	0.0654	0.961	65.7
.67	656	191	1.08	.0404	712	.0698	1.028	64.6
.67	652	190	1.08	.0406	712	.0742	1.090	62.6
.67	650	189	1.08	.0408	713	.0783	1.150	58.6
.67	646	189	1.08	.0410	714	.0822	1.210	54.8
.67	644	189	1.08	.0411	714	.0861	1.267	48.9
.67	---	---	1.08	-----	---	.0903	1.330	(a)
.67	663	195	1.08	.0399	715	.0607	.893	65.5
.67	666	195	1.08	.0397	716	.0568	.835	64.0
.67	670	196	1.08	.0395	716	.0525	.772	60.1
.67	674	196	1.08	.0392	717	.0486	.715	56.4
.67	---	---	1.08	-----	---	.0482	.709	(b)
.67	678	289	1.57	.0390	717	.0535	.787	42.8
.67	672	284	1.56	.0394	716	.0583	.858	45.0
.67	668	284	1.58	.0396	715	.0623	.916	47.9
.67	664	286	1.60	.0399	715	.0657	.966	49.6
.67	658	282	1.58	.0402	713	.0707	1.040	53.6
.67	654	282	1.59	.0404	713	.0745	1.096	50.3
.67	650	281	1.60	.0407	712	.0785	1.154	45.5
.67	---	---	---	-----	---	.0824	1.212	(a)
.67	---	---	---	-----	---	.0500	.735	(b)
.67	660	285	1.60	.0401	710	.0634	.932	48.7
.67	656	284	1.60	.0403	708	.0675	.993	54.2

^aRich blow-out.

^bLean blow-out.

NACA

TABLE II. - COMBUSTION EFFICIENCY DATA FOR 14 PURE FUELS AND 2 FUEL BLENDS IN
5-INCH RAM-JET-TYPE COMBUSTOR - Continued

(e) Cyclohexane

Inlet static pressure, P, atm	Inlet-mixture temperature, T, °R	Inlet-mixture velocity, V, ft/sec	Air flow, lb/sec	Inlet density, lb/cu ft	Inlet temperature before fuel, °R	Fuel-air ratio, f/a	Equivalence ratio	Combustion efficiency, η , percent
0.67	662	192	1.07	0.0399	713	0.0634	0.932	61.2
.67	660	190	1.06	.0401	713	.0681	1.000	61.9
.67	656	189	1.06	.0404	714	.0728	1.070	60.0
.67	652	187	1.06	.0406	714	.0781	1.149	56.4
.67	650	187	1.06	.0407	715	.0827	1.217	52.6
.67	646	186	1.06	.0409	715	.0876	1.290	47.6
.67	---	---	1.06	-----	---	.0905	1.330	(a)
.67	668	191	1.06	.0396	715	.0588	.865	58.7
.67	672	194	1.07	.0394	717	.0535	.786	56.0
.67	---	---	1.07	-----	---	.0502	.739	(b)
.67	667	192	1.06	.0397	718	.0657	.966	62.6
.67	662	192	1.07	.0400	718	.0701	1.032	62.1
.67	660	189	1.06	.0401	719	.0757	1.113	58.9
.67	674	283	1.55	.0392	720	.0600	.882	43.5
.67	670	282	1.55	.0395	720	.0631	.928	45.7
.67	667	283	1.57	.0397	718	.0660	.970	46.3
.67	664	282	1.57	.0399	718	.0694	1.020	45.8
.67	660	281	1.57	.0401	716	.0726	1.069	45.2
.67	658	281	1.58	.0402	716	.0755	1.110	47.9
.67	655	279	1.58	.0404	714	.0790	1.161	45.2
.67	651	278	1.58	.0407	714	.0823	1.210	41.3
.67	---	---	1.58	-----	---	.0840	1.236	(a)
.67	669	286	1.58	.0396	712	.0556	.817	44.4
.67	---	---	1.58	-----	---	.0525	.772	(b)

^aRich blow-out.

^bLean blow-out.

NACA

TABLE II. - COMBUSTION EFFICIENCY DATA FOR 14 PURE FUELS AND 2 FUEL BLENDS IN
5-INCH RAM-JET-TYPE COMBUSTOR - Continued

(f) Propionaldehyde

Inlet static pressure, P, atm	Inlet-mixture temperature, T, °R	Inlet-mixture velocity, V, ft/sec	Air flow, lb/sec	Inlet density, lb/cu ft	Inlet temperature before fuel, °R	Fuel-air ratio, f/a	Equivalence ratio	Combustion efficiency, η , percent
0.67	624	260	1.54	0.0425	734	0.1111	1.058	54.2
.67	624	256	1.54	.0430	734	.1040	.990	65.5
.67	630	260	1.54	.0424	734	.0967	.920	58.9
.67	636	264	1.54	.0417	734	.0898	.854	55.6
.67	643	268	1.54	.0412	734	.0823	.784	48.5
.67	---	---	1.54	-----	734	.0754	.727	(b)
.67	622	257	1.54	.0430	734	.1111	1.058	57.2
.67	614	256	1.54	.0431	734	.1194	1.138	46.1
.67	606	252	1.54	.0436	734	.1274	1.214	46.3
.67	600	252	1.56	.0441	734	.1334	1.270	43.9
.67	---	---	1.56	-----	734	.1409	1.340	(a)
.67	629	188	1.11	.0423	727	.0950	.903	71.5
.67	631	190	1.11	.0419	726	.0878	.835	67.9
.67	636	190	1.11	.0419	725	.0808	.769	63.0
.67	642	192	1.11	.0413	724	.0741	.705	57.9
.67	---	---	1.11	-----	724	.0713	.677	(b)
.67	628	185	1.09	.0421	724	.0967	.920	72.7
.67	618	183	1.10	.0428	724	.1035	.985	73.2
.67	610	180	1.09	.0434	723	.1111	1.058	67.0
.67	603	179	1.10	.0439	722	.1182	1.126	58.0
.67	597	176	1.09	.0443	722	.1264	1.206	58.2
.67	590	174	1.09	.0448	722	.1340	1.278	56.6
.67	---	---	1.09	-----	722	.1498	1.428	(a)
.34	624	---	.81	-----	720	.0984	.937	40.3

^aRich blow-out.

^bLean blow-out.

NACA

TABLE II. - COMBUSTION EFFICIENCY DATA FOR 14 PURE FUELS AND 2 FUEL BLENDS IN
5-INCH RAM-JET-TYPE COMBUSTOR - Continued

(g) n-Heptane

Inlet static pressure, P, atm	Inlet-mixture temperature, T, °R	Inlet-mixture velocity, V, ft/sec	Air flow, lb/sec	Inlet density, lb/cu ft	Inlet temperature before fuel, °R	Fuel-air ratio, f/a	Equivalence ratio	Combustion efficiency, η , percent
0.67	669	198	1.11	0.0400	725	0.0699	1.057	63.1
.67	670	198	1.11	.0399	724	.0656	.990	66.8
.67	671	201	1.11	.0394	724	.0613	.926	66.0
.67	674	202	1.11	.0392	725	.0571	.862	63.8
.67	677	202	1.11	.0391	724	.0528	.798	60.6
.67	681	204	1.11	.0389	725	.0484	.731	55.6
.67	---	---	1.11	-----	---	.0470	.710	(b)
.67	669	202	1.11	.0396	724	.0693	1.048	63.9
.67	665	201	1.11	.0398	725	.0735	1.110	61.7
.67	662	200	1.11	.0400	725	.0777	1.173	57.3
.67	658	198	1.11	.0403	725	.0820	1.239	52.8
.67	655	198	1.11	.0404	725	.0863	1.305	46.9
.67	---	---	1.11	-----	---	.0902	1.362	(a)
.67	674	283	1.55	.0393	730	.0714	1.079	47.3
.67	676	283	1.55	.0392	731	.0684	1.032	50.1
.67	678	286	1.56	.0390	732	.0648	.978	52.8
.67	682	285	1.56	.0390	733	.0619	.935	53.6
.67	685	289	1.56	.0386	734	.0586	.885	51.0
.67	687	289	1.56	.0385	734	.0577	.871	48.9
.67	690	290	1.56	.0383	735	.0527	.795	47.6
.67	694	292	1.56	.0382	736	.0497	.750	45.8
.67	---	---	1.56	-----	---	.0475	.717	(b)
.67	680	286	1.56	.0389	737	.0712	1.075	48.6
.67	677	285	1.56	.0391	738	.0743	1.122	46.7
.63	674	299	1.56	.0373	738	.0774	1.170	39.6
.71	674	266	1.56	.0418	739	.0774	1.170	50.3
.67	672	281	1.56	.0396	739	.0806	1.218	43.0
.67	---	---	1.56	-----	---	.0831	1.255	(a)

^aRich blow-out.

^bLean blow-out.

NACA

TABLE II. - COMBUSTION EFFICIENCY DATA FOR 14 PURE FUELS AND 2 FUEL BLENDS IN
5-INCH RAM-JET-TYPE COMBUSTOR - Continued

(h) Diethylether

Inlet static pressure, P, atm	Inlet-mixture temperature, T, °R	Inlet-mixture velocity, V, ft/sec	Air flow, lb/sec	Inlet density, lb/cu ft	Inlet temperature before fuel, °R	Fuel-air ratio, f/a	Equivalence ratio	Combustion efficiency, η , percent
0.67	644	193	1.11	0.0411	715	0.0941	1.046	64.1
.67	646	194	1.11	.0410	715	.0871	.969	65.1
.67	650	193	1.10	.0408	715	.0811	.902	63.7
.67	653	195	1.10	.0405	714	.0739	.822	58.5
.67	657	197	1.11	.0403	714	.0668	.743	54.3
.67	---	---	1.11	-----	---	.0647	.719	(b)
.67	645	194	1.11	.0410	714	.0941	1.046	64.8
.67	638	191	1.11	.0415	714	.1010	1.124	62.2
.67	632	190	1.11	.0419	714	.1081	1.202	57.6
.67	627	188	1.11	.0422	714	.1152	1.282	51.5
.67	622	187	1.11	.0426	713	.1224	1.360	44.7
.67	---	---	1.11	-----	713	.1249	1.389	(a)
.67	662	269	1.50	.0400	725	.0797	.886	50.7
.67	664	272	1.51	.0398	725	.0742	.825	47.3
.67	668	272	1.50	.0396	726	.0694	.772	44.9
.67	---	---	1.50	-----	---	.0660	.734	(b)
.67	664	271	1.51	.0399	727	.0795	.885	51.2
.67	660	269	1.51	.0401	728	.0847	.942	54.3
.67	656	268	1.51	.0403	728	.0900	1.000	54.2

^aRich blow-out.^bLean blow-out.

NACA

TABLE II. - COMBUSTION EFFICIENCY DATA FOR 14 PURE FUELS AND 2 FUEL BLENDS IN
5-INCH RAM-JET-TYPE COMBUSTOR - Continued

(i) Isooctane

Inlet static pressure, P, atm	Inlet-mixture temperature, T, °R	Inlet-mixture velocity, V, ft/sec	Air flow, lb/sec	Inlet density, lb/ou ft	Inlet temperature before fuel, °R	Fuel-air ratio, f/a	Equivalence ratio	Combustion efficiency, η , percent
0.67	670	203	1.12	0.0395	717	0.0662	1.000	53.0
.67	672	204	1.12	.0394	718	.0617	.932	53.4
.67	674	204	1.12	.0393	718	.0575	.869	52.2
.67	---	---	1.12	-----	---	.0543	.820	(b)
.67	669	204	1.12	.0396	717	.0659	.995	54.2
.67	666	203	1.12	.0397	717	.0704	1.062	53.1
.67	663	202	1.12	.0399	717	.0748	1.130	51.7
.67	660	201	1.12	.0401	716	.0793	1.198	47.9
.67	657	200	1.12	.0403	716	.0837	1.263	44.4
.67	---	---	1.12	-----	---	.0840	1.269	(a)
.67	669	203	1.12	.0396	716	.0641	.968	54.2
.67	667	203	1.12	.0397	717	.0681	1.030	53.6
.67	664	202	1.12	.0399	716	.0726	1.097	52.8
.67	678	278	1.52	.0390	727	.0689	1.040	40.4
.67	680	278	1.52	.0390	729	.0673	1.018	42.0
.67	680	278	1.51	.0389	729	.0658	.994	42.9
.67	682	279	1.51	.0388	730	.0640	.967	43.6
.67	684	279	1.51	.0387	731	.0624	.942	44.0
.67	684	281	1.52	.0387	731	.0605	.913	43.5
.67	686	280	1.51	.0386	731	.0591	.892	43.4
.67	688	281	1.51	.0385	732	.0574	.866	43.3
.67	690	279	1.50	.0386	732	.0559	.844	43.3
.67	---	---	1.50	-----	---	.0546	.825	(b)
.67	684	278	1.50	.0387	733	.0694	1.048	42.6
.67	682	279	1.51	.0388	734	.0708	1.069	42.0
.67	682	278	1.50	.0388	734	.0727	1.099	41.5
.67	680	278	1.51	.0389	735	.0742	1.120	40.9
.67	680	278	1.51	.0390	735	.0760	1.149	40.1
.67	678	276	1.50	.0390	736	.0780	1.178	38.7
.67	677	276	1.50	.0391	736	.0797	1.202	38.0
.67	---	---	1.50	-----	---	.0815	1.230	(a)

^aRich blow-out.

^bLean blow-out.

NACA

TABLE II. - COMBUSTION EFFICIENCY DATA FOR 14 PURE FUELS AND 2 FUEL BLENDS IN
5-INCH RAM-JET-TYPE COMBUSTOR - Continued

(j) Acetone

Inlet static pressure, P, atm	Inlet-mixture temperature, T, °R	Inlet-mixture velocity, V, ft/sec	Air flow, lb/sec	Inlet density, lb/cu ft	Inlet temperature before fuel, °R	Fuel-air ratio, f/a	Equivalence ratio	Combustion efficiency, η, percent
0.67	613	186	1.12	0.0430	700	0.0909	0.866	50.8
.67	608	183	1.11	.0435	702	.0998	.951	54.8
.67	604	181	1.11	.0438	702	.0957	.911	56.2
.67	607	182	1.11	.0436	703	.0907	.864	55.3
.67	---	---	1.11	-----	---	.0861	.820	(b)
.67	603	181	1.11	.0439	704	.1049	.999	57.5
.67	595	178	1.11	.0445	705	.1096	1.044	52.6
.67	590	177	1.11	.0448	705	.1141	1.087	47.9
.67	586	175	1.11	.0451	706	.1192	1.135	42.4
.67	582	174	1.11	.0455	706	.1242	1.183	42.2
.67	579	173	1.11	.0457	706	.1292	1.230	43.2
.67	---	---	1.11	-----	---	.1300	1.240	(a)
.67	620	271	1.61	.0425	721	.1016	.968	40.5
.67	618	269	1.61	.0428	722	.0982	.935	40.3
.67	621	270	1.61	.0426	722	.0950	.905	41.4
.67	624	272	1.61	.0424	723	.0914	.871	41.5
.67	---	---	1.61	-----	---	.0890	.847	(b)
.67	617	269	1.61	.0429	724	.1051	1.000	41.1
.67	612	267	1.61	.0432	724	.1085	1.033	37.5
.67	610	265	1.61	.0434	724	.1120	1.067	40.0
.67	606	264	1.61	.0437	725	.1156	1.101	34.8

^aRich blow-out.

^bLean blow-out.

NACA

TABLE II. - COMBUSTION EFFICIENCY DATA FOR 14 PURE FUELS AND 2 FUEL BLENDS IN
5-INCH RAM-JET-TYPE COMBUSTOR - Continued

(k) Methylcyclohexane

Inlet static pressure, P, atm	Inlet-mixture temperature, T, °R	Inlet-mixture velocity, V, ft/sec	Air flow, lb/sec	Inlet density, lb/cu ft	Inlet temperature before fuel, °R	Fuel-air ratio, f/a	Equivalence ratio	Combustion efficiency, η, percent
0.67	663	197	1.10	0.0400	715	0.0705	1.037	58.9
.67	660	197	1.10	.0401	715	.0659	.969	59.9
.67	662	197	1.10	.0400	714	.0612	.900	59.0
.67	664	197	1.10	.0399	714	.0568	.835	56.9
.67	---	---	1.10	-----	---	.0548	.805	(b)
.67	654	194	1.10	.0404	714	.0756	1.112	57.2
.67	650	194	1.10	.0407	715	.0798	1.174	53.7
.67	646	191	1.10	.0410	715	.0850	1.250	49.2
.67	---	---	1.10	-----	---	.0869	1.280	(a)
.67	660	197	1.10	.0401	714	.0633	.931	59.9
.67	658	194	1.10	.0403	715	.0688	1.012	60.7
.67	654	197	1.10	.0404	715	.0722	1.062	59.3
.67	651	193	1.10	.0407	715	.0779	1.146	56.0
.67	662	199	1.10	.0400	715	.0583	.850	58.4
.67	674	298	1.63	.0391	723	.0668	.982	49.6
.67	672	297	1.64	.0394	724	.0634	.932	44.2
.67	673	294	1.62	.0393	725	.0607	.893	42.0
.67	676	297	1.62	.0392	725	.0573	.843	42.2
.67	---	---	1.62	-----	---	.0526	.774	(b)
.67	671	296	1.62	.0392	726	.0705	1.037	50.4

^aRich blow-out.

^bLean blow-out.

NACA

TABLE II. - COMBUSTION EFFICIENCY DATA FOR 14 PURE FUELS AND 2 FUEL BLENDS IN
5-INCH RAM-JET-TYPE COMBUSTOR - Continued

(1) 2/3 Propylene oxide plus 1/3-isopentane by weight

Inlet static pressure, P, atm	Inlet-mixture temperature, T, °R	Inlet-mixture velocity, V, ft/sec	Air flow, lb/sec	Inlet density, lb/cu ft	Inlet temperature before fuel, °R	Fuel-air ratio, f/a	Equivalence ratio	Combustion efficiency, η, percent
0.67	614	175	1.05	0.0431	692	0.0963	1.102	73.3
.67	614	174	1.05	.0431	693	.0807	.925	75.6
.67	618	175	1.04	.0428	695	.0784	.899	74.8
.67	624	176	1.04	.0424	696	.0694	.795	70.0
.67	633	180	1.05	.0418	699	.0600	.687	58.2
.67	---	---	1.05	-----	---	.0590	.675	(b)
.67	611	174	1.04	.0433	702	.1054	1.210	70.6
.67	601	170	1.04	.0440	703	.1152	1.320	64.0
.67	594	168	1.04	.0446	704	.1244	1.428	55.7
.67	587	166	1.04	.0451	705	.1334	1.530	44.6
.67	---	---	1.04	-----	---	.1342	1.540	(a)
.67	628	177	1.04	.0421	713	.0925	1.060	76.3
.67	620	175	1.04	.0427	715	.1019	1.168	70.6
.33	631	254	.74	.0210	708	.0973	1.113	44.7
.33	629	254	.74	.0210	708	.0910	1.042	47.6
.33	630	254	.74	.0210	708	.0846	.970	48.0
.33	632	253	.74	.0209	709	.0788	.903	50.1
.33	638	257	.74	.0208	709	.0718	.824	48.9
.33	---	---	.74	-----	---	.0641	.734	(b)
.33	628	251	.74	.0211	711	.1044	1.199	38.9
.33	---	---	.74	-----	711	.1061	1.217	(a)
.33	644	258	.74	.0205	713	.0818	.938	47.6
.33	637	255	.74	.0208	714	.0886	1.015	46.0
.33	632	253	.74	.0209	714	.0946	1.083	43.0

^aRich blow-out.

^bLean blow-out.



TABLE II. - COMBUSTION EFFICIENCY DATA FOR 14 PURE FUELS AND 2 FUEL BLENDS IN
5-INCH RAM-JET-TYPE COMBUSTOR - Continued

(m) 1/3 Propylene oxide plus 2/3 isopentane by weight

Inlet static pressure, P, atm	Inlet-mixture temperature, T, °R	Inlet-mixture velocity, V, ft/sec	Air flow, lb/sec	Inlet density, lb/cu ft	Inlet temperature before fuel, °R	Fuel-air ratio, f/a	Equivalence ratio	Combustion efficiency, η percent
0.67	640	193	1.12	0.0414	700	0.0757	1.011	64.3
.67	639	192	1.11	.0414	702	.0716	.956	65.0
.67	642	192	1.11	.0412	704	.0679	.906	64.6
.67	646	193	1.11	.0409	705	.0633	.845	61.6
.67	650	195	1.11	.0407	707	.0591	.789	58.1
.67	---	---	1.11	-----	---	.0548	.732	(b)
.67	643	193	1.11	.0412	710	.0801	1.069	64.8
.67	638	190	1.11	.0415	711	.0875	1.168	59.6
.67	634	190	1.11	.0418	712	.0938	1.252	53.3
.67	---	---	1.11	-----	---	.0988	1.319	(a)
.67	658	196	1.11	.0403	716	.0702	.937	65.9
.67	655	195	1.11	.0404	718	.0745	.995	66.3
.67	652	194	1.11	.0406	720	.0788	1.052	64.6
.67	---	---	1.11	-----	---	.0972	1.298	(a)
.67	670	283	1.56	.0395	730	.0738	.985	55.4
.67	670	284	1.56	.0395	731	.0692	.924	52.4
.67	673	284	1.56	.0393	731	.0648	.865	51.3
.67	676	285	1.56	.0392	731	.0602	.804	48.4
.67	---	---	1.56	-----	---	.0554	.740	(b)
.67	666	282	1.56	.0397	730	.0769	1.027	54.0
.67	662	280	1.56	.0400	731	.0816	1.089	50.6
.67	658	278	1.56	.0403	730	.0861	1.149	46.0
.67	---	---	1.56	-----	---	.0891	1.189	(a)
.67	674	286	1.56	.0392	731	.0667	.890	52.9
.67	670	284	1.56	.0395	730	.0714	.953	56.3

^aRich blow-out.

^bLean blow-out.

NACA

TABLE II. - COMBUSTION EFFICIENCY DATA FOR 14 PURE FUELS AND 2 FUEL BLENDS IN
5-INCH RAM-JET-TYPE COMBUSTOR - Continued

(n) Carbon disulfide

Inlet static pressure, P, atm	Inlet-mixture temperature, T, °R	Inlet-mixture velocity, V, ft/sec	Air flow, lb/sec	Inlet density, lb/cu ft	Inlet temperature before fuel, °R	Fuel-air ratio, f/a	Equivalence ratio	Combustion efficiency, η , percent
0.33	606	286	0.86	0.0216	710	0.1692	0.927	81.4
.33	608	277	.86	.0222	711	.1502	.823	78.0
.33	614	284	.86	.0216	714	.1381	.757	78.8
.33	---	---	.86	---	---	.0812	.445	(b)
.50	624	245	1.09	.0318	725	.1720	.942	77.3
.50	622	246	1.10	.0319	725	.1553	.851	78.1
.50	626	250	1.10	.0317	725	.1378	.755	80.0
.50	632	251	1.10	.0314	723	.1227	.672	76.1
.50	642	255	1.10	.0309	724	.1073	.588	73.7
.50	---	---	1.10	---	---	.0727	---	(b)
.50	606	239	1.10	.0328	723	.1880	1.030	75.4
.53	590	222	1.10	.0355	722	.2038	1.117	73.1
.51	588	224	1.08	.0346	721	.1982	1.086	---
.50	596	238	1.10	.0333	720	.1777	.974	78.2
.50	604	239	1.10	.0329	720	.1631	.894	80.0
.50	656	260	1.10	.0303	720	.0927	.508	74.5
.50	662	263	1.10	.0300	719	.0801	.439	69.3
.33	637	284	.82	.0208	715	.1236	.677	76.7
.33	638	282	.82	.0207	714	.1050	.575	73.5
.33	646	287	.82	.0205	714	.0847	.464	66.5
.33	630	281	.82	.0210	718	.1367	.749	78.7
.33	616	272	.82	.0215	719	.1520	.833	74.7
.33	606	269	.82	.0218	719	.1680	.921	77.3
.35	592	245	.81	.0237	720	.1948	1.067	74.1
.37	583	234	.82	.0250	720	.2086	1.143	70.8
.33	594	260	.81	.0223	720	.1807	.990	77.5
.33	606	264	.82	.0221	721	.1585	.869	77.4
.33	614	269	.81	.0216	722	.1457	.798	75.5
.67	682	284	1.54	.0388	742	.0877	.481	68.4
.67	670	276	1.54	.0399	742	.1025	.562	72.6
.67	660	276	1.54	.0401	743	.1174	.643	77.4
.67	648	270	1.54	.0408	743	.1337	.733	78.1
.67	638	266	1.54	.0415	744	.1501	.822	79.8
.67	632	257	1.54	.0429	744	.1584	.868	80.1
.67	639	264	1.52	.0414	744	.1432	.785	82.0
.67	650	274	1.56	.0407	744	.1241	.680	80.3

^aRich blow-out.^bLean blow-out.

NACA

TABLE II. - COMBUSTION EFFICIENCY DATA FOR 14 PURE FUELS AND 2 FUEL BLENDS IN
5-INCH RAM-JET-TYPE COMBUSTOR - Continued

(c) Isopentane

Inlet static pressure, P, atm	Inlet-mixture temperature, T, °R	Inlet-mixture velocity, V, ft/sec	Air flow, lb/sec	Inlet density, lb/cu ft	Inlet temperature before fuel, °R	Fuel-air ratio, f/a	Equivalence ratio	Combustion efficiency, η, percent
0.67	671	195	1.08	0.0394	728	0.0667	1.018	56.3
.67	672	194	1.06	.0394	728	.0631	.963	58.3
.67	674	195	1.07	.0392	728	.0587	.896	58.7
.67	677	195	1.06	.0391	728	.0548	.837	57.1
.67	---	---	1.06	-----	---	.0506	.772	(b).
.67	672	195	1.08	.0394	733	.0667	1.018	58.3
.67	670	194	1.07	.0395	734	.0709	1.082	56.6
.67	666	191	1.06	.0397	735	.0757	1.156	53.0
.67	664	192	1.07	.0398	736	.0792	1.209	48.6
.67	---	---	1.07	-----	---	.0807	1.230	(a)
.67	690	199	1.06	.0384	746	.0608	.928	60.0
.67	686	196	1.06	.0386	746	.0656	1.002	59.8
.67	680	194	1.06	.0389	745	.0698	1.066	58.2
.67	---	---	1.55	-----	---	.0760	1.160	(a)
.67	---	---	1.55	-----	---	.0496	.757	(b)
.67	684	284	1.54	.0387	742	.0697	1.064	41.1
.67	682	287	1.56	.0388	742	.0659	1.006	43.4
.67	682	283	1.54	.0388	741	.0639	.976	44.9
.67	684	287	1.55	.0387	740	.0604	.922	46.0
.67	686	288	1.55	.0386	739	.0575	.878	46.3
.67	688	286	1.54	.0384	739	.0552	.843	45.7
.67	690	289	1.55	.0384	739	.0518	.791	45.6
.67	676	283	1.55	.0392	739	.0719	1.098	41.1

^aRich blow-out.

^bLean blow-out.

NACA

2817

TABLE II. - COMBUSTION EFFICIENCY DATA FOR 14 PURE FUELS AND 2 FUEL BLENDS IN
5-INCH RAM-JET-TYPE COMBUSTOR - Concluded

(p) Neohexane

Inlet static pressure, P, atm	Inlet-mixture temperature, T, °R	Inlet-mixture velocity, V, ft/sec	Air flow, lb/sec	Inlet density, lb/cu ft	Inlet temperature before fuel, °R	Fuel-air ratio, f/a	Equivalence ratio	Combustion efficiency, η, percent
0.67	668	190	1.05	0.0396	720	0.0683	1.036	57.1
.67	668	192	1.06	.0396	720	.0634	.962	58.6
.67	670	192	1.06	.0395	719	.0592	.898	58.6
.67	670	192	1.06	.0395	720	.0550	.835	57.3
.67	---	---	1.06	-----	---	.0519	.788	(b)
.67	664	190	1.06	.0399	718	.0676	1.026	57.6
.67	660	188	1.06	.0401	718	.0719	1.091	55.6
.67	656	186	1.05	.0404	718	.0765	1.161	52.3
.67	652	186	1.06	.0406	718	.0803	1.219	48.3
.67	---	---	1.06	-----	---	.0824	1.250	(a)
.67	664	190	1.06	.0399	717	.0611	.927	59.3
.67	662	188	1.05	.0400	717	.0659	1.000	59.2
.67	658	187	1.05	.0402	717	.0701	1.064	57.6
.67	674	291	1.60	.0393	726	.0668	1.014	41.1
.67	672	286	1.58	.0394	726	.0651	.988	42.2
.67	674	287	1.58	.0394	727	.0621	.942	43.4
.67	676	288	1.58	.0392	727	.0594	.901	43.8
.67	679	290	1.58	.0390	726	.0564	.856	43.8
.67	680	290	1.58	.0389	728	.0538	.816	44.0
.67	---	---	1.58	-----	---	.0524	.795	(b)
.67	672	288	1.58	.0394	726	.0675	1.024	42.4
.67	668	283	1.57	.0396	726	.0712	1.080	41.0
.67	666	286	1.58	.0397	726	.0729	1.106	39.8
.67	663	284	1.58	.0399	726	.0757	1.149	37.4
.67	---	---	1.58	-----	---	.0762	1.158	(a)

^aRich blow-out.
^bLean blow-out.



CS-4

TABLE III. - SUMMARY OF COMBUSTION-EFFICIENCY DATA FOR 14 PURE FUELS
AND 2 FUEL BLENDS IN 5-INCH RAM-JET-TYPE COMBUSTOR

25

Fuel	Inlet static pressure, P, atm	Inlet-mixture temperature, T, °R	Inlet-mixture velocity, V, ft/sec	Combustion efficiency, η, percent	Inlet flow parameter, $\frac{P^{0.3} T}{V^{0.8}}$	Correlation parameter, $\left(\frac{P^{0.3} T}{V^{0.8}}\right) \left(\frac{U_F}{U_{ref}}\right)^{1.1}$	Combustion efficiency calculated according to eq. (1)
n-Pentane	0.67	652	196	67.0	8.45	8.87	62.1
	.67	658	279	50.0	6.44	6.76	47.3
n-Heptane	.67	670	198	66.5	8.62	8.54	59.8
	.67	678	286	52.0	6.50	6.44	45.1
Isooctane	.67	669	204	54.3	8.45	7.94	55.6
	.67	680	278	43.5	6.68	6.28	44.0
Cyclohexane	.67	660	190	62.3	8.77	8.95	62.6
	.67	664	282	46.0	6.44	6.57	46.0
Pentene-2	.67	656	191	65.5	8.69	10.27	71.9
	.67	656	284	50.0	6.33	7.47	52.3
Benzene	.69	660	180	70.0	9.20	10.40	72.8
	.69	663	277	52.5	6.59	7.45	52.2
Propionaldehyde	.67	618	183	72.5	8.45	10.17	71.2
	.67	624	256	61.0	6.55	7.79	54.5
Diethylether	.67	646	194	65.0	8.43	10.20	71.4
	.67	656	258	54.5	6.64	8.04	56.3
Propylene oxide	.68	603	168	81.5	8.90	14.79	103.5
	.73	620	250	75.0	6.80	11.30	79.1
	.33	600	260	53.6	5.03	8.35	58.5

NACA RM E53020

TABLE III. - SUMMARY OF COMBUSTION-EFFICIENCY DATA FOR 14 PURE FUELS
AND 2 FUEL BLENDS IN 5-INCH RAM-JET-TYPE COMBUSTOR - Concluded

Fuel	Inlet static pressure, P, atm	Inlet-mixture temperature, T, °R	Inlet-mixture velocity, V, ft/sec	Combustion efficiency, η, percent	Inlet flow parameter, $\frac{P^{0.3} T}{V^{0.8}}$	Correlation parameter, $\left(\frac{P^{0.3} T}{V^{0.8}}\right) \left(\frac{U_F}{U_{ref}}\right)^{1.1}$	Combustion efficiency calculated according to eq. (1)
Acetone	0.67	603	181	56.0	8.32	8.57	60.0
	.67	617	269	41.0	6.23	6.42	44.9
Methylcyclohexane	.67	658	194	60.0	8.58	8.58	60.1
	.67	674	298	50.0	6.26	6.26	43.9
Carbon disulfide	.67	632	257	81.0	6.62	9.53	66.7
	.50	596	238	79.0	6.07	8.73	61.1
	.33	594	260	78.5	4.99	7.19	50.3
Neohexane	.67	662	188	59.2	8.86	7.89	55.2
	.67	672	286	42.7	6.45	5.74	40.2
Isopentane	.67	672	195	59.3	8.75	8.66	60.6
	.67	682	287	44.3	6.53	6.46	45.2
2/3 Propylene oxide - 1/3 isopentane by weight	.67	628	177	76.0	8.80	12.20	85.4
	.33	637	255	48.0	5.44	7.55	52.8
1/3 Propylene oxide - 2/3 isopentane by weight	.67	655	195	66.0	8.53	9.97	69.8
	.67	670	283	54.6	6.48	7.58	53.1



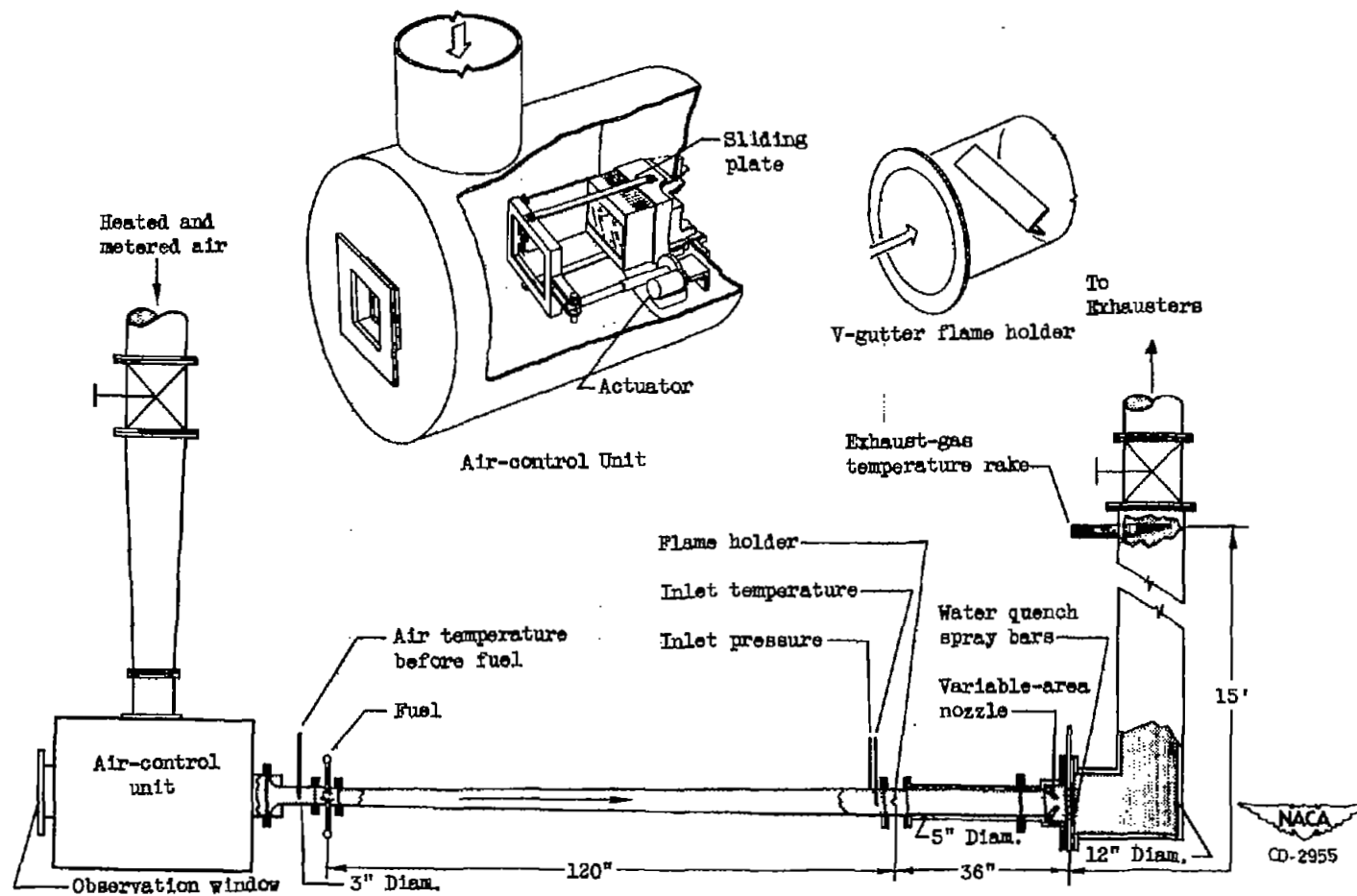

Figure 1. - Schematic illustration of 5-inch ram-jet-type combustor setup, flame holder and air-control unit.

2817

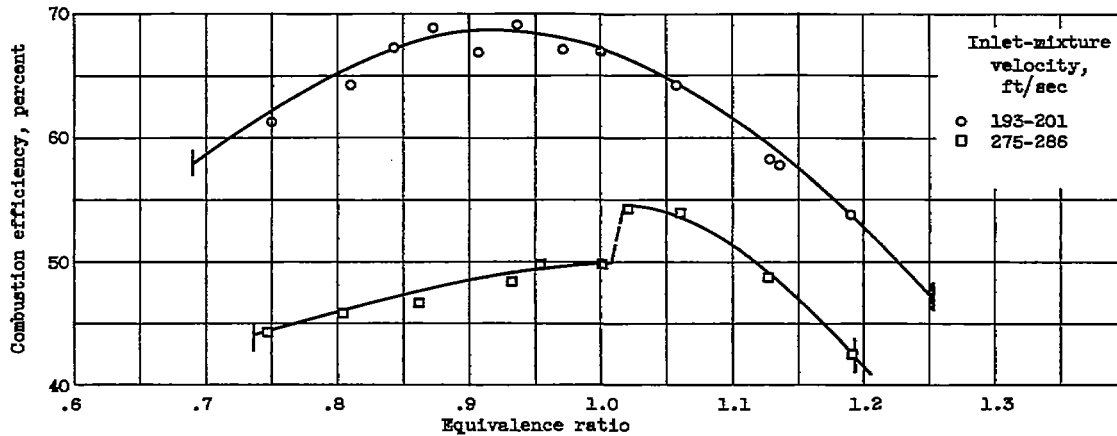

Figure 2. - Combustion efficiency of V-gutter flame holder in 5-inch ram-jet-type combustor with n-pentane. Combustor inlet pressure, 0.67 atmosphere; combustor inlet temperature, 643° to 672° R.

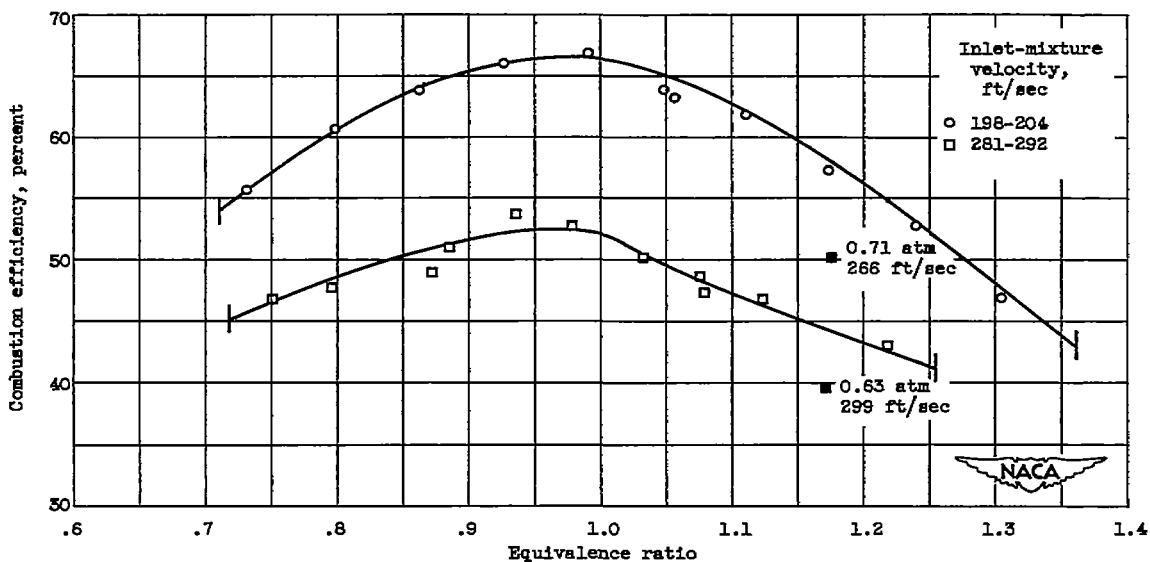

Figure 3. - Combustion efficiency of V-gutter flame holder in 5-inch ram-jet-type combustor with n-heptane. Combustor inlet pressure, 0.67 atmosphere; combustor inlet temperature, 655° to 694° R.

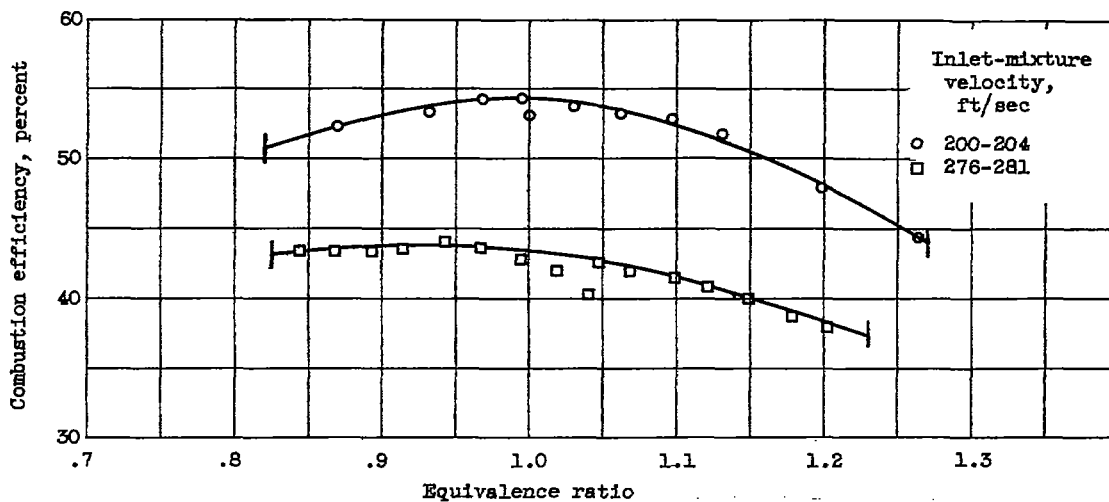

Figure 4. - Combustion efficiency of V-gutter flame holder in 5-inch ram-jet-type combustor with isooctane. Combustor inlet pressure, 0.67 atmosphere; combustor inlet temperature, 657° to 690° R.

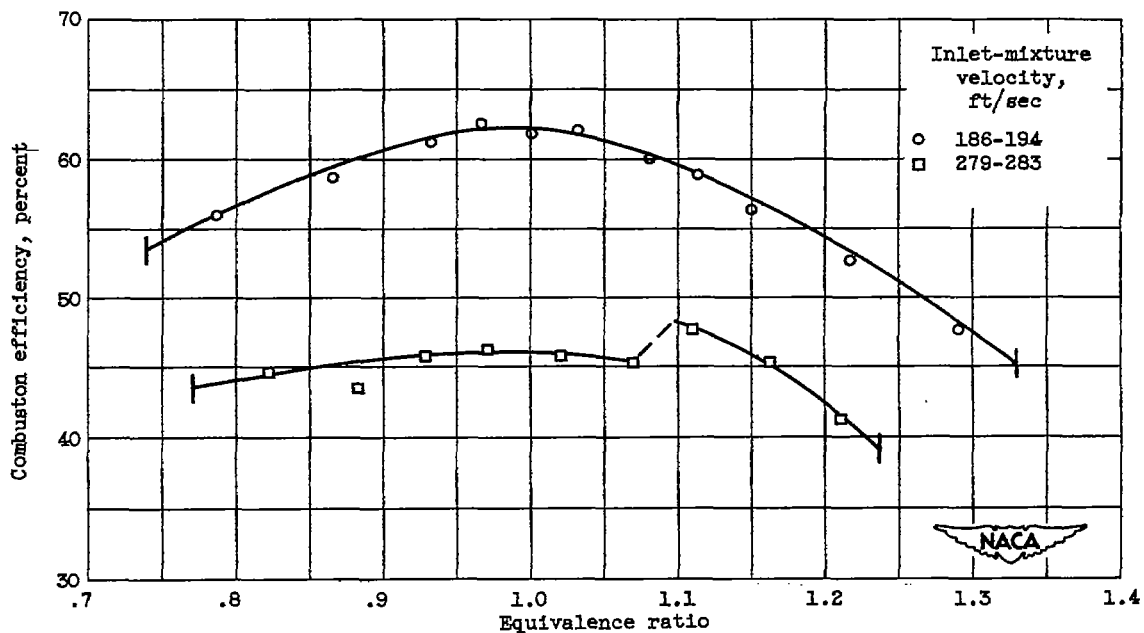

Figure 5. - Combustion efficiency of V-gutter flame holder in 5-inch ram-jet-type combustor with cyclohexane. Combustor inlet pressure, 0.67 atmosphere; combustor inlet temperature, 646° to 674° R.

2817

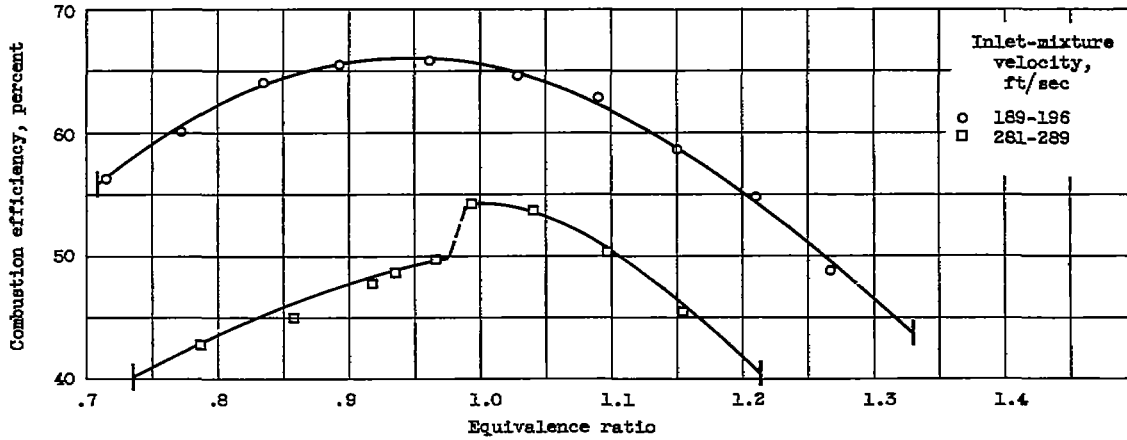

Figure 6. - Combustion efficiency of V-gutter flame holder in 5-inch ram-jet-type combustor with pentene-2. Combustor inlet pressure, 0.67 atmosphere; combustor inlet temperature, 644° to 678° R.

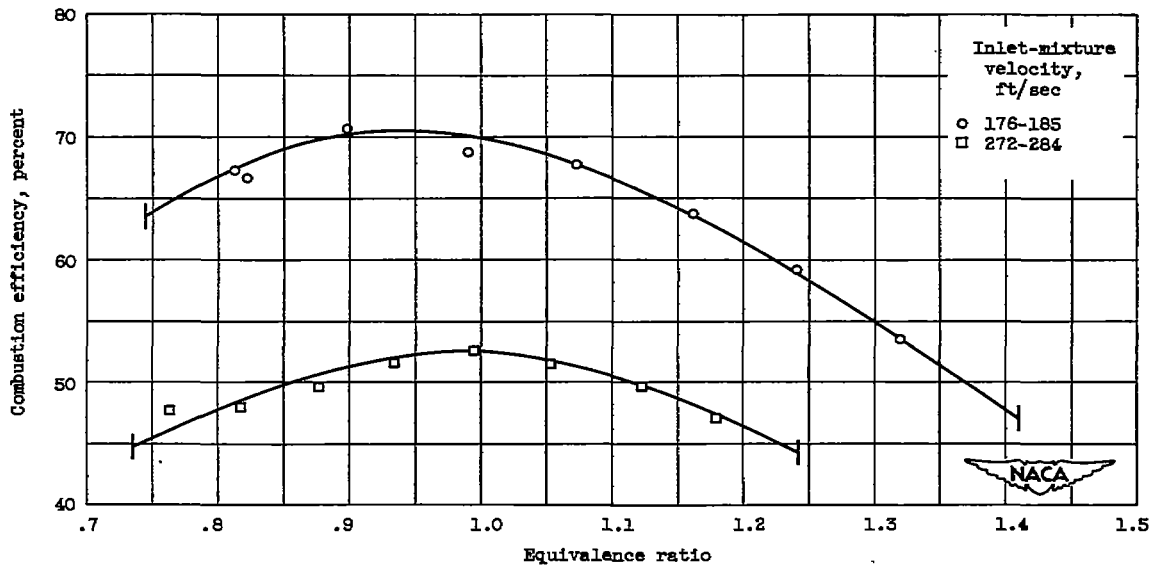

Figure 7. - Combustion efficiency of V-gutter flame holder in 5-inch ram-jet-type combustor with benzene. Combustor inlet pressure, 0.67 atmosphere; combustor inlet temperature, 639° to 680° R.

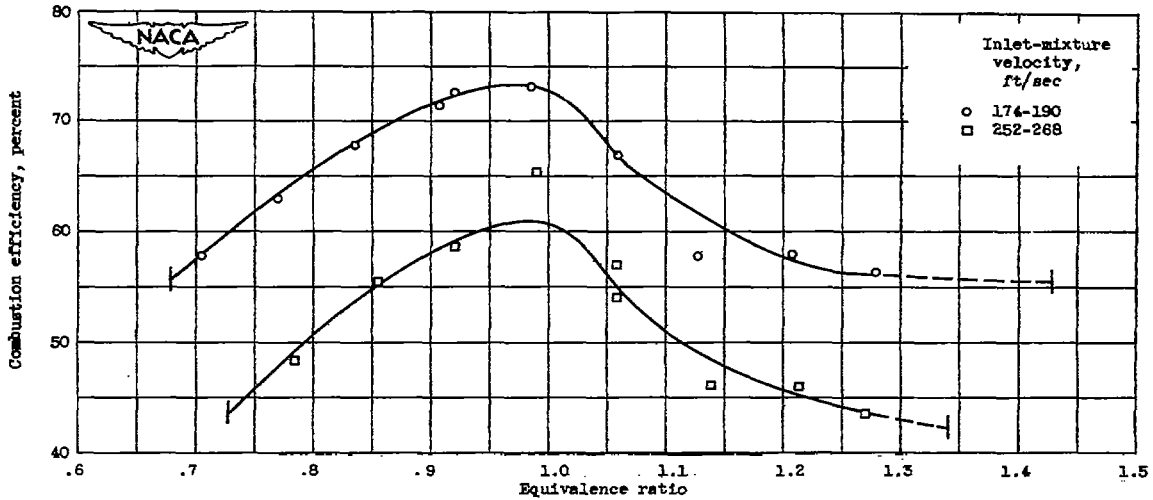

Figure 8. - Combustion efficiency of V-gutter flame holder in 5-inch ram-jet-type combustor with propionaldehyde. Combustor inlet pressure, 0.67 atmosphere; combustor inlet temperature, 590° to 643° R.

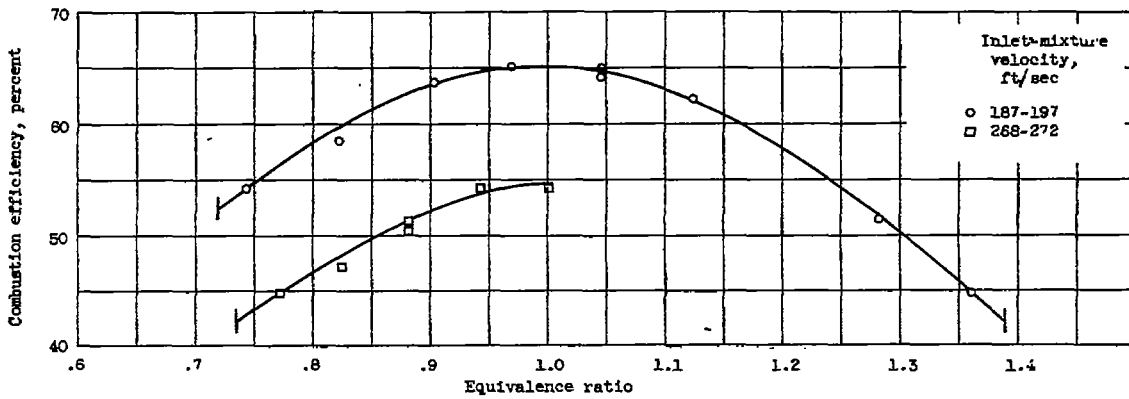

Figure 9. - Combustion efficiency of V-gutter flame holder in 5-inch ram-jet-type combustor with diethylether. Combustor inlet pressure, 0.67 atmosphere; combustor inlet temperature, 522° to 668° R.

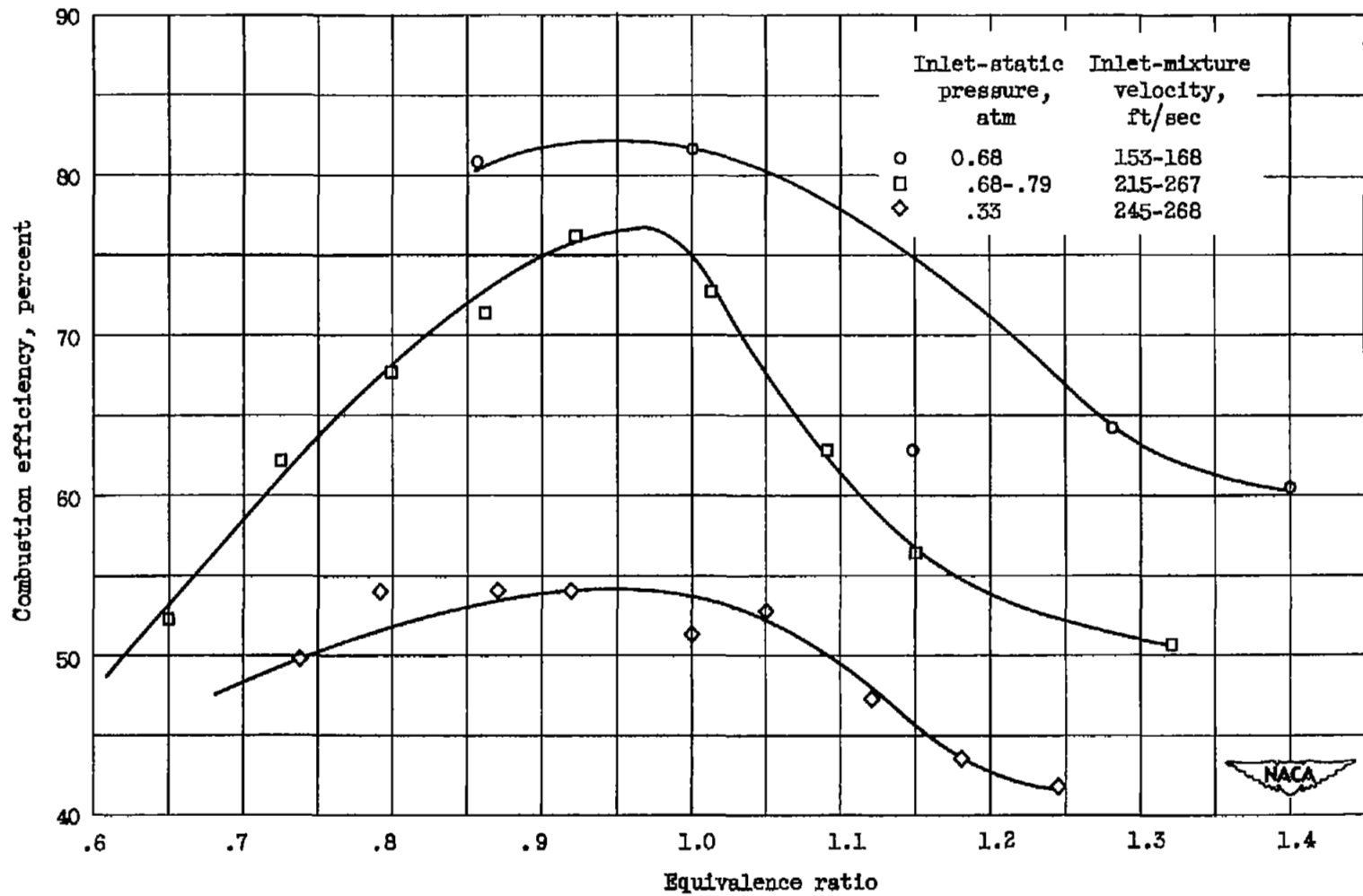

Figure 10. - Combustion efficiency of V-gutter flame holder in 5-inch ram-jet-type combustor with propylene oxide. Combustor inlet temperature, 550° to 643° R.

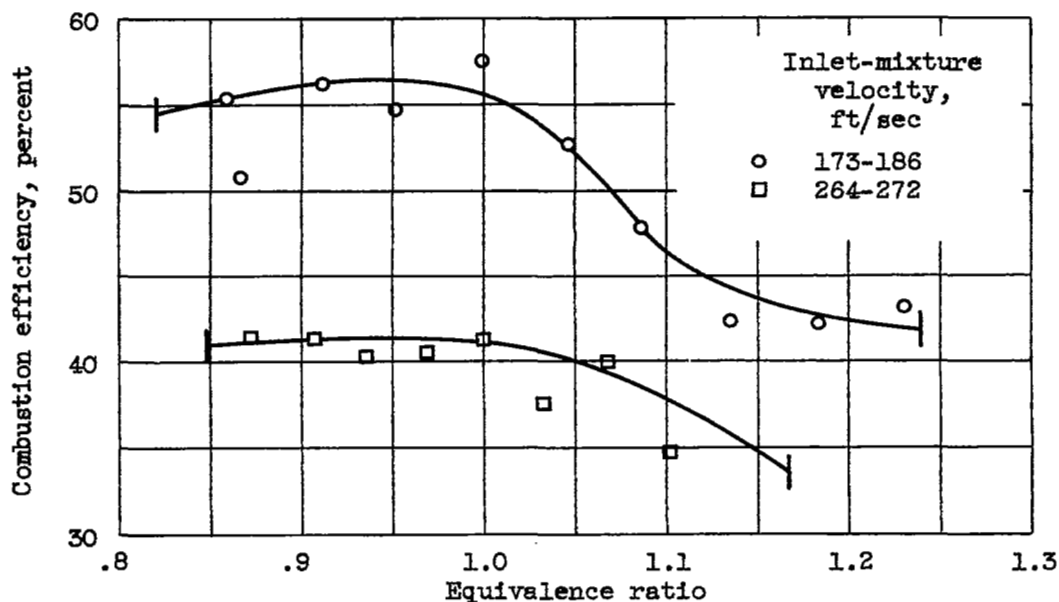

Figure 11. - Combustion efficiency of V-gutter flame holder in 5-inch ram-jet-type combustor with acetone. Combustor inlet pressure, 0.67 atmosphere; combustor inlet temperature, 579° to 624° R.

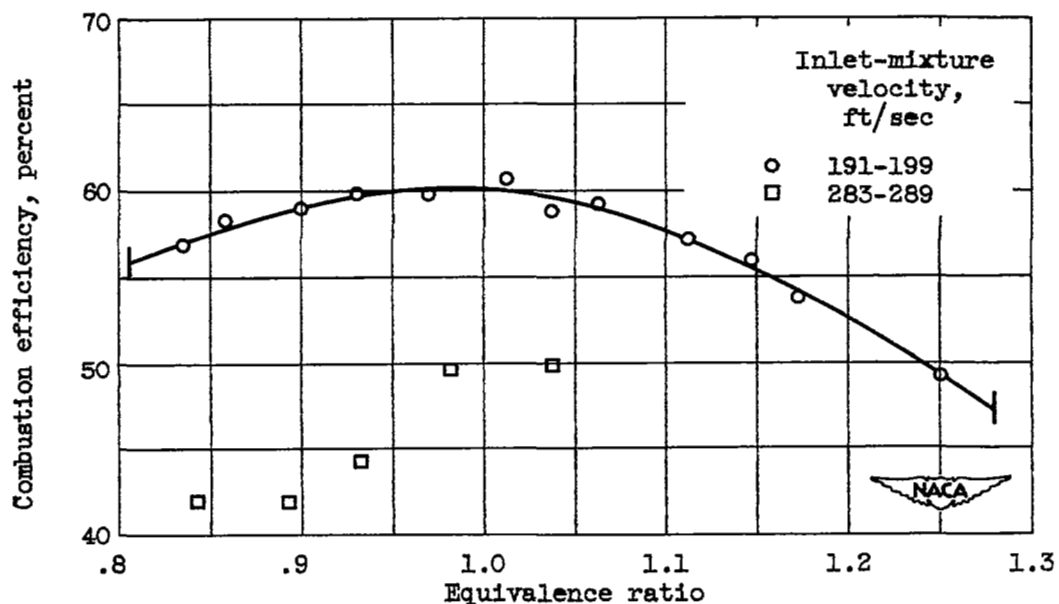

Figure 12. - Combustion efficiency of V-gutter flame holder in 5-inch ram-jet-type combustor with methylcyclohexane. Combustor inlet pressure, 0.67 atmosphere; combustor inlet temperature, 646° to 676° R.

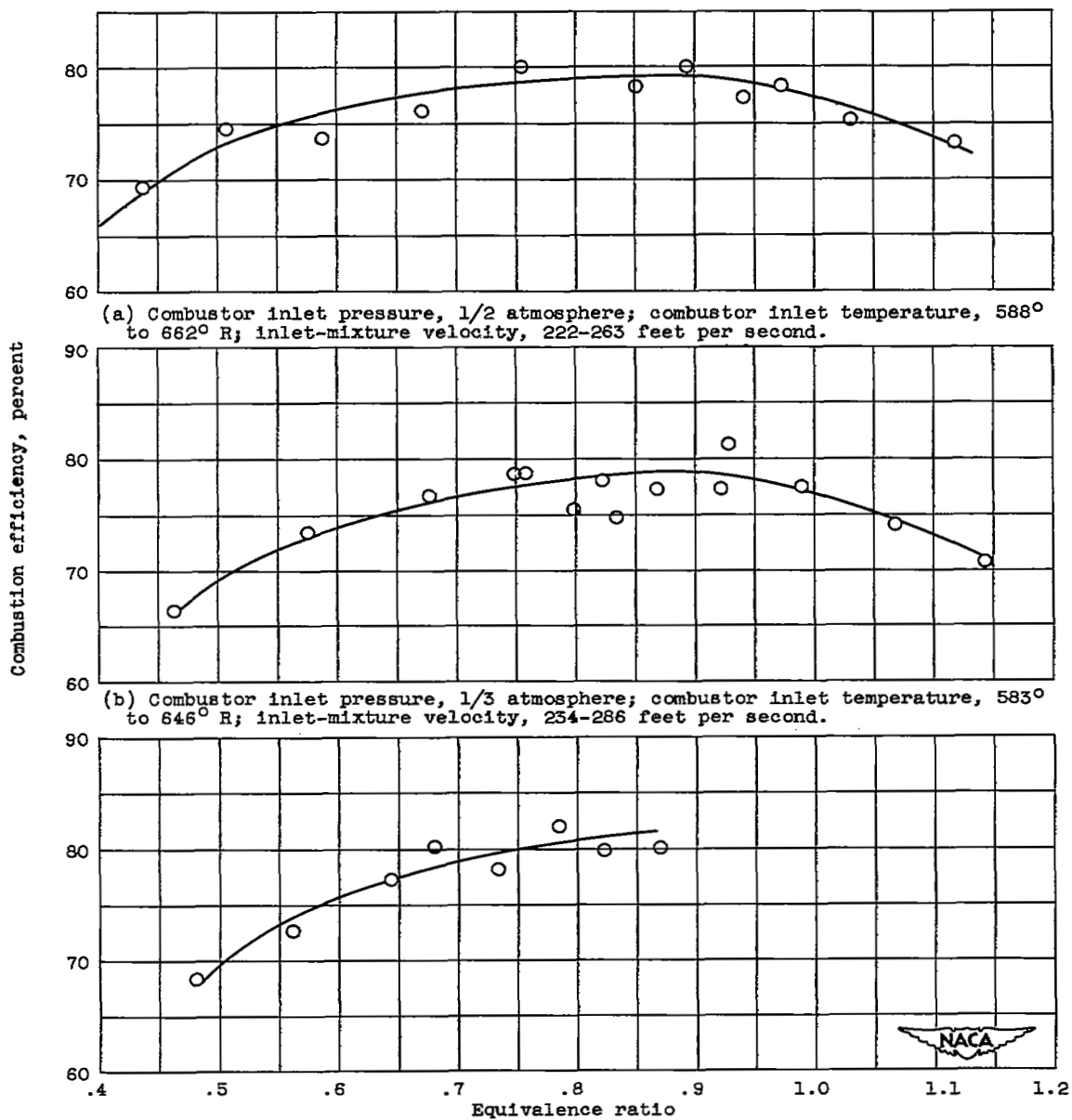

Figure 13. - Combustion efficiency of V-gutter flame holder in 5-inch ram-jet-type combustor with carbon disulfide.

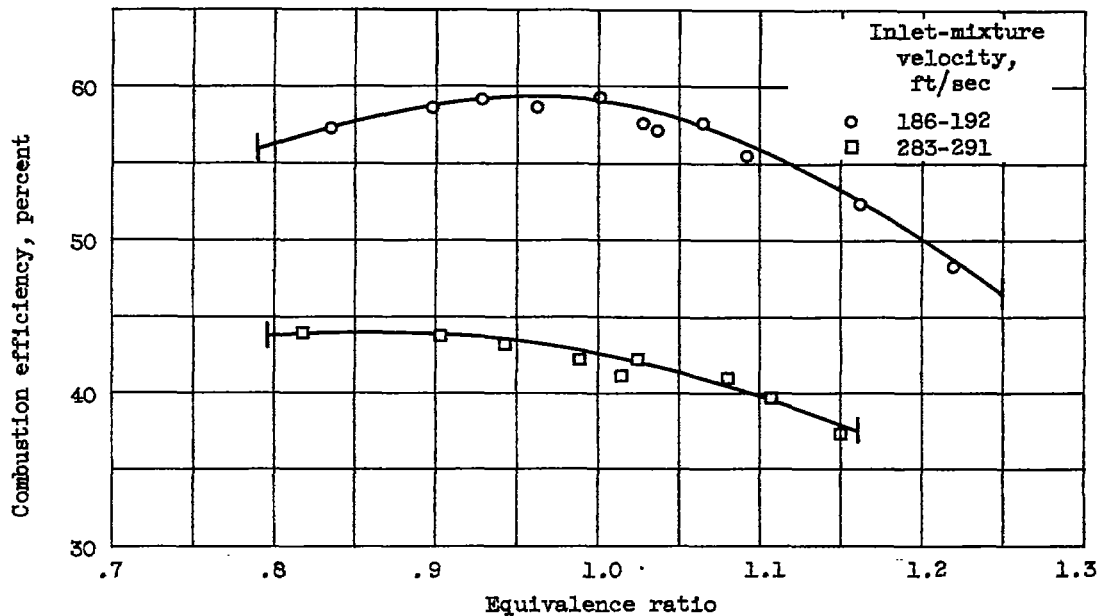

Figure 14. - Combustion efficiency of V-gutter flame holder in 5-inch ram-jet-type combustor with neohexane. Combustor inlet pressure, 0.67 atmosphere; combustor inlet temperature, 652° to 680° R.

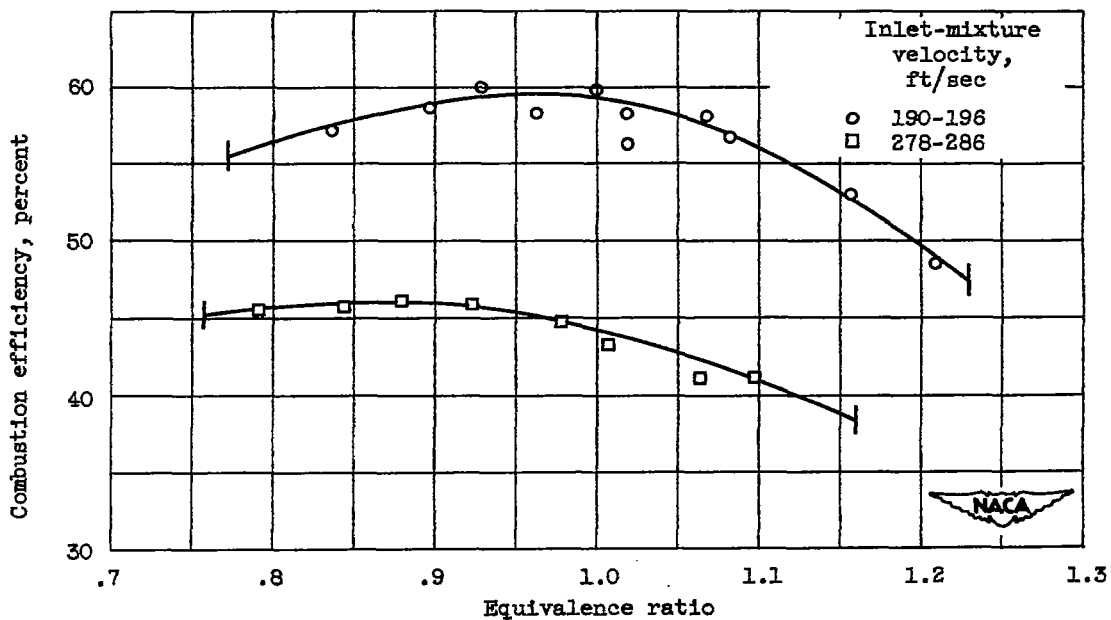

Figure 15. - Combustion efficiency of V-gutter flame holder in 5-inch ram-jet-type combustor with isopentane. Combustor inlet pressure, 0.67 atmosphere; combustor inlet temperature, 665° to 690° R.

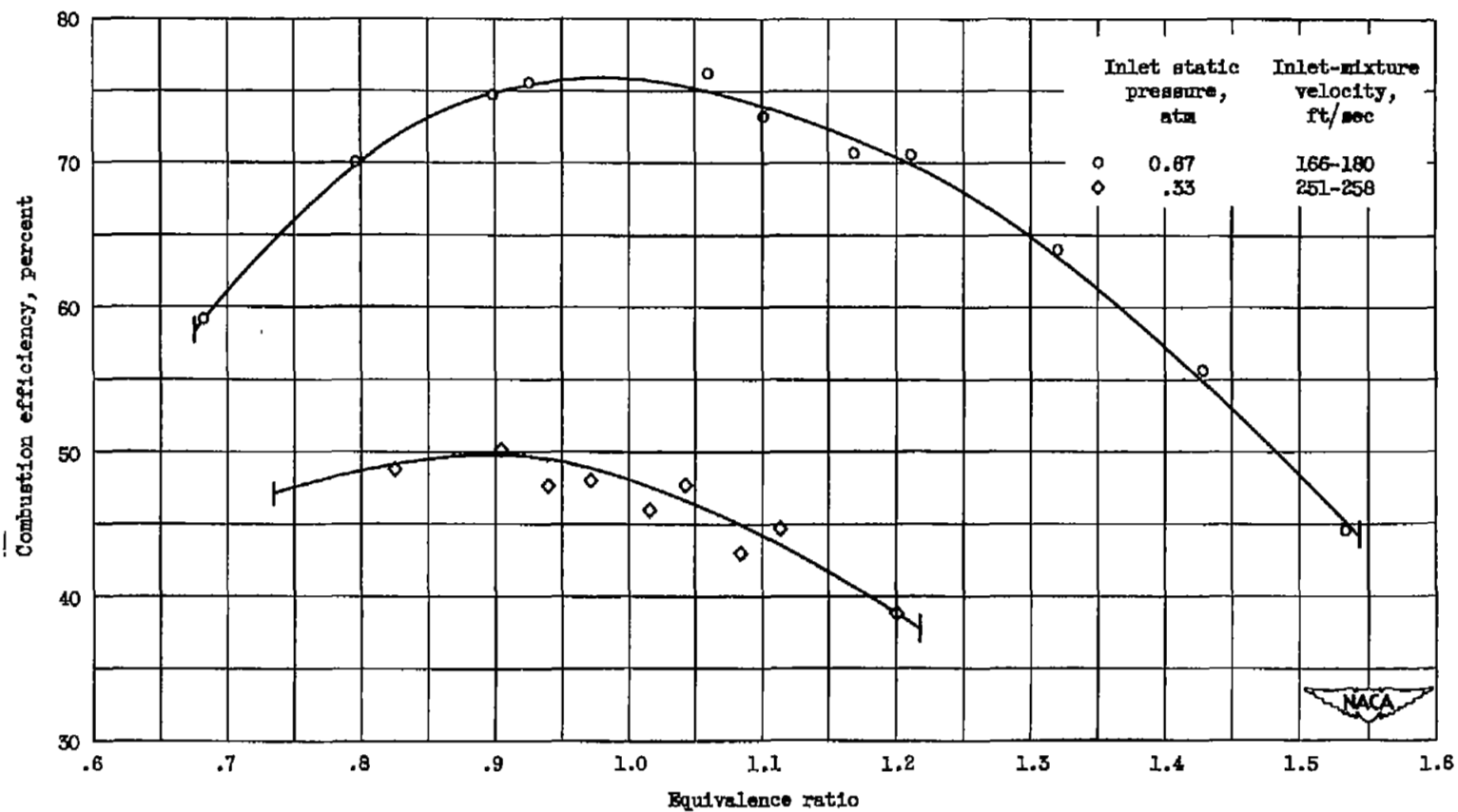

Figure 16. - Combustion efficiency of V-gutter flame holder in 5-inch ram-jet-type combustor with blend of 2/3 propylene oxide and 1/3 isopentane by weight. Combustor inlet temperature, 587° to 644° R.

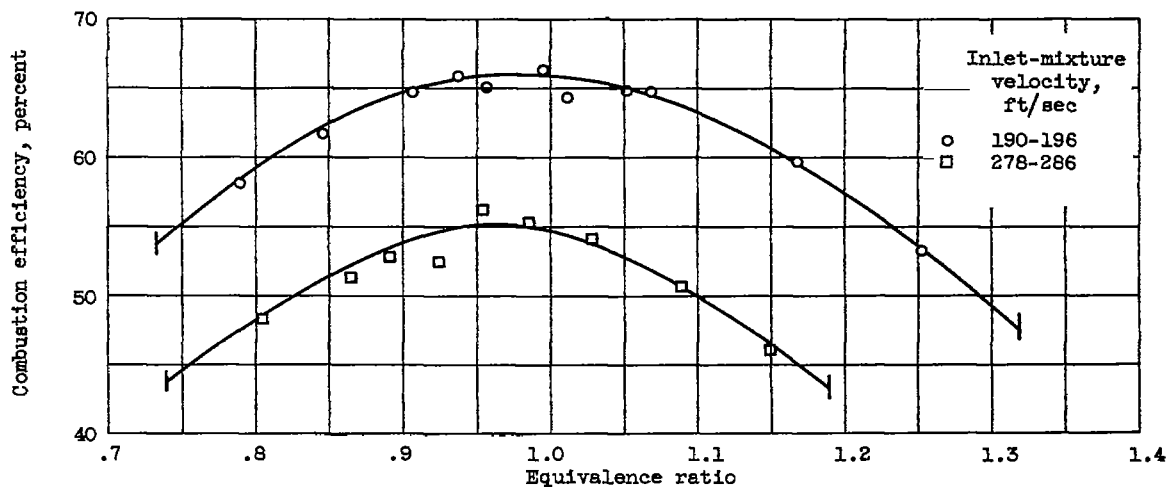

Figure 17. - Combustion efficiency of V-gutter flame holder in 5-inch ram-jet-type combustor with blend of 1/3 propylene oxide and 2/3 isopentane by weight. Combustor inlet pressure, 0.67 atmosphere; combustor inlet temperature, 638° to 676° R.

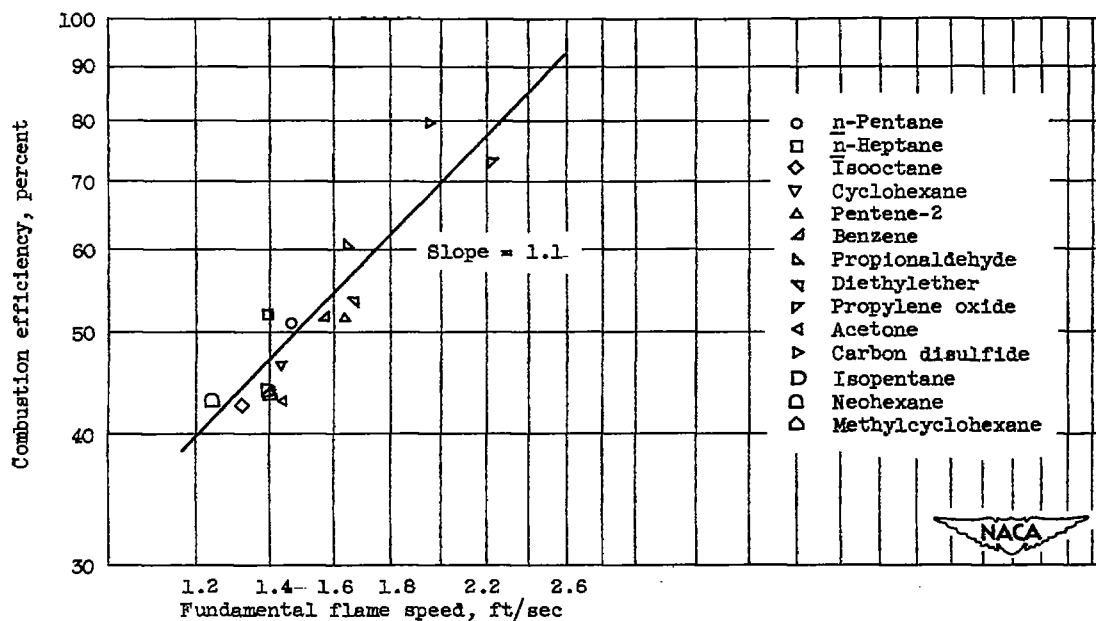

Figure 18. - Effect of fundamental flame speed on combustion efficiency at equivalence ratio of 1.0 and at inlet parameter value $p_0 \cdot 3_T / v_0 \cdot 8$ of about 6.5.

2817

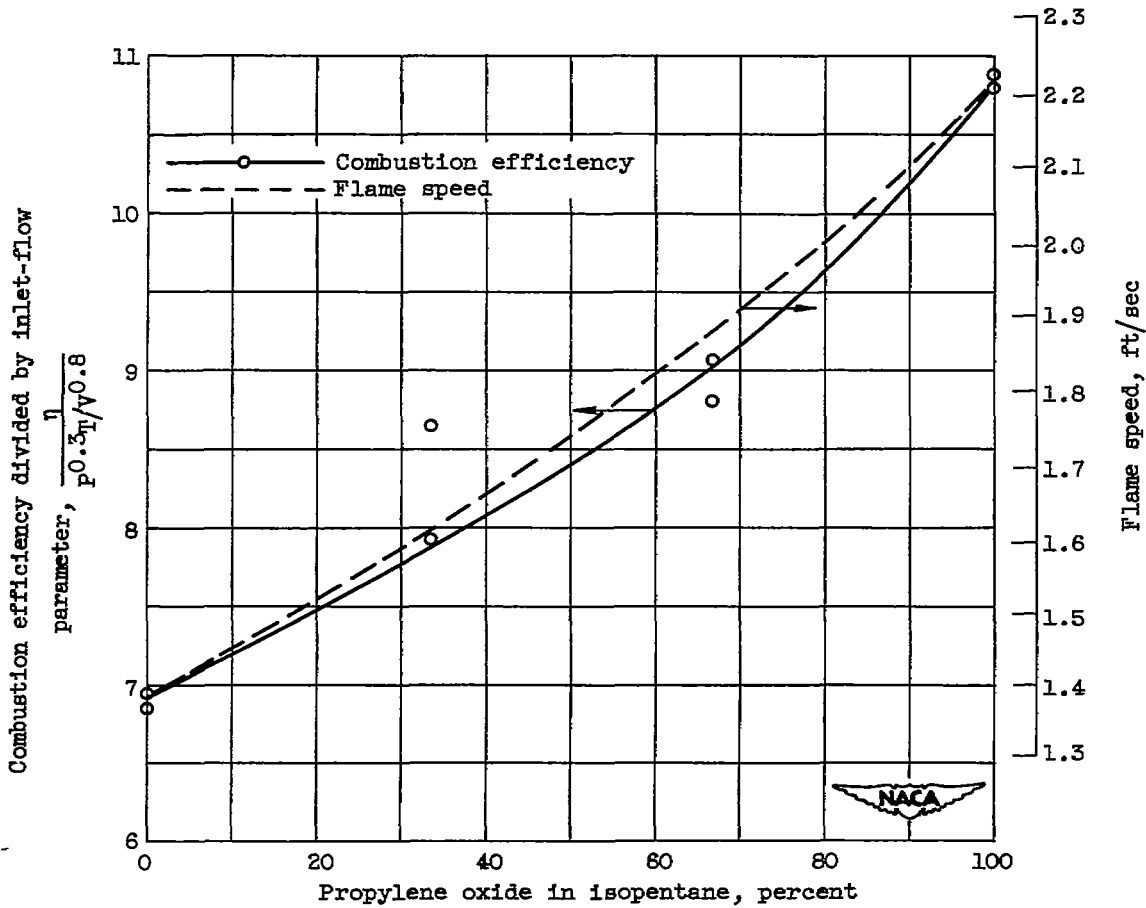

Figure 19. - Effect of blend percentage on combustion efficiency and flame speed of propylene oxide and isopentane blends at equivalence ratio of 1.0.

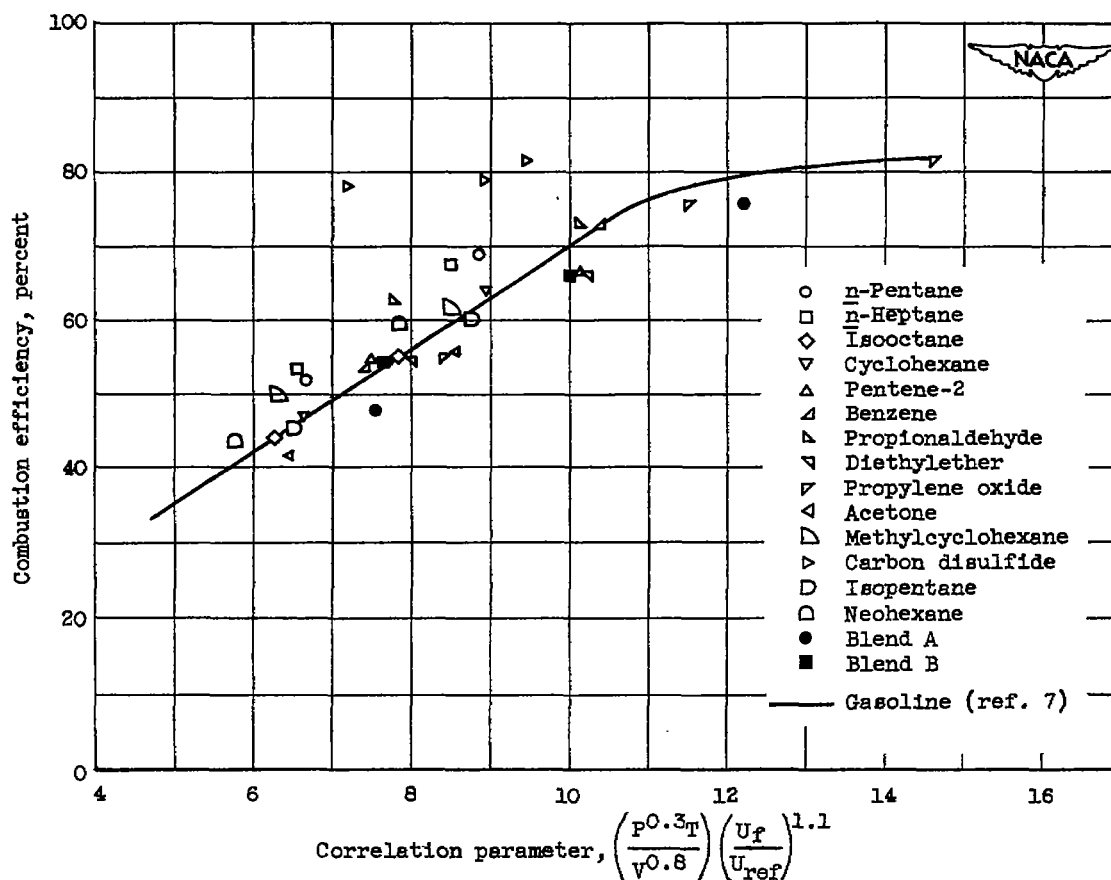



Figure 20. - Correlation of combustion efficiency for V-gutter flame holder in 5-inch ram-jet-type combustor for 14 pure fuels, a gasoline, and 2 fuel blends. (Blend A contains 2/3 propylene oxide plus 1/3 isopentane by weight; blend B, 1/3 propylene oxide plus 2/3 isopentane by weight.)

SECURITY INFORMATION



NASA Technical Library



3 1176 01435 6928

A rectangular label from the NASA Technical Library. It features a barcode in the center, the text "NASA Technical Library" at the top, and the identification number "3 1176 01435 6928" at the bottom. The right side of the label is partially obscured by a dark, textured area.