

FILE COPY
NO. /



REPORT No. 126

**AERONAUTIC INSTRUMENTS
SECTION II**

ALTITUDE INSTRUMENTS



**NATIONAL ADVISORY COMMITTEE
FOR AERONAUTICS**

THIS DOCUMENT ON LOAN FROM THE FILES OF

NATIONAL ADVISORY COMMITTEE FOR AERONAUTICS
LANGLEY AERONAUTICAL LABORATORY
LANGLEY FIELD, HAMPTON, VIRGINIA

RETURN TO THE ABOVE ADDRESS.

REQUESTS FOR PUBLICATIONS SHOULD BE ADDRESSED
AS FOLLOWS:



NATIONAL ADVISORY COMMITTEE FOR AERONAUTICS
1512 H STREET, N. W.
WASHINGTON 25, D. C.

REPRINT OF REPORT No. 126, ORIGINALLY PUBLISHED JULY, 1922

UNITED STATES
GOVERNMENT PRINTING OFFICE
WASHINGTON : 1929

REPORT No. 126

AERONAUTIC INSTRUMENTS

SECTION II

ALTITUDE INSTRUMENTS

IN FOUR PARTS

AERONAUTIC INSTRUMENTS SECTION

Bureau of Standards

REPRINT OF REPORT No. 126, ORIGINALLY PUBLISHED JULY, 1922

NATIONAL ADVISORY COMMITTEE FOR AERONAUTICS

NAVY BUILDING, WASHINGTON, D. C.

(An independent Government establishment, created by act of Congress approved March 3, 1915, for the supervision and direction of the scientific study of the problems of flight. It consists of 15 members who are appointed by the President, all of whom serve as such without compensation.)

JOSEPH S. AMES, Ph. D., *Chairman.*
President, Johns Hopkins University, Baltimore, Md.
DAVID W. TAYLOR, D. Eng., *Vice Chairman.*
Washington, D. C.
CHARLES G. ABBOT, Sc. D.,
Secretary, Smithsonian Institution, Washington, D. C.
GEORGE K. BURGESS, Sc. D.,
Director, Bureau of Standards, Washington, D. C.
WILLIAM F. DURAND, Ph. D.,
Professor Emeritus of Mechanical Engineering, Stanford University, California.
JAMES E. FECHET, Major General, United States Army,
Chief of Air Corps, War Department, Washington, D. C.
WILLIAM E. GILLMORE, Brigadier General, United States Army,
Chief, Matériel Division, Air Corps, Wright Field, Dayton, Ohio.
HARRY F. GUGGENHEIM, M. A.,
President, The Daniel Guggenheim Fund for the Promotion of Aeronautics, Inc., New
York City.
EMORY S. LAND, Captain, United States Navy.
WM. P. MACCRACKEN, Jr., Ph. B.,
Assistant Secretary of Commerce for Aeronautics.
CHARLES F. MARVIN, M. E.,
Chief, United States Weather Bureau, Washington, D. C.
WILLIAM A. MOFFETT, Rear Admiral, United States Navy,
Chief, Bureau of Aeronautics, Navy Department, Washington, D. C.
S. W. STRATTON, Sc. D.,
President Massachusetts Institute of Technology, Cambridge, Mass.
EDWARD P. WARNER, M. S.,
Cambridge, Mass.
ORVILLE WRIGHT, Sc. D.,
Dayton, Ohio.

GEORGE W. LEWIS, *Director of Aeronautical Research.*
JOHN F. VICTORY, *Secretary.*
HENRY J. E. REID, *Engineer in Charge, Langley Memorial Aeronautical Laboratory,*
Langley Field, Va.
JOHN J. IDE, *Technical Assistant in Europe, Paris, France.*

EXECUTIVE COMMITTEE

JOSEPH S. AMES, *Chairman.*
DAVID W. TAYLOR, *Vice Chairman.*

CHARLES G. ABBOT.	CHARLES F. MARVIN.
GEORGE K. BURGESS.	WILLIAM A. MOFFETT.
JAMES E. FECHET.	S. W. STRATTON.
WILLIAM E. GILLMORE.	ORVILLE WRIGHT.
EMORY S. LAND.	

JOHN F. VICTORY, *Secretary.*

REPORT No. 126

ALTITUDE INSTRUMENTS

PART I

ALTIMETERS AND BAROGRAPHS

By A. H. MEARS, H. B. HENRICKSON, AND W. G. BROMBACHER

REPRINT OF REPORT No. 126, ORIGINALLY PUBLISHED JULY, 1922

INTRODUCTION

This report is Section II of a series of reports on aeronautic instruments (Technical Reports Nos. 125 to 132, inclusive) prepared by the aeronautic instruments section of the Bureau of Standards under research authorizations formulated and recommended by the subcommittee on aerodynamics and approved by the National Advisory Committee for Aeronautics. Much of the material contained in this report was made available through the cooperation of the War and Navy Departments.

This part discusses briefly barometric altitude determinations, and describes in detail the principal types of altimeters and barographs used in aeronautics during the recent war. This is followed by a discussion of performance requirements for such instruments and an account of the methods of testing developed by the Bureau of Standards. The paper concludes with a brief account of the results of recent investigations.

Altimeters and barographs are used for determining the altitude of aircraft above the ground, the former giving direct indications on a dial, and the latter furnishing a continuous record on a chart.

For accurate measurements of altitude, reference must also be made to thermometer readings of atmospheric temperature, since the altitude is not fixed by atmospheric pressure alone. This matter is discussed in the following section on barometric altitude determination. Obviously, any instrument which purports to determine altitude solely from observations of atmospheric condition is liable to some uncertainty unless very complete observations of the state of the atmosphere are taken throughout the entire period of time and over the entire region of space corresponding to the flight, including simultaneous observations on the ground.

Thus the determination of the most probable altitude from barometric observations requires an elaborate system of observations and intricate computations. Fortunately for many purposes extreme accuracy is not necessary. It is possible to make altitude observations by direct reading of the altimeter without any computations or supplementary observations, provided an accuracy of 10 or 15 per cent is deemed sufficient. This is done by having the altimeter dial graduated directly in altitude units, based on the assumption of some particular constant value for atmospheric temperature.

BAROMETRIC ALTITUDE DETERMINATION.

It is a comparatively simple matter to deduce mathematically the relation connecting pressure, temperature, and altitude for a perfectly stationary atmosphere treated as an ideal gas. If proper account is taken of the actual variation of temperature vertically throughout the air column such a relation will be sufficient for most purposes of altitude determination. This relation may be referred to as the general altitude equation, which may be written in either of the forms

$$h = -\frac{R}{g} \int_{p_0}^p \theta \frac{dp}{p} \quad (1)$$

or

$$\int_0^h \frac{dh}{\theta} = \frac{R}{g} \log_e \frac{p_0}{p} \quad (2)$$

Evidently the choice between the two forms in any practical problem depends whether the absolute temperature, θ , has been given as a function of pressure p or as a function of altitude h . In the foregoing equations R is the gas constant which occurs in the characteristic equation of an ideal gas—

$$pv = R\theta \quad (3)$$

where v is the specific volume (reciprocal of density); g denotes as usual the acceleration of gravity; and p_0 represents the barometric pressure at the ground, where the altitude h is zero.

An example of a case where the temperature is given as a function of pressure is found in Radau's law. This is the empirical law assumed in graduating the dials of most of the altimeters manufactured in France. Evidently when θ is given explicitly as some algebraic function of p with numerical constants, the integration can be completely worked out. Upon substituting suitable numerical values for the actual gas constant of the atmosphere R and for gravity g in appropriate units, there results a definite working formula connecting altitude with pressure.

Radau's law makes the temperature a linear function of pressure. The advantages, however, of assuming the temperature to be a linear function of altitude rather than pressure have recently been urged by some authorities, and in this case the other form of the general equation would be used.

The chief value of the general relation given above is, however, for the determination of probable altitude in cases where the temperature variation has not been given mathematically but by actual observations taken throughout the flight. In such instances the integration may be worked out graphically or by some numerical step-by-step method. Unless the temperature has been actually observed all the way up the air column, it is of course impossible to arrive at any very accurate altitude determination.

So much for the use of the general altitude equation as it stands. This relation may also be simplified or extended. An example of the altitude pressure relation when reduced to its very simplest form is found in the graduation of British and American altimeters.

In both cases this simplification consists in assuming for the air column a strictly uniform temperature of 50° F. (10° C.). Thus the temperature comes outside of the integral sign, making the altitude proportional to the logarithm of the pressure ratio. The value of the gas constant and other constants adopted from the Smithsonian Meteorological Tables as a basis for American practice are such as to lead to the formula:

$$h = 62900 \log_{10} \frac{29.90}{p} \quad (4)$$

In this equation, h represents the altitude in feet corresponding to a pressure p in inches of mercury. All American altimeter dials are graduated in accordance with this formula. British altimeters are graduated by means of substantially the same formula, the difference being negligible for practical purposes.

While British and American altimeter scales are in substantial agreement, those adopted on the continent of Europe differ considerably and are not interchangeable.

When the available data and the importance of the determination warrant an extension of the general altitude relation, some of the factors which may well be taken account of are the following: Variation of barometric pressure on the ground during the time of flight; variation of the gas constant or even departure from the law of an ideal gas, due to humidity; effect of the wind in modifying the normal static distribution of pressure; small correction for variation of gravity with altitude, etc.

The foregoing discussion is intended to indicate some of the difficulties inherent in the determination of altitude from a knowledge of barometric pressure even if the pressure-measuring instrument itself were mechanically perfect.

PRINCIPLES OF ALTIMETER CONSTRUCTION.

The altimeter is not necessarily different from any other form of aneroid barometer except that the principal scale on the dial is graduated in altitude units, while the pressure scale is usually omitted. As a matter of fact the altitude scale is usually also a scale of equal parts. This is a great convenience because it would otherwise not be mathematically legitimate for the altitude scale to be rotated in order to make the zero setting at the start of the flight. This error in design occurs in the older forms of aneroid barometer, such as the familiar pocket size used in surveying and mountain climbing, in which the pressure scale is usually equally spaced. Consequently the 1,000-foot intervals on the altitude scale are about twice as close together in the neighborhood of the 20,000-foot point as they are at sea level, in accordance with the logarithmic relation (equation 4). Suppose, now, that the pressure on the ground has shifted half an inch from its normal value. With the older style aneroid, having a movable altitude scale on the bezel ring, the zero setting would naturally be made by turning the scale half an inch of pressure, which means about 500 feet at sea level but about 1,000 feet at the other end if the total altitude is, say, 20,000 feet. Thus an error of 500 feet is inadvertently introduced. For accurate work an unequally spaced altitude scale should not be rotated. It should be clamped in position and the altitude found by subtracting the initial altitude reading (on the ground) from the final altitude reading (at the top of the climb).

This awkward procedure is eliminated in the altimeter, where the equally spaced divisions of the altitude scale do permit rotation. The action of an altimeter is otherwise similar to that of any aneroid barometer.

The essential parts of an aneroid are the pressure measuring element, the transmission or multiplying mechanism, and the indicating element. In addition, auxiliary devices are sometimes introduced to compensate for possible sources of error, notably temperature changes. Throughout the discussion of the different altimeter designs which follows later, the description will in every case be taken up successively with reference to these four features; namely, the pressure element, the mechanism, the indicating element, and the compensation.

While one of the earliest forms of aneroid employed a Bourdon tube for the pressure element, the forms adopted in aviation invariably have for the pressure element some combination of flexible diaphragm and stiff steel spring. The springs serve to weigh the total force due to air pressure acting on the diaphragms, after the fashion of any spring balance. The larger the diaphragm, the greater will be the total force available to actuate the spring. As a general principle, in instruments of this class a large force action is desirable in order that friction and similar sources of error may have a relatively small influence. The diaphragm boxes or capsules are commonly called vacuum boxes, because there is usually a fairly high vacuum inside the box. This would not be necessary so far as the mechanical operation of the instrument is concerned, provided the temperature could be held constant. The practice of exhausting the boxes to a high degree is merely to avoid change of pressure due to expansion or contraction of the confined air when heated or cooled. The diaphragms are corrugated in order to make them more flexible. They are commonly constructed of German silver (nickel brass) although other materials have been used to a less extent.

The mechanism for multiplying the motion of the spring, so that a large deflection of the pointer may be realized, has been developed in a great variety of forms. The numerical multiplying power ranges in different types from about 200 to 800. Various combinations of levers, sometimes together with cam motions or gearing, will be found in the descriptions which follow.

The indicating element in altimeters consists ordinarily of a pointer moving over a graduated dial. Various methods are used for graduating the dial and controlling the zero adjustment. The microscopes, verniers, and micrometer screws which have been used on surveying aneroids are not found in the aviation type. Optical indicating devices have been tried but are not in common use.

The compensation of altimeters almost invariably includes static balancing of the mechanism by counterweights so as to overcome as far as possible the error due to inclination

of the instrument, or to linear accelerations. If not otherwise specified it may be assumed that such balancing has been satisfactorily accomplished. Angular accelerations are also always present at the instrument board of an airplane. Compensation for such accelerations is more difficult, and seems not to have been seriously attempted except in a recent French instrument. Some of the altimeters developed at the beginning of the war were rejected on account of faulty balancing in this respect.

Temperature compensation is frequently provided for by the bimetallic method, or by regulating the amount of air in the vacuum box when the instrument is manufactured, or by both methods. The bimetallic method consists in providing a compound bar in some part of the lever system; for example, a brass lever with a thin steel strip welded onto it. Change of temperature produces curvature in such a bar if normally straight; and it should be so designed that the amount of curvature per unit change of temperature will compensate for the deflection of the pointer which would otherwise take place at constant pressure due to temperature change. It will be observed that this form of compensation does not necessarily compensate for the change in the sensitivity of the instrument with temperature. Even if an instrument is so compensated that the pointer will not respond to temperature changes while the pressure is constant, it is still possible that the amount of deflection for unit change of pressure will be different at different temperatures. Without bimetallic compensation there may be a partial degree of compensation, satisfactory over a very limited temperature interval at atmospheric pressure, provided for by the admission of air into the vacuum box before sealing it up.

ALTIMETERS OF THE D-SPRING TYPE.

SHORT & MASON.



FIG. 1.—Short & Mason altimeter.

One of the oldest and best known aneroid movements is the Short & Mason (fig. 1). The Tycos altimeter, the Neko produced during the war, and several other British instruments such as the A. T. Reynolds, and S. Smith & Sons altimeters are substantially identical in general design with the Short & Mason instrument so far as a brief description would show.

These instruments form the principal group coming under what is known as the D-spring type. The Short & Mason instrument will be taken as an example and described in detail. Other instruments

need be described only so far as they deviate from this one.

Figure 2 shows a top and side view assembly drawing of the Short & Mason altimeter. The large steel mainspring (10) has somewhat the form of a letter D in cross section and is known to the trade as a D-spring; hence the designation of this type of construction. Historically the original form of this mechanism, in its main features, was devised by Naudet in France. The present Naudet altimeter will be described later.

The pressure element in the Short & Mason altimeter consists of the D-spring (10), together with one vacuum box which is coupled to it by means of a knife-edge. The vacuum box is made up of two corrugated diaphragms which are formed so as to overlap at the rim where they are joined together by soldering. The bottom diaphragm is attached to the base plate (6) by means of a very stout screw and nut (15). If the top and bottom were not forcibly held apart during exhaustion the vacuum box would collapse under atmospheric pressure. The tension in the mainspring is so adjusted by the carriage screws (8 and 9) as to hold the top and bottom diaphragms approximately parallel under normal atmospheric pressure—if anything, slightly concave. If the air pressure is now decreased, as it will be in flying to a higher altitude, the atmospheric pressure on the surface of the vacuum box diminishes, relieving the tension on the spring and allowing the free end to deflect upward. This movement is of the order of 1 millimeter in 20,000 feet of altitude.

The movement of the free end of the mainspring is transmitted to the pointer by means of the multiplying mechanism. This, in the Short & Mason instrument, begins with the main

lever (32) and a floating link (20) which connects the end of the main lever with the regulator spindle (17). The link is not attached to the rigid part of the regulator spindle but to the regulator spring (18), which is a flexible strip offset from the axis of rotation of the regulator spindle by a distance fixed by the position of a small adjusting screw shown in the drawing. Thus the upward motion of the D-spring due to a diminution of air pressure causes the floating link (20) to pull up on the regulator spring, thus rotating the regulator spindle counterclockwise in the drawing. From the middle of the regulator spindle a straight lever (19) projects in an upward direction. A fine brass chain (48) transmits the movement of the upper end of this lever (19) over to the chain arbor (49). The chain winds and unwinds on this arbor, which is connected with a hairspring (43) for taking up lost motion. The chain arbor forms a solid part of the pointer spindle (47). Thus the motion of the vacuum box and spring is transmitted successively through the main lever (32), the link (20), the regulator spindle (17), the lever (19), chain (48), and chain arbor (49) to the pointer or hand (52) which moves over the graduated dial (4).

From the side-view drawing in figure 2 it will be seen that the initial position of the lever (19) has a good deal to do with the uniformity of the altitude scale. The multiplying power may be constant in an ordinary aneroid, but must be made to vary logarithmically in the altimeter. This is not always a simple matter and constitutes one of the reasons for the great variety of multiplying mechanisms in existence.

The indicating element of the Short & Mason instrument consists of the pointer (52); the dial (4), which is movable and which carries the altitude graduations; and the dial (5) which is stationary but not graduated. Teeth are cut in the outside circumference of the movable dial which mesh with pinion (31). This pinion is actuated by means of the knurled knob (28). In order, therefore, to adjust the zero point of the altitude scale to coincide with the position of the pointer at the start of a flight it is only necessary to turn the knob (28).

The temperature compensation of the Short & Mason instrument is accomplished at sea-level pressure by the usual bimetallic method. The main lever (32) has a thin steel strip (33) welded onto the top side. For this reason the main lever is commonly known as the compound bar.

The details referred to in figure 2 may also be recognized in the photographic view of the dismantled Short & Mason altimeter (fig. 3).

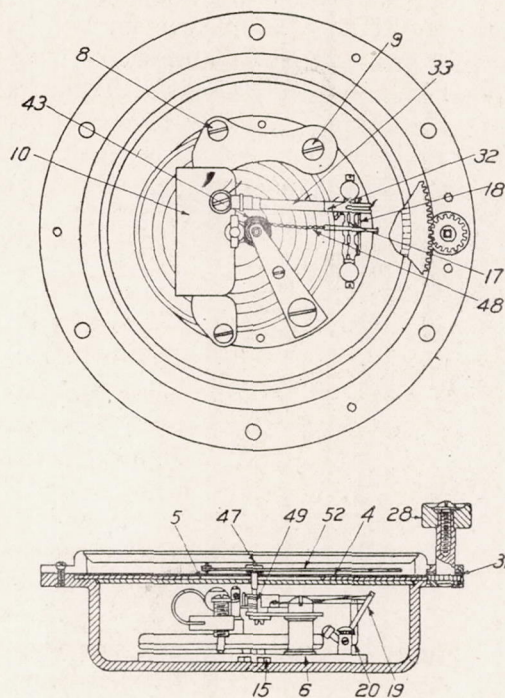

FIG. 2.—R. A. F. Mark V aneroid.

SCHNEIDER.

In the Schneider altimeter the pressure element is substantially the same as in the Short & Mason type. In place of the Maxwell point, groove, and plane mounting of the spring carriage, the carriage is held in position by three screws, two of which end in points, and the third in a polished plane. Lock nuts are provided on the carriage screws. This company has also made aneroids with steel vacuum boxes.

The multiplying mechanism, although similar in arrangement to the Short & Mason, is different in one respect: The chain arbor block is machined with a spiral groove of variable radius so as to produce a uniformly spaced altitude scale.

The indicating element is similar to the usual form but without the stationary dial.

The temperature compensation is bimetallic. Ordinarily the bimetallic bar has been incorporated in the main lever, but in some samples the lever from the regulator spindle has been used instead.

NAUDET.

The Naudet instrument (fig. 4) is simply a modification for aeronautic use of the original aneroid barometer of the D-spring type, which they were the first to develop. The descriptions of the Short & Mason instrument above will serve to give an idea of the essentials of the Naudet construction.

The pressure element differs from the Short & Mason in that the main spring carriage is swung on cylindrical bearings. The modified form of the regulator spindle in this instrument should be noted (fig. 4). The regulator spring (18) is free to move about an axis perpendicular to the axis of the regulator spindle (17) and is therefore capable of adjustment in two planes. This adjustment is obtained by means of screws (21) and (21a).

Only one dial is provided, which is movable and is graduated in meters. The usual bimetallic compensation is provided.

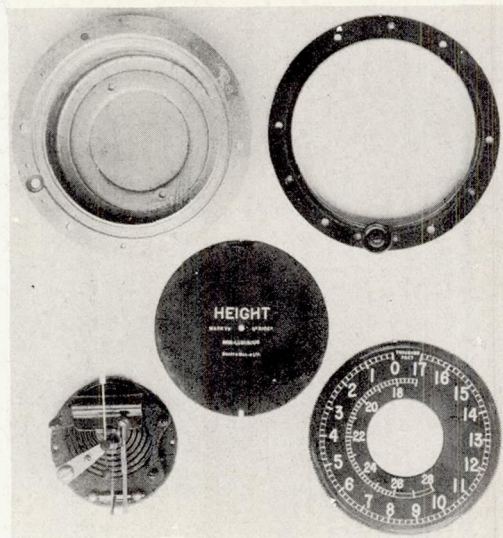

FIG. 3.—Short & Mason altimeter disassembled.

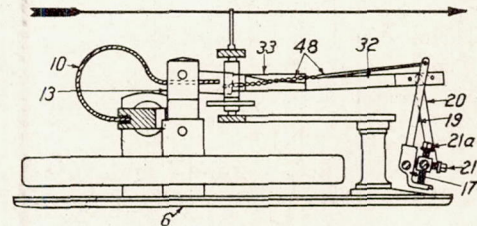
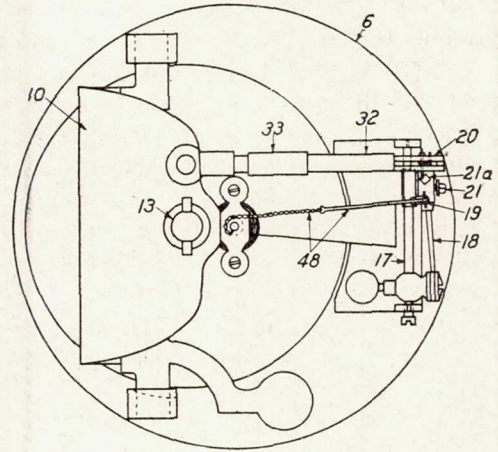

FIG. 4.—Diagram mechanism of Naudet altimeter.

COLOMBEL.

Another French altimeter is very similar to the Naudet. In addition to the movable altitude scale, there is also provided a stationary dial graduated in millimeters of mercury.

The pointer of this instrument may be set to the true pressure by means of the adjustment of the carriage screw. This is accomplished by adjusting the regulator screw through a hole in the bottom of the instrument case, as is the practice in surveying and weather aneroids.

KNUDSEN.

This instrument of Danish construction has a pressure element similar to the others except that the center portion of the spring is machined out.

The multiplying mechanism is also different. In place of the usual regulator spring there is a pin which slides in and out of a transverse hole in the regulator spindle and which is clamped in position by a set screw.

The movable altitude dial graduated in meters is rotated by means of the knurled bezel. It moves over a stationary dial, a small sector of which is graduated in millimeters. . . The temperature compensation is bimetallic.

GERMAN ALTIMETER.

This altimeter (monogram GL) has been found in two slightly different forms (figs. 5 and 6). The carriage screws point upward and fit in conical cups in the carriage. The carriage-adjusting screw is placed in the base of the instrument and acts against the arm of the carriage.

The chain and hairspring are arranged contrary to the usual manner so that the pointer moves clockwise for increasing altitude. The main lever connecting the D-spring with the mechanism is threaded, thus allowing adjustment of its length. The regulator spindle and spring are made in one piece of metal. The hairspring is of phosphor bronze.

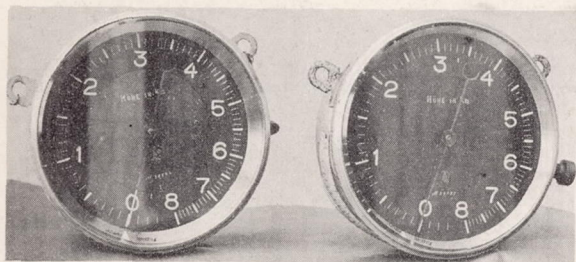

FIG. 5.—German altimeters.

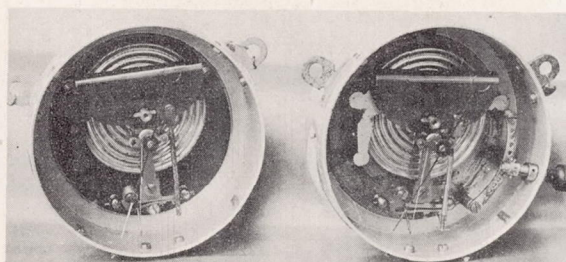

FIG. 6.—German altimeters with dial removed.

In the two forms referred to, only the indicating element is essentially different. One type has both a stationary and movable dial. The movable dial is rotated by pushing on a projecting knob which comes out sideways through a slot in the case. In a later form there is only a single dial, which is fixed to the case. The entire aneroid mechanism is revolved by a simple form of gearing shown in the photograph (fig. 6) operated by a knob on the outside of the case. The usual bimetallic compensation is provided.

OTTO BOHNE.

The pressure element of this altimeter has carriage screws pointing upward and fitting in conical cup and slot. The carriage adjusting screw is in the base of the instrument as in the other German altimeter. There is a link between the vacuum box and the D-spring as in the De Giglio altimeter.

The regulator spindle and spring are made in one piece of metal. The indicating element is provided with both a pressure scale graduated in millimeters and a movable altitude scale graduated in meters rotated by gearing and knurled knob. The temperature compensation is bimetallic.

HELICAL SPRING TYPE.

RICHARD AND SIMILAR INSTRUMENTS.

The helical-spring type is well exemplified by the Richard instrument. It differs from the D-spring type in that the mainspring consists of a vertical helical spring under compression. The spring is not directly coupled to the vacuum box, but the downward pull of the vacuum box is transmitted to the helical spring through a flat plate having its fulcrum on two steel points. The movement is shown in figure 7. The diaphragm (11) is coupled to the flat plate lever (7) by the knife-edge (14) working on a steel collar (14a). The tension of the helical spring (10) is varied by the screw fitting on which the spring rests. This can be adjusted by means of a screw reached through a hole in the base of the instrument.

Any movement of the diaphragm (11) is multiplied in the ratio about five to one at the end of the long lever arm. This movement is transmitted through the multiplying system through the pin (20). This pin strikes the curved surface of a cam causing it to rotate about the axis (25). Attached to the cam is a flat brass pin (19) whose motion is transmitted by contact with an arm projecting from the sector gear (48). The teeth of this sector gear mesh

with a small pinion on the pointer spindle. Backlash is taken up by a spiral hairspring. Thus the movement of the top of the vacuum box is transmitted to the cam through contact with a pin; the rotation of the cam and upright pin (19) transmits the movement to the sector gear, thence to the pointer spindle.

The indicating element consists of a movable dial graduated in meters revolving over a stationary dial graduated in millimeters.

Temperature compensation is accomplished by the relative expansion of the brass and steel parts of the movement, but without any bimetallic bar.

HATOT.

In this instrument, also of French construction, special care is taken with the mounting of the flat plate lever or carriage (see fig. 8). The carriage screws are of steel with sharp points and are held in small cylindrical brass posts inserted into the base plate.

The bearing surface for the carriage screws are small cylindrical pieces of steel inserted into the carriage plate and are cupped to receive the points of the carriage screws. The connection of the diaphragm to the carriage plate should be noted. There is a square hardened steel pin inserted transversely in the diaphragm pillar similar to the ordinary knife-edge. The surface of this pin facing the diaphragm is cupped to receive two steel points which are inserted in the carriage.

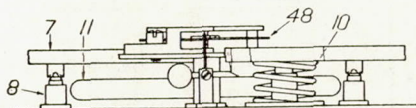
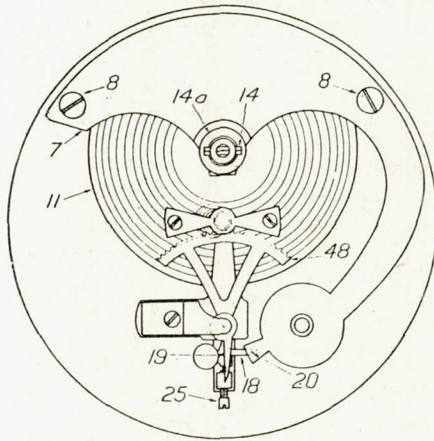

FIG. 7.—Diagram for Richard altimeter.

The diaphragm is held distended by a helical spring as in the case of the Richard. The tension of this spring can be adjusted by means of a screw which raises and lowers a brass fitting on which the spring rests.

Referring to figure 8, there is shown a screw in the offset from the circular head of the carriage plate. In the end of this screw a steel pin is inserted eccentrically. This steel pin rests on the polished face of the multiplying lever. By rotating the screw that holds the steel pin the multiplying ratio can be adjusted.

The multiplication of the motion of the carriage is accomplished in the following manner: The steel pin in the carriage rests on the polished steel surface of a lever shaped somewhat like a bell crank. The other arm of the bell crank is in the form of a steel knife-edge, and takes the place of the upright pin of the Richard instrument. This lever is counterbalanced. The steel knife-edge is in contact with the tail of a toothed sector. The motion is transmitted to the indicating hand by the sector meshing with a pinion mounted on the same arbor shaft with the hand. A tension is maintained on this lever by means of a light steel spring. Backlash is taken up by a steel hairspring.

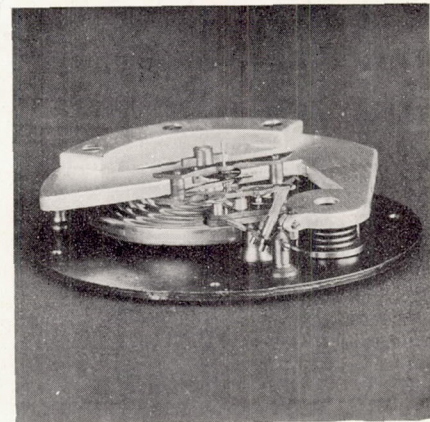
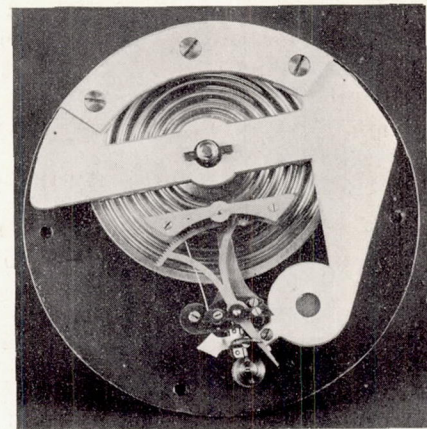

FIG. 8.—Mechanism of Hatot altimeter.

The indicating mechanism is a fixed dial graduated with a pressure scale in millimeters. Over this fits a movable illuminated dial provided with a crown gear. The dial is rotated by means of a small pinion mounted in the instrument case which is turned by a knurled thumb screw. No bimetallic compensation is used in this instrument.

DE GIGLIO.

The pressure element of this instrument differs from the Richard by providing an extra connecting link between the vacuum box and the fitting which carries the knife-edge. The mechanism is similar to that of the D-spring altimeters except that the rotation of the hand is clockwise for increasing altitudes.

The indicating element has both a stationary pressure scale graduated in millimeters and a movable altitude scale graduated in meters. There is no bimetallic temperature compensation, but the static balancing is done as in the Richard, by the insertion of a stip of lead into the back end of the flat plate lever.

FILOTECNICA.

The Filotecnica altimeter, also an Italian make, is very similar to the De Giglio except that the movable dial is rotated by turning the knurled bezel instead of a geared thumb screw.

OTHER TYPES.

MAXANT.

The pressure element of this French altimeter (fig. 9) consists of a vacuum box with an internal spring. This construction is familiar in barographs, but unusual with altimeters.

The multiplying mechanism starts with a long lever consisting of a brass rod into which is inserted transversely a long steel upright. Offset from this lever is an arm (19) which engages the top of the vacuum box. The bearings (25) of this long lever are mounted in a bridge over the vacuum box. The long steel upright actuates a geared brass sector (48). This sector meshes with a pinion on the index arbor. The zero of the instrument is adjusted by turning a steel screw which raises or lowers one end of the mechanism bridge. Backlash is taken care of by a small spiral spring.

The indicating element has been made in two forms, in each of which there is both a stationary and movable dial. In one form the movable dial giving the altitude scale in meters is rotated by gearing actuated by a knurled thumb screw. In the other form the movable dial is revolved in a knurled bezel.

SPERRY.

The pressure element of this movement is made up of a battery of two vacuum boxes with internal springs which are mounted on a U-shaped brass frame. This U-shaped casting holds the entire mechanism and is screwed to the case of the instrument.

A bimetallic bridge spans the two legs of the U-shaped piece and supports the multiplying mechanism in the center. This mechanism consists of a carefully machined helical groove in the pointer arbor. This arbor is free to turn in a polished hole in the bridge. It is caused to rotate in proper relation to the movement of the upper vacuum box by the vertical movement of a pin traveling in the helical groove. There is a spiral hairspring to take up backlash.

TAGLIABUE.

The pressure element of this altimeter consists of a single vacuum box with an internal spring. Any motion of the upper surface of the diaphragm is communicated to the multiplying mechanism by means of the jeweled bearing soldered to the top of the upper diaphragm.

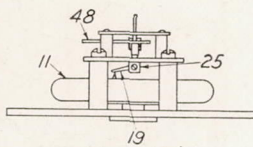
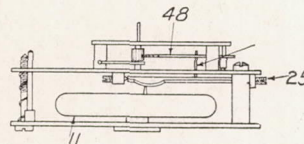
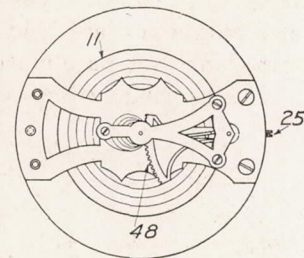

FIG. 9.—Diagram of Maxant altimeter.

The design of this instrument is unique and offers several advantages in the adjustment for calibration. The motion of the diaphragm actuates a short lever arm projecting from the regulator spindle, which rests on the jeweled bearing of the diaphragm. This lever is punched integral with the regulator spindle, and, since the material is of spring steel, considerable adjustment of its length can be accomplished by the lateral motion produced by a regulator screw.

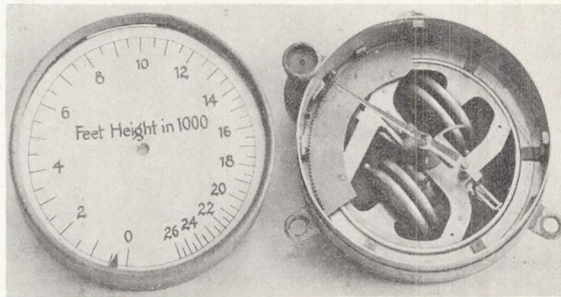

FIG. 10.—German altimeter with double action.

The vertical movement of the diaphragm serves to rotate the regulator spindle, which carries with it an upright. The movement of this upright in turn rotates a cam to which it is connected by a link. The cam rotates about a vertical axis. By means of a hairspring mounted on the cam shaft lost motion is taken up and a slight pressure maintained against the jeweled bearing. In contact with the cam surface there is a small roller bearing which is attached to the tail of a geared sector. Thus any rotation of the cam causes a corresponding movement of the geared sector. The cam is so designed that with increasing altitudes there is a gradually increasing movement of the sector for equal movements of the diaphragm. The geared sector meshes with the pinion on pointer spindle.

The stationary and movable dials are constructed in the usual way and the latter is turned by a knurled knob.

GERMAN ALTIMETERS WITH DOUBLE ACTION.

The pressure element of this altimeter consists of two batteries of two diaphragms each. The springs are internal. The vacuum boxes are mounted edgewise so that the direction of their motion on deflection is in a plane parallel to the dial of the instrument. The two batteries deflect in opposite directions as shown by figures 10 and 11.

The deflections of the diaphragms cause a rotation of the multiplying lever (17) about an axis, perpendicular to plane of motion of the diaphragms, the two arms of this lever being connected by links to the diaphragms. The motion of the multiplying lever (17) is transmitted by means of a short pin (21) to a second slotted lever (20) carrying the sector (48). The pin (21) slides in this slot when the lever (17) is displaced. The pin (21) is attached to lever (17) by a lock nut and washer and is adjustable in the slot at the end of lever (17), thereby making it possible to change the multiplying ratio of the lever system and hence the deflection of the pointer. The geared sector engages with a small pinion on the pointer spindle. A hairspring is mounted on the indicating arbor.

The indicating element has an unequally divided altitude scale which is fixed in position. The entire inside mechanism is rotated by means of a geared sector engaging in a pinion mounted in an offset in the instrument case. The altitude scale is considerably cramped at the high altitude end. The rotation of the hand for a change of altitude of 1,000 feet near the 25,000-foot point is only one-third that at sea level.

Temperature compensation is effected by the general design of the lever system.

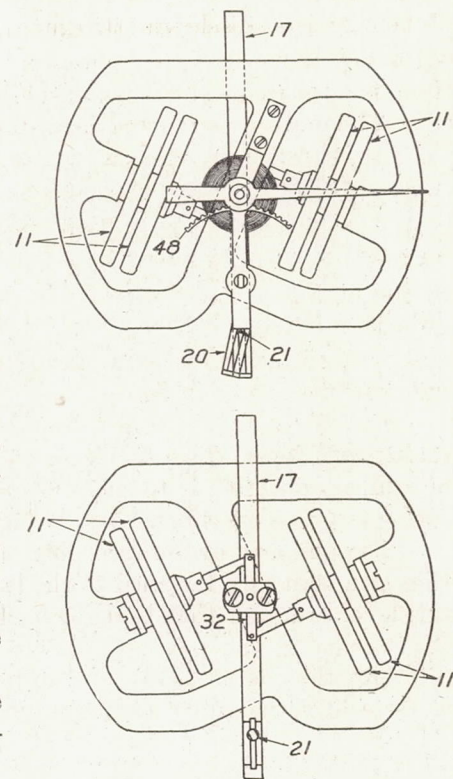

FIG. 11.—Diagram mechanism of German altimeter with double action.

PRINCIPLES OF BAROGRAPH CONSTRUCTION.

Barographs may be described with reference to the pressure element, multiplying mechanism, recording element, and compensation.

The pressure element is invariably such as to give a larger amount of deflection than in the case of altimeters. This is necessary in order to reduce the demand on the multiplying mechanism, as will be seen. The increased sensitivity of the pressure element is usually attained by having a battery of vacuum boxes one on top of another. The steel springs may either be internal or external in arrangement, the former being more common.

In barographs the mechanism has considerably less multiplying power than in altimeters. This is necessary in order to insure a sufficiently firm and powerful movement of the tracing point; otherwise the unavoidable friction of this point on the chart might cause trouble.

Various optical and other devices have been tried for the recording element, some of them with complete success, but none of these has come into very common use. Ordinarily the recording element consists of a pen-and-ink record on a paper chart. The chart is placed on a revolving drum whose time of revolution ranges in different instruments from a half hour to 24 hours or longer, according to the requirements of the work. The scale provided by the chart is rarely as open in the barograph as in altimeters.

The term altigraph has frequently been used for consistency with the term altimeter to designate a barograph whose chart is equally spaced with respect to altitude, and some charts are provided carrying only the altitude scale.

Temperature compensation is usually accomplished in barographs only so far as is possible by means of admitting air to the vacuum boxes. Bimetallic compensation is rarely provided. Balancing is also seldom attempted, for it is expected that the barograph will be held in an upright position.

INTERNAL SPRING BAROGRAPHS.

THE RICHARD BAROGRAPH AND SIMILAR INSTRUMENTS.

The most widely used and probably one of the oldest types of barographs is the Richard. The Green barograph is very similar to the Richard except for the use of a tubular-shaped pen instead of the usual form consisting of a V-shaped trough.

The pressure element is a battery of two internal spring diaphragms attached securely at the base to a flexible flat steel plate or spring. A square-headed screw operated by a key adjusts the height of the boxes above the base plate by causing an up-and-down motion of the spring and serves as a means of adjusting the zero setting of the pen. The Richard movement is shown in figure 12.

The motion of the upper diaphragms, pillar (A), is transmitted by means of a link (B) to a multiplying lever which oscillates about the axis (O). The long pen arm is actuated by means of a link connecting it to the multiplying lever and an upright (D) from the pen arm. A flat spring is provided which keeps a slight tension on the pen arm and takes up backlash.

The pen arm of the recording element is a long flexible flat spring steel shaft. This long thin arm is in turn fastened to the last rigid lever arm by two screws. It is sprung away from this lever arm and then brought back toward it by a thumbscrew. This method of regulating the tension in the pen arm serves to adjust the amount of pressure at the contact of the pen with the chart. The pen can be removed from the surface of the chart by means of an arrestment actuated by a shaft projecting outside of the case.

HÜE.

The pressure element of this barograph is similar to that of the Richard except for the zero adjustment being made by a knurled thumbscrew.

The mechanism serves to transmit the deflection of the diaphragms to the pen arm in the following manner: The movement is first transmitted to a multiplying lever by means of an upright extending from the uppermost vacuum box. Both arms of the multiplying lever are adjustable and are held in place by set screws. The pen is actuated by means of a link which

connects this multiplying lever with an adjustable arm attached to the pen arm. Thus a further degree of adjustment is possible than in the case of the Richard barograph. The recording element is similar to the Richard except in certain details. The pen arrestment is operated by a lever extending outside the case of the instrument, to which is attached a brake serving to stop the clockwork whenever the pen is thrown off the chart. The mechanism and base plate slide into a wooden case. The pen arm is counterbalanced.

SHORT & MASON.

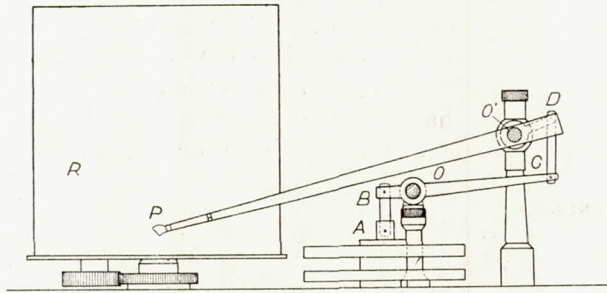

FIG. 12.—Diagram mechanism of Richard altigraph.

be varied by turning a knurled thumbscrew (S), thus adjusting the zero of the instrument. The multiplying lever is connected by means of a link (D) to the pen arm. A helical spring keeps the tension on the pen arm and serves to take up backlash.

This instrument was the first to provide a true altigraph scale. It has also an unusually open scale. This was made possible by a very high drum. The period of rotation of the drum in some forms is as short as 30 minutes, adapting it especially for performance testing and experimental work.

In this barograph a bimetallic bar is provided in the multiplying lever (C). It is the only barograph known in which bimetallic compensation has been attempted.

SCHNEIDER.

The pressure element of this barograph is similar to the Richard.

One end of the multiplying lever is attached to the vacuum boxes by means of a steel link. The other end is attached by an adjustable pin to the arbor of the pen arm.

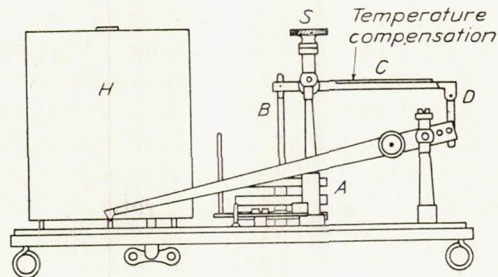
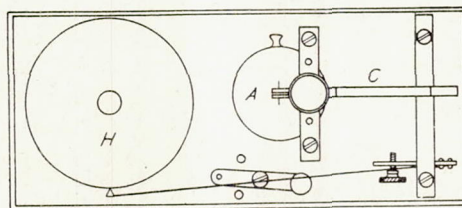

FIG. 13.—Short & Mason 10,000-foot altigraph Cover removed.

AGOLINI.

The pressure element consists of a battery of two internal spring vacuum boxes mounted rigidly on the base.

The uppermost vacuum box is connected to the multiplying lever by means of a steel link. The multiplying lever is a long brass arm, the axis of which is held in bearings mounted on a bridge. The height of the bridge above the base is adjustable by means of a thumbscrew, thus

providing for the zero setting. The thumbscrew is placed in a yoke mounted on two standards. The adjustable bridge is prevented from getting out of alignment by two guide pins placed through the yoke. The multiplying lever is counterweighted and actuates the pen arm by means of a steel link.

STOPPANI.

This Swiss barograph has a battery of two internal spring vacuum boxes mounted on the base plate by means of a short upright post.

The uppermost vacuum box is connected to the multiplying mechanism by a link. The multiplying lever is elaborate in construction, offering facilities for ready adjustment. There is a short arm made up of an adjustable pin threaded on the end. This pin is kept in tension by a helical spring, and it is held in a cylindrical-shaped fitting bored so as to receive the pin. The mounting for the multiplying lever is similar to that of the Short & Mason barograph. The pen arm is attached to the multiplying lever by means of a link. The multiplying lever is counterweighted.

KNUDSEN.

This instrument of Danish construction has for its pressure element a battery of three vacuum boxes with internal springs. The zero adjustment is made as in the French barographs.

The movement of the vacuum boxes is transmitted by a multiplying lever, one end of which is attached to the uppermost vacuum box. The other end of the multiplying lever is attached to the pen arm by means of a connecting link. The length of the arm of the multiplying lever can be adjusted by means of a slide which is held in place by a set screw. The length of the lever on the pen arm may be adjusted by means of a set of holes for the link pin.

FRIEZ SYLPHON.

The pressure element of this barograph (fig. 14) is composed of a sylphon multiple capsule instead of the usual battery of separate vacuum boxes. The sylphon consists in effect of seven capsules in series, although made of one piece of metal. Instead of the usual elliptic springs there is a single internal helical spring. In laboratory tests this instrument has shown exceptionally small elastic hysteresis and after-effect errors.

The top of the sylphon is attached to the multiplying mechanism by means of a link. This link is attached to an arm projecting downward at an angle from the main spindle. The pen arm is mounted on this same spindle. The zero adjustment is accomplished by a thumbscrew adjustment on the pen arm which permits a rotation about the main spindle.

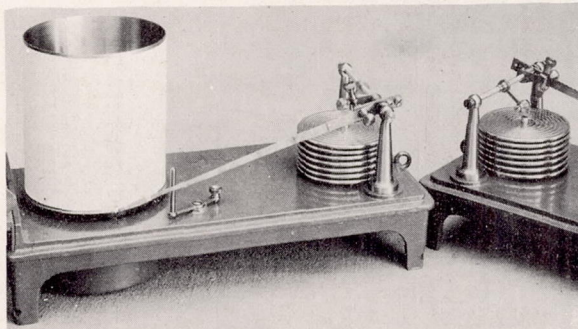

FIG. 14.—Friez sylphon barograph.

OTTO BOHNE.

This instrument, of German construction, has a battery of four internal spring vacuum boxes mounted on a flexible base so that their height may be adjusted by turning a knurled thumbscrew.

The deflection of the vacuum boxes is transmitted directly to the pen arm by means of a connection from the uppermost vacuum box to an adjustable shaft through the pen-arm arbor.

The pen arrestment is operated by a small knob which extends out through the door of the wooden instrument case. The clockwork is wound by turning the drum in the opposite direction from that in which it is driven.

EXTERNAL SPRING BAROGRAPHS.

RICHARD POCKET BAROGRAPH.

This instrument is very much smaller than the ordinary barographs. The pressure element consists of a battery of two vacuum boxes without internal springs. They are prevented from collapsing by a helical spring some distance away, which is mounted in a vertical position and which acts upward against a flat plate which serves as one of the multiplying levers. This part of the construction is somewhat similar to the helical spring altimeters. There is an adjustment for tension of the helical spring by means of a square shank screw operated by a key. This serves as a zero adjustment for the instrument. (See accompanying photograph, fig. 15.)

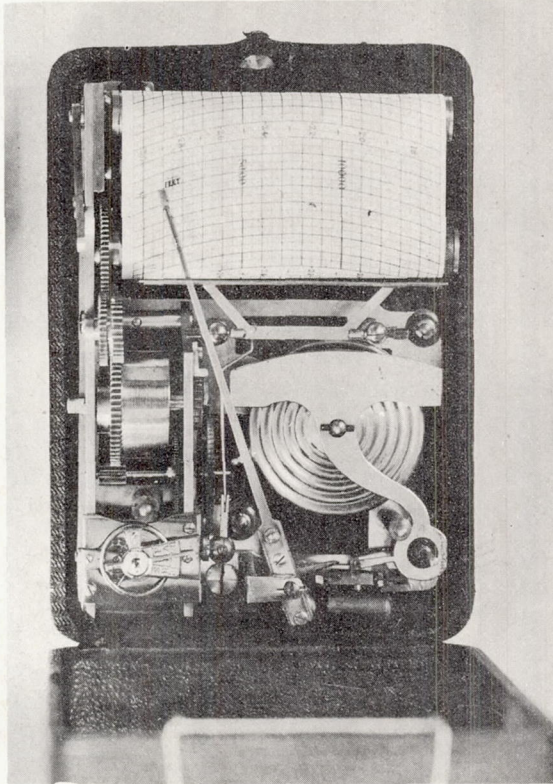

FIG. 15.—Richard pocket barograph.

Inserted into a projection from the multiplying arm or flat plate, above referred to, there is a pin which points downward. This pin acts on the curved surface of a cam. Any movement of this cam causes a spindle to rotate which carries an upright piece of wire serving as a lever. This wire rod makes a sliding contact on a fin which is mounted upon the pen arm. The back-lash of the pen arm is taken up by a hairspring. The recording element contains a mechanism for periodically raising and lowering the pen in relation to the chart. The chart is not in contact with a single cylindrical drum as in the larger barographs, but is stretched between two small rollers so that the surface receiving the record is flat. The rollers are forced apart by a spring which can be released in order to remove the paper. The pen is raised from the chart by a slotted bar in which it is free to slide. This slotted bar is raised and lowered by clockwork; thus the record consists of a series of dots, the pen being off the paper the majority of the time. This device enables the pen arm to take up the most accurate position without restraint due to friction at all times. The necessary firmness of contact for making a legible record is secured momentarily by the periodic action of the slotted bar.

DE GIGLIO.

The pressure measuring element of this instrument (fig. 16) is very similar to that of the Richard pocket barograph. It consists of a vacuum box of the external spring type which is held from collapsing by a helical spring placed at the lower end of a T-shaped plate. This plate serves, as in the pocket barograph, as one of the multiplying levers. Any movement of the diaphragm of this altigraph is multiplied further by means of another multiplying lever (B) and the pen arm (C) which are connected together, and the multiplying lever to the T-shaped plate by means of small links. The construction of the multiplying lever makes possible con-

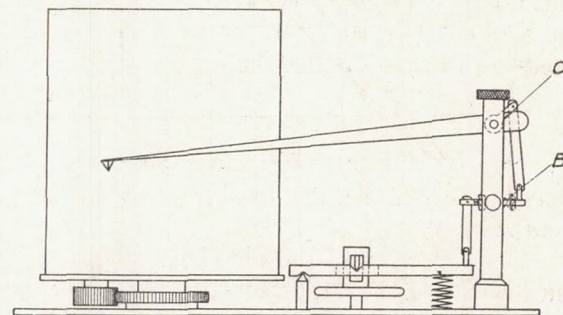

FIG. 16. Diagram mechanism of De Giglio altigraph.

siderable adjustment of the multiplying ratio. It is really a regulator spindle, and the ratio of the length of its two arms can be varied by turning a knurled nut with the fingers. The pen and pen shaft are similar to that used in the Richard barograph.

POCKET BAROGRAPH OF THE DOUGLASS PRODUCTS CORPORATION.

Except for a slight modification of the clockwork, this instrument is similar to the Richard.

PERFORMANCE REQUIREMENTS FOR ALTIMETERS AND BAROGRAPHS.

The performance requirements of altimeters and barographs are determined, on the one hand, by the degree of accuracy necessary for the particular use contemplated and, on the other hand, by the sources of error existing in the instruments under conditions corresponding to those which will be experienced in flight.

The conditions occurring in flight which may cause errors are extremes of temperature, inclination, acceleration and vibration of the instrument, and rapid change of pressure tending to cause a time lag in reading. These conditions must be reproduced in the laboratory and the instruments tested more or less completely under each condition, depending on the accuracy required and whether or not the instrument is of a new type of construction.

Schedules of permissible errors for various conditions and altitude ranges have been adopted in making tests at the Bureau of Standards. These will not be gone into numerically here, but the testing procedure will be explained and the performance characteristics to be observed in the test will be definitely stated.

METHODS OF TESTING.

The apparatus employed for the pressure and temperature tests is essentially the same for all kinds of tests on aneroids of the aviation type, and is shown in the three accompanying photographs.

Figure 17 shows various types of containers found useful in the calibration of aneroids. The bell jar to the right of figure 17 is used for experimenting on aneroids. It is equipped with

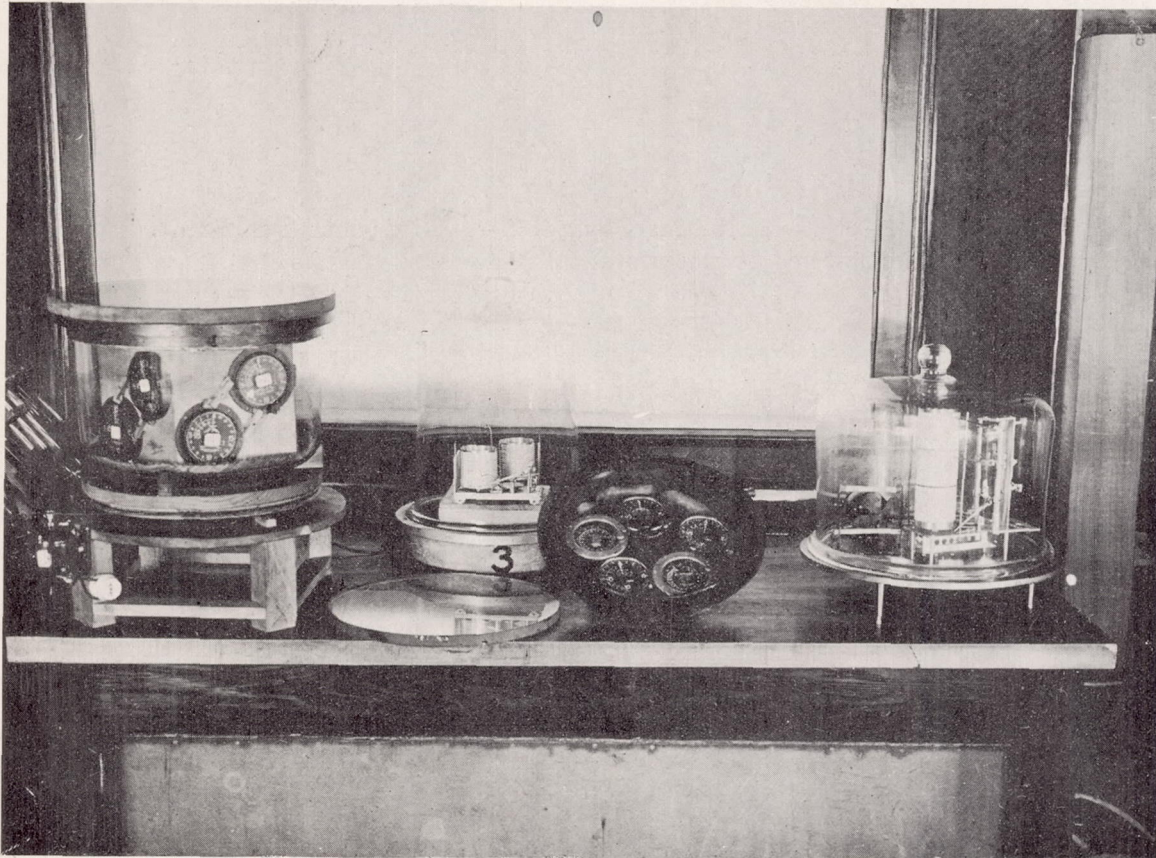

FIG. 17.—Four types of containers for aneroid testing.

electrical connections so that a small fan motor, heater, etc., may be put inside; also it is provided with small copper tubes for carbon dioxide refrigeration, so that extreme low temperatures may be maintained. Other apparatus not shown in the photograph has been used for routine tests of aneroid barometers at temperatures as low as around -40° C., especially for the flight history tests.

The container in the center of figure 17 is convenient for routine testing of small groups of aneroids and especially for checking the readjustment of aneroids following repair. It may be covered either with the adjacent flat glass disk or with a small bell jar, as shown in the rear of the photograph.

The container at the left of figure 17 is one of a type designed for testing a large number of altimeters at the same time. It consists of a large bell jar, inverted, and rotated in a motor-

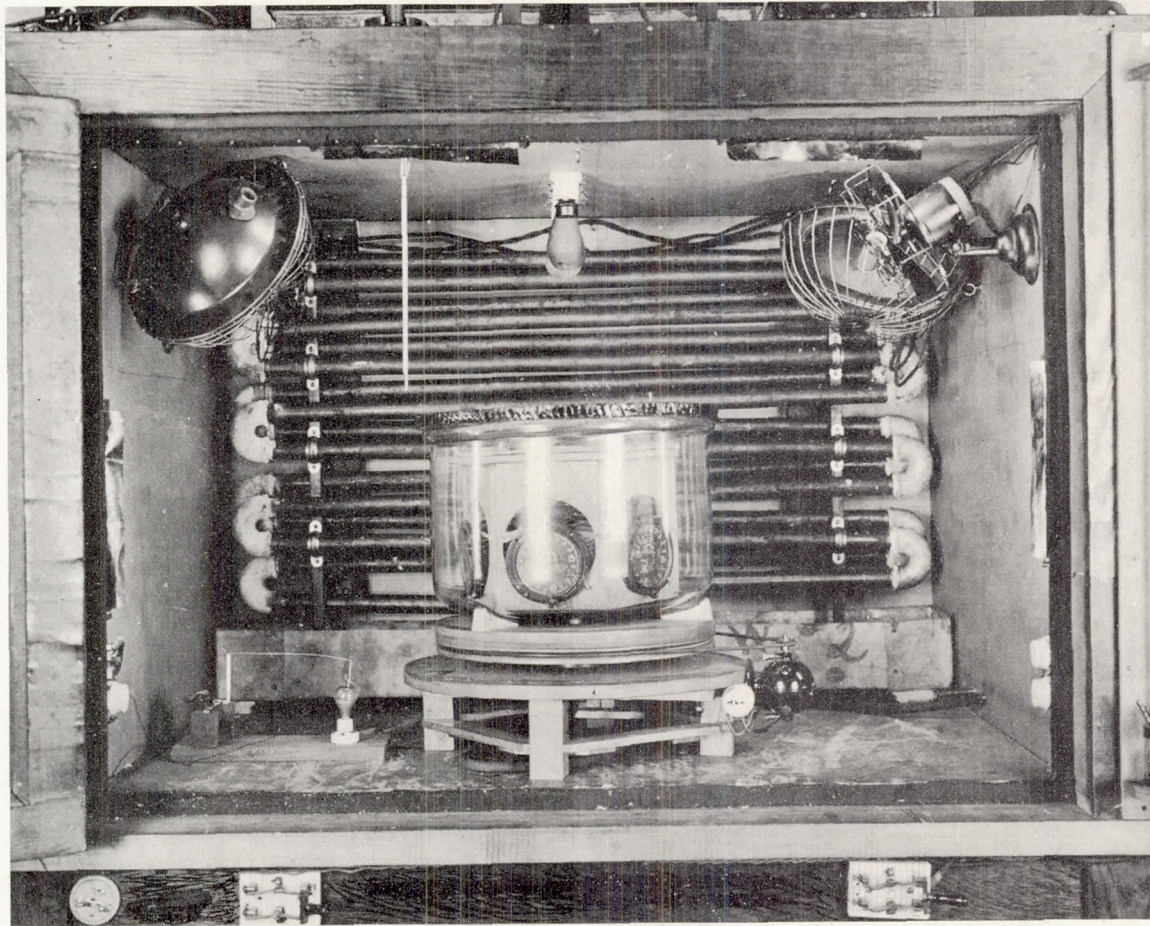

FIG. 18.—Temperature chamber with motor-driven container.

driven support. It can be read either through the top or the side. The vacuum connection is made through a special fitting in the knob of the jar.

The next photograph (fig. 18) shows a temperature chamber in which any of the foregoing containers may be placed or two of the inverted bell jar type. By the use of the brine system and heaters, any temperature down to -10° C. may be maintained, and slightly lower temperatures may be secured by using calcium chloride to remove the frost from the brine coils. The instruments are read through a double glass door. The containers are rotated by a motor that is controlled by the two knife switches shown in the lower foreground.

Figure 19 shows the mercurial standards and a vacuum control board of special design used in aneroid testing. Below is a large reserve vacuum tank. The tank is of value in minimizing the effect of slight leaks that may occur in the system. This arrangement of barometers and vacuum control board and tank makes it possible to produce different pressures in several

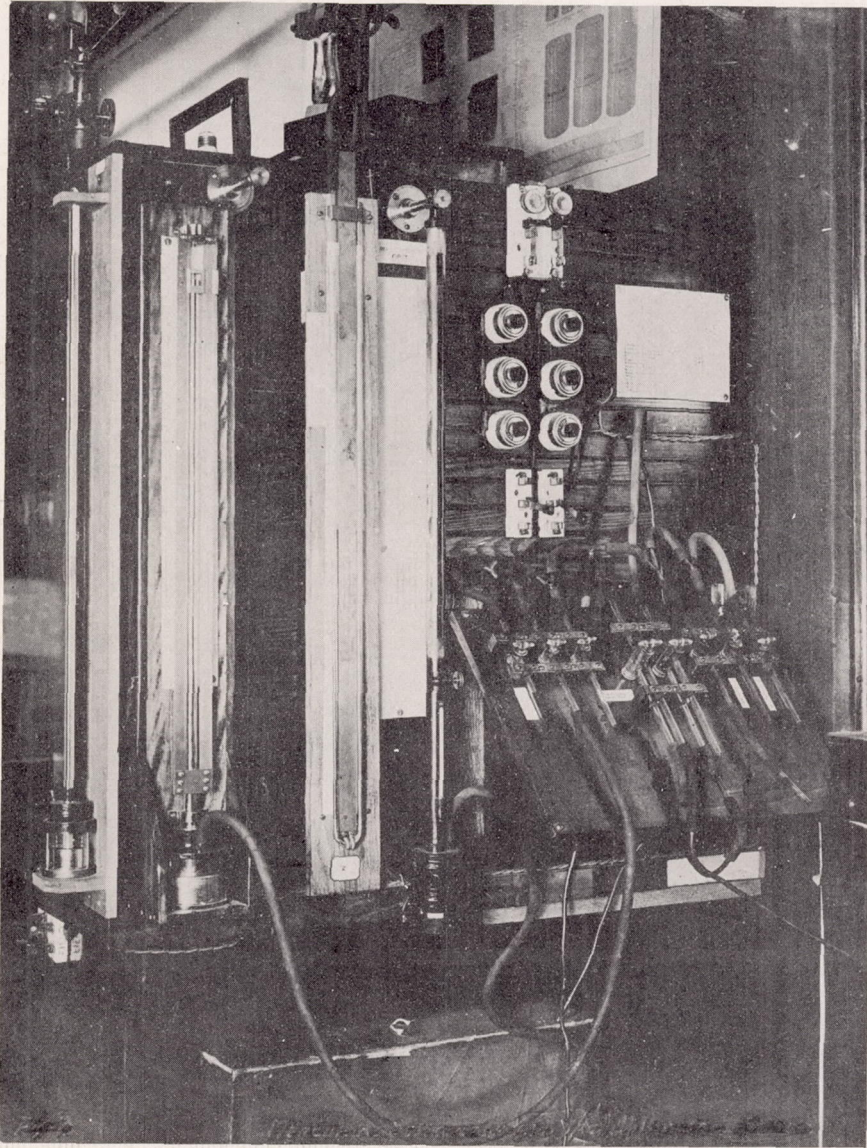

FIG. 19.—Mercurial standards and vacuum control board.

different containers simultaneously, so that instruments of different ranges may be tested in the shortest time. Also it facilitates the calibration of the mercurial standards, which were submitted to the Bureau of Standards during the war in considerable numbers.

The vibration apparatus as shown in Figure 20 is of special design in that the motor is not attached to the vibrating frame. This lengthens the life of the motor, and therefore the efficiency of the vibrator. The amplitude, frequency, and direction of the vibration can be varied at will, making it possible to subject the instruments to any desired vibration.

The chain-testing device in Figure 21 is shown to illustrate some of the special problems which may arise in sample instruments. Several different styles of chains were tested on this apparatus for a comparison of their performance and durability.

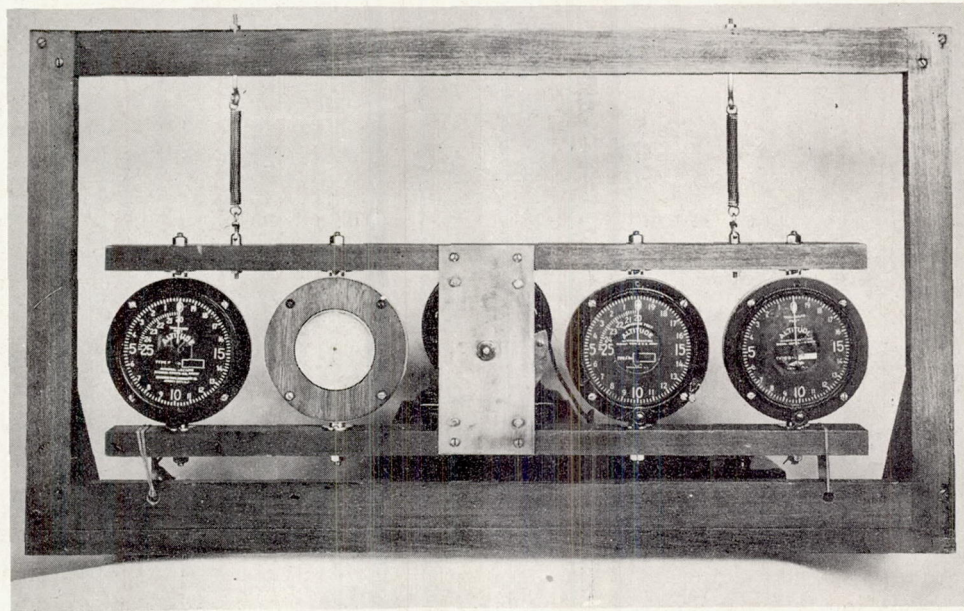

FIG. 20.—Altimeter vibrating board.

Special apparatus was also developed to test the mounting of the mainspring of the Short & Mason type of altimeter.

There are two kinds of test in common use, the general test and the special test for an experimental instrument.

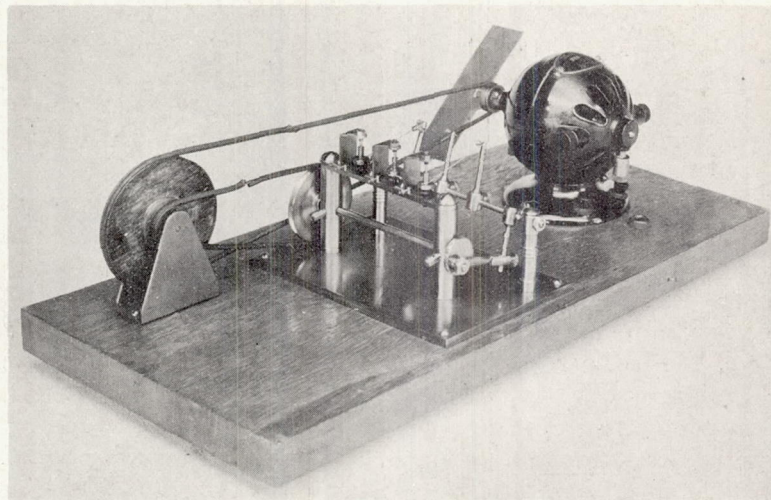

FIG. 21.—Altimeter chain-testing apparatus.

The general test is the one always given if no other is explicitly requested. It affords data for deducing approximate values of the proper correction under any given condition of use. A modification of the general test is the so-called short test on service instruments. This is an abridged form of the general test recommended only when time is not available for the

numerous stages of that test. The operations involved in the general test require a minimum of eight working days; but the short test can be finished in two days. In most cases the short test will suffice for the rejection of inaccurate instruments, but not always, and it will not provide detailed corrections. Another modification of the general test is a further extension of it in the form of supplementary tests on sample instruments. These tests include a determination of the effects of vibration, acceleration, or other aeronautic conditions not covered by the general test. Such observations are important in considering the suitability of new types or makes of instruments, but are not likely to be necessary in testing or inspecting each individual instrument.

The special test on experimental instruments consists of more precise and complete determinations of the errors for instruments of high precision to be used in experiments on aircraft. These tests may be made by extending the procedure of the general test, or, better, by taking what is known as a flight history test. This can only be done after the flight when the flight conditions are known. By a flight history test is meant one in which the actual variations of pressure and temperature experienced in the use of the instrument on a particular occasion are artificially reproduced in the laboratory.

GENERAL TEST.

The general test consists of four parts, A, B, C, and D.

TEST A (PRELIMINARY TEST).

This consists of six parts: The tapping, shift, and inclination tests; the determination of the correction at the end of the range, and of the aftereffect, by means of a pressure test; and a final examination for mechanical defects. Of course, any obvious mechanical defects that are noted upon receipt of the instrument may cause its rejection without going through any of the experimental tests.

(1) The *tapping test* is made by repeatedly tapping the instrument vigorously enough to just disturb the pointer, and noting the average deviation of the pointer reading from its mean position. Four or five taps are usually sufficient.

(2) For the *shift test* the aneroid is held in a sidewise position and struck edgewise against the palm of the hand, first with its face to the left, and then to the right. Each time it is afterwards read in a horizontal position. One half the average difference between the left and right readings is recorded, and known as the deviation by shifting, or simply the *shift*.

(3) For the *inclination test* the aneroid is held in a horizontal position, read after slightly tapping, and then again read after turning to a vertical position. The difference in readings is recorded and known as the vertical correction or inclination effect.

(4) The aneroid, having been set to read the altitude as indicated by the pressure of the mercurial standard, is placed in a container and the pressure reduced at once to the lowest point on the scale (the highest altitude). The movement of the pointer is carefully watched during this pressure change to detect jerkiness. After the pressure has been reduced, the aneroid is allowed to stand a period equal to two-thirds of the time required to ascend to that altitude at a rate of 200 feet per minute. At the end of this rest period, the readings of the standard and of the aneroid are taken and recorded. The pressure in the container is now quickly raised to atmospheric by opening the vacuum system to the air.

(5) Five minutes afterwards the aneroid and the standard are again read. The amount by which the pointer fails to come back to the true altitude is called the aftereffect. This is to be expressed in per cent of the altitude range.

(6) The mechanical defects such as jerkiness, parallax, or loose parts which have been noted during the foregoing test on which may now be found by further inspection are recorded.

The design of most aviation aneroid barometers is now such that the tapping, shift, and inclination tests are unimportant. An error of 50 feet for altimeters and 0.05 inches of mercury for aneroid barometers is excessive.

If the aneroid passes satisfactorily the six steps of test A, it is put through test B; otherwise it is rejected at this point.

TEST B (SEA-LEVEL TEMPERATURE TEST).

This test consists of two steps:

(1) After the instrument has been at the room temperature of 20°C . for at least three hours it is tapped and the pointer set to the altitude indicated by the mercurial standard and this reading recorded. It is then placed in a temperature chamber, where the temperature is lowered to -10°C . and held at this temperature for at least three hours. At the end of this period the instrument is again tapped and the position of the index observed, recorded, and compared with the reading of the standard.

(2) The aneroid is next put through the *hot test*, which is the same as the cold test except that the instrument is heated up to $+40^{\circ}\text{C}$. and a reading taken after a four-hour interval.

From the high temperature the instrument is allowed to cool down to the room temperature. After three hours it is read again and compared with the standard. This completes the temperature test at atmospheric pressure.

NOTE.—The individual steps of test B are performed in the order given to avoid the condensation of vapor within the instrument which would occur if it

were first heated and then cooled, but which is avoided by heating the instrument after the cold test. Care should be taken always to tap the instrument before reading.

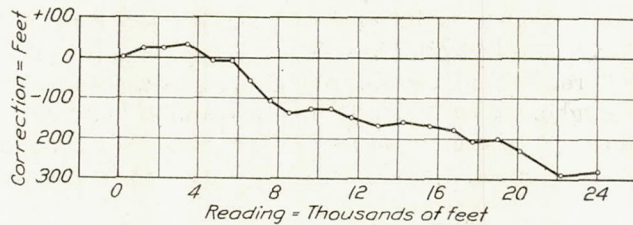

FIG. 22.—Calibration curve at 26°C . on altimeter made by S. Smith & Sons.

TEST C (CALIBRATION AND DRIFT).

(1) After setting the index to the altitude indicated by the standard, the instrument is placed in a container and the pressure decreased at an average rate of 1,000 feet for each five-minute time interval. Simultaneous readings of the instrument under test and the mercurial standard are taken at intervals of five minutes. The difference between the two readings is the correction, which is so given that the algebraic sum of the correction and the reading of the instrument under test equals the true altitude.

(2) After the pressure in the container has been reduced to correspond to the highest altitude indicated on the scale at the above rate, it is held at this value for five hours. At the end of this period the container is tapped and the instrument read, and the correction obtained as before from the mercurial standard. Extreme care must be taken that the temperature of the instrument does not change during the test, and that the pressure in the container be exactly at the same value at the beginning and the end of the five-hour period, so that the hysteresis effect is eliminated. Much fluctuation in the pressure during the five hours is decidedly to be avoided.

The maximum correction of the aneroid barometer reading is noted, and if desired a calibration curve can be drawn, with corrections plotted against readings, and attached to the report. Figures 22 and 23 are typical calibration curves, figure 22 for an altimeter and figure 23 for an aneroid barometer. The drift is the quotient, in per cent, of the change in the correction found after five hours at the high-altitude range divided by the true range. The average deviation is the average of the deviations of the calibration curve from the best representative straight line.

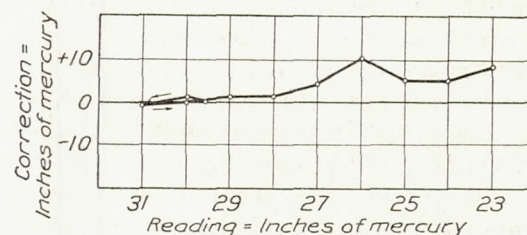

FIG. 23.—Calibration curve of Hicks pocket aneroid.

TEST D (ALTIITUDE-TEMPERATURE TEST).

Test D consists of two additional calibration tests:

- (1) At a temperature of -10° .
- (2) At a temperature of $+40^{\circ}$.

The corrections are found in the same manner as in test C (1). Straight lines are drawn through the calibration curve at each temperature, including the calibration at $+20^{\circ}$ C. This will give three straight lines. The slope of the calibration curve at 20° C. should always lie between the other two, the slope of calibration curve at -10° C. being greater and at $+40^{\circ}$ C. being less. This is for curves whose coordinates are in altitude. The slopes are determined in per cent for the curve, and the difference between the slopes for the lines for $+40^{\circ}$ C. and -10° C. is noted as the change in scale value. This value must not exceed 5 per cent. The intermediate slope at $+20^{\circ}$ C. is of value in this test in showing the regularity of the shift with temperature and as a check.

For aerobarographs or other instruments reading in inches of pressure, instead of in feet of altitude, the same methods are followed throughout tests A, B, C, and D, readings being taken at each inch of mercury pressure changes instead of each 1,000 feet. The pressure is changed at the rate of 1 inch of mercury pressure every five minutes instead of 1,000 feet every five minutes.

The four tests are purposely given in the order named. Defects due to poor workmanship can usually be discovered before the instrument is calibrated, and if the defect is serious the instrument is immediately rejected, thus saving time and labor. The temperature test B is given before the calibration because more instruments fail on this one test than on any other. Moreover the instruments are thus given a chance to rest after being strained by undergoing test A. This is an important factor which should not be overlooked. The instruments must be allowed at least 24 hours' rest after being subjected to a large pressure change, in order to obtain accurate results. Otherwise, on account of elastic fatigue, the instrument will give a false reading which may be different from one obtained after a sufficient period of rest.

The short test for service instruments differs from the general test given in the following respects: (1) Tests A and D are omitted altogether; (2) test B is made only with cooling instead of with both cooling and heating; (3) the drift observation in test C is omitted and replaced by an observation of the aftereffect. The instrument in this test is held at the low pressure for two hours only instead of for five hours.

It is inherently impossible to make the tests A, B, C, and D in less than about seven or eight days since each instrument must be allowed a period of time between each stage of the test to recover from the elastic fatigue set up in the metal by virtue of the test itself, and it is preferable that at least two days should elapse between each part of the test. The result of cutting down that time allowance would merely be to produce deceptive figures, which will not reproduce under aviation conditions.

In the supplementary test on sample instruments a vibration test lasting for one week is given. The instruments during this test are mounted on the vibration apparatus previously described. During this time observations are occasionally taken to note both the amplitude of oscillations of the pointer and whether any movement of the dial has taken place. Afterwards the instruments are again calibrated. Observations are also made on any other suspected sources of error.

In addition to the general test, additional tests are made on barographs that are to be used for competitive altitude records in order to determine the fitness of the instrument for this special purpose.

SPECIAL TESTS ON EXPERIMENTAL INSTRUMENTS.

Instruments to be used in experiments on aircraft are carefully readjusted to give the least possible errors, and calibration curves are then determined. The flight history test referred to above is also given for such instruments when the actual flight conditions are known. Only by such a test can the effects of elastic fatigue and temperature lag be properly determined.

RESULTS OF INVESTIGATION.

One of the most urgent needs of the aeronautic instrument manufacturer during the recent war was the development of reliable testing apparatus. The first problem was to design a mercurial barometer which could be easily transported and which could be read without the necessity of making numerous settings and applying corrections such as are required with ordinary laboratory barometers. Considerable experimenting was done with different types of mercurial barometers that were constructed both by the manufacturers and the Bureau of Standards, and their different characteristics were studied in detail. An interesting problem in this connection was the equipment of the fixed cistern types of mercurial barometers with an altitude scale. It was attempted to construct a fixed cistern instrument with an equally spaced altitude scale so that it would be possible to use a vernier with this scale. This idea was abandoned because the investigation showed that the advantages gained by the use of the vernier was offset by the necessity of a very much cramped scale which proved to be a decided disadvantage. The temperature corrections to fixed cistern barometers were also studied in detail. It was found that the temperature correction in altitude is approximately constant for all altitudes in the ordinary fixed cistern instrument. As a result of the above investigation, a portable standard was designed by the Bureau of Standards, satisfying the conditions that the instrument does not have to be set for the level of the mercury, and for a considerable range of temperature from room temperature it is not necessary to apply a temperature correction.

Another important problem was how and where the routine tests could be modified and still cause the rejection of all the defective instruments. In this connection an investigation was made to determine how many instruments would pass the "temperature test at sea level" (test B) and not pass "altitude-temperature test" (test D). The results showed that test D could be omitted for the ordinary service instruments, but this procedure is not recommended for an instrument that is to be used in the performance testing of aircraft. A series of tests was made to determine the shape of the curve, when the slope of the calibration curve was plotted against temperature.

The Bureau of Standards carried out an investigation on the thermometric lag of the various types of instruments for the purpose of determining how long an instrument should be held at a certain temperature during the temperature tests.

It was also necessary to devise tests to prove the fitness of the instruments to withstand the vibrations experienced under actual conditions of use in aircraft. With this in view, vibration apparatus was designed. To find out the effect of vibration the vibration of the pointer was noted; also the loosing or movement of any of the parts of the instrument and the effect of the vibration on the calibration curve, etc. Defects caused by vibration were found to be comparatively infrequent.

The most important investigation undertaken was a study of the elastic properties of aneroid diaphragm capsules. For convenience these elastic properties may be divided into three phenomena:

Drift, which is the change of displacement under a constant load.

Hysteresis, which is the excess of displacement with load decreasing over the displacement at the same load with load increasing.

Aftereffect, which is the residual displacement at any time after removal of load.

A great number of drift experiments were made to determine the shape of the drift curve, i. e., the increase of displacement plotted against time, the variation of the magnitude of the drift with the speed of loading, and the variation of drift with the load.

The improvement of the amount of drift in aneroids submitted to the Bureau of Standards from year to year has been studied, and a curve showing these results is given below (fig. 24). In this curve the average per cent of drift of the aneroids submitted during the year is plotted vertically against the year horizontally. The slight increase in the average drift during 1919

and in 1920 is due to the fact that several of the instruments submitted were manufactured previous to the war.

A detailed inquiry was made of the hysteresis of various types of instruments and the relation of hysteresis to drift was investigated. A curve showing the hysteresis in several instruments will be found in Part II of this report, under precision altimeter design.

While studying the elastic properties of a D-spring type altimeter a detailed investigation of the mechanical errors of this instrument were made.

The greatest mechanical error was found to be the method of clamping the mainspring to the carriage of this instrument. A very small amount of slipping which occurred here was greatly magnified by the multiplying mechanism, so that the error became large. This error was entirely eliminated by substituting a steel support for the brass one ordinarily used and preventing the spring from slipping in this steel support by set screws.

Slipping of the knife-edge was found to be responsible for a similar error.

Still another problem in the construction of the instrument related to the delicate chain in the indicating mechanism. A device was constructed to study the endurance of various types of chain. These tests showed that both gold and steel chains would far outlast the life of any instrument, but that the gold chain showed better performance when subject to the adverse atmospheric conditions of actual use. Phosphor bronze strips showed good endurance and performance when great care was used in attaching them in the instrument.

For the performance testing of aircraft it is often very desirable to have an instrument reading in pressure instead of altitude. Most of the aneroids reading in pressure are not suitable for aircraft. To meet this demand the bureau converted several altimeters to pressure instruments, equipping them with scales graduated in inches, millimeters, or millibars. This work led to an interesting study of the multiplying mechanisms in these instruments.

Closely connected with the conversion of altimeters to a pressure basis was the extension of the range of barographs. This was accomplished by fitting an external spring to the instrument so as to increase the stiffness of the system for a given deflection of the box. This increased the pressure range (altitude range) for the same deflection. Special charts were made for these instruments.

An optical method of testing the regularity of the motion of the drum of a barograph was developed. This consists of putting a sensitized sheet on the drum of a barograph and allowing a very fine line of light to strike the drum parallel to the axis of rotation. If the motion of the drum is uniform the paper upon development should show uniform exposure, if the motion is nonuniform the exposure will show a series of light and dark lines—light when drum is rotating fast and dark when slow.

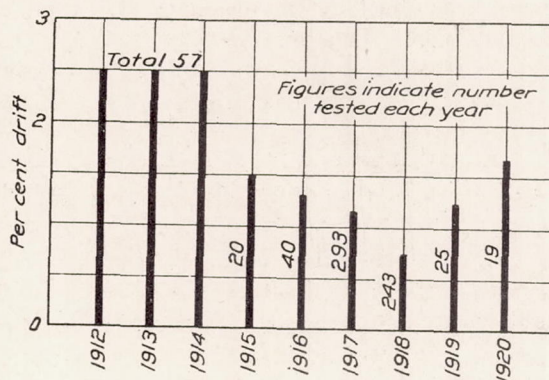

FIG. 24.—Average drift in aneroid barometers tested at the Bureau of Standards.

REPORT No. 126.
ALTITUDE INSTRUMENTS.

PART II.

PRECISION ALTIMETER DESIGN.

BY JOHN B. PETERSON AND JOHN R. FREEMAN, JR.

SUMMARY.

In this part the general principles of altimeter design are discussed and applied to the construction of a large open-scale precision altimeter, the development of which was undertaken in accordance with a program approved by the National Advisory Committee for Aeronautics.

At the beginning of the discussion data are shown indicating the amount of error due to imperfect elasticity of ordinary aneroids, showing the great need for improvement in this particular. On the same diagram the hysteresis curve resulting from the finished precision altimeter is plotted, showing the notable improvement secured. In fact, by the use of a stiff steel spring of special quality coupled to a diaphragm made of ordinary brass but sufficiently thin to contribute practically no elastic reaction, the familiar hysteresis error has actually been made negligible in comparison with the ordinary mechanical errors of the movement.

In conclusion, suggestions are made regarding compensation of the design for minor sources of error.

Instruments of the precision altimeter class are intended primarily for use in performance testing of aircraft and as working standards for reference in laboratory tests.

INTRODUCTION.

The readings of an aneroid barometer are liable to errors as great as 4 per cent even after the readings are corrected for the temperature of the atmosphere. In several special cases where accurate determination of pressure or altitude is desirable if not indispensable, the ordinary commercial altimeter does not have the desired accuracy. It was the purpose of the authors to fulfill this need by first developing a theory of aneroid design and then checking the results by experiments on an instrument constructed accordingly.

Several cases where accurate instruments are essential are:

- (1) In the performance testing of aircraft;
- (2) In landing at night or in fog;
- (3) In aerial mapping;
- (4) In bomb dropping; and
- (5) As secondary standard for laboratory or field use.

In performance tests the determination of pressure is more important than that of the altitude. Either an instrument reading in pressure units or an altimeter with a fixed dial should be used.

For landing at night, or in fog, the pilot could receive by radio from the landing station the barometer reading at the station. Knowing this pressure and having a reliable aneroid, the pilot could descend to this pressure level, i. e., ground level, as indicated by his aneroid, without danger of crashing. The necessity for accuracy here is easily seen. Too large an error may be fatal to crew and passengers.

Aerial mapping and bomb dropping are the only uses stated here where the temperature of the air need be accounted for accurately in the determination of altitudes. This being the case, temperature errors due to deviation from the altitude formula will usually overshadow errors in the pressure determination, but accurate results are desired, and instrumental errors should be eliminated when it is practical to do so.

An accurate instrument graduated in pressure units could be used to advantage as a secondary standard for the calibration and adjustment of altimeters in the laboratory and on the field. For this purpose the instrument should indicate the pressure directly with nearly the accuracy of a mercurial barometer. The ordinary commercial instrument is not satisfactory for this purpose, since its readings, owing to imperfect elasticity of the diaphragms, depend on the rate of change of pressure to which it is subjected. A secondary standard of this type is especially needed for use at aviation fields where mercurial instruments which require careful adjustment and the use of correction tables are very inconvenient.

The most difficult error to eliminate or correct for in an aneroid barometer is the elastic lag or time effect. Figure 1 shows the hysteresis in commercial altimeters. Curve B is the best instrument of a group of approximately 10 American and foreign makes which were tested. A hysteresis error of $2\frac{1}{2}$ per cent is 250 feet on a 10,000-foot instrument, or 500 feet on a 20,000-foot instrument. The cause of this hysteresis is imperfect elasticity of the spring or diaphragm, usually due to a stress too high for the material used. Also the mechanical support of the spring and the knife edge which fastens the diaphragm to the spring were found to be sources of error.

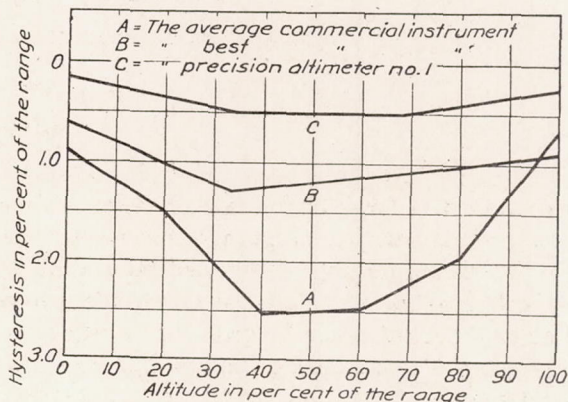

FIG. 1.—The rate of ascent and the rate of descent in the hysteresis tests were 500 feet per minute. The time at the top was 30 minutes.

ESSENTIAL PRINCIPLES OF PRECISION ALTIMETER DESIGN.

The design of an altimeter is necessarily such that the finished instrument is a compromise among the many desirable features. Some of these desirable features are:

- (1) A large diaphragm, so as to get sufficient working force to operate the mechanism properly.
- (2) A spring with low maximum stress, stiff relative to the diaphragm.
- (3) A large deflection combined with a small multiplying ratio.

After the outside diameter of the instrument has been decided upon, the problem is to put the best possible mechanism in the space available.

DIAPHRAGM DESIGN.

EFFECTIVE AREA.

The effective area of a diaphragm is defined as the ratio of the distending force applied at the center to the pressure required to produce this force.

To calculate the effective area of a diaphragm, let us assume that a section of the diaphragm from the center to the outside rim, ABCD (fig. 2), acts as a flexible cable with a uniform stress throughout a given section.

Let r = radius of the center.

R = outside radius less the radius of the center.

$\Delta\omega$ = an angular increment including the area ABCD.

P = the atmospheric pressure in pounds per square inch.

α = angle of departure of the diaphragm from face of center plate.

Using the notation of figure 2, the area of the section ABCD is $\frac{1}{2} (R^2 + 2Rr) \Delta\omega$. The load on this area is $\frac{1}{2} (R^2 + 2Rr) \Delta\omega P$, supported partly at the center and partly at the outside rim. The moment of the load on the area ABCD about the tangent to the circle at BC is $(\frac{1}{2} R^2 r \Delta\omega + \frac{1}{6} R^3 \Delta\omega) P$. Divide this moment by R and we get the part of the load supported by the center, approximately $(\frac{1}{2} Rr + \frac{1}{6} R^2) \Delta\omega P$. Now the total pressure falling on the rigid center of which AOD is a sector is transmitted to the spring and has therefore to be added. The load at the center due to the pressure on the triangle BOC is $(\frac{1}{6} R^2 + \frac{1}{2} Rr + \frac{1}{2} r^2) \Delta\omega P$. The total load on the center is

$$\int_0^{2\pi} (\frac{1}{6} R^2 + \frac{1}{2} Rr + \frac{1}{2} r^2) \Delta\omega P = (\frac{1}{3} R^2 + Rr + r^2) \pi P.$$

The effective area then, is, by definition,

$$(\frac{1}{3} R^2 + Rr + r^2) \pi$$

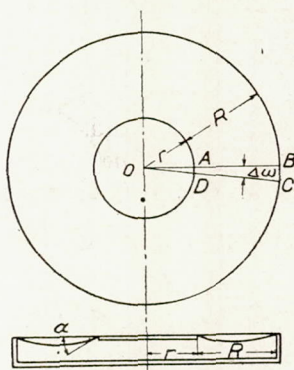

FIG. 2.—Suspension diaphragm.

The ratio of the effective area to the actual area is

$$\frac{\frac{1}{3} R^2 + Rr + r^2}{R^2 + 2Rr + r^2},$$

which may be expressed in the form

$$\frac{\frac{1}{3} + \frac{r}{R} + \left(\frac{r}{R}\right)^2}{1 + 2\frac{r}{R} + \left(\frac{r}{R}\right)^2}.$$

This ratio varies from one-third when r is zero to unity when R is zero.

The foregoing analysis is an approximation satisfactory for relatively small values of the inner radius r .

FIBER STRESS.

The maximum fiber stress in the diaphragm occurs where it is fastened to the rigid center. Considering the area ABCD again (fig. 2), the vertical load on the center due to this area was found to be $(\frac{1}{2} Rr + \frac{1}{6} R^2) \Delta\omega P$. Now we denote the angle of departure from the center (fig. 2) and consider the radial tension in the diaphragm material to be the resultant of the vertical and a horizontal pull. The total radial tension in the section AD is—

$$\frac{(\frac{1}{2} Rr + \frac{R^2}{6}) \Delta\omega P}{\sin \alpha}.$$

The area of the section in tension at the center is $rt \Delta\omega$, t being the thickness of the material. The fiber stress is then—

$$f = \frac{(\frac{1}{2} Rr + \frac{1}{6} R^2) \Delta\omega P}{rt \Delta\omega \sin \alpha} = \left(\frac{R}{2} + \frac{R^2}{6r}\right) \frac{P}{t \sin \alpha}.$$

Since the area supporting this load at any other place in the diaphragm varies directly as the distance from the center, the stress at any point is

$$\frac{r}{r_1} \left(\frac{R}{2} + \frac{R^2}{6r}\right) \frac{P}{t \sin \alpha}$$

where r_1 is the distance from the center to the point where the stress is to be calculated. This is for a smooth diaphragm.

In a corrugated diaphragm the maximum stress occurs at the bottom of the corrugation, and, using the symbols of figure 3, is

$$F = f \left(1 + \frac{6m}{t} \right) \\ = \frac{r}{r_1} \left(\frac{R}{2} + \frac{R^2}{6r} \right) \left(1 + \frac{6m}{t} \right) \frac{P}{t \sin \alpha}$$

For the proportions shown in figure 3, $1 + \frac{6m}{t} = 16$. In order that the maximum fiber stress shall not exceed a certain limit, a diaphragm having corrugations as in figure 3 should theoretically be 16 times as thick as a smooth diaphragm of the same radius and angle of departure from the center.

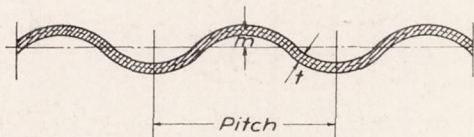

FIG. 3.—Diaphragm corrugations.

In the design of precision altimeters the diaphragm is the element which limits the general size of the mechanism. In the Bureau of Standards precision altimeter No. 1, which is described in detail later in the paper, the diaphragm diameter is about 8 inches. It is believed, however, that a diameter of 5 inches will give the proper relation of diaphragm area to spring stress and deflection. The total area of the diaphragm is then 19.6 square inches.

Substituting in the above equations, the effective area is found to be 8.6 square inches, or 44 per cent of the total area. This area is assumed to be constant for all positions of the diaphragm.

At 14.7 pounds per square inch atmospheric pressure the load which the diaphragm puts on the spring is $8.6 \times 14.7 = 126$ pounds. At 30,000 feet the pressure is about one-third of that at sea level. The load on the spring is $8.6 \times 4.9 = 42$ pounds. It is, therefore, required that the spring be designed to carry a maximum load of 126 pounds, with a working range of 42 to 126 pounds.

It is a matter of preference whether the diaphragm be corrugated or smooth. As developed above, the metal for a corrugated diaphragm should be several times the thickness of metal for a smooth diaphragm of the same size. Phosphor bronze and nickel silver are good materials for diaphragms. The stress should not exceed 12,000 pounds per square inch for either of these metals.

DRIFT COMPENSATING DIAPHRAGM.

If the altimeter diaphragm has a variable area, as shown diagrammatically in figure 4, it has two advantages over the constant area diaphragm. In the first place the area increases

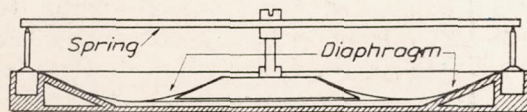

FIG. 4.—Drift compensating diaphragm.

as the altitude increases. This tends to make a straight deflection-altitude curve, or, with a constant multiplying ratio, a uniform altitude scale. The other advantage is the drift compensating feature. If the pressure on the instrument is reduced until the pressure corresponds to a chosen altitude, and is held constant at this value, the reading then increases gradually, owing to drift in the spring and diaphragm. With the variable area diaphragm, this drift causes an increase in the effective diaphragm area, thereby augmenting the load on the spring which, in turn, tends to diminish the drift.

This has been verified experimentally by the fact that the spring used in the precision altimeter, described below, shows less hysteresis when coupled with the diaphragm as used in the instrument than does the spring alone when tested by deflecting it with weights.

A possible disadvantage of the variable area diaphragm is the liability to a change in the calibration caused by stretching of the diaphragm. Further experience is necessary before the seriousness of this possibility can be determined.

SPRING DESIGN.

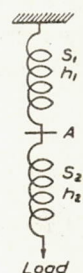

Fig. 5.—Spring system.

It can be proved that the hysteresis in an aneroid barometer may be reduced to a very low value if a spring with good elastic properties is used in conjunction with a relatively very flexible diaphragm, although the diaphragm itself may have poor elastic properties. This principle has been applied in the construction of the altimeter described in this paper and may be demonstrated as follows:¹

If two springs with stiffness S_1 and S_2 , respectively, are connected together as in figure 5, the stiffness of the system to a force applied at A is $S = S_1 + S_2$. (Stiffness is defined as the amount of force applied per unit of deflection.)

Now, if h_1 and h_2 are the hysteresis values of the two springs, respectively, for a certain range of deflection, the hysteresis of the point A for the system is—

$$h = h_1 \frac{S_1}{S} + h_2 \frac{S_2}{S}$$

If S_1 is the stiffness of the spring and S_2 is the stiffness of the diaphragm; e. g., it is estimated that in the Bureau of Standards precision altimeter No. 1 $\frac{S_1}{S} = 0.99$ and $\frac{S_2}{S} = 0.01$. If the hysteresis in the spring for the maximum range is 0.02 per cent and the hysteresis in the diaphragm for the corresponding range is 2 per cent, the hysteresis of the combination is

$$h = 0.02 \frac{99}{100} + 2.0 \frac{1}{100} = 0.04 \text{ per cent.}$$

COMPOSITION OF THE STEEL AND PERMISSIBLE STRESS.

Several investigators, in particular Bairstow,² and Smith and Wedgewood³ have studied the possible relations existing between hysteresis in steel and the fatigue strength. They have shown that the limit of proportionality as ordinarily determined can not be taken as a criterion of the limiting stress below which there is negligible or zero hysteresis, but that the fatigue limit as determined by repeated stress is the limit below which there is no measurable hysteresis. Further, the width of the hysteresis loop increases with increasing stresses beyond the fatigue limit and for a stress range greater than the fatigue range the width of the hysteresis loop increases with increasing number of repetitions of stress.

Using these facts as a basis, it is readily seen that the permissible stress in an aneroid spring, or in any steel spring where true elastic reaction is necessary, is the fatigue limit of the steel used. This fatigue limit for good grades of commercial alloy spring steels is approximately 25,000 to 30,000 pounds per square inch fiber stress. However, since the width of the hysteresis loop is very small for stresses somewhat above the fatigue limit, and because of the relatively very low number of stress alternations an aneroid spring would undergo during its lifetime, compared with the number required to cause failure from fatigue, a maximum fiber stress of 50,000 pounds per square inch is probably not excessive for heat-treated alloy steels. This is especially true in an aneroid spring where the stress is never reversed (tension to compression) and there is a consequent tendency for the spring to adjust itself to the range over which it operates.

Extensive experimenting was done in the attempt to make a suitable spring for the precision altimeter No. 1.

The best spring obtained was of a special nickel-silicon steel having a yield point of 276,500 pounds per square inch. Increasing the maximum fiber stress of this spring from zero to 100,000 pounds per square inch and back to zero in 20 minutes, the maximum width of the hysteresis loop was 0.3 per cent of the total deflection. To be on the safe side and to permit the use of

¹ M. D. Hersey. Theory of Stiffness of Elastic Systems. Journal of the Washington Academy of Sciences, Vol. VI, p. 569, 1916. The principle of having the spring as stiff as possible compared to the diaphragm was proposed by Mr. Hersey at the outset of the present work, and may be applied to altimeter design in general.

² Bairstow, Leonard. Phil. Trans. 1910, v. 210, p. 35.

³ Smith and Wedgewood. Journ. Iron Steel Inst. G. B., 1915, 1, 365.

commercial heat-treated alloy steels; 50,000 pounds per square inch is chosen as an absolute maximum permissible fiber stress. The nickel-silicon steel on a range of 50,000 pounds per square inch should give a hysteresis of only one-tenth of 1 per cent. If the range of the instrument is 20 inches of mercury, the maximum width of the hysteresis loop is 0.02 inch, or 30 feet if the instrument is an altimeter.

SHAPE, STIFFNESS, AND DEFLECTION.

The spring should be shaped so that as near as practicable there is a uniform stress over its entire length. This method decreases the stiffness but increases the deflection without increasing the maximum fiber stress.

It is desirable to have the spring straight at either the middle of its working range or at sea-level pressure. To accomplish this, the spring is made so that its free position is curved. If it is to be straight at the load which is the middle of the working range, its free shape should be the reverse of the curve taken by a similar straight spring when its total load is applied.

The following method may be used to calculate the deflection of a leaf spring the width and thickness of which varies with the position along the length of the spring.

Figure 6 represents a cantilever spring which is the same as one-half of the altimeter spring. The cantilever is fastened at A, and this corresponds to the middle of the altimeter spring. The notation used is:

- R = radius of curvature of the spring.
- E = modulus of elasticity of the steel.
- I = the moment of inertia of the section.
- M = the moment caused by the load.
- P = the load, concentrated at the end.
- b = the width of the section.
- t = the thickness of the section.
- x = the distance from the end.
- D = the deflection at the end.
- f = the fiber stress.
- a = the length of an increment for graphical computation.

The radius of curvature at any point along the length is

$$R = \frac{EI}{M} = \frac{Ebt^3}{12Px}$$

The angle α is then a/R_1 , etc.

The deflection, $d_1 = \frac{a \sin \alpha_1}{2}$

$$d_2 = a \left(\sin \alpha_1 + \frac{\sin (\alpha_1 + \alpha_2)}{2} \right)$$

The end deflection is $D = a \Sigma [(\sin \alpha_1) + \sin (\alpha_1 + \alpha_2) + \dots + \frac{1}{2} \sin (\alpha_1 + \dots + \alpha_n)]$.

This formula is used for calculating the shape of the free spring so that it will be straight at any required load, and also for calculating the stiffness and deflection. It has been found by experiment that the stiffness for such deflections as here experienced is practically constant.

Complete calculations for the spring to be used with the 5-inch diaphragm previously discussed will be given. The modulus of elasticity of the steel is taken as 29×10^6 pounds per square inch. The correct thickness for 50,000 pounds per square inch maximum fiber stress is found to be about 0.095 inch. For the shape calculation the load at the end is 42 pounds, or one-half of the diaphragm pull at the middle of the working range. The length, $3\frac{1}{4}$ inches, is divided into six parts, each 0.54 inches long.

$$R = \frac{EI}{M} = \frac{Et^3}{12p} \cdot \frac{b}{x} = \frac{29 \times 10^6 \times .000857}{12 \times 42} = 49.3 \frac{b}{x}$$

x	b	b/x	R	α	$\Sigma\alpha$	$\sin \Sigma\alpha$	$\frac{d}{.54}$	d
2.98	2.83	0.95	46.9	0.0115	0.0115	0.0115	0.0057	0.003
2.44	2.50	1.02	50.3	.0107	.0222	.0222	.0226	.012
1.89	2.16	1.14	56.2	.0096	.0318	.0318	.0496	.027
1.35	1.83	1.36	67.1	.0080	.0398	.0398	.0854	.046
.81	1.50	1.85	91.2	.0059	.0457	.0457	.1281	.069
.27	1.17	4.33	213.5	.0025	.0482	.0482	.1751	.095

The total deflection is 0.095 inch. To get the shape dimensions given in figure 6 each deflection is subtracted from the total deflection.

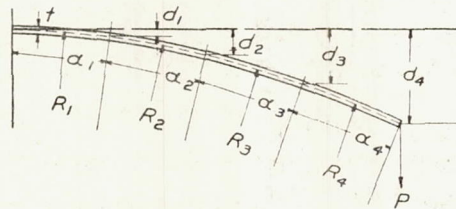

FIG. 6.—Spring deflection.

The stiffness, $s = \frac{2 \times 42}{.095} = 890$ pounds per inch. The deflection for the working range is $\frac{84}{890} = .095$ inch. The fiber stress—

$$f = \frac{6M}{bt^2} = \frac{6 \times 3.25 \times 63}{2.75 \times 0.00902} = 49,500 \text{ pounds per square inch.}$$

One-half of the maximum load of 126 pounds is used in calculating the fiber stress.

MULTIPLYING MECHANISM.

CHARACTERISTICS.

Since the area of the diaphragm and the stiffness of the spring remain constant, the diaphragm deflection will bear a linear relation to the pressure. The problem is to design a multiplying mechanism such that the movement of the end of the pointer bears a direct linear relation to the movement of the diaphragm.

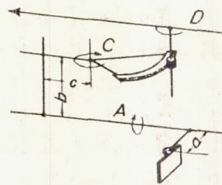

FIG. 7.—Multiplying mechanism.

Figure 7 is a representation of a lever mechanism. The sector shaft and the main shaft are perpendicular and in the same plane.

Let a , b , and c be the lengths of the first, second, and third lever arms, respectively.

Let A be the angle between a and the horizontal.

Let B be the angle between b and the vertical.

Let C be the angle between c and the plane drawn through the axes of both the main shaft and the sector shaft.

Let D be the angular deflection of the pointer.

Let x be the vertical movement of the diaphragms ($x=0$ when the arm a is horizontal).

Let R be the multiplying ratio of the sector to the pinion.

Assume that when the lever a is horizontal, b is vertical, and c is in the same plane as the sector shaft and the main shaft. That is, when $x=0$, $A=0$, $B=0$, $C=0$.

Now the locus of the point of contact between the lever arms b and c is a straight line, perpendicular to the plane in which the main shaft and the sector shaft were placed. We will use m as a symbol to denote the distance of the point of contact from this plane.

$$m = b \tan B$$

$$\text{and } m = c \tan C$$

$$\therefore c \tan C = b \tan B$$

$$\text{but } B = \sin^{-1} \frac{x}{a}$$

$$\therefore c \tan C = b \tan \sin^{-1} \frac{x}{a}$$

$$C = \tan^{-1} \left(\frac{b}{c} \tan \sin^{-1} \frac{x}{a} \right)$$

$$D = R \tan^{-1} \left(\frac{b}{c} \tan \sin^{-1} \frac{x}{a} \right)$$

If we express this equation as a series it appears that D comes very close to being exactly proportional to x when $\frac{b}{c}$ is about 1.25. As developed, the multiplying ratio is approximately constant for all positions of the diaphragm. It follows therefore that the pressure scale will be uniform.

ADJUSTMENTS.

The shape of the calibration curve may be adjusted by changing the ratio of the crossed lever arms, and the scale value, or the general direction of the calibration curve, by adjusting the length of the arm making contact with the top of the diaphragm. These adjustments should be made in the order mentioned, for the first changes the scale value but the last does not change the shape of the calibration curve.

TEMPERATURE COMPENSATION.

BIMETALLIC BARS.

It is not practicable to formulate exactly a method of temperature compensation until the nature and magnitude of the temperature errors are determined experimentally. In general, the introduction of one or more bimetallic bars somewhere in the lever mechanism will compensate the instrument.

In a bimetallic bar composed of two metals of different temperature coefficients of expansion, there is usually within each metal a neutral surface which receives no stress, the metal on one side of this surface being in tension and the metal on the other side being in compression. It can be proved that through a large range of temperatures these neutral surfaces do not change their position in the bar and, therefore, the distance between them remains constant.

When a bar, straight at one temperature, takes a curved shape at another temperature, this curve is the arc of a circle, and the radius of curvature is the same for any position along the length of the bar. Starting with these assumptions, formulæ for calculating the deflection of any bimetallic bar have been developed, leading to the conclusion that such a bar will give a maximum deflection when the steel strip is approximately two-thirds as thick as the brass strip in the usual case of the brass and steel combination.

EFFECT OF AIR IN VACUUM BOX.

Another possibility of temperature compensation is the adjustment of the amount of air left in the vacuum box. Less than one-half millimeter of air in the box has no effect on the operation of the instrument, and it is therefore never necessary to exhaust to a high vacuum. For temperature compensation 5 millimeters is the least amount which will have an appreciable effect. The box of the precision altimeter is exhausted to 0.2 millimeter.

POSITION ERROR AND BALANCING FOR VIBRATION.

The most serious vibration effect is caused by a vibration at right angles to the plane of the diaphragm. This is because it is not practical to balance the spring and diaphragm against other parts. The position error is a maximum when the face is down. To minimize position errors, the instrument should be calibrated and mounted in the airplane with the dial in the same relative position.

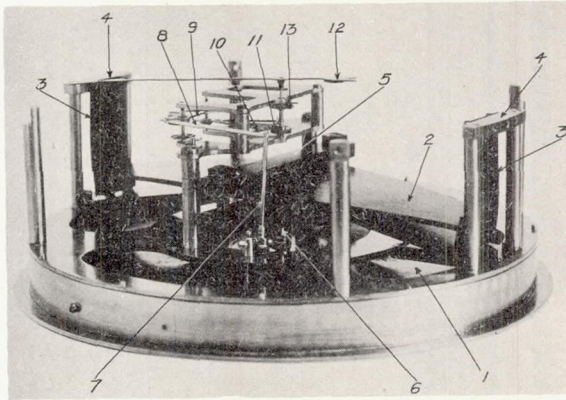

FIG. 8.—Mechanism of Bureau of Standards precision altimeter No. 1.

Both sector and pinion should be balanced about their axes. By referring to figure 7 it can be seen that an angular acceleration of the instrument in a clockwise direction tends to cause the pointer and the sector to move in a counterclockwise direction relative to the rest of the instrument. Now, they both can not move counterclockwise because they are geared together. If the moment of inertia of sector bears the same ratio to that of the pointer and pinion assembly as the ratio of the number of teeth on the sector to that on the pinion they will be balanced and the pointer will keep its position on the correct graduation. To get this ratio of the moments of inertia the sector should be made heavy and the pointer light.

THE BUREAU OF STANDARDS PRECISION ALTIMETER NO. 1.

This instrument was developed by the Bureau of Standards for the Army and the National Advisory Committee for Aeronautics, based on the theoretical considerations given above. In it are eliminated to a large extent the errors commonly found in aneroid barometers, which have also been discussed in detail in this paper.

Referring to figure 8, a flexible diaphragm (1) is coupled to a stiff mainspring (2) by means of yoke (5), the two bolts of which screw into the center plate of the diaphragm. The mainspring is swung on two thin flexible springs (3) from spring supports (4). This method of support permits the free lateral movement of the end of the spring when deflected. A short pin mounted at the end of a short arm from the spindle (6) fits into a conical bearing soldered in the center of the diaphragm plate. Deflections of the diaphragm cause (6) to rotate. This motion is multiplied by upright (7), which is connected by rod (8) to tail of cam (9). A hairspring mounted on the same shaft as cam (9) maintains a slight pressure on the conical bearing. Cam (9) is made with a varying radius so as to facilitate the adjusting of the lever system to give an equally spaced altitude scale. The movement of this cam is communicated to a sector (10) by means of a small roller bearing on the end of arm from the sector shaft. This sector meshes with pinion (11) and rotates the hand (12). The roller bearing is held on the cam (9) by the tension of the hairspring (13).

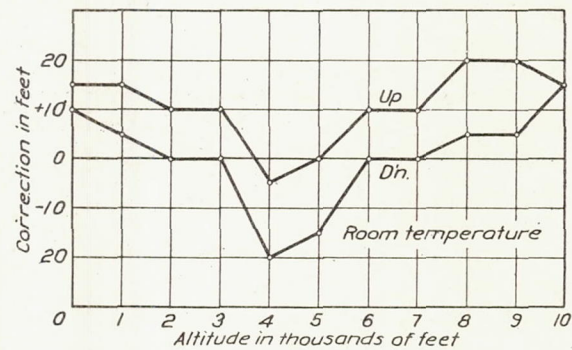

FIG. 9.—Precision altimeter calibration curve.

Figure 9 is a calibration curve of this instrument. It is important to notice that the difference between the up and down readings is only 15 feet and is very small compared with that of an ordinary service instrument. The instrument embodies the drift compensating feature. As previously stated, there is some doubt as to whether an instrument with this drift compensating feature will hold its calibration, but this particular instrument has shown no change. This point is under further investigation, however. Preliminary tests indicate the temperature error of this instrument without bimetallic bars to be small.

The successful development of a precision instrument of this type is dependent on very careful workmanship. The authors were fortunate in having the assistance of Mr. F. Cordero, of the Bureau of Standards, in the construction of this instrument.



Figure 9 is a calibration curve of this instrument. It is important to notice that the difference between the up and down readings is only 15 feet and is very small compared with that of an ordinary service instrument. The instrument embodies the drift compensating feature. As previously stated, there is some doubt as to whether an instrument with this drift compensating feature will hold its calibration, but this particular instrument has shown no change. This point is under further investigation, however. Preliminary tests indicate the temperature error of this instrument without bimetallic bars to be small.

REPORT No. 126

ALTITUDE INSTRUMENTS.

PART III.

STATOSCOPES AND RATE-OF-CLIMB INDICATORS.

By ATHERTON H. MEARS.

INTRODUCTION.

Statoscopes are used for indicating when aircraft are maintaining a constant altitude, or for quickly determining small changes of altitude. The ordinary altitude instruments, the altimeter and the barograph, are of little use for this purpose. They are too slow in action and not sufficiently sensitive. Few altimeters or barographs will indicate with reliability a change of altitude of 20 feet. The statoscope is especially useful in the navigation of balloons and dirigibles, since it shows immediately when the aircraft is ascending or descending. This gives the navigator warning before the airship has had time to gain an appreciable vertical velocity; and thus avoids the necessity of making wasteful adjustments of either the gas or ballast. Statoscopes, of the bubble type, can also be used

to indicate approximately the rate of ascent or descent of an airplane by determining the rate at which the bubble breaks.

Rate-of-climb indicators have the advantage over statoscopes of giving at once the approximate rate of climb, without time observations and in most cases without subsequent calculations. This is advantageous in helping the pilot to attain his maximum climbing speed, for example in aircraft performance tests, since he has only to observe the instru-

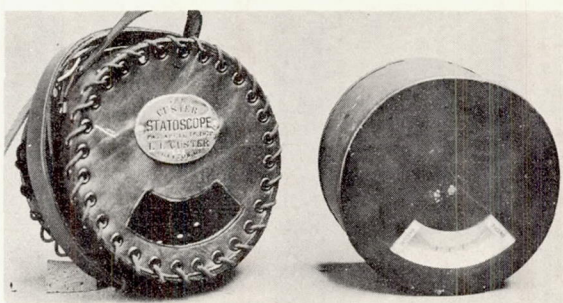

FIG. 1.—Custer bubble statoscope.

ment and so manipulate the controls as to get the maximum indications. In the landing of balloons and dirigibles it is also very important to know the rate of descent.

The Bureau of Standards has recently developed a mechanical type of rate-of-climb indicator of such sensitiveness and accuracy as to fulfill the requirements of both statoscopes and rate-of-climb indicators on nearly all types of aircraft.

DESCRIPTION OF INSTRUMENTS.

STATOSCOPES.

Bubble statoscopes—American.—The indicating bubble type, as shown in the following photograph (fig. 1) and diagram (fig. 2), consists of a thermally insulated air chamber with an outlet to the external air. To this is attached a small special radium-illuminated curved glass gauge or manometer. The curvature of this gauge is varied according to the desired sensitivity to change in altitude. In this gauge is placed a very small amount of liquid, which should have low density and low vapor pressure. Its viscosity should not be excessive at a low temperature. At each end of the gauge is blown a glass trap which prevents the liquid from escaping either into the air chamber or to the outside air. When the pressure is changed in any manner the

liquid moves toward that end of the gauge which is at the lower pressure. The enlarged end of the gauge causes the liquid to form a bubble (hence the name bubble statoscope). This bubble is now pushed still farther into the enlarged section of the gauge and breaks, allowing the air to flow past, thus equalizing the pressure between the inside and outside air. The liquid now flows back into the center of the gauge and forms an indicating medium again. The above cycle of operation continues as long as there is a change in pressure.

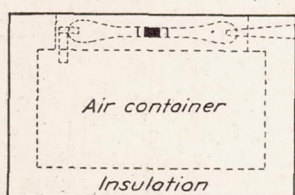
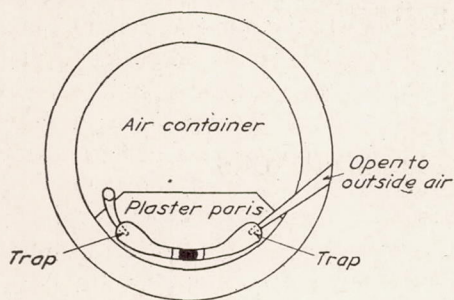

FIG. 2.—Diagram of Custer bubble statoscope.



FIG. 3.—British Wright bubble statoscope.

The sensitivity is such as to produce a movement of the bubble equal to one of the arbitrary scale divisions for a pressure change of 0.02 of an inch of mercury. This corresponds to a

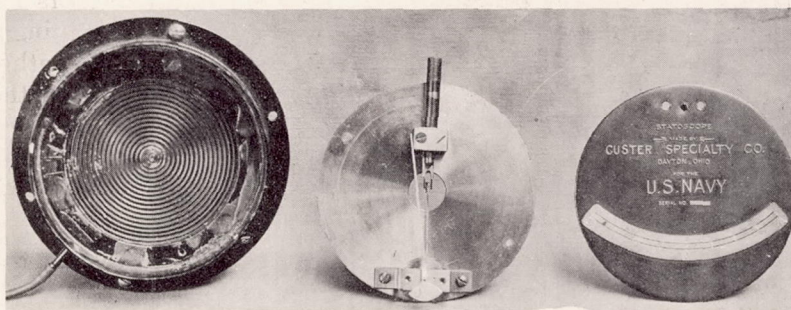

FIG. 4.—Mechanical statoscope diaphragm, multiplying mechanism and dial.

change in altitude of 20 feet at sea level or 26 feet at an altitude of 10,000 feet. This type of instrument has been the most extensively used of the various types of statoscopes.

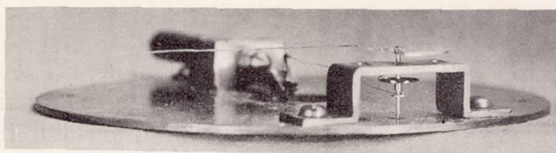

FIG. 5.—Multiplying mechanism of mechanical statoscope.

Bubble statoscopes—British.—The essential details and operations of this statoscope (fig. 3) are the same as in the American instrument. Considerable care is taken in the thermal insulation of the air chamber, which is a Dewar flask incased in wool felt. The sensitivity of the instrument is such that a change in pressure corresponding to 2 or 3 feet of altitude at sea level is indicated by this instrument.

Mechanical statoscopes—American.—The indicating pointer type shown by photographs (figs. 4 and 5) and diagrams (fig. 7), consists of a cylindrical metallic air chamber (1), one end of which is a very thin, flexible, corrugated, metallic diaphragm (2). Deflections of this diaphragm are indicated on the dial of the instrument by means of pointer (6), which is actuated by the multiplying mechanism in the following manner: The motion of the diaphragm is transmitted to the multiplying mechanism by means

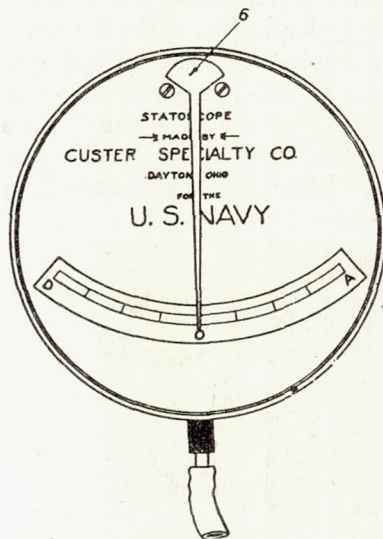

FIG. 6.—Assembly drawing mechanical statoscope.

of the upright soldered to the center of the diaphragm. This is in contact with one arm of the bell-crank shaped lever (3) to the other arm of which is attached a connecting link (4). The other end of this connecting link is attached to a small cam (5), on the shaft of which is mounted the pointer (6). There is an outlet (8) to the air chamber to which is attached a small rubber tube. The knurled-headed screw (9) is used to adjust the zero setting of the pointer. To operate the instrument the opening in the air chamber is closed by pinching the rubber tubing. If now the external air pressure on the instrument is changed, the diaphragm deflects, due to the difference in pressure; outward if the pressure is reduced, indicating an ascent; and inward if increased, showing a descent. The dial of the instrument has a luminous arbitrarily divided scale. The value of the divisions is determined by experiment. The instrument shown in the figures 4 and 5 was not thermally insulated, hence slight variations in temperature cause it to deflect when the outlet is closed, thus making it unreliable.

RATE-OF-CLIMB INDICATORS.

The katanoscope, chronometric type.—This instrument is a modification of the mechanical statoscope described above. The outlet to the external air in the instrument is automatically opened and closed at regular time intervals (every 20 seconds) by means of clockwork. It has a thermally insulated air chamber the diaphragm of which is made of rubber, oiled silk, or similar materials. Deflections of this diaphragm, as in the case of the mechanical statoscope, are indicated on the dial of the instrument through the intermediary action of a multiplying mechanism.

The operation of the instrument is as follows: Suppose the pressure of the external air to be changing as in the flight of an aircraft. The clockwork controlling the automatic valve is started. This closes the automatic valve, which traps the air in the chamber. The diaphragm deflects, due to the change of external air pressure, this motion of the diaphragm being indicated by the movement of the pointer over the dial of the instrument. This deflection continues until the valve is opened by the clockwork, equalizing the internal and external pressure. The pointer now goes back to zero, indicating that the diaphragm is back to its initial position. The amplitude of this periodic movement of the pointer is a measure of the rate of change of pressure, from which the rate of climb can be computed. These instruments are furnished with an arbitrary scale, the values of its division in rate of change of pressure (rate of climb) being determined by experiment. From data obtained in the laboratory, a

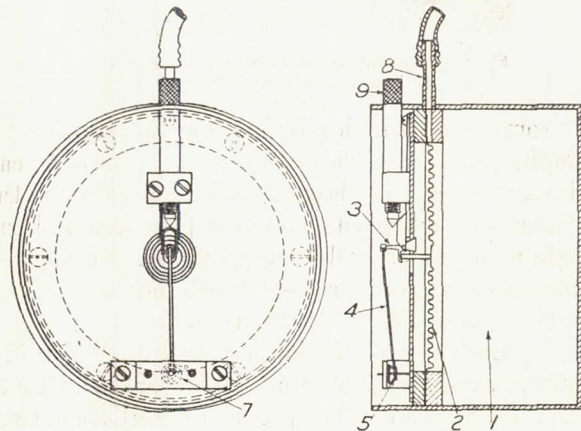

FIG. 7.—Assembly drawing mechanical statoscope.

table or chart may be constructed of the indications of the instrument at various rates of climb and altitudes. From this the readings of the instrument can be converted into rates of climb at all altitudes. Since the instrument indicates only pressure differences, the above table is necessary. A little consideration of the pressure altitude relation shows this instrument will give widely different readings for the same rate of climb at different altitudes.

Leak type of rate-of-climb indicators.—The inherent disadvantages of the katanoscope have lead to the development of rate-of-climb indicators of the capillary leak type. These instruments all operate on the same general principle. A thermally insulated air chamber is closed to the external air, except for a small opening which may consist of either a needle valve or capillary tube. If the pressure of the external air is varying in any manner, the pressure inside the air chamber will lag behind that of the external air, due to the resistance offered to the equalization of pressure by the leak opening. This causes a pressure difference which is measured

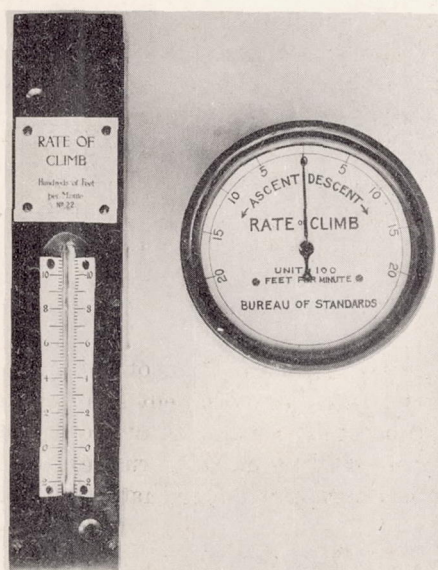

FIG. 8.—British rate-of-climb indicator and Bureau of Standards rate-of-climb indicator.

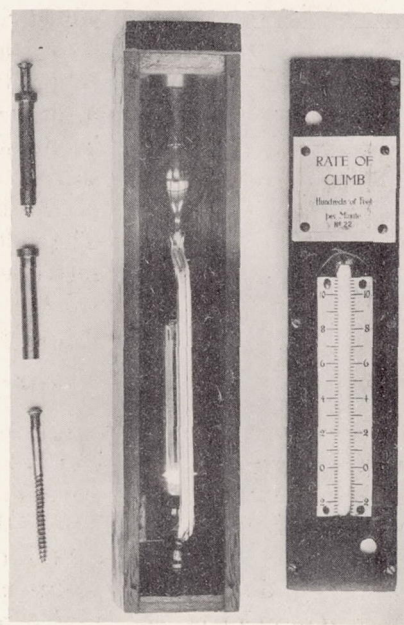

FIG. 9.—Liquid type rate-of-climb indicator.

by some type of indicating mechanism, either a liquid manometer or the deflection of a sensitive diaphragm. The nonturbulent flow through capillary tubes depends on the viscosity of the air; and since the viscosity is independent of the air density, it can be easily proved that an instrument constructed on this principle and graduated to indicate rate of climb will have a scale value which will be approximately independent of the altitude as determined by pressure. The scale value of a rate-of-climb indicator is here defined as the ratio of the true rate of climb to that indicated by the instrument.

Models using a liquid manometer—British R. A. E. model.—This instrument is typical of all liquid types of rate-of-climb indicators, which consist of an air chamber closed to the air except for a leak or vent. The pressure difference between the internal and surrounding air is measured by a liquid manometer, in most cases an ordinary U tube. This instrument, illustrated on the following pages (figs. 8, 9, and 10), consists of a thermally insulated chamber (Dewar bulb) (6) closed to the air except for a capillary leak tube (5). Any pressure difference between the two ends of the capillary tube due to variation of the external air pressure is indicated by the liquid (7) rising or falling in the specially constructed manometer tube (4). Both ends of this manometer are blown in such a manner as to prevent the liquid from spilling out no matter how the instrument is orientated or to what pressure change it is subjected, a decided advantage over some other types of instruments.

There is attached to the trap (3), by means of a rubber tube (2), a device for flushing the manometer (1). This is operated by pressing a small knob inward, then closing the hole through

1. Valve for flushing manometer.
2. Rubber tube connection.
3. Trap for indicating liquid.
4. Manometer tube.
5. Capillary leak tube.
6. Dewar Bulb (Air chamber)
7. Indicating liquid

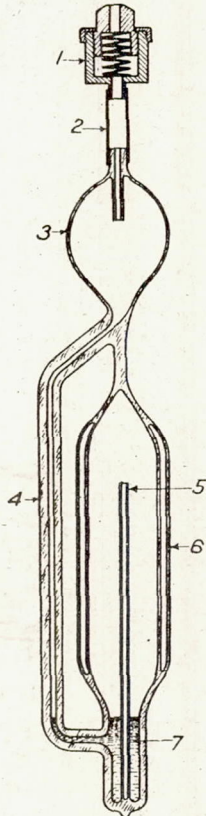

FIG. 10.—R. A. E. (British) rate-of-climb indicator.

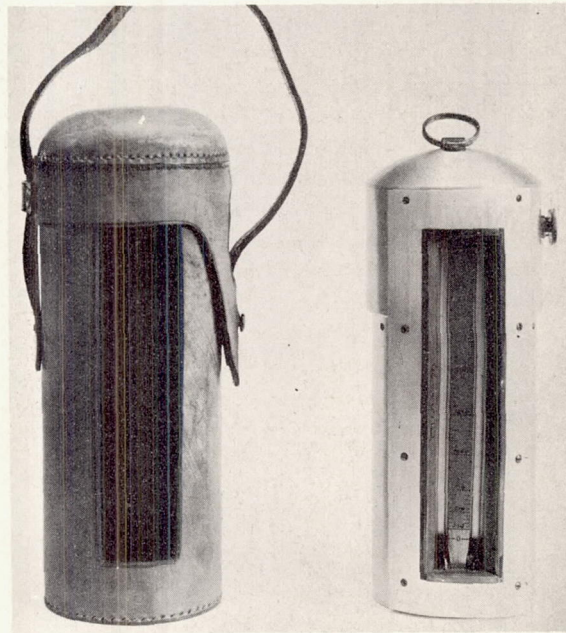

FIG. 11.—British Wright rise-and-fall indicator and case.

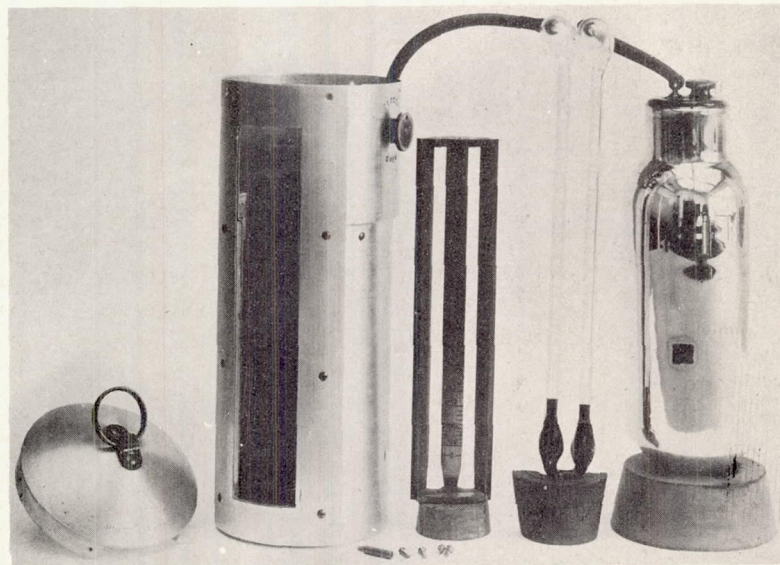

FIG. 12.—Rise-and-fall indicator and case disassembled.

this knob by the finger and allowing the knob to be pressed outward by the spring tension. The suction produced causes the liquid to rise in the manometer tube, thus flushing it.

This instrument has a range of rate of ascent up to 1,100 feet per minute and a rate of descent of 200 feet per minute. The time lag is rather large in this instrument, about 30 seconds. That is the time interval required before the instrument indicates its true rate of climb when properly calibrated.

The British Wright Co. rise and fall indicator.—The main details of this rate-of-climb indicator, as may be seen by referring to the following photographs (figs. 11 and 12), are the same as in the previously described instrument. The glass capillary is replaced by one of platinum. The specially designed manometer is replaced by a U tube. There is a cock attached to the manometer which when closed prevents the instrument from indicating. The range is from 0 to 2,000 feet per minute, both for ascent and descent.

German balloon variometer (fig. 13).—This instrument is similar to the British R. A. E. described above. The main difference is the addition of a filter and dryer for the air before it passes through the capillary leak tube. The manometer is inclined and hence requires only a small pressure difference for a given reading, thereby cutting down the time lag but at the same time making it necessary to exercise great care in maintaining the instrument level. The air chamber is a Dewar bulb surrounded with cork, which provides exceptionally good thermal insulation. This instrument is made in two ranges from 0 to 600, or 0 to 1,200 feet per minute. The time lag is small, about 5 seconds. Sometimes instruments of both ranges are mounted together, the combination being known as a double variometer.

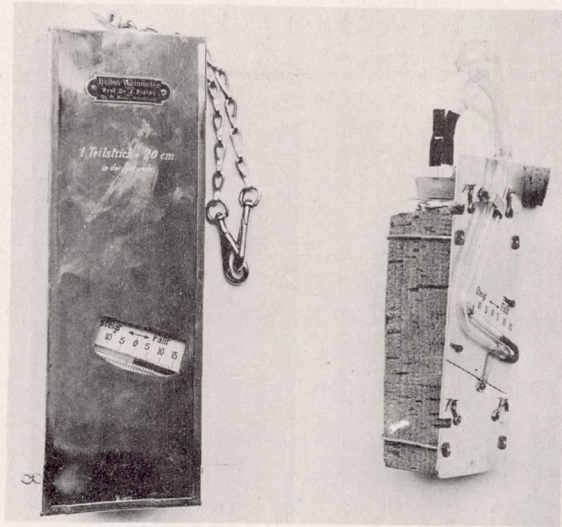

FIG. 13.—German balloon variometer.

Vertimeter (fig. 14).—This instrument, of American manufacture, presents a unique departure from the general construction of rate-of-climb indicators. The air chamber consists of a large uninsulated stream-lined receptacle, which is mounted on the plane away from the cockpit, where it will maintain the temperature of the free air. The indicating mechanism of this instrument is shown in the following diagram (fig. 15). The air chamber is attached to the indicating mechanism by a long rubber tubing, the length and bore of which must be of the proper dimensions or the calibration of the instrument will be affected. The outlet (5) of

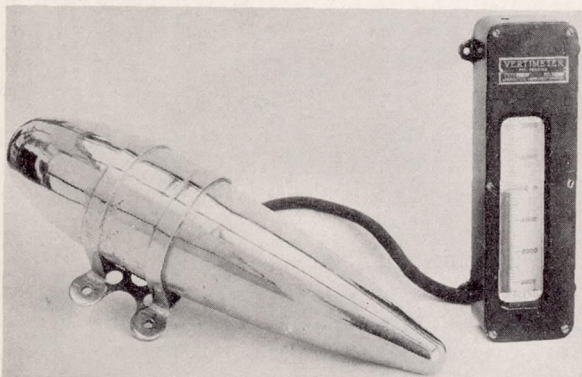

FIG. 14.—The vertimeter, an American rate-of-climb indicator.

the indicating mechanism is directly connected to the manometer (1) and a needle valve (4), the needle valve taking the place of the capillary leak tubes in the other instruments. This valve is in communication with the surrounding air through the outlet (6). When the needle valve is adjusted so that the manometer gives the proper indications of rate of climb, the valve lock nut (7) of the valve is soldered in position. The trap in this instrument does not prevent the escape of liquid, either into the external air if the rate of ascent is excessive or into the needle valve and the air chamber in the case of too rapid descent. The design of the trap is such that a loss of liquid occurs whenever the velocity of the latter is great. In the former case the instrument must be refilled, and in the latter the needle valve must be taken out and cleaned and the instrument recalibrated. Either contingency is likely to happen in flight, especially if the instrument is tilted during climb or descent. The range of the instrument is from 0 to 2,000 feet per minute for ascent and 0 to 3,000 feet per minute for descent. The time lag is small, 5 seconds, but the scale is not so open as in other instruments.

The outlet (5) of the indicating mechanism is directly connected to the manometer (1) and a needle valve (4), the needle valve taking the place of the capillary leak tubes in the other instruments. This valve is in communication with the surrounding air through the outlet (6). When the needle valve is adjusted so that the manometer gives the proper indications of rate of climb, the valve lock nut (7) of the valve is soldered in position. The trap in this instrument does not prevent the escape of liquid, either into the external air if the rate of ascent is excessive or into the needle valve and the air chamber in the

Models using a diaphragm manometer.—Mechanical rate-of-climb indicators differ radically from the liquid type in the substitution of a sensitive diaphragm in the pressure-measuring element in place of the liquid manometer. Several models of this type have been designed and constructed at the Bureau of Standards. Two designs, known as models No. 2 and No. 3, are in practical use and are described below in detail.

Bureau of Standards, model No. 2: The operation of this instrument may be studied by referring to the following diagram and photographs (figs. 16 and 17). A bank of metallic diaphragms (1) connected together at the center by metallic rings forms the air chamber of this instrument. To this air chamber is attached a capillary leak tube (2). The deflection of these diaphragms is communicated to the indicating hand attached at (8) through the multiplying lever (3), by the phosphor-bronze strip (4). This motion is communicated to the arbor (7) by means of another phosphor-bronze strip (4'). A slight

- | | |
|------------------------|---------------------------|
| 1. Manometer tube | 5. Conn. to air chamber |
| 2. Needle valve stem | 6. External air inlet |
| 3. Needle valve spring | 7. Locknut for valve stem |
| 4. Needle valve | 8. Wire gauze (brass) |
| | 9. Indicating liquid |

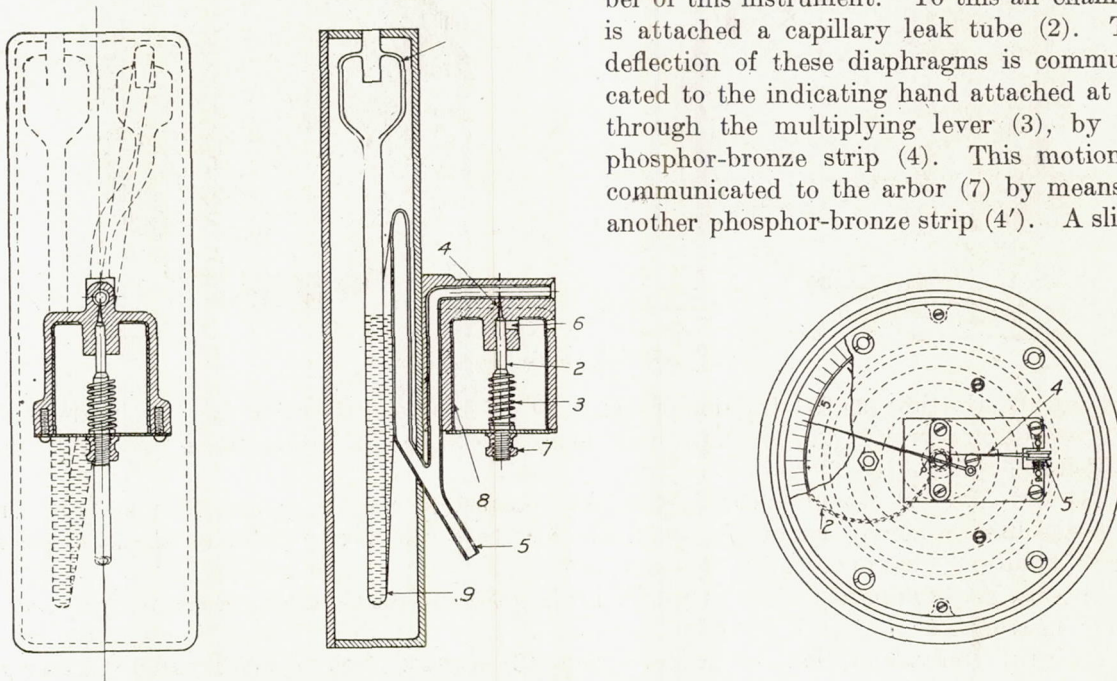

FIG. 15.—Vertimeter.

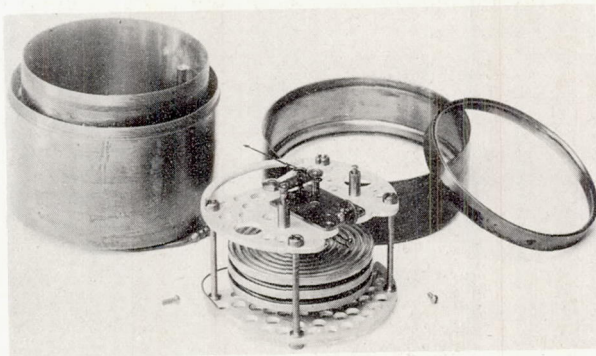

FIG. 16.—Disassembled Bureau of Standards rate-of-climb indicator.

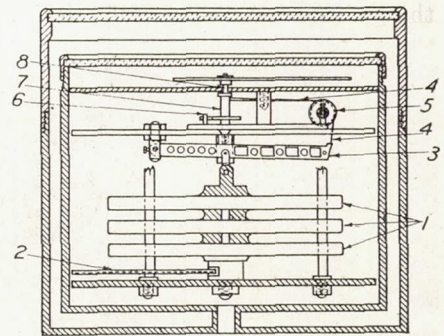

FIG. 17.—Bureau of Standards rate-of-climb indicator mechanical type. Model No. 2.

tension is kept on this system by the hairspring (6). Thermal insulation is provided by an air jacket around the mechanism. The range of this instrument is from 0 to 2,000 feet per minute both for ascent and descent, but it can be subjected to all rates that would be experienced in the flight of aircraft without damage. The time lag of the instrument is 30 seconds.

Bureau of Standards, model No. 3: Certain modifications of the above-described model were found desirable in order to reduce the time lag, and to diminish other sources of error.

These instruments were incorporated in the design of a new instrument for the Balloon and Airship Division, Army Air Service. Referring to diagrams and illustrations of model No. 3 (figs. 18, 19, and 20), the following are the more important changes:

First. The substitution of a large-diameter rigid type of air chamber (1) with thin diaphragm (3) in place of a bank of metallic diaphragms connected together at the center by metallic rings, which formed the air chamber in the older model. This modification makes it possible to get a sufficient deflection of the diaphragm with a smaller pressure difference, thus

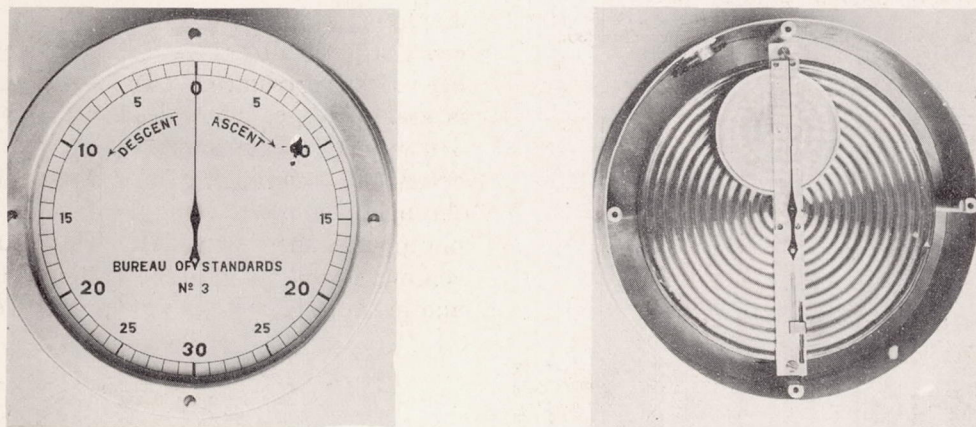

FIG. 18.—Rate-of-climb indicator, model No. 3.

cutting down the time lag to a fraction of its former value, and at the same time eliminating the large inclination error in the previous instrument, due to the mounting and mass of the diaphragms.

Second. The use of a glass capillary tube (6) instead of one of copper. This modification suggested itself when the calibration of model No. 2 was observed to change slightly, which was thought to be due to corrosion of copper tube.

Third. The elimination of all levers, facilitating the counterbalancing of the working parts of the instrument.

Fourth. The substitution of a helical spring (13) in place of an ordinary watch hairspring. This allows the addition of the zero regulator, and has also the following advantages: It makes it possible to obtain a much finer adjustment of the tension on the diaphragm; it furnishes a

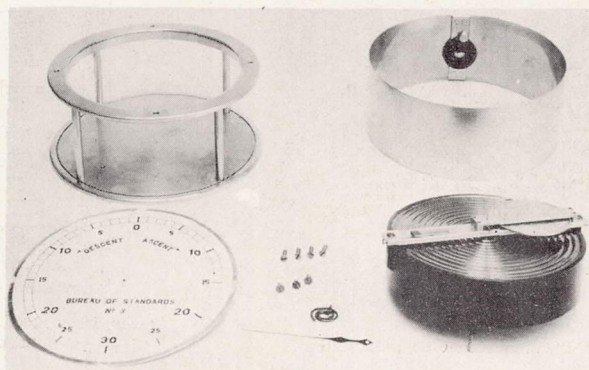

FIG. 19.—Rate-of-climb indicator, model No. 3.

means of adjusting the calibration of the instrument; and it provides a means of compensating the instrument for temperature.

The operation of the mechanism is as follows: Deflections in the diaphragm (3) are multiplied and communicated to the indicating hand (28) through the phosphor-bronze connecting strip (20), which actuates the multiplying pulley (18), which in turn transmits the motion to the

pulley on the indicating arbor (26) by means of the phosphor-bronze connecting strip (21). This motion is read on the dial by means of the indicating hand (28). The helical spring (13) serves the purpose of taking up all backlash in the instrument, and also to adjust the zero setting of the indicating hand by varying the tension on the diaphragm (3) by means of the slide (15) and the adjusting screw (16). The range of the instrument is from 0 to 3,000 feet per minute ascent to 0 to 3,000 feet per minute descent, but, like the previous model, can be subjected to all rates up to about 9,000 feet per minute ascent and to 30,000 feet per minute descent without injury, so that it is almost impossible to damage the instrument by subjecting it to a too great change in pressure. The time lag is about 5 seconds.

German mechanical rate-of-climb indicator.—This instrument (figs. 21 to 24) is similar in many respects to the Bureau of Standards model No. 3, although the two instruments were developed independently. The operation of the instrument is as follows: The movement of the diaphragm is communicated to the pointer by means of a connecting thread (3), which actuates the multiplying lever (6). This lever is counterbalanced by a counterweight. The

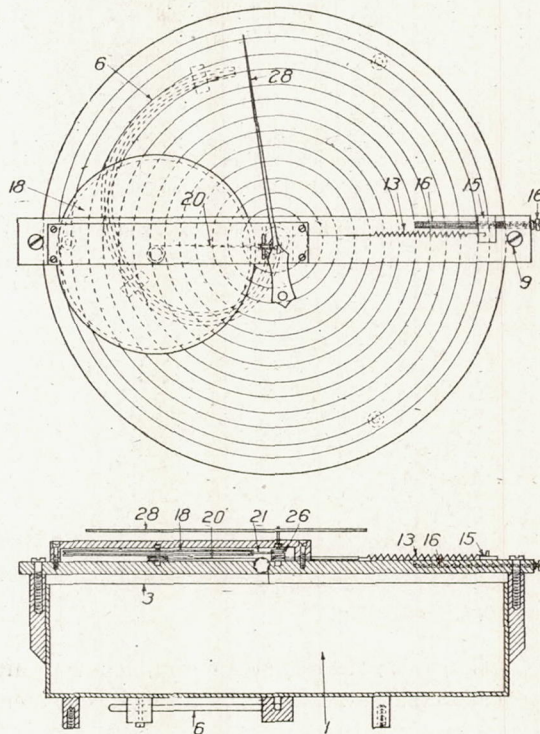

FIG. 20.—Bureau of Standards rate-of-climb indicator, mechanical type, model No. 3.

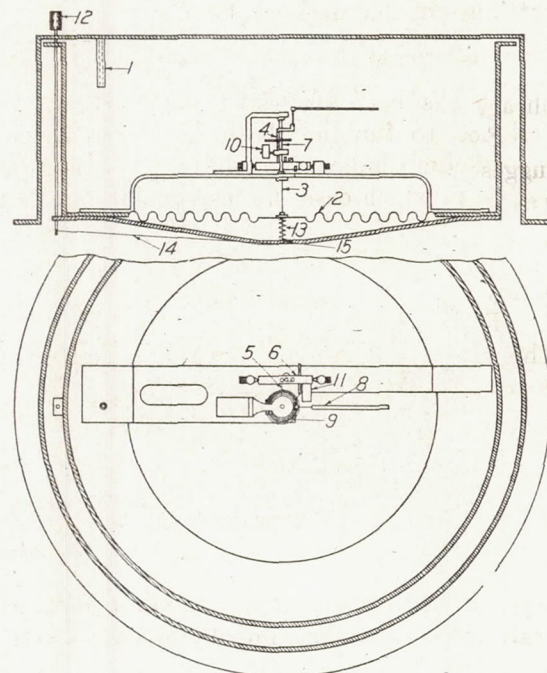

FIG. 21.—German rate-of-climb indicator, mechanical type, No. 1027.

multiplying arm of this lever communicates its motion to the indicating pulley (7) to which is attached the pointer (8) and is rotated by means of the winding and unwinding of the thread on the pulley against the tension of the hairspring (9) which is attached to the same shaft. This shaft is also counterbalanced. The motion of the above mechanism is limited by two stops inserted into the multiplying lever and bent so as to allow for proper movement of the pointer, but preventing the mechanism from being damaged by excessive pressure differences.

There is a zero regulator attached. It operates by putting tension on a light helical spring (13) which is attached to the center of the diaphragm. This is accomplished by turning the knurled screw (12) placed on the outside of the instrument case, which winds or unwinds thread (14), the other end of which passes over guide pulley (15), thus adjusting the tension on the spring (13).

The leak device of this instrument is unusual. It consists of a tube (1), into which is inserted a tapering pin. The instrument is calibrated by adjusting the position of this pin in

the tube. Thermal insulation is effected by an air jacket between the air chamber and the outer case.

The range of the instrument is from 0 to 1,000 feet per minute, both for descent and ascent. The time lag is about the same as in Bureau of Standards model No. 3.

Magnetic type.—While instruments of the leak type and automatic statoscopes represented by the katanoscope constitute the only types of rate-of-climb indicators which have found practical use, various other types of rate-of-climb indicators have been suggested. A magnetic instrument of Dutch manufacture uses a propeller-driven armature revolving in the field of a permanent magnet. This magnet swings like a pendulum and is always in a vertical position. The rate of climb is determined by the speed of rotation and orientation of the armature in the magnetic field, since the rate of climb is a function of the air speed and the position of the armature in the magnetic field.

COMBINATION STATOSCOPE AND RATE-OF-CLIMB INDICATOR.

It has been suggested that an instrument be designed to function both as a statoscope and a rate-of-climb indicator. One way of doing this would be to provide a valve to close the leak orifice, in which case the instrument can be used as a statoscope. With instruments as sensi-

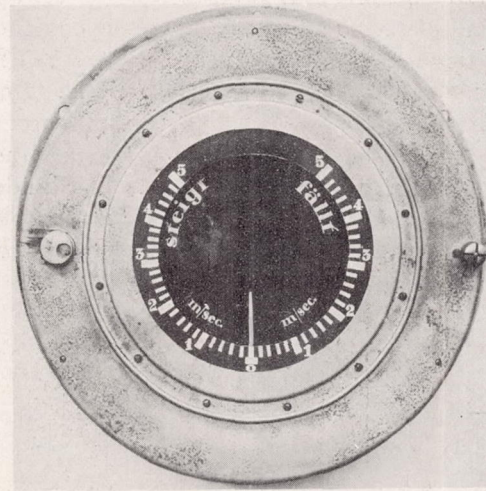

FIG. 22.—German rate-of-climb indicator.

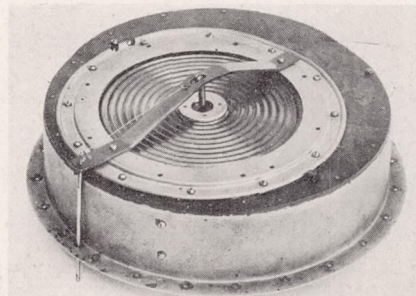
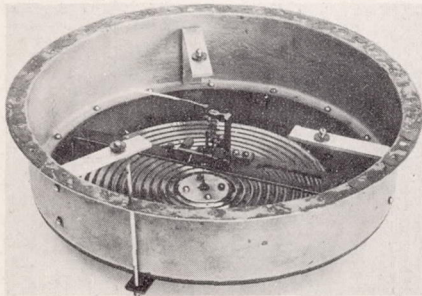

FIG. 23.—German rate-of-climb indicator.

tive as the mechanical rate-of-climb indicator this will not be necessary for heavier-than-air craft, since these instruments indicate a rate of climb as small as 20 feet per minute; however,

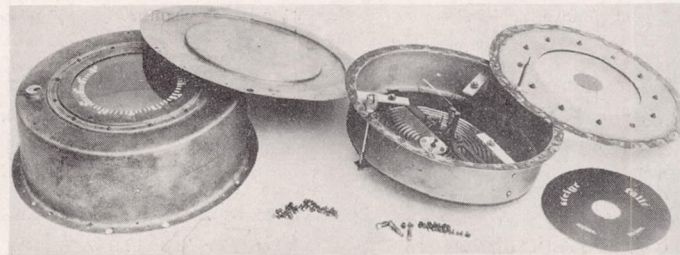
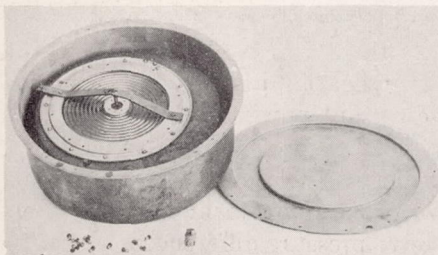

FIG. 24.—German rate-of-climb indicator, disassembled.

in the operation of lighter-than-air craft an instrument giving much more sensitive indications than is possible with a rate-of-climb indicator is required, and for this purpose a combined instrument would be advantageous.

TESTING METHODS FOR STATOSCOPES.

PRELIMINARY TESTS.

Before proceeding with the ordinary routine tests, all types of statoscopes are examined as regards workmanship and for any mechanical defects. A bubble instrument is inspected for broken and disconnected tubes. A mechanical type is tapped lightly to determine whether the pointer is loose on the shaft. It is then given a slight rotary motion, so as to deflect the pointer. If serious oscillations occur, the hairspring is too weak or a part of the lever system is disconnected. The mechanism is then tested for balance by placing the instrument first in a horizontal and then in a vertical position and noting any change in the position of the pointer.

Mechanical instruments are tested for leaks in the following manner: The instrument, with its air outlet closed, is placed in a glass bell jar or other container in which it can be observed. The pressure is reduced until the pointer indicates the maximum deflection, and the instrument is held at this pressure for one hour. If during this time the reading of the instrument decreases, a leak is indicated. Care is taken that the temperature of the instrument is kept constant throughout this test.

TEMPERATURE TESTS.

The thermal insulation of the air chamber of the instrument is tested as follows: The instrument is placed in a temperature chamber at -10° C. and kept there for three hours to

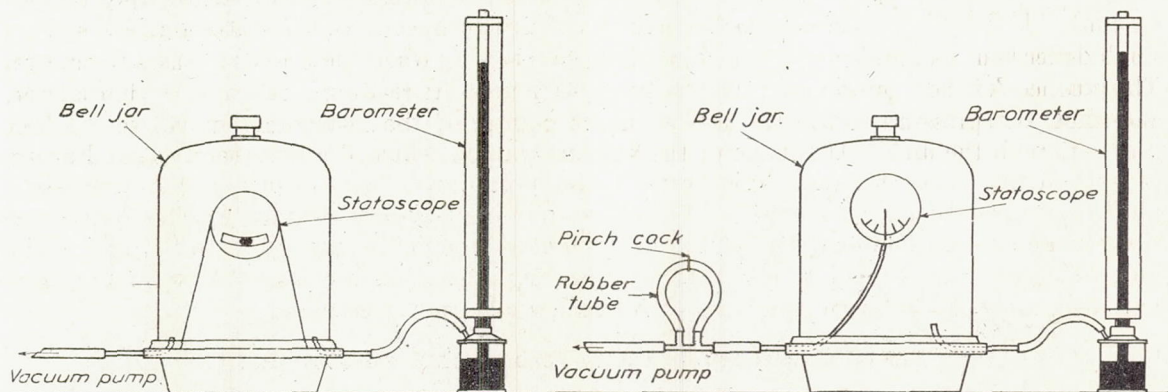

FIG. 25.—Diagram of connections for testing bubble type statoscope.

FIG. 26.—Diagram of connections for testing mechanical statoscope.

make sure that it has attained throughout the temperature of the chamber. It is then quickly placed in a second chamber, at a temperature of $+40^{\circ}$ C. and read at intervals for two hours. The barometric pressure is also noted so that corrections can be applied for change of atmospheric pressure. During this test the instrument should not give a greater indication than would be produced by a change in altitude of 1,000 feet (i. e., a change of pressure of about 1 inch of mercury), allowance having been made for any change of atmospheric pressure during the test. The instrument is also observed for any change of reading due to expansion or contraction of the mechanism, with temperature change, and the bubble statoscope for large changes in viscosity of the indicating liquid.

PRESSURE DIFFERENCE TESTS.

These tests are conducted in the following manner: In the case of the bubble type, the instrument is placed in a bell jar which is connected to the barometer and the vacuum pump as is shown in the following illustration (fig. 25). When adjusted and the apparatus is found free from leaks, the pressure in the system is reduced until one end of the bubble is brought to a certain mark on the curved gauge. After the pressure has been kept constant for a short time, the reading of the barometer is noted. The pressure is now reduced until the bubble breaks, and comes back to the same chosen position in the curved gauge. Another reading of the barometer is taken, and the change of pressure computed from the two readings of the barom-

eter. These observations of the instrument should be repeated about ten times. The average of the readings is computed, and is known as "the pressure equivalent of the bubble." This may also be expressed as a change in altitude.

The mechanical statoscope requires some method by which the outlet to the external air may be closed at any desired pressure. This was done at the Bureau of Standards by means of a specially designed hose connection as shown in the accompanying diagrams. Figure 26

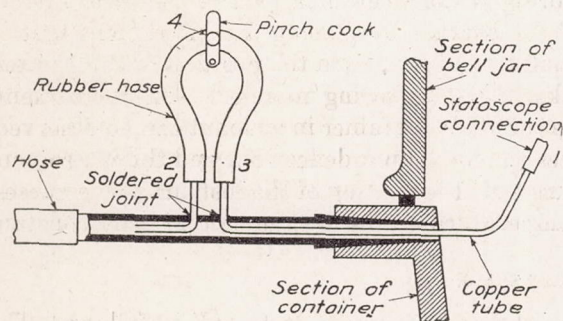

FIG. 27.—Detail of tube connections for mechanical statoscope.

shows the barometer,⁴ vacuum-pump, and bell-jar connections, and figure 27 the detailed tube connection. The small rubber tube of the instrument is attached at (1). Another small rubber tube equipped with a pinchcock is attached to the copper tubes (2) and (3). After these connections are made and the system is free from leaks, the instrument is tested in the following manner: The pinchcock is removed so that the air chamber of the instrument is subjected to the pressure in the testing system, the pump is started, and the pressure reduced to the desired

amount. If there is a resistance to the flow of air in the connections, the statoscope will show a small deflection, but the pointer will come to its zero setting when the pressure ceases to change. The pinchcock is now put on the rubber tube at (4), a pressure reading is taken on the barometer, and then the pressure slowly reduced until the pointer of the instrument moves to the first graduation on the dial. At this point the vacuum pump is shut off and as soon as equilibrium is reached the barometer reading is noted. This procedure is continued for each graduation until the end of the scale is reached. The pressure in the bell jar is now increased and observations made at each point on the scale of instrument through the zero point to the end of the descent scale. Check readings are taken by repeating the above procedure. From these observations a table of "pressure equivalents" for each graduation is prepared.

TESTING METHODS FOR RATE-OF-CLIMB INDICATORS.

TESTING APPARATUS.

The set-up for testing rate-of-climb indicators is shown diagrammatically in figure 28 and consists of the following equipment:

Bell jars and stand.—The bell jars are of glass, various sizes being used to meet the needs of the instruments to be tested. The stand is made of a circular steel plate, 20 inches in diameter and one-half inch thick, mounted on three steel legs. This plate is equipped with both pressure and electrical connections. Two pressure connections are required for the testing of rate-of-climb indicators, one for an outlet to the pump, the other for the connection to the barometer, since it is necessary to minimize the friction of the flow of air between the bell jar and the barometer so that the barometer will indicate the true pressure change (rate of climb) in the bell jar. The bell jar is sealed to the stand with a soft paste made of paraffin, beeswax, vaseline, and rosin.

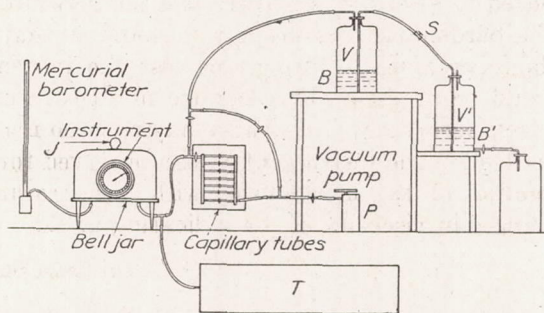

FIG. 28.—Diagram of connections for testing rate-of-climb indicators.

⁴ The method of connecting the barometer to the bell jar so that it will indicate the proper pressure should be noted. This connection should be as short as possible, so as not to offer resistance to the flow of air and thus cause a time lag. This effect is extremely annoying when testing rate-of-climb indicators.

Barometer.—The barometer used was designed and constructed at the Bureau of Standards and is provided with both pressure and altitude scales. The altitude scale is read during the tests on rate-of-climb indicators; and the rate of climb determined by finding with a stop watch the time required for the mercury to fall a chosen altitude interval. This altitude interval should not be greater than 1,000 feet since the rate of climb is likely to change during larger intervals and thus give inaccurate results. By using a large-capacity pump and volumes of about 12 cubic feet, a fairly constant rate of climb can be obtained over a pressure interval corresponding to several thousand feet of altitude.

Capillary tubes.—The capillary tubes are adjusted so as to give the desired rate of climb by grinding to the proper length and by properly constricting the bore. By making up a set of these and using them in various combinations in conjunction with a variable volume, any rate of climb can be produced from 100 feet up to the maximum range of any instrument.

Variable volume.—This consists of a large glass bottle (B) of about 2 cubic feet capacity connected to the expansion tank (T) and to a second bottle (B') of the same capacity. By varying the level of (B') water can be forced to or from the bottle (B) thereby varying the volume of the system which included the calibrating bell jar (J). Since the pump (P) is operated at a constant speed the same rate the change of pressure (rate of climb) in the bell jar can in this manner be accurately controlled. When the required volume adjustment has been made the bottle (B') is cut off by closing the stopcock (S).

Expansion tank.—This is a hot-water boiler (T) (fig. 28) of about 10 cubic feet capacity which serves the purpose of adding volume to the system. It is insulated so as not to cause any pressure changes in the system due to sudden changes in the room temperature.

Vacuum pump.—For ordinary testing a small pump (P) (fig. 28) connected directly to the test chamber is sufficient, but for rapid rate of ascent and for more accurate work a large pump and tank are required. The pump used has sufficient capacity to evacuate 10 cubic feet from 30 to 6 inches of mercury in 10 minutes.

TESTING OF RATE-OF-CLIMB INDICATOR.

The tests on rate-of-climb indicators used by the Bureau of Standards are arranged to determine the accuracy of the instrument under the various conditions of flight. The main factors which affect the reading of the instrument are lag, changes of temperature, and changes of air density.

Preliminary tests.—Each instrument is inspected for defects in workmanship, defective tubes, and leaks. The capillary leak tube should be clean and made of material that will not corrode.

Calibration tests.—The apparatus is assembled as indicated in figure 28. A chosen rate of climb is produced by starting the vacuum pump and opening the stopcocks connected to the capillary tube which has been selected to give the desired rate of climb in the system. If the tests require that this rate be definitely specified—for example, exactly 100 feet per minute—the levels of the liquid in the variable-volume bottles are adjusted until this rate of climb is obtained. When the apparatus gives the proper rate of climb the system is opened to the air and allowed to come back to atmospheric pressure (care of course being taken that the instrument is not damaged by being subjected to a too rapid rate of change of pressure).

The pump is now started again, and as the mercury passes a chosen altitude division on the barometer, say, the 1,000 feet mark, the stop watch is started. When the mercury passes another chosen mark on the barometer the watch is stopped and the time interval noted. During the above operation another observer simultaneously takes readings of the instrument. From the observed time interval required for the mercury to pass the two chosen altitude divisions the rate of climb is computed. This operation is repeated until the desired number of points on the scale of the rate-of-climb indicator are tested. The results of these tests are charted by plotting the rate of climb as given by the barometer against the reading of the instrument. See following curves (figs. 29 to 35) of various instruments tested at this bureau.

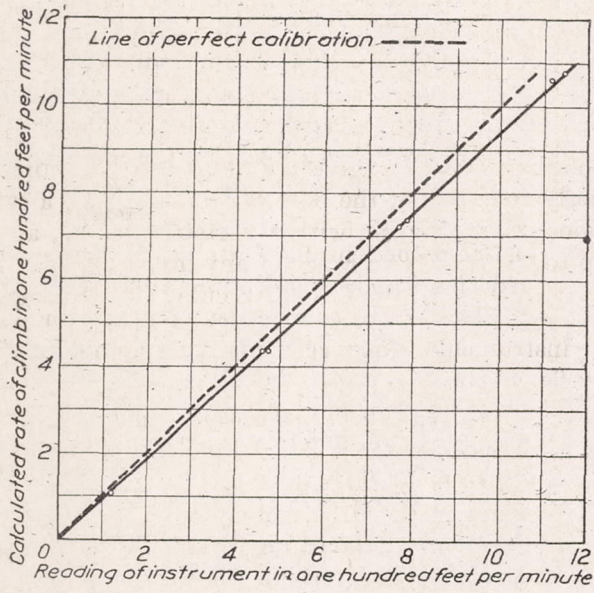

FIG. 29.—Calibration of British rate-of-climb indicator No. 22.

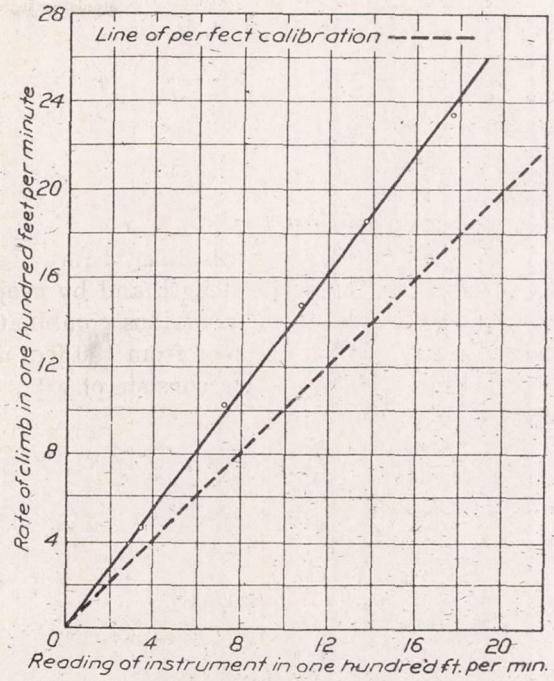

FIG. 30.—Calibration of vertimeter.

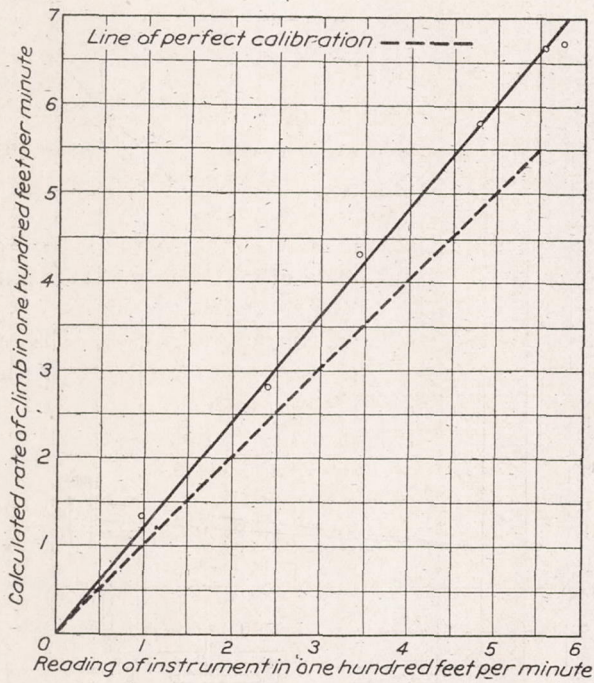

FIG. 31.—Calibration of German balloon variometer No. 1.

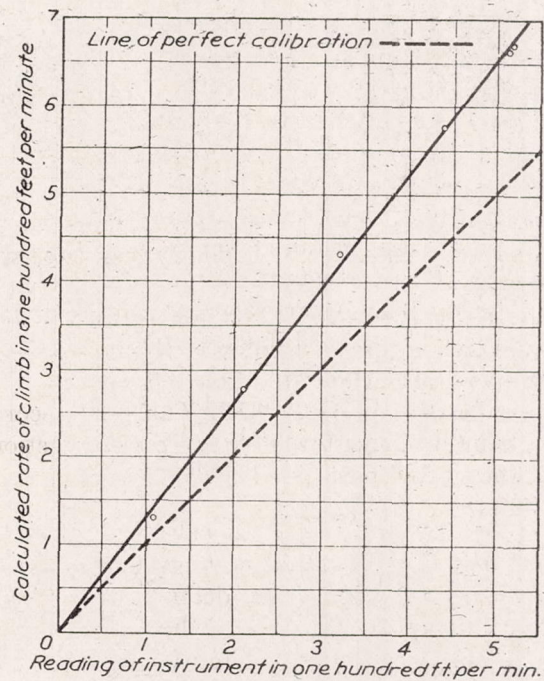

FIG. 32.—Calibration of German balloon variometer No. 2.

Tests to determine variation of scale value with altitude.—This test is conducted by maintaining a constant rate of climb in the test apparatus and making rate-of-climb observations on

barometer and instrument as in the calibration test, for every 5,000 feet from sea level to 40,000 feet.

From the data obtained in these tests the ratio of the calculated rate of climb from the barometer and stopwatch observations to the reading from the instrument are computed and plotted against the altitude.

Results of tests on various types are shown on the following graphs (figs. 36 to 40).

Lag tests.—The theory of the behavior of rate-of-climb indicators shows that the time lag depends both on the altitude and the pressure difference between the two ends of the leak tube. Therefore tests are conducted to determine the variation of the lag, both with altitude and deflection.

The lag of the instrument is determined in the following manner: A chosen rate of

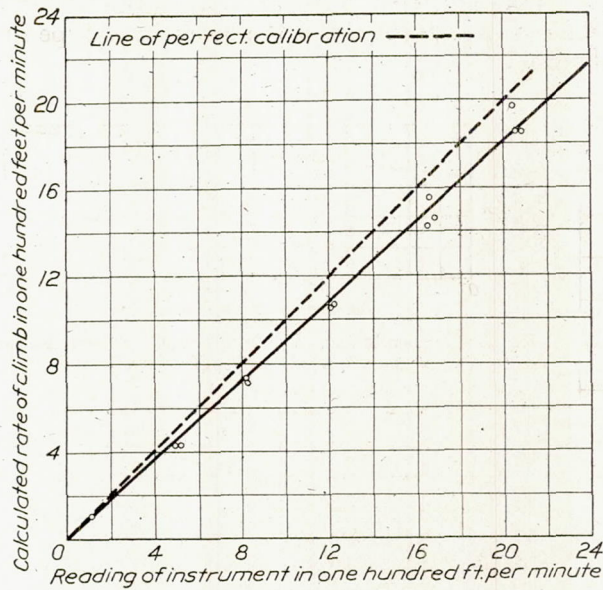

FIG. 33.—Calibration of Bureau of Standards rate-of-climb indicator No. 2.

climb is produced in the apparatus. When this has been held constant until the pointer becomes steady (in most cases a minute is sufficient) the instrument is read. The calibration tank

and pump are then suddenly shut off from the system thus stopping the pressure change in the container. At the same instant a stop watch is started and then stopped when the reading of the instrument comes to one-third of its former value. The lag is the time required in seconds. For a constant deflection these readings are repeated every 5,000 feet until 40,000 feet of altitude are reached.

The lag is also observed for a series of rates of climb, thus showing variation with deflection.

Temperature tests.—A calibration test is run at a temperature of -10° C. to determine the change in slope of the calibration curve with temperature. The instrument is placed in a temperature chamber where it is kept for four hours at the above temperature to allow the instrument to come practically to the temperature of its surroundings; then a calibration similar to that described above is obtained. The following observations are made during the

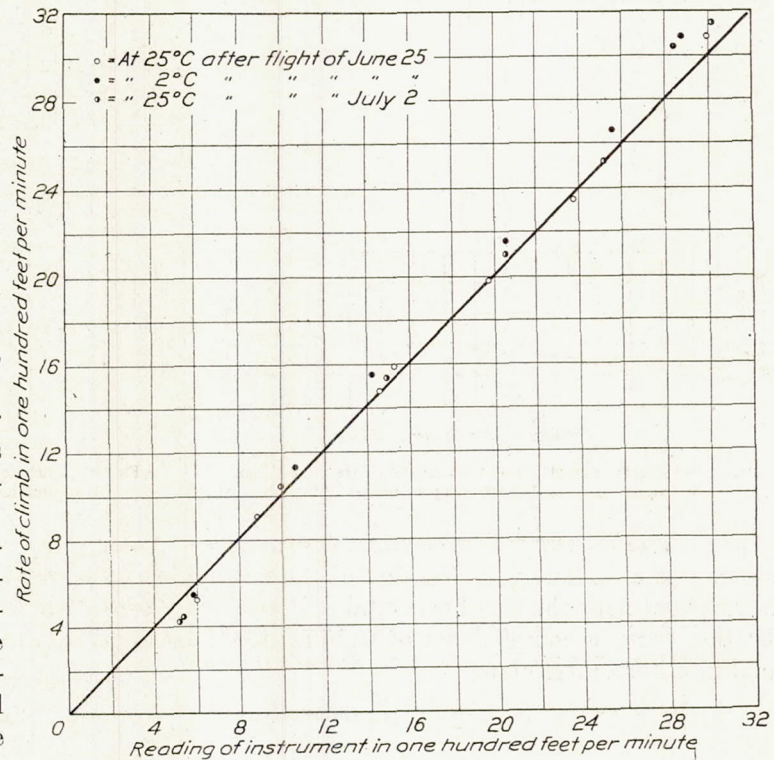

FIG. 34.—Calibration of B. S. rate-of-climb indicator No. 3 after flight tests.

progress of the above test. Just after the instruments are placed in the cold chamber they are observed to see if they indicate a descent. This shows the efficiency of the thermal insulation. After an instrument of a liquid type has been subjected to a low temperature for two hours the indicating liquid is observed for change in its viscosity, and the mechanical type for change in zero due to contractions in the mechanism.

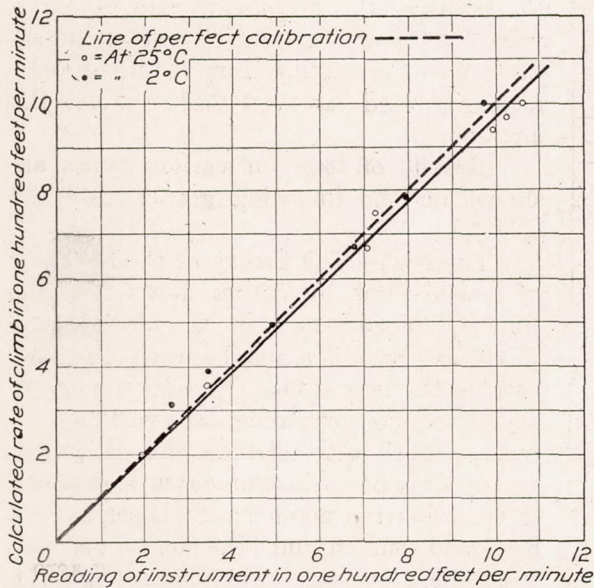

FIG. 35.—Calibration of German rate-of-climb indicator, mechanical type No. 1027.

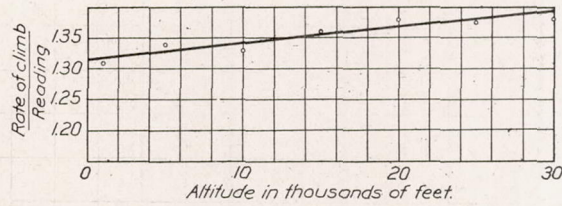

FIG. 37.—Variation of scale value with altitude. German balloon variometer No. 2 at 600 feet per minute.

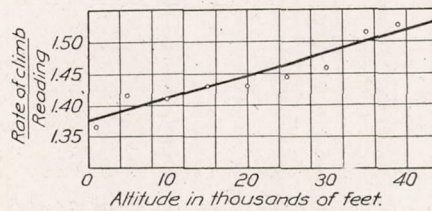

FIG. 38.—Variation of scale value with altitude vertimeter.

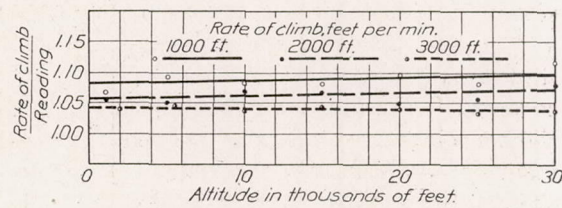

FIG. 39.—Variation of scale value with altitude and deflection. Bureau of Standards rate-of-climb indicator No. 3.

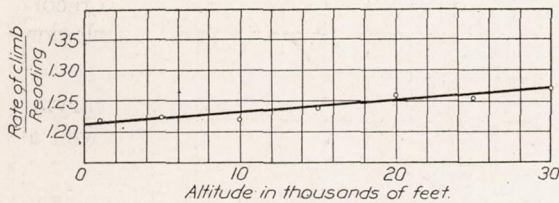

FIG. 36.—Variation of scale value with altitude. German balloon variometer No. 1 at 600 feet per minute.

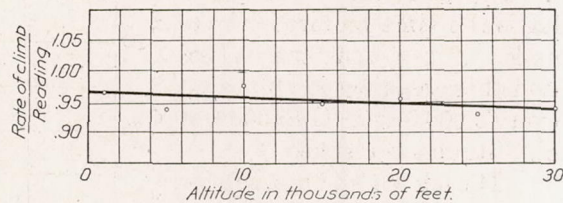

FIG. 40.—Variation of scale value with altitude. German rate-of-climb indicator No. 1027 at 600 feet per minute.

Inclination tests on mechanical instruments.—All of the above tests on the mechanical instruments are made with the dial of the instruments in a vertical position. A calibration test is repeated with the dial horizontal. If there is a considerable change in the slope of the calibration curve a complete set of tests as described above are made on the instrument with the dial in a horizontal plane.

REPORT No. 126.
ALTITUDE INSTRUMENTS.

PART IV.

AEROGRAPHS AND STRUT THERMOMETERS.

BY JOHN A. C. WARNER.

SUMMARY.

This part contains a description of the principal types of thermographs and other aerographic instruments, together with a discussion of performance characteristics and methods of testing.

Direct and remote indicating strut thermometers are also included, for while these instruments are not mechanically self-recording, they are commonly employed for the purpose of preparing curves to show the temperature distribution at successive altitudes and are therefore chiefly of interest in connection with aerographic instruments.

THERMOGRAPHS.

In the field of aeronautics it is often important that a temperature-time record be secured, either in connection with performance tests of aircraft or in obtaining meteorological information of value to the flyer. The thermograph is designed for this purpose, and may be used to record cockpit temperatures to which the flight instruments are subjected or in its meteorological capacity to record the free-air temperature at the ground or at any altitude to which it has been lifted by airplane, balloon, or kite. The records thus obtained facilitate the application of instrumental corrections made necessary by the errors of the instruments due to varying temperature conditions, or provide data for the reduction of altitude determinations as well as useful meteorological information unobtainable by other means.

All types of thermographs combine some form of temperature element and recording device with a timing or clock mechanism in such a manner that the record chart presents a curve of temperature against time over some definite period. The general principles of operation are identical, no matter what the particular duty of the instrument may be.

TEMPERATURE ELEMENT AND RECORDING DEVICE.

The commonest types of thermograph depend for temperature indications upon either the Bourdon tube or the bimetallic strip. Of these, the Bourdon tube instrument is perhaps more common and will be considered first.

Bourdon tube type.—The action of the liquid-filled Bourdon tube as a temperature element is so well understood that very little explanation will be undertaken in this paper. Suffice it to say that the effect of varying temperatures upon the curved metal tube of elliptical cross-section, completely filled with a liquid at the proper pressure, and hermetically sealed at its ends, is to cause it to change its curvature and assume varying positions as the inclosed liquid expands or contracts with temperature changes.

Referring to fig. 1, the Bourdon element will be seen at (A), pivoted at the end of a bracket which holds it outside the instrument case where it may be influenced by free-air conditions. The Bourdon element of a typical instrument has an elliptical cross section approximately

33 millimeters along its major axis by 2 millimeters along its minor axis, and has a length of 65 millimeters along its curved edge. Adjusting screw (B) acts upon the tube through the lever arm attached to the pivoted end of the tube and so allows for satisfactory adjustment. The adjusting arm is held in place by the compression spring shown at (B). The wire frame below the tube serves as a protection from mechanical injury as the instrument is moved about.

At the lower or movable end of the tube and rigidly attached to it is a connecting rod which transmits the motion of the tube through a simple linkage, pivoted near the top of post (C) to the light spring metal arm (D), which carries the recording pen at its outer extremity. A thumb nut is provided at (G) so that the pressure of the pen on the chart may be properly regulated. The vertical spindle (F) may be moved by the small lever attached at its lower end in the base of the instrument so as to raise the pen from the chart when the temperature record is not desired.

Bimetallic strip type.—The bimetallic strip principle has long been used in many types of instruments and apparatus. When two strips of metal with different thermal coefficients of expansion are firmly joined by soldering, welding, or otherwise along their entire length, a change

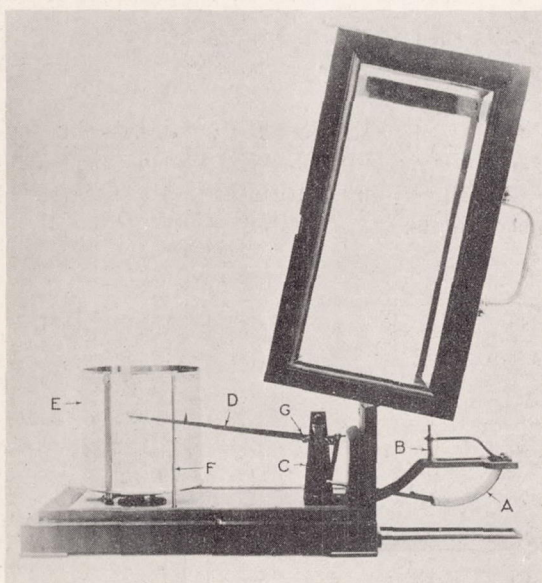

FIG. 1.—Bourdon tube thermograph.

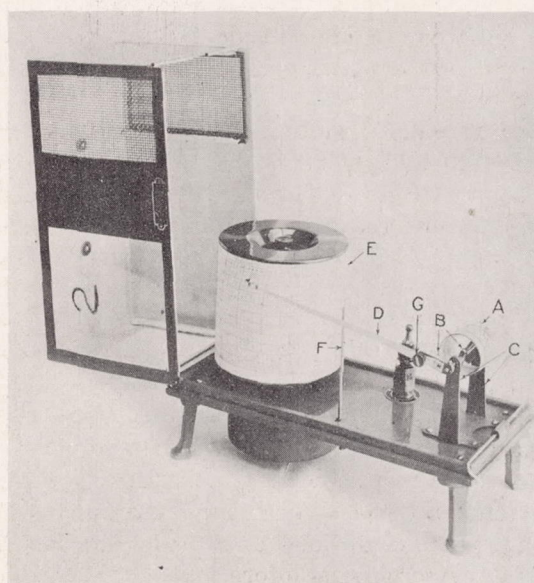

FIG. 2.—Bimetallic strip thermograph.

in temperature causes a distortion so that the bimetallic strip assumes a shape approximating an arc of a circle. When the initial temperature is restored, the strip returns to its former shape. Inasmuch as the distortion has a definite and practically fixed relation (within proper temperature limits) to the existing temperature, the bimetallic strip presents itself as a suitable element for a temperature-recording instrument.

It is possible to combine practically any two metals with different thermal coefficients of expansion to form a temperature element, but in cases where a relatively large distortion is desired it is necessary to choose metals whose coefficients differ materially. Brass or bronze with steel or invar make suitable combinations. The ratio of the coefficients of expansion at room temperature is approximately 2 in the case of ordinary brass to steel and 18 in that of brass to invar. These ratios vary over a considerable range, however, according to the alloys employed.

The strips are used in the form of helices, U-shaped members, or as straight pieces. The advantage gained by the helical or coiled form is that the distortion which takes place under varying temperature conditions produces a direct rotative motion thus making the use of linkages or levers in the recording mechanism unnecessary.

Such is the case with the American instrument shown by Figure 2, in which the helical member is seen at (A). In a certain instrument of this type the strip has the following approximate dimensions: length, 355 millimeters; width, 6.5 millimeters; thickness, 1 millimeter. This forms a helix approximately 33 millimeters in length by 32 millimeters outside diameter. A spindle coincident with the axis of the helix cylinder and supported at its extremities by bearing posts (C) holds the element in position and serves to transmit its motion of rotation to the light spring metal arm (D) mounted at the end of the spindle and carrying the recording pen point at its outer end.

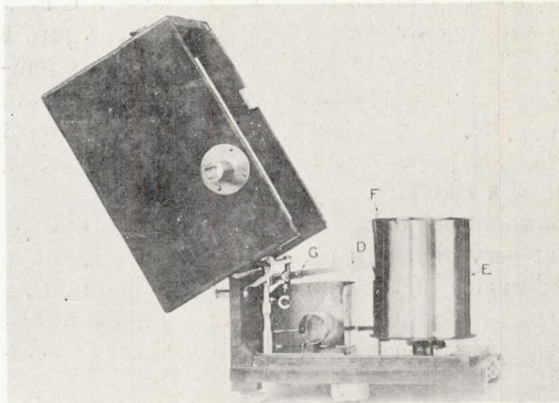

FIG. 3.—Italian thermograph.

screw which holds the recording arm in place at the end of the spindle. The pen-point pressure may be varied by the adjusting thumb nut (G) and the pen raised from the record chart by movement of the vertical rod (F) as previously described.

Figure 3 shows an interesting Italian adaptation of the bimetallic strip temperature element replacing the pressure chambers of an ordinary aneroid type of barograph, thus converting it into a thermograph. This particular instrument is provided with two recording pens, the first to give temperature records and the second to mark time intervals when acted upon by an electromagnet energized at definite intervals by an intermittent current externally controlled. The record drum is caused to rotate by the original barograph clock mechanism.

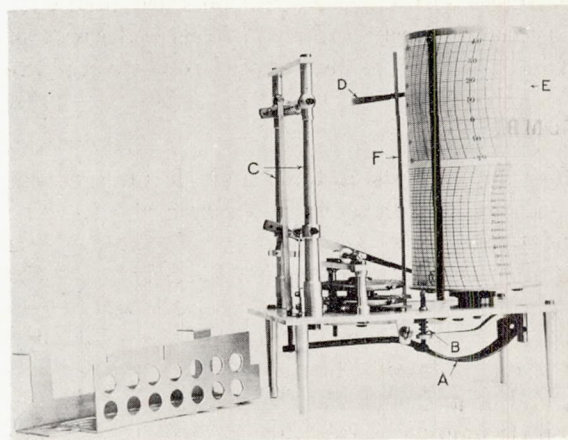

FIG. 5.—Baro-thermograph.

sired to remove the chart. The instrument is lightness and weighs but 624 grams.

The element is provided with two adjusting devices indicated by (B) which also connect it to its spindle. A still further adjustment may be effected by means of the set screw which holds the recording arm in place at the end of the spindle. The pen-point

pressure may be varied by the adjusting thumb nut (G) and the pen raised from the record chart by movement of the vertical rod (F) as previously described.

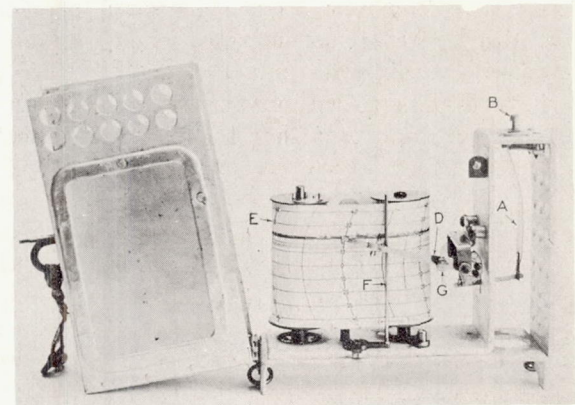

FIG. 4.—German thermograph.

A metal tube mounted on the case cover provides for communication with the outer air so that a satisfactory circulation around the temperature element may be maintained. (Letters represent same elements as in previous description.)

Figure 4 shows a small bimetallic strip (zinc-steel) thermograph of German manufacture. Several interesting features are incorporated in the mechanism, such as the straight bimetallic element, the method of balancing the linkage (see weight at end of recording arm), and the timing mechanism which is contained in one of the vertical record cylinders. The other cylinder is mounted on a movable base so that the distance between the two cylinders may be varied by moving a lever when it is deconstructed throughout with a view to extreme

RECORD CHART AND TIMING DRUM.

The record chart and timing drum common to all thermographs are very similar in design in all cases. The record chart, in the form of a paper strip suitably ruled and marked, is held in place upon the rotating timing drum either by a spring strip of metal as shown in figure 1 or by having its ends secured by means of glue. The ordinates of the chart represent temperatures and the abscissæ, time. The Bourdon tube and bimetallic strip instruments are adapted to a comparatively large range of temperatures, and so may be used with charts of varying limits. The initial adjustment is made for each type of chart by means of adjusting screws, as the indications are compared with those of a standard.

The charts generally provided cover a range of about 50° or 60° of centigrade scale, but the instruments designed for the study of conditions at very high altitudes require a greater range with a comparatively extreme lower limit. A millimeter of the temperature scale ordinarily represents about 1° or 2°. The instruments shown by figures 1 and 2 make a weekly record on a chart about 29 centimeters long, while the German thermograph and French baro-thermograph each make 21-centimeter records in 5 and 6 hours, respectively.

The clock mechanism which causes the record drum to rotate at a definite rate is usually contained within the drum itself. It may, however, be mounted in the base of the instrument as shown in figure 2. In this latter disposition the drum may be removed for the renewal of the record chart without disturbing the clock mechanism. By this arrangement the drum is also lightened considerably and friction reduced thereby. When the clock movement is inclosed within the drum, a space otherwise unused is utilized, and the simple handling of the clock mechanism without involving the whole instrument is made possible.

It is important that the driving connections between clock movement and record drum of an instrument for use on aircraft be free from lost motion. This difficulty may be overcome in most cases by careful workmanship in the construction of the parts and in their adjustment. In some instances this cause of irregular drum action has been avoided by making a direct connection between the mainspring and drum.

The construction of the clock movement as regards the time required for a complete rotation is dependent upon the kind of service for which the instrument is to be used. The common meteorological thermograph for recording temperatures at ground level is ordinarily equipped with an eight-day clock movement which carries the drum through one complete turn in a week's interval, with graduations and markings on the record chart indicating the successive days—while the instrument to be used in the upper atmosphere is designed so as to provide for a complete rotation in the maximum number of hours which the flight may occupy.

Certain of the more recent instruments are equipped with clock mechanisms provided with a gear-shifting device which allows the choice of several different rotative speeds. Records of flights of varying length may thus be made and the time scale value adjusted so as to suit the conditions.

THERMOGRAPH COMBINATIONS.

The thermograph is often combined with other instruments to form a single unit recording several distinct quantities against time, the records appearing upon a single chart. The barograph or the hygograph is most frequently found in this combination. Figure 5 shows a baro-thermograph (without case) of French manufacture, the pressure markings being at the lower part of the chart, with temperature record above. The Bourdon tube element is underneath the base of the instrument where it is protected from mechanical injury by the cage as shown. (Letters represent same elements as in previous descriptions.)

A description of the Marvin, the Fergusson, and of a French meteorograph will be found below. These meteorographs are combination instruments incorporating the temperature element with others.

TESTING OF THERMOGRAPHS.

Two principal thermograph tests are required for the determination of calibration errors and lag constant of the instrument. The laboratory installation for this work consists of a properly constructed temperature chamber with glass observation window and equipped with heating and cooling coils of sufficient capacity to cover the temperature range of the instrument under test. A fan system is usually arranged to provide proper circulation, which insures uniform temperature conditions throughout the chamber. A standard thermometer of known calibration and characteristics is mounted in the chamber, where its readings may be compared with those of the instrument under test.

Calibration test.—The instrument is first put into proper running order with the clock mechanism functioning and the recording pen making a fine line upon the record chart. The adjusting screws are then regulated to make the reading correct for the surrounding temperature. The thermograph is next placed in the chamber, which is then closed and the test begun.

The temperature of the chamber is first raised to the upper limit of the instrument in two or three stages of approximately equal temperature intervals. At each stage the temperature is held constant for a sufficient period to allow the pen to come to rest and for the standard to reach its equilibrium temperature. Readings of the thermograph and standard are taken. The thermograph is then shaken and the reading taken again. The difference in these two readings is the friction error of the instrument.

The heating coils are then disconnected and the temperature allowed to fall. In case it is desirable to determine the magnitude of hysteresis effects, the descent from the higher temperature may also be made in stages and the "up" and "down" readings compared. The same procedure as outlined above is followed for the lower part of the scale by bringing the cooling coils into action.

A thermograph calibration curve is shown by figure 6. The large departures at the lower end of the temperature scale are due primarily to the change in the ratio of the effective lengths of the lever arms

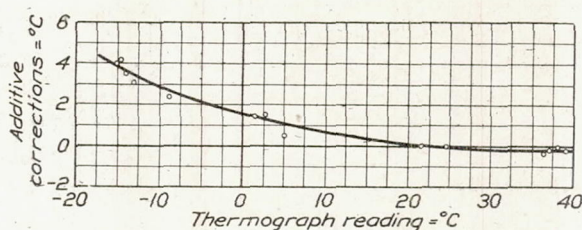

FIG. 6.—Thermograph calibration curve.

as the deflection increases. The simplest method of overcoming this error is to determine by experiment the deflections corresponding to given temperatures, and to rule the chart accordingly. If, however, the thermograph is adjusted to cover some temperature interval other than that for which the chart is prepared, the ruling will in general show calibration errors, since the adjustment shifts the position of the lever arms with reference to the chart.

Lag test.—Considerable lag is found in even the best thermographs. In the determination of the lag constant, temperature chamber and standard thermometer are used as in the above test. The temperature of the air immediately surrounding the thermograph is first carefully determined. The heating coils in the chamber are then connected and the temperature of the chamber brought to a point 10° or 15° warmer than that of the instrument under test. The thermograph is then quickly transferred to the chamber and careful note is made of the time required for the difference between the instrument reading and the chamber temperature to be reduced to $\frac{1}{e}$ times its original value. It is in order to simplify mathematical calculations in which occurs the value e (equal to 2.718), base of the Napierian system of logarithms, that the fraction is customarily taken as $\frac{1}{e}^5$. As an example, let us assume that the initial difference between thermograph indication and chamber temperature is 10.8° C. The lag constant would be taken as the number of seconds required for the thermograph indication to reach to within $\frac{1}{e} \times 10.8^\circ$ C., that is, 4° of the chamber temperature. It is well to make several observations

of this time lag constant with the chamber at various temperatures, each time bringing the instrument back to its original temperature before making a new test.

Clock test.—The clock may be compared with a standard timepiece in order to investigate its proper functioning and to determine the errors in rotative speed of the timing drum. This test should be made with the record chart in place and with the pen resting thereon as in actual service.

Clock mechanism subjected in service to very low temperatures should be given low temperature tests. As is the case with other instruments, the mechanism should be warmed after these tests so as to drive out any collected moisture which might otherwise cause corrosion.

It may be advisable in some cases to conduct additional tests such as that to determine the effect of vibration, but this procedure is ordinarily unnecessary.

Additional tests.—In case the thermograph is likely to be subjected to vibration during use, as, for example, on an airplane, it is advisable to conduct a vibration test by mounting the instrument on a vibrating board and determining whether the action of the recording pen is satisfactory. It should not show excessive vibration.

A tilting test may also be conducted by placing the instrument in various positions and noting the changes in position of the pen.

It is sometimes advisable to make a pressure test on Bourdon tube thermographs. In a properly constructed instrument of this type very little effect is noticed with the decrease in atmospheric pressure which takes place with changing altitudes. In case it is desirable to investigate this point, the instrument may be placed in a vacuum chamber in which the pressure is reduced to correspond to the maximum altitude and minimum temperature for which the instrument is to be used. There should be no appreciable change in the indications of a properly filled instrument as the pressure is reduced, if the temperature is kept constant.

Care should be taken to see that the Bourdon tube contains sufficient liquid to keep the tube under pressure throughout the temperature range measured. Otherwise the apparatus may exhibit an erratic and irregular behavior.

METEOROGRAPHS.

THE MARVIN KITE METEOROGRAPH.

The instrument illustrated by figure 7 is the Marvin kite meteorograph, designed by Prof. C. F. Marvin, Chief of the United States Weather Bureau. Intended for use in exploring regions of high altitude, this instrument is very light in weight (1,138 grams) and makes simultaneous records of atmospheric pressure, temperature, relative humidity, and wind velocity upon a suitably divided record sheet mounted upon a timing drum.

In service this instrument, inclosed in its protective case, is secured in proper position on an aircraft or inside a kite having sufficient lifting power to carry it to the desired altitude. The screening tube seen above the record drum in figure 7 contains the anemometer for air velocity measurement, the temperature element for temperature measurement, and the hygrograph hair which serves as the sensitive element for humidity records. The aneroid pressure element is seen in its position between the screening tube and record drum. All of these sensitive elements connect through suitable devices and linkages with pens resting upon the record chart.

Air velocity element.—The air velocity element consists of a small anemometer fan mounted on light bearings inside the forward end of the screening tube. The rotative motion of this anemometer element is transmitted through worm gearing to a cam. A lever connected to the recording pen pivot bears against the cam so that as the latter comes to a certain period in its motion the lever is pulled down and the pen makes a mark upon the chart. The pen and lever then return to their original positions, and the action is repeated at intervals whose length depends upon the pitch at which the fan is adjusted.

Temperature element.—This instrument depends upon a bimetallic (bronze-invar) strip for the temperature records. The element, 25 millimeters in width and bent into circular form, is mounted in the screening tube, and its free end, which changes position in a definite and regular

manner with temperature variations, is connected to the recording pen arm by means of a simple linkage. An adjustment is provided for changing the initial position of the pen upon the record chart, and another device makes it possible to vary the scale value as desired.

Humidity element.—Similar to most devices for recording indications of relative humidities, this meteorograph employs a series of human hairs which have the property of changing their length with varying conditions of moisture. Instead of combining the hairs in the usual bundle form, the designer has mounted them separately, which enables the hairs to come into equilibrium with the surrounding air more promptly. Two sets of hairs are mounted longitudinally in the screening tube upon suitable fixtures provided with the necessary adjustments, and the element is connected by direct linkage to the recording pen. Inasmuch as the change in length of the hairs is not linear with respect to the humidity change, it is necessary to provide a special scale for the individual element employed. Adjustments are provided for varying the scale value and for controlling the initial position of the recording pen upon the chart.

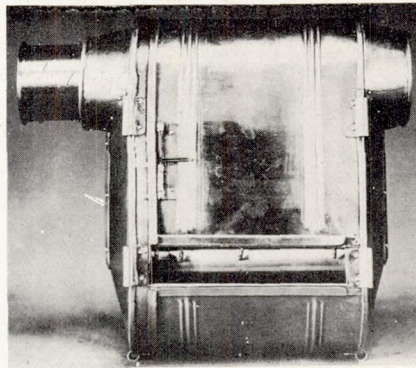
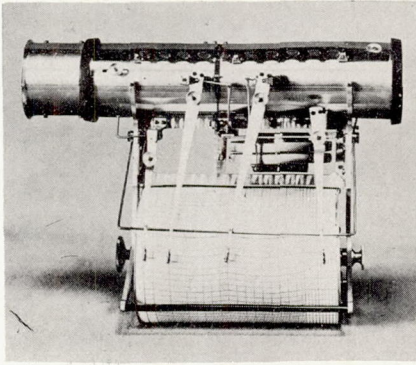

Fig. 7.—Marvin meteorograph.

Pressure element.—Two nickel-plated steel aneroid chambers provided with internal steel springs are employed as the pressure sensitive element of this instrument. In the photograph they are clearly seen mounted between the screening tube and record drum. A suitable linkage connects the aneroids with the recording pen so that the latter traces the pressure curve upon the chart with expansion or contraction of the flexible steel aneroid chambers as the external air pressure changes. A small quantity of air allowed to remain within the aneroid chambers is intended to compensate in part for deflection of the element due to temperature variation. A bimetallic strip in the connecting linkage is also provided for this purpose. The scale value may be varied by adjustment of the linkage.

Record drum and chart.—The record chart is properly ruled to receive the traces of the pens connected with the four elements. The wind curve comes at the top of the sheet, with those for temperature, pressure, and humidity occupying successive spaces over the ruled chart. The latter is held upon a removable timing drum with clock movement inclosed. The drum makes a complete rotation in an eight-hour period.

Instrument housing.—The protective housing (shown in place in the illustration) slips over the instrument so that no part is exposed excepting the screening tube which contains the several sensitive elements. Two bakelite strips insulate the tube from the case. A mica observation window is provided for the inspection of the recording elements when the housing is in place.

THE FERGUSSON METEOROGRAPH.

One of the most interesting of recent developments is the meteorograph by S. P. Fergusson, meteorologist of the United States Weather Bureau. It is essentially a modified baro-thermo-hygrograph designed with a view to extreme lightness, thus making it possible to carry it to great altitudes by means of sounding balloons. The instrument with its case (see fig. 8) weighs but 180 grams, as compared with 400 grams, the weight of the next heavier instrument of its type. In addition to its lightness, it possesses several other important advantages as noted in the brief description which follows:

Temperature element.—The bronze-invar bimetallic strip temperature element upon which this meteorograph depends for temperature records is mounted in the vertical screening tube at the right side of the instrument where it is exposed to the circulating air. The mounting is so designed and arranged as to avoid the effects of radiation and conduction from surrounding parts. The strip is bent into circular form and its free end is connected by a simple linkage to the recording stylus which rests upon the record drum. One millimeter of the temperature scale represents a change of 2° C.

Humidity element.—The humidity element is composed of six or eight series of human hairs of three strands each. They are mounted upon suitable fixtures and extend vertically inside the screening tube. Tension on the hairs is maintained by a flat spring, one end of which is connected to the recording stylus.

Pressure element.—Perhaps the most interesting feature of this instrument is the method for obtaining a comparatively open scale for the pressure records which may cover practically the entire range of atmospheric pressures. Inasmuch as the pressure scale becomes greatly contracted at extremely high altitudes, thus making the records uncertain, it is desirable that a special arrangement be made in the instrument design so as to compensate for this characteristic.

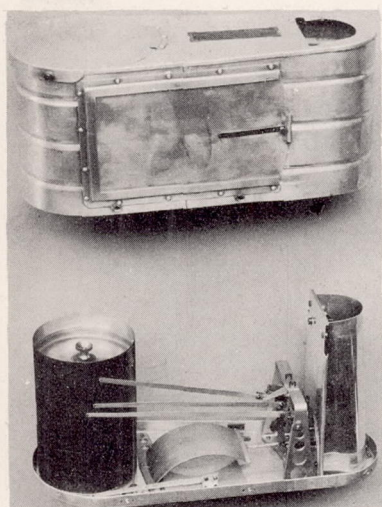

FIG. 8.—Fergusson meteorograph.

The pressure element itself is a common form of exhausted Bourdon tube with one end securely fixed to the instrument base and with its movable extremity acting upon the recording stylus through a linkage of ingenious design. It is this linkage which cares for the open-scale feature mentioned in the preceding paragraph by causing the recording stylus to make two traverses of the record chart. The first or upward traverse covers a certain range in altitudes and the second or downward trace continues the record to the upper limit. It is also possible by the adjustment of this linkage to vary the scale so that a certain upward motion of the stylus has a value equal to twice that of the downward motion in order that small pressure changes above 10,000 meters may be determined with greater precision than would be possible with a uniform scale.

Record drum and chart.—The record drum seen at the left of the illustration surrounds the clock movement which is mounted upon the base plate. The clock causes the drum to turn through one complete rotation in one hour and is so designed and connected to the latter that the clock may be rewound by turning the drum backward; the number of turns depends upon the number of rotations desired for the record.

The chart or record sheet is made of very thin sheet aluminum (0.03 millimeter in thickness) wrapped once around the drum and with the ends secured by a special lock joint. In making the instrument ready for service a layer of smoke is deposited upon the aluminum chart by holding it (in place on drum) over a camphor or kerosene flame. The recording styli rest upon this smoke film and make fine lines as the drum rotates. In addition to the recording styli mentioned above, there is a fourth one which is fixed so as to mark a base line at the bottom of the chart. A stylus lifter is provided to raise the markers from the chart when no record is desired. Finally, the record may be fixed or made fast, after it has been obtained, by applying a suitable preparation (white shellac and glycerin) which hardens the film. The record is examined and evaluated by the use of a transparent scale suitably divided.

The designer of this instrument has endeavored to avoid complication so that the parts may be easily and economically manufactured and assembled. The entire instrument, including the case, is constructed with a view to compactness and lightness without loss of rigidity. The outside length of the instrument is 210 millimeters, the height 90 millimeters, and greatest width 85 millimeters. The clock drum is 80 millimeters in height, 57 millimeters in diameter, with a time scale of 3 millimeters per minute.

FRENCH BARO-THERMO-HYGROGRAPH.

Figure 9 shows a view of a baro-thermo-hygrograph of French design. The instrument is similar to the baro-thermograph shown in figure 5 of this paper, with the exception that in this instrument the hygrograph element is added.

Temperature element.—The Bourdon tube temperature element is mounted underneath the instrument base, where it is protected from mechanical injury by a sheet-metal framework. A simple linkage connects it to the recording pen arm resting upon the uppermost section of the chart, which is ruled to cover a temperature range from minus 30° C. to plus 30° C. in a 60 millimeter vertical direction.

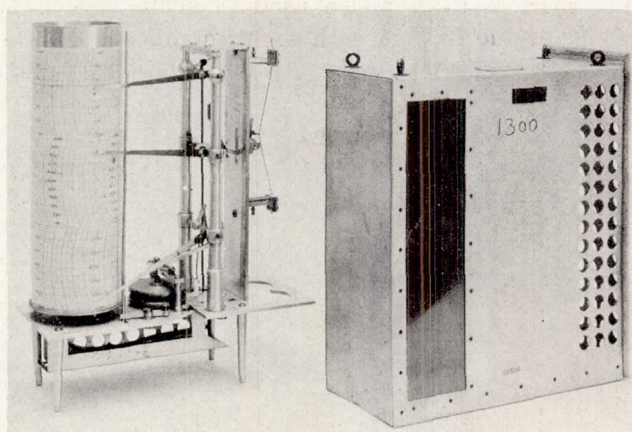

FIG. 9.—French baro-thermo-hygrograph.

Humidity element.—The usual form of hair hygrograph element is employed. A bundle of approximately 25 hairs is mounted upon fixtures upon the right-hand vertical frame section of the instrument. Tension adjustments are provided. A small hook looped over the hairs midway between the supports is connected with a pivoted lever which carries an arm shaped in the form of a cam and resting upon a second pivoted cam-shaped arm which transmits its motion to the recording pen. These cams are held in contact by a light spring in tension. This arrangement converts the changes of hair length so as to make the recording pen movement linear with respect to humidity changes. This makes possible the use of an evenly divided humidity scale, which is seen at the center of the chart. This section is 60 millimeters in height and is divided into 50 equal spaces.

Pressure element.—As in the baro-thermograph, a double aneroid element is used. This is connected through a simple linkage with the recording pen, which moves over the lowest portion of the chart and covers a range from 750 millimeters to 150 millimeters in a height of scale of 60 millimeters.

Record drum and chart.—The record drum, which contains the clock mechanism and upon which the chart is held in place by a spring clamp, has a height of 208 millimeters and a diameter of approximately 67 millimeters. It makes a complete turn in a period of eight hours. The chart is 190 millimeters in height.

Instrument dimensions.—This baro-thermo-hygrograph complete with case weighs about 1,456 grams. It stands about 30 centimeters high, has a width of 10 centimeters, and a length of approximately 22 centimeters.

STRUT THERMOMETERS.

As previously outlined in this paper, the proper reduction of aircraft performance data requires the use of figures showing free-air temperatures observed at various altitudes during flight. The strut thermometer, so called because of its usual location on the strut of an airplane where it may be affected by free-air conditions, is most often used for this purpose and for similar duty in other experimental flight. The two principal types will be considered in this paper.

REMOTE-INDICATING LIQUID-EXPANSION TYPE.

The liquid expansion principle which forms the basis of operation of one of the common types of airplane engine thermometer is also used in strut-thermometer construction. In fact the same arrangement and mechanism with slight modifications may be used interchangeably in either capacity. The liquid-filled bulb with its radiation fins (fig. 10) is mounted in a

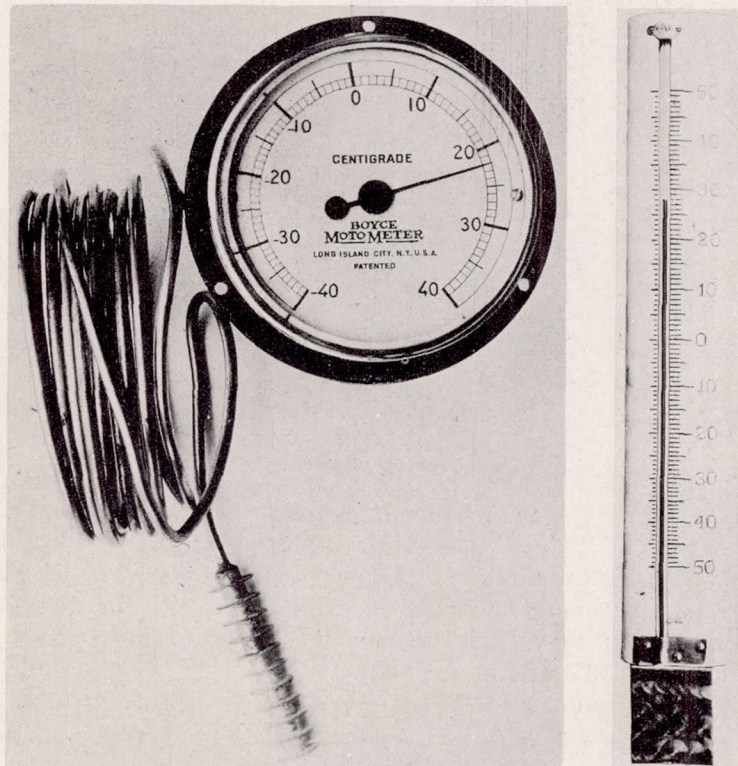

FIG. 10.—Strut thermometers.

suitable position on the aircraft, usually on a strut or on the landing gear. An increase in the temperature of the bulb causes the confined liquid to expand, which in turn produces a motion of the Bourdon element in the indicator with which the bulb is connected by means of an armored capillary tube of fine bore. The Bourdon tube is formed in several concentric helical coils, and its movable end connected to the indicating pointer through a bimetallic-strip helical coil. This bimetallic strip member is provided to compensate for the changes in the temperature of the gage and tubing. The strut bulb should be shielded from the direct rays of the sun by some arrangement which will permit satisfactory air circulation around the bulb. A complete discussion of this type of instrument may be found under the title "Thermometers for Aircraft Engines," Part III of Report No. 129.

In order to allow for a more open scale, the dials of strut thermometers have a greater diameter than those of the engine instruments, and the scale covers a range of about 80° C., with -40° or -50° as lower limit. An instrument of this type recently examined had a dial 10 centimeters in diameter, with a sufficiently open scale to allow for readings to within one or two tenths of a degree.

Suitably designed thermometers of the vapor-pressure type may also be readily adapted for use as strut thermometers.

LIQUID-COLUMN GLASS TYPE.

The second type of strut thermometer shown in the photograph is a liquid-column glass thermometer of usual form, designed for the proper temperature range and so mounted in its backing as to make it readily adaptable to use on an airplane. This instrument is ordinarily fastened to a strut of the airplane where it is subjected to an unobstructed circulation of free air and is easily observed by the test pilot. The bulb is surrounded by a brass case intended to protect it from mechanical injury and also to shield it from the direct rays of the sun.

The wooden backing of the glass thermometer tube is so shaped as to accommodate itself to the strut form, and felt strips are provided to avoid marring the strut when the instrument is strapped in place. The scale is graduated and proportioned so as to make possible the correct reading of the instrument to within about 1° C. from the pilot's position.

TESTING OF STRUT THERMOMETERS.

A detailed descriptive treatment of thermometer testing methods and apparatus may be found in Part III of Report No. 129, under the title "Thermometers for Aircraft Engines."



ADDITIONAL COPIES
OF THIS PUBLICATION MAY BE PROCURED FROM
THE SUPERINTENDENT OF DOCUMENTS
U. S. GOVERNMENT PRINTING OFFICE
WASHINGTON, D. C.
AT
25 CENTS PER COPY

