

AERO. & ASTRO. LIBRARY

AERO. & ASTRO. LIBRARY
JUN 8 1967
M. I. T.

**NATIONAL ADVISORY COMMITTEE
FOR AERONAUTICS**

REPORT No. 215

c. 3

**AIR FORCES, MOMENTS AND DAMPING ON MODEL OF
FLEET AIRSHIP SHENANDOAH**

By A. F. ZAHM, R. H. SMITH, and F. A. LOUDEN



WASHINGTON
GOVERNMENT PRINTING OFFICE
1925

AERONAUTICAL SYMBOLS.

1. FUNDAMENTAL AND DERIVED UNITS.

| | Symbol. | Metric. | | English. | |
|------------|----------|-----------------------------|----------|-------------------------|----------------|
| | | Unit. | Symbol. | Unit. | Symbol. |
| Length... | <i>l</i> | meter..... | m. | foot (or mile)..... | ft. (or mi.). |
| Time..... | <i>t</i> | second..... | sec. | second (or hour)..... | sec. (or hr.). |
| Force..... | <i>F</i> | weight of one kilogram..... | kg. | weight of one pound.... | lb. |
| Power.... | <i>P</i> | kg.m/sec..... | | horsepower..... | HP |
| Speed..... | | m/sec..... | m. p. s. | mi/hr..... | M. P. H. |

2. GENERAL SYMBOLS, ETC.

Weight, $W = mg$.

Standard acceleration of gravity,

$$g = 9.806 \text{ m/sec.}^2 = 32.172 \text{ ft/sec.}^2$$

Mass, $m = \frac{W}{g}$

Density (mass per unit volume), ρ

Standard density of dry air, 0.1247 (kg.-m.-sec.) at 15.6°C. and 760 mm. = 0.00237 (lb.-ft.-sec.)

Specific weight of "standard" air, 1.223 kg/m.³ = 0.07635 lb/ft.³

Moment of inertia, mk^2 (indicate axis of the radius of gyration, k , by proper subscript).

Area, S ; wing area, S_w , etc.

Gap, G

Span, b ; chord length, c .

Aspect ratio = b/c

Distance from $c. g.$ to elevator hinge, f .

Coefficient of viscosity, μ .

3. AERODYNAMICAL SYMBOLS.

True airspeed, V

Dynamic (or impact) pressure, $q = \frac{1}{2} \rho V^2$

Lift, L ; absolute coefficient $C_L = \frac{L}{qS}$

Drag, D ; absolute coefficient $C_D = \frac{D}{qS}$

Cross-wind force, C ; absolute coefficient

$$C_c = \frac{C}{qS}$$

Resultant force, R

(Note that these coefficients are twice as large as the old coefficients L_c, D_c .)

Angle of setting of wings (relative to thrust line), i_w

Angle of stabilizer setting with reference to thrust line i_s

Dihedral angle, γ

Reynolds Number = $\rho \frac{Vl}{\mu}$, where l is a linear dimension.

e. g., for a model airfoil 3 in. chord, 100 mi/hr., normal pressure, 0°C: 255,000 and at 15.6°C, 230,000;

or for a model of 10 cm. chord, 40 m/sec., corresponding numbers are 299,000 and 270,000.

Center of pressure coefficient (ratio of distance of C. P. from leading edge to chord length), C_p .

Angle of stabilizer setting with reference to lower wing. $(i_s - i_w) = \beta$

Angle of attack, α

Angle of downwash, ϵ

REPORT No. 215

**AIR FORCES, MOMENTS AND DAMPING ON MODEL OF
FLEET AIRSHIP SHENANDOAH**

By A. F. ZAHM, R. H. SMITH, and F. A. LOUDEN

Aerodynamical Laboratory, Bureau of Construction and Repair, U. S. Navy

ADDITIONAL COPIES
OF THIS PUBLICATION MAY BE PROCURED FROM
THE SUPERINTENDENT OF DOCUMENTS
GOVERNMENT PRINTING OFFICE
WASHINGTON, D. C.
AT
15 CENTS PER COPY

REPORT No. 215

AIR FORCES, MOMENTS, AND DAMPING ON MODEL OF FLEET AIRSHIP SHENANDOAH

By A. F. Zahm, R. H. Smith, and F. A. Loudon

INTRODUCTION

To furnish data for the design of the fleet airship *Shenandoah*, a model was made and tested in the 8 by 8 foot wind tunnel for wind forces, moments, and damping, under conditions described in this report. The results are given for air of standard density, $\rho = .00237$ slugs per cubic foot without VL/v correction, and with but a brief discussion of the aerodynamic design features of the ship. This account is a slightly revised form of Report No. 195, prepared for the Bureau of Aeronautics, July 22, 1922, and by it submitted for publication to the National Advisory Committee for Aeronautics.

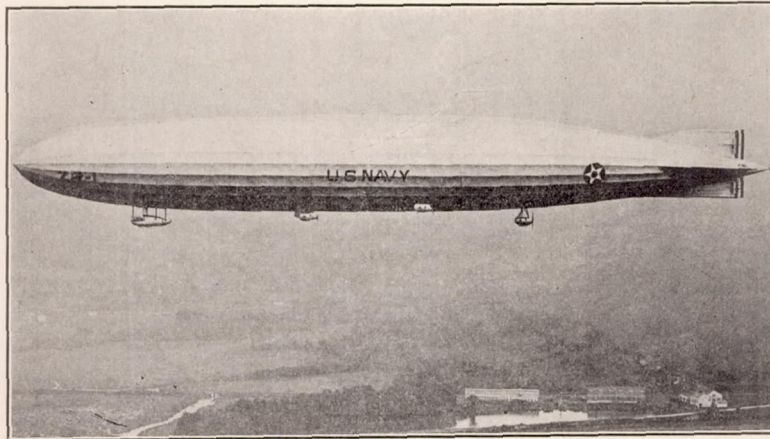

Fleet airship Shenandoah of which two models were made and used in these tests

DESCRIPTION OF THE MODEL

The model during its first tests was 67.75 inches long, and was then shortened 3.28 inches by removal of a cylindrical midship section to receive further tests. The external appearance of the shorter hull is given in Figure 1; the dimensions of both are given in Figure 2. During the test the long hull was first bare, then fitted successively with the controls 1, 2, 3, 4, 5, shown in Figures 4, 5, 6; the short hull was first bare, then fitted successively with controls 5, 6A, 6B, 6C, 6D; the latter shown in Figure 7. The bodies were of dry pine and varnished; the movable controls all were of brass; the thin fins Nos. 1, 3, were of brass; the thick ones of wood. The cross sections of the fins at their thickest point is given in Figure 3, and the areas of the various fins and controls are given in Table I.

The following classification of the controls has been furnished by the Bureau of Aeronautics:

- Type 1.—Original L-49 controls, flat surfaces.
- Type 2.—Similar to Type 1, but surface double-cambered.
- Type 3.—Flat surfaces, cantilever balance, area approximately 20 per cent greater than Type 1.
- Type 4.—Similar to Type 3, but surfaces double-cambered.
- Type 5.—Internally braced fins, "Handley Page" balance. Area approximately the same as Type 3.
- Type 6.—Movable surfaces A, B, C, D with common fins slightly larger than fins 5.

cannot be physical Max of 2nd

| Dimensions | Short size | | Long size | |
|-----------------------------|-------------------------|--|-------------------------|--|
| | Model | Full size | Model | Full size |
| Length..... | 64.468 inches | 196.5 meters = 644.7 feet | 67.748 inches | 206.5 meters = 677.5 feet |
| Surface of hull..... | 1,253.205 square inches | 11,643 square meters = 125,321 square feet | 1,334.136 square inches | 12,395 square meters = 133,414 square feet |
| Air volume of hull..... | 2,131.598 cubic inches | 60,363 cubic meters = 2,131,598 cubic feet | 2,289.736 cubic inches | 64,843 cubic meters = 2,289,736 cubic feet |
| Maximum sectional area..... | 48.220 square inches | 448 square meters = 4,822 square feet | 48.220 square inches | 448 square meters = 4,822 square feet |
| Mass of hull..... | 0.00292 slugs | 5,051.89 slugs | 0.00314 slugs | 5,426.67 slugs |

Hinge of elevator and rudder, long model, is at station 41.
 Hinge of elevator and rudder, short model, is at station 39.

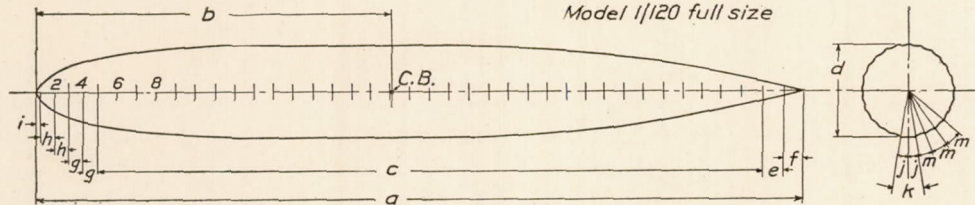

- a = 67.748" (1720.81 mm) for long model
- 64.468" (1637.49 ") " short "
- b = 31.640" (803.66 ") " long "
- 30.000" (762.00 ") " short "
- c = 59.040" (1499.62 ") " long "
- 36 divisions 1.64" (41.656 mm) each
- c = 55.760" (1416.31 mm) for short model
- 34 divisions 1.64" each
- d = 7.874" (200.00 mm)
- e = 1.773" (45.03 ")
- f = 1.675" (42.55 ")
- g = 1.315" (33.40 ")
- h = 1.150" (29.21 ")
- i = 0.330" (8.38 ")
- j = 9.00° k = 18.00°
- m = 14.25°
- m = 24 gores except at stations 38 to 42 on long model and 36 to 40 on short model, where there are 12 gores 28.5° apart = 342°

FIG. 2.—Models used in tests for Shenandoah

SHORT MODEL

| | Station No. | | | | | | | | | | | | | | | | |
|--|-------------|-------|-------|-------|-------|-------|-------|-------|-------|-------|-------|-------|-------|-------|-------|-------|-------|
| | 1 | 2 | 3 | 4 | 5 | 6 | 7 | 8 | 9 | 10 | 11 | 12 | 13 | 14 | 15-21 | 22 | 23 |
| Diameter of circumscribing circle specified..... | 1.454 | 3.248 | 4.248 | 5.062 | 5.686 | 6.280 | 6.726 | 7.070 | 7.332 | 7.526 | 7.668 | 7.768 | 7.828 | 7.858 | 7.874 | 7.854 | 7.818 |
| Width of all gores except keel specified..... | .180 | .403 | .527 | .628 | .705 | .779 | .834 | .877 | .909 | .933 | .951 | .964 | .971 | .975 | .977 | .974 | .970 |
| Width of keel specified..... | .229 | .510 | .666 | .793 | .891 | .984 | 1.054 | 1.108 | 1.149 | 1.179 | 1.201 | 1.217 | 1.226 | 1.231 | 1.233 | 1.230 | 1.225 |

| | Station No. | | | | | | | | | | | | | | | | |
|--|-------------|-------|-------|-------|-------|-------|-------|-------|-------|-------|-------|-------|-------|-------|-------|-------|-------|
| | 24 | 25 | 26 | 27 | 28 | 29 | 30 | 31 | 32 | 33 | 34 | 35 | 36 | 37 | 38 | 39 | 40 |
| Diameter of circumscribing circle specified..... | 7.762 | 7.660 | 7.516 | 7.332 | 7.110 | 6.848 | 6.542 | 6.190 | 5.800 | 5.368 | 4.892 | 4.376 | 3.810 | 3.208 | 2.536 | 1.802 | 0.988 |
| Width of all gores except keel specified..... | .963 | .950 | .932 | .909 | .882 | .849 | .811 | .768 | .719 | .666 | .607 | .539 | .438 | .290 | .162 | .043 | .243 |
| Width of keel specified..... | 1.216 | 1.200 | 1.177 | 1.149 | 1.114 | 1.072 | 1.025 | .970 | .909 | .841 | .767 | .686 | .597 | .504 | .398 | .283 | .000 |

LONG MODEL

| | Station No. | | | | | | | | | | | | | | | | |
|--|-------------|-------|-------|-------|-------|-------|-------|-------|-------|-------|-------|-------|-------|-------|-------|-------|-------|
| | 1 | 2 | 3 | 4 | 5 | 6 | 7 | 8 | 9 | 10 | 11 | 12 | 13 | 14 | 15-23 | 24 | 25 |
| Diameter of circumscribing circle specified..... | 1.454 | 3.248 | 4.248 | 5.062 | 5.686 | 6.280 | 6.726 | 7.070 | 7.332 | 7.526 | 7.668 | 7.768 | 7.828 | 7.858 | 7.874 | 7.854 | 7.818 |
| Width of all gores except keel specified..... | .180 | .403 | .527 | .628 | .705 | .779 | .834 | .877 | .909 | .933 | .951 | .964 | .971 | .975 | .977 | .974 | .970 |
| Width of keel specified..... | .229 | .510 | .666 | .793 | .891 | .984 | 1.054 | 1.108 | 1.149 | 1.179 | 1.201 | 1.217 | 1.226 | 1.231 | 1.233 | 1.230 | 1.225 |

| | Station No. | | | | | | | | | | | | | | | | |
|--|-------------|-------|-------|-------|-------|-------|-------|-------|-------|-------|-------|-------|-------|-------|-------|-------|-------|
| | 26 | 27 | 28 | 29 | 30 | 31 | 32 | 33 | 34 | 35 | 36 | 37 | 38 | 39 | 40 | 41 | 42 |
| Diameter of circumscribing circle specified..... | 7.762 | 7.660 | 7.516 | 7.332 | 7.110 | 6.848 | 6.542 | 6.190 | 5.800 | 5.368 | 4.892 | 4.376 | 3.810 | 3.208 | 2.536 | 1.802 | 0.988 |
| Width of all gores except keel specified..... | .963 | .950 | .932 | .909 | .882 | .849 | .811 | .768 | .719 | .666 | .607 | .539 | .438 | .290 | .162 | .043 | .243 |
| Width of keel specified..... | 1.216 | 1.200 | 1.177 | 1.149 | 1.114 | 1.072 | 1.025 | .970 | .909 | .841 | .767 | .686 | .597 | .504 | .398 | .283 | .000 |

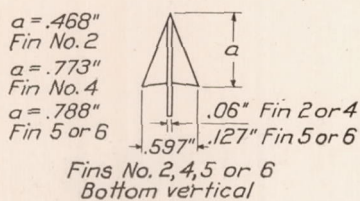
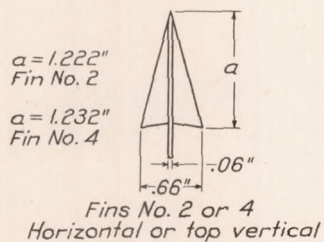
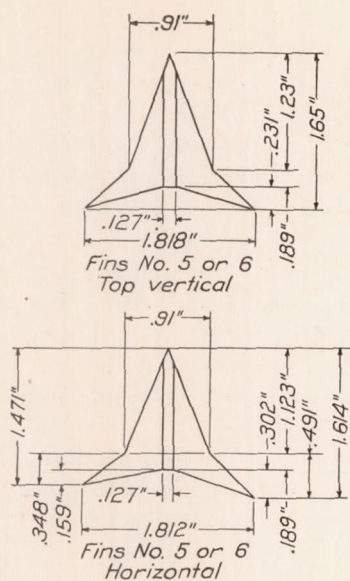

FIG. 3.—Cross section of fins at maximum thickness

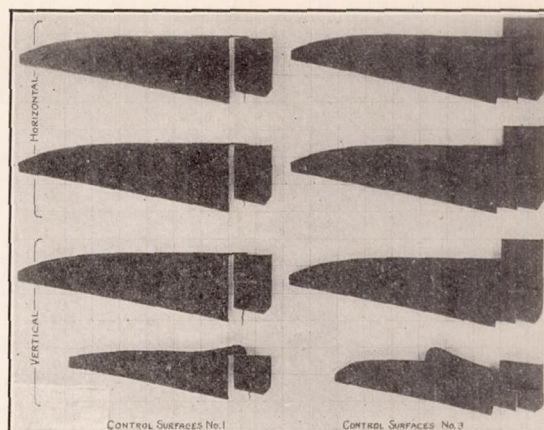

FIG. 4

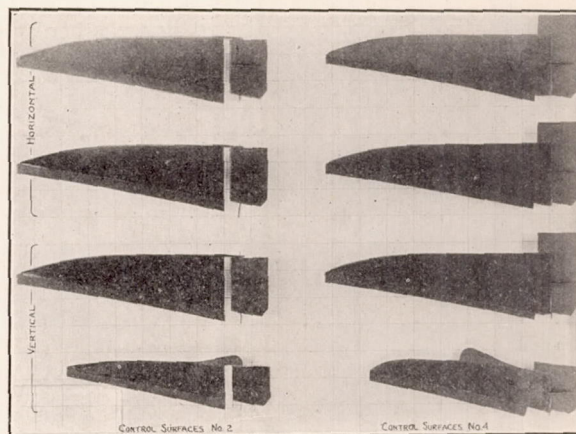

FIG. 5

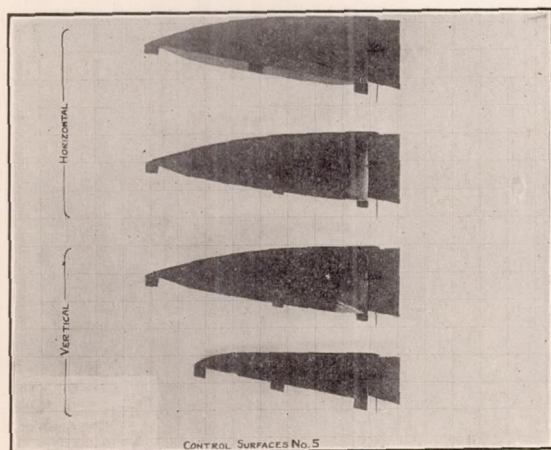

FIG. 6

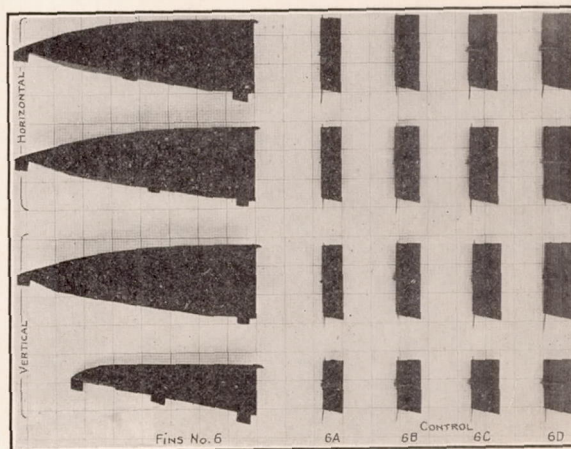

FIG. 7

METHODS OF TEST

During the tests for forces and moments the models were supported from the flange at the bottom of the wind balance shank, as shown in Figure 1, by means of a horizontal frame, from which fine wires ran to suspension points on the hull before and after its center. The mechanism and operation of this balance are described in Report No. 146 of the National Advisory Committee for Aeronautics. The head-on net drag so obtained was checked by measurements on the bifilar balance. In the part of the tunnel under the first named balance the wind has no static pressure gradient, hence correction for horizontal buoyancy for that region was not necessary, as it was for the space under the bifilar balance.

During some of the tests five components of the air force,¹ i. e., the lift, drag, cross-wind force, pitching and yawing moments, were measured simultaneously.

The damping coefficients were determined with the aerodynamic oscillator shown in Figure 8. The oscillator axle had a counterweight at one end, and at the other ran squarely into the hull at its buoyancy center.

The wind speeds and model settings for the various tests are sufficiently disclosed in the tables and diagrams accompanying this text. The oscillation values in the tables are faired from three or four sets of observations made for each condition of model and wind.

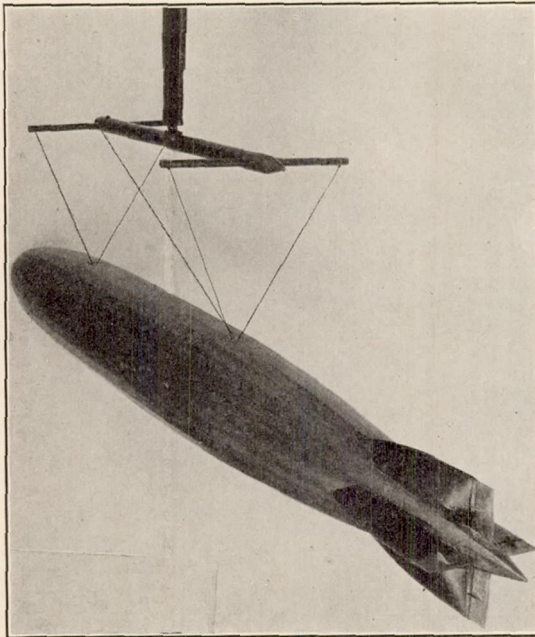

FIG. 1.—Model of fleet airship No. 1 suspended on wind balance

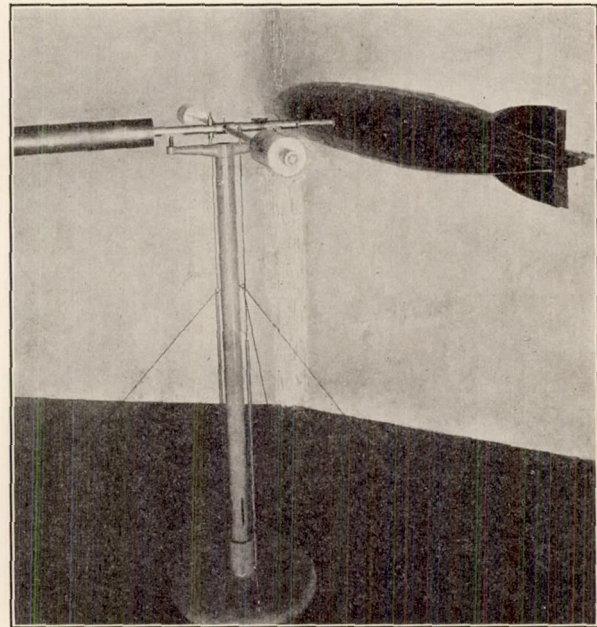

FIG. 8

DRAG OF BARE HULLS

Tables II and III give the head-on drag and the shape coefficient for the bare hulls, long and short, as found for speeds of 20, 30, 40, 50, and 60 miles an hour; also the head-on drag and shape coefficient for 40 miles an hour, with control surfaces 1, 2, 3, 4, and 5. Figs. 9 and 10 show familiar graphs of the head-on drag and shape coefficients for the two bare hulls, at speeds of 20 to 60 miles an hour. At speeds of 40 to 60 miles the long hull has 2 to 3 per cent more drag than the short one, but has a perceptibly smaller shape coefficient, due to its greater volume.

¹ "Dyname" may be used as the exact term for the entire urge of the air on the model. The dyname can have three components of force, and three of moment; for example X, Y, Z, L, M, N. See Routh, Analytical Statics, Vol. I.

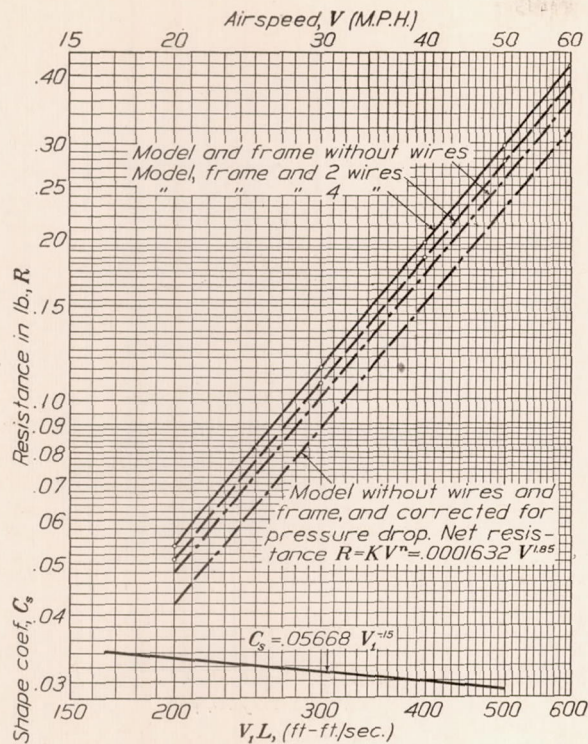

FIG. 9.—Resistance and shape coefficient for long model, bare hull, at 0° pitch and 0° yaw

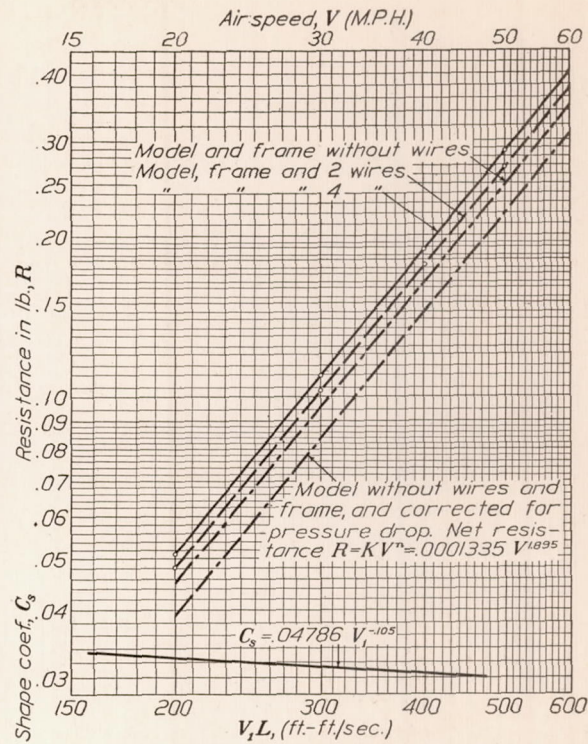

FIG. 10.—Resistance and shape coefficient for short model, bare hull, at 0° pitch and 0° yaw

The disk ratio and shape coefficient, as found at 40 miles an hour, are given for these two bare hulls and some earlier ones in the following table. The drag of a hull's major section, normally exposed as a thin disk, is taken as 0.00283 SV^2 pounds at V miles an hour, and the ratio of this force to the actual head-on drag of the hull is called the "disk ratio."

Comparison of various bare hulls

| Model | Disk ratio | Shape coefficient $C_s = \frac{2R}{\rho(\text{Vol.})^{2/3}V_1^2}$ |
|-----------------------|------------|--|
| Short Shenandoah..... | 10.51 | 0.03122 |
| Long Shenandoah..... | 10.16 | .03077 |
| Goodrich B..... | 15.4 | .03090 |
| E. P..... | 17.2 | .02932 |
| C class..... | 16.9 | .02872 |

FORCES FOR VARIOUS ADJUSTMENTS

Tables IV to XV, inclusive, give, for numerous settings, the lift, drag, and side drag on the models, at 40 miles an hour, measured parallel to the axes of the tunnel and balance. Tables XVI to XXIII give the X, Y, Z forces thence derived by simple analysis. Figures 11 to 18 contain plots of the Y, Z forces against angles of pitch and yaw. The X force is too nearly constant from model to model to justify plotting. Figures 14 and 18 show that the forces on the long hull can be closely estimated from the measured forces found with the short hull, thus obviating the need for repeating with the long hull many of the tests first made on the short one. In this estimate it is assumed that any air force increment due to adding the midship segment is the same when the hulls are bare as when furnished with either type of control.

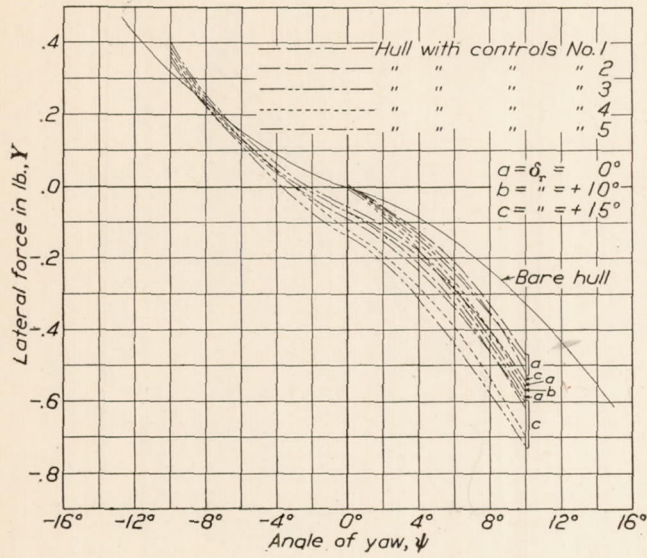

FIG. 11.—Y force for long model with controls Nos. 1 to 5. Model at 0° pitch and elevators neutral. Airspeed 40 M. P. H.

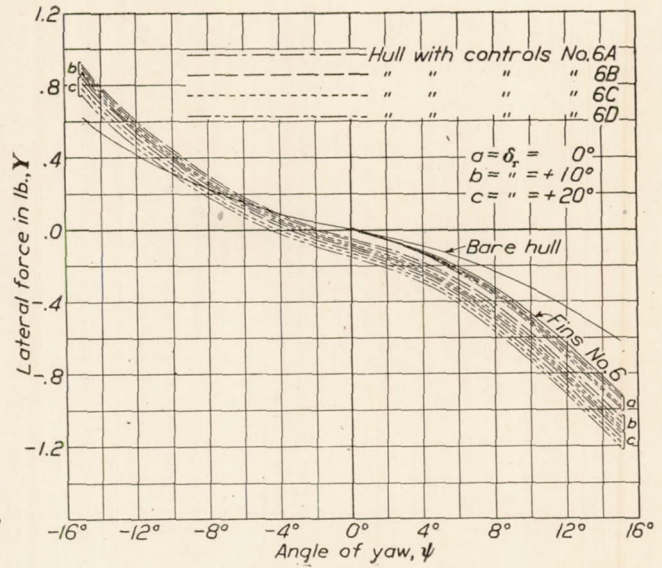

FIG. 12.—Y force for long model with controls No. 6. Model at 0° pitch and elevators neutral. Airspeed 40 M. P. H.

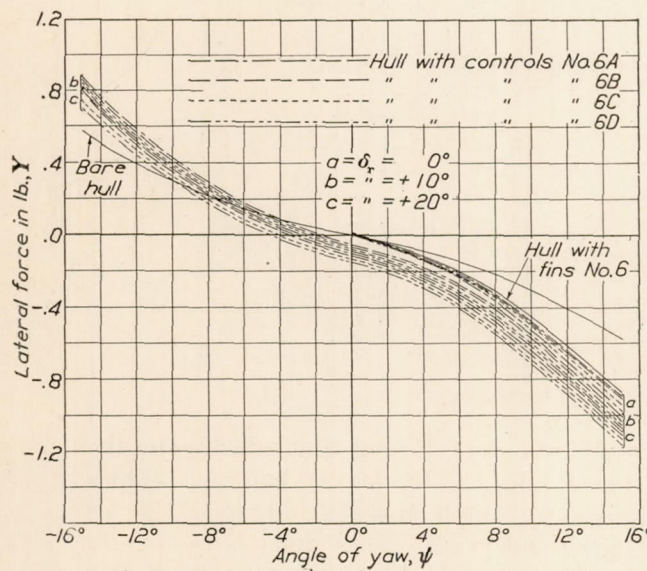

FIG. 13.—Y force for short model with controls No. 6. Model at 0° pitch and elevators neutral. Airspeed 40 M. P. H.

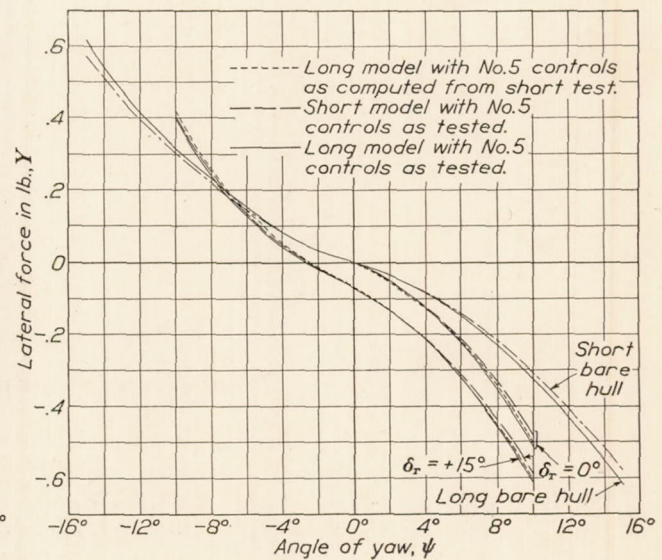

FIG. 14.—Comparison of tested and computed Y force. Model at 0° pitch and elevators neutral. Airspeed 40 M. P. H.

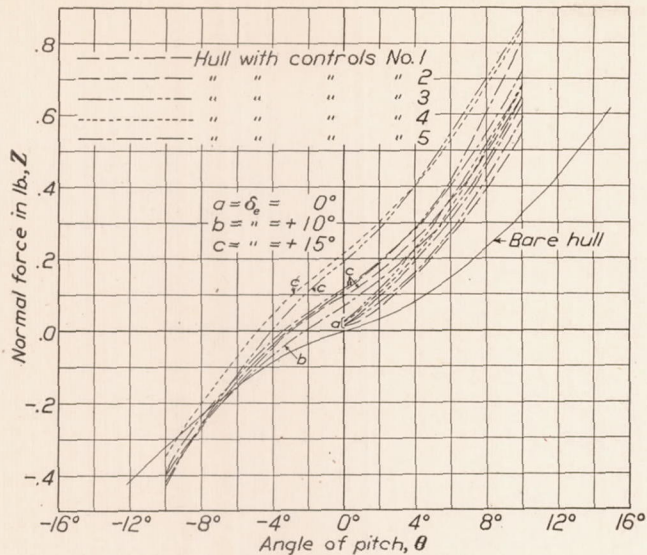

FIG. 15.—Z force for long model with controls No. 1 to 5. Model at 0° yaw and rudders neutral. Airspeed 40 M. P. H.

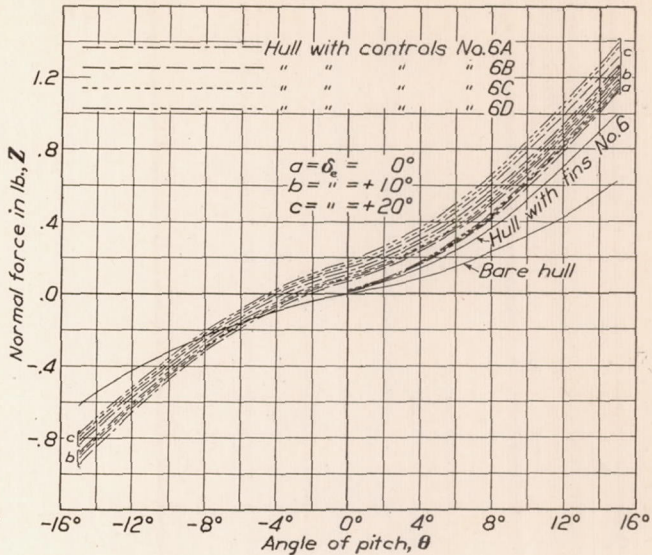

FIG. 16.—Z force for long model with controls No. 6. Model at 0° yaw and rudders neutral. Airspeed 40 M. P. H.

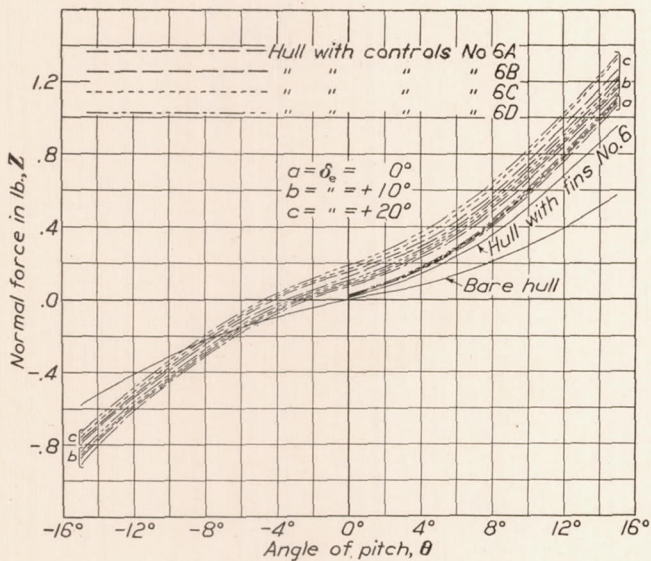

FIG. 17.—Z force for short model with controls No. 6. Model at 0° yaw and rudders neutral. Airspeed 40 M. P. H.

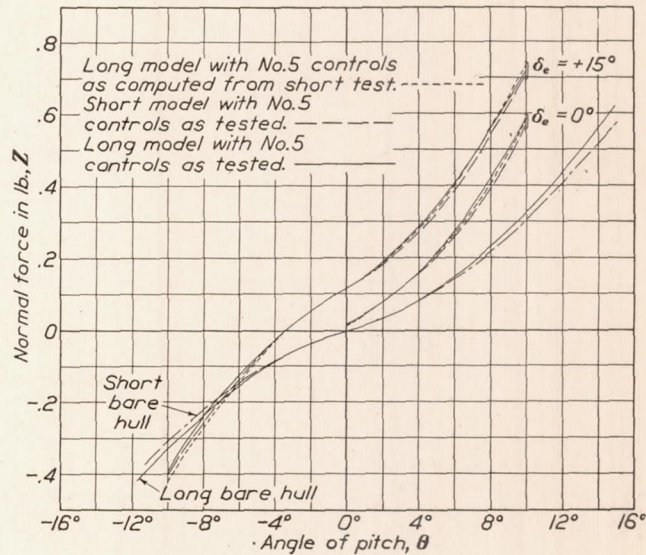

FIG. 18.—Comparison of tested and computed Z force. Model at 0° yaw and rudders neutral. Airspeed 40 M. P. H.

MOMENTS FOR VARIOUS ADJUSTMENTS

Tables XXIV to XXX, inclusive, give the pitching and yawing moments, at 40 miles an hour, for the manifold conditions therein specified. Figures 19 to 25 contain plots of these moments against angles of pitch and yaw. Figures 22 and 26 show that the moments on the long model can be accurately estimated from measurements with the short one.

In this estimate the distance of the control force from the center of buoyancy of the short hull is computed as $\Delta M / \Delta Z$, where ΔM , ΔZ are the increments of moment and force due to adding either type of control. This distance plus half the length of the midship segment is the arm of the control surface of the long hull. The product of this arm by the force on the control, plus the moment on the long bare hull, gives the total moment for the hull and control.

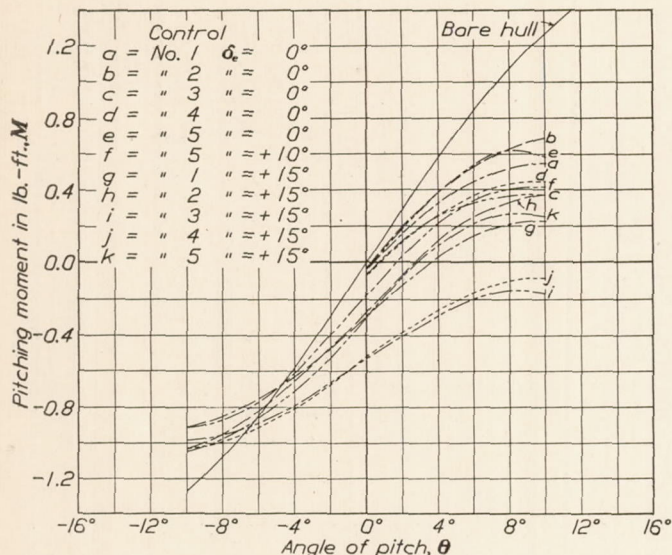

FIG. 19.—Pitching moment for long model about C. B. Bare hull and hull with controls, Nos. 1 to 5. Model at 0° yaw and rudders neutral. Airspeed 40 M. P. H.

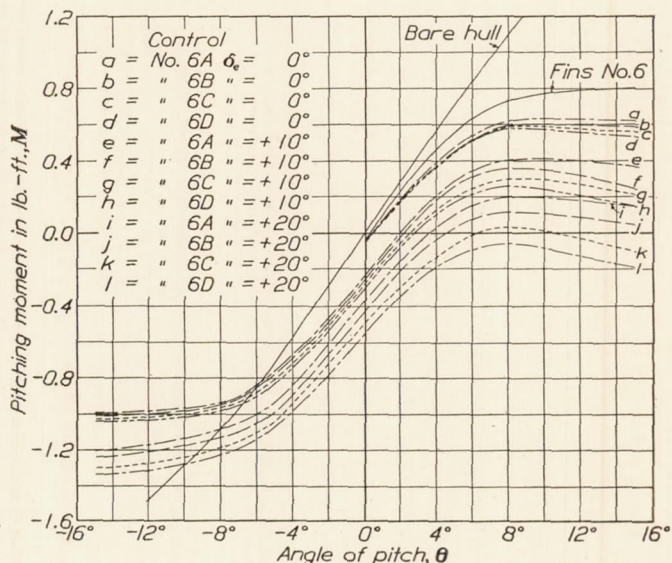

FIG. 20.—Pitching moment for long model about B. C. Bare hull and hull with controls, No. 6. Model at 0° yaw and rudders neutral. Airspeed 40 M. P. H.

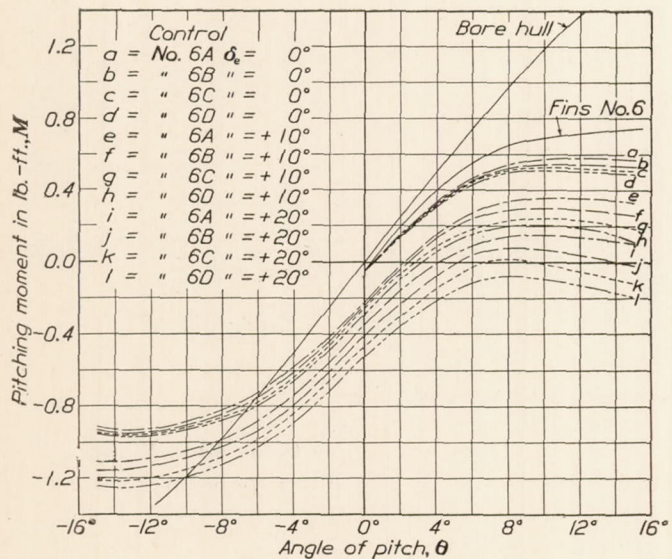

FIG. 21.—Pitching moment for short model about C. B. Bare hull and hull with controls No. 6. Model at 0° yaw and rudders neutral. Airspeed 40 M. P. H.

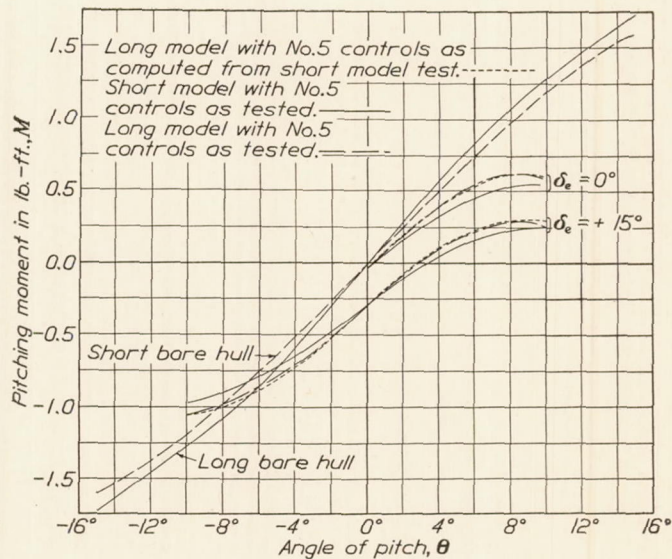

FIG. 22.—Comparison of tested and computed pitching moments. Model at 0° yaw and rudders neutral. Airspeed 40 M. P. H. Moment axis at C. B.

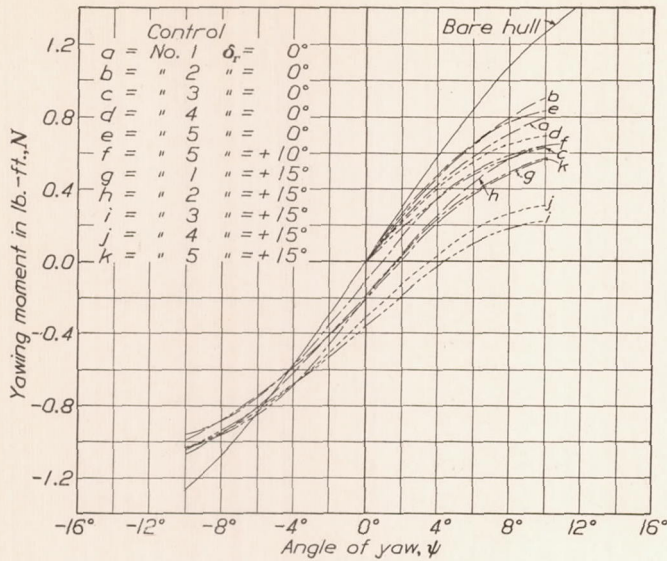

FIG. 23.—Yawing moment for long model about C. B. Bare hull and hull with controls, Nos. 1 to 5. Model at 0° pitch and elevators neutral. Airspeed 40 M. P. H.

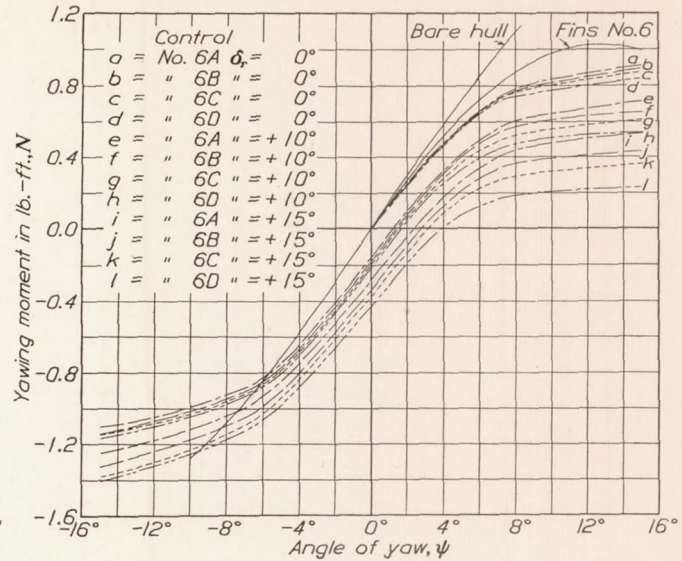

FIG. 24.—Yawing moment for long model about C. B. Bare hull and hull with controls No. 6. Model at 0° pitch and elevators neutral. Airspeed 40 M. P. H.

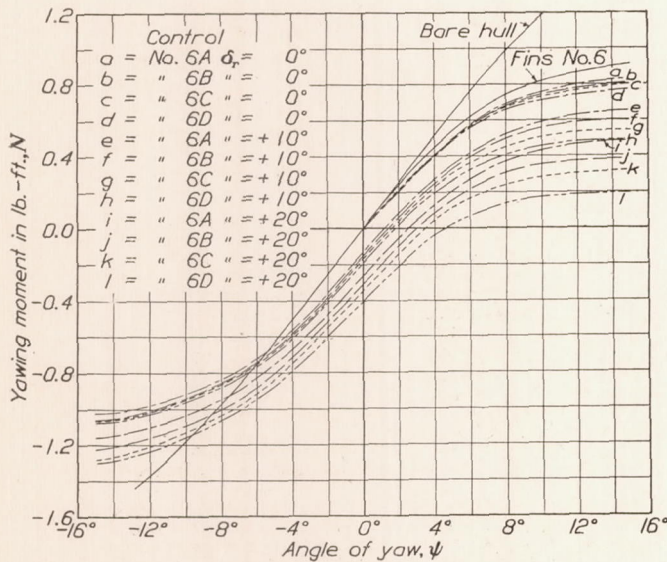

FIG. 25.—Yawing moment for short model about C. B. Bare hull and hull with controls No. 6. Model at 0° pitch and elevators neutral. Airspeed 40 M. P. H.

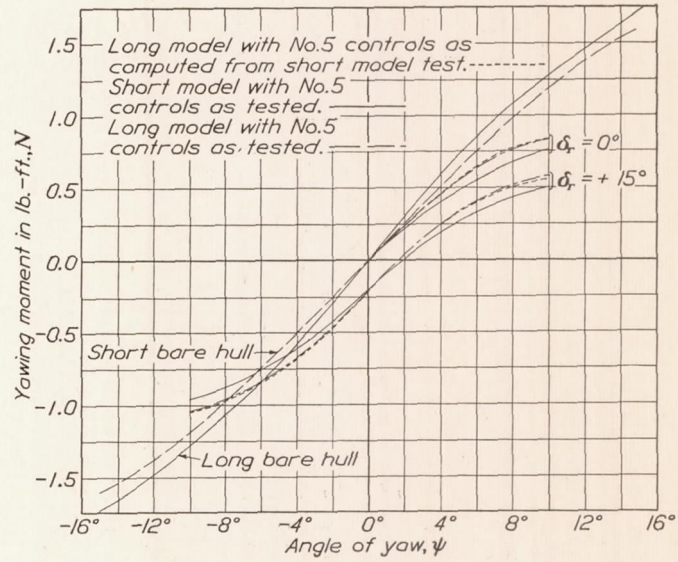

FIG. 26.—Comparison of tested and computed moments. Model at 0° pitch and elevators neutral. Airspeed 40 M. P. H. Moment axis at C. B.

FORCES AND MOMENTS AT LARGE ANGLES

Table XXXI gives, for the long hull with No. 5 controls all neutral, the drag, cross-wind force, and yawing moment in a 30-mile wind, on the model set at 0° pitch, and at yaw angles of 0° to 90°. The values of X, Y, N , derived from these data, are plotted against ψ in Figure 27. The vector diagram for this test is given in Figure 28. It shows that when the model is pivoted about the Z axis, as a weather vane, it is unstable in yaw at all angles below 70°. It is noteworthy that X becomes a propulsive force at large angles of attack, as has been observed in similar tests.

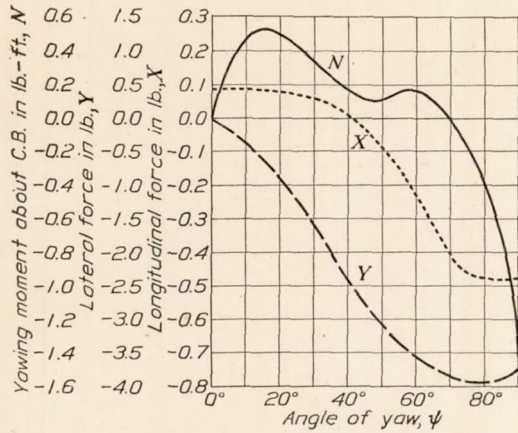

FIG. 27.—X and Y forces and yawing moments *N* for long model with No. 5 control surfaces. Model at 0° pitch. Elevators and rudders neutral. Airspeed 30 M. P. H.

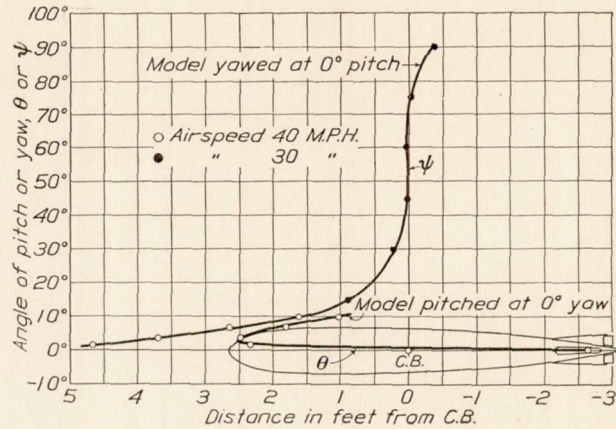

FIG. 29.—Center of pressure travel of long hull with No. 5 control surfaces. Elevators and rudders neutral. Airspeed 30 and 40 M. P. H.

CENTER OF PRESSURE

Figure 29 delineates the center of pressure in yaw for the data in Tables XXXI, XX, XXIX, also the center of pressure in pitch for the data in Tables XXII, XXV. As the yaw angle falls below 10°, the center of pressure runs rapidly forward, and travels even beyond the nose of the hull. The same effect is not observed in pitch because the fins are adjusted to give a negative pitching moment at zero pitch.

The forward travel of the center of pressure at small angles of yaw is further illustrated by Figure 30, giving the line of resultant air force on the long hull with Nos. 3 and 4 controls.

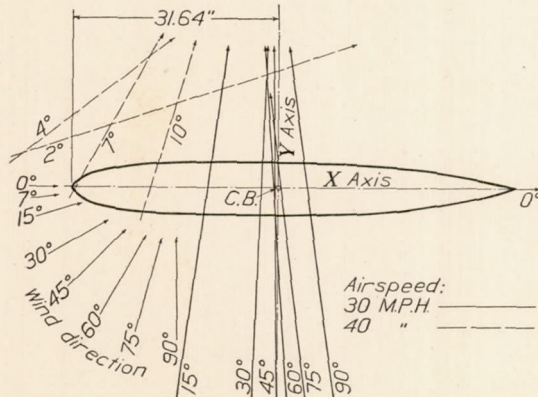

FIG. 28.—Line of resultant air force on long hull with No. 5 controls. Model at 0° pitch. Elevators and rudders neutral. Scale of model 1/120 full size

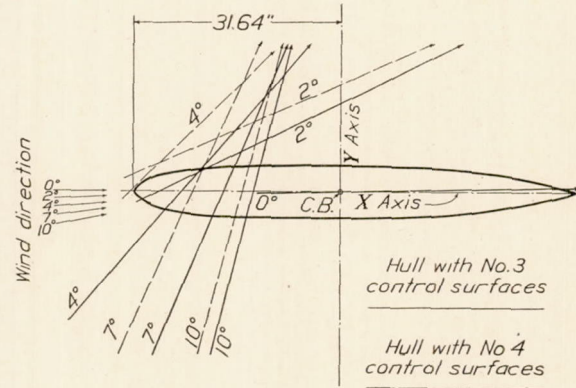

FIG. 30.—Line of resultant air force on long hull with Nos. 3 and 4 controls. Model at 0° pitch. Elevators and rudders neutral. Airspeed 40 M. P. H. Scale of model 1/120 full size

COEFFICIENTS OF DAMPING MOMENT

Tables XXXII to XXXIV give the data and derived values for finding the damping coefficient, and Table XXXV the net damping coefficient itself, for the long hull, first bare then with controls 1, 2, 3, 4, 6A, 6D. In Figure 32 these net values are plotted against speed, giving straight-line diagrams, as usual.

The logarithmic decrement, λ , used in computing the damping coefficients, was computed from faired plots of the oscillation data, made in pencil, for all the tests, during the individual runs. Some typical plots on semilog paper are shown in Figure 31.

The structure and theory of the aerodynamic oscillator used in these tests are well known, hence the method of finding the coefficient, μ , of damping moment in the present work is omitted.

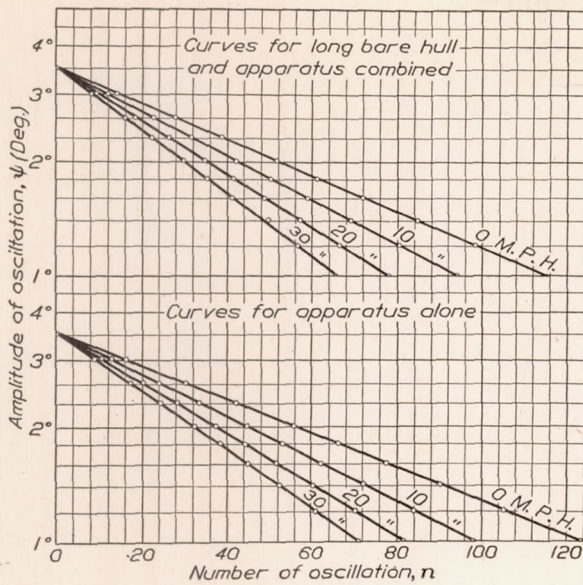

Fig. 31.—Oscillations at various airspeeds. Model at 0° pitch. Bare hull

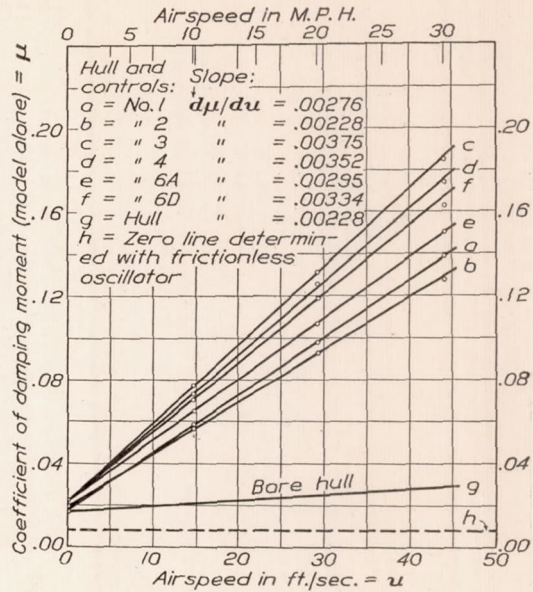

Fig. 32.—Coefficient of damping moment in yaw vs. various airspeeds. Model at 0° pitch. Elevators and rudders neutral

STABILITY CRITERIA

By (13), Report No. 212 of the National Advisory Committee for Aeronautics, an airship is stable in yaw if

$$a \frac{\mu}{u} \frac{Y_{\psi}}{N_{\psi}} > 1 \dots\dots\dots (1)$$

where all the symbols but a refer to the model conventionally. Following the earlier usage in aerodynamics, one may write $a = s^3/m$, where s is the scale ratio of ship to model, and m is the natural mass of the ship.

In the present case $a = 120^3/5427 = 318.4$, the denominator being slugs. The working yaw criterion then is

$$318.4 \frac{\mu}{u} \frac{Y_{\psi}}{N_{\psi}} \dots\dots\dots (2)$$

and gives for the full-scale hull the values listed in Table XXXVI.

The last column indicates that the ship is sufficiently stable with some of the types of controls, notably 3, 4. For experience with this kind of craft teaches that satisfactory stability may be expected when the yaw criterion here used somewhat exceeds $1/3$.²

Report No. 212, National Advisory Committee for Aeronautics, derives a in the form $a = s^3/mn$, where n is a constant peculiar to the model. For motion at small angles in yaw it appears that for this model n is less than $1/2$, and hence that the values of the criterion in the last column of Table XXXVI should be at least doubled. The value $n=1$ was used in computing this table merely to make the values of the criterion directly comparable to those given in other publications, such as the one here cited. On the other hand, if one takes $m=1.5x$ natural mass of the ship, and $n=1/2$, the value of a becomes $1/3$ greater; and the given criteria must be increased by that amount.

² British R. & M. (new series) No. 361, p. 61.

CONCLUSION

It is believed the designing staff, which initiated the program for the present measurements, will not require a detailed discussion of the data and diagrams, since these are of familiar form and very numerous. The stability criterion, presented in somewhat novel form in Table XXXVI, is derived and discussed in Report No. 212, National Advisory Committee for Aeronautics. If the numerical equations of motion for one or more of the present airship types be required, they can be developed subsequently in such fullness as may seem necessary.

TABLE I
AREA OF MODEL CONTROL SURFACES

[In square inches]

| Control member | Number of control surface | | | | | | |
|-------------------------------------|---------------------------|--------|-------|-------|-------|-------|-------|
| | 1 or 2 | 3 or 4 | 5 | 6A | 6B | 6C | 6D |
| Horizontal fin..... | 9.59 | 10.89 | 11.44 | 12.15 | 12.15 | 12.15 | 12.15 |
| Elevator for horizontal fins..... | 2.86 | 3.34 | 2.72 | 1.83 | 2.18 | 2.61 | 3.01 |
| Top vertical fin..... | 9.59 | 10.89 | 11.80 | 12.40 | 12.40 | 12.40 | 12.40 |
| Rudder for top vertical fin..... | 2.86 | 3.34 | 2.72 | 1.83 | 2.18 | 2.61 | 3.01 |
| Bottom vertical fin..... | 4.80 | 7.20 | 6.43 | 6.85 | 6.85 | 6.85 | 6.85 |
| Rudder for bottom vertical fin..... | 1.78 | 1.95 | 1.87 | 1.28 | 1.55 | 1.84 | 2.12 |

NOTE: Ratio model to full size=1:120.
1 sq. in. on model=100 sq. ft. on full size.
=9.29 sq. meters on full size.

TABLE II

RESISTANCE OF BARE HULL AND HULL WITH CONTROLS NOS. 1 TO 5

| Air speed | Displacement due to model and four wires | Corresponding resistance | Displacement due to model and two wires | Corresponding resistance | Resistance of model without wires | Resistance due to frame | Resistance due to pressure drop | Net total resistance |
|--|---|--------------------------|---|--------------------------|-----------------------------------|-------------------------|---------------------------------|----------------------|
| Bare hull, long model | | | | | | | | |
| <i>M. p. h.</i> | <i>Inches</i> | <i>Pounds</i> | <i>Inches</i> | <i>Pounds</i> | <i>Pounds</i> | <i>Pounds</i> | <i>Pounds</i> | <i>Pounds</i> |
| 20 | 0.310 | 0.054 | 0.290 | 0.051 | 0.048 | 0 | 0.006 | 0.042 |
| 30 | .656 | .115 | .615 | .108 | .101 | 0 | .013 | .088 |
| 40 | 1.115 | .196 | 1.040 | .184 | .172 | 0 | .022 | .150 |
| 50 | 1.685 | .297 | 1.580 | .278 | .250 | -.001 | .032 | .228 |
| 60 | 2.358 | .414 | 2.215 | .388 | .362 | -.002 | .044 | .320 |
| Bare hull, short model | | | | | | | | |
| 20 | 0.298 | 0.051 | 0.278 | 0.048 | 0.045 | 0 | 0.006 | 0.039 |
| 30 | .635 | .110 | .594 | .103 | .096 | 0 | .012 | .084 |
| 40 | 1.090 | .189 | 1.017 | .177 | .165 | 0 | .020 | .145 |
| 50 | 1.655 | .287 | 1.555 | .269 | .251 | -.001 | .030 | .222 |
| 60 | 2.325 | .403 | 2.178 | .378 | .353 | -.002 | .041 | .314 |
| Control surface No. | Long model hull with control surface at 40 m. p. h. | | | | | | | |
| 1 | 1.143 | 0.206 | 1.074 | 0.194 | 0.182 | 0 | 0.022 | 0.160 |
| 2 | 1.139 | .206 | 1.070 | .194 | .182 | 0 | .022 | .160 |
| 3 | 1.155 | .209 | 1.086 | .197 | .185 | 0 | .022 | .163 |
| 4 | 1.150 | .209 | 1.085 | .197 | .185 | 0 | .022 | .163 |
| 5 | 1.120 | .209 | 1.057 | .197 | .185 | 0 | .022 | .163 |
| Short model hull with control surface at 40 m. p. h. | | | | | | | | |
| 1 | 1.132 | 0.201 | 1.064 | 0.189 | 0.177 | 0 | 0.020 | 0.157 |
| 2 | 1.119 | .200 | 1.052 | .188 | .176 | 0 | .020 | .156 |
| 3 | 1.140 | .204 | 1.073 | .192 | .180 | 0 | .020 | .160 |
| 4 | 1.135 | .204 | 1.069 | .192 | .180 | 0 | .020 | .160 |
| 5 | 1.110 | .205 | 1.045 | .193 | .181 | 0 | .020 | .161 |

R= Resistance of model in pounds.
L= Length of model in feet.
Vol.= Volume of model in cubic feet.

V_1 = Airspeed in feet per second.
 V = Airspeed in miles per hour.
 ρ = Air density=.00237 slugs per cubic foot.

TABLE III

SHAPE COEFFICIENT AND CORRESPONDING VALUES OF VL

[Symbols defined below]

| Air speed | Shape coefficient C_s $\frac{C_s}{2R}$ $\frac{C_s}{\rho(\text{Vol.})^{2/3} V_1^2}$ | $V_1 L$ (ft.ft./sec.) | VL (ft.mi./hr.) |
|--|--|--------------------------|--------------------|
| Bare hull, long model | | | |
| <i>M. p. h.</i> | | | |
| 20 | 0.03442 | 165.0 | 112.6 |
| 30 | .03205 | 247.7 | 169.0 |
| 40 | .03077 | 330.0 | 225.1 |
| 50 | .02994 | 412.8 | 281.6 |
| 60 | .02917 | 495.4 | 337.9 |
| Bare hull, short model | | | |
| 20 | 0.03355 | 157.1 | 107.1 |
| 30 | .03216 | 235.7 | 160.7 |
| 40 | .03122 | 314.2 | 214.3 |
| 50 | .03062 | 392.9 | 267.8 |
| 60 | .03004 | 471.5 | 321.4 |
| Control surface No. | Long model hull with control surface at 40 m. p. h. | | |
| 1 | 0.03260 | 330.0 | 225.1 |
| 2 | .03260 | 330.0 | 225.1 |
| 3 | .03321 | 330.0 | 225.1 |
| 4 | .03321 | 330.0 | 225.1 |
| 5 | .03321 | 330.0 | 225.1 |
| Short model hull with control surface at 40 m.p.h. | | | |
| 1 | 0.03361 | 314.2 | 214.3 |
| 2 | .03340 | 314.2 | 214.3 |
| 3 | .03425 | 314.2 | 214.3 |
| 4 | .03425 | 314.2 | 214.3 |
| 5 | .03445 | 314.2 | 214.3 |

TABLE VI

NET MEASURED LIFT IN POUNDS FOR BARE HULLS AND HULLS WITH CONTROL SURFACES NOS. 1 TO 5

[Model at 0° pitch and elevators neutral. Airspeed, 40 miles per hour]

| Rudder setting δ_r | Angle of yaw ψ | Long bare hull | Short bare hull | Long hull with control No. — | | | | Short hull, control No. 5 | Long hull, control No. 5 | Long hull, control No. 5, computed from short |
|---------------------------|---------------------|----------------|-----------------|------------------------------|--------|--------|--------|---------------------------|--------------------------|---|
| | | | | 1 | 2 | 3 | 4 | | | |
| Degrees 0 | Degrees 0 | +0 | +0.001 | +0.013 | +0.013 | +0.019 | +0.017 | +0.020 | +0.019 | +0.020 |
| | +2 | +0.001 | +0.002 | +0.013 | +0.010 | +0.019 | +0.018 | +0.021 | +0.019 | +0.021 |
| | +4 | +0.001 | +0.001 | +0.014 | +0.011 | +0.020 | +0.018 | +0.020 | +0.021 | +0.020 |
| | +7 | +0.001 | 0 | +0.012 | +0.010 | +0.020 | +0.019 | +0.021 | +0.020 | +0.021 |
| | +10 | +0.001 | 0 | +0.013 | +0.010 | +0.021 | +0.017 | +0.019 | +0.020 | +0.019 |
| | +15 | 0 | 0 | | | | | | | |
| | -7 | | | | | | | | +0.021 | |
| | -4 | | | | | | | | +0.020 | |
| | -2 | | | | | | | | +0.022 | |
| | 0 | | | | | | | | +0.020 | |
| +10 | +2 | | | | | | | | +0.019 | |
| | +4 | | | | | | | | +0.021 | |
| | +7 | | | | | | | | +0.022 | |
| | +10 | | | | | | | | +0.020 | |
| | +15 | | | | | | | | +0.019 | |
| +15 | -10 | | | +0.013 | +0.010 | +0.019 | +0.017 | +0.019 | +0.020 | +0.019 |
| | -7 | | | +0.011 | +0.012 | +0.020 | +0.018 | +0.019 | +0.020 | +0.019 |
| | -4 | | | +0.013 | +0.012 | +0.020 | +0.017 | +0.021 | +0.021 | +0.021 |
| | -2 | | | +0.011 | +0.011 | +0.020 | +0.017 | +0.021 | +0.021 | +0.021 |
| | 0 | | | +0.012 | +0.012 | +0.021 | +0.018 | +0.019 | +0.021 | +0.019 |
| | +2 | | | +0.013 | +0.011 | +0.021 | +0.018 | +0.020 | +0.020 | +0.020 |
| | +4 | | | +0.012 | +0.011 | +0.020 | +0.017 | +0.020 | +0.018 | +0.020 |
| | +7 | | | +0.013 | +0.012 | +0.021 | +0.017 | +0.018 | +0.020 | +0.018 |
| | +10 | | | +0.012 | +0.011 | +0.020 | +0.017 | +0.018 | +0.020 | +0.018 |
| | | | | | | | | | +0.017 | |

TABLE VII

NET MEASURED LIFT FOR SHORT MODEL AND COMPUTED LIFT IN POUNDS FOR LONG MODEL WITH NO. 6 CONTROL SURFACES

[Model at 0° pitch and elevators neutral. Airspeed, 40 miles per hour]

| Rudder setting δ_r | Angle of yaw ψ | Short or long hull and fins No. 6, without elevators or rudders | Short or long hull with control No. — | | | |
|---------------------------|---------------------|---|---------------------------------------|--------|--------|--------|
| | | | 6A | 6B | 6C | 6D |
| Degrees 0 | Degrees 0 | +0.020 | +0.021 | +0.020 | +0.017 | +0.022 |
| | +2 | +0.018 | +0.019 | | | |
| | +4 | +0.022 | +0.019 | | | |
| | +7 | +0.020 | +0.018 | | | |
| | +10 | +0.019 | +0.018 | | | |
| | +15 | +0.018 | +0.019 | +0.018 | +0.017 | +0.017 |
| | -15 | | +0.016 | +0.021 | +0.017 | +0.017 |
| | -10 | | +0.018 | | | |
| | -7 | | +0.018 | | | |
| | -4 | | +0.019 | | | |
| +10 | -2 | | +0.020 | | | |
| | 0 | | +0.017 | +0.018 | +0.019 | +0.021 |
| | +2 | | +0.019 | | | |
| | +4 | | +0.020 | | | |
| | +7 | | +0.019 | | | |
| +20 | +10 | | +0.019 | | | |
| | +15 | | +0.018 | +0.021 | +0.021 | +0.023 |
| | -15 | | +0.021 | +0.021 | +0.020 | +0.023 |
| | -10 | | +0.018 | | | |
| | -7 | | +0.019 | | | |
| | -4 | | +0.018 | | | |
| | -2 | | +0.019 | | | |
| | 0 | | +0.019 | +0.019 | +0.019 | +0.021 |
| | +2 | | +0.018 | | | |
| | +4 | | +0.020 | | | |
| +7 | | +0.015 | | | | |
| +10 | | +0.018 | | | | |
| +15 | | +0.018 | +0.019 | +0.018 | +0.020 | |

TABLE VIII

NET MEASURED DRAG IN POUNDS FOR BARE HULLS AND HULLS WITH CONTROL SURFACES NOS. 1 TO 5
 [Model at 0° yaw and rudders neutral. Airspeed, 40 miles per hour]

| Elevator setting δ_e | Angle of pitch θ | Long bare hull | Short bare hull | Long hull with control No. — | | | | Short hull, control No. 5 | Long hull, control No. 5 | Long hull, control No. 5, computed from short |
|-----------------------------|-------------------------|----------------|-----------------|------------------------------|-------|-------|-------|---------------------------|--------------------------|---|
| | | | | 1 | 2 | 3 | 4 | | | |
| Degrees | 0 | 0.146 | 0.144 | 0.158 | 0.157 | 0.160 | 0.159 | 0.155 | 0.160 | 0.155 |
| | +2 | .146 | .145 | .159 | .158 | .162 | .159 | .157 | .160 | .158 |
| | +4 | .147 | .147 | .165 | .165 | .169 | .165 | .162 | .165 | .164 |
| | +7 | .156 | .153 | .197 | .194 | .204 | .200 | .195 | .190 | .198 |
| | +10 | .188 | .184 | .254 | .249 | .272 | .264 | .256 | .258 | .260 |
| | +15 | .271 | .261 | | | | | | | |
| | -10 | | | | | | | | .218 | |
| | -7 | | | | | | | | .174 | |
| | -4 | | | | | | | | .161 | |
| | -2 | | | | | | | | .161 | |
| +10 | 0 | | | | | | | | .162 | |
| | +2 | | | | | | | | .166 | |
| | +4 | | | | | | | | .175 | |
| | +7 | | | | | | | | .210 | |
| | +10 | | | | | | | | .280 | |
| | -10 | | | .230 | .224 | .230 | .216 | .208 | .213 | .212 |
| | -7 | | | .178 | .176 | .187 | .175 | .165 | .175 | .168 |
| | -4 | | | .163 | .162 | .170 | .170 | .162 | .165 | .164 |
| | -2 | | | .163 | .162 | .170 | .171 | .161 | .165 | .162 |
| | 0 | | | .164 | .163 | .174 | .175 | .161 | .166 | .161 |
| +15 | +2 | | | .173 | .169 | .189 | .187 | .165 | .171 | .166 |
| | +4 | | | .183 | .183 | .215 | .209 | .179 | .182 | .181 |
| | +7 | | | .231 | .219 | .266 | .261 | .217 | .217 | .220 |
| | +10 | | | .295 | .284 | .339 | .321 | .278 | .295 | .282 |

TABLE IX

NET MEASURED DRAG FOR SHORT MODEL AND COMPUTED DRAG IN POUNDS FOR LONG MODEL WITH NO. 6 CONTROL SURFACES

[Model at 0° yaw and rudders neutral. Airspeed, 40 miles per hour]

| Elevator setting δ_e | Angle of pitch θ | Fins No. 6 (without elevators or rudders) on— | | Control No. 6A on— | | Control No. 6B on— | | Control No. 6C on— | | Control No. 6D on— | |
|-----------------------------|-------------------------|---|-----------|--------------------|-----------|--------------------|-----------|--------------------|-----------|--------------------|-----------|
| | | Short hull | Long hull | Short hull | Long hull | Short hull | Long hull | Short hull | Long hull | Short hull | Long hull |
| Degrees | 0 | 0.155 | 0.155 | 0.155 | 0.155 | 0.155 | 0.155 | 0.155 | 0.155 | 0.155 | 0.155 |
| | +2 | .156 | .157 | .156 | .157 | .157 | .158 | .157 | .158 | .161 | .162 |
| | +4 | .159 | .161 | .165 | .167 | .168 | .170 | .169 | .171 | .175 | .177 |
| | +7 | .181 | .184 | .198 | .201 | .205 | .208 | .210 | .213 | .215 | .218 |
| | +10 | .233 | .237 | .260 | .264 | .270 | .274 | .274 | .278 | .282 | .286 |
| | +15 | .382 | .388 | .430 | .436 | .439 | .445 | .444 | .450 | .454 | .460 |
| | -15 | | | .376 | .382 | .372 | .378 | .369 | .375 | .372 | .378 |
| | -10 | | | .220 | .224 | .218 | .222 | .220 | .224 | .218 | .222 |
| | -7 | | | .174 | .177 | .177 | .180 | .178 | .181 | .181 | .184 |
| | -4 | | | .160 | .162 | .158 | .160 | .159 | .161 | .161 | .162 |
| +10 | -2 | | | .158 | .159 | .158 | .159 | .159 | .160 | .161 | .161 |
| | 0 | | | .158 | .158 | .158 | .158 | .159 | .159 | .161 | .161 |
| | +2 | | | .162 | .163 | .164 | .165 | .164 | .165 | .169 | .170 |
| | +4 | | | .175 | .177 | .175 | .177 | .176 | .178 | .181 | .183 |
| | +7 | | | .207 | .210 | .215 | .218 | .218 | .221 | .223 | .226 |
| | +10 | | | .274 | .278 | .281 | .285 | .292 | .296 | .300 | .304 |
| | +15 | | | .450 | .456 | .466 | .472 | .478 | .484 | .489 | .495 |
| | -15 | | | .350 | .356 | .324 | .330 | .346 | .352 | .338 | .344 |
| | -10 | | | .216 | .220 | .219 | .223 | .215 | .219 | .220 | .224 |
| | -7 | | | .175 | .178 | .175 | .178 | .178 | .181 | .180 | .183 |
| +20 | -4 | | | .163 | .165 | .158 | .160 | .164 | .166 | .165 | .167 |
| | -2 | | | .162 | .163 | .158 | .159 | .164 | .165 | .164 | .165 |
| | 0 | | | .164 | .164 | .163 | .163 | .166 | .166 | .165 | .165 |
| | +2 | | | .167 | .168 | .170 | .171 | .173 | .174 | .173 | .174 |
| | +4 | | | .178 | .180 | .184 | .186 | .192 | .194 | .200 | .202 |
| | +7 | | | .219 | .222 | .231 | .234 | .241 | .244 | .254 | .257 |
| | +10 | | | .295 | .299 | .309 | .313 | .324 | .328 | .340 | .344 |
| | +15 | | | .477 | .483 | .500 | .506 | .529 | .535 | .548 | .554 |

TABLE X

NET MEASURED DRAG IN POUNDS FOR BARE HULLS AND HULLS WITH CONTROL SURFACES NOS. 1 TO 5
 [Model at 0° pitch and elevators neutral. Airspeed, 40 miles per hour.]

| Rudder setting δ_r | Angle of yaw ψ | Long bare hull | Short bare hull | Long hull with control No.— | | | | Short hull, control No. 5 | Long hull, control No. 5 | Long hull, control No. 5 computed from short |
|---------------------------|---------------------|----------------|-----------------|-----------------------------|-------|-------|-------|---------------------------|--------------------------|--|
| | | | | 1 | 2 | 3 | 4 | | | |
| Degrees 0 | Degrees 0 | 0.146 | 0.144 | 0.158 | 0.157 | 0.160 | 0.160 | 0.155 | 0.160 | 0.155 |
| | +2 | .146 | .145 | .158 | .158 | .161 | .160 | .157 | .161 | .158 |
| | +4 | .147 | .147 | .160 | .162 | .164 | .163 | .161 | .165 | .163 |
| | +7 | .156 | .153 | .183 | .183 | .198 | .185 | .182 | .188 | .185 |
| | +10 | .188 | .184 | .236 | .234 | .250 | .244 | .231 | .240 | .235 |
| | +15 | .271 | .261 | | | | | | | |
| | -10 | | | | | | | | .234 | |
| | -7 | | | | | | | | .178 | |
| | -4 | | | | | | | | .163 | |
| | -2 | | | | | | | | .161 | |
| +10 | 0 | | | | | | | | .162 | |
| | +2 | | | | | | | | .164 | |
| | +4 | | | | | | | | .169 | |
| | +7 | | | | | | | | .199 | |
| | +10 | | | | | | | | .250 | |
| | -10 | | | .217 | .209 | .221 | .221 | .218 | .233 | .222 |
| | -7 | | | .171 | .172 | .186 | .178 | .177 | .178 | .180 |
| | -4 | | | .163 | .161 | .170 | .170 | .163 | .166 | .165 |
| | -2 | | | .162 | .161 | .169 | .170 | .160 | .165 | .161 |
| | 0 | | | .164 | .162 | .171 | .172 | .159 | .164 | .159 |
| +15 | +2 | | | .174 | .168 | .176 | .177 | .161 | .166 | .162 |
| | +4 | | | .180 | .178 | .191 | .192 | .170 | .173 | .172 |
| | +7 | | | .213 | .208 | .231 | .227 | .199 | .206 | .202 |
| | +10 | | | .269 | .260 | .304 | .298 | .258 | .264 | .262 |

TABLE XI

NET MEASURED DRAG FOR SHORT MODEL AND COMPUTED DRAG IN POUNDS FOR LONG MODEL WITH NO. 6 CONTROL SURFACES
 [Model at 0° pitch and elevators neutral. Airspeed, 40 miles per hour]

| Rudder setting δ_r | Angle of yaw ψ | Fins No. 6 (without elevators or rudders) on— | | Control No. 6A on— | | Control No. 6B on— | | Control No. 6C on— | | Control No. 6D on— | |
|---------------------------|---------------------|---|-----------|--------------------|-----------|--------------------|-----------|--------------------|-----------|--------------------|-----------|
| | | Short hull | Long hull | Short hull | Long hull | Short hull | Long hull | Short hull | Long hull | Short hull | Long hull |
| | | Degrees | Degrees | | | | | | | | |
| 0 | 0 | 0.155 | 0.155 | 0.155 | 0.155 | 0.156 | 0.156 | 0.155 | 0.155 | 0.155 | 0.155 |
| | +2 | .155 | .156 | .156 | .157 | .157 | .158 | .159 | .160 | .159 | .160 |
| | +4 | .158 | .160 | .159 | .161 | .162 | .164 | .165 | .167 | .167 | .169 |
| | +7 | .175 | .178 | .182 | .185 | .186 | .189 | .191 | .194 | .195 | .198 |
| | +10 | .221 | .225 | .231 | .235 | .239 | .241 | .240 | .244 | .248 | .252 |
| | +15 | .365 | .371 | .384 | .390 | .389 | .395 | .404 | .410 | .410 | .416 |
| | -15 | | | .362 | .368 | .360 | .366 | .364 | .370 | .367 | .373 |
| | -10 | | | .216 | .220 | .214 | .218 | .214 | .218 | .212 | .216 |
| | -7 | | | .179 | .182 | .178 | .181 | .178 | .181 | .179 | .182 |
| | -4 | | | .162 | .164 | .162 | .164 | .161 | .163 | .163 | .165 |
| +10 | -2 | | | .160 | .161 | .158 | .159 | .158 | .159 | .159 | .160 |
| | 0 | | | .160 | .160 | .159 | .159 | .159 | .159 | .160 | .160 |
| | +2 | | | .161 | .162 | .163 | .164 | .163 | .164 | .163 | .164 |
| | +4 | | | .170 | .172 | .170 | .172 | .175 | .177 | .177 | .179 |
| | +7 | | | .195 | .198 | .203 | .206 | .214 | .217 | .219 | .222 |
| | +10 | | | .251 | .255 | .260 | .264 | .269 | .273 | .281 | .285 |
| | +15 | | | .409 | .415 | .425 | .431 | .436 | .442 | .442 | .448 |
| | -15 | | | .363 | .369 | .351 | .357 | .342 | .348 | .332 | .338 |
| | -10 | | | .222 | .226 | .214 | .218 | .214 | .218 | .216 | .220 |
| | -7 | | | .177 | .180 | .177 | .180 | .178 | .181 | .179 | .182 |
| +20 | -4 | | | .162 | .164 | .160 | .162 | .163 | .165 | .163 | .165 |
| | -2 | | | .160 | .161 | .159 | .160 | .162 | .163 | .163 | .164 |
| | 0 | | | .160 | .160 | .161 | .161 | .163 | .163 | .164 | .164 |
| | +2 | | | .162 | .163 | .169 | .170 | .174 | .175 | .177 | .178 |
| | +4 | | | .172 | .174 | .182 | .184 | .191 | .193 | .199 | .201 |
| | +7 | | | .205 | .208 | .223 | .226 | .237 | .240 | .251 | .254 |
| | +10 | | | .268 | .272 | .290 | .294 | .310 | .314 | .328 | .332 |
| | +15 | | | .431 | .437 | .461 | .467 | .478 | .484 | .494 | .500 |

TABLE XII

NET MEASURED CROSS-WIND FORCE IN POUNDS FOR BARE HULLS AND HULLS WITH CONTROL SURFACES NOS. 1 TO 5
 [Model at 0° yaw and rudders neutral. Airspeed, 40 miles per hour]

| Elevator setting δ_e | Angle of pitch θ | Long bare hull | Short bare hull | Long hull with control No.— | | | | Short hull, control No. 5 | Long hull, control No. 5 | Long hull, control No. 5, computed from short | |
|-----------------------------|-------------------------|----------------|-----------------|-----------------------------|--------|--------|--------|---------------------------|--------------------------|---|--------|
| | | | | 1 | 2 | 3 | 4 | | | | |
| Degrees 0 | Degrees 0 | 0 | -0.001 | 0 | -0.001 | 0 | 0 | -0.001 | +0.002 | -0.001 | |
| | +2 | -.001 | -.002 | -.001 | 0 | -.001 | 0 | -.001 | +0.004 | -.001 | |
| | +4 | -.001 | -.001 | -.001 | -.001 | -.001 | -.002 | 0 | +0.002 | 0 | |
| | +7 | -.001 | 0 | 0 | -.002 | -.003 | -.003 | -.001 | +0.001 | -.001 | |
| | +10 | -.001 | 0 | 0 | -.001 | -.001 | 0 | -.002 | +0.001 | -.002 | |
| | +15 | 0 | 0 | | | | | | | | |
| | -10 | | | | | | | | -.001 | | |
| | -7 | | | | | | | | -.001 | | |
| | -4 | | | | | | | | +0.001 | | |
| | -2 | | | | | | | | 0 | | |
| Degrees +10 | 0 | | | | | | | | +0.002 | | |
| | +2 | | | | | | | | 0 | | |
| | +4 | | | | | | | | 0 | | |
| | +7 | | | | | | | | +0.001 | | |
| | +10 | | | | | | | | 0 | | |
| | -10 | | | | -.001 | -.003 | -.002 | -.001 | -.001 | 0 | -.001 |
| | -7 | | | | -.001 | -.002 | -.001 | -.003 | -.001 | 0 | -.001 |
| | -4 | | | | +0.001 | -.002 | -.002 | -.001 | -.001 | 0 | -.001 |
| | -2 | | | | +0.002 | +0.001 | +0.001 | +0.001 | -.001 | +0.001 | -.001 |
| | 0 | | | | +0.002 | -.001 | -.001 | 0 | +0.001 | +0.005 | +0.001 |
| Degrees +15 | +2 | | | | +0.001 | 0 | +0.001 | 0 | +0.005 | 0 | |
| | +4 | | | | +0.001 | -.002 | +0.001 | 0 | +0.004 | 0 | |
| | +7 | | | | -.002 | -.002 | -.001 | -.001 | +0.001 | -.001 | |
| | +10 | | | | -.001 | -.002 | -.001 | -.002 | +0.001 | -.002 | |

TABLE XIII

NET MEASURED CROSS-WIND FORCE FOR SHORT MODEL AND COMPUTED CROSS-WIND FORCE IN POUNDS FOR LONG MODEL WITH NO. 6 CONTROL SURFACES
 [Model at 0° yaw and rudders neutral. Airspeed, 40 miles per hour]

| Elevator setting δ_e | Angle of pitch θ | Short or long hull and fins No. 6, without elevators or rudders | Short or long hull with control No. — | | | |
|-----------------------------|-------------------------|---|---------------------------------------|--------|--------|--------|
| | | | 6A | 6B | 6C | 6D |
| Degrees 0 | Degrees 0 | -0.002 | 0 | -0.001 | -0.002 | +0.001 |
| | +2 | -.002 | 0 | 0 | | |
| | +4 | -.003 | -.002 | -.002 | | |
| | +7 | 0 | -.004 | -.001 | | |
| | +10 | -.001 | -.001 | -.002 | | |
| | +15 | -.002 | -.002 | -.003 | 0 | +0.003 |
| | -15 | | -.001 | -.002 | -.002 | +0.002 |
| | -10 | | -.003 | | | |
| | -7 | | -.002 | | | |
| | -4 | | -.003 | | | |
| Degrees +10 | -2 | | -.003 | | | |
| | 0 | | -.001 | +0.001 | -.004 | +0.002 |
| | +2 | | -.002 | | | |
| | +4 | | -.001 | | | |
| | +7 | | -.002 | | | |
| | +10 | | -.002 | | | |
| | +15 | | -.003 | -.003 | +0.002 | +0.001 |
| | -15 | | -.002 | -.002 | -.005 | +0.002 |
| | -10 | | -.003 | | | |
| | -7 | | -.002 | | | |
| Degrees +20 | -4 | | -.003 | | | |
| | -2 | | +0.002 | | | |
| | 0 | | +0.002 | -.001 | -.002 | +0.002 |
| | +2 | | -.004 | | | |
| | +4 | | -.004 | | | |
| | +7 | | -.003 | | | |
| | +10 | | -.002 | | | |
| | +15 | | -.002 | -.001 | -.003 | +0.003 |

TABLE XVI

X FORCE IN POUNDS FOR BARE HULLS AND HULLS WITH CONTROL SURFACES NOS. 1 TO 5
 [Model at 0° yaw and rudders neutral. Airspeed, 40 miles per hour]

| Elevator setting δ_e | Angle of pitch θ | Long bare hull | Short bare hull | Long hull with control No. — | | | | Short hull, control No. 5 | Long hull, control No. 5 | Long hull, control No. 5, computed from short | |
|-----------------------------|-------------------------|----------------|-----------------|------------------------------|-------|-------|-------|---------------------------|--------------------------|---|------|
| | | | | 1 | 2 | 3 | 4 | | | | |
| Degrees | 0 | 0.146 | 0.144 | 0.158 | 0.157 | 0.160 | 0.159 | 0.155 | 0.160 | 0.155 | |
| | +2 | .144 | .143 | .156 | .156 | .158 | .155 | .154 | .157 | .154 | |
| | +4 | .141 | .142 | .152 | .154 | .154 | .151 | .151 | .154 | .152 | |
| | +7 | .134 | .132 | .152 | .156 | .153 | .149 | .154 | .149 | .156 | |
| | +10 | .134 | .133 | .147 | .156 | .155 | .148 | .159 | .154 | .161 | |
| | +15 | .115 | .117 | | | | | | | | |
| | -10 | | | | | | | | .145 | | |
| | -7 | | | | | | | | .149 | | |
| | -4 | | | | | | | | .157 | | |
| | -2 | | | | | | | | .161 | | |
| | +10 | 0 | | | | | | | | .162 | |
| | | +2 | | | | | | | | .161 | |
| | | +4 | | | | | | | | .157 | |
| | | +7 | | | | | | | | .162 | |
| | | +10 | | | | | | | | .166 | |
| -10 | | | | .159 | .159 | .162 | .158 | .141 | .147 | .143 | |
| -7 | | | | .155 | .154 | .165 | .161 | .143 | .154 | .145 | |
| -4 | | | | .161 | .162 | .171 | .174 | .160 | .163 | .161 | |
| -2 | | | | .166 | .163 | .174 | .176 | .163 | .166 | .163 | |
| +15 | | 0 | | | .164 | .163 | .173 | .175 | .163 | .166 | .163 |
| | | +2 | | | .166 | .163 | .177 | .176 | .158 | .164 | .158 |
| | | +4 | | | .164 | .167 | .186 | .181 | .160 | .162 | .161 |
| | | +7 | | | .170 | .168 | .191 | .187 | .162 | .160 | .164 |
| | | +10 | | | .158 | .173 | .193 | .188 | .157 | .171 | .159 |

TABLE XVII

X FORCE IN POUNDS FOR HULLS WITH NO. 6 CONTROL SURFACES
 [Model at 0° yaw and rudders neutral. Airspeed, 40 miles per hour]

| Elevator setting δ_e | Angle of pitch θ | Fins No. 6 (without elevator or rudders) on— | | Control No. 6A on— | | Control No. 6B on— | | Control No. 6C on— | | Control No. 6D on— | | |
|-----------------------------|-------------------------|--|-----------|--------------------|-----------|--------------------|-----------|--------------------|-----------|--------------------|-----------|------|
| | | Short hull | Long hull | Short hull | Long hull | Short hull | Long hull | Short hull | Long hull | Short hull | Long hull | |
| Degrees | 0 | 0.155 | 0.155 | 0.155 | 0.155 | 0.155 | 0.155 | 0.155 | 0.155 | 0.155 | 0.155 | |
| | +2 | .153 | .153 | .153 | .153 | .154 | .154 | .154 | .154 | .158 | .158 | |
| | +4 | .150 | .151 | .154 | .155 | .157 | .158 | .158 | .159 | .163 | .164 | |
| | +7 | .147 | .149 | .157 | .159 | .162 | .164 | .168 | .170 | .173 | .175 | |
| | +10 | .146 | .148 | .162 | .164 | .170 | .172 | .173 | .175 | .179 | .181 | |
| | +15 | .143 | .146 | .158 | .161 | .165 | .168 | .169 | .172 | .174 | .177 | |
| | -15 | | | .146 | .149 | .151 | .154 | .154 | .157 | .161 | .164 | |
| | -10 | | | .144 | .146 | .145 | .147 | .148 | .150 | .149 | .151 | |
| | -7 | | | .147 | .149 | .151 | .153 | .152 | .154 | .157 | .159 | |
| | -4 | | | .156 | .157 | .154 | .155 | .157 | .158 | .157 | .158 | |
| | -2 | | | .158 | .158 | .159 | .159 | .160 | .160 | .162 | .162 | |
| | +10 | 0 | | | .158 | .158 | .157 | .157 | .159 | .159 | .161 | .161 |
| | | +2 | | | .157 | .157 | .158 | .158 | .158 | .158 | .163 | .163 |
| | | +4 | | | .159 | .160 | .158 | .159 | .159 | .160 | .162 | .163 |
| | | +7 | | | .158 | .160 | .164 | .166 | .166 | .168 | .168 | .170 |
| +10 | | | | .163 | .165 | .167 | .169 | .176 | .178 | .179 | .181 | |
| +15 | | | | .159 | .162 | .171 | .174 | .178 | .181 | .184 | .187 | |
| -15 | | | | .152 | .155 | .156 | .159 | .156 | .159 | .155 | .158 | |
| -10 | | | | .152 | .154 | .156 | .158 | .155 | .157 | .155 | .157 | |
| -7 | | | | .153 | .155 | .156 | .158 | .162 | .164 | .160 | .162 | |
| -4 | | | | .163 | .164 | .159 | .160 | .166 | .166 | .171 | .172 | |
| -2 | | | | .165 | .165 | .161 | .161 | .167 | .167 | .168 | .168 | |
| +20 | | 0 | | | .164 | .164 | .163 | .163 | .166 | .166 | .164 | .164 |
| | | +2 | | | .160 | .160 | .163 | .163 | .164 | .164 | .164 | .164 |
| | | +4 | | | .156 | .157 | .163 | .164 | .169 | .170 | .175 | .176 |
| | | +7 | | | .161 | .163 | .169 | .171 | .176 | .178 | .186 | .188 |
| | +10 | | | .172 | .174 | .177 | .179 | .192 | .194 | .199 | .201 | |
| | +15 | | | .168 | .171 | .179 | .182 | .194 | .197 | .206 | .209 | |

TABLE XVIII

X FORCE IN POUNDS FOR BARE HULLS AND HULLS WITH CONTROL SURFACES NOS. 1 TO 5

[Model at 0° pitch and elevators neutral. - Airspeed, 40 miles per hour]

| Rudder setting δ_r | Angle of yaw ψ | Long bare hull | Short bare hull | Long hull with control No.— | | | | Short hull, control No. 5 | Long hull, control No. 5 | Long hull, control No. 5, computed from short |
|---------------------------|---------------------|----------------|-----------------|-----------------------------|-------|-------|-------|---------------------------|--------------------------|---|
| | | | | 1 | 2 | 3 | 4 | | | |
| Degrees | 0 | 0.146 | 0.144 | 0.158 | 0.157 | 0.160 | 0.160 | 0.155 | 0.160 | 0.155 |
| | +2 | .144 | .143 | .156 | .156 | .158 | .158 | .155 | .159 | .155 |
| | +4 | .141 | .142 | .150 | .153 | .152 | .153 | .153 | .157 | .154 |
| | +7 | .134 | .132 | .148 | .152 | .155 | .146 | .151 | .155 | .153 |
| | +10 | .134 | .133 | .150 | .155 | .151 | .150 | .149 | .153 | .151 |
| | +15 | .115 | .117 | | | | | | | |
| | -10 | | | | | | | | .167 | |
| | -7 | | | | | | | | .155 | |
| | -4 | | | | | | | | .159 | |
| | -2 | | | | | | | | .161 | |
| +10 | 0 | | | | | | | | .161 | |
| | +2 | | | | | | | | .162 | |
| | +4 | | | | | | | | .161 | |
| | +7 | | | | | | | | .157 | |
| | +10 | | | | | | | | .157 | |
| | -10 | | | .154 | .150 | .158 | .158 | .151 | .154 | |
| | -7 | | | .150 | .151 | .165 | .156 | .155 | .163 | .153 |
| | -4 | | | .160 | .158 | .169 | .170 | .160 | .163 | .157 |
| | -2 | | | .163 | .162 | .172 | .172 | .160 | .163 | .161 |
| | 0 | | | .164 | .162 | .171 | .172 | .159 | .165 | .160 |
| +15 | +2 | | | .169 | .164 | .169 | .172 | .159 | .164 | .159 |
| | +4 | | | .164 | .165 | .170 | .170 | .156 | .162 | .156 |
| | +7 | | | .167 | .167 | .171 | .173 | .155 | .158 | .156 |
| | +10 | | | .167 | .167 | .173 | .173 | .155 | .160 | .157 |
| | | | | .167 | .167 | .180 | .180 | .158 | .160 | .160 |

TABLE XIX

X FORCE IN POUNDS FOR HULLS WITH NO. 6 CONTROL SURFACES

[Model at 0° pitch and elevators neutral. Airspeed, 40 miles per hour]

| Rudder setting δ_r | Angle of yaw ψ | Fins No. 6 (with-out elevators or rudders) on— | | Control No. 6A on— | | Control No. 6B on— | | Control No. 6C on— | | Control No. 6D on— | |
|---------------------------|---------------------|--|-----------|--------------------|-----------|--------------------|-----------|--------------------|-----------|--------------------|-----------|
| | | Short hull | Long hull | Short hull | Long hull | Short hull | Long hull | Short hull | Long hull | Short hull | Long hull |
| Degrees | 0 | 0.155 | 0.155 | 0.155 | 0.155 | 0.156 | 0.156 | 0.155 | 0.155 | 0.155 | 0.155 |
| | +2 | .154 | .154 | .154 | .154 | .155 | .155 | .157 | .157 | .157 | .157 |
| | +4 | .150 | .151 | .151 | .152 | .154 | .155 | .156 | .157 | .158 | .159 |
| | +7 | .146 | .148 | .152 | .154 | .155 | .157 | .160 | .162 | .162 | .164 |
| | +10 | .145 | .147 | .150 | .152 | .155 | .157 | .157 | .159 | .163 | .165 |
| | +15 | .145 | .148 | .156 | .159 | .155 | .158 | .167 | .170 | .168 | .171 |
| | -10 | | | .141 | .144 | .144 | .147 | .153 | .156 | .160 | .163 |
| | -7 | | | .143 | .145 | .145 | .147 | .149 | .151 | .149 | .151 |
| | -4 | | | .155 | .157 | .154 | .156 | .154 | .156 | .158 | .160 |
| | -2 | | | .156 | .157 | .157 | .158 | .157 | .158 | .159 | .160 |
| +10 | 0 | | | .160 | .160 | .158 | .158 | .159 | .159 | .160 | .160 |
| | +2 | | | .167 | .167 | .159 | .159 | .159 | .159 | .160 | .160 |
| | +4 | | | .158 | .158 | .159 | .159 | .159 | .159 | .160 | .160 |
| | +7 | | | .158 | .159 | .157 | .158 | .161 | .162 | .162 | .163 |
| | +10 | | | .156 | .158 | .160 | .162 | .169 | .171 | .173 | .175 |
| | +15 | | | .155 | .157 | .159 | .161 | .166 | .168 | .177 | .179 |
| | -10 | | | .156 | .159 | .155 | .158 | .171 | .174 | .174 | .177 |
| | -7 | | | .157 | .159 | .155 | .157 | .159 | .159 | .157 | .160 |
| | -4 | | | .158 | .160 | .160 | .162 | .163 | .165 | .166 | .168 |
| | -2 | | | .159 | .160 | .160 | .161 | .164 | .165 | .166 | .168 |
| +15 | 0 | | | .161 | .161 | .161 | .161 | .165 | .165 | .166 | .166 |
| | +2 | | | .160 | .160 | .161 | .161 | .163 | .163 | .164 | .164 |
| | +4 | | | .156 | .156 | .163 | .163 | .177 | .177 | .170 | .170 |
| | +7 | | | .157 | .158 | .166 | .167 | .172 | .173 | .179 | .180 |
| | +10 | | | .156 | .158 | .183 | .185 | .183 | .185 | .195 | .197 |
| | +15 | | | .160 | .162 | .178 | .180 | .193 | .195 | .207 | .209 |
| | | | | .155 | .158 | .182 | .185 | .189 | .192 | .201 | .204 |

TABLE XX

Y FORCE IN POUNDS FOR BARE HULLS AND HULLS WITH CONTROL SURFACES NOS. 1 TO 5

[Model at 0° pitch and elevators neutral. Airspeed, 40 miles per hour]

| Rudder setting δ_r | Angle of yaw ψ | Long bare hull | Short bare hull | Long hull with control No.— | | | | Short hull, control No. 5 | Long hull, control No. 5 | Long hull control No. 5, computed from short |
|---------------------------|---------------------|----------------|-----------------|-----------------------------|--------|--------|--------|---------------------------|--------------------------|--|
| | | | | 1 | 2 | 3 | 4 | | | |
| Degrees | 0 | +0.001 | +0.001 | +0.002 | -0.002 | -0.003 | +0.003 | -0.002 | +0.005 | 0 |
| | +2 | -.035 | -.036 | -.065 | -.057 | -.078 | -.070 | -.052 | -.053 | -.055 |
| | +4 | -.083 | -.082 | -.146 | -.123 | -.176 | -.151 | -.127 | -.125 | -.130 |
| | +7 | -.191 | -.179 | -.295 | -.268 | -.363 | -.326 | -.264 | -.283 | -.276 |
| | +10 | -.322 | -.304 | -.483 | -.468 | -.582 | -.555 | -.485 | -.511 | -.503 |
| | +15 | -.619 | -.574 | | | | | | | |
| | -10 | | | | | | | | + .397 | |
| | -7 | | | | | | | | + .202 | |
| | -4 | | | | | | | | + .067 | |
| | -2 | | | | | | | | -.002 | |
| +10 | 0 | | | | | | | | -.046 | |
| | +2 | | | | | | | | -.101 | |
| | +4 | | | | | | | | -.177 | |
| | +7 | | | | | | | | -.351 | |
| | +10 | | | | | | | | -.566 | |
| | -10 | | | + .379 | + .351 | + .372 | + .378 | + .403 | + .408 | + .421 |
| | -7 | | | + .180 | + .179 | + .178 | + .187 | + .187 | + .181 | + .199 |
| | -4 | | | + .040 | + .046 | + .016 | -.001 | + .055 | + .046 | + .058 |
| | -2 | | | -.031 | -.017 | -.073 | -.055 | -.011 | -.013 | -.008 |
| | 0 | | | -.080 | -.067 | -.132 | -.114 | -.067 | -.068 | -.066 |
| +15 | +2 | | | -.149 | -.120 | -.207 | -.185 | -.128 | -.129 | -.129 |
| | +4 | | | -.234 | -.194 | -.309 | -.280 | -.212 | -.211 | -.213 |
| | +7 | | | -.386 | -.346 | -.505 | -.455 | -.370 | -.385 | -.382 |
| | +10 | | | -.603 | -.549 | -.726 | -.691 | -.589 | -.613 | -.607 |

TABLE XXI

Y FORCE IN POUNDS FOR HULLS WITH NO. 6 CONTROL SURFACES

[Model at 0° pitch and elevators neutral. Airspeed, 40 miles per hour]

| Rudder setting δ_r | Angle of yaw ψ | Fins No. 6 (without elevators and rudders) on— | | Control No. 6A on— | | Control No. 6B on— | | Control No. 6C on— | | Control No. 6D on— | |
|---------------------------|---------------------|--|-----------|--------------------|-----------|--------------------|-----------|--------------------|-----------|--------------------|-----------|
| | | Short hull | Long hull | Short hull | Long hull | Short hull | Long hull | Short hull | Long hull | Short hull | Long hull |
| | | Degrees | Degrees | | | | | | | | |
| 0 | 0 | +0.003 | +0.003 | +0.002 | +0.002 | +0.001 | +0.001 | +0.007 | +0.007 | +0.004 | +0.004 |
| | +2 | -0.044 | -0.045 | -0.054 | -0.055 | -0.053 | -0.054 | -0.055 | -0.056 | -0.055 | -0.056 |
| | +4 | -0.115 | -0.118 | -0.125 | -0.128 | -0.128 | -0.131 | -0.126 | -0.129 | -0.128 | -0.131 |
| | +7 | -0.247 | -0.259 | -0.261 | -0.273 | -0.266 | -0.278 | -0.274 | -0.286 | -0.277 | -0.289 |
| | +10 | -0.451 | -0.469 | -0.480 | -0.498 | -0.487 | -0.505 | -0.493 | -0.511 | -0.503 | -0.521 |
| | +15 | -0.871 | -0.913 | -0.902 | -0.944 | -0.891 | -0.933 | -0.936 | -0.978 | -0.954 | -0.996 |
| | -15 | | | +0.873 | +0.915 | +0.854 | +0.896 | +0.836 | +0.878 | +0.818 | +0.860 |
| | -10 | | | +0.435 | +0.453 | +0.412 | +0.430 | +0.392 | +0.410 | +0.375 | +0.393 |
| | -7 | | | +0.225 | +0.237 | +0.207 | +0.219 | +0.198 | +0.210 | +0.190 | +0.202 |
| | -4 | | | +0.081 | +0.084 | +0.070 | +0.073 | +0.056 | +0.059 | +0.059 | +0.062 |
| +10 | -2 | | | +0.007 | +0.008 | -0.005 | -0.004 | -0.010 | -0.009 | -0.018 | -0.017 |
| | 0 | | | -.050 | -.050 | -.058 | -.058 | -.067 | -.067 | -.072 | -.072 |
| | +2 | | | -.101 | -.102 | -.118 | -.119 | -.123 | -.124 | -.126 | -.127 |
| | +4 | | | -.178 | -.181 | -.192 | -.195 | -.203 | -.206 | -.214 | -.217 |
| | +7 | | | -.336 | -.348 | -.359 | -.371 | -.374 | -.386 | -.388 | -.400 |
| | +10 | | | -.563 | -.581 | -.589 | -.607 | -.602 | -.620 | -.617 | -.635 |
| | +15 | | | -.999 | -1.041 | -1.026 | -1.068 | -1.042 | -1.084 | -1.063 | -1.105 |
| | -15 | | | + .820 | + .862 | + .774 | + .816 | + .738 | + .780 | + .700 | + .742 |
| | -10 | | | + .385 | + .403 | + .352 | + .370 | + .326 | + .344 | + .304 | + .322 |
| | -7 | | | + .171 | + .183 | + .153 | + .165 | + .133 | + .145 | + .116 | + .128 |
| +20 | -4 | | | + .034 | + .037 | + .012 | + .015 | -.002 | + .001 | -.018 | -.015 |
| | -2 | | | -.036 | -.035 | -.055 | -.054 | -.072 | -.071 | -.086 | -.085 |
| | 0 | | | -.097 | -.097 | -.112 | -.112 | -.126 | -.126 | -.144 | -.144 |
| | +2 | | | -.156 | -.157 | -.169 | -.170 | -.183 | -.184 | -.203 | -.204 |
| | +4 | | | -.235 | -.238 | -.244 | -.247 | -.270 | -.273 | -.290 | -.293 |
| | +7 | | | -.407 | -.419 | -.460 | -.472 | -.452 | -.464 | -.476 | -.488 |
| | +10 | | | -.636 | -.654 | -.676 | -.694 | -.689 | -.707 | -.709 | -.727 |
| | +15 | | | -1.085 | -1.127 | -1.107 | -1.149 | -1.137 | -1.179 | -1.166 | -1.208 |

TABLE XXII

Z FORCE IN POUNDS FOR BARE HULLS AND HULLS WITH CONTROL SURFACES NOS. 1 TO 5
 [Model at 0° yaw and rudders neutral. Airspeed, 40 miles per hour]

| Elevator setting δ_e | Angle of pitch θ | Long bare hull | Short bare hull | Long hull with control No.— | | | | Short hull, control No. 5 | Long hull, control No. 5 | Long hull, control No. 5, computed from short | | |
|-----------------------------|-------------------------|----------------|-----------------|-----------------------------|--------|--------|--------|---------------------------|--------------------------|---|--------|--------|
| | | | | 1 | 2 | 3 | 4 | | | | | |
| Degrees | Degrees | 0 | -0.001 | -0.001 | +0.014 | +0.012 | +0.027 | +0.025 | +0.015 | +0.017 | +0.015 | |
| | | +2 | +0.035 | +0.036 | +0.093 | +0.062 | +0.114 | +0.113 | +0.080 | +0.079 | +0.081 | |
| | | +4 | +0.083 | +0.082 | +0.193 | +0.164 | +0.226 | +0.203 | +0.157 | +0.157 | +0.160 | |
| | | +7 | +0.191 | +0.179 | +0.372 | +0.322 | +0.435 | +0.421 | +0.318 | +0.345 | +0.330 | |
| | | +10 | +0.322 | +0.304 | +0.625 | +0.552 | +0.681 | +0.681 | +0.567 | +0.587 | +0.585 | |
| | | +15 | +0.619 | +0.574 | | | | | | | | |
| | | -10 | -7 | | | | | | | | -0.428 | |
| | | -4 | | | | | | | | | -0.210 | |
| | | -2 | | | | | | | | | -0.063 | |
| | | 0 | | | | | | | | | +0.007 | |
| | | +2 | | | | | | | | | +0.070 | |
| | | +4 | | | | | | | | | +0.136 | |
| | | +7 | | | | | | | | | +0.224 | |
| | | +10 | | | | | | | | | +0.402 | |
| | | -10 | | | | -0.425 | -0.389 | -0.399 | -0.349 | -0.401 | -0.396 | -0.419 |
| -7 | | | | -0.198 | -0.188 | -0.192 | -0.130 | -0.191 | -0.180 | -0.203 | | |
| -4 | | | | -0.033 | -0.040 | +0.009 | +0.049 | +0.023 | -0.022 | -0.026 | | |
| -2 | | | | +0.045 | +0.039 | +0.110 | +0.137 | +0.051 | +0.052 | +0.050 | | |
| 0 | | | | +0.110 | +0.097 | +0.192 | +0.216 | +0.116 | +0.116 | +0.116 | | |
| +2 | | | | +0.184 | +0.165 | +0.286 | +0.305 | +0.185 | +0.188 | +0.186 | | |
| +4 | | | | +0.284 | +0.256 | +0.435 | +0.407 | +0.273 | +0.290 | +0.276 | | |
| +7 | | | | +0.512 | +0.421 | +0.624 | +0.612 | +0.462 | +0.477 | +0.474 | | |
| +10 | | | | +0.803 | +0.653 | +0.857 | +0.840 | +0.710 | +0.726 | +0.728 | | |

TABLE XXIII

Z FORCE, IN POUNDS, FOR HULLS WITH NO. 6 CONTROL SURFACES
 [Model at 0° yaw and rudders neutral. Airspeed, 40 miles per hour]

| Elevator setting δ_e | Angle of pitch θ | Fins No. 6 (without elevators or rudders) on— | | Control No. 6A on— | | Control No. 6B on— | | Control No. 6C on— | | Control No. 6D on— | | |
|-----------------------------|-------------------------|---|-----------|--------------------|-----------|--------------------|-----------|--------------------|-----------|--------------------|-----------|--------|
| | | Short hull | Long hull | Short hull | Long hull | Short hull | Long hull | Short hull | Long hull | Short hull | Long hull | |
| Degrees | Degrees | 0 | +0.017 | +0.017 | +0.019 | +0.019 | +0.017 | +0.017 | +0.019 | +0.019 | +0.015 | +0.015 |
| | | +2 | +0.078 | +0.079 | +0.083 | +0.084 | +0.084 | +0.085 | +0.087 | +0.088 | +0.083 | +0.084 |
| | | +4 | +0.147 | +0.150 | +0.163 | +0.166 | +0.163 | +0.166 | +0.165 | +0.168 | +0.169 | +0.172 |
| | | +7 | +0.287 | +0.299 | +0.337 | +0.349 | +0.337 | +0.349 | +0.348 | +0.360 | +0.353 | +0.365 |
| | | +10 | +0.516 | +0.534 | +0.574 | +0.592 | +0.587 | +0.605 | +0.595 | +0.613 | +0.603 | +0.621 |
| | | +15 | +0.946 | +0.988 | +1.068 | +1.110 | +1.080 | +1.122 | +1.085 | +1.127 | +1.102 | +1.144 |
| | | -15 | | | -0.907 | -0.949 | -0.871 | -0.913 | -0.850 | -0.892 | -0.838 | -0.880 |
| | | -10 | | | -0.447 | -0.465 | -0.437 | -0.455 | -0.425 | -0.443 | -0.414 | -0.432 |
| | | -7 | | | -0.232 | -0.244 | -0.223 | -0.235 | -0.218 | -0.230 | -0.202 | -0.214 |
| | | -4 | | | -0.071 | -0.074 | -0.059 | -0.062 | -0.028 | -0.031 | -0.034 | -0.037 |
| | | -2 | | | +0.015 | +0.014 | +0.025 | +0.024 | +0.031 | +0.030 | +0.042 | +0.041 |
| | | 0 | | | +0.074 | +0.074 | +0.085 | +0.085 | +0.092 | +0.092 | +0.105 | +0.105 |
| | | +2 | | | +0.148 | +0.149 | +0.157 | +0.158 | +0.170 | +0.171 | +0.179 | +0.180 |
| | | +4 | | | +0.230 | +0.233 | +0.245 | +0.248 | +0.254 | +0.257 | +0.277 | +0.280 |
| | | +7 | | | +0.410 | +0.422 | +0.426 | +0.438 | +0.438 | +0.450 | +0.456 | +0.468 |
| +10 | | | +0.645 | +0.663 | +0.666 | +0.684 | +0.684 | +0.702 | +0.704 | +0.722 | | |
| +15 | | | +1.140 | +1.182 | +1.163 | +1.205 | +1.178 | +1.220 | +1.201 | +1.243 | | |
| -15 | | | -0.788 | -0.830 | -0.671 | -0.713 | -0.754 | -0.796 | -0.730 | -0.772 | | |
| -10 | | | -0.385 | -0.403 | -0.371 | -0.389 | -0.352 | -0.370 | -0.330 | -0.348 | | |
| -7 | | | -0.177 | -0.189 | -0.158 | -0.170 | -0.145 | -0.160 | -0.129 | -0.141 | | |
| -4 | | | +0.006 | +0.003 | +0.008 | +0.005 | +0.020 | +0.017 | +0.084 | +0.081 | | |
| -2 | | | +0.074 | +0.073 | +0.099 | +0.098 | +0.105 | +0.104 | +0.125 | +0.124 | | |
| 0 | | | +0.133 | +0.133 | +0.154 | +0.154 | +0.172 | +0.172 | +0.195 | +0.195 | | |
| +2 | | | +0.204 | +0.205 | +0.221 | +0.222 | +0.245 | +0.246 | +0.253 | +0.254 | | |
| +4 | | | +0.287 | +0.290 | +0.314 | +0.317 | +0.340 | +0.343 | +0.367 | +0.370 | | |
| +7 | | | +0.483 | +0.495 | +0.514 | +0.526 | +0.549 | +0.561 | +0.566 | +0.578 | | |
| +10 | | | +0.721 | +0.739 | +0.773 | +0.791 | +0.800 | +0.818 | +0.826 | +0.844 | | |
| +15 | | | +1.221 | +1.263 | +1.269 | +1.311 | +1.323 | +1.365 | +1.341 | +1.383 | | |

TABLE XXVI

NET MEASURED PITCHING MOMENT FOR SHORT MODEL AND COMPUTED PITCHING MOMENT IN POUND-FEET FOR LONG MODEL WITH NO. 6 CONTROL SURFACES

[Model at 0° yaw and rudders neutral. Moment axis at C. B. Airspeed, 40 miles per hour]

| Elevator setting δ_e | Angle of pitch θ | Fins No. 6 (without elevators or rudders) on— | | Control No. 6A on— | | Control No. 6B on— | | Control No. 6C on— | | Control No. 6D on— | |
|-----------------------------|-------------------------|---|-----------|--------------------|-----------|--------------------|-----------|--------------------|-----------|--------------------|-----------|
| | | Short hull | Long hull | Short hull | Long hull | Short hull | Long hull | Short hull | Long hull | Short hull | Long hull |
| 0 | 0 | -0.046 | -0.048 | -0.054 | -0.057 | -0.054 | -0.057 | -0.052 | -0.055 | -0.052 | -0.054 |
| | +2 | +0.197 | +0.235 | +0.148 | +0.185 | +0.144 | +0.181 | +0.142 | +0.179 | +0.148 | +0.186 |
| | +4 | +0.407 | +0.470 | +0.332 | +0.393 | +0.325 | +0.373 | +0.317 | +0.377 | +0.316 | +0.376 |
| | +7 | +0.612 | +0.701 | +0.516 | +0.598 | +0.497 | +0.578 | +0.491 | +0.571 | +0.483 | +0.563 |
| | +10 | +0.695 | +0.796 | +0.575 | +0.630 | +0.544 | +0.598 | +0.535 | +0.589 | +0.516 | +0.566 |
| | +15 | +0.734 | +0.804 | +0.570 | +0.621 | +0.535 | +0.588 | +0.511 | +0.561 | +0.492 | +0.539 |
| | -15 | | | -0.916 | -0.993 | -0.930 | -1.010 | -0.943 | -1.028 | -0.948 | -1.034 |
| | -10 | | | -0.887 | -0.960 | -0.905 | -0.980 | -0.919 | -0.996 | -0.932 | -1.010 |
| | -7 | | | -0.792 | -0.909 | -0.816 | -0.903 | -0.835 | -0.934 | -0.845 | -0.946 |
| | -4 | | | -0.592 | -0.666 | -0.614 | -0.689 | -0.642 | -0.721 | -0.655 | -0.734 |
| | -2 | | | -0.412 | -0.463 | -0.435 | -0.488 | -0.459 | -0.512 | -0.483 | -0.537 |
| | 0 | | | -0.215 | -0.225 | -0.232 | -0.256 | -0.257 | -0.270 | -0.287 | -0.302 |
| | +10 | +2 | | -0.017 | +0.012 | -0.037 | -0.019 | -0.073 | -0.048 | -0.100 | -0.075 |
| | | +4 | | +0.160 | +0.211 | +0.132 | +0.082 | +0.087 | +0.135 | +0.061 | +0.106 |
| | | +7 | | +0.321 | +0.393 | +0.273 | +0.343 | +0.212 | +0.281 | +0.182 | +0.247 |
| | +10 | | +0.359 | +0.411 | +0.304 | +0.349 | +0.250 | +0.291 | +0.202 | +0.240 | |
| | +15 | | +0.329 | +0.375 | +0.261 | +0.242 | +0.182 | +0.217 | +0.118 | +0.141 | |
| | -15 | | -1.107 | -1.204 | -1.158 | -1.267 | -1.208 | -1.305 | -1.240 | -1.341 | |
| | -10 | | -1.044 | -1.128 | -1.087 | -1.170 | -1.153 | -1.239 | -1.191 | -1.280 | |
| | -7 | | -0.946 | -1.050 | -0.995 | -1.102 | -1.047 | -1.155 | -1.082 | -1.193 | |
| | -4 | | -0.747 | -0.831 | -0.782 | -0.867 | -0.844 | -0.930 | -0.891 | -0.986 | |
| | -2 | | -0.550 | -0.610 | -0.604 | -0.666 | -0.658 | -0.721 | -0.721 | -0.788 | |
| | 0 | | -0.357 | -0.375 | -0.408 | -0.429 | -0.475 | -0.499 | -0.525 | -0.553 | |
| | +2 | | -0.171 | -0.150 | -0.225 | -0.207 | -0.310 | -0.295 | -0.358 | -0.345 | |
| | +4 | | -0.009 | +0.034 | -0.075 | -0.036 | -0.163 | -0.128 | -0.217 | -0.185 | |
| | +7 | | +0.125 | +0.187 | +0.056 | +0.114 | -0.021 | +0.031 | -0.117 | -0.065 | |
| | +10 | | +0.152 | +0.188 | +0.073 | +0.100 | -0.017 | +0.007 | -0.106 | -0.087 | |
| | +15 | | +0.111 | +0.146 | -0.019 | +0.046 | -0.117 | -0.100 | -0.196 | -0.183 | |

TABLE XXVII

PITCHING MOMENT AT 40 MILES PER HOUR

[Model at 0° pitch and elevators neutral]

| Condition of model | Rudder setting δ_r | Angle of yaw ψ | Net measured pitching moment | Axis of net measured moment | Pitching moment about C. B. | |
|--|---------------------------|---------------------|------------------------------|-----------------------------|-----------------------------|--------|
| | Degrees | Degrees | Pound-inches | | Pound-feet | |
| Long bare hull | 0 to +15 | -10 to +10 | 0 | 1.88" forward of C. B. | 0 | |
| Short bare hull | | | 0 | 1.78" forward of C. B. | -0.038 | |
| Long hull, control No. 1 | | | -0.45 | 0.70" forward of C. B. | -0.033 | |
| Long hull, control No. 2 | | | -0.40 | do | -0.053 | |
| Long hull, control No. 3 | | | -0.65 | do | -0.048 | |
| Long hull, control No. 4 | | | -0.59 | do | -0.054 | |
| Short hull, control No. 5 | | | -0.65 | At C. B. | -0.056 | |
| Long hull, control No. 5 ¹ | | | -0.67 | 0.61" aft C. B. | -0.054 | |
| Short hull, fins No. 6 | | | -0.55 | 0 to +15 | At C. B. | -0.046 |
| Without elevators or rudders | | | -0.55 | 0 to +15 | At C. B. | -0.046 |
| Long hull, fins No. 6 ¹ | | | -0.65 | -15 to +15 | At C. B. | -0.054 |
| Without elevators or rudders | | | -0.65 | -15 to +15 | do | -0.052 |
| Short hull, control No. 6A | | | -0.62 | -15 to +15 | do | -0.052 |
| Long hull, control No. 6A ¹ | | | -0.62 | -15 to +15 | do | -0.052 |
| Short hull, control No. 6B | | | -0.62 | -15 to +15 | do | -0.052 |
| Long hull, control No. 6B ¹ | -0.62 | -15 to +15 | do | -0.052 | | |
| Short hull, control No. 6C | -0.62 | -15 to +15 | do | -0.052 | | |
| Long hull, control No. 6C ¹ | -0.62 | -15 to +15 | do | -0.052 | | |
| Short hull, control No. 6D | -0.62 | -15 to +15 | do | -0.052 | | |
| Long hull, control No. 6D ¹ | -0.62 | -15 to +15 | do | -0.052 | | |

¹ Computed from short model.

TABLE XXX

NET MEASURED YAWING MOMENT FOR SHORT MODEL AND COMPUTED YAWING MOMENT IN POUND-FEET FOR LONG MODEL WITH NO. 6 CONTROL SURFACES

[Model at 0° pitch and elevators neutral. Moment axis at C. B. Airspeed, 40 miles per hour]

| Rudder setting δ_r | Angle of yaw ψ | Fins No. 6 (without elevators or rudders) on— | | Control No. 6A on— | | Control No. 6B on— | | Control No. 6C on— | | Control No. 6D on— | |
|---------------------------|---------------------|---|-----------|--------------------|-----------|--------------------|-----------|--------------------|-----------|--------------------|-----------|
| | | Short hull | Long hull | Short hull | Long hull | Short hull | Long hull | Short hull | Long hull | Short hull | Long hull |
| 0 | 0 | 0 | 0 | 0 | 0 | 0 | 0 | 0 | 0 | 0 | 0 |
| | +2 | + 234 | + 277 | + 207 | + 249 | + 204 | + 246 | + 208 | + 249 | + 207 | + 248 |
| | +4 | + 450 | + 535 | + 402 | + 468 | + 400 | + 466 | + 404 | + 470 | + 403 | + 469 |
| | +7 | + 695 | + 789 | + 646 | + 739 | + 638 | + 730 | + 633 | + 724 | + 617 | + 707 |
| | +10 | + 812 | + 984 | + 758 | + 826 | + 745 | + 812 | + 733 | + 799 | + 712 | + 777 |
| | +15 | + 910 | + 993 | + 830 | + 906 | + 811 | + 890 | + 800 | + 872 | + 767 | + 836 |
| | -15 | | | -1.023 | -1.104 | -1.062 | -1.146 | -1.062 | -1.147 | -1.079 | -1.168 |
| | -10 | | | - 918 | - 992 | - 938 | -1.016 | - 950 | -1.030 | - 960 | -1.043 |
| | -7 | | | - 792 | - 889 | - 808 | - 908 | - 817 | - 918 | - 831 | - 933 |
| | -4 | | | - 572 | - 644 | - 579 | - 653 | - 595 | - 678 | - 604 | - 683 |
| | -2 | | | - 362 | - 410 | - 375 | - 425 | - 392 | - 443 | - 401 | - 453 |
| | 0 | | | - 140 | - 147 | - 154 | - 154 | - 175 | - 184 | - 190 | - 200 |
| | +2 | | | + 074 | + 109 | + 054 | + 087 | + 033 | + 065 | + 017 | + 049 |
| | +4 | | | + 263 | + 322 | + 250 | + 306 | + 225 | + 280 | + 192 | + 245 |
| | +7 | | | + 478 | + 561 | + 456 | + 536 | + 414 | + 492 | + 372 | + 446 |
| +10 | | | + 584 | + 640 | + 551 | + 605 | + 502 | + 554 | + 458 | + 508 | |
| +15 | | | + 651 | + 716 | + 592 | + 651 | + 544 | + 604 | + 485 | + 539 | |
| -15 | | | -1.161 | -1.249 | -1.233 | -1.328 | -1.282 | -1.382 | -1.300 | -1.406 | |
| -10 | | | -1.036 | -1.118 | -1.093 | -1.178 | -1.133 | -1.223 | -1.160 | -1.253 | |
| -7 | | | - 894 | - 999 | - 948 | -1.056 | - 982 | -1.093 | -1.017 | -1.130 | |
| -4 | | | - 675 | - 754 | - 708 | - 789 | - 746 | - 828 | - 791 | - 877 | |
| -2 | | | - 473 | - 527 | - 517 | - 573 | - 552 | - 611 | - 602 | - 663 | |
| 0 | | | - 263 | - 280 | - 308 | - 326 | - 353 | - 370 | - 403 | - 424 | |
| +2 | | | - 059 | - 032 | - 100 | - 075 | - 150 | - 127 | - 200 | - 179 | |
| +4 | | | + 130 | + 181 | + 083 | + 133 | + 042 | + 086 | - 038 | + 004 | |
| +7 | | | + 328 | + 401 | + 275 | + 340 | + 202 | + 267 | + 106 | + 167 | |
| +10 | | | + 426 | + 475 | + 352 | + 393 | + 282 | + 320 | + 171 | + 207 | |
| +15 | | | + 483 | + 536 | + 389 | + 437 | + 318 | + 364 | + 189 | + 230 | |

TABLE XXXI

YAW FORCES AND MOMENTS ON LONG MODEL HULL WITH NO. 5 CONTROL SURFACES

[Model at 0° pitch. Elevators and rudders neutral. Airspeed, 30 miles per hour]

| Angle of yaw ψ | Net measured cross-wind force C | Net measured drag D | Yawing moment N , axis 0.61" aft C. B. | X force | Y force | Yawing moment N , axis at C. B. |
|---------------------|-----------------------------------|-----------------------|--|---------|---------|-----------------------------------|
| 0 | 0 | 0.090 | 0 | + 090 | 0 | 0 |
| +15 | - 560 | . 237 | +6. 72 | + 085 | - 602 | + 529 |
| +30 | -1. 342 | . 847 | +5. 06 | + 062 | -1. 585 | + 341 |
| +45 | -1. 980 | 1. 936 | +3. 02 | - 032 | -2. 769 | + 111 |
| +60 | -1. 975 | 2. 962 | +4. 16 | - 230 | -3. 553 | + 166 |
| +75 | -1. 457 | 3. 665 | + 35 | - 461 | -3. 916 | - 169 |
| +90 | - 477 | 3. 738 | -14. 69 | - 477 | -3. 738 | -1. 415 |

TABLE XXXII

OSCILLATION DATA FOR LONG MODEL AND APPARATUS AT VARIOUS AIR SPEEDS

[Model at 0° pitch. Elevators and rudders neutral]

| Air speed, miles per hour | Number of oscillations to reduce amplitude from 3.5 to ψ | | | | | | | | | |
|---|---|------|------|------|------|------|------|------|-------|-------|
| | Amplitude ψ (degrees) | | | | | | | | | |
| | 3.5 | 3.0 | 2.6 | 2.3 | 2.0 | 1.8 | 1.6 | 1.4 | 1.2 | 1.0 |
| Apparatus and bare hull combined | | | | | | | | | | |
| 0 | 0 | 14.0 | 27.5 | 39.0 | 51.5 | 61.0 | 72.0 | 84.5 | 98.5 | 115.0 |
| 10 | 0 | 12.0 | 22.5 | 31.5 | 42.0 | 50.0 | 59.0 | 69.0 | 80.5 | 94.0 |
| 20 | 0 | 9.5 | 18.5 | 26.5 | 34.5 | 41.5 | 48.5 | 57.0 | 66.5 | 78.0 |
| 30 | 0 | 8.5 | 16.0 | 22.5 | 29.5 | 35.0 | 41.0 | 49.5 | 56.5 | 65.5 |
| Apparatus and hull with control No. 1 combined | | | | | | | | | | |
| 0 | 0 | 14.5 | 28.0 | 39.0 | 52.5 | 62.0 | 73.0 | 85.5 | 99.5 | 116.5 |
| 10 | 0 | 7.5 | 15.0 | 21.0 | 27.5 | 32.5 | 38.5 | 45.0 | 52.5 | 61.0 |
| 20 | 0 | 5.5 | 10.0 | 14.0 | 19.0 | 22.5 | 26.5 | 31.0 | 36.0 | 42.0 |
| 30 | 0 | 4.0 | 7.5 | 10.5 | 14.0 | 17.0 | 20.0 | 23.0 | 27.0 | 31.5 |
| Apparatus and hull with control No. 2 combined | | | | | | | | | | |
| 0 | 0 | 15.0 | 28.5 | 40.0 | 53.5 | 63.0 | 74.0 | 87.0 | 101.0 | 119.0 |
| 10 | 0 | 8.0 | 15.5 | 22.0 | 29.0 | 35.0 | 41.0 | 48.0 | 56.0 | 65.5 |
| 20 | 0 | 5.5 | 11.0 | 15.0 | 20.0 | 24.0 | 28.0 | 33.0 | 38.5 | 45.0 |
| 30 | 0 | 4.0 | 8.0 | 11.5 | 15.0 | 18.0 | 21.0 | 25.0 | 29.0 | 34.0 |
| Apparatus and hull with control No. 3 combined | | | | | | | | | | |
| 0 | 0 | 14.0 | 27.5 | 39.0 | 51.5 | 61.0 | 72.5 | 85.0 | 99.0 | 116.0 |
| 10 | 0 | 6.5 | 12.5 | 17.5 | 23.5 | 28.0 | 33.0 | 38.5 | 45.0 | 53.0 |
| 20 | 0 | 4.5 | 8.5 | 12.0 | 16.0 | 19.0 | 22.5 | 26.5 | 31.0 | 36.0 |
| 30 | 0 | 3.0 | 6.5 | 9.0 | 11.5 | 14.0 | 16.5 | 19.0 | 22.5 | 26.0 |
| Apparatus and hull with control No. 4 combined | | | | | | | | | | |
| 0 | 0 | 14.0 | 27.5 | 39.0 | 51.5 | 61.5 | 72.0 | 84.5 | 98.5 | 115.0 |
| 10 | 0 | 7.0 | 14.0 | 19.5 | 25.5 | 31.0 | 36.0 | 42.5 | 49.5 | 58.0 |
| 20 | 0 | 5.0 | 9.0 | 12.5 | 17.0 | 20.0 | 23.5 | 27.5 | 32.0 | 37.5 |
| 30 | 0 | 3.5 | 7.0 | 9.0 | 12.5 | 15.0 | 17.5 | 20.5 | 24.0 | 28.0 |
| Apparatus and hull with control No. 6A combined | | | | | | | | | | |
| 0 | 0 | 15.0 | 28.5 | 40.0 | 53.0 | 63.0 | 74.0 | 86.0 | 100.0 | 117.5 |
| 10 | 0 | 8.0 | 15.0 | 21.0 | 28.0 | 34.0 | 40.0 | 46.5 | 54.0 | 64.0 |
| 20 | 0 | 5.0 | 9.5 | 13.5 | 18.0 | 21.5 | 25.0 | 29.5 | 34.5 | 40.0 |
| 30 | 0 | 3.5 | 7.0 | 10.0 | 13.5 | 16.0 | 19.0 | 22.0 | 26.0 | 30.5 |
| Apparatus and hull with control No. 6D combined | | | | | | | | | | |
| 0 | 0 | 14.0 | 27.5 | 39.0 | 52.0 | 61.5 | 72.0 | 85.0 | 99.0 | 116.0 |
| 10 | 0 | 7.5 | 14.0 | 20.0 | 26.5 | 31.5 | 37.0 | 43.5 | 51.0 | 59.5 |
| 20 | 0 | 5.0 | 9.5 | 13.0 | 17.5 | 21.0 | 25.0 | 29.0 | 34.0 | 40.0 |
| 30 | 0 | 3.5 | 7.0 | 10.0 | 13.0 | 16.0 | 19.0 | 22.0 | 26.0 | 30.0 |
| Apparatus alone (taken after test on bare hull) | | | | | | | | | | |
| 0 | 0 | 16.0 | 30.0 | 42.0 | 55.5 | 66.0 | 77.5 | 90.0 | 105.0 | 123.0 |
| 10 | 0 | 12.5 | 23.5 | 33.0 | 44.5 | 53.0 | 62.0 | 72.0 | 84.0 | 98.0 |
| 20 | 0 | 10.5 | 20.0 | 28.0 | 37.0 | 44.0 | 51.5 | 60.0 | 70.0 | 81.5 |
| 30 | 0 | 9.0 | 17.0 | 24.0 | 32.0 | 38.0 | 44.5 | 52.0 | 61.0 | 71.0 |
| Apparatus alone (taken after test on hull with No. 2 control) | | | | | | | | | | |
| 0 | 0 | 16.0 | 30.0 | 43.0 | 57.0 | 67.5 | 79.5 | 92.5 | 108.0 | 126.0 |
| 10 | 0 | 13.0 | 24.5 | 34.5 | 46.0 | 55.0 | 64.5 | 75.5 | 88.0 | 103.0 |
| 20 | 0 | 10.8 | 20.0 | 28.0 | 37.5 | 44.0 | 51.5 | 61.0 | 70.5 | 82.0 |
| 30 | 0 | 8.5 | 16.5 | 24.0 | 32.0 | 38.5 | 45.0 | 53.0 | 62.0 | 72.0 |

TABLE XXXIII

COEFFICIENT OF DAMPING MOMENT FOR LONG MODEL AND APPARATUS AT VARIOUS AIR SPEEDS

[Model at 0° pitch. Elevators and rudders neutral]

| Airspeed, miles per hour | Number of oscillations to damp amplitude from 3° to 2° = n | Duration of damping t (seconds) | Period of complete oscillation T=t/n (seconds) | Logarith- mic decrement $\lambda = \frac{1}{n} \log_e \frac{3^\circ}{2^\circ}$ = .405/n | Coefficient of damping moment μ_c or $\mu_a = \frac{2I\lambda}{T}$ (slug-ft. ² / sec.) |
|---|---|--|--|---|--|
| Bare hull and apparatus combined | | | | | |
| 0 | 37.5 | 61.6 | 1.643 | 0.0108 | 0.055 |
| 10 | 30.0 | 49.5 | 1.650 | .0135 | .069 |
| 20 | 25.0 | 42.8 | 1.671 | .0162 | .082 |
| 30 | 21.0 | 35.9 | 1.708 | .0193 | .095 |
| Hull with control No. 1 and apparatus combined | | | | | |
| 0 | 38.0 | 64.3 | 1.692 | 0.0107 | 0.056 |
| 10 | 20.0 | 34.3 | 1.713 | .0203 | .107 |
| 20 | 13.5 | 23.3 | 1.727 | .0300 | .155 |
| 30 | 10.0 | 17.6 | 1.763 | .0405 | .205 |
| Hull with control No. 2 and apparatus combined | | | | | |
| 0 | 33.5 | 66.5 | 1.728 | 0.0105 | 0.057 |
| 10 | 21.0 | 36.4 | 1.732 | .0193 | .104 |
| 20 | 14.5 | 25.4 | 1.749 | .0279 | .149 |
| 30 | 11.0 | 19.6 | 1.780 | .0368 | .193 |
| Hull with control No. 3 and apparatus combined | | | | | |
| 0 | 37.5 | 64.8 | 1.727 | 0.0108 | 0.058 |
| 10 | 17.5 | 30.4 | 1.737 | .0231 | .124 |
| 20 | 11.5 | 20.1 | 1.750 | .0352 | .187 |
| 30 | 8.5 | 15.1 | 1.777 | .0477 | .250 |
| Hull with control No. 4 and apparatus combined | | | | | |
| 0 | 37.5 | 65.4 | 1.743 | 0.0108 | 0.059 |
| 10 | 18.5 | 32.2 | 1.741 | .0219 | .119 |
| 20 | 12.0 | 21.1 | 1.762 | .0338 | .182 |
| 30 | 9.0 | 16.1 | 1.786 | .0450 | .239 |
| Hull with control No. 6A and apparatus combined | | | | | |
| 0 | 38.0 | 66.4 | 1.747 | 0.0107 | 0.058 |
| 10 | 20.0 | 35.0 | 1.748 | .0203 | .110 |
| 20 | 13.0 | 22.9 | 1.765 | .0300 | .162 |
| 30 | 10.0 | 17.9 | 1.790 | .0405 | .216 |
| Hull with control No. 6D and apparatus combined | | | | | |
| 0 | 38.0 | 66.6 | 1.751 | 0.0107 | 0.058 |
| 10 | 19.0 | 33.3 | 1.750 | .0213 | .117 |
| 20 | 12.5 | 22.1 | 1.770 | .0324 | .175 |
| 30 | 9.5 | 17.0 | 1.790 | .0426 | .228 |
| Apparatus alone (taken after test on bare hull) | | | | | |
| 0 | 39.5 | 47.8 | 1.211 | 0.0103 | 0.039 |
| 10 | 32.0 | 38.8 | 1.213 | .0127 | .048 |
| 20 | 26.5 | 32.2 | 1.214 | .0153 | .058 |
| 30 | 23.0 | 28.0 | 1.215 | .0176 | .066 |
| Apparatus alone (taken after test on hull with control No. 2) | | | | | |
| 0 | 41.0 | 49.6 | 1.211 | 0.0099 | 0.037 |
| 10 | 33.0 | 40.0 | 1.213 | .0123 | .046 |
| 20 | 27.5 | 33.4 | 1.214 | .0147 | .056 |
| 30 | 23.5 | 28.6 | 1.215 | .0172 | .065 |

¹ For values of I see Table XXXIV. μ_c = Coefficient of damping moment for model and apparatus combined. μ_a = Coefficient of damping moment for apparatus alone.

TABLE XXXIV

COMPUTATIONS FOR MOMENT OF INERTIA $I = K_o T^2 / 4\pi^2$.

[$K_o = M/\psi = 61.60$ lb.-ft./rad. $4\pi^2 = 39.47$]

| Oscillating system | T (seconds) | I (slug-foot. ²) |
|--|-------------|------------------------------|
| Bare hull and apparatus combined..... | 1.643 | 4.213 |
| Hull with control No. 1 and apparatus combined..... | 1.692 | 4.467 |
| Hull with control No. 2 and apparatus combined..... | 1.728 | 4.661 |
| Hull with control No. 3 and apparatus combined..... | 1.727 | 4.655 |
| Hull with control No. 4 and apparatus combined..... | 1.743 | 4.740 |
| Hull with control No. 6A and apparatus combined..... | 1.747 | 4.763 |
| Hull with control No. 6D and apparatus combined..... | 1.751 | 4.785 |
| Apparatus alone..... | 1.211 | 2.288 |

TABLE XXXV

COEFFICIENT OF DAMPING MOMENT FOR LONG MODEL ALONE AT VARIOUS AIR SPEEDS

[Model at 0° pitch. Elevators and rudders neutral]

| Air speed, miles per hour | Apparatus and model combined, $\mu_c = \frac{2I\lambda}{T}$ (Slug-ft. ² /sec.) | Oscillating apparatus alone, $\mu_a = \frac{2I_a\lambda_a}{T_a}$ (Slug-ft. ² /sec.) | Model alone, $\mu = \mu_c - \mu_a$ (Slug-ft. ² /sec.) |
|-----------------------------------|---|--|--|
| Bare hull | | | |
| 0 | 0.055 | 0.039 | 0.016 |
| 10 | .069 | .048 | .021 |
| 20 | .082 | .058 | .024 |
| 30 | .095 | .066 | .029 |
| Hull with control surfaces No. 1 | | | |
| 0 | 0.056 | 0.039 | 0.017 |
| 10 | .107 | .048 | .059 |
| 20 | .155 | .058 | .097 |
| 30 | .205 | .066 | .139 |
| Hull with control surfaces No. 2 | | | |
| 0 | 0.057 | 0.037 | 0.020 |
| 10 | .104 | .046 | .058 |
| 20 | .149 | .056 | .093 |
| 30 | .193 | .065 | .128 |
| Hull with control surfaces No. 3 | | | |
| 0 | 0.058 | 0.037 | 0.021 |
| 10 | .124 | .046 | .078 |
| 20 | .187 | .056 | .131 |
| 30 | .250 | .065 | .185 |
| Hull with control surfaces No. 4 | | | |
| 0 | 0.059 | 0.037 | 0.022 |
| 10 | .119 | .046 | .073 |
| 20 | .182 | .056 | .126 |
| 30 | .239 | .065 | .174 |
| Hull with control surfaces No. 6A | | | |
| 0 | 0.058 | 0.037 | 0.021 |
| 10 | .110 | .046 | .064 |
| 20 | .162 | .056 | .106 |
| 30 | .216 | .065 | .151 |
| Hull with control surfaces No. 6D | | | |
| 0 | 0.059 | 0.037 | 0.021 |
| 10 | .117 | .046 | .071 |
| 20 | .175 | .056 | .119 |
| 30 | .228 | .065 | .163 |

as far as I can determine $\mu = \frac{dM}{dq}$

TABLE XXXVI

STABILITY CRITERION FOR LONG MODEL IN YAW

[Model at 0° pitch. Elevators and rudders neutral. Test speed, 40 miles per hour]

| Condition of model | Moment arms ³ | | Criterion ² = ratio of arms= $\frac{\mu^1 Y_\psi}{a u N_\psi}$ |
|--------------------------------|--------------------------|-----------------|--|
| | Disturbing | Reacting | |
| | N_ψ / Y_ψ | $a\mu/u^1$ | |
| | <i>Per cent</i> | <i>Per cent</i> | |
| Bare hull..... | -145.7 | 1.58 | -0.011 |
| Hull with No. 1 controls..... | -58.8 | 15.57 | -.265 |
| Hull with No. 2 controls..... | -82.2 | 12.86 | -.156 |
| Hull with No. 3 controls..... | -38.9 | 21.15 | -.544 |
| Hull with No. 4 controls..... | -56.8 | 19.86 | -.350 |
| Hull with No. 6A controls..... | -76.4 | 16.63 | -.218 |
| Hull with No. 6D controls..... | -73.2 | 18.83 | -.257 |

¹ Here, μ/u denotes slopes of lines in Figure 32.² This criterion = $Y_\psi N_\psi / U N_\psi$, see Report No. 212, National Advisory Committee for Aeronautics. $(Y_\psi, N_\psi) = (\partial Y / \partial \psi, \partial N / \partial \psi)$ at $\psi = 0^\circ$. $a = s^3/m$ = scale ratio³/mass of ship.= $120^3/5426.67$ slugs = 318.4.³ Given in percentage of airship length = 644.68 feet.

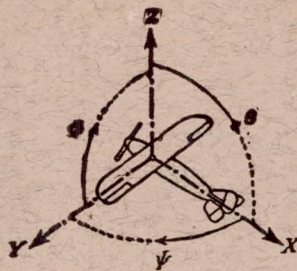

Positive directions of axes and angles (forces and moments) are shown by arrows.

| Axis. | | Force (parallel to axis) symbol. | Moment about axis. | | | Angle. | | Velocities. | |
|-------------------|--------------|---|--------------------|--------------|-----------------------------|-------------------|--------------|---|----------|
| Designation. | Sym- bol. | | Designa- tion. | Sym- bol. | Positive direc- tion. | Designa- tion. | Sym- bol. | Linear (compo- nent along axis). | Angular. |
| Longitudinal..... | X | X | rolling..... | L | Y → Z | roll. | Φ | u | p |
| Lateral..... | Y | Y | pitching... | M | Z → X | pitch..... | Θ | v | q |
| Normal..... | Z | Z | yawing..... | N | X → Y | yaw..... | Ψ | w | r |

Absolute coefficients of moment

$$C_l = \frac{L}{q b S} \quad C_m = \frac{M}{q c S} \quad C_n = \frac{N}{q f S}$$

Angle of set of control surface (relative to neutral position), δ . (Indicate surface by proper subscript.)

4. PROPELLER SYMBOLS.

- Diameter, D
- Pitch (a) Aerodynamic pitch, p_a
- (b) Effective pitch, p_e
- (c) Mean geometric pitch, p_g
- (d) Virtual pitch, p_v
- (e) Standard pitch, p_s
- Pitch ratio, p/D
- Inflow velocity, V'
- Slipstream velocity, V_s

- Thrust, T
- Torque, Q
- Power, P
- (If "coefficients" are introduced all units used must be consistent.)
- Efficiency $\eta = T V/P$
- Revolutions per sec., n ; per min., N
- Effective helix angle $\Phi = \tan^{-1} \left(\frac{V}{2\pi r n} \right)$

5. NUMERICAL RELATIONS.

- 1 HP = 76.04 kg. m/sec. = 550 lb. ft/sec.
- 1 kg. m/sec. = 0.01315 HP
- 1 mi/hr. = 0.44704 m/sec.
- 1 m/sec. = 2.23693 mi/hr.
- 1 lb. = 0.45359 kg.
- 1 kg. = 2.20462 lb.
- 1 mi. = 1609.35 m. = 5280 ft.
- 1 m. = 3.28083 ft.

