

REPORT No. 459

THE N.A.C.A. FULL-SCALE WIND TUNNEL

By SMITH J. DE FRANCE

SUMMARY

This report gives a complete description of the full-scale wind tunnel of the National Advisory Committee for Aeronautics. The tunnel is of the double-return flow type with a 30 by 60 foot open jet at the test section. The air is circulated by two propellers 35 feet 5 inches in diameter, located side by side, and each directly connected to a 4,000-horsepower slip-ring induction motor. The motor control equipment permits varying the speed in 24 steps between 25 and 118 miles per hour. The tunnel is equipped with a 6-component balance for obtaining the forces in 3 directions and the moments about the 3 axes of an airplane. All seven dial scales of the balance system are of the recording type, which permits simultaneous records to be made of all forces.

The tunnel has been calibrated and surveys have shown that the dynamic-pressure distribution over that portion of the jet which would be occupied by an airplane having a wing span of 45 feet is within $\pm 1\frac{1}{2}$ percent of a mean value. Based on the mean velocity of 118 miles per hour at the jet, the ratio of the kinetic energy per second to the energy input to the propellers per second is 2.84. Since it is generally recognized that a long open jet is a source of energy loss, the above figure is considered very satisfactory.

Comparative tests on several airplanes have given results which are in good agreement with those obtained on the same airplanes in flight. This fact, together with information obtained in the tunnel on Clark Y airfoils, indicates that the flow in the tunnel is satisfactory and that the air stream has a very small amount of turbulence.

INTRODUCTION

It is a generally accepted fact that the aerodynamic characteristics of a small model cannot be directly applied to a full-sized airplane without using an empirical correction factor to compensate for the lack of dynamic similarity. Two methods have been used to overcome this difficulty. One is to compress the working fluid and vary the kinematic viscosity to compen-

sate for the reduction in the size of the model. This method is used in the variable-density wind tunnel where tests can be conducted at the same Reynolds Number as would be experienced in flight. The other method is to conduct tests on the full-scale airplane.

The variable-density wind tunnel offers a satisfactory means for testing the component parts of an airplane and is particularly suitable for conducting fundamental research on airfoil sections and streamline bodies. However, this equipment has its limitations when the aerodynamic characteristics of a complete airplane are desired, especially if the effect of the slipstream is to be considered. It is practically impossible to build a model of the required size that is a true reproduction of a complete airplane. This difficulty is increased by the requirement that the model withstand large forces.

It is apparent that the most satisfactory method of obtaining aerodynamic characteristics of a complete airplane is to conduct a full-scale investigation. Heretofore such investigations have been conducted only in flight. Because of the variation in atmospheric conditions, it has been necessary to make a large number of check flights to obtain enough data to average out the discrepancies. Furthermore, in flight testing the scope of experiments is often limited by the fact that the possible alterations that can be made are restricted to those that do not seriously affect the weight or airworthiness of the airplane. In order to provide a means of full-scale investigation by which the conditions can be controlled and alterations made without serious limitations, the full-scale wind tunnel has been erected. Of course, only the steady-flight conditions can be readily investigated in the wind tunnel, but the execution of this work in the tunnel will facilitate full-scale testing and allow the flight-research personnel of the laboratory to concentrate on those problems possible of solution only in flight.

The full-scale wind tunnel may be used to determine the lift and drag characteristics of a complete airplane, to study the control and stability characteristics both

with and without the slipstream, and to study body interference. In addition, equipment has been installed to determine the direction and velocity of the flow at any point around an airplane. Aircraft engine cooling and cowling problems can also be investigated under conditions similar to those in flight.

The design of the full-scale wind tunnel was started in 1929. Since this was to be the first wind tunnel

tunnel was started in the spring of 1930; it was completed and operated for the first time in the spring of 1931.

DESCRIPTION OF TUNNEL

The general arrangement of the tunnel is shown in figure 1 and an external view of the building is given in figure 2. The tunnel is of the double-return flow

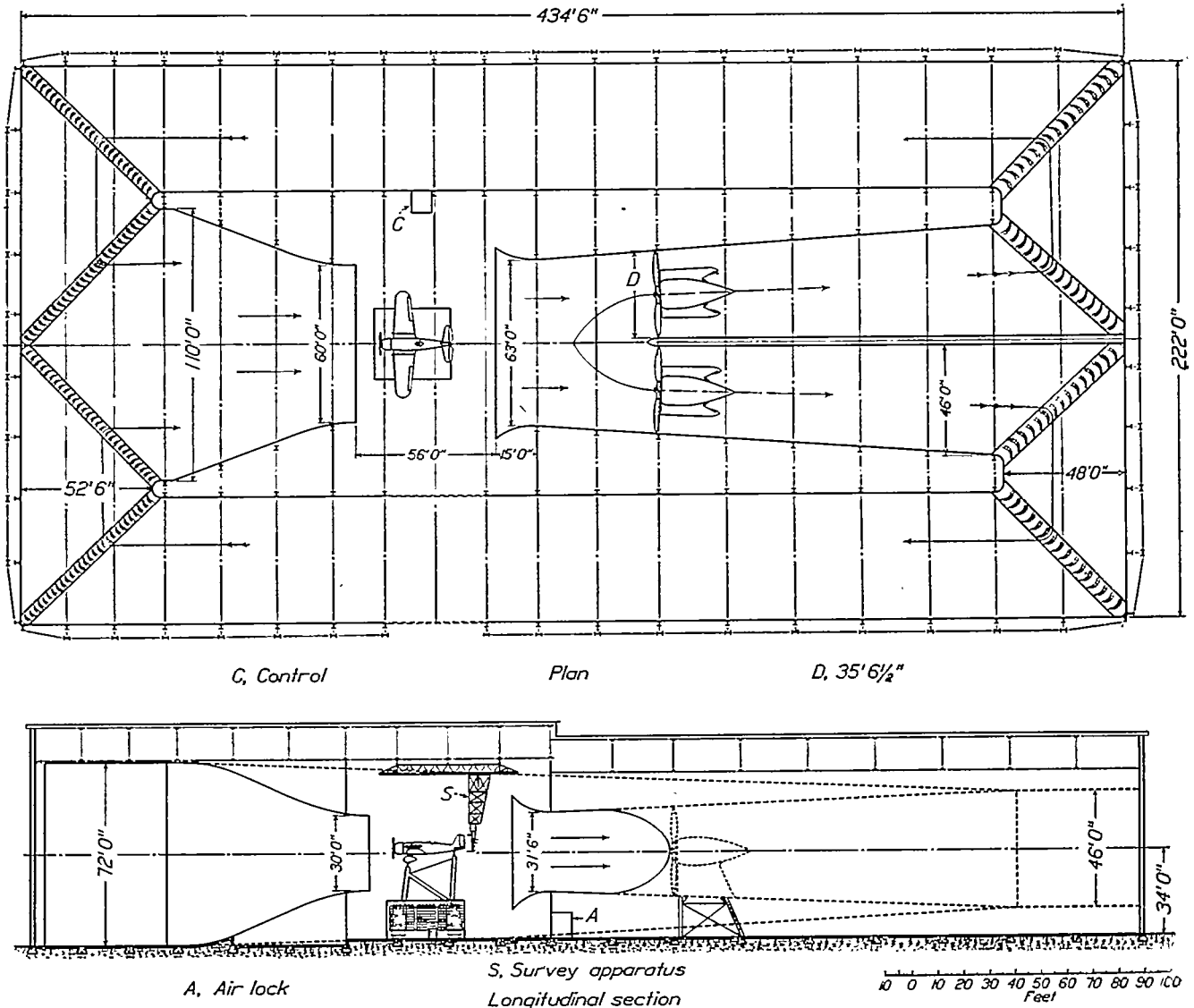

FIGURE 1.—Plan and elevation of the tunnel.

constructed with an elliptic throat and with two propellers mounted side by side, a $\frac{1}{16}$ -scale model was constructed to study the flow problems. Very satisfactory flow conditions were obtained in the model tunnel. This piece of equipment is now being used for small-scale testing. Construction of the full-scale wind

type with an open throat having a horizontal dimension of 60 feet and a vertical dimension of 30 feet. On either side of the test chamber is a return passage 50 feet wide, with the height varying from 46 to 72 feet. The entire equipment is housed in a structure, the outside walls of which serve as the outer walls of the

return passages. The over-all length of the tunnel is 434 feet 6 inches, the width 222 feet, and the maximum height 97 feet. The framework is of structural steel and the walls and roof are of $\frac{3}{8}$ -inch corrugated cement asbestos sheets. The entrance and exit cones are constructed of 2-inch wood planking, attached to a steel frame and covered on the inside with galvanized sheet metal as a protection against fire.

Entrance cone.—The entrance cone is 75 feet in length and in this distance the cross section changes from a rectangle 72 by 110 feet to a 30 by 60 foot elliptic section. The area reduction in the entrance

is approximately 30 by 40 feet, which provide excellent lighting conditions for daytime operation; eight 1,000-watt flood lights provide adequate artificial illumination for night operation. Attached to the roof trusses and running across the test chamber at right angles to the air stream and also in the direction of the air stream are tracks for an electric crane which lifts the airplanes onto the balance.

Exit cone.—Forward of the propellers and located on the center line of the tunnel is a smooth fairing which transforms the somewhat elliptic section of the single passage into two circular ones at the propellers.

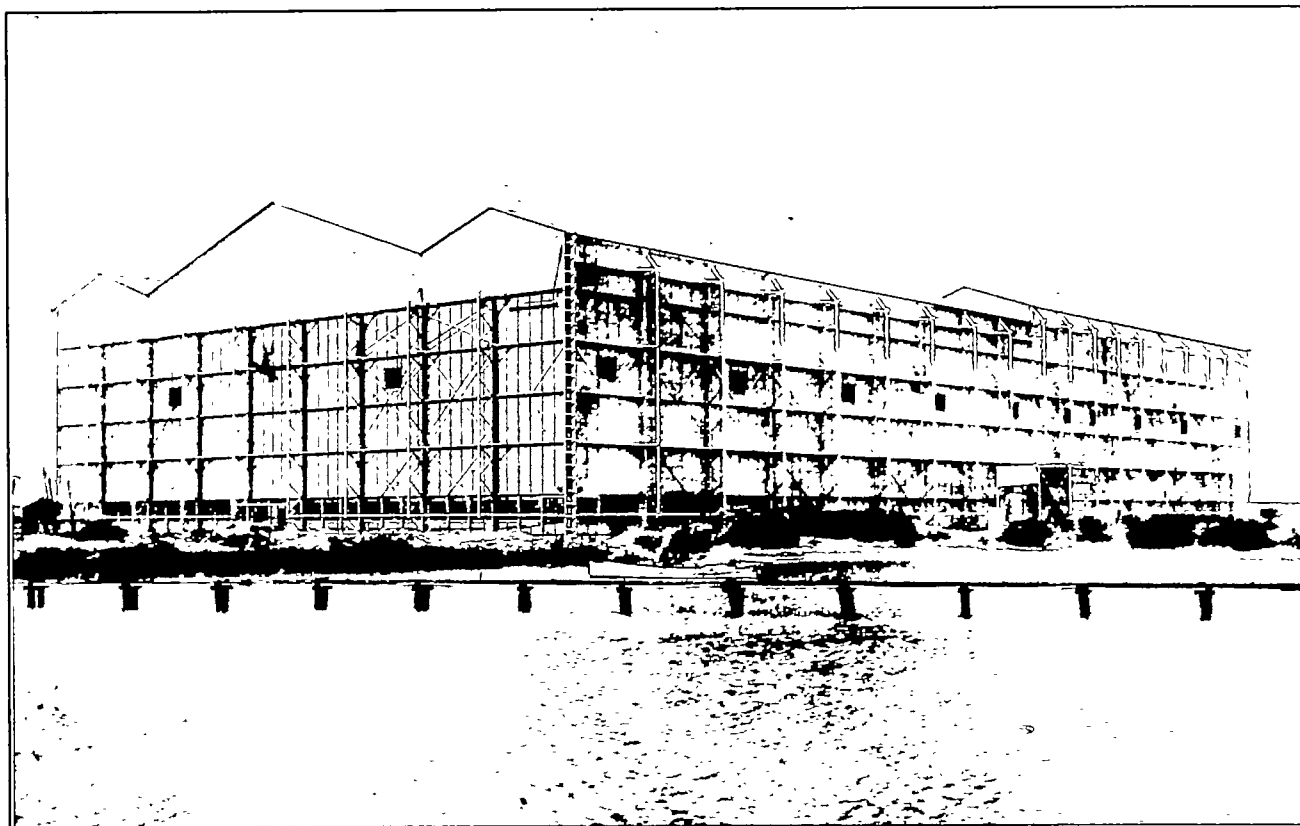

FIGURE 2.—Exterior view of the tunnel.

cone is slightly less than 5:1. The shape of the entrance cone was chosen to give as far as possible a constant acceleration to the air stream and to retain a 9-foot length of nozzle for directing the flow.

Test chamber.—The test chamber, in which is located the working section of the jet, is 80 by 122 feet. The length of the jet, or the distance between the end of the entrance cone and the smallest cross section of the exit-cone collector, is 71 feet. Doors 20 by 40 feet located in the walls of the return passage on one side provide access for airplanes. In the roof of the test chamber are two skylights, each approxi-

From the propellers aft, the exit cone is divided into two passages and each transforms in the length of 132 feet from a 35-foot $6\frac{1}{2}$ -inch circular section to a 46-foot square. The included angle between the sides of each passage is 6° .

Propellers.—The propellers are located side by side and 48 feet aft of the throat of the exit-cone bell. The propellers are 35 feet 5 inches in diameter and each consists of four cast aluminum alloy blades screwed into a cast-steel hub.

Motors.—The most commonly used power plant for operating a wind tunnel is a direct-current motor and

motor-generator set with Ward Leonard control system. For the full-scale wind tunnel it was found that alternating current slip-ring induction motors, together with satisfactory control equipment, could be purchased for

of speed one pole change was provided and the other variations are obtained by the introduction of resistance in the rotor circuit. This control permits a variation in air speed from 25 to 118 miles per hour. The two

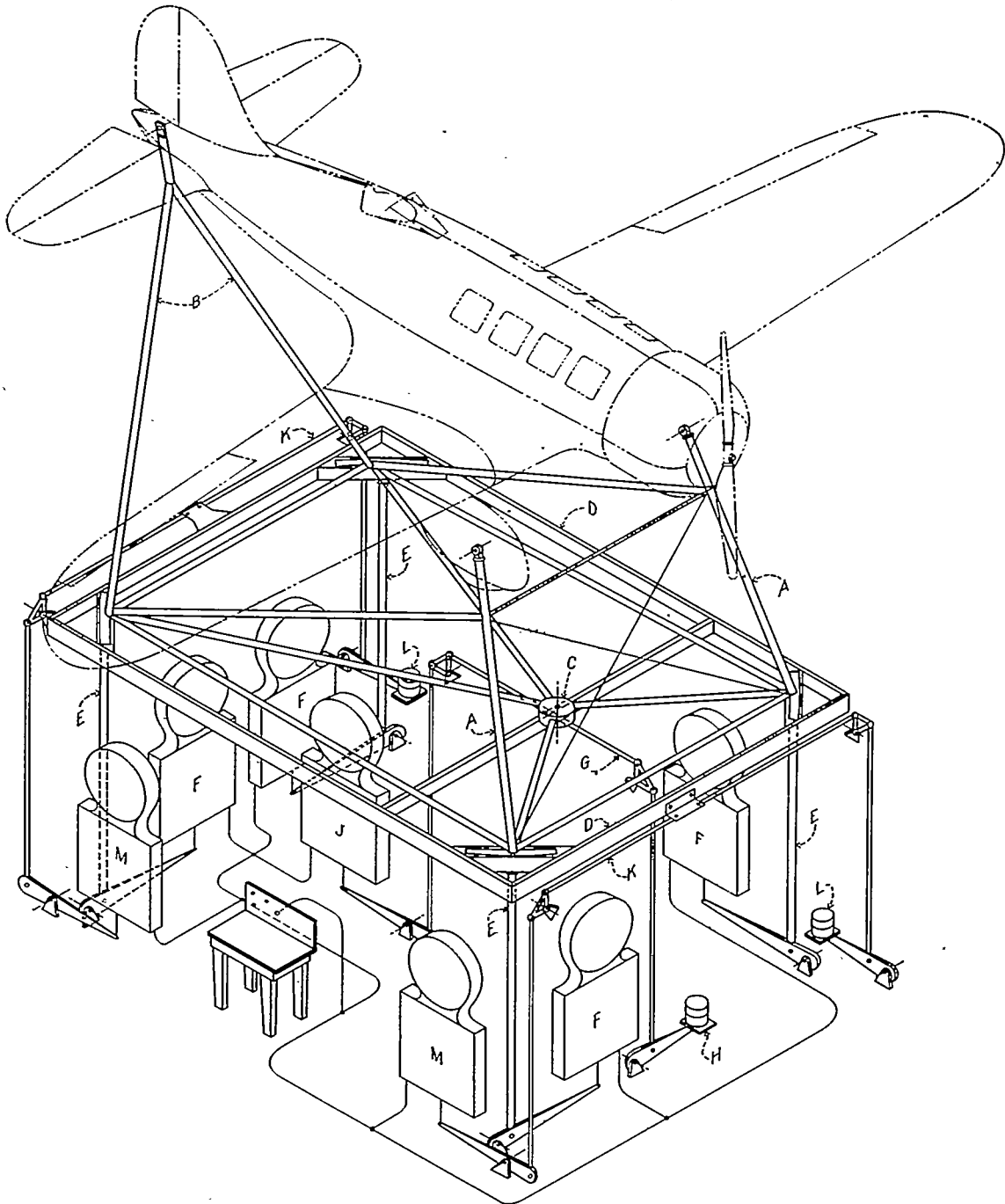

FIGURE 3.—Schematic drawing of the balance.

approximately 30 percent less than the direct-current equipment. Two 4,000-horsepower slip-ring induction motors with 24 steps of speed between 75 and 300 r.p.m. were therefore installed. In order to obtain the range

motors are connected through an automatic switchboard to one drum-type controller located in the test chamber. All the control equipment is interlocked and connected through time-limit relays, so that regardless

of how fast the controller handle is moved the motors will increase in speed at regular intervals.

The motors are provided with ball and roller bearings, which reduce the friction losses to a minimum. Roller bearings of 8.5- and 11.8-inch bores are provided at the slip-ring and propeller ends respectively, while the thrust of the propellers is taken on a ball bearing at the rear end of each motor shaft. The motors are mounted with the rotor shafts centered in the exit-cone passages. The motors and supporting structure are

opposite end of the tunnel have chords of 3 feet 6 inches and are spaced at 0.41 of a chord length. By a proper adjustment of the angular setting of the vanes, a satisfactory velocity distribution has been obtained and no honeycomb has been found necessary.

Balance.—The balance, which is of the 6-component type, is shown diagrammatically in figure 3. Ball and socket fittings at the top of each of the struts A hold the axles of the airplane to be tested; the tail is attached to the triangular frame B. These struts are secured to

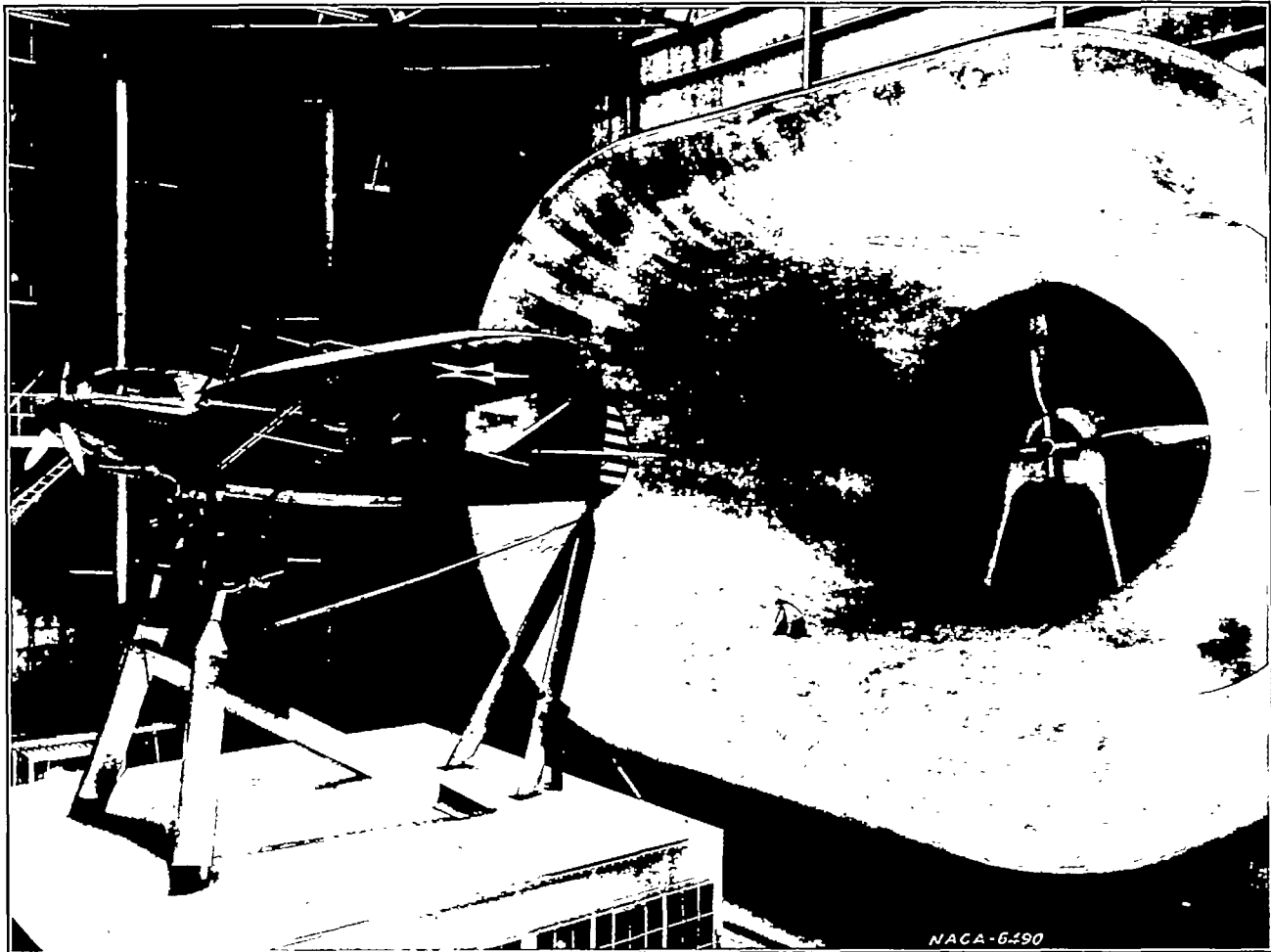

FIGURE 4.—The YO-31A airplanes ready for test in the tunnel.

enclosed in fairings so that they offer a minimum resistance to the air flow.

Guide vanes.—The air is turned at the four corners of each return passage by guide vanes. The vanes are of the curved-airfoil type formed by two intersecting arcs with a rounded nose. The arcs were so chosen as to give a practically constant area through the vanes.

The vanes at the first two corners back of the propellers have chords of 7 feet and are spaced at 0.45 and 0.47 of a chord length, respectively. Those at the

the turntable C, which is attached to the floating frame D. This frame rests on the struts E, which transmit the lift forces to the scales F. The drag linkage G is attached to the floating frame on the center line and, working against a known counterweight H, transmits the drag force to the scale J. The cross-wind force linkages K are attached to the floating frame on the front and rear sides at the center line. These linkages, working against known counterweights L, transmit the cross-wind force to scales M. In the above manner the

forces in three directions are measured and by combining the forces and the proper lever arms, the pitching, rolling, and yawing moments can be computed.

The scales are of the dial type and are provided with solenoid-operated printing devices. When the proper test condition is obtained, a push-button switch is momentarily closed and the readings on all seven scales are recorded simultaneously, eliminating the possibility of personal errors.

free from the balance. In figure 4 it can be seen that a very limited amount of the supporting structure is exposed to the air stream. The tare-drag measurements are therefore reduced to a minimum.

Survey equipment.—Attached to the bottom chord of the roof trusses is a 55-foot structural steel bridge (fig. 5), which can be rolled across the full width of the test chamber; mounted on this bridge is a car which can be rolled along the entire length. Suspended

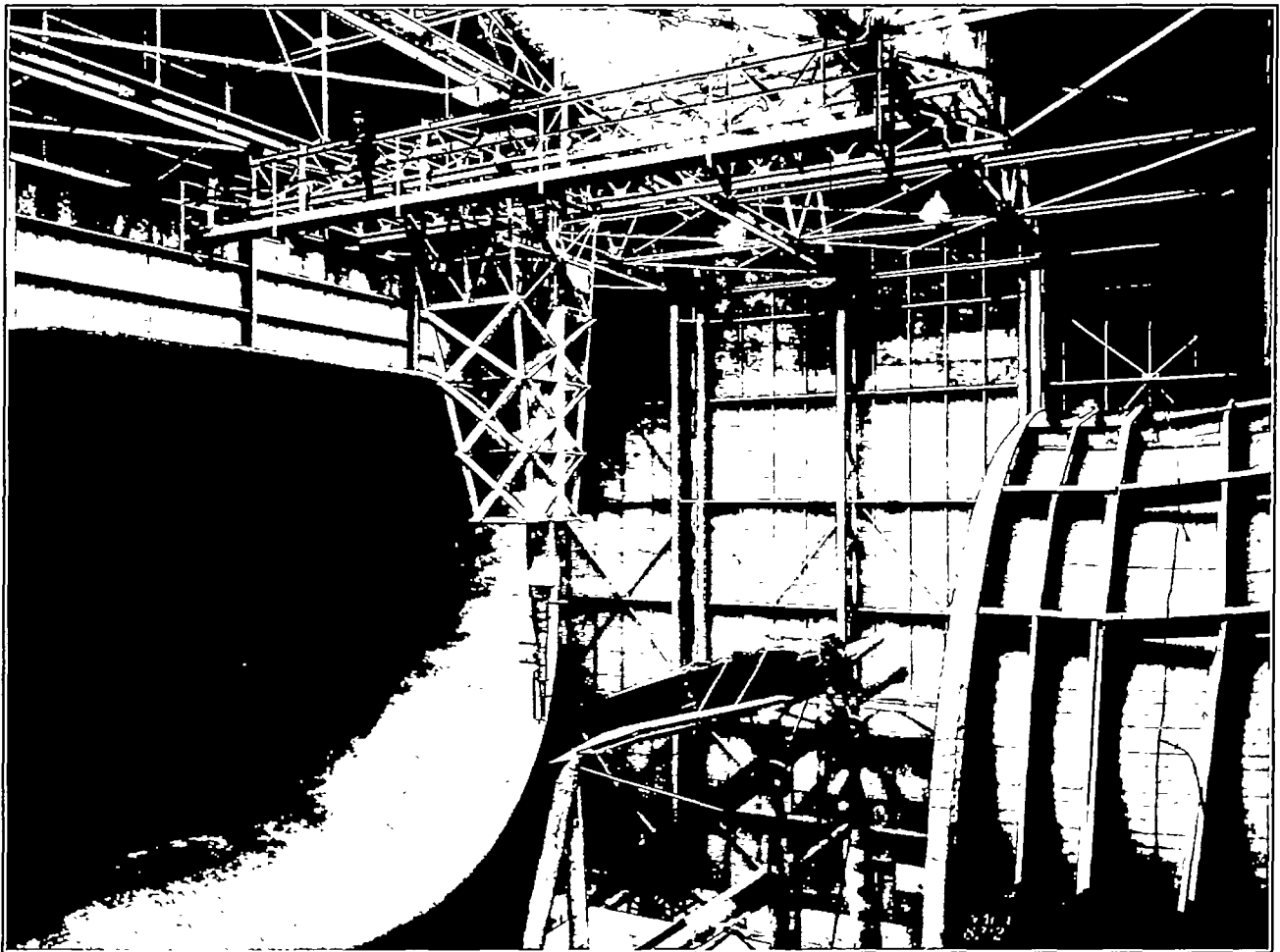

FIGURE 5.—Yaw, pitch, and pitot survey apparatus in position for survey at tail of airplane.

The triangular frame B is caused to telescope by electrically operated screws which raises and lowers the tail of the airplane and thereby varies the angle of attack. By a similar mechanism the turntable C can be moved so as to yaw the airplane from 20° left to 20° right.

The entire floating frame and scale assembly is enclosed in a room for protection from air currents and the supporting struts are shielded by streamlined fairings which are secured to the roof of the balance room and

below the car is a combined pitot, pitch, and yaw tube which can be raised or lowered and pitched or yawed by gearing with electrical control on the car. This arrangement permits the alinement of the tube with the air flow at any point around an airplane. The alinement of the tube is indicated by null readings on the alcohol manometers connected to the pitch and yaw openings in the head and the angle of pitch or yaw is read from calibrated Veeder counters connected to the electric operating motors. This equipment is very

valuable for studying the downwash behind wings and the flow around the tail surfaces of an airplane.

CALIBRATIONS AND TESTS

The velocity distribution has been measured over several planes at right angles to the jet, but the plane representing approximately the location of the wings of an airplane during tests was most completely explored. The dynamic-pressure distribution over the area that would be occupied during tests by an airplane with a wing span of 45 feet is within $\pm 1\frac{1}{2}$ percent

static pressure is within ± 1 percent of the mean dynamic pressure at the test section.

Two wall plates with static orifices are located in each return passage just ahead of the guide vanes at the entrance-cone end of the tunnel. The orifices are connected by a common pressure line, which is led to a micromanometer on the control desk in the test chamber. The other side of the manometer is left open to the test-chamber pressure. This installation has been calibrated against the average dynamic pressure determined by pitot surveys of the jet at the test

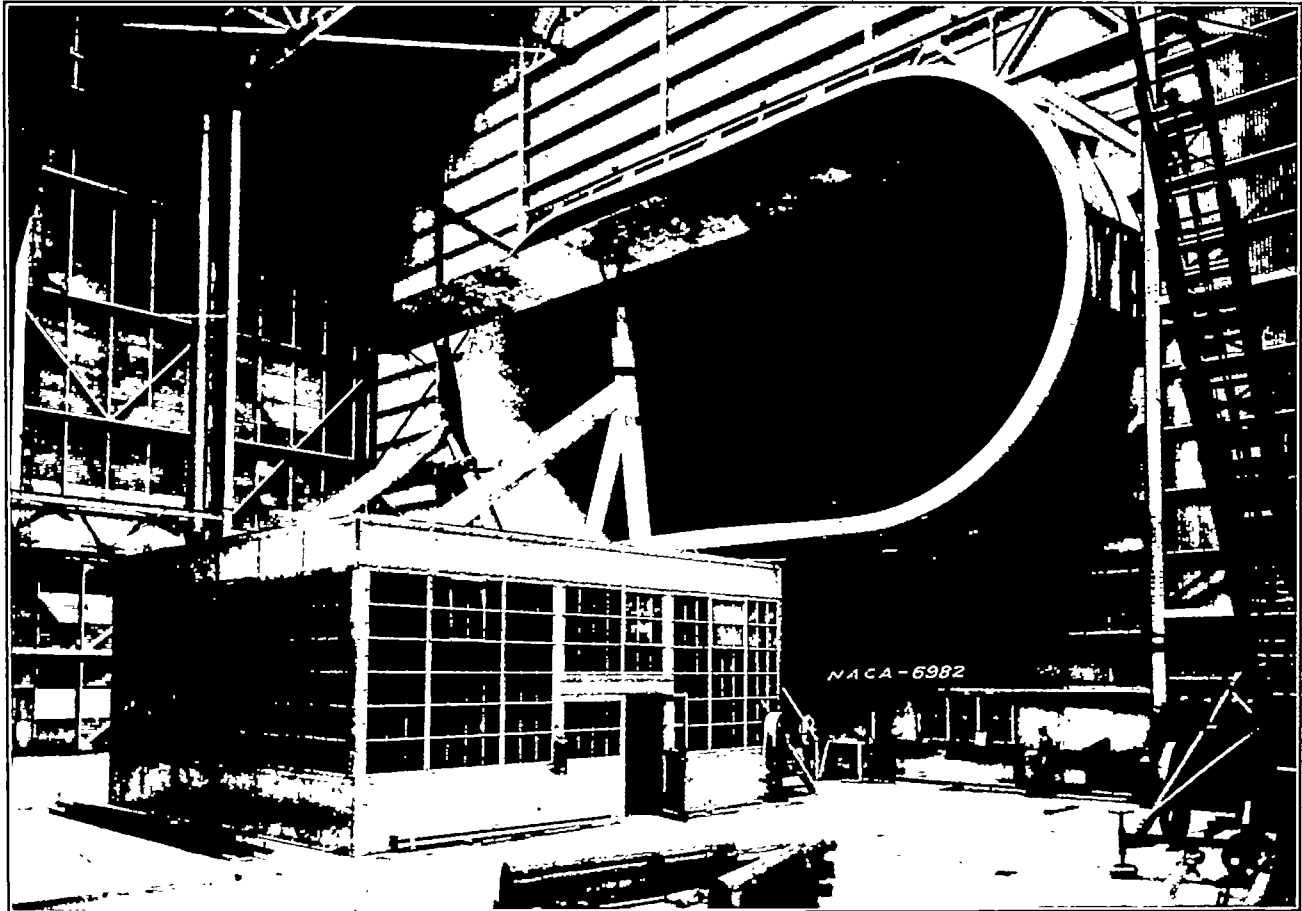

FIGURE 6.—A 6 by 36 foot Clark Y airfoil mounted in the tunnel.

of a mean value. It is possible to improve the distribution by further adjustment of the guide vanes. However, tests already conducted in the tunnel indicate that the present distribution does not detrimentally affect the results. This fact has been shown by the excellent agreement which has been obtained between the tunnel and flight results.

A survey of the static pressure along the axis of the tunnel showed that the longitudinal pressure gradient is small, as evidenced by the fact that between 11 and 36 feet from the entrance cone the variation of the

location and it is used to determine the dynamic head during tests.

A series of Clark Y airfoils of the same aspect ratio, but with spans of 12, 24, 36, and 48 feet, have been tested at the same Reynolds Number to determine the jet-boundary correction. Tests have also been made to determine the blocking effect of an airplane in the jet. The results of the complete investigation will be presented in a separate report.

Using the mean velocity across the jet of 118 miles per hour for computing the kinetic energy per second

at the working section and dividing this by the energy input to the propellers per second

$$\frac{\frac{1}{2} \rho A V^3}{550 \times \text{b.hp. input}}$$

gives an energy ratio for the tunnel of 2.84. This ratio, considering the length of the open jet, compares

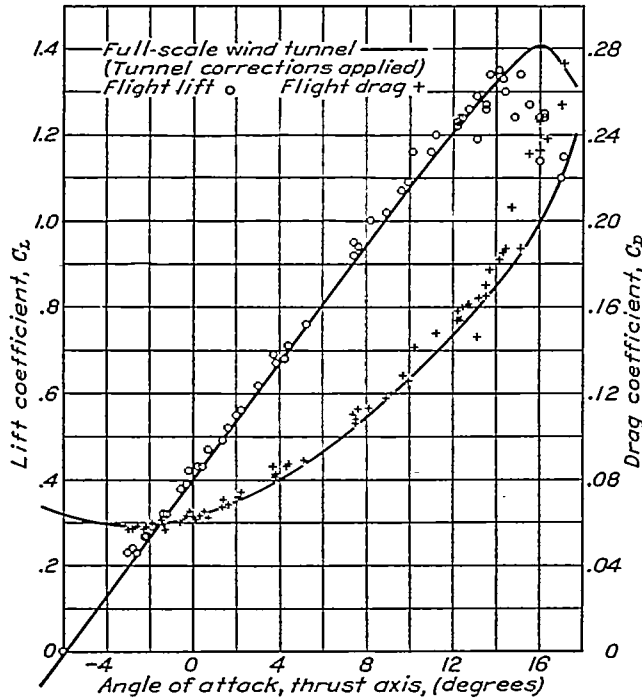

FIGURE 7.—Lift and drag characteristics of the F-23 airplane.

very favorably with the most efficient open-throat tunnels now in operation and exceeds the efficiency expected when the tunnel was designed.

Before force measurements are made on an airplane, the airplane is suspended from the roof trusses by cables and held within one half inch from the balance supports

while the tare forces are measured. The tare-drag coefficient determined in the above manner has been of the order of 25 percent of the minimum drag coefficient of the airplanes tested.

When testing airfoils the airplane supports are replaced by those shown in figure 6. The angle of attack is changed by displacing the rear support arms and rotating the airfoil about pins in the top of the main supports. The rear support arms are moved by linkages, which are connected to long screws on the back of the main supports, and the screws are operated by hand cranks inside the balance house. The tare drag of this support system is exceptionally small and amounts to only 3 percent of the minimum drag of a 6 by 36 foot Clark Y airfoil.

The lift and drag characteristics have been measured in the tunnel on several airplanes which had been previously tested in flight and their polars determined. These tests were conducted to obtain a check between the tunnel results and those from flight tests. A comparison of the results from the two methods of testing for one of the airplanes, the Fairchild F-22, is shown in figure 7. The wind-tunnel results are shown by the solid lines and the flight results are presented by the experimental points. These curves are representative of the results obtained with the different airplanes.

The agreement that has been obtained between the flight and full-scale tunnel results, together with the consistent manner in which measurements can be repeated when check tests are made, has demonstrated the accuracy and value of the equipment for aeronautical research.

LANGLEY MEMORIAL AERONAUTICAL LABORATORY,
NATIONAL ADVISORY COMMITTEE FOR AERONAUTICS,
LANGLEY FIELD, VA., March 13, 1933.