

19930092586 A-32

MR Sept. 1944

NATIONAL ADVISORY COMMITTEE FOR AERONAUTICS

# WARTIME REPORT

ORIGINALLY ISSUED

September 1944 as  
Memorandum Report

MEASUREMENTS IN FLIGHT OF THE LATERAL-CONTROL  
CHARACTERISTICS OF AN AIRPLANE EQUIPPED WITH FULL-SPAN  
ZAP FLAPS AND SIMPLE CIRCULAR-ARC-TYPE AILERONS

By J. Richard Spahr and Don R. Christophersen

Ames Aeronautical Laboratory  
Moffett Field, California

The NACA logo consists of the letters "NACA" in a bold, sans-serif font, centered within a stylized, wing-like shape that tapers at the ends.

WASHINGTON

NACA WARTIME REPORTS are reprints of papers originally issued to provide rapid distribution of advance research results to an authorized group requiring them for the war effort. They were previously held under a security status but are now unclassified. Some of these reports were not technically edited. All have been reproduced without change in order to expedite general distribution.

A-32

(MR Sept 44)

NATIONAL ADVISORY COMMITTEE FOR AERONAUTICS

MEMORANDUM REPORT

for the

Bureau of Aeronautics, Navy Department

MEASUREMENTS IN FLIGHT OF THE LATERAL-CONTROL CHARACTERISTICS  
OF AN AIRPLANE EQUIPPED WITH FULL-SPAN ZAP FLAPS AND  
SIMPLE CIRCULAR-ARC-TYPE AILERONS

By J. Richard Spahr and Don R. Christophersen

SUMMARY

The lateral-control characteristics of an airplane equipped with full-span Zap flaps and modified to accommodate simple circular-arc-type ailerons of two different designs were measured in flight at the Ames Aeronautical Laboratory.

Structural and space limitations restricted the circular-arc aileron designs to a type which resulted in large control forces. Thus, though the effectiveness of the two circular-arc-type aileron systems tested was of the same order as that of the original Zap-type surfaces, the high control forces restricted the rate of roll with the circular-arc designs. A decrease in the distance from the aileron center of curvature to the hinge line resulted in some reduction in control forces. The lateral lag characteristics of the airplane and the lateral control near the stall were considered satisfactory. In general, the rolling velocity and control force were very low for small control deflections.

INTRODUCTION

The need for more effective high-lift devices has become increasingly great with the trend toward higher wing loadings. The use of full-span wing flaps has been recognized as an effective solution to this problem, but their application has been limited principally by the lack of a satisfactory associated lateral-control system.

Among the lateral-control devices designed for use with full-span flaps is the plug-type circular-arc Zap aileron. Ailerons of this type were installed on a navy test airplane equipped with full-span Zap flaps. A description of this airplane and results of flight tests were presented in reference 1. These results showed that the airplane possessed the following lateral-control characteristics which were unsatisfactory in relation to the criteria of reference 2:

- (a) A nonlinear variation of rolling effectiveness (max. pb/2V) and aileron control force with lateral control-stick movement
- (b) A deficiency in the maximum rolling effectiveness
- (c) Excessive aileron control forces at large aileron deflections
- (d) Excessive stretch, friction, and inertia of the system

From wind-tunnel and flight-test investigations it appeared that a circular-arc type of aileron in combination with a suitable actuating linkage could be installed in the test airplane to provide most of the satisfactory lateral-control characteristics recommended in reference 2. The installation of ailerons most desirable from an aerodynamic viewpoint would have involved a relocation of the existing aileron actuating torque tube and some modifications of the wing structure itself, and these changes were considered impracticable. It was believed, however, that valuable data could be obtained in flight from tests of a simple circular-arc-type aileron directly connected to the actuating torque tube. The ailerons which were installed were designed to give approximately the same rolling effectiveness as did the original plug-type circular-arc Zap surfaces. Structural and space limitations restricted the design to a type which would result in large control forces. Two aileron test installations were made, and these differed only in the inclination of the projecting surface with the wing upper surface. The lateral-control characteristics of the airplane equipped with each of the above-mentioned systems were determined from data obtained in stalls and rudder-fixed aileron rolls.

#### DESCRIPTION OF AIRPLANE AND REVISED AILERONS

The major specifications and dimensions of the test airplane used in this investigation have been presented in reference 1. Views of the airplane in its original condition are shown in figures 1 to 4.

The two sets of revised ailerons installed in the airplane, hereinafter designated as revised ailerons I and revised ailerons II, respectively, are shown in detail and as installed in the wing in figures 5 to 11. Each set of ailerons was attached directly to the aileron actuating torque tube the center line of which was thus the hinge line. The plug-type circular-arc Zap ailerons, hereinafter referred to as the original ailerons, are illustrated in figures 3 and 12 for the purpose of comparison.

The original differential linkage shown in figure 13 was used with slight modifications to accommodate the direct connections of the revised ailerons. In order to reduce the excessive elasticity in the control system of revised ailerons II, the original actuating torque tube (used in revised ailerons I) was replaced by a tube of greater cross-sectional moment of inertia.

The kinematics of the revised and original control systems are presented in figure 14. Zero aileron angle corresponds to the position at which the upper edge of the aileron was flush with the wing upper surface. Stick position represents the horizontal deflection from the neutral position of the top of the control-stick grip (35 in. from the stick hinge point). The term "total aileron angle" used in this report refers to the angular deflection of the up-aileron (the down-aileron being aerodynamically ineffective), and is denoted "left" when the left aileron is up.

During the flight tests the average airplane weight was 5015 pounds and the center of gravity was located at 28.0 percent of the mean aerodynamic chord.

#### INSTRUMENTATION

NACA photographically recording instruments were installed in the airplane to obtain records from which the following quantities were evaluated: indicated airspeed; normal acceleration; elevator, aileron, and rudder angles; rolling, yawing, and pitching velocities; elevator and aileron control forces; and angle of sideslip. All records were synchronized by means of an NACA 1-second-interval timer. Standard airplane indicating instruments were used to determine manifold pressure, engine speed, altitude, and free-air temperature.

The airspeed recorder was connected to a vaned airspeed head which was free to rotate in pitch and yaw. The airspeed head was mounted on the forward end of a boom which was located near the left wing tip and extended approximately one wing-chord length ahead of the wing leading edge. The sideslip-angle recorder vane was mounted on the forward end of a boom

which extended approximately one wing-chord length ahead of the right wing near the wing tip. (See fig. 2.)

The elevator-, aileron-, and rudder-angle recorders were attached to the control system as close to the control horns as possible; thereby minimizing the effects of control-system elasticity on the recorded values of control positions.

The combination aileron and elevator control-force recorder was installed on a specially constructed control stick, the grip of which was in the same location as that of the normal stick (33 in. from the center of grip to the stick hinge point).

## TESTS

### Mechanical Characteristics of Aileron

#### Control Systems

Friction.— The static friction in the lateral-control systems was ascertained from the records of aileron angle and control force obtained on the ground during several slow left and right movements of the control stick through the deflection range.

Elasticity.— The elasticity or stretch in the lateral-control systems was determined from ground measurements of the deflections of the left and right ailerons when separately subjected to various static loadings with the control stick fixed at the maximum left and right positions.

#### Lateral-Control Characteristics

Aileron effectiveness and control force.— Records were taken during rudder-fixed aileron rolls produced by abrupt left or right stick deflections to a predetermined position which was held until the rolling velocity had reached a maximum. Four or five left and right stick positions were employed for each of the following configurations:

Power	Flap position	Indicated airspeed (mph)
Revised Ailerons I		
Rated	Up	93, 152
	Down	109
Revised Ailerons II		
Rated	Up	83, 95, 121, 196
	Down	68, 77, 94
Off	Up	95

The tests with revised ailerons I were brief, due to unsatisfactory force characteristics.

Aileron control in stalls.- Stalls were made from steady straight flight by slowly moving the control stick rearward until the stall occurred. An attempt was made to maintain the wings level by means of the ailerons alone (rudder fixed).

## RESULTS AND DISCUSSION

### Mechanical Characteristics of Aileron

#### Control Systems

Friction.- The friction in the lateral-control system, considered as one-half the measured difference between the left and right control force corresponding to a given aileron angle, is shown in figure 15 for revised ailerons I and II, and for the original aileron system. It is observed that an average of 1.5 pounds of friction existed in revised ailerons I as compared to 7.5 pounds in the original condition. This reduction was due principally to the elimination of the aileron supporting tracks and rollers of the original system.

Although the control system of revised ailerons II was essentially the same as that of revised ailerons I, the curves of figure 15(b) indicate an average frictional resistance of 4 pounds in the system. It is believed that this increase in friction was introduced into the system by the interference and misalignments accompanying the installation of the

enlarged torque tube.

The departure from horizontal lines of the mean curves of figure 15 indicates slight mass unbalance.

The frictional characteristics of the revised control systems impressed the pilots favorably and were considered greatly improved over those of the original system.

Elasticity.— The stretch in each lateral-control system is presented as a function of aileron control force in figure 16. In order to facilitate a comparison of the stretch characteristics of the systems, these curves are replotted in figure 17 with the stretch expressed in percent of total aileron angle. It is observed from figure 17 that the increased torsional stiffness of the enlarged tube for revised ailerons II reduced the stretch in the system appreciably. However, the elasticity was still considered excessive. The installation of an actuating torque tube with sufficient stiffness appeared impractical because of the prohibitive size and weight. A satisfactory actuating system which would employ push-pull rods, cables, or a combination of both, could no doubt be designed to reduce the stretch in the system.

#### Lateral-Control Characteristics

Aileron effectiveness and control force.— The variations of aileron effectiveness (max. pb/2V) and aileron control force with total aileron angle are presented in figure 18 for rudder-fixed aileron rolls in the rated-power, flaps-up condition of flight. Similar curves for the original control system are included for the purpose of comparison.

It is difficult to make direct comparisons from the data of figure 18, because of the differences in kinematics and stretch characteristics of the three lateral-control systems, the irregular variations of rolling velocity and control force with control-surface angle, and the paucity of data for the revised ailerons I. In order to give an indication of the over-all effectiveness of the various systems, the variation with airspeed of stick deflection and maximum pb/2V for a 30-pound aileron control force has been plotted in figure 19. The stick positions correspond to those for rigid control systems, and were obtained from the data of figure 14. The test points of figure 19 represent the averages of the values for left and right rolls. It is seen that greater stick deflections (considering a rigid control system) were required for the original system than for either of the revised systems, and that, as would be expected, the deflections for revised

ailerons II were greater than those for revised ailerons I. The corresponding curves for  $pb/2V$  show similar relations. From these curves it is seen that for a 30-pound stick force the rolling effectiveness was greatest for the original ailerons, next largest for the revised ailerons II, and smallest for the revised ailerons I.

The aileron control forces for given stick deflections of the revised ailerons (control system assumed rigid) were somewhat larger than those of the original ailerons, due principally to the relocation of the aileron hinge line and the resulting longer moment arm from the hinge line to the resultant pressure on the aileron surfaces. This moment arm was shorter for revised ailerons II than for revised ailerons I, and the corresponding control forces were thus less.

Computations of the effectiveness for given stick positions (rigid control system) at various airspeeds indicated that the values for the three systems were of the same order, and no consistent differences were noted.

The results of a limited number of tests in the rated-power flaps-down condition are presented in figure 20. Irregular variations with control deflection of aileron control force and maximum  $pb/2V$  are shown, and it is difficult to draw comparisons. It appears, as was the case with flaps up, that the original aileron system was more satisfactory than the revised ailerons and that the rolling characteristics of revised ailerons II were superior to those of revised ailerons I.

It is noted that the values of both effectiveness and control force were low in the small-deflection range. This "flat" portion near neutral is presumably due to wing boundary-layer effects.

Lag characteristics.— Time histories of typical rudder-fixed aileron rolls, as shown in figure 21, indicate that with flaps either up or down the delay in rolling motion following a stick movement was satisfactorily small for all three aileron systems, indicating that the chordwise location of the ailerons was sufficiently rearward (reference 3).

Aileron control in stalls.— Curves are presented in figure 22 which show that adequate control near the stall was possible with revised ailerons II and undoubtedly would have been possible with revised ailerons I. Pilots' impressions of the aileron effectiveness near the stalls were favorable.



Proposed improved design.- The development of a satisfactory circular-arc aileron for the test airplane would require at least the relocation of the hinge line at a point close to the rear spar and the upper surface of the wing to permit the extension of sufficient aileron surface for the development of adequate rolling moments. A possible arrangement of surfaces in which the center of curvature is coincident with the hinge line is shown in figure 23. This design would have less friction than did the original ailerons. On the basis of the wind-tunnel and flight-test investigations reported in references 4, 5, and 6, zero aileron hinge moments would be expected from the curved surface. Therefore, an upper plate is incorporated to provide sufficient control force for "feel" and self-centering characteristics. It is believed that this type of design would produce rolling characteristics satisfying the minimum requirement of a  $pb/2V$  of 0.07 with a 30-pound control force at airspeeds up to 0.8 maximum level-flight speed (reference 2). It is possible, however, that the variation of control force with aileron angle would not be linear and the rolling moments at small deflections might be low. Means would have to be found for eliminating these undesirable effects before the control could be regarded as entirely satisfactory.

### CONCLUSIONS

The following conclusions can be drawn from the flight tests results presented herein for the test airplane equipped with simple circular-arc-type ailerons of two different designs:

1. The rolling effectiveness of both sets of revised (simple circular arc) ailerons was of the same order as that of the original plug-type circular-arc ailerons.
2. The aileron control forces with the revised ailerons were considerably greater than those with the original surfaces and, as anticipated, the forces with the revised ailerons were a function of the distance from the aileron center of curvature to the hinge line.
3. The lateral-control lag characteristics exhibited by the airplane while equipped with the revised ailerons were not objectionable.
4. The revised ailerons were capable of controlling the rolling tendencies of the airplane near the stall.
5. The use of aileron actuating torque tubes along the entire wing span appears to be impracticable because of the excessive size required to provide adequate stiffness.

6. It is probable that the best design of a circular-arc-type aileron system which would provide sufficient rolling effectiveness without requiring excessive control forces should have the center of curvature coincident with the hinge line, and should have the hinge line located near or above the surface of the wing.

Ames Aeronautical Laboratory,  
National Advisory Committee for Aeronautics,  
Moffett Field, Calif., September 22, 1944.

#### REFERENCES

1. Spahr, J. Richard, and Christopherson, Don R.: Measurements in Flight of the Stability, Lateral-Control, and Stalling Characteristics of an Airplane Equipped With Full-Span Zap Flaps and Spoiler-Type Ailerons. NACA RIR, Dec. 1943.
2. Anon.: Specification for Stability and Control Characteristics of Airplanes. Spec. No. SR-119, Bur. Aero., Oct. 1, 1942.
3. Wenzinger, Carl J., and Rogallo, Francis M.: Wind-Tunnel Investigation of Spoiler, Deflector, and Slot Lateral-Control Devices on Wings with Full-Span Split and Slotted Flaps. NACA Rep. No. 706, 1941.
4. Wenzinger, Carl J., and Bamber, Hillard J.: Wind-Tunnel Tests of Three Lateral-Control Devices in Combination with a Full-Span Slotted Flap on an NACA 23012 Airfoil. NACA TN No. 659, 1938.
5. Wetmore, J. W.: Flight Tests of Retractable Ailerons on a Highly Tapered Wing. NACA TN No. 714, 1939.
6. Soule, H. A. and McAvoy, W. H.: Flight Investigation of Lateral Control Devices for Use with Full-Span Flaps. NACA Rep. No. 517, 1935.

NATIONAL ADVISORY  
COMMITTEE FOR AERONAUTICS

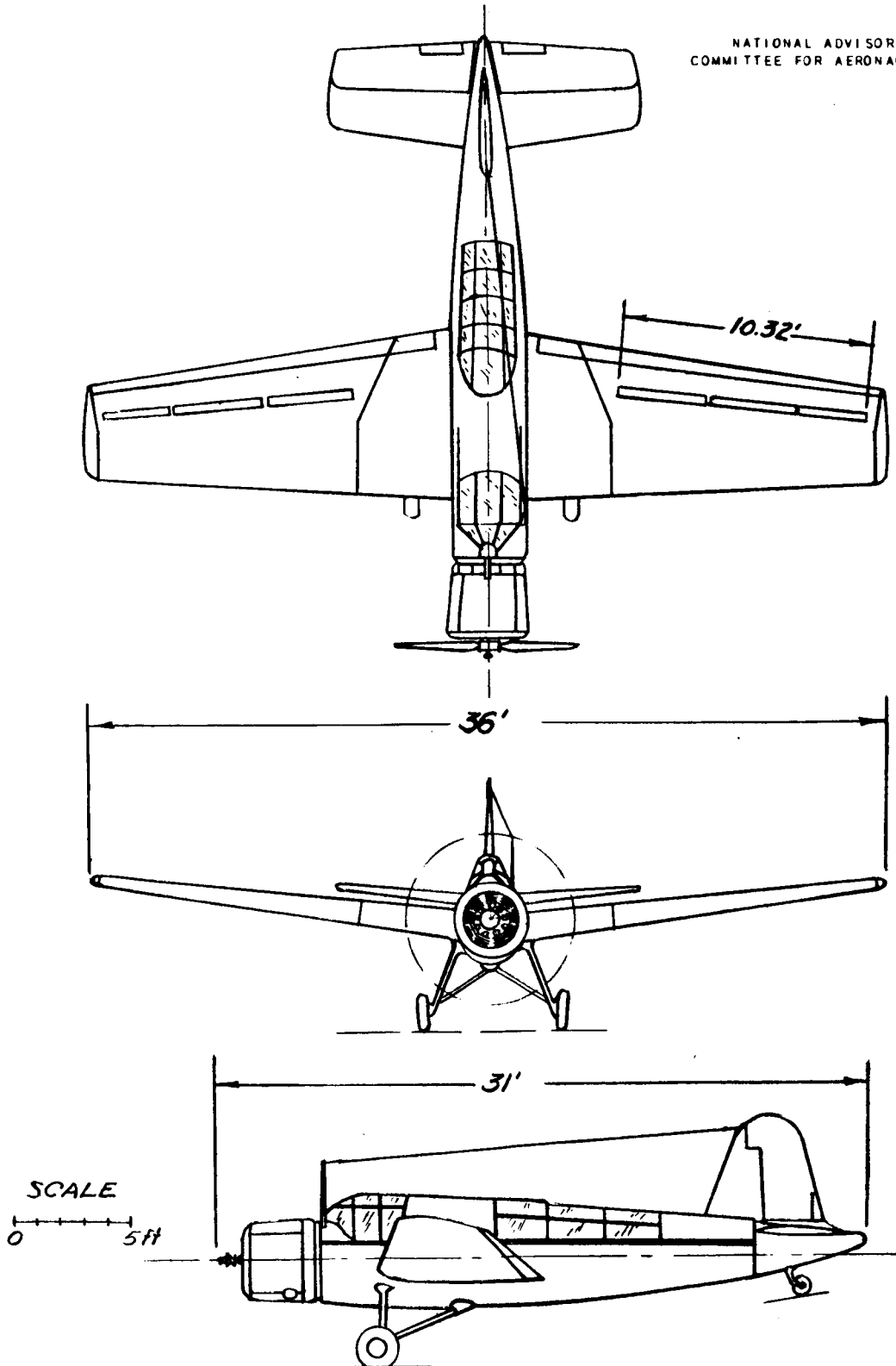

FIGURE 1.— THREE-VIEW DRAWING OF THE  
TEST AIRPLANE.



Figure 2.- Front view of the test airplane  
as instrumented for flight tests.

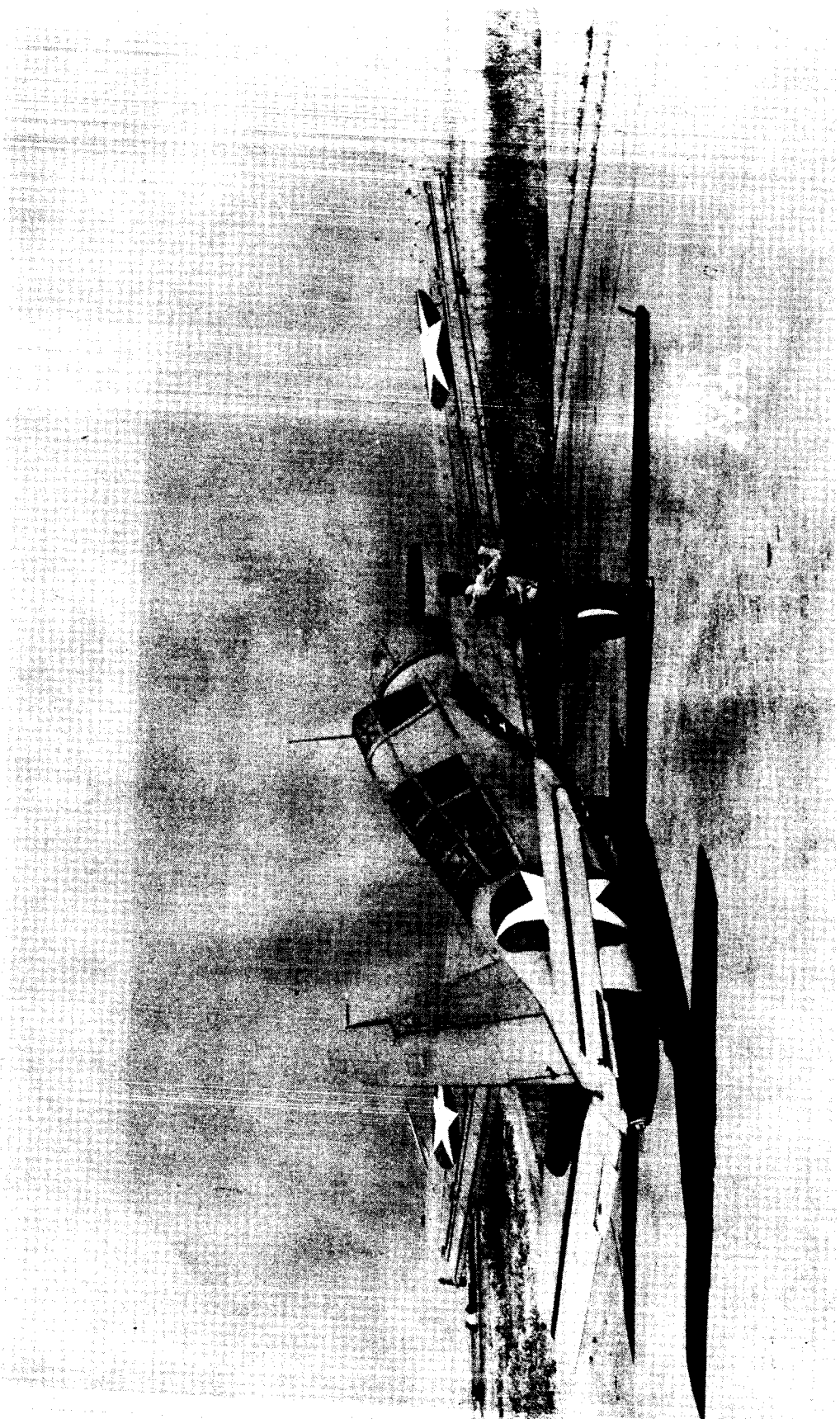

Figure 3.- Rear view of the test airplane  
with original Zap ailerons.

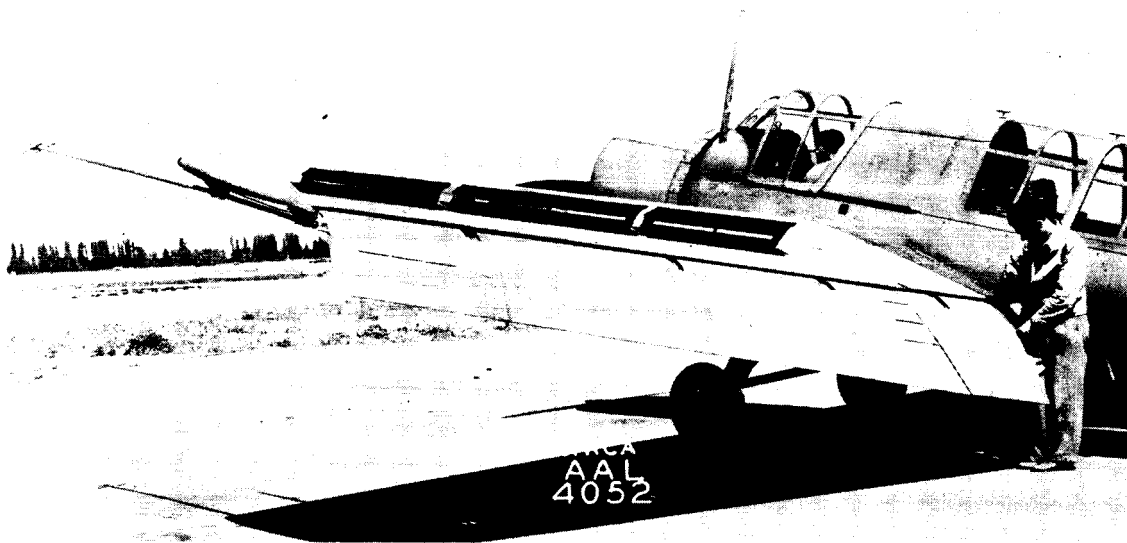

Figure 4.- Left wing with flaps and ailerons fully extended.

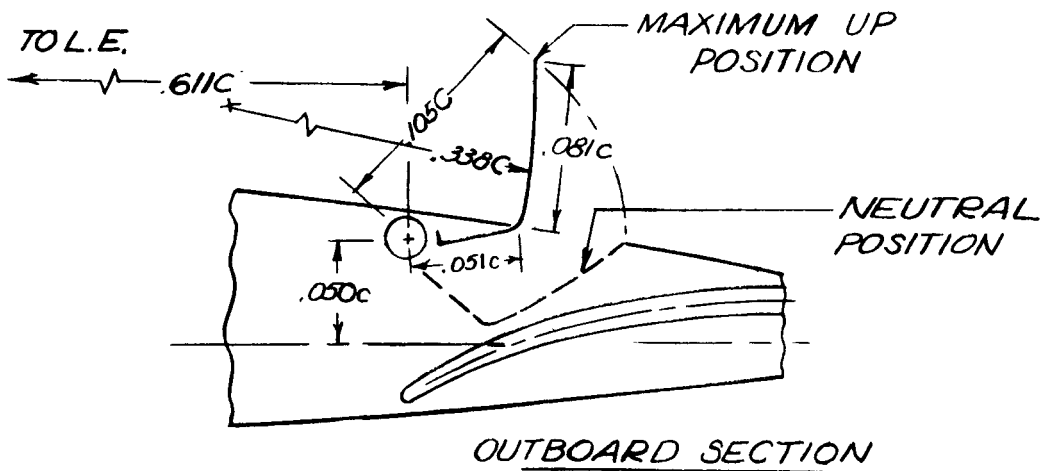
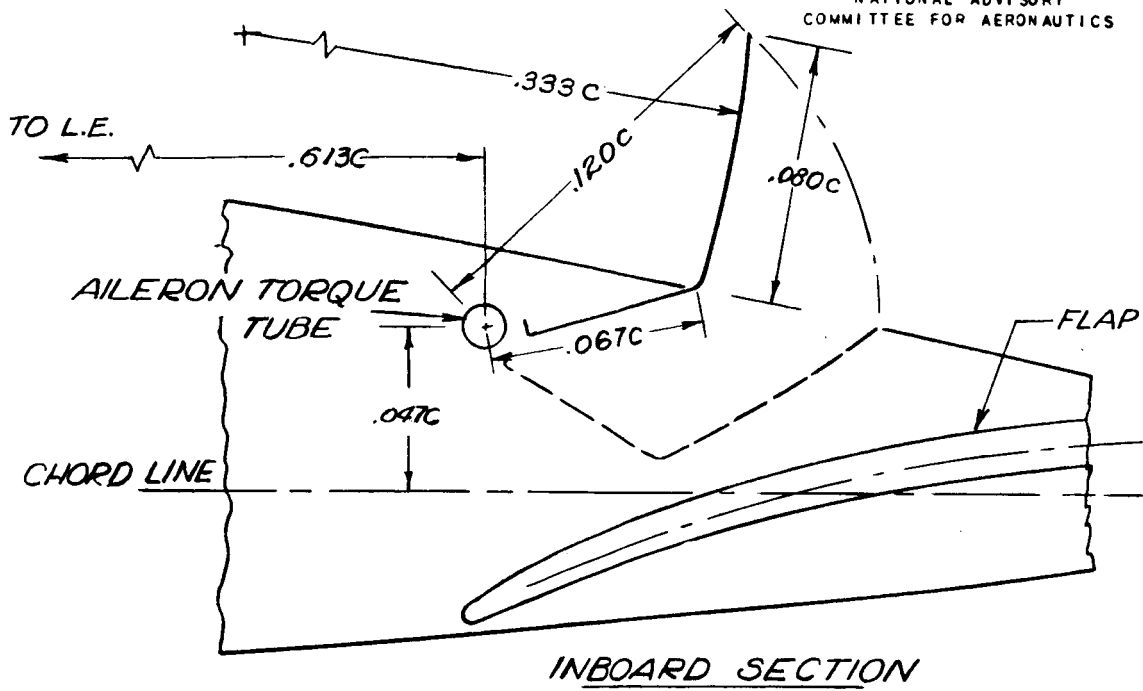
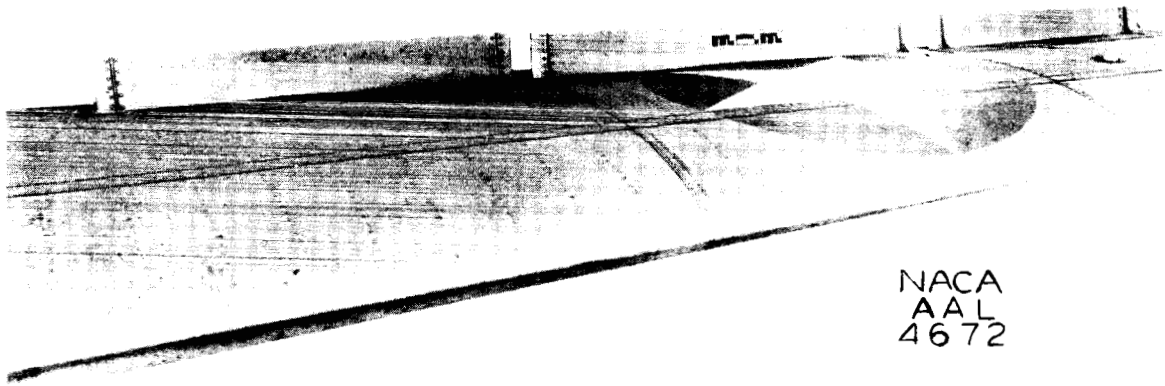
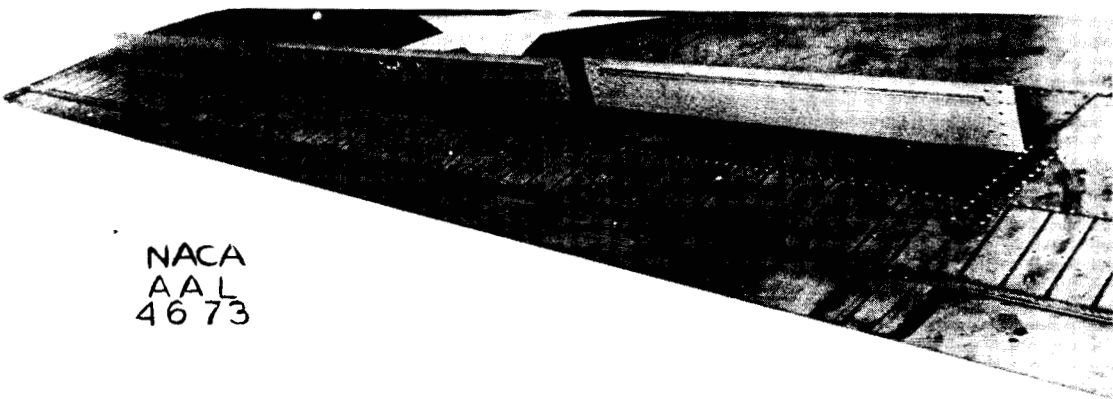

FIGURE 5.—DETAILS OF REVISED AILERONS I.



(a) Front view



(b) Rear view

Figure 6.- Left wing with revised ailerons I fully deflected.



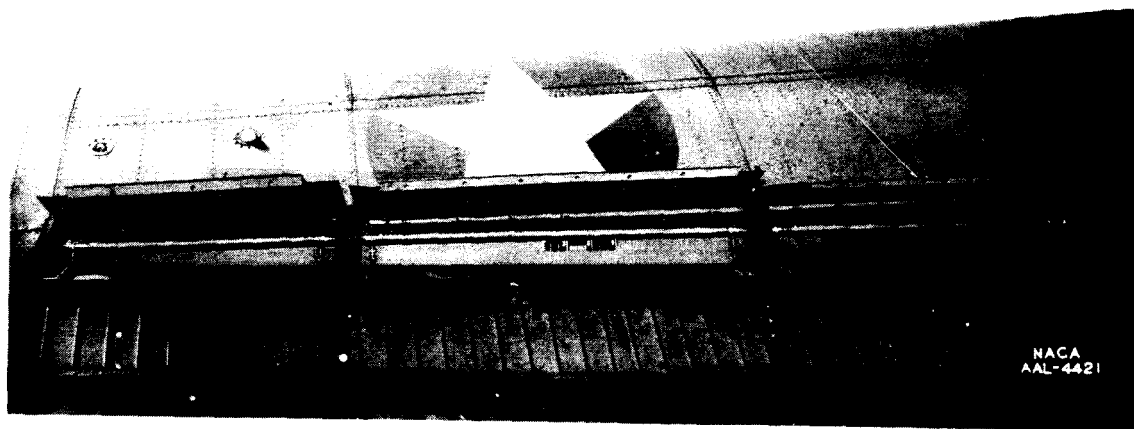
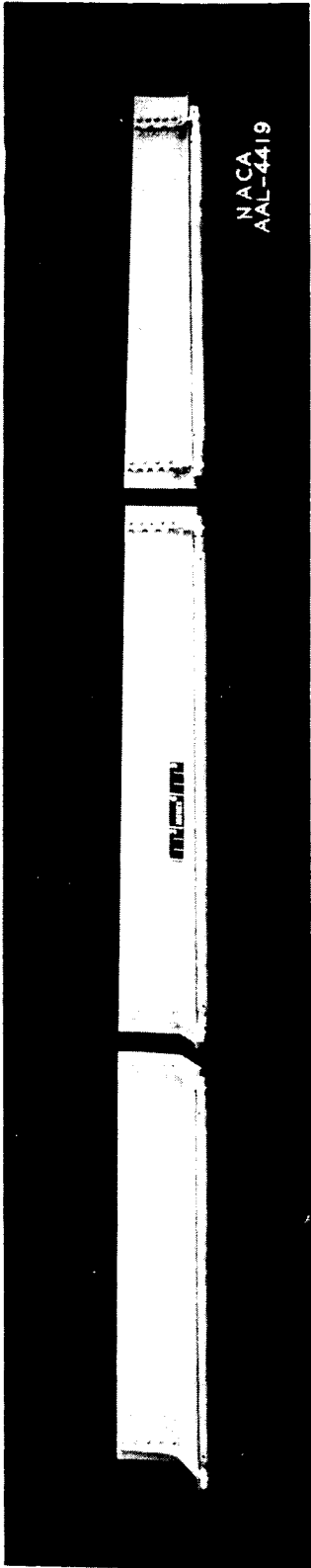
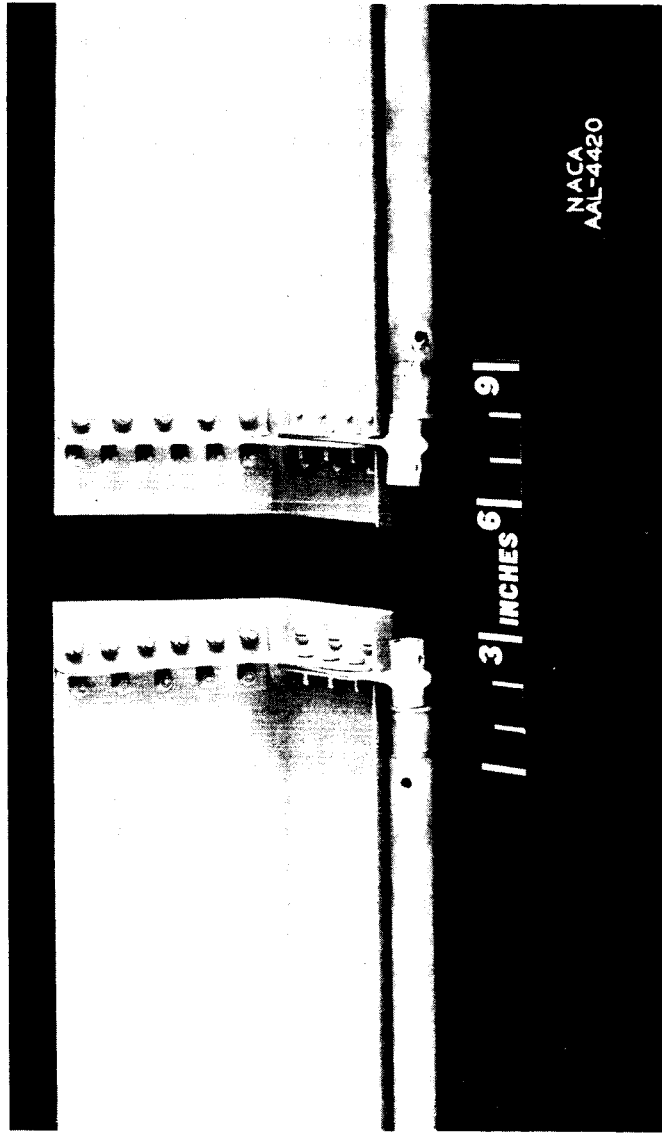

Figure 7.- Top view of left wing with revised ailerons I in neutral position with cover plates open.



(a) Three aileron panels removed from wing



(b) Typical attachments

Figure 8.- Details of revised ailerons, I.

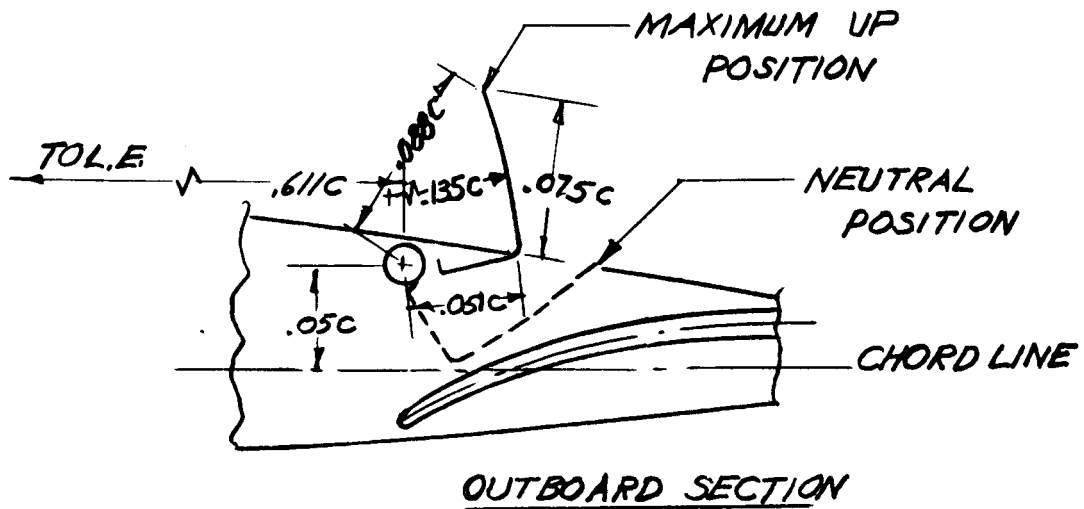
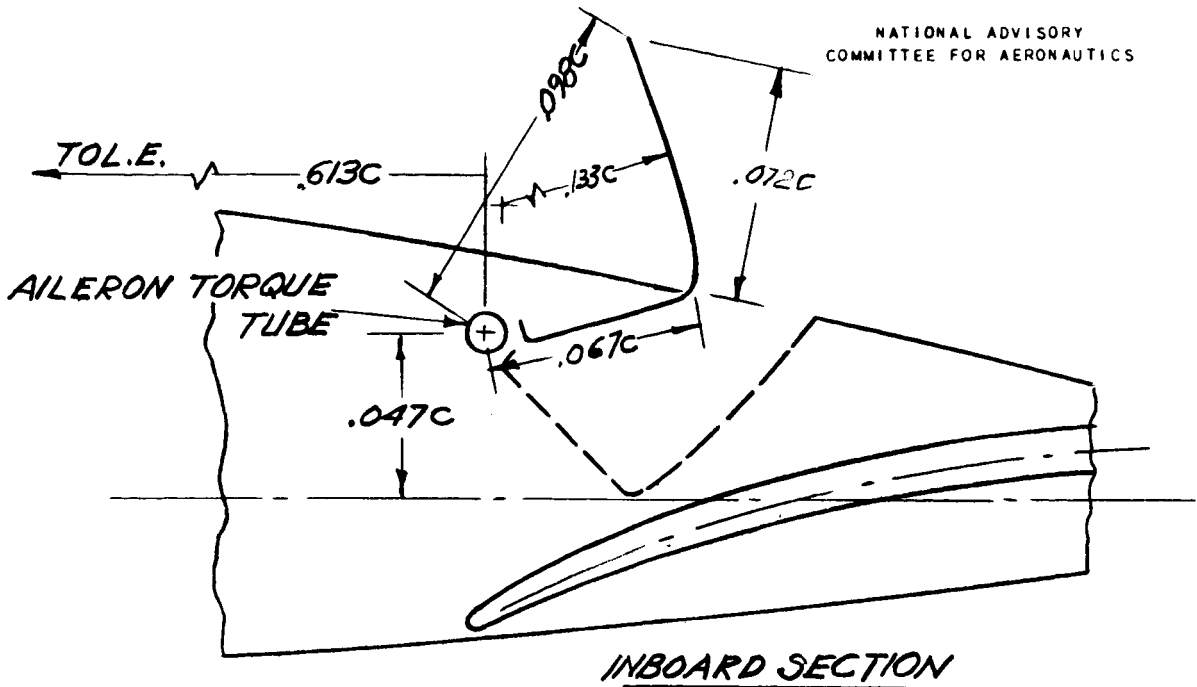
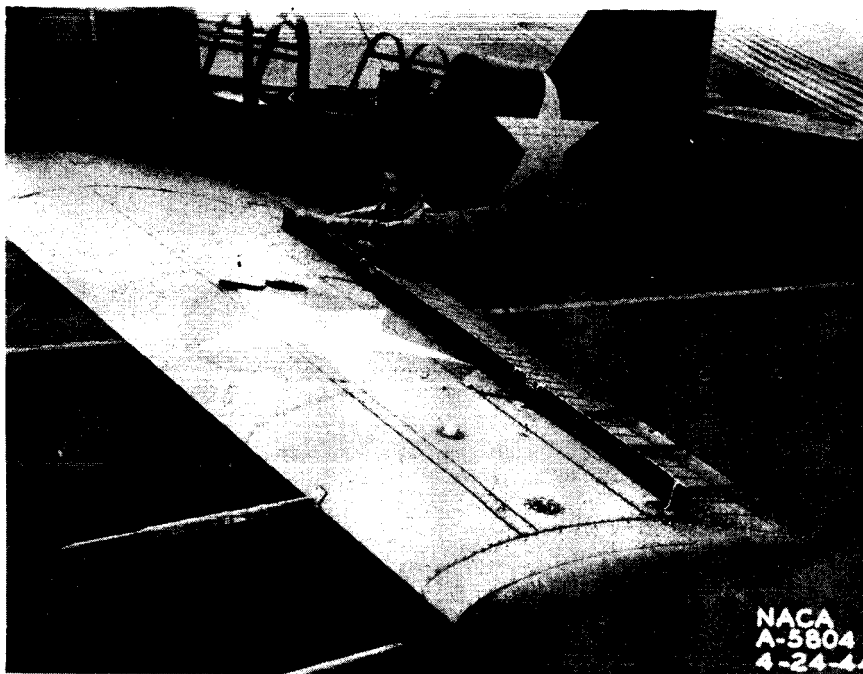

FIGURE 9.- DETAILS OF REVISED AILERONS II



(a) Front view



(b) Rear view

Figure 10.- Left wing with revised ailerons II fully deflected.



Figure 11.- Top view of left wing with revised ailerons II in neutral position with cover plates open.

NATIONAL ADVISORY  
COMMITTEE FOR AERONAUTICS

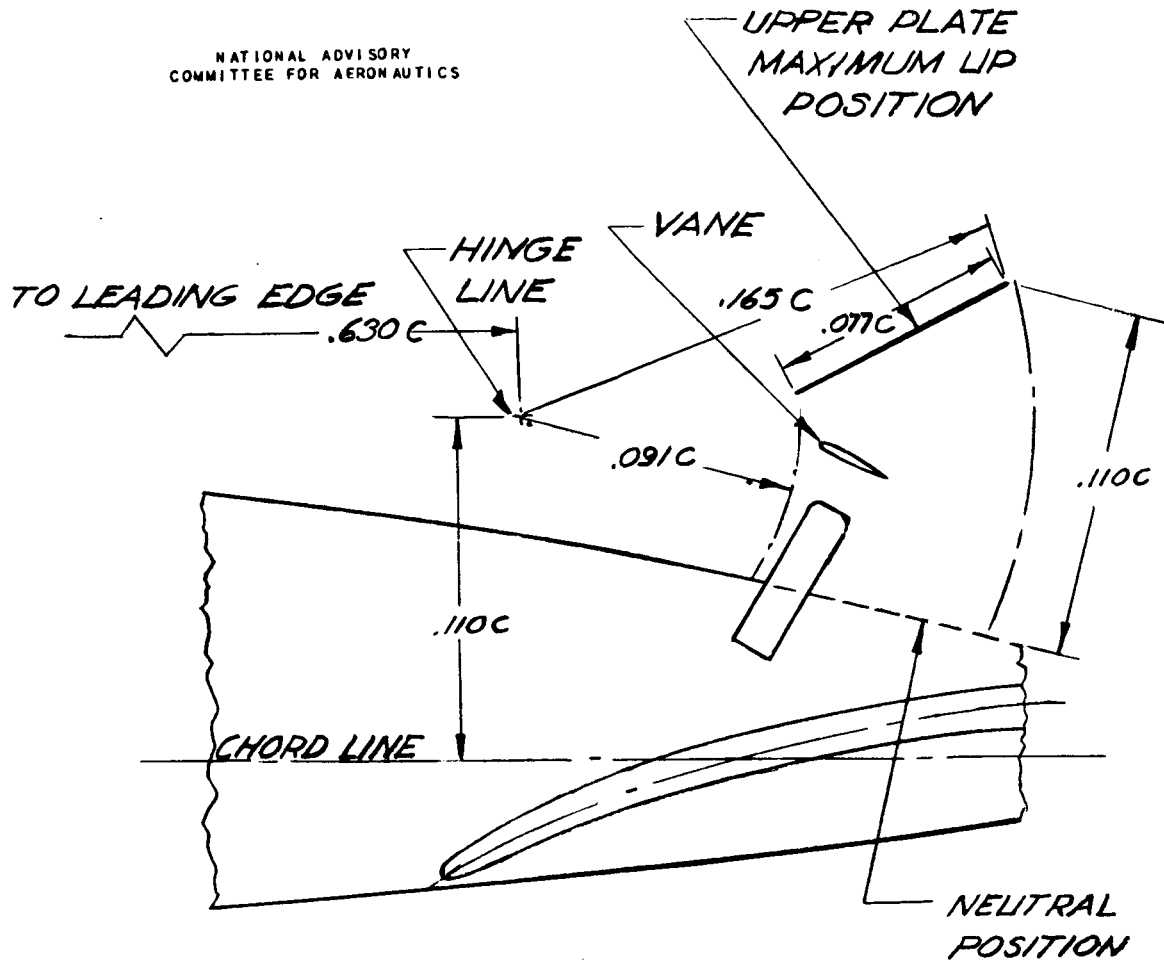
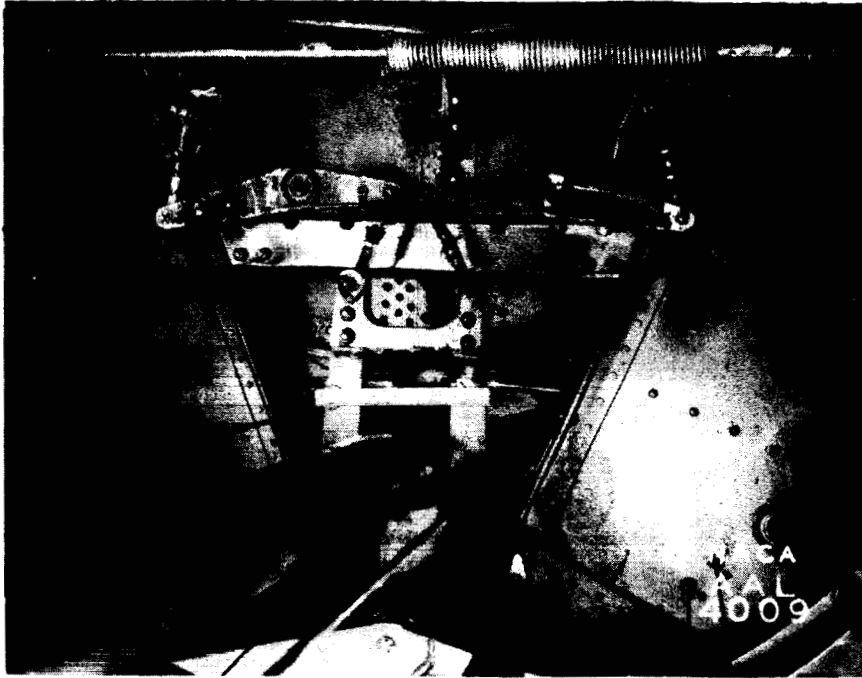
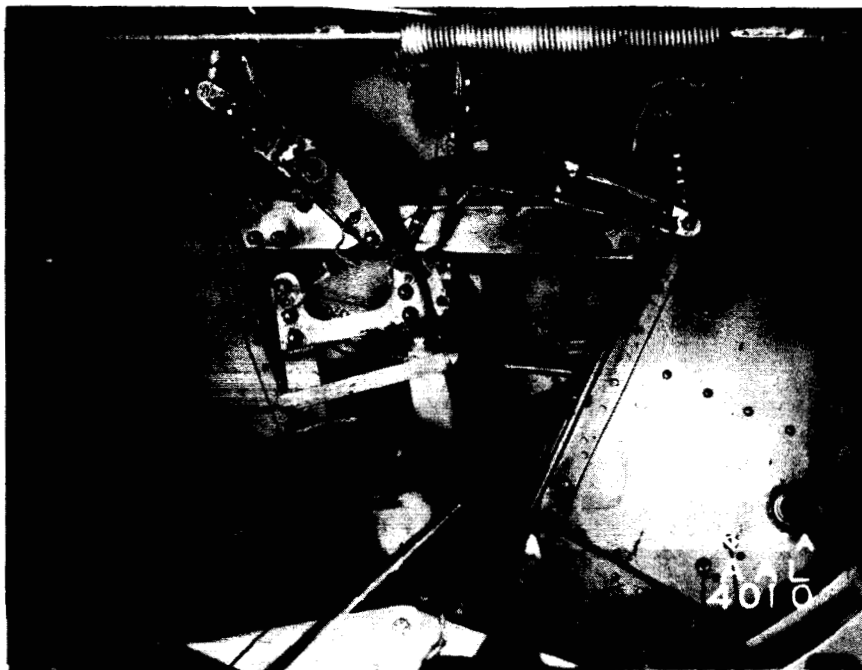

FIGURE 12.—DETAILS OF ORIGINAL ZAP AILERONS



(a) Control stick neutral.



(b) Control stick full left.

Figure 13. - Original differential linkage in fuselage.

TOP OF STICK GRIP 35 IN  
FROM HINGE POINT

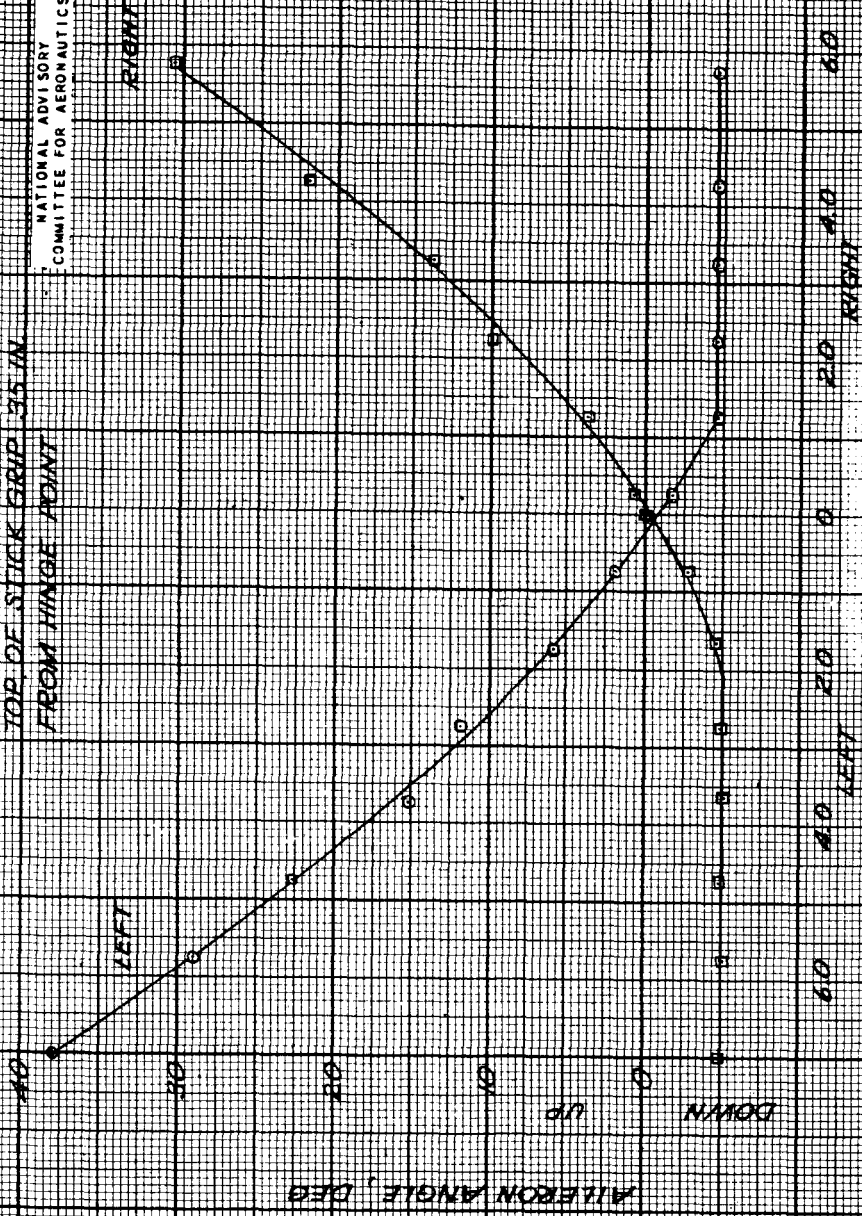
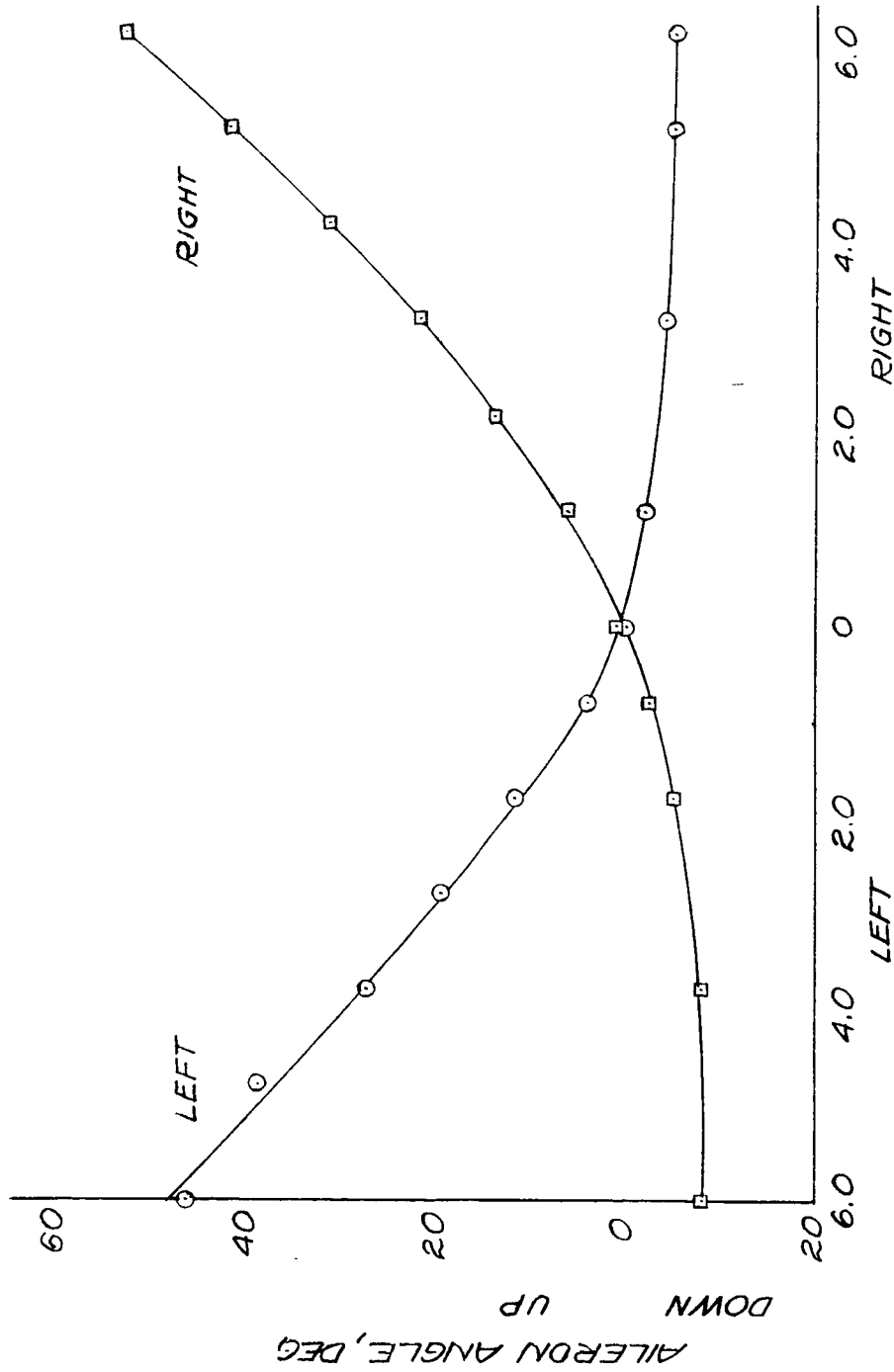

FIGURE 1A - VARIATION OF AILERON ANGLE WITH CONTROL STICK POSITION AS MEASURED ON THE GROUND WITH NO LOAD ON THE SURFACES.

STICK POSITION FROM NEUTRAL, IN  
(UNREVISED AIRCRAFT)



TOP OF STICK GRIP 35 IN  
FROM HINGE POINT



STICK POSITION FROM NEUTRAL, IN.  
(b) REVISED AILERONS II  
FIGURE 14. - CONTINUED.

TOP OF STICK GRIP 35 IN.  
FROM HINGE POINT

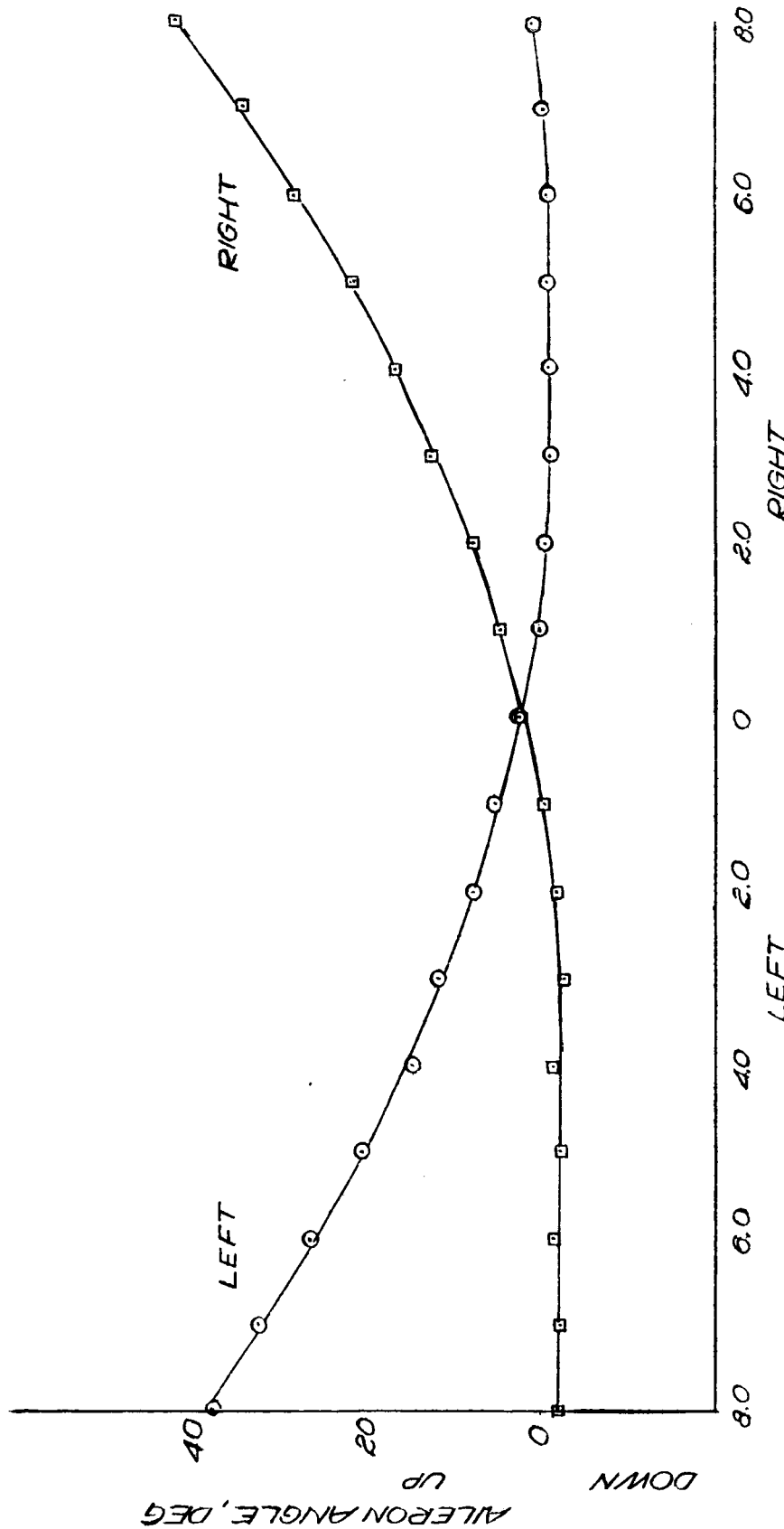

(C) ORIGINAL ZAP AILERONS  
STICK POSITION FROM NEUTRAL, IN.

FIGURE 14. - CONCLUDED.

A-16

AILERON CONTROL FORCE, LB  
RIGHT  
LEFT

NATIONAL ADVISORY  
COMMITTEE FOR AERONAUTICS

FRICITION 1.5 LB (AVERAGE)

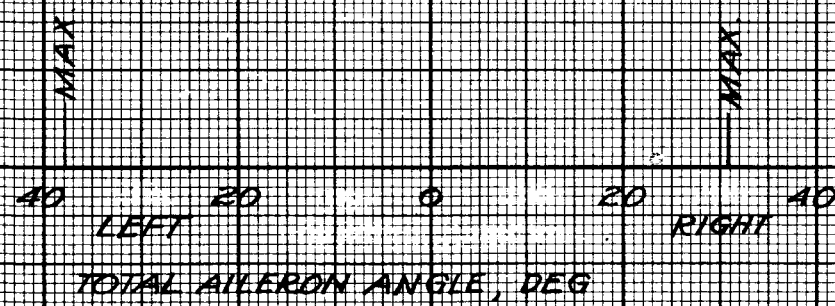

(C) REVISED AILERONS I

FIGURE 15 - STATIC FRICTION IN LATERAL CONTROL SYSTEM

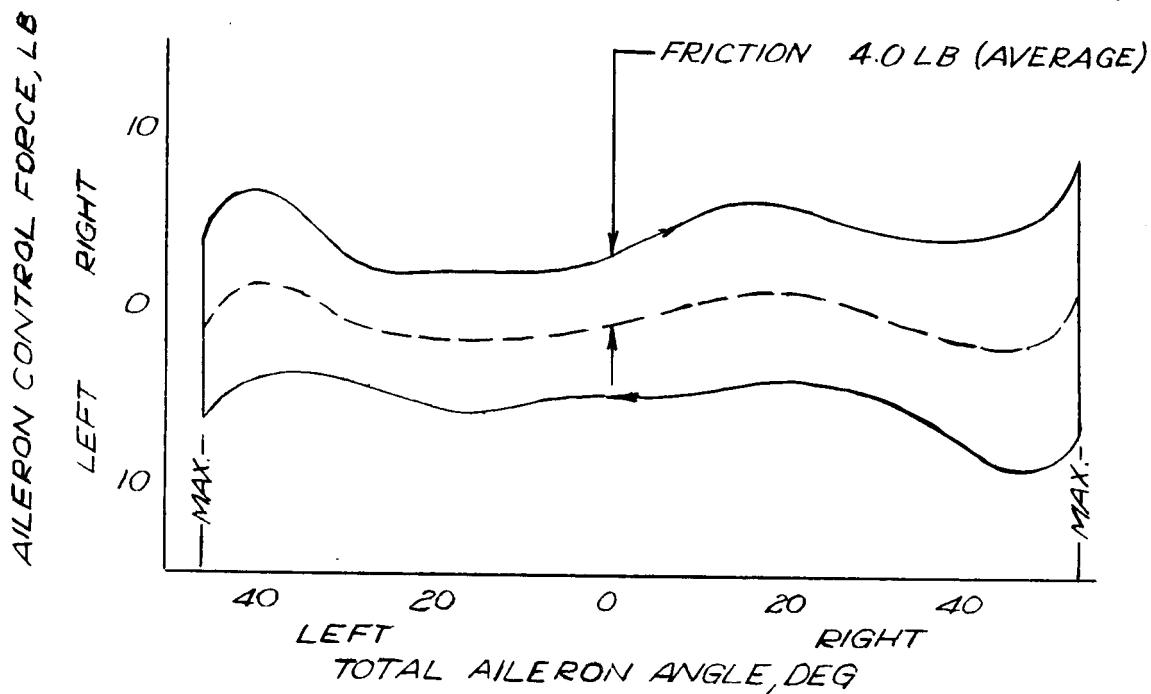

(b) REVISED AILERONS II  
FIGURE 15.— CONTINUED.

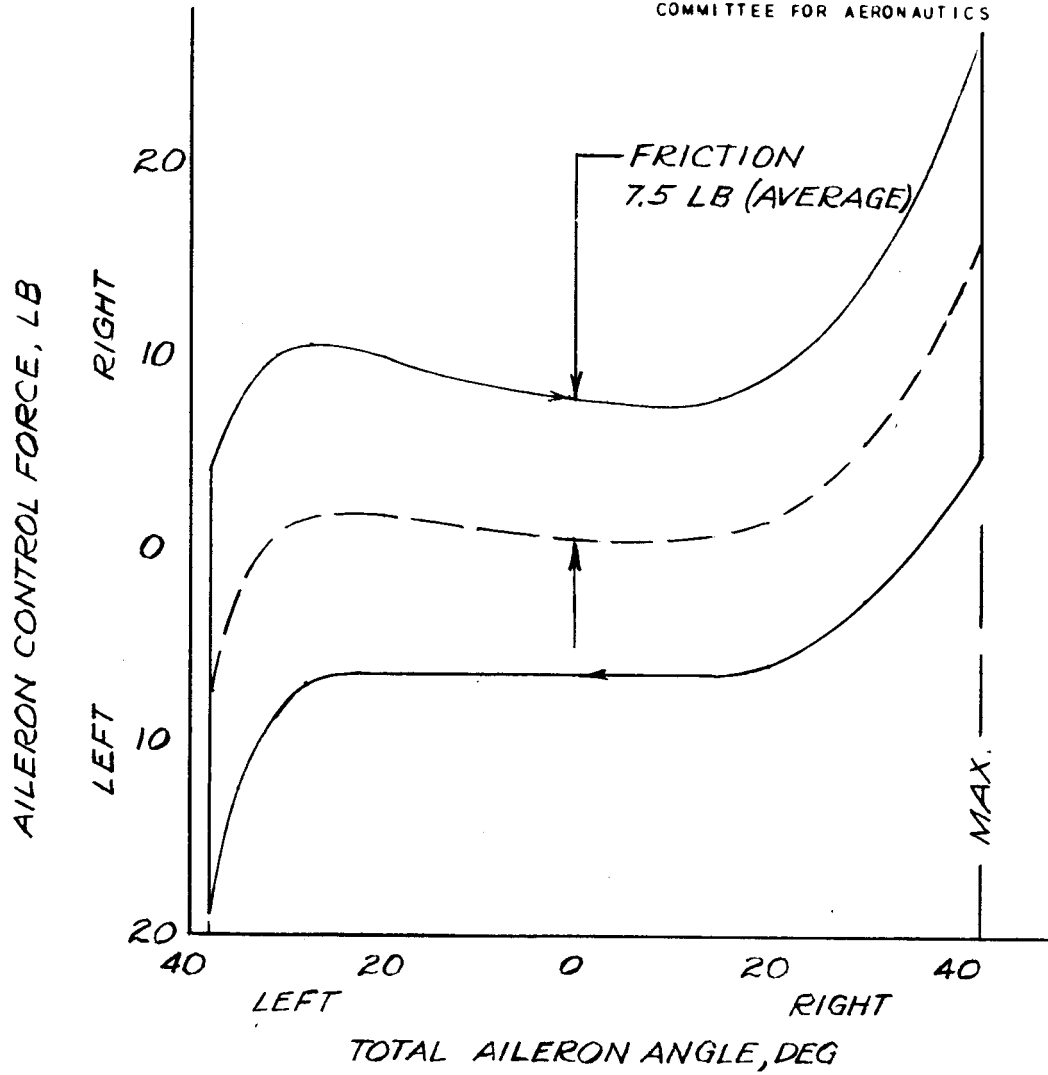

(C) ORIGINAL ZAP AILERONS  
FIGURE 15. - CONCLUDED.

NATIONAL ADVISORY  
COMMITTEE FOR AERONAUTICS

MEASURED ON THE GROUND  
WITH CONTROL STICK AT  
MAXIMUM DEFLECTION

REVISED AILERONS II  
REVISED AILERONS I  
ORIGINAL ZAP  
AILERONS

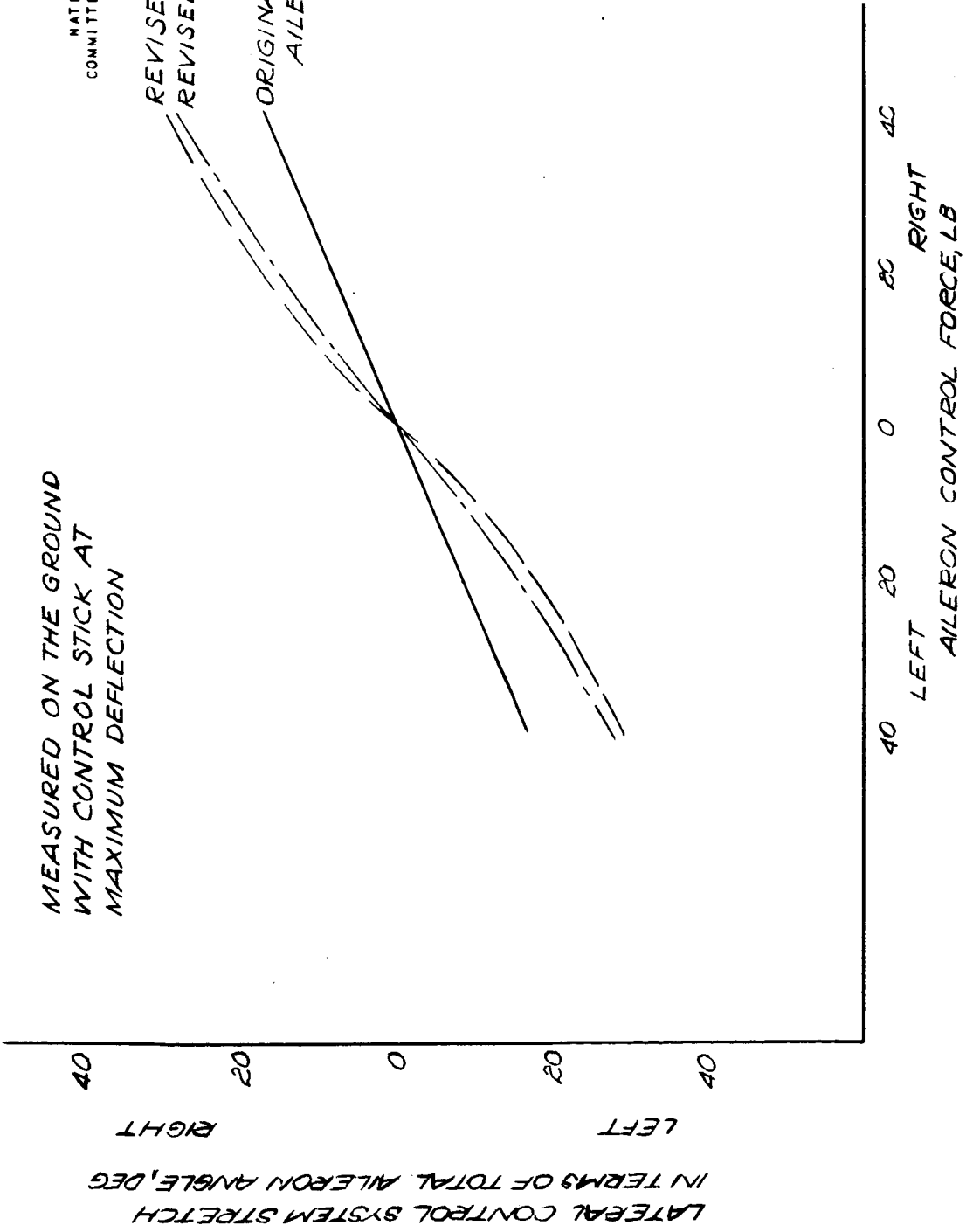

FIGURE 16. - LATERAL-CONTROL-SYSTEM STRETCH CHARACTERISTICS.

NATIONAL ADVISORY  
COMMITTEE FOR AERONAUTICS

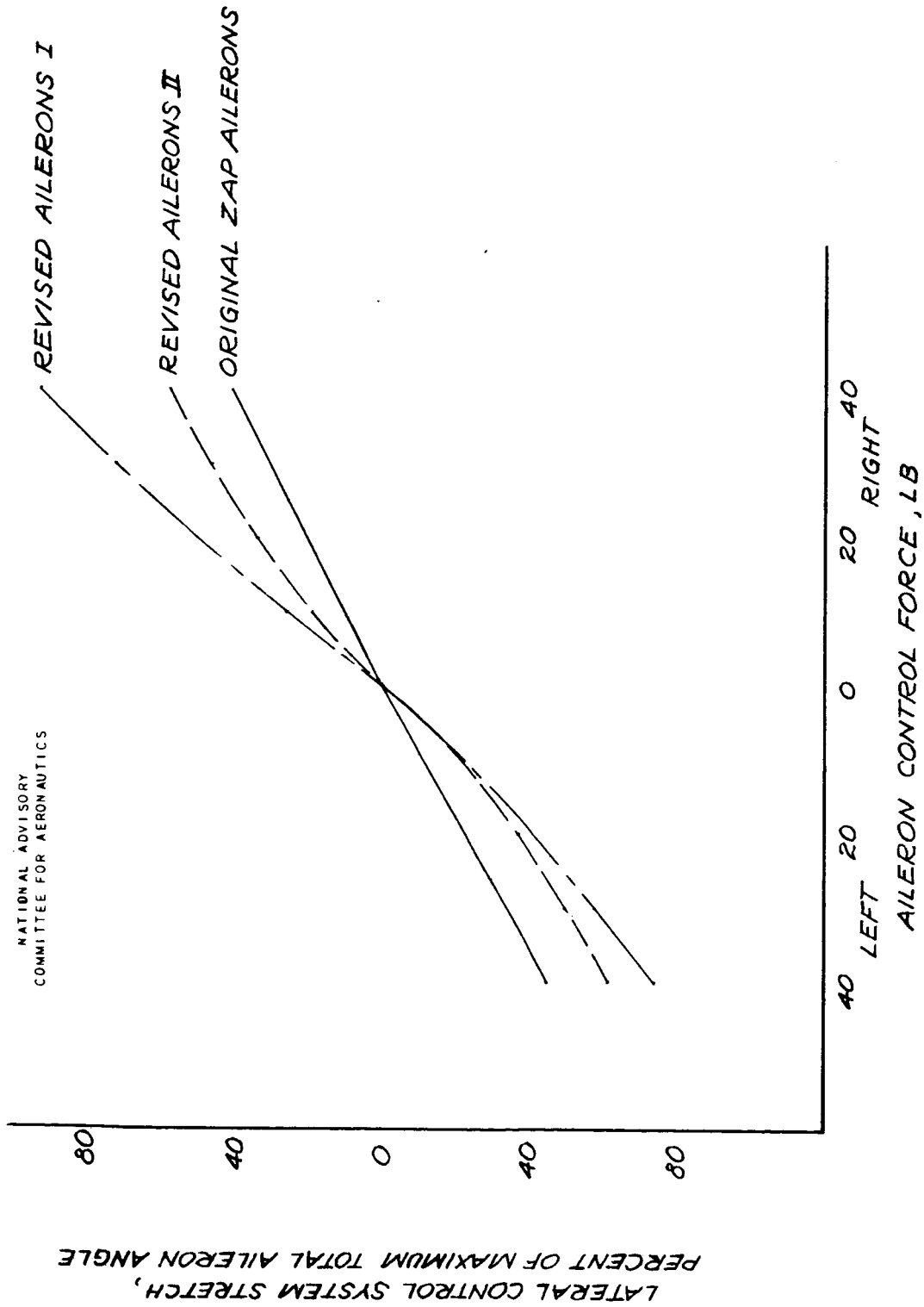
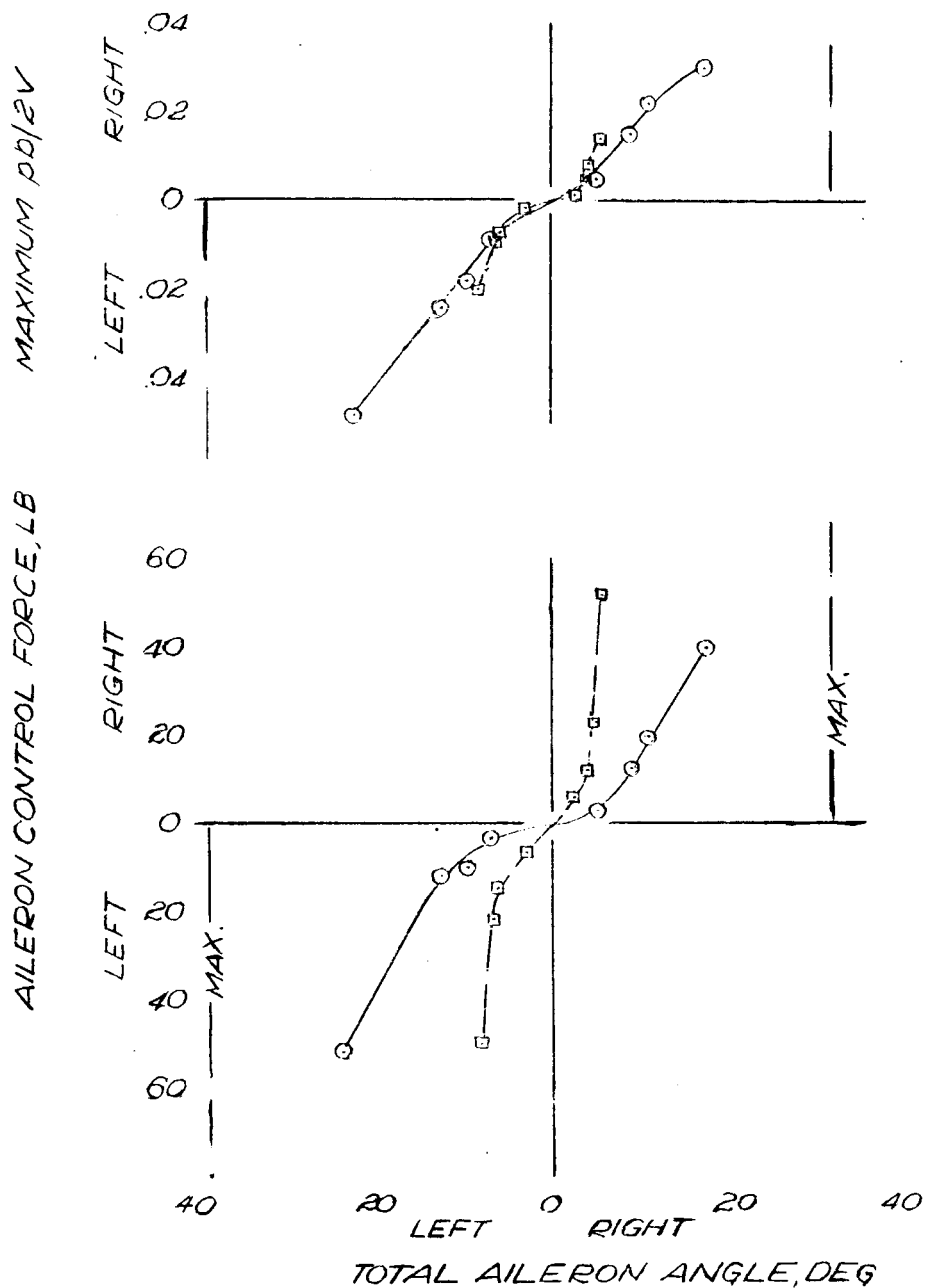

FIGURE 17. - COMPARISON OF STRETCH IN LATERAL-CONTROL SYSTEMS

○ 93

□ 152



TOTAL AILERON ANGLE, DEG

(a) REVISED AILERONS I

FIGURE 18.—AILERON CONTROL CHARACTERISTICS,  
RATED POWER, FLAPS UP.



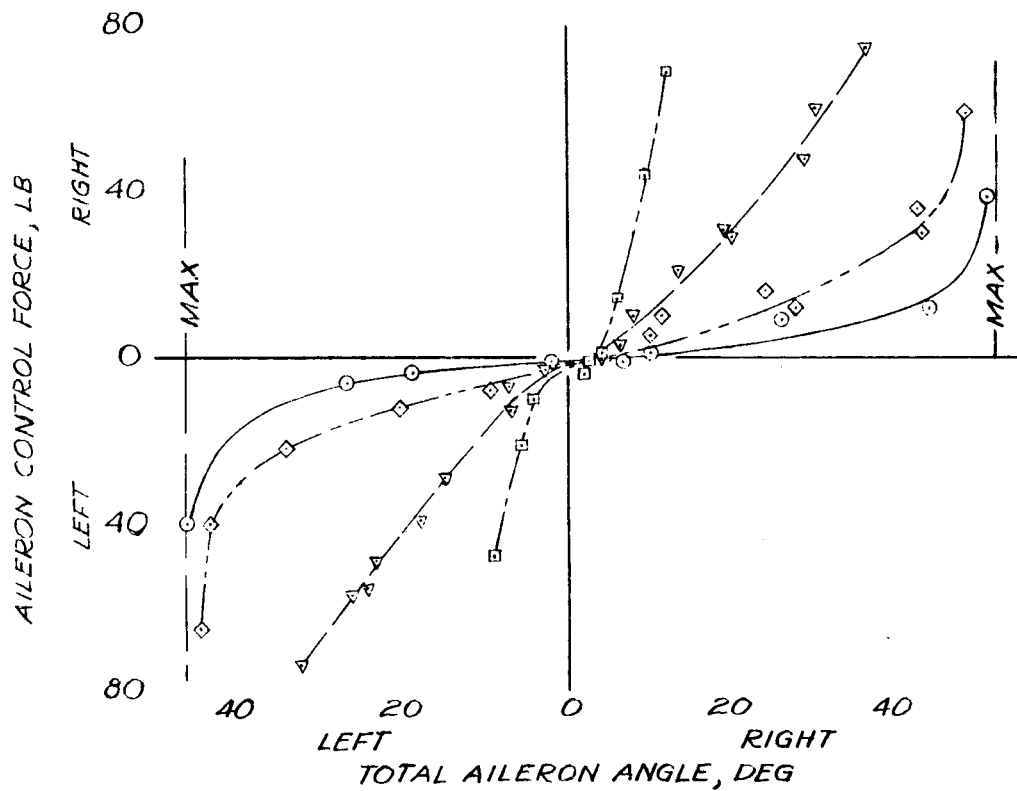
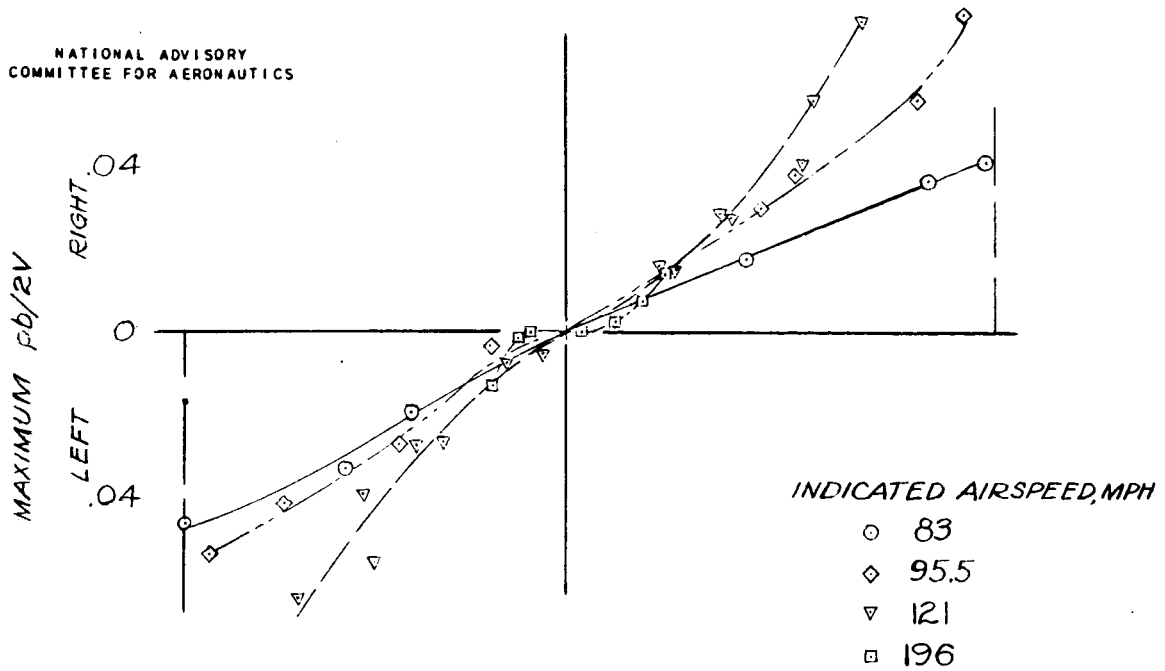

(b) REVISED AILERONS II  
FIGURE 18.—CONTINUED.

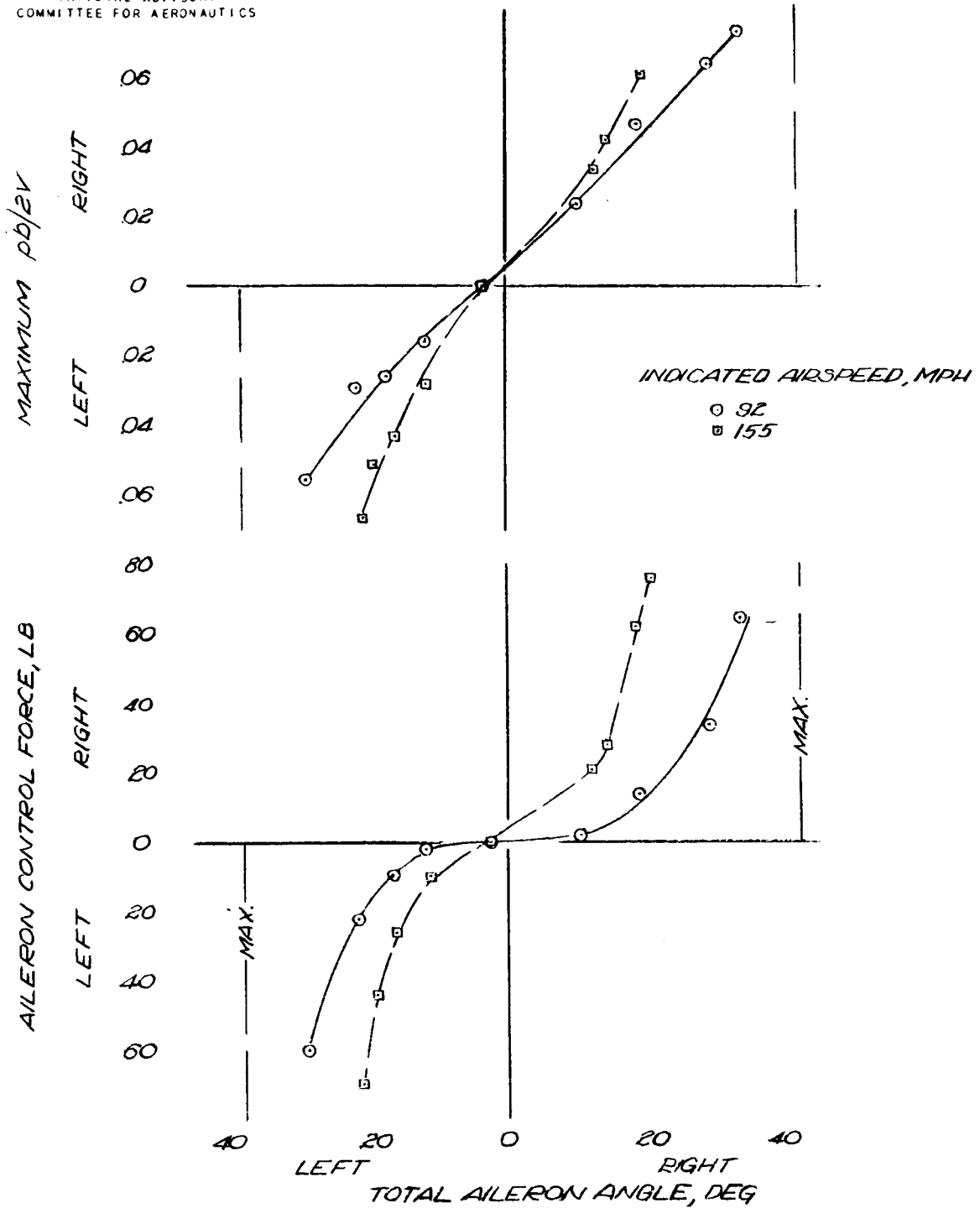

(c) ORIGINAL ZAP AILERONS  
FIGURE 18.- CONCLUDED.

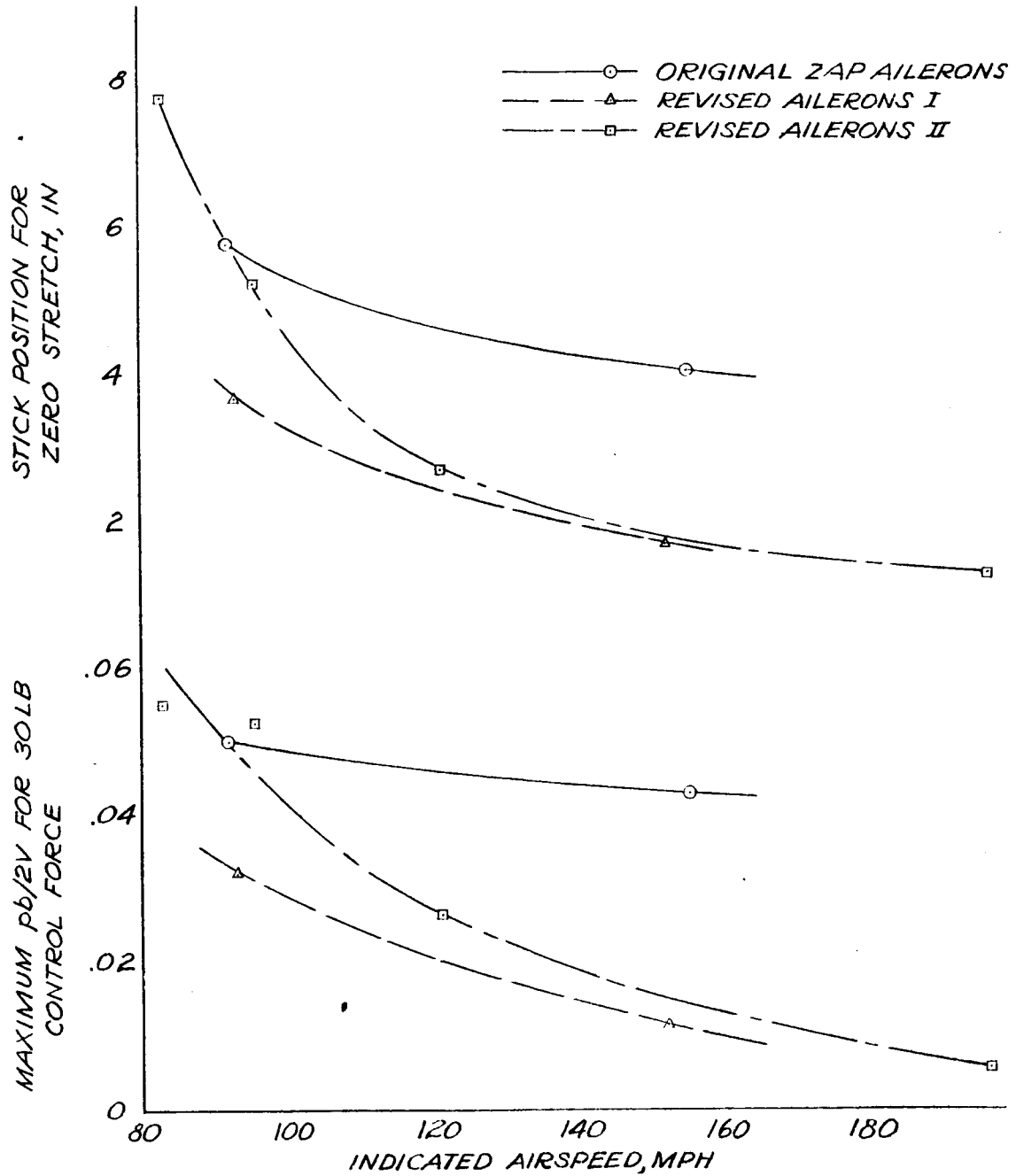
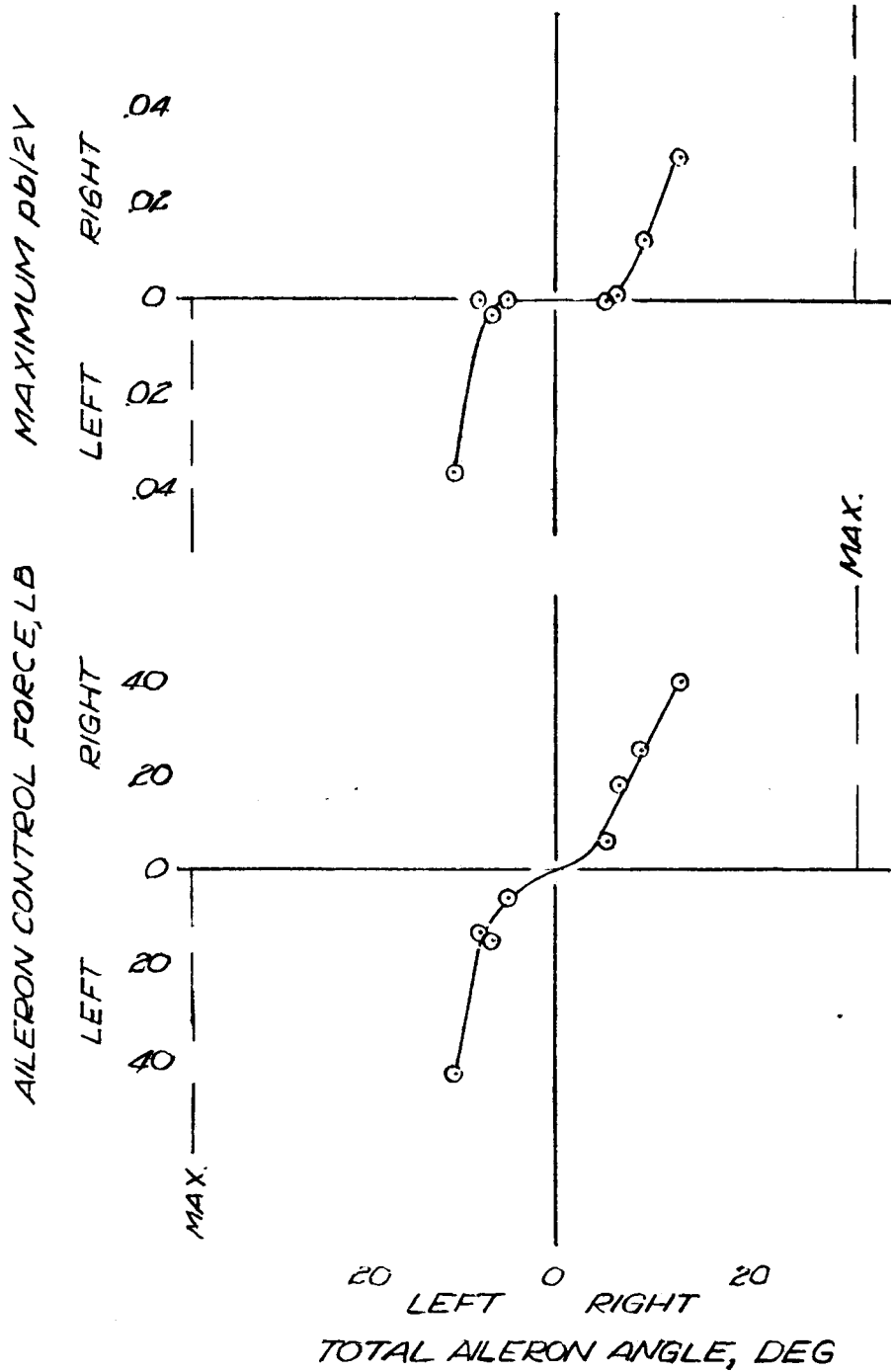

FIGURE 19.—VARIATION WITH INDICATED AIRSPEED OF STICK POSITION FOR ZERO STRETCH AND MAXIMUM  $pb/2v$  FOR 30-POUND CONTROL FORCE, RATED POWER, FLAPS UP.

INDICATED AIRSPEED  
109 MPH



(a) REVISED ALERONS I

FIGURE 20.--AILERON CONTROL CHARACTERISTICS,  
RATED POWER, FLAPS DOWN.

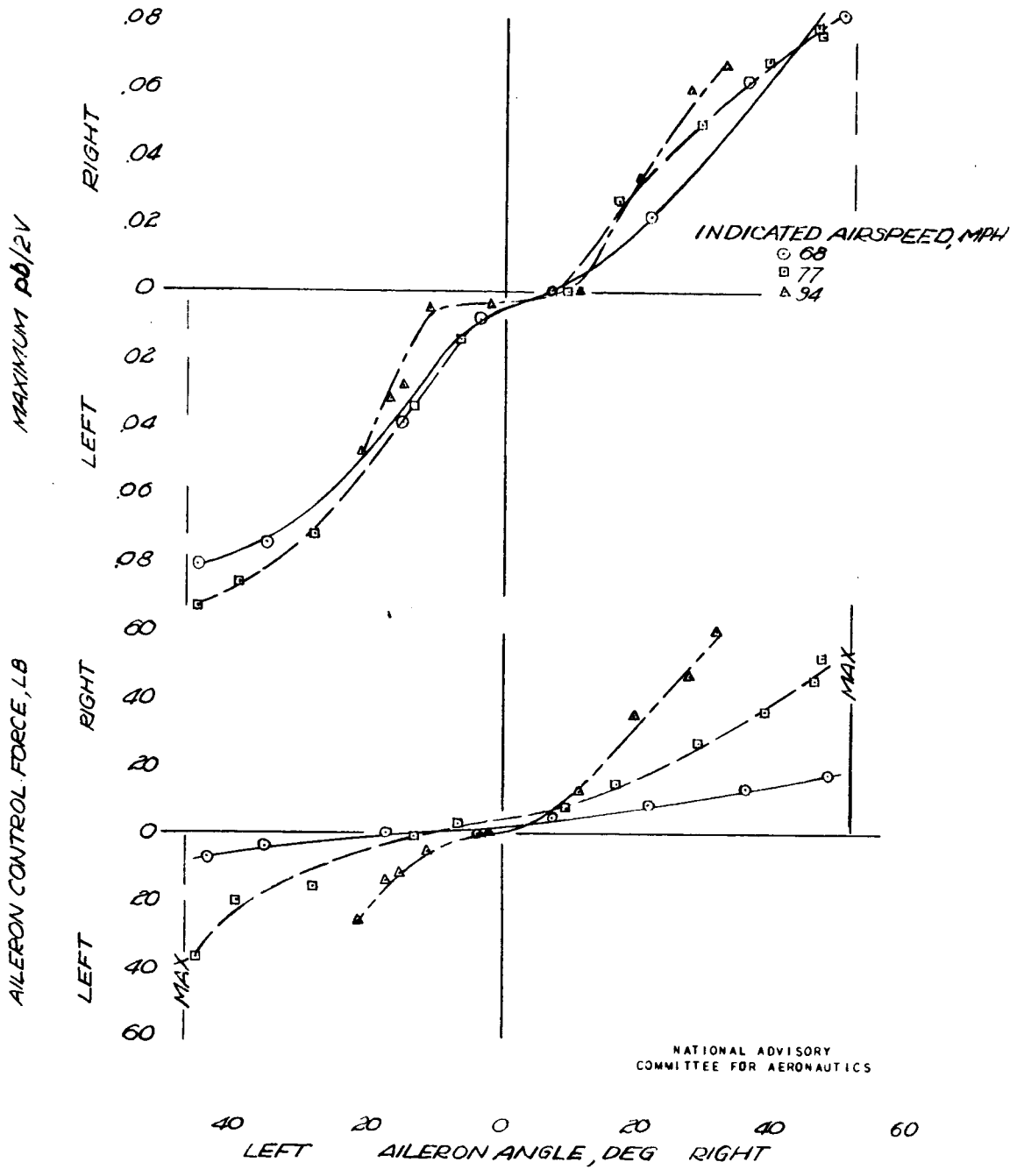

NATIONAL ADVISORY  
COMMITTEE FOR AERONAUTICS

(b) REVISED AILERONS II  
FIGURE 20. — CONTINUED.

MAXIMUM DB/2V

RIGHT  
LEFT

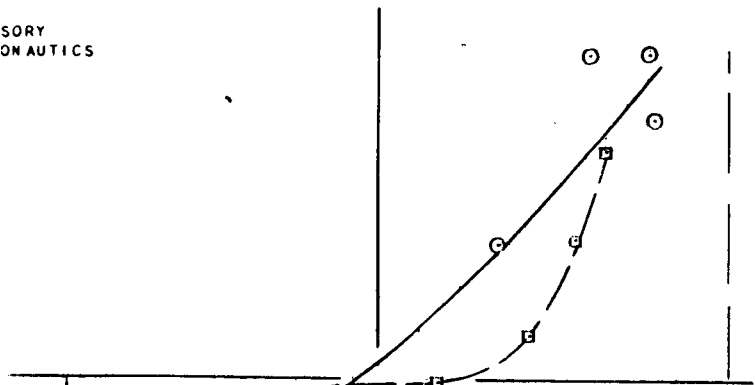

INDICATED AIRSPEED, MPH

○ 92  
□ 122

AILERON CONTROL FORCE, LB

RIGHT  
LEFT

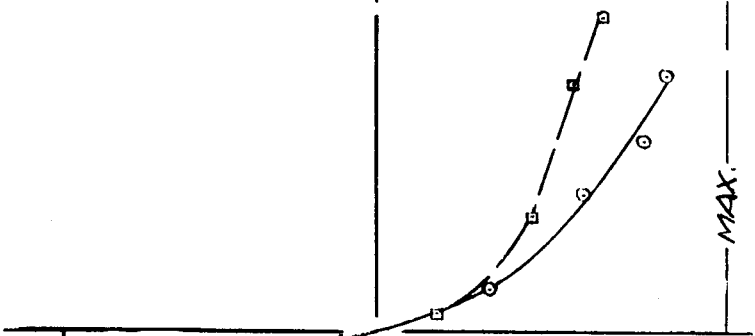

MAX.

MAX.

40 LEFT 20 0 20 RIGHT 40  
TOTAL AILERON ANGLE, DEG

(C) ORIGINAL ZAP AILERONS

FIGURE 20.— CONCLUDED

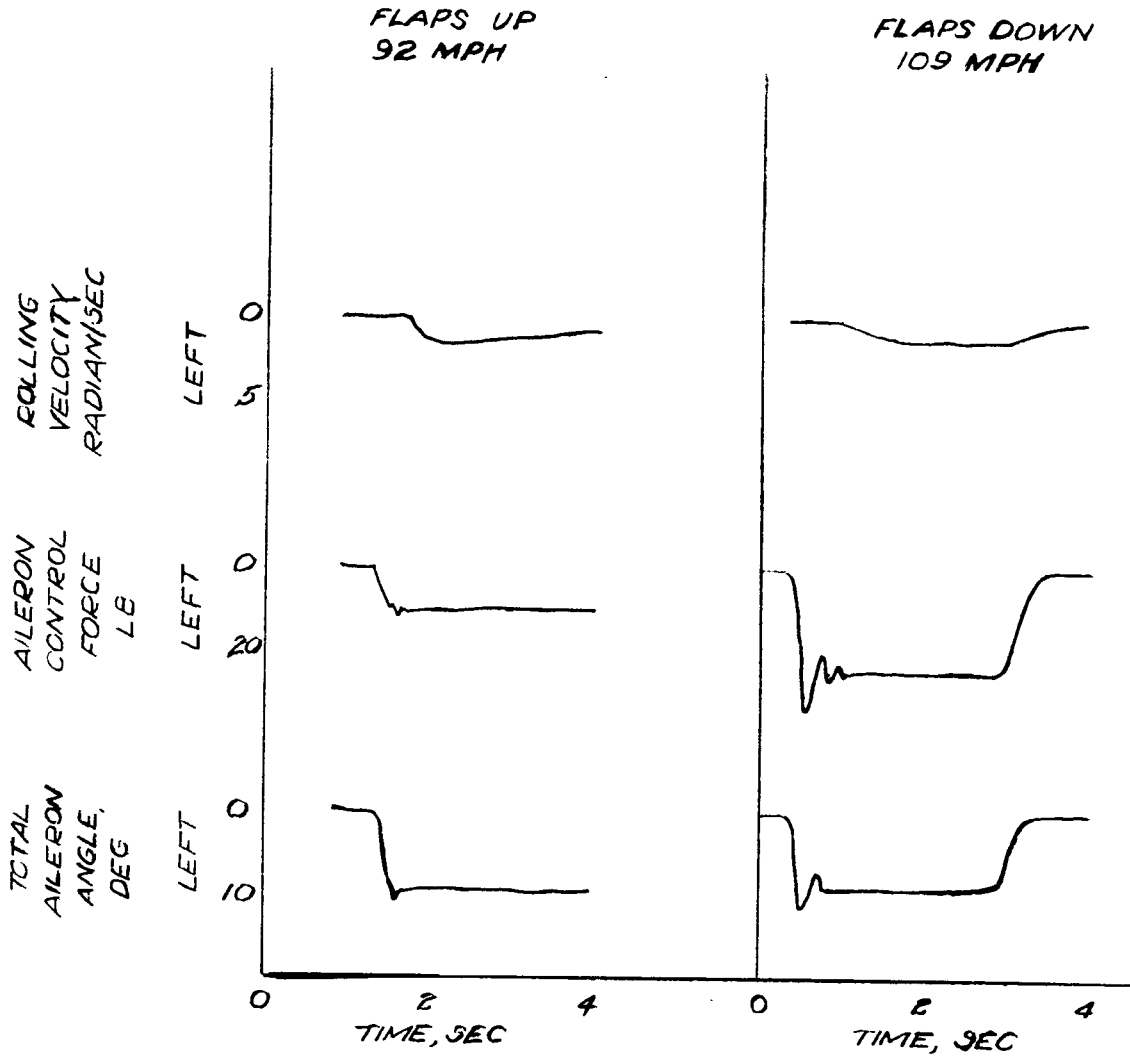

(a) REVISED AILERONS I  
FIGURE 21 - TIME HISTORIES OF AILERON ROLLS,  
RATED POWER.

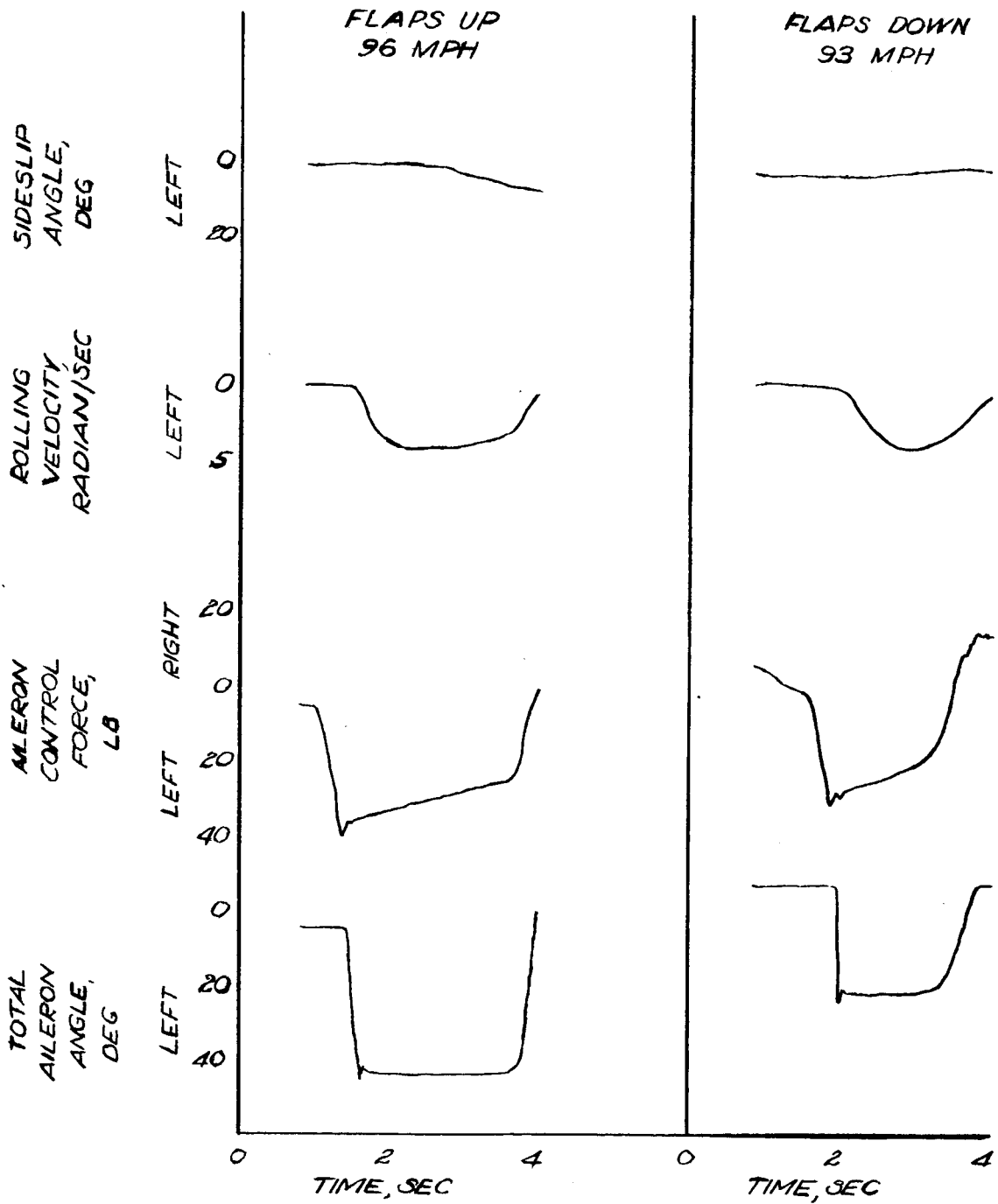

(b) REVISED AILERONS II  
FIGURE 21.— CONTINUED.



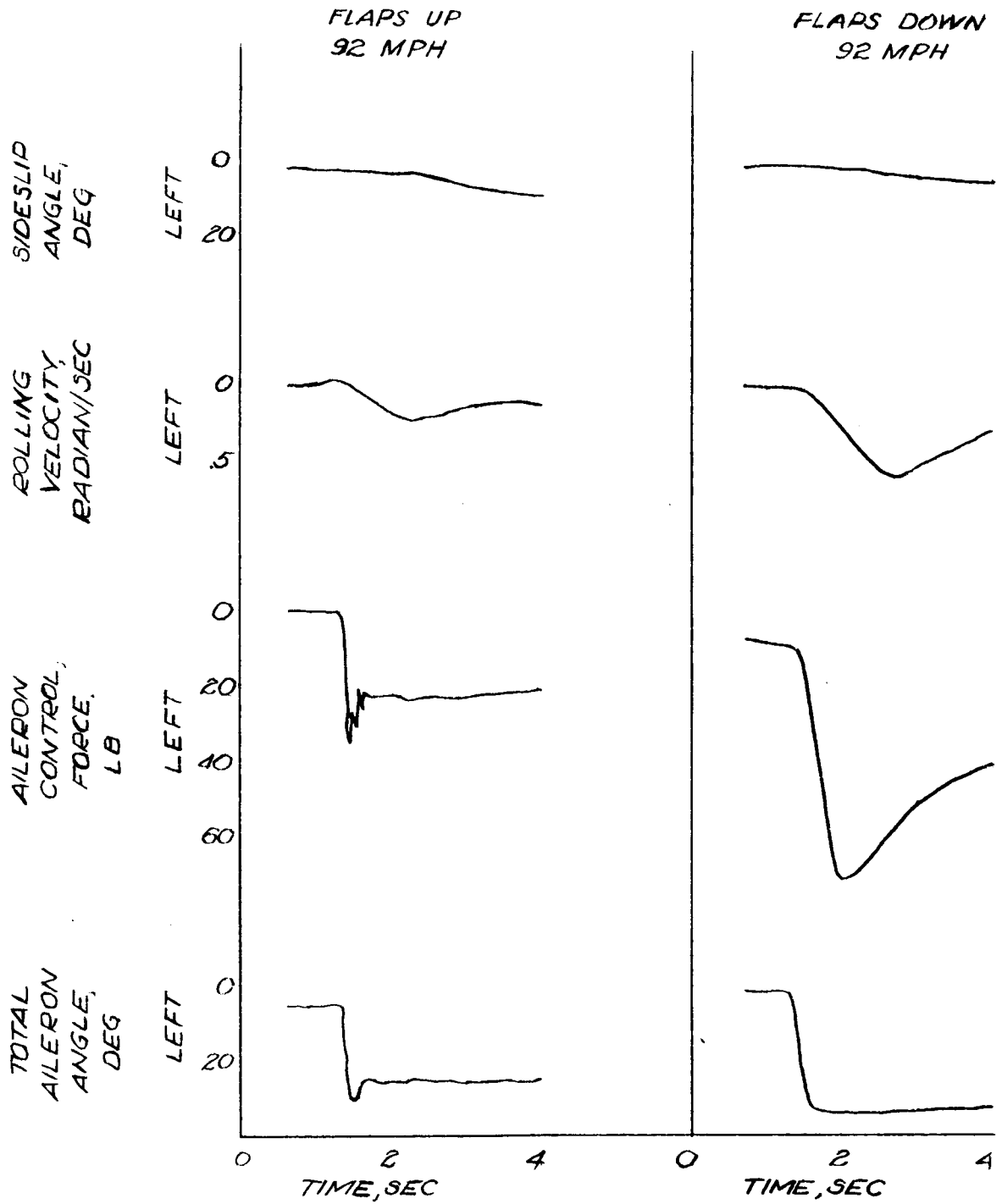

(c) ORIGINAL ZAP AILERONS  
FIGURE 21. - CONCLUDED.

ELEVATOR TAB 7" UP

NATIONAL ADVISORY  
COMMITTEE FOR AERONAUTICS

CONTROL  
SURFACE  
ANGLES,  
DEG

CONTROL  
FORCES,  
LB

ANGULAR  
VELOCITIES,  
RADIAN/SEC

SIDESLIP  
ANGLE,  
DEG

NORMAL  
ACCELERATION  
FACTOR

INDICATED  
AIRSPEED,  
MPH

20  
UP  
10  
0  
10  
RIGHT  
0  
40  
20  
RIGHT  
0  
LEFT  
20  
40  
40  
RIGHT  
PULL  
20  
0  
PUSH  
LEFT  
20  
.5  
RIGHT  
UP  
0  
DOWN  
LEFT  
.5  
0  
LEFT  
20  
1.5  
1.0  
.5  
90  
80  
70

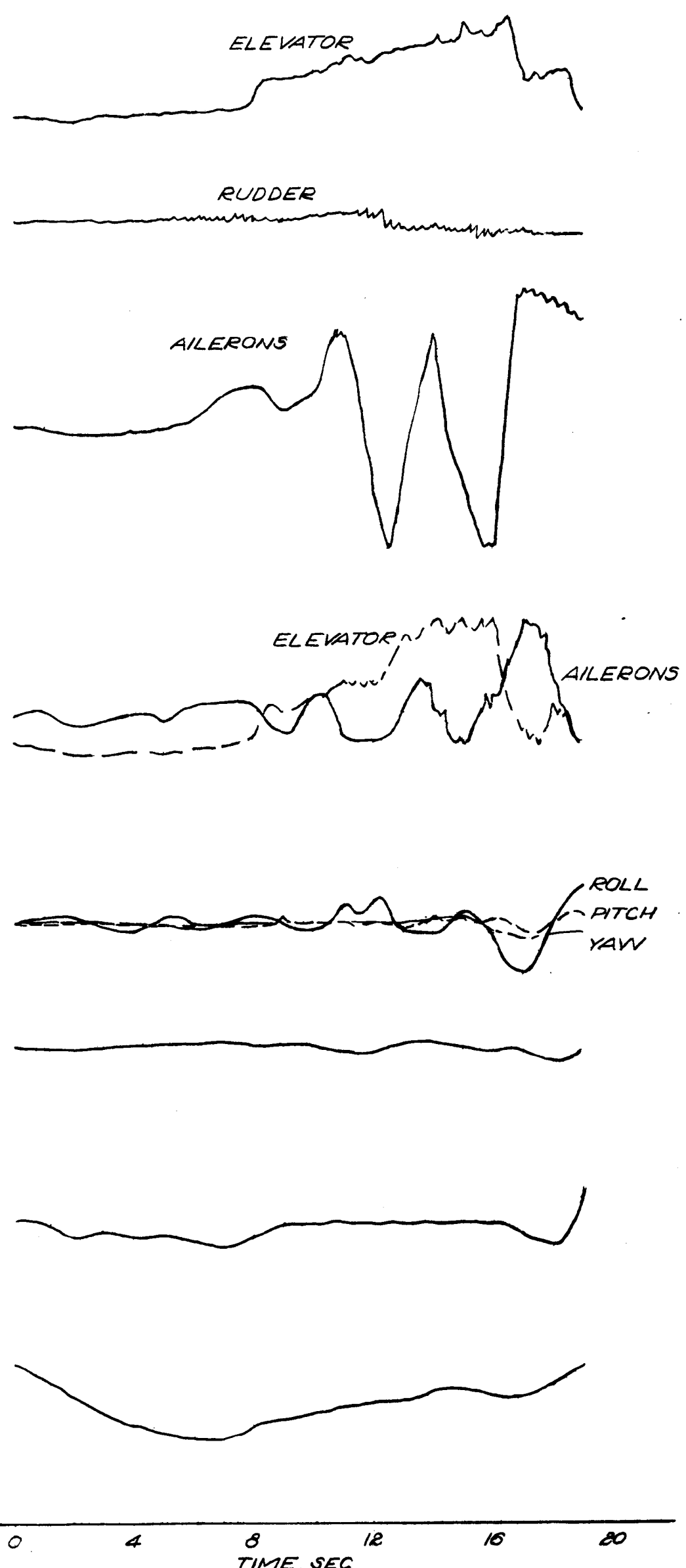

(d) RATED POWER, FLAPS UP  
 FIGURE 22. - TIME HISTORIES OF AILERON-CONTROLLED  
 STALLS. REVISED AILERONS, II.

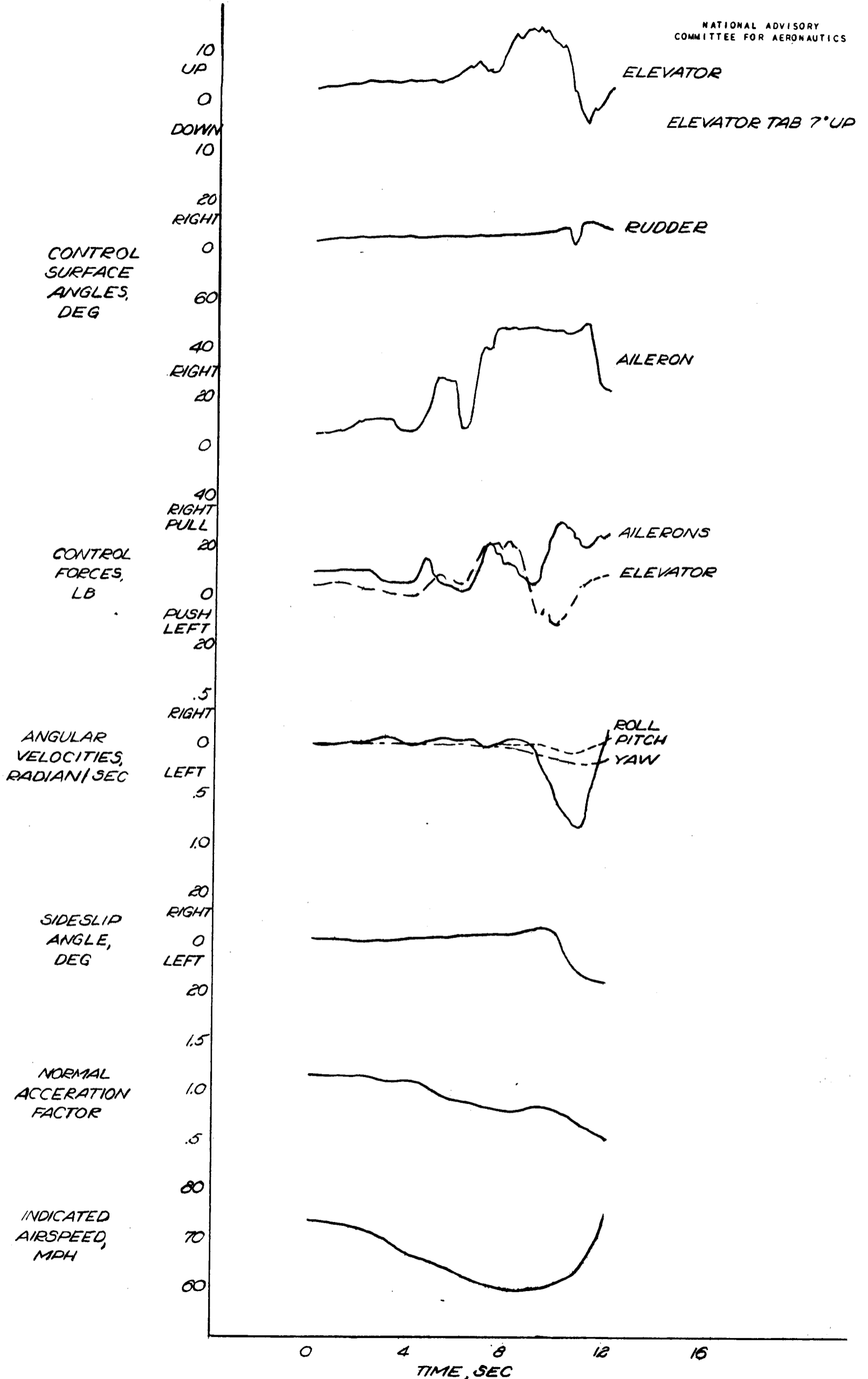

(b) RATED POWER, FLAPS DOWN  
FIGURE 22. — CONTINUED.

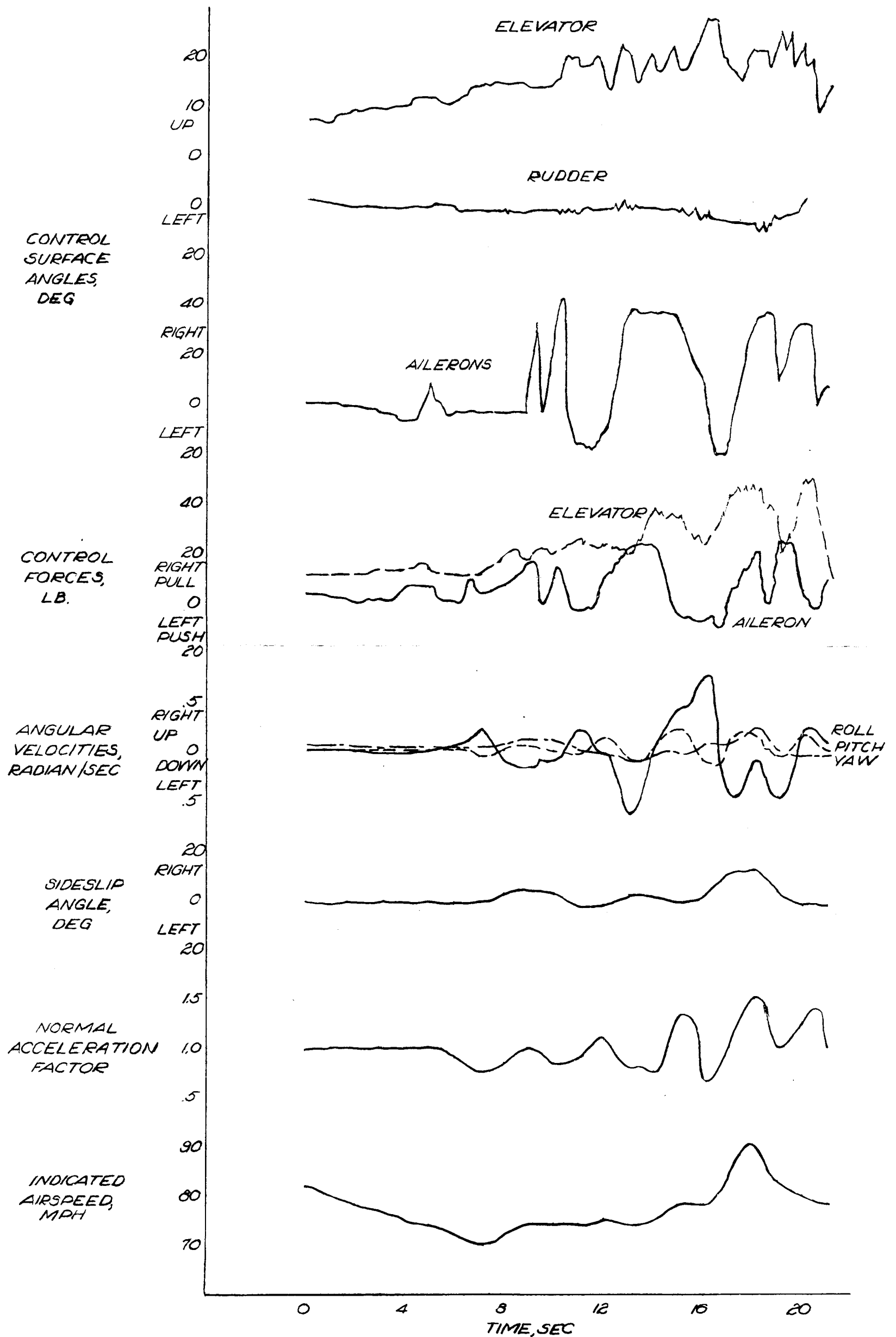

(c) POWER OFF, FLAPS DOWN  
FIGURE 22.— CONCLUDED.

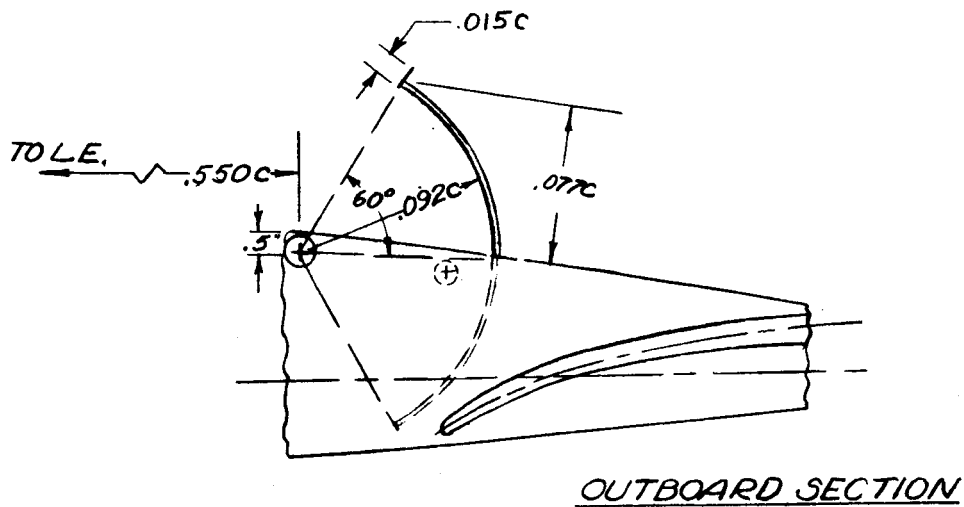
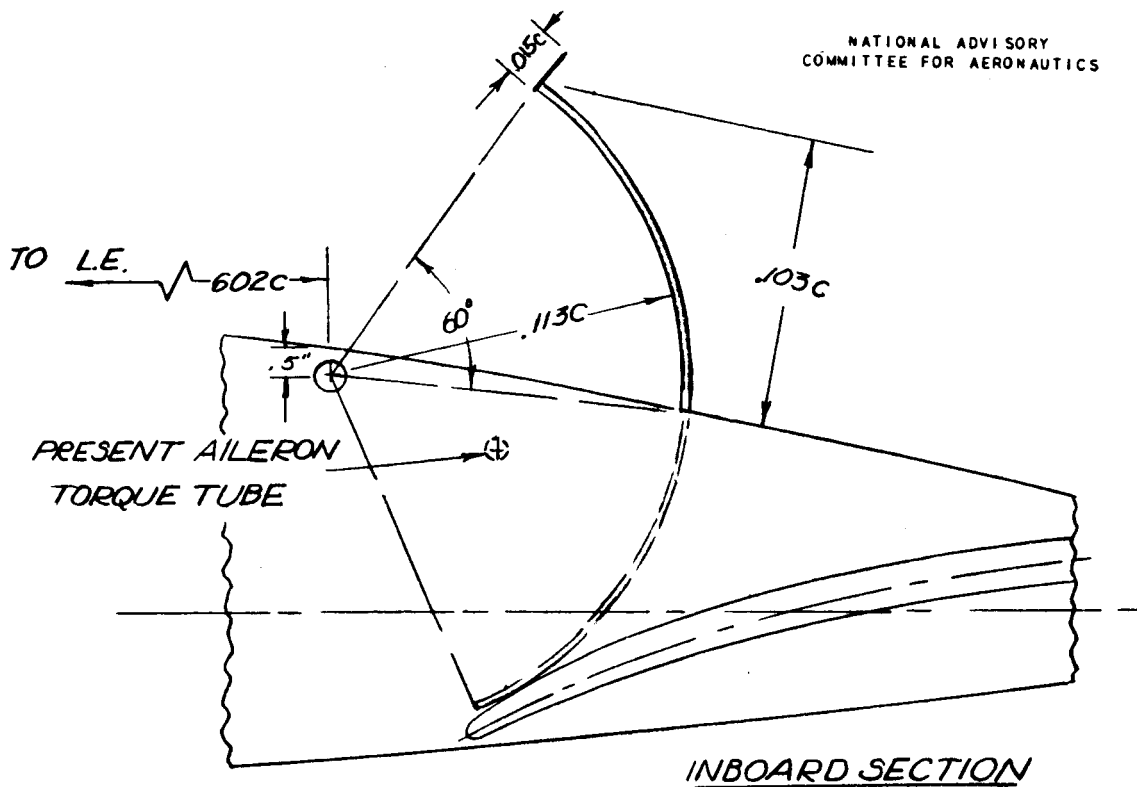

FIGURE 23.- DETAILS OF PROPOSED AILERONS