

ARR No. L5F30

Handwritten signature

NATIONAL ADVISORY COMMITTEE FOR AERONAUTICS

WARTIME REPORT

ORIGINALLY ISSUED
August 1945 as
Advance Restricted Report L5F30

HINGE MOMENTS OF SEALED-INTERVAL-BALANCE

ARRANGEMENTS FOR CONTROL SURFACES

I - THEORETICAL INVESTIGATION

By Harry E. Murray and Mary A. Erwin

Langley Memorial Aeronautical Laboratory
Langley Field, Va.

FOR REFERENCE

NOT TO BE TAKEN FROM THIS ROOM



WASHINGTON

NACA LIBRARY
LANGLEY MEMORIAL AERONAUTICAL
LABORATORY
Langley Field, Va.

NACA WARTIME REPORTS are reprints of papers originally issued to provide rapid distribution of advance research results to an authorized group requiring them for the war effort. They were previously held under a security status but are now unclassified. Some of these reports were not technically edited. All have been reproduced without change in order to expedite general distribution.

NACA ARR No. L5F30

NATIONAL ADVISORY COMMITTEE FOR AERONAUTICS

ADVANCE RESTRICTED REPORT

HINGE MOMENTS OF SEALED-INTERNAL-BALANCE
ARRANGEMENTS FOR CONTROL SURFACES

I - THEORETICAL INVESTIGATION

By Harry E. Murray and Mary A. Erwin

SUMMARY

The results of a theoretical analysis of the hinge-moment characteristics of various sealed-internal-balance arrangements for control surfaces are presented. The analysis considered overhangs sealed to various types of wing structure by flexible seals spanning gaps of various widths or sealed to the wing structure by a flexible system of linked plates. Leakage was not considered; the seal was assumed to extend the full spanwise length of the control surface. The effect of the developed width of the flexible seal and of the geometry of the structure to which the seal was anchored was investigated, as well as the effect of the gap width that is sealed.

The results of the investigation indicated that the most nearly linear control-surface hinge-moment characteristics can probably be obtained from a flexible seal over a narrow gap (about 0.1 of the overhang chord), which is so installed that the motion of the seal is restricted to a region behind the point of attachment of the seal to the wing structure. Control-surface hinge moments that tend to be high at large deflections and low or over-balanced at small deflections will result if a very narrow seal is used.

INTRODUCTION

Experimental data on control surfaces having various arrangements of sealed internal balances have been collected and a correlation has been made of the hinge-moment characteristics for small deflections (reference 1). The data used in this correlation were for balances consisting

of an overhang sealed to a wing structure by a flexible seal made of thin rubber or fabric. The effect of the overhang-seal combinations was assumed to be the same as that of an effective overhang chord equal to the chord of the actual overhang plus one-half the width of the gap closed by the flexible seal. Obviously, such an assumption could be expected at best to account approximately only for the effect of the balance configuration near zero deflection of the control surface and to neglect the effects of variations of the dimensions of the balance chamber, the developed seal width, and large control-surface deflections.

Because sealed internal balances are coming into rather wide use on the closely balanced control surfaces of high-speed airplanes, a systematic investigation has been made by the Stability Research Division of the NACA to determine the characteristics of such balances. The results of the investigation provided data that may be used in obtaining better original designs of sealed internally balanced control surfaces and that allow a more accurate estimate of the change in hinge-moment characteristics associated with modifications of the balance arrangement.

The investigation included both a theoretical and an experimental study. The theoretical investigation, which is presented herein, has as its object the isolation of the most important variables affecting the characteristics of sealed balances and the determination of the effects of as many of these variables as possible. The theoretical analysis was supplemented by an experimental study (reference 2), which served as a check on the theory and produced data on many important details not adapted to theoretical procedure.

For the general investigation, two types of internal balance were considered, typical installations of which are shown in figure 1. In one case the overhang was considered to be connected to the wing structure by a flexible seal capable of sustaining only tensile stress; whereas in the other case the seal was a flexible system of linked plates.

The theoretical analysis given herein presents results showing the effects of variations of gap width, developed seal width, and shape of wing structure to which the seal is attached for the flexible sealed balance and the effect

of varying the length of the seal plate in a linked-plate balance consisting of two plates.

SYMBOLS

c_b	overhang chord
Δp	pressure difference across balance
x, y	coordinates referred to origin at overhang hinge axis
h, k	coordinates of seal arc center
L_1	vertical clearance required for seal to develop moments presented in figures 9 to 11, fraction of overhang chord
g	width of gap between points of attachment of seal when $\delta_b = 0^\circ$, fraction of overhang chord
δ_b	overhang deflection, degrees (See fig. 2 for sign conventions.)
r	radius of seal arc
ρ	mass density of air, slugs per cubic foot
T	tensile force in fabric seal per unit span
P_R	pressure coefficient across balance $\left(\frac{\Delta p}{q}\right)$
V	free-stream velocity
q	free-stream dynamic pressure $\left(\frac{1}{2}\rho V^2\right)$
M_B	total balance moment of balance system of unit span
v	volume of balance system at deflection δ_b
δ	control-surface deflection, degrees
M_b	moment of overhang of unit span $\left(\frac{\Delta p}{2} \left[c_b^2 - \left(\frac{t}{2}\right)^2 \right]\right)$
M_s	seal moment; incremental hinge moment resulting from seal of unit span

t	thickness of overhang at hinge axis
m_s	seal-moment ratio for overhang having $t = 0$ (M_s/M_b)
s	developed seal width, fraction of overhang chord
Δc_h	increment of section hinge-moment coefficient resulting from balance
c_f	control-surface chord
c_a	aileron chord
ψ	leading-edge angle of overhang
c	airfoil chord
h	control-surface section hinge moment
c_h	section hinge-moment coefficient (h/qc_f^2)
α	angle of attack, degrees

ANALYSIS

Methods

The present theoretical analysis was an investigation of the characteristics of various configurations of sealed internal balances. These configurations consist mainly of the two types illustrated in figure 1: (1) overhang balances sealed to the wing structure by flexible material capable of sustaining only tensile stresses and (2) overhang balances sealed to the wing structure by a flexible system of linked plates.

The moments resulting from the types of balance shown in figure 1 were determined by the following two methods:

(1) Resolution of forces - The method of the resolution of forces consists of finding the forces exerted by each part of the balance system as a result of a pressure difference across these parts. The moments of these forces about the control-surface hinge are then added to get the total moment of the balance system.

(2) Volume displacement - The method of volume displacement consists of finding the rate of change of volume swept by the balance with deflection. The moment of the balance is then

$$M_B = \left(\frac{dv}{d\delta} \right) \Delta p \quad (1)$$

Overhang Balance with Flexible Seal

The configurations investigated are shown in figures 3 to 5. The moments of such balances can be written as the sum of the moment resulting from the overhang and that resulting from the seal; therefore,

$$M_B = \frac{\Delta p}{2} \left[c_b^2 - \left(\frac{t}{2} \right)^2 \right] + M_s \quad (2)$$

The moment exerted by the seal can be expressed in terms of the seal-moment ratio m_s . Then

$$M_B = \frac{\Delta p}{2} \left[c_b^2 - \left(\frac{t}{2} \right)^2 \right] + \frac{\Delta p}{2} c_b^2 m_s \quad (3)$$

or, in terms of an increment of hinge-moment coefficient,

$$\Delta c_h = \frac{P_R}{2} \left(\frac{c_b}{c_f} \right)^2 \left[1 - \left(\frac{t}{2c_b} \right)^2 + m_s \right] \quad (4)$$

In order to obtain numerical values for Δc_h , an investigation was made of the variation of the seal-moment ratio m_s with the two important balance dimensions - the width of the gap to be sealed and the developed width of the seal. Such variations were investigated for seals attached at the leading edges to the following backplates, which simulate three representative types of wing structure:

- (1) Horizontal-line backplate (fig. 3)
- (2) Vertical-line backplate (fig. 4)
- (3) Circular-arc backplate (fig. 5)

The flexible seals analyzed were assumed to be non-porous, inextensible, perfectly flexible, and weightless. These assumptions imply that the unrestrained part of the seal forms an arc of a circle and has a tensile force, per unit span, of $T = \Delta p r$ acting everywhere tangent to the arc. The moments resulting from these seals arise either from the tensile stress in the seal (figs. 3, 4(a), and 5(a)) or from the seal lying along and equalizing the pressure over part of the overhang (figs. 4(b) and 5(b)).

In order to apply the resolution-of-forces method to the seals shown in figures 3, 4(a), and 5(a), the radius of the seal arc and the point at which the seal leaves the backplate were determined. The investigation showed these unknowns to be related to the other variables in the balance system as indicated by the equations presented in appendix A. After these unknowns had been determined as suggested in appendix A, the balance systems were constructed as shown in figures 3, 4(a), and 5(a). The seal moment was then computed from the seal tension and the lever arm, which was measured from the construction. If the resolution-of-forces method is applied to the seals shown in figures 4(b) and 5(b), the lever arm of the tensile force in the seal is zero. The reduction in effective overhang chord caused by such seals was equal to the amount of overhang covered by the seal; this amount can be determined as explained in appendix B.

In order to apply the volume-displacement method to the seals shown in figures 3, 4(a), and 5(a), the balance system was again constructed graphically. The area swept by the seal, which equals the volume for a unit span, was then mechanically integrated and plotted against flap deflection. The slopes of this curve could then be estimated for use in the formula for M_B . Because of the difficulty of estimating the slopes from these curves, the volume-displacement method proved to be the less accurate of the two methods. If the effective-overhang reduction corresponding to the seals of figures 4(b) and 5(b) is found by the method of appendix B, the moment resulting from the seal can be determined in terms of the volume swept by the effective-overhang reduction.

Pressure-distribution data showed that, at high angles of attack, the deflection of a control surface from -8° to -12° may be necessary before the pressure across the seal changes sign. At such deflections the seal is extended in a direction opposite that of the overhang. This deflection range corresponds to the negative values of the overhang deflection δ_b . (See fig. 2.) As soon as the pressure changes sign, the seal blows across the gap and δ_b is again positive. In order to investigate this phenomenon, seal moments were computed for values of δ_b from -12° to 20° except in cases of very small gaps, for which the computation of seal moments for the entire negative range was sometimes impractical.

Overhang Balance with Linked-Plate Seal

Figures 6 and 7 show linked-plate balances consisting of two and three hinged plates, respectively. The total moment of the balance system can again be represented by equation (3) in which the seal moment is the moment of all parts of this balance except the moment of the overhang rigidly attached to the control surface. As indicated in appendix C, the moments exerted by such balances can be determined by both the resolution-of-forces and the volume-displacement methods.

RESULTS AND DISCUSSION

An investigation of the seal-moment characteristics of the various seal arrangements was made by the resolution-of-forces method and was checked by the volume-displacement method. Only the moment characteristics of the seals are presented. The effects of the entire balance system can be obtained from the seal-moment characteristics by means of equation (4). Figure 8 presents the characteristics of flexible seals for various gaps as given by the approximate formula of reference 1.

Hinge moments of internally balanced control surfaces normally become heavy at large deflections as a result of a decrease in $\partial P_R / \partial \delta$ with deflection. In order to offset somewhat the effect of a decrease in $\partial P_R / \partial \delta$ with deflection and to give the most nearly linear control-surface

hinge moments, $\partial m_s / \partial \delta_b$ should have a positive value. (A positive value of $\partial m_s / \partial \delta_b$ that increased with deflection would be even more desirable but generally cannot be obtained.) This positive value of $\partial m_s / \partial \delta_b$ may be considered favorable inasmuch as linear or nearly linear control-surface hinge moments, although not altogether necessary, are generally desirable.

Flexible Seals

The characteristics of the flexible seals are presented in figures 9 to 11 for the horizontal-line, vertical-line, and circular-arc backplates. A comparison of these figures with figure 8 shows that, in general, large errors in the seal moments may result from the use of the approximate formula. Corresponding large errors can also be expected in control-surface hinge moments estimated by the approximate formula, except when the seal effect is small relative to the total balance moment. The seal characteristics shown in figures 9 to 11 can be discussed best in terms of the following seal variables: gap width, developed seal width, type of backplate, and type of overhang.

Effect of gap width.- The effect of changes in gap width can be seen best by reference to the curves for $s = 0.6$ (figs. 9 to 11) for any backplate. These curves indicate that an increase in gap width for a seal of constant width increases the seal moment at small positive deflections and decreases the seal moment at large positive deflections; the effect is, therefore, a change in $\partial m_s / \partial \delta_b$ in the negative or unfavorable direction. If the most nearly linear control-surface hinge-moment characteristics over the entire deflection range are desired, small gaps of the order of $g = 0.1$ should be used. In terms of control-surface hinge moments, increasing the gap width tends to result in high control-surface hinge moments at large control-surface deflections and low or overbalanced moments at small control-surface deflections.

Effect of developed seal width.- Figures 9 to 11 indicate that decreasing the developed seal width tends to change $\partial m_s / \partial \delta_b$ in the negative direction, a change which is unfavorable. This effect should be the most important single consideration in the design of a flexible

sealed balance. The seal must be sufficiently long that it does not become taut (see fig. 12) within the usable deflection range. The seal shown in figure 12 has a very large radius of arc; therefore, a very large tensile force is to be expected. Because this force is so directed as to unbalance the control surface, a sharp control-surface hinge-moment increase is to be expected at large deflections.

Very wide seals contact the balance-chamber boundaries at large deflections. A reduction of the seal moment then results at large deflections and this reduction also tends to change $\partial m_s / \partial \delta_b$ in the negative or unfavorable direction. Because of the difficulties involved in the analysis of the seal effect after the seal has contacted a balance-chamber boundary, such effects have been determined experimentally (reference 2). Figures 13 to 15, however, were included to indicate the ranges of gap, seal width, and deflection in which the seal moments presented in figures 9 to 11 can be expected to be valid if the balance-chamber depth is known.

Effect of backplates.- The effect on the seal moments of the three backplates investigated is shown in figure 16. Figure 16(a) shows that, for a small gap ($g = 0.1$), the horizontal-line backplate tends to give large balance moments at small deflections and small balance moments at large deflections. The horizontal-line backplate therefore tends to result in an unfavorable value of $\partial m_s / \partial \delta_b$ and should be avoided. The vertical-line and circular-arc backplates, which restrain the motion of the seal to a region behind the point of attachment of the seal to the wing structure and give a favorable value of $\partial m_s / \partial \delta_b$, should be used. Increasing the gap width tends to reduce the difference between the seal-moment characteristics of the three backplates as indicated by figure 16(b), which shows seal-moment characteristics for $g = 0.5$. These backplate effects are summarized for only one representative seal width, since other widths would give variations similar in character but differing somewhat in magnitude.

Effect of overhang shape.- If the overhang is changed from the thin line assumed in the analysis to a triangular cross section as shown in figure 17, the angle at the point of attachment of the seal can have a value up to 40° and yet effect no change in the seal moments presented in

figures 9 to 11 for positive deflections and for gaps of about $g = 0.15$ or larger. This result is obtained because the added overhang thickness does not touch the seal. A rather large range of overhang shapes therefore seems to exist, for which the presented seal-moment characteristics will be altered little if any.

Linked-Plate Seals

The possibility of improving the hinge-moment characteristics of control surfaces having limited overhang chords by using linked-plate seals such as illustrated in figures 6 and 7 led to an investigation of such seals. Figure 18 indicates that the linked-plate seal consisting of two plates (fig. 6) exhibits an unfavorable value of $\partial m_s / \partial \delta_b$.

Another problem is the practical consideration of preventing leakage around the moving leading edge of the seal plate. One method of preventing leakage is to use a third plate as shown in figure 7. This third plate may be small with respect to both the original seal plate and the overhang so that the seal moments still approximate those of figure 18. If more exact characteristics of the three-plate balance are desired, the method of appendix C can be used.

EXAMPLE

In order to show how the characteristics of a sealed internally balanced control surface can be obtained from those of the sealed unbalanced surface and to indicate the magnitude of some of the effects about which conclusions have already been drawn, the effects of two balance configurations on the hinge-moment characteristics of the aileron section shown in figure 19 have been determined. The characteristics of the unbalanced aileron section are shown in figure 20. From equation (4) the incremental hinge-moment coefficients were computed for two balances having vertical-line backplates and the following dimensions:

Configuration	c_b/c_a	g	s
1	0.417	0.5	0.7
2	.521	0	.6

The effective overhang as given by the approximate formula is

$$\frac{c_b}{c_a} = 0.521$$

for both configurations. The hinge-moment characteristics of the balanced aileron are therefore the same for either configuration according to the approximate formula and are shown in figure 20.

The section shown in figure 19 has $L_1 \approx 0.5$ in the region in which the seal is located. Inasmuch as figure 14(d) indicates that a value of $L_1 \approx 0.34$ is required with configuration 1 and $L_1 \approx 0.46$ with configuration 2 for a deflection range of $\pm 20^\circ$, ample space is provided for the seal to develop the moments indicated by figures 10(a) and 10(f).

In order to show the computation procedure, the calculations of the incremental hinge moments for configuration 1 are presented. Equation (4) was written as follows to represent configuration 1:

$$\Delta c_h = P_R(0.0868) (0.7975 + m_s)$$

Table I shows the computations required for obtaining hinge moments of the balanced aileron from this equation. A similar procedure is used for configuration 2 and for the approximate solution.

The computed characteristics of both configurations are shown in figure 20. This figure indicates that the large gap and rather short seal of configuration 1 result in heavy hinge moments at large deflections and that the approximate rule does not properly represent this configuration. It can also be seen that the approximate rule represents configuration 2 reasonably well at large deflections but leads to considerable error at small deflections when the seal lies along part of the overhang.

CONCLUSIONS

The hinge-moment characteristics of various arrangements of sealed internal balances were investigated

theoretically. The results of the investigation indicated the following conclusions:

1. Increasing the gap width for a seal of constant width or decreasing the developed seal width tends to result in high control-surface hinge moments at large deflections and low or overbalanced moments at small deflections.
2. Backplates that restrain the motion of the seal to a region behind the point of attachment of the seal to the wing structure probably give the most nearly linear control-surface characteristics.
3. Varying the cross section of the overhang from that of a thin plate presents no important aerodynamic disadvantage and, if such a change is desired for structural reasons, a considerable range of design is available in which the seal moments are unaltered.

Langley Memorial Aeronautical Laboratory
National Advisory Committee for Aeronautics
Langley Field, Va. April 30, 1945

APPENDIX A

EQUATIONS OBTAINED WHEN NO PART OF SEAL LIES
AGAINST OVERHANG

The following equations relate the quantities involved in fixing the position of the seal arc when no part of the seal lies against the overhang:

- (1) For horizontal-line backplate (fig. 3),

$$s = 2r \sin^{-1} \frac{\sqrt{(x_1 - x_3)^2 + y_1^2}}{2r} + (x_3 - x_2)$$

$$r = \frac{1}{2} \left[\frac{(x_1 - h)^2}{y_1} + y_1 \right]$$

- (2) For vertical-line backplate (fig. 4(a)),

$$s = 2r \sin^{-1} \frac{\sqrt{(x_2 - x_1)^2 + (k - y_1)^2}}{2r} + k$$

$$r = \frac{1}{2} \left[(x_2 - x_1) - \frac{(y_1 - k)^2}{x_1 - x_2} \right]$$

- (3) For circular-arc backplate with center at overhang hinge axis (fig. 5(a)),

$$s = 2r \sin^{-1} \frac{\sqrt{(x_3 - x_1)^2 + (y_3 - y_1)^2}}{2r} + x_2 \sin^{-1} \frac{y_3}{x_2}$$

$$r = x_2 \left[1 - \frac{1}{2} \left(\frac{c_b^2 + x_2^2}{x_1 x_3 + y_1 y_3 - x_2^2} \right) \right]$$

In these formulas, the first term represents the length of seal in a free arc and the second term represents the length of seal lying against the backplate. If conditions are such that no part of the seal lies against the backplate, all three cases may be solved by

$$s = 2r \sin^{-1} \frac{\sqrt{(x_1 - x_2)^2 + (y_1 - y_2)^2}}{2r}$$

If these relationships are subject to a practical condition - for example, requiring that the seal width remain constant - the radius of seal arc and the location of the point at which the seal leaves the backplate should be determined in order that the system may be constructed for a graphical type of solution. None of the equations could be solved for any quantity other than s , however, because of the inverse trigonometric functions involved; curves of the equations were therefore plotted and the necessary values were read from the curves.

APPENDIX B

EQUATIONS OBTAINED WHEN PART OF SEAL LIES
AGAINST OVERHANG

The following equations relate quantities involved in fixing the position of the seal arc when part of the seal lies against the overhang. (The meaning of symbols used in these equations but not defined in the list of symbols can be obtained from figures 4(b) and 5(b).)

(1) For horizontal-line backplate, the equations are omitted since the case is of little practical importance.

(2) For vertical-line backplate (fig. 4(b)),

$$s = \left(\frac{d}{\tan \frac{90^\circ - \delta_b}{2}} \frac{270^\circ + \delta_b}{57.3} \right) + (d + x_2 \tan \delta_b) \\ + (d - c_b + x_2 \sec \delta_b)$$

(3) For circular-arc backplate with center at overhang hinge axis (fig. 5(b)),

$$s = \left[\frac{r(270^\circ - \beta)}{57.3} \right] + \left[\frac{\beta(c_b + g)}{57.3} + \frac{\delta_b(c_b + g)}{57.3} \right] + d$$

$$\beta = \tan^{-1} \frac{r}{(c_b + g) - (c_b + g)(1 - \cos \beta) - r \cos \beta}$$

$$d = (c_b + g)(1 - \cos \beta) + r \cos \beta - g$$

In these formulas the first term represents the width of seal in a free arc; the second term, the width of seal

lying along the backplate; and the third term, the width of seal lying along the overhang.

In order to find the amount of overhang covered by the seal, the distance d must be known. This quantity can most conveniently be found if d is plotted against the seal width s for various overhang deflections. Appropriate values can then be read from the curves.

APPENDIX C

APPLICATION OF METHODS TO LINKED-PLATE BALANCES

A linked-plate balance consisting of two hinged plates is shown in figure 6(a). Figure 6(b) shows the force breakdown of the system for the resolution-of-forces method. (The symbols used in this appendix and not defined in the list of symbols can be obtained from figures 6 and 7.) The moments exerted are as follows:

The moment of plate LM is

$$\frac{\Delta p A^2}{2}$$

The moment of normal force F_N is

$$\frac{\Delta p BA}{2} \left[\cos \delta_b \sqrt{1 - \left(\frac{A}{B}\right)^2 \sin^2 \delta_b} - \frac{A}{B} \sin^2 \delta_b \right]$$

The moment of axial force F_A is

$$\frac{\Delta p A^2}{2} \left[\frac{\sin^2 \delta_b + \frac{A}{B} \cos \delta_b \sin^2 \delta_b}{\sqrt{1 - \left(\frac{A}{B}\right)^2 \sin^2 \delta_b}} \right]$$

$$M_B = \frac{\Delta p BA}{2} \left[\frac{\cos \delta_b - 2 \left(\frac{A}{B}\right)^2 \cos \delta_b \sin^2 \delta_b}{\sqrt{1 - \left(\frac{A}{B}\right)^2 \sin^2 \delta_b}} - 2 \left(\frac{A}{B}\right) \sin^2 \delta_b \right] + \frac{\Delta p A^2}{2}$$

For the volume-displacement method, the volume enclosed by plates A and B is

$$v = \frac{A^2}{4} \sin 2\delta_b + \frac{BA}{2} \sin \delta_b \sqrt{1 - \left(\frac{A}{B}\right)^2 \sin^2 \delta_b}$$

Then

$$\frac{dv}{d\delta_b} = \frac{AB}{2} \left[\frac{\cos \delta_b - 2\left(\frac{A}{B}\right)^2 \cos \delta_b \sin^2 \delta_b}{\sqrt{1 - \left(\frac{A}{B}\right)^2 \sin^2 \delta_b}} - 2\left(\frac{A}{B}\right) \sin^2 \delta_b \right] + \frac{A^2}{2}$$

$$M_B = \Delta P \frac{dv}{d\delta_b} = \frac{\Delta P AB}{2} \left[\frac{\cos \delta_b - 2\left(\frac{A}{B}\right)^2 \cos \delta_b \sin^2 \delta_b}{\sqrt{1 - \left(\frac{A}{B}\right)^2 \sin^2 \delta_b}} - 2\left(\frac{A}{B}\right) \sin^2 \delta_b \right] + \frac{\Delta P A^2}{2}$$

In terms of seal-moment ratio, with plate B considered as the seal,

$$m_s = \frac{B}{A} \left[\cos \delta_b \frac{\left(1 - 2\left(\frac{A}{B}\right)^2 \sin^2 \delta_b\right)}{\sqrt{1 - \left(\frac{A}{B}\right)^2 \sin^2 \delta_b}} - 2\left(\frac{A}{B}\right) \sin^2 \delta_b \right]$$

In order to solve the three-plate linked balance shown in figure 7(a), the system should be broken down as shown in figure 7(b); the normal force F_N and the axial force F_A exerted by plate LM and plate KL at joint L should then be determined. Since the dimensions of the plates are known, F_A can be expressed as

$$F_A = \frac{1}{2} \left[\frac{MN}{\cos (\theta - 90^\circ)} + LM \tan (\theta - 90^\circ) \right] \Delta p$$

The value of F_N depends only on the length of plate LM and the pressure difference so that

$$F_N = \frac{\Delta p}{2} LM$$

The vector forces F_A and F_N can be added graphically as shown in figure 7(b) to find the resultant force and its lever arm, the product of which is the moment of plates LM and MN. The sum of this moment and the moment of plate KL is the total moment of the system, which can then be checked by the volume-displacement method.

REFERENCES

1. Rogallo, F. M., and Lowry, John G.: Résumé of Data for Internally Balanced Ailerons. NACA RB, March 1943.
2. Fischel, Jack: Hinge Moments of Sealed-Internal-Balance Arrangements for Control Surfaces. II - Experimental Investigation of Fabric Seals in the Presence of Thin-Plate Overhangs. NACA ARR No. L5F30a, 1945

TABLE I
COMPUTATION OF HINGE-MOMENT COEFFICIENTS OF
BALANCED AILERON FROM THOSE OF UNBALANCED AILERONS

(1)	(2)	(3)	(4)	(5)	(6)	(7)	(8)	(9)
δ (deg)	P_R	δ_b (deg)	m_s	0.0868 \times (2)	0.7975 $+$ (4)	Δc_h (5) \times (6)	c_h (Unbalanced)	c_h (Balanced) (7) + (8)
-18	-0.650	18	-0.0400	-0.0564	0.7575	-0.0427	0.1705	0.1278
-16	-.645	16	.1300	-.0560	.9275	-.0519	.1523	.1004
-14	-.615	14	.2400	-.0534	1.0375	-.0554	.1273	.0719
-12	-.562	12	.3200	-.0488	1.1175	-.0545	.1000	.0455
-10	-.490	10	.3800	-.0425	1.1775	-.0501	.0726	.0225
-8	-.360	8	.4210	-.0313	1.2185	-.0381	.0453	.0072
-6	-.253	6	.4520	-.0220	1.2495	-.0274	.0214	-.0060
-4	-.120	4	.4730	.0104	1.2705	-.0132	.0052	-.0080
-2	.005	-2	.5050	.0004	1.3025	.0006	-.0127	-.0121
0	.143	0	.5080	.0124	1.2975	.0161	-.0330	-.0169
2	.295	2	.4900	.0256	1.2875	.0330	-.0548	-.0219
4	.412	4	.4730	.0358	1.2705	.0454	-.0795	-.0341
6	.537	6	.4520	.0466	1.2495	.0582	-.1041	-.0459
8	.625	8	.4210	.0543	1.2185	.0661	-.1288	-.0627
10	.712	10	.3800	.0618	1.1775	.0728	-.1540	-.0812
12	.774	12	.3200	.0672	1.1175	.0751	-.1779	-.1028
14	.845	14	.2400	.0734	1.0375	.0761	-.2000	-.1239
16	.895	16	.1300	.0777	.9275	.0721	-.2186	-.1465
18	.940	18	-.0400	.0816	.7575	.0618	-.2363	-.1745
20	.960	20	-.3150	.0833	.4825	.0402	-.2530	-.2138

NATIONAL ADVISORY
COMMITTEE FOR AERONAUTICS

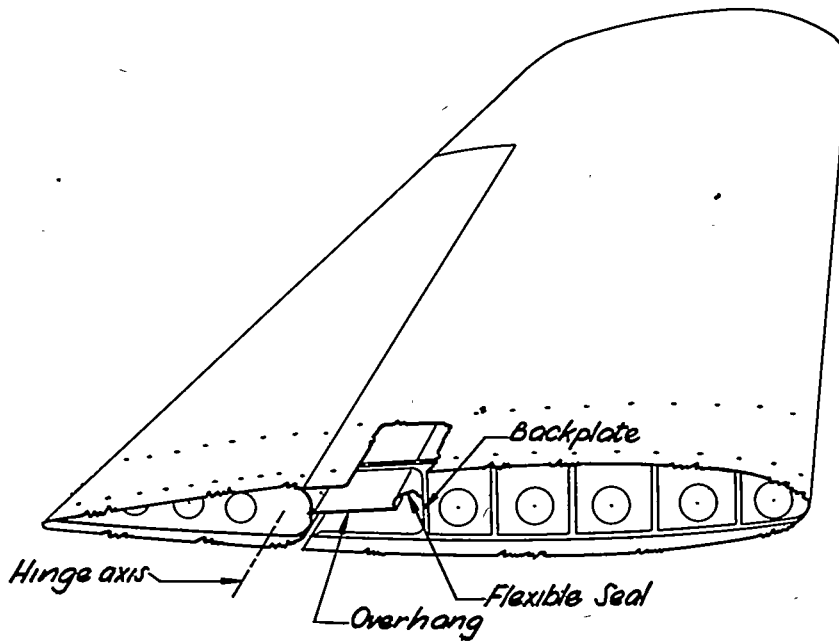

(a) Control surface with flexible seal.

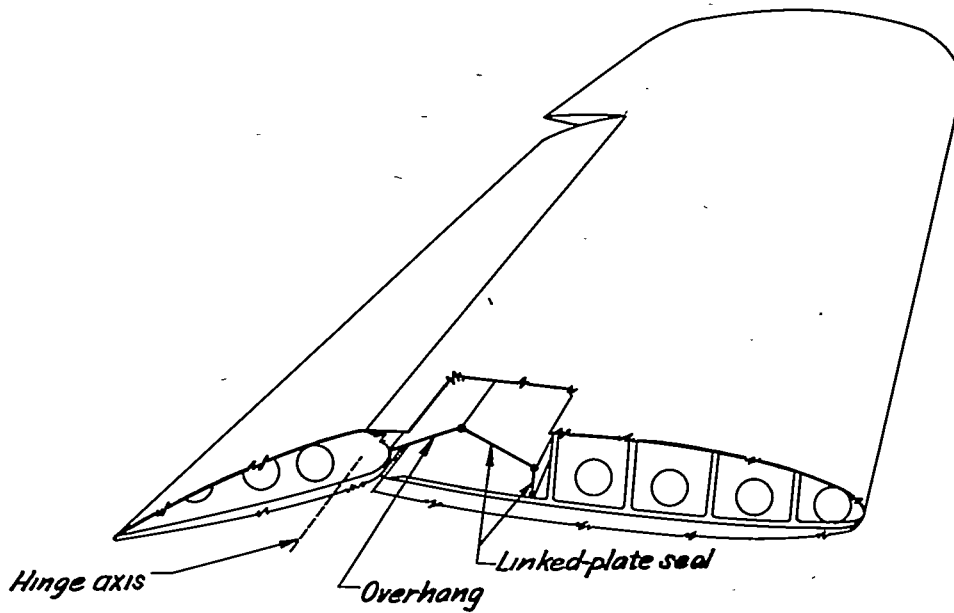

(b) Control surface with linked-plate seal.

Figure 1. — Typical installation of an internally sealed and balanced control surface.

NATIONAL ADVISORY
COMMITTEE FOR AERONAUTICS

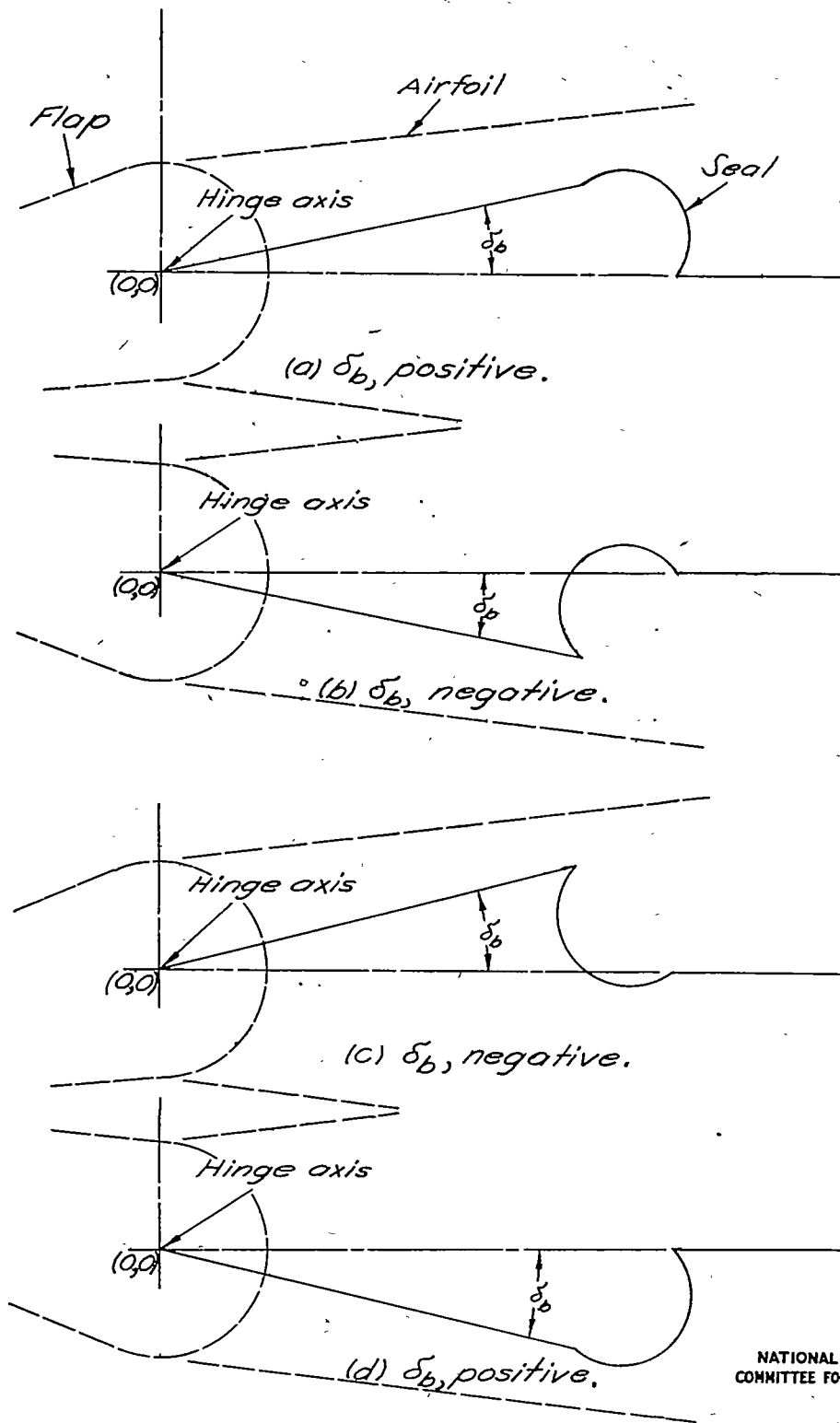

NATIONAL ADVISORY
COMMITTEE FOR AERONAUTICS

Figure 2.- Sign conventions for overhanging deflection.

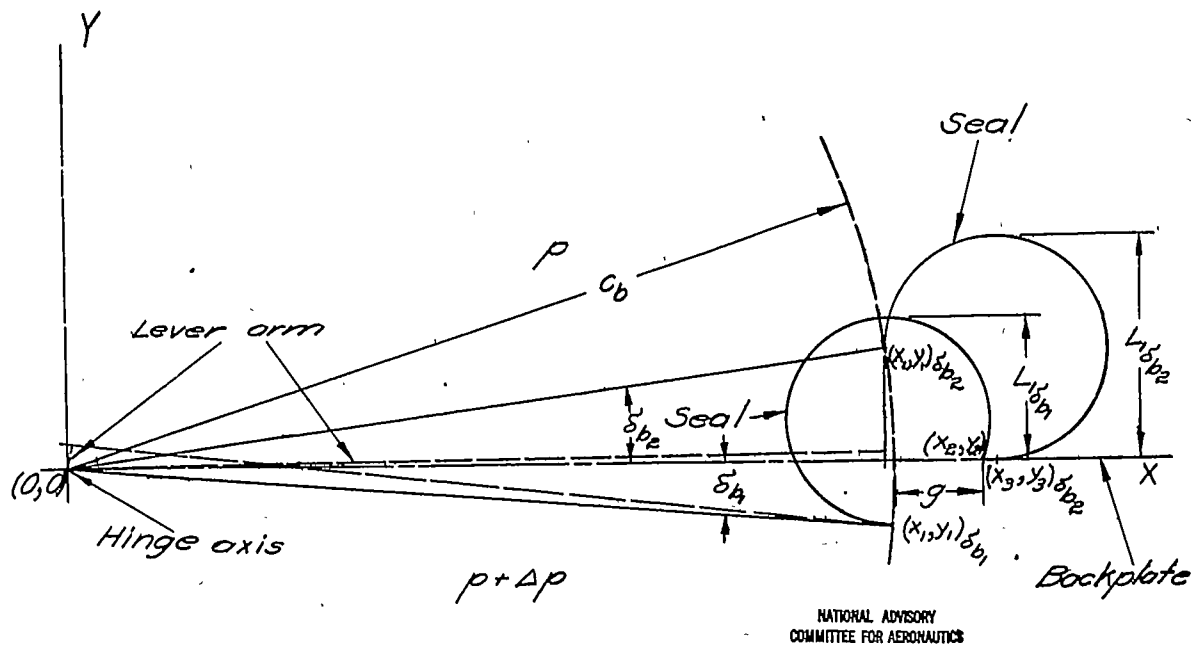
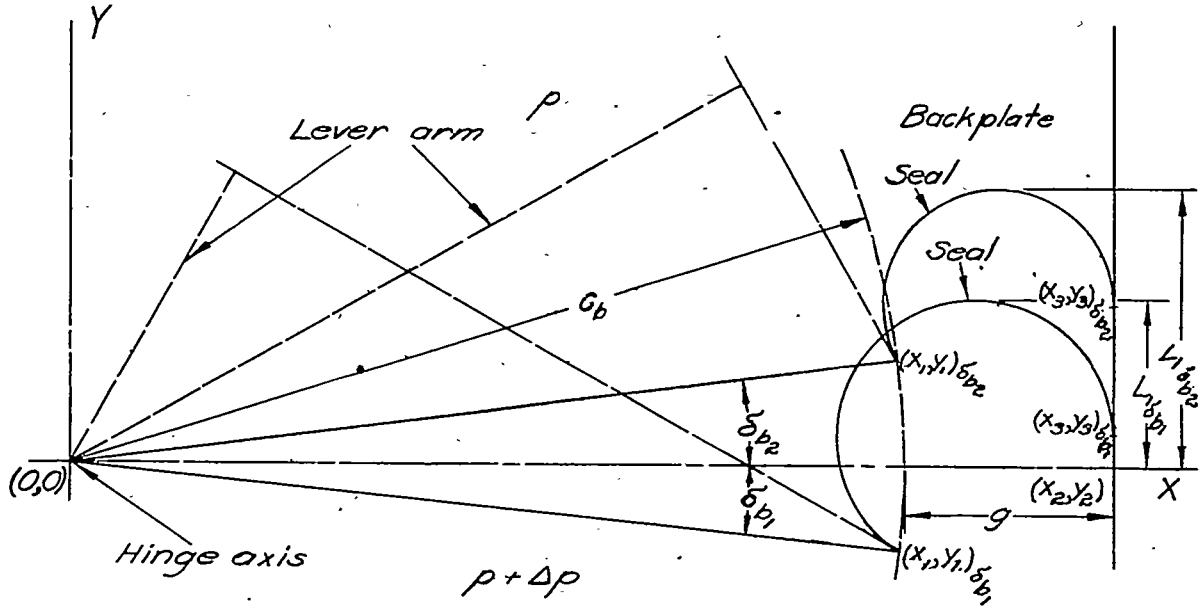
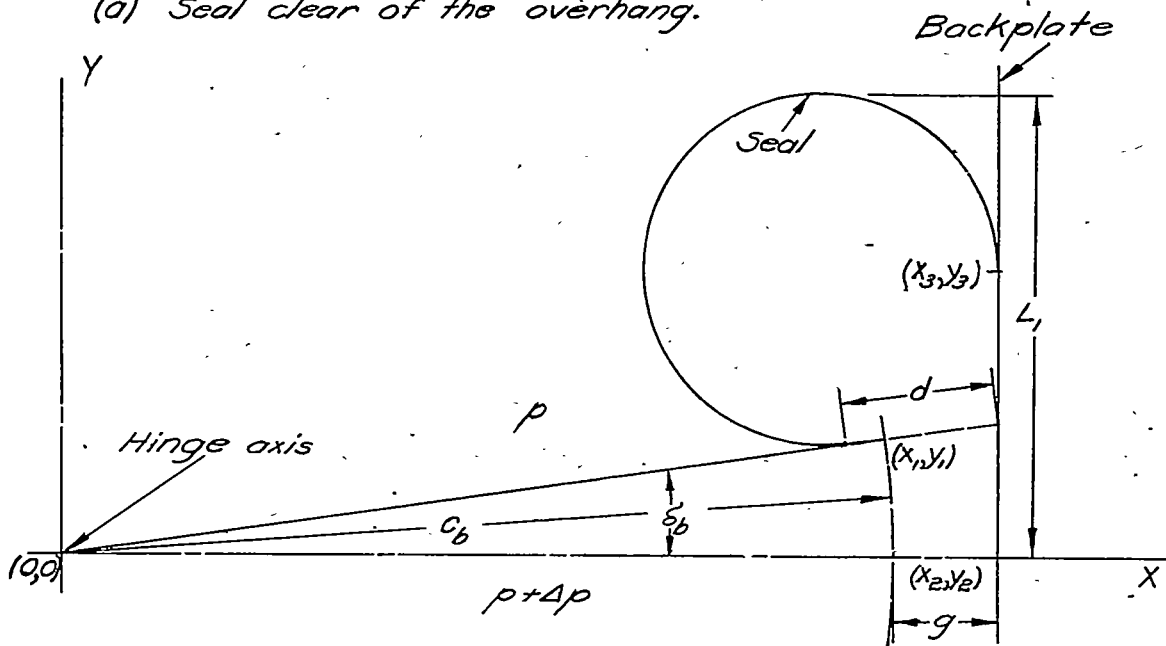

Figure 3.- Internal balance with seal and horizontal-line backplate.



(a) Seal clear of the overhang.



(b) Seal lying against the overhang.

NATIONAL ADVISORY
COMMITTEE FOR AERONAUTICS

Figure 4. - Internal balance with seal and vertical-line backplate.

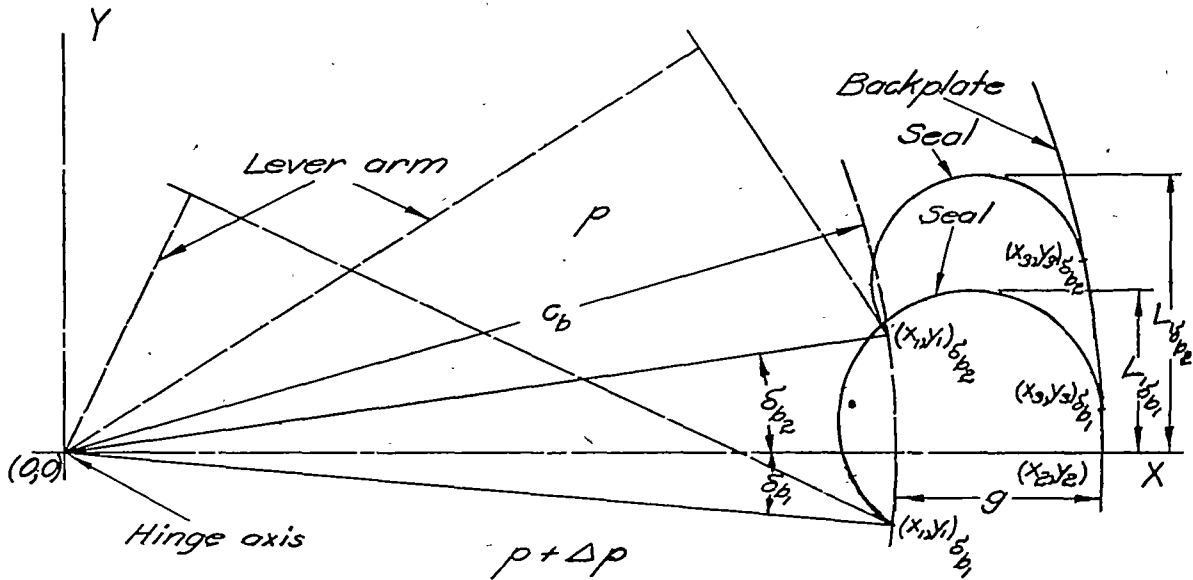

(a) Seal clear of the overhang.

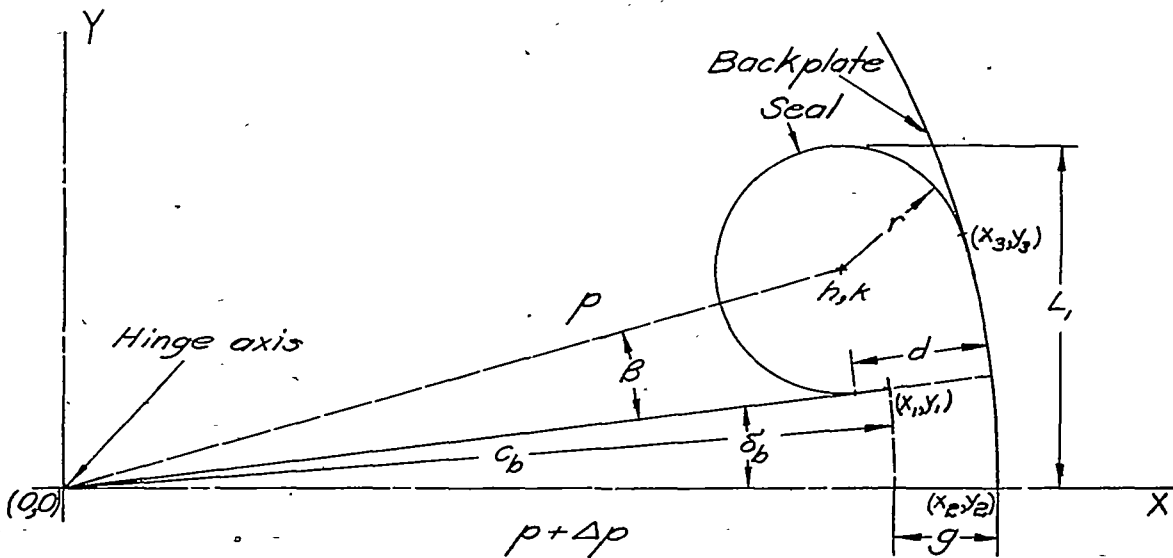

(b) Seal lying against the overhang.

NATIONAL ADVISORY
COMMITTEE FOR AERONAUTICS

Figure 5. - Internal balance with seal and circular-arc backplate, center at (0,0).

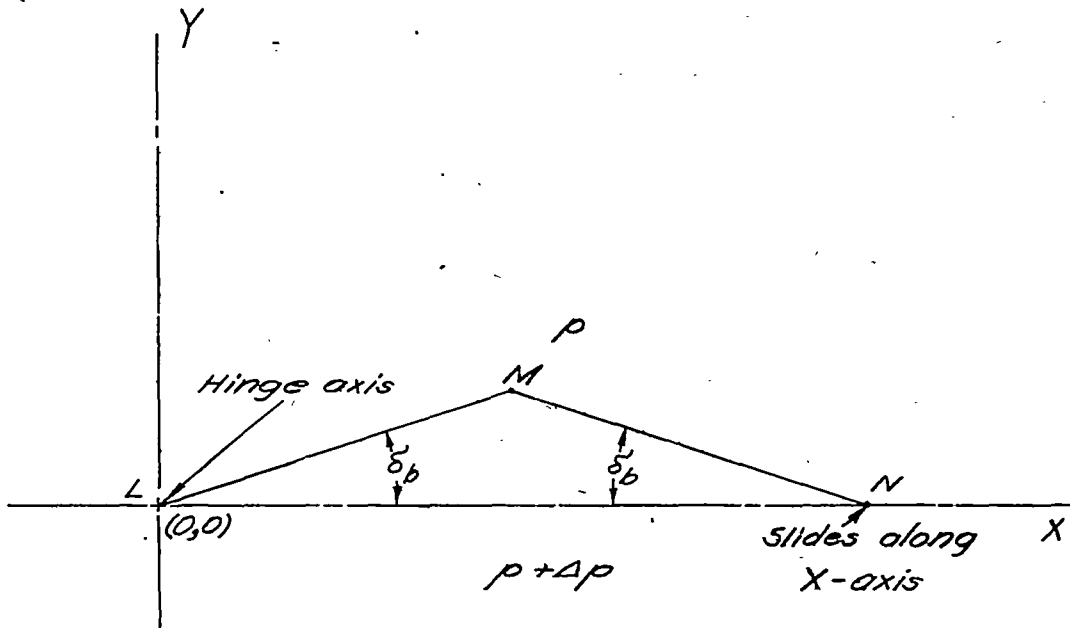

(a) Balance arrangement.

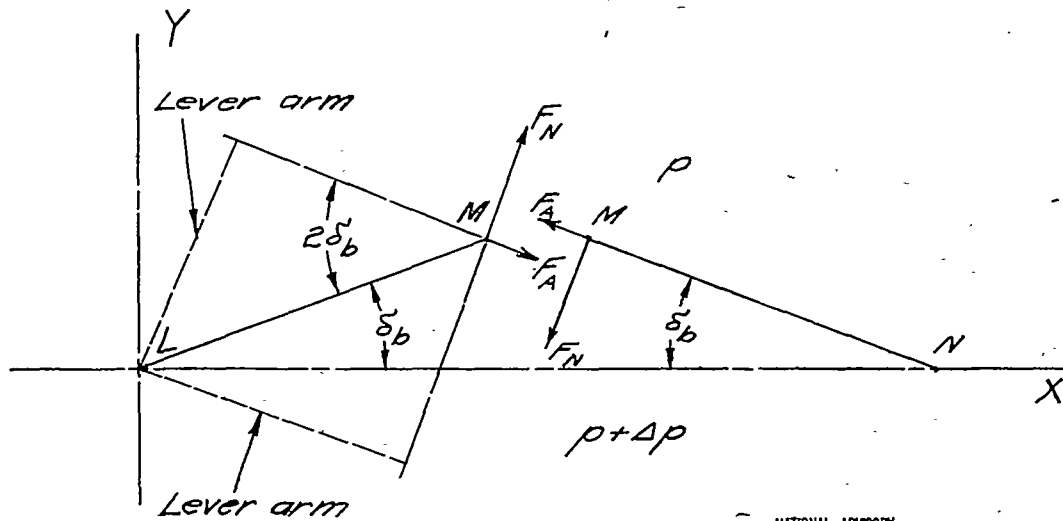

(b) Force breakdown.

NATIONAL ADVISORY
COMMITTEE FOR AERONAUTICS

Figure 6. - Linked-plate balance consisting of two hinged plates. $LM = A$; $MN = B$.

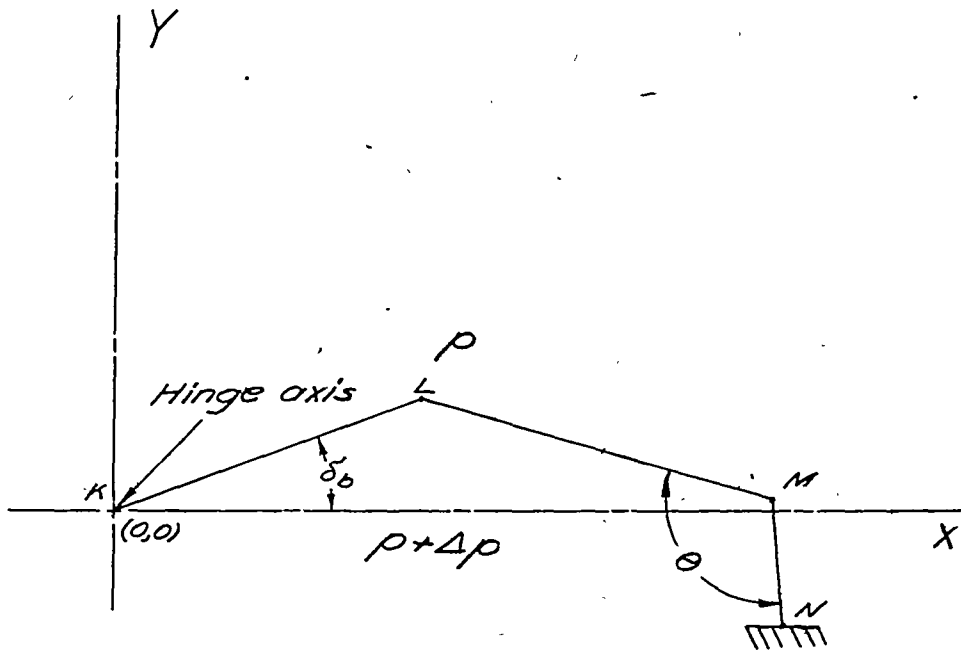

(a) Balance arrangement.

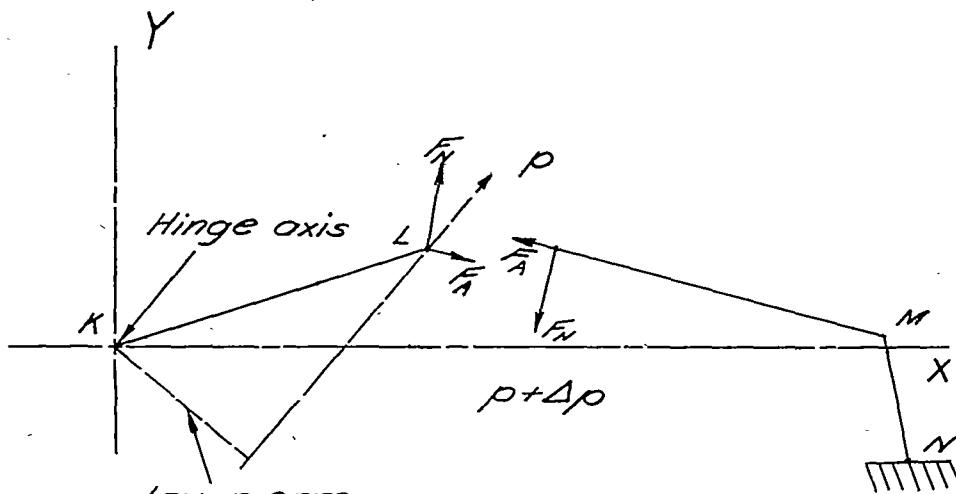

(b) Force breakdown.

NATIONAL ADVISORY
COMMITTEE FOR AERONAUTICS

Figure 7.- Linked-plate balance consisting of three plates.

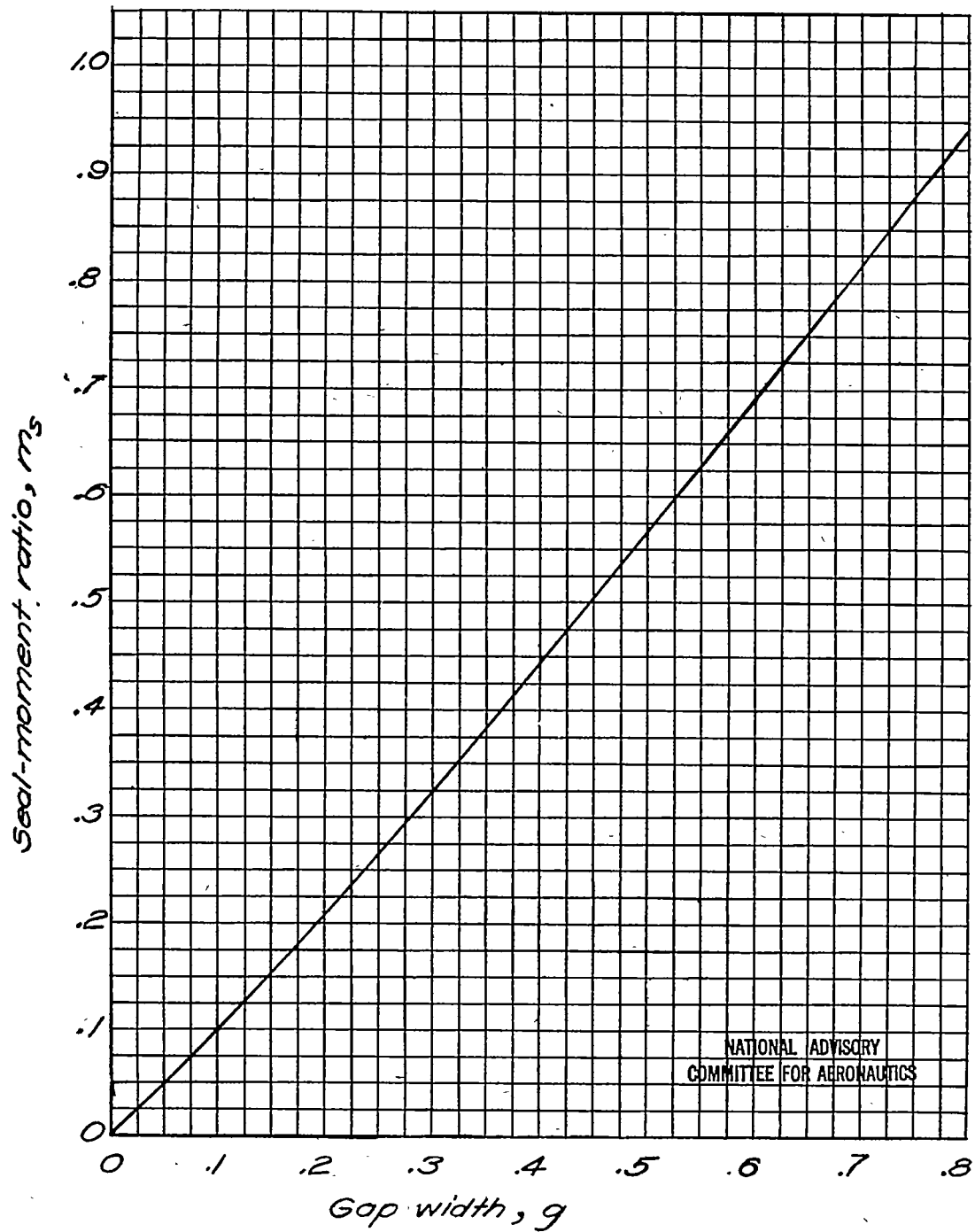

Figure 8.- Equivalent seal-moment characteristics of an increment of overhang equal to one-half gap width. $m_s = g + \frac{g^2}{4}$.

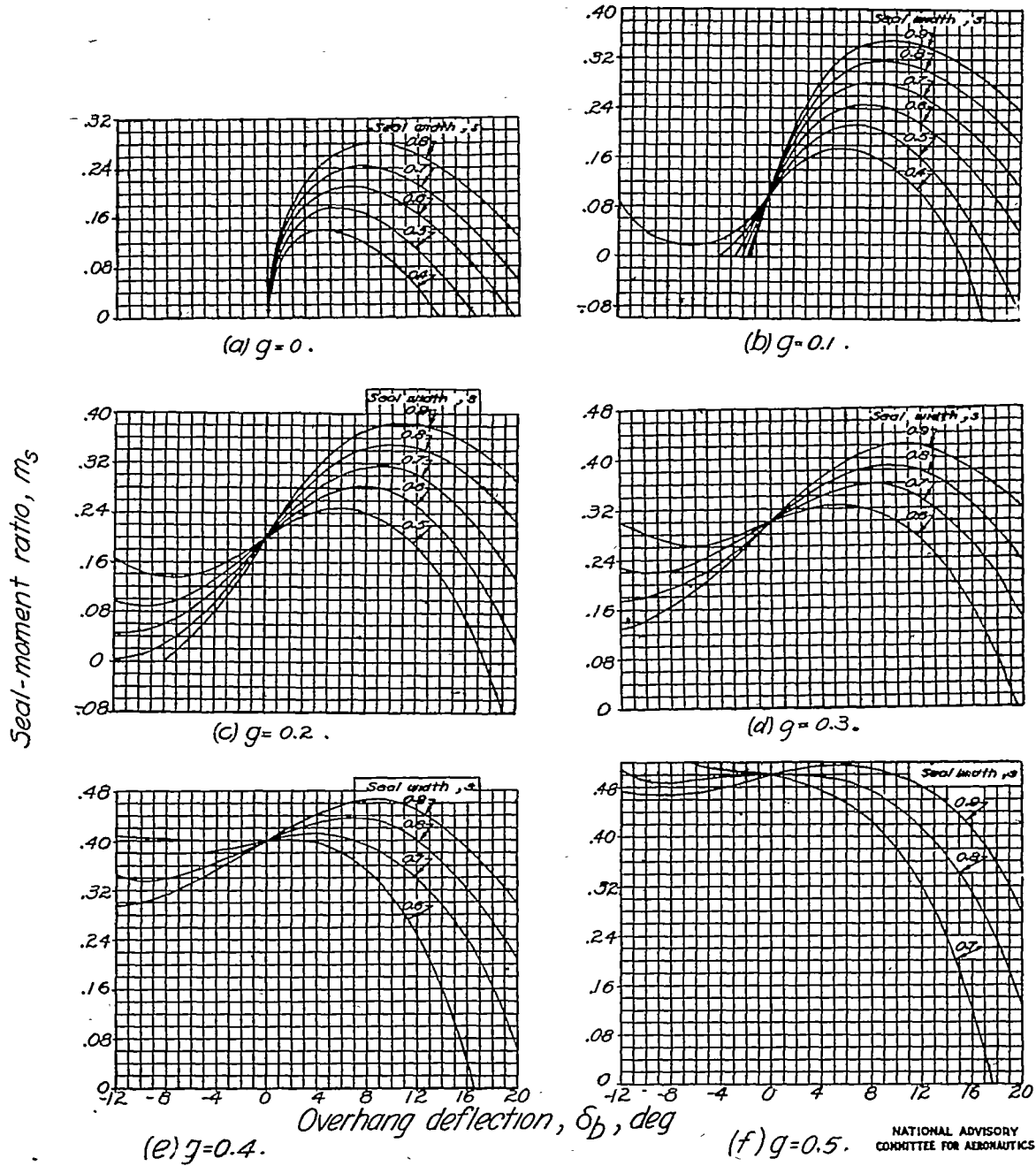
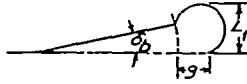

Figure 9.- Moment characteristics of flexible seals with horizontal-line backplates.

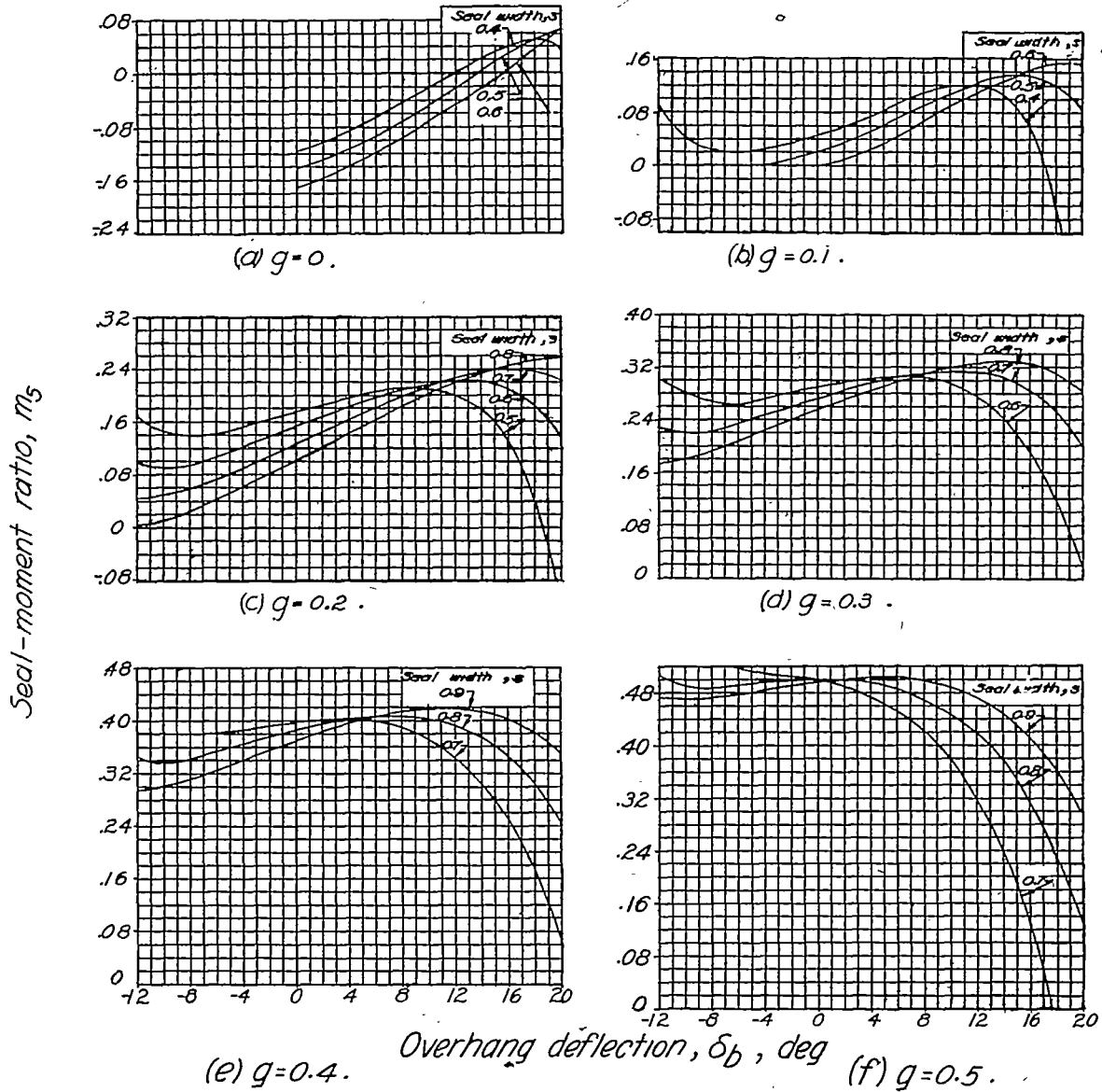
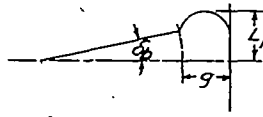

Figure 10-Moment characteristics of flexible seals with vertical-line backplates.

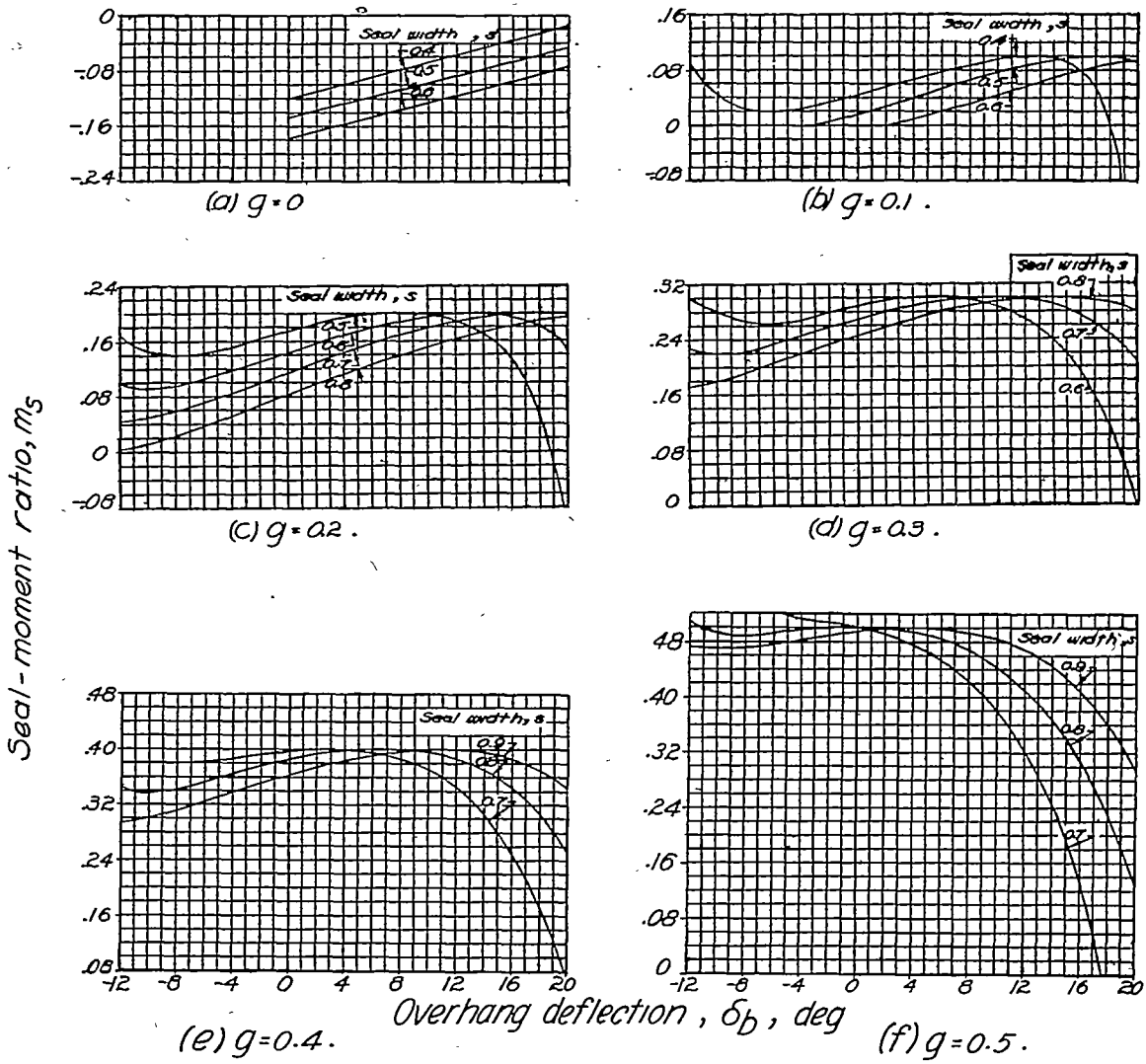
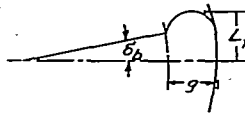
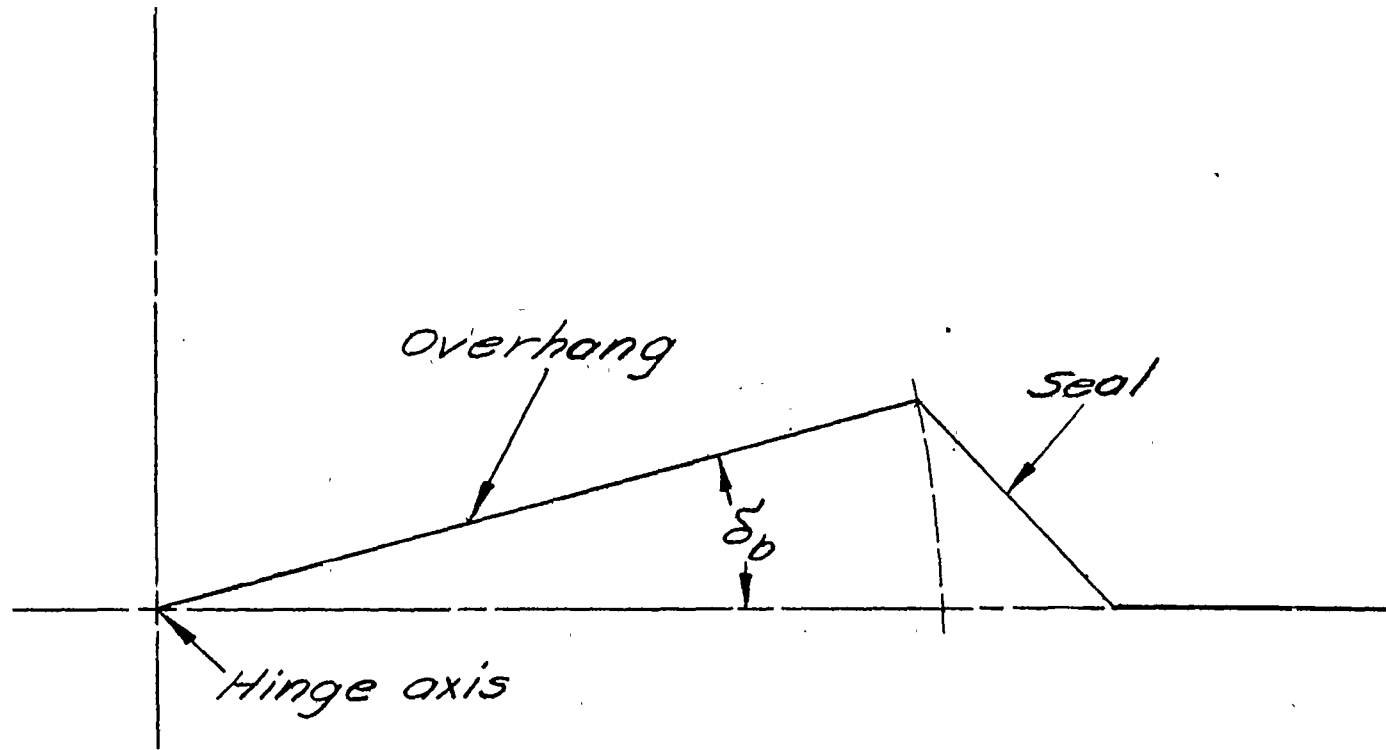
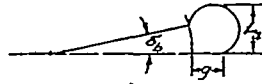

Figure 11.- Moment characteristics of flexible seals with circular-arc backplates.



NATIONAL ADVISORY
COMMITTEE FOR AERONAUTICS

Figure 12.- Balance with flexible seal of insufficient width.



Vertical clearance, L_1

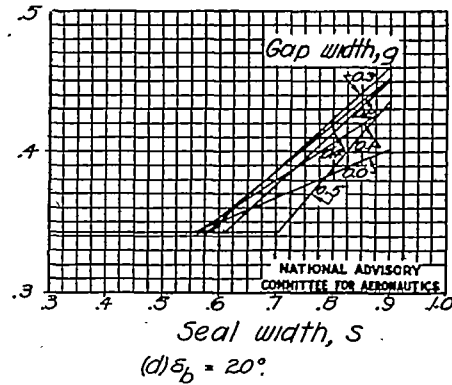
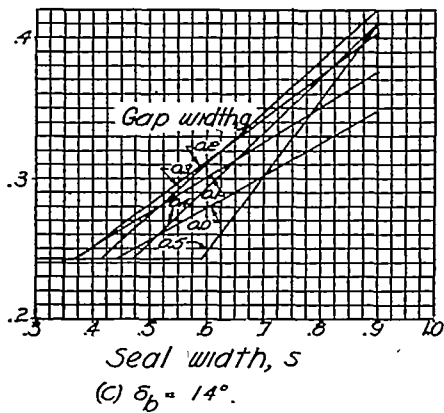
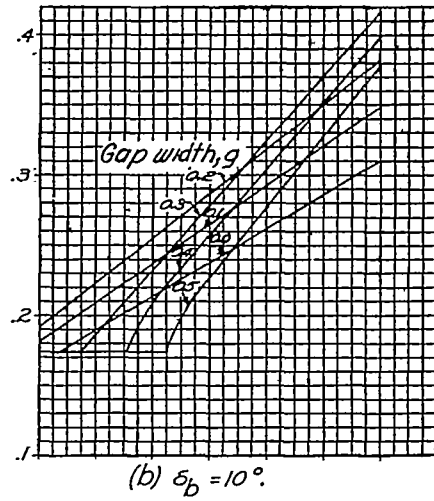
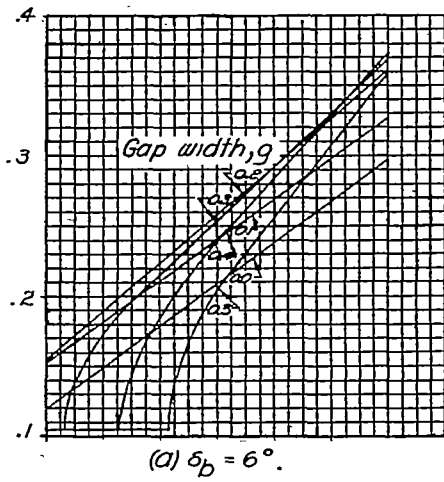
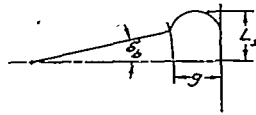
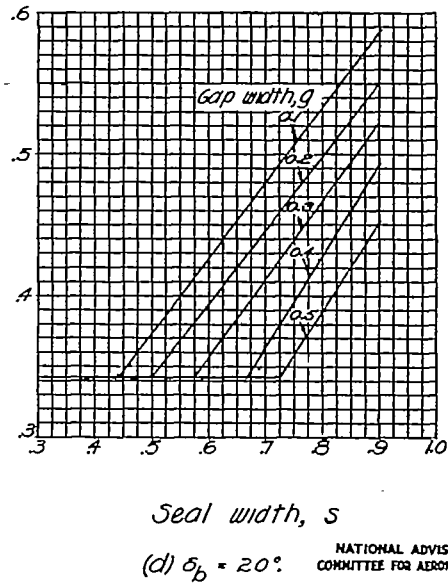
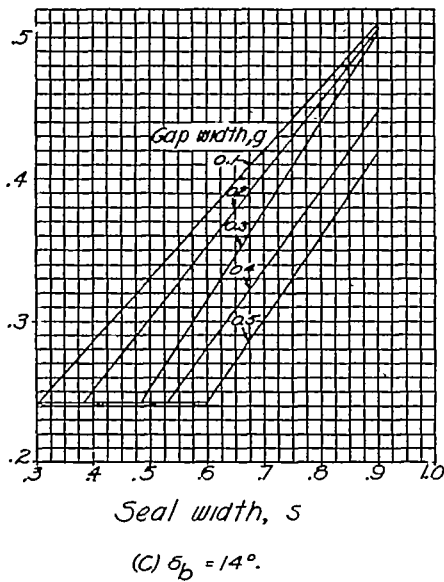
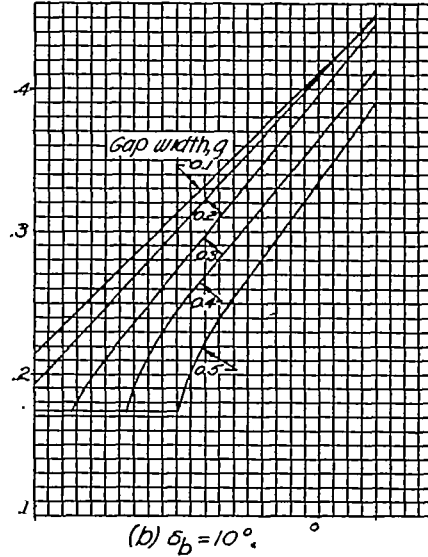
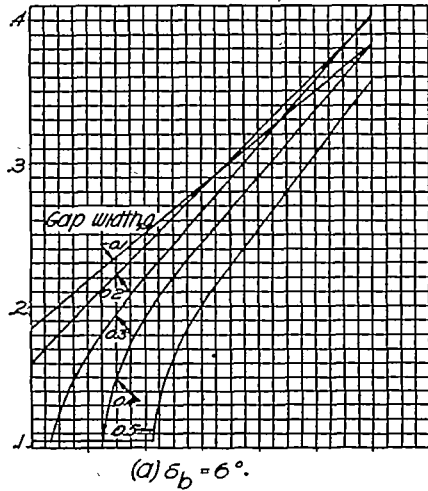

Figure 13.-Vertical clearance required for flexible seals with horizontal-line backplates.



Vertical clearance, L_1



NATIONAL ADVISORY
COMMITTEE FOR AERONAUTICS

Figure 14.- Vertical clearance required for flexible seals with vertical-line backplates.

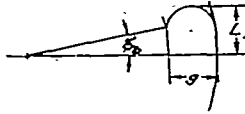

Vertical clearance, L_1

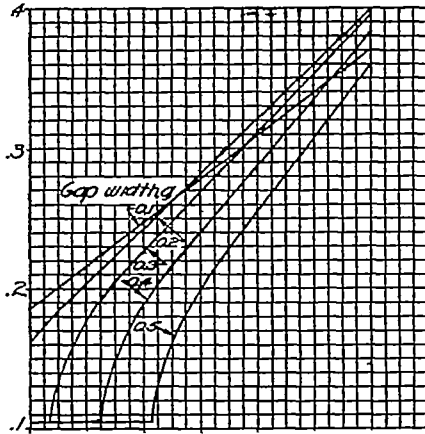

(a) $\delta_b = 6^\circ$.

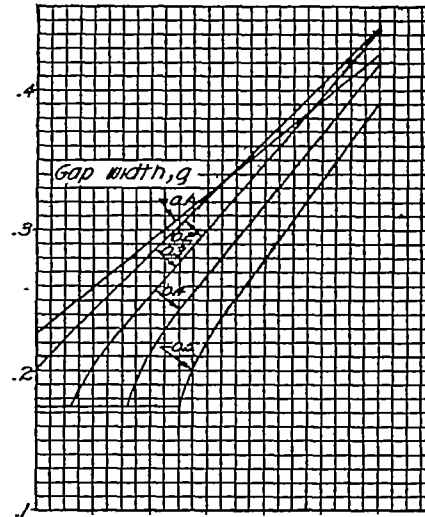

(b) $\delta_b = 10^\circ$.

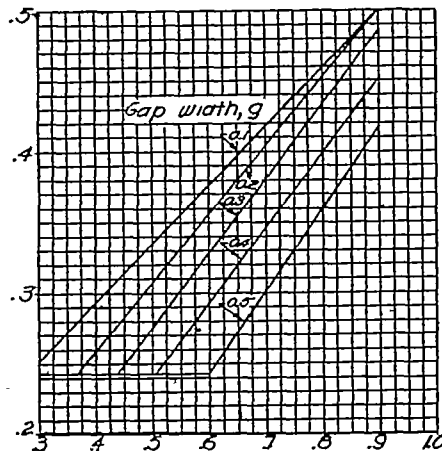

(c) $\delta_b = 14^\circ$.

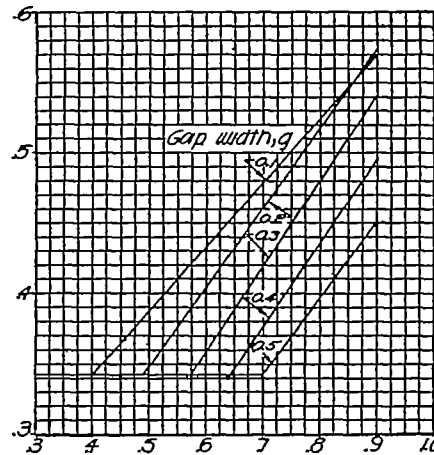

(d) $\delta_b = 20^\circ$.

NATIONAL ADVISORY
COMMITTEE FOR AERONAUTICS

Figure 15.- Vertical clearance required for flexible seals with circular-arc backplates.

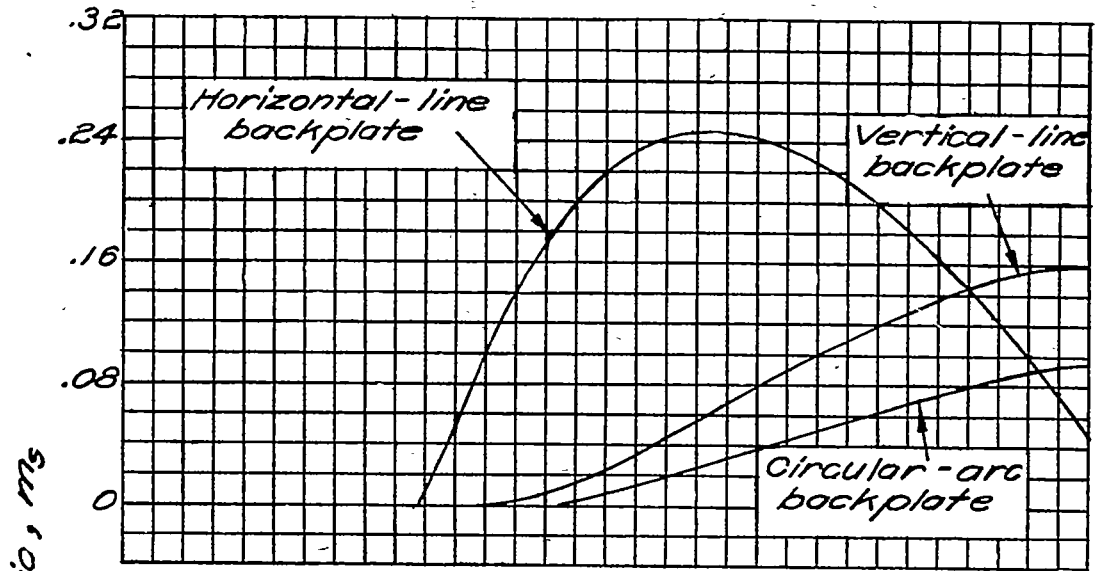

(a) $g = 0.1 ; s = 0.6$.

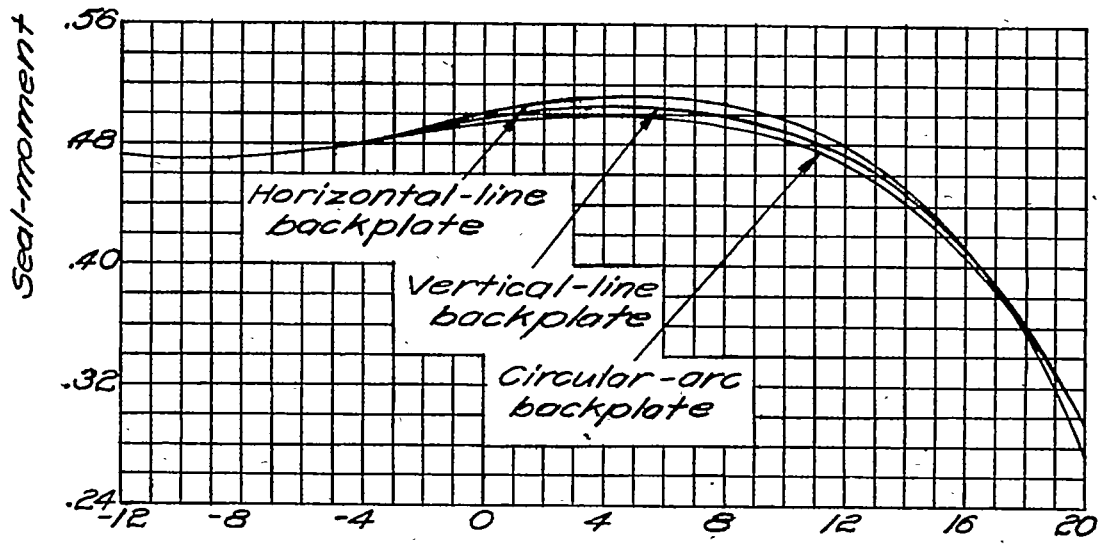

Overhang deflection, δ_b , deg

(b) $g = 0.5 ; s = 0.9$.

NATIONAL ADVISORY
COMMITTEE FOR AERONAUTICS

Figure 16.- Moment characteristics of two seals having three different backplates.

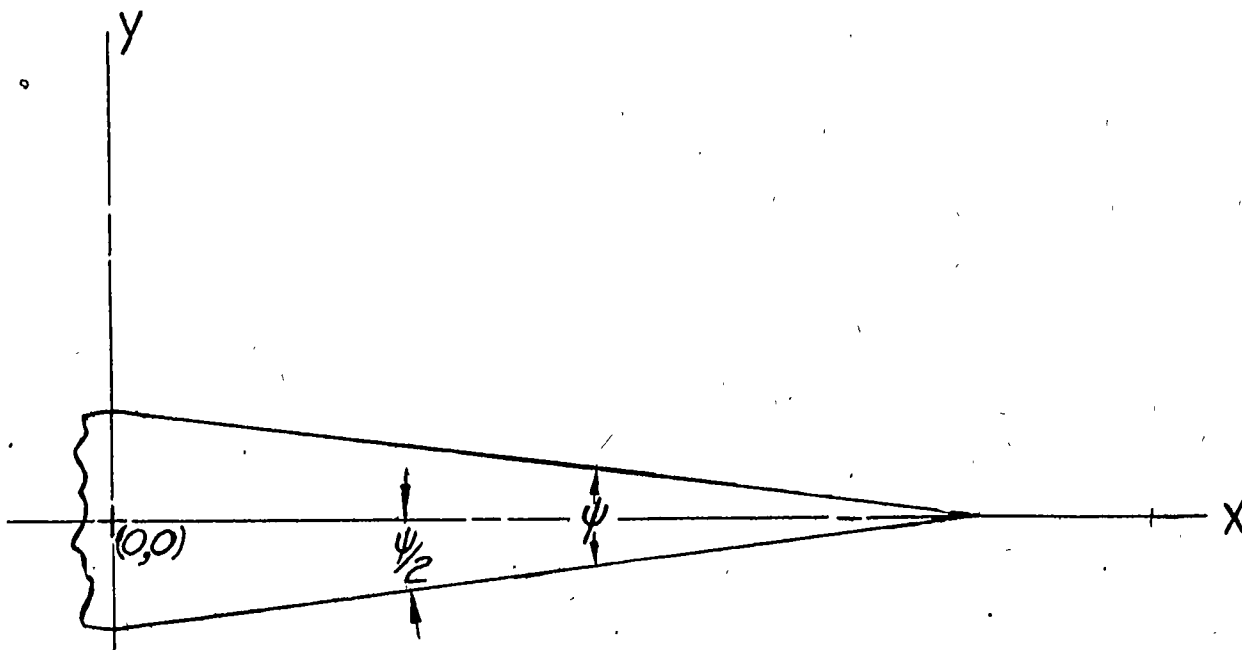

NATIONAL ADVISORY
COMMITTEE FOR AERONAUTICS

Figure 17.- Modification of the overhang cross section that will not appreciably alter seal moments.

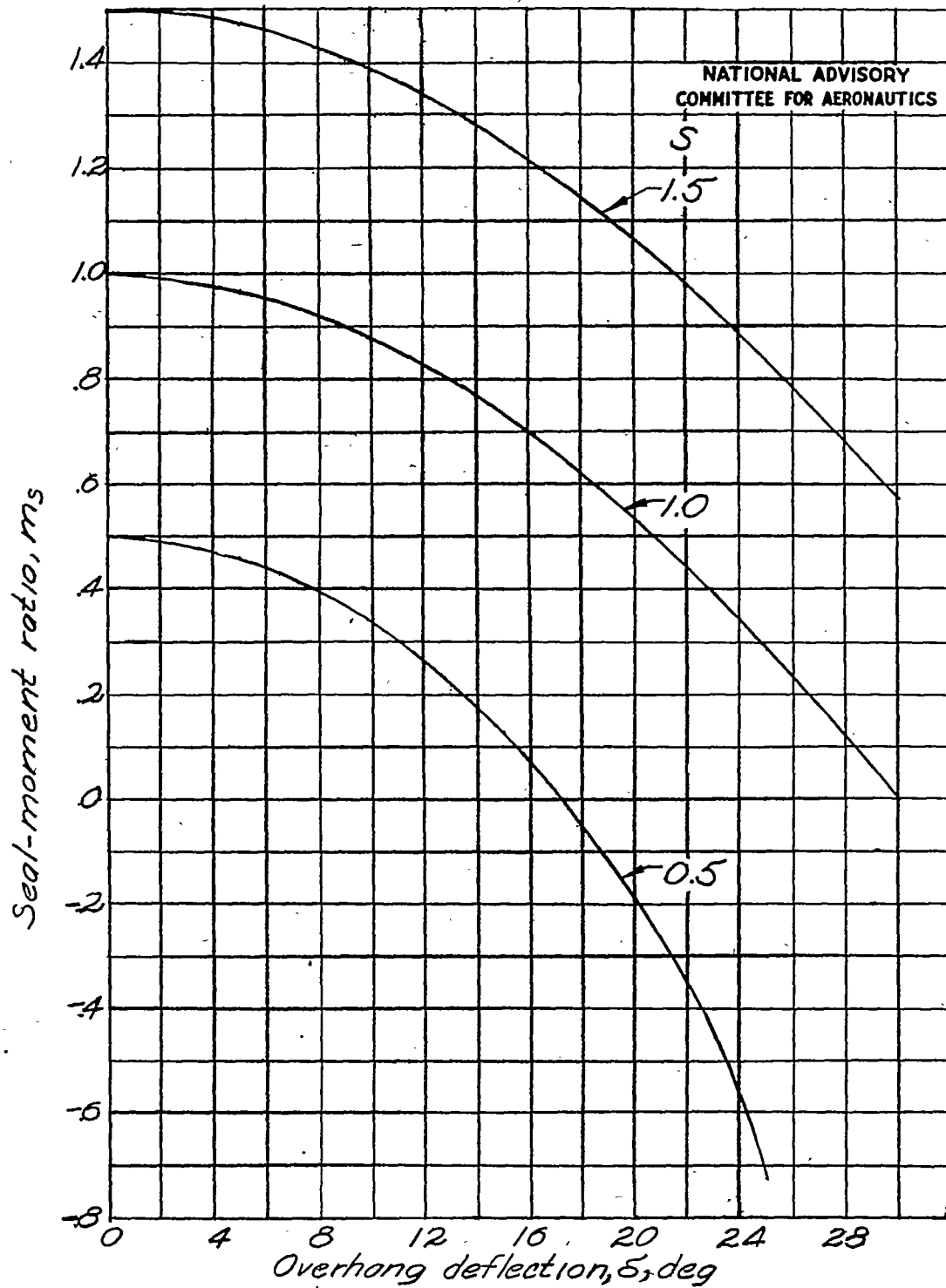
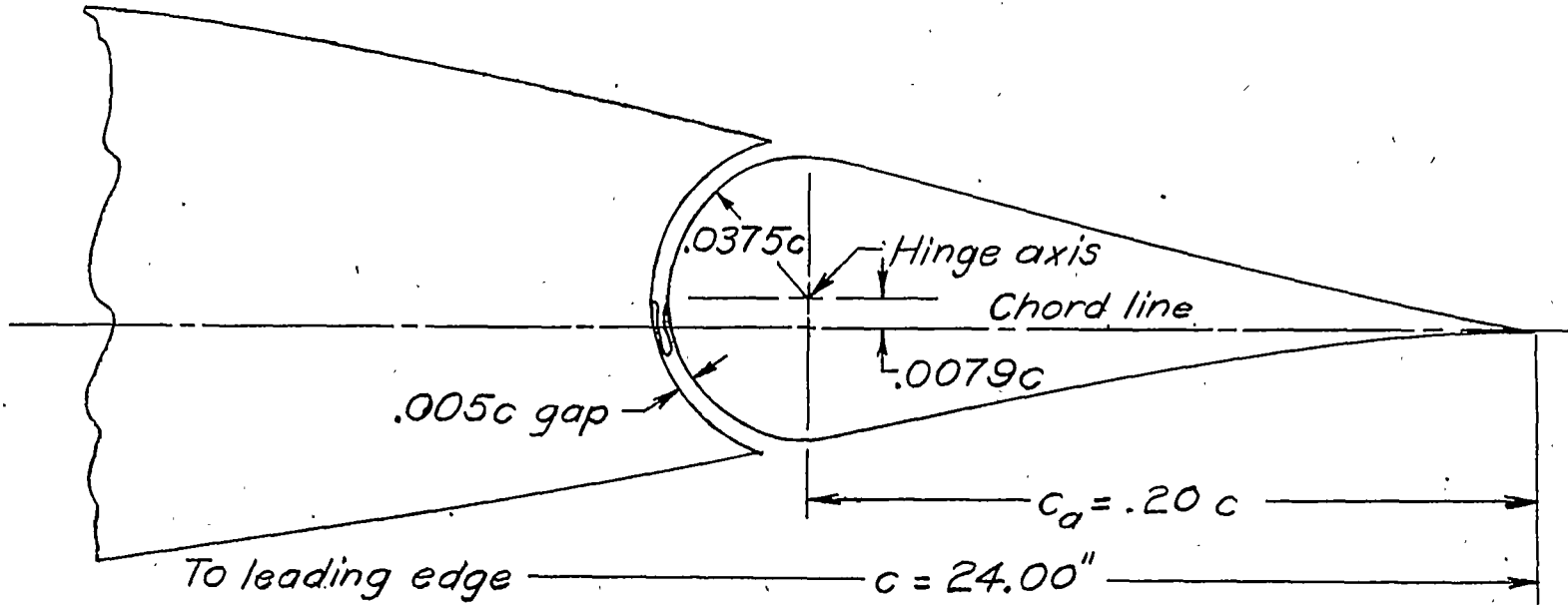

Figure 18.- Moment characteristics of linked-plate seals.



NATIONAL ADVISORY
COMMITTEE FOR AERONAUTICS

Figure 19.- True-contour plain sealed aileron on an airfoil section.

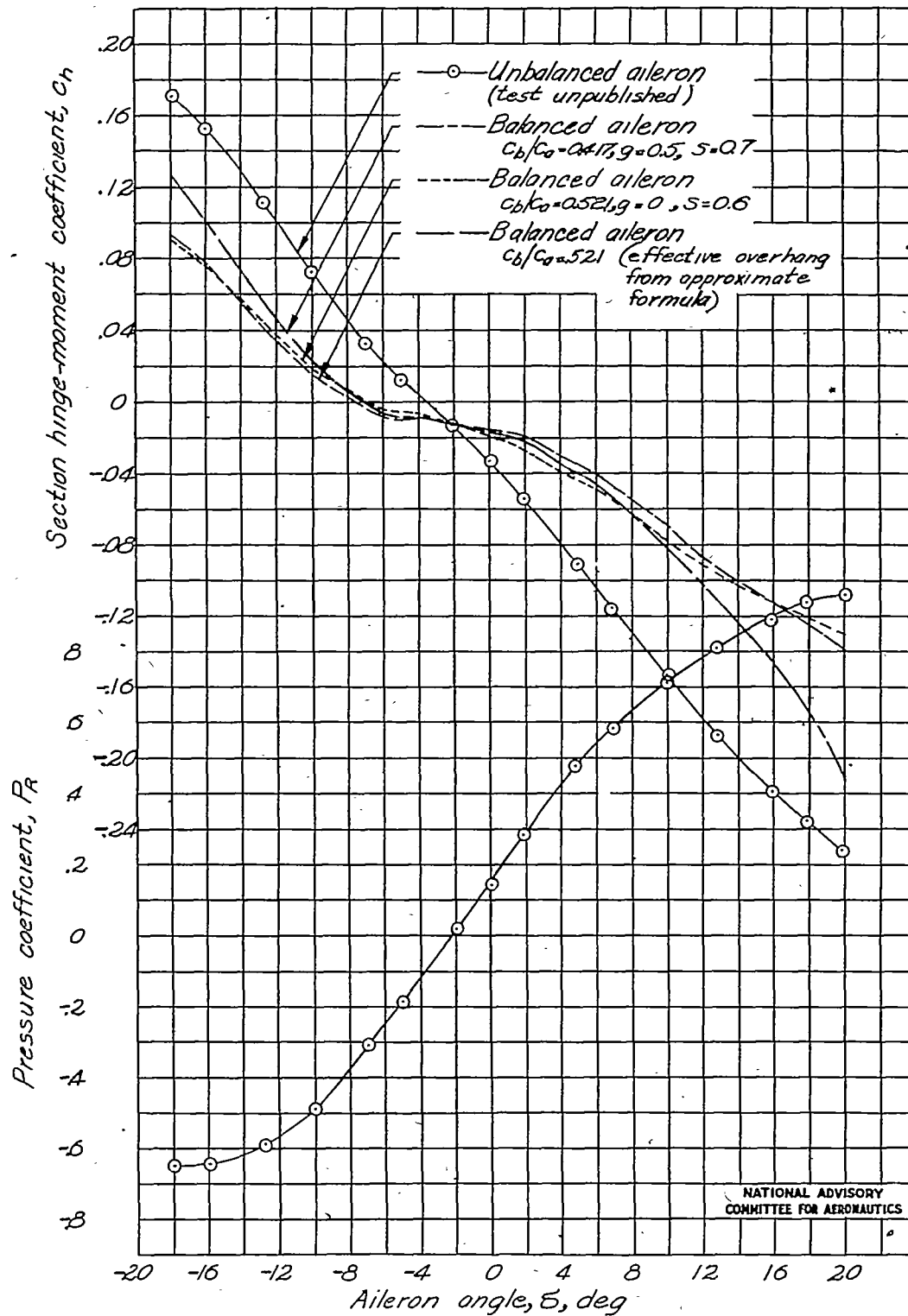

Figure 20.- Hinge-moment characteristics of an aileron on an airfoil section having two balance configurations with the same effective overhang and vertical-line backplates. $\alpha = 0^\circ$.

DD FORM (10 FEB 57)

Murray, H. E.
Erwin, M. Q.

R-7-3-15

ATI- 13665

DIVISION: Stress Analysis and Structures (7)

SECTION: Structural Design and Details (3)

CROSS REFERENCES: Control surfaces - Structural design
(25900); Control surfaces - Aerodynamic balancing
(25500); Control surfaces - Hinge moments (25705)

ORIG. AGENCY NUMBER

ARR-15F30

REVISION

AUTHOR(S)

AMER. TITLE: Hinge moments of sealed internal balance arrangements for control surfaces - I -
Theoretical investigation

FORG'N. TITLE:

ORIGINATING AGENCY: National Advisory Committee for Aeronautics, Washington, D. C.

TRANSLATION:

COUNTRY	LANGUAGE	FORG'N. CLASS.	U. S. CLASS.	DATE	PAGES	ILLUS.	FEATURES
U.S.	Eng.		Unclass.	Aug '45	41	21	table, diagrs, graphs

ABSTRACT

The analysis considers overhangs sealed to various types of wing structure by flexible seals spanning gaps of various widths or sealed to the wing structure by flexible system of linked plates. Results of the investigation indicated that the most nearly linear control-surface hinge-moment characteristics can probably be obtained from a flexible seal over a narrow gap which is so installed that the motion of the seal is restricted to a region behind the point of attachment of the seal to the wing structure.

NOTE: Requests for copies of this report must be addressed to: N.A.C.A.,
Washington, D. C.