

FILE COPY
NO. I-W

MR July 1944

CASE FILE COPY

NATIONAL ADVISORY COMMITTEE FOR AERONAUTICS

WARTIME REPORT

ORIGINALLY ISSUED
July 1944 as
Memorandum Report

FLIGHT TESTS OF VARIOUS TAIL MODIFICATIONS

ON THE BREWSTER XSBA-1 AIRPLANE

III - MEASUREMENTS OF FLYING QUALITIES

WITH TAIL CONFIGURATION 3

By H. L. Crane and J. P. Reeder

Langley Memorial Aeronautical Laboratory
Langley Field, Va.

FILE COPY
To be returned to
the files of the National
Advisory Committee
for Aeronautics
Washington D. C.



WASHINGTON

NACA WARTIME REPORTS are reprints of papers originally issued to provide rapid distribution of advance research results to an authorized group requiring them for the war effort. They were previously held under a security status but are now unclassified. Some of these reports were not technically edited. All have been reproduced without change in order to expedite general distribution.

NATIONAL ADVISORY COMMITTEE FOR AERONAUTICS

MEMORANDUM REPORT

for the

Bureau of Aeronautics, Navy Department
FLIGHT TESTS OF VARIOUS TAIL MODIFICATIONS
ON THE BREWSTER XSBA-1 AIRPLANE
III - MEASUREMENTS OF FLYING QUALITIES
WITH TAIL CONFIGURATION 3

By H. L. Crane and J. P. Reeder

INTRODUCTION

At the request of the Bureau of Aeronautics, Navy Department, a series of tests on the Brewster XSBA-1 airplane is being conducted to determine the effects of various tail modifications. The modifications include (1) variations of the chord of the elevator and rudder while the span and total area of the surfaces are kept constant and (2) variations of the total area of the vertical tail surface. This report presents the results of the tests of the narrow-chord movable surfaces of tail configuration 3 and a comparison of these results with those obtained for the wide-chord movable surfaces of tail configurations 1 and 2. Only those handling qualities affected by the modifications of the tail will be considered. The flight tests were conducted at the Langley Memorial Aeronautical Laboratory between November 1942 and October 1943.

DESCRIPTION OF BREWSTER XSBA-1 AIRPLANE

The XSBA-1 airplane is a two-place, single-engine, midwing, cantilever monoplane with retractable landing gear. For this series of investigations, the cut-outs in the flaps were covered to give conventional partial-span split flaps. The general specifications of the airplane are given in reference 1. Figure 1 is a

three-view drawing of the airplane with tail configuration 1. Figure 2 is a side-view photograph of the airplane with tail configuration 3.

TAIL CONFIGURATIONS

The surfaces of tail configuration 1, which are shown in figures 3 and 4, were horn-balanced and had approximately equal movable and fixed areas. The surfaces of configuration 2 (figs. 5 and 6) had approximately equal movable and fixed areas but were not horn-balanced. The elevator area of configuration 3 (figs. 7 through 10) was reduced to about 25 percent of the total horizontal area and the rudder area was reduced to 35 percent of the total vertical-tail area. Figure 11 shows trailing-edge sections of the various tail surfaces. The positions of the hinge lines with reference to the fuselage were the same in all cases so that the tail length of tail 3 was about 1 foot less in l_7 than that of tails 1 and 2.

The elevator and rudder of tail configuration 1 were mass-balanced with lead in the horns. The elevators and rudders of configurations 2 and 3 were mass-balanced with lead mounted on loops which passed through the fixed surfaces.

No seals were used on the control surfaces.

A table of tail-surface area for the three configurations follows:

L-599

| Configuration | 1 | 2 | 3 |
|--|---------------------------------------|------|-------------------|
| Fin, above fuselage, ahead of hinge line | 12.1 excluding horn | 12.4 | 16.2 |
| Rudder, behind hinge line | 13.9 including 1.5 horn balance | 13.6 | 9.6 |
| Total vertical tail | 26.0 | 26.0 | 25.8 |
| Rudder trimming tab | None | .9 | .7 |
| Stabilizer, ahead of hinge line, including fuselage area | 30.6 excluding horn | 33.3 | 49.8 |
| Elevator, behind hinge line | 30.6 including 2.7 horn balance | 27.9 | 13.8 |
| Total horizontal tail | 61.2 | 61.2 | ^a 63.6 |
| Elevator trimming tab | 1.7 | 1.7 | 1.7 |

^aThe increase in total area is due to increase in included fuselage area.

The relations between control positions and control-surface deflections are shown in figure 12. Figure 13 is a calibration of the elevator trimming tab. The stabilizer incidence was 0° from the thrust axis. Elevator angles were measured from the thrust axis.

INSTRUMENT INSTALLATION

A description of the instrument installation is given in reference 1. Deflections of the rudder and

elevator were either measured at the surface or corrected for cable stretch. Aileron deflections were not corrected for cable stretch.

AIRSPEED CALIBRATION

The calibration of the airspeed recorder was made by the use of a trailing airspeed bomb. The airspeeds referred to in this report as correct service indicated airspeeds were obtained from the difference in total and static pressure corrected for position error and for compressibility at sea level using the formula

$V_i = 45.08 f_o \sqrt{q_c}$, where q_c is the correct difference between static and total pressures in inches of water and f_o is the compressibility correction at sea level.

TESTS, RESULTS, AND DISCUSSION

With tail configuration 3, measurements of longitudinal stability and control were made with the center of gravity at approximately 25, 31, and 35 percent of the mean aerodynamic chord. Measurements of lateral stability and control for configuration 3 and all measurements for other configurations were made at the 25-percent center-of-gravity position. The weight of the airplane varied from 5400 to 6000 pounds or the wing loading varied from 21 to 23 pounds per square foot. The vertical location of the center of gravity was about 3 percent of the mean aerodynamic chord above the thrust axis for the airplane with full gas load and landing gear up or about 1 percent of the mean aerodynamic chord above the thrust axis with the landing gear extended. Retracting the landing gear had no effect on the horizontal location of the center of gravity.

The effect of fuel consumption on the center-of-gravity position was small enough to be ignored in the tests of tail configurations 1 and 2. However, during the tests of tail configuration 3, which were to be used for neutral-point determinations, the shift of the center-of-gravity position due to fuel consumption was approximated.

Longitudinal Stability and Control

Characteristics of uncontrolled longitudinal motion.-

The degree of damping of the short-period oscillation was determined by quickly deflecting and releasing the elevator in high-speed flight. For each of the tail configurations with the center of gravity at 25 percent mean aerodynamic chord, the requirement that the subsequent variation of normal acceleration and elevator angle should have completely disappeared after 1 cycle was satisfied. Figure 14 is a plot of two short-period oscillations with tail configuration 3.

The long-period (phugoid) oscillation was not investigated.

Characteristics of elevator control in steady flight.- The characteristics of the elevator control of the XSBA-1 airplane in steady flight with the various tail configurations were measured by recording the elevator positions and forces required for trim at various airspeeds and trimming-tab settings. These measurements were made in the following conditions of flight:

| Flight condition | Manifold pressure at 6000 ft (in. Hg) | Engine speed (rpm) | Approx. power (hp) | Flap position | Landing-gear position |
|------------------|---------------------------------------|--------------------|--------------------|---------------|-----------------------|
| Cruising | 25 | 1800 | 500 | Up | Up |
| Climbing | 32 | 1800 | 650 | Up | Up |
| Gliding | Throttle closed | ----- | ----- | Up | Up |
| Landing | Throttle closed | ----- | ----- | Down | Down |
| Approach | 18 | 1900 | 360 | Half down | Down |
| Wave-off | 34 | 2100 | 800 | Down | Down |

The results of the tests of the elevator control characteristics with the various tail modifications may be summarized as follows:

1(a). With tail configuration 3 and with the center of gravity at 25 percent of the mean aerodynamic chord, the airplane was stable, stick fixed, for all flight conditions at low speeds. At the upper end of

L-599

the speed range, the stick-fixed static stability had decreased but was still at least slightly positive for all flight conditions. This is illustrated by the curves of elevator position against airspeed in figures 15 through 20.

1(b). The stick-fixed neutral points have been determined for the airplane with tail 3 at lift coefficients of 0.4 and 1.0 from flight tests at three center-of-gravity positions. Figure 21 contains the plots of $d\delta_e/dC_L$ against center-of-gravity position, where δ_e is elevator position and C_L is airplane lift coefficient, from which the stick-fixed neutral points were determined. Figure 22, a plot of δ_e against C_L , illustrates for one condition, landing, the intermediate step between the plots of elevator deflection against airspeed and the plots of $d\delta_e/dC_L$ against center-of-gravity position.

Values of $d\delta_e/dC_L$ for tails 1 and 2 for the one test center-of-gravity position are plotted in figure 21. Although it is not always true, in general the values of $d\delta_e/dC_L$ for tails 1 and 2 are about equal and about two-thirds of the corresponding value for tail 3. Values of $d\delta_e/dC_L$ for tails 1 and 2 would be expected to be equal because the areas behind the hinge line were the same. The value for tail 3 would be expected to be about 50 percent greater because of its reduced elevator chord. The stick-fixed neutral points should be approximately the same for the three tails because the aspect ratios and products of tail area times tail length are nearly the same.

The airplane was stable, stick fixed, in all conditions except wave-off with the center of gravity back to about 29 percent mean aerodynamic chord and satisfied the requirement of reference 3 to that point. A table of neutral points is given in paragraph 2(b).

The slopes of the curves of $d\delta_e/dC_L$ against center-of-gravity position are greatest with power off at high lift coefficients and least with power on at high lift coefficients. The slope of these curves varies with the ratio q_t/q , where q_t is impact pressure at the tail and q is free-stream impact

L-555

pressure. With power on at low speeds, q_t/q would be a maximum and with power off at low speeds, a minimum. It was found during tests of the airplane in the full-scale tunnel that due to the sharpness of the cowling q_t/q became as low as 0.8 in the power-off condition at low speed.

2(a). The curves of elevator control force against indicated airspeed in figures 15 through 20 show the degree of stick-free static stability of the XSBA-1 airplane with tail configuration 3 with the trimming tabs undeflected. The force curves for the two center-of-gravity positions are parallel as would be expected with the same trimming-tab setting. With the center of gravity at 25 percent of the mean aerodynamic chord the airplane was stable, stick free, in all conditions except wave-off for any trim speed within the speed range for that flight condition. This statement is based on the calculated elevator force curves for various trim speeds which can be found using the power of the elevator trimming tabs as given by figure 24.

A summary of the stick-free static-stability characteristics with the three tail configurations for the 25-percent center-of-gravity position follows:

| Condition | Configuration - 1 | 2 | 3 |
|-----------|-------------------|----------|---------|
| Gliding | Stable | Stable | Stable |
| Cruising | -----do----- | Neutral | Do. |
| Climbing | -----do----- | ---do--- | Do. |
| Approach | -----do----- | ---do--- | Do. |
| Landing | -----do----- | Stable | Do. |
| Wave-off | -----do----- | Unstable | Neutral |

Due to the peculiar reversal of the elevator control force variation with speed which occurred with tail 2 in the cruising, climbing, and approach conditions, the airplane was unstable over part of the speed range in these conditions and did not satisfy the requirements of reference 3.

2(b). The stick-free neutral points have been determined at lift coefficients of 0.4 and 1.0 for the airplane with tail configuration 3 from flight tests at three center-of-gravity positions. Figure 23 contains plots of the variation of F/q_c with C_L against center-of-gravity position, where F is elevator control force and q_c is impact pressure, from which the neutral points are determined. The intermediate step, a plot of F/q_c against C_L , is again illustrated for one condition by figure 22.

With tail configuration 3 the airplane was stable, stick free, with the center of gravity back to about 27.5 percent mean aerodynamic chord in all conditions except wave-off. A table of neutral points, both stick free and stick fixed, for the XSBA-1 airplane with tail configuration 3 follows:

| Condition | C_L | Neutral point, stick fixed | Neutral point, stick free |
|-----------|-------|-------------------------------|------------------------------|
| Gliding | 0.4 | 35 | 35 |
| | 1.0 | 39 | 36 |
| Cruising | .4 | 30 | 28 |
| | 1.0 | 41 | 32 |
| Climbing | .4 | 29 | 27 |
| | 1.0 | 40 | 31 |
| Landing | .4 | 35 | 34 |
| | 1.0 | 35 | 35 |
| Approach | .4 | 31 | 29 |
| | 1.0 | 31 | 29 |
| Wave-off | .4 | 27 | 24 |
| | 1.0 | 27 | 24 |

The table indicates that the stick-fixed neutral points are usually aft of the stick-free neutral points.

3. For the airplane with tail configuration 3 with the center of gravity at 25 percent of the mean

L-599

aerodynamic chord the elevator did not have sufficient power to stall the airplane in the landing condition either at altitude or during an actual landing, as shown by figures 22 and 34. With the wider chord surfaces of tails 1 and 2 the elevator angles required for trim were well within the available range for all flight conditions.

Characteristics of elevator control in accelerated flight.- The characteristics of the elevator control of the XSBA-1 airplane in accelerated flight were determined from measurements taken in abrupt pull-ups and push-downs from level flight, and in turns. The results of the pull-ups and push-downs with tail configuration 3 are presented in figure 25. Time histories of representative turns are presented in figures 26 to 29. The variation of stick force with normal acceleration and elevator position with C_L in turns for three center-of-gravity positions is plotted in figures 30 to 32. Figure 33 shows the stick-fixed and stick-free neutral points for accelerated conditions.

The results of these tests may be summarized as follows:

1. With tail configurations 1 and 2 the elevator control was sufficiently powerful to develop either the maximum lift coefficient or the allowable load factor at every airspeed. With the narrow-chord elevators of tail configuration 3, full up-elevator deflection was required to make a 3.5g stalled turn with the center of gravity at 25 percent mean aerodynamic chord.
2. With all three tails the normal acceleration was observed to increase progressively with elevator angle.
3. With tail configurations 1 and 2 the stick motion required to go quickly from a lift coefficient of 0.2 to the stall was over 4.5 inches and, with tail 3, over 7 inches for the 25-percent center-of-gravity position. It is believed that, with the center of gravity at 29 percent, the requirement of 4-inch travel would at least be nearly satisfied with all three configurations.

4. With any of the three tails the change in normal acceleration was proportional to the elevator control force applied.

5. The force per g to make a turn was 30 pounds with tail 1, 27 pounds with tail 2, and 20 pounds with tail 3 for the 25-percent center-of-gravity position. With tail 3 the force was about 15 pounds per g with the center of gravity at 30 percent of the mean aerodynamic chord, which would be a reasonable upper limit of force per g for this type of airplane.

6. The values of the rate of change of elevator hinge-moment coefficient with elevator deflection and with angle of attack, $C_{h\delta}$ and $C_{h\alpha}$, for tail 3 have been calculated from the turn data. The value of $C_{h\delta}$ was between -0.010 and -0.011 per degree; that of $C_{h\alpha}$ was between 0 and -0.001 per degree.

Characteristics of elevator control in landing.-

It was not possible to make a three-point landing with tail configuration 3 when the center of gravity was at 25 percent of the mean aerodynamic chord using full up-elevator deflection of 23.5° . With configurations 1 and 2, 21° of up-elevator deflection was sufficient to produce a three-point landing. On the XSBA-1 the same amount of elevator deflection is required to stall in the landing condition at altitude as to land.

Figure 34 is a plot of elevator deflection required to land against center-of-gravity position for the airplane with tail 3.

The elevator control force required to land was about 41 pounds with tail configurations 1 and 2, which exceeded by 6 pounds the upper limit recommended in reference 3. The force required to deflect fully the elevator of tail 3 during landing was approximately 26 pounds.

Characteristics of elevator control in take-off.-

For any one of the tail configurations for all test center-of-gravity positions the elevator control was adequate to adjust the attitude angle as desired during take-off.

Longitudinal trim changes due to power and flaps.-

The trim change caused by lowering the flaps was in the direction tending to cause the airplane to nose up. Application of power produced a nosing-up tendency and lowering the landing gear produced a nosing-down tendency. The following table illustrates the magnitude of the trim changes at an airspeed of 120 miles per hour with the trimming tabs at 0° , the position for trim in the gliding condition at about 160 miles per hour.

| Condition | | | Trim change by configurations | | |
|-----------|--------------|----------|-------------------------------|----------------------|----------------------|
| Flaps | Landing gear | Power | ΔF_1 (lb) | ΔF_2 (lb) | ΔF_3 (lb) |
| Up | Up | Off | 0 | 0 | 0 |
| Down | Down | Off | 17 push | 9 push | 5 push |
| Down | Down | Wave-off | 40 push | 22 push | 18 push |

The upper limit recommended in reference 3 for trim changes due to power and flaps was 35 pounds. Configurations 2 and 3 easily satisfy this requirement (with the trimming tabs neutral). However, the pilot found the trim changes due to power and flaps objectionable because of their direction.

Characteristics of longitudinal trimming device.-

1. As is shown in figures 3, 5, and 7, the elevator trimming tabs on the three tail configurations were of the same area. The power of the tab on tail 3 in pounds of stick force per degree of tab deflection, shown in figure 24, was about one-third that of the tabs on tails 1 and 2. With a deflection range of $\pm 11^\circ$ the elevator trimming tab on tail 3 was inadequate in the landing condition. For every 3.5° of tab deflection on tail 3, 1° of elevator deflection in the opposite direction was required to trim the airplane at a given speed.

2. Unless changed manually, the trimming tabs retained a given setting indefinitely.

Lateral Stability and Control

Characteristics of uncontrolled lateral and directional motion.- The control-free lateral oscillation of the airplane with tail configuration 3 damped to one-half amplitude in about one-half cycle, as shown in figure 35, satisfying the requirement of reference 3. The rate of damping decreased slightly with speed. With either tail 2 or tail 3 the period and rate of damping were the same. The number of cycles required to damp to one-half amplitude with tail 1 increased from one-half to $1\frac{1}{2}$ with airspeed. The period of the oscillation was about two-thirds as long throughout the speed range with tail configuration 1 as with tails 2 and 3. The relation of yaw angle to rudder angle showed that rudder 2 floated with the relative wind thus decreasing the effective angle of attack and restoring tendency of the vertical tail, and rudder 1 floated against the relative wind with the opposite effect, as would be expected with a horn balance. Rudder 3 also had a slight tendency to float with the relative wind. This is the reason why the period of the lateral oscillation was longer and the damping more rapid with tail configurations 2 and 3.

Rudder control characteristics.- The rudder control characteristics were measured in steady flight, in rolls, in sideslips, and in abrupt rudder kicks. In the rudder-kick maneuvers, records were taken of rudder position, rudder force, rolling velocity, yawing velocity, and sideslip angle resulting from abrupt deflections of the rudder in steady flight while the other controls were held fixed. The results of the rudder kicks are shown in figures 36 through 38. The results of the sideslips are shown in figures 39 through 46. The rolls were made as turn entries with full aileron deflection using the rudder to maintain zero sideslip and also with the rudder locked in its trim position. Figures 47 through 51 are time histories of these maneuvers.

A summary of rudder control characteristics follows:

1. The rudder control with tail configuration 3 was not sufficiently powerful to overcome the adverse aileron yawing moment in all conditions tested. This is shown in figure 48(a), a right roll in the cruising condition at 82 miles per hour using full aileron

deflection. The rudders of configurations 1 and 2 met this requirement although almost full rudder deflection was necessary in some flight conditions.

2. The rudders of all three tail configurations were sufficiently powerful to maintain directional control during take-off and landing.

3. The amount of rudder deflection required to trim the airplane for level flight in various conditions is shown in figures 15 through 20. Considerably more rudder deflection was required with the narrow-chord rudder of tail 3 than with rudders 1 and 2. The pilot stated that in some runs he "ran out of rudder" near the stall in the wave-off condition with tail configuration 3 but did not consider the rudder control inadequate on this account. In these instances the correct rudder deflection was almost 20° compared with about 10° required with rudders 1 and 2. Because of differences in the gas loading in the wing tanks, there may have been differences in the lateral position of the center of gravity which would have affected the amount of rudder deflection required for trim. Inasmuch as no records were kept of the lateral loading conditions, the effects of this variable on the rudder deflection were not determined. Subsequent flight tests have shown that a lateral center-of-gravity shift of a few inches produces a large effect on the amount of rudder deflection required for trim near the stall.

4. The effectiveness of the rudder control in recovery from spins was not investigated.

5. The rudder control force was proportional to rudder deflection with each of the tail configurations. Right-rudder force was required to hold right-rudder deflections and left-rudder force, to hold left-rudder deflections.

6. The rudder control forces required to produce a given angle of sideslip were about 25 percent larger with tail 1 than with tail 2. Rudders 2 and 3 were about equally heavy for small angles of sideslip. For larger angles of sideslip, rudder 3 was slightly heavier than rudder 2. However, for a given deflection at zero sideslip, rudder 3 was considerably lighter than rudder 2. With rudder 3, a right force increment of about 185 pounds was required to deflect the rudder

fully in an attempt to overcome the yawing moment due to full aileron deflection in the cruising condition at 85 miles per hour. The increment of force required to overcome the aileron yaw was 240 pounds at 110 miles per hour. Data obtained from turn entries with tails 1 and 2 indicated that the rudder force required to overcome the yawing moment due to full aileron deflection at low speed was about 150 pounds. Complete data were not obtained for configurations 1 and 2, but the largest recorded trimming force with the tab neutral was 75 pounds at 56 miles per hour in the wave-off condition. With rudder 3, for the same condition and speed, the force required to hold zero sideslip was approximately 40 pounds. The pilot considered the magnitude of the directional trim changes with speed with tail 3 very satisfactory compared to those of other single-engine airplanes.

Values of change in hinge-moment coefficient ΔC_h with deflection for constant angle of attack and corresponding values of $\Delta C_h/\Delta\delta$ were calculated for all three rudders from the initial portion of rudder kicks where the rudder had been deflected, but the sideslip angle had not started to change. Values of change in hinge-moment coefficient ΔC_h with angle of attack and $\Delta C_h/\Delta\alpha$ were calculated for the latter portion of the rudder kicks during which the sideslip angle built up and the deflection was held constant. This calculation assumed that the change in angle of attack at the tail was equal to the measured change in sideslip. The method of calculation of $\Delta C_h/\Delta\alpha$ took account of any slight changes of rudder deflection that occurred. The results are plotted in figures 52 through 56. The values of $\Delta C_h/\Delta\alpha$ for rudder 1, which are not plotted, were very slightly positive.

With rudder 3, forces in excess of 180 pounds were required, so that this rudder was too heavy according to reference 3. It should be remembered that the tail length of tail 3 was somewhat shorter (5 percent) than that of tails 1 and 2. The value of $\Delta C_h/\Delta\delta$ (figs. 52 through 54) was largest for rudder 3. These factors plus the reduced effectiveness of the narrow-chord surface offset the tendency of the reduced chord and area to reduce the rudder control forces.

Pitching moment due to sideslip.- It was recommended in reference 3 that not more than 1° of elevator movement should be required to counteract the pitching moment due to steady sideslip caused by 5° of rudder deflection right or left from the trim position. For the XSBA-1 airplane with tail configurations 1 and 2, a maximum of $1\frac{1}{2}^\circ$ of elevator motion was required. With the narrow-chord elevators of configuration 3, the maximum was about $3\frac{1}{2}^\circ$ in the cruising condition at 87 miles per hour, although in all other conditions tested the elevator motion was small. The pilot did not consider the magnitude of pitching moment due to sideslip objectionable.

CONCLUSIONS

The comparison, as far as possible, of the handling qualities of the XSBA-1 airplane with the three tail configurations may be summarized as follows:

Longitudinal Stability and Control

1. The XSBA-1 airplane was statically stable, stick fixed, with the center of gravity back to 29 percent mean aerodynamic chord, except in the wave-off condition. The stability was small with power on at low lift coefficients. The data generally indicated that the variation of elevator angle with lift coefficient was about 50 percent greater with tail configuration 3, which had the narrow-chord elevator.

2. The stick-free static stability was satisfactory for the 25-percent center-of-gravity position with tail configurations 1 and 3. Due to the peculiar reversal of the elevator control force variation with speed which occurred with tail 2 in the cruising, climbing, and approach conditions, the airplane was unstable over part of the speed range in these conditions for the 25-percent center-of-gravity position. With tail configuration 3, the airplane was stable, stick free, with center of gravity back to about 27.5 percent mean aerodynamic chord in all conditions except wave-off.

3. The average elevator control force gradient was 30, 27, and 20 pounds per g with tail configurations 1, 2, and 3 with the center of gravity at 25 percent mean aerodynamic chord. With the center of gravity at 30 percent mean aerodynamic chord, the gradient with tail 3 was about 15 pounds per g, which would be a reasonable upper limit for this type of airplane.

4. The stick travel required to go from cruising speed to the stall in maneuvers was satisfactory. It was about 4.5 inches with tails 1 and 2, and 7 inches with tail 3, with the center of gravity at 25 percent mean aerodynamic chord.

5. The elevator control force required to land with tail configurations 1 and 2 with the center of gravity at 25 percent of the mean aerodynamic chord exceeded by about 5 pounds the limit of 35 pounds recommended by reference 3. For this center-of-gravity position the elevator control with tail configuration 3 was not sufficient to make a three-point landing.

6. The trim changes due to power and flaps were smallest with tail configuration 3 and excessive only with tail configuration 1 for which the maximum change in force for trim caused by power and flaps at any airspeed with the trimming tab undeflected was about 40 pounds.

7. As indicated in section 5, the elevator control was inadequate with tail configuration 3. It was not possible to make a three-point landing or reach the stall in turns with the 25-percent center-of-gravity position.

8. The rudder control was adequate with tails 1 and 2. With tail configuration 3 the rudder control was not sufficient to overcome aileron yaw in the cruising condition at low speed. The power of rudder 3 to trim the airplane for straight flight near the stall in the wave-off condition was inadequate. Rudder 1 was about 25 percent heavier than rudder 2 in sideslips. Rudder 3 was slightly heavier than rudder 2 for large angles of sideslip. The force required to overcome the yawing moment due to full aileron deflection with rudder 3 was excessive and was probably

greater than for rudders 1 and 2. The directional trim changes with speed were satisfactorily small.

Langley Memorial Aeronautical Laboratory
National Advisory Committee for Aeronautics
Langley Field, July 12, 1944

I-599

REFERENCES

1. Phillips, W. H., and Nissen, J. M.: Flight Tests of Various Tail Modifications on the Brewster XSBA-1 Airplane. I - Measurements of Flying Qualities with Original Tail Surfaces. NACA ARR No. 3FO7, 1943.
2. Phillips, W. H., and Crane, H. L.: Flight Tests of Various Tail Modifications on the Brewster XSBA-1 Airplane. II - Measurements of Flying Qualities with Tail Configuration Number Two. NACA MR, Dec. 2, 1943.
3. Gilruth, R. R.: Requirements for Satisfactory Flying Qualities of Airplanes. NACA ACR, April 1941.

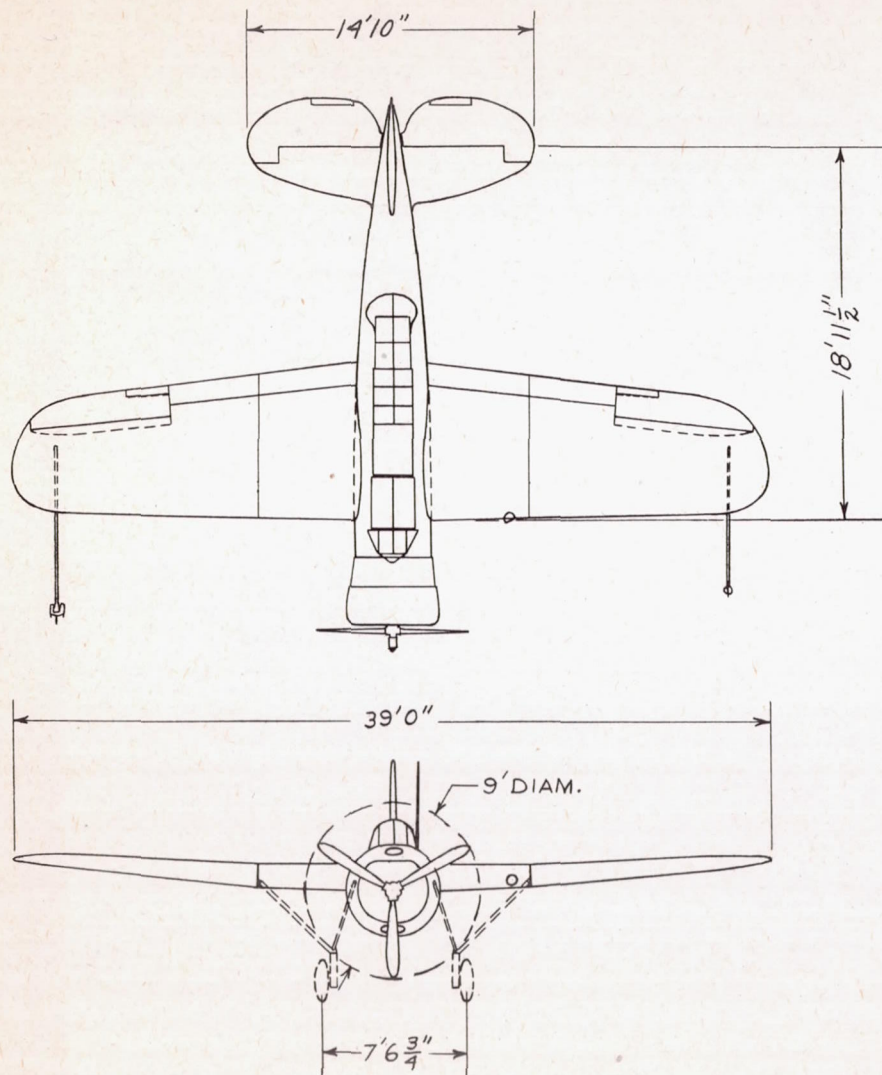

NATIONAL ADVISORY
COMMITTEE FOR AERONAUTICS

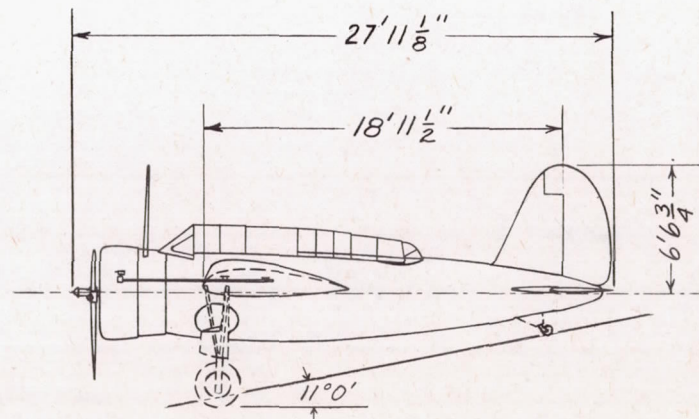
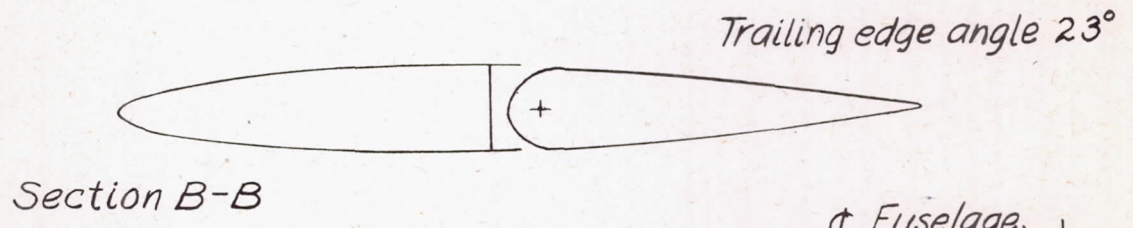
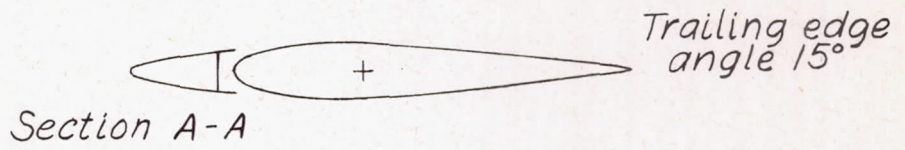

Figure 1.- Three-view drawing of Brewster XSBA-1 airplane with configuration 1.



Figure 2.- Side view of Brewster XSBA-1 with tail configuration 3.



NATIONAL ADVISORY
COMMITTEE FOR AERONAUTICS

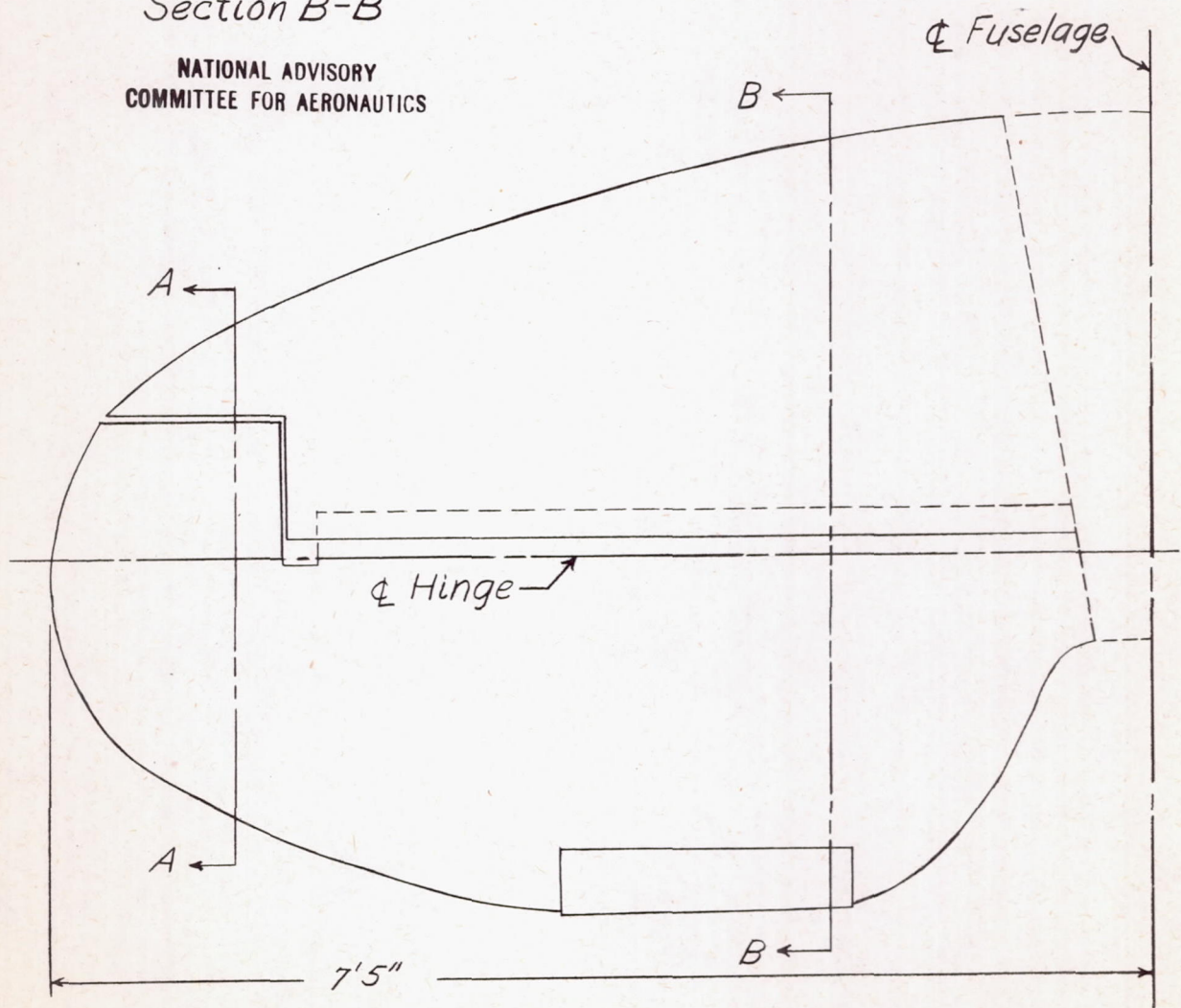
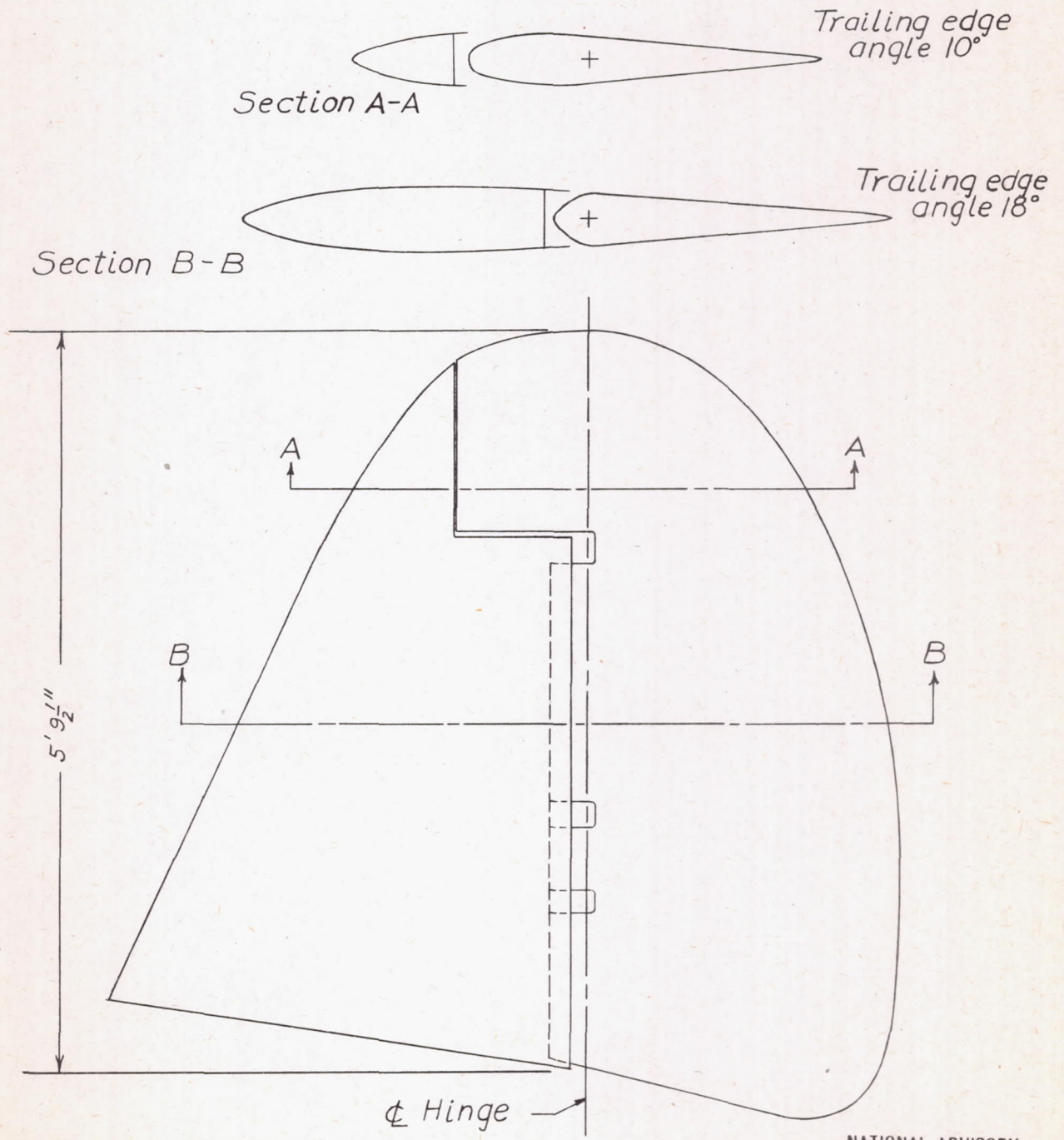

Figure 3.- Horizontal tail configuration number one. Brewster XSBA-1 airplane.



NATIONAL ADVISORY
COMMITTEE FOR AERONAUTICS

Figure 4.- Vertical tail configuration number one. Brewster XSB-1 airplane.

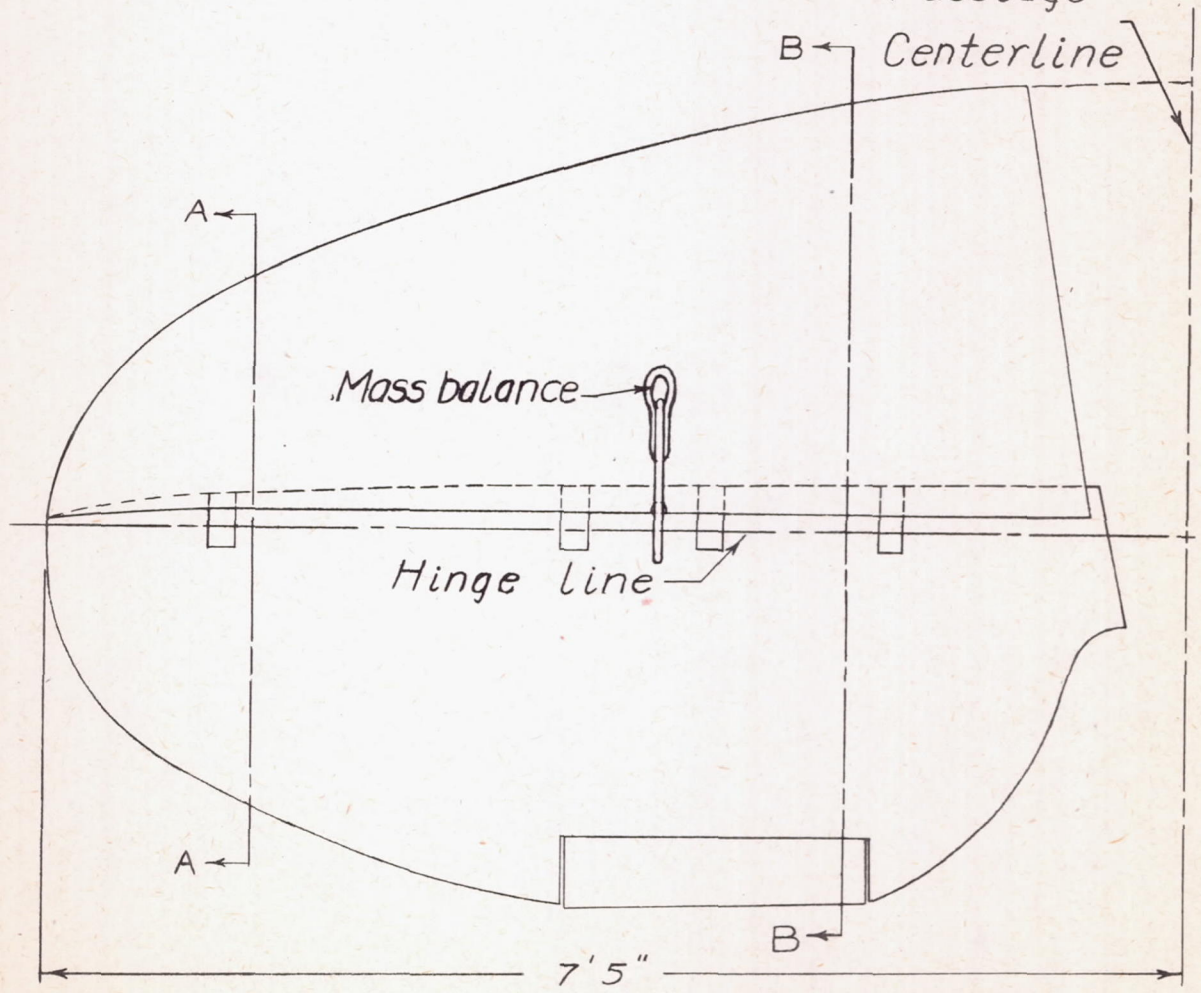
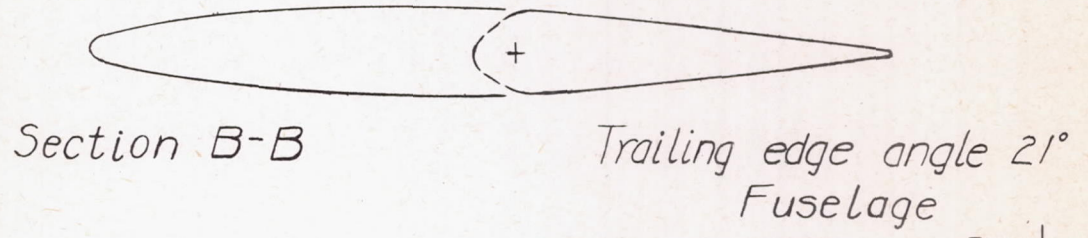
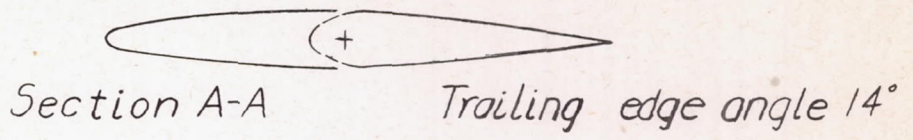
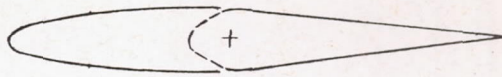
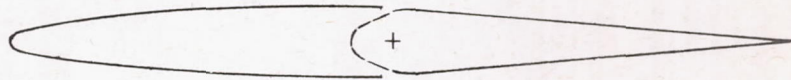

Figure 5.- Horizontal tail configuration number two. Brewster XSBA-1 airplane.



Section A-A

Trailing edge angle 10°



Section B-B

Trailing edge angle $8\frac{1}{2}^\circ$

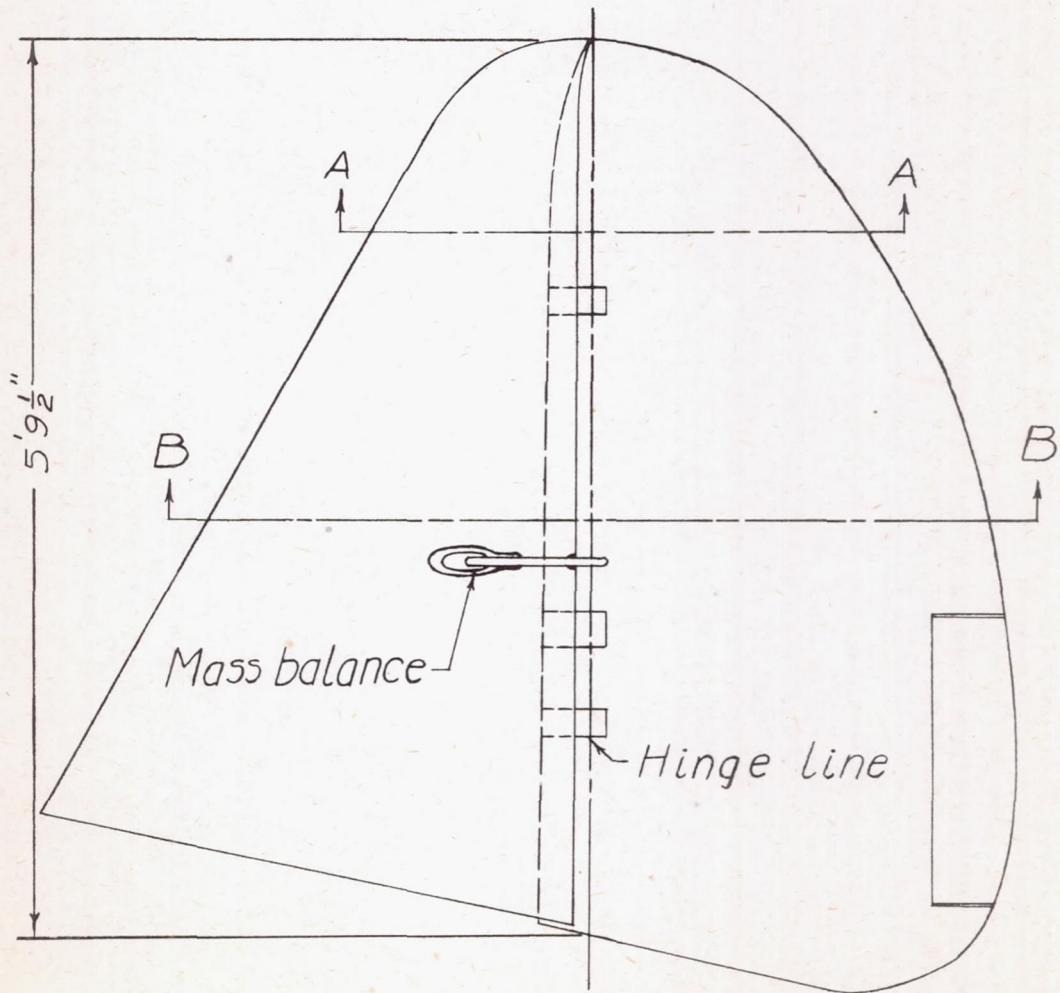

NATIONAL ADVISORY
COMMITTEE FOR AERONAUTICS

Figure 6.- Vertical tail configuration number two. Brewster XSBA-1 airplane.

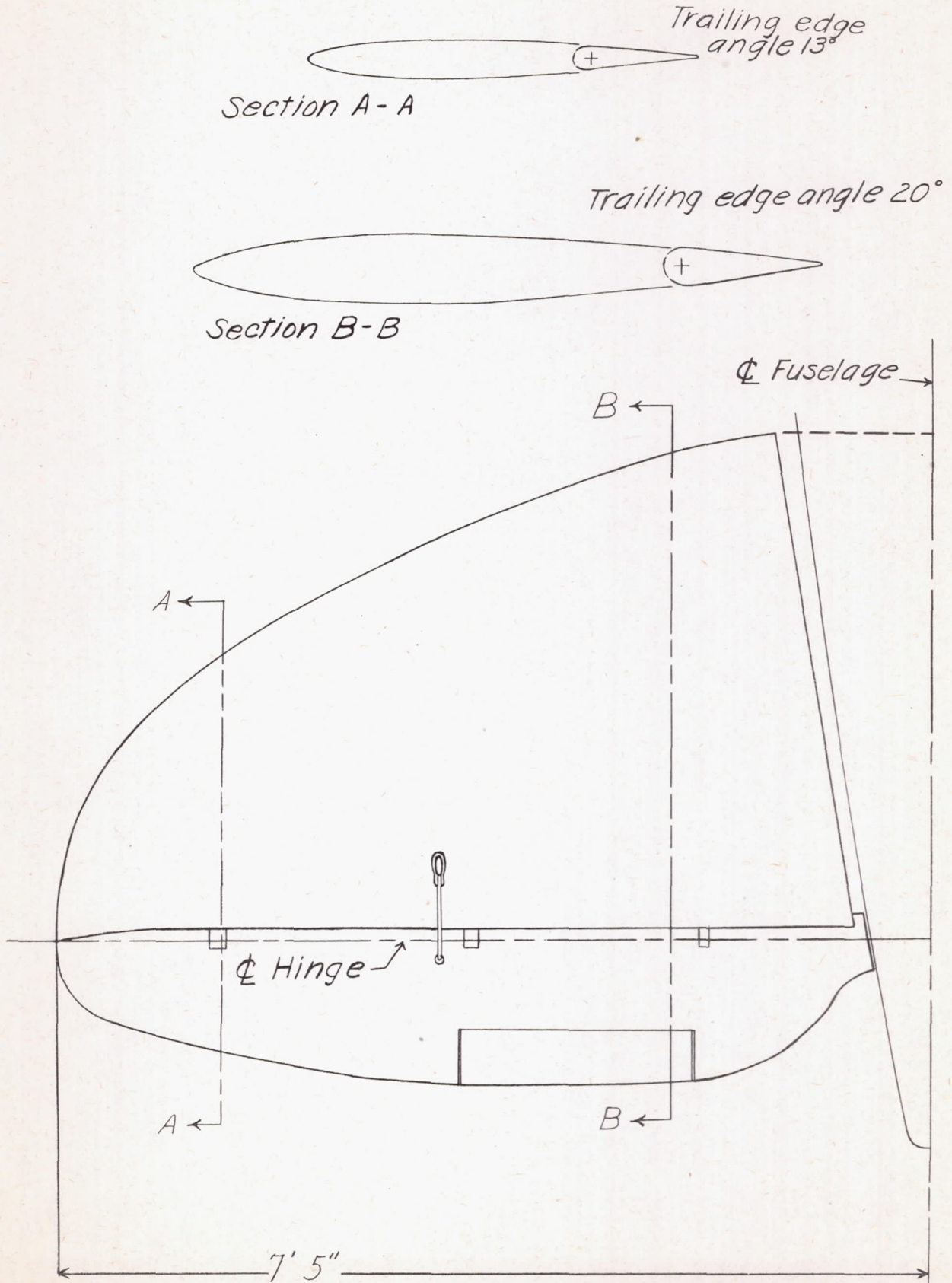

NATIONAL ADVISORY
COMMITTEE FOR AERONAUTICS

Figure 7.- Horizontal tail configuration 3; Brewster XSBA-1 airplane.

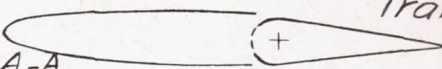
Section A-A  Trailing edge angle 12°

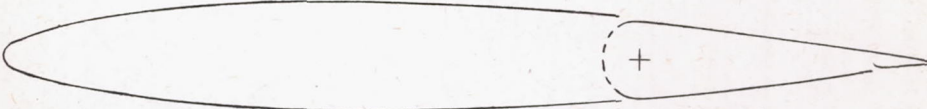
Section B-B  Trailing edge angle 12°

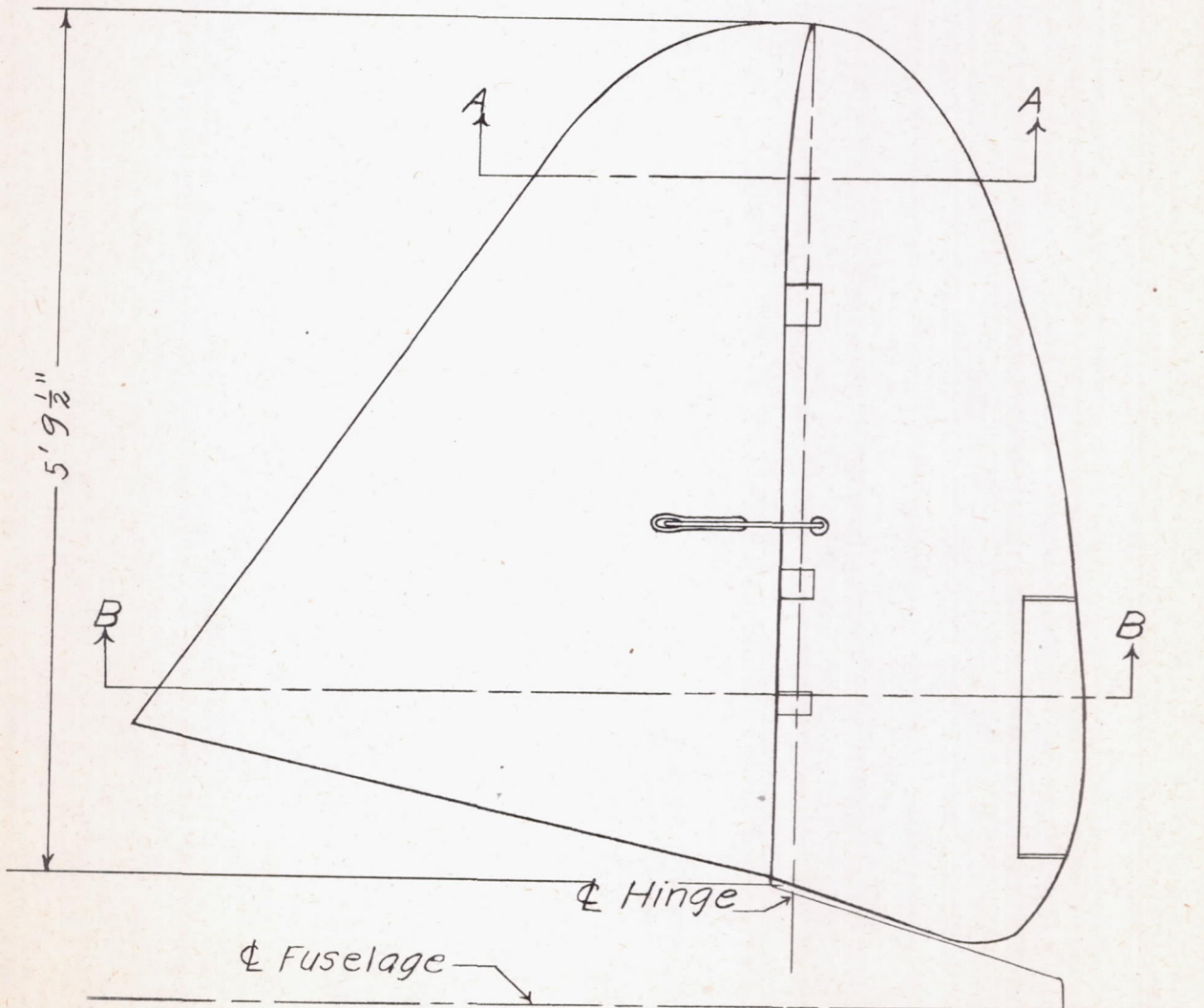

NATIONAL ADVISORY
COMMITTEE FOR AERONAUTICS

Figure 8.- Vertical tail configuration 3; Brewster XSBA-1 airplane.

L-599

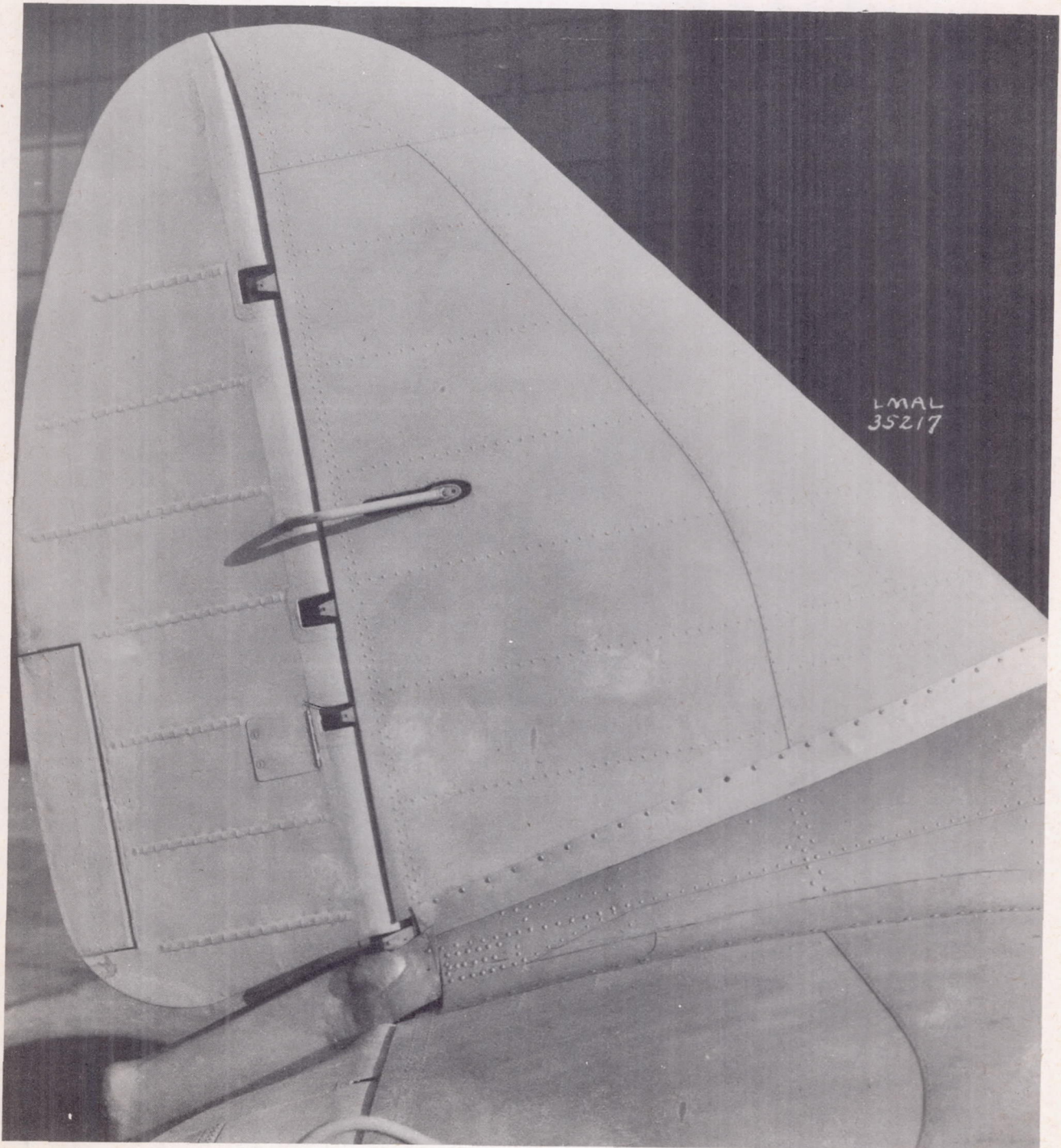

Figure 9.- Close-up of the vertical tail of configuration 3;
XSBA-1 airplane.

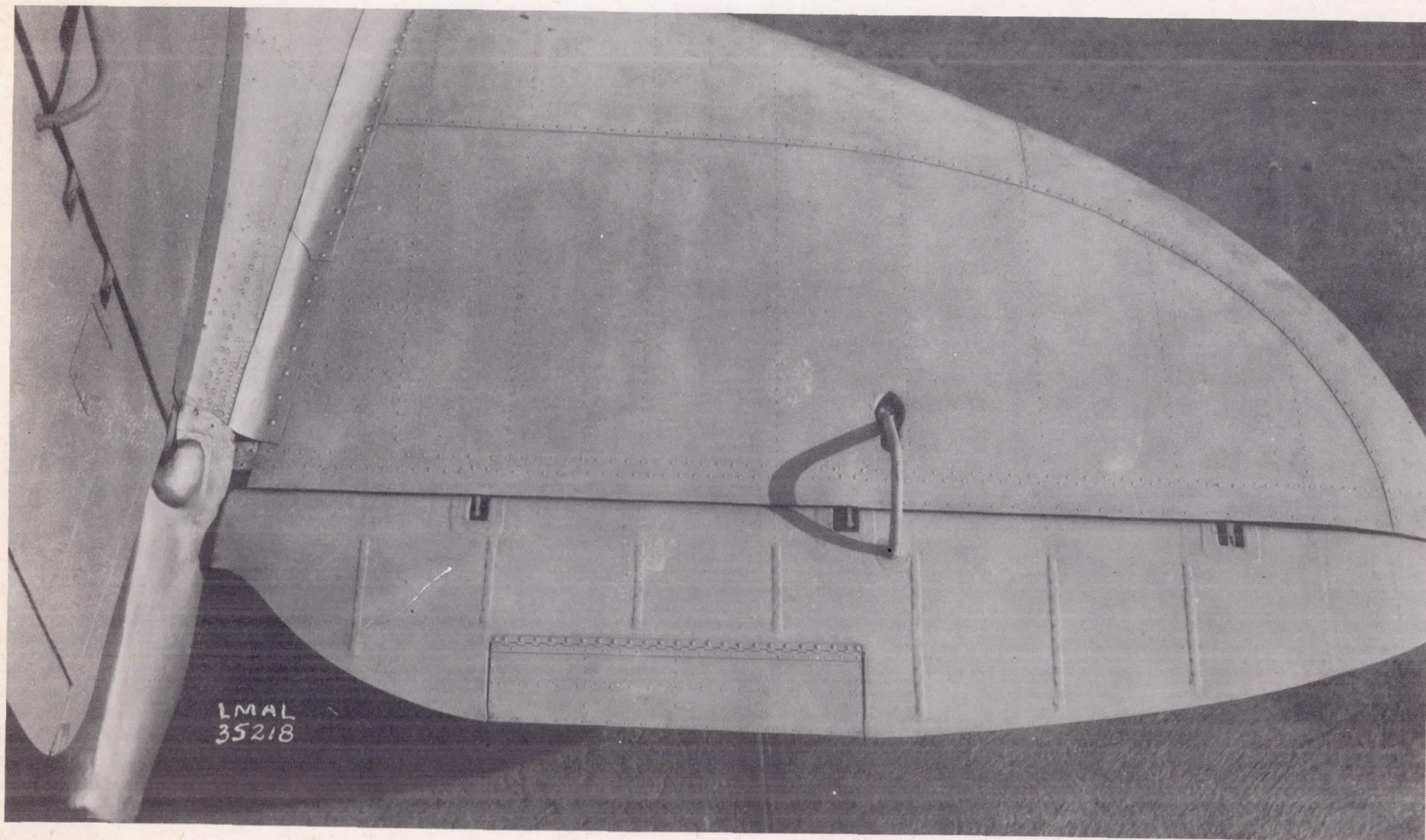
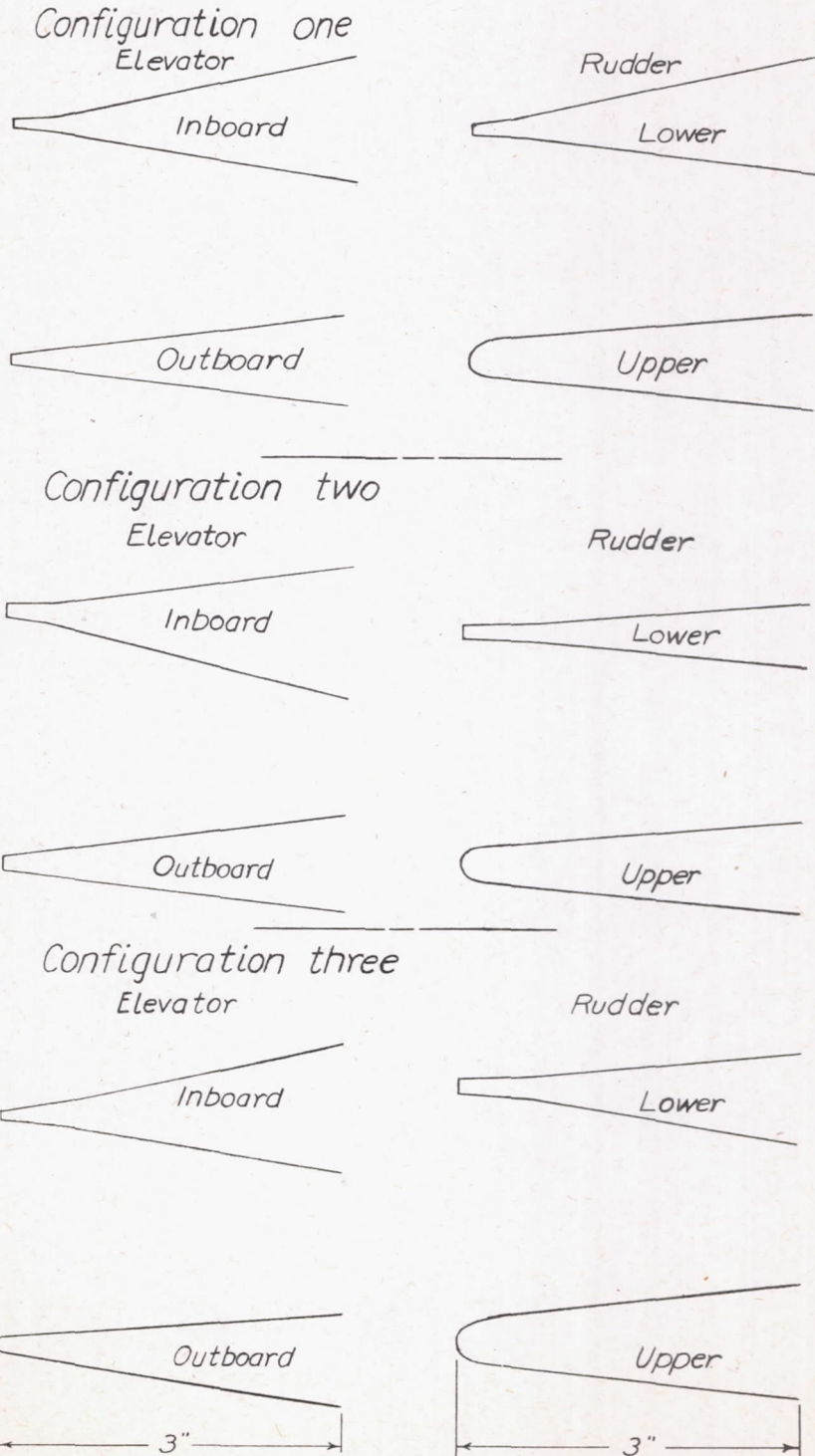
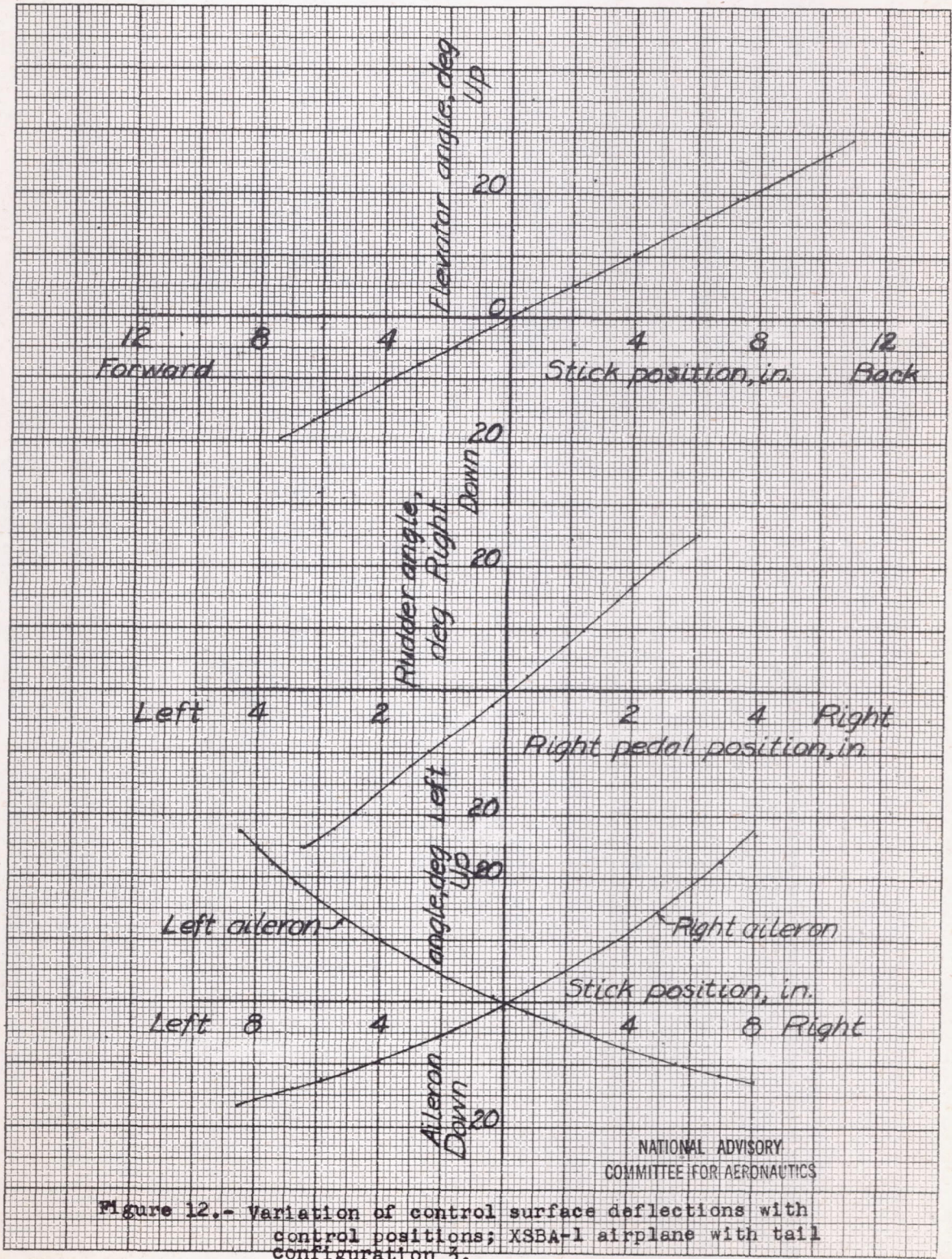

Figure 10.- Close-up of the horizontal tail of configuration 3; XSBA-1 airplane.



NATIONAL ADVISORY
COMMITTEE FOR AERONAUTICS

Figure 11.- Trailing edge sections of X8BA-1 tail surfaces at the stations indicated in figures 3 through 8.



NATIONAL ADVISORY
COMMITTEE FOR AERONAUTICS

Figure 12.- Variation of control surface deflections with control positions; XSB-1 airplane with tail configuration 3.

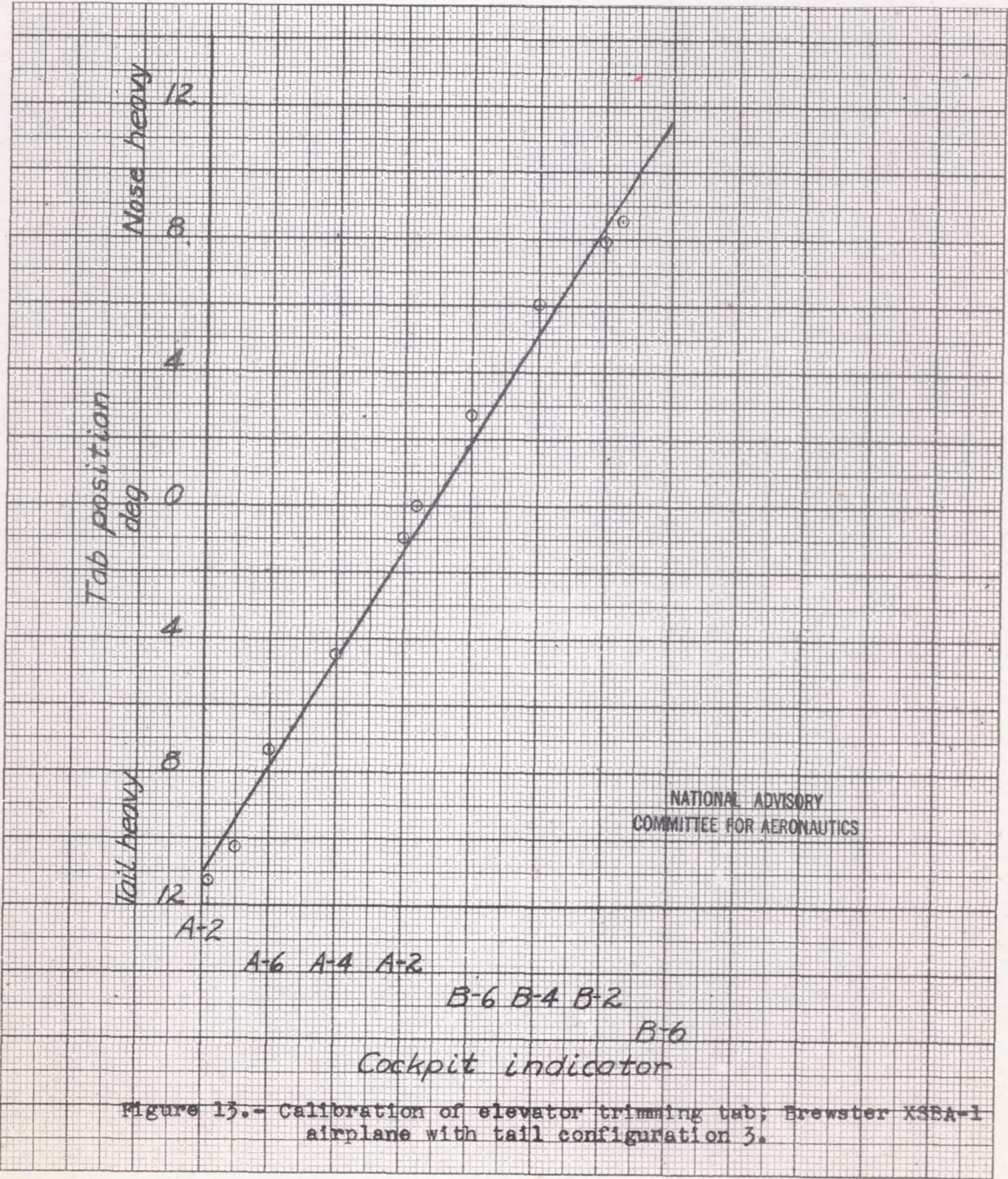

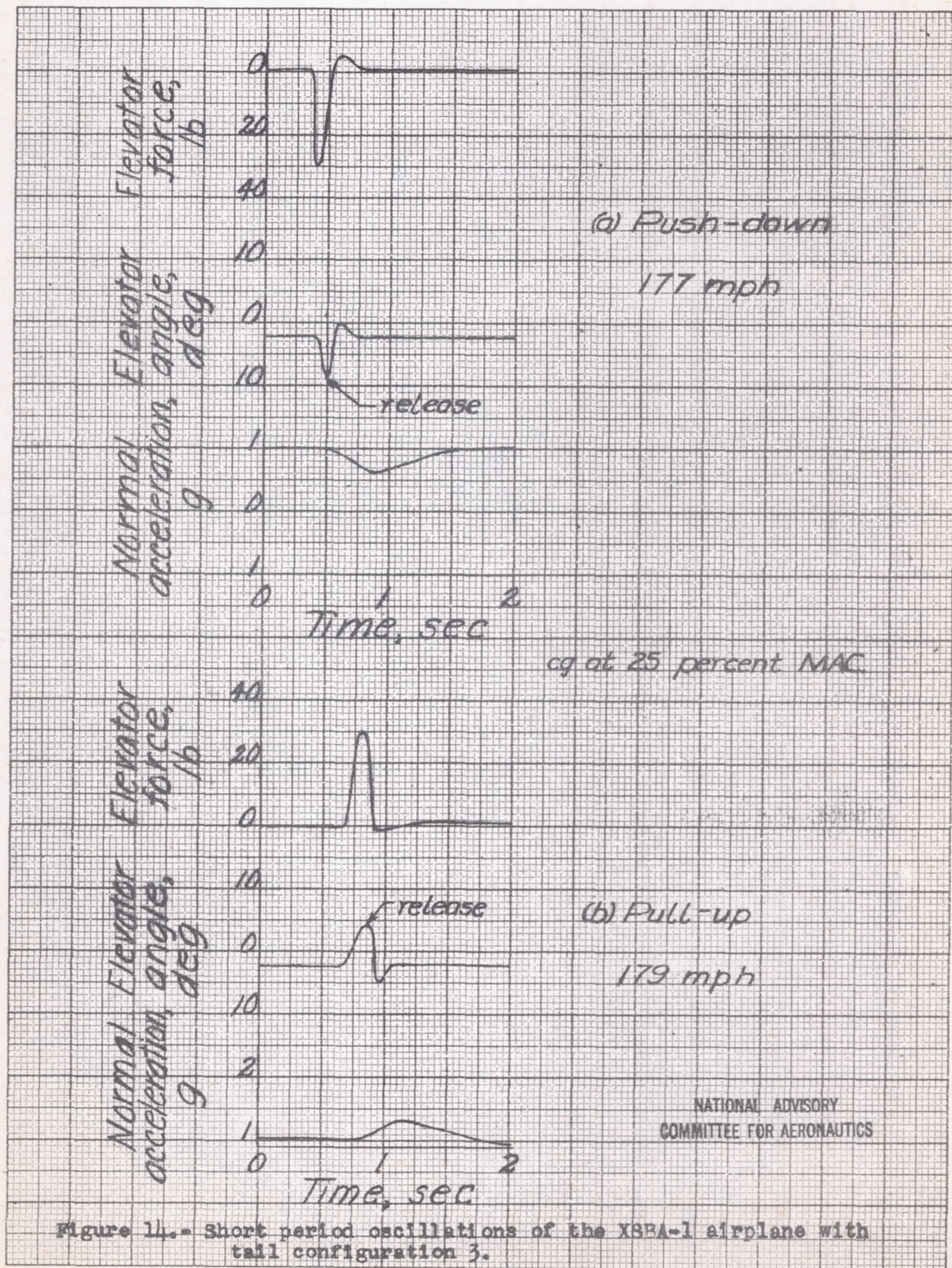

NATIONAL ADVISORY
COMMITTEE FOR AERONAUTICS

Figure 14.- Short period oscillations of the XSB-1 airplane with tail configuration 3.

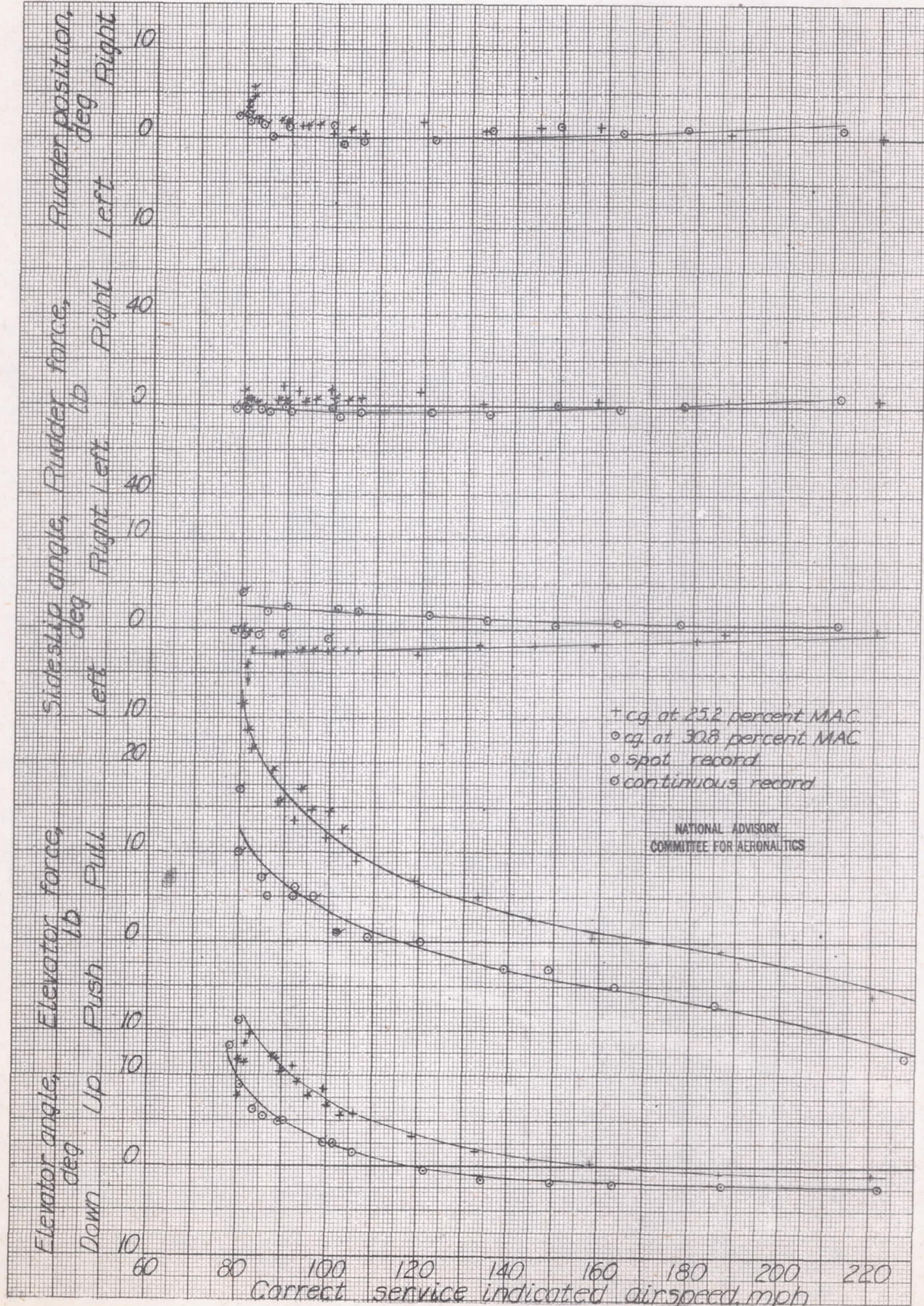

Figure 15.- Static longitudinal stability characteristics of the XSBA-1 airplane with tail configuration 3 in the gliding condition.

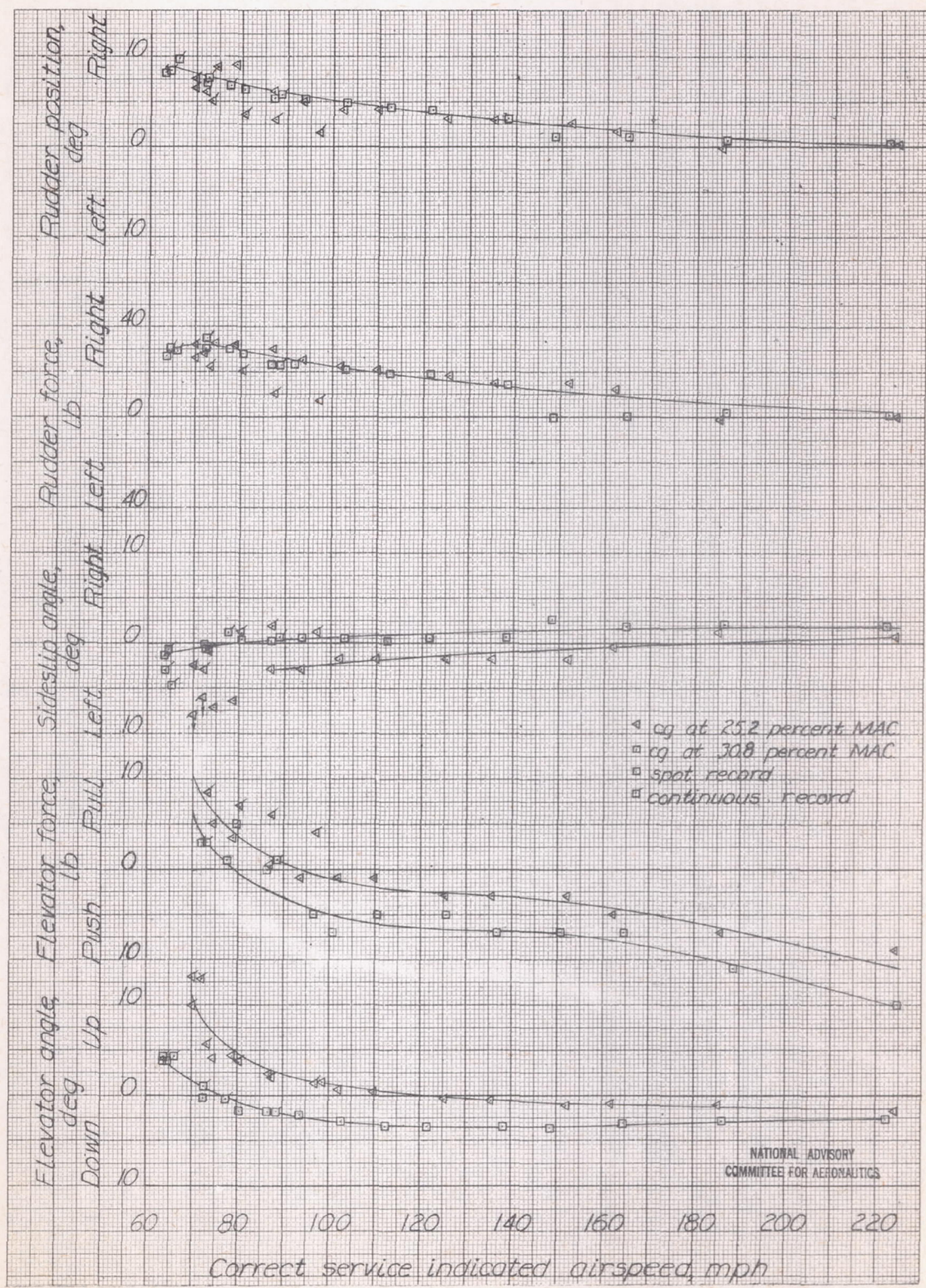

Figure 16.- Static longitudinal stability characteristics of the XSBA-1 airplane with tail configuration 3 in the cruising condition.

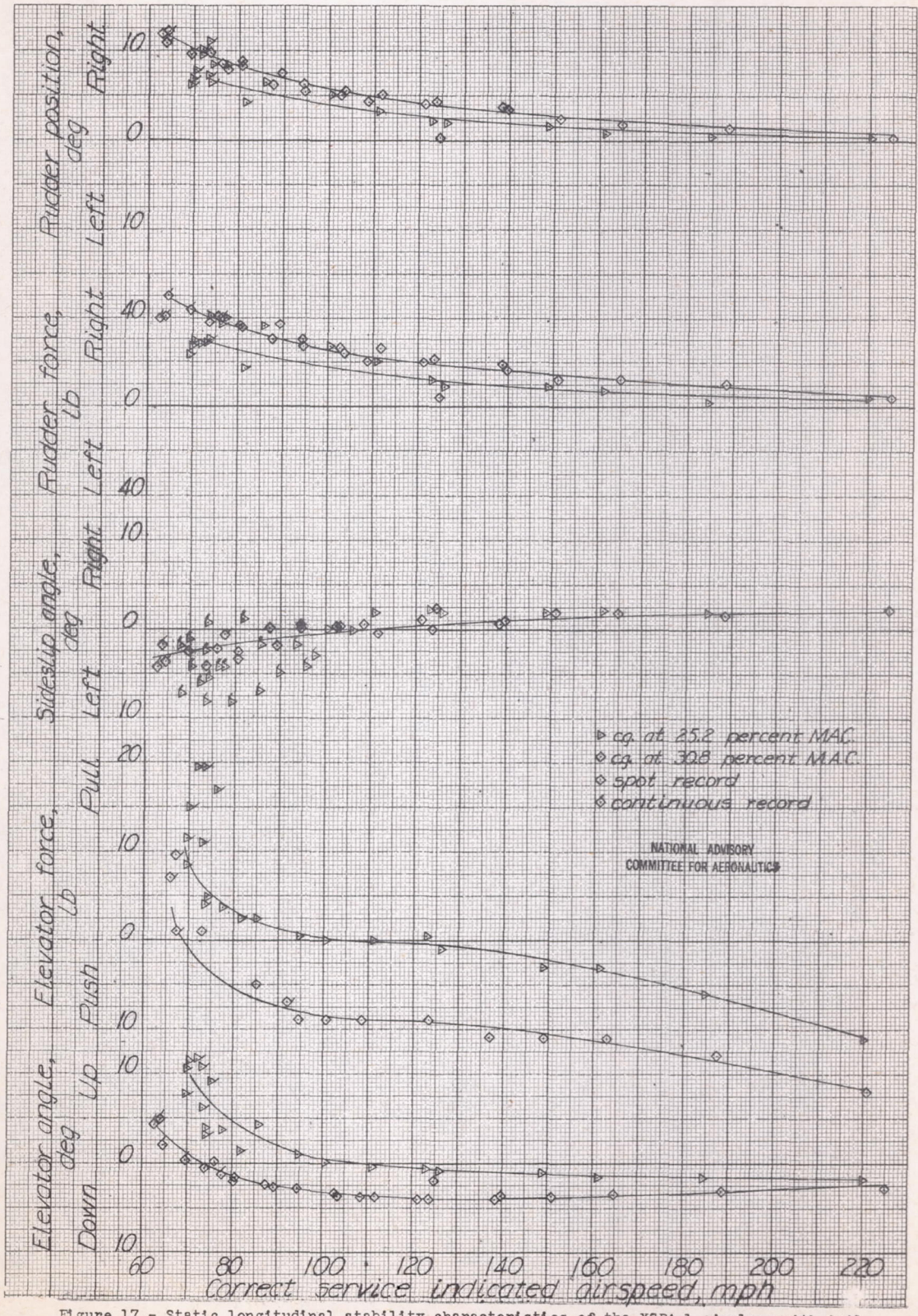

Figure 17.- Static longitudinal stability characteristics of the XSB-1 airplane with tail configuration 3 in the climbing condition.

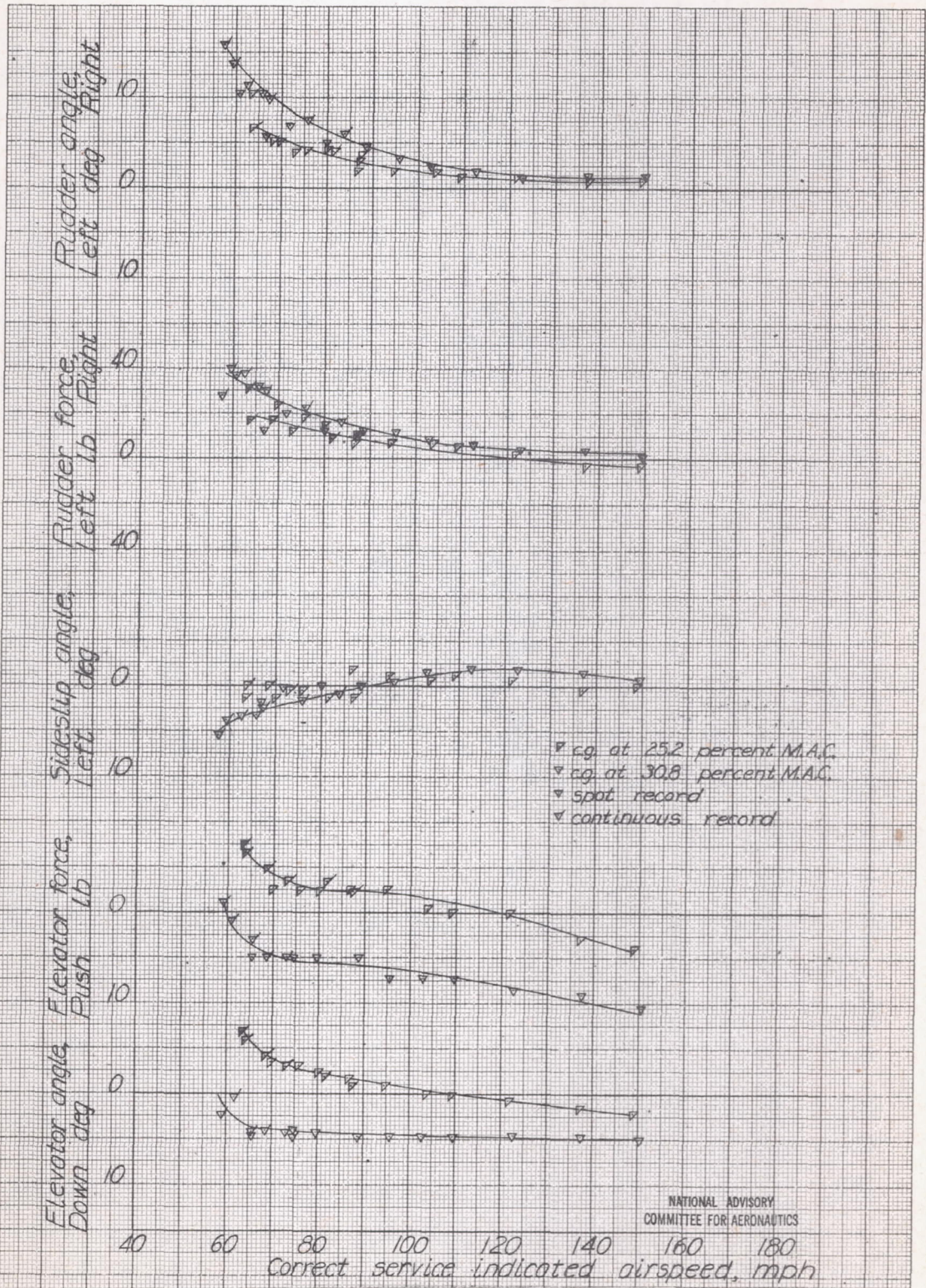

Figure 13.- Static longitudinal stability characteristics of the XSEA-1 airplane with tail configuration 3 in the approach condition.

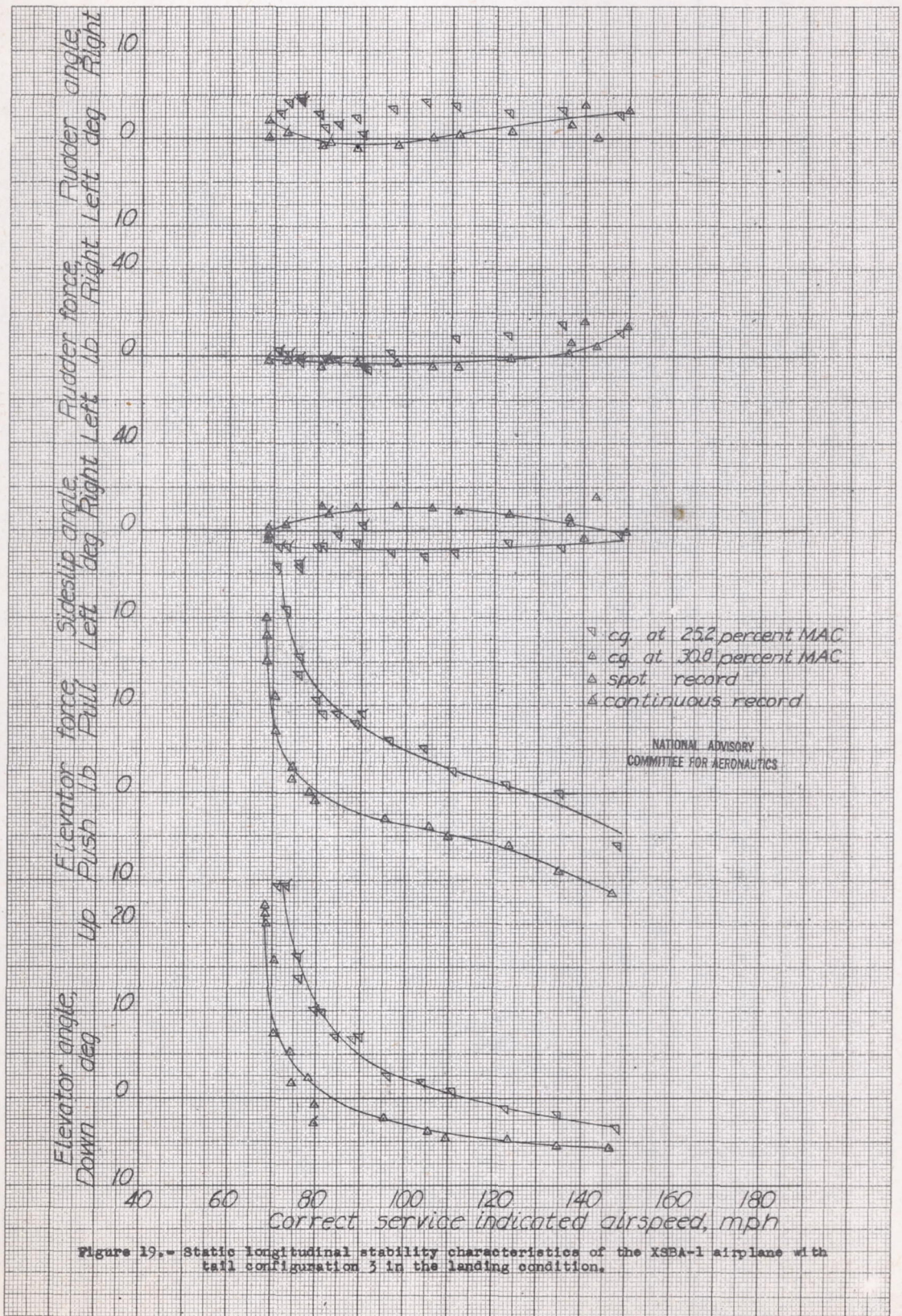

Figure 19.- Static longitudinal stability characteristics of the XSB-1 airplane with tail configuration 3 in the landing condition.

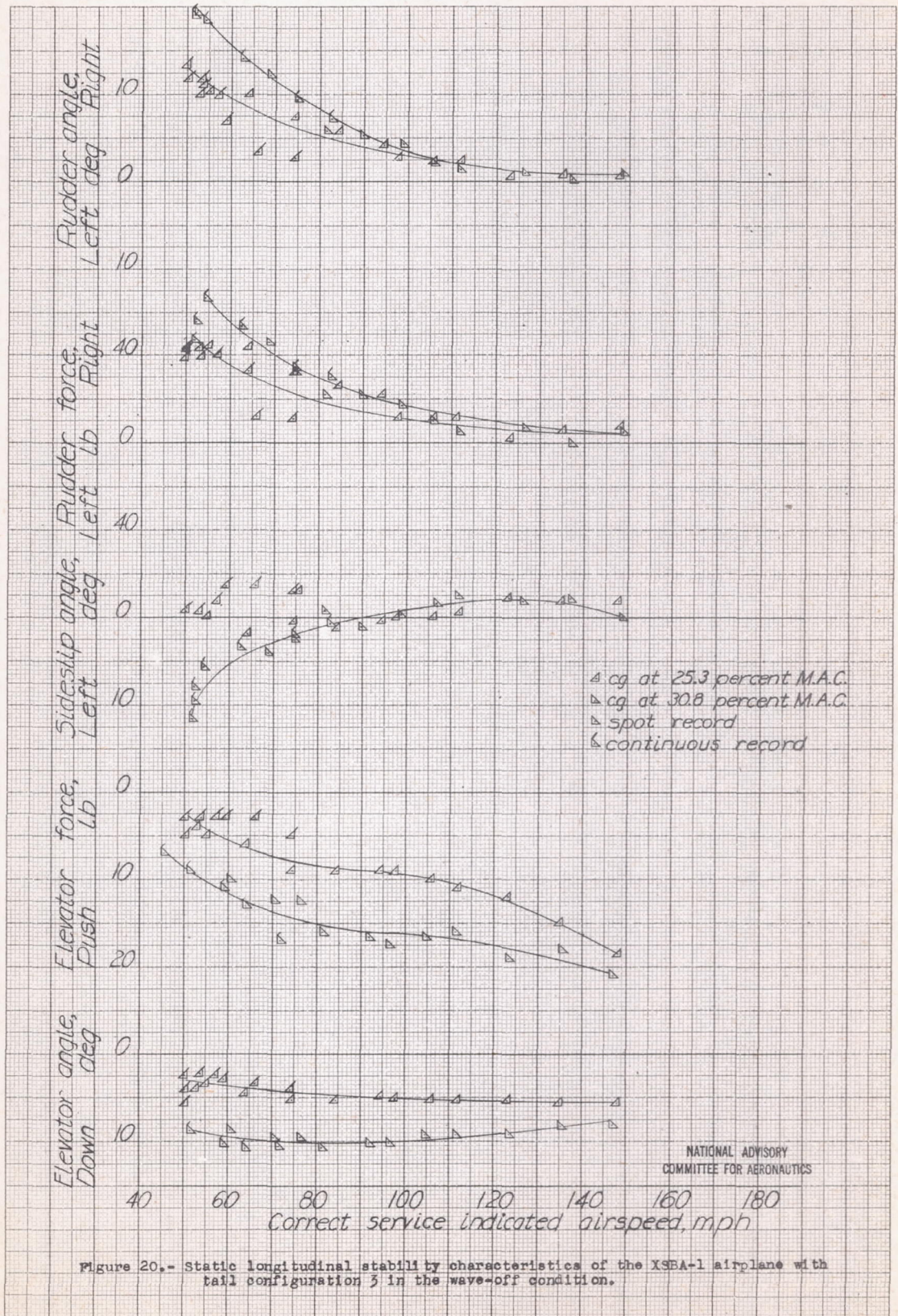

Figure 20.- Static longitudinal stability characteristics of the XSEA-1 airplane with tail configuration 3 in the wave-off condition.

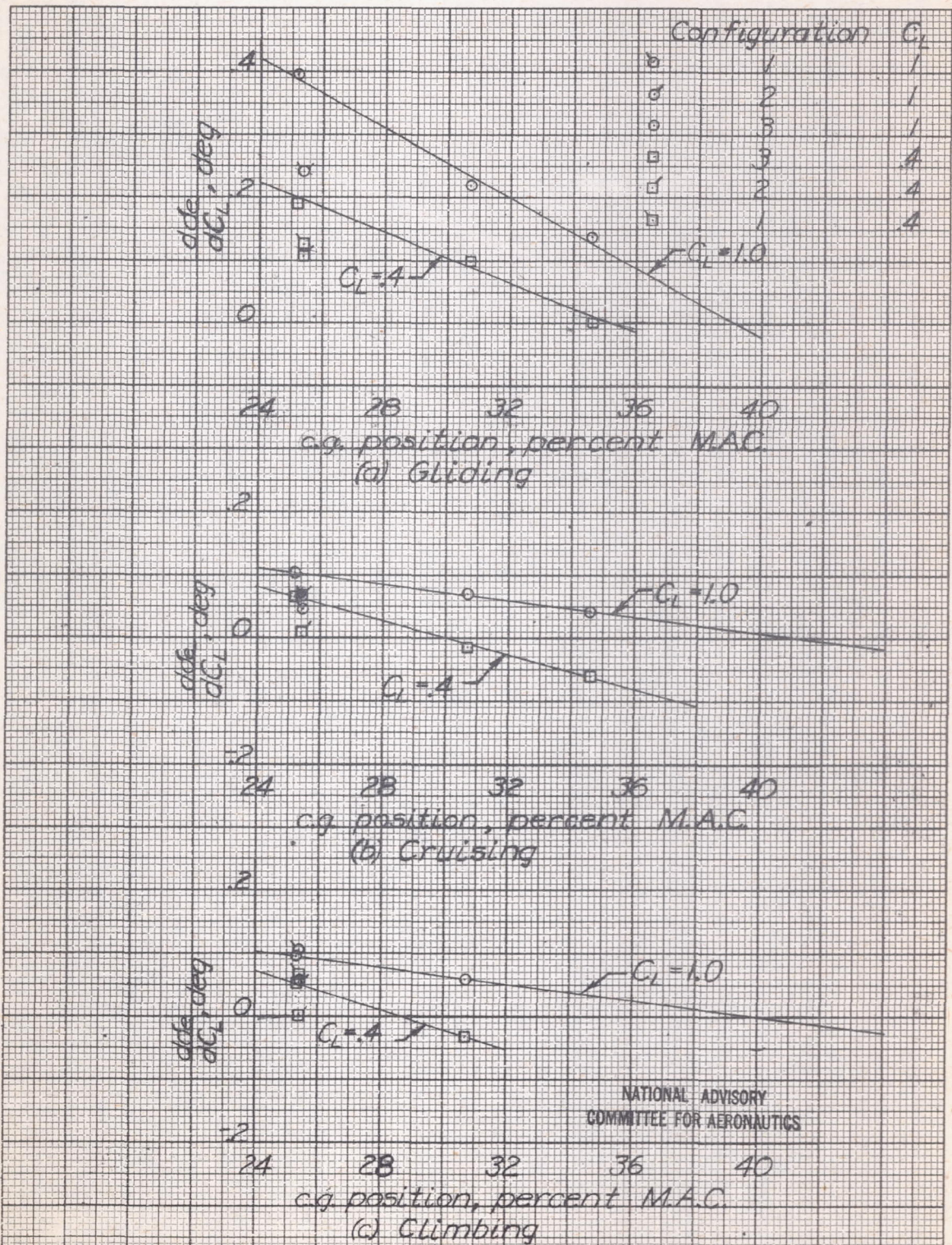

Figure 21.- Plots showing stick-fixed neutral points in various flight conditions for the XSBA-1 airplane.

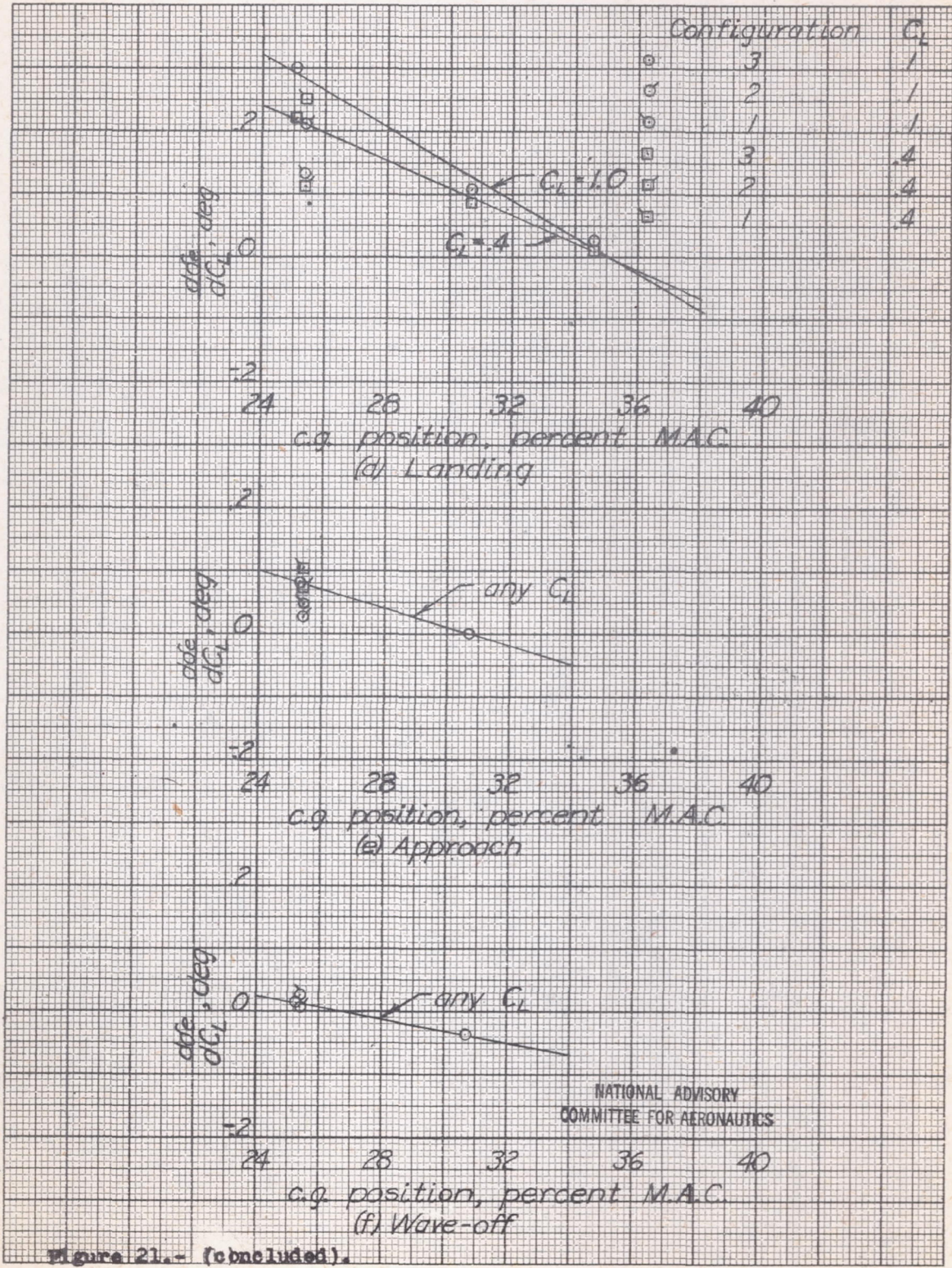
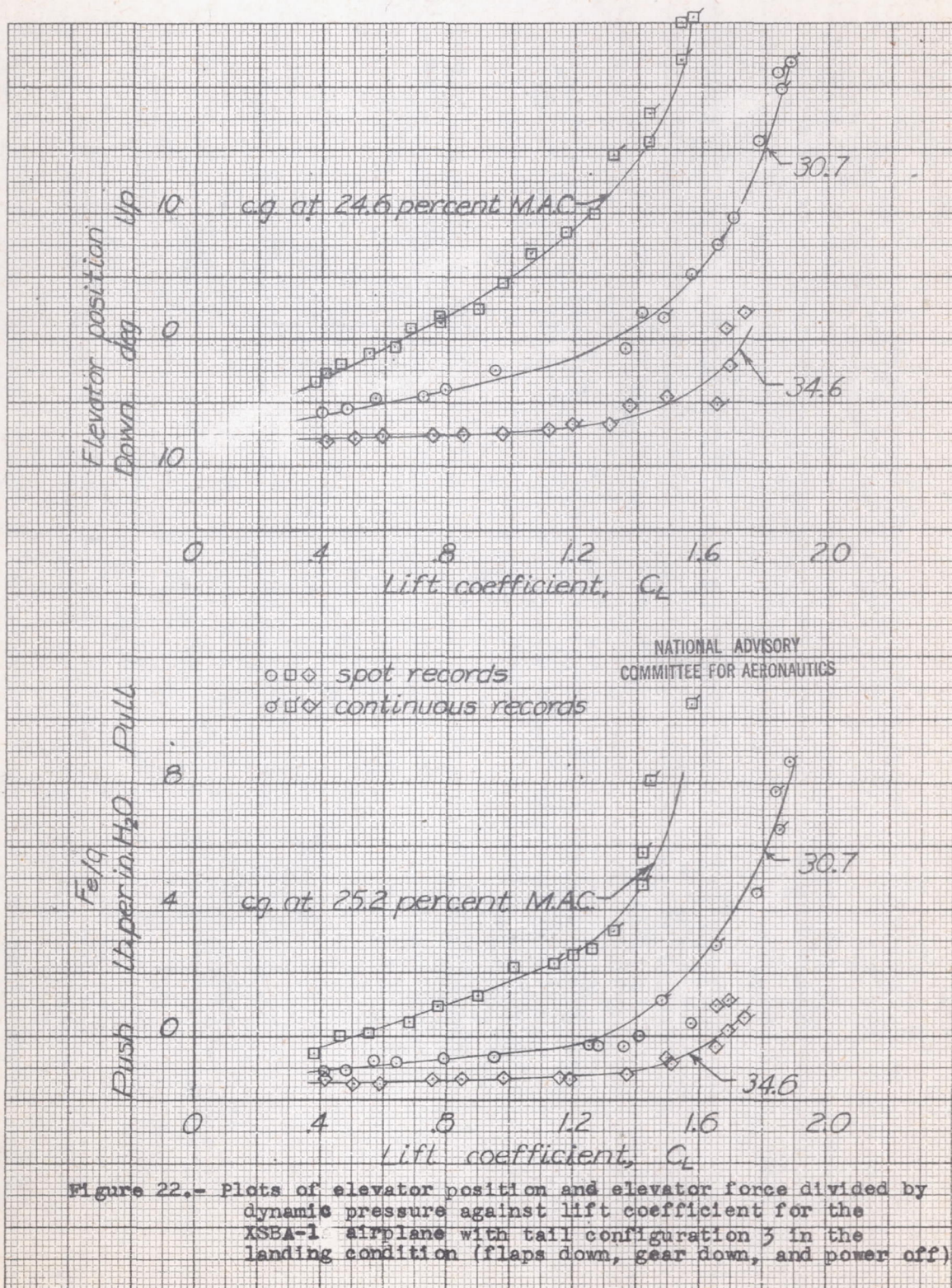

Figure 21.- (concluded).



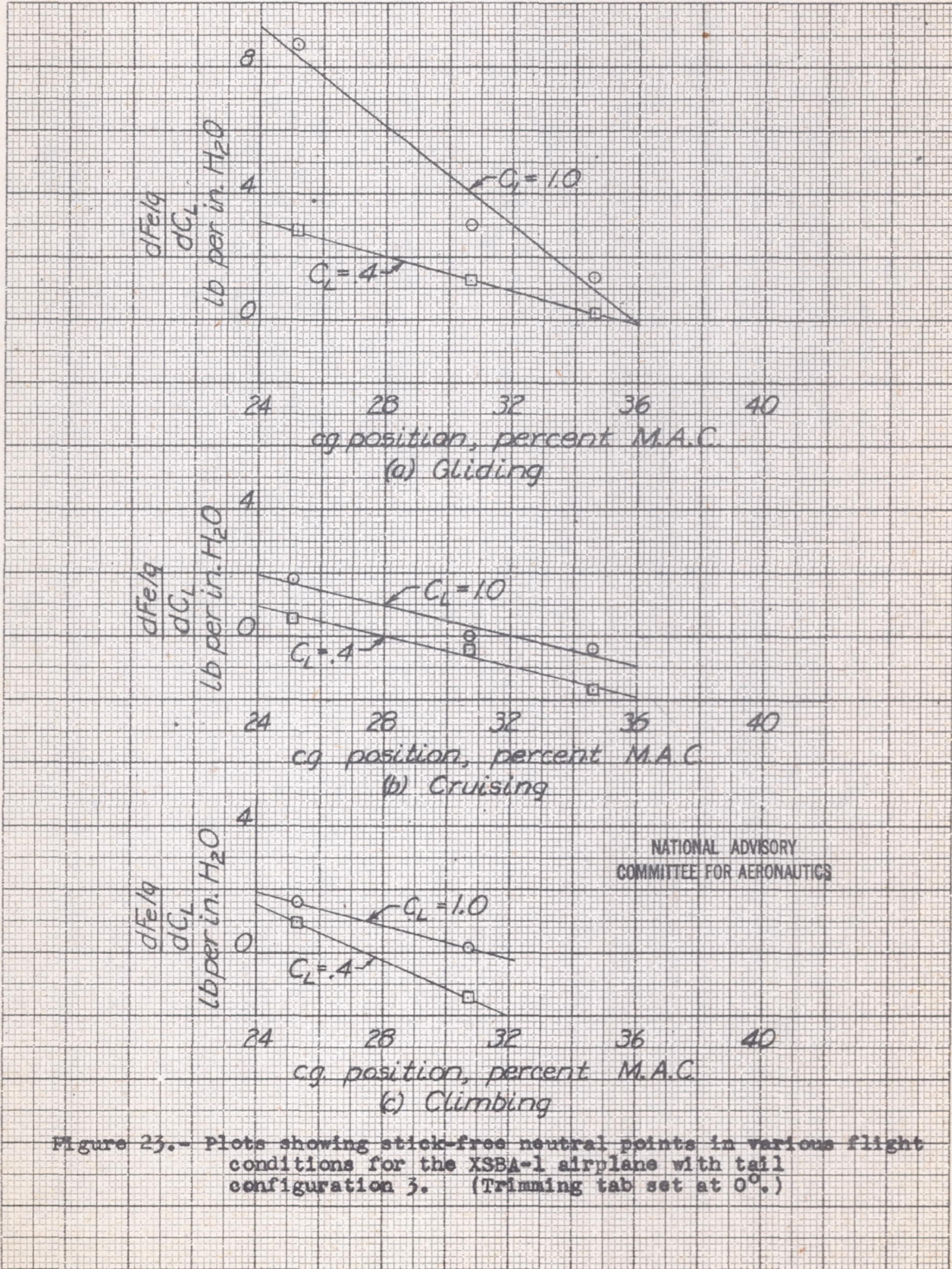

Figure 23.- Plots showing stick-free neutral points in various flight conditions for the XSBA-1 airplane with tail configuration 3. (Trimming tab set at 0°.)

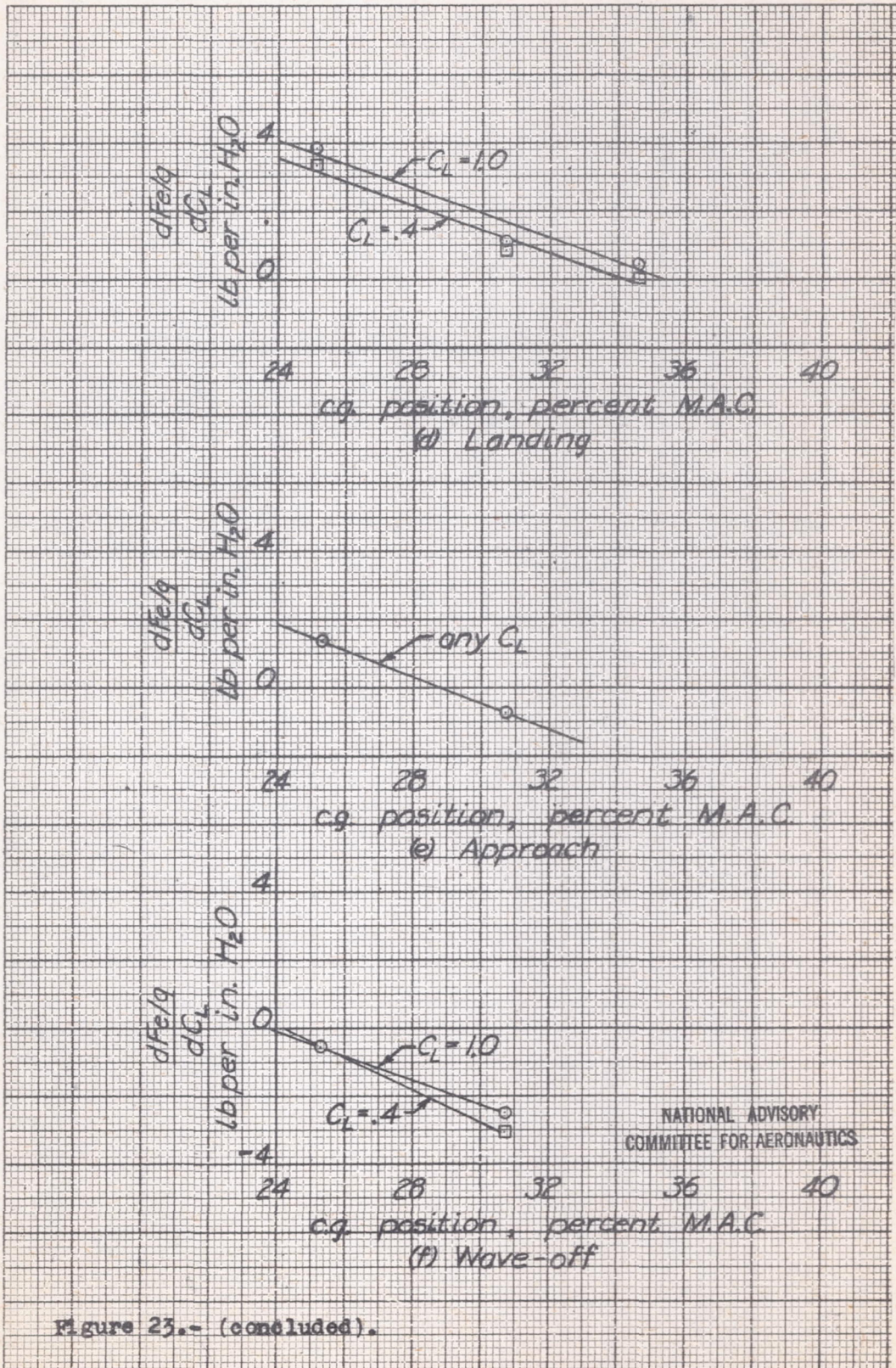

Figure 23.- (concluded).

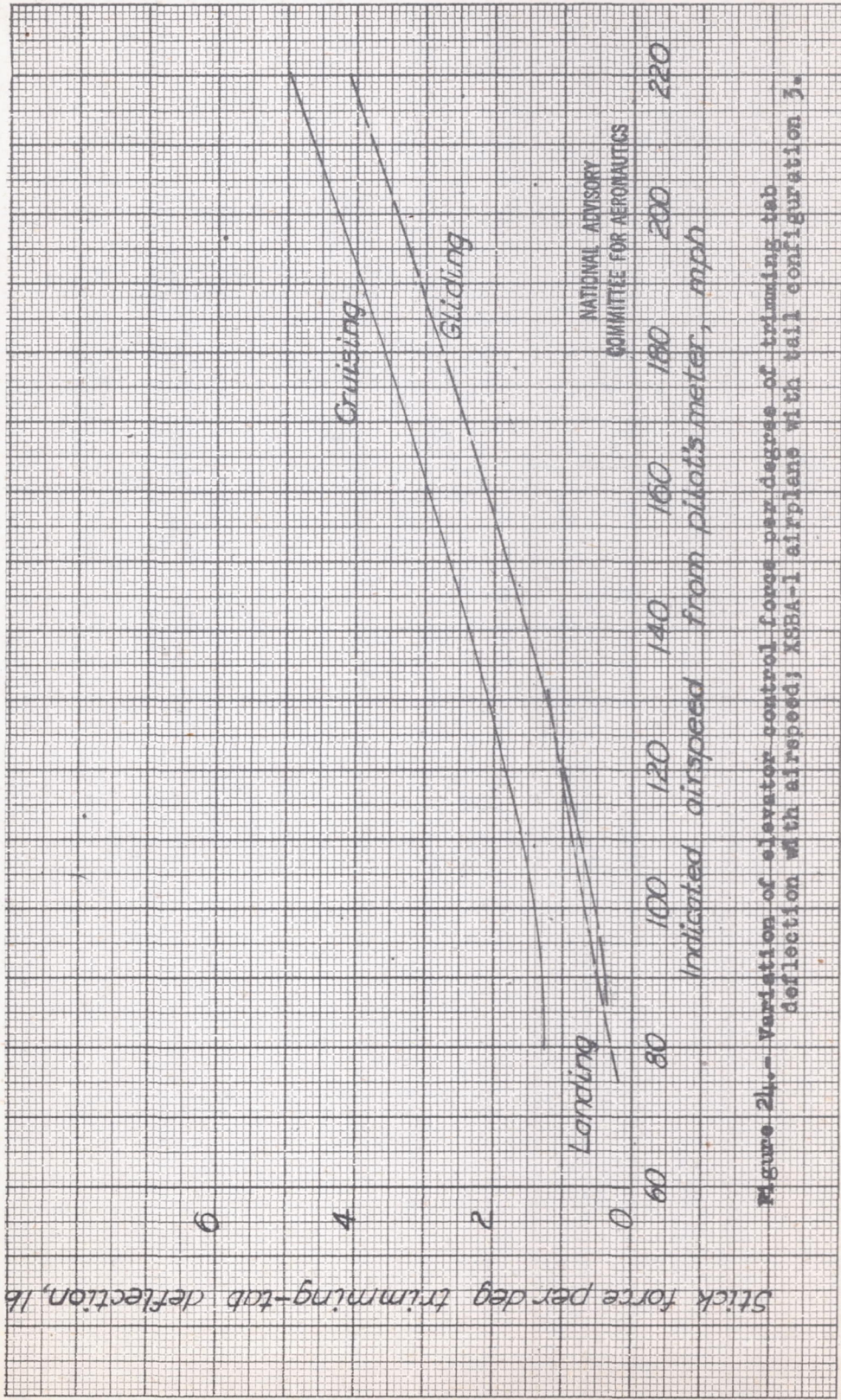

Figure 24.- Variation of elevator control force per degree of trimming tab deflection with airspeed; X8BA-1 airplanes with tail configuration 3.

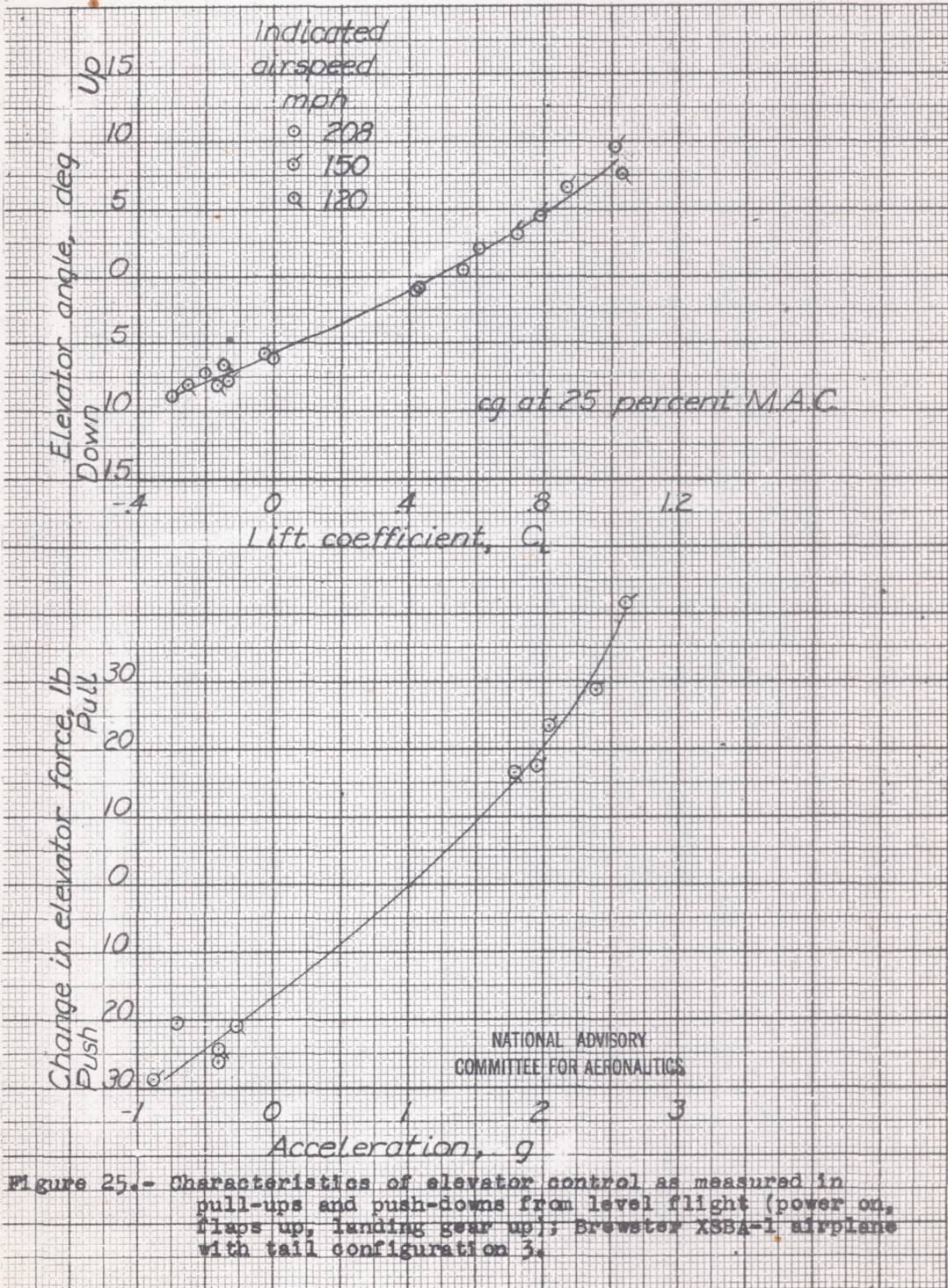

Figure 25.- Characteristics of elevator control as measured in pull-ups and push-downs from level flight (power on, flaps up, landing gear up); Brewster XSB-1 airplane with tail configuration 3.

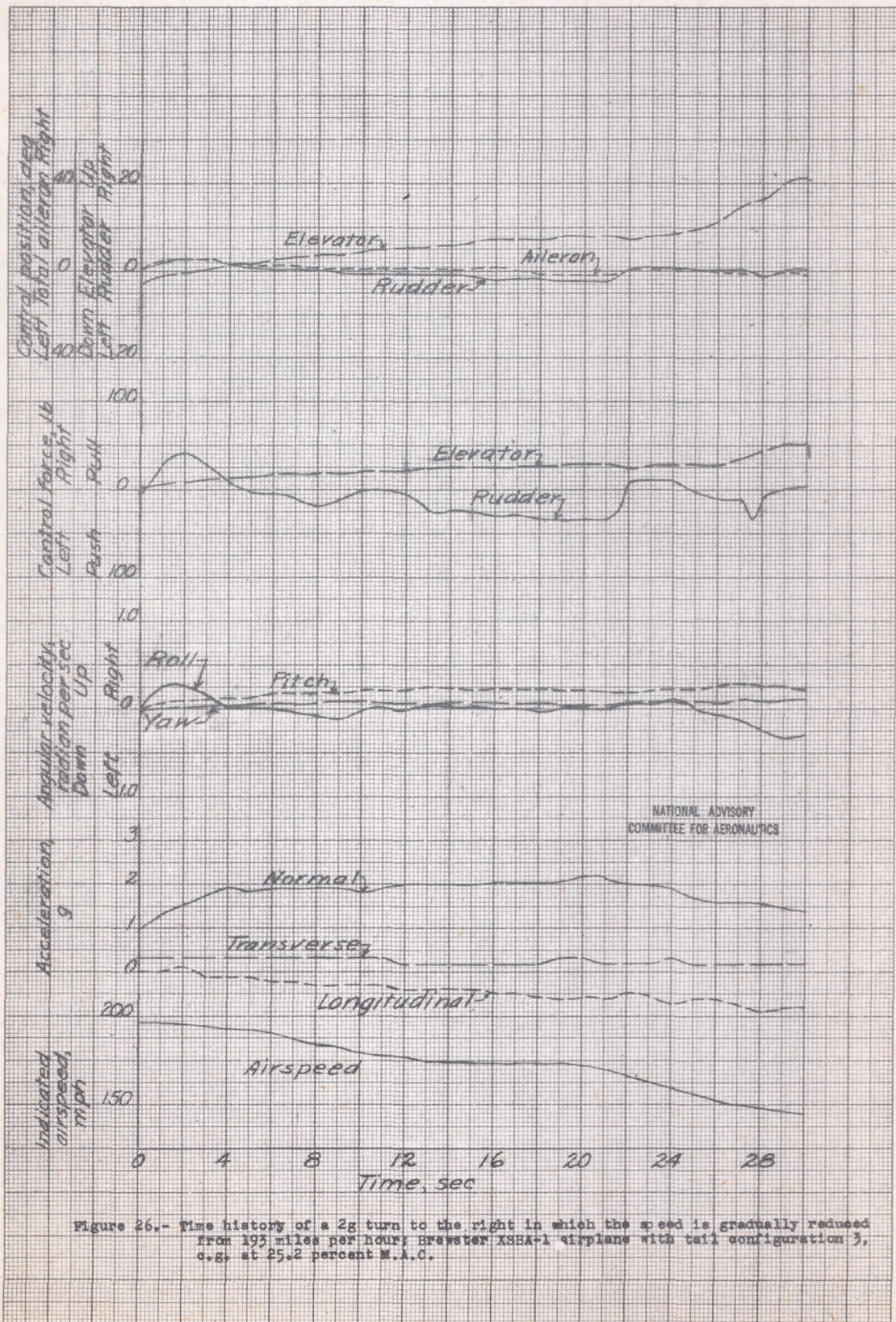

Figure 26.- Time history of a 2g turn to the right in which the speed is gradually reduced from 195 miles per hour; Brewster XSB-1 airplane with tail configuration 3, c.g. at 25.2 percent M.A.C.

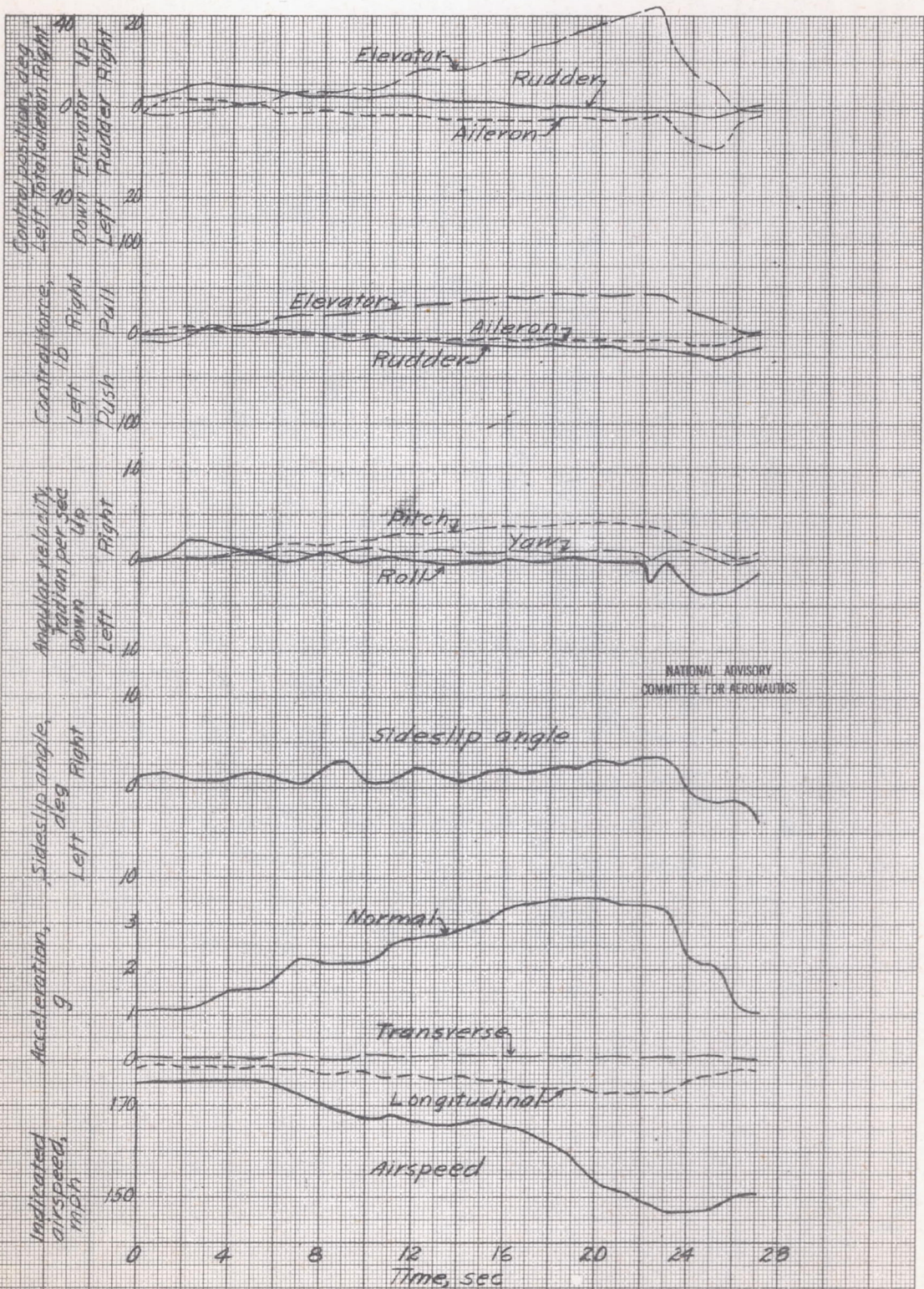

Figure 27.- Time history of a 3.5g right turn to the stall; Brewster XSBA-1 airplane with tail configuration 3; c.g. at 25.2 percent M.A.C.

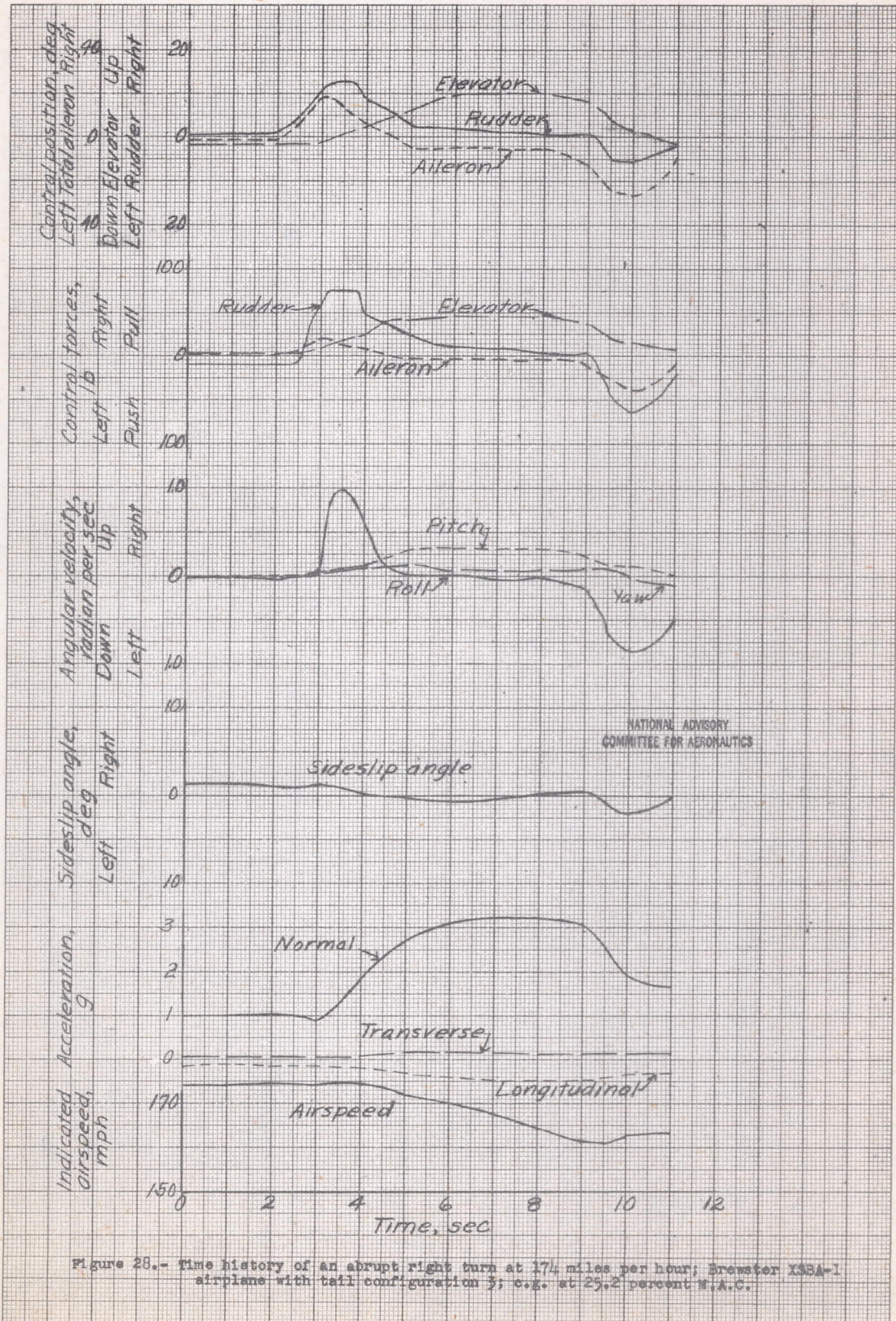

Figure 28.- Time history of an abrupt right turn at 174 miles per hour; Brewster X33A-1 airplane with tail configuration 3; c.g. at 25.2 percent M.A.C.

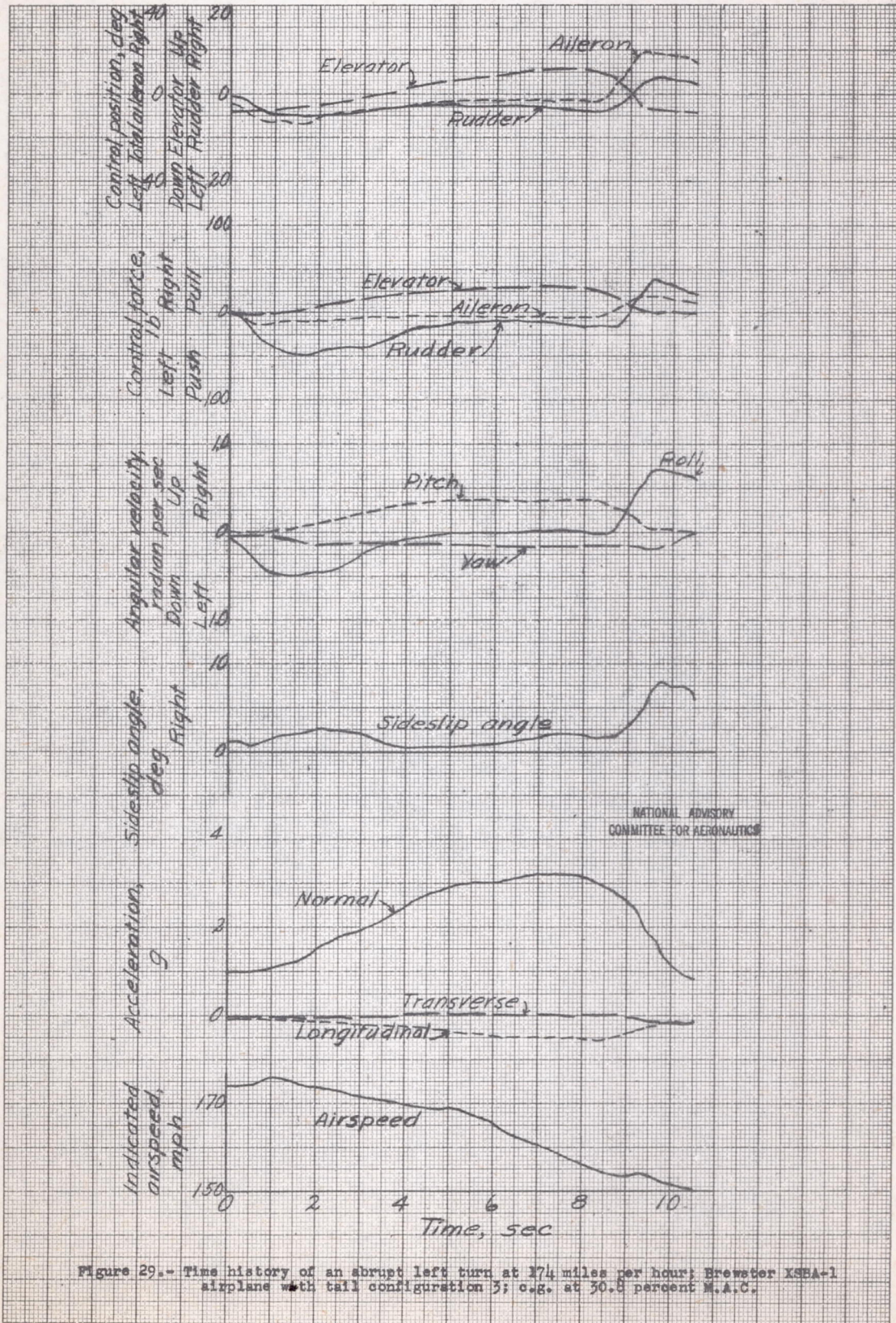

Figure 29.- Time history of an abrupt left turn at 174 miles per hour; Brewster XSEA-1 airplane with tail configuration 5; c.g. at 30.8 percent M.A.C.

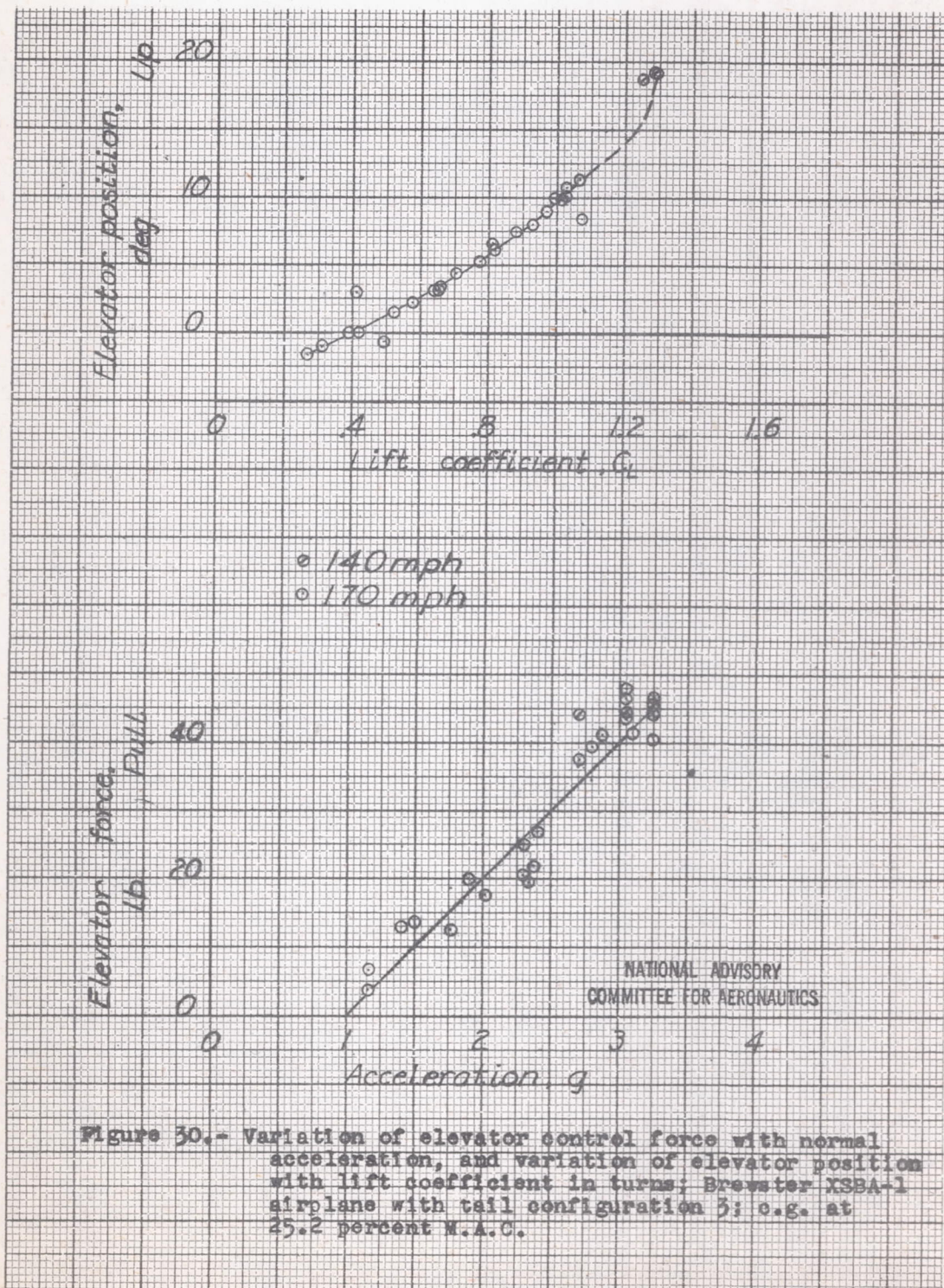

Figure 30.- Variation of elevator control force with normal acceleration, and variation of elevator position with lift coefficient in turns; Brewster XSBA-1 airplane with tail configuration 3; c.g. at 25.2 percent M.A.C.

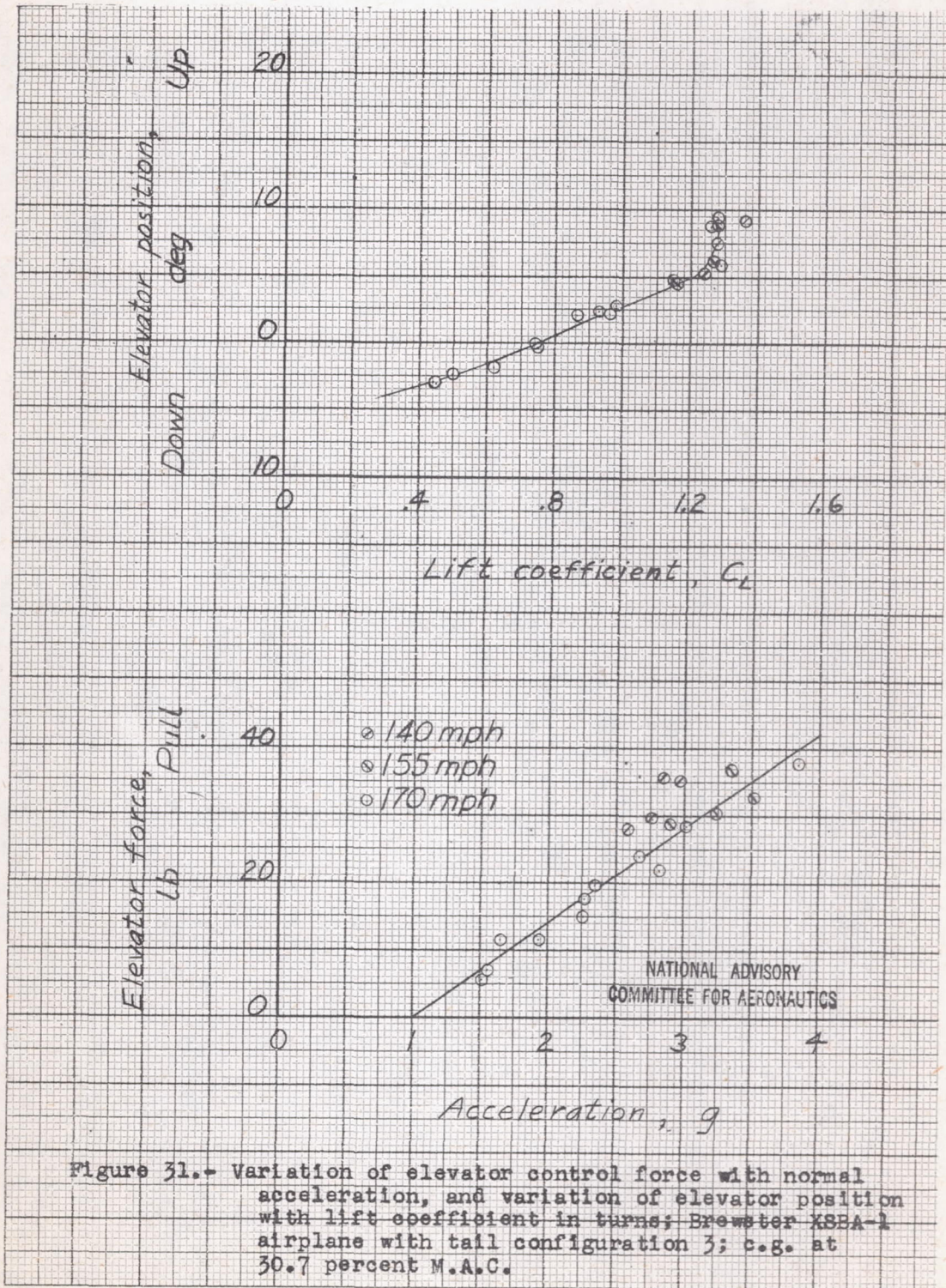
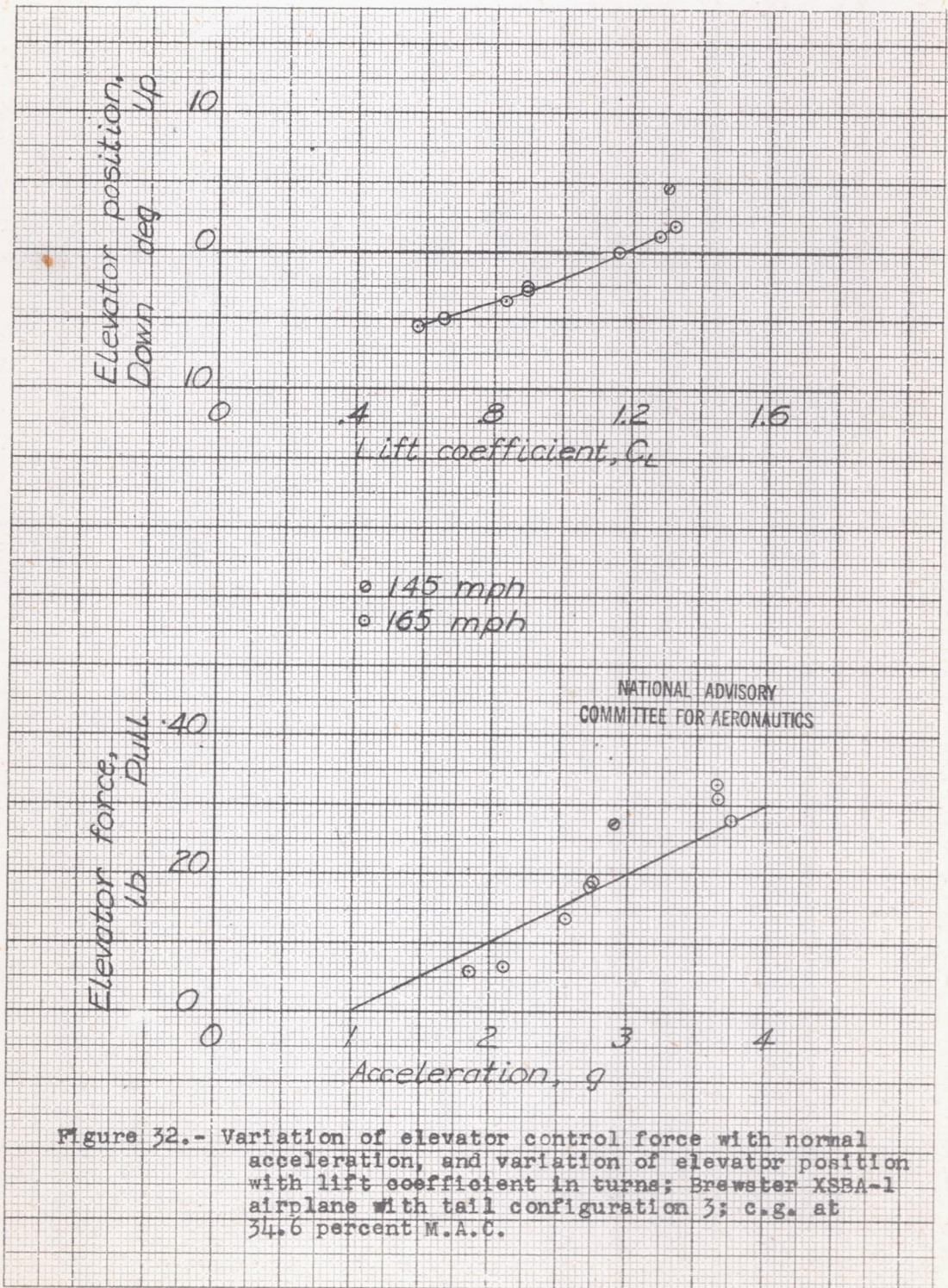

Figure 31.- Variation of elevator control force with normal acceleration, and variation of elevator position with lift coefficient in turns; Brewster XSEA-1 airplane with tail configuration 3; c.g. at 30.7 percent M.A.C.



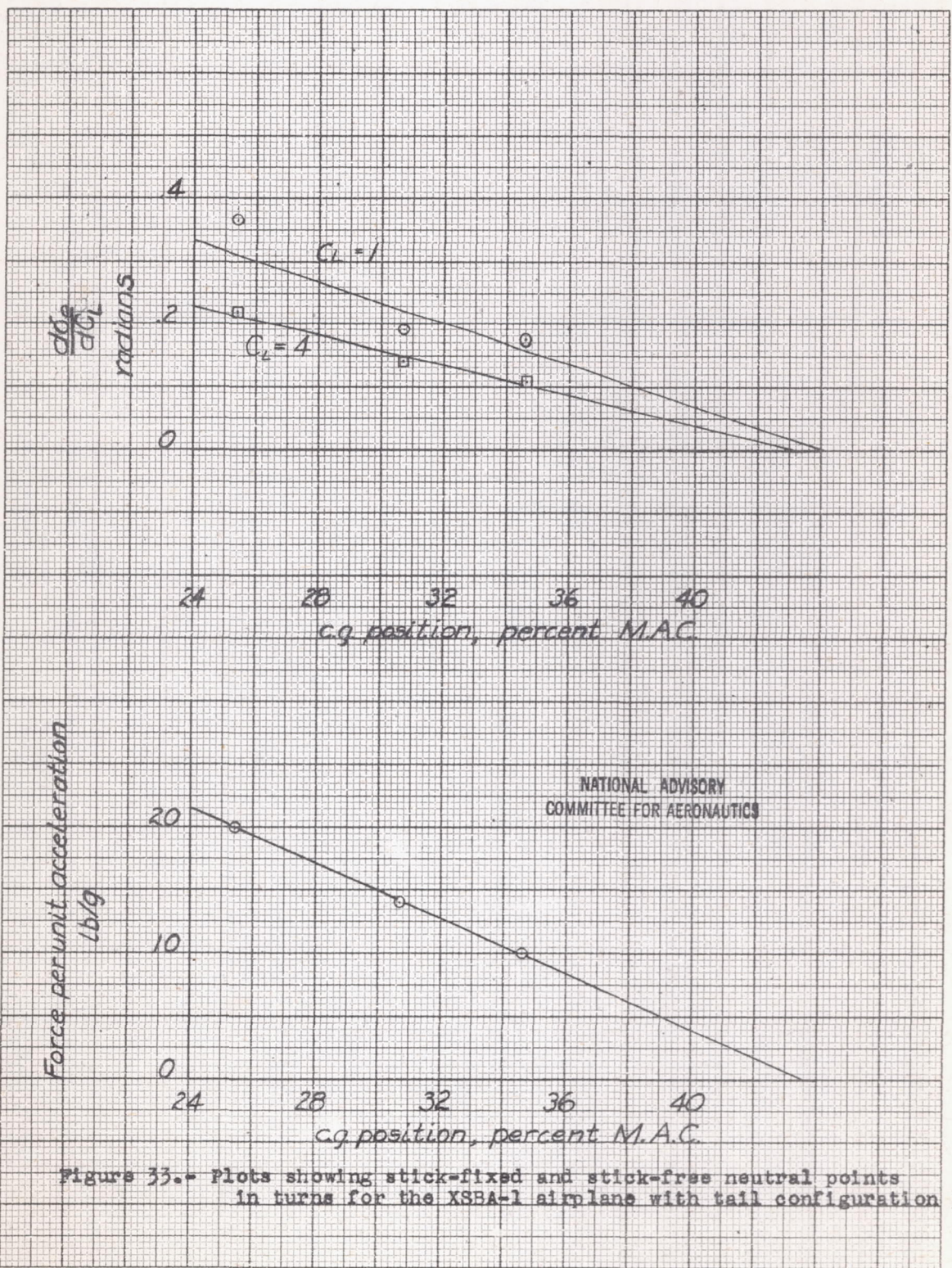

Figure 33.- Plots showing stick-fixed and stick-free neutral points in turns for the XSBA-1 airplane with tail configuration 3.

NATIONAL ADVISORY
COMMITTEE FOR AERONAUTICS

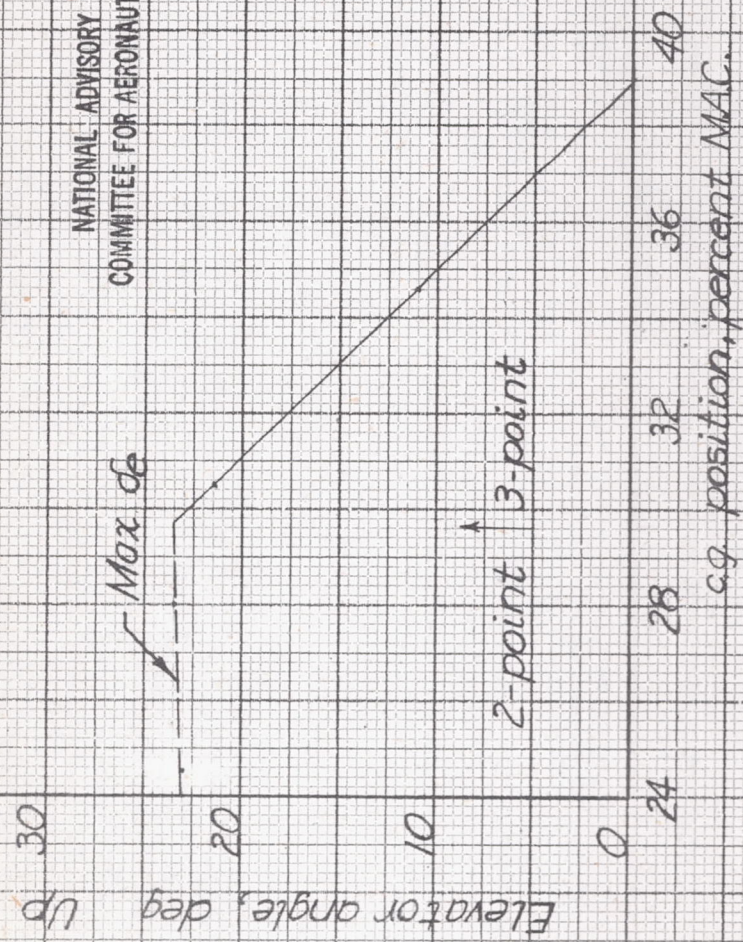

Figure 34.- Elevator deflection required to land XSEB-1 airplane with tail configuration 3 (power off, flaps down).

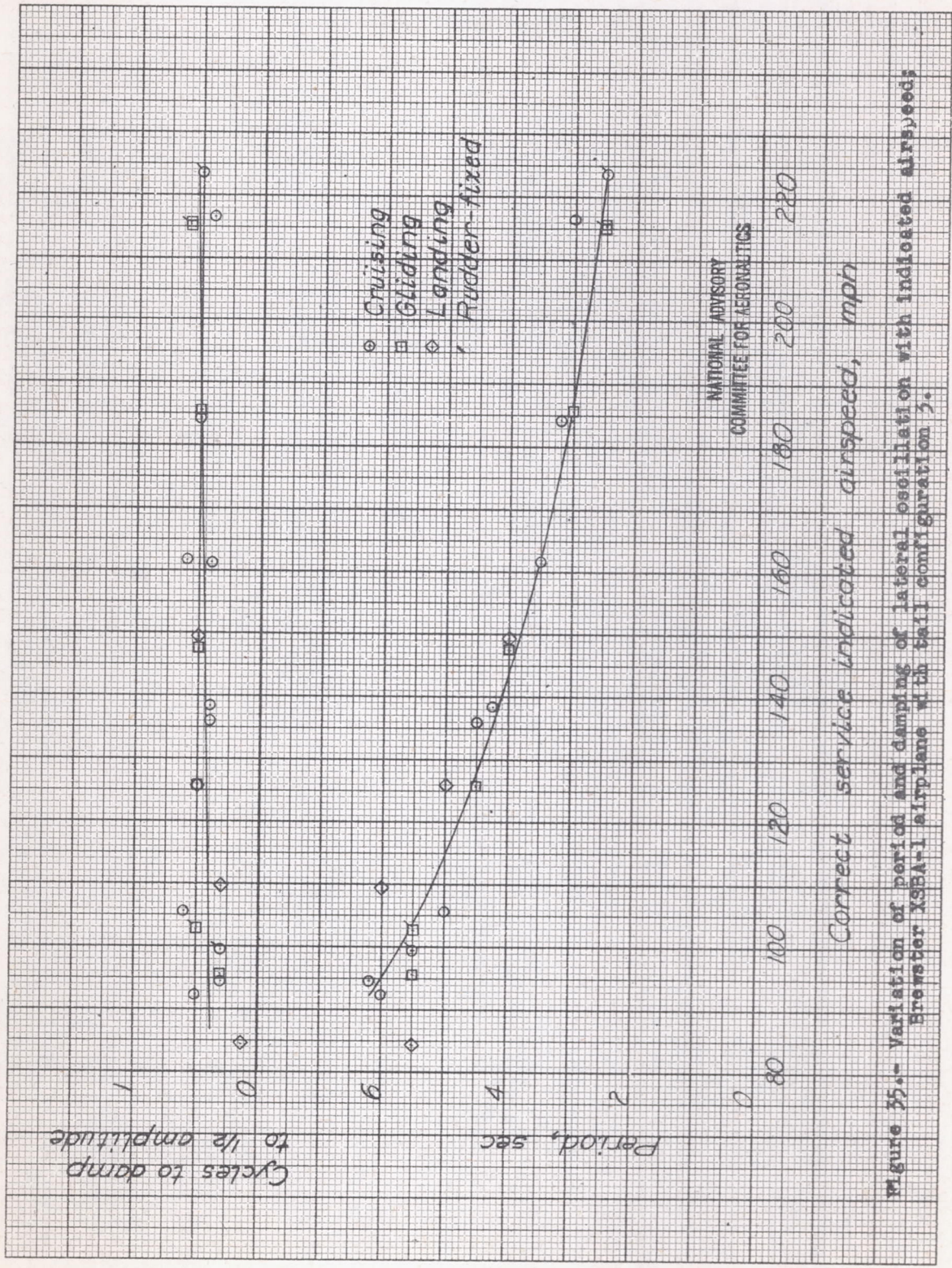

Figure 35.- Variation of period and damping of lateral oscillation with indicated airspeed; Frewster X3BA-1 airplane with tail configuration 3.

NATIONAL ADVISORY
COMMITTEE FOR AERONAUTICS

Correct service indicated airspeed, mph

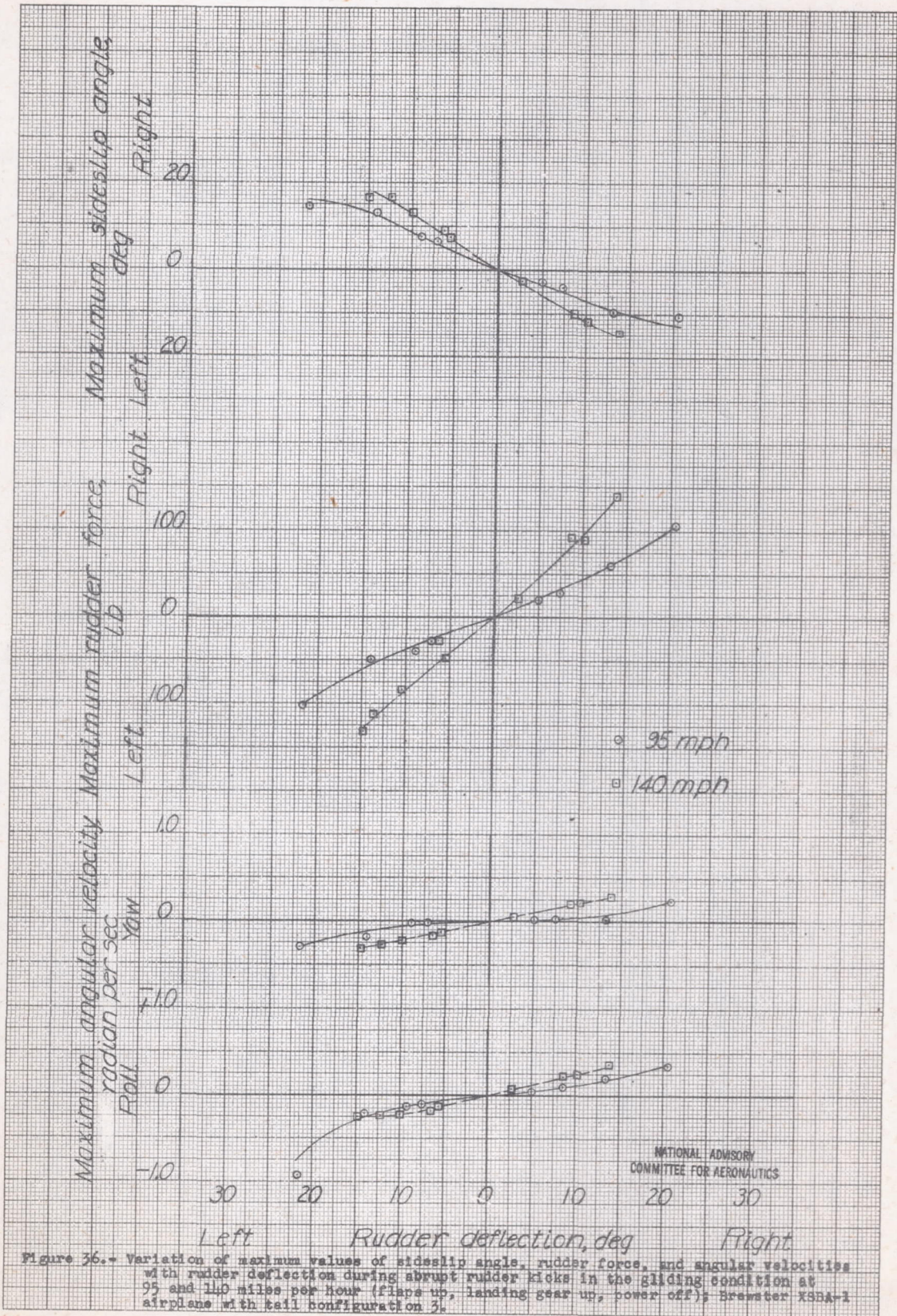

Figure 36. Variation of maximum values of sideslip angle, rudder force, and angular velocities with rudder deflection during abrupt rudder kicks in the gliding condition at 95 and 140 miles per hour (flaps up, landing gear up, power off); Brewster X3BA-1 airplane with tail configuration 3.

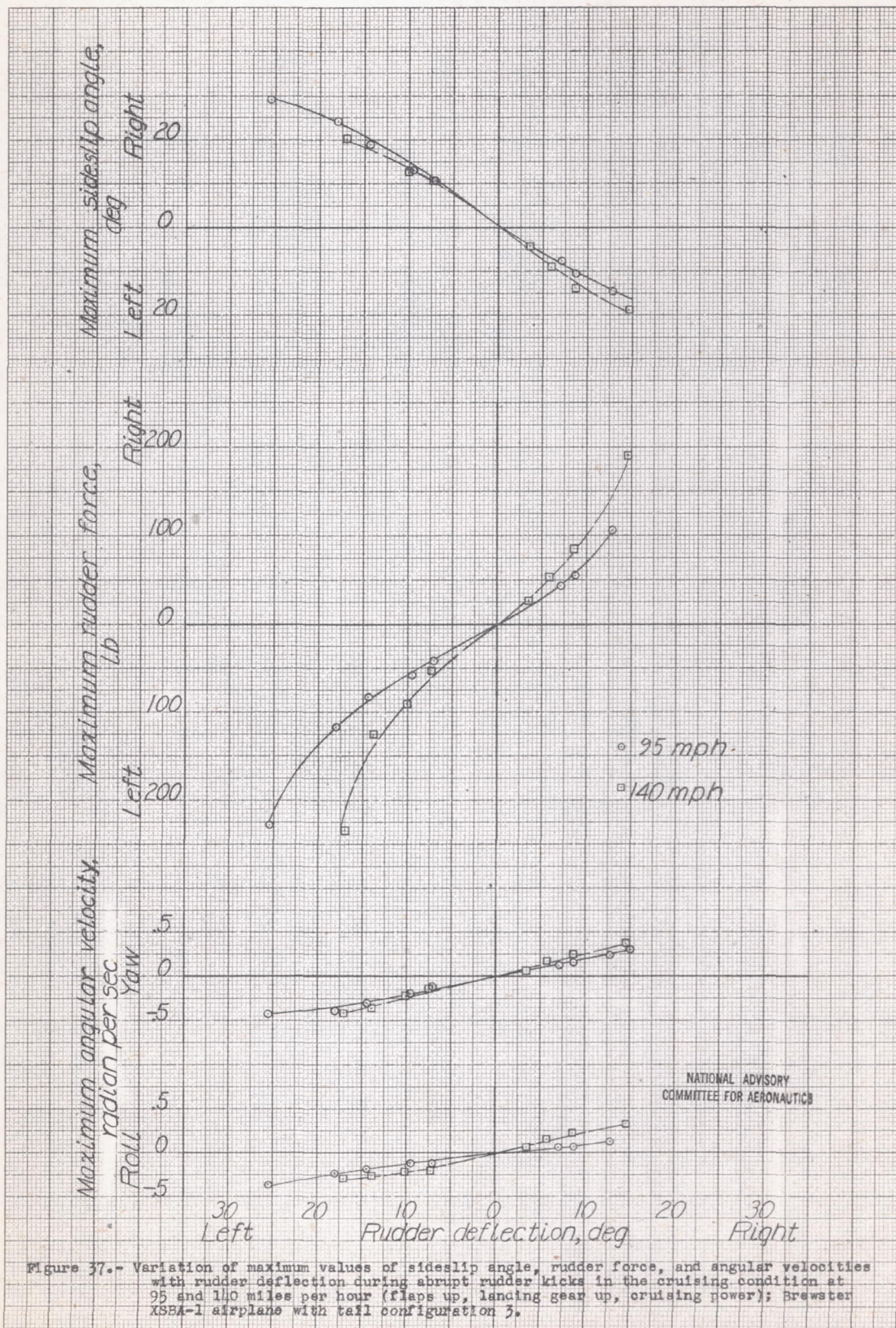
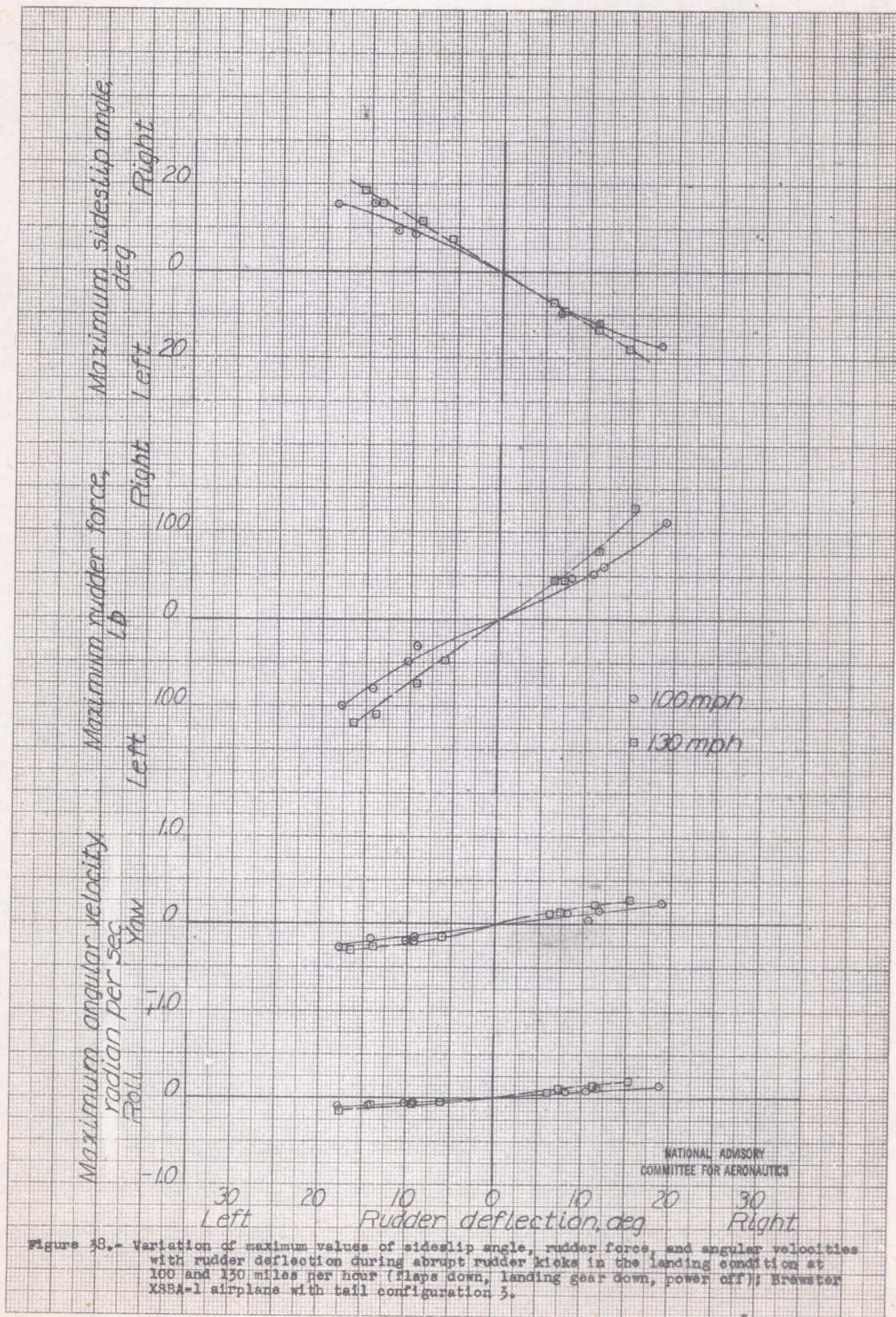

Figure 37.- Variation of maximum values of sideslip angle, rudder force, and angular velocities with rudder deflection during abrupt rudder kicks in the cruising condition at 95 and 140 miles per hour (flaps up, landing gear up, cruising power); Brewster XB5A-1 airplane with tail configuration 3.



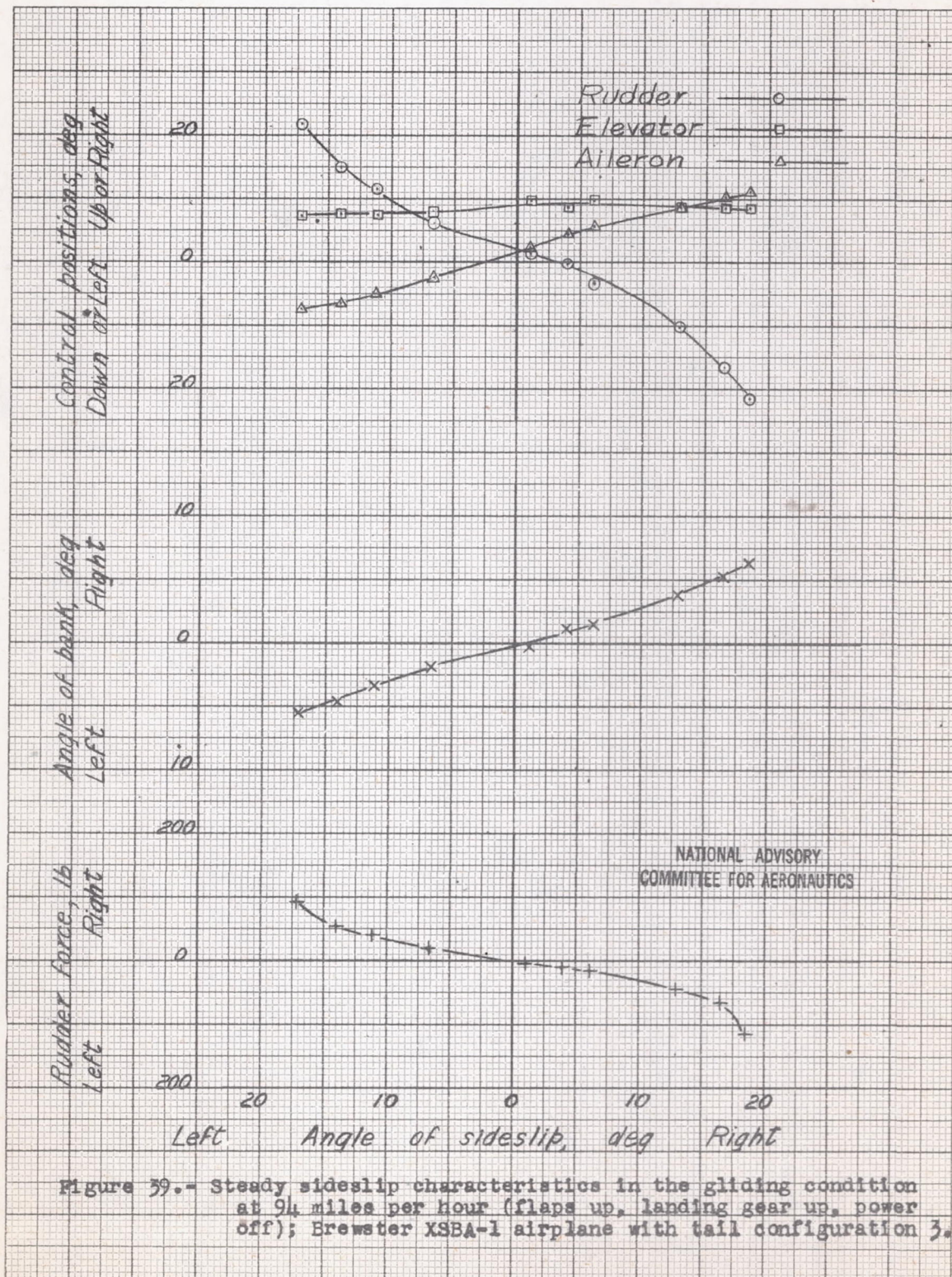
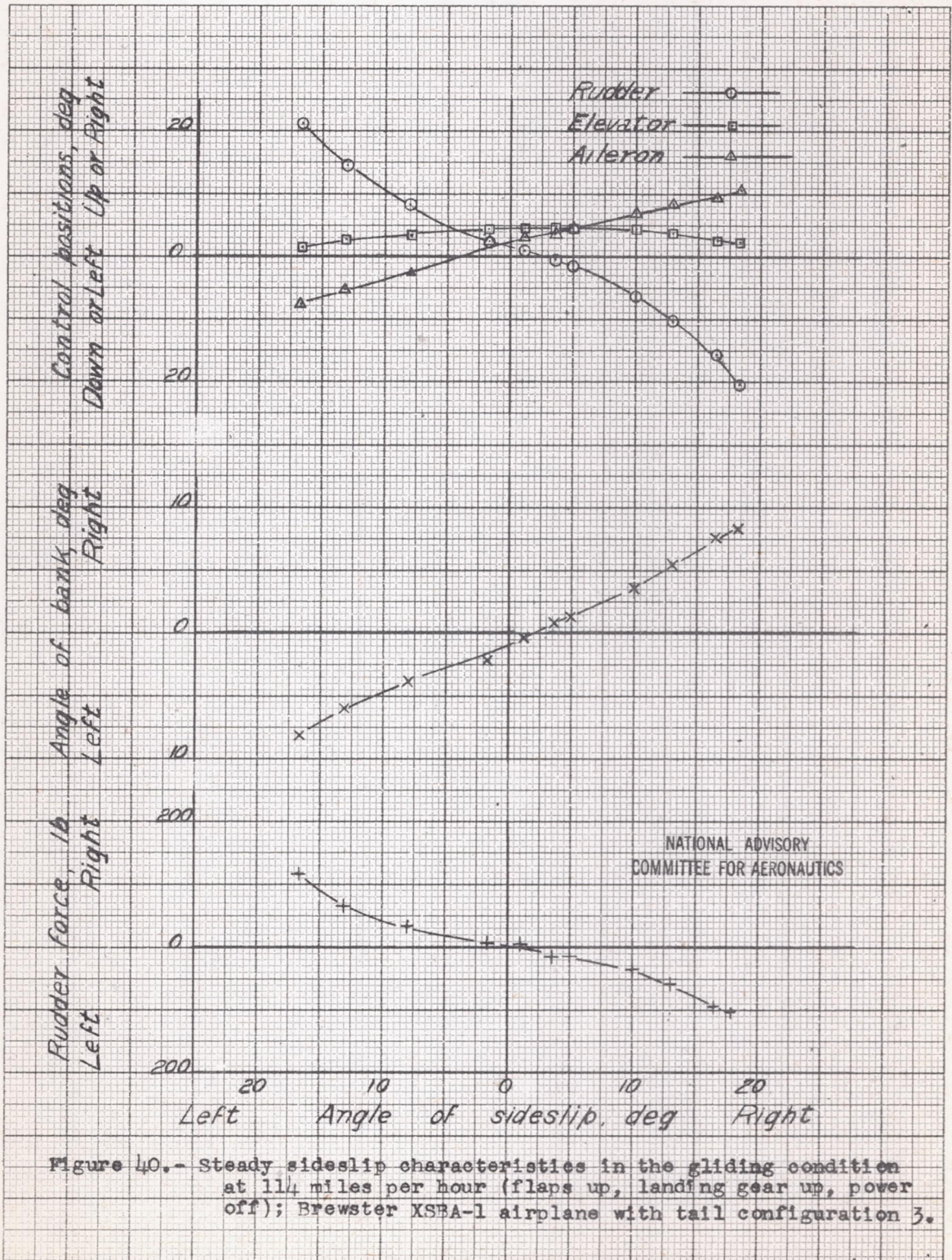

Figure 39.- Steady sideslip characteristics in the gliding condition at 94 miles per hour (flaps up, landing gear up, power off); Brewster XSBA-1 airplane with tail configuration 3.



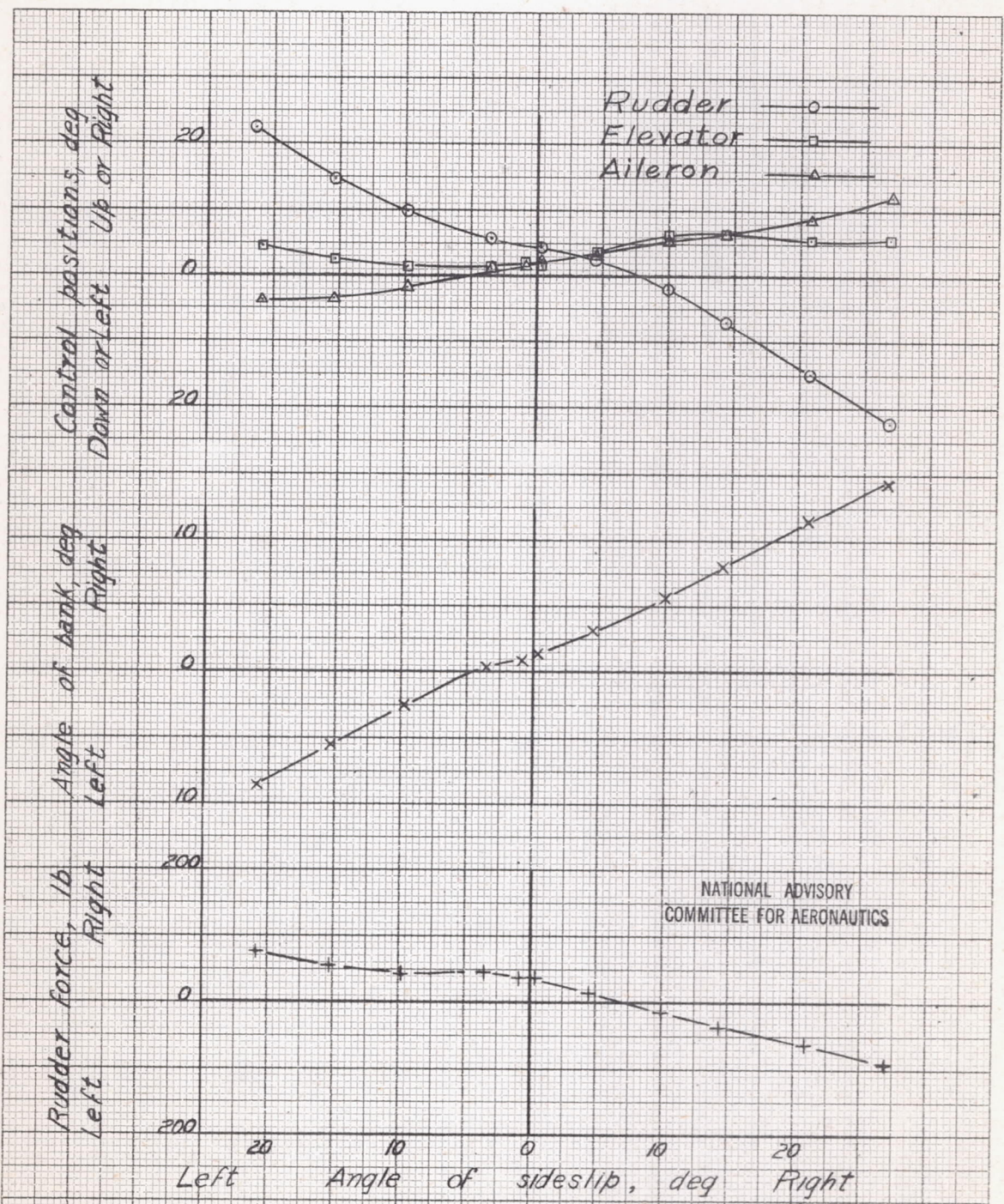

Figure 41.- Steady sideslip characteristics in the cruising condition at 87 miles per hour (flaps up, landing gear up, cruising power); Brewster XSBA-1 airplane with tail configuration 3.

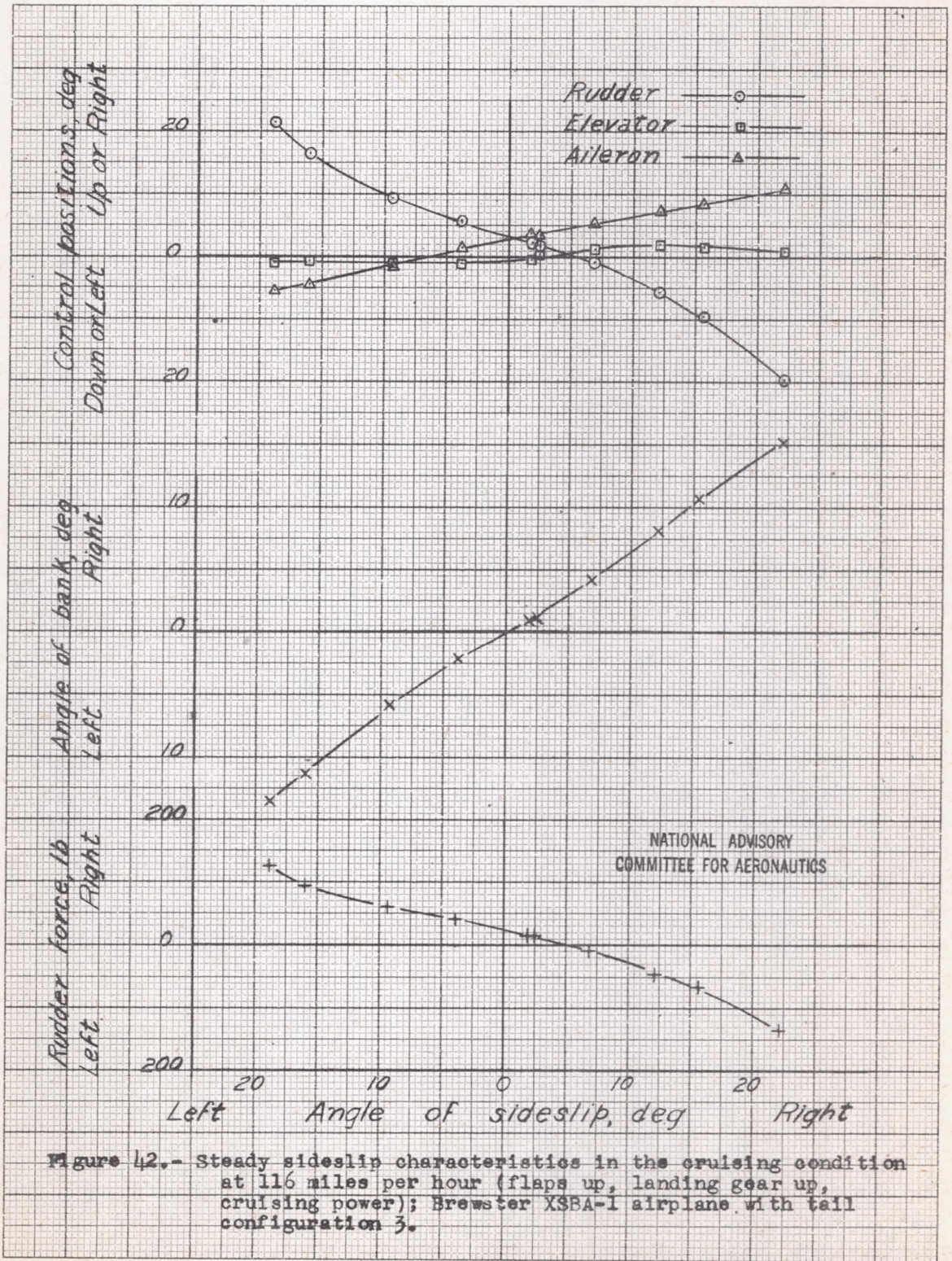

Figure 42.- Steady sideslip characteristics in the cruising condition at 116 miles per hour (flaps up, landing gear up, cruising power); Brewster XSBA-1 airplane with tail configuration 3.

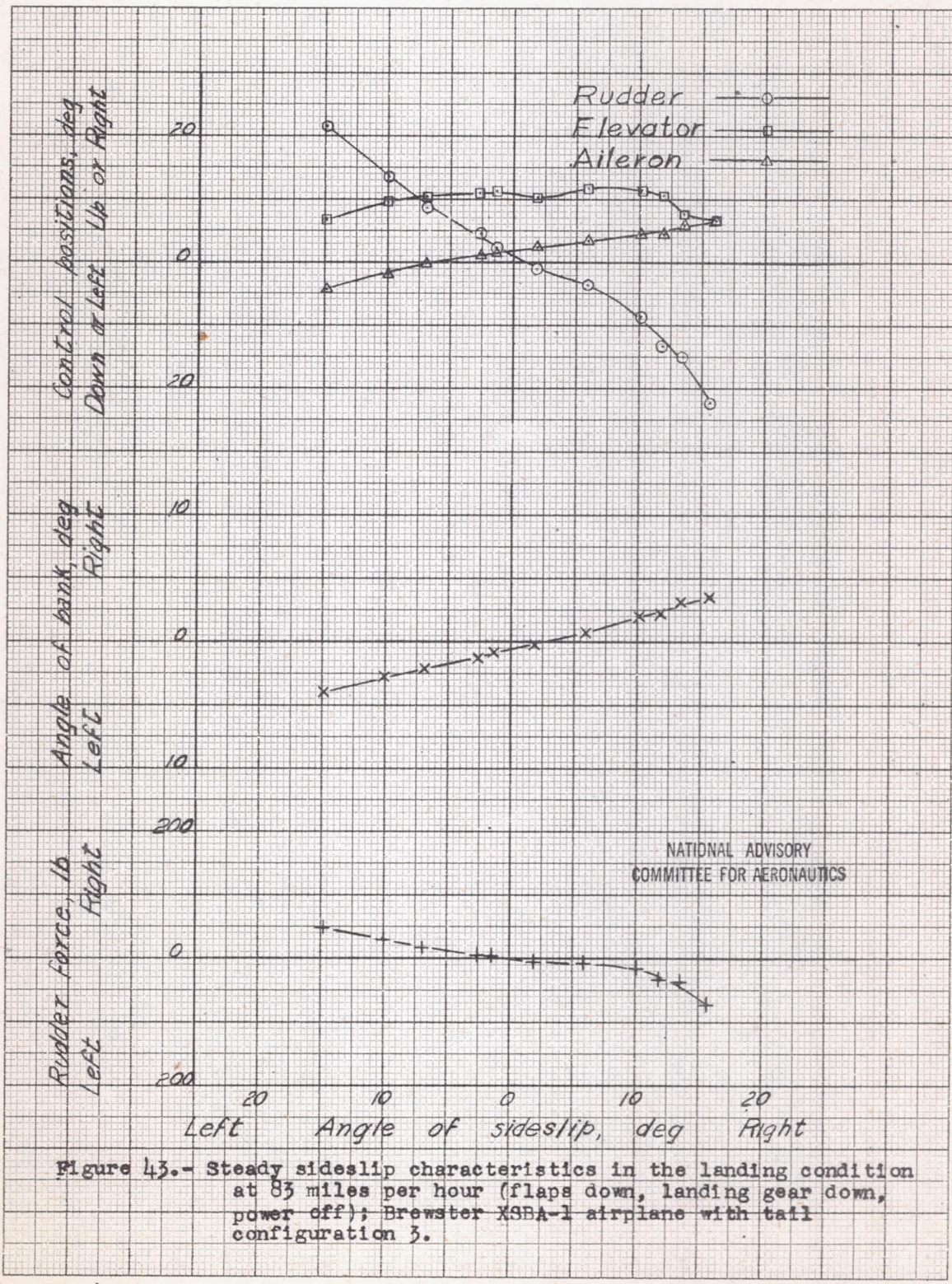

Figure 43.- Steady sideslip characteristics in the landing condition at 83 miles per hour (flaps down, landing gear down, power off); Brewster X3BA-1 airplane with tail configuration 3.

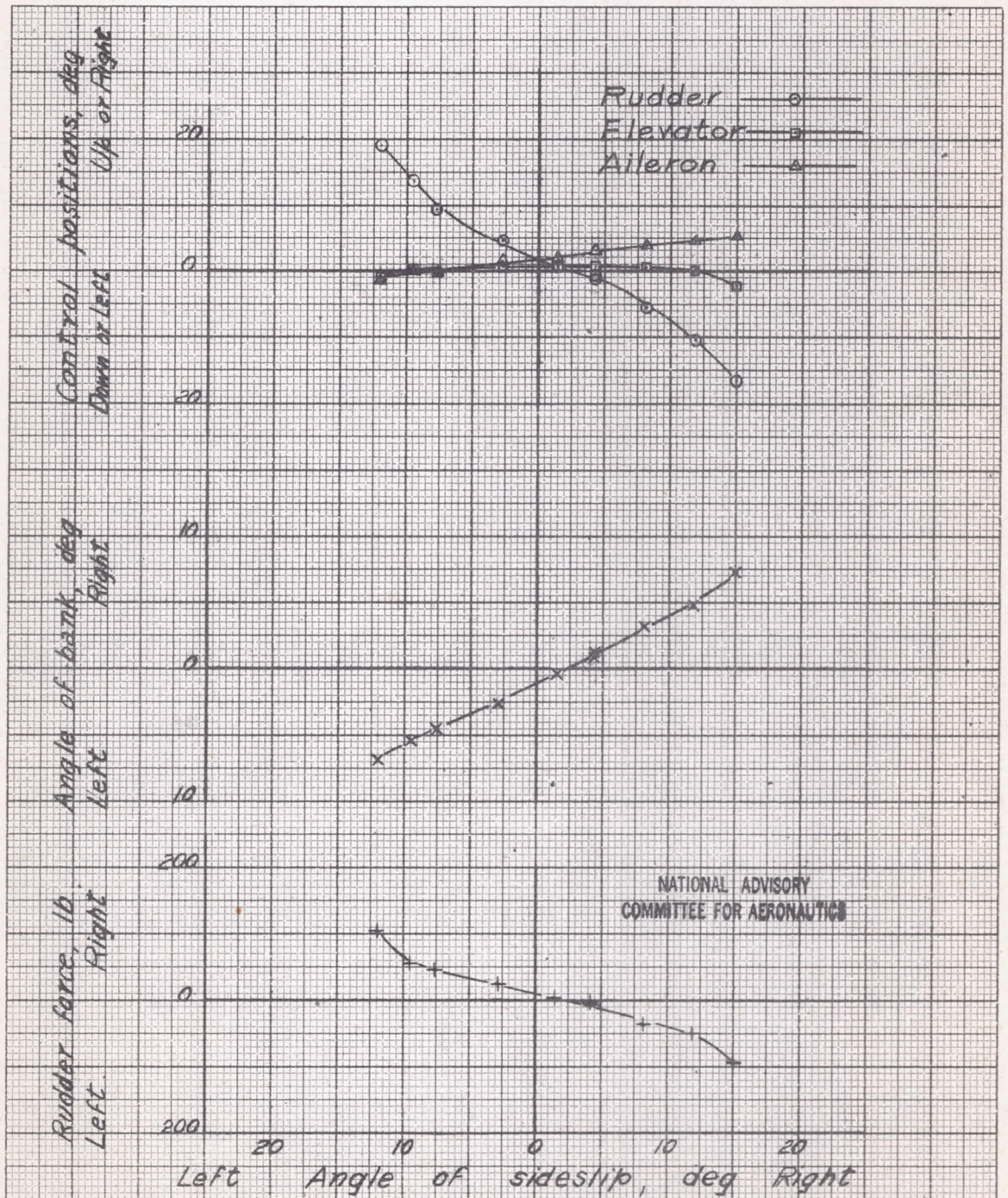

Figure 44.- Steady sideslip characteristics in the landing condition at 112 miles per hour (flaps down, landing gear down, power off); Brewster XSBA-1 airplane with tail configuration 3.

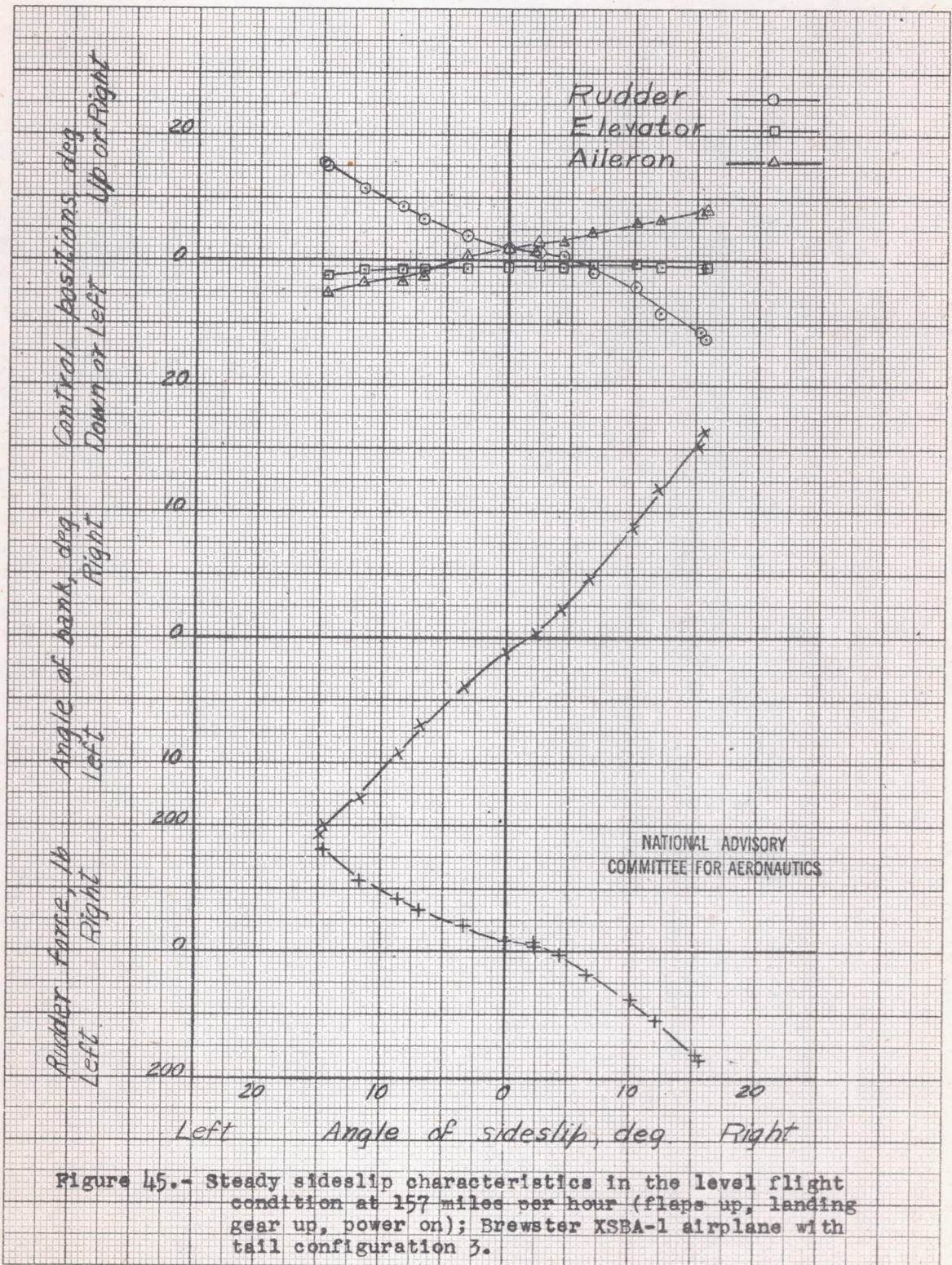

Figure 45.- Steady sideslip characteristics in the level flight condition at 157 miles per hour (flaps up, landing gear up, power on); Brewster XSBA-1 airplane with tail configuration 3.

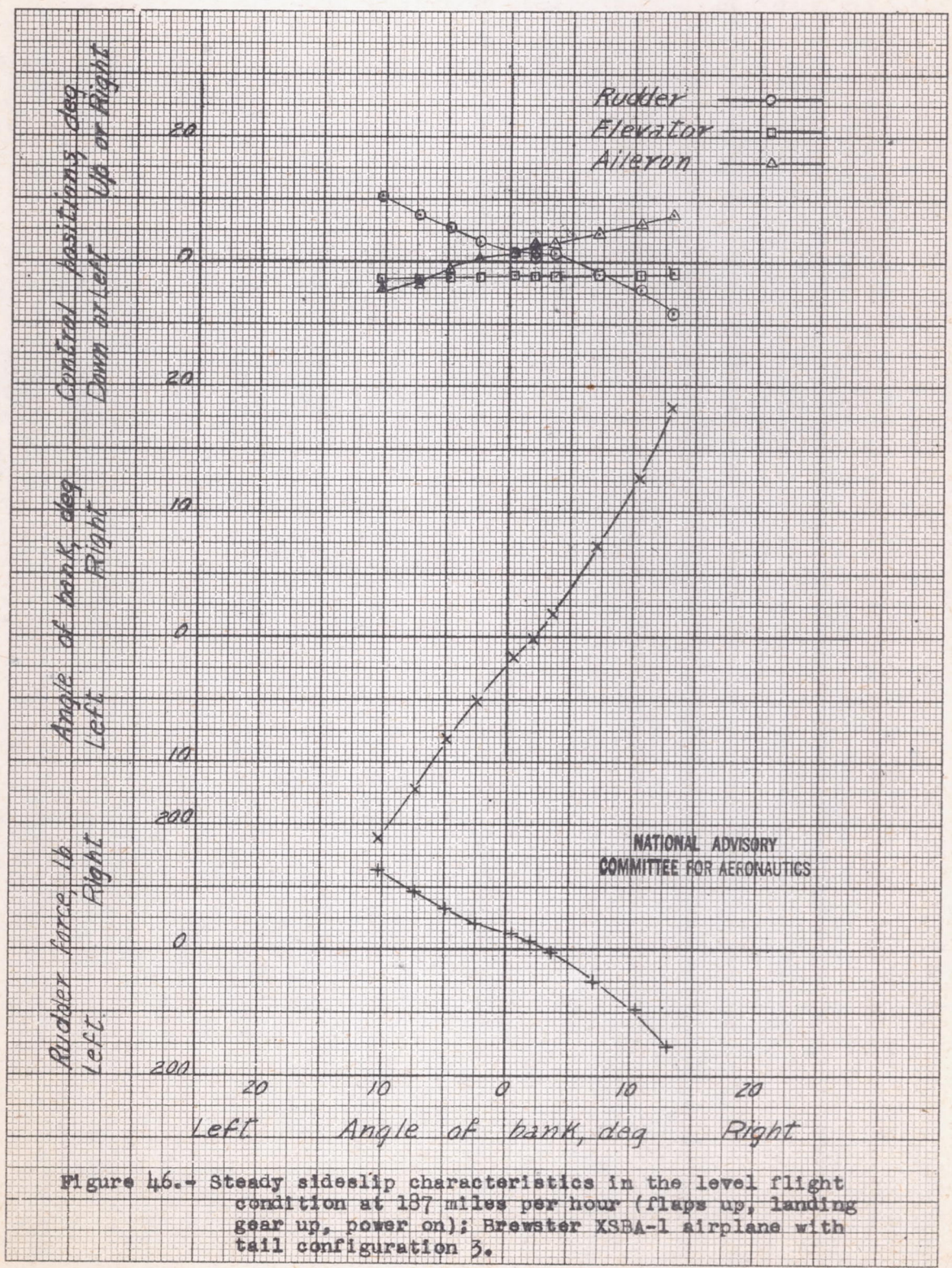
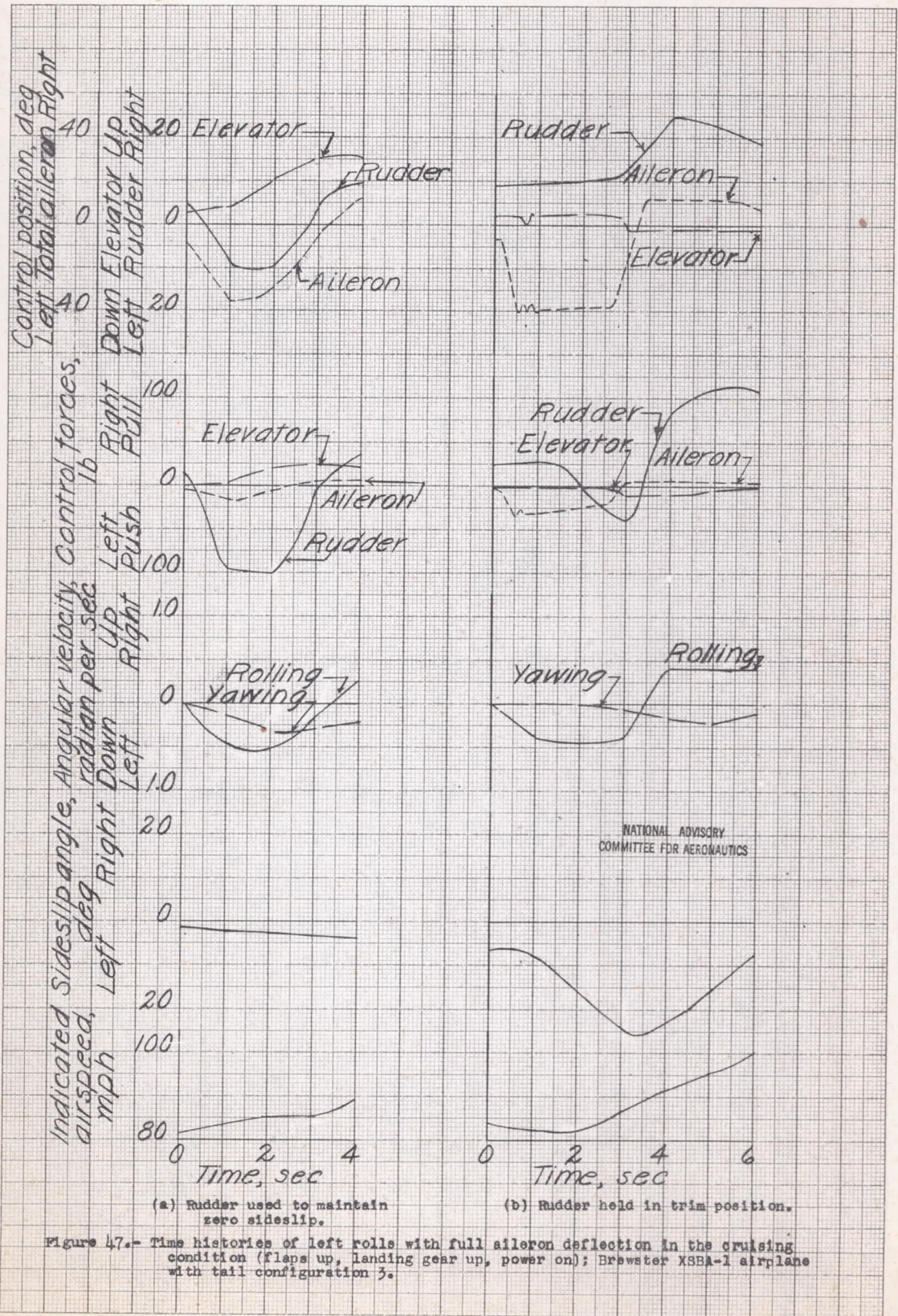
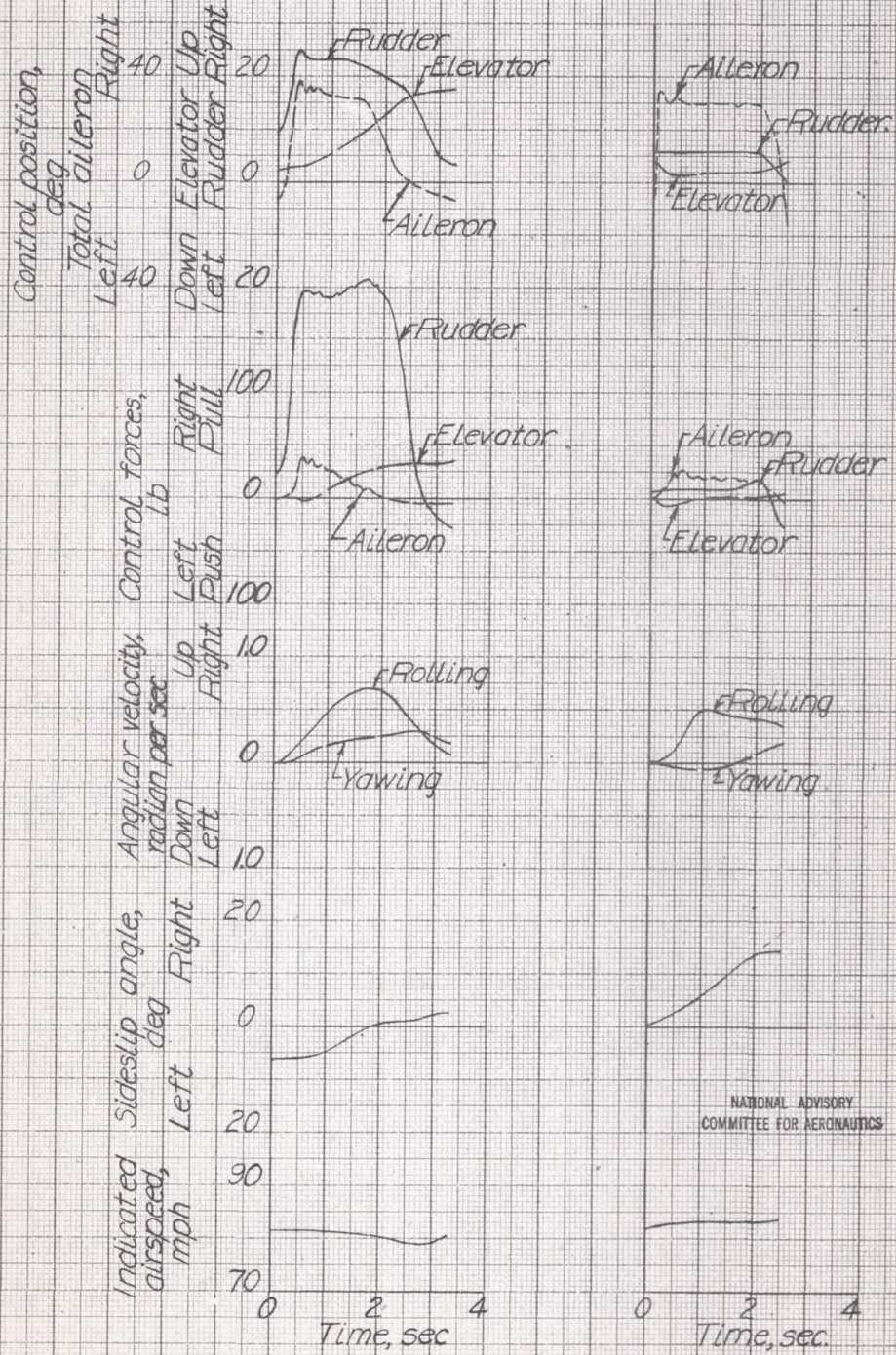

Figure 46.- Steady sideslip characteristics in the level flight condition at 137 miles per hour (flaps up, landing gear up, power on); Brewster XSBA-1 airplane with tail configuration 3.





NATIONAL ADVISORY
COMMITTEE FOR AERONAUTICS

(a) Rudder used to maintain zero sideslip. (b) Rudder held in trim position.

Figure 48.- Time histories of right rolls with full aileron deflection in the cruising condition (flaps up, landing gear up, power on); Brewster XSB-1 airplane with tail configuration 3.

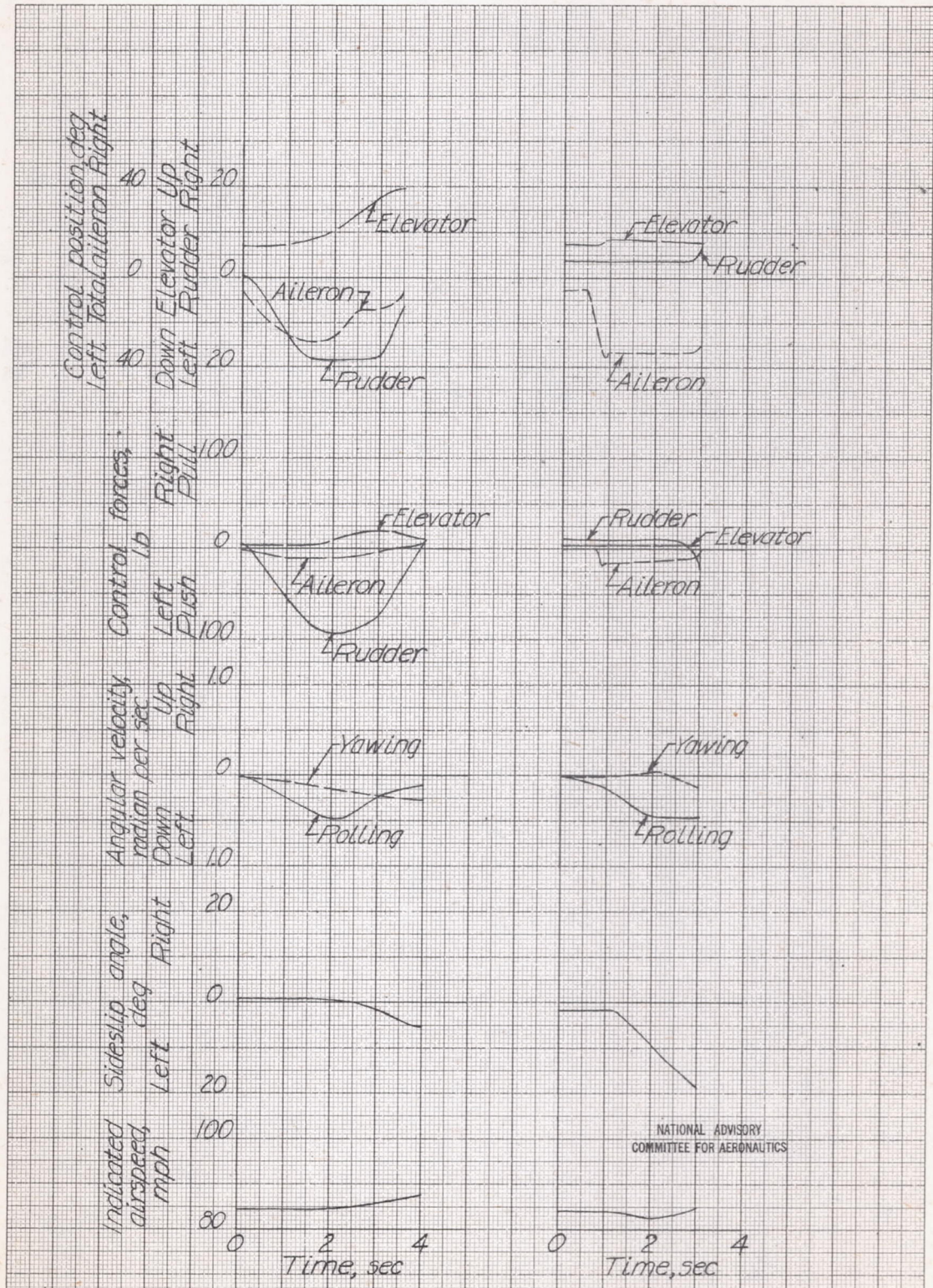

NATIONAL ADVISORY
COMMITTEE FOR AERONAUTICS

(a) Rudder used to maintain zero sideslip.

(b) Rudder held in trim position.

Figure 49.-- Time histories of left rolls with full aileron deflection in the landing condition (flaps down, landing gear down, and power off); Brewster XSBA-1 airplane with tail configuration 3.

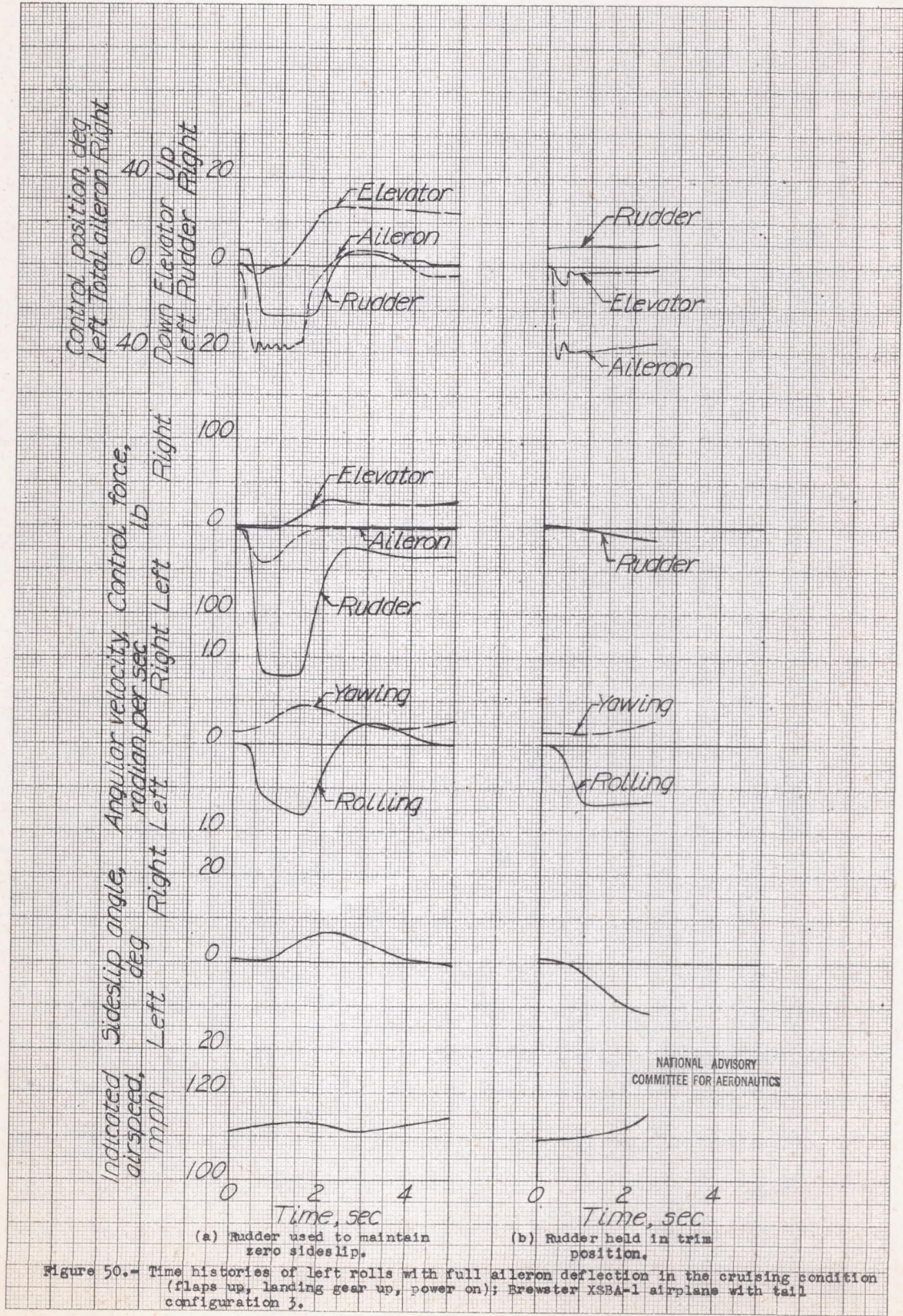
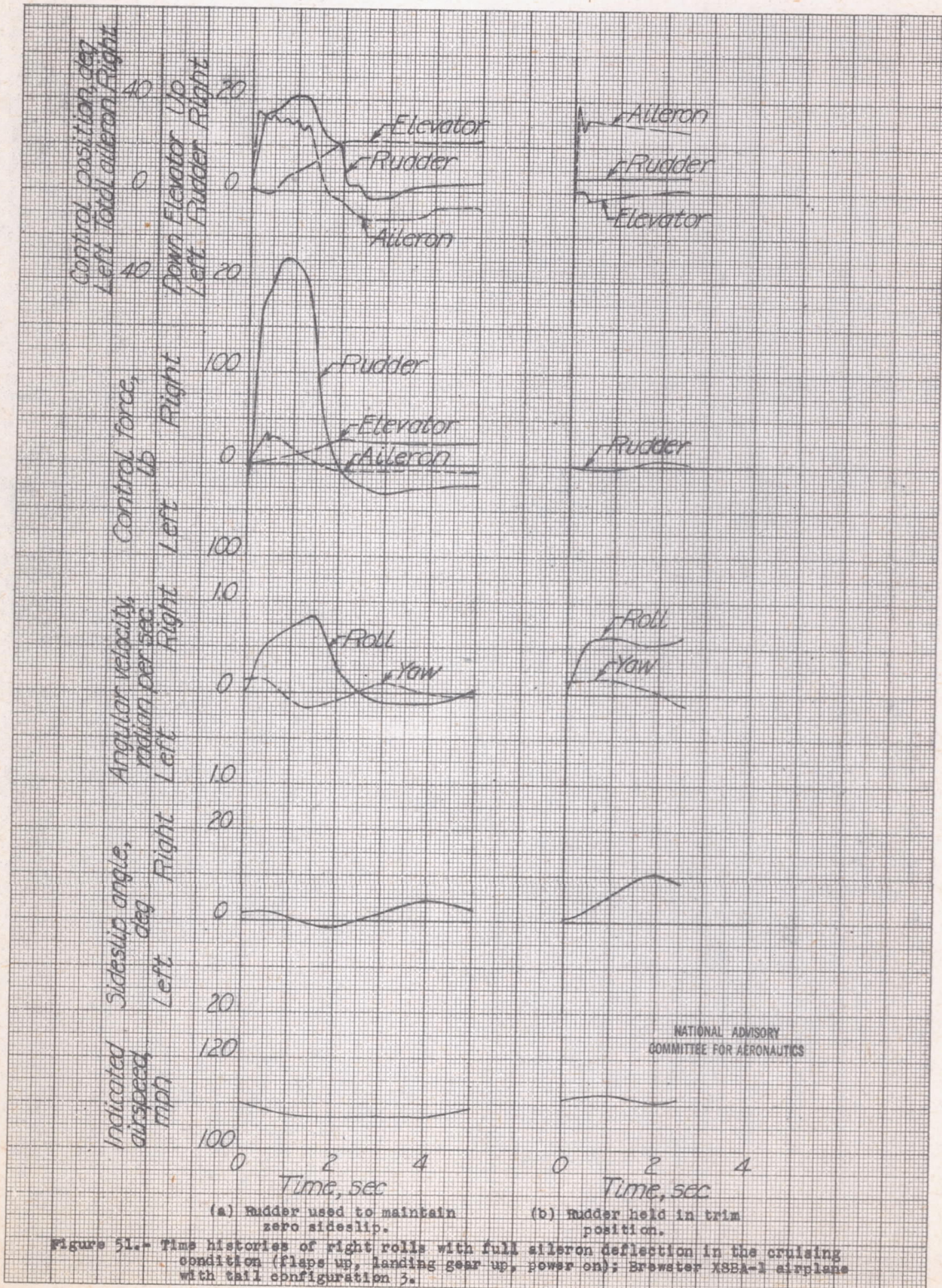

Figure 50.- Time histories of left rolls with full aileron deflection in the cruising condition (flaps up, landing gear up, power on); Brewster X3BA-1 airplane with tail configuration 3.



(a) rudder used to maintain zero sideslip. (b) rudder held in trim position.

Figure 51.- Time histories of right rolls with full aileron deflection in the cruising condition (flaps up, landing gear up, power on); Brewster XSB-1 airplane with tail configuration 3.

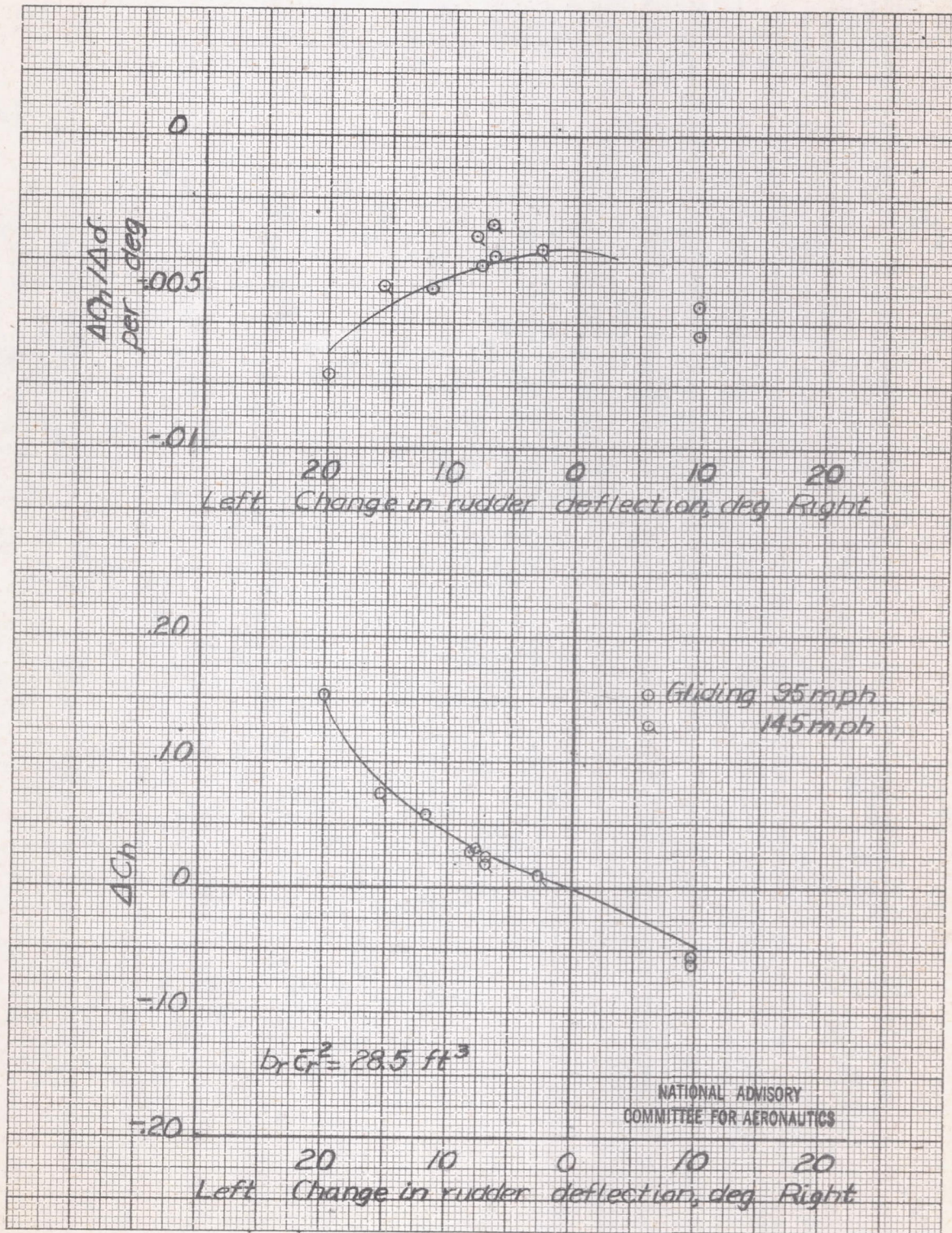

Figure 52.- Plots of $\Delta C_l / \Delta \delta$ and ΔC_l for constant α against change of rudder deflection during rudder kicks; XSB-1 airplane with tail configuration 1.

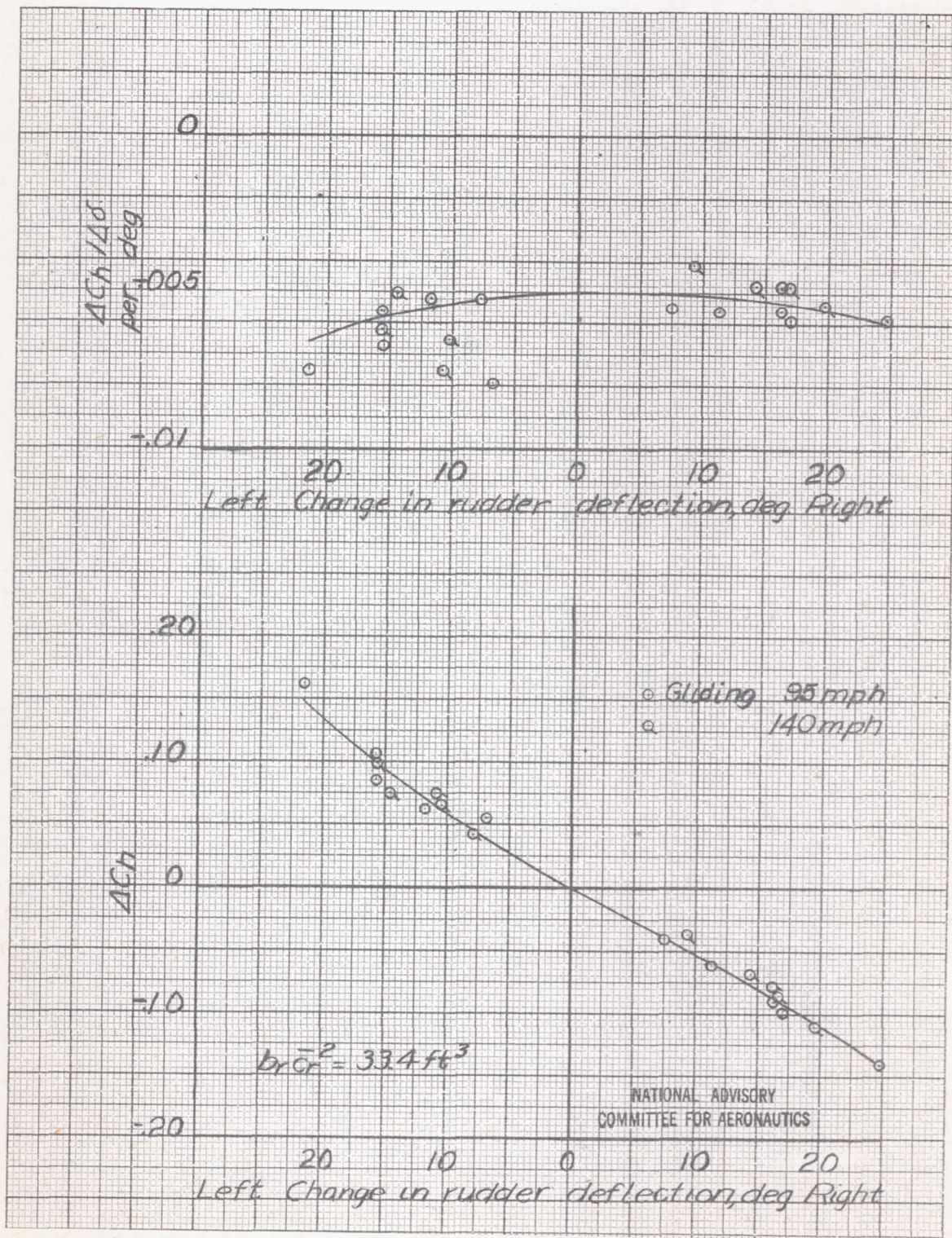

Figure 53.- Plots of $\Delta C_h / \Delta \delta$ and ΔC_h for constant α against change of rudder deflection during rudder kicks; XSBA-1 airplane with tail configuration 2.

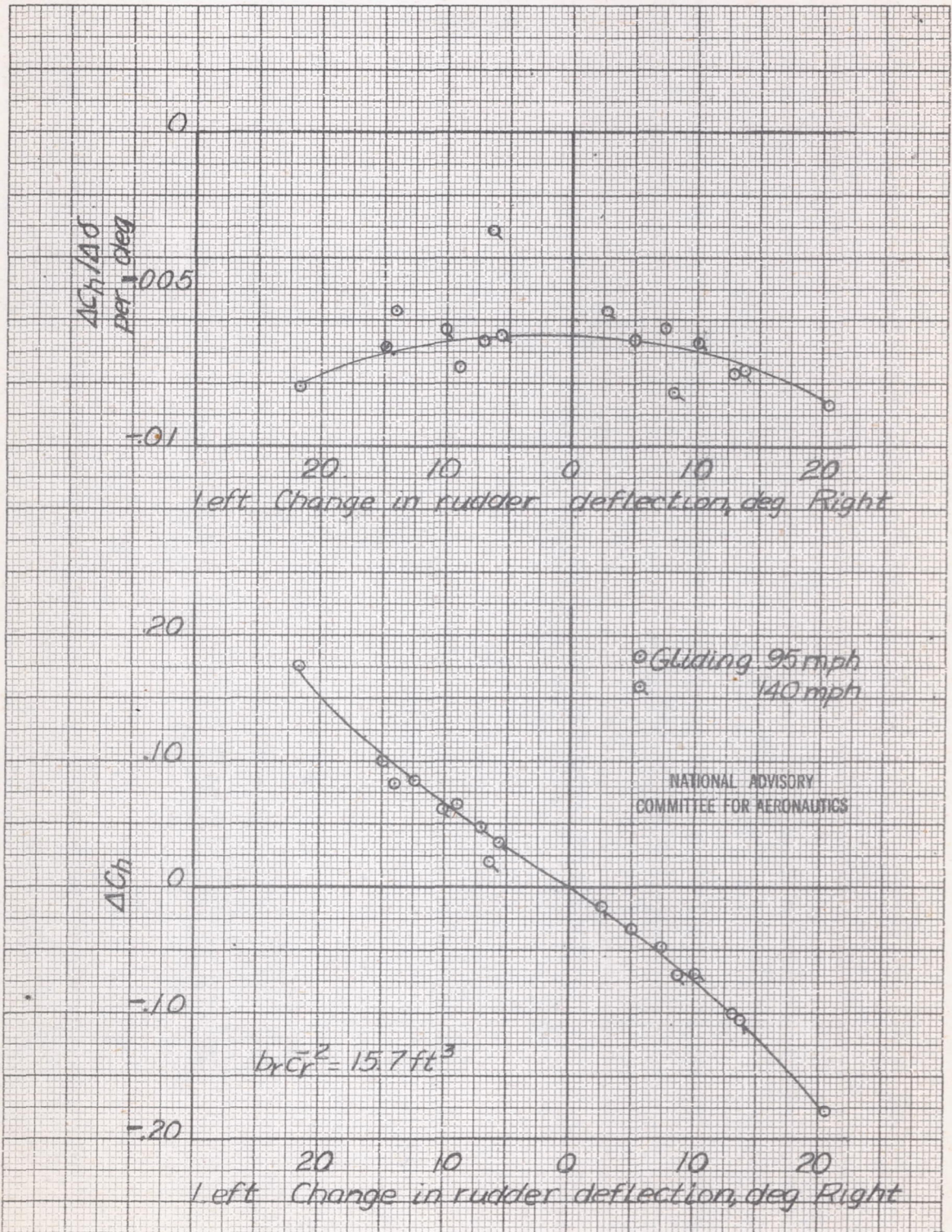

Figure 54.- Plots of $\Delta C_h / \Delta \delta$ and ΔC_h for constant α against change of rudder deflection during rudder kicks; XSBA-1 airplane with tail configuration 3.

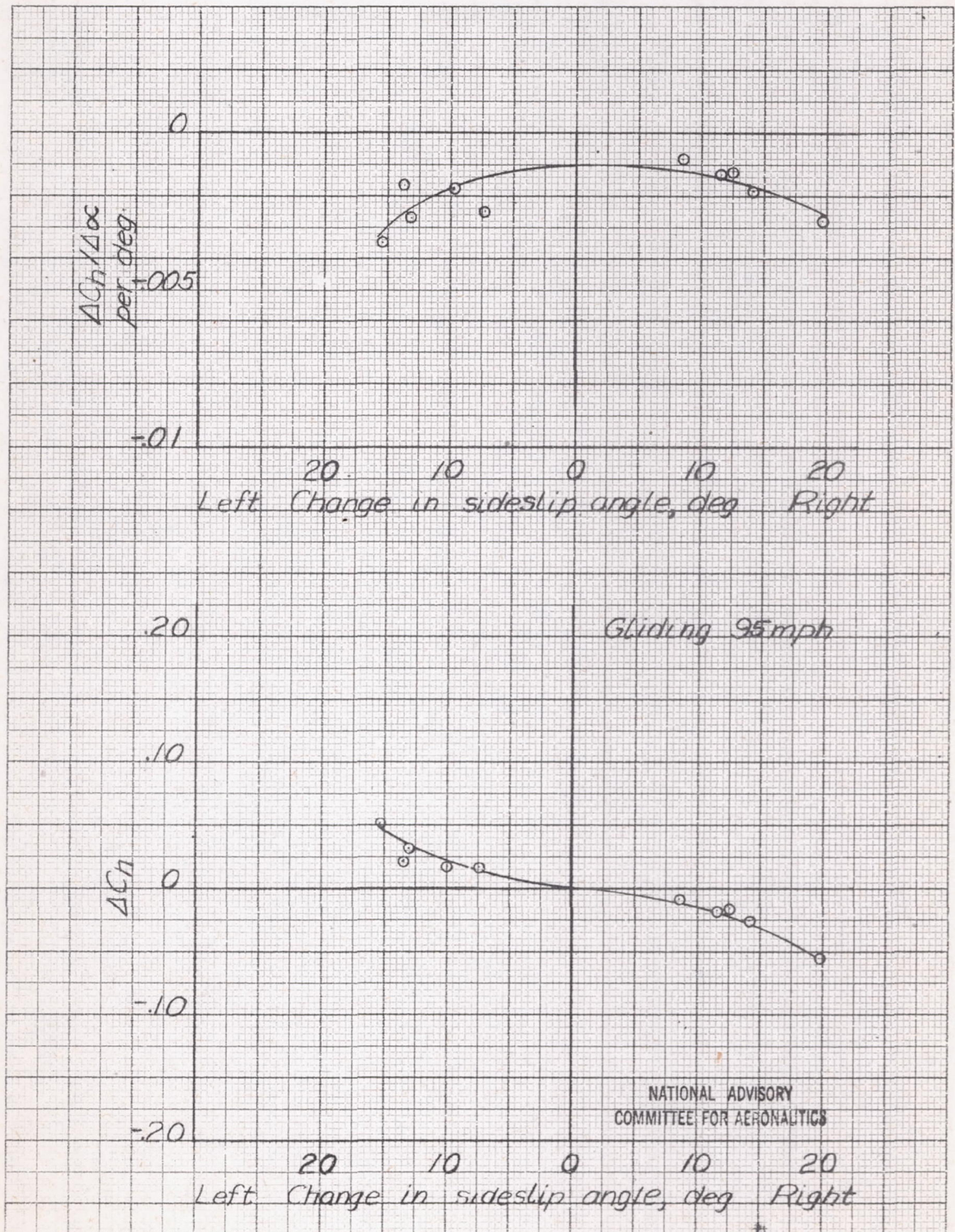

Figure 55.- Plots of $\Delta C_h / \Delta \alpha$ and ΔC_h against change of sideslip angle during rudder kicks; XSBA-1 airplane with tail configuration 2.

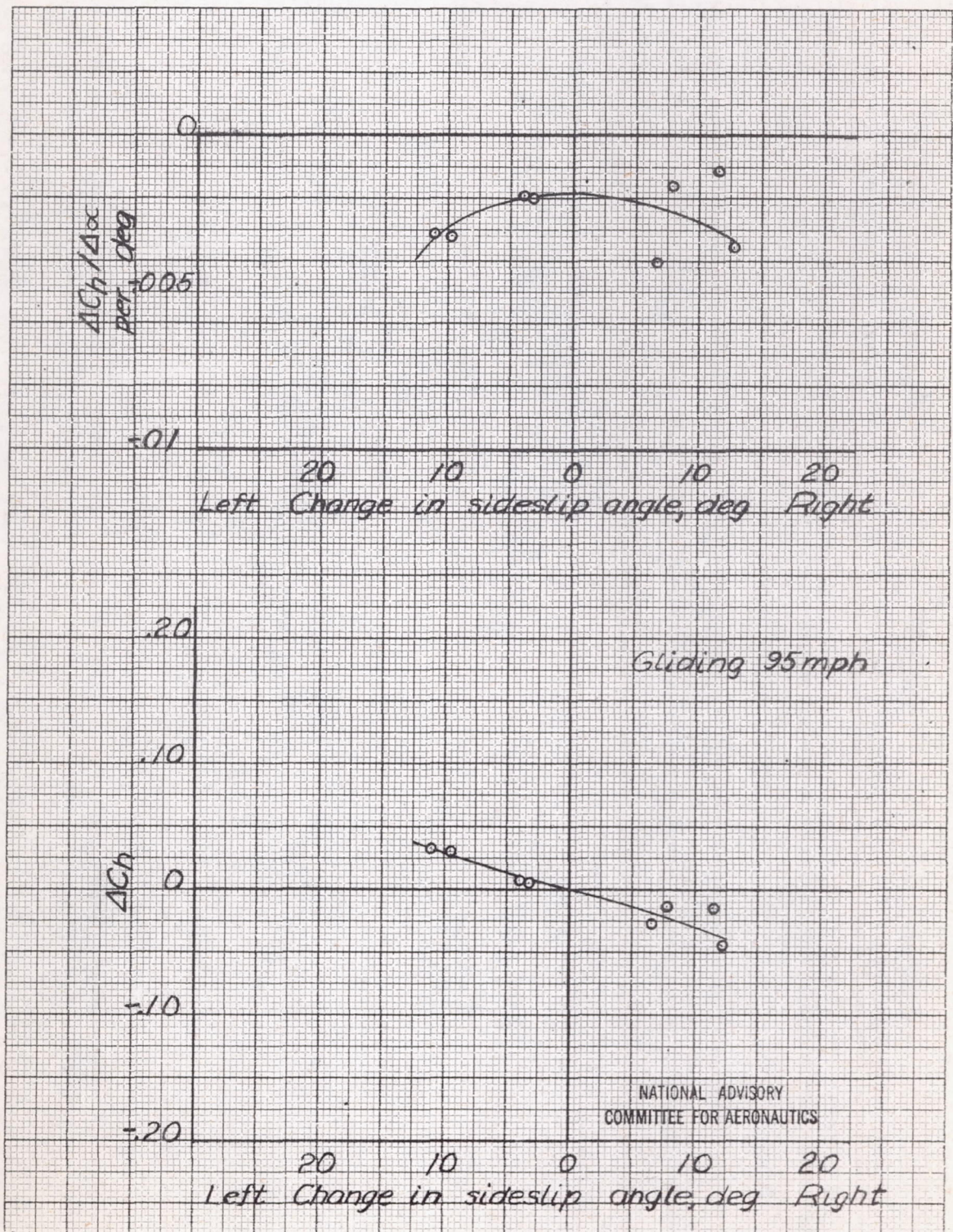

Figure 56.- Plots of $\Delta C_h / \Delta \alpha$ and ΔC_h against change of sideslip angle during rudder kicks; XSBA-1 airplane with tail configuration 3.