

NATIONAL ADVISORY COMMITTEE FOR AERONAUTICS

# WARTIME REPORT

ORIGINALLY ISSUED

October 1944 as

Advance Restricted Report L4F06

TENSILE TESTS OF NACA AND CONVENTIONAL

MACHINE-COUNTERSUNK FLUSH RIVETS

By Mervyn W. Mandel and Leonard M. Bartone

Langley Memorial Aeronautical Laboratory  
Langley Field, Va.

CASE FILE  
COPY

PROPERTY OF JET PROPULSION LABORATORY LIBRARY  
CALIFORNIA INSTITUTE OF TECHNOLOGY



WASHINGTON

NACA WARTIME REPORTS are reprints of papers originally issued to provide rapid distribution of advance research results to an authorized group requiring them for the war effort. They were previously held under a security status but are now unclassified. Some of these reports were not technically edited. All have been reproduced without change in order to expedite general distribution.

L-176

NATIONAL ADVISORY COMMITTEE FOR AERONAUTICS

---

ADVANCE RESTRICTED REPORT

---

TENSILE TESTS OF NACA AND CONVENTIONAL  
MACHINE-COUNTERSUNK FLUSH RIVETS

By Mervyn W. Mandel and Leonard M. Bartone

SUMMARY

An investigation was conducted to determine and compare the tensile strength of NACA and conventional machine-countersunk flush rivets of several rivet-head angles and varying countersunk depth. The results of the investigation are presented in the form of curves that show the variation of the tensile strength of the rivet with the ratio of the sheet thickness to the rivet diameter.

INTRODUCTION

Comparative data on the tensile strength of machine-countersunk flush rivets are scarce, although it is known that rivets are under tensile load in many applications. An investigation was therefore conducted to determine and compare the tensile strength of NACA machine-countersunk flush rivets and of conventional machine-countersunk flush rivets. The effect of rivet-head angle and depth of countersink on the tensile strength of both types of rivet was investigated.

SPECIMENS AND RIVETING PROCEDURE

Each specimen consisted of two sheets of 24S-T aluminum alloy of equal thickness, assembled with one Al7S-T aluminum-alloy rivet, as shown in figure 1. Tables I and II give the rivet diameters and sheet thicknesses for all specimens, the depths of countersink for the NACA flush-rivet specimens, and the heights of the rivet heads above the sheet surface before



driving for the conventional countersunk-rivet specimens. For the NACA flush rivets, the depth of countersink (designated  $c$  and shown in fig. 2(a)) was measured with a  $40^\circ$  conical spindle mounted on a dial gage graduated in ten-thousandths of an inch. For the conventional countersunk rivets, the height of the rivet head above the sheet surface before driving (designated  $h_b$  and shown in fig. 2(b)) was also measured with a dial gage.

The NACA flush-riveting procedure (method E of reference 1) is shown in figure 2(a). The rivet hole in the sheets of the specimen was machine-countersunk with a  $60^\circ$ ,  $82^\circ$ , or  $100^\circ$  countersinking tool. An AN430 round-head rivet was inserted from the back of the joint, and the manufactured head of the rivet was then driven with a vibrating gun while the shank end of the rivet was bucked into the countersunk hole with a bar. The protruding portion of the rivet head was removed with a flush-rivet milling tool similar to that described in reference 2.

The conventional riveting procedure for countersunk rivets (method C of reference 1) is shown in figure 2(b). The rivet hole in the sheets of the specimen was machine-countersunk with an  $82^\circ$  countersinking tool for the AN425  $78^\circ$  countersunk-head rivets, and with a  $100^\circ$  countersinking tool for the AN426  $100^\circ$  countersunk-head rivets. The rivet was inserted in the rivet hole and the manufactured head was driven with a vibrating gun while the shank end was bucked with a bar.

#### TEST PROCEDURE

The test procedure was the same as that described in reference 3. The specimens were mounted in the fixtures shown in figure 3. The small rods on each of the fixtures pass through the holes in one of the sheets of the specimen and bear against the other sheet. When load is applied, the rods push the sheets of the specimen apart. Loads were applied to the specimens in a hydraulic testing machine accurate within one-half of 1 percent. Maximum load and type of failure were recorded for each test.

## RESULTS AND CONCLUSIONS

The results of the tests are given in tables I and II, and typical specimens after failure are shown in figure 4. The variation of the maximum tensile load with the sheet thickness is shown in figures 5 to 9. It may be noted in figures 8 and 9 that the tensile strength of the  $\frac{3}{32}$ -inch-diameter conventional countersunk rivets was increased slightly for values of  $h_p$  greater than zero and decreased slightly for values of  $h_p$  less than zero.

In order to permit comparison of the results for the different types of rivet tested, the values of the tensile strength of the rivet, expressed as a fraction of the tensile strength of the rivet shank, were plotted against the ratio of the sheet thickness to the rivet diameter in figures 10 and 11. The tensile strength of the rivet shank was taken as an average of the maximum loads for those specimens that failed by tension of the shank. Curves were faired through the points so plotted, as shown in figures 10 and 11. These curves were used in the preparation of additional figures (figs. 12 to 15) in which the effects of the different variables are revealed.

NACA machine-countersunk flush rivets.- For a given rivet-head angle the tensile strength increased with the ratio of countersunk depth to rivet diameter  $c/d$ . (See fig. 12.) For  $c/d = 0.50$  and rivet-head angles of  $60^\circ$ ,  $82^\circ$ , and  $100^\circ$ , the full tensile strength of the rivet shank was developed for values of the ratio of sheet thickness to rivet diameter  $t/d$  greater than 0.7.

For a given value of  $c/d$ , the tensile strength increased with rivet-head angle, but at  $c/d = 0.50$  the tensile strengths of the  $100^\circ$  rivets were only very slightly greater than for the  $82^\circ$  rivets. (See fig. 13.) For  $c/d = 0.36$  and  $0.50$ , the tensile strength of the  $60^\circ$  rivets approached the tensile strength of  $82^\circ$  and  $100^\circ$  rivets as  $t/d$  approached 0.7.

Conventional countersunk flush rivets.- For values of  $t/d$  greater than about 0.4 the tensile strength of AN425  $78^\circ$  conventional rivets was higher than for AN426  $100^\circ$  conventional rivets. (See fig. 14.)



For  $t/d$  greater than about 0.7, the  $78^\circ$  rivets developed more than nine-tenths and the  $100^\circ$  rivets, more than about eight-tenths of the tensile strength of the rivet shank. From the tensile tests of the NACA rivets, it is concluded that the greater tensile strengths for the  $78^\circ$  rivets were caused by the higher  $c/d$  ratio ( $c/d = 0.50$  for the  $78^\circ$  conventional rivets;  $c/d = 0.33$  to  $0.38$  for the  $100^\circ$  conventional rivets).

Comparison of NACA and conventional machine-countersunk rivets.- For the same rivet-head angle - or essentially the same rivet-head angle - and for a given value of  $c/d$ , the NACA rivets developed higher tensile strength than the conventional rivets. (See fig. 15.)

Langley Memorial Aeronautical Laboratory  
National Advisory Committee for Aeronautics  
Langley Field, Va.

#### REFERENCES

1. Lundquist, Eugene E., and Gottlieb, Robert: A Study of the Tightness and Flushness of Machine-Countersunk Rivets for Aircraft. NACA RB, June 1942.
2. Gottlieb, Robert, and Mandel, Mervin W.: An Improved Flush-Rivet Milling Tool. NACA RB No. 3E18, 1943.
3. Schuette, Evan H., Bartone, Leonard M., and Mandel, Mervin W.: Tensile Tests of Round-Head, Flat-Head, and Brazier-Head Rivets. NACA TN No. 930, 1944.



TABLE I

TENSILE STRENGTH OF NACA MACHINE-COUNTERSUNK FLUSH RIVETS

Sheet thickness, t (in.)	t/d	Depth of countersink, c (in.)	c/d	Rivet-head angle, 60°			Rivet-head angle, 82°			Rivet-head angle, 100°		
				Max. load (lb)	R (a)	Type of failure	Max. load (lb)	R (a)	Type of failure	Max. load (lb)	R (a)	Type of failure
Rivet diameter d = 3/32 in.												
0.025	0.270	0.025	0.267	109	0.253	(b)	184	0.428	(b)	114	0.265	(b)
.025	.270	.035	.374	139	.323	(b)	79	.183	(b)	106	.247	(b)
.032	.342	.025	.267	147	.342	(b)	190	.442	(b)	239	.558	(b)
.032	.342	.035	.374	151	.351	(b)	213	.495	(b)	240	.558	(b)
.032	.342	.045	.480	191	.444	(b)	280	.651	(b)	293	.682	(c)
.040	.429	.025	.267	210	.488	(b)	230	.535	(c)	233	.541	(b)
.040	.429	.035	.374	205	.477	(b)	244	.567	(b)	284	.660	(c)
.040	.429	.045	.480	255	.593	(b)	260	.605	(b)	351	.816	(b)
.051	.544	.025	.267	230	.535	(b)	273	.635	(c)	354	.823	(c)
.051	.544	.035	.374	325	.756	(b)	367	.853	(b)	371	.863	(c)
.051	.544	.045	.480	338	.786	(b)	395	.919	(c)	423	.984	(c)
.064	.685	.025	.267	258	.600	(b)	284	.660	(c)	290	.674	(c)
.064	.685	.035	.374	360	.837	(b)	301	.700	(c)	387	.900	(c)
.064	.685	.045	.480	409	.951	(b)	422	.981	(d)	438	1.019	(d)
Rivet diameter d = 1/8 in.												
0.032	0.256	0.035	0.280	224	0.299	(b)	261	0.348	(b)	289	0.385	(b)
.032	.256	.045	.360	221	.295	(b)	265	.353	(b)	315	.420	(b)
.040	.320	.035	.280	284	.379	(b)	316	.422	(b)	369	.492	(c)
.040	.320	.045	.360	281	.375	(b)	340	.453	(b)	417	.556	(b)
.051	.406	.045	.360	426	.569	(b)	431	.575	(b)	506	.676	(b)
.051	.406	.065	.520	420	.560	(b)	558	.745	(b)	552	.737	(b)
.064	.513	.045	.360	515	.687	(b)	641	.855	(c)	508	.677	(c)
.064	.513	.065	.520	576	.769	(b)	665	.887	(c)	790	1.052	(c)
.081	.645	.045	.360	582	.777	(c)	652	.870	(c)	612	.816	(c)
.081	.645	.055	.440	659	.879	(c)	682	.909	(c)	719	.959	(d)
.081	.645	.065	.520	726	.969	(d)	753	1.004	(d)	806	1.075	(d)
Rivet diameter d = 5/32 in.												
0.040	0.258	0.045	0.288	344	0.301	(b)	373	0.326	(b)	481	0.421	(b)
.040	.258	.055	.353	329	.288	(b)	406	.355	(b)	415	.363	(b)
.051	.325	.045	.288	373	.326	(b)	636	.558	(b)	669	.585	(b)
.051	.325	.055	.353	419	.366	(b)	570	.498	(b)	810	.708	(b)
.064	.410	.055	.353	535	.469	(b)	788	.689	(b)	955	.835	(c)
.064	.410	.075	.481	747	.653	(b)	880	.770	(b)	970	.848	(b)
.081	.518	.055	.353	779	.680	(b)	995	.870	(c)	1040	.910	(c)
.081	.518	.075	.481	975	.852	(b)	1160	1.014	(c)	960	.840	(c)
.102	.654	.055	.353	1110	.971	(d)	1000	.875	(b)	1100	.972	(c)
.102	.654	.065	.417	1130	.901	(d)	1060	.928	(d)	1170	1.023	(d)
.102	.654	.075	.481	1159	1.012	(d)	1164	1.019	(d)	1210	1.059	(d)
Rivet diameter d = 3/16 in.												
0.051	0.271	0.055	0.283	539	0.337	(b)	780	0.488	(b)	762	0.476	(b)
.051	.271	.065	.346	422	.264	(b)	605	.378	(b)	780	.488	(b)
.064	.342	.055	.283	658	.411	(b)	915	.572	(b)	923	.577	(c)
.064	.342	.065	.346	690	.431	(b)	906	.566	(b)	983	.615	(b)
.081	.431	.055	.283	892	.558	(c)	1032	.645	(c)	1093	.694	(c)
.081	.431	.065	.346	930	.581	(b)	1295	.800	(c)	1240	.775	(c)
.102	.544	.065	.346	1125	.703	(b)	1428	.892	(c)	1480	.925	(c)
.125	.667	.065	.346	1444	.903	(c)	1285	.804	(c)	1555	.972	(c)
.125	.667	.075	.399	1574	.985	(c)	1536	.960	(c)	1635	1.021	(d)
.125	.667	.085	.452	1565	.979	(d)	1599	1.000	(d)	1707	1.067	(c)

<sup>a</sup> R =  $\frac{\text{Tensile strength of rivet}}{\text{Tensile strength of rivet shank}}$

NATIONAL ADVISORY  
COMMITTEE FOR AERONAUTICS

- <sup>b</sup>Countersunk head of rivet pulled through sheet.
- <sup>c</sup>Countersunk head of rivet sheared.
- <sup>d</sup>Tension failure of rivet shank.



TABLE II  
TENSILE STRENGTH OF CONVENTIONAL MACHINE-COUNTERSUNK FLUSH RIVETS

Sheet thickness, t (in.)	t/d	h <sub>b</sub> (in.)	Rivet-head angle, 78°				Rivet-head angle, 100°					
			Max. load (lb)	R (a)	Type of failure	Rivet-head height, C (in.)	C/d	Max. load (lb)	R (a)	Type of failure	Rivet-head height, C (in.)	C/d
Rivet diameter d = 3/32 in.												
0.032	0.342	0.010	274	0.637	(b)	0.047	0.500	275	0.639	(b)	0.036	0.383
.032	.342	.000	201	.467	(b)	.047	.500	258	.600	(b)	.036	.383
.032	.342	-.005	195	.454	(b)	.047	.500	202	.470	(b)	.036	.383
.040	.429	.010	319	.741	(b)	.047	.500	301	.700	(c)	.036	.383
.040	.429	.000	245	.570	(b)	.047	.500	270	.627	(b)	.036	.383
.040	.429	-.005	247	.564	(b)	.047	.500	255	.593	(b)	.036	.383
.051	.544	.010	354	.824	(b)	.047	.500	360	.837	(c)	.036	.383
.051	.544	.000	393	.914	(b)	.047	.500	348	.809	(c)	.036	.383
.051	.544	-.005	340	.790	(b)	.047	.500	330	.767	(c)	.036	.383
.064	.685	.010	408	.949	(c)	.047	.500	384	.893	(c)	.036	.383
.064	.685	.000	397	.923	(c)	.047	.500	379	.881	(c)	.036	.383
.064	.685	-.005	374	.870	(c)	.047	.500	369	.858	(c)	.036	.383
Rivet diameter d = 1/8 in.												
0.040	0.320	0.000	300	0.400	(b)	0.062	0.496	311	0.415	(b)	0.042	0.336
.051	.406	.000	504	.671	(b)	.062	.496	466	.622	(c)	.042	.336
.064	.513	.000	621	.829	(b)	.062	.496	520	.694	(c)	.042	.336
.081	.645	.000	714	.951	(b)	.062	.496	515	.687	(c)	.042	.336
Rivet diameter d = 5/32 in.												
0.051	0.324	0.000	646	0.565	(b)	0.078	0.500	516	0.452	(b)	0.055	0.352
.064	.410	.000	733	.640	(b)	.078	.500	704	.615	(b)	.055	.352
.081	.518	.000	1035	.915	(b)	.078	.500	790	.690	(c)	.055	.352
.102	.654	.000	1075	.940	(c)	.078	.500	815	.713	(c)	.055	.352
Rivet diameter d = 3/16 in.												
0.064	0.342	0.000	815	0.509	(b)	0.094	0.500	815	0.509	(b)	0.070	0.372
.081	.431	.000	1235	.772	(b)	.094	.500	1200	.750	(c)	.070	.372
.102	.544	.000	1409	.880	(b)	.094	.500	1260	.788	(c)	.070	.372
.125	.667	.000	1417	.885	(c)	.094	.500	1320	.825	(c)	.070	.372

$$a \ R = \frac{\text{Tensile strength of rivet}}{\text{Tensile strength of rivet shank}}$$

<sup>b</sup>Countersunk head of rivet pulled through sheet.

<sup>c</sup>Countersunk head of rivet sheared.

<sup>d</sup>Tension failure of rivet shank.

NATIONAL ADVISORY  
COMMITTEE FOR AERONAUTICS



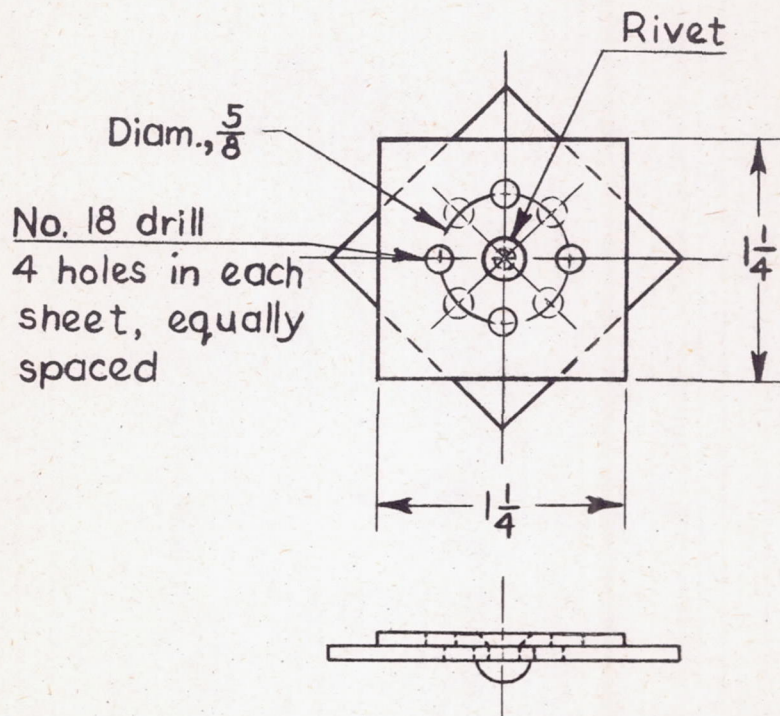

NATIONAL ADVISORY  
COMMITTEE FOR AERONAUTICS

Figure 1.- Test specimen.



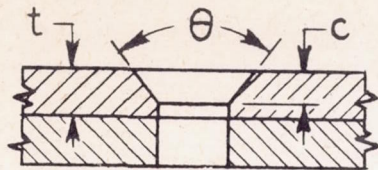

Hole preparation and rivets

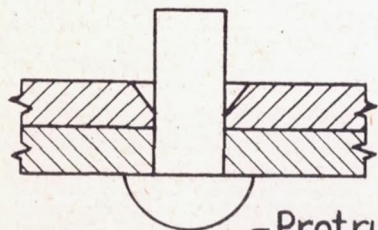
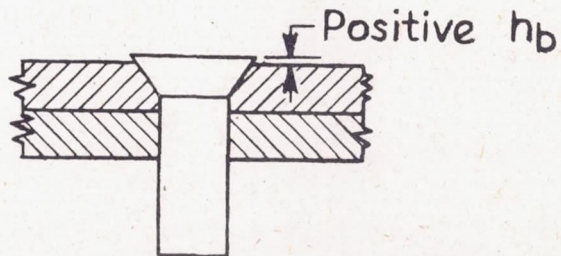
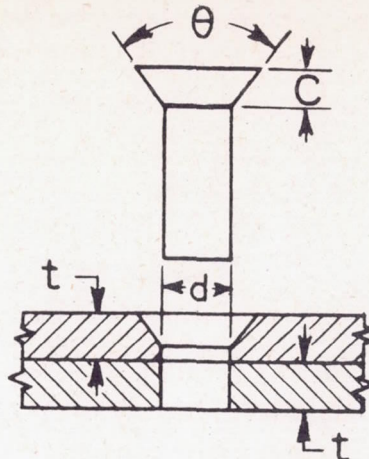
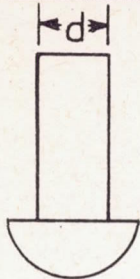

Rivets before driving

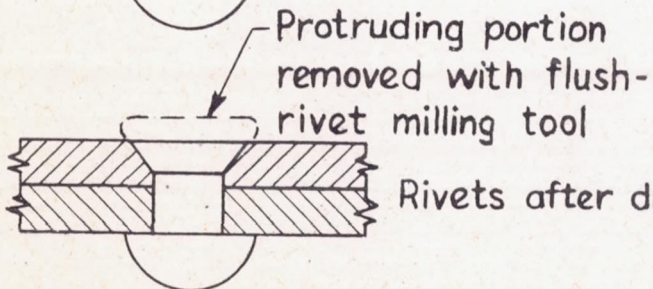

Rivets after driving

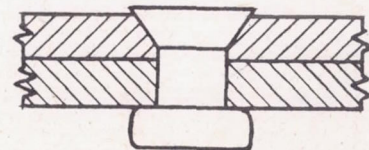

(a) NACA flush rivet.

(b) Conventional countersunk rivet.

Figure 2. - Riveting procedures.

NATIONAL ADVISORY  
COMMITTEE FOR AERONAUTICS



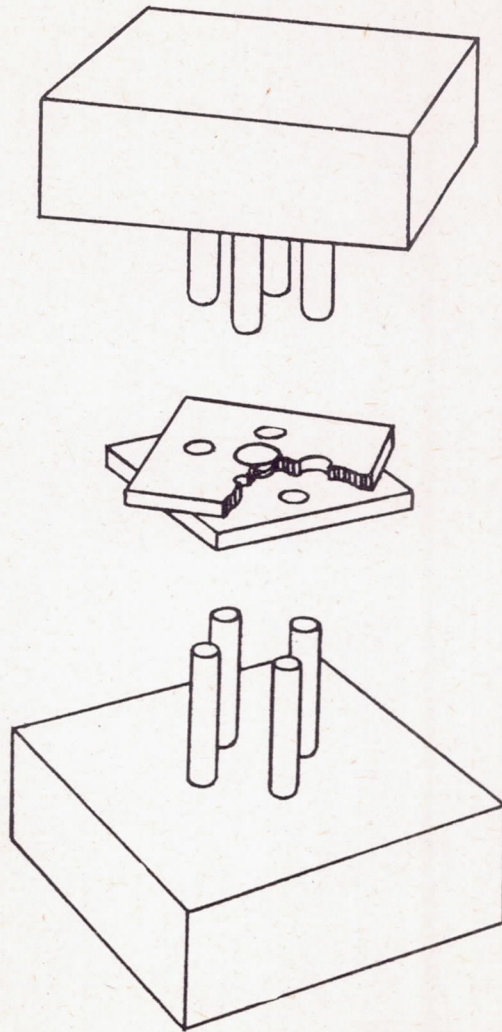

NATIONAL ADVISORY  
COMMITTEE FOR AERONAUTICS

Figure 3.- Fixtures and specimen  
for tension tests of rivets.



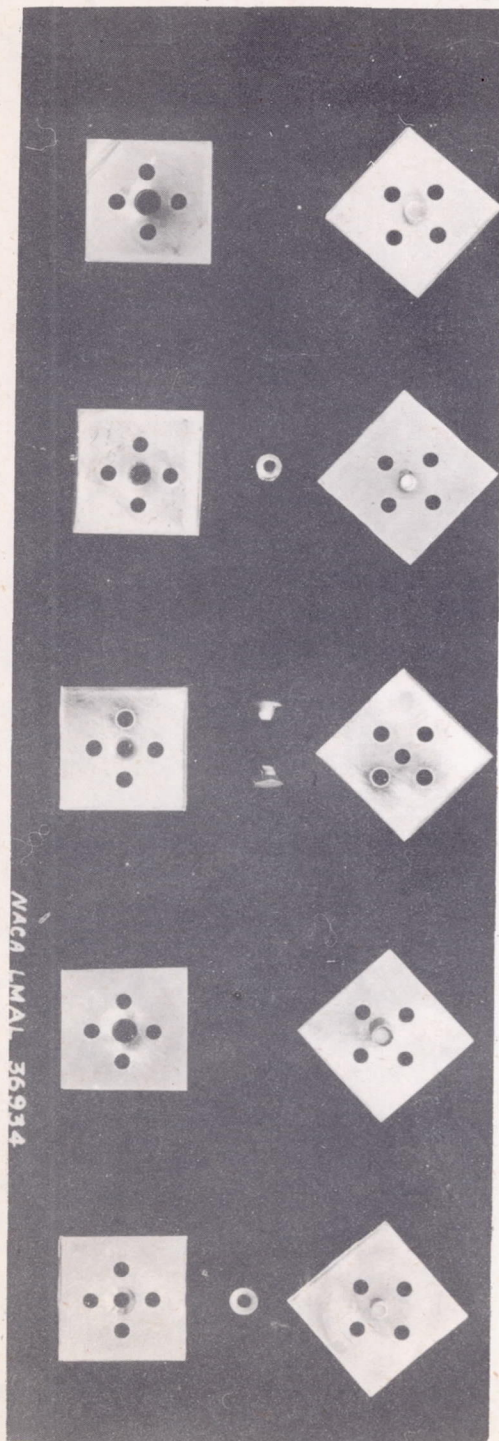

(a) NACA rivet; countersunk head pulled through sheet.

(b) NACA rivet; countersunk head sheared.

(c) NACA rivet; rivet shank failed in tension.

(d) Conventional rivet; countersunk head pulled through sheet.

(e) Conventional rivet; countersunk head sheared.

Figure 4.- Typical  $\frac{5}{32}$ -inch-diameter rivet specimens of  $100^\circ$  head angle after failure.



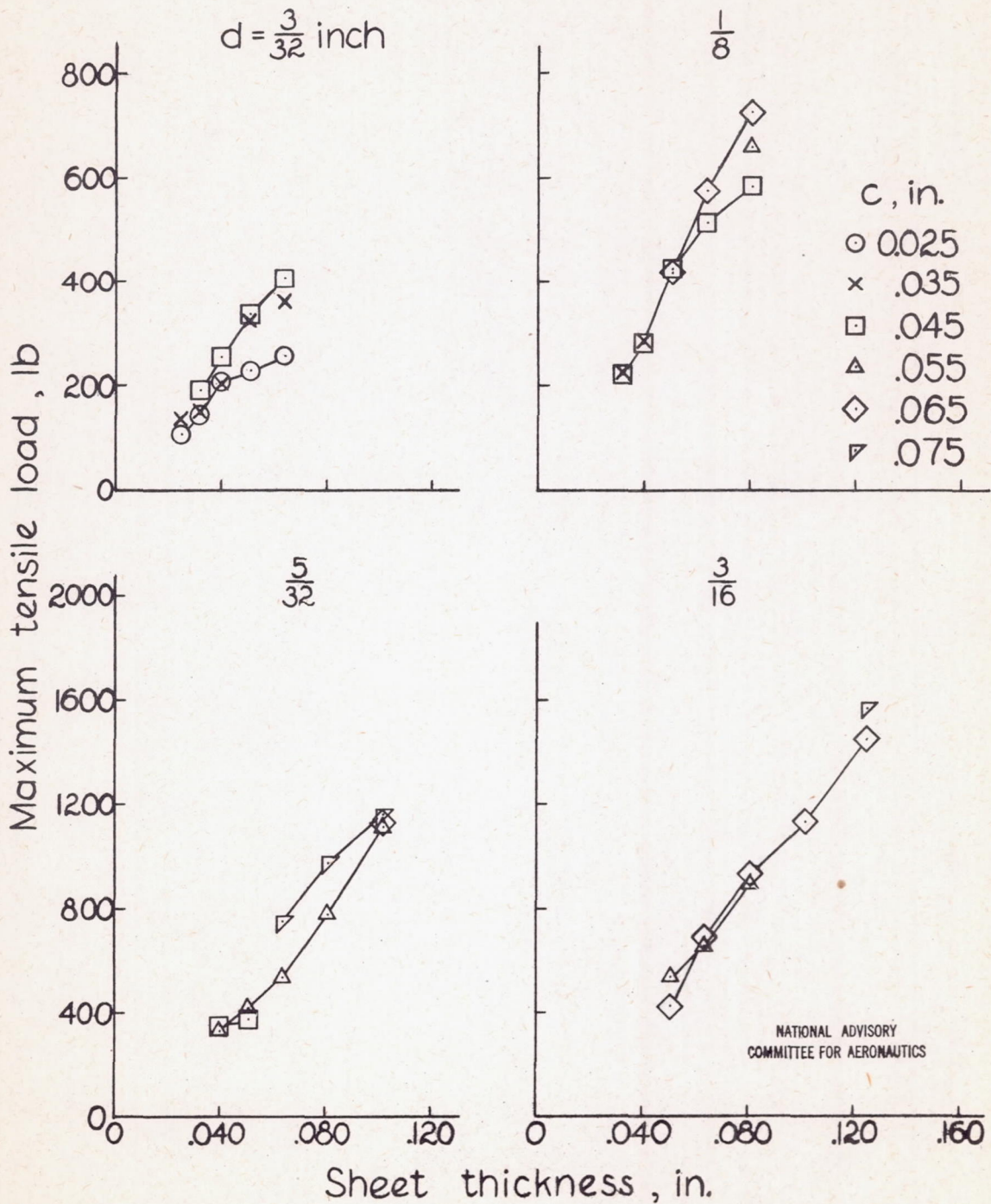

Figure 5. - Variation of maximum tensile load with sheet thickness for NACA machine-countersunk flush rivets ; rivet-head angle = 60°



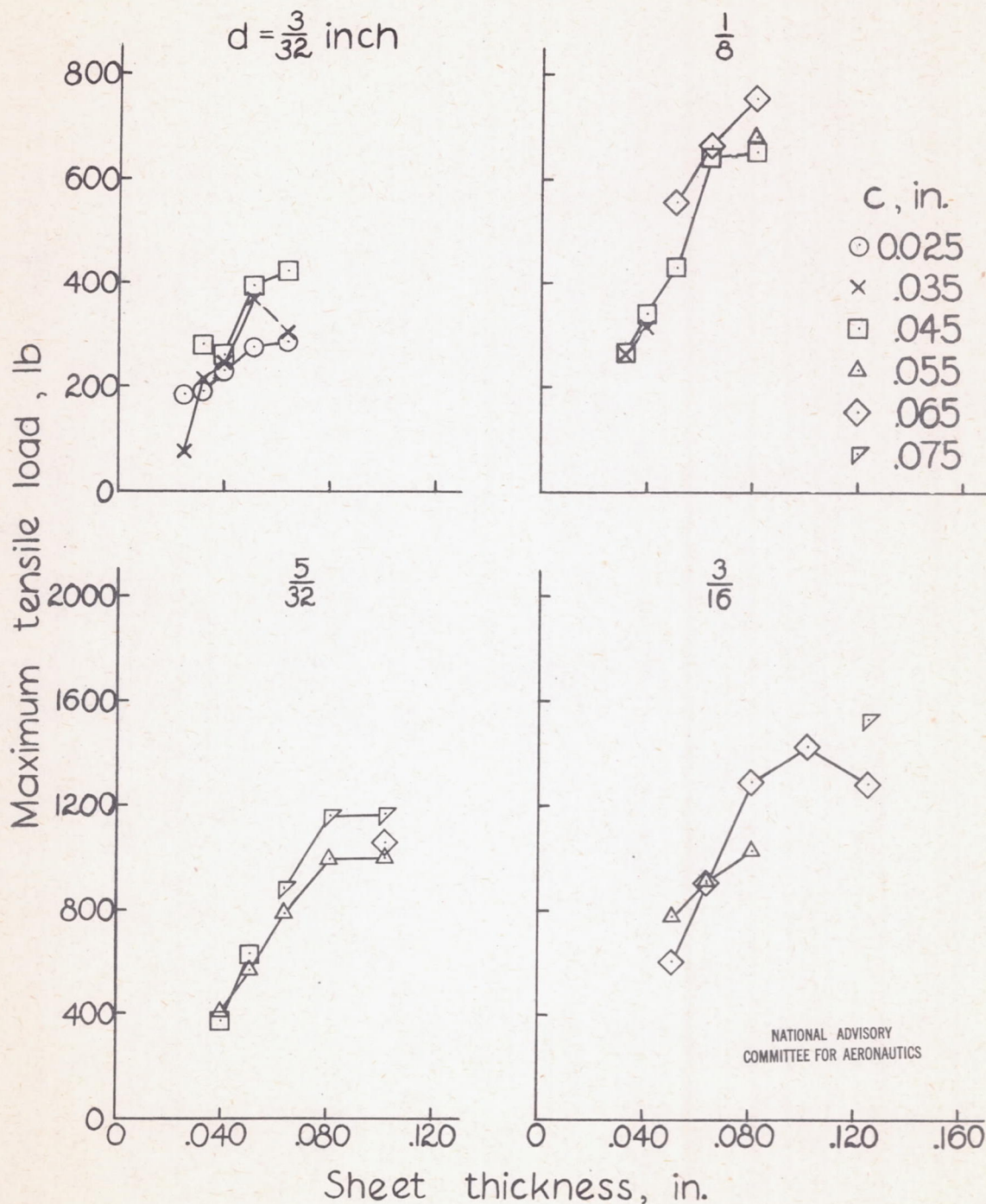

Figure 6.-Variation of maximum tensile load with sheet thickness for NACA machine-countersunk flush rivets ; rivet-head angle = 82°.



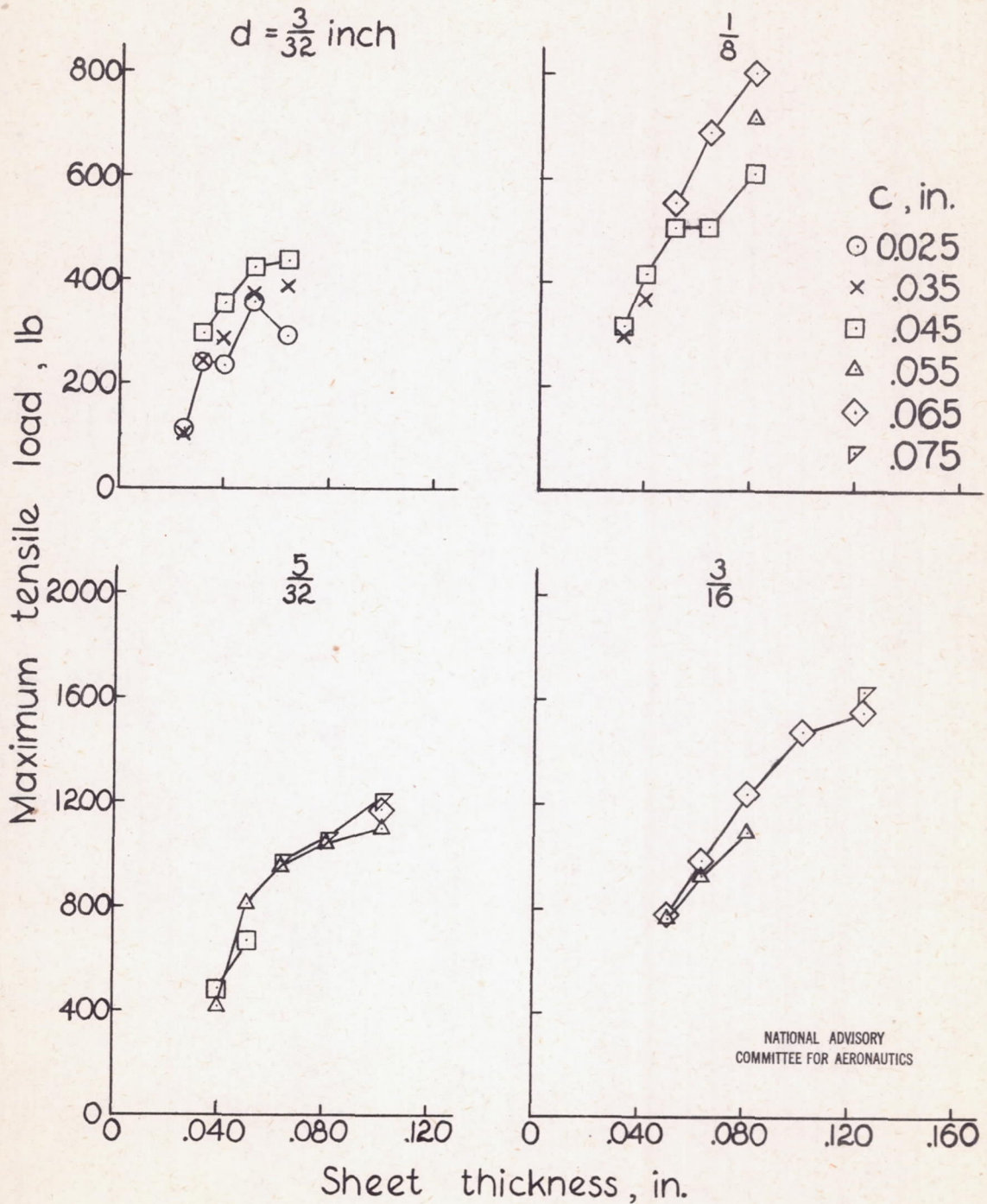

Figure 7.-Variation of maximum tensile load with sheet thickness for NACA machine-countersunk flush rivets ; rivet-head angle = 100°.



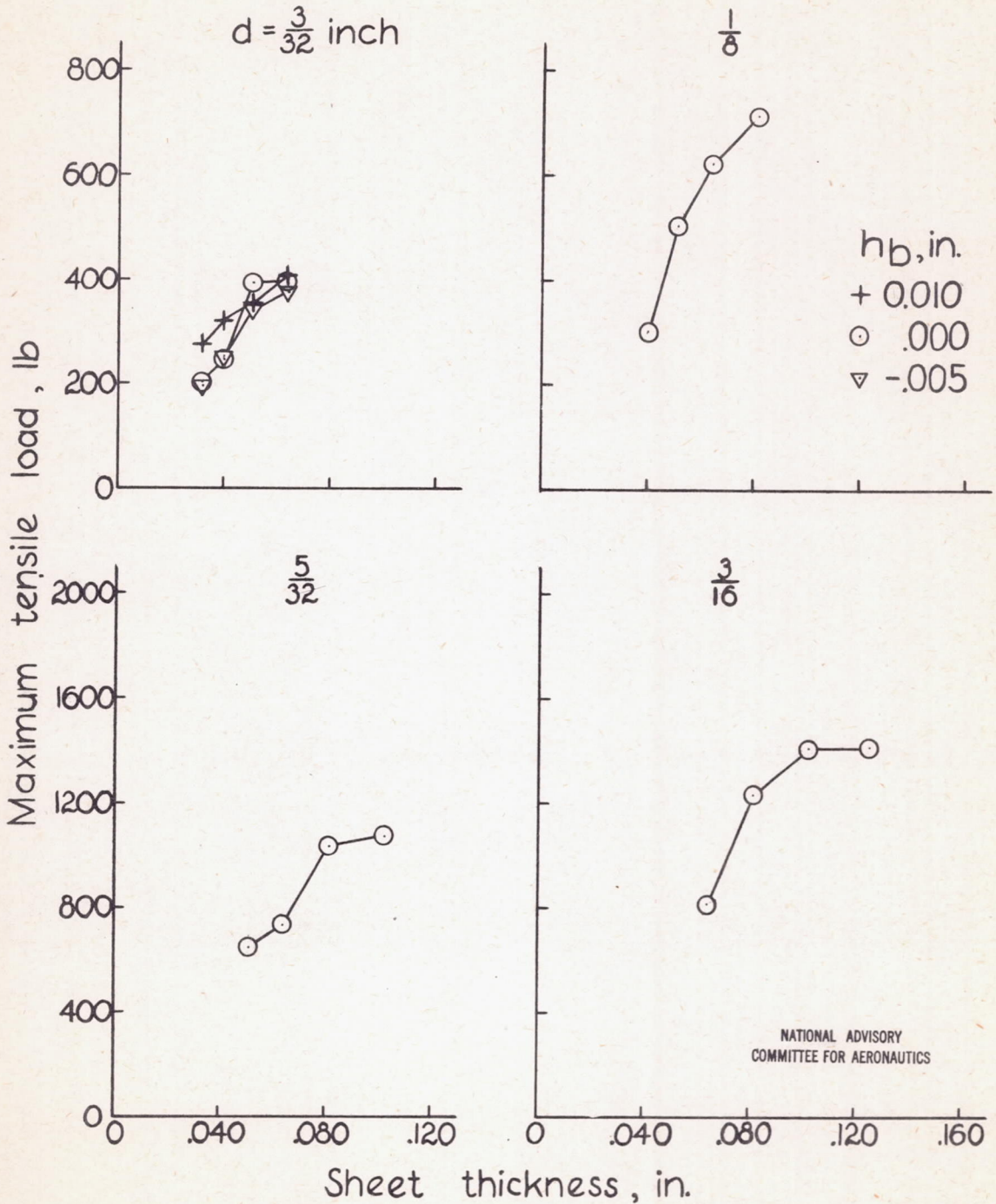

Figure 8.-Variation of maximum tensile load with sheet thickness for conventional machine-countersunk flush rivets; rivet-head angle = 78°.



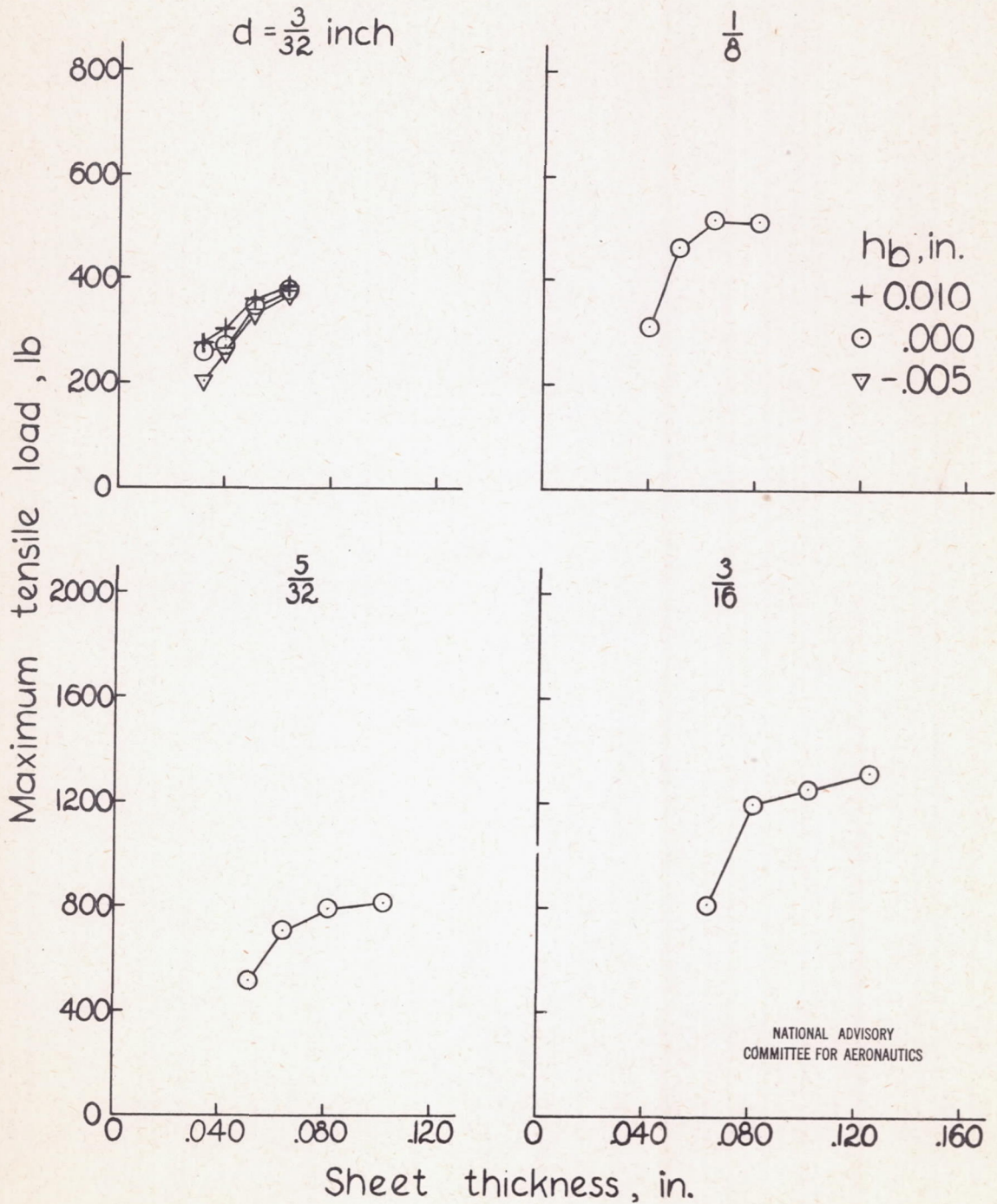

Figure 9.-Variation of maximum tensile load with sheet thickness for conventional machine-countersunk flush rivets; rivet-head angle = 100°



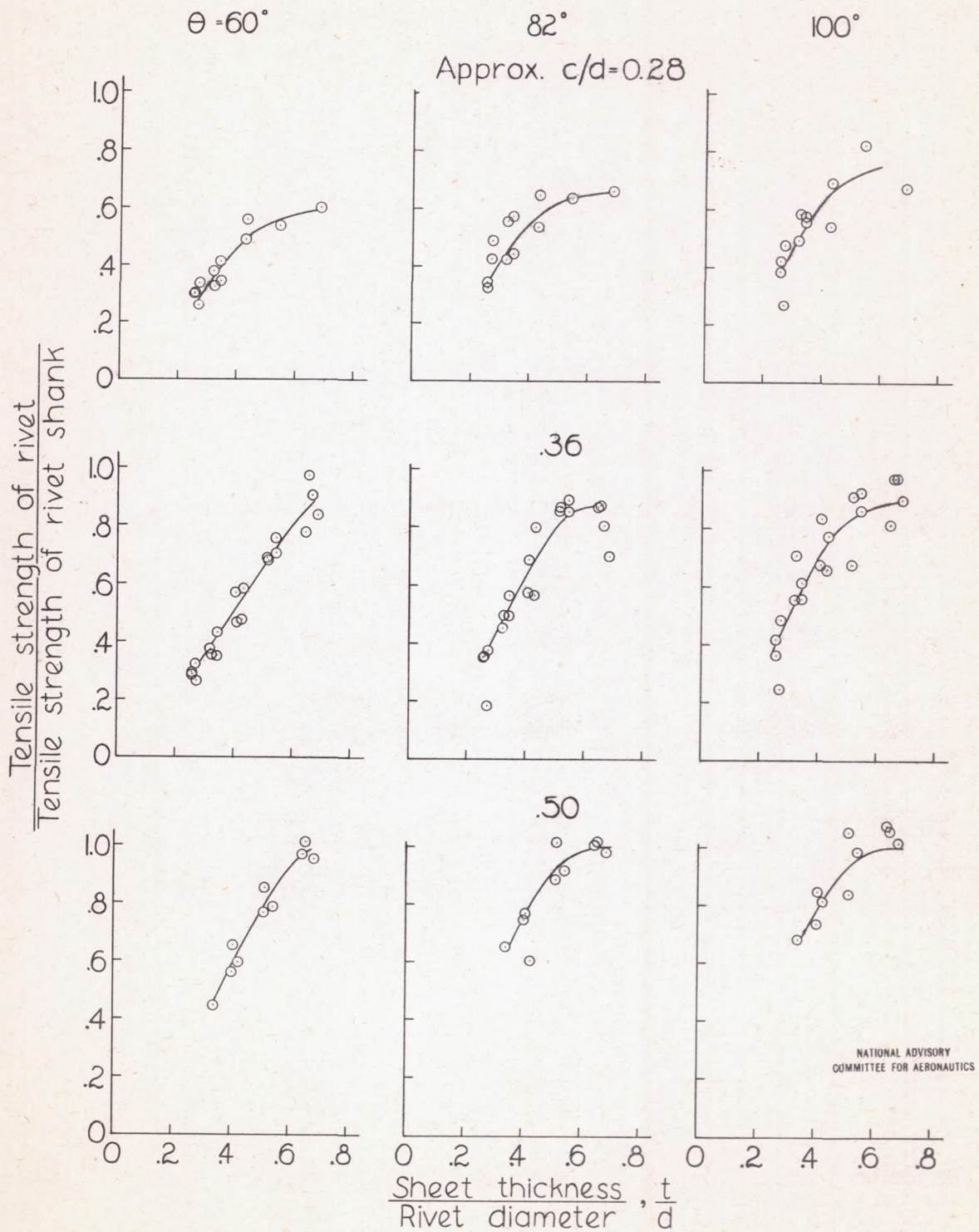

Figure 10. - Variation of rivet tensile strength with  $t/d$  for NACA machine-countersunk flush rivets.



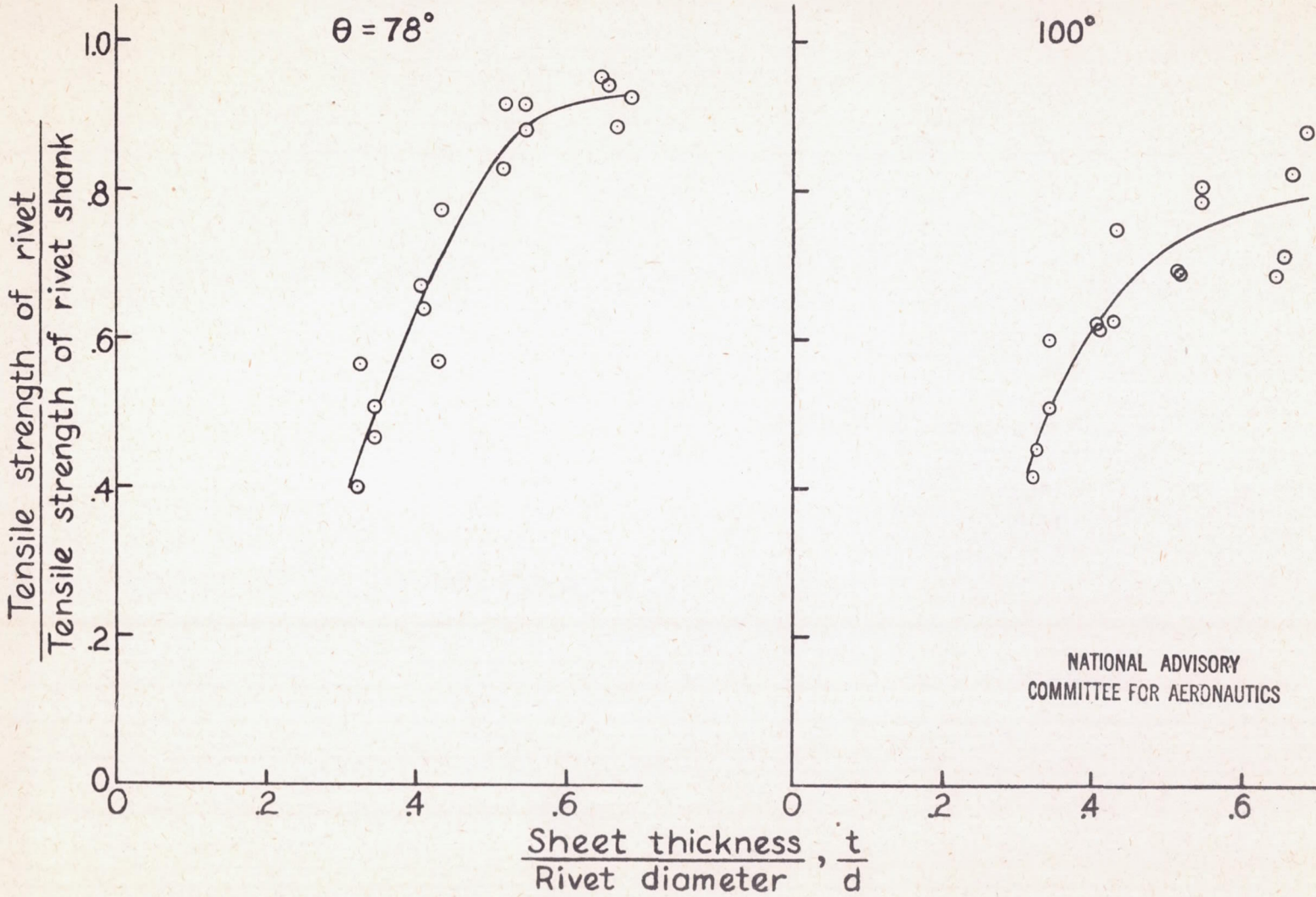

Figure 11. - Variation of rivet tensile strength with  $t/d$  for conventional machine-countersunk flush rivets;  $h_b = 0.000$  inch.



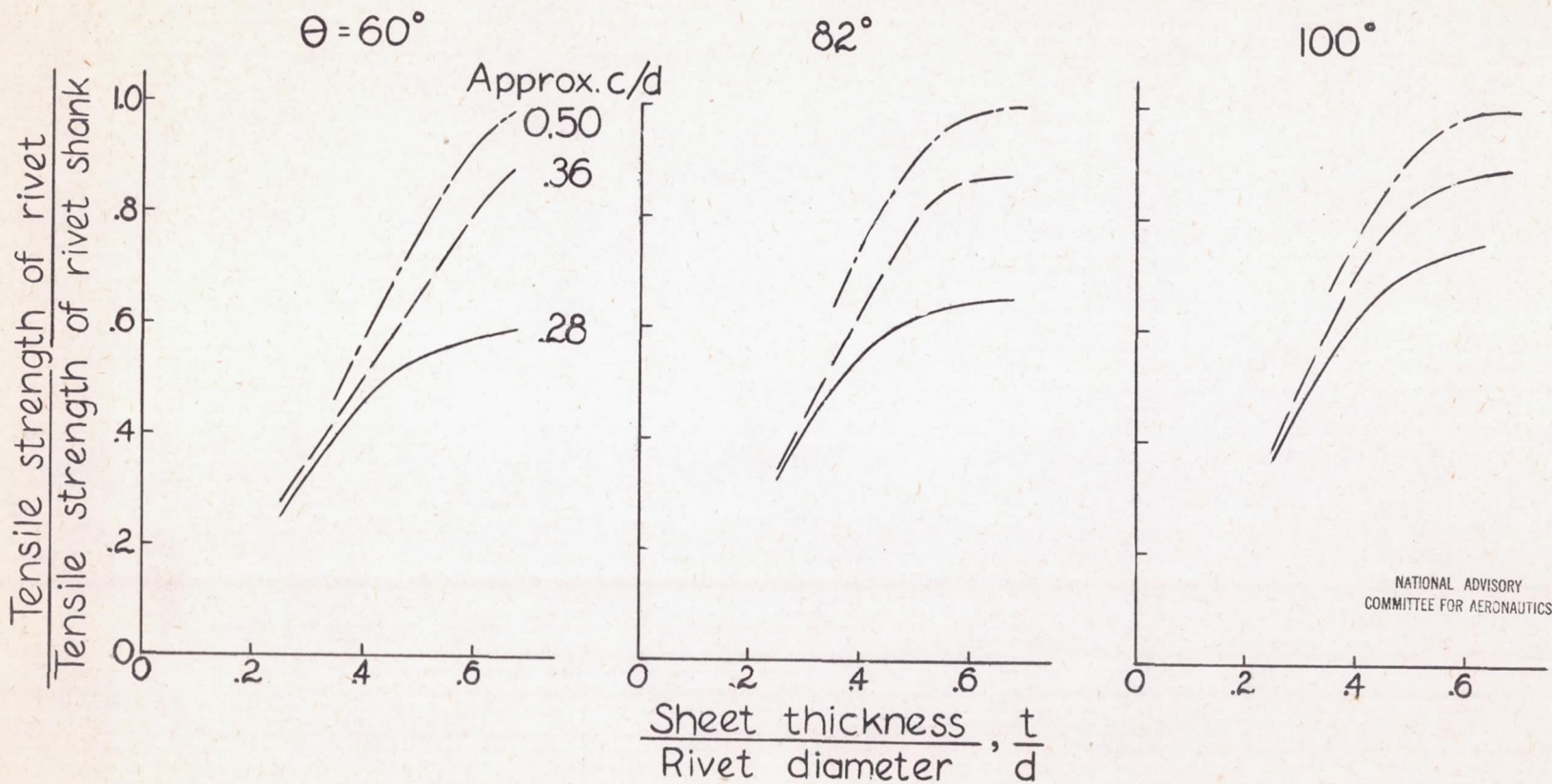

Figure 12.- Average curves for the tensile strength of NACA machine-countersunk flush rivets.

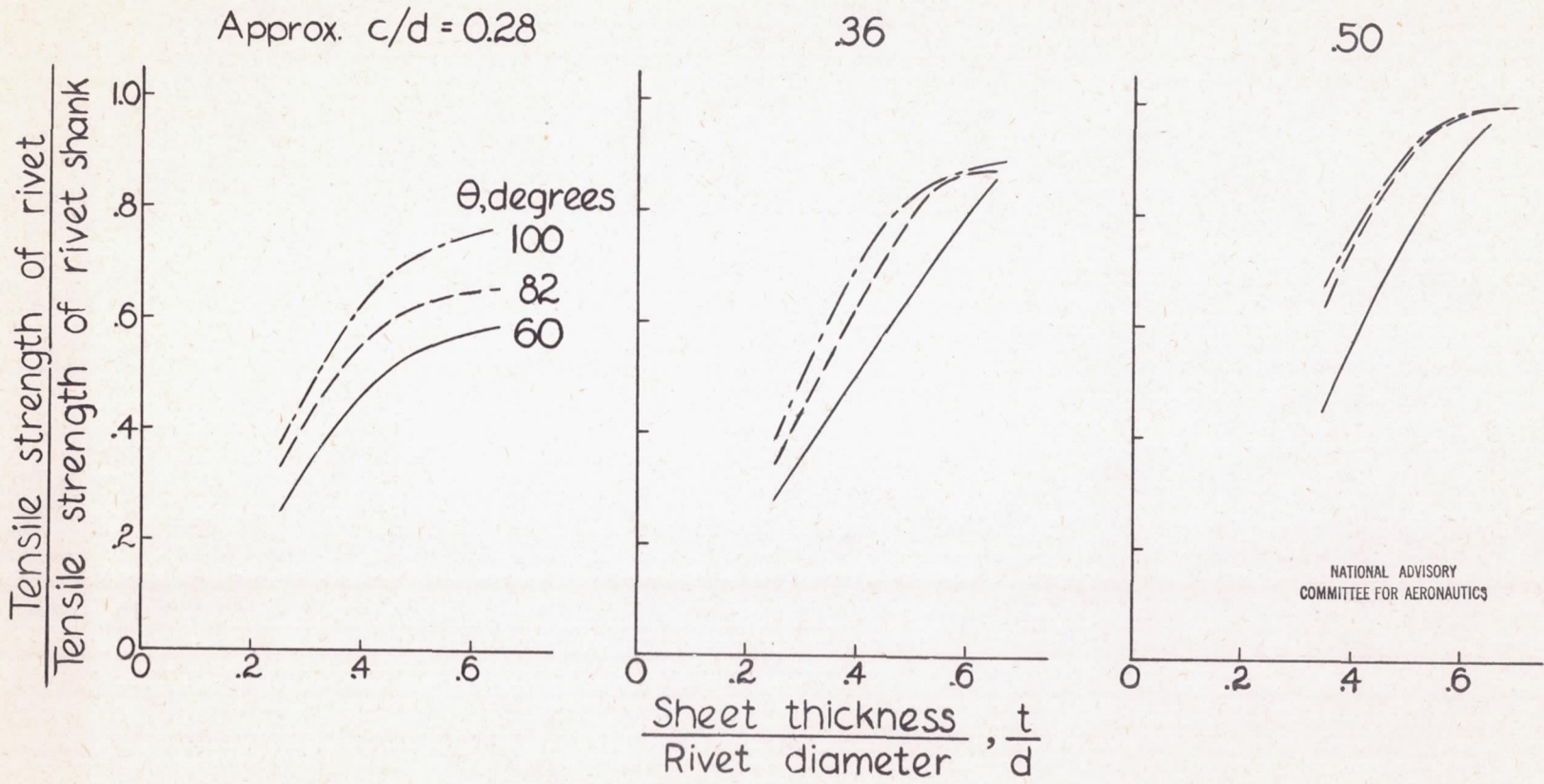

Figure 13.- Average curves for the tensile strength of NACA machine-countersunk flush rivets.



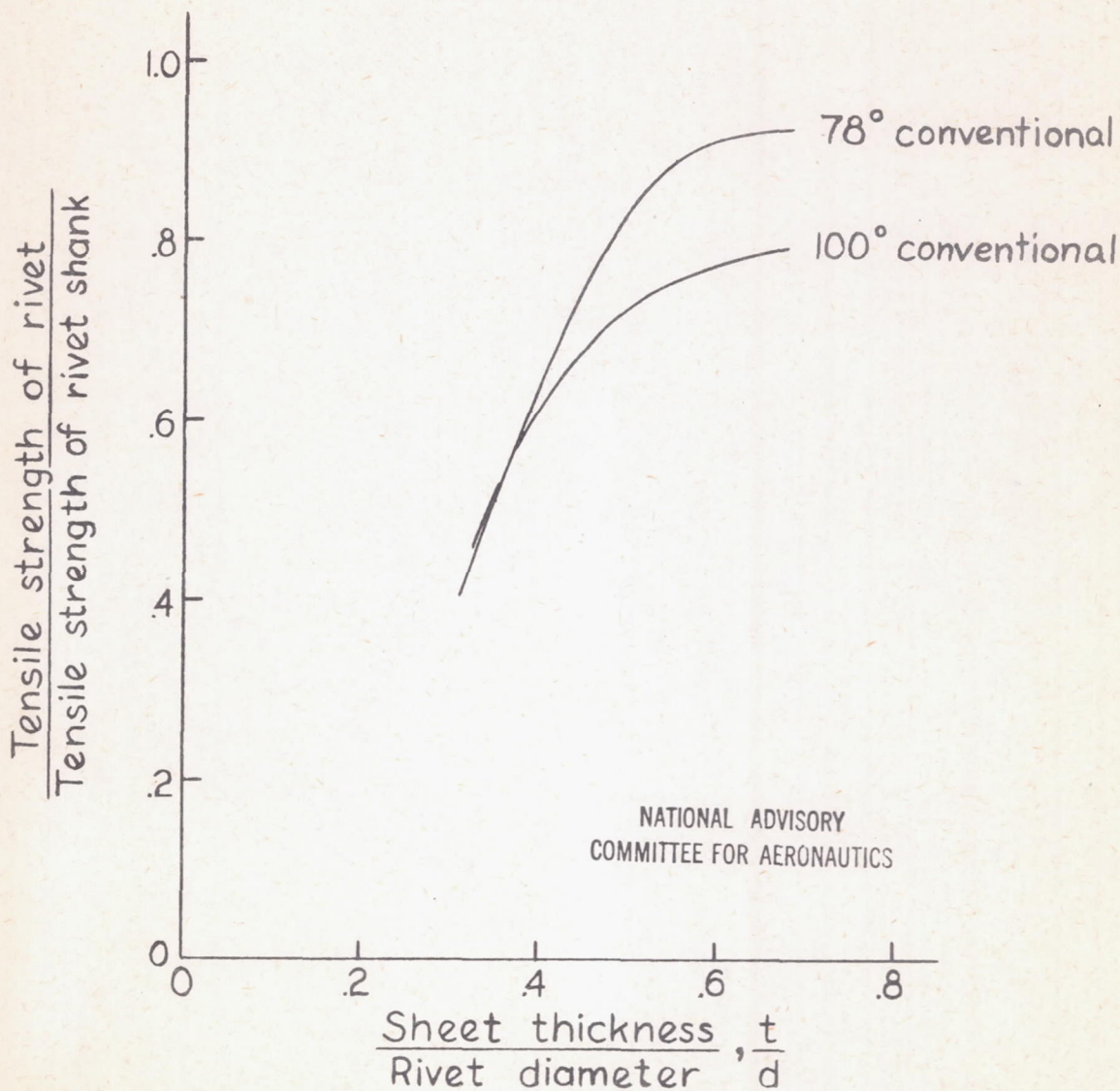

Figure 14.- Average curves for the tensile strength of conventional 78° and 100° machine-counter-sunk flush rivets;  $h_b = 0.000$  inch.

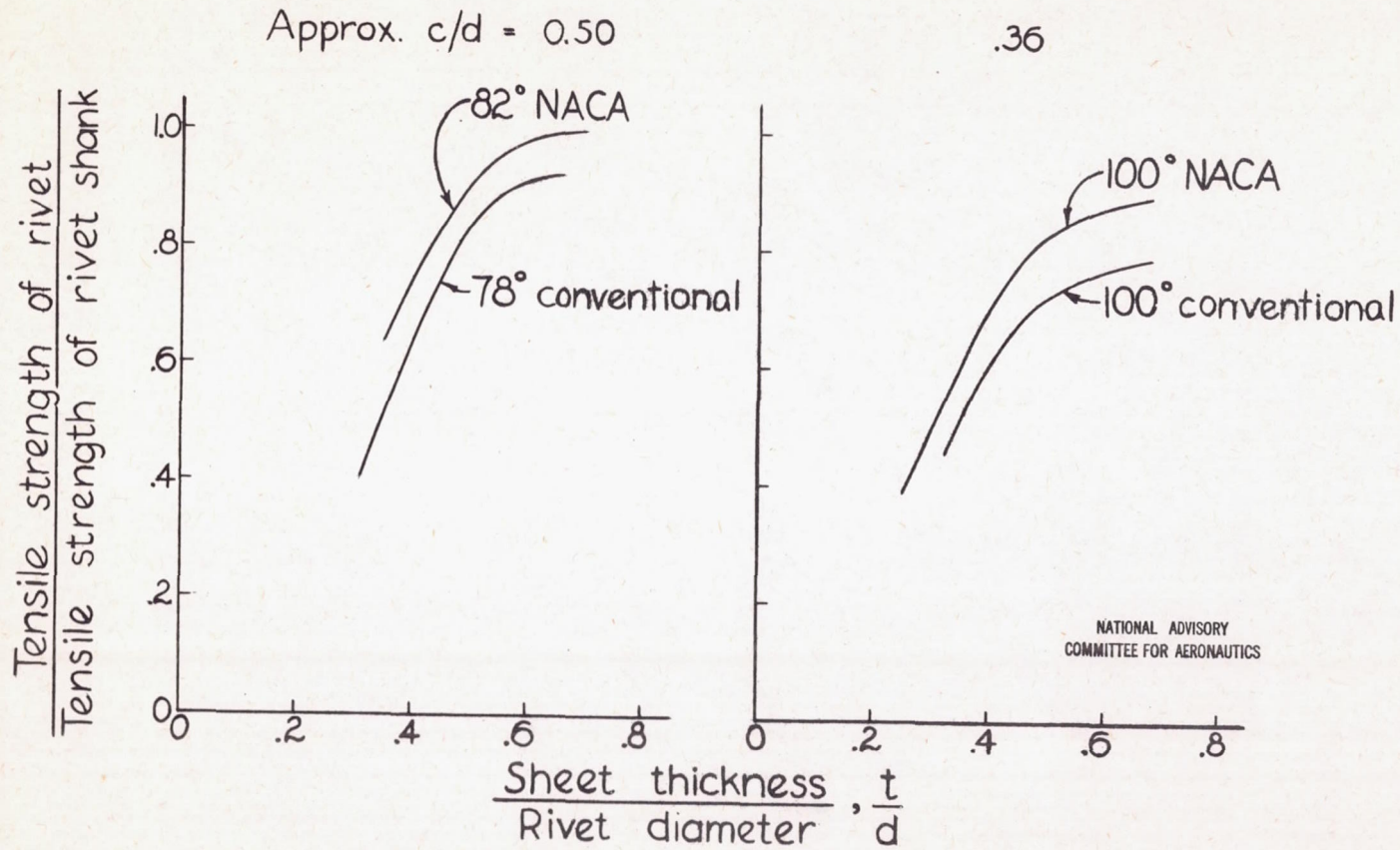

Figure 15. - Comparison of average curves for the tensile strength of NACA and conventional machine-countersunk flush rivets with corresponding  $c/d$  ratios.