

NO RECORD

AAB3276

DR. TH. VON KÁRMÁN

RM No. L6L18

AERONAUTICS LIBRARY  
California Institute of Technology



# RESEARCH MEMORANDUM

LANGLEY FULL-SCALE-TUNNEL INVESTIGATION OF THE  
FACTORS AFFECTING THE STATIC LATERAL-  
STABILITY CHARACTERISTICS OF A  
TYPICAL FIGHTER-TYPE AIRPLANE

3.27  
3.30

By

Roy H. Lange

Langley Memorial Aeronautical Laboratory  
Langley Field, Va.

**NATIONAL ADVISORY COMMITTEE  
FOR AERONAUTICS**

WASHINGTON

April 15, 1947

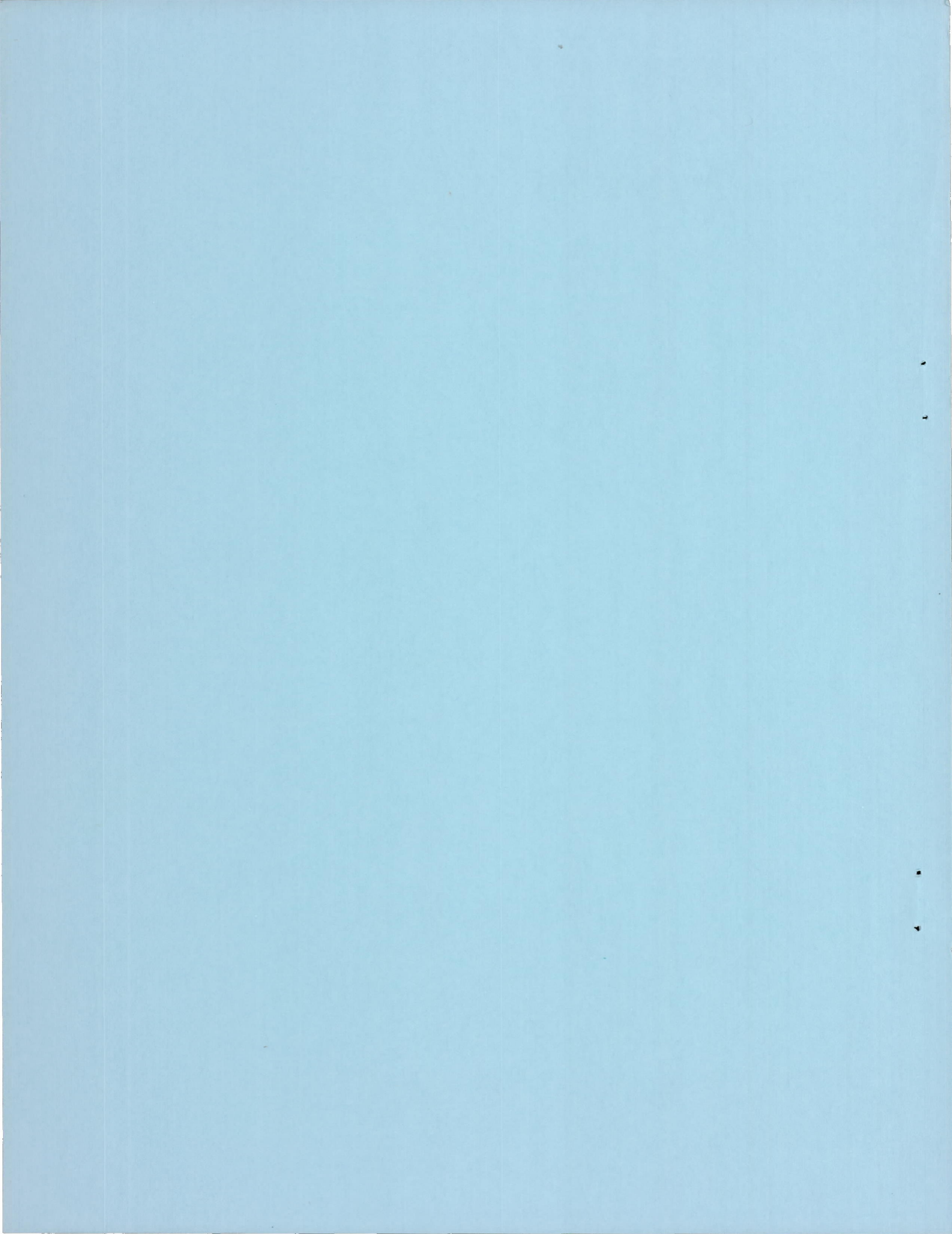

NATIONAL ADVISORY COMMITTEE FOR AERONAUTICS

RESEARCH MEMORANDUM

LANGLEY FULL-SCALE-TUNNEL INVESTIGATION OF THE  
FACTORS AFFECTING THE STATIC LATERAL-  
STABILITY CHARACTERISTICS OF A  
TYPICAL FIGHTER-TYPE AIRPLANE

By Roy H. Lange

SUMMARY

The factors that affect the rate of change of rolling moment with yaw of a typical fighter-type airplane were investigated in the Langley full-scale tunnel on a typical fighter-type airplane. Eight representative flight conditions were investigated in detail. The separate effects of propeller operation, of the wing-fuselage combination, and of the vertical tail to the effective dihedral of the airplane in each condition were determined.

The results of the tests showed that for the airplane with the propeller removed, the wing-fuselage combination had positive dihedral effect which increased considerably with increasing angle of attack for all conditions. Flap deflection decreased the dihedral effect of the wing-fuselage combination slightly as compared with that with the flaps retracted. The contribution of the vertical tail to  $C_{l\psi}$  of the airplane with the propeller removed decreased from about 0.0002 at  $\alpha = 1.0^\circ$  to zero for angles of attack greater than  $8.9^\circ$ . Flap deflection resulted in negative dihedral effect due to the vertical tail. Propeller operation decreased the lateral stability parameter of the airplane for all the conditions investigated with larger decreases being measured for the flaps deflected conditions.

INTRODUCTION

Systematic wind-tunnel tests were made in the Langley full-scale tunnel to determine the factors affecting the static directional and lateral stability characteristics of a typical fighter-type airplane. The results of the directional stability tests

are given in reference 1. The present report gives the results of the tests made to determine the lateral stability characteristics.

The lateral stability tests consisted of the determination of the rolling moments of the airplane in yaw for a wide range of flight conditions. For each of the flight conditions investigated, tests were made of the complete airplane, of the airplane less the propeller, of the airplane less the vertical tail, and of the airplane less both the propeller and the vertical tail. The effect of landing-flap deflection on the lateral stability characteristics was also investigated. The data thus obtained permitted determinations of the separate contributions of the propeller, of the wing-fuselage combination, and of the vertical tail to the effective dihedral of the complete airplane.

#### SYMBOLS

$C_L$	lift coefficient ( $Lift/q_0 S$ )
$C_l$	rolling-moment coefficient ( $L/q_0 S b$ )
$T_c$	effective thrust coefficient ( $T_e/2q_0 D^2$ )
$Q_c$	torque coefficient ( $Q/2q_0 D^3$ )
$L$	moment about X-axis; positive when it tends to depress right wing
$T_e$	effective propeller thrust ( $X_R - X'$ )
$X_R$	resultant force along X-axis with propeller operating
$X'$	force along X-axis, propeller removed
$Q$	propeller torque
$D$	propeller diameter (13.08 ft)
$S$	wing area (334 sq ft)
$b$	wing span (42.83 ft)
$\psi$	angle of yaw, degrees; positive with left wing forward
$\alpha$	angle of attack of fuselage reference line relative to free-stream direction, degrees

$\delta_f$	angle of flap deflection, degrees
$\beta$	propeller blade angle at 0.75 radius, degrees
$q_0$	free-stream dynamic pressure
$V_i$	indicated airspeed
$C_{L\psi}$	rate of change of $C_L$ with respect to $\psi$ , per degree
$\Delta C_{L\psi_t}$	increment of $C_{L\psi}$ contributed by the vertical tail $\left( C_{L\psi}(\text{tail installed}) - C_{L\psi}(\text{tail removed}) \right)$

#### AIRPLANE

The tests were made of the Grumman XF6F-4, which is a low midwing single-place fighter airplane weighing about 11,400 pounds and equipped with a Pratt & Whitney R-2800-27 engine rated at 1600 horsepower at 2400 rpm at an altitude of 5700 feet. A three-view drawing of the airplane showing the principal dimensions and surface areas is given in figure 1. Details of the vertical tail surface are given in figure 3 of reference 1. Photographs of the airplane mounted on the balance-support struts in the Langley full-scale tunnel are given as figure 2. The vertical tail was removed from the airplane for some of the tests and was replaced by a fairing shown in the photograph of figure 3.

#### METHODS AND TESTS

Tests.— All the tests were made with the airplane landing gear retracted and the cowling flaps closed at a tunnel airspeed of approximately 60 miles per hour, which corresponds to a Reynolds number of approximately 4,380,000 based on a mean wing chord of 7.80 feet. The rudder was locked in the neutral for all the tests with the vertical tail in place. No attempt was made in the tests to duplicate the "blow-up" characteristics of the landing flaps.

The separate effects of the airplane component parts on the rolling moments of the complete airplane were determined for the eight representative flight conditions summarized in table I. Forces and moments were measured on the airplane for each

flight condition at approximately  $5^\circ$  increments of angle of yaw between  $\pm 15^\circ$ . For each flight condition, tests were made of the airplane with the propeller both removed and operating and with the vertical tail surface both removed and in place.

For the tests with the propeller operating, it was desired to simulate the variations shown in figure 4 of thrust and torque coefficient with lift coefficient for constant-power operation at sea level. It was found that these relationships could very nearly be reproduced with a constant propeller-blade-angle setting of  $24.8^\circ$  measured at the 0.75 radius; hence, this blade-angle setting was used for all the tests with the propeller operating. A comparison of the variation of thrust coefficient with torque coefficient for constant-power operation and for the propeller with a blade-angle setting of  $24.8^\circ$  measured at the 0.75 radius is shown in figure 5. For the idling-power conditions, the engine was run at the lowest speed considered possible (700 rpm) without fouling the engine spark plugs. The thrust and torque coefficients thus obtained for the idling-power conditions were 0.01 and 0.005, respectively.

Precision of measurements.-- The accuracy of the results is shown by the scatter of the test points of figures 6 and 7. Although considerable scatter is shown in some cases, it is believed that the fairing of the curves represents a mean evaluation of the data. Deviations of the test results from zero for apparently symmetrical conditions are probably due to differences in the airplane on the two sides of the plane of symmetry and to asymmetries in the tunnel flow.

## RESULTS AND DISCUSSION

The data are given in standard nondimensional coefficient form with respect to the stability axes and center-of-gravity location shown in figure 1. The stability axes are a system of axes having their origin at the center of gravity and in which the Z-axis is in the plane of symmetry and perpendicular to the relative wind, the X-axis is in the plane of symmetry and perpendicular to the Z-axis, and the Y-axis is perpendicular to the plane of symmetry.

The results of the force tests are given in figures 6 and 7 which show the variations of  $C_l$  with  $\psi$  for each of the eight test conditions listed in table I. For each test condition, curves are presented for the complete airplane, for the airplane with the propeller removed, for the airplane with the vertical tail removed, and for the airplane with both the propeller

and the vertical tail removed. No test points are shown in figures 6 and 7 for the propeller-removed data as these data were obtained from faired curves. Values of  $C_{L\psi}$  for the complete airplane in each flight attitude investigated are given in table I. From these values of  $C_{L\psi}$ , the effective dihedral can be determined, assuming that a  $C_{L\psi}$  of 0.0002 is equivalent to  $1^\circ$  of effective dihedral.

#### Tests with Propeller Removed

Wing-fuselage combination.— Values of  $C_{L\psi}$  for the wing-fuselage combination are shown plotted in figure 8 as a function of angle of attack for flaps retracted and flaps deflected  $50^\circ$ . These values of  $C_{L\psi}$  were obtained from the results shown in figure 7 at small angles of yaw (between  $\psi = \pm 5^\circ$ ) for the airplane with the propeller and the vertical tail removed. As shown in figure 8 the wing-fuselage combination has positive dihedral effect which increases with angle of attack both with the flaps retracted and with flaps deflected  $50^\circ$ . With flaps retracted the value of  $C_{L\psi}$  increased from 0.0012 at  $\alpha = 1.0^\circ$  to about 0.0022 at  $\alpha = 12.3^\circ$ . Flap deflection decreased the value of  $C_{L\psi}$  slightly throughout the angle-of-attack range investigated.

Theoretical computations were made in an effort to account for the large increases in  $C_{L\psi}$  with angle of attack. The results of these computations given in figure 16 of reference 2 indicate a value of  $C_{L\psi}$  for the wing alone of 0.00146. No account is taken in the theory for the effect of wing-tip shape. Reference 3 shows large increases in the value of  $C_{L\psi}$  with angle of attack for a wing having blunt tips. It is expected from the data of reference 4 that the low midwing position on this airplane would produce wing-fuselage interference tending to decrease the value of  $C_{L\psi}$  with angle of attack. It is indicated, therefore, from the data of figure 8 that the effects of blunt wing tips predominate.

Vertical tail.— The increments of  $C_{L\psi}$  at small angles of yaw ( $\psi = \pm 5^\circ$ ) due to the addition of the vertical tail to the airplane are given in figure 9. With the flaps retracted, the contribution of the vertical tail to  $C_{L\psi}$  decreases from about 0.0002 at  $\alpha = 1.0^\circ$  to about 0 for angles of attack greater

than  $8.9^\circ$ . (See fig. 9.) At low angles of attack the center of pressure of the vertical tail is above the center of gravity of the airplane which results in an increment of positive dihedral effect. The flow conditions of the tail are such as to produce a small decrease of  $C_{l\psi}$  with angle of attack. (See reference 1.)

It is believed, however, that as the angle of attack is increased the center of pressure of the vertical tail is lowered with respect to the center of gravity of the airplane and thus has the predominate effect on the decrease of  $\Delta C_{l\psi_t}$ .

Flap deflection resulted in negative dihedral effect due to the vertical tail throughout the range of angle of attack investigated. (See fig. 9.) While the reason for this change in the increment of  $C_{l\psi}$  due to the vertical tail with flap deflection is not apparent, it is believed that change in flow conditions at the tail due to flap deflection may be the cause for this change.

#### Effects of Propeller Operation

The values of  $C_{l\psi}$  of the complete airplane with the propeller operating were obtained from figure 6 and are listed in table I and are compared with the values of  $C_{l\psi}$  for the airplane with the propeller removed. For the airplane with the flaps retracted and deflected  $50^\circ$ , propeller operation decreased the values of  $C_{l\psi}$  at angles of yaw between  $\pm 5^\circ$  for all the conditions investigated. With the flaps retracted a slight increase in effective dihedral with angle of attack was noted. These results are not what would normally be expected inasmuch as previously published data for this airplane and data for other airplanes of similar type indicate a decrease in effective dihedral with increasing angle of attack. With the flaps deflected  $50^\circ$ , the decrease of effective dihedral due to propeller operation was about 0.0001 for the landing condition (idling power,  $T_c = 0.01$ ), about 0.0007 for the approach condition (0.65 rated power,  $T_c = 0.33$ ), and about 0.0009 for the wave-off condition (rated power,  $T_c = 0.51$ ), as shown in table I.

The decrease in effective dihedral caused by propeller operation is due mainly to the fact that, when the airplane is yawed, the slipstream is deflected over the trailing-wing panel which increases the dynamic pressure, and consequently, the lift of the trailing wing. This increased trailing-wing lift produces rolling moments which tend to decrease the effective dihedral. The rotational component of the propeller slipstream tends to increase



the effective dihedral as indicated by the sidewash angle values given in reference 1; however, this effect is overbalanced by the slipstream action on the yawed wing as shown in table I. These effects are larger with the flaps deflected because the lift increment due to the propeller slipstream over the wing with flaps deflected is greater than with the flaps retracted.

The effect of propeller operation on the effective dihedral of the wing-fuselage combination is shown in figure 7 which presents tail-removed curves of  $C_{L\psi}$  versus  $\psi$  for the airplane with both the propeller operating and with the propeller removed. Values of  $C_{L\psi}$  of the wing-fuselage combination at small angles of yaw with the propeller operating are summarized in table I for all the conditions investigated. Values of  $C_{L\psi}$  for corresponding angles of attack but with the propeller removed are also given in table I for comparison. The curves of figure 7 with the propellers operating include both the direct effect of the propeller forces and the effect of slipstream passage over the wing-fuselage combination.

As shown by table I, propeller operation decreased the dihedral effect of the wing-fuselage combination appreciably for all conditions except those with idling power. For the two idling-power conditions (gliding and landing) the effect of propeller operation was negligible. As expected, the decrease in dihedral effect due to propeller operation was greater for the flaps-deflected conditions than for the flaps-retracted conditions. For the wave-off condition (rated power  $T_c = 0.51$ ), the value of  $C_{L\psi}$  of the wing-fuselage combination was decreased 0.0011 as a result of propeller operation. At the same thrust coefficient but with flaps retracted (climb condition), the value of  $C_{L\psi}$  of the wing-fuselage combination decreased only 0.0002 due to propeller operation.

The effects of the propeller slipstream on the contribution of the vertical tail to the effective dihedral is shown in table II which gives increments of  $C_{L\psi}$  due to the vertical tail with the propeller removed and with the propeller operating. The results of table II show no consistent variations of  $\Delta C_{L\psi_t}$  with propeller operation; however, the effects of the propeller slipstream on the contribution of the vertical tail to the airplane effective dihedral are generally small.

## SUMMARY OF RESULTS

Data are presented of measurements made in the Langley full-scale tunnel on a typical fighter-type airplane to investigate the factors affecting the rate of change of rolling moment with yaw of a fighter-type airplane. Although these data are quantitative for this particular airplane, the trends are believed to be generally applicable to reasonably similar airplanes. The results are summarized as follows:

1. With the flaps both retracted and deflected  $50^\circ$ , the wing-fuselage combination with the propeller removed had positive dihedral effect at angles of yaw between  $\pm 5^\circ$  which increased considerably with increasing angle of attack.

2. Flap deflection decreased the lateral-stability parameter  $C_{l\psi}$  of the wing-fuselage combination with propeller removed slightly at small angles of yaw as compared with that obtained with flaps retracted.

3. For the airplane with the propeller removed and with flaps retracted, the contribution of the vertical tail to  $C_{l\psi}$  decreased from about 0.0002 at  $\alpha = 1.0^\circ$  to about zero for angles of attack greater than  $8.9^\circ$ . Flap deflection resulted in negative dihedral effect due to the vertical tail throughout the range of angle of attack investigated.

4. Propeller operation decreased the lateral stability parameter of the airplane at small angles of yaw for all the conditions investigated. With the flaps retracted the effect of propeller operation was small; however, with the flaps deflected  $50^\circ$  the decrease of effective dihedral due to propeller operation was about 0.0001 for the landing condition,

about 0.0007 for the landing-approach condition, and about 0.0009 for the wave-off condition.

Langley Memorial Aeronautical Laboratory  
National Advisory Committee for Aeronautics  
Langley Field, Va.

#### REFERENCES

1. Sweberg, Harold H., Guryansky, Eugene R., and Lange, Roy H.: Langley Full-Scale Tunnel Investigation of the Factors Affecting the Directional Stability and Trim Characteristics of a Fighter-Type Airplane. NACA ARR No. L5H09, 1945.
2. Pearson, Henry A., and Jones, Robert T.: Theoretical Stability and Control Characteristics of Wings with Various Amounts of Taper and Twist. NACA Rep. No. 635, 1938.
3. Shortal, Joseph A.: Effect of Tip Shape and Dihedral on Lateral-Stability Characteristics. NACA Rep. No. 548, 1935.
4. House, Rufus O., and Wallace, Arthur R.: Wind-Tunnel Investigation of Effect of Interference on Lateral-Stability Characteristics of Four NACA 23012 Wings, an Elliptical and a Circular Fuselage, and Vertical Fins. NACA Rep No. 705, 1941.

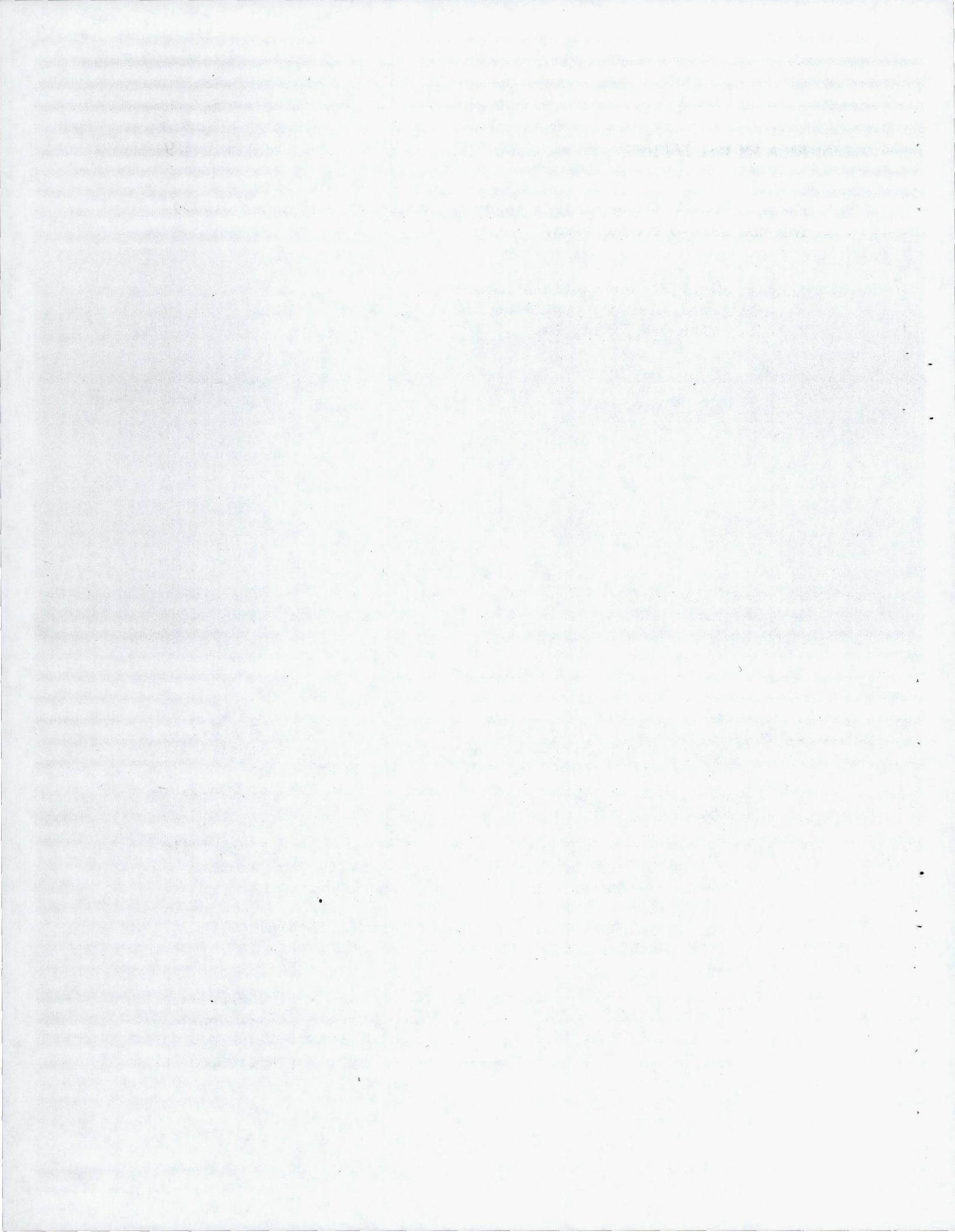

TABLE I.-- EFFECT OF PROPELLER OPERATION ON THE VALUES OF  $C_{L\psi}$  OF THE COMPLETE AIRPLANE AND OF THE WING-FUSELAGE COMBINATION

Condition	Power	$\delta_f$ (deg)	$\alpha$ (deg)	$C_L$ (a)	$C_{L\psi}$ (b)			
					Complete airplane		Wing-fuselage combination	
					Propeller operating	Propeller removed	Propeller operating	Propeller removed
Climb	Rated ( $T_c = 0.05$ )	0	1.0	0.24	0.0014	0.0014	0.0009	0.0012
Climb	Rated ( $T_c = 0.11$ )	0	3.4	.43	.0014	.0017	.0011	.0014
Climb	Rated ( $T_c = 0.30$ )	0	8.9	.96	.0018	.0020	.0016	.0020
Climb	Rated ( $T_c = 0.51$ )	0	12.3	1.39	.0020	.0022	.0020	.0022
Glide	Idling ( $T_c = 0.01$ )	0	9.2	.83	.0019	.0020	.0019	.0020
Landing approach	0.65 rated ( $T_c = 0.33$ )	50	5.8	1.37	.0006	.0013	.0003	.0016
Wave-off	Rated ( $T_c = 0.51$ )	50	4.9	1.39	.0003	.0012	.0004	.0015
Landing	Idling ( $T_c = 0.01$ )	50	11.8	1.58	.0015	.0016	.0021	.0020

<sup>a</sup>Values given for  $C_L$  are values with the propeller operating.

<sup>b</sup>Values given for slopes are average values between  $\psi = 5^\circ$  and  $\psi = -5^\circ$ .

NATIONAL ADVISORY  
COMMITTEE FOR AERONAUTICS

TABLE II.-- CONTRIBUTION OF VERTICAL TAIL TO  $C_{L\psi}$ 

Condition	$\alpha$ (deg)	$\delta_F$ (deg)	$\Delta C_{L\psi_t}$ (a)	
			Propeller operating	Propeller removed
Climb	1.0	0	0.0005	0.0002
Climb	3.4	0	.0003	.0003
Climb	8.9	0	.0002	0
Climb	12.3	0	0	0
Glide	9.2	0	0	0
Landing approach	5.8	50	-.0002	-.0003
Wave off	4.9	50	-.0001	-.0003
Landing	11.8	50	-.0006	-.0004

<sup>a</sup>Values given for slopes are average values between  $\psi = 5^\circ$  and  $\psi = -5^\circ$ .

NATIONAL ADVISORY  
COMMITTEE FOR AERONAUTICS

Wing area (including ailerons, flaps, and 48.5 sq ft of body area) ..... 334 sq ft  
 Control surface areas:

Full flap area (NACA slotted) ..... 39.8 sq ft  
 Total horizontal tail surface area... 77.84 sq ft  
 Fin area (incl. 1.9 sq ft of contained rudder balance)..... 14.4 sq ft  
 Rudder area aft of hinge (incl. 0.62 sq ft of tab)..... 9.0 sq ft

Engine..... Pratt and Whitney R-2800-27  
 BHP normal rating, 1600 at 2400 rpm at 5700 ft  
 Hamilton Standard Hydromatic Propeller,  
 Blade Design 6501A-0  
 Propeller gear ratio, 2:1  
 Gross weight, 11,400 lb

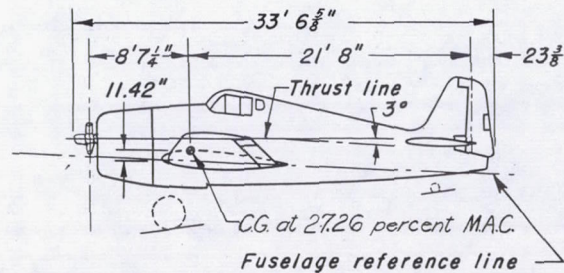
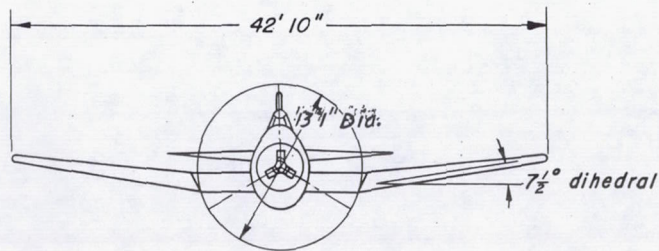
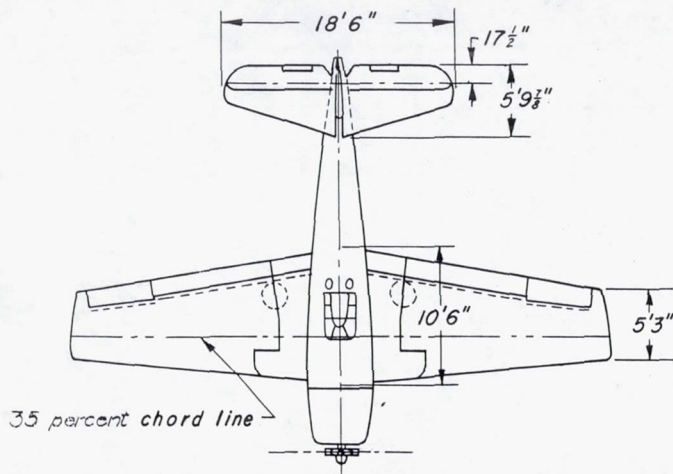

NATIONAL ADVISORY  
 COMMITTEE FOR AERONAUTICS

Figure 1.- Three-view drawing of the airplane.

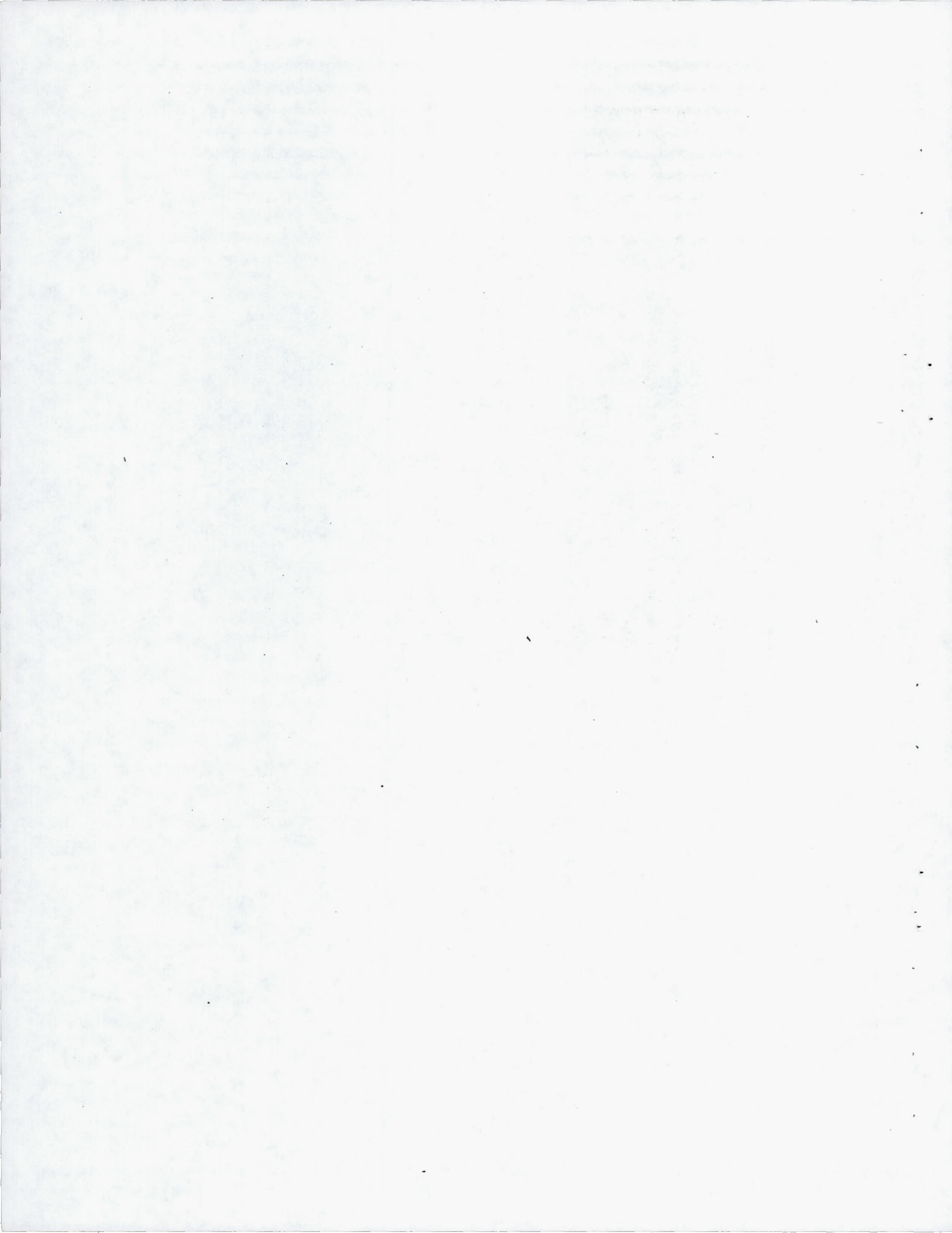



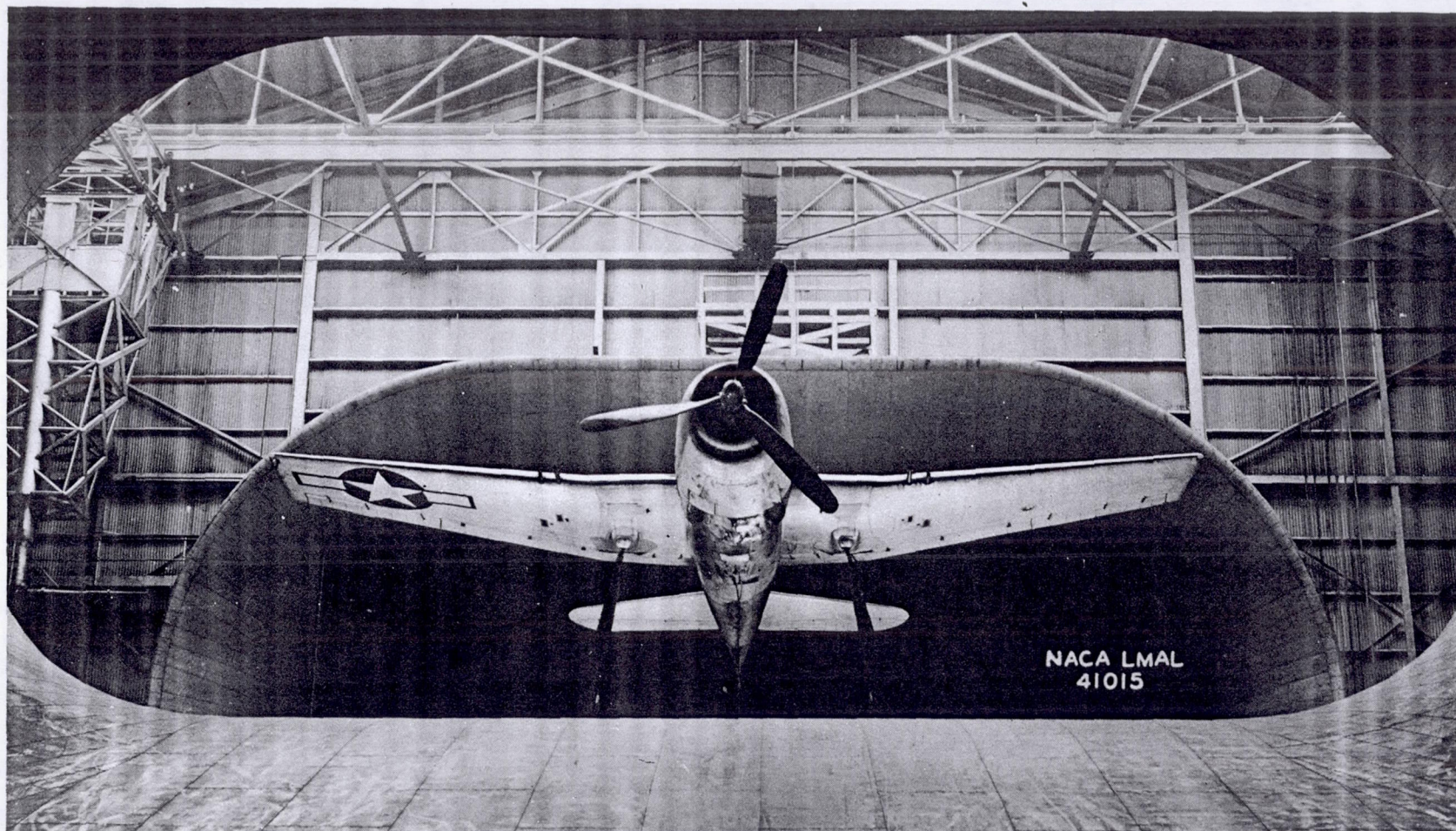

(a) Front view

Figure 2.- Airplane mounted for tests in the Langley full-scale tunnel.

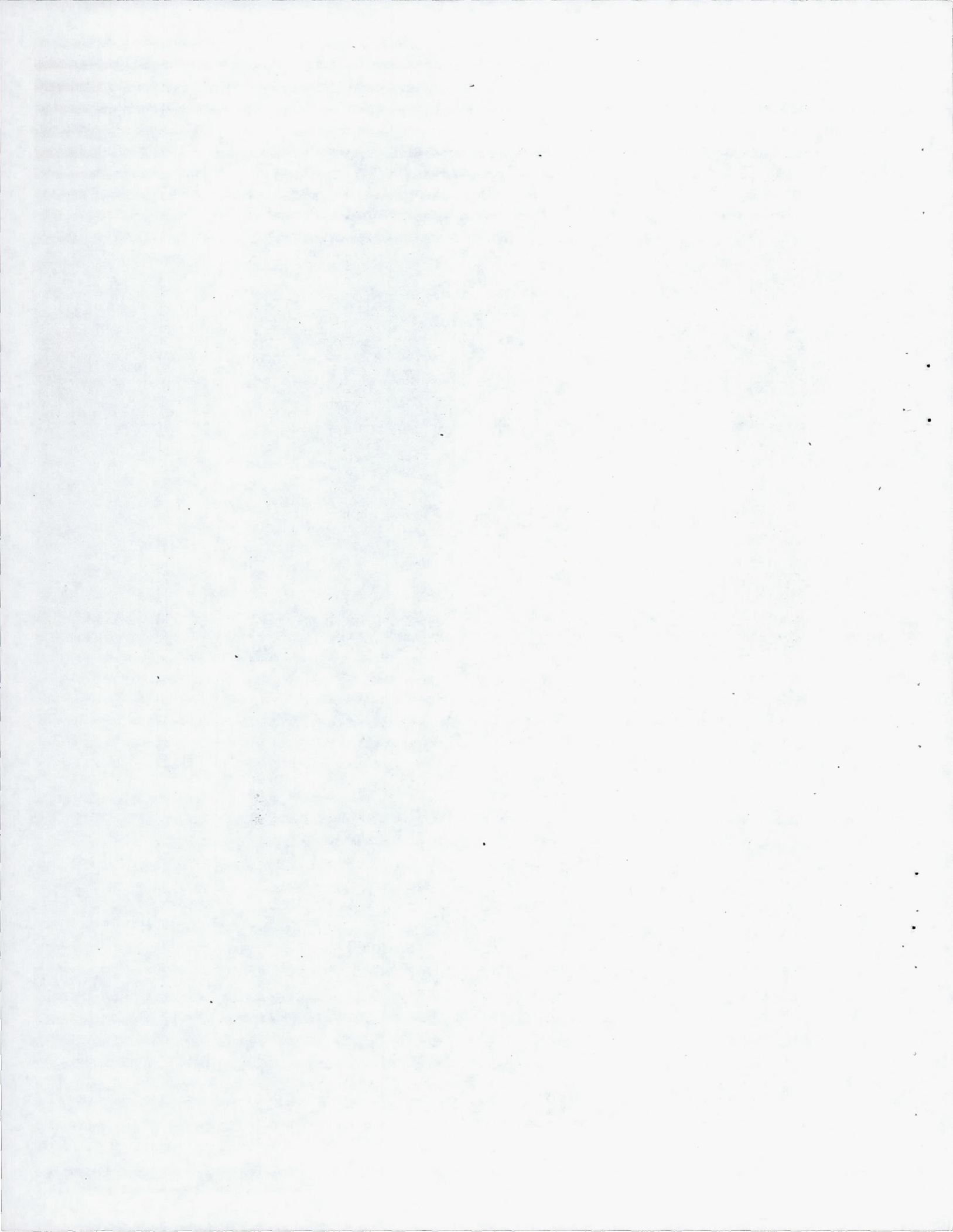

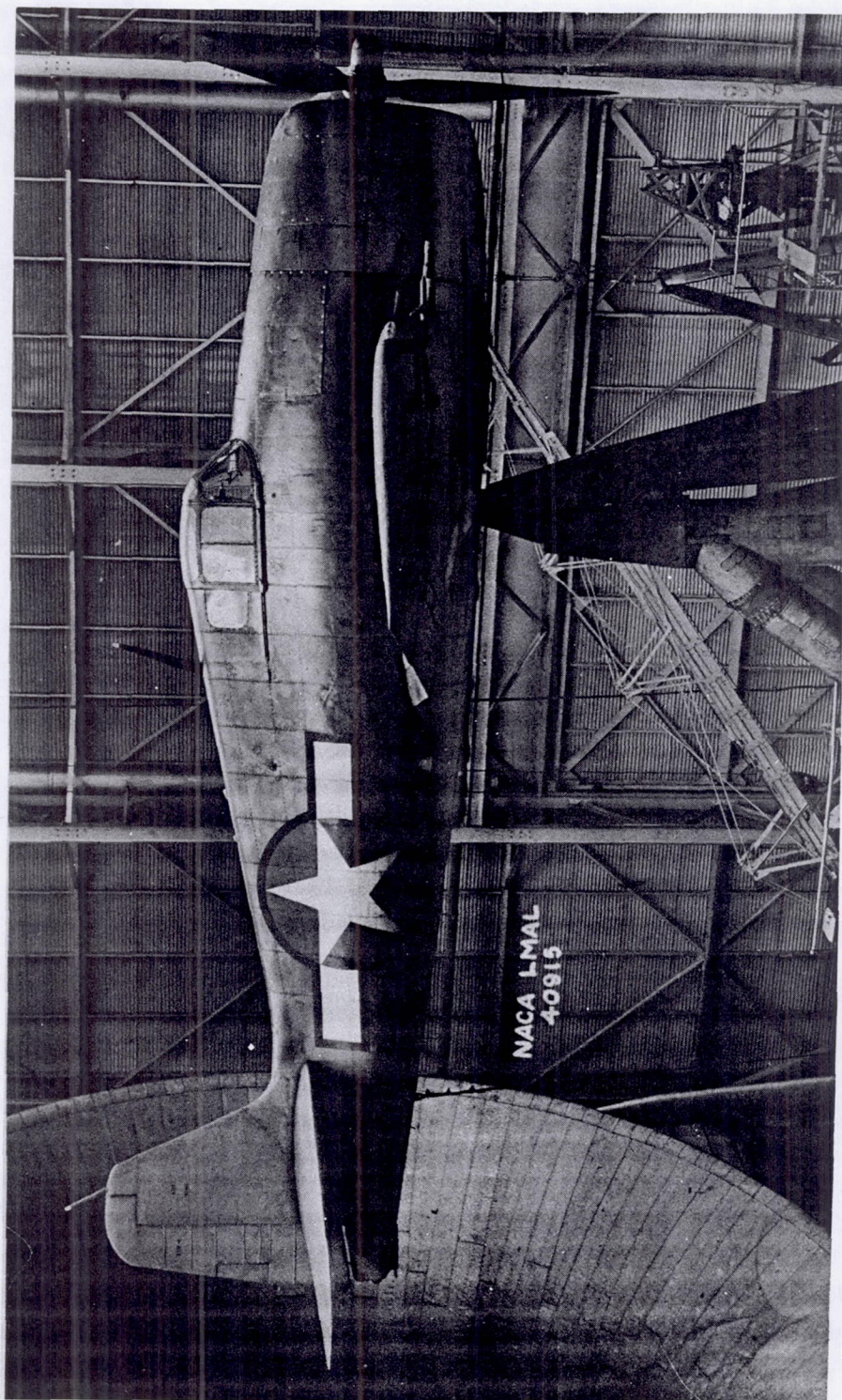

(b) Side view.

Figure 2.- Concluded.

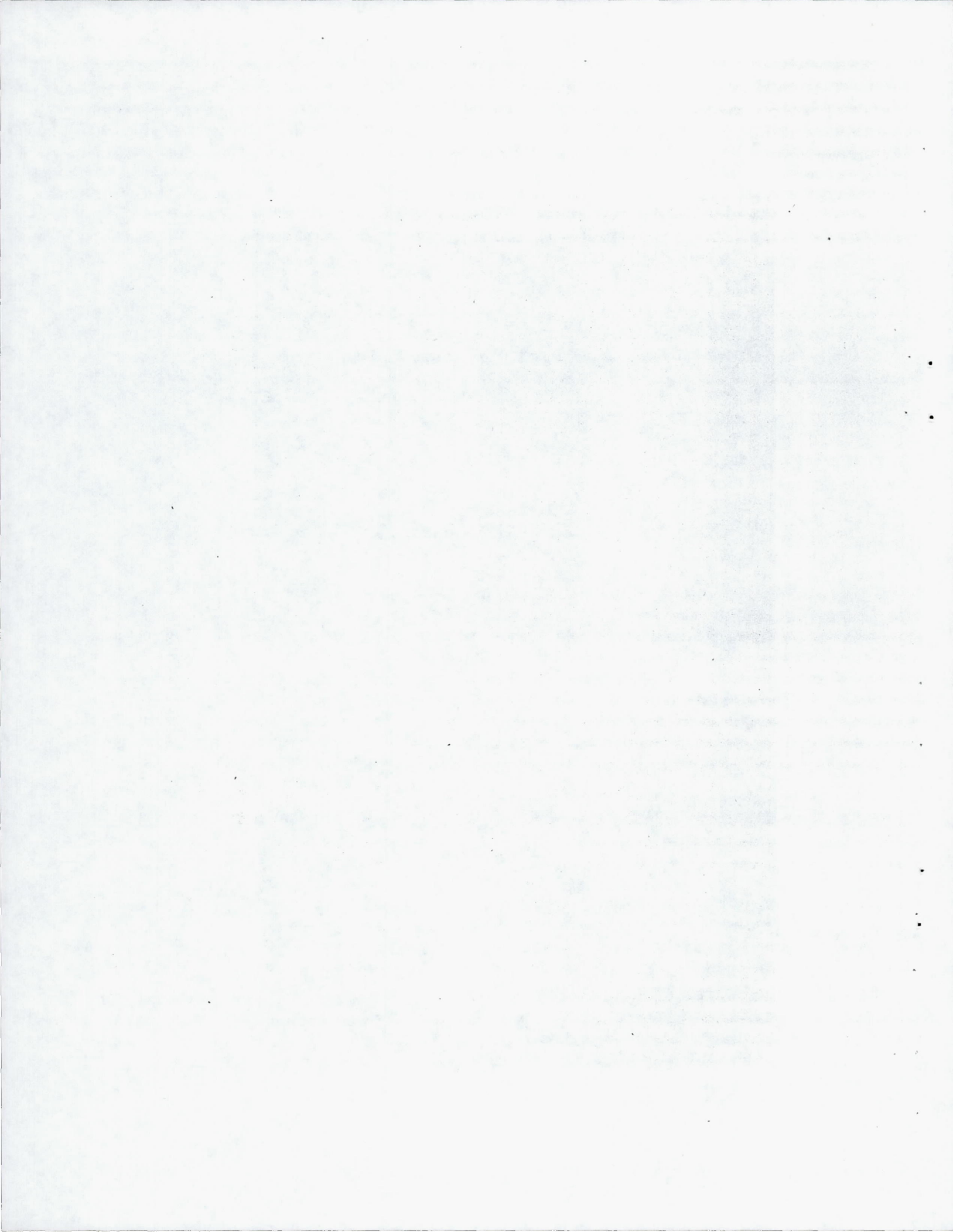

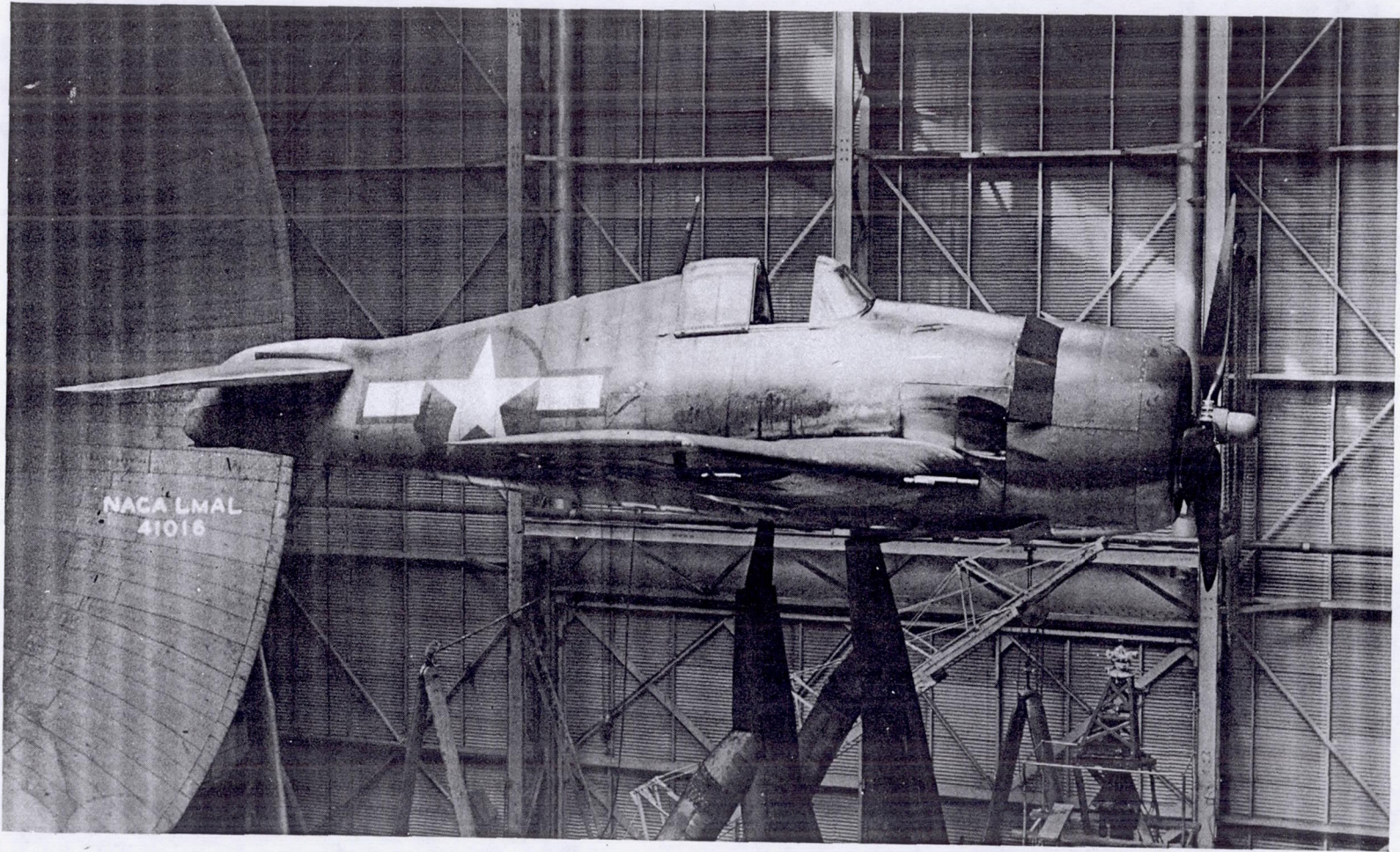
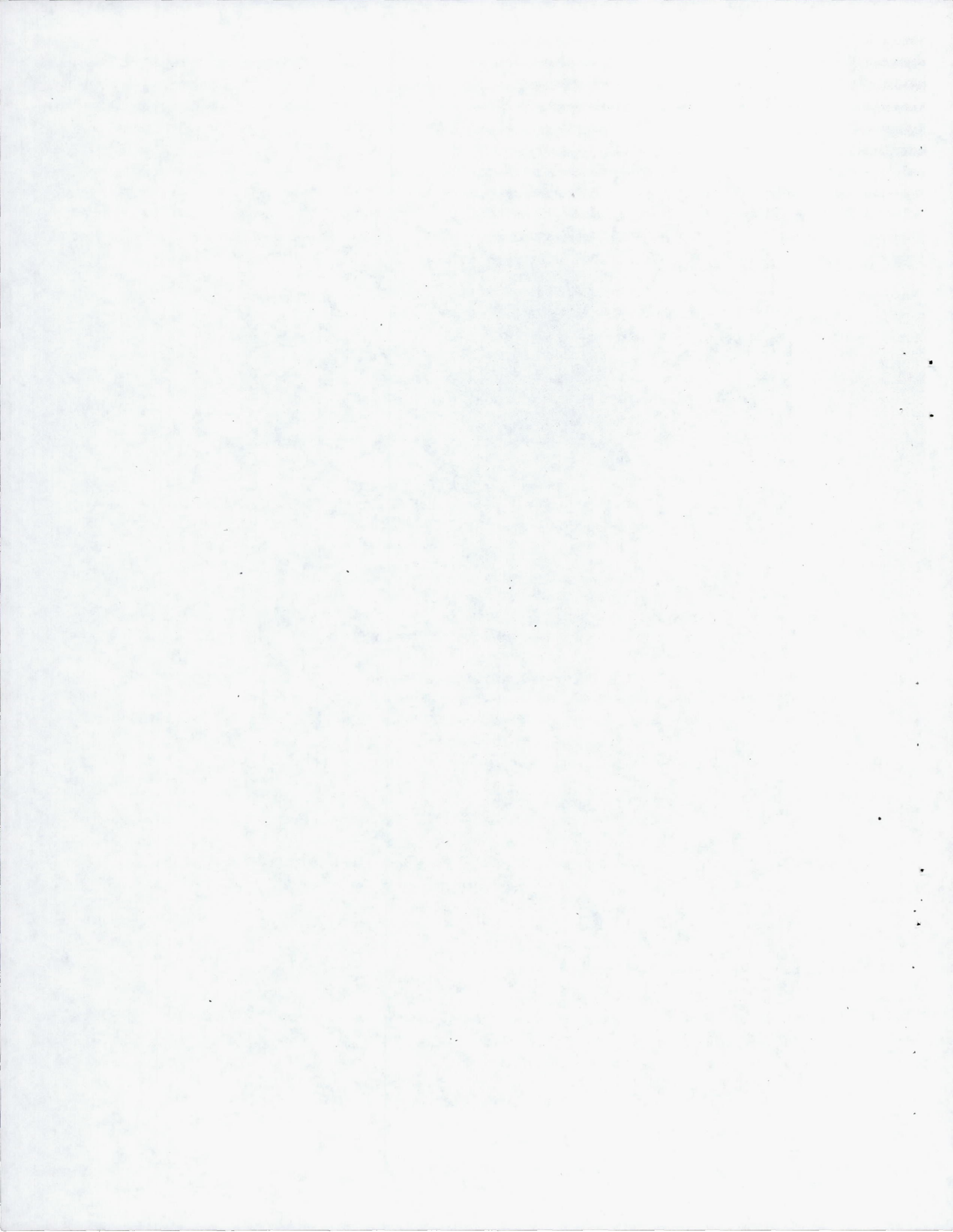

Figure 3.- Three-quarter side view of airplane with vertical tail removed and tail fairing installed.



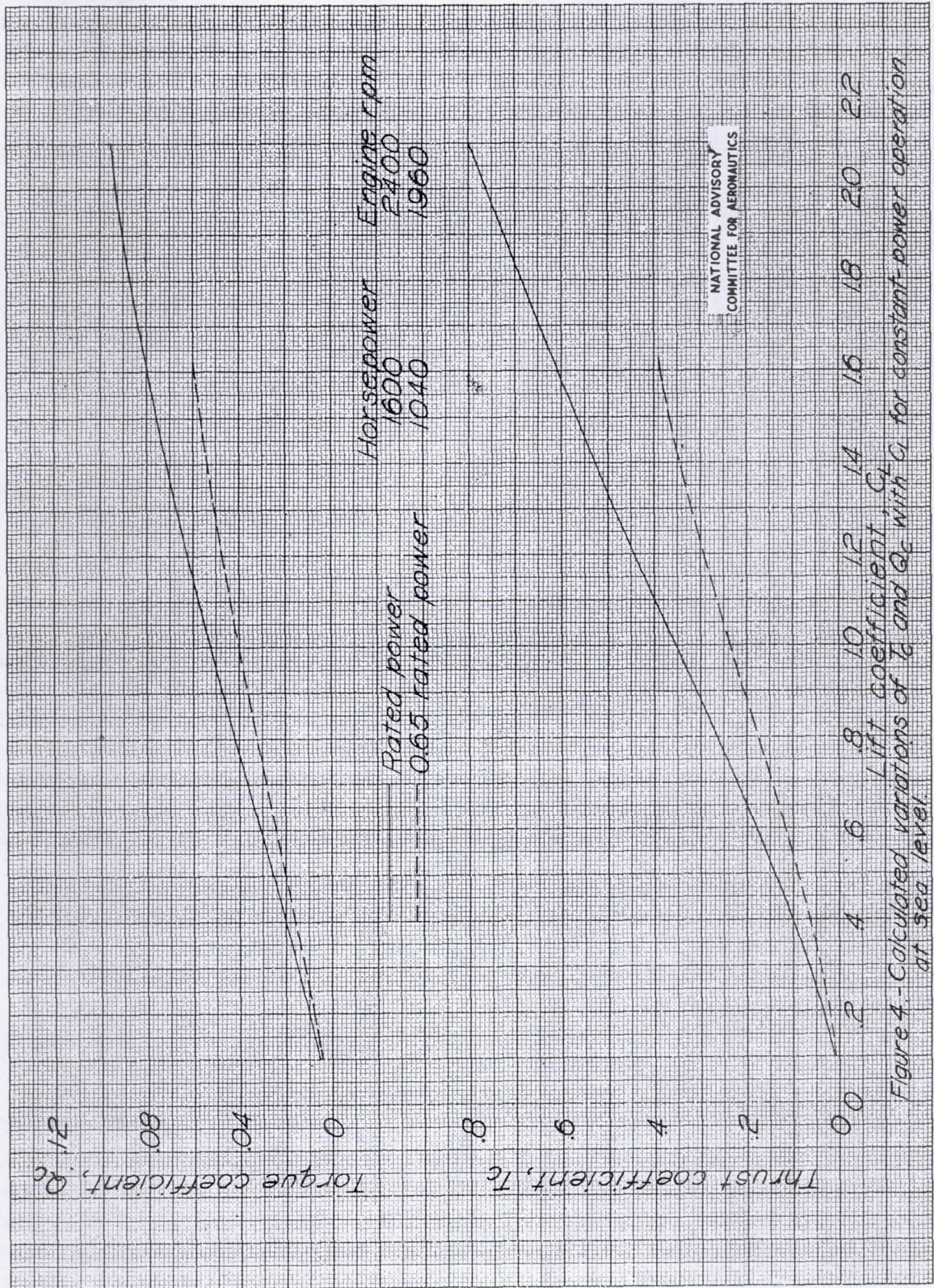

Figure 4 - Calculated variations of  $T_c$  and  $Q_c$  with  $C_l$  for constant-power operation at sea level

	Horsepower	Engine rpm
—— Rated power	1600	2400
--- 0.65 rated power	1040	1960
----- $\beta, 24.8^\circ$ measured at 0.75 R		

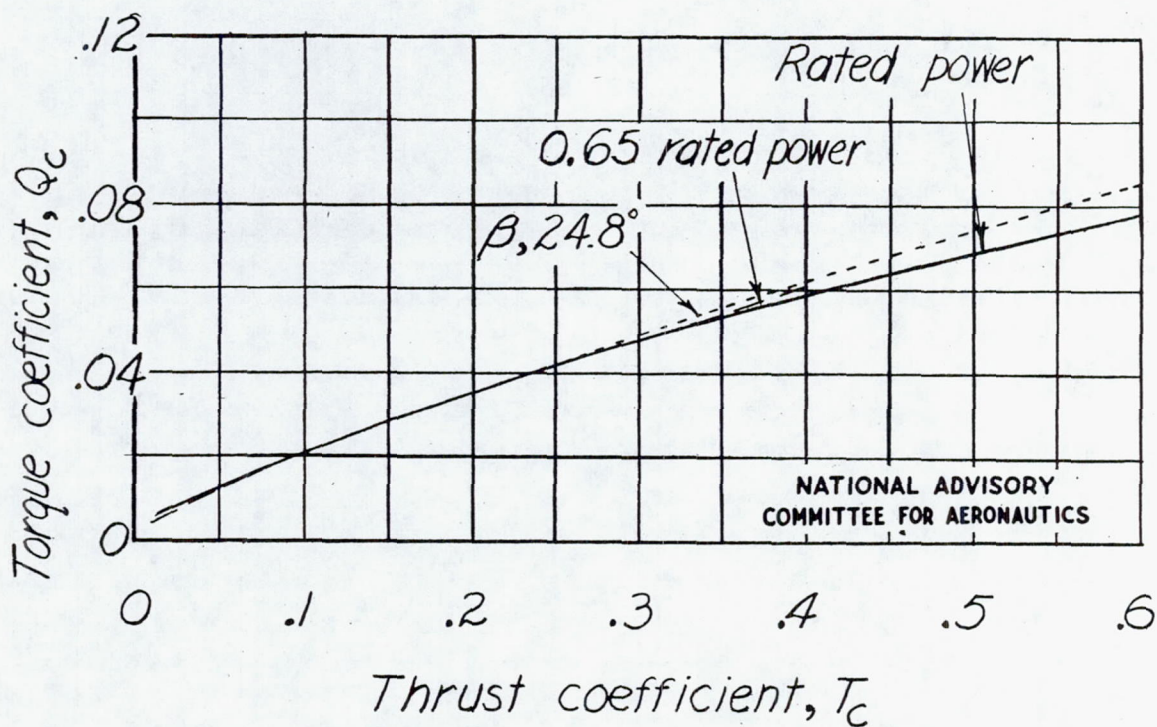

Figure 5.- Comparison of variation of  $T_c$  with  $Q_c$  for constant-power operation and for the propeller with blade angle fixed at  $24.8^\circ$  at 0.75 radius.



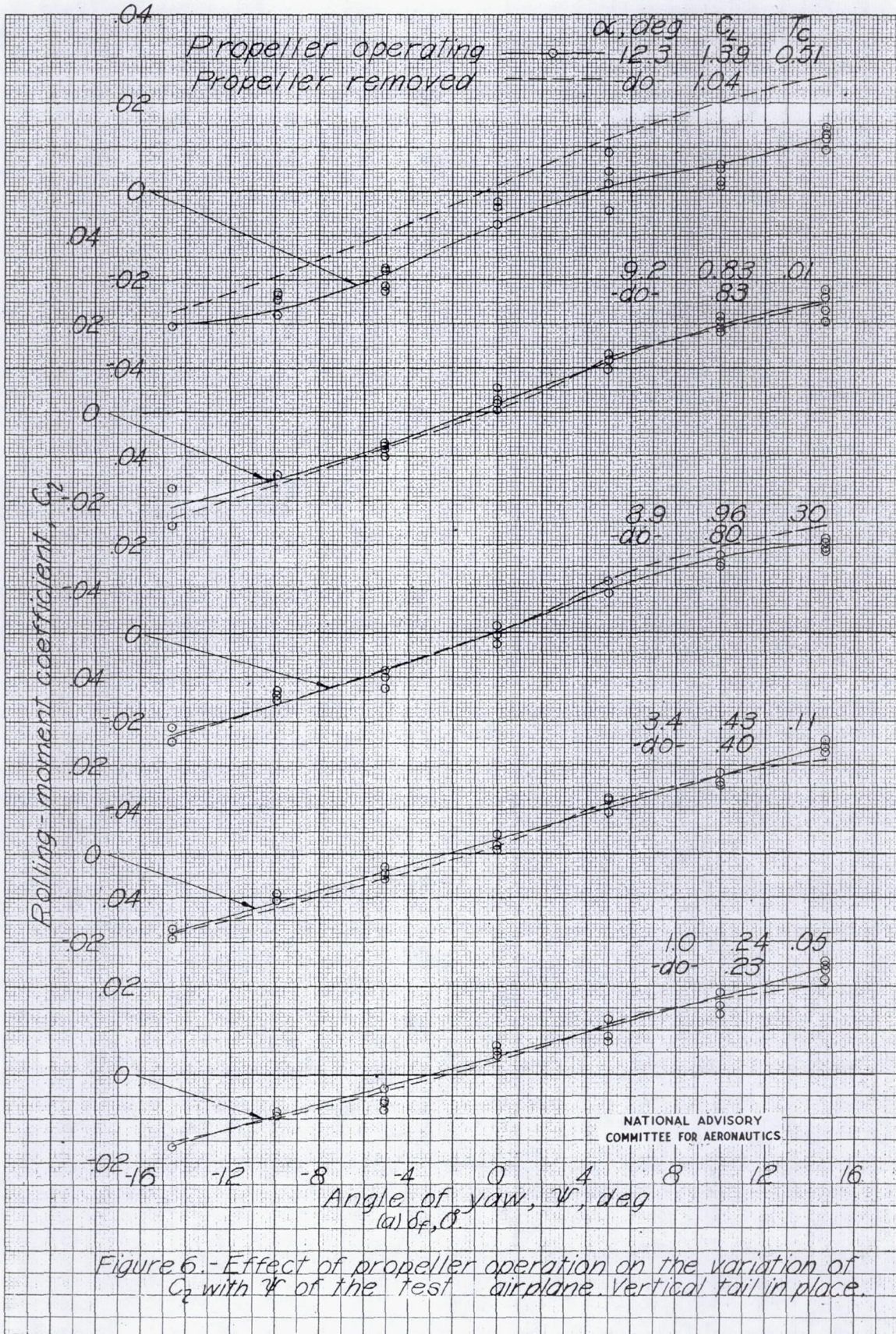
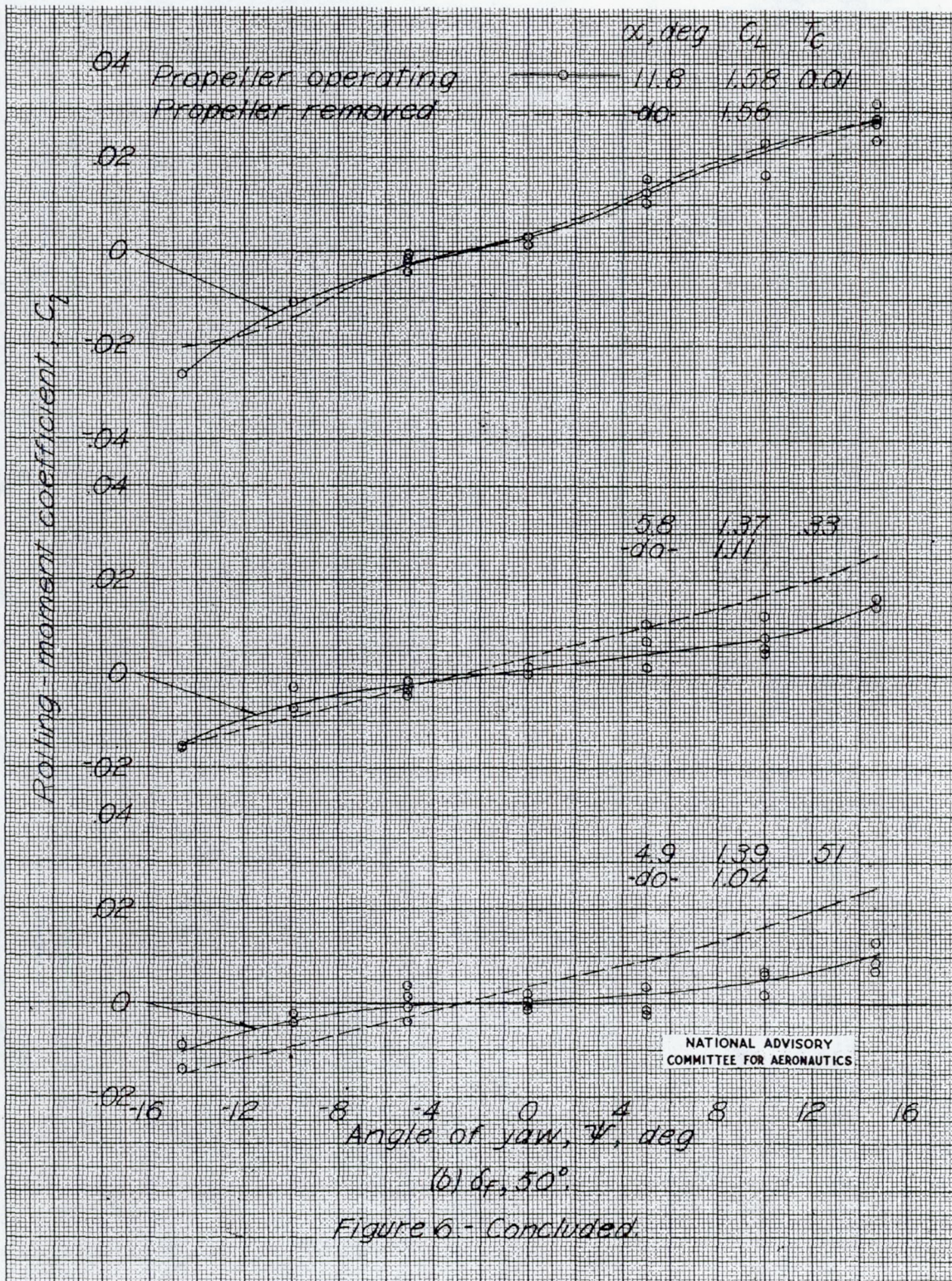

Fig. 6b



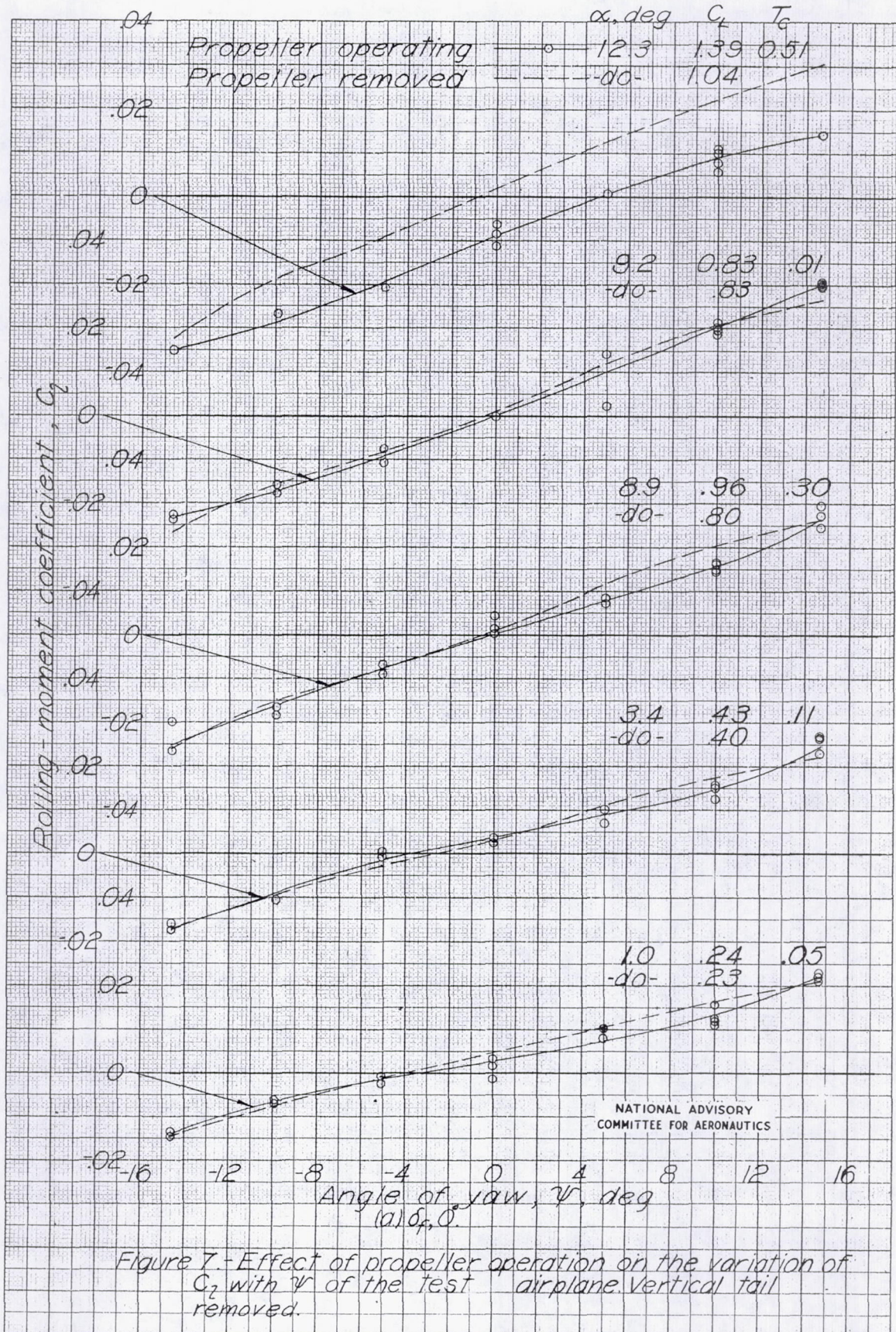

Fig. 7b

