

N 62 55630

NACA TN 3630

**CASE FILE  
COPY**

**NATIONAL ADVISORY COMMITTEE  
FOR AERONAUTICS**

**TECHNICAL NOTE 3630**

HOVERING-FLIGHT TESTS OF A MODEL OF A TRANSPORT  
VERTICAL-TAKE-OFF AIRPLANE WITH TILTING  
WING AND PROPELLERS

By Powell M. Lovell, Jr., and Lysle P. Parlett

Langley Aeronautical Laboratory  
Langley Field, Va.



Washington  
March 1956

24

---

TECHNICAL NOTE 3630

---

HOVERING-FLIGHT TESTS OF A MODEL OF A TRANSPORT

VERTICAL-TAKE-OFF AIRPLANE WITH TILTING

WING AND PROPELLERS

By Powell M. Lovell, Jr., and Lysle P. Parlett

SUMMARY

An investigation of the take-off, landing, and hovering-flight characteristics of a four-engine transport vertical-take-off airplane with tilting wing and propellers has been conducted with a remotely controlled free-flight model. The model had four propellers distributed along the wing with the thrust axes in the wing-chord plane. In order to produce direct lift for hovering flight with the fuselage horizontal, the wing and propellers were rotated  $90^\circ$  with respect to the fuselage. Despite the fact that the pitching and rolling motions of the model were unstable oscillations, the model could be flown smoothly and easily without the use of any automatic stabilization devices because the periods of the oscillations were fairly long and the controls were powerful. The pitching oscillation could be completely stabilized by the use of artificial damping in pitch; thus the model could be flown in pitch for long periods of time without the use of the manual pitch control. Although there was no stability of yaw position, the model was easy to control in yaw because the motions were slow and the yaw control was powerful. There were no noticeable interactions between the rolling and yawing motions or between the roll and yaw controls. Vertical take-offs and landings could be performed fairly easily, although some forward or backward motion of the model was often present.

INTRODUCTION

During the past few years the interest in vertically rising airplanes has increased because of the development of turboprop engines of high power-to-weight ratio. For a transport-type vertically rising airplane it is, of course, desirable to have the fuselage remain essentially horizontal throughout the flight range so that cargo may be stowed and secured with a minimum of difficulty and so that passengers may have a maximum amount of freedom.

Two basic types have been proposed to accomplish this aim: one, a configuration which has wings and flaps capable of turning the propeller slipstream through large angles to produce direct lift for hovering flight with the fuselage essentially horizontal, and the other, a configuration with wings and propellers which can be rotated  $90^\circ$  with respect to the fuselage. In order to determine whether such airplanes are feasible from a stability and control standpoint, flying models of these two basic types have been tested at the Langley Aeronautical Laboratory. Results of hovering-flight tests of the first type are presented in references 1 and 2, whereas hovering-flight results for the second type are given in the present report.

The model used in the present investigation had four propellers mounted on the wing with the thrust axes in the chord plane. The wing could be rotated through  $90^\circ$  incidence so that the propeller thrust axes were vertical for hovering flight. The wing had a full-span control flap of 25 percent chord which provided pitch and yaw control for hovering flight. Roll control was obtained by differentially varying the total pitch of the two outboard propellers.

The investigation consisted primarily of flight tests and included hovering flight and vertical take-offs and landings. The stability and controllability were determined from visual observation, from the pilots' impressions of the flying qualities of the model, and also from motion-picture records of the flight tests. In addition to the flight tests a few force tests were made to determine the control effectiveness in hovering flight.

#### SYMBOLS

The motions of the model are referred to the body system of axes. Figure 1 shows these axes and the positive directions of the forces, moments, and angular displacements. In order to simplify the reduction of the records, linear displacements in time histories of the model motions are presented with reference to horizontal and vertical space axes.

$\theta$	angle of pitch of longitudinal fuselage axis relative to horizontal, deg
$\psi$	angle of yaw, deg
$\phi$	angle of roll, deg
$M_x$	rolling moment, ft-lb
$M_y$	pitching moment, ft-lb

$M_Z$	yawing moment, ft-lb
$I_X$	moment of inertia about X-axis, slug-ft <sup>2</sup>
$I_Y$	moment of inertia about Y-axis, slug-ft <sup>2</sup>
$I_Z$	moment of inertia about Z-axis, slug-ft <sup>2</sup>
X,Y,Z	body axes

#### TEST SETUP

The tests were made in a large building which provides protection from the random effects of outside air currents and thereby permits the basic stability and control characteristics of the model to be determined more readily. This facility has a useful test space approximately 48 feet wide, 70 feet long, and 50 feet high.

A sketch of the test setup is shown in figure 2. The wires and plastic tubes which supplied the power for the main propulsion motor and electric control solenoids and the air for the control actuators were suspended from above and taped to a safety cable (1/16-inch braided aircraft cable) from a point about 15 feet above the model down to the model itself. The safety cable, which was attached to the fuselage near the center of gravity, was used to prevent crashes in the event of a power or control failure or in the event that the pilots lost control of the model. During flight the cable was kept slack so that it did not appreciably influence the motions of the model. The flight test technique is described in detail in reference 1.

#### MODEL

The model was designed to represent a possible turboprop transport airplane. A photograph of the model is presented in figure 3 and a three-view drawing is presented in figure 4. Table I lists some of the geometric characteristics of the model. The model was powered by a 10-horsepower electric motor which turned four 2-blade propellers with the thrust axes in the wing-chord plane. The speed of the motor was changed to vary the thrust of the model.

The wing had full-span control flaps of 25 percent chord which provided pitch and yaw control for hovering flight. Pitch control was

obtained by deflection of the left and right control flaps together and yaw control was provided by deflection of the left and right flaps differentially. Roll control was provided by differentially varying the pitch of the outboard propellers. The controls were deflected by flicker-type (full-on or off) pneumatic actuators which were remotely operated by the pilots. The following control deflections from the trim position and the corresponding control moments were used in all flights:

	Deflection, deg	Moment, ft-lb
Pitch control . . . . .	±15	±7
Yaw control . . . . .	±10	±11
Roll control . . . . .	±3	±16

The actuators were equipped with an integrating-type trimmer. Each time a control deflection was applied the control was trimmed a small amount in that same direction. With actuators of this type, a model becomes trimmed after flying a short time in a given flight condition. Although one pilot handled all three controls in some tests, separate pilots were used in most of the tests to control the model in pitch, roll, and yaw. It has been found that, if a single pilot operates all three controls, he is so busy controlling the model that he has difficulty in studying closely any particular phase of the stability and control characteristics about any particular axis.

A rate-sensitive artificial stabilizing device was used in a few of the tests to increase the damping of the pitching motions. This pitch damper consisted of a rate gyroscope which, in response to a rate of pitch, provided signals to a proportional control actuator which moved the control surface to oppose the pitching motion. An override was provided which cut out the damper when the pilot applied control. The manual control deflection obtained with the damper installed was the same as that provided without the damper installed.

The response of the control surface to the damper system was not calibrated but experience with dampers of this type indicates that the response factor was of the order of magnitude of  $1^{\circ}$  of control deflection per degree per second of pitching velocity.

#### TESTS

The investigation consisted of flight tests to determine the stability and control characteristics of the model in vertical take-offs

and landings and in hovering flight in still air. As previously mentioned, the test results were obtained from the pilots' observations and opinions of the behavior of the model, from motion-picture records of the motions of the model, and from time histories of the tests made from the motion-picture records.

The take-off tests were made by increasing the power to the model fairly rapidly until it took off. After the take-off, power was reduced until the model stabilized at a height of about 15 feet above the ground. For all take-off tests, the controls were set for trim in hovering flight for the particular condition.

Landing tests were started with the model in steady hovering flight at a height of about 10 to 15 feet above the ground. The power was reduced slightly so that the model descended slowly until the landing gear was about 6 inches above the ground. At this point the throttle was reduced quickly to the idle position and the model settled to the ground.

The hovering-flight tests were made at a height of about 15 to 20 feet above the ground in order to study the basic stability and control characteristics of the model when it was high enough to eliminate any possible effect of ground proximity. In these tests the ease with which the model could be flown in steady hovering flight and maneuvered from one position to another was studied. The uncontrolled pitching and rolling motions and the ease with which these motions could be stopped after they had been allowed to develop was also studied.

All the tests were made with the center of gravity located 0.21 inches (0.016 mean aerodynamic chord) behind the wing pivot point except the tests in which the effect of center-of-gravity position was being studied. In these latter tests, the center of gravity was varied about  $\pm 8$  percent mean aerodynamic chord about the wing pivot point which was located at 0.30 mean aerodynamic chord.

## RESULTS AND DISCUSSION

The results of the present investigation are illustrated more graphically by motion pictures of the flights of the model than is possible in a written presentation. For this reason a motion-picture film supplement to this paper has been prepared and is available on loan from the NACA Headquarters, Washington, D. C.

### Hovering Flight

The hovering flights in which one pilot operated all the controls demonstrated that the model could be flown satisfactorily by a single pilot without any automatic stabilization. It was found that a single pilot could fly the model for an indefinite time, and a long flight using this technique is shown in the film supplement to this paper. Because it required considerable concentration on the part of the pilot just to fly the model under these conditions, the detailed studies of stability and control in this investigation were made with three pilots flying the model.

Pitching motions.- The flight tests showed that the model had an unstable pitching oscillation. This oscillation is shown in the time histories presented in figure 5(a) which show the instability of the uncontrolled pitching motion and also show how quickly the oscillation could be stopped by the use of the controls.

These unstable pitching oscillations could be controlled easily because the period of the oscillation was fairly long and the pitch control was powerful. The smoothness with which the model could be flown in pitch is illustrated in figure 5(b). To a person not familiar with the flying of remotely controlled models the motions shown in figure 5(b) may seem erratic but this record actually represents very smooth flight for tests of this type. A full-scale airplane could be flown much more smoothly than the model because the angular velocities of the airplane would be much lower than those of the model and because the pilot could sense the movements of the airplane more quickly and apply the proper amount of corrective control more exactly than was possible with the model.

The pitch damper was used on the model as a means of improving its stability by increasing the damping in pitch. Time histories of the uncontrolled pitching motions with the damper operating are presented in figure 6. It can be seen that with the pitch damper operating the model was flown "hands-off" in pitch for a long period of time. The model, of course, had no stability of position and, consequently, wandered around somewhat in response to disturbances introduced by the flight cable and by recirculation of the propeller slipstream.

It was found that the model could be flown satisfactorily within a longitudinal center-of-gravity range of 16 percent of the mean aerodynamic chord ( $\pm 8$  percent mean aerodynamic chord about the wing pivot point) with the pitch control flaps without changing the incidence of the wing. Adequate pitch control could be maintained for this center-of-gravity range even though the control flaps had to be deflected  $30^\circ$  to trim the model for the most forward and most rearward center-of-gravity positions.

It should be realized that, since the center of gravity was above the wing pivot point, the incidence of the wing could have been varied to trim the model for a range of center-of-gravity positions with an elevator deflection of  $0^\circ$  or to trim the model for a larger center-of-gravity range with an elevator deflection of  $\pm 30^\circ$ . In this investigation, however, no tests were made in which the wing incidence was varied to provide longitudinal trim.

Yawing motions.- The observations of the yaw pilot indicated that the yaw control was very powerful. There was no noticeable cross-coupling effect of the rolling motions or roll control on the yawing motions of the model. Regardless of the attitude or speed of translation of the model (which sometimes reached large values where uncontrolled pitching or rolling motions were being studied), the yaw pilot was always able to keep the model properly oriented. The yaw-control deflection appeared to be slightly excessive for smooth flying, but the deflection was not reduced because of mechanical limitations in the control system.

There was no stability of yaw position because there was no static restoring moment in yaw. Continual use of yaw control was therefore required to prevent yawing as a result of random disturbances on the model. It is important to maintain a constant heading when flying the model because the model must be properly oriented with respect to the remote pilots in order for them to control it effectively.

Rolling motions.- The uncontrolled rolling motion consisted of an unstable oscillation involving rolling and lateral translation as can be seen from figure 7(a). The pilot could control the rolling motions easily despite the unstable oscillation. The smoothness with which the model could be controlled in roll is illustrated in figure 7(b). The roll control was very powerful and, even with the small deflections used for control ( $\pm 3^\circ$  pitch change), the pilot had to be very careful to avoid overcontrolling. As in the case of the yaw control, the roll pilot felt that the control deflection was excessive for smooth flying, but the deflection was not reduced because of mechanical limitations in the control system. No records were obtained in which the pilot stopped the oscillation by applying roll control, but it was apparent from the ease of flying the model that it would have been even easier to stop the rolling oscillation than the pitching oscillation. There was no noticeable cross-coupling effect of the yawing motions or yaw control on the rolling motions of the model.

Vertical motions.- The model had no vertical-position stability but had positive rate-of-climb stability because of the pronounced inverse variation of propeller thrust with axial velocity. This rate-of-climb stability tended to offset the effect of time lag in the thrust control so that the altitude could be controlled satisfactorily in hovering flight well above the ground.



### Take-Offs and Landing

Vertical take-offs and landings could be performed fairly easily although some forward or backward motion was generally present. The model moved forward as much as two fuselage lengths when the center of gravity was in the most forward position and moved rearward about half a fuselage length when the center of gravity was in the most rearward position. This forward and backward motion is shown by the time histories of take-offs and landings presented in figures 8 and 9. These records show that with the center of gravity forward of or slightly behind the wing pivot, the model moved forward on take off; whereas, for the more rearward center-of-gravity positions, it moved rearward. Successful take-offs and landings were made for the entire range of center-of-gravity positions for which the model could be flown satisfactorily in hovering flight -  $\pm 8$  percent mean aerodynamic chord about the wing pivot point. The forward and rearward motion on landing, which consisted mainly of ground roll after landing, was not as clearly influenced by the center-of-gravity location as it was on take-off since the direction of motion of the model during the last part of the descent had a strong effect.

There are several factors involved in this forward and rearward motion during take-off and landing: (1) a reduction in control effectiveness caused by proximity to the ground, (2) an upwash at the horizontal tail caused by the presence of the ground, and (3) the characteristics of the flicker-control system used in the model. The nature of these factors will be discussed in more detail later, but first it seems desirable to examine their effects on the motions of the model.

For a take-off with the center of gravity in the normal position (0.014 mean aerodynamic chord behind the wing pivot point) and with the elevator in the trim position for hovering flight ( $5^\circ$  deflection), the upwash on the tail caused the model to nose down and move forward as it left the ground. With the flicker control system the pilot could apply only  $15^\circ$  corrective pitch control from the trim position, and the pitch control was not very effective until the model rose so that the control flap was not so near the ground. The model therefore moved forward an appreciable distance before the control moment and the natural nosing-up moment which results from the forward velocity could pitch the model to stop the forward movement.

For a take-off with the center of gravity in a forward location, the forward motion was more severe. The model sat on the ground with the fuselage level and the pitch control trimmed rearward to provide the trim required in hovering flight. With this setting of the pitch-control flap, the model tended to roll forward on the ground as the thrust was brought up. The pilot could apply  $15^\circ$  forward deflection of

the flap which moved the flap nearer  $0^\circ$  deflection. As the model left the ground, the pitch control was weak at first so the model nosed down and moved forward because of both the upwash on the tail and the nose-down moment of the thrust about the center of gravity. These two sources of nose-down moment caused the model to move forward faster than for the normal center-of-gravity condition. Since the trim condition for hovering flight with a forward center-of-gravity location was a nose-up attitude instead of a fuselage-level attitude, the length of time required to pitch the model and stop the forward movement was considerably greater than for the normal center-of-gravity condition. For the most forward center-of-gravity location for which hovering flight was considered satisfactory, the model moved forward about two fuselage lengths before the forward motion was stopped.

For the extreme rearward center-of-gravity condition, the model tended to move rearward but the problem was no more severe than the forward movement for the normal center-of-gravity position. The model sat on the ground with the fuselage level and the pitch control flap trimmed forward  $30^\circ$  for trim in hovering flight. The pilot deflected the flap  $15^\circ$  toward  $0^\circ$  deflection to minimize the tendency of the model to roll backward on the ground as the thrust was brought up. As the model left the ground, the nose-down moments caused by the upwash on the tail tended to offset the nose-up moment caused by the thrust so that the backward movement was small. As the model rose far enough above the ground for the pitch-control flap to become really effective, the model nosed down quickly to the nose-down attitude required for trim in hovering flight with a rearward center-of-gravity position.

It is obvious from the foregoing discussion that there should have been a center-of-gravity position behind the wing pivot point at which the model would have virtually no tendency to move either forward or backward on take-off. This center-of-gravity position was slightly less than 0.05 mean aerodynamic chord behind the wing pivot, as indicated by the time histories of figures 8(d) and 8(e).

During landings the model always tended to move forward unless it had inadvertently attained a considerable rearward velocity during the descent. As the model neared the ground the effect of the upwash on the tail caused the model to tend to nose down and move forward slightly. Ground proximity reduced the effectiveness of the pitch control flap and allowed a greater nose-down moment when the center of gravity was in a forward position. Conversely, the reduced effectiveness tended to cancel the nose-down moment caused by upwash on the tail when the center of gravity was in a rearward position. When the pilot became familiar with the tendency of the model to nose down and move forward on landing he could check this motion by giving nose-up control as the model neared the ground but before the nosing-down motion could be detected. (See fig. 9.)

One of the factors previously mentioned as affecting the take-off and landing characteristics was the use of flicker controls. A pitch-control deflection of  $\pm 15^\circ$  from the trim position was chosen to avoid overcontrolling in steady hovering flight. Since this control deflection was only a small part of the total allowable deflection of  $\pm 45^\circ$  it was obviously not always possible to obtain the maximum control deflection in the desired direction. Since an airplane need not have this control limitation, it should be possible to obtain full control deflection with the airplane controls at any time.

As previously noted, qualitative observations of the pilots indicated that there is a considerable reduction in control effectiveness when the model is very near the ground. A similar ground effect has been encountered with other models and has been investigated for one model by means of tuft tests and dynamic-pressure surveys of the slipstream near the ground. These tests showed that the reduction in control effectiveness was caused by a reduction in the axial velocity of the slipstream because it spreads out as it nears the ground. It was found in these tests that there was no noticeable reduction in the control effectiveness when the control surfaces were more than 1 propeller diameter above the ground.

The upwash on the tail was similar to that encountered with the deflected slipstream model of reference 2. This upwash seems to be a fundamental characteristic of airplanes of this type in which the propellers are located side by side at some distance from the plane of symmetry with the slipstream directed toward the ground. The flow might be visualized more readily if the plane of symmetry were considered as a solid wall through which no flow will pass because of the exactly opposite flow on the other side. When the slipstream of the propeller nears the ground, it tends to spread out and flow outward along the ground in all directions. Since it can not flow through the plane of symmetry, the flow that starts along the ground toward the plane of symmetry tends to go upward to escape. The flow at the plane of symmetry, therefore, is straight upward directly between the propellers and upward at progressively smaller angles at greater distances ahead of and behind the propellers. This type of flow has been observed by tuft studies around the present model. These tuft tests indicated that the flow at the horizontal tail was upward at an angle of about  $30^\circ$  from the ground. This upwash at the tail caused by proximity to the ground produced large changes in longitudinal trim with small changes in height. These trim changes, combined with the lag in the thrust control, made it impossible to fly the model continuously near the ground. Since the pilot of an airplane of this type would have a much better thrust control and could apply the correct amount of pitch and thrust control more quickly than could the pilot of the model, the problem of hovering near the ground should be greatly alleviated for the airplane.

Since part of the trouble with forward and rearward motion during the take-offs could be attributed to the characteristics of the flicker control system used on the model, the take-off characteristics of a full-scale airplane of this type would be expected to be better than those of the model. The adverse effect of the upwash at the tail and ground effect on control effectiveness, however, would be expected to occur on a full-scale airplane of this type as well as on the model. These adverse effects could be minimized by proceeding as quickly as possible through the range of heights at which the adverse ground effect on control effectiveness occurs. Better low-altitude characteristics may be obtained by the use of variable incidence of the horizontal tail so that it may be aligned as nearly as possible with the direction of the air flow when the airplane is on or near the ground and by use of another type of pitch control, such as a movable jet at the tail of the airplane, which would not be affected by the proximity of the ground.

#### SUMMARY OF RESULTS

The following results were obtained from take-off, landing, and hovering-flight tests of a model of a transport-type vertical-take-off airplane with tilting wing and propellers:

1. Despite the fact that the pitching and rolling motions of the model were unstable oscillations, the model could be flown smoothly and easily without the use of any automatic stabilization devices because the periods of the oscillations were fairly long and the controls were powerful.
2. The use of artificial damping in pitch made the model stable in pitch and enabled it to be flown "hands-off" in pitch for long periods of time.
3. The model could be flown satisfactorily within a range of longitudinal center-of-gravity locations of 16 percent mean aerodynamic chord ( $\pm 8$  percent mean aerodynamic chord about the wing pivot point).
4. Although there was no stability of yaw position, the model was easy to control in yaw because the motions were slow and the yaw control was powerful.
5. There were no noticeable interactions between the rolling and yawing motions or between the roll and yaw controls.
6. Take-offs could be performed fairly easily for the entire range of center-of-gravity positions for which the model could be flown satisfactorily in hovering flight. The model moved forward as much as two

fuselage lengths when the center of gravity was in the most forward position and moved rearward about half a fuselage length when the center of gravity was in the most rearward position.

7. Landings could be made accurately on a predetermined spot but the model tended to nose down and move forward as it neared the ground for a landing. With practice, however, the pilot was able to prevent any forward motion on landing by applying a nose-up moment with the controls as the model neared the ground.

Langley Aeronautical Laboratory,  
National Advisory Committee for Aeronautics,  
Langley Field, Va., December 21, 1955.

#### REFERENCES

1. McKinney, Marion O., Tosti, Louis P., and Davenport, Edwin E.: Dynamic stability and Control Characteristics of a Cascade-Wing Vertically Rising Airplane Model in Take-Offs, Landings, and Hovering Flight. NACA TN 3198, 1954.
2. Tosti, Louis P., and Davenport, Edwin E.: Hovering Flight Tests of a Four-Engine-Transport Vertical Take-Off Airplane Model Utilizing a Large Flap and Extensible Vanes for Redirecting the Propeller Slipstream. NACA TN 3440, 1955.

TABLE I  
GEOMETRIC CHARACTERISTICS OF MODEL

Weight, lb . . . . .	55.3
Moment of inertia for normal center-of-gravity location:	
$I_x$ , slug-ft <sup>2</sup> . . . . .	2.58
$I_y$ , slug-ft <sup>2</sup> . . . . .	3.05
$I_z$ , slug-ft <sup>2</sup> . . . . .	5.13
Fuselage length, in. . . . .	84.8
Propellers (two blades each):	
Diameter, in. . . . .	20
Solidity (each propeller) . . . . .	0.079
Design . . . . .	Modification of modified NACA propeller A described in NACA Report 237
Wing:	
Sweepback (leading edge), deg . . . . .	6°
Airfoil section . . . . .	NACA 0015
Aspect ratio . . . . .	5.85
Tip chord, in. . . . .	9.4
Root chord (at center line), in. . . . .	17.6
Taper ratio . . . . .	0.54
Area (total to center line), sq in. . . . .	988
Span, in. . . . .	76.0
Mean aerodynamic chord, in. . . . .	13.0
Control flap hinge line, percent chord . . . . .	75
Dihedral angle, deg . . . . .	0
Vertical tail:	
Sweepback (leading edge), deg . . . . .	5.0
Airfoil section . . . . .	NACA 0009
Aspect ratio . . . . .	1.94
Tip chord, in. . . . .	7.54
Root chord (at center line), in. . . . .	11.12
Taper ratio . . . . .	0.68
Area (total to center line - excluding dorsal area), sq in. . . . .	169.1
Span, in. . . . .	18.125
Mean aerodynamic chord, in. . . . .	9.45
Rudder (hinge line perpendicular to fuselage center line):	
Tip chord, in. . . . .	2.5
Root chord, in. . . . .	4.05
Span, in. . . . .	14.03
Horizontal tail:	
Sweepback (leading edge), deg . . . . .	7.3
Airfoil section . . . . .	NACA 0009
Aspect ratio . . . . .	5.81
Tip chord, in. . . . .	4.6
Root chord (at center line), in. . . . .	8.3
Taper ratio . . . . .	0.55
Area (total to center line), sq in. . . . .	241.9
Span, in. . . . .	37.5
Mean aerodynamic chord, in. . . . .	6.62
Elevator (hinge line perpendicular to fuselage center line):	
Tip chord, in. . . . .	2.13
Root chord, in. . . . .	3.30
Span (each), in. . . . .	16.94

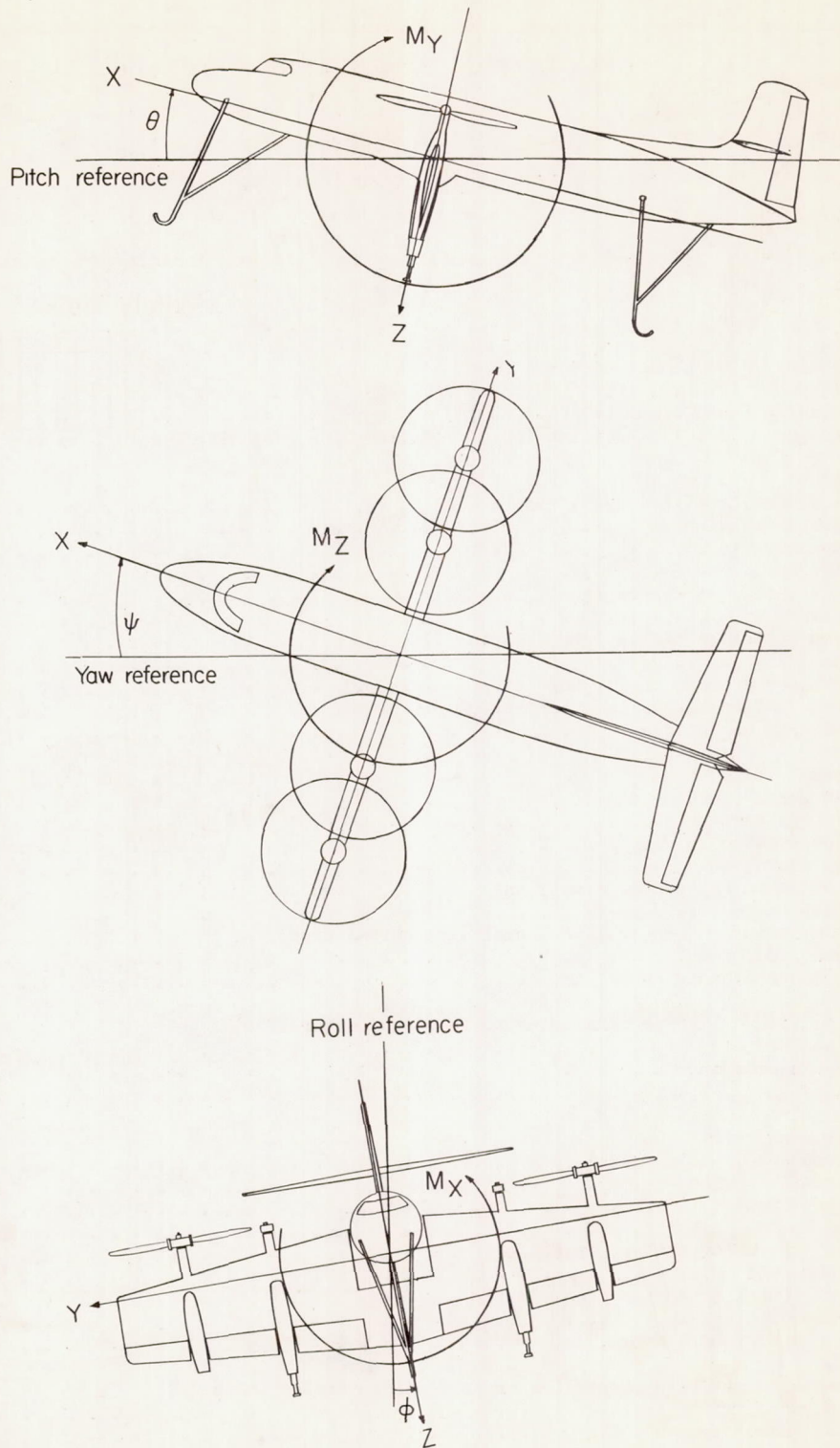

Figure 1.- The body system of axes. Arrows indicate positive directions of forces, moments, and angular displacements.

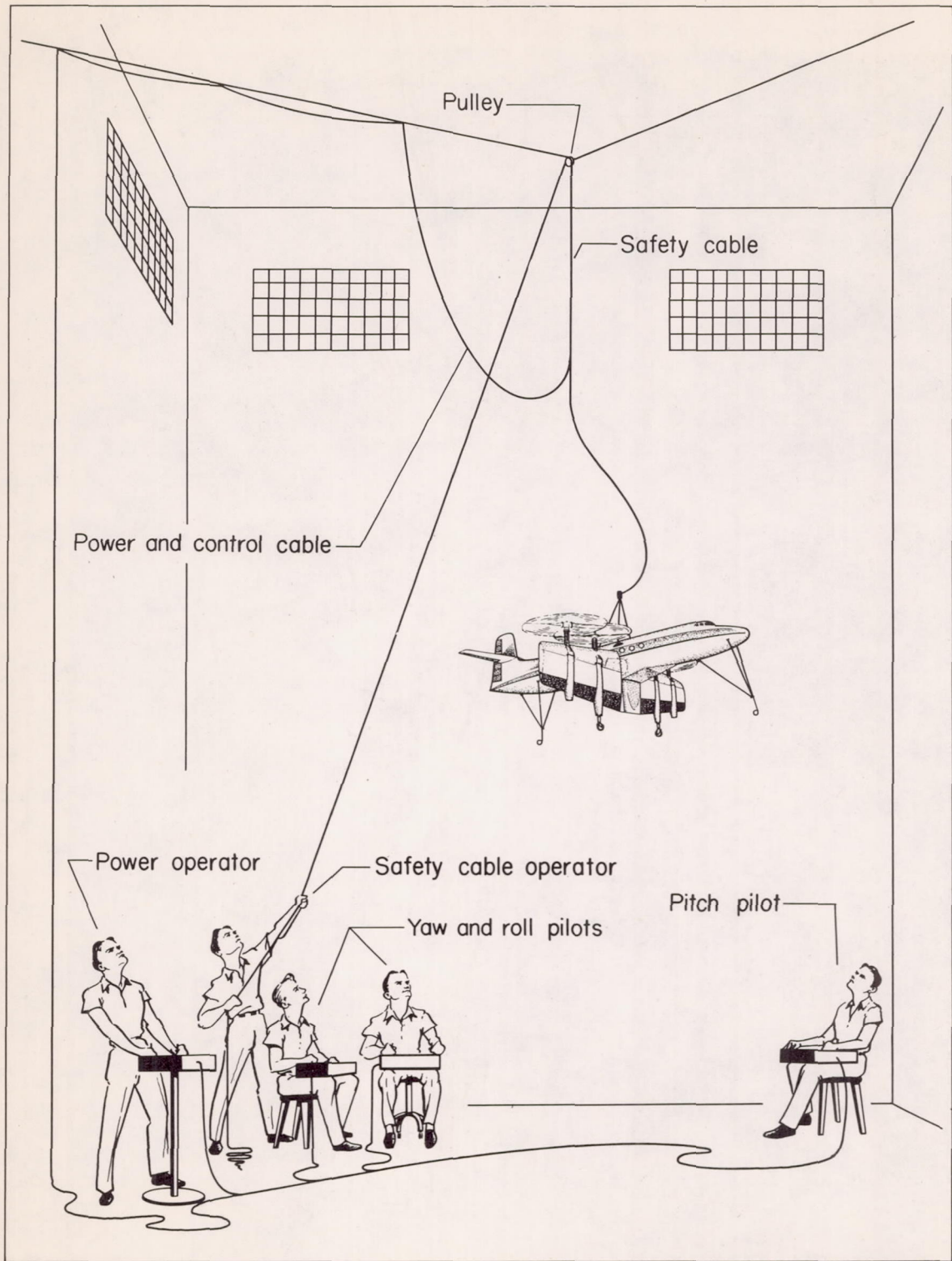

Figure 2.- Indoor test setup used in the flight testing of hovering models.





Figure 3.- Photograph of the model in the hovering configuration.

L-89656

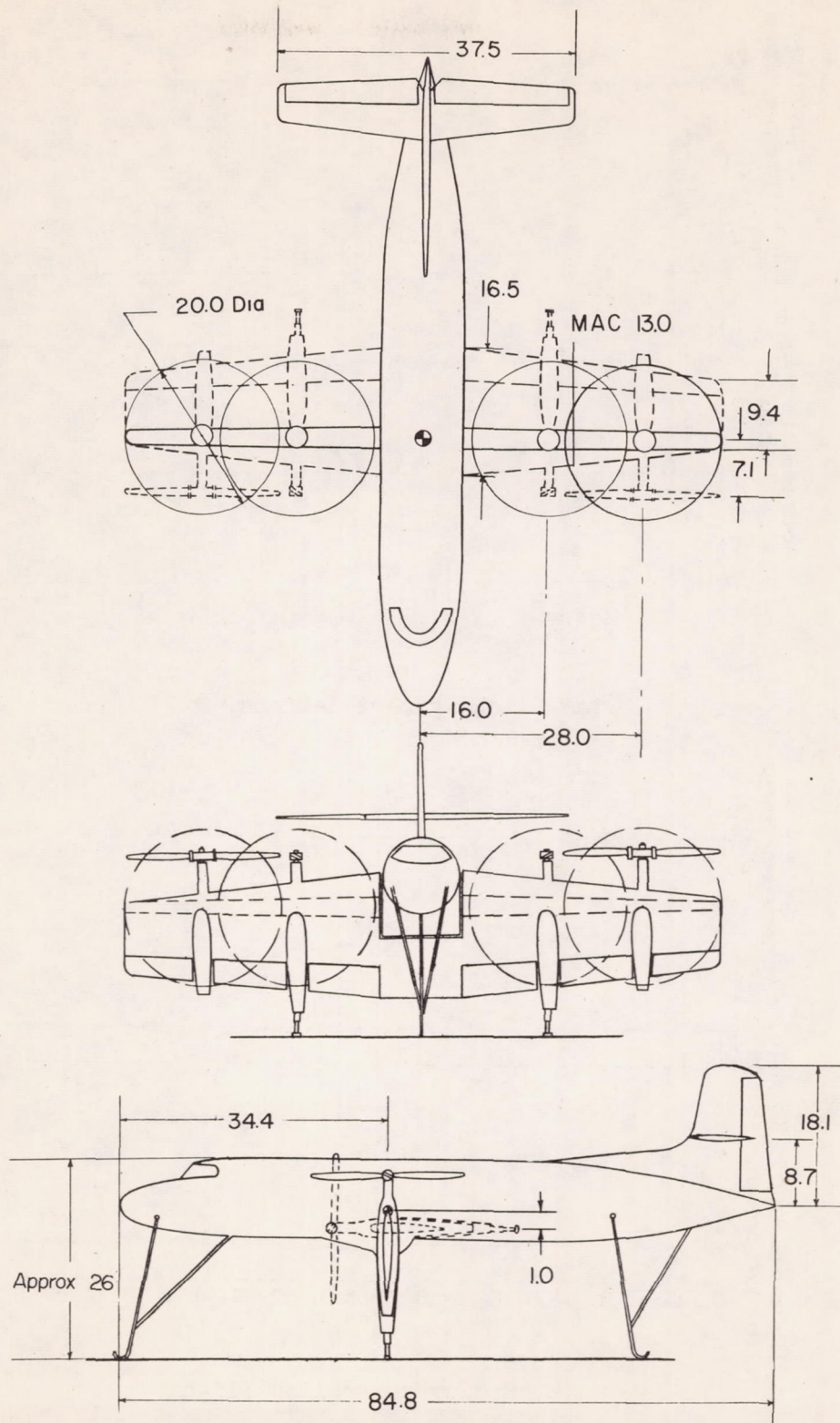
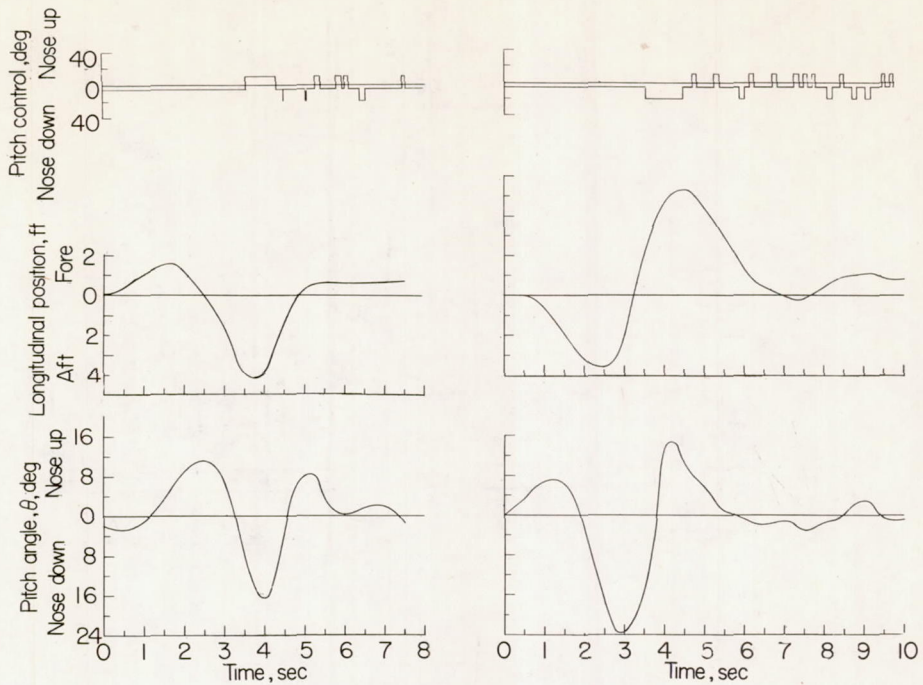
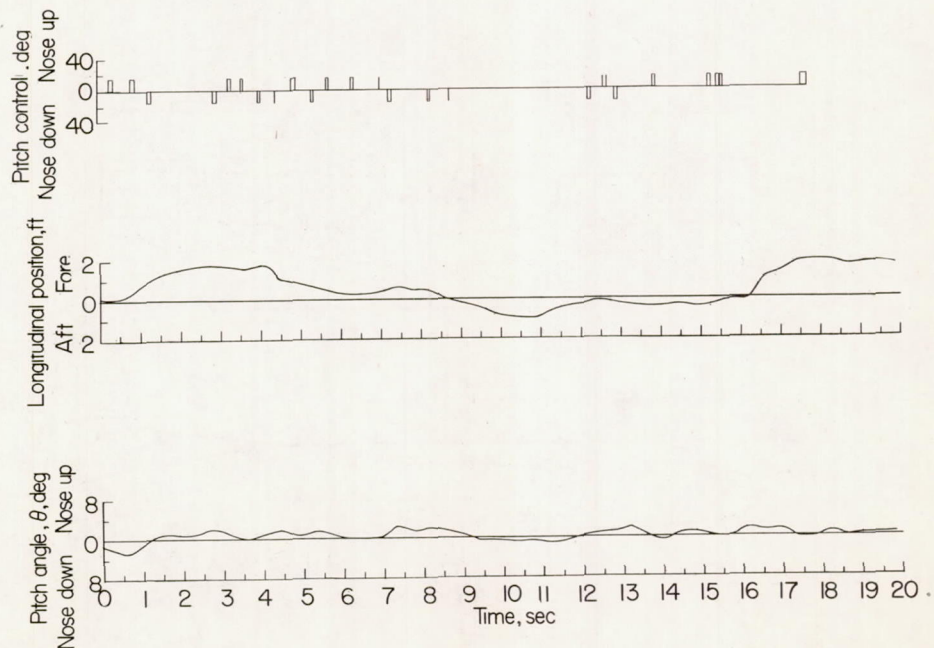

Figure 4.- Three-view sketch of the model. All dimensions are in inches.



(a) Pitching oscillations.



(b) Steady controlled flight.

Figure 5.- Pitching motions of model without pitch damper.

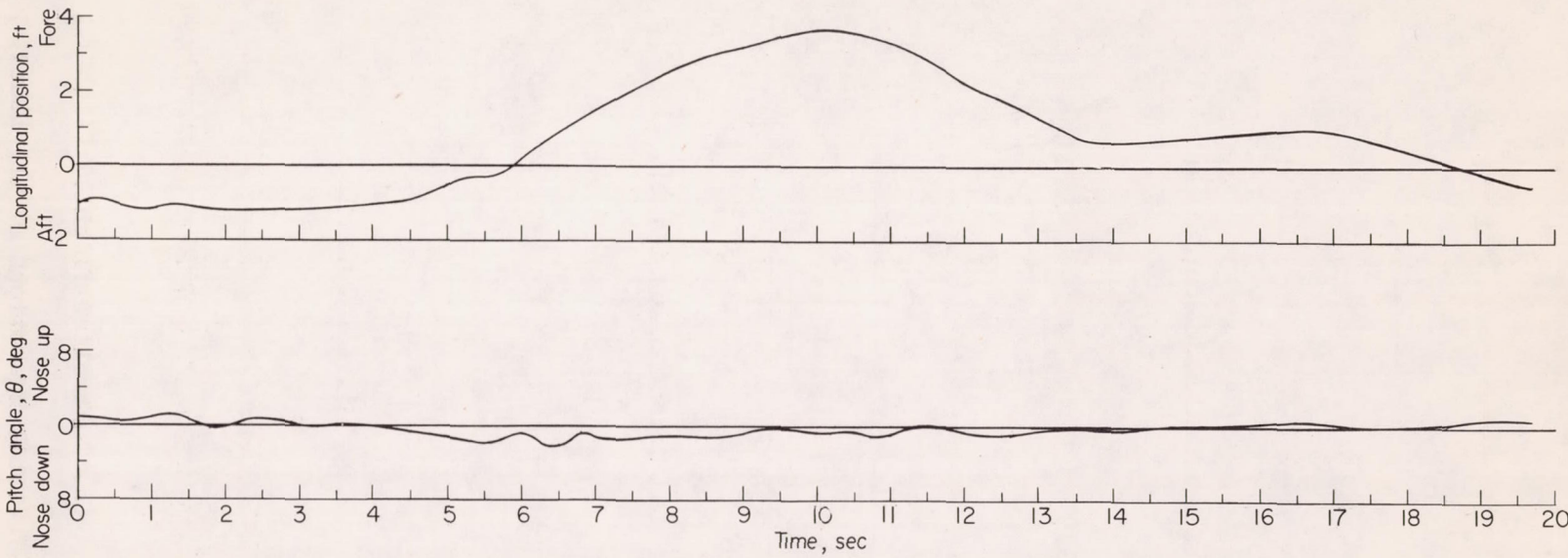
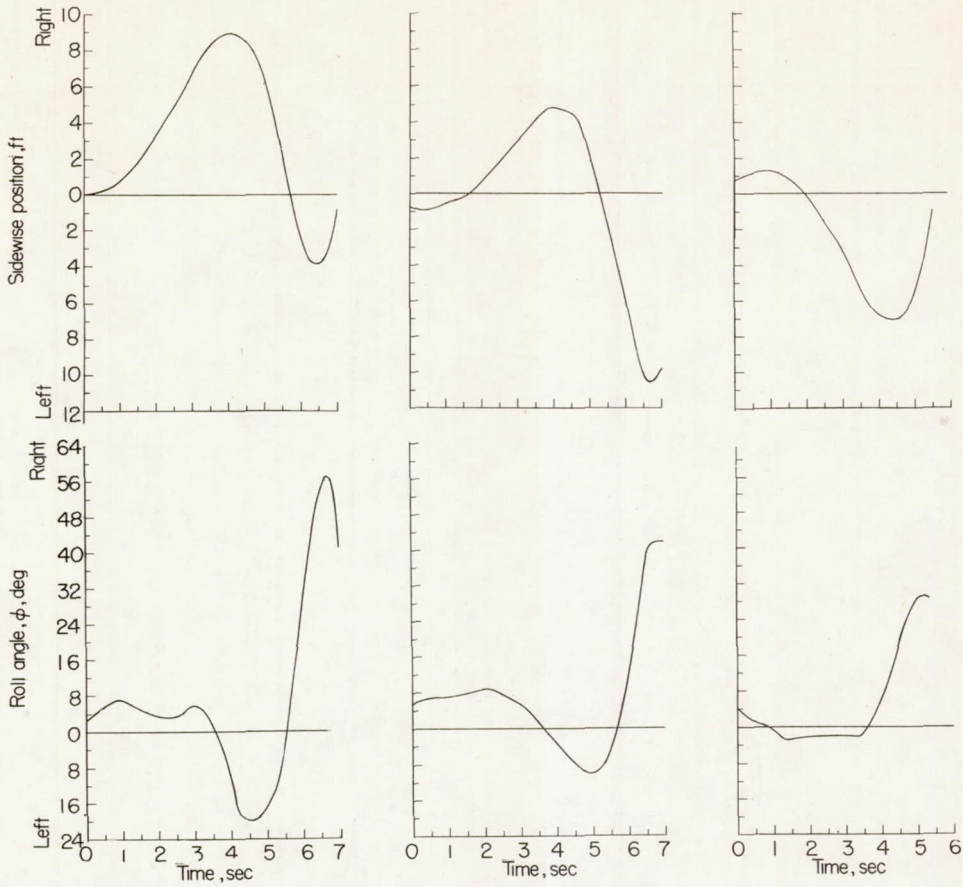
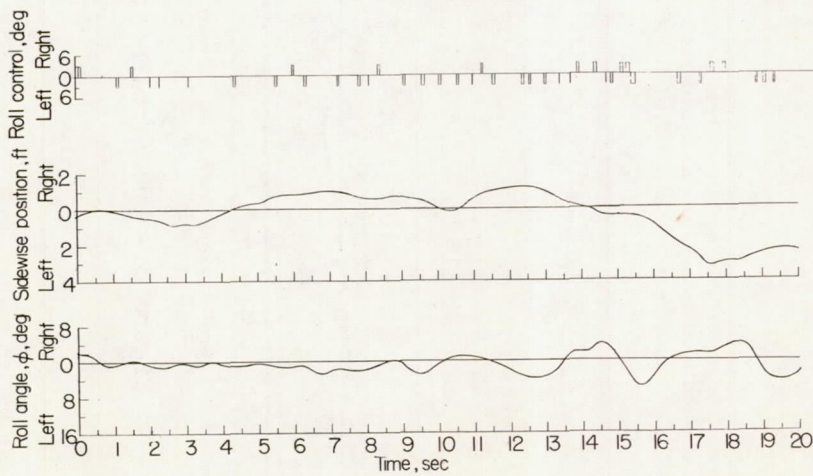

Figure 6.- Uncontrolled pitching motions of model with pitch damper.



(a) Uncontrolled flight.



(b) Controlled flight.

Figure 7.- Rolling motions of the model.

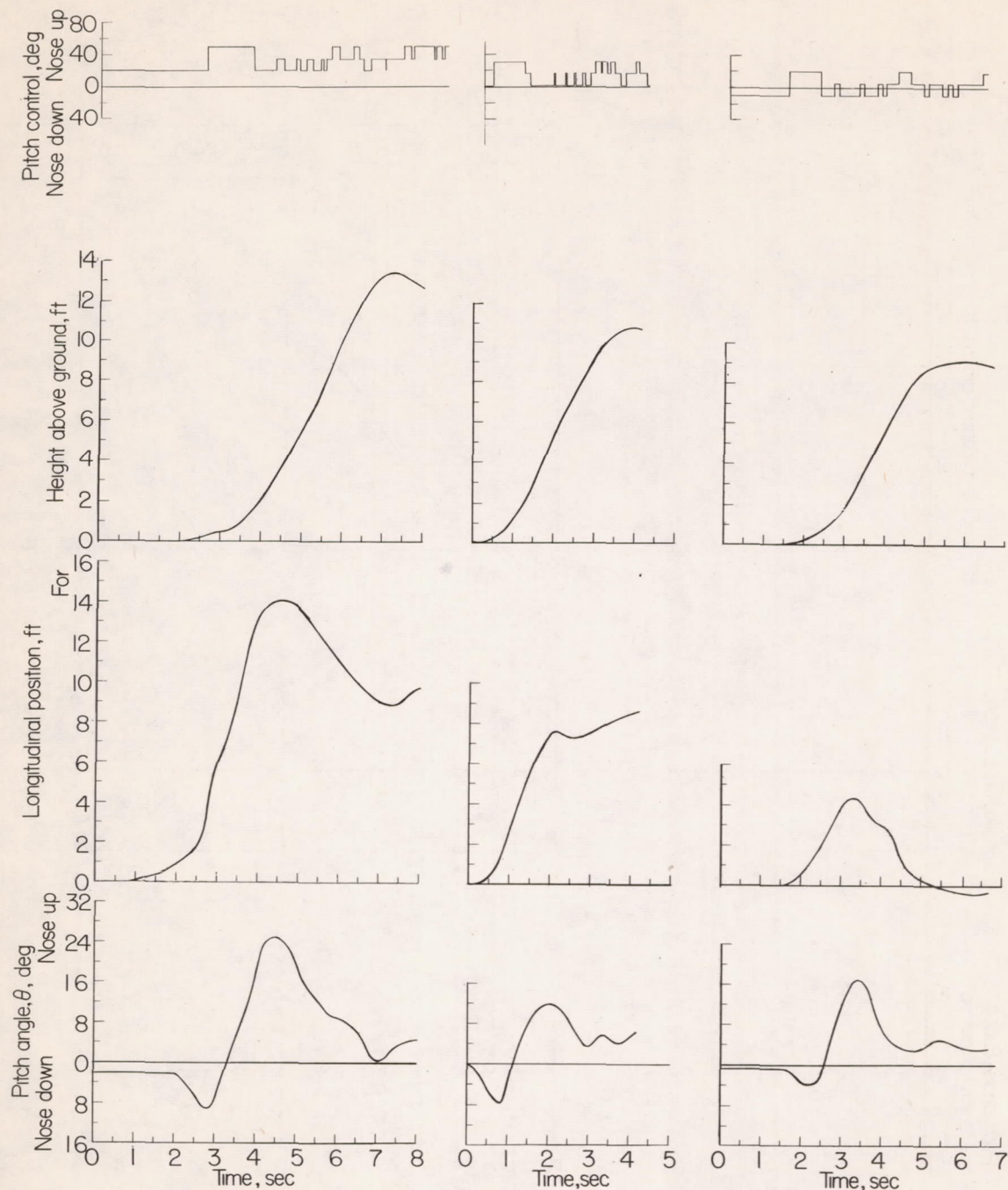

(a) Center of gravity 0.084 mean aerodynamic chord forward of wing pivot point. (b) Center of gravity 0.051 mean aerodynamic chord forward of wing pivot point. (c) Center of gravity 0.017 mean aerodynamic chord forward of wing pivot point.

Figure 8.- Time histories of take-offs for various center-of-gravity locations.

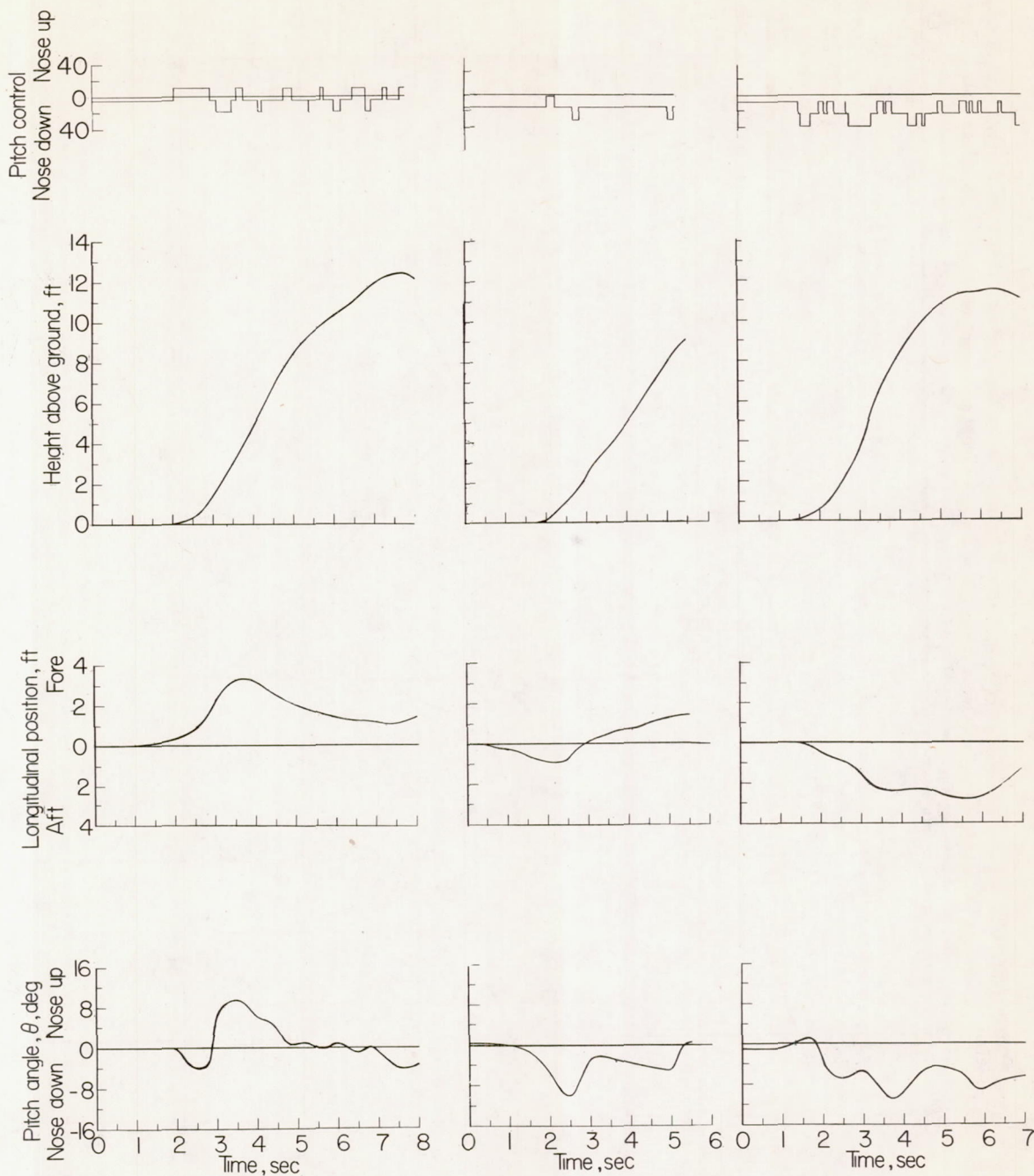

(d) Center of gravity  
0.016 mean aerodynamic chord aft of wing pivot point.

(e) Center of gravity  
0.050 mean aerodynamic chord aft of wing pivot point.

(f) Center of gravity  
0.084 mean aerodynamic chord aft of wing pivot point.

Figure 8.- Concluded.

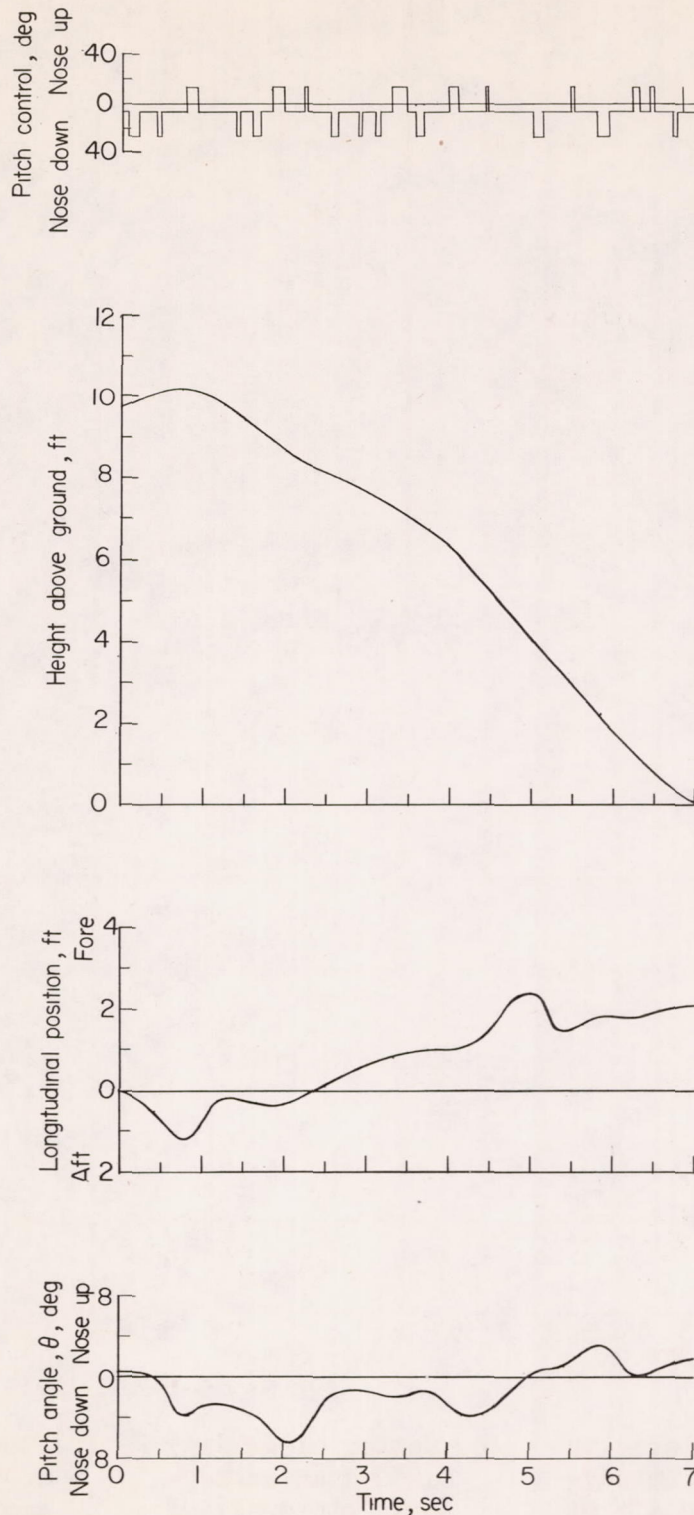

Figure 9.- Time history of a landing for normal center-of-gravity location (0.016 mean aerodynamic chord aft of wing pivot point).