

N 9 4 - 1 7 3 5 3

## Low Cost Paths to Binary Optics

February, 1993

Arthur Nelson and Lawrence Domash  
Foster-Miller, Inc.  
Waltham, MA 02154

### ABSTRACT

Application of binary optics has been limited to a few major laboratories because of the the limited availability of fabrication facilities such as e-beam machines and the lack of standardized design software. Foster-Miller has attempted to identify low cost approaches to medium-resolution binary optics using readily available computer and fabrication tools, primarily for the use of students and experimenters in optical computing. An early version of our system, MacBEEP, made use of an optimized laser film recorder from the commercial typesetting industry with 10  $\mu\text{m}$  resolution. This report is an update on our current efforts to design and build a second generation MacBEEP, which aims at 1  $\mu\text{m}$  resolution and multiple phase levels. Trials included a low cost scanning electron microscope in microlithography mode, and alternative laser inscribers or photomask generators. Our current software approach is based on Mathematica and PostScript compatibility.

### 1. Introduction: The need for more widely available binary optics

It is widely agreed in the binary optics community that in spite of many successful applications and demonstrations the technology has been slow to be utilized in industrial and scientific optics due to the requirement for highly specialized fabrication facilities unavailable outside of a few major laboratories. The microlithographic, multimask methods from the electronics industry shown to yield highest performance represent a capital investment of many millions of dollars. Until very recently, few commercial services were available to offer design and fabrication capabilities. In any case, multimask fabrication is too costly for many research budgets.

Fortunately, not every optical designer or researcher experimenting with binary optics needs state of the art submicron e-beam, multimask fabrication with optimum diffraction efficiency. In many cases, optical computing researchers, students and engineers testing new ideas would be adequately supported if they had access to moderate resolution elements, provided they could obtain them easily and quickly, at reasonable cost, and use design software they already have or can easily obtain. This approach is particularly appropriate for non-lens applications such as Dammann or interconnect gratings, Gerchberg-Saxton kinoforms, beam combiners or other elements required in optics research.

Foster-Miller designed the original MacBEEP (Macintosh-based, Binary Elements Encoding Phase) desktop manufacturing system around personal computers and a widely accessible laser film recorder from the publishing industry (Linotronic) with 10  $\mu\text{m}$  resolution and two level output processible into phase elements. PostScript compatibility assured that a wide range of existing personal computer CAD software could be

combined to design elements and create files. Although the first MacBEEP system had strict limitations of modest resolution and low diffraction efficiency, it has proven useful at its installation in the Naval Surface Warfare Center in support of optical processing research. Other users around the country have been able to apply the processing and software methods developed for MacBEEP to generate their own binary phase elements using Linotronic machines available in their local communities at printing service bureaus.

This paper is a status report on our continuing development program for a second generation MacBEEP, in which our goal is to develop methods for multiphase levels with 1  $\mu$ m resolution, incorporating designs generated from any PostScript compatible source such as Mathematica. In evaluating the best way to pursue this, we have evaluated low cost e-beam methods and are presently studying laser direct write methods.

In comparing the facility we plan with existing fabrication laboratories, it is important to understand the fundamental tradeoffs that are involved between system cost, diffractive performance, and range of applications. Our preferred approach will incorporate a 0.5-1  $\mu$ m resolution laser microlithography system originally developed for the production of microwave integrated circuits. It employs acousto-optic modulators to accurately control both the position and intensity of the laser beam for exposing photoresist. The capital cost of the exposure system as such is less than \$100K. We expect to be able to expose multilevel resist patterns (up to 8 levels) through exposure/dose control. This should yield reasonably high diffraction efficiency (95% for a simple grating) with relatively low fabrication complexity. In comparison, presently the most advanced fabrication facilities rely on electron beam machines to expose e-beam resist to an accuracy of 0.1  $\mu$ m. E-beam laboratories also require that software definitions be provided in file formats used by the microelectronics industry, such as MEBUS.

The advantages of the electron beam process will remain very high resolution (0.1  $\mu$ m or better) and superior (up to 99%) diffraction efficiency. This level of performance can probably not be matched by any laser direct write approach. By accepting somewhat reduced performance adequate for many concept demonstration purposes, our goal is to offer fabrication services for approximately \$500-1000 per element. The tradeoffs are a reduction in maximum theoretical diffraction efficiency from 99% to 95% and a projected maximum resolution in production on the order of 1.0  $\mu$ m, as opposed to the 0.1  $\mu$ m achievable with electron beam techniques. Multimask methods will remain the path of choice for highest performance applications and creation of embossing master elements. But as illustrated in Figure 1, there is an enormous gap between the performance and cost range of e-beam systems and the original MacBEEP. A capability for 1  $\mu$ m features with 4-8 phase levels in resist or glass substrates would be valuable for proving the value of many proposed designs before investing in e-beam elements. Users also emphasize the need to use readily available commercial scientific or CAD software; computations in standard computational environments such as Mathematica and graphics files in PostScript format are a highly desirable standard.

In Section 2, we briefly review the original MacBEEP program and its capabilities. This is followed in Section 3 with a report on our evaluation of a relatively low cost scanning electron microscope (SEM) in a microlithography mode to replace the less widely available e-beam machine for creating binary optic elements for optical interconnects. In Section 4, we describe our work in progress to develop MacBEEP II.

## 2. Review of MacBEEP I

MacBEEP originated when we discovered that PostScript (1), the industry standard page description computer language for desktop publishing, could be used to efficiently encode holographic patterns (2). PostScript describes patterns in a universal file format which is interpreted by each compatible output device at its own limit of resolution. Thus files representing holographic or diffractive patterns can be proofed on paper at 80  $\mu\text{m}$  resolution using PostScript-compatible office laser printers and then used to produce film output at 10  $\mu\text{m}$  resolution using PostScript-compatible laser typesetters such as the Linotronic made by Linotype-Hell AG. One of the techniques we demonstrated for PostScript, a language designed for typesetting, is the creation of a "diffractive font" in which the "characters" are a set of Fresnel zone plates, line gratings, or other patches of fringe patterns which can be tiled together by a word processor. This approach to diffractive optics could probably be accomplished from any PC, but we chose the Macintosh because it was optimized for the PostScript compatible graphics environment and allowed effortless interchange of graphics files from program to program through universal "cut and paste" operations, performing different operations as the data was passed between different graphical or scientific Macintosh programs. This meant that a suite of commercial software applications could often be combined to carry out functions which otherwise would require writing new programs. The personal computer selected was the Macintosh IIfx, supplemented by a 50 Mhz 68030 hardware accelerator board to speed up numerical processing. A frame grabbing board and CCD camera or document scanner adds image input capabilities to the host computer. Foster-Miller developed the software keystone for the system, also named "MacBEEP". MacBEEP incorporated modules from the source code of a basic image processing and frame grabbing program created at the National Institute of Health (Image 1.4) and added powerful Fourier transform and related capabilities. Most important, MacBEEP contains algorithms to optimize printing of files on PostScript printers, for which precision control of pixel placement proved important in holographic applications. MacBEEP software capabilities include computation of up to 512 X 512, 32 bit forward and inverse fast Fourier transforms in about 150 seconds; input images may be bitmaps or analytic patterns from a variety of sources. MacBEEP also has facilities for exchanging large 32 bit files with Mathematica, and offers precise software control of the Linotronic at the pixel level, particularly with regard to scaling, pixel boundaries, page placement and tiling of patterns.

Our chosen output device was the Linotronic 300 Imagesetter, a 2540 pixel per inch HeNe laser-based laser film recorder manufactured in Germany by Linotype AG; other PostScript compatible devices of similar resolution are also available. Our program included purchasing a Linotronic (cost approximately \$70K) and optimizing the internal hardware, adjusting it to expose special films and other techniques which require access to a dedicated machine. However, many of our results can be duplicated simply by outputting PostScript files to any standard service-bureau Linotronic, available in most communities for charges on the order of \$10-20 per page of film, containing up to 20,000 X 25,000 binary pixels.

### 2.1 Processing Alternatives

We investigated various alternative methods of converting binary amplitude films produced by the Linotronic to binary phase elements. The methods we tried included bleached film, contact printing to photoresist, contact printing to a photopolymer, etched glass, and 5X photoreduction. As a standard against which to evaluate the results, we had an outside vendor fabricate a submicron resolution binary phase

Dammann grating by traditional means of e-beam lithography, and used this as a reference master in optical reconstruction tests to compare the performance of various lower cost approaches.

**Bleaching.** Bleaching is the simplest technique to convert amplitude to phase and yielded our best results. While standard high contrast Linotronic graphic arts film can be bleached, we obtained better results by loading a Linotronic with the holographic film Agfa 10E75. A photomicrograph of a bleached 10E75 film exposed directly in the Linotronic is shown in Figure 6a. Figure 6b shows an optical reconstruction with the DC spot almost eliminated and indicates a successful exposure.

**Photoresist.** Photoresists, typically used as acid resists for photolithography, are also convenient media for binary optical elements formed by UV contact printing from Linotronic masks. A photomicrograph of a photoresist plate is shown in Figure 2.

**Photopolymer.** Photopolymers such as Polaroid DMP-128 are high resolution phase recording materials primarily used for holography. Modulation of the film's index of refraction results from variations in porosity which are proportional to the local light intensity during exposure; diffraction efficiency has been reported to exceed 80% (3). A Dammann grating binary amplitude mask produced on Linotronic film was the source for contact printing onto the DMP-128. Phase of exposed areas depended on the size of the area, exposure and processing variables.

**Etched glass.** Photoresist-coated glass plates which have been exposed and developed may also be further processed with an etching step. In this case, the photoresist pattern, which remains after development, serves as an acid resist. For standard glass plates, a dilute solution of aqueous hydrofluoric acid is used to etch away exposed portions of the glass to a predetermined depth. There is a tendency to introduce some optical noise due to micro-pitting and nonuniform etching. Depth of etch is process and materials sensitive, so that optimization of the phase modulation requires repeated trials.

**Photoreduction.** Photoreduction has been used as a method to produce computer holograms since the 1960's, when wall-sized plotter output was reduced in a sequence of camera steps. Multistep photoreduction introduces distortions and inhomogeneities, however. In our experiments, Linotronic films with 20 $\mu$ m features provided excellent masters for single-step photoreduction. In our trials, an outside vendor used a step-and-repeat system to produce 5X reductions of Linotronic film output providing nominal 4  $\mu$ m features with better than 0.8  $\mu$ m resolution at a cost of approximately \$250 per sample. The standard mask used as a source for electronics industry photoreduction is chromium on a glass plate but we found that a typical photoreduction apparatus can also accommodate the film transparency masks produced on the Linotronic 300. Restrictions on distortion and depth of field of the lenses used necessitate that the input aperture for the photoreducer be small; in our case 12 mm X 12 mm, yielding 2.4 mm X 2.4 mm after reduction or 600 X 600 pixels. Larger fields are routinely reduced by precision step and repeat. In our tests, photoresist-coated chrome-on-glass plates were exposed in the photoreduction output plane, and the plates were developed and etched to generate a finished chrome pattern on the glass to make a high resolution binary amplitude object.

In summary, bleaching of holographic film loaded and exposed directly in the Linotronic yields satisfactory binary phase objects at 10  $\mu$ m resolution provided the researcher has direct access to the Linotronic; otherwise, an extra step of contact printing may be used. To achieve 2-4  $\mu$ m features defined with submicron resolution,

Linotronic films are excellent masters for photoreduction through standard services available at moderate prices in the microelectronics industry.

## 2.2 Applications

MacBEEP outputs have been shown to be suitable for many different applications. As examples, we demonstrated zone plates, Fourier plane filters, Dammann gratings, detour phase holograms, line gratings, 3D holograms, and various binary elements incorporating random phase, error diffusion, or band pass filtering.

Binary phase Dammann gratings may be designed to produce holographic reconstructions consisting of 2D arrays of equal intensity focussed laser spots or beamlets, and are of interest for optical interconnects, laser beam combining, and photoreproduction. One half period of a Dammann grating is typically described by a "basic cell," which is rotated and translated to build up a complete grating (Figure 3). In our studies, we created the basic cells in Mathematica and imported the patterns to MacBEEP, where rotations and translations of the basic cells could be easily accomplished.

The quality of a Dammann grating may be conveniently quantified since a perfect binary phase sample yields equal intensity among all the reconstructed beamlets and no extra DC spot. Thus they provide a good standard test to compare the performance versus cost for different processing alternatives. Several processing methods were applied to the pattern of Figure 4, designed to produce a 9 X 9 array of equal intensity beamlets assuming a  $\pi$  binary phase step. The optical reconstructions were generated with a 35 cm Fourier transform lens and digitally imaged by a CCD camera.

The simplest process yields binary amplitude film; the Dammann grating was printed on Linotronic standard film at 10  $\mu\text{m}$  per pixel (ie, one printer pixel for each grating pixel). A 100X photomicrograph of the film is shown in Figure 5a. Since this sample was binary in amplitude, the reconstruction (Figure 5b) displays a large DC spot at the center, but the other beamlets show approximately equal intensities (Figure 5c). If the DC spot may be ignored, this binary amplitude element might be useful for many purposes; the materials cost to produce such a film would be less than \$20 at a typical laser typesetting service bureau.

To make a binary phase version, we produced the sample of Figure 6a by the bleaching of Agfa 10E75 exposed directly in the Linotronic, as described earlier. The optical reconstruction and densitometry traces show excellent equality of intensity peaks (Figures 6b,c). Materials cost for this approach is on the order of \$50 per sample, but the cooperation of the Linotronic operator or service is required. In the absence of such cooperation, an additional step of contact printing the Linotronic film onto 10E75 would be necessary using a parallel exposer.

A reference master Dammann grating was produced for comparison purposes by an outside vendor according to our specifications based on a mathematical definition. The pattern and features were identical to those produced on Linotronic film in our laboratory, but the vendor used e-beam exposure and plasma-etching to produce a glass element with 0.5  $\mu\text{m}$  resolution and a highly uniform phase step, at a cost of \$3000 and a turnaround time of two months. The pattern edges of this sample are much sharper than those of the Linotronic films. For many experimental purposes however, the MacBEEP film based elements were remarkably competitive in performance at about 1/300 the cost.

### 2.3 Detour-phase Filters for Optical Correlators.

Development of the MacBeep system included the creation of several custom Mathematica-language routines (known as "packages"). One of these packages calculates the Brown-Lohmann detour-phase encoding for a complex-valued array (4). Mathematica was used in conjunction with MacBeep to calculate the detour phase hologram of a sample pattern consisting of a 3 x 3 matrix of apertures, of which the central aperture was 50% transmissive, as shown in Figure 7. An enlarged view of the resulting detour phase hologram is shown in Figure 8. This hologram consists of 64 X 64 detour-phase cells, each cell containing 16 X 16 pixels, for a total of 1024 X 1024 physical pixels. Phase and amplitude of the Fourier transform of the original image are each quantized in 8 levels. The detour phase hologram was produced on Linotronic binary amplitude transparency film at 20 microns per pixel. The Fourier optical reconstruction is shown in Figure 9. For comparison with the detour phase encoding, a 512 X 512 binary Fourier filter computed simply as the binarized real part of the FFT was computed from the original pattern (Figure 10) and produced as a binary amplitude film, also with 20  $\mu$ m pixels; the reconstruction from this reference filter is shown in Figure 11.

Finally, the detour phase encoded filter was photoreduced 5X by an outside vendor as a chrome-on-glass element with an effective mapping of 4 X 4  $\mu$ m for each of the original 1024 X 1024 hologram pixels; a 100X photomicrograph of the photoreduction is shown in Figure 12. The improvement in reconstruction quality due to the photoreduction step is evident in Figure 13, where the 50% gray of the central cell is accurately reproduced. Here again, the use of MacBEEP to create masks for photoreduction yielded excellent results. Figure 14 shows a test of the optical performance of the photoreduced detour phase hologram used in the filter plane of a 4f optical correlator constructed using 35 cm focal length Fourier lenses.

### 2.5 Summary of MacBEEP I

The Linotronic is the highest resolution output device which is available virtually everywhere. The MacBEEP system was successful within its narrow goal, to explore the optimum use of such equipment. Good quality bleached phase elements can be obtained if access to a dedicated unit permits loading the Linotronic with holographic film. Film outputs also make excellent masks for photoreduction. The system may be used to produce useful binary optics for a variety of experimental, developmental and proof-of-concept applications. However, an order of magnitude improvement in feature size is needed to greatly expand the range of applications.

### 3. Low Cost E-beam Lithography Using a Scanning Electron Microscope

The next phase of our program aimed at increasing the resolution while maintaining the low cost philosophy. One major effort was to evaluate a low cost alternative to e-beam methods.

Very high resolution binary optic elements are generally produced using traditional microelectronics electron beam systems (e-beams). We evaluated the possibility that a scanning electron microscope (SEM) can be used in a microlithography mode as a replacement for the much less common and more expensive e-beam machines. Precision control of the electron beam in the SEM offers extremely high resolution (0.05  $\mu$ m), higher than that usually obtained with microelectronics e-beam systems. The e-beam system employs a larger current and therefore has faster writing speed, but this is not a significant advantage for fabricating prototype or small numbers of diffractive elements.

SEMs typically cost less than 1/10 as much as e-beam systems and are much more widely available to the scientific community.

To test the suitability of the SEM for this application, we fabricated and tested several 7x7 Dammann gratings. The original procedure for fabricating the Dammann grating is illustrated in Figure 15. Starting with a flat SiO<sub>2</sub> substrate, an AlF<sub>3</sub> coating is evaporated on the glass with a thickness chosen to yield a precise  $\pi$  phase step for light passing through the AlF<sub>3</sub> relative to air. Following the coating with AlF<sub>3</sub>, the substrate is spin coated with e-beam resist, and the Dammann pattern is written in the resist with an SEM. The resist is then developed, and the Dammann pattern is then fabricated in the AlF<sub>3</sub> using appropriate etchants.

The SEM can expose a 1 mm<sup>2</sup> area with little geometric distortion, but beyond those dimensions, rounding of rectangles may occur due to the excessive deflection of the electron beam. With the SEM the substrate is not translated under the electron beam. Larger areas may possibly be fabricated in the future with the addition of corrections in the software to compensate for the beam deflection. Estimating that a minimum of 10 grating cycles were necessary, we specified a 10 x 10 cell pattern to be written in 1 mm<sup>2</sup>. Thus each cell was about 100 microns wide, and individual rectangles in a cell were as small as 5  $\mu$ m. The software and electronics interface to drive the SEM from a PC was developed by J.C. Nability Lithography (Bozeman, MT) and sent to the University of Oregon for use on their SEM.

Several samples were exposed at the University of Oregon using PMMA on the fused silica directly. Figure 16 shows a photograph at 400X. The pattern appears to have excellent definition at this magnification and the diffraction pattern indicates excellent construction and edge resolution. Subsequent measurements were made on the e-beam resist pattern, as opposed to the pattern etched in the substrate or AlF<sub>3</sub>. Figure 17 is a printed copy of the image as captured on the computer by the CCD camera using the HeNe laser. The image is further analyzed quantitatively in Figure 18, where intensity traces have been taken for several "lines" of the grating pattern. Additional diffracted orders at reduced intensity are, of course, also visible beyond the original 7x7 array. In order to suppress these additional orders, multistep grating levels are required. The bright central spot due to the undiffracted beam results from poor control of the phase depth, and this processing step still requires improvement.

### 3.1 Summary of SEM approach

Demonstration that the SEM can be used in a very high resolution microlithography mode was successful, although considerable effort would be necessary to optimize the process. The PC driving arrangement permits controlling the SEM beam to render virtually any pattern which can be designed in standard CAD software. However, the system is not designed to write a field larger than about 1 mm on a side. Within the program goals of reduced costs, the SEM is of limited value because the costs of the remainder of the processing cycle were not affected and in some respects may be increased. Low cost electron beam recording as such does not help with multimask fabrication to achieve high diffraction efficiency through multiple phase levels. Because the beam current is low, direct write e-beam methods such as those recently reported by UCSD (5) would be more difficult using the SEM. We concluded that overall the SEM was not the best alternative for low cost binary optics.

#### 4. Laser Direct Write and Current Plan for MacBEEP II

Our current program for extension of MacBEEP performance has two major thrusts: improvement in resolution from the 10  $\mu\text{m}$  range to 1.0  $\mu\text{m}$  and fabrication of 4-8 phase levels. Our discussions with users indicate that a facility offering 1  $\mu\text{m}$  resolution with eight phase levels (95% diffraction efficiency) would meet many needs.

Based on a total assessment of performance goals, user needs, equipment costs and processing alternatives, the plan we are currently pursuing employs a laser microlithography system to write multilevel patterns directly in photoresist with a single pass exposure at approximately 1  $\mu\text{m}$  resolution. The laser system employs acousto-optic modulators for intensity control and positioning of the laser beam over 0.1 mm dimensions. Laser interferometric control of air-bearing mechanical stages are used to translate the substrate over larger dimensions. The local acousto-optic writing ability yields faster writing speed (100 mm/s) compared with mechanical translation alone. A block diagram of a laser system with 1  $\mu\text{m}$  resolution available from Newport Electro-optic Systems is shown in Figure 19.

Capability to fabricate multilevel diffractive elements is key requirement for the MacBEEP II system. Simple two-level phase gratings offer only 41% diffraction efficiency, while four levels increases the 81%, and eight levels to 95%. In the direct write approach, a variable intensity laser beam exposes a multilevel resist pattern directly, and the subsequent pattern is anisotropically etched using ion milling or reactive ion etching into the substrate (Figure 20).

Previous reported efforts (6,7) have shown the ability to perform direct multilevel writing with photoresist, although primarily with slower mechanical systems. Figure 21 shows the dependence of photoresist relief depth with energy from reference (6). Using an optical energy bias (pre-exposure) on the resist, it is possible to have nearly linear etch depth with optical exposure energy. However, the difference in etch rates between the resist and the substrate will likely require adjustments in the linearity of the resist step structure to obtain a linear stepped pattern in the substrate.

#### 5. Software compatibility

Constructing a fabrication facility for diffractive optics is not sufficient to guarantee easy access to outside users. The biggest barrier to effective use of the system continues to be the myriad of incompatible software systems and specialized file formats being used by researchers to design and specify diffractive optics. To date, there exists no accepted standard software environment in which to design and specify diffractive masks for a wide range of applications. Also, there is no standard file interface to carry the design into a driver for the inscribing engine. A distinction must be made between lens designs, as for example generated by Code V and other programs which are beginning to incorporate diffractive capabilities, and non-lens applications. Our approach is biased towards non-lens uses.

In addition to input universality in terms of design, there must be provision for output universality as well, to interface with a laser writing engine. This means that the patterns defined by the CAD or scientific design software must be prepared into files which are set up to drive the desired mask fabricating engine via the electronics which move the laser beams (via acousto-optic cells) and computer controlled stage. It also implies capabilities for manipulation of the output as graphics. This requirement is similar to the need faced by the desktop publishing industry which led to the definition of PostScript, which has since become a standard of computer graphics hardcopy; in



fact we believe that PostScript is probably also a viable format to describe laser recorded holograms.

## 5.1 Mathematica as a Software Standard

While there is no universal and complete solution for this problem, we believe that standardizing on Mathematica as a software environment goes some distance to the goal.

Mathematica, a complete environment for computation offered by Wolfram Research Corp. is rapidly being accepted worldwide as a standard environment for all sorts of scientific computation and graphics. It incorporates capabilities (compiler, 2D FFT, statistics) which could only be duplicated in a special diffractive optics application at the cost of many many years of work, runs on almost every computer platform in common use by scientists (PC, Mac, Unix workstations, VAX, supercomputers) and is constantly being upgraded and expanded. Mathematica has recently been extended specifically to make the import and export of code and files from other applications more manageable. Also, the computational kernel can be operated remotely on a networked supercomputer without any change in software to accelerate computationally intensive problems, such as optimization routines or iterative diffractive optics algorithms (for example, simulated annealing). Several of the potential users who contacted us specifically mentioned that computations of phase profiles had been carried out in Mathematica. Also, Mathematica has flexible capabilities for graphical output centered around the PostScript file format.

Figure 22 shows an example of PostScript graphics created in Mathematica. If it were possible to send this for "printing" not just to an office laser printer or publishing system, but rather to our laser incirbing engine with micrometer resolution and multiple phase levels in each pixel, a very large variety of diffractive optical concepts could be produced quickly and with low cost.

To demonstrate this and accomplish the first practical examples, we plan to develop a body of Mathematica routines and "packages" (a term for modules of related routines) to implement a full system of desktop diffractive optics. These Mathematica templates can then be distributed to outside users as vehicles for their designs. Resulting PostScript files for fabrication would then be sent or downloaded to the Foster-Miller laboratory to produce physical realizations.

Mathematical Version 2, recently released by Wolfram, has new features which make it sufficiently mature to become an environment for diffractive optics. These include a 2D FFT command, and a compiler to speed execution of programs. Another key feature is that the kernel performing basic computation is separate from the user interface front end, which differs from computer platform to platform. This means not only that different computer systems can easily share development efforts, but also that the kernel can, for example, run on a remote Cray over a network from a front end on a desktop PC. Thus local development by a graduate student in a home office is no barrier to very high speed execution over a supercomputer network.

Wolfram Research Corp. has recently released a communications standard called Mathlink, along with supporting software which promises to interconnect a wide variety of software languages with Mathematica. MathLink provides the format and software for the translation of functions, strings, symbols, messages and real, complex and integer numbers between external programs and Mathematica. This gives the tools to integrate other software with Mathematica operationally without rewriting code.

## 5.2 PostScript Language

In the past, file formats of diffractive optical patterns have often been cast into MEBUS or other forms suitable for driving microelectronics e-beam machines. However, e-beam software formats are by nature very poorly adapted to diffractive patterns; for example, their primitive graphic shapes are restricted to rectangles. Our early MacBEEP research showed that PostScript, although also not designed for scientific optics, was in fact much better adapted because the graphical primitives were Bezier curves with natural similarities to fringe patterns. Figure 22 showed a PostScript graphic created in Mathematica which, if converted to a physical representation at a micrometer fabrication scale so that gray scale mapped to phase, could be used directly as a diffractive element. All graphics generated by Mathematica are automatically encoded in PostScript format. Our existing MacBEEP software incorporates a number of optimizations relating PostScript to diffractive optics design. Tiling, scaling, distortion, pixel mapping and precision page placement are all functions which are conveniently defined within PostScript and are therefore accessible within Mathematica as well as within MacBEEP. Pixel mapping refers to the exact number of output device pixels which are to be used to represent an original pattern pixel.

A full PostScript driver for the laser inscription system will ultimately be required. This would permit any PostScript file to be output on the system automatically, including not only diffractive optics but other graphical files or even word processing documents, if desired. This requires an integration of the electronic control interface for the laser writer and stage control engines, and the design of a Mac compatible hardware board which incorporates the driver including a PostScript interpreter

## 6. Summary and Conclusions

Foster-Miller's binary optics program has different goals than most other laboratories. Our development of a relatively low cost, easy-to-access system is complementary rather than competitive with traditional multimask e-beam facilities. Whereas the e-beam approach is not likely to be replaced for state of the art diffractive performance, there appears to be a need for an alternative, lower resolution method which can provide rapid turn around and ease of use for a broader community of users. Ultimately, our goal is to offer a process for designing and making diffractive elements which is as easy to access as a publishing service bureau.

## 7. Acknowledgements

The work reported here was supported by the U.S. Navy SBIR program, managed through the Naval Surface Weapons Center, and by the US Army SBIR program, managed by the Center for Night Vision and Electro-Optics. We wish to express our appreciation for the encouragement and guidance of Nick Cavaris, Scott Spence, and Robert Spande.

## 8. References

1. PostScript is a product of Adobe Systems, Inc.
2. L. Domash and P. Levin, Computer Holographic Elements Using PostScript Laser Printers, Topical Meeting on Optical Computing, Technical Digest Vol 9, Optical Society of America, Salt Lake City, 1989. Also: P. Levin and L. Domash,

MacBEEP: A Desktop System for Binary Optics, Proc. First Topical Mtg. Diffractive Optics, OSA, New Orleans, April, 1992.

3. R. Ingwall and M. Troll, Mechanism of hologram formation in DMP-128 Photopolymer, Opt. Eng. 28, p586, 1989.
4. Brown and Lohmann, Applied Optics, v.5, p. 967, (1966).
5. Urquhart, Stein and Lee, Computer generated holograms fabricated by direct write of positive e-beam resist, Opt. Lett. 18, p.308, 1993.
6. Andersson, Ekberg, Hard, Jacobsson, Larsson and Nilsson, Simple photomask multilevel kinoforms in quartz and photoresist: manufacture and evaluation, Appl. Opt. 29, p.4259, 1990.
7. Gale, Lang, Raynor, Schutz and Prongue, Fabrication of kinoform structures for optical computing, Appl. Opt. 31, p.5712, 1992.

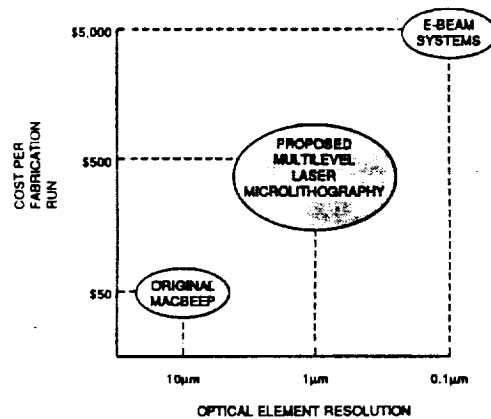

Fig 1. Comparative cost of several methods of diffractive optics fabrication.

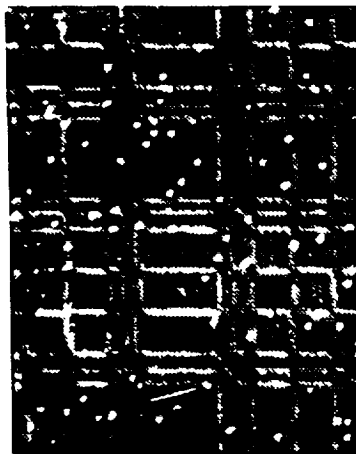

Fig 2. MacBEEP film transparency contact printed onto photoresist. (100X photomicrograph of Damman grating.)

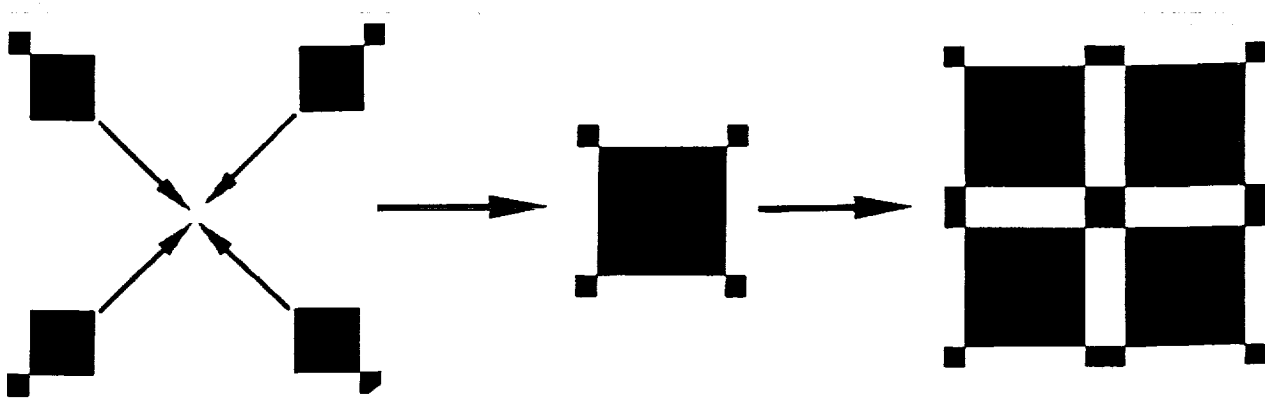

Fig 3. A Dammann grating is composed of basic cells.

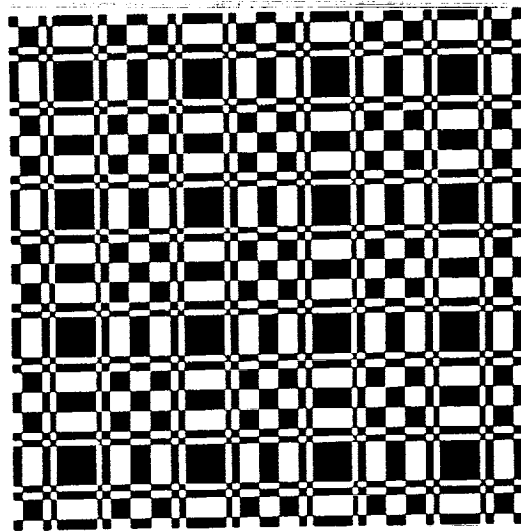

Fig 4. Binary Dammann grating pattern computed in Mathematica and MacBEEP.

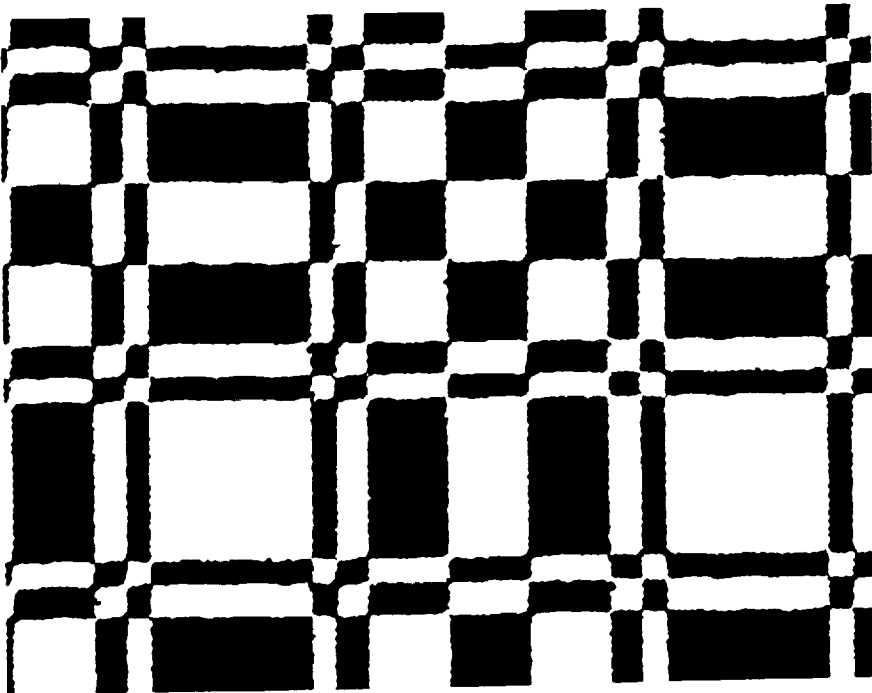

Fig 5(a). 100X photomicrograph of binary amplitude Linotronic film output: no further processing.

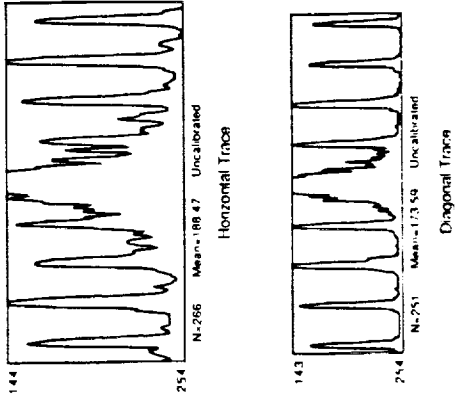

Fig 5(c).

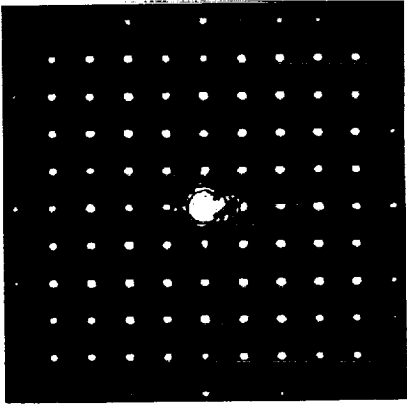

Fig 5(b). Optical reconstruction. DC spot is characteristic of binary amplitude grating. Materials cost <\$10.

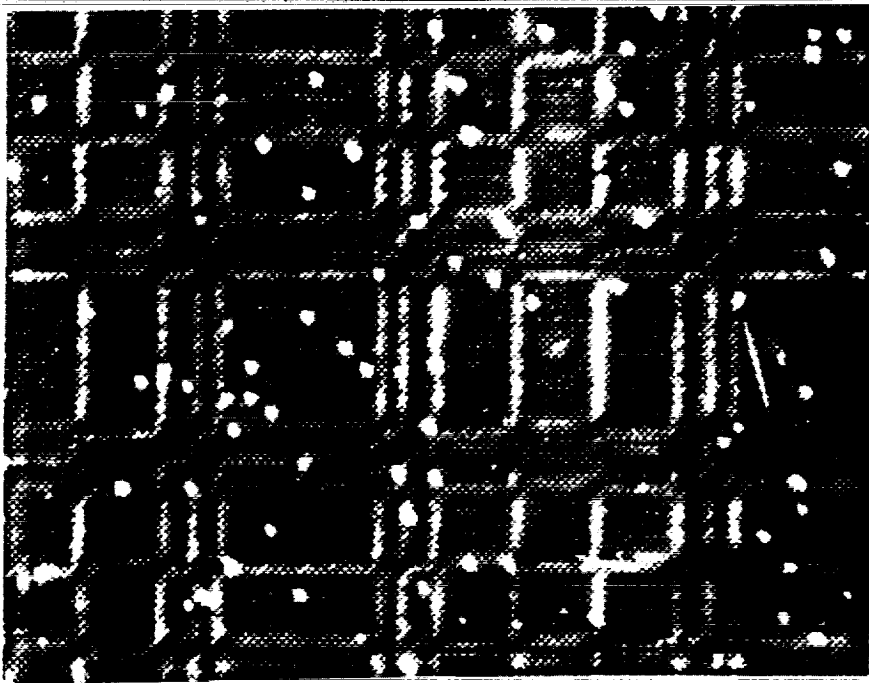

Fig 6(a) 100X photomicrograph of binary phase element produced by bleaching Linotronic film output.

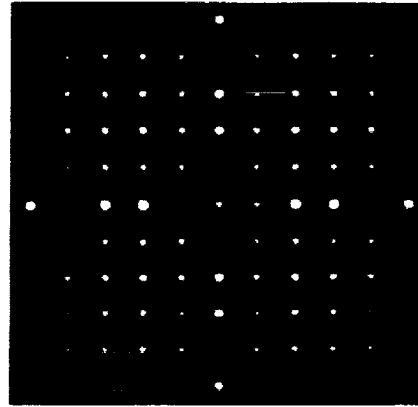
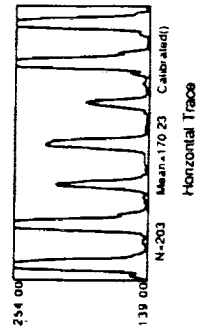
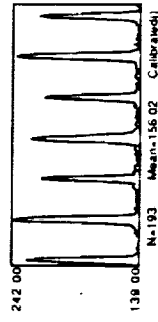

Fig 6(b). Optical reconstruction: Material cost <\$150.



Horizontal Trace



Diagonal Trace

Fig 6(c)

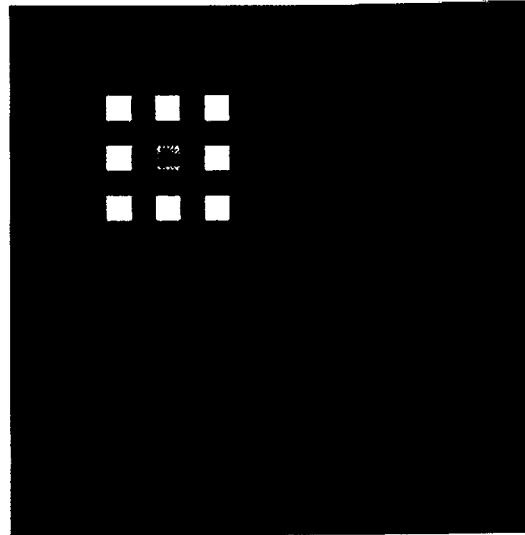

Fig 7. 3x3 matrix of apertures.

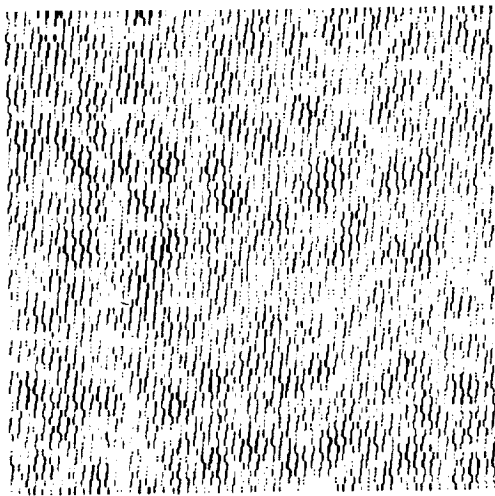

Fig 8. Detour-phase encoding using a combination of MacBEEP and Mathematica.

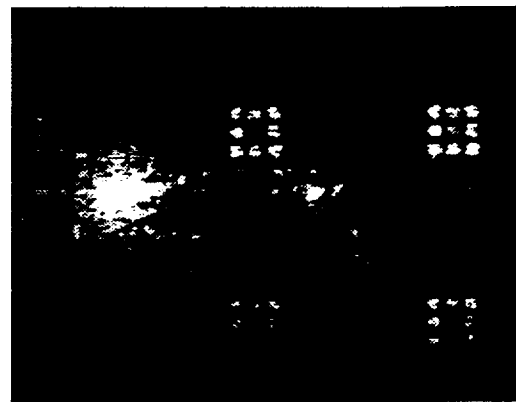

Fig 9. Optical reconstruction from the detour phase encoding.

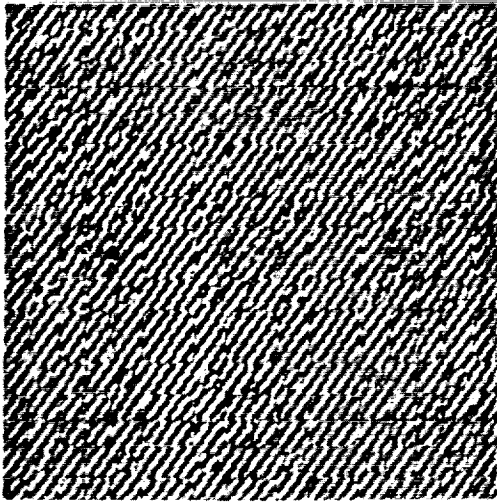

Fig. 10. Binarized  $\text{Re}(\text{FFT})$  (512x512) using MacBEEP.

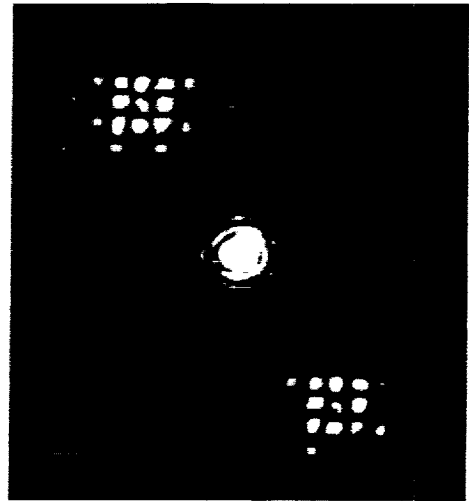

Fig. 11. Optical reconstruction from the binarized  $\text{Re}(\text{FFT})$ .

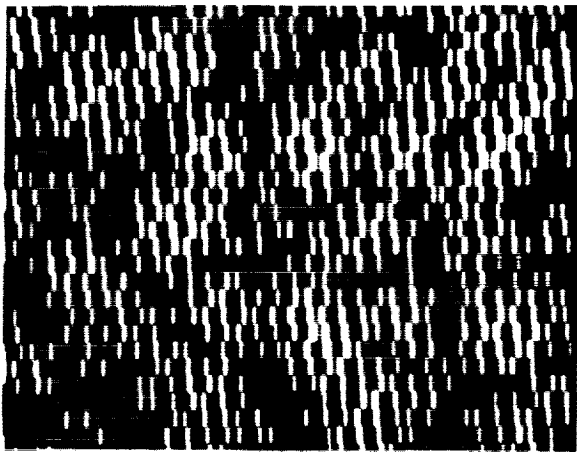

Fig. 12. Photomicrograph of higher quality element achieved by 5x photoreduction of Linotronic film output.

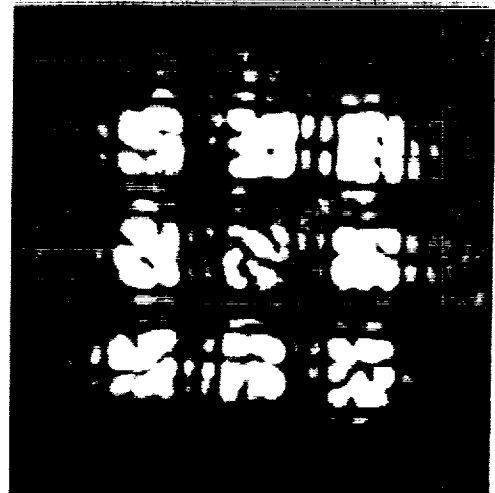

Fig. 13. Optical reconstruction from the photoreduced detour-phase filter.



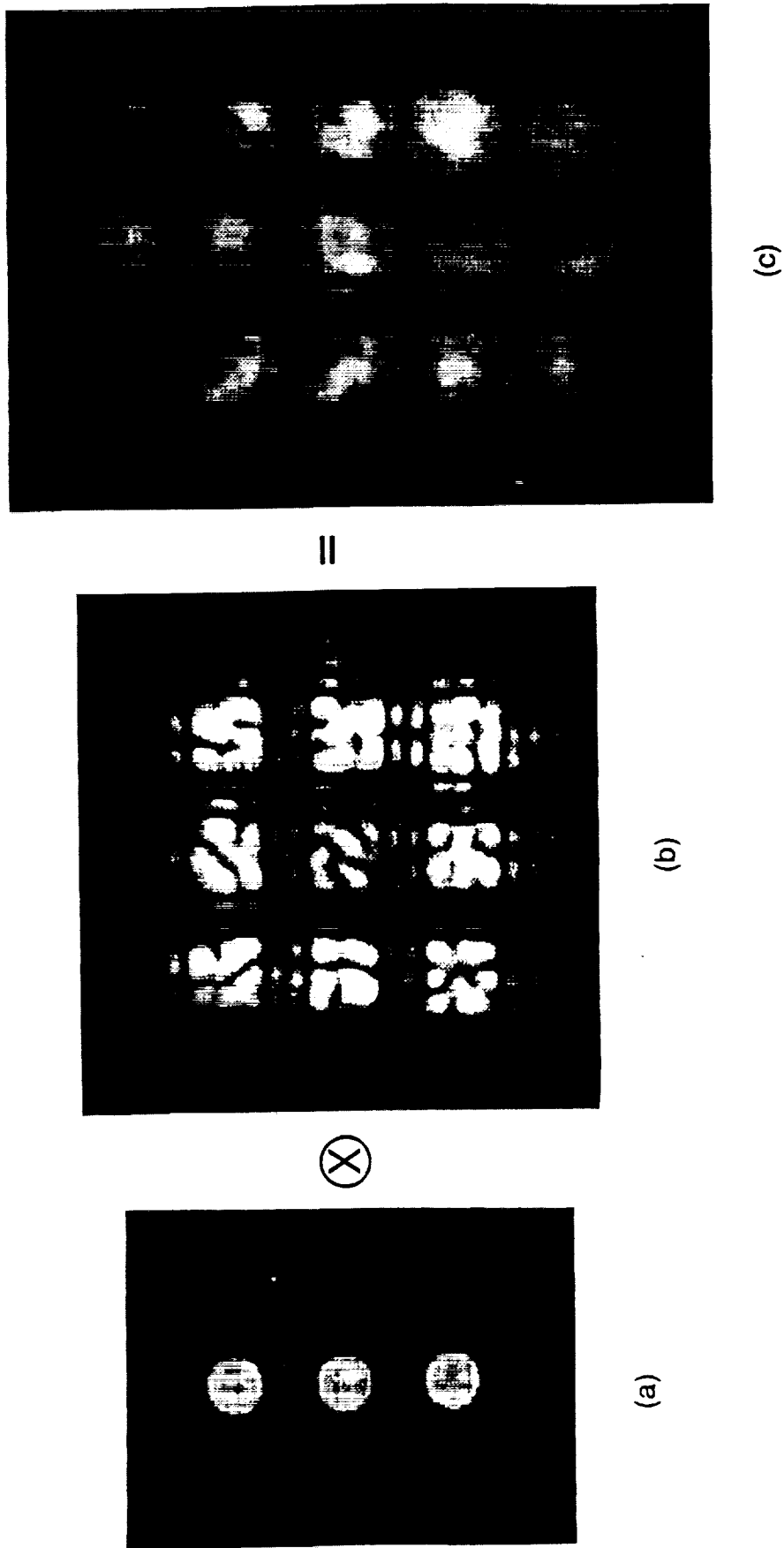

Fig. 14. Correlation of input pattern with photoreduced detour phase filter. (a) input pattern, (b) optical reconstruction from the photoreduced detour-phase filter, (c) CCD image of the correlation plane.

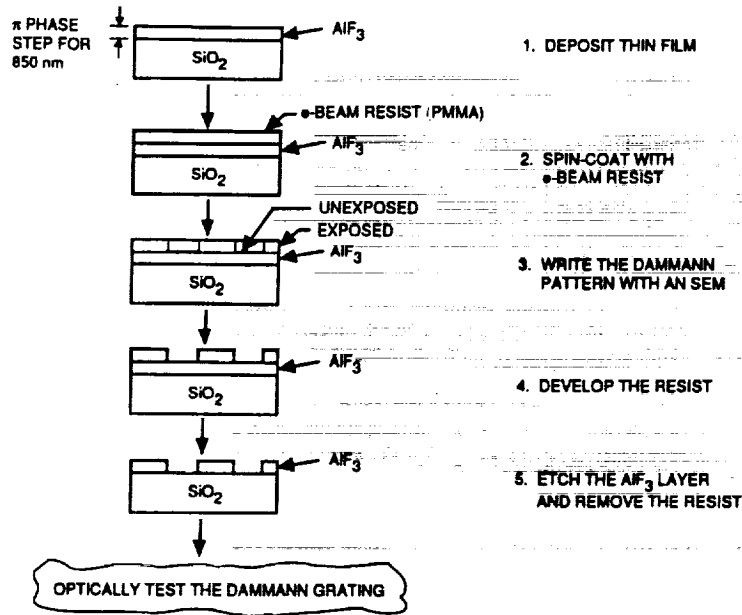

Fig. 15. Fabrication of Dammann grating using SEM.

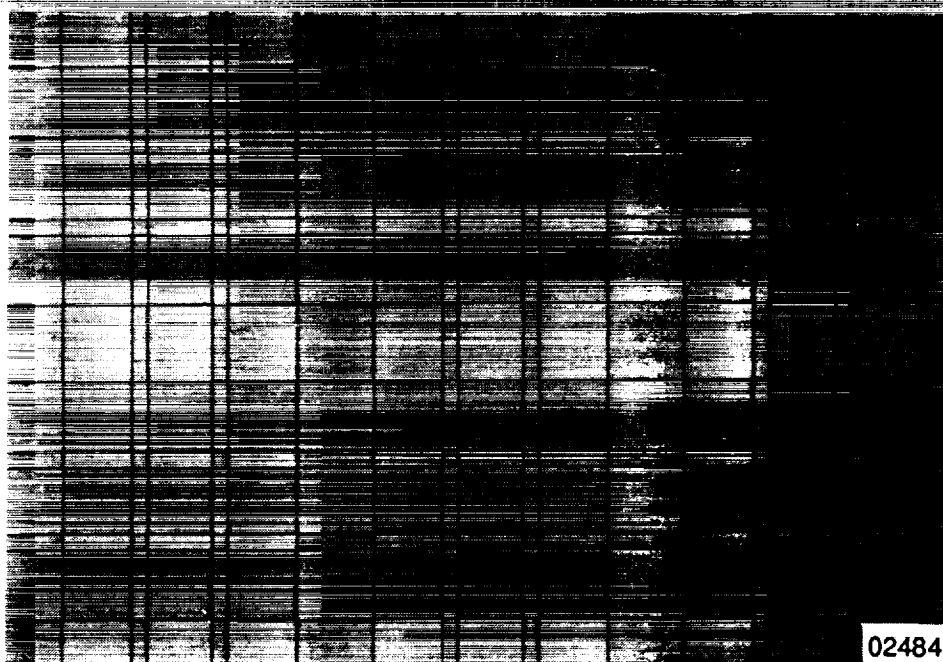

Fig. 16. 200X photomicrograph of SEM-exposed Dammann grating.

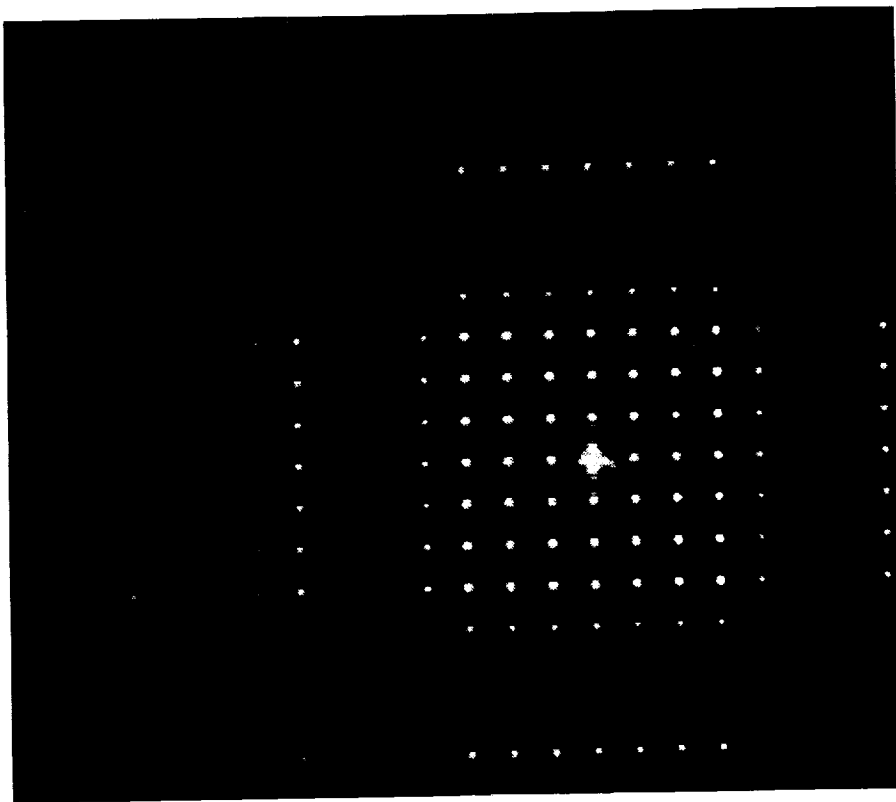

Fig. 17. Optical reconstruction from the SEM fabricated Dammann grating.

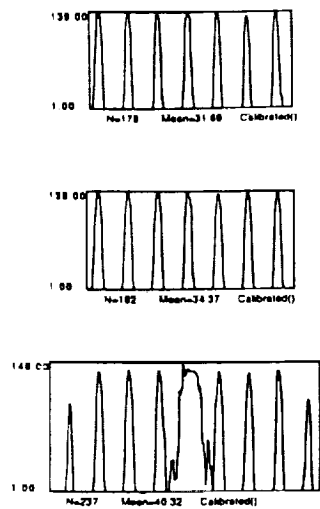

Fig. 18. Optical intensity traces from Figure 17.

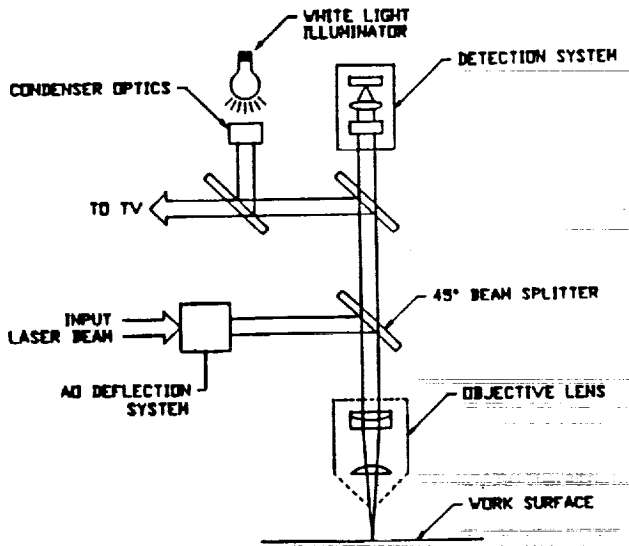

Fig. 19. Direct write laser microlithography from NEOS Corporation.

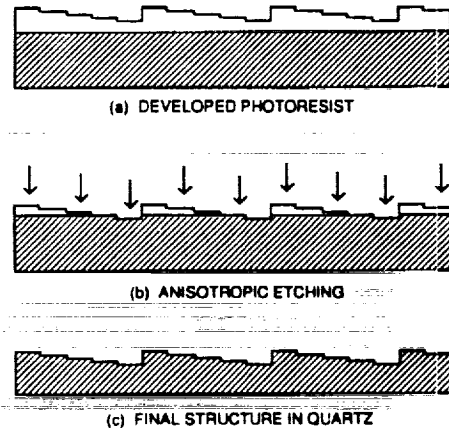

Fig. 20. Etching photoresist pattern in substrate.

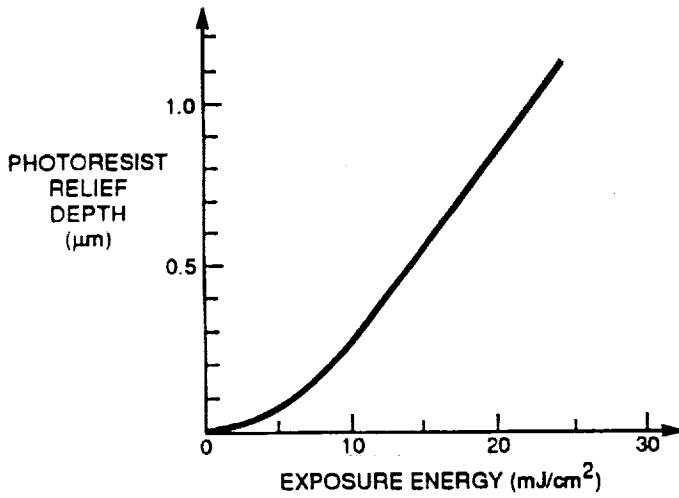

Fig. 21. Photoresist relief depth versus exposure energy from reference 6.

Op[2] = Show[... Mesh -> False]

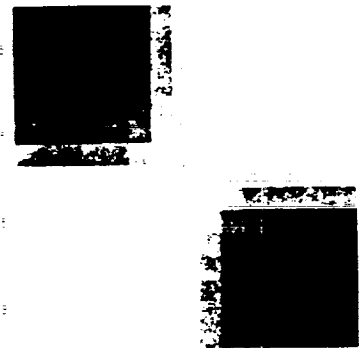

Fig. 22. Example of PostScript graphics created in Mathematica.