

N 9 4 - 2 2 8 2 5

Study on Networking Issues of Medium Earth Orbit Satellite Communications Systems

Noriyuki Araki, Hideyuki Shinonaga and Yasuhiko Ito
KDD R&D Laboratories
Ohara 2-1-15, Kamifukuoka, Saitama
356 Japan

Telephone : +81-492-66-7857

Facsimile : +81-492-66-7524

ABSTRACT

Two networking issues of communications systems with medium earth orbit (MEO) satellites, i.e. network architectures, and location determination and registration methods for handheld terminals, are investigated in this paper. For network architecture, five candidate architectures are considered and evaluated in terms of signaling traffic. For location determination and registration, two methods are discussed and evaluated.

INTRODUCTION

With the potential demand for global personal communications using handheld terminals, satellite communications systems using low earth orbit (LEO) and MEO satellites, namely, the LEO systems and the MEO systems, have attracted much attention. These systems provide advantageous features in terms of propagation delay and loss. Mobility management of handheld terminals in these systems, however, becomes complex, since the satellites are moving relative to fixed terminals on the earth. Comparing these two non-geostationary satellite systems, mobility management associated with the MEO systems is expected to be less complex than that associated with the LEO systems, since MEO satellites move slower than LEO satellites, which is one of the advantageous features of the MEO systems.

In this paper, the MEO systems are considered, and network architectures, and location determination and registration methods

Table 1. Constellation parameters.

Number of orbital planes	3
Number of satellites per plane	4
Number of satellites	12
Inclination angle	50.7 deg.
Orbital plane offset	120 deg.
Satellite offset in a plane	90 deg.
Altitude	10,355 km
Orbital period	6 hours

for handheld terminals are investigated.

SATELLITE CONSTELLATION

In this paper, a 'Rosette' constellation[1] consisting of twelve MEO satellites, whose parameters are tabulated in Table 1, is assumed. The rosette constellation formed by satellites at the altitude of 10,355 kilometers guarantees single satellite visibility from anywhere on the earth at an elevation angle of larger than 20 degrees. Figure 1 shows satellite coverages at a minimum elevation angle of 20 degrees. To ensure multiple satellite visibility, handheld terminals are to be linked with a satellite at a minimum elevation angle of 10 degrees. Satellites are assumed to employ 61 spot beams for communications with handheld terminals. Satellites and land earth stations (LES's), feeder links, are to be linked at a minimum elevation angle of 10 degrees. Global beams are used for these feeder links.

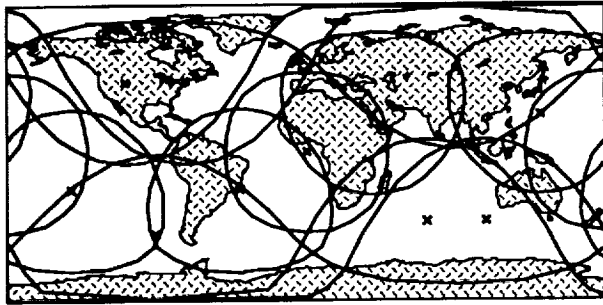

Figure 1. Satellite coverages.

Table 2. Network architectures.

	HLR	VLR
	Location / Number	Location / Number
1	One Region / 1	- / None
2	Each Region / 5	Each Region / 5
2D	Each Region / 5 (D-HLR)	- / None
3	Each LES / 25	Each LES / 25
3D	Each LES / 25 (D-HLR)	- / None

NETWORK ARCHITECTURES

In this section, five candidate network architectures, in which locations and functions of location registers differ, are presented and evaluated in terms of signaling traffic required for an outgoing call from a handheld terminal, an incoming call to a handheld terminal, and location registration by a handheld terminal.

Candidate network architecture

Five candidate network architectures are shown in Table 2. Both the number of Regions and the number of LES's per Region are assumed to be five for all architectures. The terms 'HLR' and 'VLR', which stand for a home location register and a visitor location register, respectively, are used to represent different types of database facilities or equipment in accordance with each network architecture. An HLR contains information about handheld terminals that are initially registered to that HLR, and manages these terminals when they are within the service area associated with that HLR. A

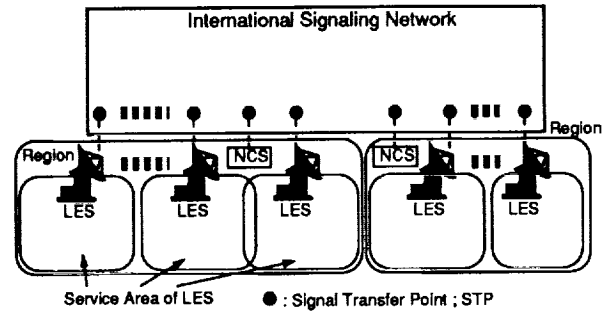
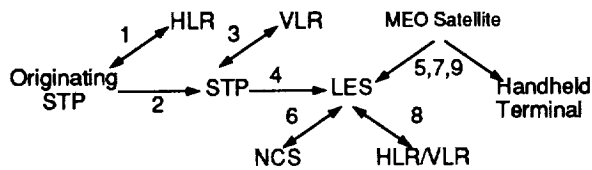

Figure 2. Network configuration.

VLR is assumed to be at the same location as an HLR, and contains information about roaming terminals from service areas associated with other HLR's. A VLR manages information about roaming terminals only when they are within the service area associated with that VLR. When the VLR is informed that a roaming terminal whose information is stored in that VLR has moved outside the service area, information about that terminal is deleted.

In Type 1, only one HLR is employed in the system, which manages information about all the handheld terminals no matter where they are located. In Types 2 and 2D, one HLR is located in each Region, and in Types 3 and 3D, one HLR at each LES. In Types 2 and 3, VLR's are also employed in the system. In Types 2D and 3D, no VLR's are employed and each HLR manages information about all the terminals. To ensure correct routing, when information about a terminal is changed or updated in one HLR, information about that terminal in the other HLR's must be updated immediately. Since the information about all HLR's in Types 2D and 3D is duplicated, these HLR's are named "duplicated-HLR's (D-HLR's)".

An example of a network configuration is shown in Fig. 2. It is assumed that LES's and network control stations (NCS's) are connected through an international signaling network. One NCS is assumed to be located in each Region, which is responsible for network coordination, namely allocation of PN codes and / or frequency slots and / or time slots. The dots in Fig. 2 represent signal transfer points (STP's), which are responsible for switching of signaling messages.



- 1 Location Inquiry / Notification of Location (LES or Region)
- 2 Initial Address Message
- 3 Location Inquiry / Notification of Location (LES)
- 4 Initial Address Message
- 5 Call Announcement / Response
- 6 Channel Assignment Request / Channel Assignment
- 7 Channel Assignment
- 8 Authentication Request / Random Number + Result
- 9 Random Number / Result

Figure 3. Procedure for an incoming call to a handheld terminal.

Evaluation of network architectures

For the evaluation of candidate network architectures, procedures for an outgoing call from a handheld terminal, an incoming call to a handheld terminal, and location registration by a handheld terminal, are defined. The defined procedure for the incoming call is shown in Fig. 3, for reference. First, location of the called terminal is requested from an HLR, and the HLR notifies the location. The call is then connected to the objective LES. In Type 2, when the terminal is roaming in another Region, the call is connected to the LES after the location of the terminal is requested from and notified by the VLR. Namely, the third and fourth steps in Fig. 3 are to be considered only in Type 2. A call announcement or paging message is then sent to the terminal, and the terminal responds to it. Next, a channel is assigned by an NCS, and an authentication procedure follows. When an authentication procedure succeeds, the call will be connected.

Signaling traffic for an averaged one event is calculated by the following method. An event here refers to an outgoing call, an incoming call and one location registration event.

First, signaling traffic, given by the product of the number of signaling bits (unit : bit) and the transmission distance (unit : kilometers), is calculated for each step in each procedure. The transmission distance at each step in each procedure differs in accordance with the

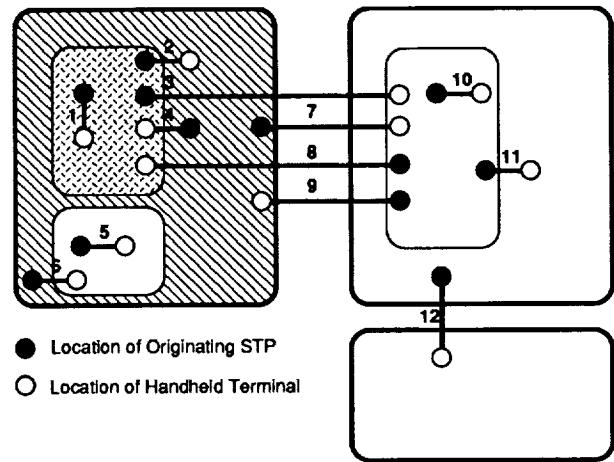

Figure 4. Twelve possible cases for an incoming call.

locations of the handheld terminal, the call originating point, and so on. To cover all the cases taken into account, three, twelve and fourteen cases are considered, respectively, for an outgoing call, an incoming call and location registration. Cases considered for an incoming call are shown in Fig. 4, for reference. Black dots represent locations of the STP's nearest to the call originating subscribers, and white dots locations of the called handheld terminals. An inner dashed area represents the service area of the HLR to which the terminal is initially registered. An outer hatched area represents a Region where that objective HLR is located. For example, case number 3 represents an incoming call from a subscriber located in the service area of the HLR, where the called terminal is initially registered, to the terminal roaming in a Region not covered by the service area of that HLR.

Second, the average of the signaling traffic for each event, namely for an outgoing call, an incoming call and location registration, is calculated by equally weighing all the cases considered for each event. The signaling traffic for an averaged one call is, then, calculated assuming the ratio of the number of outgoing calls to that of incoming calls is 60 % : 40 %. Finally, the signaling traffic for an averaged one event is derived assuming the ratios of the number of calls and that of location registration are 90 % : 10 % and 99 % : 1 %.

The number of signaling bits assumed is

categorized into the following three types :

- 400 bits, for call request, acknowledgment and location inquiry,
- 500 bits, for location information, and
- 900 bits, for information about a handheld terminal.

Transmission distances are categorized into the following three types :

- 2,000 kilometers, between an LES and the nearest STP,
- 6,500 kilometers, for transmission within the same Region,
- 13,000 kilometers, for transmission across Regions, and
- NA for transmission by the satellite links.

Transmission by satellite links is not taken into account in the evaluation, because the links and the procedures associated with them are common to all architectures.

The calculated signaling traffic is shown in Fig. 5(a), for an outgoing call, an incoming call, an averaged one call and for one location registration event. It is understood from Fig. 5(a) that signaling traffic for calls in the network types 3 and 3D is least and that in Types 2 and 2D, it is second least. With regard to location registration, signaling traffic in Types 2D and 3D are greater than that in Types 2 and 3. Especially, in Type 3D where twenty-five D-HLR's are employed in the system, signaling traffic required for one location registration event is estimated to be approximately 30×10^7 bit · kilometer, which is approximately ten times as much as that for Type 2D. This results from the assumption that the D-HLR's should be updated immediately when one of them is updated. Figure 5(b) indicates that Type 3 is the most appropriate architecture among all the architectures considered.

LOCATION DETERMINATION AND REGISTRATION

Two location determination and registration methods, named an LES-ID code detection

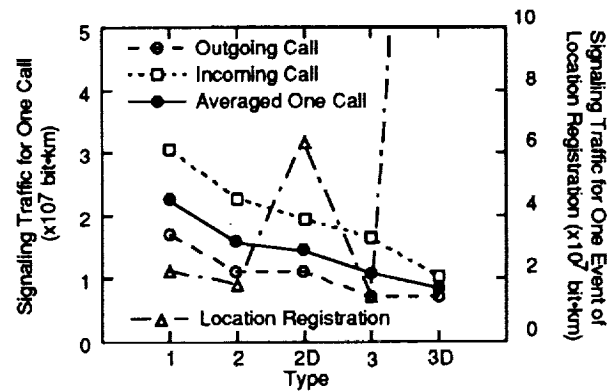

(a) For calls and location registration.

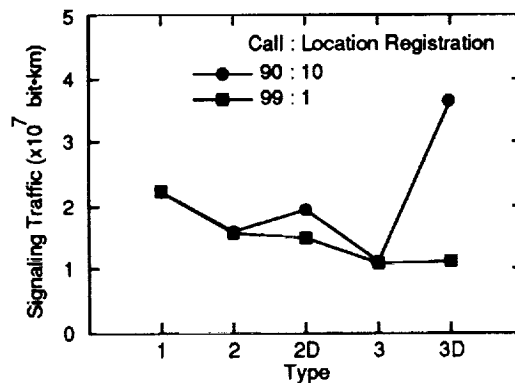

(b) For one event.

Figure 5. Signaling traffic.

method and a location prediction method, are considered in this section. First, detailed descriptions are given for each method. Then, the number of spotbeams required for paging, or call announcement, is evaluated.

LES-ID Code Detection Method

In the LES-ID code detection method, a service area is predetermined for each LES, which should be smaller than the area that LES can cover in 100 % of time. Areas covered by an LES in 100 % of time are shown in Fig. 6. Degrees in Fig. 6 represent the latitude of LES's. These areas are calculated by assuming that a satellite and an LES are linked at a minimum elevation angle of ten degrees, and that a satellite and a handheld terminal are linked at a minimum elevation angle of 20 degrees. In the LES-ID code detection method, each LES transmits its own ID code (LES-ID code) to the

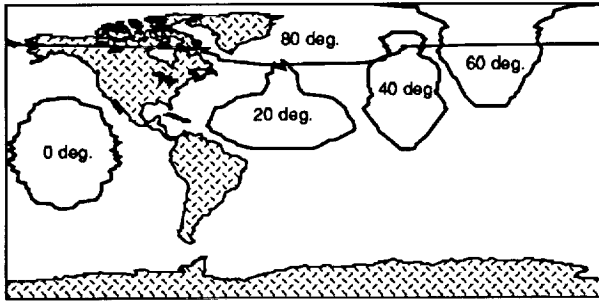

Figure 6. Example of areas covered by an LES in 100 % of time.

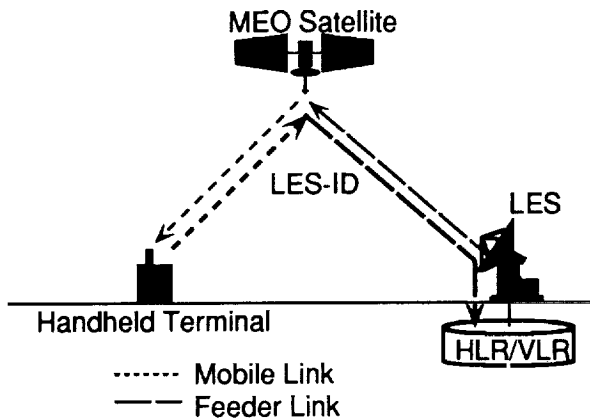

Figure 7. LES-ID code detection method.

service area, as shown in Fig. 7, through spotbeams which illuminate the service area. For this purpose, the accurate orbit parameters of each satellite as well as computing facilities are required. A handheld terminal detects an LES-ID code by scanning all the prescribed PN codes or frequencies for receiving an LES-ID code when logging-on, at specified intervals, and when the signal quality is degraded under the predetermined threshold. The terminal registers the detected LES-ID code in an objective location register (HLR or VLR) if it does not coincide with the previously registered ID code. The location of the terminal is registered by the LES-ID code. For call announcement, spotbeams illuminating the service area of the LES with the registered ID code are identified using the orbit parameters, and a message is transmitted through these beams. As the LES service area becomes wider, location registration will be made less frequently, however, the number of

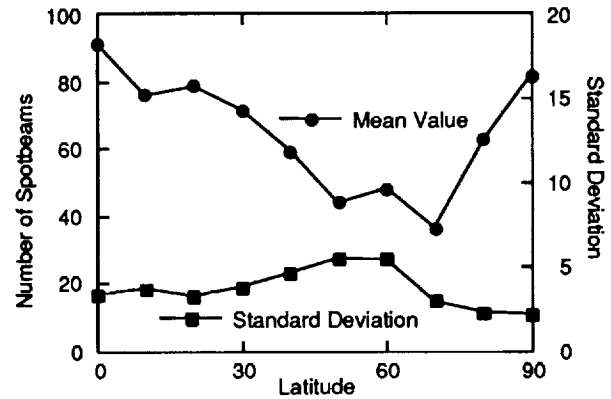

Figure 8. Number of spotbeams required for call announcement in the LES-ID code detection method.

spotbeams required for call announcement becomes larger. The number of spotbeams required for call announcement is calculated for the areas shown in Fig. 6. Figure 8 shows the calculated results. It is seen from Fig. 8 that the mean number of spotbeams required for the call announcement is a minimum for an LES at the latitude of approximately 70 degrees.

Location Prediction Method

In the location prediction method, a handheld terminal receives a spotbeam ID code and time information, namely the time of reception, and transmits that data to an LES at a prescribed time interval. The LES routes this information to the computing facility possibly located at an NCS. The computer calculates the area the spotbeam with the received ID code illuminates at that time. For this purpose, accurate orbit parameters of all the satellites are required at the computing facility. Based on the calculated area, the computer predicts the area in which the handheld terminal is contained taking account of errors in orbit parameters and mobility of the terminal. Then, the computer sends the predicted area information to the objective location register, which is registered as the location of that terminal. With this method, the predicted area is not necessarily associated with the service area of one LES, which would be a disadvantage. Hence, two or more LES's are required for transmitting a call announcement

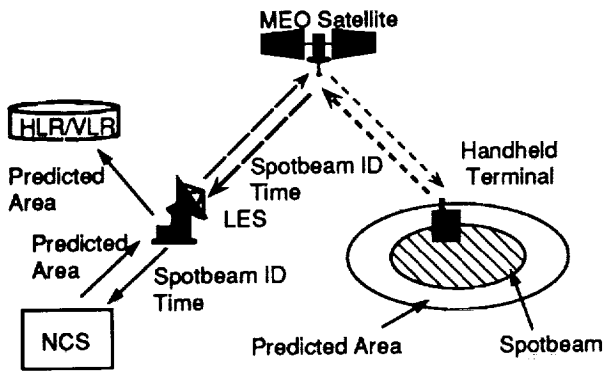

Figure 9. Location prediction method.

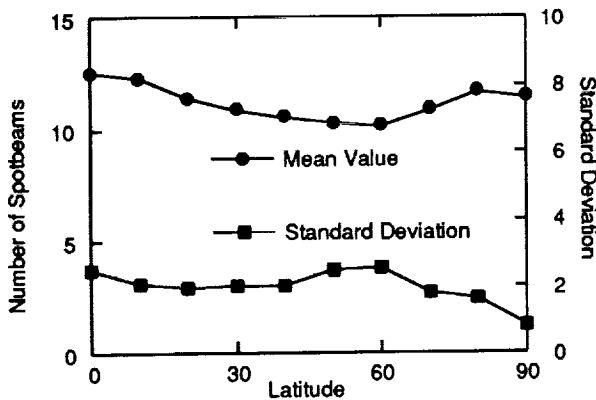

Figure 10. Number of spotbeams required for call announcement in the location prediction method.

message to a terminal. The number of spotbeams required for call announcement is calculated, and the results are shown in Fig. 10. It is assumed that the predicted area is exactly the same as the area illuminated by the spotbeam.

Discussion

Both methods for the location determination and registration considered here require accurate orbit information of all the satellites as well as computing facilities. Since a satellite at an altitude of 10,355 kilometers moves around the earth with a period of six hours, calculation of the position of all the satellites is not a heavy load for a computer. As far as the number of spotbeams required for call announcement is concerned, the location prediction method is advantageous, however, call announcement

through two or more LES's is mandatory for most of the cases. With regard to the number of location registration events made, the LES-ID code detection method is advantageous since the area covered by an LES in 100 % of time is wide, as shown in Fig. 6, and since the terminals moving in this area are not required to update their location information. To make the number of spotbeams required for call announcement with the LES-ID code detection method small, sectorization of the LES into multiple narrow service areas assigned different ID codes will be effective.

CONCLUSION

Network architectures, and location determination and registration methods for the MEO system were investigated. It was found that the network in which an HLR and a VLR are located at each LES is the most appropriate in terms of signaling traffic. With regard to the location determination and registration method, two methods, one is based on receiving an LES-ID code and the other on predicting the area in which the handheld terminal is contained, were evaluated, and advantageous and disadvantageous features of these two methods were identified.

ACKNOWLEDGMENTS

The authors would like to express their gratitude to Dr. Y. Urano, Dr. K. Ono, Dr. G. Sato, Mr. K. Koga, Dr. T. Mizuno, Dr. H. Kobayashi, Mr. M. Fujioka, Mr. Y. Takeuchi and Mr. A. Yamaguchi for their encouragement, advice and grateful support.

REFERENCE

- [1] A. H. Ballard : "Rosette Constellations of Earth Satellites," *IEEE Trans. Aerosp. Electron. Syst.*, vol. AES-16, No.5, pp. 656-673 (Sept. 1980).