

N94- 25106

## Aircraft Digital Flight Control Technical Review

Otha B. Davenport, Technical Director  
Directorate of Engineering & Technical Management  
Headquarters Air Force Materiel Command  
Wright-Patterson AFB OH

David B. Leggett  
Flying Qualities Section  
Wright Laboratory  
Wright-Patterson AFB OH

## Introduction

The Aircraft Digital Flight Control Technical Review was initiated by two pilot induced oscillation (PIO) incidents in the spring and summer of 1992. Maj Gen Franklin (PEO) wondered why the Air Force development process for digital flight control systems was not preventing PIO problems. Consequently, a technical review team was formed to examine the development process and determine why PIO problems continued to occur. The team was also to identify the "best practices" used in the various programs they looked at.

The charter of the team was to focus on the PIO problem, assess the current development process, and document the "best practices". A multi-agency, multi-disciplinary team was established with members from Air Force Materiel Command/Engineering (AFMC/EN), Wright Laboratory/Flight Dynamics Directorate (WL/FIG), Aeronautical Systems Center/Engineering (ASC/EN) (both engineers and managers were represented), and Air Force Flight Test Center (AFFTC) (both engineers and pilots were represented). The team conducted the review in July and August of 1992 and prepared the final report and briefing for Gen Yates, the AFMC commander, in August and September 1992.

The team reviewed all major USAF aircraft programs with digital flight controls, specifically, the F-15E, F-16C/D, F-22, F-111, C-17, and B-2. The team interviewed contractor, System Program Office (SPO), and Combined Test Force (CTF) personnel on these programs. The team also went to NAS Patuxent River to interview USN personnel about the F/A-18 program. The team also reviewed experimental USAF and NASA systems with digital flight control systems: the X-29, X-31, F-15 STOL and Maneuver Technology Demonstrator (SMTD), and the Variable In-Flight Stability Test Aircraft (VISTA). The team also discussed the problem with other experts in the field, including Ralph Smith and personnel from Calspan. The following are the major conclusions and recommendations of that review.

## Findings: Digital Mechanization

First of all, a review of aircraft that have experienced PIO problems in the past indicates that PIO is not a problem caused by digital mechanization per se. PIOs have been encountered with all kinds of control system mechanizations. Mechanical, hydromechanical, electromechanical, and analog electronic systems have all encountered PIOs in the past. Table 1, from Reference 1, shows several PIO problems that have occurred in the past.

However, digital electronic flight control systems have allowed us to break the space, weight,

and power barriers that effectively limited the flight control complexity that could be achieved with other control system mechanizations. With digital flight mechanization we can tailor the flight control system for a far wider variety of flight conditions and flight tasks than was possible before. This added complexity adds some additional risk that may require a more disciplined, more structured process to manage in the development process.

#### Findings: Development Process

All of the programs we looked at used pretty much the same development process. A simple schematic of that process is shown in Figure 1. This process is inherently iterative. Each step is intended to better identify the system and reevaluate the system based on the latest identification. When problems are encountered the design should be modified, re-identified and reevaluated. When problems are overcome the process moves on to the next step. This process is intended to reduce risk as the uncertainty decreases. Our conclusions about the process were that the process had the right steps, but the execution varied from program to program.

In some programs, the twin constraints of cost and schedule sometimes drove the process to run "open-loop" when flying qualities problems (including possible PIO problems) were encountered. For example, if a design did not meet the quantitative requirements in the specification and the necessary fix significantly impacted cost or schedule, some programs discounted the applicability of the requirements and decided to proceed with simulation to see if the problems existed. If problems were encountered in simulation and the necessary fix significantly impacted cost or schedule, some programs discounted the fidelity of the simulator and decided to proceed with flight test to see if the problems existed.

#### Findings: PIO

Figure 2 shows a simplified schematic of the pilot-vehicle system. The pilot can be viewed as a feedback system that closes the outer-loop around the airframe-sensor-flight control system. The feedback path for the pilot is a multi-channel path that includes the pilot's visual cues (outside and inside the cockpit), motion cues, aural cues, tactile cues (force and displacement) from his controllers, and others. A PIO occurs when this outer loop becomes dynamically unstable or neutrally stable. In the most general sense, a PIO is the result of a disharmony between the pilot's action and the expected aircraft reaction. This occurs when one or more of these feedback cues provide confusing or even conflicting information to the pilot and his gain is high enough to drive the outer-loop system unstable. PIO susceptibility is when the aircraft possesses certain characteristics that make it prone to get into a PIO in flight conditions and tasks in which it must frequently fly. The typical causes of PIO susceptibility are well known: high stick sensitivity, excessive system phase lag, large system nonlinearities, lightly damped response modes, unstable response modes, coupled response modes, etc. Each of these problems causes some kind of disharmony in one or more of the pilot's feedback channels.

However, the presence of such characteristics does not mean that the aircraft will PIO all the time. There are other factors involved as well. First of all, a PIO is more likely to occur when the pilot is performing a "high gain" task, that is, he is trying hard to minimize an error in aircraft attitude or rate. Such "high gain" tasks include precision landing, carrier landing, aerial refuelling (particularly probe-and-drogue), LAPES, close formation flying, target tracking, etc. A PIO is more likely to occur in these kinds of tasks than in tasks where the pilot is only loosely monitoring aircraft attitude or rate and making occasional corrections.

The pilot is a factor in the probability of a PIO occurrence because a pilot can learn to avoid PIOs in a specific airplane by learning the tasks and the conditions in which that airplane is PIO prone, and learning to avoid it by lowering his gain in those tasks and conditions. Thus a PIO is less likely with a pilot who is experienced with the airplane's PIO tendencies and has learned the appropriate technique to avoid it. PIO is more likely with a pilot who is unfamiliar with the airplane or is unaware of its PIO tendencies. The fact that the pilot is a factor in a PIO should not be interpreted to mean that the pilot is at fault. PIO susceptibility is a design flaw because the aircraft is supposed to be designed such that a pilot can command the necessary degree of precision to do the task without fear of driving the outer loop unstable. An aircraft can and should be designed such that it is not PIO prone in tasks or conditions in which it must commonly operate. The team struggled with the perception that such a design might be impractical from a cost, weight or performance perspective until a very high performance front-line fighter was considered that had never had a PIO and was clearly in the "good" handling qualities regime. This aircraft had set the standard in cost, weight and performance. It was not designed specifically for PIO but careful attention had been paid during its design to the characteristics that cause good handling qualities.

Sometimes a PIO is initiated by a discrete event, commonly called a "trigger event". A trigger event is not necessary for a PIO to occur, nor will the identical trigger event initiate a PIO every time. This is because the trigger event is not the cause of a PIO, it is only a catalyst. A trigger event could be something related to the aircraft such as a discontinuity in the control system (e.g. a sudden failure or a large discontinuity in the control law gain schedule), or it could be something totally unrelated to the aircraft such as a large, abrupt atmospheric disturbance or a pilot distraction. In a PIO prone aircraft, the trigger event will initiate the PIO by causing the pilot to make abrupt corrections, and the PIO tendencies (due to whatever factors) will provide the "confusion" that sustains the PIO. If the aircraft is not PIO prone to begin with, the trigger event will probably not cause a PIO because the pilot can apply sudden corrections without becoming "confused".

Of all of these factors, only the aircraft susceptibility and certain trigger events are within the control of the designer. Mission requirements may demand that certain "high gain" tasks be done. The aircraft will be flown by pilots with a wide range of experience (the only way to gain experience with an aircraft is to start learning without any). Certain trigger events are random events with a high probability that they will happen to someone sometime in the aircraft's service life. In order to design an aircraft that is not PIO prone the designer must control those well-known factors that cause PIO susceptibility. The difficult question for the designer is "What values of these factors provide the appropriate level of PIO resistance?"

The reason that this is a difficult question is that, like all sciences that involve the human element, flying qualities issues, including PIO susceptibility, have the characteristics of a "soft" science. That is, since a human being's appraisal is the measure of merit, it is very subjective in nature, and highly variable depending on what human being is doing the evaluating. This variability exists in both the research end, where you are trying to develop criteria to address the problem, and on the verification end, where you are trying to prove that your delivered product is satisfactory. Thus, there is not necessarily an absolute answer, but instead a certain probability based on evaluation by a number of human beings.

The nature of the problem is illustrated in Figure 3. Cooper-Harper pilot ratings are the most common quantitative measure used in flying qualities evaluations. For a typical handling qualities experiment, the correlation curve of a parameter that correlated with Cooper-Harper ratings would

typically look something like that shown in Figure 3. At the "good" end of the curve, there is a certain point up to which, in a typical experiment, all of the pilots will agree that the aircraft is good, and the diversity of Cooper-Harper ratings will be small. At the "bad" end of the curve, there is a certain point beyond which all of the pilots will agree that the aircraft is bad, and the diversity of Cooper-Harper ratings will be small. Between these two points is an area where it is more difficult to say precisely how bad the aircraft is because the diversity of pilot ratings will be much greater at any point in this region than at the ends (References 2 and 3). Consequently, the objective, open-loop requirements derived from handling qualities research must be considered inferential in nature. That is, meeting them will provide a high probability of having good handling qualities, but it does not guarantee good handling qualities.

#### **Findings: Flying qualities specifications**

The quantitative PIO criteria available in the current flying qualities specification, MIL-STD-1797, and from other sources, are based largely on data generated in experiments conducted on ground-based and in-flight simulators in the 1960s and 1970s. The review team found that of all the available criteria, no one criteria seems to be universally accepted by the community at large. In the flying qualities specifications, most of the quantitative PIO requirements resided in paragraphs that were intended to assure good overall flying qualities, not just to preclude PIO. For example, in MIL-STD-1797 requirements on phase lag in the pitch response reside in paragraph 4.2.1.2 Short-term Pitch Response. In the specifications, paragraphs intended explicitly to preclude PIO problems have been largely qualitative in nature ("there shall be no tendency for PIO"). Finally, the verification requirements in MIL-STD-1797 do not specifically call for testing for PIO characteristics. The lack of a strong tie between the requirements and the verification at each stage of the process has led some programs to defer critical actions at a time when small changes could have precluded a much more significant change later on.

#### **Findings: Flight Test Phase**

The final test of the flying qualities and the PIO tendencies of an aircraft is in the flight test phase. The problem with waiting until the flight test phase to determine the degree of PIO susceptibility is that by this point in the development the number of realistic options to resolve problems is dramatically reduced, and design changes at this stage have a greater impact on cost and schedule than at earlier stages. Often a cheaper and easier solution at this stage is to train the pilots to avoid the PIO if they can. Consequently, a system with a PIO tendency sometimes does not get fixed unless the pilots cannot find a technique to avoid the PIO or it prevents mission accomplishment.

#### **Conclusions**

As a result of these findings, the Review Team concluded that the process, as currently implemented, had the the following flaws:

- 1) The available criteria and analysis methods are inferential in nature, they lack universal acceptance, and the current test techniques are not rigorous for PIO problems.
- 2) Because of this, the current process lacks firm go/no-go criteria at each step in the process for the manager to assess the risk of PIO and decide whether to proceed or whether further iteration is necessary.

3) Consequently, with regard to flying qualities in general and PIO in particular, the development process tends to be driven "open-loop" instead of as an iterative process.

4) Finally, the decision of what is good enough is typically left until the flight test phase, where many options that were available in previous development phases are now precluded by cost and schedule constraints, and changes are made only if the pilots cannot be trained to avoid the PIO or the task cannot be modified and retain its military utility.

#### Recommendations

The Review Team made the following recommendations to resolve these problems in the process.

First, establish an Integrity Approach for flight control similar in nature to those established for structures and propulsion. The intent of this program would be to change the paradigm from one of "proceed unless a PIO problem is proven to exist" to one of "proceed only when a PIO problem is proven not to exist". This would be done through establishment of firm go/no-go criteria for each step in the development process. At the design stage it would consist of improved flying qualities criteria. However, since these would still be inferential in nature, further "gates" would be established at other steps in the process. Rigorous demonstration maneuvers, such as Handling Qualities During Tracking (HQDT) would be required in early stages of the development process, such as ground simulation. In-flight simulation would be recommended, perhaps even required if results were inconclusive in the earlier stages. Finally, the verification of adequate PIO resistance would not just be compliance with the inferential requirements, but also satisfactory handling qualities in the demonstration maneuvers during flight test. With the requirements and verification agreed to between the Air Force and the contractor, this process provides a relevant measure of the capability of the aircraft to be operated by the vast majority of the pilot corps.

The second recommendation was to establish a Flying Qualities Working Group in each SPO that has an aircraft under development. The initial purpose of this group is to conduct an assessment of the system and attempt to achieve the appropriate balance between design, pilot-training and military utility. This working group consists of engineers from the SPO, the contractor, the laboratories, and the Flight Test Center, and the test pilots from the contractor and the Flight Test Center. The purpose of the Flying Qualities Working Group is to monitor the progress of the flying qualities of the design through the development stages, help resolve problems, and insure that potential problems are communicated to all the agencies involved.

The third recommendation was to enhance the flying qualities research program to improve the criteria and analysis methods available. The objective is to resolve the conflicts between existing criteria, develop a more comprehensive analysis method, and, hopefully, reduce the region of uncertainty in the present predictive methodology. Another objective would be to develop criteria and analysis methods for new flight regimes (such as high angle of attack) and unconventional response modes (such as direct lift).

The fourth recommendation was to incorporate the "Best Practices" into a new tool being developed for the SPO engineer called the Air Force Acquisition Model (AFAM). The Review Team identified 22 "Best Practices". Space limitations preclude listing all of them here, but they are summarized below:

1) In the requirements definition stage, use quantitative PIO requirements in the specifications, with specific verification requirements.

2) In the design stage, use multiple analysis methods and criteria to assess the flying qualities of the design.

3) Keep the needs of flight test in mind during the design. For example, include a means to change control system gains during the flight test phase in anticipation of the need to adjust them in order to resolve problems.

4) Ground test with hardware in the loop to identify system characteristics.

5) Use full-up ground simulation and in-flight simulation to assess handling qualities and PIO tendencies and use well-defined "high gain" pilot-in-the-loop tasks.

6) In the flight test stage, use well-defined "high gain" pilot-in-the-loop handling qualities testing (HQDT, etc.) as part of the envelope expansion process.

On 5 Feb 1993, the findings and recommendations of the Review Team were briefed to the Commander of Air Force Materiel Command. He has directed that AFMC implement the recommendations.

As a result of these and previous briefings to the senior leadership of the Air Force, the "best practices" are being included in the AFAM for use in current and future Air Force programs. The SPO's either have or are now forming the working groups and conducting assessments to be reviewed by the Program Director. The Air Force Science and Technology program funding for flying qualities has been increased by over 100%. Finally, the Commander of Aeronautical Systems Center through the Directorate of Engineering is planning to release a draft Integrity Program standard by the end of 1993. The focus of the Air Force on the total system requirements for affordable, capable and sustainable aircraft that meet the users needs has been improved by the contributions of all of the team members.

#### References

1. Ashkenas, Irving L., Henry R. Jex, and Duane T. McRuer, Pilot-Induced Oscillations: Their Cause and Analysis, Norair Report NOR-64-143 and STI Report TR-239-2, 20 Jun 1964.
2. Wilson, David J. and David R. Riley, Cooper-Harper Pilot Rating Variability, AIAA Paper 89-3358, 14-16 Aug 1989.
3. Riley, David R. and David J. Wilson, More on Cooper-Harper Pilot Rating Variability, AIAA Paper 90-2822, 20-22 Aug 1990.
4. Military Standard. Flying Qualities of Piloted Aircraft, MIL-STD-1797A, 30 Jan 1990.

TABLE I. Some Past PIO Problems (Taken from NOR-64-143)

Examples shown as: SPECIES (Aircraft): Critical Subsystem: Critical Flight Condition : Remarks

CLASS	TYPE		
	I. LINEAR	II. SERIES NONLINEAR ELEMENTS	III. SUBSIDIARY FEEDBACK NONLINEAR ELEMENTS
PITCH	<p><b>IMPROPER SIMULATION (D, V, a):</b> Abnormally high values of <math>1/T_{\theta 2}</math> and low <math>\zeta_{\theta}</math> led to zero <math>\zeta_{\theta}</math> when regulating large disturbances.</p> <p><b>OCA-INDUCED PHUGOID (C-97):</b> D, c, h: Lag from radar-detected error to voice command led to unstable closed-loop phugoid mode.</p> <p><b>ARM ON STICK (A4D-1, T-38A): F:</b> a: Arm mass increases feel system inertia; leads via B feedback to unstable coupling with short-period dynamics if pilot merely hangs loosely onto stick after a large input.</p>	<p><b>PORPOISING (SR7C-1): F, c:</b> Hysteresis in stick versus elevator deflection resulted in low frequency speed and climb oscillations.</p> <p><b>I. C. MANEUVER (F-36-D, F-100C): F, S, a:</b> Valve friction plus compliant cabling resulted in large oscillations at short period.</p> <p><b>FITCH-UP (XF-104, F-101B, F-102A): V, a:</b> Unstable kink in <math>M(\alpha)</math> curve led to moderate-period oscillations of varying amplitudes (depending on extent and nature of the kink) during maneuvers near the critical angle of attack.</p> <p><b>LANDING PIO (X-15): S, h:</b> Closed-loop around elevator rate-limiting caused moderate oscillations at short period.</p>	<p><b>BOBWEIGHT BREAKOUT (A4D-1, T-38A):</b> E, B, a: At high-g maneuvers the bobweight overcomes system friction and reduces apparent damping of the aircraft in response to force inputs, resulting in large oscillations at short period.</p> <p><b>LOSS OF PITCH DAMPER</b></p>
LATERAL-DIRECTIONAL	<p><b>M/IN EFFECT (X-15, T-33V3A, F-101B, F-104A, KC-135A, B-58): V:</b> a: Zeros of roll aircraft transfer function are higher than dutch roll frequency, <math> z_1/z_2  &gt; 1.0</math>, leading to closed-loop instability at low <math>\zeta_{\phi}</math> conditions.</p> <p><b>BORESIGHT OSCILLATIONS (F-5A):</b> D, V, c: Spiral roll mode driven unstable if roll information is degraded during runway.</p>		<p><b>LOSS OF YAW DAMPER</b></p>
YAW	<p><b>FUEL SLOSH SNAKING (KC-135A, T-37A): V, c:</b> Fuel slosh mode couples with dutch roll mode when rudder used to stop yaw oscillations.</p>	<p><b>TRANSONIC SNAKING (A4D): V, F, a, c:</b> Separation over rudder causes control reversal for small deflections, leading to limit cycle if rudder used to damp yaw oscillations.</p>	
ROLL	NONE KNOWN	<p><b>PILOT-INDUCED CHATTER (F-104R): A, c:</b> Small limit cycle due to damper aggravated whenever pilot attempted to control it.</p>	

\*Critical Subsystem:

- D = Display
- F = Fuel system (except B)
- B = Bobweight
- S = Power servo actuator
- V = Vehicle (airframe)
- A = Augmenter (damper)

\*\*Critical Flight Condition:

- a = Low altitude, near-escape Mach
- b = Landing approach and takeoff
- c = Cruise

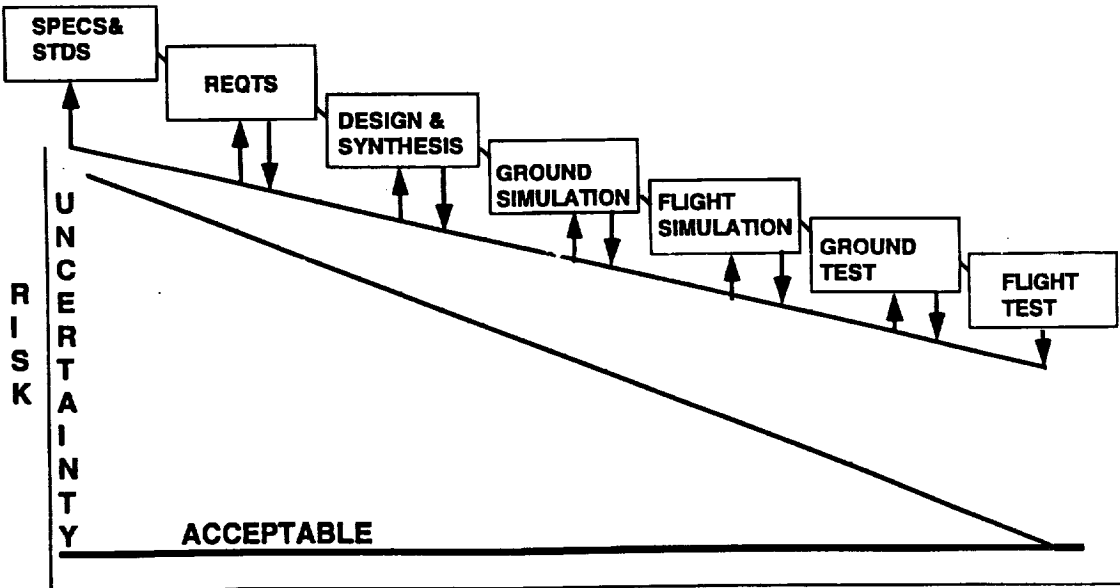

FIGURE 1. Simple Schematic of the Development Process

FIGURE 2. Simplified Schematic of Pilot-Vehicle System

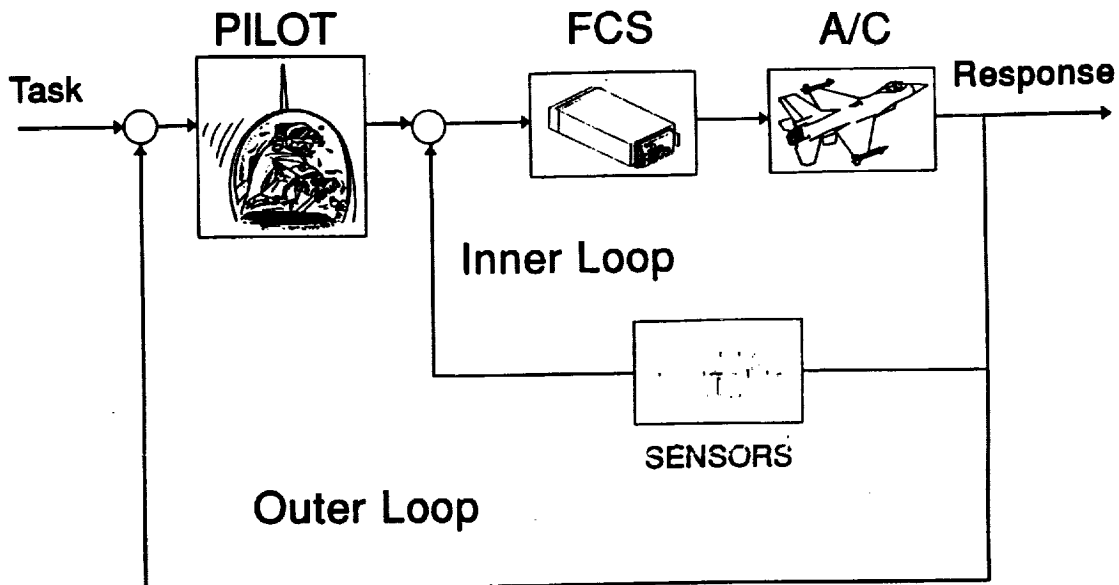
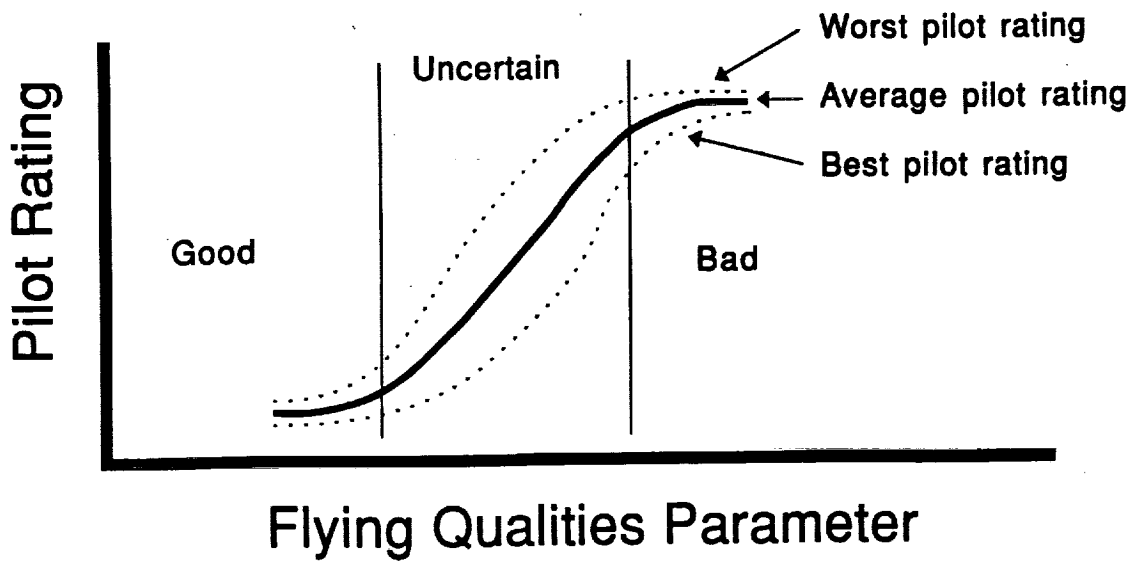

FIGURE 3. Pilot Rating Correlation With a Flying Qualities Parameter





**FIGHTER/ATTACK AIRCRAFT GROUP**

**NASA AGILITY DESIGN STUDY:  
PROJECT DESCRIPTION AND STATUS**

**NASA LaRC Workshop on Guidance, Navigation, and  
Controls**

**March 18, 1993**

**Michael J. Logan, P.E.**

**Group Leader, Fighter/Attack Aircraft, Vehicle Integration Branch  
NASA Langley Research Center, Hampton VA**



The NASA Agility Design Study Project was started in late 1991 in response to a request from NASA Headquarters to assess the impact of "agility" requirements and related technology research projects on fighter aircraft. The study is currently being conducted through the Vehicle Integration Branch within the Advanced Vehicles Division. The Project Engineer is Mike Logan of VIB.

# FIGHTER/ATTACK AIRCRAFT GROUP

## AGILITY DESIGN STUDY

- ▣ PROJECT OVERVIEW
- ▣ INTERIM RESULTS
- ▣ IN-HOUSE CONFIGURATION STUDIES
- ▣ CONCLUDING REMARKS

**This presentation will provide a brief project overview, provide some preliminary results, discuss in-house activities and show the future plans for the activity.**

## FIGHTER/ATTACK AIRCRAFT GROUP

### PROJECT DESCRIPTION

- ▣ OBJECTIVE:   » TO ASSESS THE IMPACT OF AGILITY BASED REQUIREMENTS ON AIRCRAFT DESIGN DECISIONS
  
- ▣ APPROACH:   » IDENTIFY AGILITY REQUIREMENTS
- » DEVELOP ASSOCIATED DATA BASES AND PREDICTIVE METHODOLOGY
- » CONDUCT DESIGN TRADE STUDIES
- » OPERATIONAL IMPACT ANALYSES
  
- ▣ ANTICIPATED RESULTS:
  - » QUANTIFIED AGILITY METRICS
  - » BALANCED DESIGN TRADE DATA
  - » MISSION EFFECTIVENESS vs. COSTS OF VARYING LEVELS OF AGILITY

The purpose of this project is to assess the impact of "agility" requirements on aircraft design decisions and technology requirements. The approach being taken is to divide the effort into four distinct phases. These are to a) Identify agility requirements, b) develop a data base and predictive requirements, c) conduct design trade studies using these levels and predictive methods and d) perform an operational analysis to determine the impact on the combat effectiveness of the vehicles. Each of these task areas will be explained further. Out of this effort will come quantified agility metrics, design trade data, and mission effectiveness vs. costs of varying the levels of agility.

# FIGHTER/ATTACK AIRCRAFT GROUP

## PROJECT OVERVIEW

### PARTICIPANTS:

▣ **NASA:**

Langley  
Dryden  
Ames

▣ **INDUSTRY:**

Boeing  
Eidetics  
General Dynamics  
McDonnell-Douglas  
Others

▣ **AIR FORCE:**

ASD/XR  
Wright Labs

▣ **NAVY:**

NAWC

### WORK EFFORTS:

▣ **IN-HOUSE  
RESEARCH**

▣ **CONTRACTED  
STUDIES**

▣ **WORKING  
GROUP  
MEETINGS**

Task 1 - Requirements ID

Task 2 - DB & Methodology

Task 3 - Config. Studies

Task 4 - Ops. Analysis

DISCIPLINE  
RESEARCH

DESIGN  
METHODODOLOGY

FLIGHT  
VALIDATION

FOCUS

NEEDS



**The effort is being conducted using a combination of in-house research, contracted studies, and working group meetings to accomplish the tasks. The participants include NASA, industry, and the military services, both Air Force and Navy.**

# FIGHTER/ATTACK AIRCRAFT GROUP

## TASK 1- REQUIREMENTS IDENTIFICATION

### ▣ "METRIFICATION":

- Review of existing metrics research
- Operator input
- Definition/selection of appropriate metrics

### ▣ QUANTITATIVE ASSESSMENT OF CURRENT CAPABILITIES

### ▣ EVALUATION OF AGILITY GOALS FOR FUTURE AIRCRAFT

**Task 1 involved identifying an appropriate set of agility requirements. This was done by conducting reviews of existing metrics research, gathering operator input from the Air Force Fighter Weapons School, and developing a consensus from the working group on which "metrics" to use. As part of this phase, current capability was also assessed and goal levels assigned.**

# FIGHTER/ATTACK AIRCRAFT GROUP

## METRIC SELECTION RESULTS

### ▣ WORKING GROUP CONSENSUS

- Government Inputs: NASA, AF
- Industry Inputs: Boeing, Eidetics, General Dynamics, McDonnell-Douglas

### ▣ METRICS SELECTED:

METRIC	CONDITIONS
1. Maximum Negative Ps	0.6M @ 15,000 ft., max inst. $\psi$ 450kts. @ sea level, max inst. $\psi$
2. Time-to-bank 90°	0.6M @ 15,000 ft., max inst. Nz 450kts. @ sea level, 5g
3. Minimum nose-down pitch acceleration	Condition for $C_m^*$
4. Max. achievable, departure-free, trimmed angle-of-attack	Subsonic
5. Maximum lateral acceleration	Max. inst. Nz (Air-to-Air) 1g wings level (Air-to-ground)

The first working group meeting included representatives from NASA, industry, and the Air Force. Five metrics were selected and flight conditions for both air-to-air and air-to-ground were assigned. Note that these metrics were not selected because they "define" agility but rather because they are readily computable in the conceptual design phase of the aircraft's development and because taken together they can reasonably "categorize" the potential agility of the aircraft when it is built.

## **FIGHTER/ATTACK AIRCRAFT GROUP**

### **TASK 2- DATA BASE & METHODOLOGY DEVELOPMENT**

#### **▣ COLLECTION OF SUPPORTING DATA**

- Current fleet capabilities
- Technology research reports

#### **▣ ALGORITHM DEVELOPMENT / VALIDATION**

- Identifying appropriate techniques
- Computerization
- Benchmarking

#### **▣ INTEGRATION INTO DESIGN SYNTHESIS PROCESS**

- Code integration into FLOPS
- Data generation

**The second phase of the activity was oriented towards developing the necessary predictive methodology for the effort. In addition, a limited data base was developed to assess current fleet capabilities with regards to the chosen metrics. The prediction codes have been developed and will be integrated into the VIB aircraft sizing/synthesis program, FLOPS when they have been validated against the collected data.**

# FIGHTER/ATTACK AIRCRAFT GROUP

## TASK 3- CONFIGURATION TRADE STUDIES

- DEFINE MISSIONS AND REQUIREMENTS/CONSTRAINTS
- DEVELOP CONCEPTUAL DESIGNS OF CONFIGURATION MATRIX:

OBSERVABLES	AGILITY		
	Low	Medium	High
Conventional			
Reduced			
Low			

- IDENTIFY TECHNOLOGY EXPLOITATION OPPORTUNITIES

- DOCUMENT FUTURE RESEARCH NEEDS

- Flight research
- Wind tunnel testing
- Methodology development



**The third phase of the activity seeks to define the design and configuration related tradeoffs necessary to achieve given levels of agility. The approach here is to define a common set of missions and "conventional" range/payload/mission requirements and apply agility constraints to vehicles of differing observables classes. These studies will provide both design information as well as identifying technology needs. The effort is being done with contracted studies with airframers as well as in-house systems studies by VIB.**

# FIGHTER/ATTACK AIRCRAFT GROUP

## TASK 4 - OPERATIONAL ANALYSIS

▣ DETERMINISTIC + MAN-IN-LOOP SIMULATION

▣ STUDY MATRIX FROM TASK 3

▣ AIR-TO-AIR EVALUATION

- Exchange ratios
- $1 \vee 1, M \vee N$

▣ AIR-TO-GROUND EVALUATION

- $P_k$  (Lethality)
- $P_s$  (Survivability)

**The fourth phase of the activity would identify the operational benefits associated with increasing levels of agility. This would be accomplished by means of simulation and combat effectiveness evaluations in both an air-to-air and air-to-ground context.**

# FIGHTER/ATTACK AIRCRAFT GROUP

## PROJECT STATUS

### TASK 1 STARTED NOVEMBER 1991

- Metric evaluation conducted
- Group meeting consensus on 5 metrics
- Current fleet evaluation underway
- Completion of task scheduled for late '92

### TASK 2 UNDERWAY

- Task Order issued to Boeing 9/92
- Data/methods selection meetings held
- "Validated" methods available 1Q '93

### TASK 3 GETTING STARTED

- Configuration study task assignments defined
- Task Order mods issued to 2 of 3 contractors (GD, McAir)
- Studies to be completed by 3Q 93

**The project is presently only one and a half years old. The Phase I activity has been completed. Phases II and III are currently in work with Phase II nearly complete. Phase III is expected to be complete by the end of the third quarter of '93. Phase IV has not yet received a funding decision from NASA HQ.**

## FIGHTER/ATTACK AIRCRAFT GROUP

### IN-HOUSE CONFIGURATION STUDIES

- ▣ OBJECTIVE:
  - » WORK IN PARALLEL TO INDUSTRY TO DEVELOP AGILITY-CONFIGURATION DECISION RELATIONSHIPS
  
- ▣ APPROACH:
  - » CONDUCT CONVENTIONAL CONCEPTUAL DESIGN USING STUDY MATRIX
  - » APPLY AGILITY CONSTRAINTS TO VEHICLES
  - » ANALYZE IMPACT ON PROCESS AND DESIGN DECISIONS

**The Phase III design trade studies activity involves both contracted and in-house systems studies. The objective of the in-house studies is to help develop agility vs. configuration decision relationships. The approach is to develop a set of configurations which are sized to "conventional" range/payload/mission requirements using the same observables matrix as the airframers. Agility constraints will then be applied to these vehicles. The results of this imposition will be studied in terms of both its change on the configuration process as well as the designs themselves.**

# FIGHTER/ATTACK AIRCRAFT GROUP

## SYSTEM STUDY PROCESS

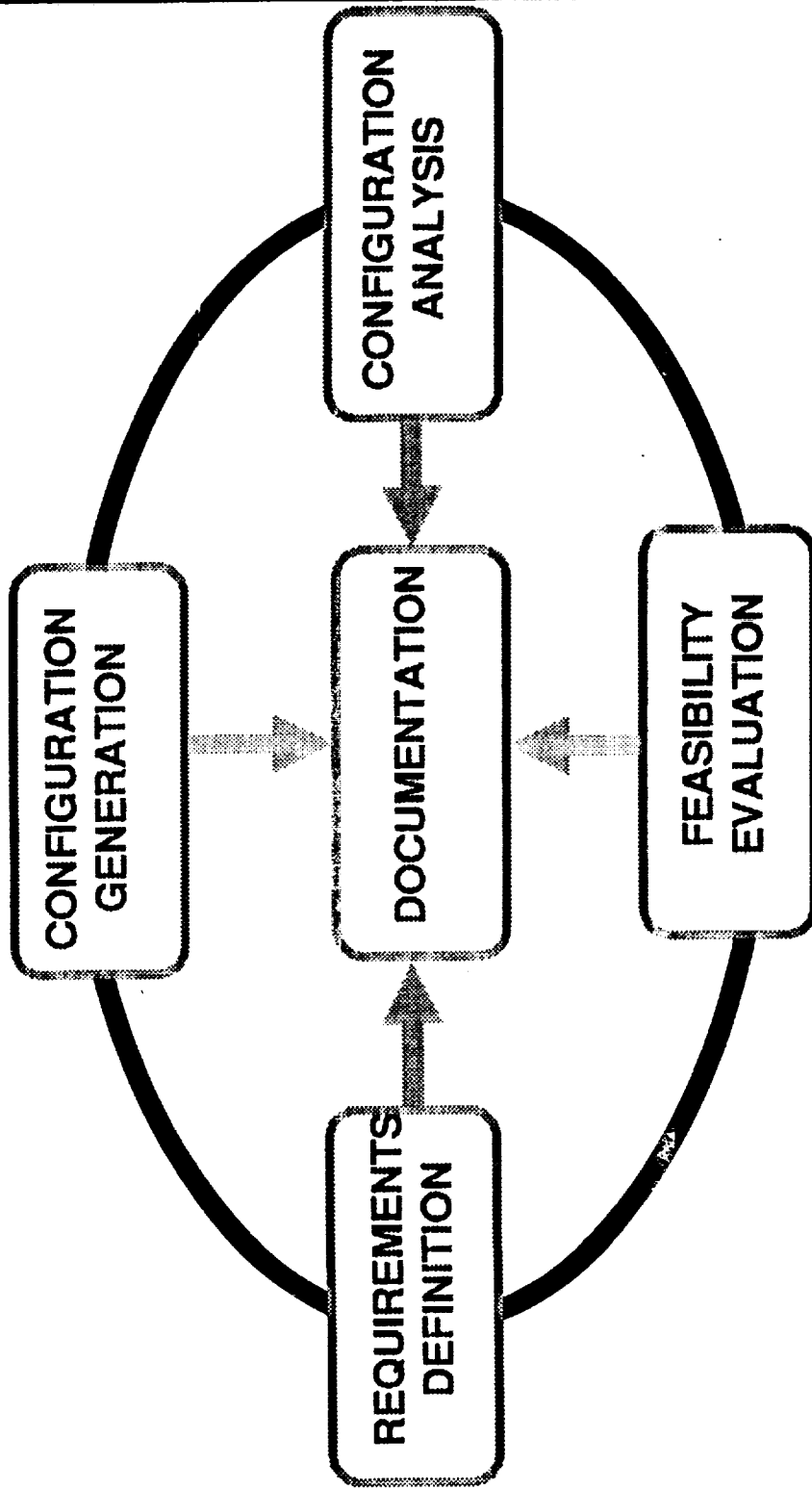



The system study process being followed is similar to that being used by the airframers. VIB developed the range/payload/mission requirements using input provided by the Air Force in terms of an aircraft of practical interest, namely a multi-role fighter class vehicle. A set of configurations was generated using the study matrix. Each of these configurations was analyzed and trade studies of variations in initial assumptions and technology sets was conducted. Each baseline configuration was subjected to a feasibility evaluation to determine its suitability to the mission and its strengths/weaknesses relative to existing configurations and each other. As part of the study, documentation of the results and methods used is being produced.

# FIGHTER/ATTACK AIRCRAFT GROUP

## MISSION DEFINITIONS

### AIR-TO-GROUND:

#### BATTLEFIELD AIR INTERDICTION (BAI) PROFILE



### AIR-TO-AIR:

#### DEFENSIVE COUNTER AIR (DCA) PROFILE

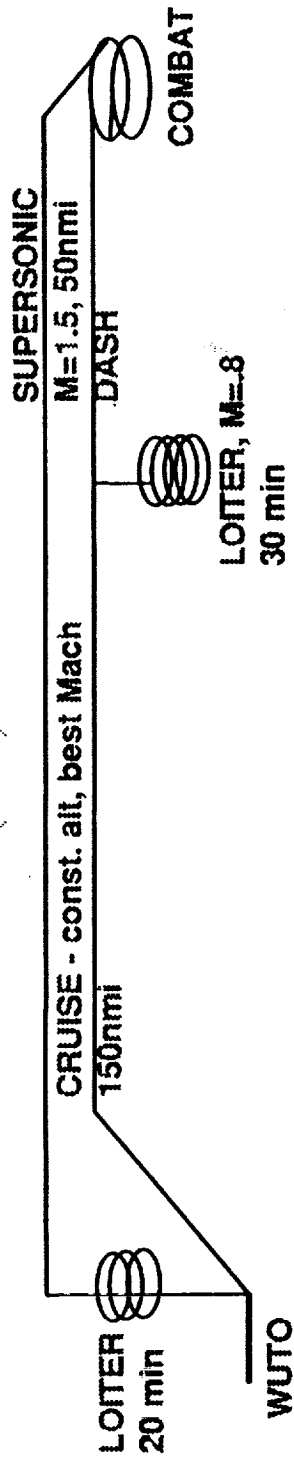

**These missions are the ones being used for the Agility Design Study project. They are similar to the Air Forces Multi-Role Forces baseline missions and are representative of this class of vehicle. Note that there is both an air-to-air as well as an air-to-ground requirement.**

# FIGHTER/ATTACK AIRCRAFT GROUP

## SIZING CONSTRAINTS AND ASSUMPTIONS

▣ TECHNOLOGY AVAILABILITY DATE: 2000-2010

▣ PERFORMANCE:

- NZ  $\geq$  6.5 (Air-to-ground load, SL, M=0.9)
- ACCEL M=0.8-1.5  $\leq$  60 sec. (Air-to-air load, after hold)
- NZ  $\geq$  3.5 (Air-to-air load, 35k', M=0.9)
- NZ  $\geq$  6.5 (Air-to-air load, 20k', M=0.9)

▣ PAYLOAD:

- Basic Air-to-ground: 2xMk84 (LGB), 2xAim-9, 20mm/500 rd.
- Basic Air-to-air: 2xAim-120, 2xAim-9, 20mm/500 rd.

▣ SYSTEMS

- Avionics: 1800 lb. installed
- Engine: 100 HP, 1% Bleed extraction

**A common set of initial assumptions were made regarding technology timeframe, performance, payload, and potential variations to use in trade studies.**

# FIGHTER/ATTACK AIRCRAFT GROUP

## CONFIGURATION CONCEPTS

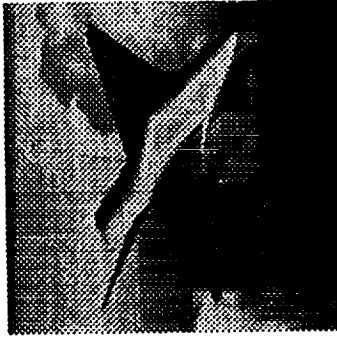

Single Engine White  
(SEW)

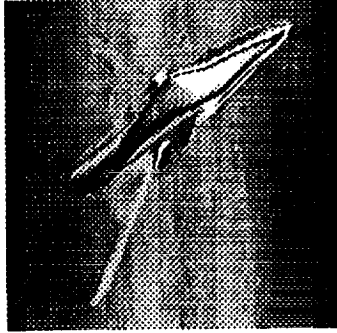

Single Engine Grey  
(SEG)



Single Engine  
Stealthy (SES)

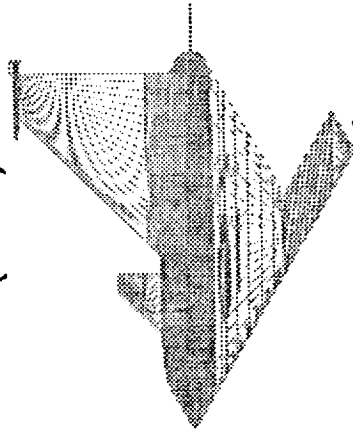

Advanced  
Reconfigurable  
Fighter (ARF)

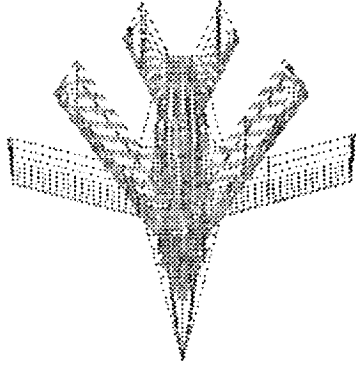

Swing Wing Fighter  
(SWF)

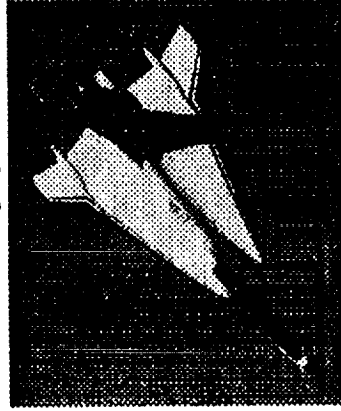

F-16XL

Several configuration concepts were evaluated for this effort. Three configurations were generated which correspond to the three levels of "observables" used in the study matrix. Two alternate configurations were also reviewed for applicability. These were an advanced reconfigurable fighter which has common fuselage, engine, cockpit, etc. and removable empennage. This concept would in theory provide less of a compromise for the differing roles the aircraft must perform, namely, air-to-air combat and ground attack. A less radical approach is represented by a variable sweep concept which will be used to determine both its conventional performance benefits and its agility benefits (if any). As a reference to existing aircraft capable of performing the basic mission the F-16XL is being used (although it cannot meet the desired performance levels unmodified).

C-4

# FIGHTER/ATTACK AIRCRAFT GROUP

## SINGLE ENGINE WHITE- BASELINE SUMMARY

### ▣ GEOMETRY:

SW=390 sq ft.

AR=2.31

$t/c=0.06$

L=50.5



### ▣ FEATURES:

"Conventional" shaping

V-tail, all-flying

Thrust vectoring

External weapons carriage

### ▣ WEIGHTS:

GTOW: 38650 (F110 29k#)

Empty: 19250

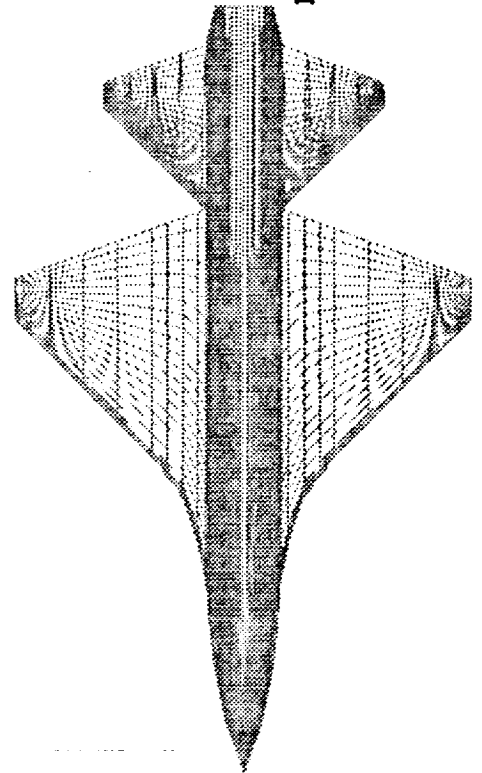



**This summarizes the salient characteristics of the "conventional" observable level concept. It is a wing-body-tail configuration (although it is a V-tail) with thrust vectoring a potential option. All weapons are carried externally.**

# FIGHTER/ATTACK AIRCRAFT GROUP

## SINGLE ENGINE GRAY - BASELINE SUMMARY

### ▣ GEOMETRY:

Sw=560 sq. ft.

AR=3.15

t/c=0.06

L=59'10"

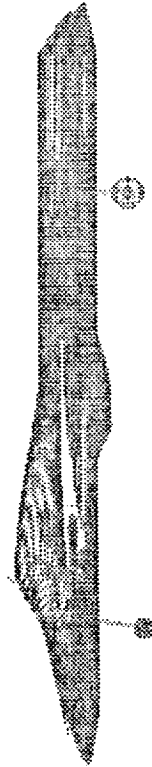

### ▣ FEATURES:

Internal Weapons Carriage

50 Deg. Wing Sweep

Small Canard

Fixed Inlets Underwing

P/Y Thrust Vectoring

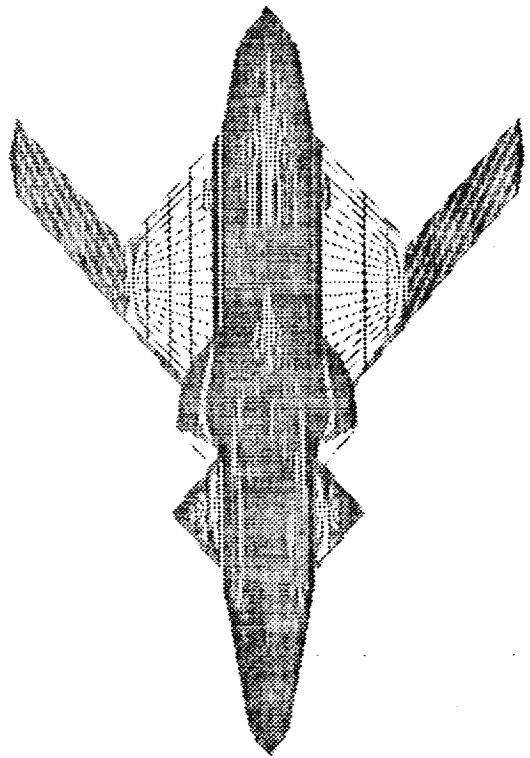

### ▣ WEIGHTS:

GTOW: 38120 (F110 29k#)

Empty: 21340

**This is the configuration developed by the Dryden engineer who was on-site at LaRC to participate in the study. It assumes pitch and yaw thrust vectoring with internal carriage weapons.**

# FIGHTER/ATTACK AIRCRAFT GROUP

## SINGLE ENGINE STEALTHY- BASELINE SUMMARY

### ▣ GEOMETRY

SW=740 sq. ft.

AR=2.16

Vc=10-15-6 (Large Bay)

6-8-4 (Small Bay)

L=46'4"

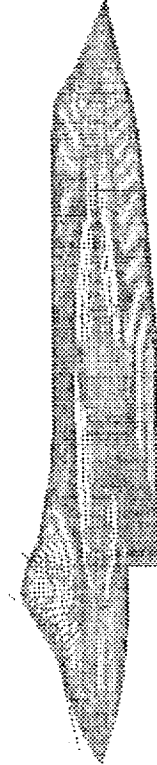

### ▣ FEATURES:

Internal Weapons Carriage

Blended 60° Wing-Body

"L.O. Vectoring Nozzle"

Several TE Devices

### ▣ WEIGHTS:

GTOW: 35600 (SB,M1.4)

36400 (LB,M=1.05)

39200 (SB, F110 @ 33k#)

Empty: 19500-21100

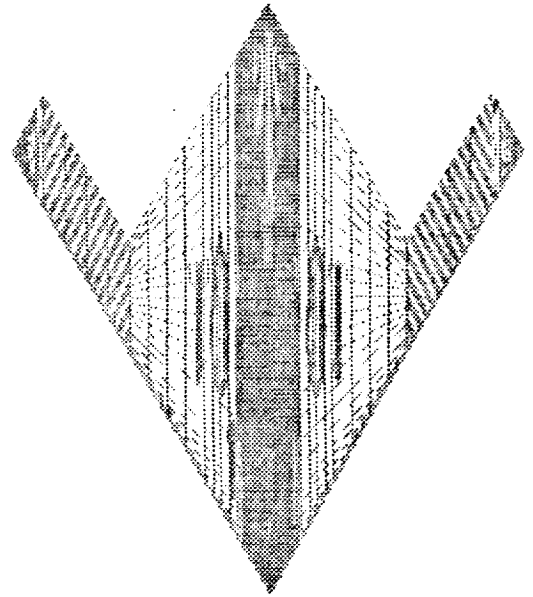

**This is a "flying wing" concept designed to incorporate low observable features. All weapons are carried internally and it has an aligned edge platform.**

## FIGHTER/ATTACK AIRCRAFT GROUP

### CONFIGURATION STUDIES NEEDS

#### ▣ AERO PREDICTION METHODS FOR CONCEPTUAL DESIGN:

- HIGH- $\alpha$  PREDICTION CURRENTLY NOT SUITABLE
- SEMI-EMPIRICAL METHOD NECESSARY
- PARAMETRIC TEST PROGRAM TO GENERATE DATA BASE
- INDUSTRY RECOGNIZES NEED, LOOKS TO NASA

#### ▣ WEIGHT PREDICTION:

- STATISTICAL METHODS INSENSITIVE TO TECHNOLOGY
- UNIQUE CONFIGURATIONS FALL OUTSIDE DATA BASE
- SEMI-ANALYTICAL STRUCTURES/SYSTEMS METHODS NEEDED
- ISSUES BEING ADDRESSED AS PART OF CRITICAL DISCIPLINES
- INDUSTRY WILLING TO PARTICIPATE

One of the important "by-products" of this study is the identification of critical needs in terms of methodology necessary to support the application of NASA developed technology into future or existing vehicles. Two of the areas of current need include aerodynamics prediction for the non-linear region simple and fast enough to use during conceptual design and advanced, second level weight prediction. Note that in both cases, industry is looking to NASA to help develop this capability.

# FIGHTER/ATTACK AIRCRAFT GROUP

## CONCLUDING REMARKS

### AGILITY DESIGN STUDY UNDERWAY

- First phase nearly complete
- Second phase in work
- Third phase starting

### IN-HOUSE CONFIGURATION STUDIES

- Three basic configurations developed
- Trade study data base generated
- Needs for predictive methodology identified

### FUTURE PLANS

- Incorporate agility prediction into synthesis (1Q '93)
- Re-evaluate in-house configurations (2Q '93)
- Compile industry results (3Q '93)
- Conduct operational effectiveness (Phase IV)



**In conclusion, the NASA Agility Design Study is underway with current work in Phases II and III. Near term plans include completing the validation of the metric prediction algorithms and incorporation of them into the vehicle sizing system. The airframer design studies will be completed by 3Q '93. Far term plans are to conduct operational effectiveness studies.**

