

NASA WIRING PROGRAM—SURVEY OF NASA EXPERIENCES IN WIRING SYSTEM SAFETY

Mark W. Stavnes
Sverdrup Technology, Inc.
Lewis Research Center Group
Brook Park, Ohio

N94- 28700

NASA Wiring Program

Wiring System Technology

OBJECTIVE

To address safety and reliability issues of complete wiring systems.

PLANS

- **Determine Wiring System Design Factors**
- **Investigate Circuit Protection Technologies**
- **Address Manufacturing and Maintenance Procedures**

NASA Wiring Program

Wiring System Failure Survey

PURPOSE

Form a comprehensive view of wiring safety, not only including the insulation, but also taking into account the wiring system factors.

- Apollo 13 Review Board.
- Space Shuttle Program Office and Inspection Teams (NASA Johnson, NASA Kennedy, NASA Marshall, and contractors).
- NASA Payload Inspections (NASA Marshall).

JUSTIFICATION

For failures such as arc tracking and others to happen, insulation degradation of some degree must have occurred. The wiring system factors can often lead to degradation.

Overview of Space Missions with Wiring System Failures

Mission	Cause	Result
Gemini 8	Electrical Wiring Short	Shortened Mission - Near Loss of Crew
Apollo 204	Damaged Insulation, Electrical Spark, 100% O ₂	Fire, 3 Astronauts Lost
Apollo 13	Damaged Insulation/Short Circuit/Flawed Design	Oxygen Tank Explosion, Mission Incomplete
STS - 6	Abrasion of Insulation/Arc Tracking	Wire Insulation Pyrolysis 6 Conductors Melted
STS - 28	Damaged Insulation/Arc Tracking	Teleprinter Cable Insulation Pyrolysis
Magellan	Wrong Connection, Wiring Short	Wiring Insulation Pyrolysis - Ground Processing
Spacelab	Damaged Insulation/Arc Tracking	Wiring Insulation Pyrolysis During Maintenance
Delta 178/GOES-G	Mechanical or Electrochemical Insulation Damage	Loss of Vehicle
ESA - Olympus	Electrical Wiring Short	Loss of Solar Array

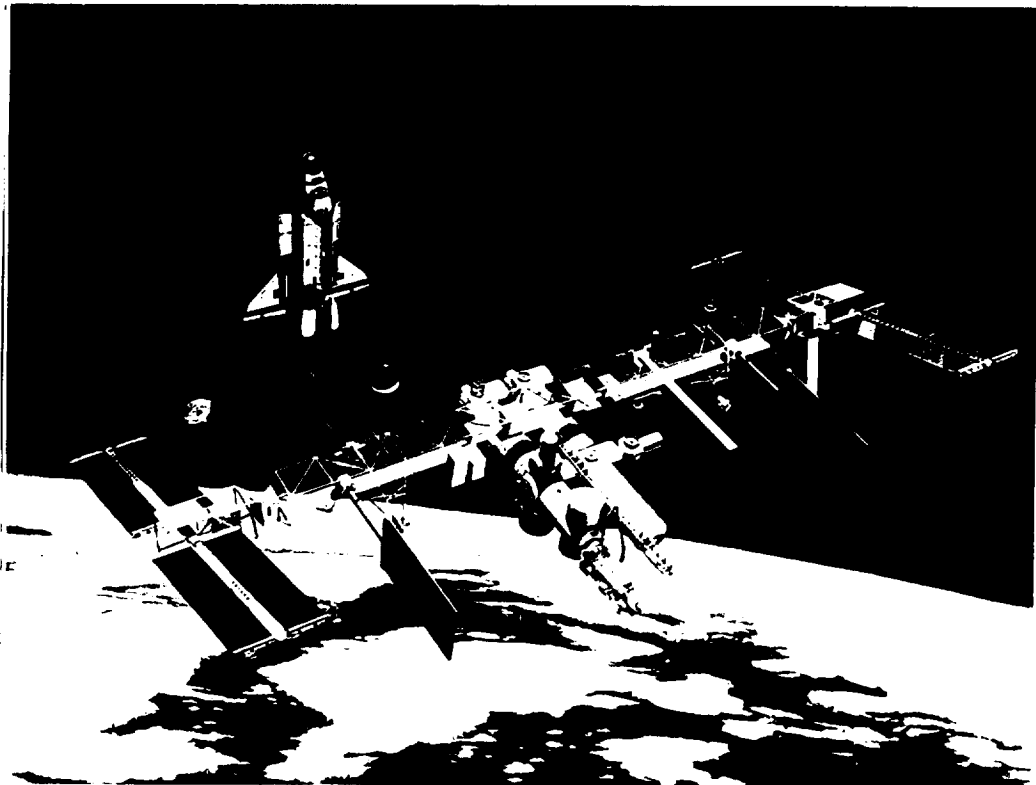
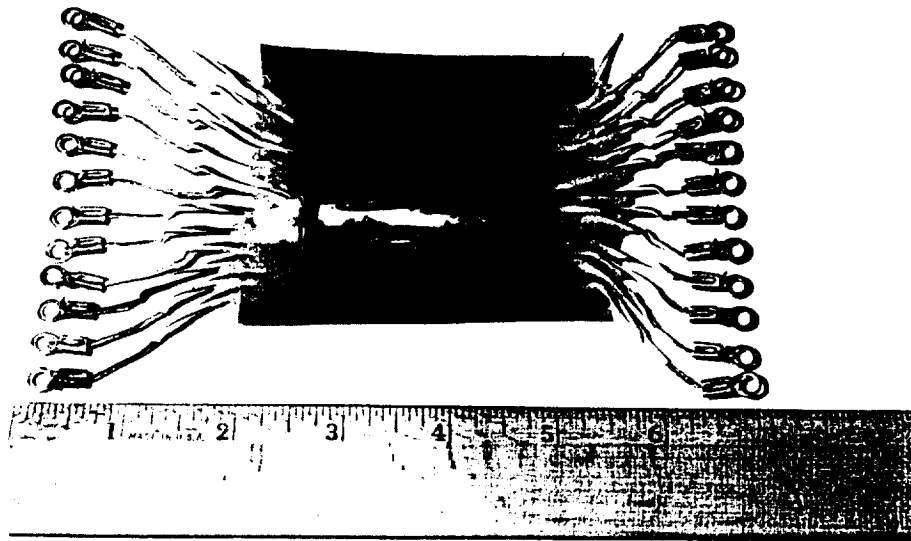

Electrical Wiring System Failures

Influenced by a Combination of Factors

Wiring System Design

Circuit Protection Technology

Manufacturing/Maintenance Procedures

Insulation Construction/Material

Electrical Wiring System Failures

EXAMPLES

Wiring System Design

Space Shuttle (STS-28)

Original Teleprinter Cable

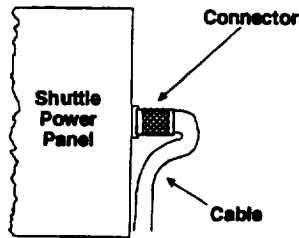

- Wire makes 180° bend.
- Repeated bending damaged insulation.

Redesigned Teleprinter Cable

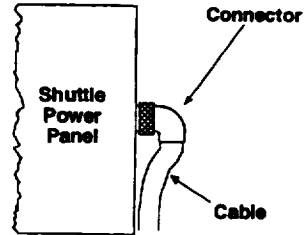

- 90° Strain relief added.
- More flexible insulation used.

Wiring System Design

Command and Service Module (Apollo 13)

Oxygen Tank Failure

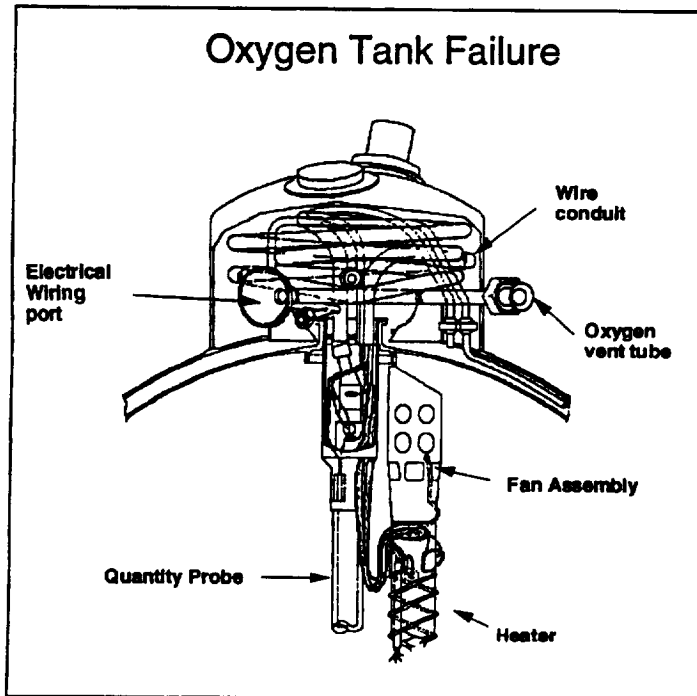

- Tanks contained ignition sources, combustible materials, and oxygen.
- Electrical wiring conduit constrictive.
- Wiring in close proximity to heaters.
- Pressure against sharp edges could lead to "Cold Flow".
- Failure modes were not detectable by normal post assembly testing.

Maintenance Procedures

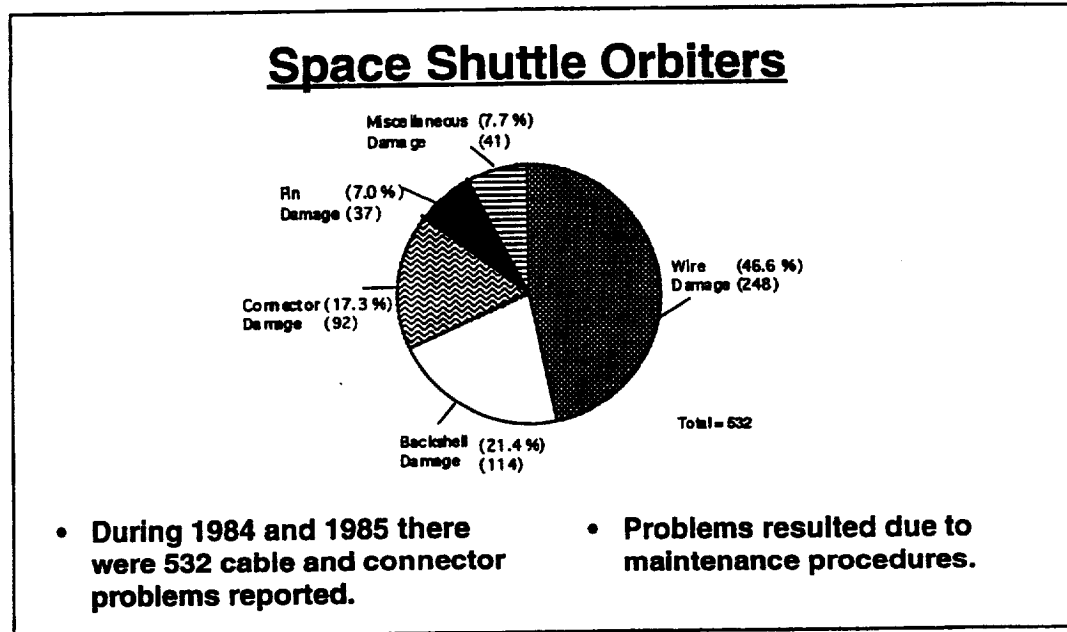

Circuit Protection Technology Space Shuttle (STS-28)

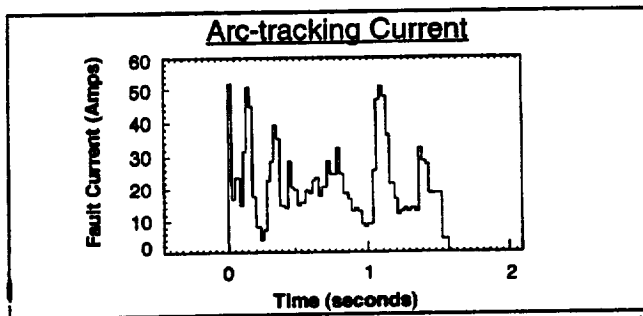

- Circuit breakers based on the thermal energy in the fault, may be ineffective in detecting arc-tracking.

- NASA Johnson Space Center Test Program - arc propagation limited to lengths of less than 1" up to 6".
- New technologies may improve detection.

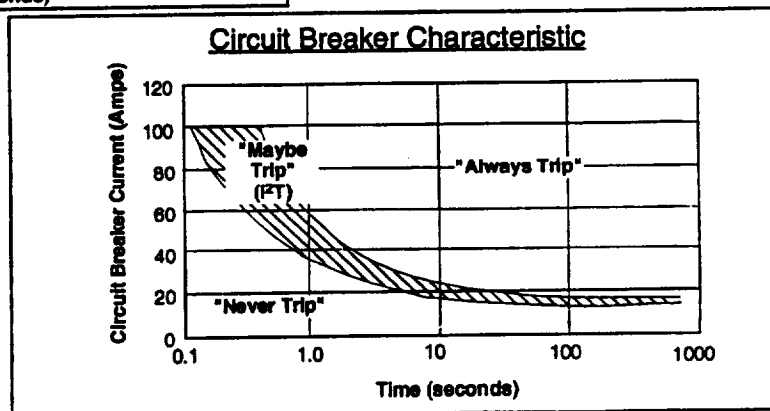

Electrical Wiring System Improvements

EXAMPLES

Wiring System Design Improvements

- Awareness of designers to fault mechanisms.
- Specify new insulation constructions and materials for use in NASA spacecraft.

Manufacturing/Maintenance Procedure Improvements

- Improved training of personnel in "Wiring Awareness" techniques
- Routing/Protecting of wiring to avoid physical damage
- Improved quality control, including non-intrusive inspections
- Application of methods such as dynamic system engineering and total quality management.

Wiring Protection Measures

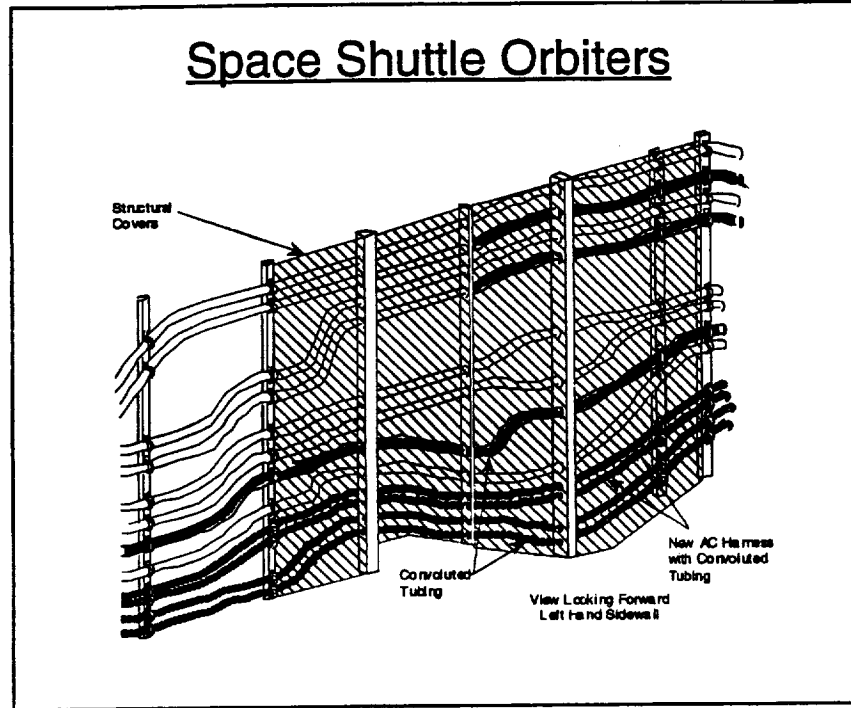

Advanced Protection Technology

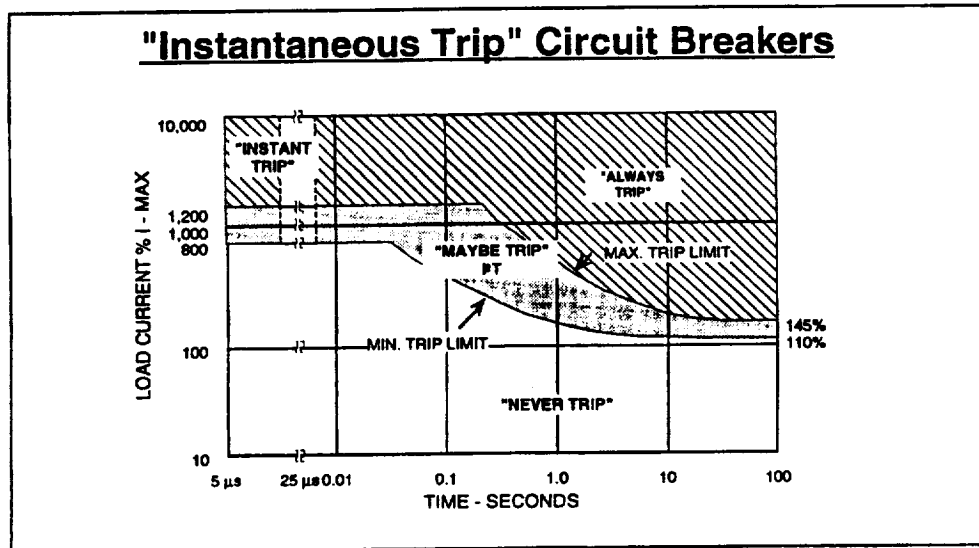

- Commercially Available Solid State Power Controllers (SSPC)
- Air Force 270 VDC SSPC Program

Advanced Protection Technology

"Smart" Fuses

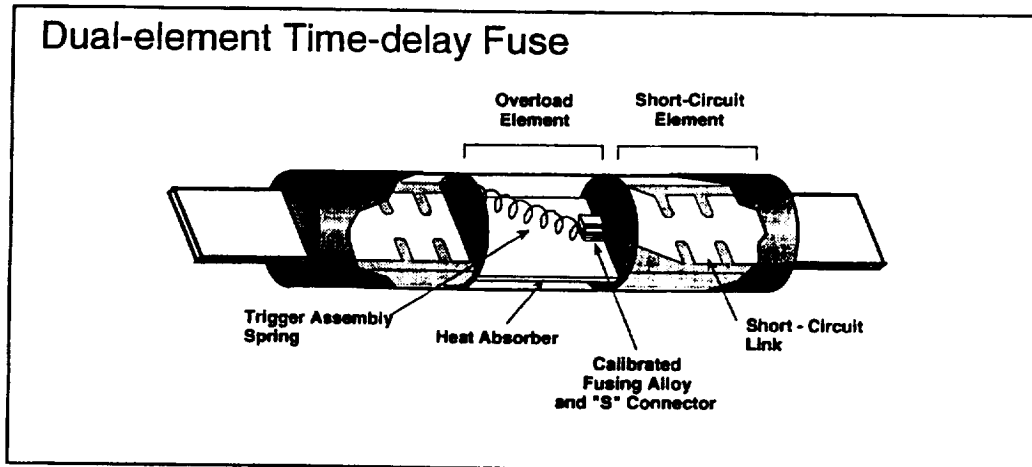

- Provide protection against low-level overload current or a short circuit current.





Lewis Research Center

UNRECORDED COPY - MARK NOT FILMED

POWER TECHNOLOGY DIVISION

DIFFERENTIAL PROTECTION OF DCSU USING FIBER OPTIC CURRENT SENSING

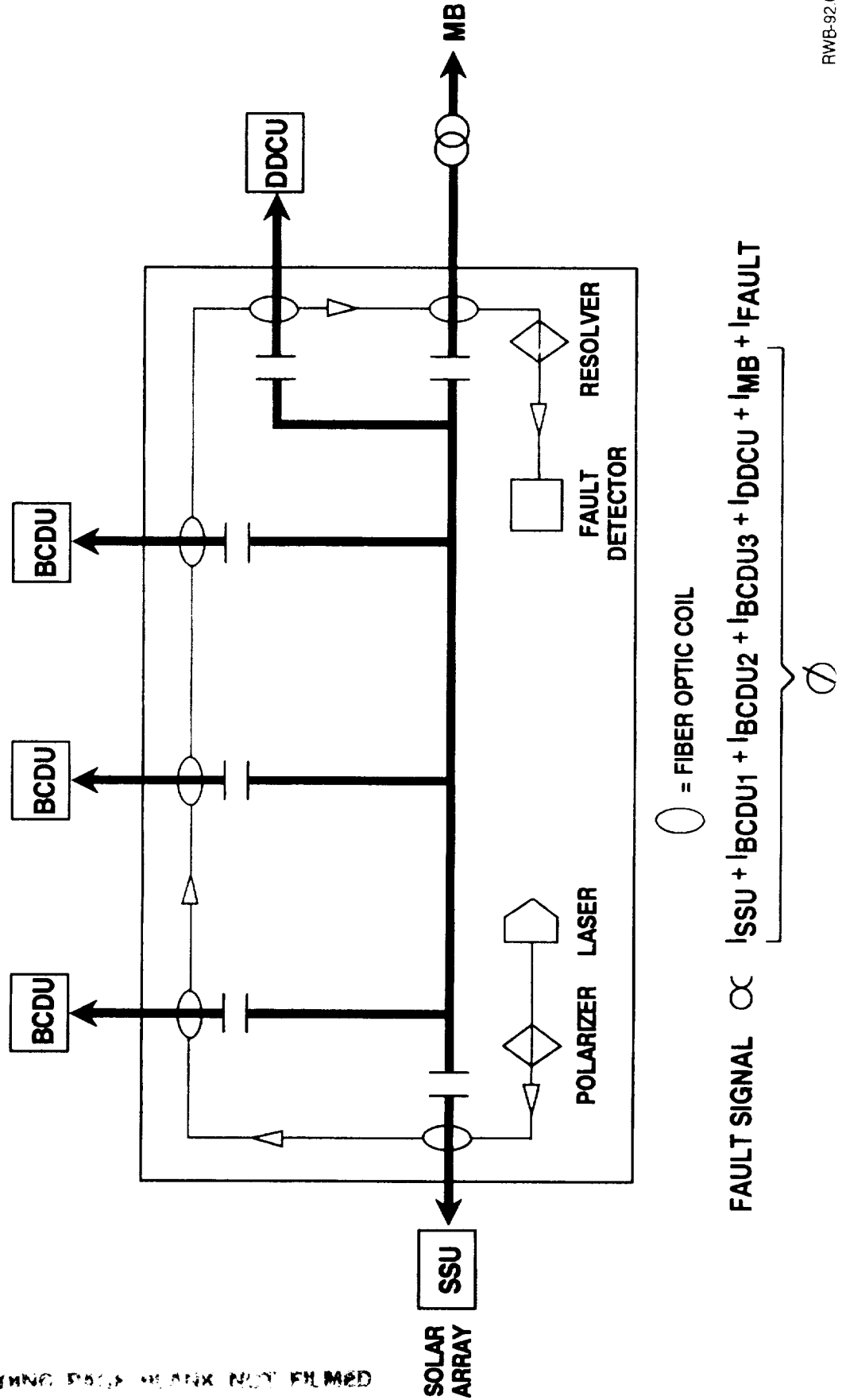



Advanced Protection Technology

"Intelligent" Fault Detection Methods

- Incipient fault detection via "footprint" or "signature"
- Knowledge based expert systems
- Neural network methods
- Fuzzy logic methods

Summary

- The wiring system is an important consideration in designing a spacecraft power system.
- Arc-tracking has recently been identified as a failure mode which may not be completely eliminated through the use of new wiring constructions/materials
- The total wiring system including insulation, system design, handling procedures, and circuit protection need to be considered further.

